



SM No. CMP700000019

PROPOSAL AND CONTRACT DOCUMENTS

FOR THE CONSTRUCTION OF
(EXEMPT)

15

Installing ADA Curb Cuts in Liberty, Natchez, and Woodville, known as Maintenance Project No. MP-7000-00(019) / 302776, in the Counties of Adams, Amite, and Wilkinson, State of Mississippi.

Project Completion: November 15, 2005

NOTICE

BIDDERS MUST PURCHASE A BOUND PROPOSAL
FROM MDOT CONTRACT ADMINISTRATION DIVISION
TO BID ON THIS PROJECT.

Electronic addendum updates will be posted on www.goMDOT.com

SECTION 900
OF THE CURRENT
(2004) STANDARD SPECIFICATIONS
FOR ROAD AND BRIDGE CONSTRUCTION
MISSISSIPPI DEPARTMENT OF TRANSPORTATION
JACKSON, MISSISSIPPI

**BIDDER CHECK LIST
(FOR INFORMATION ONLY)**

- _____ All unit prices and item totals have been entered in accordance with Subsection 102.06 of the Mississippi Standard Specifications for Road and Bridge Construction.
- _____ If the bid sheets were prepared using MDOT's Electronic Bid System, proposal sheets have been stapled and inserted into the proposal package.
- _____ First sheet of SECTION 905--PROPOSAL has been completed.
- _____ Second sheet of SECTION 905--PROPOSAL has been completed and signed.
- _____ Addenda, if any, have been acknowledged. Second sheet of Section 905 listing the addendum number has been substituted for the original second sheet of Section 905. Substituted second sheet of Section 905 has been properly completed, signed, and added to the proposal.
- _____ DBE/WBE percentage, when required by contract, has been entered on last sheet of the bid sheets of SECTION 905 - PROPOSAL.
- _____ Form OCR-485, when required by contract, has been completed and signed.
- _____ The last sheet of the bid sheets of SECTION 905--PROPOSAL has been signed.
- _____ Combination Bid Proposal of SECTION 905--PROPOSAL has been completed for each project which is to be considered in combination (See Subsection 102.11).
- _____ Equal Opportunity Clause Certification, when included in contract, has been completed and signed.
- _____ Subcontract Certificate, when included in contract, has been completed and signed.
- _____ The Certification regarding Non-Collusion, Debarment and Suspension, etc. has been executed in duplicate.
- _____ A certified check, cashier's check or bid bond payable to the State of Mississippi in the principal amount of 5% of the bid has been included with project number identified on same. Bid bond has been signed by the bidder and has also been signed or countersigned by a Mississippi Resident Agent for the Surety with Power of Attorney attached or on file with the Department's Contract Administration Engineer.
- _____ Non-resident Bidders: ON STATE FUNDED PROJECTS ONLY, a copy of the current laws regarding any preference for local Contractors from State wherein domiciled has been included. See Subsection 103.01, Mississippi Standard Specifications for Road and Bridge Construction, and Section 31-7-47, MCA, 1972 regarding this matter.

Return the proposal and contract documents in its entirety in a sealed envelope. **DO NOT** remove any part of the contract documents; exception - an addendum requires substitution of second sheet of Section 905. A stripped proposal is considered as an irregular bid and will be rejected.

Failure to complete any or all of the applicable requirements will be cause for the proposal to be considered irregular.

MISSISSIPPI DEPARTMENT OF TRANSPORTATION

SECTION 904 - NOTICE TO BIDDERS NO. 335

CODE: (SP)

DATE: 03/28/2005

SUBJECT: READVERTISEMENT

PROJECT: MP-7000-00(019)/302776 - Adams, Amite, & Wilkinson Counties

The contents of this proposal are the same as January 2005 Letting, except as follows:

Revised Advertisement;

Notice To Bidders No. 267 dated 3/28/2005, replaces same dated 11/29/2004;

Notice To Bidders No. 268 dated 3/28/2005, replaces same dated 9/28/2004;

Notice To Bidders No. 440, replaces Notice To Bidders No. 303;

Add Special Provision 907-105-2;

Add Special Provision 907-108-2;

Add this Notice to Bidders No. 335.

MISSISSIPPI DEPARTMENT OF TRANSPORTATION

TABLE OF CONTENTS

PROJECT: MP-7000-00(019)/302776 - Adams, Amite, & Wilkinson Counties

READVERTISEMENT NOTICE TO BIDDER NO. 335

901--Advertisement

904--Notice to Bidders: Governing Specs. - # 1
Final Cleanup - # 3
On-The-Job Training Program - # 7
Standard Drawings, W/Supplement - # 11
Federal Bridge Formula - # 12
Fiber Reinforced Concrete - # 152
Errata & Modifications to 2004 Standard Specifications - # 204
Contract Time - # 267
Scope of Work - # 268
Concrete For Sidewalks - # 289
Petroleum Products Base Price - # 440
Cooperation Between Contractors - # 475

907-105-2: Cooperation By Contractors
907-107-1: Liability Insurance
907-108-2: Notice To Proceed
907-608-2: Detectable Warning Panels (Truncated Domes)
907-618-1: Placement of Temporary Stripe, W/Supplement
907-711-2: Synthetic Structural Fiber Reinforcement
906-3: MDOT On-the-Job Training Program
906-5: MDOT On-the-Job Training Program - Alternate Program

SECTION 905 – PROPOSAL,
PROPOSAL SHEET NOS. 2-1 THRU 2-3,
COMBINATION BID PROPOSAL,
STATE BOARD OF CONTRACTORS REQUIREMENTS,
NON-COLLUSION CERTIFICATE,
SECTION 902 - CONTRACT FORM, AND SECTION 903 - CONTRACT BOND FORM,
HAUL PERMIT FOR BRIDGES WITH POSTED WEIGHT LIMITS.

(REVISIONS TO THE ABOVE WILL BE INDICATED ON THE SECOND SHEET
OF SECTION 905 AS ADDENDA)

MISSISSIPPI DEPARTMENT OF TRANSPORTATION

SECTION 901 - ADVERTISEMENT

Sealed bids will be received by the Mississippi Transportation Commission in the Office of the Contract Administration Engineer, Room 1013, Mississippi Department of Transportation Administration Building, 401 North West Street, Jackson, Mississippi, until 9:30 o'clock A.M., Tuesday, May 24, 2005; thereafter, bids will be received in the First Floor Auditorium of the Mississippi Department of Transportation Administration Building, Jackson, Mississippi, until 10:00 o'clock A.M., Tuesday, May 24, 2005, and shortly thereafter publicly opened for:

Construction of ADA Curb Cuts in Liberty, Natchez, and Woodville, known as Maintenance Project No. MP-7000-00(019)/302776, in the Counties of Adams, Amite, and Wilkinson, State of Mississippi.

The attention of bidders is directed to the predetermined minimum wage rate set by the U. S. Department of Labor under the Fair Labor Standards Act.

The Mississippi Department of Transportation hereby notifies all bidders that it will affirmatively insure that in any contract entered into pursuant to this advertisement, disadvantaged business enterprises will be afforded full opportunity to submit bids in response to this invitation and will not be discriminated against on the grounds of race, color, sex, religion or national origin in consideration for an award.

The specifications are on file in the offices of the Mississippi Department of Transportation.

Bid proposals must be acquired from the MDOT Contract Administration Division. These proposals are available at a cost of Ten Dollars (\$10.00) per proposal. Specimen proposals are also available at the MDOT Contract Administration Division at a cost of Ten Dollars (\$10.00) per proposal, or can be viewed or downloaded at no cost at www.gomdot.com.

Bid bond, signed or countersigned by a Mississippi Resident Agent, with Power of Attorney attached or on file with the Contract Administration Engineer of the Department, a Cashier's check or Certified Check for five (5%) percent of bid, payable to STATE OF MISSISSIPPI, must accompany each proposal.

The attention of bidders is directed to the provisions of Subsection 102.07 pertaining to irregular proposals and rejection of bids.

LARRY L. "BUTCH" BROWN
EXECUTIVE DIRECTOR

(SPWOP)

MISSISSIPPI DEPARTMENT OF TRANSPORTATION

SECTION 904 - NOTICE TO BIDDERS NO. 1

CODE: (IS)

DATE: 05/03/2004

SUBJECT: Governing Specifications

The current (2004) Edition of the Standard Specifications for Road and Bridge Construction adopted by the Mississippi Transportation Commission is made a part hereof fully and completely as if it were attached hereto, except where superseded by special provisions, or amended by revisions of the Specifications contained herein. Copies of the specification book may be purchased from the MDOT Construction Division.

A reference in any contract document to controlling requirements in another portion of the contract documents shall be understood to apply equally to any revision or amendment thereof included in the contract.

In the event the plans or proposal contain references to the 1990 Edition of the Standard Specifications for Road and Bridge Construction, it is to be understood that such references shall mean the comparable provisions of the 2004 Edition of the Standard Specifications.

MISSISSIPPI DEPARTMENT OF TRANSPORTATION

SECTION 904 - NOTICE TO BIDDERS NO. 3

CODE: (SP)

DATE: 05/03/2004

SUBJECT: Final Clean-Up

Immediately prior to final inspection for release of maintenance, the Contractor shall pick up, load, transport and properly dispose of all litter from the entire highway right-of-way that is within the termini of the project.

Litter shall include, but not be limited to, solid wastes such as glass, paper products, tires, wood products, metal, synthetic materials and other miscellaneous debris.

Litter removal is considered incidental to other items of work and will not be measured for separate payment.

MISSISSIPPI DEPARTMENT OF TRANSPORTATION

SECTION 904 - NOTICE TO BIDDERS NO. 7

CODE: (IS)

DATE: 05/03/2004

SUBJECT: On-The-Job Training Program

Payment for training hours will be handled as outlined in Special Provision 906-4. A pay item for trainees will not be included in individual construction projects. Payment for training individuals will be processed in accordance with the conditions in MDOT's ON-THE-JOB TRAINING PROGRAM (Special Provision 906-4).

On Federal-Aid projects, failure on the part of the Contractor to carryout the terms of the Alternate Training Special Provision (Special Provision 906-4) will be considered grounds to preclude the Contractor from participating in the Alternate On-The-Job Training Program. In the event the Department is required to preclude the Contractor from participating in the program, the Contractor will be required to adhere to the requirements of the Training Special Provision (Special Provision 906-3), for which purpose the special provision is also made a part of this proposal.

SUPPLEMENT TO NOTICE TO BIDDERS NO. 11

CODE: (SP)

DATE: 10/07/2004

PROJECT: MP-7000-00(019)/302776 - Adams, Amite, & Wilkinson Counties

After the last drawing of Notice To Bidders No. 11, add the attached drawing(s).

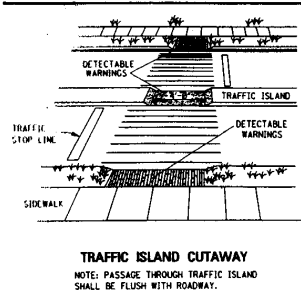

TRAFFIC ISLAND CUTAWAY
NOTE: PASSAGE THROUGH TRAFFIC ISLAND SHALL BE FLUSH WITH ROADWAY.

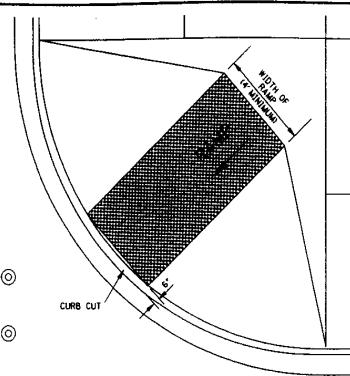
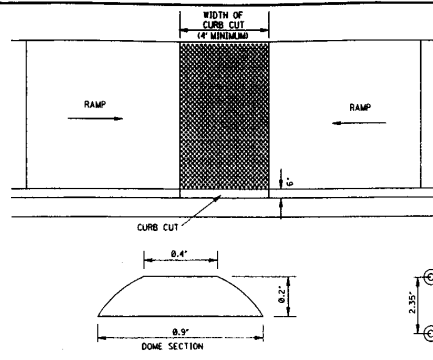

DETECTABLE WARNINGS (TRUNCATED DOMES) FOR BLIND & LOW VISION PEDESTRIANS

STATE	PROJECT NO.
MISS.	

- GENERAL NOTES:
1. LOCATION AND TYPE OF CURB RAMP SHALL BE AS SHOWN ON THE PLANS OR AS DIRECTED.
 2. THE CURB RAMP SHALL BE PAID FOR AS SIDEWALK.
 3. THE THICKNESS OF THE CURB RAMP SHALL BE A MINIMUM OF 4".
 4. ALL RAMP SLOPES SHALL NOT BE STEEPER THAN 12:1.
 5. DETECTABLE WARNINGS ARE REQUIRED ON CURB CUT RAMPS AT ALL STREET CROSSINGS AND AT SIGNALIZED DRIVEWAY CROSSINGS.
 6. THERE SHALL BE A MINIMUM OF 70% CONTRAST IN LIGHT REFLECTANCE BETWEEN THE DETECTABLE WARNING AREA AND THE ADJOINING AREAS, OR THE DETECTABLE AREA SHALL BE "SAFETY YELLOW".

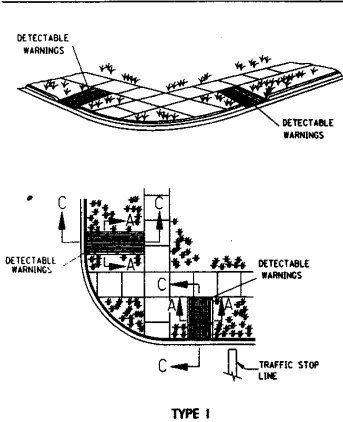

TYPE I

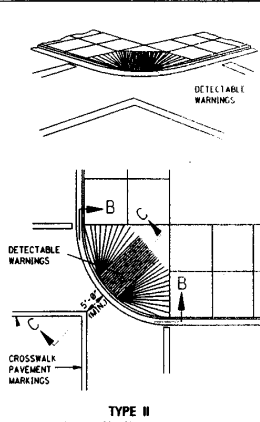

TYPE II

NOTE: IN NEW CONSTRUCTION, THE TYPE II DIAGONAL CURB RAMP SHALL ONLY BE USED IF OTHER CURB RAMP TYPES AS SHOWN ON THIS SHEET ARE NOT PRACTICAL FOR THE LOCATION.

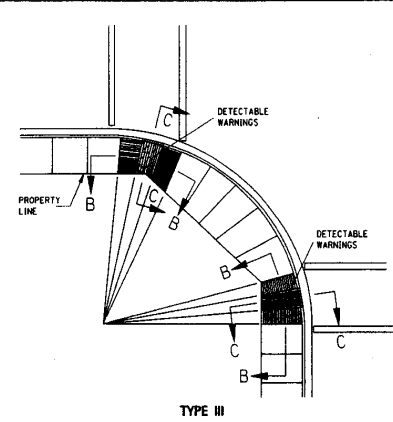

TYPE III

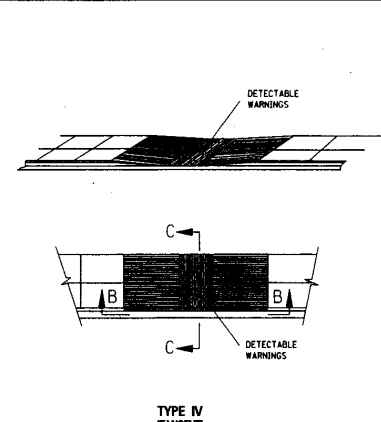

TYPE IV (TANGENT)

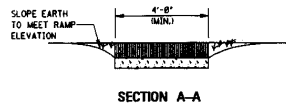

SECTION A-A

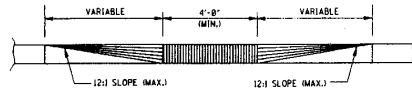

SECTION B-B

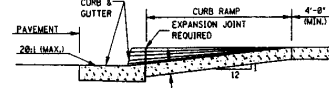

SECTION C-C

DATE SCALE SHEET NO. REVISION	MISSISSIPPI DEPARTMENT OF TRANSPORTATION ROADWAY DESIGN DIVISION STANDARD PLAN		
	CURB - CUT RAMP		
	WORKING NUMBER CCR-1	SHEET NUMBER 289	
	ISSUE DATE: OCTOBER 1, 1998		

MISSISSIPPI DEPARTMENT OF TRANSPORTATION

SECTION 904 – NOTICE TO BIDDERS NO. 11

CODE: (SP)

DATE: 05/30/2004

SUBJECT: Standard Drawings

Standard Drawings attached hereto shall govern appropriate items of required work.

Larger copies of Standard Drawings may be purchased from:

MDOT Plans Print Shop
MDOT Administration Building
401 North West Street, Room 1100
P.O. Box 1850
Jackson, MS 39215-1850
Telephone: (601) 359-7460
or FAX: (601) 359-7461
or e-mail: plans@mdot.state.ms.us

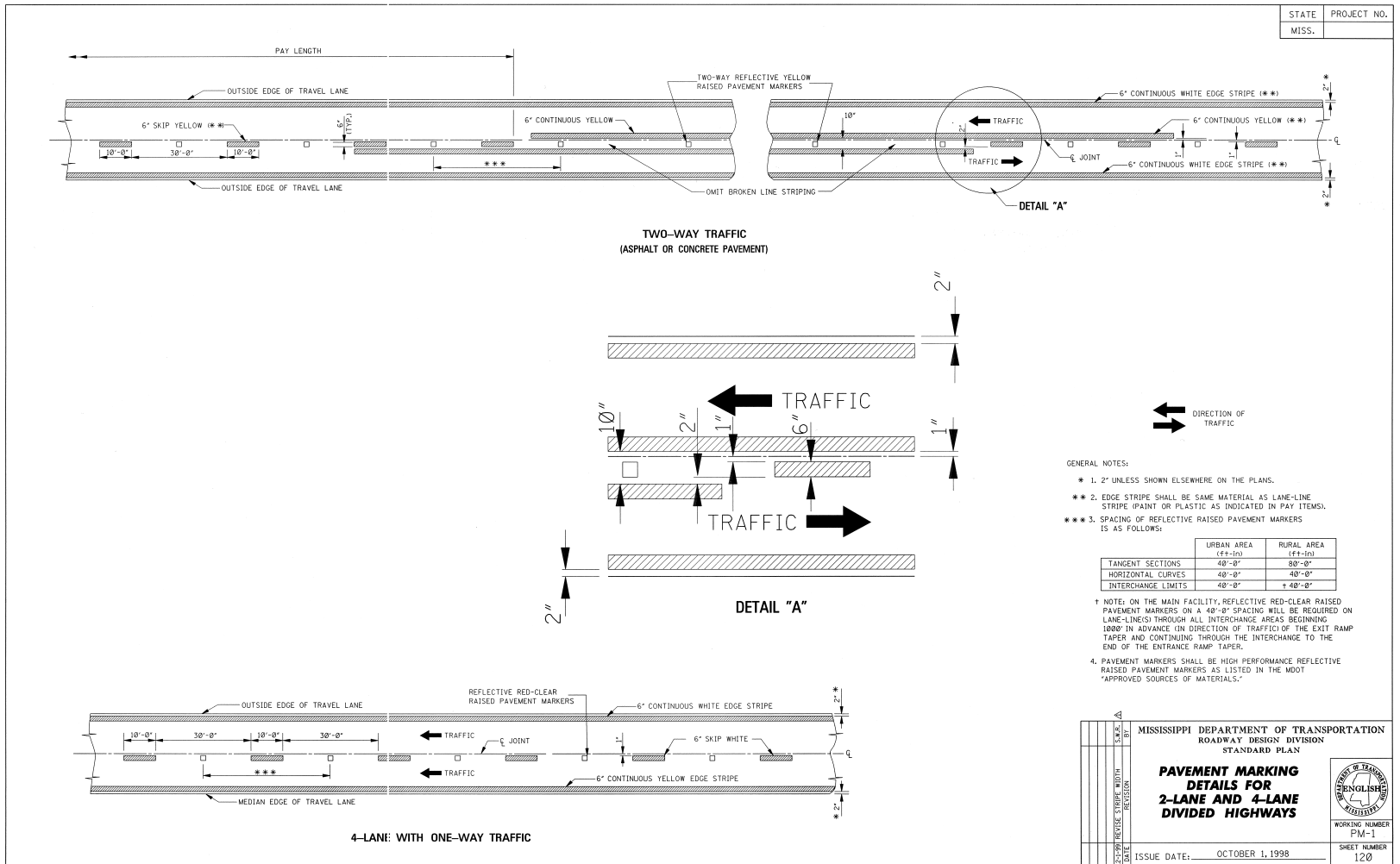

MISSISSIPPI DEPARTMENT OF TRANSPORTATION
ROADWAY DESIGN DIVISION
STANDARD PLAN

**PAVEMENT MARKING
DETAILS FOR
2-LANE AND 4-LANE
DIVIDED HIGHWAYS**

ISSUE DATE: OCTOBER 1, 1998

WORKING NUMBER
PM-1

SHEET NUMBER
120

STATE	PROJECT NO.
MISS.	

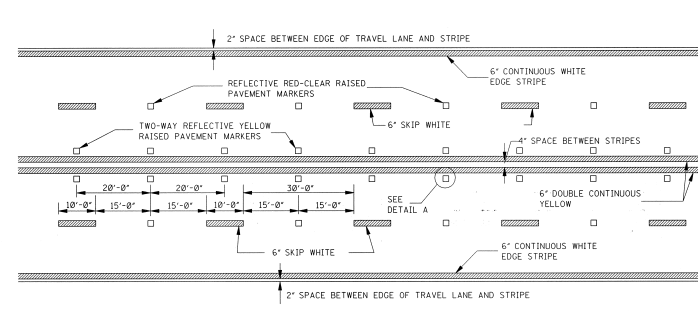

TYPICAL STRIPING AND RAISED PAVEMENT MARKERS FOR 4-LANE SECTION

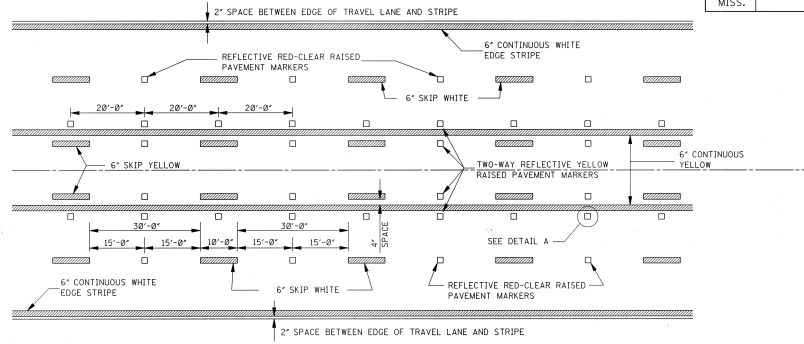

TYPICAL STRIPING AND RAISED PAVEMENT MARKERS FOR 5-LANE SECTION

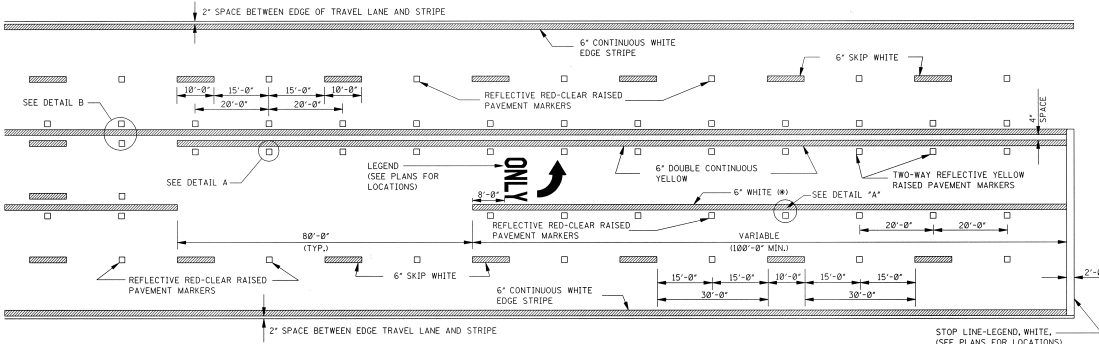

TYPICAL STRIPING AND RAISED PAVEMENT MARKERS AT LEFT TURN LANES

*NOTE: USE DETAIL STRIPING IF LENGTH \leq 150' AT THIS LOCATION, OTHERWISE USE CONTINUOUS STRIPING.

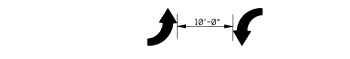

TYPICAL TWO-WAY ARROW INSTALLATION

- NOTES: 1. CONSIDER EACH SEGMENT OF CONTINUOUS TWO-WAY LEFT TURN LANE SEPARATELY.
 2. IF SEGMENT IS LESS THAN 350', PLACE ONE SET OF ARROWS IN CENTER OF SEGMENT.
 3. IF SEGMENT IS GREATER THAN 350', PLACE FIRST SET OF ARROWS 50' TO 100' FROM BEGINNING AND/OR END OF SEGMENT AND SPACE ADDITIONAL SETS OF ARROWS 1250' O.C..

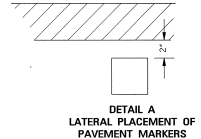

DETAIL A LATERAL PLACEMENT OF PAVEMENT MARKERS

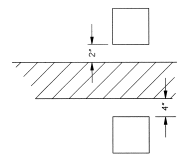

DETAIL B LATERAL PLACEMENT OF PAVEMENT MARKERS

GENERAL NOTE:

1. PAVEMENT MARKERS SHALL BE HIGH PERFORMANCE RAISED PAVEMENT MARKERS AS LISTED IN THE MOOT *APPROVED SOURCES OF MATERIALS*.

MISSISSIPPI DEPARTMENT OF TRANSPORTATION ROADWAY DESIGN DIVISION STANDARD PLAN	
PAVEMENT MARKING DETAILS FOR 4-LANE AND 5-LANE UNDIVIDED ROADWAYS	
DATE: OCTOBER 1, 1998	WORKING NUMBER PM-2 SHEET NUMBER 121

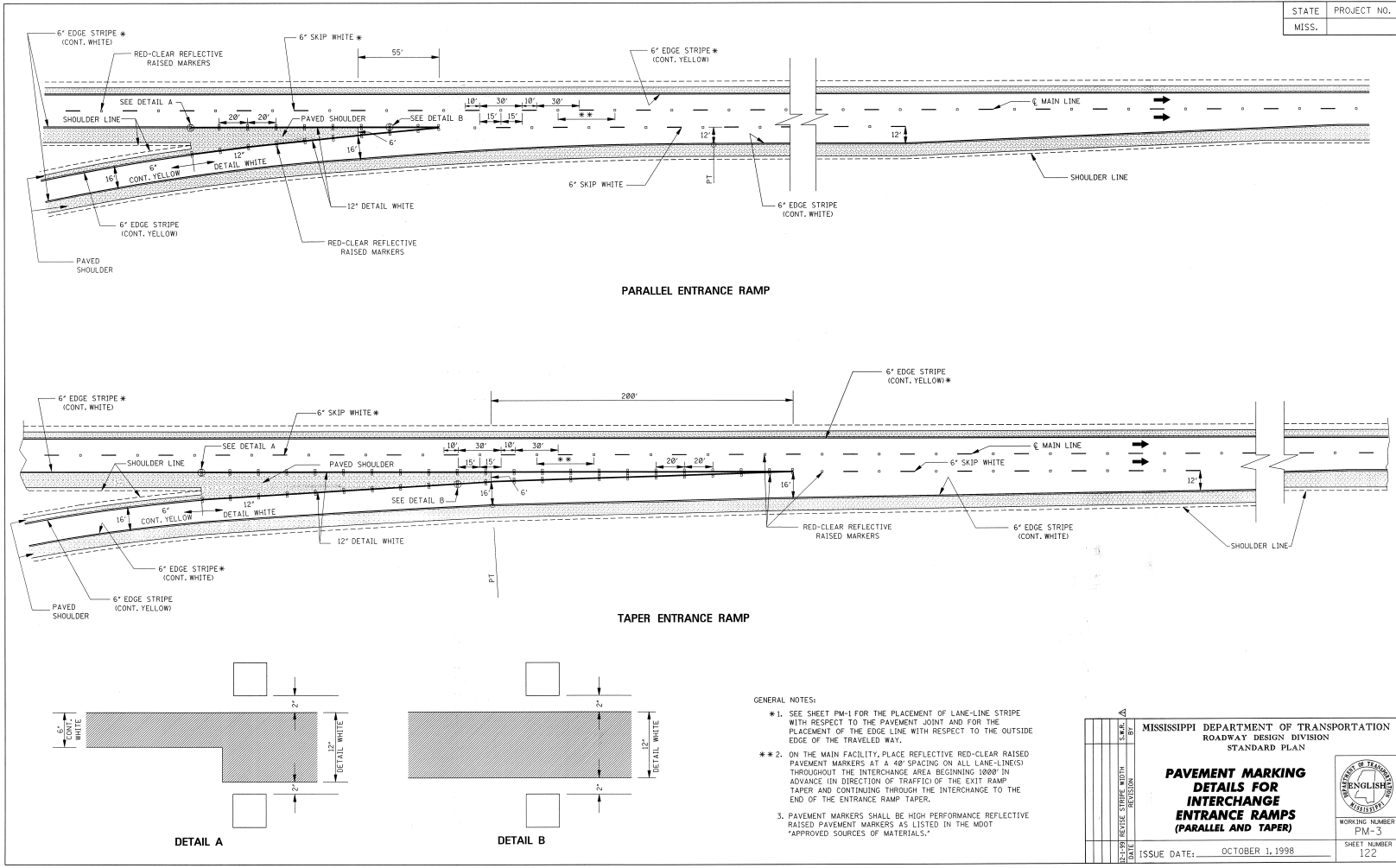

STATE	PROJECT NO.
MISS.	

- GENERAL NOTES:
- * 1. SEE SHEET PM-1 FOR THE PLACEMENT OF LANE-LINE STRIPE WITH RESPECT TO THE PAVEMENT JOINT AND FOR THE PLACEMENT OF THE EDGE LINE WITH RESPECT TO THE OUTSIDE EDGE OF THE TRAVELED WAY.
 - * 2. ON THE MAIN FACILITY, PLACE REFLECTIVE RED-CLEAR RAISED PAVEMENT MARKERS AT A 40' SPACING ON ALL LANE-LINE(S) THROUGHOUT THE INTERCHANGE AREA BEGINNING 1000' IN ADVANCE (IN DIRECTION OF TRAFFIC) OF THE EXIT RAMP TAPER AND CONTINUING THROUGH THE INTERCHANGE TO THE END OF THE ENTRANCE RAMP TAPER.
 - 3. PAVEMENT MARKERS SHALL BE HIGH PERFORMANCE REFLECTIVE RAISED PAVEMENT MARKERS AS LISTED IN THE MDT "APPROVED SOURCES OF MATERIALS."

MISSISSIPPI DEPARTMENT OF TRANSPORTATION ROADWAY DESIGN DIVISION STANDARD PLAN			
PAVEMENT MARKING DETAILS FOR INTERCHANGE ENTRANCE RAMP (PARALLEL AND TAPER)			
ISSUE DATE: OCTOBER 1, 1998			WORKING NUMBER PM-3
			SHEET NUMBER 122

STATE	PROJECT NO.
MISS.	

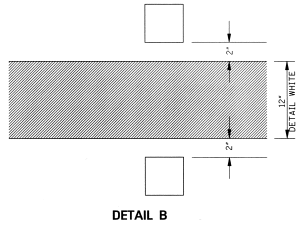
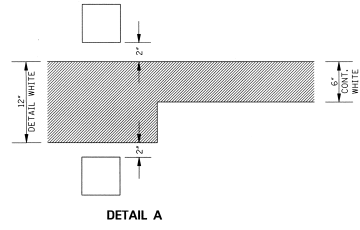
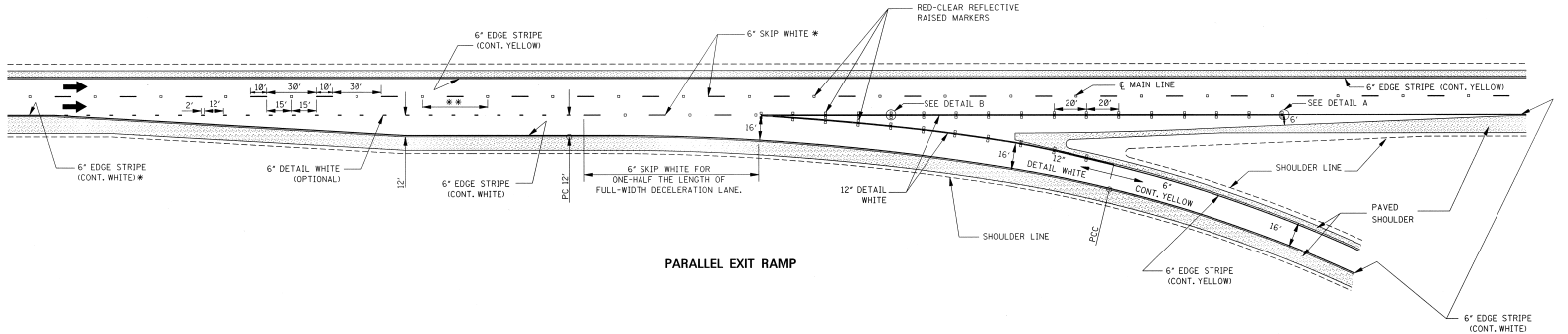
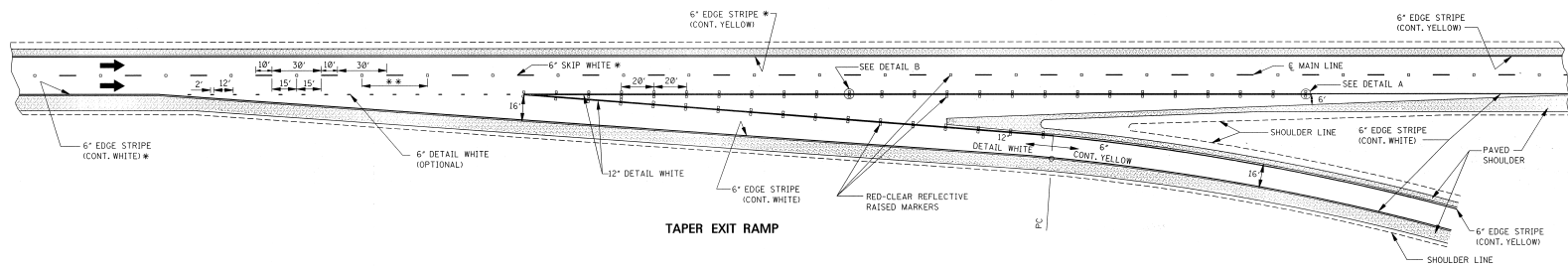

- GENERAL NOTES:
- * 1. SEE SHEET PM-1 FOR THE PLACEMENT OF LANE-LINE STRIPE WITH RESPECT TO THE PAVEMENT JOINT AND FOR THE PLACEMENT OF THE EDGE LINE WITH RESPECT TO THE OUTSIDE EDGE OF THE TRAVELED WAY.
 - ** 2. ON THE MAIN FACILITY, PLACE REFLECTIVE RED-CLEAR RAISED PAVEMENT MARKERS AT A 40' SPACING ON ALL LANE-LINES THROUGHOUT THE INTERCHANGE AREA BEGINNING 1000' IN ADVANCE (IN DIRECTION OF TRAFFIC) OF THE EXIT RAMP TAPER AND CONTINUING THROUGH THE INTERCHANGE TO THE END OF THE ENTRANCE RAMP TAPER.
 - 3. PAVEMENT MARKERS SHALL BE HIGH PERFORMANCE REFLECTIVE RAISED PAVEMENT MARKERS AS LISTED IN THE MDT "APPROVED SOURCES OF MATERIALS."

STATE	PROJECT NO.
MISS.	

MISSISSIPPI DEPARTMENT OF TRANSPORTATION
 ROADWAY DESIGN DIVISION
 STANDARD PLAN

**PAVEMENT MARKING
 DETAILS FOR
 INTERCHANGE
 EXIT RAMP
 (PARALLEL AND TAPER)**

WORKING NUMBER
 PM-4

SHEET NUMBER
 123

ISSUE DATE: OCTOBER 1, 1998

STATE PROJECT NO.
 MISS.

STOP

RIGHT

LEFT

TURN

LANE

AHEAD

YIELD

EXIT

SIGNAL

SCHOOL

GENERAL NOTES:

- UNLESS OTHERWISE SHOWN ON THE PLANS, ALL PAVEMENT MARKING LEGENDS SHALL BE APPLIED USING HIGH PERFORMANCE MATERIALS.
- TWO HORIZONTAL GAPS (CAUSED BY TEMPLATE CONNECTORS) OF 1/2" OR LESS AND EXTENDING THE FULL WIDTH ARE PERMITTED IN EACH LETTER.
- FOR OTHER DETAILS, SEE THE MANUAL ON UNIFORM TRAFFIC CONTROL DEVICES.
- PAY QUANTITIES FOR PAVEMENT MARKING LEGENDS ARE AS FOLLOWS:

LEGEND	AREA (ft ²)
STOP	24.6
RIGHT	28.6
LEFT	19.6
TURN	27.7
LANE	22.7
AHEAD	32.3
YIELD	26.8
EXIT	18.5
SIGNAL	32.5
SCHOOL	35.5

	DATE	BY	MISSISSIPPI DEPARTMENT OF TRANSPORTATION ROADWAY DESIGN DIVISION STANDARD PLAN
		REVISION	PAVEMENT MARKING LEGEND DETAILS
	ISSUE DATE:	OCTOBER 1, 1998	 WORKING NUMBER PM-5 SHEET NUMBER 124

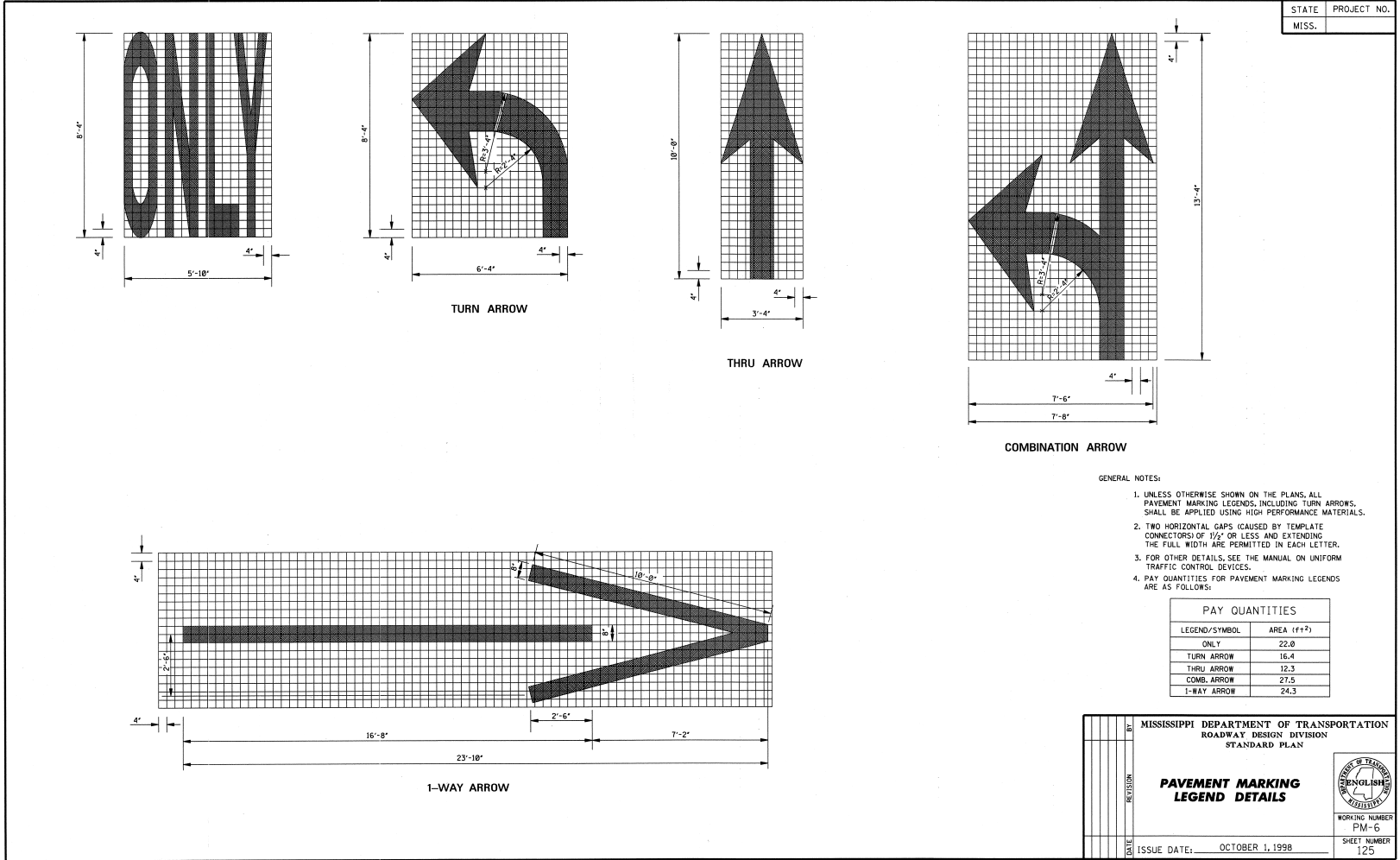

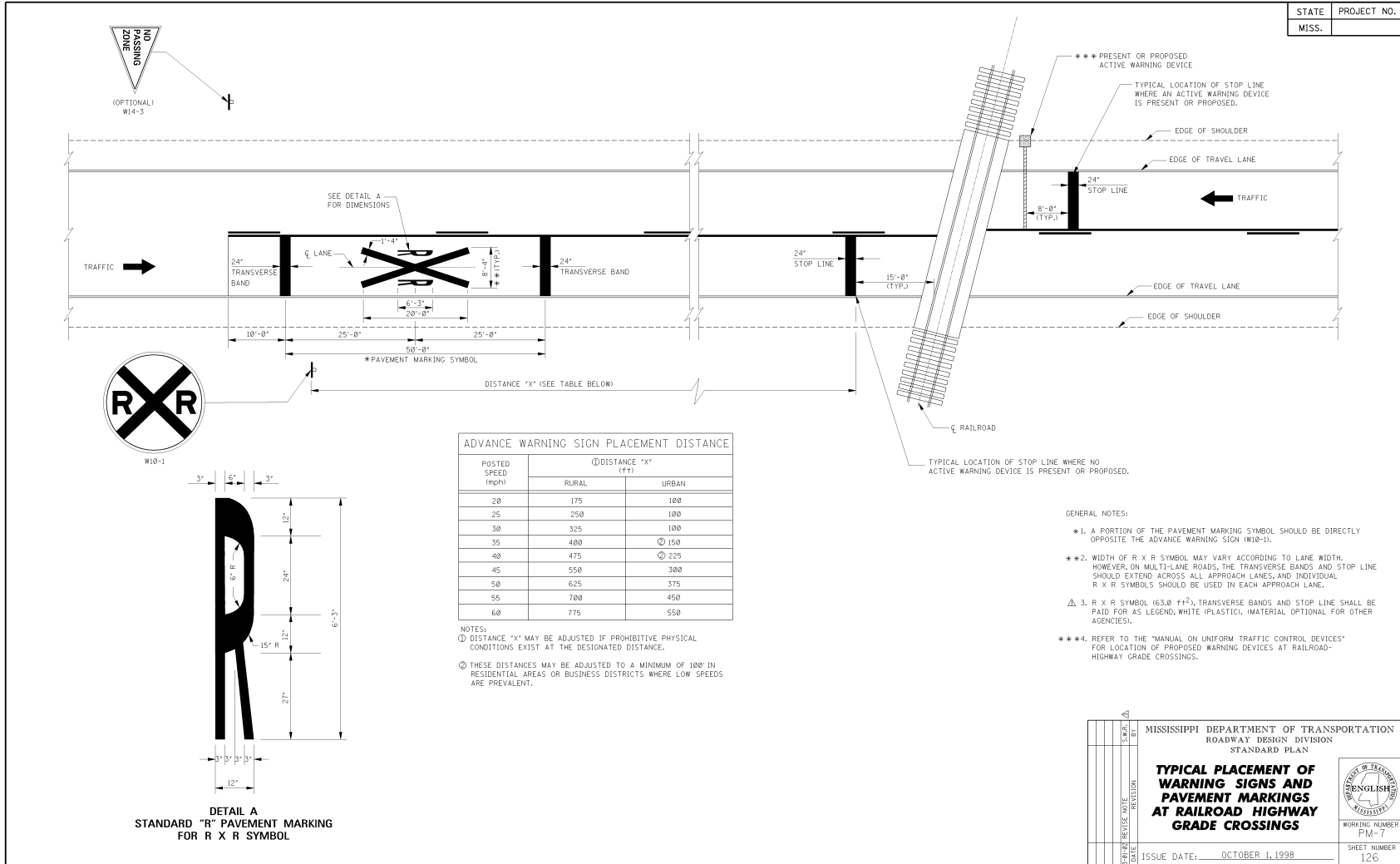

DATE	REVISION	S.M.P.C.	BY	MISSISSIPPI DEPARTMENT OF TRANSPORTATION ROADWAY DESIGN DIVISION STANDARD PLAN TYPICAL PLACEMENT OF WARNING SIGNS AND PAVEMENT MARKINGS AT RAILROAD HIGHWAY GRADE CROSSINGS	 WORKING NUMBER PM-7 SHEET NUMBER 126
ISSUE DATE: OCTOBER 1, 1998					

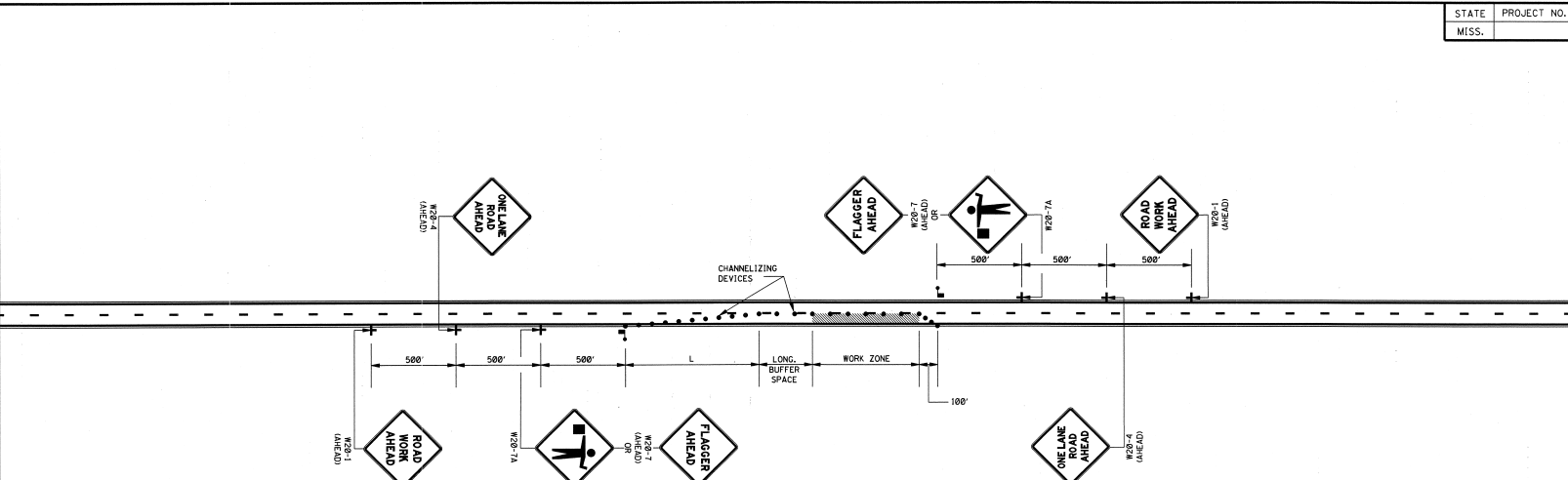

GENERAL NOTES:

1. THE LOCATION OF CHANNELIZING DEVICES AND THE WORK AREA LAYOUT SHALL BE BASED ON THE CRITERIA IN THE FOLLOWING TABLE:

POSTED SPEED AND/OR DESIGN SPEED	MAXIMUM CHANNELIZING DEVICE SPACING (FF)		MINIMUM LONGITUDINAL BUFFER SPACE (FF)	TAPER RATES
	TAPER	ALONG LANE LINE & WORK ZONE		
mph				
≤40	40	80	170	27:1
45	45	90	220	45:1
50	50	100	280	50:1
55	55	110	335	55:1
60	60	120	415	60:1
65	65	130	485	65:1
70	70	140	575	70:1

* NOTE: TAPER RATES ARE DETERMINED USING THE FOLLOWING EQUATIONS:
 $L = WS$ FOR SPEEDS OF 45 MPH OR GREATER
 $L = WS^2/60$ FOR SPEEDS OF 40 MPH OR LESS
 WHERE: L = MINIMUM LENGTH OF TAPER IN FEET
 W = WIDTH OF OFFSET (USUALLY LANE WIDTH) IN FEET
 S = DESIGN SPEED OR 85TH PERCENTILE SPEED IN MILES PER HOUR

- ALL CHANNELIZING DEVICES SHALL BE A MINIMUM OF 24" IN HEIGHT.
- ALL TRAFFIC CONTROL ITEMS SHOWN ON THIS SHEET WILL NOT BE MEASURED FOR SEPARATE PAYMENT. THIS WORK IS TO BE INCLUDED IN THE PRICE BID FOR MAINTENANCE OF TRAFFIC.
- DIAMOND SHAPED TRAFFIC CONTROL SIGNS SHALL BE A MINIMUM OF 48" x 48".
- WHEN THERE IS NO EXISTING HAZARD OR AT THE END OF THE WORK DAY, ALL SIGNS SHALL BE COVERED OR REMOVED AND ALL CHANNELIZING DEVICES SHALL BE MOVED TO THE SHOULDER EDGE.
- WHERE THE WORK ZONE IS STATIONARY, THE W20-7 (500 FT.) SIGN OR THE W20-7A SIGN TOGETHER WITH THE W20-7 (500 FT.) SUPPLEMENTAL PLATE SHOULD BE USED TO INDICATE THE DISTANCE TO THE FLAGGER.

LEGEND
 FLAGGER
 CHANNELIZING DEVICES

DATE	BY	REVISION	MISSISSIPPI DEPARTMENT OF TRANSPORTATION ROADWAY DESIGN DIVISION STANDARD PLAN
<p>TRAFFIC CONTROL PLAN WITH FLAGGER (ONE-LANE CLOSURE OF TWO-WAY TRAFFIC)</p>			
ISSUE DATE:	OCTOBER 1, 1998		

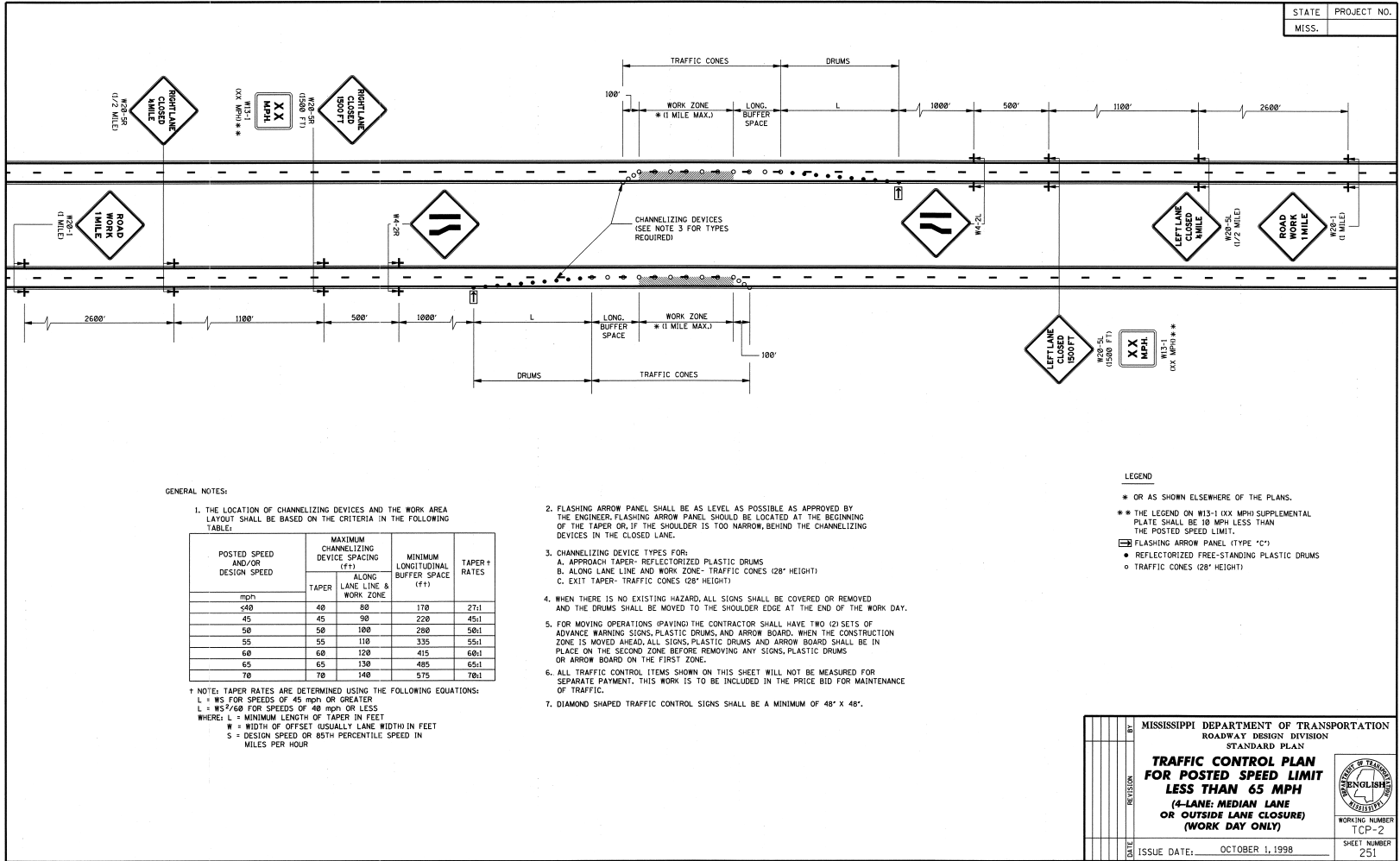

STATE PROJECT NO.
MISS.

GENERAL NOTES:

1. THE LOCATION OF CHANNELIZING DEVICES AND THE WORK AREA LAYOUT SHALL BE BASED ON THE CRITERIA IN THE FOLLOWING TABLE:

POSTED SPEED AND/OR DESIGN SPEED	MAXIMUM CHANNELIZING DEVICE SPACING (ft)		MINIMUM LONGITUDINAL BUFFER SPACE (ft)	TAPER RATES
	TAPER	ALONG LANE LINE & WORK ZONE		
40	40	80	170	27:1
45	45	90	220	45:1
50	50	100	280	50:1
55	55	110	335	55:1
60	60	120	415	60:1
65	65	130	485	65:1
70	70	140	575	70:1

† NOTE: TAPER RATES ARE DETERMINED USING THE FOLLOWING EQUATIONS:
 L = WS FOR SPEEDS OF 45 MPH OR GREATER
 L = WS²/60 FOR SPEEDS OF 40 MPH OR LESS
 WHERE: L = MINIMUM LENGTH OF TAPER IN FEET
 W = WIDTH OF OFFSET USUALLY LANE WIDTH IN FEET
 S = DESIGN SPEED OR 85TH PERCENTILE SPEED IN MILES PER HOUR

- FLASHING ARROW PANEL SHALL BE AS LEVEL AS POSSIBLE AS APPROVED BY THE ENGINEER. FLASHING ARROW PANEL SHOULD BE LOCATED AT THE BEGINNING OF THE TAPER OR, IF THE SHOULDER IS TOO NARROW, BEHIND THE CHANNELIZING DEVICES IN THE CLOSED LANE.
- CHANNELIZING DEVICE TYPES FOR:
 A. APPROACH TAPER- REFLECTORIZED PLASTIC DRUMS
 B. ALONG LANE LINE AND WORK ZONE- TRAFFIC CONES (28" HEIGHT)
 C. EXIT TAPER- TRAFFIC CONES (28" HEIGHT)
- WHEN THERE IS NO EXISTING HAZARD, ALL SIGNS SHALL BE COVERED OR REMOVED AND THE DRUMS SHALL BE MOVED TO THE SHOULDER EDGE AT THE END OF THE WORK DAY.
- FOR MOVING OPERATIONS (PAYING) THE CONTRACTOR SHALL HAVE TWO (2) SETS OF ADVANCE WARNING SIGNS, PLASTIC DRUMS, AND ARROW BOARD. WHEN THE CONSTRUCTION ZONE IS MOVED AHEAD, ALL SIGNS, PLASTIC DRUMS AND ARROW BOARD SHALL BE IN PLACE ON THE SECOND ZONE BEFORE REMOVING ANY SIGNS, PLASTIC DRUMS OR ARROW BOARD ON THE FIRST ZONE.
- ALL TRAFFIC CONTROL ITEMS SHOWN ON THIS SHEET WILL NOT BE MEASURED FOR SEPARATE PAYMENT. THIS WORK IS TO BE INCLUDED IN THE PRICE BID FOR MAINTENANCE OF TRAFFIC.
- DIAMOND SHAPED TRAFFIC CONTROL SIGNS SHALL BE A MINIMUM OF 48" X 48".

LEGEND

- * OR AS SHOWN ELSEWHERE OF THE PLANS.
- ** THE LEGEND ON W13-1 (XXX MPH) SUPPLEMENTAL PLATE SHALL BE 10 MPH LESS THAN THE POSTED SPEED LIMIT.
- ◻ FLASHING ARROW PANEL (TYPE "C")
- REFLECTORIZED FREE-STANDING PLASTIC DRUMS
- TRAFFIC CONES (28" HEIGHT)

DATE		BY		REVISION	
MISSISSIPPI DEPARTMENT OF TRANSPORTATION ROADWAY DESIGN DIVISION STANDARD PLAN TRAFFIC CONTROL PLAN FOR POSTED SPEED LIMIT LESS THAN 65 MPH (4-LANE; MEDIAN LANE OR OUTSIDE LANE CLOSURE) (WORK DAY ONLY)					
ISSUE DATE: OCTOBER 1, 1998				MISSISSIPPI DEPARTMENT OF TRANSPORTATION WORKING NUMBER TCP-2 SHEET NUMBER 251	

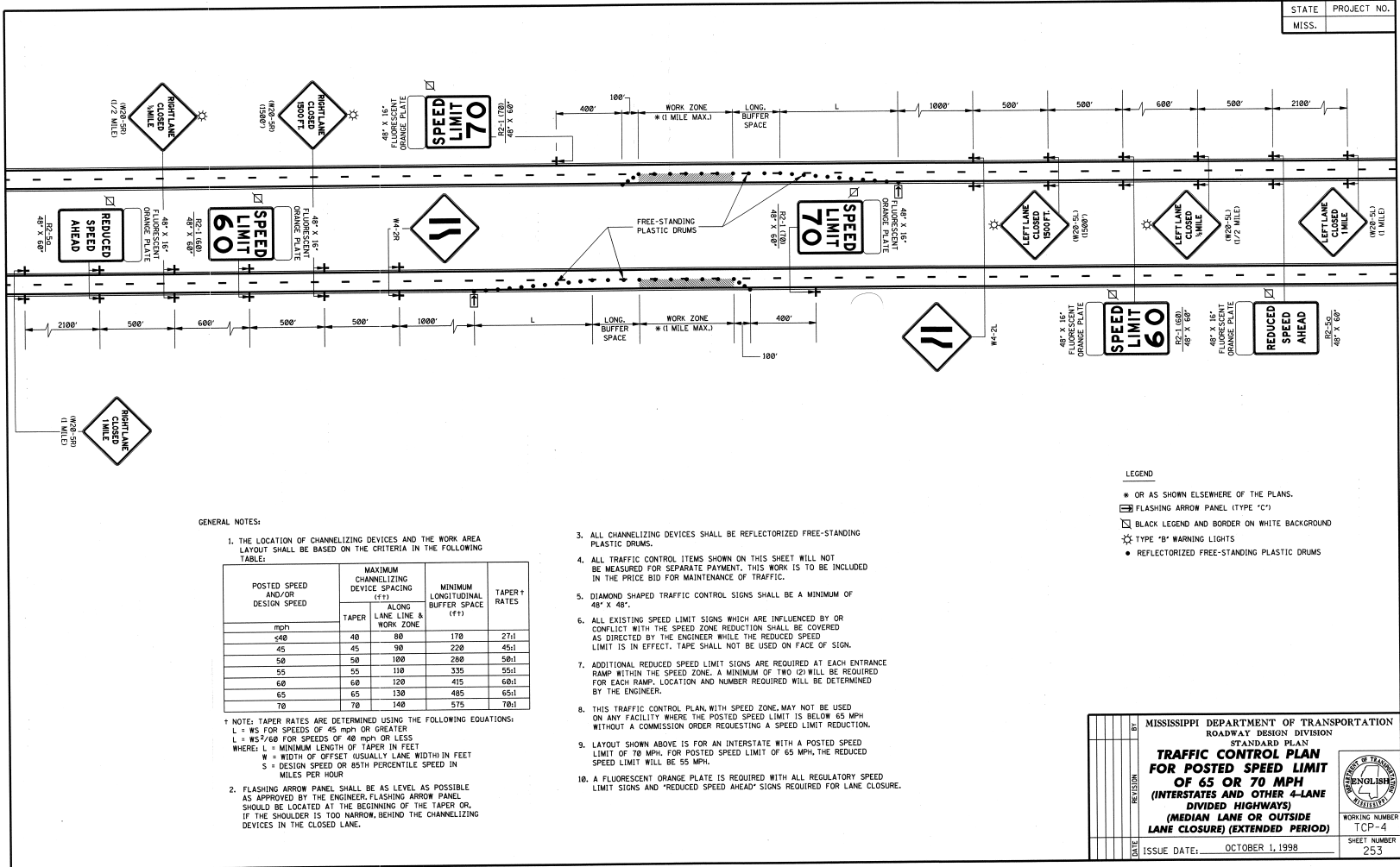

STATE PROJECT NO.
MISS. _____

GENERAL NOTES:

1. THE LOCATION OF CHANNELIZING DEVICES AND THE WORK AREA LAYOUT SHALL BE BASED ON THE CRITERIA IN THE FOLLOWING TABLE.

POSTED SPEED AND/OR DESIGN SPEED	MAXIMUM CHANNELIZING DEVICE SPACING (ft)		MINIMUM LONGITUDINAL BUFFER SPACE (ft)	TAPER RATES
	TAPER	ALONG LANE LINE & WORK ZONE		
≤40	40	80	170	27:1
45	45	90	220	45:1
50	50	100	280	50:1
55	55	110	335	55:1
60	60	120	415	60:1
65	65	130	485	65:1
70	70	140	575	70:1

* NOTE: TAPER RATES ARE DETERMINED USING THE FOLLOWING EQUATIONS:
 L = WS FOR SPEEDS OF 45 MPH OR GREATER
 L = WS²/60 FOR SPEEDS OF 40 MPH OR LESS
 WHERE: L = MINIMUM LENGTH OF TAPER IN FEET
 W = WIDTH OF OFFSET USUALLY LANE WIDTH IN FEET
 S = DESIGN SPEED OR 85TH PERCENTILE SPEED IN MILES PER HOUR

2. FLASHING ARROW PANEL SHALL BE AS LEVEL AS POSSIBLE AS APPROVED BY THE ENGINEER. FLASHING ARROW PANEL SHOULD BE LOCATED AT THE BEGINNING OF THE TAPER OR, IF THE SHOULDER IS TOO NARROW, BEHIND THE CHANNELIZING DEVICES IN THE CLOSED LANE.

- ALL CHANNELIZING DEVICES SHALL BE REFLECTORIZED FREE-STANDING PLASTIC DRUMS.
- ALL TRAFFIC CONTROL ITEMS SHOWN ON THIS SHEET WILL NOT BE MEASURED FOR SEPARATE PAYMENT. THIS WORK IS TO BE INCLUDED IN THE PRICE BID FOR MAINTENANCE OF TRAFFIC.
- DIAMOND SHAPED TRAFFIC CONTROL SIGNS SHALL BE A MINIMUM OF 48" X 48".
- ALL EXISTING SPEED LIMIT SIGNS WHICH ARE INFLUENCED BY OR CONFLICT WITH THE SPEED ZONE REDUCTION SHALL BE COVERED AS DIRECTED BY THE ENGINEER WHILE THE REDUCED SPEED LIMIT IS IN EFFECT. TAPE SHALL NOT BE USED ON FACE OF SIGN.
- ADDITIONAL REDUCED SPEED LIMIT SIGNS ARE REQUIRED AT EACH ENTRANCE RAMP WITHIN THE SPEED ZONE. A MINIMUM OF TWO (2) WILL BE REQUIRED FOR EACH RAMP. LOCATION AND NUMBER REQUIRED WILL BE DETERMINED BY THE ENGINEER.
- THIS TRAFFIC CONTROL PLAN, WITH SPEED ZONE, MAY NOT BE USED ON ANY FACILITY WHERE THE POSTED SPEED LIMIT IS BELOW 65 MPH, WITHOUT A COMMISSION ORDER REQUESTING A SPEED LIMIT REDUCTION.
- LAYOUT SHOWN ABOVE IS FOR AN INTERSTATE WITH A POSTED SPEED LIMIT OF 70 MPH. FOR POSTED SPEED LIMIT OF 65 MPH, THE REDUCED SPEED LIMIT WILL BE 55 MPH.
- A FLUORESCENT ORANGE PLATE IS REQUIRED WITH ALL REGULATORY SPEED LIMIT SIGNS AND 'REDUCED SPEED AHEAD' SIGNS REQUIRED FOR LANE CLOSURE.

- LEGEND
- * OR AS SHOWN ELSEWHERE OF THE PLANS.
 - FLASHING ARROW PANEL (TYPE "C")
 - BLACK LEGEND AND BORDER ON WHITE BACKGROUND
 - TYPE "B" WARNING LIGHTS
 - REFLECTORIZED FREE-STANDING PLASTIC DRUMS

MISSISSIPPI DEPARTMENT OF TRANSPORTATION
 ROADWAY DESIGN DIVISION
 STANDARD PLAN
**TRAFFIC CONTROL PLAN
 FOR POSTED SPEED LIMIT
 OF 65 OR 70 MPH
 (INTERSTATES AND OTHER 4-LANE
 DIVIDED HIGHWAYS)
 (MEDIAN LANE OR OUTSIDE
 LANE CLOSURE) (EXTENDED PERIOD)**

ISSUE DATE: OCTOBER 1, 1998

WORKING NUMBER: TCP-4
 SHEET NUMBER: 253

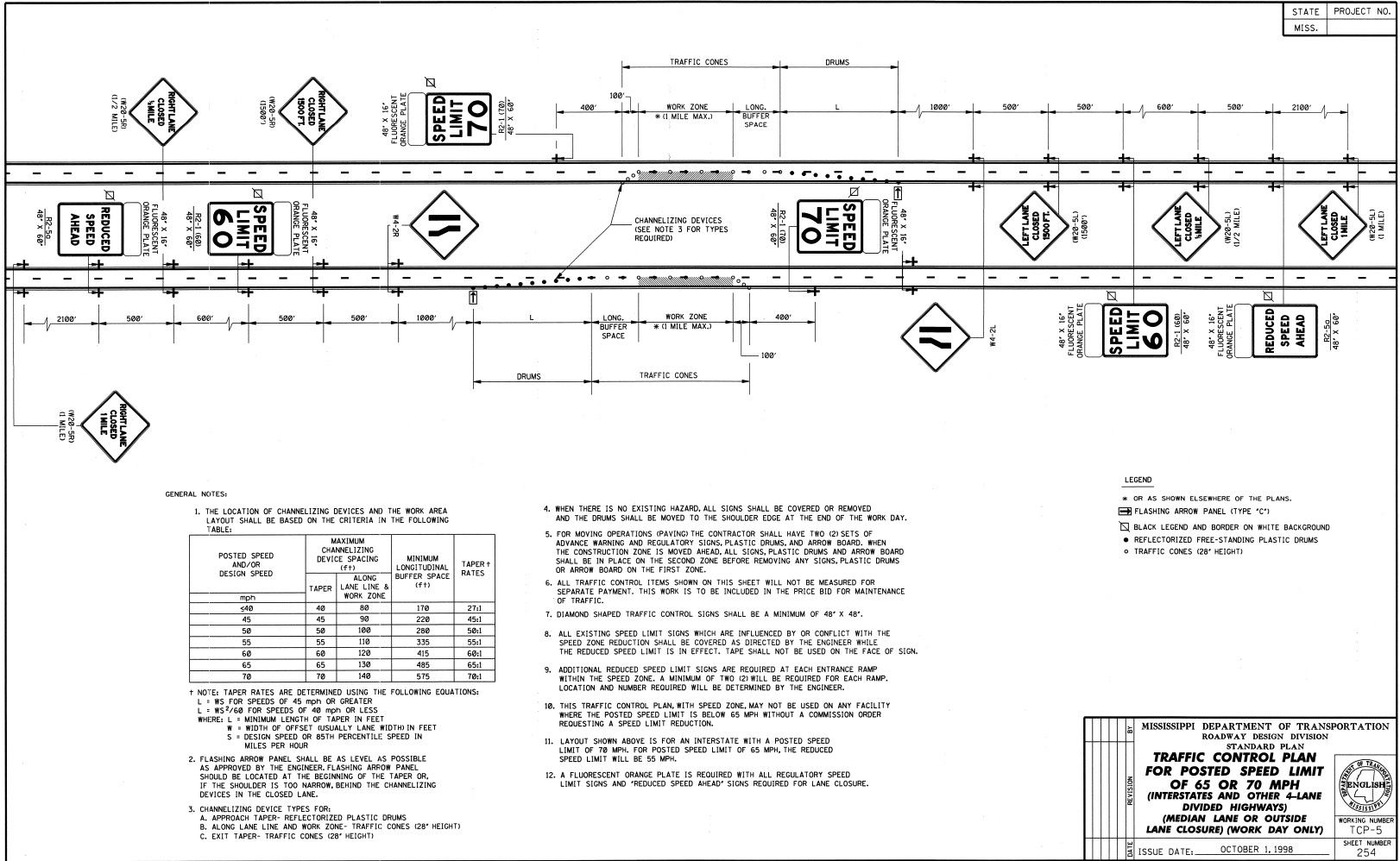

STATE PROJECT NO.
MISS. _____

GENERAL NOTES:

1. THE LOCATION OF CHANNELIZING DEVICES AND THE WORK AREA LAYOUT SHALL BE BASED ON THE CRITERIA IN THE FOLLOWING TABLE:

POSTED SPEED AND/OR DESIGN SPEED	MAXIMUM CHANNELIZING DEVICE SPACING (ft)		MINIMUM LONGITUDINAL BUFFER SPACE (ft)	TAPER† RATES
	TAPER	ALONG LANE LINE & WORK ZONE		
40	48	80	170	27:1
45	45	90	220	45:1
50	50	100	280	50:1
55	55	110	335	55:1
60	60	120	415	60:1
65	65	130	485	65:1
70	70	140	575	70:1

- † NOTE: TAPER RATES ARE DETERMINED USING THE FOLLOWING EQUATIONS:
 L = WS FOR SPEEDS OF 45 MPH OR GREATER
 L = WS²/60 FOR SPEEDS OF 40 MPH OR LESS
 WHERE: L = MINIMUM LENGTH OF TAPER IN FEET
 W = WIDTH OF OFFSET (USUALLY LANE WIDTH) IN FEET
 S = DESIGN SPEED OR 85TH PERCENTILE SPEED IN MILES PER HOUR
2. FLASHING ARROW PANEL SHALL BE AS LEVEL AS POSSIBLE AS APPROVED BY THE ENGINEER. FLASHING ARROW PANEL SHOULD BE LOCATED AT THE BEGINNING OF THE TAPER OR, IF THE SHOULDER IS TOO NARROW, BEHIND THE CHANNELIZING DEVICES IN THE CLOSED LANE.
 3. CHANNELIZING DEVICE TYPES FOR:
 A. APPROACH TAPER- REFLECTORIZED PLASTIC DRUMS
 B. ALONG LANE LINE AND WORK ZONE- TRAFFIC CONES (28" HEIGHT)
 C. EXIT TAPER- TRAFFIC CONES (28" HEIGHT)

4. WHEN THERE IS NO EXISTING HAZARD, ALL SIGNS SHALL BE COVERED OR REMOVED AND THE DRUMS SHALL BE MOVED TO THE SHOULDER EDGE AT THE END OF THE WORK DAY.
5. FOR MOVING OPERATIONS (PAYING) THE CONTRACTOR SHALL HAVE TWO (2) SETS OF ADVANCE WARNING AND REGULATORY SIGNS, PLASTIC DRUMS, AND ARROW BOARD. WHEN THE CONSTRUCTION ZONE IS MOVED AHEAD, ALL SIGNS, PLASTIC DRUMS AND ARROW BOARD SHALL BE IN PLACE ON THE SECOND ZONE BEFORE REMOVING ANY SIGNS, PLASTIC DRUMS OR ARROW BOARD ON THE FIRST ZONE.
6. ALL TRAFFIC CONTROL ITEMS SHOWN ON THIS SHEET WILL NOT BE MEASURED FOR SEPARATE PAYMENT. THIS WORK IS TO BE INCLUDED IN THE PRICE BID FOR MAINTENANCE OF TRAFFIC.
7. DIAMOND SHAPED TRAFFIC CONTROL SIGNS SHALL BE A MINIMUM OF 48" X 48".
8. ALL EXISTING SPEED LIMIT SIGNS WHICH ARE INFLUENCED BY OR CONFLICT WITH THE SPEED ZONE REDUCTION SHALL BE COVERED AS DIRECTED BY THE ENGINEER WHILE THE REDUCED SPEED LIMIT IS IN EFFECT. TAPE SHALL NOT BE USED ON THE FACE OF SIGN.
9. ADDITIONAL REDUCED SPEED LIMIT SIGNS ARE REQUIRED AT EACH ENTRANCE RAMP WITHIN THE SPEED ZONE. A MINIMUM OF TWO (2) WILL BE REQUIRED FOR EACH RAMP. LOCATION AND NUMBER REQUIRED WILL BE DETERMINED BY THE ENGINEER.
10. THIS TRAFFIC CONTROL PLAN, WITH SPEED ZONE, MAY NOT BE USED ON ANY FACILITY WHERE THE POSTED SPEED LIMIT IS BELOW 65 MPH WITHOUT A COMMISSION ORDER REQUESTING A SPEED LIMIT REDUCTION.
11. LAYOUT SHOWN ABOVE IS FOR AN INTERSTATE WITH A POSTED SPEED LIMIT OF 70 MPH. FOR POSTED SPEED LIMIT OF 65 MPH, THE REDUCED SPEED LIMIT WILL BE 55 MPH.
12. A FLUORESCENT ORANGE PLATE IS REQUIRED WITH ALL REGULATORY SPEED LIMIT SIGNS AND "REDUCED SPEED AHEAD" SIGNS REQUIRED FOR LANE CLOSURE.

LEGEND

- * OR AS SHOWN ELSEWHERE OF THE PLANS.
- ◻ FLASHING ARROW PANEL (TYPE "C")
- ◻ BLACK LEGEND AND BORDER ON WHITE BACKGROUND
- ◻ REFLECTORIZED FREE-STANDING PLASTIC DRUMS
- ◻ TRAFFIC CONES (28" HEIGHT)

DATE	BY	REVISION	MISSISSIPPI DEPARTMENT OF TRANSPORTATION ROADWAY DESIGN DIVISION STANDARD PLAN TRAFFIC CONTROL PLAN FOR POSTED SPEED LIMIT OF 65 OR 70 MPH (INTERSTATES AND OTHER 4-LANE DIVIDED HIGHWAYS) (MEDIAN LANE OR OUTSIDE LANE CLOSURE) (WORK DAY ONLY)	 WORKING NUMBER TCP-5 SHEET NUMBER 25-4
ISSUE DATE: _____	OCTOBER 1, 1998			

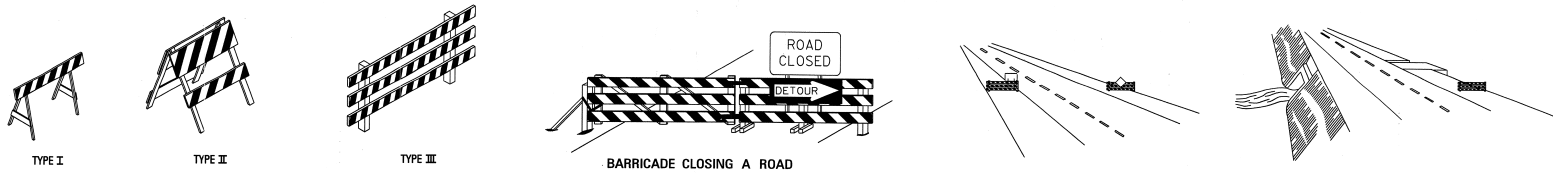

TYPE I TYPE II TYPE III

BARRICADE CLOSING A ROAD

STANDARD BARRICADES

1. A TYPE I BARRICADE CONSISTS OF ONE (1) HORIZONTAL RAIL SUPPORTED BY A DEMOUNTABLE FRAME OR A LIGHT 'A' FRAME. A TYPE I BARRICADE NORMALLY WOULD BE USED ON CONVENTIONAL ROADS OR URBAN STREETS AND ARTERIALS.
2. A TYPE II BARRICADE CONSISTS OF TWO (2) HORIZONTAL RAILS ON A LIGHT 'A' FRAME. TYPE II BARRICADES ARE INTENDED FOR USE ON EXPRESSWAYS AND FREEWAYS AND OTHER HIGH-SPEED ROADWAYS.
3. TYPE I AND TYPE II BARRICADES ARE INTENDED FOR USE WHERE THE HAZARD IS RELATIVELY SMALL, AS, FOR EXAMPLE, ON CITY STREETS, OR FOR THE MORE OR LESS CONTINUOUS DELIMITING OF A RESTRICTED ROADWAY, OR FOR TEMPORARY DAYTIME USE.
4. A TYPE III BARRICADE CONSISTS OF THREE (3) HORIZONTAL RAILS SUPPORTED BY FIXED POSTS, A RIGID SKID, A HEAVY DEMOUNTABLE FRAME OR A HEAVY, HINGED 'A' FRAME.
5. TYPE III BARRICADES ARE INTENDED FOR USE ON CONSTRUCTION AND MAINTENANCE PROJECTS AS WING BARRICADES AND AT ROAD CLOSURES, WHERE THEY MUST REMAIN IN PLACE FOR EXTENDED PERIODS.
6. THE MARKING FOR BARRICADE RAILS SHALL BE ORANGE AND WHITE ISLOPING DOWNWARD AT AN ANGLE OF 45° IN THE DIRECTION TRAFFIC IS TO PASS.
7. DO NOT PLACE SANDBAGS OR OTHER DEVICES TO PROVIDE MASS ON THE BOTTOM RAIL THAT WILL BLOCK VIEW OR RAIL FACE.
8. FOR ADDITIONAL INFORMATION OR DETAILS, SEE MUTCD, LATEST EDITION.

BARRICADE CHARACTERISTICS

	I	II	III
WIDTH OF RAIL **	8" MIN. - 12" MAX.	8" MIN. - 12" MAX.	8" MIN. - 12" MAX.
LENGTH OF RAIL **	24" MIN.	24" MIN.	48" MIN.
WIDTH OF STRIPE *	6"	6"	6"
HEIGHT	36" MIN.	36" MIN.	60" MIN.
NUMBER OF REFLECTORIZED RAIL FACES	2 (ONE EACH DIRECTION)	4 (TWO EACH DIRECTION)	3 IF FACING TRAFFIC IN ONE DIRECTION 6 IF FACING TRAFFIC IN TWO DIRECTIONS
TYPE OF FRAME	LIGHT	LIGHT 'A' FRAME	POST OR SKID

* 1. FOR RAILS LESS THAN 36" LONG, 4" WIDE STRIPES MAY BE USED.
 ** 2. BARRICADES INTENDED FOR USE ON EXPRESSWAYS, FREEWAYS AND OTHER HIGH SPEED ROADWAYS, SHALL HAVE A MINIMUM OF 270 IN² OF REFLECTIVE AREA FACING TRAFFIC.

WING BARRICADES

1. WING BARRICADES ARE TYPE III BARRICADES ERECTED ON THE SHOULDER ON ONE OR BOTH SIDES OF THE PAVEMENT TO GIVE THE SENSATION OF A NARROWING OR RESTRICTED ROADWAY. WING BARRICADES MAY BE USED AS A MOUNTING FOR THE ADVANCE WARNING SIGNS OR FLASHERS.
2. WING BARRICADES SHOULD BE USED:
 - A. IN ADVANCE OF A CONSTRUCTION PROJECT EVEN WHEN NO PART OF THE ROADWAY IS ACTUALLY CLOSED.
 - B. IN ADVANCE OF ALL BRIDGE OR CULVERT WIDENING OPERATIONS.

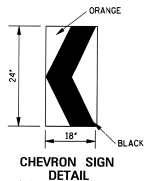

CHEVRON SIGN DETAIL

1. A CHEVRON SIGN CONSISTS OF A BLACK CHEVRON TYPE MARKING ON AN ORANGE BACKGROUND AND SHALL POINT IN THE DIRECTION OF TRAFFIC FLOW.
2. THE CHEVRON SIGN SHALL BE MOUNTED ON FIXED POST OR RIGID SKID.
3. CHEVRON SIGNS MAY BE USED TO SUPPLEMENT OTHER STANDARD DEVICES WHERE ONE OR MORE LANES ARE CLOSED FOR CONSTRUCTION OR MAINTENANCE. THEY SHALL BE PLACED APPROXIMATELY 2'-0" BEHIND THE LANE TRANSITION STRIPES.

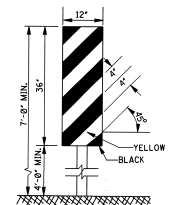

TYPE 3 OBJECT MARKER (OM-3R)

1. TYPE 3 OBJECT MARKERS SHALL BE USED AT ALL EXPOSED BRIDGE ABUTMENTS AND AT OTHER LOCATIONS AS DEEMED NECESSARY BY THE ENGINEER.
2. THE OM-3R IS SHOWN. THE OM-3L IS SIMILAR EXCEPT THE STRIPES SLOPE DOWNWARD FROM THE UPPER LEFT SIDE TO THE LOWER RIGHT SIDE AND SHALL BE PLACED ON THE LEFT SIDE OF THE OBJECT.
3. THE INSIDE EDGE OF THE MARKER SHALL BE IN LINE WITH THE INNER EDGE OF THE OBSTRUCTION.

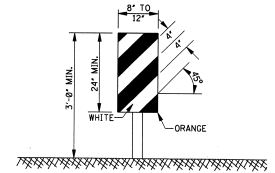

VERTICAL PANEL

1. VERTICAL PANELS CONSIST OF AT LEAST ONE PANEL 8" TO 12" IN WIDTH AND A MINIMUM OF 24" IN HEIGHT.
2. THE DIAGONAL STRIPES SHALL SLOPE DOWNWARD IN THE DIRECTION THAT TRAFFIC IS TO PASS THE PANEL. THE PANELS SHALL BE MOUNTED WITH THE TOP A MINIMUM OF 36" ABOVE THE ROADWAY ON A SINGLE LIGHTMASS POST.
3. VERTICAL PANELS USED ON EXPRESSWAYS, FREEWAYS AND OTHER HIGH-SPEED ROADWAYS SHALL HAVE A MINIMUM OF 270 IN² OF RETROREFLECTIVE AREA FACING TRAFFIC.
4. FOR TWO-WAY TRAFFIC OPERATIONS, BACK-TO-BACK PANELS SHALL BE USED.

GENERAL NOTES:
 1. MARKINGS ON ALL DEVICES SHOWN ON THIS SHEET SHALL BE HIGH INTENSITY REFLECTIVE SHEETING.
 2. THE TRAFFIC CONTROL PLAN WILL LIST THE VARIOUS TRAFFIC CONTROL DEVICES REQUIRED FOR EACH PROJECT.

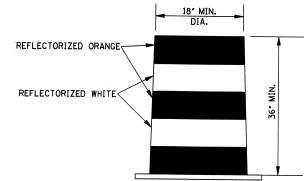

PLASTIC DRUM STRIPING DETAIL

1. PLASTIC DRUMS SHALL BE ON END AND USED AS AN EXPEDIENT METHOD FOR TRAFFIC CHANNELIZATION. THE COLOR AND MARKING OF DRUMS SHALL BE CONSISTENT WITH MARKING STANDARDS FOR BARRICADE. THE PREDOMINANT COLOR ON DRUMS SHALL BE ORANGE WITH FOUR (4) REFLECTORIZED, HORIZONTAL, CIRCUMFERENTIAL STRIPES (2 ORANGE & 2 WHITE) 6" WIDE.
2. DRUMS SHOULD NEVER BE PLACED IN THE ROADWAY WITHOUT WARNING SIGNS.
3. WHERE PRACTICAL PLASTIC DRUMS SHALL BE PLACED NO CLOSER THAN 3'-0" FROM THE EDGE OF TRAVELED LANE.

MISSISSIPPI DEPARTMENT OF TRANSPORTATION ROADWAY DESIGN DIVISION STANDARD PLAN									
HIGHWAY SIGN AND BARRICADE DETAILS FOR CONSTRUCTION PROJECTS									
<table border="1"> <tr><td>DATE</td><td> </td></tr> <tr><td>REVISION</td><td> </td></tr> </table>	DATE		REVISION		<table border="1"> <tr><td>WORKING NUMBER</td><td>TCP-10</td></tr> <tr><td>SHEET NUMBER</td><td>253</td></tr> </table>	WORKING NUMBER	TCP-10	SHEET NUMBER	253
DATE									
REVISION									
WORKING NUMBER	TCP-10								
SHEET NUMBER	253								
ISSUE DATE: OCTOBER 1, 1998									

MOBILE OPERATIONS ON MULTILANE ROAD ▲

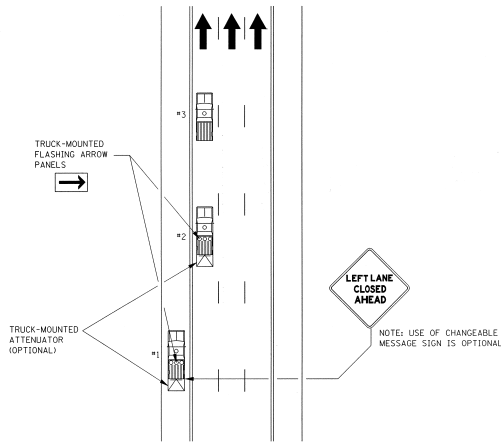

MOBILE OPERATIONS ON MULTILANE ROAD

NOTES:

1. VEHICLES USED FOR THESE OPERATIONS SHOULD BE MADE HIGHLY VISIBLE WITH APPROPRIATE EQUIPMENT, SUCH AS FLASHING LIGHTS, ROTATING BEACONS, FLAGS, SIGNS, OR ARROW PANELS.
2. PROTECTION VEHICLE #1 SHOULD BE EQUIPPED WITH AN ARROW PANEL. AN APPROPRIATE LANE CLOSURE SIGN SHOULD BE PLACED ON PROTECTION VEHICLE #1 SO AS NOT TO OBSCURE THE ARROW PANEL.
3. PROTECTION VEHICLE #2 SHOULD BE EQUIPPED WITH AN ARROW PANEL AND TRUCK-MOUNTED ATTENUATOR (TMA).
4. PROTECTION VEHICLE #1 SHOULD TRAVEL AT A VARYING DISTANCE FROM THE WORK OPERATION SO AS TO PROVIDE ADEQUATE SIGHT DISTANCE FOR TRAFFIC APPROACHING FROM THE REAR.
5. WHEN ADEQUATE SHOULDER WIDTH IS NOT AVAILABLE, PROTECTION VEHICLE #1 SHOULD BE ELIMINATED.
6. ON HIGH-SPEED ROADWAYS, A THIRD PROTECTION VEHICLE SHOULD BE USED (I.E., VEHICLE #1 ON THE SHOULDER IF PRACTICAL, VEHICLE #2 IN THE CLOSED LANE, AND VEHICLE #3 IN THE CLOSED LANE).
7. ARROW PANELS SHALL BE AS A MINIMUM TYPE B, 60" X 30" IN ACCORDANCE WITH THE CRITERIA PRESENTED IN THE MUTCD.
8. WORK SHOULD NORMALLY BE DONE DURING OFF-PEAK HOURS.
9. ALL TRAFFIC CONTROL ITEMS SHOWN ON THIS SHEET WILL NOT BE MEASURED FOR SEPARATE PAYMENT. THIS WORK IS TO BE INCLUDED IN THE PRICE BID FOR MAINTENANCE OF TRAFFIC.

MOBILE OPERATIONS ON TWO-LANE ROAD

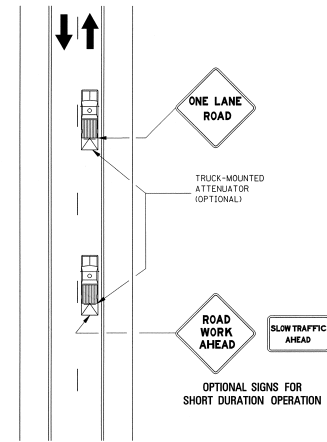

MOBILE OPERATIONS ON TWO-LANE ROAD

NOTES:

1. WHERE PRACTICAL AND WHEN NEEDED, THE WORK AND PROTECTION VEHICLES SHOULD PULL OVER PERIODICALLY TO ALLOW TRAFFIC TO PASS. IF THIS CAN NOT BE DONE FREQUENTLY, AS AN ALTERNATIVE, A "DO NOT PASS" SIGN MAY BE PLACED ON THE REAR OF THE VEHICLE BLOCKING THE LANE.
2. THE DISTANCE BETWEEN THE WORK AND PROTECTION VEHICLES MAY VARY ACCORDING TO TERRAIN, PAINT DRYING TIME, AND OTHER FACTORS. PROTECTION VEHICLES ARE USED TO WARN TRAFFIC OF THE OPERATION AHEAD. WHENEVER ADEQUATE STOPPING SIGHT DISTANCE EXISTS TO THE REAR, THE PROTECTION VEHICLE SHOULD MAINTAIN THE MINIMUM DISTANCE AND PROCEED AT THE SAME SPEED AS THE WORK VEHICLE. THE PROTECTION VEHICLE SHOULD SLOW DOWN IN ADVANCE OF VERTICAL OR HORIZONTAL CURVES THAT RESTRICT SIGHT DISTANCE.
3. ADDITIONAL PROTECTION VEHICLES TO WARN AND REDUCE THE SPEED OF ONCOMING OR OPPOSING TRAFFIC MAY BE USED. POLICE PATROL CARS MAY BE USED FOR THIS PURPOSE.
4. A TRUCK-MOUNTED ATTENUATOR (TMA) SHOULD BE USED ON THE PROTECTION VEHICLE AND MAY BE USED ON THE WORK VEHICLE.
5. THE WORK VEHICLE SHALL BE EQUIPPED WITH BEACONS, AND THE PROTECTION VEHICLES SHALL BE EQUIPPED WITH TWO HIGH-INTENSITY FLASHING LIGHTS MOUNTED ON THE REAR, ADJACENT TO THE SIGN. PROTECTION AND WORK VEHICLES SHOULD DISPLAY FLASHING OR ROTATING BEACONS BOTH FORWARD AND TO THE REAR.
6. VEHICLE-MOUNTED SIGNS SHALL BE MOUNTED WITH THE BOTTOM OF THE SIGN LOCATED AT A MINIMUM HEIGHT OF 48" ABOVE THE PAVEMENT. SIGN LEGENDS SHALL BE COVERED OR TURNED FROM VIEW WHEN WORK IS NOT IN PROGRESS.
7. ALL TRAFFIC CONTROL ITEMS SHOWN ON THIS SHEET WILL NOT BE MEASURED FOR SEPARATE PAYMENT. THIS WORK IS TO BE INCLUDED IN THE PRICE BID FOR MAINTENANCE OF TRAFFIC.

STATE	PROJECT NO.
MISS.	

MISSISSIPPI DEPARTMENT OF TRANSPORTATION ROADWAY DESIGN DIVISION STANDARD PLAN	
TRAFFIC CONTROL PLAN MOBILE OPERATIONS MULTILANE ROADS AND TWO-LANE ROADS	
WORKING NUMBER TCP-11	 SHEET NUMBER 260
ISSUE DATE: OCTOBER 1, 1998	

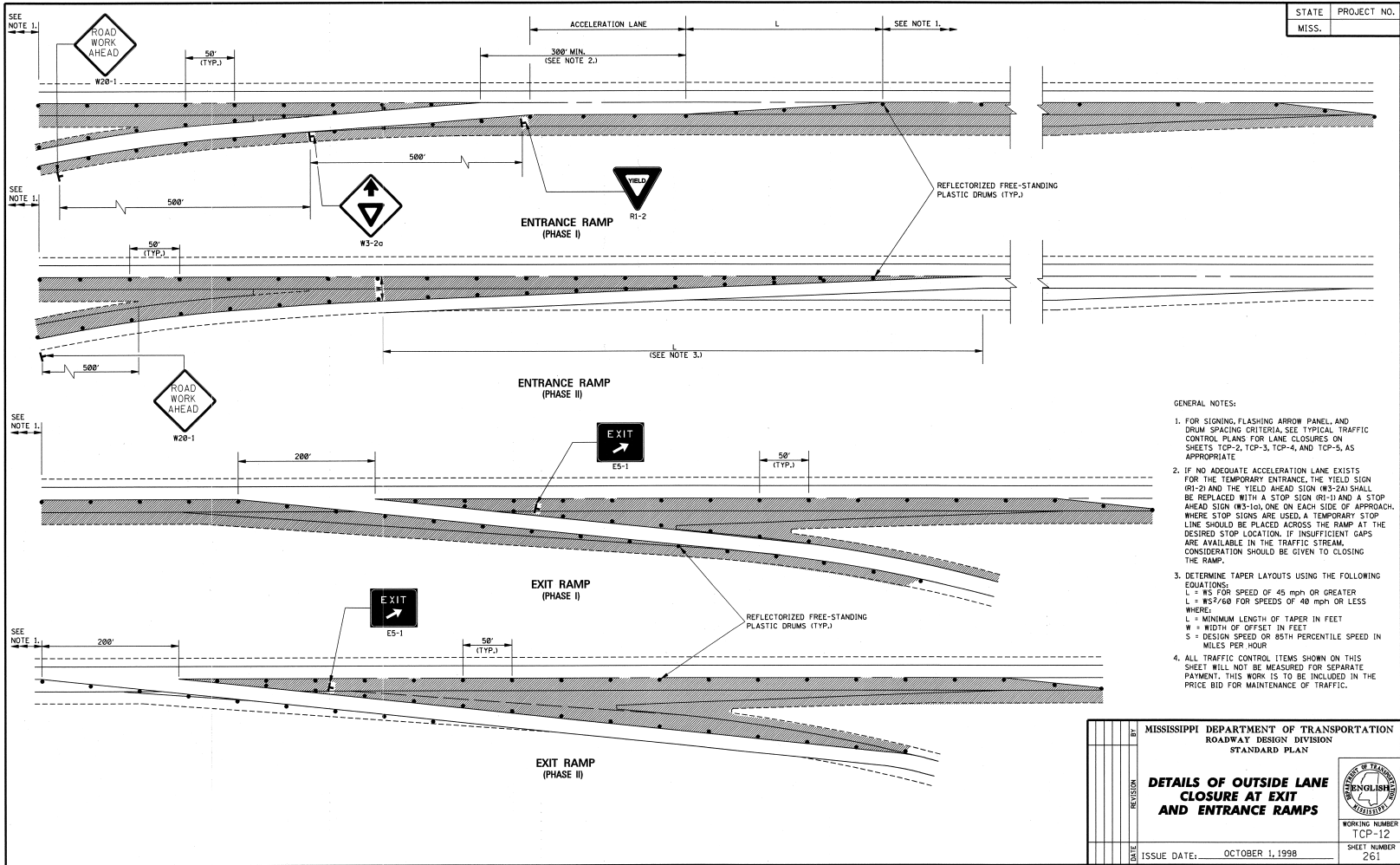

STATE	PROJECT NO.
MISS.	

- GENERAL NOTES:
1. FOR SIGNING, FLASHING ARROW PANEL, AND DRUM SPACING CRITERIA SEE TYPICAL TRAFFIC CONTROL PLANS FOR LANE CLOSURES ON SHEETS TCP-2, TCP-3, TCP-4, AND TCP-5, AS APPROPRIATE.
 2. IF NO ADEQUATE ACCELERATION LANE EXISTS FOR THE TEMPORARY ENTRANCE, THE YIELD SIGN (RI-2) AND THE YIELD AHEAD SIGN (W3-2A) SHALL BE REPLACED WITH A STOP SIGN (RI-1) AND A STOP AHEAD SIGN (W3-1a), ONE ON EACH SIDE OF APPROACH. WHERE STOP SIGNS ARE USED, A TEMPORARY STOP LINE SHOULD BE PLACED ACROSS THE RAMP AT THE DESIRED STOP LOCATION. IF INSUFFICIENT GAPS ARE AVAILABLE IN THE TRAFFIC STREAM, CONSIDERATION SHOULD BE GIVEN TO CLOSING THE RAMP.
 3. DETERMINE TAPER LAYOUTS USING THE FOLLOWING EQUATIONS:
 $L = WS$ FOR SPEED OF 45 mph OR GREATER
 $L = WS^2/60$ FOR SPEEDS OF 40 mph OR LESS
 WHERE:
 L = MINIMUM LENGTH OF TAPER IN FEET
 W = WIDTH OF OFFSET IN FEET
 S = DESIGN SPEED OR 85TH PERCENTILE SPEED IN MILES PER HOUR
 4. ALL TRAFFIC CONTROL ITEMS SHOWN ON THIS SHEET WILL NOT BE MEASURED FOR SEPARATE PAYMENT. THIS WORK IS TO BE INCLUDED IN THE PRICE BID FOR MAINTENANCE OF TRAFFIC.

DATE	BY	REVISION	MISSISSIPPI DEPARTMENT OF TRANSPORTATION ROADWAY DESIGN DIVISION STANDARD PLAN
			DETAILS OF OUTSIDE LANE CLOSURE AT EXIT AND ENTRANCE RAMP
			WORKING NUMBER TCP-12
			SHEET NUMBER 261
ISSUE DATE:			OCTOBER 1, 1998

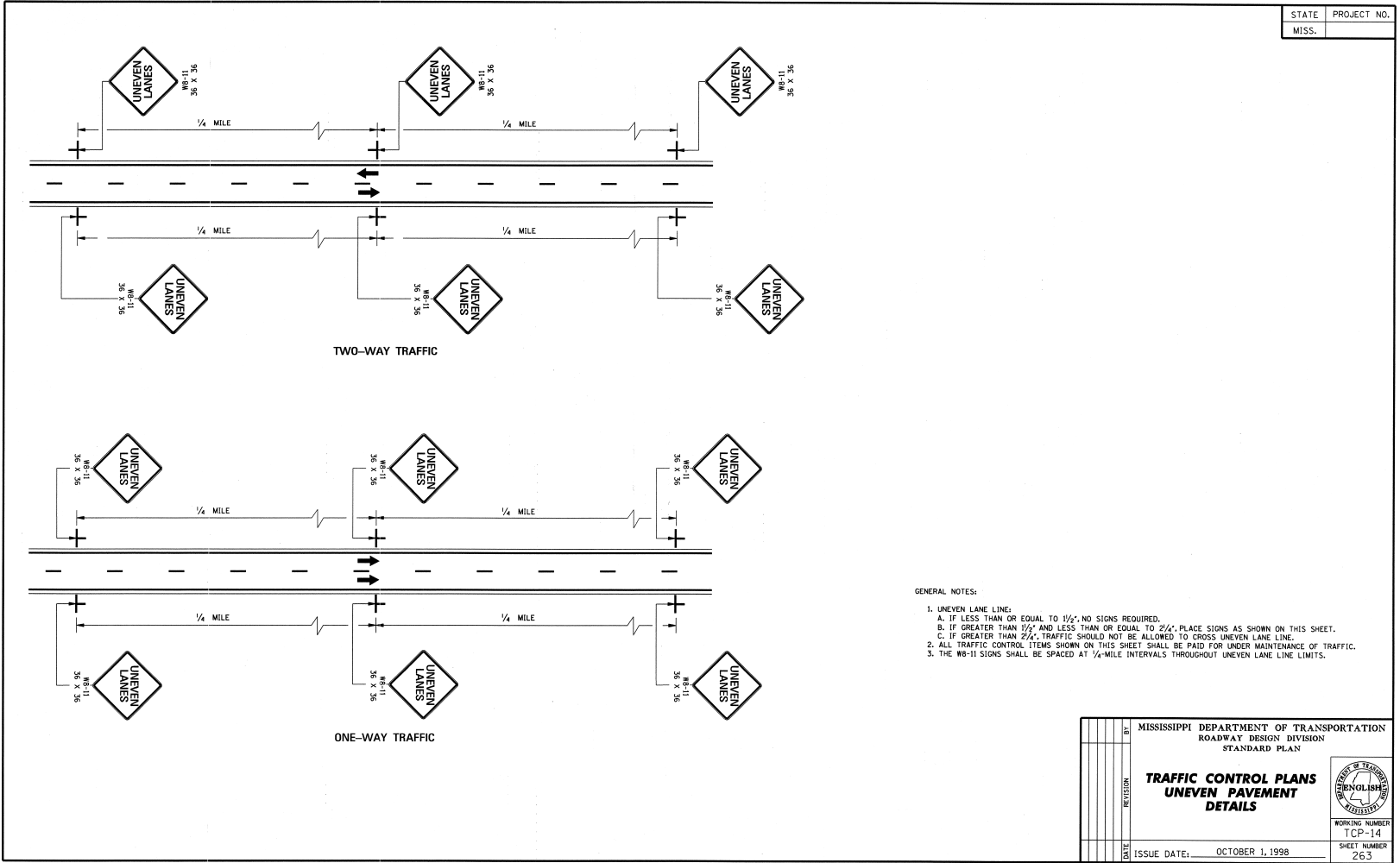

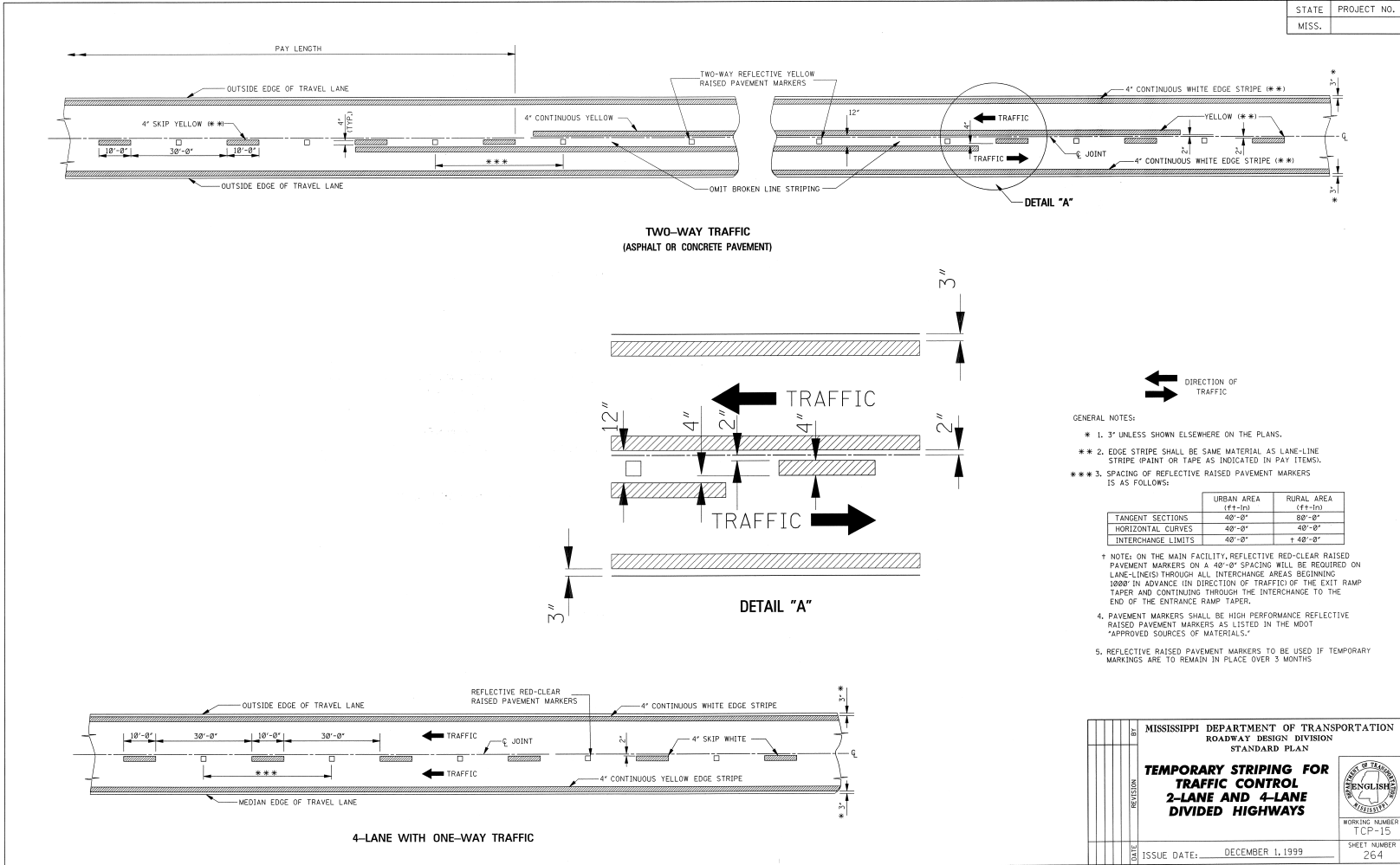

STATE	PROJECT NO.
MISS.	

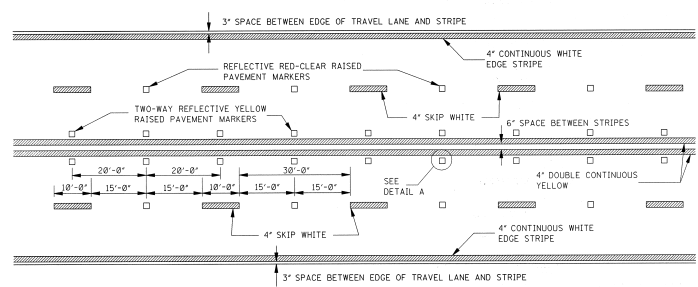

TYPICAL STRIPING AND RAISED PAVEMENT MARKERS FOR 4-LANE SECTION

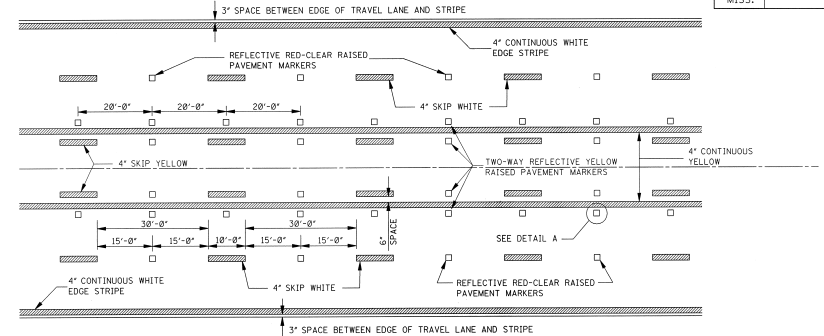

TYPICAL STRIPING AND RAISED PAVEMENT MARKERS FOR 5-LANE SECTION

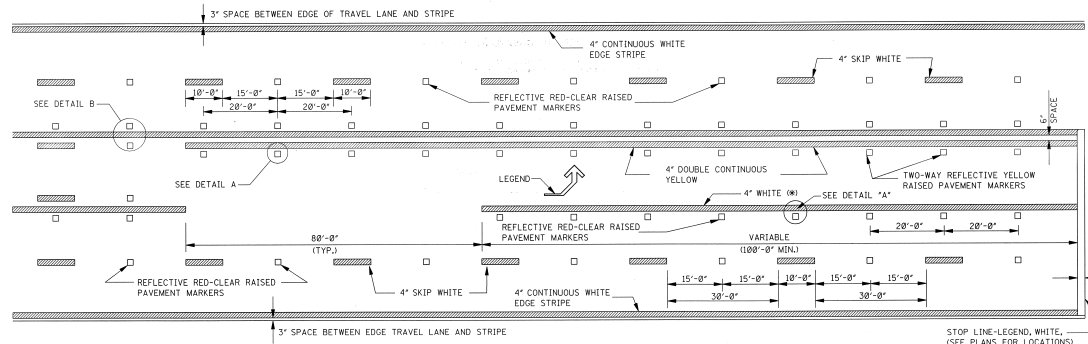

TYPICAL STRIPING AND RAISED PAVEMENT MARKERS AT LEFT TURN LANES

*NOTE: USE DETAIL STRIPING IF LENGTH ≤ 150' AT THIS LOCATION, OTHERWISE USE CONTINUOUS STRIPING.

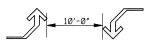

TYPICAL TWO-WAY ARROW INSTALLATION

- NOTES: 1. CONSIDER EACH SEGMENT OF CONTINUOUS TWO-WAY LEFT TURN LANE SEPARATELY.
 2. IF SEGMENT IS LESS THAN 350', PLACE ONE SET OF ARROWS IN CENTER OF SEGMENT.
 3. IF SEGMENT IS GREATER THAN 350', PLACE FIRST SET OF ARROWS 50' TO 100' FROM BEGINNING AND/OR END OF SEGMENT AND SPACE ADDITIONAL SETS OF ARROWS (250' O.C.).

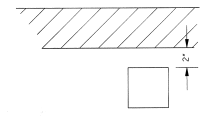

DETAIL A LATERAL PLACEMENT OF PAVEMENT MARKERS

GENERAL NOTE:

1. PAVEMENT MARKERS SHALL BE HIGH PERFORMANCE RAISED PAVEMENT MARKERS AS LISTED IN THE MDT "APPROVED SOURCES OF MATERIALS".
2. REFLECTIVE RAISED PAVEMENT MARKERS TO BE USED IF TEMPORARY MARKINGS ARE TO REMAIN IN PLACE OVER 3 MONTHS.
3. TEMPORARY TURN ARROW TO BE PAID FOR AS TEMPORARY TRAFFIC STRIPE (LEGEND), ESTIMATED AT 10.9 SQ. FT. PER ARROW.

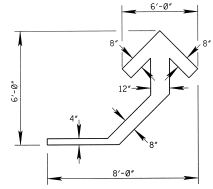

DETAIL OF TEMPORARY TURN ARROW

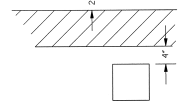

DETAIL B LATERAL PLACEMENT OF PAVEMENT MARKERS

MISSISSIPPI DEPARTMENT OF TRANSPORTATION ROADWAY DESIGN DIVISION STANDARD PLAN			WORKING NUMBER TCP-16
TEMPORARY STRIPING FOR TRAFFIC CONTROL 4-LANE AND 5-LANE UNDIVIDED ROADWAYS			SHEET NUMBER 265
DATE	ISSUE DATE:	DECEMBER 1, 1999	

MISSISSIPPI DEPARTMENT OF TRANSPORTATION

SECTION 904 - NOTICE TO BIDDERS NO. 12

CODE: (IS)

DATE: 05/03/2004

SUBJECT: Federal Bridge Formula

Bidders are hereby advised that Federal Highway Administration Publication No. FHWA-MC-94-007, **BRIDGE FORMULA WEIGHTS**, dated January 1994, is made a part of this contract when applicable.

Prior to the preconstruction conference, the Contractor shall advise the Engineer, in writing, what materials, if any, will be delivered to the jobsite via Interstate route(s).

Copies of the **BRIDGE FORMULA WEIGHTS** publication may be obtained by contacting:

Federal Highway Administration
400 7th Street, SW
Washington, DC 20590
(202) 366-2212

or

<http://ops.fhwa.dot.gov/freight/regulate/sw/>

MISSISSIPPI DEPARTMENT OF TRANSPORTATION

SECTION 904 - NOTICE TO BIDDERS NO. 152

CODE: (IS)

DATE: 07/15/2004

SUBJECT: Fiber Reinforced Concrete

Bidders are hereby advised that synthetic structural fibers meeting the requirements of Subsection 907-711.04 may be used in lieu of wire mesh in some items of construction. Substitution of fibers for wire mesh will be allowed in the construction of paved ditches, paved flumes, paved inlet apron, driveways and guard rail anchors. Substitution in any other items of work must be approved by the State Construction Engineer prior to use.

MISSISSIPPI DEPARTMENT OF TRANSPORTATION

SECTION 904 - NOTICE TO BIDDERS NO. 204

CODE: (IS)

DATE: 09/01/2004

SUBJECT: ERRATA AND MODIFICATIONS TO THE 2004 STANDARD SPECIFICATIONS

<u>Page</u>	<u>Subsection</u>	<u>Change</u>
236	401.01	Change the header from "Section 403" to "Section 401".
242	401.02.3.2	In the first sentence of the third full paragraph, add "1/8" in the blank before the inch mark.
253	401.02.6.4.2	In the paragraph preceding the table, change "91.0" to "89.0".
259	401.03.1.4	In the first paragraph, change "92.0 percent" to "the specified percentage (92.0 or 93.0)".
278	404.04	In the second sentence, change the subsection from "401.04" to "403.04".
283	409.02.2	Change "PG 64-22" to "PG 67-22".
294	413.02	In the first sentence of the second paragraph, change "707.02.1.3" to "Subsection 707.02.1.3".
340	511.04	In the second sentence of the second paragraph, change "412" to "512".
349	601.03.3	In the first sentence, change "804.03.2" to "804.03.5".
355	603.02	Change the subsection reference for Joint mortar from "707.03" to "714.11".
369	604.04	In the first sentence, change "601.04" to "Subsection 601.04".
427	619.04	Delete the second paragraph.
442	625.04	In the third paragraph, change "626.04" to "Subsection 626.04".
444	626.03.1.2	Delete the third sentence of the first paragraph.

464	631.02	Change the subsection reference for Water from “714.01.0” to “714.01.1”.
575	683.10.4	Change the subsection number from “683.10.4” to “683.04”.
575	683.10.5	Change the subsection number from “683.10.5” to “683.05”.
596	701.02	In the table under the column titled “Cementations material required”, change Class F, FA” to “Class F FA,”.
603	702.11	In the first sentence, change “702.12” to “Subsection 702.12”.
612	703.04.2	In the fifth paragraph, delete “Subsection 703.11 and”.
616	703.07.2	In the Percentage By Weight Passing Square Mesh Sieves table, change the No. 10 requirement for Class 7 material from “30 - 10” to “30 - 100”.
618	703.13.1	In the first sentence of the first paragraph, change “703.09” to “703.06”.
618	703.13.2	In the first sentence, change “703.09” to “703.06”.
671	712.06.2.2	In the first sentence, change “712.05.1” to “Subsection 712.05.1”.
689	714.11.2	In the first sentence, change “412” to “512”.
741	720.05.2.2	In the last sentence of this subsection, change “720.05.2.1” to “Subsection 720.05.2.1”.
827	803.03.2.3.7.5.2	In the first sentence of the second paragraph, change “803.03.5.4” to “803.03.2.3.4”.
833	803.03.2.6	In the first sentence, change “803.03.7” to “803.03.2.5”.
854	804.02.11	In the last sentence of the first paragraph, change “automatically” to “automatic”.
859	804.02.13.1.3	In the last sentence, change Subsection “804.02.12.1” to “804.02.12”.
879	804.03.19.3.2	In the first sentence of the third paragraph, change “listed on of Approved” to “listed on the Approved”.

- 879 804.03.19.3.2 In the last sentence of the last paragraph, change “804.03.19.3.1” to “Subsection 804.03.19.3.1”.
- 962 814.02.3 In the first sentence, change “710.03” to “Subsection 710.03”.
- 976 820.03.2.1 In the first sentence, change “803.02.6” to “803.03.1.7”.
- 976 820.03.2.2 In the first sentence, change “803.03.9.6” to “803.03.1.9.2”.
- 985 Index Change the subsection reference for Petroleum Asphalt Cement from “702.5” to “702.05”.
- 985 Index Change the subsection reference for the Definition of Asphaltic Cement or Petroleum Asphalt from “700.2” to “700.02”.
- 985 Index Change the subsection reference for Automatic Batchers from “501.03.2.4” to “804.02.10.4”.
- 986 Index Delete “501.03.2” as a subsection reference for Batching Plant & Equipment.
- 988 Index Change the subsection reference for the Central Mixed Concrete from “501.03.3.2” to “804.02.11”.
- 988 Index Change the subsection reference for the Concrete Batching Plant & Equipment from “501.03.2” to “804.02.11”.
- 999 Index Delete “501.03.3.3” as a subsection reference for Truck Mixers.
- 1001 Index Change the subsection reference for Edge Drain Pipes from “605.3.5” to “605.03.5”.
- 1002 Index Change the subsection reference for Metal Posts from “713.05.2” to “712.05.2”.
- 1007 Index Change the subsection reference for Coarse Aggregate of Cement Concrete Table from “703.3” to “703.03”.
- 1007 Index Change the subsection reference for Composite Gradation for Mechanically Stabilized Courses Table from “703.8” to “703.08”.
- 1009 Index Delete “501.03.3.3” as a subsection reference for Truck Mixers and Truck Agitators.
- 1010 Index Delete reference to “Working Day, Definition of”.

MISSISSIPPI DEPARTMENT OF TRANSPORTATION

SECTION 904 - NOTICE TO BIDDERS NO. 267

CODE: (SP)

DATE: 03/28/2005

SUBJECT: CONTRACT TIME

PROJECT: MP-7000-00(019)/302776 - Adams, Amite, & Wilkinson Counties

The calendar date for completion of work to be performed by the Contractor for this project shall be **November 15, 2005** which date or extended date as provided in Subsection 108.06 shall be the end of contract time. It is anticipated that the Notice of Award will be issued by not later than **June 15, 2005** and the date for issuing the Notice to Proceed / Beginning of Contract Time will be **July 7, 2005**.

Should the Contractor request a Notice to Proceed earlier than **July 7, 2005**, the date the Notice to Proceed is issued will also be the Beginning of Contract Time date.

A progress schedule as referenced to in Subsection 108.03 will not be required for this contract.

MISSISSIPPI DEPARTMENT OF TRANSPORTATION

SECTION 904-NOTICE TO BIDDERS NO. 268

CODE: (SP)

DATE: 03/28/2005

SUBJECT: Scope of Work

PROJECT: MP-7000-00(019)/302776 - Adams, Amite, & Wilkinson Counties

The contract documents do not include an official set of construction plans, but may, by reference, include some Standard Drawings when so specified in a Notice to Bidders entitled, "Standard Drawings". All other references to plans in the contract documents and Standard Specifications for Road and Bridge Construction are to be disregarded.

The work to be accomplished using the pay items and corresponding specifications set forth in the contract is to construct ADA accessible Curb Cut ramps in Liberty, along Hwy 24 and Hwy 48, Woodville, along Hwy 24 and Natchez, along US 61, Hwy 930 and Hwy 932.

The number of ramps is as follows:

- 1: (5) Five locations in Liberty, (2) two along SR 48 and (3) three along SR 24.
- 2: (20) Twenty locations in Woodville all along SR 24.
- 3: (77) Seventy-Seven locations in Natchez, (3) three along north bound US 61, (61) sixty-one along west bound SR 932 (Devereux) south side of roadway and (13) thirteen along east bound SR 930 (Devereux).

The ADA Curb Cut Ramp work shall consist of:

- 1: Removal of the existing curb &/or curb and gutter and sidewalk, either by jackhammer or by sawing. The jackhammering and sawing shall be absorbed items.
- 2: Construct ADA accessible areas as per attached Standard Drawings. A small amount of asphalt may be required in areas of curb &/or curb and gutter removal, this will be absorbed.
- 3: ADA ramps cannot be placed at First West Street South on the east side (picture attached) and at the Town Hall (picture attached) in Wilkinson County.

Incidental work that is necessary to complete the work will not be paid for in direct Compensation and will be considered included in the bid prices for the listed items.







DISTRICT 7 ADA CURB CUTS
ADAMS COUNTY

STATION	WIDTH	LENGTH 1	LENGTH 2	AREA SF	SIDEWALK REMOVAL SY	SIDEWALK SY	CURB REMOVAL LF	REMARKS
0+00	4.00	8.00	6.00	28.00	3.11	3.11	9	EOM SR 932 (DEVEREUX) WEST
4+34 CL DRIVE	4.00	15.00	11.00	52.00	5.78	5.78	21	SR 932(DEVERUX)
4+34 CL DRIVE	4.00	6.00	4.00	20.00	2.22	2.22	10	SR 932(DEVERUX)
9+58 CONCORD	4.00	12.00	12.00	48.00	5.33	5.33	12	SR 932(DEVERUX)
9+58 CONCORD	4.00	9.00	9.00	36.00	4.00	4.00	0	SR 932(DEVERUX)
11+68 CL DRIVE	4.00	10.00	10.00	40.00	4.44	4.44	10	SR 932(DEVERUX)
11+68 CL DRIVE	4.00	14.00	14.00	56.00	6.22	6.22	14	SR 932(DEVERUX)
13+58 CL DRIVE	4.00	10.00	6.00	32.00	3.56	3.56	17	SR 932(DEVERUX)
13+58 CL DRIVE	4.00	13.00	8.00	42.00	4.67	4.67	19	SR 932(DEVERUX)
15+68 CL DRIVE	4.00	10.00	6.00	32.00	3.56	3.56	16	SR 932(DEVERUX)
15+68 CL DRIVE	4.00	21.00	16.00	74.00	8.22	8.22	23	SR 932(DEVERUX)
16+68 CL DRIVE	4.00	9.00	6.00	30.00	3.33	3.33	14	SR 932(DEVERUX)
16+68 CL DRIVE	4.00	10.00	6.00	32.00	3.56	3.56	18	SR 932(DEVERUX)
17+92 CL DRIVE	4.00	9.00	6.00	30.00	3.33	3.33	19	SR 932(DEVERUX)
17+92 CL DRIVE	4.00	11.00	7.00	36.00	4.00	4.00	19	SR 932(DEVERUX)
19+58 CL DRIVE	4.00	11.00	7.00	36.00	4.00	4.00	21	SR 932(DEVERUX)
19+58 CL DRIVE	4.00	12.00	9.00	42.00	4.67	4.67	19	SR 932(DEVERUX)
21+18 CL DRIVE	4.00	11.00	7.00	36.00	4.00	4.00	22	SR 932(DEVERUX)
21+18 CL DRIVE	4.00	10.00	6.00	32.00	3.56	3.56	18	SR 932(DEVERUX)
22+68 CL DRIVE	4.00	11.00	7.00	36.00	4.00	4.00	16	SR 932(DEVERUX)
22+68 CL DRIVE	4.00	14.00	10.00	48.00	5.33	5.33	17	SR 932(DEVERUX)
23+64 CL DRIVE	4.00	10.00	7.00	34.00	3.78	3.78	14	SR 932(DEVERUX)
24+00 CL DRIVE	4.00	11.00	7.00	36.00	4.00	4.00	17	SR 932(DEVERUX)
24+00 CL DRIVE	4.00	9.00	6.00	30.00	3.33	3.33	14	SR 932(DEVERUX)
26+78 CL DRIVE	4.00	19.00	14.00	66.00	7.33	7.33	22	SR 932(DEVERUX)
26+78 CL DRIVE	4.00	11.00	7.00	36.00	4.00	4.00	17	SR 932(DEVERUX)
SUB-TOTALS				1020.00	113.33	113.33	418	

DISTRICT 7 ADA CURB CUTS
ADAMS COUNTY

STATION	WIDTH	LENGTH 1	LENGTH 2	AREA SF	SIDEWALK REMOVAL SY	SIDEWALK SY	CURB REMOVAL LF	REMARKS
30+32 CL DRIVE	4.00	13.00	13.00	52.00	5.78	5.78	13	EOM SR 932 (DEVEREUX) WEST
30+32 CL DRIVE	4.00	13.00	13.00	52.00	5.78	5.78	13	SR 932(DEVERUX)
31+00 CL DRIVE	4.00	30.00	30.00	120.00	13.33	13.33	30	SR 932(DEVERUX)
32+05 CL DRIVE	4.00	10.00	10.00	40.00	4.44	4.44	10	SR 932(DEVERUX)
32+05 CL DRIVE	4.00	6.00	6.00	24.00	2.67	2.67	6	SR 932(DEVERUX)
33+30 CL DRIVE	4.00	4.00	4.00	16.00	1.78	1.78	0	SR 932(DEVERUX)
33+30 CL DRIVE	4.00	15.00	15.00	60.00	6.67	6.67	15	SR 932(DEVERUX)
34+60 CL DRIVE	4.00	8.00	8.00	32.00	3.56	3.56	8	SR 932(DEVERUX)
35+10 CL DRIVE	4.00	19.00	19.00	76.00	8.44	8.44	19	SR 932(DEVERUX)
35+10 CL DRIVE	4.00	10.00	10.00	40.00	4.44	4.44	10	SR 932(DEVERUX)
36+40 CL DRIVE	4.00	11.00	10.00	42.00	4.67	4.67	14	SR 932(DEVERUX)
36+40 CL DRIVE	4.00	7.00	5.00	24.00	2.67	2.67	10	SR 932(DEVERUX)
37+20 CL DRIVE	4.00	8.00	5.00	26.00	2.89	2.89	13	SR 932(DEVERUX)
37+20 CL DRIVE	4.00	13.00	10.00	46.00	5.11	5.11	19	SR 932(DEVERUX)
38+31 CL DRIVE	4.00	10.00	5.00	30.00	3.33	3.33	13	SR 932(DEVERUX)
38+91 CL DRIVE	4.00	27.00	17.00	88.00	9.78	9.78	32	SR 932(DEVERUX)
38+91 CL DRIVE	4.00	9.00	4.00	26.00	2.89	2.89	12	SR 932(DEVERUX)
40+04 CL DRIVE	4.00	9.00	5.00	28.00	3.11	3.11	10	SR 932(DEVERUX)
40+04 CL DRIVE	4.00	9.00	4.00	26.00	2.89	2.89	13	SR 932(DEVERUX)
41+08 CL DRIVE	4.00	13.00	7.00	40.00	4.44	4.44	18	SR 932(DEVERUX)
41+08 CL DRIVE	4.00	11.00	5.00	32.00	3.56	3.56	18	SR 932(DEVERUX)
42+83 CL DRIVE	4.00	7.00	5.00	24.00	2.67	2.67	15	SR 932(DEVERUX)
43+65 CL DRIVE	4.00	34.00	24.00	116.00	12.89	12.89	55	SR 932(DEVERUX)
43+65 CL DRIVE	4.00	26.00	21.00	94.00	10.44	10.44	36	SR 932(DEVERUX)
45+05 CL DRIVE	4.00	19.00	15.00	68.00	7.56	7.56	26	SR 932(DEVERUX)
45+05 CL DRIVE	4.00	12.00	5.00	34.00	3.78	3.78	13	SR 932(DEVERUX)
SUB-TOTALS				1,256.00	139.56	139.56	441	

DISTRICT 7 ADA CURB CUTS
ADAMS COUNTY

STATION	WIDTH	LENGTH 1	LENGTH 2	AREA SF	SIDEWALK REMOVAL SY	SIDEWALK SY	CURB REMOVAL LF	REMARKS
47+62 CL DRIVE	4.00	12.00	6.00	36.00	4.00	4.00	21	EOM SR 932 (DEVEREUX) WEST
47+62 CL DRIVE	4.00	12.00	6.00	36.00	4.00	4.00	20	SR 932(DEVERUX)
49+50 CL DRIVE	4.00	12.00	5.00	34.00	3.78	3.78	25	SR 932(DEVERUX)
49+50 CL DRIVE	4.00	12.00	5.00	34.00	3.78	3.78	22	SR 932(DEVERUX)
50+73 CL DRIVE	4.00	10.00	5.00	30.00	3.33	3.33	22	SR 932(DEVERUX)
50+73 CL DRIVE	4.00	15.00	10.00	50.00	5.56	5.56	26	SR 932(DEVERUX)
51+50 CL DRIVE	4.00	12.00	5.00	34.00	3.78	3.78	24	SR 932(DEVERUX)
51+50 CL DRIVE	4.00	11.00	5.00	32.00	3.56	3.56	15	SR 932(DEVERUX)
53+09	4.00	9.00	5.00	28.00	3.11	3.11	24	SR 932(DEVERUX)
12+30	4.00	15.00	15.00	60.00	6.67	6.67	15	SR 930 (DEVERUX) EAST
13+00 CL DRIVE	4.00	12.00	10.00	44.00	4.89	4.89	18	SR 930 (DEVERUX) EAST
13+00 CL DRIVE	4.00	23.00	19.00	84.00	9.33	9.33	31	SR 930 (DEVERUX) EAST
13+75 CL DRIVE	4.00	11.00	7.00	36.00	4.00	4.00	17	SR 930 (DEVERUX) EAST
16+59 CL DRIVE	4.00	10.00	10.00	40.00	4.44	4.44	6	SR 930 (DEVERUX) EAST
16+59 CL DRIVE	4.00	10.00	10.00	40.00	4.44	4.44	6	SR 930 (DEVERUX) EAST
18+35 CL DRIVE	4.00	20.00	15.00	70.00	7.78	7.78	24	SR 930 (DEVERUX) EAST
18+35 CL DRIVE	4.00	8.00	6.00	28.00	3.11	3.11	12	SR 930 (DEVERUX) EAST
20+45 CL DRIVE	4.00	7.00	5.00	24.00	2.67	2.67	12	SR 930 (DEVERUX) EAST
20+45 CL DRIVE	4.00	8.00	6.00	28.00	3.11	3.11	17	SR 930 (DEVERUX) EAST
22+75 CL DRIVE	4.00	10.00	6.00	32.00	3.56	3.56	19	SR 930 (DEVERUX) EAST
22+75 CL DRIVE	4.00	6.00	4.00	20.00	2.22	2.22	9	SR 930 (DEVERUX) EAST
26+00 EOW	4.00	10.00	10.00			4.44	0	SR 930 (DEVERUX) EAST
75+25 RT CL	4.00	6.00	6.00	24.00	2.67	2.67	6	61 NB (EAST BROOK DRIVE)
76+93 RT. CL	6.00	6.00	6.00	36.00	4.00	4.00	0	61 NB @ BRIDGE OVER RR
78+53 RT. CL.	6.00	6.00	6.00	36.00	4.00	4.00	0	61 NB @ BRIDGE OVER RR
SUB-TOTALS				916.00	101.78	106.22	391	
TOTALS				3,192.00	354.67	359.11	1,250	

DISTRICT 7 ADA CURB CUTS

AMITE COUNTY

STATION	WIDTH	LENGTH 1	LENGTH 2	AREA SF	SIDEWALK REMOVAL SY	SIDEWALK SY	CURB REMOVAL LF	REMARKS
0+36 LT. CL.	6.00	6.00	6.00	36.00	4.00	4.00	6	SR 48
7+09 LT. CL.	4.00	9.00	9.00	36.00	4.00	4.00	0	SR 48
55+91 RT. CL.	4.00	9.00	7.00	32.00	3.56	3.56	19	SR. 24 CHURCH ST. RT
61+03 RT. CL.	7.00	8.00	8.00	56.00	6.22	6.22	9	SR 24 @ 584 INT.
61+78 LT. CL.	8.00	11.00	9.00	80.00	8.89	8.89	26	SR 24 @ 569 INT. LT.
61+78 LT. CL.	8.00	10.00	9.00	76.00	8.44	8.44	24	SR 24 @ 569 INT. RT.
SUB-TOTALS				316.00	35.11	35.11	84	

DISTRICT 7 ADA CURB CUTS
SR 24
WILKINSON COUNTY

STATION	WIDTH	LENGTH 1	LENGTH 2	AREA SF	SIDEWALK REMOVAL SY	SIDEWALK SY	CURB REMOVAL LF	REMARKS
192+79 RT. CL	4.00	6.00	6.00	24.00	2.67	2.67	12	
193+29 LT. CL.	4.00	9.00	6.00	30.00	3.33	3.33	24	PARK RD.
207+03 CL. ST.	5.00	9.00	8.00	42.50	4.72	4.72	14	SLIGO RD. LT. CL.
207+03 CL. ST.	5.00	12.00	12.00	60.00	6.67	6.67	22	SLIGO RD. RT. CL.
NATCHEZ ST. S	5.00	10.00	10.00	50.00	5.56	5.56	12	LT. CL
NATCHEZ ST. N	5.00	6.00	6.00	30.00	3.33	3.33	16	LT. CL
NATCHEZ ST. N	5.00	9.00	9.00	45.00	5.00	5.00	16	RT. CL.
FIRST WEST ST.	5.00	14.00	14.00	70.00	7.78	7.78	13	SOUTH SR 24 LT. CL.
FIRST WEST ST.	5.00	9.00	9.00	45.00	5.00	5.00	12	NORTH SR. 24 LT. CL.
9+50 RT. CL.	5.00	11.00	9.00	50.00	5.56	5.56	16	BRICK SIDEWALK
10+29 LT. CL.	5.00	8.00	8.00	40.00	4.44	4.44	13	LT. CL
10+29 LT. CL.	5.00	12.00	10.00	55.00	6.11	6.11	21	RT. CL.
11+05 LT. CL	5.00	7.00	6.00	32.50	3.61	3.61	3	LT. CL
11+05 LT. CL	5.00	6.00	6.00	30.00	3.33	3.33	3	RT. CL.
12+00 LT. CL.	5.00	6.00	4.00	25.00	2.78	2.78	1	LT. CL
12+00 LT. CL.	5.00	4.00	3.00	17.50	1.94	1.94	1	RT. CL.
14+69 LT. CL	4.00	11.00	7.00	36.00	4.00	4.00	17	RT. CL.
14+69 RT. CL.	4.00	9.00	8.00	34.00	3.78	3.78	18	RT. CL.
19+34 LT. CL.	4.00	8.00	7.00	30.00	3.33	3.33	18	RT. CL.
7+00 RT. CL.	4.00	0.00	0.00	0.00	0.00	2.67	0	DRIVEWAY INTO MARKET
SUB-TOTALS				746.50	82.94	85.61	252	

42

-9-

Notice To Bidders No.268 -- Cont'd

MISSISSIPPI DEPARTMENT OF TRANSPORTATION

SECTION 904- NOTICE TO BIDDERS NO. 289

CODE: (SP)

DATE: 10/13/2004

SUBJECT: Concrete for Sidewalk

PROJECT: MP-7000-00(019)/302776 - Amite, Adams, & Wilkinson Counties

Bidders are hereby advised that the concrete testing on this project shall comply with TMD-20-05-00-000 Sampling and Testing of Small Quantities of Miscellaneous materials.

MISSISSIPPI DEPARTMENT OF TRANSPORTATION

SECTION 904 – NOTICE TO BIDDERS NO. 440

CODE: (SP)

DATE: 4/8/2005

SUBJECT: Petroleum Products Base Prices For Contracts Let in May, 2005

REFERENCE: Subsection 109.07

The following base prices are to be used for adjustment in compensation due to changes in costs of petroleum products:

FUELS

	<u>Per Gallon</u>	<u>Per Liter</u>
Gasoline	\$2.0403	\$0.5390
Diesel	\$2.1219	\$0.5605

MATERIALS OF CONSTRUCTION

<u>ASPHALT CEMENT</u>	Per Gallon	Per Ton	Per Liter	Per Metric Ton
Viscosity Grade AC-5	\$0.8189	\$194.29	\$0.2163	\$214.16
Viscosity Grade AC-10	\$0.8249	\$195.71	\$0.2179	\$215.73
Viscosity Grade AC-20	\$0.8099	\$192.14	\$0.2139	\$211.79
Viscosity Grade AC-30	\$0.8009	\$190.00	\$0.2116	\$209.44
Grade PG 64-22	\$0.8069	\$191.43	\$0.2132	\$211.01
Grade PG 67-22	\$0.7979	\$189.29	\$0.2108	\$208.65
Grade PG 76-22	\$1.1591	\$275.00	\$0.3062	\$303.13
Grade PG 82-22	\$1.3488	\$320.00	\$0.3563	\$352.73

EMULSIFIED ASPHALTS

Grade EA-4 (SS-1)	\$0.7441	\$0.1966
Grade RS-2C (CRS-2)	\$0.7678	\$0.2028
Grade CRS-2P	\$0.9065	\$0.2395

PRIMES

Grade EA-1 & MC-70	\$1.0127	\$0.2675
--------------------	----------	----------

MISSISSIPPI DEPARTMENT OF TRANSPORTATION

SECTION 904- NOTICE TO BIDDERS NO. 475

CODE: (SP)

DATE: 04/07/2005

SUBJECT: Cooperation Between Contractors

PROJECT: MP-7000-00(019) / 302776 - Adams, Amite & Wilkinson Counties

Bidders are hereby advised that an asphalt overlay project with similar project limits is being let the same month as this project.

The Bidder's attention is hereby called to Subsection 105.07, Cooperation Between Contractors, of the 2004 Edition of the Mississippi Standard Specifications for Road and Bridge Construction.

The Contractor shall cooperate in all respects and coordinate a sequence of construction with the other Contractor. Scheduling conflicts shall not be a claim for additional time on this project.

MISSISSIPPI DEPARTMENT OF TRANSPORTATION

SPECIAL PROVISION NO. 907-105-2

CODE: (IS)

DATE: 12/02/2004

SUBJECT: Cooperation by Contractor

Section 105, Control of Work, of the 2004 Edition of the Mississippi Standard Specifications for Road and Bridge Construction is modified as follows:

907-105.05-- Cooperation by Contractor. In the third sentence of the second paragraph of Subsection 105.05, change “Notice to Proceed” to “Notice of Award”.

MISSISSIPPI DEPARTMENT OF TRANSPORTATION

SPECIAL PROVISION NO. 907-107-1

CODE: (IS)

DATE: 05/03/2004

SUBJECT: Liability Insurance

Section 107, Legal Relations and Responsibility to Public, of the 2004 Edition of the Mississippi Standard Specifications for Road and Bridge Construction is hereby amended as follows:

907-107.14.2--Liability Insurance. Delete in toto Subsection 107.14.2 beginning on page 60 and substitute:

907-107.14.2.1--General. The Contractor shall carry Contractor's liability, including subcontractors and contractual, with limits not less than: \$300,000 each occurrence; \$1,000,000 aggregate; automobile liability - \$500,000 combined single limit - each accident; Workers' Compensation and Employers' Liability - Statutory & \$100,000 each accident; \$100,000 each employee; \$500,000 policy limit. Each policy shall be signed or countersigned by a Mississippi Resident Agent of the insurance company.

The Contractor shall have certificates furnished to the Department from the insurance companies providing the required coverage. The certificates shall be on the form furnished by the Department and will show the types and limits of coverage.

907-107.14.2.2--Railroad Protective. The following provisions are applicable to all work performed under a contract on, over or under the rights-of-way of each railroad shown on the plans.

The Contractor shall assume all liability for any and all damages to work, employees, servants, equipment and materials caused by railroad traffic.

Prior to starting any work on railroad property, the Contractor shall furnish satisfactory evidence to the Department that insurance of the forms and amounts set out herein in paragraphs (a) and (b) has been obtained. Also, the Contractor shall furnish similar evidence to the Railroad Company that insurance has been obtained in accordance with the Standard Provisions for General Liability Policies and the Railroad Protective Liability Form as published in the Code of Federal Regulations, 23 CFR 646, Subpart A. Evidence to the Railroad Company shall be in the form of a Certificate of Insurance for coverages required in paragraph (b), and the original policy of the Railroad Protective Liability Insurance for coverage required in paragraph (a).

All insurance herein specified shall be carried until the contract is satisfactorily complete as evidenced by a release of maintenance from the Department.

The Railroad Company shall be given at least 30 days notice prior to cancellation of the Railroad Protective Liability Insurance policy.

For work within the limits set out in Subsection 107.18 and this subsection, the Contractor shall provide insurance for bodily injury liability, property damage liability and physical damage to property with coverages and limits no less than shown in paragraphs (a) and (b). Bodily injury shall mean bodily injury, sickness, or disease, including death at anytime resulting therefrom. Property damage shall mean damages because of physical injury to or destruction of property, including loss of use of any property due to such injury or destruction. Physical damage shall mean direct and accidental loss of or damage to rolling stock and their contents, mechanical construction equipment or motive power equipment.

(a) **Railroad Protective Liability Insurance** shall be purchased on behalf of the Railroad Company with limits of \$2,000,000 each occurrence; \$6,000,000 aggregate applying separately to each annual period for lines without passenger trains. If the line carries passenger train(s), railroad protective liability insurance shall be purchased on behalf of the Railroad Company with limits of \$5,000,000 each occurrence; \$10,000,000 aggregate applying separately to each annual period.

Coverage shall be limited to damage suffered by the railroad on account of occurrences arising out of the work of the Contractor on or about the railroad right-of-way, independent of the railroad's general supervision or control, except as noted in paragraph 4 below.

Coverage shall include:

- (1) death of or bodily injury to passengers of the railroad and employees of the railroad not covered by State workmen's compensation laws,
- (2) personal property owned by or in the care, custody or control of the railroads,
- (3) the Contractor, or any of the Contractor's agents or employees who suffer bodily injury or death as a result of acts of the railroad or its agents, regardless of the negligence of the railroads, and
- (4) negligence of only the following classes of railroad employees:
 - (i) any supervisory employee of the railroad at the job site
 - (ii) any employee of the railroad while operating, attached to, or engaged on, work trains or other railroad equipment at the job site which are assigned exclusively to the Contractor, or
 - (iii) any employee of the railroad not within (i) or (ii) above who is specifically loaned or assigned to the work of the Contractor for prevention of accidents or protection or property, the cost of whose services is borne specifically by the Contractor or Governmental authority.

(b) **Regular Contractor's Liability**, including subcontractors, XCU and railroad contractual with limits of \$1,000,000 each occurrence; \$2,000,000 aggregate. **Automobile** with limits of \$1,000,000 combined single limit any one accident; **Workers' Compensation and Employer's Liability** - statutory and \$100,000 each accident; \$100,000 each employee; \$500,000 policy limit. **Excess/Umbrella Liability** \$5,000,000 each occurrence; \$5,000,000 aggregate. All coverage to be issued in the name of the Contractor shall be so written as to furnish protection to the Contractor respecting the Contractor's operations in performing work covered by the contract. Coverage shall include protection from damages arising out of bodily injury or death and damage or destruction of property which may be suffered by persons other than the Contractor's own employees.

In addition, the Contractor shall provide for and on behalf of each subcontractor by means of a separate and individual liability and property damage policy to cover like liability imposed upon the subcontractor as a result of the subcontractor's operations in the same amounts as contained above; or, in the alternative each subcontractor shall provide same.

MISSISSIPPI DEPARTMENT OF TRANSPORTATION

SPECIAL PROVISION NO. 907-108-2

CODE: (IS)

DATE: 12/10/2004

SUBJECT: Notice to Proceed

Section 108, Prosecution and Progress, of the 2004 Edition of the Mississippi Standard Specifications for Road and Bridge Construction is hereby amended as follows:

907-108.02--Notice To Proceed. Delete the fourth paragraph of Subsection 108.02 on page 75 and substitute the following:

Upon written request from the Contractor and if circumstances permit, the Notice to Proceed may be issued at an earlier date subject to the conditions stated therein. The Contractor shall not be entitled to any monetary damages or extension of contract time for any delay claim or claim of inefficiency occurring between the early issuance Notice To Proceed date and the Notice to Proceed date stated in the contract.

MISSISSIPPI DEPARTMENT OF TRANSPORTATION

SPECIAL PROVISION NO. 907-608-2

CODE: (SP)

DATE: 10/13/2004

SUBJECT: Detectable Warning Panels (Truncated Domes)

PROJECT: MP-7000-00(019) / 302776 - Amite, Adams & Wilkinson Counties

Section 608, Concrete Sidewalks, of the 2004 Edition of the Mississippi Standard Specifications for Road and Bridge Construction is hereby amended as follows.

907-608.01--Description.

After the first paragraph of Subsection 608.01 on page 390, add the following:

When called for on the plans, this work consists of installing detectable warning panel(s) in concrete sidewalk at the locations shown on the plans.

907-608.02--Materials.

After the last paragraph of Subsection 608.02 on page 390, add the following:

The detectable warning panels shall be *In-line Dome Paver Tile* by ADA Solutions, Inc., or an approved equal. The size shall be as shown on the plans. The panels shall be made of a color impregnated composite which is colorfast and UV stable. It shall also meet the following:

<u>Characteristic</u>	<u>Requirement</u>	<u>Test Method</u> <u>ASTM Designation:</u>
Compressive Strength	23,800 psi	D 695
Flexural Strength	24,600 psi	D 790
Tensile Strength	12,100 psi	D 638
Water Absorption	0.13% - 2 weeks	D 570
Slip Resistance	Exceeds 0.80 wet/dry	C 1028
Flame Spread Index	15	E 84
Smoke Developed	145	E 84
Salt Spray	No Change (120 hours)	B 117
Chemical/Stain Resistance	No Deterioration	D 1308
Accelerated Weathering	No Change (3,000 hours)	G 26
Abrasion resistance	564	C 501
Rockwell Hardness	122	D 785
Freeze/Thaw/Heat	No Disintegration	C 1026

907-608.03.9--Detectable Warning Panels.

After Subsection 608.03.8 on page 392, add the following:

The detectable warning panels shall be installed to the dimension and in the locations shown on the plans. They may be pre-filled with concrete and set in place or pressed in freshly poured concrete.

907-608.04--Method of Measurement.

Delete the last paragraph of Subsection 608.04 on page 392, and substitute the following:

Excavation, backfill, expansion joint material, detectable warning panels and other miscellaneous items will not be measured for separate payment.

MISSISSIPPI DEPARTMENT OF TRANSPORTATION

SUPPLEMENT TO SPECIAL PROVISION NO. 907-618-1

DATE: 09/28/2004

PROJECT: MP-7000-00(019)/302776 - Adams, Amite, & Wilkinson Counties

After the first paragraph of Subsection 907-618.01.2 on page 1, add the following:

Additional signs will be required as follows:

Woodville Highway 24

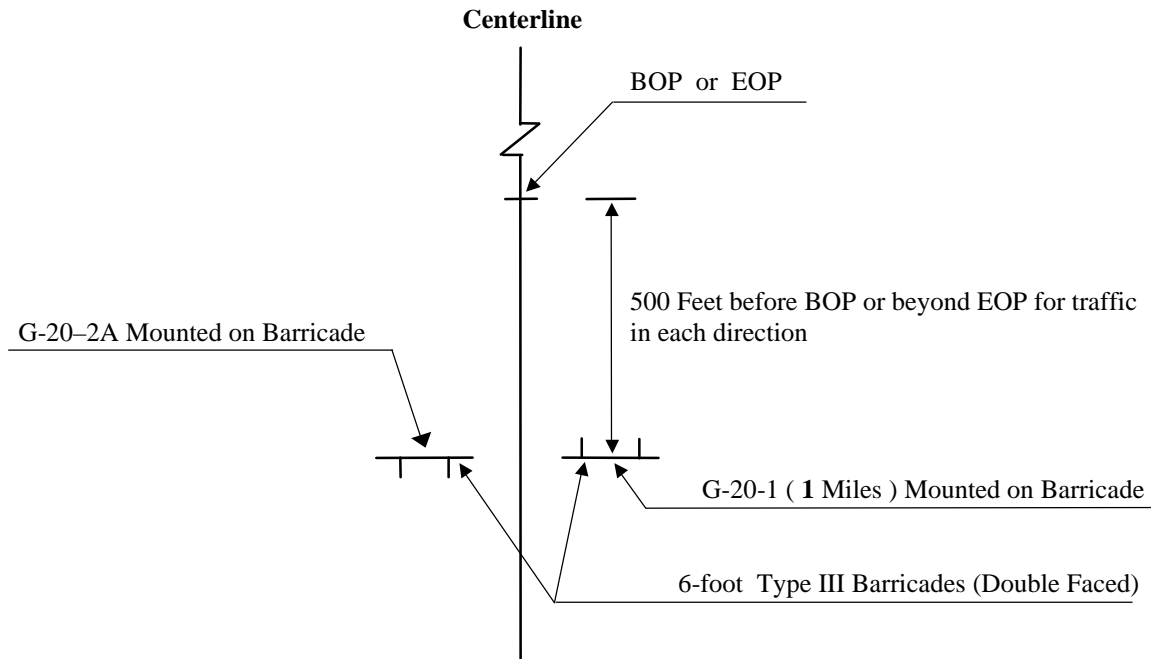

ADDITIONAL TRAFFIC CONTROL SIGNS REQUIRED:

- * 13 - W20-1 (AHEAD) signs required.
- * 00 - R4 -1 "DO NOT PASS" signs required.
- * 00 - R4 -2 "PASS WITH CARE" signs required.
- * 00 - W14 -3 "NO PASSING ZONE" signs required.

- * One (1) W20-1 (AHEAD) sign is required at each local road or street entering the project.

R4 -1 " DO NOT PASS ", R4 -2 " PASS WITH CARE" , and W14 -3 "NO PASSING ZONE" signs are required in accordance with Subsection 618.03.3 and as specified in the Manual on Uniform Traffic Control Devices. If no passing zones are 1,000 feet or more, install additional "DO NOT PASS" signs on maximum spacing of 750 feet.

All Construction signing is included in the bid for Pay Item 618-A, Maintenance of Traffic. Fluorescent orange sheeting shall be used on all construction and traffic control signs except for R4-1 and R4-2 signs which shall be black legend and border on white background.

Liberty Highway 24

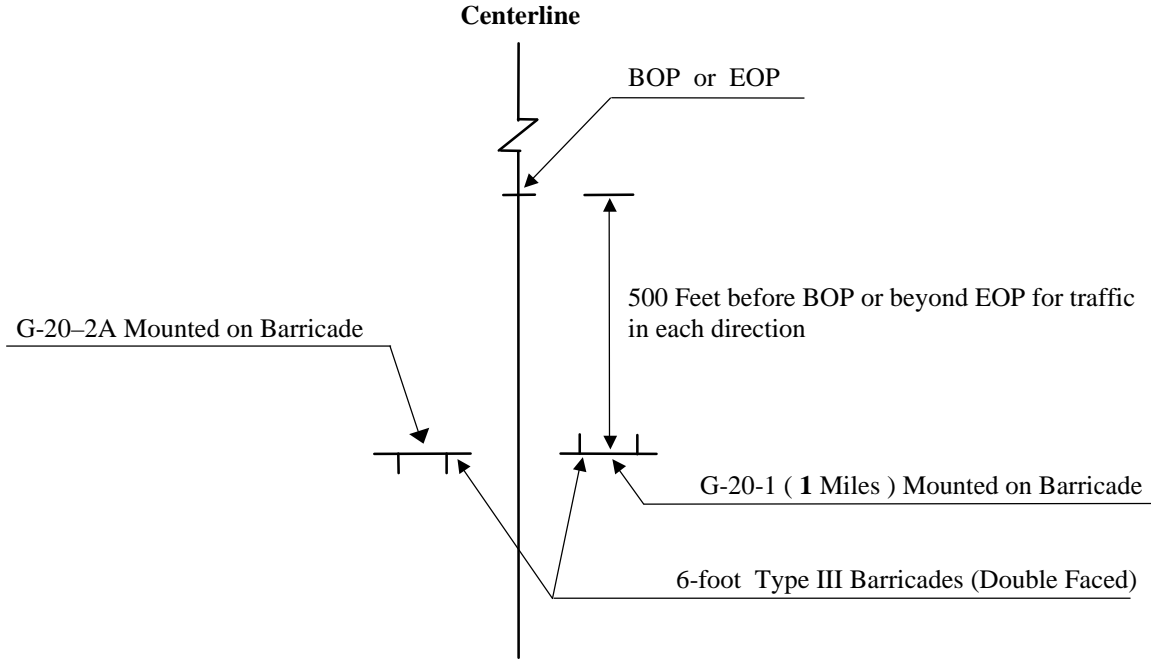

ADDITIONAL TRAFFIC CONTROL SIGNS REQUIRED:

- * 11 - W20-1 (AHEAD) signs required.
- 00 - R4 -1 “DO NOT PASS” signs required.
- 00 - R4 -2 “PASS WITH CARE” signs required.
- 00 - W14 -3 “NO PASSING ZONE” signs required.

* One (1) W20-1 (AHEAD) sign is required at each local road or street entering the project.

R4 -1 “ DO NOT PASS ”, R4 -2 “ PASS WITH CARE” , and W14 -3 “NO PASSING ZONE” signs are required in accordance with Subsection 618.03.3 and as specified in the Manual on Uniform Traffic Control Devices. If no passing zones are 1,000 feet or more, install additional “DO NOT PASS” signs on maximum spacing of 750 feet.

All Construction signing is included in the bid for Pay Item 618-A, Maintenance of Traffic. Fluorescent orange sheeting shall be used on all construction and traffic control signs except for R4-1 and R4-2 signs which shall be black legend and border on white background.

Natchez US 61, SR 932, & SR 930

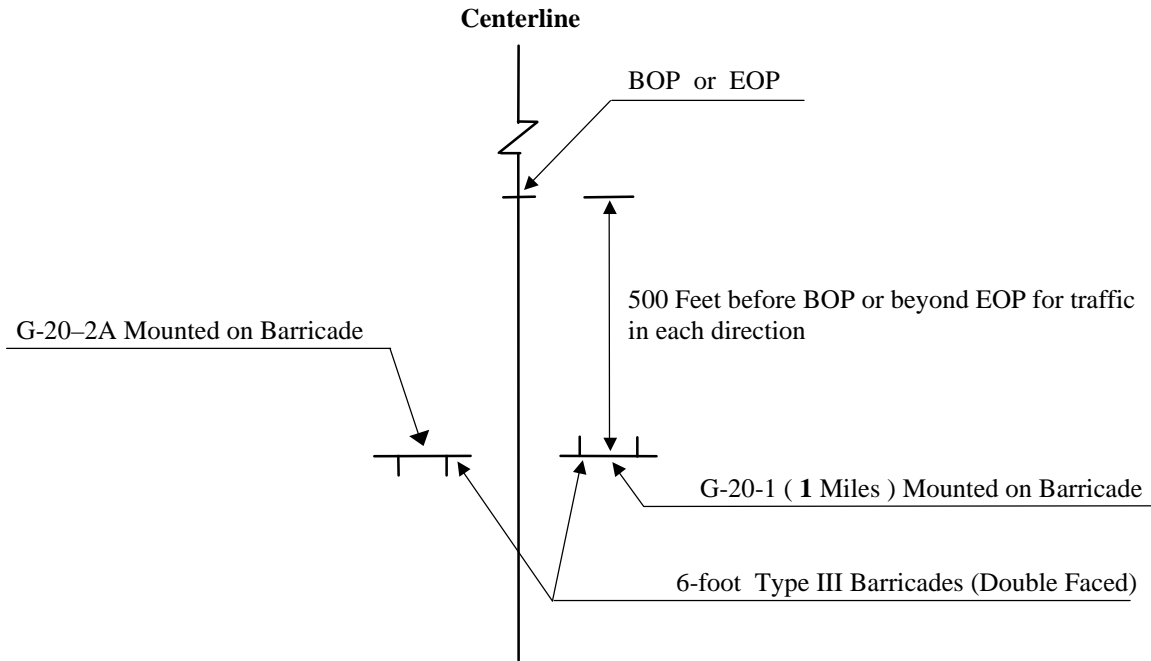

ADDITIONAL TRAFFIC CONTROL SIGNS REQUIRED:

- * 05 - W20-1 (AHEAD) signs required.
- * 00 - R4 -1 “DO NOT PASS” signs required.
- * 00 - R4 -2 “PASS WITH CARE” signs required.
- * 00 - W14 -3 “NO PASSING ZONE” signs required.
- * One (1) W20-1 (AHEAD) sign is required at each local road or street entering the project.

R4 -1 “ DO NOT PASS ”, R4 -2 “ PASS WITH CARE” , and W14 -3 “NO PASSING ZONE” signs are required in accordance with Subsection 618.03.3 and as specified in the Manual on Uniform Traffic Control Devices. If no passing zones are 1,000 feet or more, install additional “DO NOT PASS” signs on maximum spacing of 750 feet.

All Construction signing is included in the bid for Pay Item 618-A, Maintenance of Traffic. Fluorescent orange sheeting shall be used on all construction and traffic control signs except for R4-1 and R4-2 signs which shall be black legend and border on white background.

MISSISSIPPI DEPARTMENT OF TRANSPORTATION

SPECIAL PROVISION NO. 907-618-1

CODE: (SP)

DATE: 04/29/2004

SUBJECT: Additional Signing Requirements

Section 618, Maintenance of Traffic and Traffic Control Plan, of the 2004 Edition of the Mississippi Standard Specifications for Road and Bridge Construction is hereby amended as follows.

907-618.01.2--Traffic Control Plan. At the end of Subsection 618.01.2 on page 413, add the following:

For compliance with the traffic control plan, the Contractor will be required to install and maintain construction signs at various location throughout the project. Payment for these signs will be included in the price bid for pay item no. 618-A, Maintenance of Traffic per lump sum.

MISSISSIPPI DEPARTMENT OF TRANSPORTATION

SPECIAL PROVISION NO. 907-711-2

CODE: (IS)

DATE: 11/03/2004

SUBJECT: Synthetic Structural Fiber Reinforcement

Section 711, Reinforcement and Wire Rope, of the 2004 Edition of the Mississippi Standard Specifications for Road and Bridge Construction is hereby amended as follows:

After Subsection 711.03.4.3 on page 665, add the following:

907-711.04--Synthetic Structural Fiber. Synthetic structural fibers shall meet the requirements of ASTM Designation: C 1116, Section 4.1.3, Note 3. The fibers shall be monofilament made of polypropylene or polypropylene/polyethylene blend meeting the following conditions:

<u>Property</u>	<u>Results</u>
Length, minimum	1.5 inches
Aspect Ratio (length / equivalent diameter)	90
Breaking tenacity, minimum *	530 mN/tex
(Tensile Strength, minimum	70 ksi)
Chord modulus, minimum *	980 cN/tex
(Modulus of Elasticity, minimum	1,300 ksi)

* When tested in accordance with ASTM Designation: D 3822

The dosage rate for the fibers shall be a minimum of three pounds per cubic yard (3 lb / yd³).

The manufacturer shall furnish the Engineer three copies of the certified test report(s) showing results of all required tests, and certification that the material meets the specifications.

SPECIAL PROVISION NO. 906-3

Training Special Provisions

This Training Special Provision supersedes subparagraph 7b of the Special Provision entitled "Specific Equal Employment Opportunity Responsibilities," (Attachment 1), and is in implementation of 23 U.S.C. 140(a).

As part of the Contractor's equal employment opportunity affirmative action program training shall be provided as follows:

The Contractor shall provide on-the-job training aimed at developing full journeymen in the type of trade or job classification involved.

The number of trainees to be trained under this special provision will be as indicated in the bid schedule of the contract.

In the event that a Contractor subcontracts a portion of the contract work, he shall determine how many, if any, of the trainees are to be trained by the subcontractor, provided, however, that the Contractor shall retain the primary responsibility for meeting the training requirements imposed by this special provision. The Contractor shall also insure that this training special provision is made applicable to such subcontract. Where feasible, 25 percent of apprentices or trainees in each occupation shall be in their first year of apprenticeship or training.

The number of trainees shall be distributed among the work classifications on the basis of the Contractor's needs and the availability of journeymen in the various classifications within a reasonable area of recruitment. Prior to commencing construction, the Contractor shall submit to the State highway agency for approval the number of trainees to be trained in each selected classification and training program to be used. Furthermore, the Contractor shall specify the starting time for training in each of the classifications. The Contractor will be credited for each trainee employed by him on the contract work who is currently enrolled or becomes enrolled in an approved program and will be reimbursed for such trainees as provided hereinafter.

Training and upgrading of minorities and women toward journeymen status is a primary objective of this Training Special Provision. Accordingly, the Contractor shall make every effort to enroll minority trainees and women (e.g., by conducting systematic and direct recruitment through public and private sources likely to yield minority and women trainees) to the extent that such persons are available within a reasonable area of recruitment. The Contractor will be responsible for demonstrating the steps that he has taken in pursuance thereof, prior to a determination as to whether the Contractor is in compliance with this Training Special Provision. This training commitment is not intended, and shall not be used, to discriminate against any applicant for training, whether a member of a minority group or not.

No employee shall be employed as a trainee in any classification in which he has successfully completed a training course leading to journeyman status or in which he has been employed as a

journeyman. The Contractor should satisfy this requirement by including appropriate questions in the employee application or by other suitable means. Regardless of the method used the Contractor's records should document the findings in each case.

The minimum length and type of training for each classification will be as established in the training program selected by the Contractor and approved by the State highway agency and the Federal Highway Administration. The State highway agency and the Federal Highway Administration shall approve a program if it is reasonably calculated to meet the equal employment opportunity obligations of the Contractor and to qualify the average trainee for journeyman status in the classification concerned by the end of the training period. Furthermore, apprenticeship programs registered with the U.S. Department of Labor, Bureau of Apprenticeship and Training, or with a State apprenticeship agency recognized by the Bureau and training programs approved but not necessarily sponsored by the U.S. Department of Labor, Manpower Administration, Bureau of Apprenticeship and Training shall also be considered acceptable provided it is being administered in a manner consistent with the equal employment obligations of Federal-aid highway construction contracts. Approval or acceptance of a training program shall be obtained from the State prior to commencing work on the classification covered by the program. It is the intention of these provisions that training is to be provided in the construction crafts rather than clerk-typists or secretarial-type positions. Training is permissible in lower level management positions such as office engineers, estimators, timekeepers, etc., where the training is oriented toward construction applications. Training in the laborer classification may be permitted provided that significant and meaningful training is provided and approved by the division office. Some offsite training is permissible as long as the training is an integral part of an approved training program and does not comprise a significant part of the overall training.

Except as otherwise noted below, the Contractor will be reimbursed 80 cents per hour of training given an employee on this contract in accordance with an approved training program. As approved by the engineer, reimbursement will be made for training persons in excess of the number specified herein. This reimbursement will be made even though the Contractor receives additional training program funds from other sources, provided such other does not specifically prohibit the Contractor from receiving other reimbursement. Reimbursement for offsite training indicated above may only be made to the Contractor where he does one or more of the following and the trainees are concurrently employed on a Federal-aid project; contributes to the cost of the training, provides the instruction to the trainee or pays the trainee's wages during the offsite training period.

No payment shall be made to the Contractor if either the failure to provide the required training, or the failure to hire the trainee as a journeyman, is caused by the Contractor and evidences a lack of good faith on the part of the Contractor in meeting the requirements of this Training Special Provision. It is normally expected that a trainee will begin his training on the project as soon as feasible after start of work utilizing the skill involved and remain on the project as long as training opportunities exist in his work classification or until he has completed his training program. It is not required that all trainees be on board for the entire length of the contract. A

Contractor will have fulfilled his responsibilities under this Training Special Provision if he has provided acceptable training to the number of trainees specified. The number trained shall be determined on the basis of the total number enrolled on the contract for a significant period.

Trainees will be paid at least 60 percent of the appropriate minimum journeyman's rate specified in the contract for the first half of the training period, 75 percent for the third quarter of the training period, and 90 percent for the last quarter of the training period, unless apprentices or trainees in an approved existing program are enrolled as trainees on this project. In that case, the appropriate rates approved by the Departments of Labor or Transportation in connection with the existing program shall apply to all trainees being trained for the same classification who are covered by this Training Special Provision.

The Contractor shall furnish the trainee a copy of the program he will follow in providing the training. The Contractor shall provide each trainee with a certification showing the type and length of training satisfactorily completed.

The Contractor will provide for the maintenance of records and furnish periodic reports documenting his performance under this Training Special Provision.

SPECIAL PROVISION NO. 906-5

2005 MISSISSIPPI DEPARTMENT OF TRANSPORTATION ON-THE-JOB TRAINING PROGRAM

ALTERNATE TRAINING SPECIAL PROVISION

PURPOSE

The purpose of the On-The-Job Training (OJT) Program is to provide training for minority, female and economically disadvantaged individuals in order that they may develop marketable skills and gain journey status in the skilled craft classifications in which they are being trained.

INTRODUCTION

The Year 2005 OJT Program has been developed through the partnering efforts of the Road Builders of Mississippi, the Federal Highway Administration (FHWA) and the Mississippi Department of Transportation (MDOT).

The OJT Program has been designed for use by participating contractors and subcontractors in meeting their training needs. The objective of the OJT Program is to develop skilled workers in the skilled craft trade areas of highway construction who are sufficiently trained to be productive employees in the highway construction industry work force.

The success of the OJT Program will require that contractors and subcontractors follow uniform and basic procedures in training in keeping records of trainees' progress toward journey status, and in reporting trainees' successful completion or termination from the program.

FUNDING

MDOT will establish an annual OJT Fund in which, contractors and subcontractors may bill the Department directly for hours worked by trainees. The funding source of this money will be state and federal funds for MDOT's OJT Program.

PROCEDURE

Trainee positions will be selected by prime and sub contractors and will not be project specific. Provided below are some of the factors that will be used to establish the number of trainee positions each contracting year, they are:

- number of contracts let during a contracting year
- dollar volume
- type of project
- location
- available trainees
- training program(s) submitted by contractor

Each contractor will submit a yearly certification with regard to their participation in the OJT Program. This certification will also identify the number of trainees each prime or sub contractor intends to train on either federal or state funded highway projects.

DISBURSEMENT OF FUNDS

Contractors will be paid \$3.00 rate for each hour of training performed by all trainees in an approved training program. Program reimbursements will be made directly to the prime or sub contractor. Request for payment will be submitted to the [Office of Civil Rights](#) for approval.

Contractors must complete the form providing the following information to be reimbursed.

Contractor's Name
Mailing Address

Trainee Name _____

Social Security Number _____

Type of Program _____

Total Number of Training Hours Required _____

Training Hours Completed for Reimbursement _____

Type of Statement: Monthly _____ Quarterly _____ Annual _____

Work Period or Time Frame	Project Number	Total Hours Worked By Project	Cumulative Hours in Program	Number of Hours to be paid on this Voucher

I hereby certify that this information is true... (Must have customary certification of information).

Signed by: _____ Date: _____

TRAINING PROGRAM APPROVAL

- A. To use the OJT Program on highway construction projects, the contractor will notify the Department [Office of Civil Rights](#) using the Request for On-the-Job Training Program Approval. The notification must include the following information:
- Trainee Starting Date
 - Project number (s) trainee starting on
 - Training program (classification) to be used; and
 - Anticipated date of trainee employment
 - Number of classroom training hours by subject
- B. If a contractor chooses to use a training program different from those listed in the OJT Program, or desires to train in a different classification, the training program must be submitted in its entirety for approval by the Department and FHWA. The training proposal must include the following:
1. The primary objective of the program: To provide training for minority, female and economically disadvantaged individuals for development to full journey status in the work classifications in which they are being trained.
 2. The minimum number of hours and type of training the trainee will receive as it relates to each specific task required to achieve journey status.
 3. Minimum wage.
 4. Trainee certification of completion.
 5. Records and reports submitted to the [Office of Civil Rights](#) on a quarterly basis.

DEPARTMENT RESPONSIBILITY

1. Department project staff will monitor trainees on the project. They will monitor payrolls for payment of correct wage rates and fringe benefits. The [Office of Civil Rights](#) will maintain a master list by contractor name, project number, trainee name and trainee social security number to aid project staff in monitoring trainees who work on multiple projects.
2. The [Office of Civil Rights](#) may elect to interview trainees periodically during the training period to assess their performance and training program. To facilitate the interviews, the [Office of Civil Rights](#) will contact contractors for the location of the trainees.

CONTRACTOR RESPONSIBILITY

1. Trainees must be identified on payrolls (i.e. dragline trainee).

2. When any trainee completes a program, or is terminated for a reason or reasons other than successful completion, the contractor must include the date of completion or an explanation for the termination and date of termination on the quarterly training report.
3. The contractor will assign each trainee to a particular person--either a supervisor or a journeyman/woman who is proficient in the craft the trainee is being trained in, to ensure that timely instructional experience is received by the trainee. This person, cooperating with the appropriate company personnel, will see that proper records and the total intended training hours are completed during the allocated number of hours set up in the classification criteria.
4. The contractor has the prerogative of terminating the training period of the trainee and advancing the trainee to journey status. Approval requests must be submitted to the [Office of Civil Rights](#) with an explanation (*refer to 2 above*).
5. Upon notification from the contractor, the Department will issue a certificate of completion to the trainee.
6. Trainees may be transferred to state-aid highway construction projects in order to complete the training program. If transfers are made the [Office of Civil Rights](#) must be notified on the Quarterly Reporting Form. All of the training hours completed by trainees will count toward overall program completion.
7. Program reimbursements will be made directly to the prime or sub contractor.

CLASSROOM TRAINING

1. Classroom training programs must be pre-approved by the Department, if the contractor wishes to count the hours toward the trainee's training program.
 2. Contractors will be reimbursed for classroom training hours after the trainee has completed 20 hours of work on a highway construction project.
 3. Reimbursement for classroom training will be limited to 40 hours per trainee per construction season.
- **NOTE:** All proposed classroom training must be submitted as part of the trainee's OJT training program.

WAGE RATE

1. The wage rate for all trainees is \$5.15, during their OJT training program. Trainees shall be paid full fringe benefit amounts, where applicable. At the completion of the training program, the trainee shall receive the wages of a skilled journey.

2. For the purpose of this training program, a quarter does not represent three months. The first two quarters of a 500-hour training program would end after 250 hours. On a 750-hour training program, the first two quarters would end after 375 hours, the third quarter after 560 or an additional 186 hours of work and the fourth after 750 hours.

JOURNEY WORKER RATIO

The ratio of trainee to journey will be less than 1:4 and not more than 1:10.

RECRUITMENT AND SELECTION PROCEDURES

A. Prerequisites for Trainees

To be qualified for enrollment in the OJT Program, trainees must possess basic physical fitness for the work to be performed, dependability, willingness to learn and ability to follow instructions.

B. Licenses

Truck driver trainees must possess appropriate driver permits or licenses for the operation of Class A, B and C trucks. However, when an instructional permit is used in lieu of a license, the trainee must be accompanied by an operator who:

1. Holds a license corresponding to the vehicle being operated;
2. Has had at least one year of driving experience; and
3. Is occupying the seat next to the driver.

C. Recruitment

1. Notices and posters setting forth the contractor's Equal Employment Opportunity Policy and availability of training programs will be placed in areas readily accessible to employees, applicants for employment and potential employees.
2. The contractor must target minority, female or economically disadvantaged trainees.
3. The contractor will conduct systematic and direct recruitment through public and private employee referral sources. Contractors must submit the trainee's name and completed application form to the [Office of Civil Rights](#) for review and approval. Approval must be obtained before the trainee can begin work under the training program.
4. Present employees will be screened for upgrading.

D. Selection

1. The selection and employment of a person by participating contractor shall qualify the person for the OJT Program.
 2. Selection will be made without regard to race, color, religion, sex, age or national origin and shall be completely nondiscriminatory.
 3. Employment of trainees will be in accordance with the work force requirements of the contractor. Each contractor will hire and train the trainees for uses in their own organization.
 4. Written certification of individuals under the category of economically disadvantaged can be provided to the contractor at the time of the interview. This certification must then be provided to the [Office of Civil Rights](#) with the other required information as part of the approval process for trainees.
- **NOTE:** The OJT Program is to provide training for minority, female and economically disadvantaged individuals in order that they may develop marketable skills and gain journey status in the skilled craft classifications in which they are being trained. However, this program does not exclude trainees that are not members of the above groups.

SECTION 905 - PROPOSAL

Date _____

Mississippi Transportation Commission
Jackson, Mississippi

Sirs: The following proposal is made on behalf of _____
_____ of _____

for constructing the following designated project(s) within the time(s) hereinafter specified.

The plans are composed of drawings and blue prints on file in the offices of the Mississippi Department of Transportation, Jackson, Mississippi.

The Specifications are the current Standard Specifications of the Mississippi Department of Transportation approved by the Federal Highway Administration, except where superseded or amended by the plans, Special Provisions and Notice(s) to Bidders attached hereto and made a part thereof.

I (We) certify that I (we) possess a copy of said Standard and Supplemental Specifications.

Evidence of my (our) authority to submit the Proposal is hereby furnished. The proposal is made without collusion on the part of any person, firm or corporation. I (We) certify that I (we) have carefully examined the Plans, the Specifications, including the Special Provisions and Notice(s) to Bidders, herein, and have personally examined the site of the work. On the basis of the Specifications, Special Provisions, Notice(s) to Bidders, and Plans, I (we) propose to furnish all necessary machinery, tools, apparatus and other means of construction and do all the work and furnish all the materials in the manner specified. I (We) understand that the quantities mentioned herein are approximate only and are subject to either increase or decrease, and hereby propose to perform any increased or decreased quantities of work at the unit prices bid, in accordance with the above.

Attached hereto is a certified check, cashier's check or Proposal Guaranty Bond in the amount as required in the Advertisement (or, by law).

INSTRUCTION TO BIDDERS: Alternate and Optional Items on Bid Schedule.

1. Two or more items entered opposite a single unit quantity WITHOUT DEFINITE DESIGNATION AS "ALTERNATE ITEMS" are considered as "OPTIONAL ITEMS". Bidders may or may not indicate on bids the Optional Item proposed to be furnished or performed WITHOUT PREJUDICE IN REGARD TO IRREGULARITY OF BIDS.
2. Items classified on the bid schedule as "ALTERNATE ITEMS" and/or "ALTERNATE TYPES OF CONSTRUCTION" must be preselected and indicated on bids. However, "Alternate Types of Construction" may include Optional Items to be treated as set out in Paragraph 1, above.
3. Optional items not preselected and indicated on the bid schedule MUST be designated in accordance with Subsection 102.06 prior to or at the time of execution of the contract.
4. Optional and Alternate items designated must be used throughout the project.

I (We) further propose to perform all "force account or extra work" that may be required of me (us) on the basis provided in the Specifications and to give such work my (our) personal attention in order to see that it is economically performed.

SECTION 905 -- PROPOSAL (CONTINUED)

I (We) further propose to execute the attached contract agreement (Section 902) as soon as the work is awarded to me (us), and to begin and complete the work within the time limit(s) provided for in the Specifications and Advertisement. I (We) also propose to execute the attached contract bond (Section 903) in an amount not less than one hundred (100) percent of the total of my (our) part, but also to guarantee the excellence of both workmanship and materials until the work is finally accepted.

I (We) enclose a certified check, cashier's check or bid bond for **five percent (5%) of total bid** and hereby agree that in case of my (our) failure to execute the contract and furnish bond within Ten (10) days after notice of award, the amount of this check (bid bond) will be forfeited to the State of Mississippi as liquidated damages arising out of my (our) failure to execute the contract as proposed. It is understood that in case I am (we are) not awarded the work, the check will be returned as provided in the Specifications.

Respectfully Submitted,

DATE _____

Contractor

BY _____
Signature

TITLE _____

ADDRESS _____

(To be filled in if a corporation)

Our corporation is chartered under the Laws of the State of _____ and the names, titles and business addresses of the executives are as follows:

President Address

Secretary Address

Treasurer Address

The following is my (our) itemized proposal.

SECTION 905

PROPOSAL (Sheet No. 2- 1)

INSTALLING ADA CURB CUTS IN LIBERTY, NATCHEZ, AND WOODVILLE, KNOWN AS MAINTENANCE PROJECT NO. MP-7000-00(019) / 302776, IN THE COUNTIES OF ADAMS, AMITE, AND WILKINSON, STATE OF MISSISSIPPI.

I (We) agree to complete the entire project within the specified contract time.

***** SPECIAL NOTICE TO BIDDERS *****

BIDS WILL NOT BE CONSIDERED UNLESS BOTH UNIT PRICES AND ITEM TOTALS ARE ENTERED

BIDS WILL NOT BE CONSIDERED UNLESS THE BID CERTIFICATE LOCATED AT THE END OF THE BID SHEETS IS SIGNED

BID SCHEDULE

REF. NO.	PAY ITEM NO.	ADJ. CODE	APPROX. QUANTITY	UNIT	DESCRIPTION	UNIT PRICE		ITEM TOTAL	
						DOLLAR	CENT	DOLLAR	CENT
<u>DIRECT PAY ITEMS</u>									
(10)	202-B		1,586 linear foot		Removal of Curb &/or Curb and Gutter, All Types				
(20)	202-B		473 square yard		Removal of Concrete Sidewalk				
(30)	608-B	(S)	480 square yard		Concrete Sidewalk, With Reinforcement				

SUBTOTAL - DIRECT PAY ITEMS.....\$ _____

SECTION 905

MP-7000-00(019) / 302776

PROPOSAL (Sheet No. 2- 2)

Adams, Amite, & Wilkinson County

REF. NO.	PAY ITEM NO.	ADJ. CODE	APPROX. QUANTITY	UNIT	DESCRIPTION	UNIT PRICE		ITEM TOTAL	
						DOLLAR	CENT	DOLLAR	CENT
<u>DEPENDENT PAY ITEMS</u>									
(40)	618-A				lump sum Maintenance of Traffic	XXXXXXXXXXXX	XXXX		
						XXXXXXXXXXXX	XXXX		
						XXXXXXXXXXXX	XXXX		
						XXXXXXXXXXXX	XXXX		
(50)	620-A				lump sum Mobilization	XXXXXXXXXXXX	XXXX		
						XXXXXXXXXXXX	XXXX		
						XXXXXXXXXXXX	XXXX		
						XXXXXXXXXXXX	XXXX		

SUBTOTAL - DEPENDENT ITEMS.....\$ _____

SECTION 905

PROPOSAL (Sheet No. 2- 3)

MP-7000-00(019) / 302776

Adams, Amite, & Wilkinson County

TOTAL BID - DIRECT AND DEPENDENT ITEMS\$ _____

*** SIGNATURE STATEMENT ***

BIDDER ACKNOWLEDGES THAT HE/SHE HAS CHECKED ALL ITEMS IN THIS PROPOSAL FOR ACCURACY AND CERTIFIED THAT THE FIGURES SHOWN THEREIN CONSTITUTE THEIR OFFICIAL BID.

BIDDER'S SIGNATURE

CONDITIONS FOR COMBINATION BID

If a bidder elects to submit a combined bid for two or more of the contracts listed for this month's letting, the bidder must complete and execute these sheets of the proposal in each of the individual proposals to constitute a combination bid. In addition to this requirement, each individual contract shall be completed, executed and submitted in the usual specified manner.

Failure to execute this Combination Bid Proposal in each of the contracts combined will be just cause for each proposal to be received and evaluated as a separate bid.

COMBINATION BID PROPOSAL

I. This proposal is tendered as one part of a Combination Bid Proposal utilizing option ___* of Subsection 102.11 on the following contracts:

* Option to be shown as either (a), (b), or (c).

<u>Project No.</u>	<u>County</u>	<u>Project No.</u>	<u>County</u>
1. _____	_____	6. _____	_____
2. _____	_____	7. _____	_____
3. _____	_____	8. _____	_____
4. _____	_____	9. _____	_____
5. _____	_____	10. _____	_____

A. If option (a) has been selected, then go to II, and sign Combination Bid Proposal.

B. If option (b) has been selected, then complete the following, go to II, and sign Combination Bid Proposal.

SECTION 905 - COMBINATION BID PROPOSAL (Continued)

Project Number	Pay Item Number	Unit	Unit Price Reduction	Total Item Reduction	Total Contract Reduction
1. _____	_____ _____	_____ _____	_____ _____	_____ _____	
2. _____	_____ _____	_____ _____	_____ _____	_____ _____	
3. _____	_____ _____	_____ _____	_____ _____	_____ _____	
4. _____	_____ _____	_____ _____	_____ _____	_____ _____	
5. _____	_____ _____	_____ _____	_____ _____	_____ _____	
6. _____	_____ _____	_____ _____	_____ _____	_____ _____	
7. _____	_____ _____	_____ _____	_____ _____	_____ _____	
8. _____	_____ _____	_____ _____	_____ _____	_____ _____	

SECTION 905 - COMBINATION BID PROPOSAL (Continued)

Project Number	Pay Item Number	Unit	Unit Price Reduction	Total Item Reduction	Total Contract Reduction
9. _____	_____ _____	_____ _____	_____ _____	_____ _____	
10. _____	_____ _____	_____ _____	_____ _____	_____ _____	

C. If option (c) has been selected, then initial and complete one of the following, go to II. and sign Combination Bid Proposal.

_____ I (We) desire to be awarded work not to exceed a total monetary value of \$ _____.

_____ I (We) desire to be awarded work not to exceed _____ number of contracts.

II. It is understood that the Mississippi Transportation Commission not only reserves the right to reject any and all proposals, but also the right to award contracts upon the basis of lowest separate bids or combination bids most advantageous to the State.

It is further understood and agreed that the Combination Bid Proposal is for comparison of bids only and that each contract shall operate in every respect as a separate contract in accordance with its proposal and contract documents.

I (We), the undersigned, agree to complete each contract on or before its specified completion date.

SIGNED _____

MISSISSIPPI DEPARTMENT OF TRANSPORTATION

CERTIFICATION
(Execute in duplicate)

State of Mississippi

County of _____

I, _____,
(Name of person signing certification)

individually, and in my capacity as _____ of
(Title)

_____ do hereby certify under
(Name of Firm, Partnership, or Corporation)

penalty of perjury under the laws of the United States and the State of Mississippi that
_____, Bidder
(Name of Firm, Partnership, or Corporation)

on Project No. **MP-7000-00(019) / 302776** _____,

in **Adams, Amite, & Wilkinson** County(ies), Mississippi, has not either directly or indirectly entered into any agreement, participated in any collusion; or otherwise taken any action in restraint of free competitive bidding in connection with this contract; nor have any of its corporate officers or principal owners.

Except as noted hereafter, it is further certified that said legal entity and its corporate officers, principal owners, managers, auditors and others in a position of administering federal funds are not currently under suspension, debarment, voluntary exclusion or determination of ineligibility; nor have a debarment pending; nor been suspended, debarred, voluntarily excluded or determined ineligible within the past three years by the Mississippi Transportation Commission, the State of Mississippi, any other State or a federal agency; nor been indicted, convicted or had a civil judgment rendered by a court of competent jurisdiction in any matter involving fraud or official misconduct within the past three years.

Initial here " _____ " if exceptions are attached and made a part thereof. Any exceptions shall address to whom it applies, initiating agency and dates of such action.

Note: Exceptions will not necessarily result in denial of award but will be considered in determining bidder responsibility. Providing false information may result in criminal prosecution or administrative sanctions.

All of the foregoing and attachments (when indicated) is true and correct.

Executed on _____ Signature _____

MISSISSIPPI DEPARTMENT OF TRANSPORTATION

CERTIFICATION
(Execute in duplicate)

State of Mississippi

County of _____

I, _____,
(Name of person signing certification)

individually, and in my capacity as _____ of
(Title)

_____ do hereby certify under
(Name of Firm, Partnership, or Corporation)

penalty of perjury under the laws of the United States and the State of Mississippi that
_____, Bidder
(Name of Firm, Partnership, or Corporation)

on Project No. **MP-7000-00(019) / 302776** _____,

in **Adams, Amite, & Wilkinson** County(ies), Mississippi, has not either directly or indirectly entered into any agreement, participated in any collusion; or otherwise taken any action in restraint of free competitive bidding in connection with this contract; nor have any of its corporate officers or principal owners.

Except as noted hereafter, it is further certified that said legal entity and its corporate officers, principal owners, managers, auditors and others in a position of administering federal funds are not currently under suspension, debarment, voluntary exclusion or determination of ineligibility; nor have a debarment pending; nor been suspended, debarred, voluntarily excluded or determined ineligible within the past three years by the Mississippi Transportation Commission, the State of Mississippi, any other State or a federal agency; nor been indicted, convicted or had a civil judgment rendered by a court of competent jurisdiction in any matter involving fraud or official misconduct within the past three years.

Initial here " _____ " if exceptions are attached and made a part thereof. Any exceptions shall address to whom it applies, initiating agency and dates of such action.

Note: Exceptions will not necessarily result in denial of award but will be considered in determining bidder responsibility. Providing false information may result in criminal prosecution or administrative sanctions.

All of the foregoing and attachments (when indicated) is true and correct.

Executed on _____ Signature _____

S E C T I O N 9 0 2

CONTRACT FOR MP-7000-00(019) / 302776

LOCATED IN THE COUNTY(IES) OF Adams, Amite, & Wilkinson

STATE OF MISSISSIPPI,

COUNTY OF HINDS

This contract entered into by and between the Mississippi Transportation Commission on one hand, and the undersigned contractor, on the other witnesseth;

That, in consideration of the payment by the Mississippi Transportation Commission of the prices set out in the proposal hereto attached, to the undersigned contractor, such payment to be made in the manner and at the time of times specified in the specifications and the special provisions, if any, the undersigned contractor hereby agrees to accept the prices stated in the proposal in full compensation for the furnishing of all materials and equipment and the executing of all the work contemplated in this contract.

It is understood and agreed that the advertising according to law, the Advertisement, the instructions to bidders, the proposal for the contract, the specifications, the revisions of the specifications, the special provisions, and also the plans for the work herein contemplated, said plans showing more particularly the details of the work to be done, shall be held to be, and are hereby made a part of this contract by specific reference thereto and with like effect as if each and all of said instruments had been set out fully herein in words and figures.

It is further agreed that for the same consideration the undersigned contractor shall be responsible for all loss or damage arising out of the nature of the work aforesaid; or from the action of the elements and unforeseen obstructions or difficulties which may be encountered in the prosecution of the same and for all risks of every description connected with the work, exceptions being those specifically set out in the contract; and for faithfully completing the whole work in good and workmanlike manner according to the approved Plans, Specifications, Special Provisions, Notice(s) to Bidders and requirements of the Mississippi Department of Transportation.

It is further agreed that the work shall be done under the direct supervision and to the complete satisfaction of the Executive Director of the Mississippi Department of Transportation, or his authorized representatives, and when Federal Funds are involved subject to inspection at all times and approval by the Federal Highway Administration, or its agents as the case may be, or the agents of any other Agency whose funds are involved in accordance with those Acts of the Legislature of the State of Mississippi approved by the Governor and such rules and regulations issued pursuant thereto by the Mississippi Transportation Commission and the authorized Federal Agencies.

The Contractor agrees that all labor as outlined in the Special Provisions may be secured from list furnished by

It is agreed and understood that each and every provision of law and clause required by law to be inserted in this contract shall be deemed to be inserted herein and this contract shall be read and enforced as though it were included herein, and, if through mere mistake or otherwise any such provision is not inserted, then upon the application of either party hereto, the contract shall forthwith be physically amended to make such insertion.

The Contractor agrees that he has read each and every clause of this Contract, and fully understands the meaning of same and that he will comply with all the terms, covenants and agreements therein set forth.

Witness our signatures this the _____ day of _____, _____.

Contractor (s)
By _____

MISSISSIPPI TRANSPORTATION COMMISSION

Title _____
Signed and sealed in the presence of:
(names and addresses of witnesses)

By _____
Executive Director

Secretary to the Commission

Award authorized by the Mississippi Transportation Commission in session on the ____ day of _____, _____, Minute Book No. _____, Page No. _____.

S E C T I O N 9 0 3

CONTRACT BOND FOR: MP-7000-00(019) / 302776

LOCATED IN THE COUNTY(IES) OF: Adams, Amite, & Wilkinson

STATE OF MISSISSIPPI,

COUNTY OF HINDS

Know all men by these presents: that we, _____

_____ Principal, a _____

residing at _____ in the State of _____

and _____

residing at _____ in the State of _____,

authorized to do business in the State of Mississippi, under the laws thereof, as surety, are held and firmly bound unto the State of Mississippi in the sum of _____

_____ (\$ _____) Dollars, lawful money of the United States of America, to be paid to it for which payment well and truly to be made, we bind ourselves, our heirs, administrators, successors, or assigns jointly and severally by these presents.

Signed and sealed this the ____ day of _____ A.D. _____.

The conditions of this bond are such, that whereas the said _____

_____ principal, has (have) entered into a contract with the Mississippi Transportation Commission, bearing the date of _____ day of _____ A.D. _____ hereto annexed, for the construction of certain projects(s) in the State of Mississippi as mentioned in said contract in accordance with the Contract Documents therefor, on file in the offices of the Mississippi Department of Transportation, Jackson, Mississippi.

Now therefore, if the above bounden _____

_____ in all things shall stand to and abide by and well and truly observe, do keep and perform all and singular the terms, covenants, conditions, guarantees and agreements in said contract, contained on his (their) part to be observed, done, kept and performed and each of them, at the time and in the manner and form and furnish all of the material and equipment specified in said contract in strict accordance with the terms of said contract which said plans, specifications and special provisions are included in and form a part of said contract and shall maintain the said work contemplated until its final completion and acceptance as specified in Subsection 109.11 of the approved specifications, and save harmless said Mississippi Transportation Commission from any loss or damage arising out of or occasioned by the negligence, wrongful or criminal act, overcharge, fraud, or any other loss or damage whatsoever, on the part of said principal (s), his (their) agents, servants, or employees in the performance of said work or in any manner connected therewith, and shall be liable and responsible in a civil action instituted by the State at the instance of the Mississippi Transportation Commission or any officer of the State authorized in such cases, for double any amount in money or property, the State may lose or be overcharged or otherwise defrauded of, by reason of wrongful or criminal act, if any, of the Contractor(s), his (their) agents or

SECTION 903 - CONTINUED

employees, and shall promptly pay the said agents, servants and employees and all persons furnishing labor, material, equipment or supplies therefor, including premiums incurred, for Surety Bonds, Liability Insurance, and Workmen's Compensation Insurance; with the additional obligation that such Contractor shall promptly make payment of all taxes, licenses, assessments, contributions, damages, any liquidated damages which may arise prior to any termination of said principal's contract, any liquidated damages which may arise after termination of the said principal's contract due to default on the part of said principal, penalties and interest thereon, when and as the same may be due this state, or any county, municipality, board, department, commission or political subdivision: in the course of the performance of said work and in accordance with Sections 31-5-51 et seq. Mississippi Code of 1972, and other State statutes applicable thereto, and shall carry out to the letter and to the satisfaction of the Executive Director of the Mississippi Department of Transportation, all, each and every one of the stipulations, obligations, conditions, covenants and agreements and terms of said contract in accordance with the terms thereof and all of the expense and cost and attorney's fee that may be incurred in the enforcement of the performance of said contract, or in the enforcement of the conditions and obligations of this bond, then this obligation shall be null and void, otherwise to be and remain in full force and virtue.

Witness our signatures and seals this the _____ day of _____ A.D. _____.

_____	_____
(Contractors) Principal	Surety
By _____	By _____
	(Signature) Attorney in Fact

Title _____	_____
(Contractor's Seal)	(Name and Address of Local (Mississippi) Representative) (Surety Seal)

MISSISSIPPI DEPARTMENT OF TRANSPORTATION

HAUL PERMIT FOR BRIDGES

WITH

POSTED WEIGHT LIMITS

DATE: _____

PROJECT: MP-7000-00(019) / 302776

COUNTIES: Adams, Amite, & Wilkinson

LOCATION: IN LIBERTY, NATCHEZ, AND WOODVILLE.

A permit is issued to _____ for transporting loads exceeding the posted limit for any such bridge located on State designated routes within the project termini provided that such transport vehicles comply with all other governing statutory weight limits.

This permit is valid on all State designated routes from the point of origin to the point of delivery for materials and equipment utilized in construction of said project and also valid for sub-contractors and vendors upon written permission of the Contractor. The permit is non-transferable and no other haul permit for posted bridges will be issued to other individuals, vendors, or companies for construction of this project.

A copy of this signed permit shall be carried in all vehicles operating under the authority of this permit and also a copy of the Contractor's written permission when the vehicle is other than Contractor owned.

In accordance with State law, the above named Contractor will be liable for damages directly attributable to vehicles operating under this permit.

EXECUTIVE DIRECTOR