

MDOT Use Only

Checked \_\_\_\_\_

Loaded \_\_\_\_\_

Keyed \_\_\_\_\_

3 -



SM No. CSTP2170000111

# PROPOSAL AND CONTRACT DOCUMENTS

FOR THE CONSTRUCTION OF  
(EXEMPT)

3  
Widen and Overlay US 11 from Green's Creek Bridge to the Jones County Line, known as Federal Aid Project No. STP-2170-00(011) / 105466301, in the County of Forrest, State of Mississippi.  
Project Completion: 30 Time Units

## NOTICE

**BIDDERS MUST PURCHASE A BOUND PROPOSAL FROM MDOT CONTRACT ADMINISTRATION DIVISION TO BID ON THIS PROJECT.**

Electronic addendum updates will be posted on [www.goMDOT.com](http://www.goMDOT.com)

**SECTION 900**  
**OF THE CURRENT**  
**(2004) STANDARD SPECIFICATIONS**  
**FOR ROAD AND BRIDGE CONSTRUCTION**  
**MISSISSIPPI DEPARTMENT OF TRANSPORTATION**  
**JACKSON, MISSISSIPPI**

**BIDDER CHECK LIST  
(FOR INFORMATION ONLY)**

- \_\_\_\_\_ All unit prices and item totals have been entered in accordance with Subsection 102.06 of the Mississippi Standard Specifications for Road and Bridge Construction.
- \_\_\_\_\_ If the bid sheets were prepared using MDOT's Electronic Bid System, proposal sheets have been stapled and inserted into the proposal package.
- \_\_\_\_\_ First sheet of SECTION 905--PROPOSAL has been completed.
- \_\_\_\_\_ Second sheet of SECTION 905--PROPOSAL has been completed and signed.
- \_\_\_\_\_ Addenda, if any, have been acknowledged. Second sheet of Section 905 listing the addendum number has been substituted for the original second sheet of Section 905. Substituted second sheet of Section 905 has been properly completed, signed, and added to the proposal.
- \_\_\_\_\_ DBE/WBE percentage, when required by contract, has been entered on last sheet of the bid sheets of SECTION 905 - PROPOSAL.
- \_\_\_\_\_ Form OCR-485, when required by contract, has been completed and signed.
- \_\_\_\_\_ The last sheet of the bid sheets of SECTION 905--PROPOSAL has been signed.
- \_\_\_\_\_ Combination Bid Proposal of SECTION 905--PROPOSAL has been completed for each project which is to be considered in combination (See Subsection 102.11).
- \_\_\_\_\_ Equal Opportunity Clause Certification, when included in contract, has been completed and signed.
- | \_\_\_\_\_ The Certification regarding Non-Collusion, Debarment and Suspension, etc. has been executed in duplicate.
- \_\_\_\_\_ A certified check, cashier's check or bid bond payable to the State of Mississippi in the principal amount of 5% of the bid has been included with project number identified on same. Bid bond has been signed by the bidder and has also been signed or countersigned by a Mississippi Resident Agent for the Surety with Power of Attorney attached.
- | \_\_\_\_\_ Non-resident Bidders: ON STATE FUNDED PROJECTS ONLY, a copy of the current laws regarding any preference for local Contractors from State wherein domiciled has been included. See Subsection 103.01, Mississippi Standard Specifications for Road and Bridge Construction, and Section 31-7-47, MCA, 1972 regarding this matter.

Return the proposal and contract documents in its entirety in a sealed envelope. DO NOT remove any part of the contract documents; exception - an addendum requires substitution of second sheet of Section 905. A stripped proposal is considered as an irregular bid and will be rejected.

Failure to complete any or all of the applicable requirements will be cause for the proposal to be considered irregular.

# MISSISSIPPI DEPARTMENT OF TRANSPORTATION

## TABLE OF CONTENTS

**PROJECT: STP-2170-00(011) / 105466301 - Forrest County**

901--Advertisement

904--Notice to Bidders:

- Governing Specs. - # 1
- Final Cleanup - # 3
- Gopher Tortoises - # 151
- Fiber Reinforced Concrete - # 640
- Disadvantage Business Enterprise W/Supplement - # 696
- On-The-Job Training Program - # 777
- Payroll Requirements - # 883
- Rumble Stripe - # 1312
- Errata & Modifications to 2004 Standard Specifications - # 1405
- Advancement of Materials - # 1546
- Safety Apparel - # 1808
- Minimum Wage Rate - # 1869
- DBE Forms, Participation and Payment - # 1918
- Non-Quality Control/Assurance Concrete - # 1922
- Federal Bridge Formula - # 1928
- Standard Drawings - # 2105
- Department of Labor Ruling - # 2239
- Petroleum Products Base Price - # 2345
- Mississippi Resident Agent Requirement - # 2361
- Status of ROW, W/Attachments - # 2382
- Contract Time - # 2395
- Specialty Items - # 2396
- Scope of Work - # 2397
- Removal of Haul Permit - # 2400
- Project Number Change - # 2415

906: Required Federal Contract Provisions -- FHWA-1273, W/Supplement

907-105-3: Cooperation By Contractors, W/Supplement  
907-107-1: Liability Insurance, W/Supplement  
907-107-6: Legal Relations & Responsibility to Public, W/Supplement  
907-108-17: Prosecution and Progress  
907-109-3: Partial Payment, W/Supplement  
907-401-2: Hot Mix Asphalt (HMA), W/Supplement  
907-403-4: Hot Mix Asphalt (HMA), W/Supplement  
907-407-1: Tack Coat  
907-413-2: Sawing & Sealing Transverse Joints in Asphalt Pavement  
907-618-1: Additional Signing Requirements, W/Supplement  
907-618-4: Placement of Temporary Traffic Stripe

**-CONTINUED ON NEXT PAGE-**

**PAGE 2 - PROJECT NO. STP-2170-00(011) / 105466301 - Forrest County**

- 907-626-14: Double Drop Thermoplastic Markings
- 907-626-15: Thermoplastic Traffic Markings
- 907-701-3: Hydraulic Cement, W/Supplement
- 907-711-3: Synthetic Structural Fiber Reinforcement
- 907-713-1: Admixtures for Concrete
- 907-714-5: Miscellaneous Materials, W/Supplement
- 907-720-1: Pavement Marking Material
- 907-804-8: Concrete Bridges and Structures, W/Supplement
- 906-3: MDOT On-the-Job Training Program
- 906-6: MDOT On-the-Job Training Program - Alternate Program

SECTION 905 - PROPOSAL,  
PROPOSAL SHEET NOS. 2-1 THRU 2-4,  
COMBINATION BID PROPOSAL,  
CERTIFICATE OF PERFORMANCE - PRIOR FEDERAL-AID CONTRACTS,  
NON-COLLUSION CERTIFICATE,  
SECTION 902 - CONTRACT FORM, AND SECTION 903 - CONTRACT BOND FORM,  
PROGRESS SCHEDULE,  
OCR-485,

(REVISIONS TO THE ABOVE WILL BE INDICATED ON THE SECOND SHEET  
OF SECTION 905 AS ADDENDA)

# MISSISSIPPI DEPARTMENT OF TRANSPORTATION

## SECTION 901 - ADVERTISEMENT

Sealed bids will be received by the Mississippi Transportation Commission in the Office of the Contract Administration Engineer, Room 1013, Mississippi Department of Transportation Administration Building, 401 North West Street, Jackson, Mississippi, until 9:30 o'clock A.M., Tuesday, March 24, 2009; thereafter, bids will be received in the First Floor Auditorium of the Mississippi Department of Transportation Administration Building, Jackson, Mississippi, until 10:00 o'clock A.M., Tuesday, March 24, 2009, and shortly thereafter publicly opened for:

Widen and Overlay US 11 from Green's Creek Bridge to the Jones County Line, known as Federal Aid Project No. STP-2170-00(011) / 105466301, in the County of Forrest, State of Mississippi.

The attention of bidders is directed to the Contract Provisions governing selection and employment of labor. Minimum wage rates have been predetermined by the Secretary of Labor and are subject to Public Law 87-58 1, Work Hours Act of 1962, as set forth in the Contract Provisions.

The Mississippi Department of Transportation hereby notifies all bidders that it will affirmatively insure that in any contract entered into pursuant to this advertisement, disadvantaged business enterprises will be afforded full opportunity to submit bids in response to this invitation and will not be discriminated against on the grounds of race, color, sex, age, disability, religion or national origin in consideration for an award.

**The award of this contract will be contingent upon the Contractor satisfying the DBE requirements.**

The specifications are on file in the offices of the Mississippi Department of Transportation.

Bid proposals must be acquired from the MDOT Contract Administration Division. These proposals are available at a cost of Ten Dollars (\$10.00) per proposal. Specimen proposals are also available at the MDOT Contract Administration Division at a cost of Ten Dollars (\$10.00) per proposal, or can be viewed or downloaded at no cost at [www.gomdot.com](http://www.gomdot.com).

Bid bond, signed or countersigned by a Mississippi Resident Agent or Qualified Nonresident Agent, with Power of Attorney attached or on file with the Contract Administration Engineer of the Department, a Cashier's check or Certified Check for five (5%) percent of bid, payable to STATE OF MISSISSIPPI, must accompany each proposal.

The attention of bidders is directed to the provisions of Subsection 102.07 pertaining to irregular proposals and rejection of bids.

LARRY L. "BUTCH" BROWN  
EXECUTIVE DIRECTOR

# MISSISSIPPI DEPARTMENT OF TRANSPORTATION

**SECTION 904 - NOTICE TO BIDDERS NO. 1**

**CODE: (IS)**

**DATE: 05/03/2004**

**SUBJECT: Governing Specifications**

The current (2004) Edition of the Standard Specifications for Road and Bridge Construction adopted by the Mississippi Transportation Commission is made a part hereof fully and completely as if it were attached hereto, except where superseded by special provisions, or amended by revisions of the Specifications contained herein. Copies of the specification book may be purchased from the MDOT Construction Division.

A reference in any contract document to controlling requirements in another portion of the contract documents shall be understood to apply equally to any revision or amendment thereof included in the contract.

In the event the plans or proposal contain references to the 1990 Edition of the Standard Specifications for Road and Bridge Construction, it is to be understood that such references shall mean the comparable provisions of the 2004 Edition of the Standard Specifications.

# MISSISSIPPI DEPARTMENT OF TRANSPORTATION

**SECTION 904 - NOTICE TO BIDDERS NO. 3**

**CODE: (SP)**

**DATE: 05/03/2004**

**SUBJECT: Final Clean-Up**

Immediately prior to final inspection for release of maintenance, the Contractor shall pick up, load, transport and properly dispose of all litter from the entire highway right-of-way that is within the termini of the project.

Litter shall include, but not be limited to, solid wastes such as glass, paper products, tires, wood products, metal, synthetic materials and other miscellaneous debris.

Litter removal is considered incidental to other items of work and will not be measured for separate payment.

**MISSISSIPPI DEPARTMENT OF TRANSPORTATION**

**SECTION 904 - NOTICE TO BIDDERS NO. 151**

**CODE: (IS)**

**DATE: 06/18/2004**

**SUBJECT: Gopher Tortoises**

Bidders are hereby advised that the Contractor will be required to make special considerations regarding gopher tortoises on this project. In addition to the normal required documentation associated with borrow pits, the Contractor shall, for each site used to obtain or dispose of materials associated with this project, provide the Engineer with a letter from a qualified biologist certifying that the site was inspected prior to any clearing of vegetation or disposal of project materials and that the site is not inhabited by gopher tortoises, or appropriate avoidance measures have been installed. No individual lacking the proper State or Federal license shall touch or otherwise harass a gopher tortoise.



## MISSISSIPPI DEPARTMENT OF TRANSPORTATION

| SECTION 904 - NOTICE TO BIDDERS NO. 640

CODE: (IS)

| DATE: 09/26/2005

SUBJECT: Fiber Reinforced Concrete

Bidders are hereby advised that synthetic structural fibers meeting the requirements of Subsection 907-711.04 may be used in lieu of wire mesh in some items of construction. Substitution of fibers for wire mesh will be allowed in the construction of paved ditches, paved flumes, paved inlet apron, driveways, guard rail anchors and pile encasements. Substitution in any other items of work must be approved by the State Construction Engineer prior to use.

## **SUPPLEMENT TO NOTICE TO BIDDERS NO. 696**

**DATE: 06/06/2008**

The goal is 1 percent for the Disadvantaged Business Enterprise. The low bidder is required to submit Form OCR-481 for all DBEs. Bidders are advised to check the bid tabulation link for this project on the MDOT website (<http://www.gomdot.com/applications/bidsystem/currentletting.aspx>) for results. Bid tabulations are usually posted by 3:00 pm on Letting Day.

Form OCR-481 is available at [http://www.gomdot.com/Divisions/CivilRights/Resources/Forms/pdf/MDOT\\_OCR481.pdf](http://www.gomdot.com/Divisions/CivilRights/Resources/Forms/pdf/MDOT_OCR481.pdf) or by calling 601-359-7466.

All OCR-481s must be returned within 10 days following the bid letting to the MDOT Office of Civil Rights, P.O. Box 1850, Jackson, MS 39215-1850.

For answers to questions, contact the MDOT Office of Civil Rights at (601) 359-7466.

The bidder's execution of the signature portion of the proposal shall constitute execution of the following assurance:

The bidder hereby gives assurance pursuant to the applicable requirements of "Safe, Accountable, Flexible, Efficient Transportation Equity Act, A Legacy For Users (SAFETEA-LU)" and "Part 26, Title 49, Code of Federal Regulation" that the bidder has made a good faith effort to meet the contract goal for DBE participation for which this proposal is submitted.

A pre-bid meeting will be held in Amphitheater 1 & 2 of the Hilton Jackson located at I-55 and County Line Road, Jackson, Mississippi at 2:00 P.M. on the day preceding the date of the bid opening.

This meeting is to inform DBE firms of subcontracting and material supply opportunities. Attendance at this meeting is considered of prime importance in demonstrating good faith effort to meet the contract goal.

A list of "Certified DBE Contractors" which have been certified as such by the Mississippi Department of Transportation and other Unified Certification Partners (UPC) can be found on the Mississippi Department of Transportation website at [www.gomdot.com](http://www.gomdot.com). The DBE firm must be on the Department's list of "Certified DBE Contractors" that is posted online at the time the job is let and approved by MDOT to count towards meeting the DBE goal.

# MISSISSIPPI DEPARTMENT OF TRANSPORTATION

SECTION 904 - NOTICE TO BIDDERS NO. 696

CODE: (IS)

DATE: 12/20/2005

SUBJECT: DISADVANTAGED BUSINESS ENTERPRISES IN FEDERAL-AID HIGHWAY CONSTRUCTION

This contract is subject to the [Safe, Accountable, Flexible, Efficient Transportation Equity Act, A Legacy For Users \(SAFETEA-LU\)](#) and applicable requirements of "Part 26, Title 49, Code of Federal Regulations." Portions of the Act are set forth in this Notice as applicable to compliance by the Contractor and all of the Act, and the MDOT DBE Program, is incorporated by reference herein.

The Department has developed a Disadvantaged Business Enterprise Program that is applicable to this contract and is made a part thereof by reference.

Copies of the program may be obtained from:

Office of Civil Rights  
Mississippi Department of Transportation  
P. O. Box 1850  
Jackson, Mississippi 39215-1850

## POLICY

It is the policy of the Mississippi Department of Transportation to provide a level playing field, to foster equal opportunity in all federally assisted contracts, to improve the flexibility of the DBE Program, to reduce the burdens on small businesses, and to achieve that amount of participation that would be obtained in a non-discriminatory market place. In doing so, it is the policy of MDOT that there will be no discrimination in the award and performance of federally assisted contracts on the basis of race, color, sex, age, religion, national origin, or any handicap.

## ASSURANCES THAT CONTRACTORS MUST TAKE:

MDOT will require that each contract which MDOT signs with a subrecipient or a Contractor, and each subcontract the Prime Contractor signs with a Subcontractor, includes the following assurances:

“The Contractor, subrecipient or Subcontractor shall not discriminate on the basis of race, color, national origin, or sex in the performance of this contract. The Contractor shall carry out applicable requirements of 49 CFR 26 in the award and administration of federally assisted contracts. Failure by the Contractor to carry out these requirements is a material breach of this contract, which may result in the termination of this contract or such other remedy as MDOT deems appropriate.”

**DEFINITIONS**

For purposes of this provision the following definitions will apply:

"Disadvantaged Business" means a small business concern: (a) which is at least 51 percent owned by one or more socially and economically disadvantaged individual(s) or in the case of any publicly owned business, at least 51 percent of the stock of which is owned by one or more socially and economically disadvantaged individual(s); and (b) whose management and daily business operations are controlled by one or more of the socially and economically disadvantaged individual(s) who own it. It is important to note that the business owners themselves must control the operations of the business. Absentee ownership or title ownership by an individual who does not take an active role in controlling the business is not consistent with eligibility as a DBE under CFR 49 Part 26.71.

**CONTRACTOR'S OBLIGATION**

The Contractor and all Subcontractors shall take all necessary and reasonable steps to ensure that DBE firms can compete for and participate in the performance of a portion of the work in this contract and shall not discriminate on the basis of race, color, national origin, religion or sex. Failure on the part of the Contractor to carry out the DBE requirements of this contract constitutes a breach of contract and after proper notification the Department may terminate the contract or take other appropriate action as determined by the Department.

When a contract requires a zero percent (0%) DBE goal, the Contractor still has the responsibility to take all necessary and reasonable steps to ensure that DBE firms can compete for and participate in the performance of the work in the contract. **In this case,** all work performed by a certified DBE firm is considered to be a "race neutral" measure and the Department will receive DBE credit towards the overall State goals when the DBE firm is paid for their work. If the Prime Contractor is a certified DBE firm, the Department can receive DBE credit only for the work performed by the Prime Contractor's work force or any work subcontracted to another DBE firm. Work performance by a non-DBE Subcontractor is not eligible for DBE credit.

**CONTRACT GOAL**

The goal for participation by DBEs is established for this contract in the attached Supplement. The Contractor shall exercise all necessary and reasonable steps to ensure that participation is equal to or exceeds the contract goal.

The percentage of the contract that is proposed for DBEs shall be so stated on the last bid sheet of the proposal.

The apparent lowest responsive bidder shall submit to the Contract Administration Division Form OCR-481, signed by the Prime Contractor and the DBE Subcontractors, no later than the 10th day after opening of the bids.

FORMS ARE AVAILABLE FROM THE CONTRACT ADMINISTRATION DIVISION

The OCR-481 Form must contain the following information:

The name and address of each certified DBE Contractor / Supplier;

The Reference Number, percent of work and the dollar amount of each item. If a portion of an item is subcontracted, a breakdown of that item including quantities and unit price must be attached, detailing what part of the item the DBE firm is to perform and who will perform the remainder of the item.

If the DBE Commitment shown on the last bid sheet of the proposal, does not equal or exceed the contract goal, the bidder must submit, with the proposal, information to satisfy the Department that adequate good faith efforts have been made to meet the contract goal.

Failure of the lowest bidder to furnish acceptable proof of good faith efforts, submitted with the bid proposal, shall be just cause for rejection of the proposal. Award may then be made to the next lowest responsive bidder or the work may be readvertised.

The following factors are illustrative of matters the Department will consider in judging whether or not the bidder has made adequate good faith effort to satisfy the contract goal.

- (1) Whether the bidder attended the pre-bid meeting that was scheduled by the Department to inform DBEs of subcontracting opportunities;
- (2) whether the bidder advertised in general circulation, trade association, and minority-focus media concerning the subcontracting opportunities;
- (3) whether the bidder provided written notice to a reasonable number of specific DBEs that their interest in the contract is being solicited;
- (4) whether the bidder followed up initial solicitations of interest by contacting DBEs to determine with certainty whether they were interested;
- (5) whether the bidder selected portions of the work to be performed by DBEs in order to increase the likelihood of meeting the contract goal;
- (6) whether the bidder provided interested DBEs with adequate information about the plans, specifications and requirements of the contract;

- (7) whether the bidder negotiated in good faith with interested DBEs and did not reject them as unqualified without sound reasons based on a thorough investigation of their capabilities; and
- (8) whether the bidder made efforts to assist interested DBEs in obtaining any required bonding or insurance.

**DIRECTORY**

Included with this Bid Proposal is a list of "Certified DBE Contractors" which have been certified as such by the Mississippi Department of Transportation and other Unified Certification Partners (UCP).

The DBE firm must be on the Department's list of "Certified DBE Contractors" that is attached to this proposal and approved by MDOT to count towards meeting the DBE goal.

**REPLACEMENT**

If a DBE Subcontractor cannot perform satisfactorily, and this causes the OCR-481 commitment to fall below the contract goal, the Contractor shall take all necessary reasonable steps to replace the DBE with another certified DBE Subcontractor or submit information to satisfy the Mississippi Department of Transportation that adequate good faith efforts have been made to replace the DBE. The replacement DBE must be a DBE who was on the Department's list of "Certified DBE Contractors" when the job was awarded, and who is still active. All DBE replacements must be approved by the Department.

Under no circumstances shall the Prime or any Subcontractor perform the DBE's work (as shown on the OCR-481) without prior written approval from the Department. See "Sanctions" at the end of this document for penalties for performing DBE's work.

When a Contractor proposes to substitute/replace/terminate a DBE that was originally named on the OCR-481, the Contractor must obtain a release, in writing, from the named DBE explaining why the DBE Subcontractor cannot perform the work. A copy of the original DBE's release must be attached to the Contractor's written request to substitute/replace/terminate along with appropriate Subcontract Forms for the substitute/replacement/terminated Subcontractor, all of which must be submitted to the DBE Coordinator and approved, in advance, by MDOT.

**GOOD FAITH EFFORTS**

To demonstrate good faith efforts to replace any DBE that is unable to perform successfully, the Contractor must document steps taken to subcontract with another certified DBE Contractor. Such documentation shall include no less than the following:

- (a) Proof of written notification to certified DBE Contractors by certified mail that their interest is solicited in subcontracting the work defaulted by the previous DBE or in subcontracting other items of work in the contract.
- (b) Efforts to negotiate with certified DBE Contractors for specific items shall include as a minimum:
  - (1) The name, address, and telephone number of each DBE contacted;
  - (2) A description of the information provided about the plans and specifications for those portions of the work to be subcontracted; and
  - (3) A statement of why agreements were not reached.
- (c) For each DBE contacted that was rejected as unqualified, the reasons for such conclusion.
- (d) Efforts made to assist each DBE that needed assistance in obtaining bonding or insurance required by the Contractor.

Failure of the Contractor to demonstrate good faith efforts to replace a DBE Subcontractor that cannot perform as intended with another DBE Subcontractor, when required, shall be a breach of contract and may be just cause to be disqualified from further bidding for a period of up to 12 months after notification by certified mail.

**PARTICIPATION / DBE CREDIT**

Participation shall be counted toward meeting the goal in this contract as follows:

- (1) If the Prime Contractor is a certified DBE firm, only the value of the work actually performed by the DBE Prime can be counted towards the project goal, along with any work subcontracted to a certified DBE firm.
- (2) If the Contractor is not a DBE, the work subcontracted to a certified DBE Contractor will be counted toward the goal.
- (3) The Contractor may count toward the goal a portion of the total dollar value of a contract with a joint venture eligible under the standards of this provision equal to the percentage of the DBE partner in the joint venture.
- (4) Expenditures to DBEs that perform a commercially useful function may be counted toward the goal. A business is considered to perform a commercially useful function when it is responsible for the execution of a distinct element of the work and carries out its responsibilities by actually performing, managing, and supervising the work involved.

- (5) The Contractor may count 100% of the expenditures for materials and supplies obtained from certified DBE suppliers and manufacturers that produce goods from raw materials or substantially alters them for resale provided the suppliers and manufacturers assume the actual and contractual responsibility for the provision of the materials and supplies. The Contractor may count 60 percent of the expenditures to suppliers that are not manufacturers, provided the supplier performs a commercially useful function in the supply process. Within 30 days after receipt of the materials, the Contractor shall furnish to the DBE Coordinator invoices from the certified supplier to verify the DBE goal.
- (6) Any work that a certified DBE firm subcontracts or sub-subcontracts to a non-DBE firm will not count towards the DBE goal.
- (7) Only the dollars actually paid to the DBE firm may be counted towards the DBE goal.

### **AWARD**

Award of this contract to the low bidder will be contingent upon the following conditions:

- (1) Concurrence from Federal Highway Administration, when applicable.
- (2) Bidder must submit to the Contract Administration Division for approval, Form OCR-481 (DBE Commitment) no later than the 10th day after opening of the bids, or submit information with the bid proposal to satisfy the Department and that adequate good faith efforts have been made to meet the contract goal.
- (3) Bidder must submit **with the bid proposal** a list of all firms that submitted quotes for material supplies or items to be subcontracted. This information must be submitted on form OCR-485 in the back of the contract proposal.

Prior to the start of any work, the bidder must notify the Project Engineer, in writing, of the name of the designated "DBE Liaison Officer" for this project. This notification must be posted on the bulletin board at the project site.

### **DEFAULT**

The contract goal established by MDOT in this proposal must be met to fulfill the terms of the contract. The Contractor may list DBE Subcontractors and items that exceed MDOT's contract goal, but should unforeseen problems arise that would prevent a DBE from completing its total commitment percentage, the Contractor will meet the terms of the contract as long as it meets or exceeds MDOT's Contract Goal. For additional information, refer to "Replacement" section of this Notice.



## **DBE REPORTS**

- (1) OCR-481: Refer to 'CONTRACT GOAL' section of this Notice to Bidders for information regarding this form.
- (2) OCR-482: At the conclusion of the project the Contractor will submit to the Project Engineer for verification of quantities and further handling Form OCR-482 whereby the Contractor certifies to the amounts of payments made to each Contractor / Supplier. The Project Engineer shall submit the completed Form OCR-482 to the DBE Coordinator (Office of Civil Rights). Final acceptance of the project is dependent upon Contract Administration Division's receipt of completed Form OCR-482 which they will receive from the Office of Civil Rights.
- (3) OCR-483: The Project Engineer/Inspector will complete Form OCR-483, the Commercially Useful Function (CUF) Performance Report, in accordance with MDOT S.O.P. No. OCR-03-09-01-483. Evaluations reported on this form are used to determine whether or not the DBE firm is performing a CUF. The Prime Contractor should take corrective action when the report contains any negative evaluations. DBE credit may be disallowed and/or other sanctions imposed if it is determined the DBE firm is not performing a CUF. This form should also be completed and returned to the DBE Coordinator (Office of Civil Rights).
- (4) OCR-484: Each month, the Contractor will submit to the Project Engineer OCR-484 certifying payments to all Subcontractors.
- (5) OCR-485: The bidder must submit **with the bid proposal** a list of all firms that submitted quotes for material supplies or items to be subcontracted.
- (6) OCR-487: Only used by Prime Contractors that are certified DBE firms. This form is used in determining the exact percentage of DBE credit for the specified project. It should be returned to MDOT with the OCR-481 form, or can also be returned with the Permission to Subcontract Forms (CAD-720 or CAD-725).

## **SANCTIONS**

The Department has the option to enforce any of the following penalties for failure of the Prime Contractor to fulfill the DBE goal as stated on the OCR-481 form or any violations of the DBE program guidelines:

- (1) Disallow credit towards the DBE goal
- (2) Withhold progress estimate payments
- (3) Deduct from the final estimate an amount equal to the unmet portion of the DBE goal

- (4) Recover an amount equal to the unmet contract goal
- (5) Debar the Contractor involved from bidding on Mississippi Department of Transportation projects.
- (6) Deduct from the Contractor's final estimate all or any combination of the following.

<u>Offense</u>	<u>Percentage of the monetary amount disallowed from (1) above</u>	<u>Lump Sum</u>
# 1	10%	\$ 5,000 or both
# 2	20%	\$ 10,000 or both
# 3	40%	\$ 20,000 & debarment

## MISSISSIPPI DEPARTMENT OF TRANSPORTATION

| SECTION 904 - NOTICE TO BIDDERS NO. [777](#)

CODE: (IS)

| DATE: [04/13/2006](#)

**SUBJECT: On-The-Job Training Program**

| Payment for training hours will be handled as outlined in Special Provision 906-6. A pay item for trainees will not be included in individual construction projects. Payment for training individuals will be processed in accordance with the conditions in MDOT's ON-THE-JOB TRAINING PROGRAM (Special Provision 906-6).

| On Federal-Aid projects, failure on the part of the Contractor to carryout the terms of the Alternate Training Special Provision (Special Provision 906-6) will be considered grounds to preclude the Contractor from participating in the Alternate On-The-Job Training Program. In the event the Department is required to preclude the Contractor from participating in the program, the Contractor will be required to adhere to the requirements of the Training Special Provision (Special Provision 906-3), for which purpose the special provision is also made a part of this proposal.

## MISSISSIPPI DEPARTMENT OF TRANSPORTATION

**SECTION 904 - NOTICE TO BIDDERS NO. 883**

**CODE: (IS)**

**DATE: 04/28/2006**

**SUBJECT: Payroll Requirements**

Bidders are hereby advised that the Contractor and Subcontractor(s) are required to submit payroll information to the Project Engineers on a weekly basis.

On Federal-Aid Projects, CAD-880, CAD-881 and certified payroll submissions are required each week the Contractor or a Subcontractor performs work on the project. This is addressed in Section V, page 6 of Form FHWA-1273.

On State-Funded Projects, CAD-880 is required each week the Contractor or a Subcontractor performs work on the project.

When no work is performed on either Federal-Aid and State-Funded Projects, the Contractor should only submit CAD-880 showing no work activities.

The Contractor shall make all efforts necessary to submit this information to the Project Engineer in a timely manner. The Engineer will have the authority to suspend the work wholly or in part and to withhold payments because of the Contractor's failure to submit the required information. Submission of forms and payrolls shall be current through the first full week of the month for the estimate period in order for the Project Engineer to process an estimate.

Bidders are advised to review the requirements regarding payroll submissions in Section 110 of the Standard Specifications.

**MISSISSIPPI DEPARTMENT OF TRANSPORTATION**

**SECTION 904 - NOTICE TO BIDDERS NO. 1312**

**CODE: (SP)**

**DATE: 01/22/2007**

**SUBJECT: Rumble Stripe**

Bidders are hereby advised that when edge lines are placed over rumble strips, the pavement marking stripe must be applied using the atomization method instead of extrusion / ribbon method. The thickness of the stripe will be 60-mils, unless otherwise noted in the plans/proposal or pay item description. To ensure the proper alignment of the rumble stripes, the Contractor will be required to place a layout line to be followed during installation of the edge lines over the rumble strips.

# MISSISSIPPI DEPARTMENT OF TRANSPORTATION

SECTION 904 - NOTICE TO BIDDERS NO. 1405

CODE: (IS)

DATE: 03/15/2007

SUBJECT: ERRATA AND MODIFICATIONS TO THE 2004 STANDARD SPECIFICATIONS

<u>Page</u>	<u>Subsection</u>	<u>Change</u>
101	201.01	In the second sentence of the first paragraph, change “salvable” to “salvageable”.
107	202.04	In the fourth sentence of the fourth paragraph, change “yard” to “feet”.
107	202.05	In the list of units measurements for 202-B, add “square foot”.
132	211.03.4	In the second sentence of the second paragraph, change “planted” to “plated”.
192	306.02.4	In the first line of the first paragraph, delete the word “be”.
200	307.03.7	In the fourth sentence of the second paragraph, change “lime-fly ash” to “treated”.
236	401.01	Change the header from “Section 403” to “Section 401”.
242	401.02.3.2	In the first sentence of the third full paragraph, add “1/8” in the blank before the inch mark.
250	401.02.6.3	In the second sentence of the first paragraph on page 250, change “rutting over ”” to “rutting over 1/8” ”.
253	401.02.6.4.2	In the paragraph preceding the table, change “91.0” to “89.0”.
259	401.03.1.4	In the first paragraph, change “92.0 percent” to “the specified percentage (92.0 or 93.0)”.
269	403.03.2	In the table at the top of page 269, change the PI requirement from “ = ” to “ ≤ ”.

- 278 404.04 In the second sentence, change the subsection from “401.04” to “403.04”.
- 283 409.02.2 Change “PG 64-22” to “PG 67-22”.
- 294 413.02 In the first sentence of the second paragraph, change “707.02.1.3” to “Subsection 707.02.1.3”.
- 340 511.04 In the second sentence of the second paragraph, change “412” to “512”.
- 349 601.03.3 In the first sentence, change “804.03.2” to “804.03.5”.
- 355 603.02 Change the subsection reference for Joint mortar from “707.03” to “714.11”.
- 369 604.04 In the first sentence, change “601.04” to “Subsection 601.04”.
- 427 619.04 Delete the second paragraph.
- 442 625.04 In the third paragraph, change “626.04” to “Subsection 626.04”.
- 444 626.03.1.2 Delete the third sentence of the first paragraph.
- 464 631.02 Change the subsection reference for Water from “714.01.0” to “714.01.1”.
- 570 682.03 Change the subsection number from “682-03” to “682.03”.
- 575 683.10.4 Change the subsection number from “683.10.4” to “683.04”.
- 575 683.10.5 Change the subsection number from “683.10.5” to “683.05”.
- 596 701.02 In the table under the column titled “Cementations material required”, change Class F, FA” to “Class F FA,”.
- 603 702.11 In the first sentence, change “702.12” to “Subsection 702.12”.
- 612 703.04.2 In the fifth paragraph, delete “Subsection 703.11 and”.
- 616 703.07.2 In the Percentage By Weight Passing Square Mesh Sieves table, change the No. 10 requirement for Class 7 material from “30 - 10” to “30 - 100”.

- 618 703.13.1 In the first sentence of the first paragraph, change “703.09” to “703.06”.
- 618 703.13.2 In the first sentence, change “703.09” to “703.06”.
- 671 712.06.2.2 In the first sentence, change “712.05.1” to “Subsection 712.05.1”.
- 689 714.11.2 In the first sentence, change “412” to “512”.
- 709 715.09.5 In the first sentence of the first paragraph, change “guage” to “gauge”.
- 717 717.02.3.4 In the top line of the tension table, change “1 1/2” to “1 1/8” and change “1 1/8” to “1 1/2”.
- 741 720.05.2.2 In the last sentence of this subsection, change “720.05.2.1” to “Subsection 720.05.2.1”.
- 827 803.03.2.3.7.5.2 In the first sentence of the second paragraph, change “803.03.5.4” to “803.03.2.3.4”.
- 833 803.03.2.6 In the first sentence, change “803.03.7” to “803.03.2.5”.
- 854 804.02.11 In the last sentence of the first paragraph, change “automatically” to “automatic”.
- 859 804.02.13.1.3 In the last sentence, change Subsection “804.02.12.1” to “804.02.12”.
- 879 804.03.19.3.2 In the first sentence of the third paragraph, change “listed on of Approved” to “listed on the Approved”.
- 879 804.03.19.3.2 In the last sentence of the last paragraph, change “804.03.19.3.1” to “Subsection 804.03.19.3.1”.
- 962 814.02.3 In the first sentence, change “710.03” to “Subsection 710.03”.
- 976 820.03.2.1 In the first sentence, change “803.02.6” to “803.03.1.7”.
- 976 820.03.2.2 In the first sentence, change “803.03.9.6” to “803.03.1.9.2”.
- 985 Index Change the subsection reference for Petroleum Asphalt Cement from “702.5” to “702.05”.



985	Index	Change the subsection reference for the Definition of Asphaltic Cement or Petroleum Asphalt from “700.2” to “700.02”.
985	Index	Change the subsection reference for Automatic Batchers from “501.03.2.4” to “804.02.10.4”.
986	Index	Delete “501.03.2” as a subsection reference for Batching Plant & Equipment.
988	Index	Change the subsection reference for the Central Mixed Concrete from “501.03.3.2” to “804.02.11”.
988	Index	Change the subsection reference for the Concrete Batching Plant & Equipment from “501.03.2” to “804.02.11”.
999	Index	Delete “501.03.3.3” as a subsection reference for Truck Mixers.
1001	Index	Change the subsection reference for Edge Drain Pipes from “605.3.5” to “605.03.5”.
1002	Index	Change the subsection reference for Metal Posts from “713.05.2” to “712.05.2”.
1007	Index	Change the subsection reference for Coarse Aggregate of Cement Concrete Table from “703.3” to “703.03”.
1007	Index	Change the subsection reference for Composite Gradation for Mechanically Stabilized Courses Table from “703.8” to “703.08”.
1009	Index	Delete “501.03.3.3” as a subsection reference for Truck Mixers and Truck Agitators.
1010	Index	Delete reference to “Working Day, Definition of”.

**MISSISSIPPI DEPARTMENT OF TRANSPORTATION**

**SECTION 904 - NOTICE TO BIDDERS NO. 1546**

**CODE: (SP)**

**DATE: 05/23/2007**

**SUBJECT: Advancement of Materials**

Bidders are advised that **NO ADVANCEMENT OF MATERIALS**, as addressed in Subsection 109.06.2 of the Standard Specifications, will be allowed on this project.

## MISSISSIPPI DEPARTMENT OF TRANSPORTATION

SECTION 904 - NOTICE TO BIDDERS NO. 1808

CODE: (IS)

DATE: 09/09/2008

SUBJECT: Safety Apparel

Bidders are advised that the Code of Federal Regulations CFR 23 Part 634 final rule was adopted November 24, 2006 with an effective date of November 24, 2008. This rule requires that **"All workers within the right-of-way of a Federal-Aid Highway who are exposed either to traffic (vehicles using the highway for the purposes of travel) or to construction equipment within the work area shall wear high-visibility safety apparel"**. High-visibility safety apparel is defined in the CFR as **"personnel protective safety clothing that is intended to provide conspicuity during both daytime and nighttime usage, and that meets the Performance Class 2 or 3 requirements of the ANSI/ISEA 107-2004 publication entitled American National Standard for High-Visibility Safety Apparel and Headwear"**. All workers on Mississippi State Highway right-of-way shall comply with this Federal Regulation. Workers are defined by the CFR as **"people on foot whose duties place them within the right-of way of a Federal-Aid Highway, such as highway construction and maintenance forces, survey crews, utility crews, responders to incidents within the highway right-of-way, and law enforcement personnel when directing traffic, investigating crashes, and handling lane closures, obstructed roadways, and disasters within the right-of-way of a Federal-Aid Highway"**.

You can access this final rule at the following link:

<http://a257.g.akamaitech.net/7/257/2422/01jan20061800/edocket.access.gpo.gov/2006/pdf/E6-19910.pdf>

**MISSISSIPPI DEPARTMENT OF TRANSPORTATION**

**SECTION 904 - NOTICE TO BIDDERS NO. 1869**

**CODE: (SP)**

**DATE: 02/01/2008**

**SUBJECT: Minimum Wage Rate**

Bidders are advised of an increase in the minimum federal wage rate established by the United States Department of Labor Wage and Hour Division beginning July 24, 2007. On July 24, 2007, the minimum wage rate was increased to \$5.85 per hour.

MDOT gets the minimum wage rates and classifications that are used in proposals from the Department of Labor website. Because of delays in posting to the website, the wages rates and classifications in this proposal may not contain the latest information regarding wage rates and classifications.

Bidders are advised that regardless of the wage rates listed in the Supplement to FHWA 1273, minimum federal wage rates must be paid.

Below are Federal minimum wage rates and effective dates.

Beginning July 24, 2007 .....	\$ 5.85
Beginning July 25, 2008 .....	\$ 6.55
Beginning July 24, 2009 .....	\$ 7.25

## MISSISSIPPI DEPARTMENT OF TRANSPORTATION

SECTION 904 - NOTICE TO BIDDERS NO. 1918

CODE: (IS)

DATE: 03/26/2008

SUBJECT: DBE Forms, Participation and Payment

Bidders are hereby advised that the participation of a DBE Firm can not be counted towards the Prime Contractor's DBE goal until the amount being counted towards the goal has been paid to the DBE.

Form OCR-482 has been developed to comply with this requirement. Bidders are hereby advised that at the end of the job, the Prime Contractor will submit this form to the Project Engineer before the final estimate is paid and the project is closed out. This form certifies payments to all DBE Subcontractors over the life of the contract.

Form OCR-484 has also been developed to comply with this requirement. Bidders are hereby advised that each month, the Prime Contractors will submit this form to the Project Engineer no later than the 20<sup>th</sup> of each month. This form certifies payments to all Subcontractors and shows all firms even if the Prime Contractor has paid no monies to the firm during that estimate period (negative report). The Project Engineer will attach this form to the monthly estimate before forwarding the estimate to the Contract Administration Division for processing.

Bidders are also advised that Form OCR-485 will be completed by **ALL BIDDERS** submitting a bid proposal and **must be signed and included in the bid proposal package**. Failure to include Form OCR-485 in the bid proposal package will cause the Contractor's bid to be considered **irregular**.

DBE Forms, including Forms OCR-482, OCR-484 and OCR-485, can be obtained from the Office of Civil Rights Division, MDOT Administration Building, 401 North West Street, Jackson, MS, or at [www.gomdot.com](http://www.gomdot.com) under *Business, Disadvantaged Enterprise, Applications and Forms for the DBE Program, MDOT Forms*.

**MISSISSIPPI DEPARTMENT OF TRANSPORTATION**

**SECTION 904 - NOTICE TO BIDDERS NO. 1922**

**CODE: (SP)**

**DATE: 03/31/2008**

**SUBJECT: Non-Quality Control / Quality Assurance Concrete**

Bidders are advised that the following pay items will not be accepted based on the Quality Control / Quality Assurance (QC/QA) requirements of Section 804 of the specifications. The acceptance of these pay items will be based on sampling and testing at the project site by MDOT forces. The Contractor is required to submit mix designs to accomplish this work in accordance with Section 804 and perform normal Quality Control functions at the concrete plant. Acceptance will be in accordance with the requirements of 907-601, Structural Concrete, and TMD-20-04-00-000. At the discretion of the Engineer, the Contractor may request that the concrete be accepted based on QC/QA requirements.

<b><u>Pay Item</u></b>	<b><u>Description</u></b>
221	Paved Ditches
601	Structural Concrete, Minor Structures - manholes, inlets, catch basins, junction boxes, pipe headwalls, and pipe collars.
606	Guardrail Anchors
607	Fence Post Footings
608	Sidewalks
609	Curb and Gutter
614	Driveways
616	Median and Island Pavement
630	Sign Footings, except Overhead Sign Supports

## MISSISSIPPI DEPARTMENT OF TRANSPORTATION

| SECTION 904 - NOTICE TO BIDDERS NO. 1928

CODE: (IS)

| DATE: 04/14/2008

**SUBJECT: Federal Bridge Formula**

Bidders are hereby advised that Federal Highway Administration Publication No. FHWA-MC-94-007, **BRIDGE FORMULA WEIGHTS**, dated January 1994, is made a part of this contract when applicable.

Prior to the preconstruction conference, the Contractor shall advise the Engineer, in writing, what materials, if any, will be delivered to the jobsite via Interstate route(s).

Copies of the **BRIDGE FORMULA WEIGHTS** publication may be obtained by contacting:

Federal Highway Administration  
400 7<sup>th</sup> Street, SW  
Washington, DC 20590  
(202) 366-2212

or

| [http://ops.fhwa.dot.gov/freight/sw/brdgcalf/calc\\_page.htm](http://ops.fhwa.dot.gov/freight/sw/brdgcalf/calc_page.htm)

**MISSISSIPPI DEPARTMENT OF TRANSPORTATION**

**SECTION 904 – NOTICE TO BIDDERS NO. 2105**

**CODE: (SP)**

**DATE: 09/02/2008**

**SUBJECT: Standard Drawings**

Standard Drawings attached hereto shall govern appropriate items of required work.

Larger copies of Standard Drawings may be purchased from:

MDOT Plans Print Shop  
MDOT Shop Complex, Building C, Room 114  
2567 North West Street  
P.O. Box 1850  
Jackson, MS 39215-1850  
Telephone: (601) 359-7460  
or FAX: (601) 359-7461  
or e-mail: [plans@mdot.state.ms.us](mailto:plans@mdot.state.ms.us)



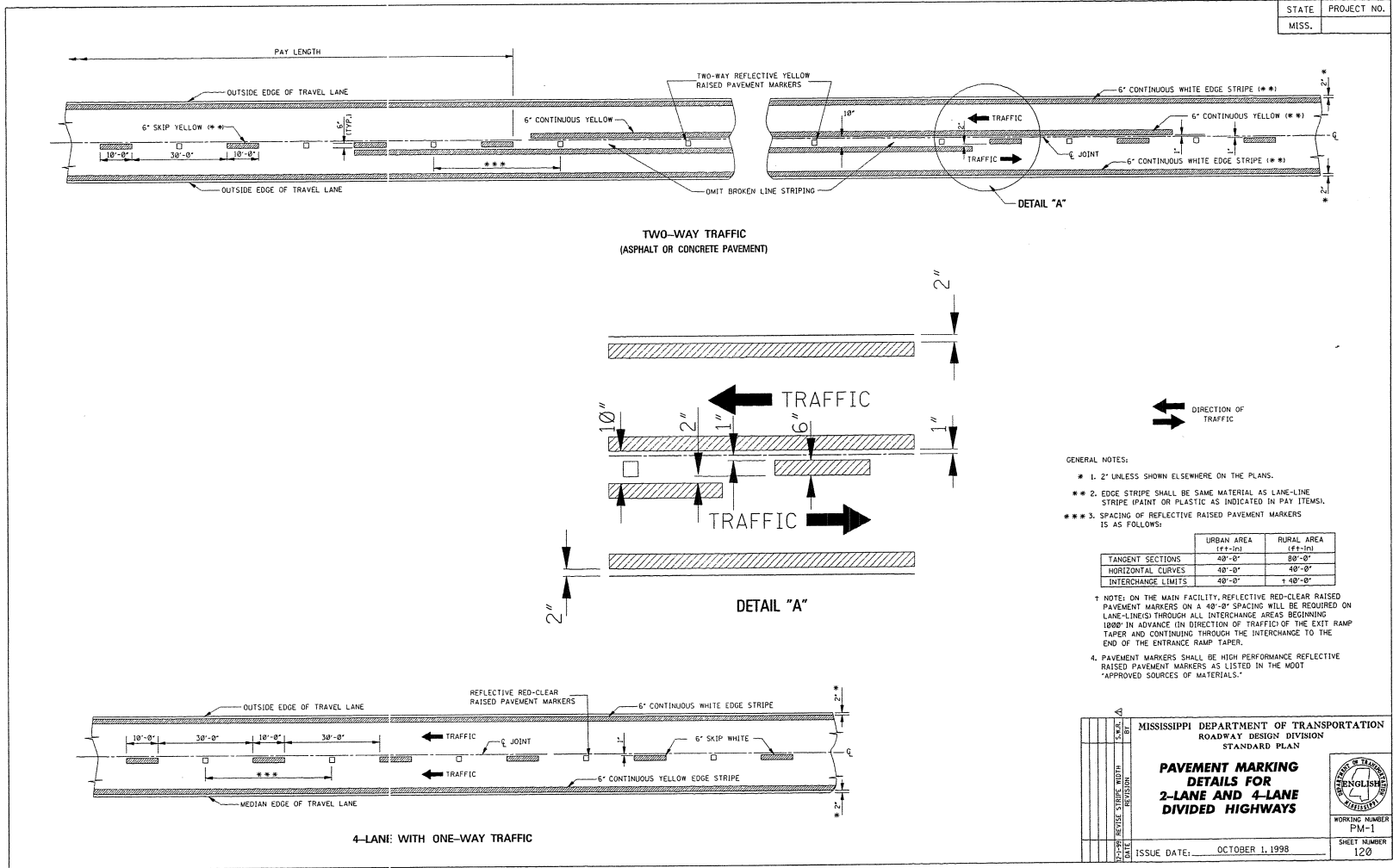

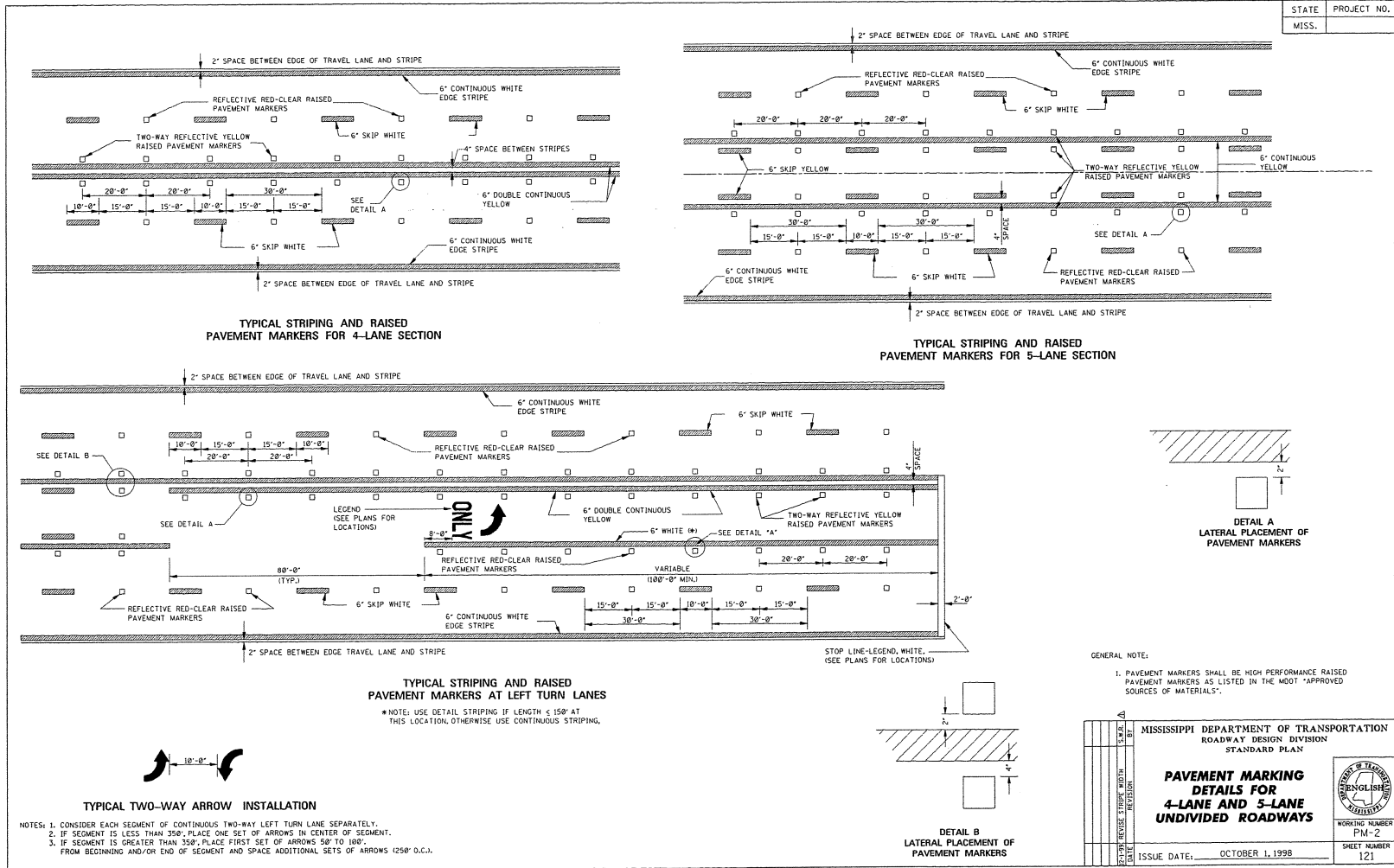

STATE	PROJECT NO.
MISS.	

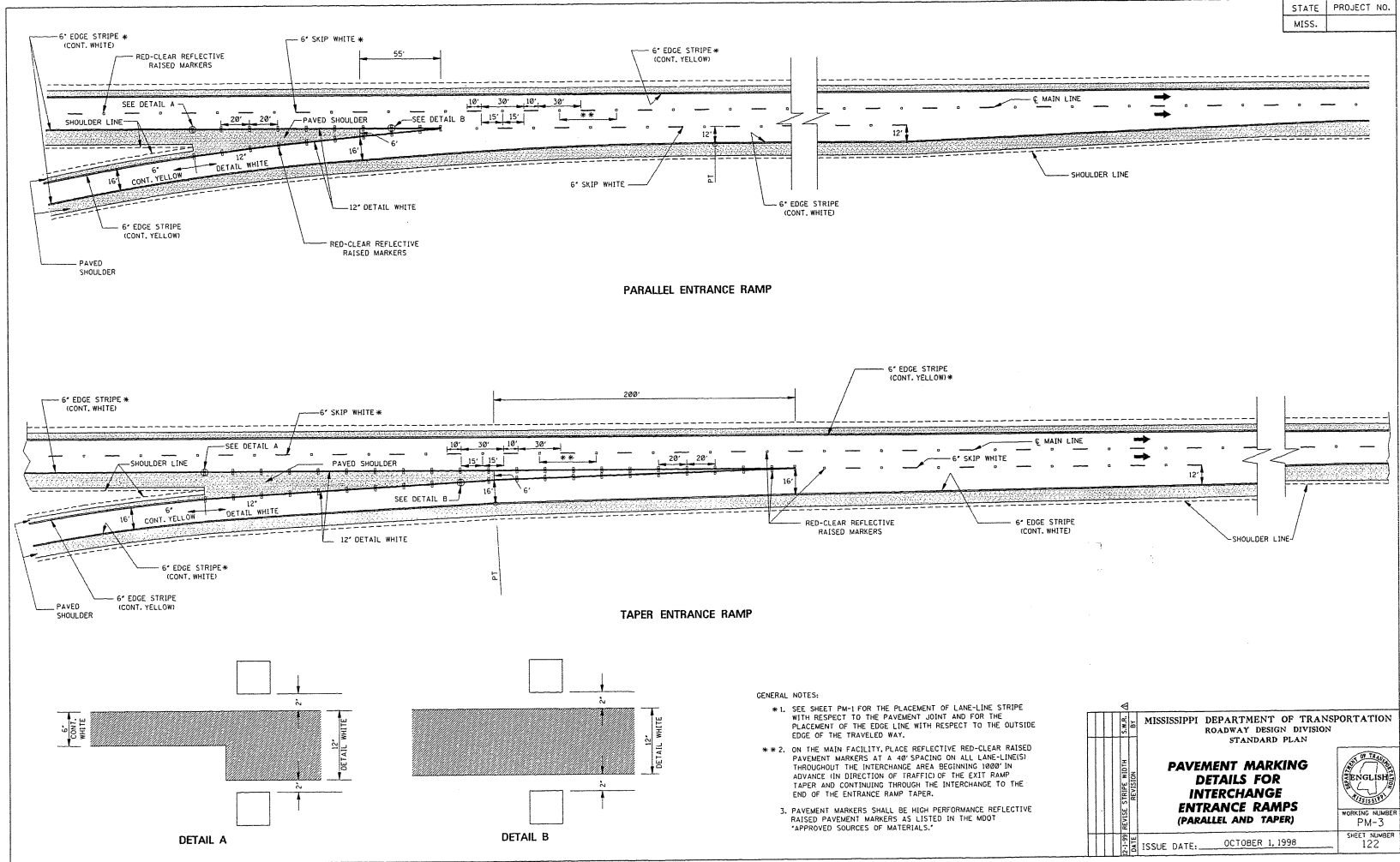

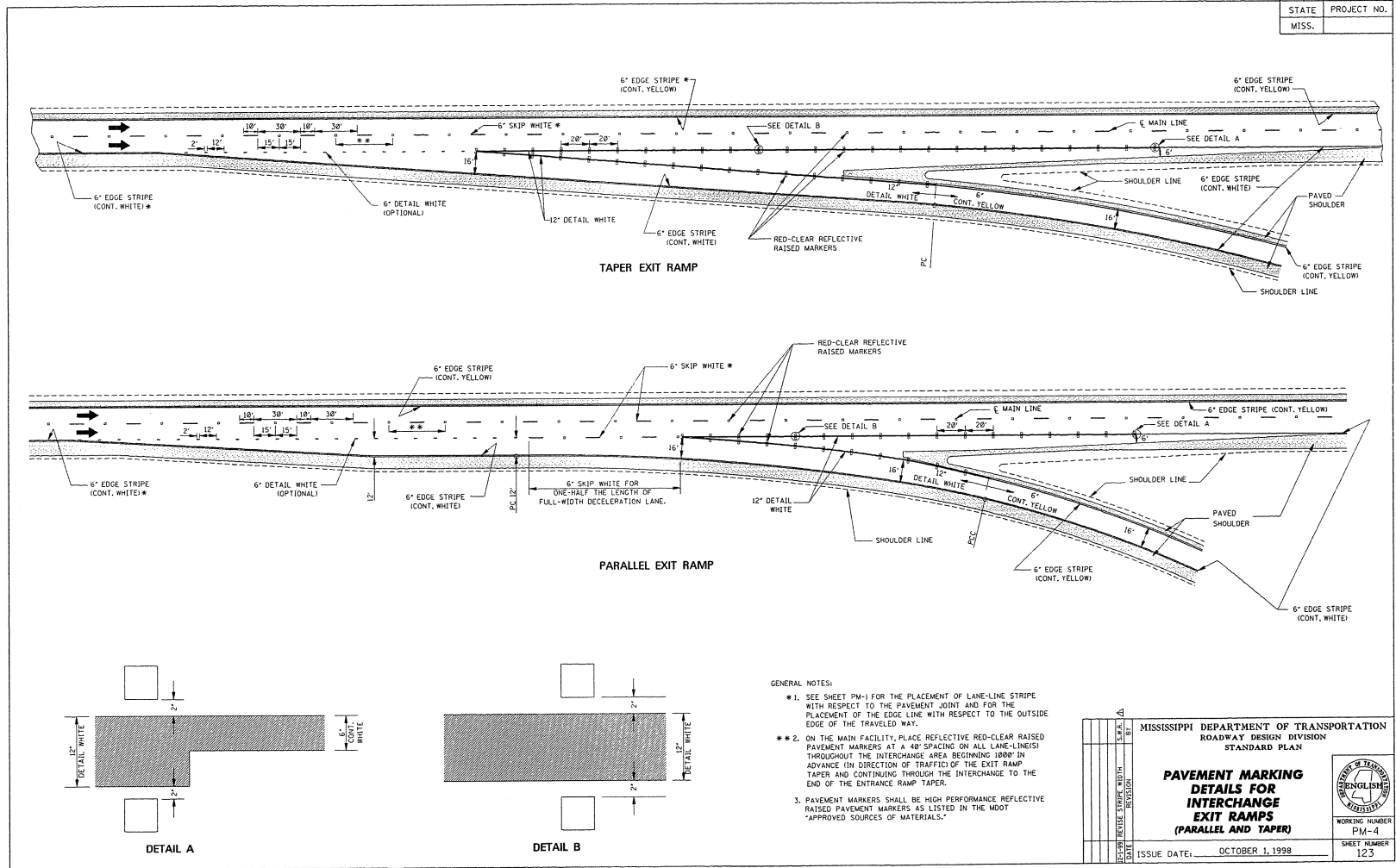

STATE PROJECT NO.  
MISS.

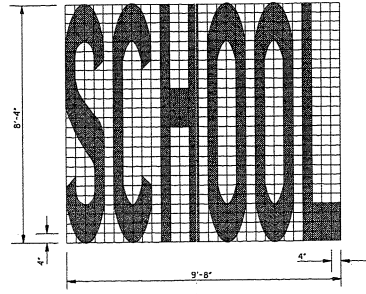
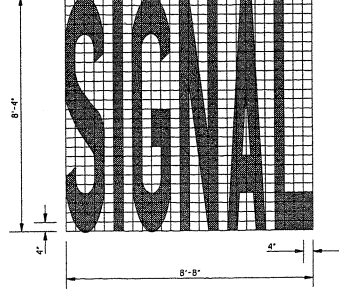
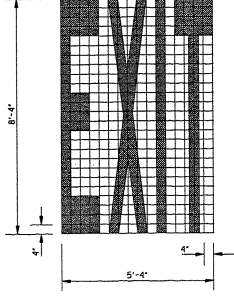
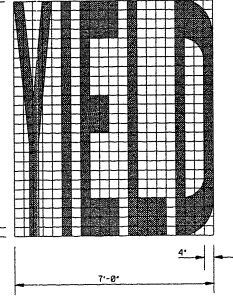
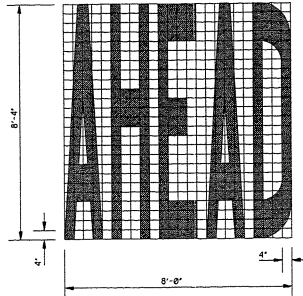
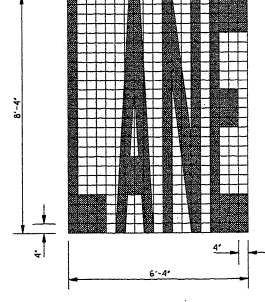
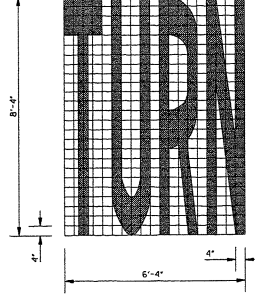
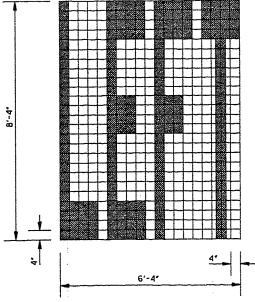
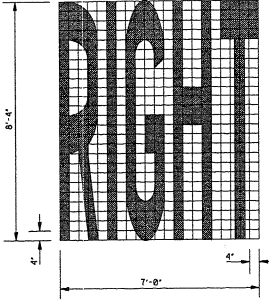
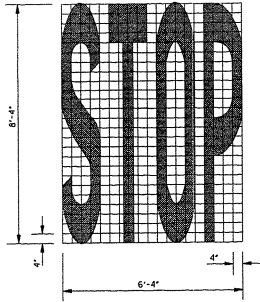

- GENERAL NOTES:
- UNLESS OTHERWISE SHOWN ON THE PLANS, ALL PAVEMENT MARKING LEGENDS SHALL BE APPLIED USING HIGH PERFORMANCE MATERIALS.
  - TWO HORIZONTAL GAPS CAUSED BY TEMPLATE CONNECTORS OF 1/4" OR LESS AND EXTENDING THE FULL WIDTH ARE PERMITTED IN EACH LETTER.
  - FOR OTHER DETAILS, SEE THE MANUAL ON UNIFORM TRAFFIC CONTROL DEVICES.
  - PAY QUANTITIES FOR PAVEMENT MARKING LEGENDS ARE AS FOLLOWS:

LEGEND	AREA (ft <sup>2</sup> )
STOP	24.6
RIGHT	28.6
LEFT	19.9
TURN	27.3
LANE	22.7
AHEAD	32.3
YIELD	26.8
EXIT	18.5
SIGNAL	32.5
SCHOOL	35.9

MISSISSIPPI DEPARTMENT OF TRANSPORTATION  
ROADWAY DESIGN DIVISION  
STANDARD PLAN

**PAVEMENT MARKING  
LEGEND DETAILS**

ISSUE DATE: OCTOBER 1, 1998

WORKING NUMBER  
PM-5

SHEET NUMBER  
124



STATE PROJECT NO.  
 MISS.

ONLY

TURN ARROW

THRU ARROW

COMBINATION ARROW

1-WAY ARROW

**GENERAL NOTES:**

- UNLESS OTHERWISE SHOWN ON THE PLANS, ALL PAVEMENT MARKING LEGENDS, INCLUDING TURN ARROWS, SHALL BE APPLIED USING HIGH PERFORMANCE MATERIALS.
- TWO HORIZONTAL GAPS (CAUSED BY TEMPLATE CONNECTORS) OF 1/2" OR LESS AND EXTENDING THE FULL WIDTH ARE PERMITTED IN EACH LETTER.
- FOR OTHER DETAILS, SEE THE MANUAL ON UNIFORM TRAFFIC CONTROL DEVICES.
- PAY QUANTITIES FOR PAVEMENT MARKING LEGENDS ARE AS FOLLOWS:

PAY QUANTITIES	
LEGEND/SYMBOL	AREA (ft <sup>2</sup> )
ONLY	22.0
TURN ARROW	16.4
THRU ARROW	12.3
COMB. ARROW	27.5
1-WAY ARROW	24.3

MISSISSIPPI DEPARTMENT OF TRANSPORTATION  
ROADWAY DESIGN DIVISION  
STANDARD PLAN

**PAVEMENT MARKING  
LEGEND DETAILS**

DATE  
 SCALE  
 ISSUE DATE: OCTOBER 1, 1998

WORKING NUMBER  
PM-6  
SHEET NUMBER  
125

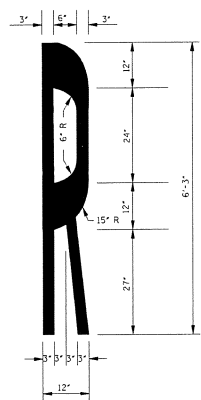
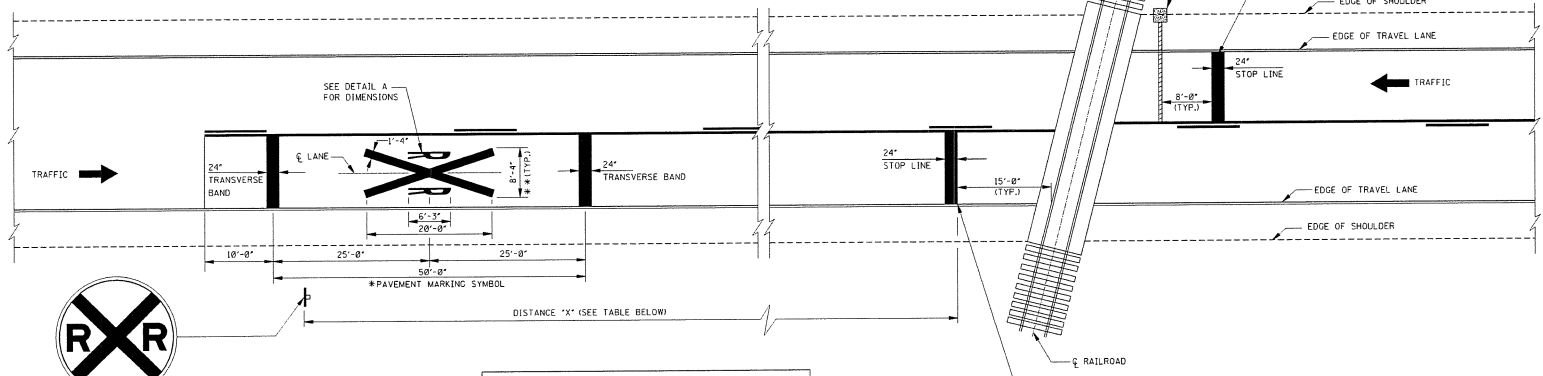
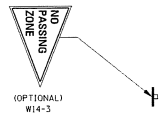

DETAIL A  
STANDARD "R" PAVEMENT MARKING  
FOR R X R SYMBOL

POSTED SPEED (mph)	DISTANCE "X" (FT)	
	RURAL	URBAN
20	175	100
25	250	100
30	325	100
35	400	150
40	475	225
45	550	300
50	625	375
55	700	450
60	775	550

NOTES:  
 ① DISTANCE "X" MAY BE ADJUSTED IF PROHIBITIVE PHYSICAL CONDITIONS EXIST AT THE DESIGNATED DISTANCE.  
 ② THESE DISTANCES MAY BE ADJUSTED TO A MINIMUM OF 100' IN RESIDENTIAL AREAS OR BUSINESS DISTRICTS WHERE LOW SPEEDS ARE PREVALENT.

- GENERAL NOTES:
- \*1. A PORTION OF THE PAVEMENT MARKING SYMBOL SHOULD BE DIRECTLY OPPOSITE THE ADVANCE WARNING SIGN (W10-1).
  - \*2. WIDTH OF R X R SYMBOL MAY VARY ACCORDING TO LANE WIDTH. HOWEVER, ON MULTI-LANE ROADS, THE TRANSVERSE BANDS AND STOP LINE SHOULD EXTEND ACROSS ALL APPROACH LANES, AND INDIVIDUAL R X R SYMBOLS SHOULD BE USED IN EACH APPROACH LANE.
  - \*3. R X R SYMBOL (63.0 ft<sup>2</sup>), TRANSVERSE BANDS AND STOP LINE SHALL BE PAID FOR AS LEGEND, WHITE (PLASTIC), MATERIAL (OPTIONAL FOR OTHER AGENCIES).
  - \*4. REFER TO THE "MANUAL ON UNIFORM TRAFFIC CONTROL DEVICES" FOR LOCATION OF PROPOSED WARNING DEVICES AT RAILROAD-HIGHWAY GRADE CROSSINGS.

MISSISSIPPI DEPARTMENT OF TRANSPORTATION  
ROADWAY DESIGN DIVISION  
STANDARD PLAN

**W10-1  
W14-3  
W15-1  
W15-2  
W15-3  
W15-4  
W15-5  
W15-6  
W15-7  
W15-8  
W15-9  
W15-10  
W15-11  
W15-12  
W15-13  
W15-14  
W15-15  
W15-16  
W15-17  
W15-18  
W15-19  
W15-20  
W15-21  
W15-22  
W15-23  
W15-24  
W15-25  
W15-26  
W15-27  
W15-28  
W15-29  
W15-30  
W15-31  
W15-32  
W15-33  
W15-34  
W15-35  
W15-36  
W15-37  
W15-38  
W15-39  
W15-40  
W15-41  
W15-42  
W15-43  
W15-44  
W15-45  
W15-46  
W15-47  
W15-48  
W15-49  
W15-50  
W15-51  
W15-52  
W15-53  
W15-54  
W15-55  
W15-56  
W15-57  
W15-58  
W15-59  
W15-60  
W15-61  
W15-62  
W15-63  
W15-64  
W15-65  
W15-66  
W15-67  
W15-68  
W15-69  
W15-70  
W15-71  
W15-72  
W15-73  
W15-74  
W15-75  
W15-76  
W15-77  
W15-78  
W15-79  
W15-80  
W15-81  
W15-82  
W15-83  
W15-84  
W15-85  
W15-86  
W15-87  
W15-88  
W15-89  
W15-90  
W15-91  
W15-92  
W15-93  
W15-94  
W15-95  
W15-96  
W15-97  
W15-98  
W15-99  
W15-100**

**TYPICAL PLACEMENT OF WARNING SIGNS AND PAVEMENT MARKINGS AT RAILROAD HIGHWAY GRADE CROSSINGS**

STATE OF MISSISSIPPI  
WORKING NUMBER  
PM-7  
SHEET NUMBER  
126

ISSUE DATE: OCTOBER 1, 1998

STATE PROJECT NO.  
MISS.

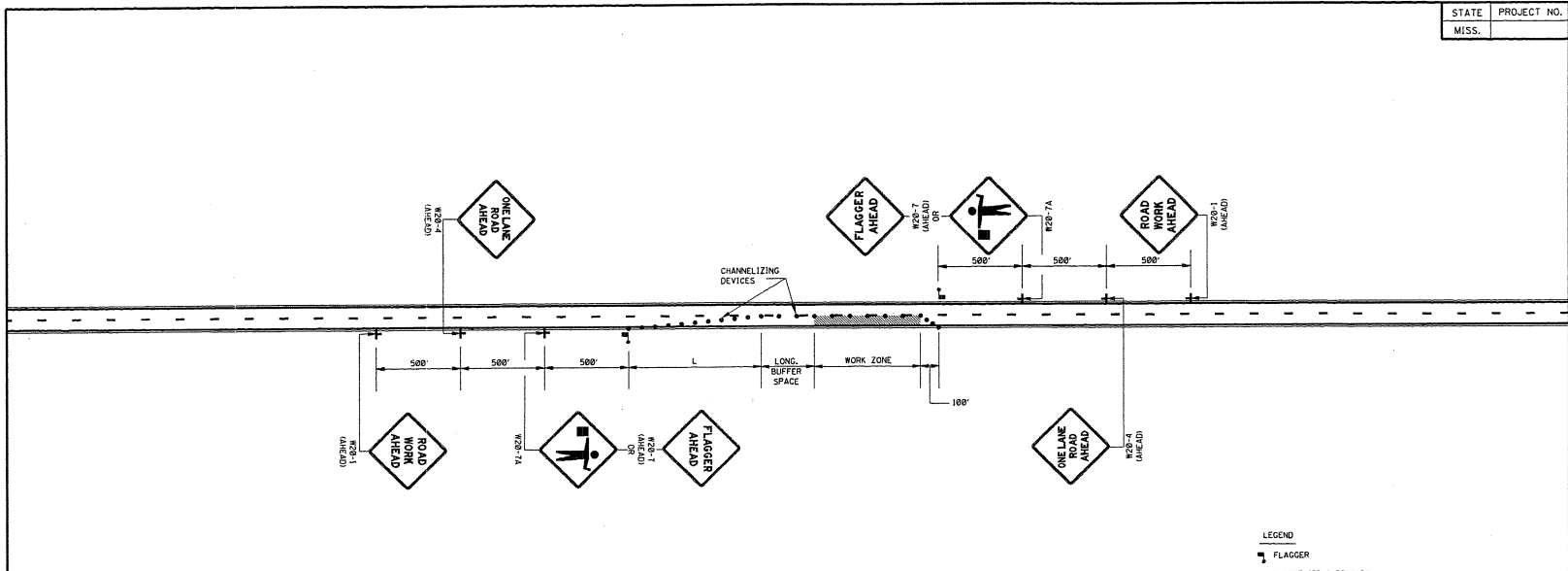

LEGEND  
 FLAGGER  
 CHANNELIZING DEVICES

GENERAL NOTES:  
 1. THE LOCATION OF CHANNELIZING DEVICES AND THE WORK AREA LAYOUT SHALL BE BASED ON THE CRITERIA IN THE FOLLOWING TABLE:

POSTED SPEED AND/OR DESIGN SPEED	MAXIMUM CHANNELIZING DEVICE SPACING (ft)		MINIMUM LONGITUDINAL BUFFER SPACE (ft)	TAPER RATES
	TAPER	ALONG LANE LINE & WORK ZONE		
40	40	80	170	27:1
45	45	90	220	45:1
50	50	100	280	58:1
55	55	110	335	55:1
60	60	120	415	60:1
65	65	130	485	65:1
70	70	140	575	70:1

\* NOTE: TAPER RATES ARE DETERMINED USING THE FOLLOWING EQUATIONS:  
 $L = WS$  FOR SPEEDS OF 45 mph OR GREATER  
 $L = WS^2/60$  FOR SPEEDS OF 40 mph OR LESS  
 WHERE: L = MINIMUM LENGTH OF TAPER IN FEET  
 W = WIDTH OF OFFSET (USUALLY LANE WIDTH) IN FEET  
 S = DESIGN SPEED OR 85TH PERCENTILE SPEED IN MILES PER HOUR

- ALL CHANNELIZING DEVICES SHALL BE A MINIMUM OF 24" IN HEIGHT.
- ALL TRAFFIC CONTROL ITEMS SHOWN ON THIS SHEET WILL NOT BE MEASURED FOR SEPARATE PAYMENT. THIS WORK IS TO BE INCLUDED IN THE PRICE BID FOR MAINTENANCE OF TRAFFIC.
- DIAMOND SHAPED TRAFFIC CONTROL SIGNS SHALL BE A MINIMUM OF 48" x 48".
- WHEN THERE IS NO EXISTING HAZARD OR AT THE END OF THE WORK DAY, ALL SIGNS SHALL BE COVERED OR REMOVED AND ALL CHANNELIZING DEVICES SHALL BE MOVED TO THE SHOULDER EDGE.
- WHERE THE WORK ZONE IS STATIONARY, THE W20-7 (500 FT.) SIGN OR THE W20-7A SIGN TOGETHER WITH THE W20-7 (500 FT.) SUPPLEMENTAL PLATE SHOULD BE USED TO INDICATE THE DISTANCE TO THE FLAGGER.

MISSISSIPPI DEPARTMENT OF TRANSPORTATION  
 ROADWAY DESIGN DIVISION  
 STANDARD PLAN

**TRAFFIC CONTROL PLAN  
 WITH FLAGGER  
 (ONE-LANE CLOSURE OF  
 TWO-WAY TRAFFIC)**

WORKING NUMBER  
 TCP-1

SHEET NUMBER  
 250

ISSUE DATE: OCTOBER 1, 1998



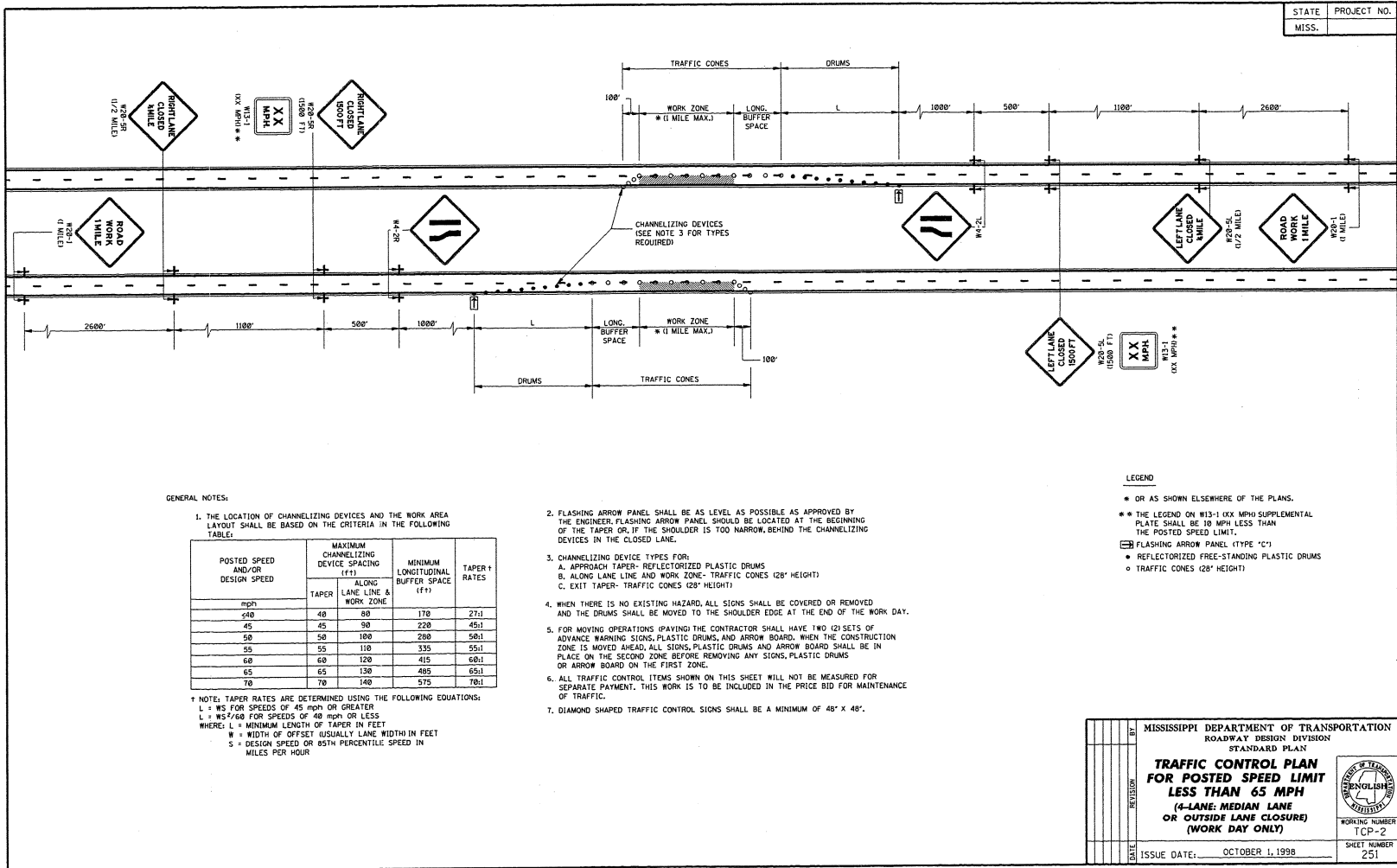

STATE PROJECT NO.  
MISS. \_\_\_\_\_

GENERAL NOTES:

1. THE LOCATION OF CHANNELIZING DEVICES AND THE WORK AREA LAYOUT SHALL BE BASED ON THE CRITERIA IN THE FOLLOWING TABLE:

POSTED SPEED AND/OR DESIGN SPEED	MAXIMUM CHANNELIZING DEVICE SPACING (ft)		MINIMUM LONGITUDINAL BUFFER SPACE (ft)	TAPER † RATES
	TAPER	ALONG LANE LINE & WORK ZONE		
≤40	40	80	170	27:1
45	45	90	220	45:1
50	50	100	280	50:1
55	55	110	335	55:1
60	60	120	415	60:1
65	65	130	485	65:1
70	70	140	575	70:1

† NOTE: TAPER RATES ARE DETERMINED USING THE FOLLOWING EQUATIONS:  
 L = WS FOR SPEEDS OF 45 MPH OR GREATER  
 L = WS<sup>2</sup>/68 FOR SPEEDS OF 40 MPH OR LESS  
 WHERE: L = MINIMUM LENGTH OF TAPER IN FEET  
 W = WIDTH OF OFFSET USUALLY LANE WIDTH IN FEET  
 S = DESIGN SPEED OR 85TH PERCENTILE SPEED IN MILES PER HOUR

- FLASHING ARROW PANEL SHALL BE AS LEVEL AS POSSIBLE AS APPROVED BY THE ENGINEER. FLASHING ARROW PANEL SHOULD BE LOCATED AT THE BEGINNING OF THE TAPER OR, IF THE SHOULDER IS TOO NARROW, BEHIND THE CHANNELIZING DEVICES IN THE CLOSED LANE.
- CHANNELIZING DEVICE TYPES FOR:  
 A. APPROACH TAPER- REFLECTORIZED PLASTIC DRUMS  
 B. ALONG LANE LINE AND WORK ZONE- TRAFFIC CONES (28" HEIGHT)  
 C. EXIT TAPER- TRAFFIC CONES (28" HEIGHT)
- WHEN THERE IS NO EXISTING HAZARD, ALL SIGNS SHALL BE COVERED OR REMOVED AND THE DRUMS SHALL BE MOVED TO THE SHOULDER EDGE AT THE END OF THE WORK DAY.
- FOR MOVING OPERATIONS (PAVING) THE CONTRACTOR SHALL HAVE TWO (2) SETS OF ADVANCE WARNING SIGNS, PLASTIC DRUMS, AND ARROW BOARD. WHEN THE CONSTRUCTION ZONE IS MOVED AHEAD, ALL SIGNS, PLASTIC DRUMS AND ARROW BOARD SHALL BE IN PLACE ON THE SECOND ZONE BEFORE REMOVING ANY SIGNS, PLASTIC DRUMS OR ARROW BOARD ON THE FIRST ZONE.
- ALL TRAFFIC CONTROL ITEMS SHOWN ON THIS SHEET WILL NOT BE MEASURED FOR SEPARATE PAYMENT. THIS WORK IS TO BE INCLUDED IN THE PRICE BID FOR MAINTENANCE OF TRAFFIC.
- DIAMOND SHAPED TRAFFIC CONTROL SIGNS SHALL BE A MINIMUM OF 48" X 48".

LEGEND

- OR AS SHOWN ELSEWHERE OF THE PLANS.
- THE LEGEND ON W13-1 (XX MPH) SUPPLEMENTAL PLATE SHALL BE 10 MPH LESS THAN THE POSTED SPEED LIMIT.
- FLASHING ARROW PANEL (TYPE 'C')
- REFLECTORIZED FREE-STANDING PLASTIC DRUMS
- TRAFFIC CONES (28" HEIGHT)

MISSISSIPPI DEPARTMENT OF TRANSPORTATION ROADWAY DESIGN DIVISION STANDARD PLAN		
<b>TRAFFIC CONTROL PLAN FOR POSTED SPEED LIMIT LESS THAN 65 MPH (4-LANE, MEDIAN LANE OR OUTSIDE LANE CLOSURE) (WORK DAY ONLY)</b>		
ISSUE DATE: OCTOBER 1, 1998	WORKING NUMBER TCP-2	SHEET NUMBER 251

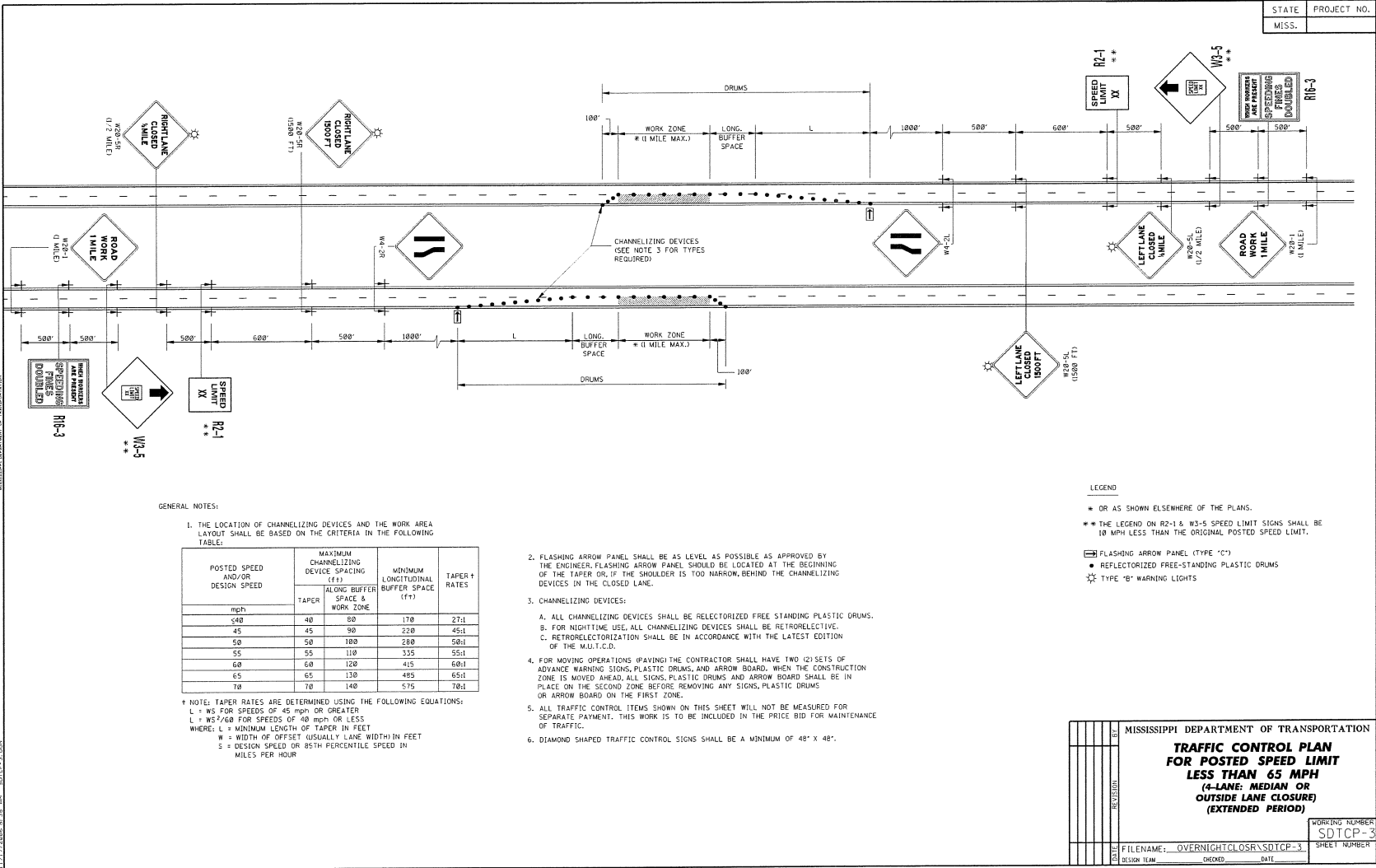

STATE	PROJECT NO.
MISS.	

GENERAL NOTES:

1. THE LOCATION OF CHANNELIZING DEVICES AND THE WORK AREA LAYOUT SHALL BE BASED ON THE CRITERIA IN THE FOLLOWING TABLE:

POSTED SPEED AND/OR DESIGN SPEED	MAXIMUM CHANNELIZING DEVICE SPACING (FT)		MINIMUM LONGITUDINAL BUFFER SPACE (FT)	TAPER RATES
	TAPER	ALONG BUFFER SPACE & WORK ZONE		
≤40	40	80	170	27:1
45	45	90	220	45:1
50	50	100	280	50:1
55	55	110	335	55:1
60	60	120	415	60:1
65	65	130	485	65:1
70	70	140	575	70:1

\* NOTE: TAPER RATES ARE DETERMINED USING THE FOLLOWING EQUATIONS:  
 L = WS FOR SPEEDS OF 45 MPH OR GREATER  
 L = WS<sup>2</sup>/60 FOR SPEEDS OF 40 MPH OR LESS  
 WHERE: L = MINIMUM LENGTH OF TAPER IN FEET  
 W = WIDTH OF OFFSET (USUALLY LANE WIDTH) IN FEET  
 S = DESIGN SPEED OR 85TH PERCENTILE SPEED IN MILES PER HOUR

- FLASHING ARROW PANEL SHALL BE AS LEVEL AS POSSIBLE AS APPROVED BY THE ENGINEER. FLASHING ARROW PANEL SHOULD BE LOCATED AT THE BEGINNING OF THE TAPER OR, IF THE SHOULDER IS TOO NARROW, BEHIND THE CHANNELIZING DEVICES IN THE CLOSED LANE.
- CHANNELIZING DEVICES:
  - ALL CHANNELIZING DEVICES SHALL BE REFLECTORIZED FREE STANDING PLASTIC DRUMS.
  - FOR NIGHTTIME USE, ALL CHANNELIZING DEVICES SHALL BE RETROREFLECTIVE.
  - RETROREFLECTORIZATION SHALL BE IN ACCORDANCE WITH THE LATEST EDITION OF THE M.U.T.C.D.
- FOR MOVING OPERATIONS (PAVING) THE CONTRACTOR SHALL HAVE TWO (2) SETS OF ADVANCE WARNING SIGNS, PLASTIC DRUMS, AND ARROW BOARDS. WHEN THE CONSTRUCTION ZONE IS MOVED AHEAD, ALL SIGNS, PLASTIC DRUMS AND ARROW BOARD SHALL BE IN PLACE ON THE SECOND ZONE BEFORE REMOVING ANY SIGNS, PLASTIC DRUMS OR ARROW BOARD ON THE FIRST ZONE.
- ALL TRAFFIC CONTROL ITEMS SHOWN ON THIS SHEET WILL NOT BE MEASURED FOR SEPARATE PAYMENT. THIS WORK IS TO BE INCLUDED IN THE PRICE BID FOR MAINTENANCE OF TRAFFIC.
- DIAMOND SHAPED TRAFFIC CONTROL SIGNS SHALL BE A MINIMUM OF 48" X 48".

- LEGEND
- OR AS SHOWN ELSEWHERE OF THE PLANS.
  - \*\* THE LEGEND ON R2-1 & W3-5 SPEED LIMIT SIGNS SHALL BE 10 MPH LESS THAN THE ORIGINAL POSTED SPEED LIMIT.
  - FLASHING ARROW PANEL (TYPE "C")
  - REFLECTORIZED FREE-STANDING PLASTIC DRUMS
  - TYPE "B" WARNING LIGHTS

MISSISSIPPI DEPARTMENT OF TRANSPORTATION	
<b>TRAFFIC CONTROL PLAN FOR POSTED SPEED LIMIT LESS THAN 65 MPH (4-LANE: MEDIAN OR OUTSIDE LANE CLOSURE) (EXTENDED PERIOD)</b>	
WORKING NUMBER SDTCP-3	SHEET NUMBER
FILENAME: OVERNIGHTCLOS\SDTCP-3	
DESIGN TEAM	CHECKED DATE

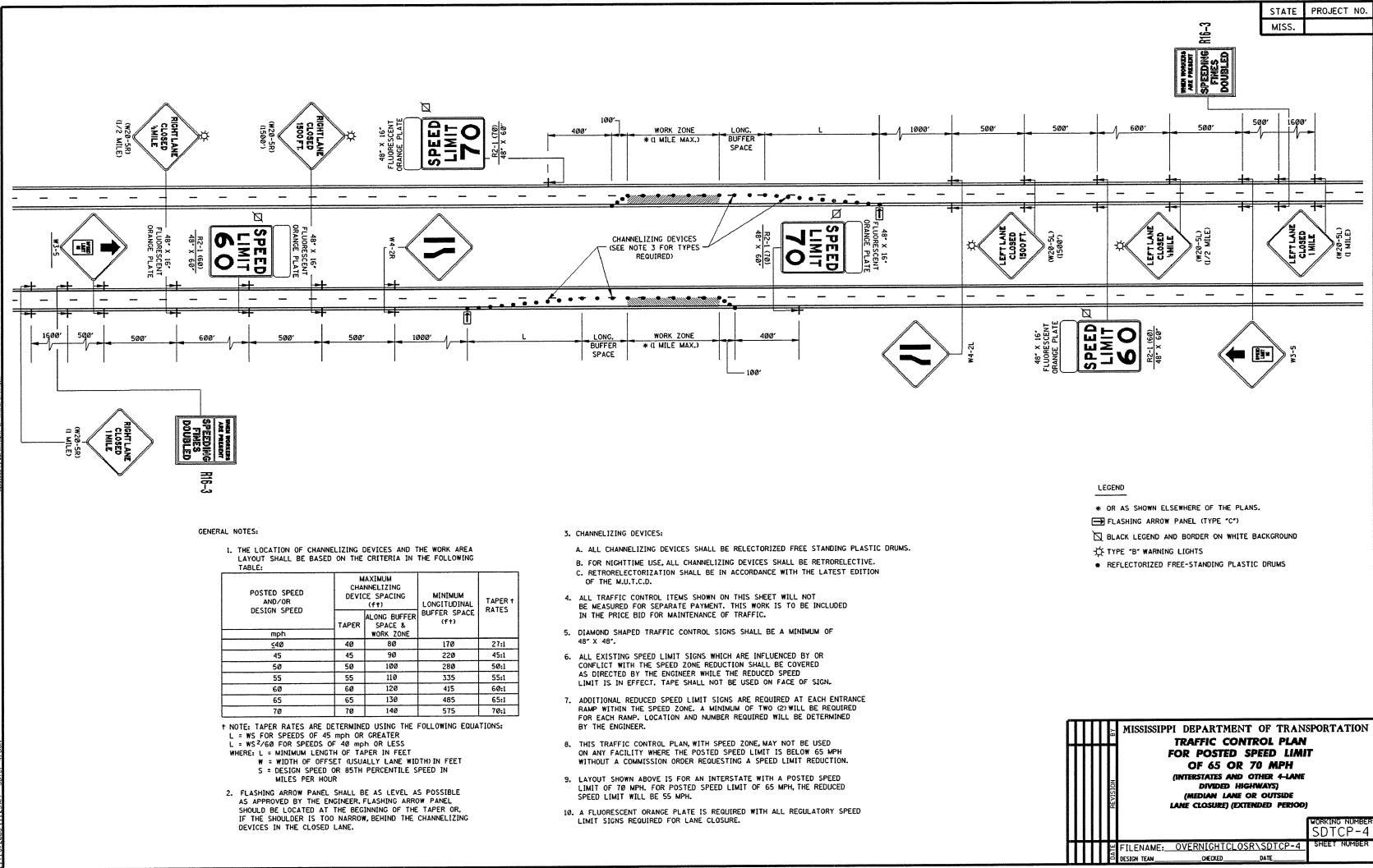

STATE PROJECT NO.  
MISS. \_\_\_\_\_

GENERAL NOTES:  
1. THE LOCATION OF CHANNELIZING DEVICES AND THE WORK AREA LAYOUT SHALL BE BASED ON THE CRITERIA IN THE FOLLOWING TABLE:

POSTED SPEED AND/OR DESIGN SPEED	MAXIMUM CHANNELIZING DEVICE SPACING (ft)		MINIMUM LONGITUDINAL BUFFER SPACE (ft)	TAPER + RATES
	TAPER	ALONG BUFFER SPACE & WORK ZONE		
≤40	40	80	120	27:1
45	45	90	220	45:1
50	50	100	280	50:1
55	55	110	335	55:1
60	60	120	415	60:1
65	65	130	485	65:1
70	70	140	575	70:1

\* NOTE: TAPER RATES ARE DETERMINED USING THE FOLLOWING EQUATIONS:  
 L = WS FOR SPEEDS OF 45 MPH OR GREATER  
 L = WS/50 FOR SPEEDS OF 40 MPH OR LESS  
 WHERE: L = MINIMUM LENGTH OF TAPER IN FEET  
 W = WIDTH OF OFFSET (USUALLY LANE WIDTH) IN FEET  
 S = DESIGN SPEED OR 85TH PERCENTILE SPEED IN MILES PER HOUR

2. FLASHING ARROW PANEL SHALL BE AS LEVEL AS POSSIBLE AS APPROVED BY THE ENGINEER. FLASHING ARROW PANEL SHOULD BE LOCATED AT THE BEGINNING OF THE TAPER OR, IF THE SHOULDER IS TOO NARROW, BEHIND THE CHANNELIZING DEVICES IN THE CLOSED LANE.

3. CHANNELIZING DEVICES:  
 A. ALL CHANNELIZING DEVICES SHALL BE RELECTORIZED FREE STANDING PLASTIC DRUMS.  
 B. FOR NIGHTTIME USE, ALL CHANNELIZING DEVICES SHALL BE RETROREFLECTIVE.  
 C. RETROREFLECTORIZATION SHALL BE IN ACCORDANCE WITH THE LATEST EDITION OF THE M.U.T.C.D.
4. ALL TRAFFIC CONTROL ITEMS SHOWN ON THIS SHEET WILL NOT BE MEASURED FOR SEPARATE PAYMENT. THIS WORK IS TO BE INCLUDED IN THE PRICE BID FOR MAINTENANCE OF TRAFFIC.
5. DIAMOND SHAPED TRAFFIC CONTROL SIGNS SHALL BE A MINIMUM OF 48" X 48".
6. ALL EXISTING SPEED LIMIT SIGNS WHICH ARE INFLUENCED BY OR CONFLICT WITH THE SPEED ZONE REDUCTION SHALL BE COVERED AS DIRECTED BY THE ENGINEER WHILE THE REDUCED SPEED LIMIT IS IN EFFECT. TAPE SHALL NOT BE USED ON FACE OF SIGN.
7. ADDITIONAL REDUCED SPEED LIMIT SIGNS ARE REQUIRED AT EACH ENTRANCE RAMP WITHIN THE SPEED ZONE. A MINIMUM OF TWO (2) WILL BE REQUIRED FOR EACH RAMP. LOCATION AND NUMBER REQUIRED WILL BE DETERMINED BY THE ENGINEER.
8. THIS TRAFFIC CONTROL PLAN, WITH SPEED ZONE, MAY NOT BE USED ON ANY FACILITY WHERE THE POSTED SPEED LIMIT IS BELOW 65 MPH WITHOUT A COMMISSION ORDER REQUESTING A SPEED LIMIT REDUCTION.
9. LAYOUT SHOWN ABOVE IS FOR AN INTERSTATE WITH A POSTED SPEED LIMIT OF 70 MPH. FOR POSTED SPEED LIMIT OF 65 MPH, THE REDUCED SPEED LIMIT WILL BE 55 MPH.
10. A FLUORESCENT ORANGE PLATE IS REQUIRED WITH ALL REGULATORY SPEED LIMIT SIGNS REQUIRED FOR LANE CLOSURE.

- LEGEND
- OR AS SHOWN ELSEWHERE OF THE PLANS.
  - FLASHING ARROW PANEL (TYPE "C")
  - BLACK LEGEND AND BORDER ON WHITE BACKGROUND
  - TYPE "B" WARNING LIGHTS
  - REFLECTORIZED FREE-STANDING PLASTIC DRUMS

MISSISSIPPI DEPARTMENT OF TRANSPORTATION  
**TRAFFIC CONTROL PLAN**  
**FOR POSTED SPEED LIMIT**  
**OF 65 OR 70 MPH**  
 (INTERSTATES AND OTHER 4-LANE  
 DIVIDED HIGHWAYS)  
 (MEDIAN LANE OR OUTSIDE  
 LANE CLOSURE) (EXTENDED PERIOD)

WORKING NUMBER: SDTCP-4  
 SHEET NUMBER: \_\_\_\_\_

FILENAME: OVERNIGHTCLOS\SDTCP-4  
 DESIGN TEAM: \_\_\_\_\_ CHECKED: \_\_\_\_\_ DATE: \_\_\_\_\_

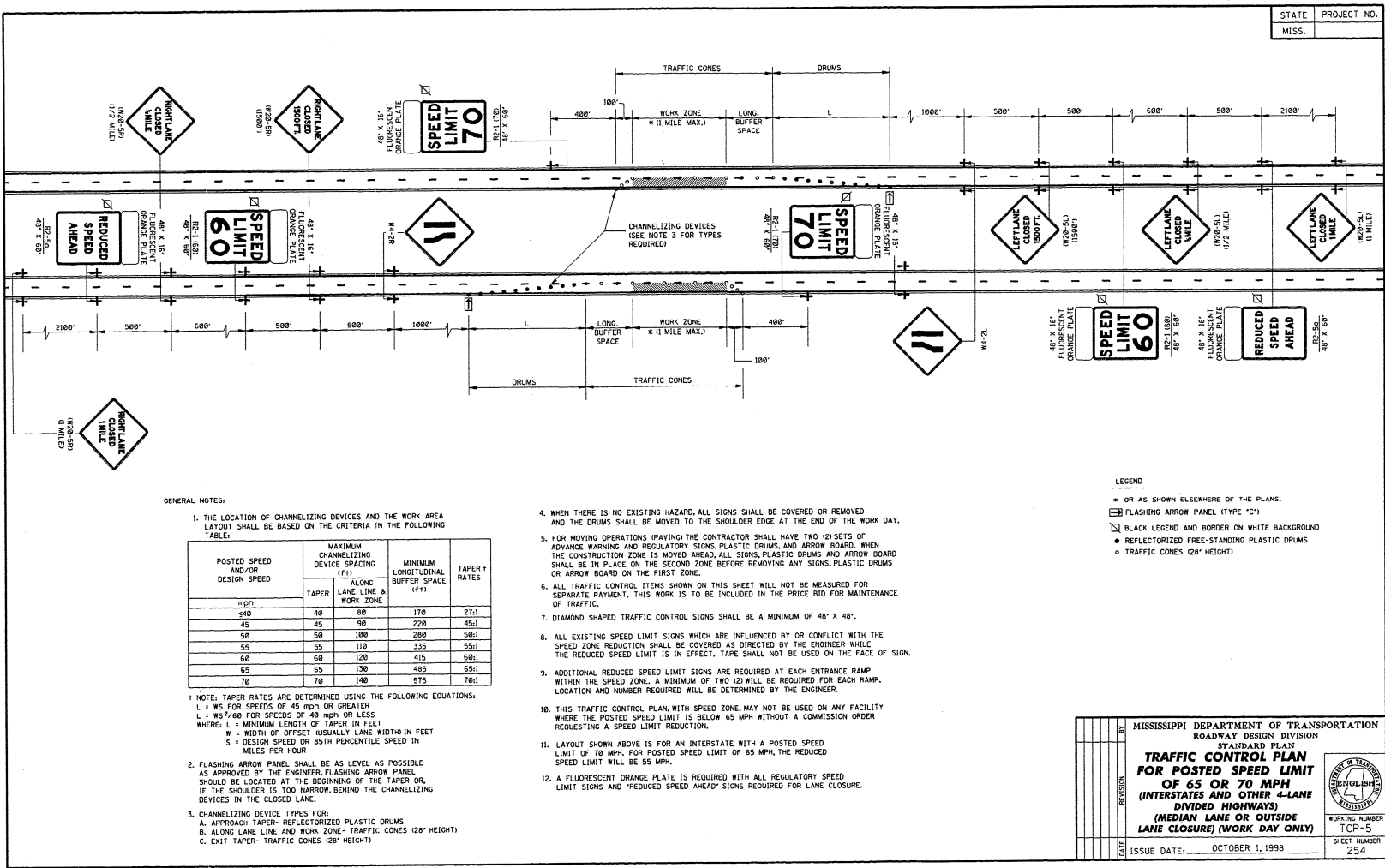

MISSISSIPPI DEPARTMENT OF TRANSPORTATION  
ROADWAY DESIGN DIVISION  
STANDARD PLAN  
**TRAFFIC CONTROL PLAN**  
**FOR POSTED SPEED LIMIT**  
**OF 65 OR 70 MPH**  
**(INTERSTATES AND OTHER 4-LANE**  
**DIVIDED HIGHWAYS)**  
**(MEDIAN LANE OR OUTSIDE**  
**LANE CLOSURE) (WORK DAY ONLY)**

WORKING NUMBER  
TCP-5

SHEET NUMBER  
254

ISSUE DATE: OCTOBER 1, 1998

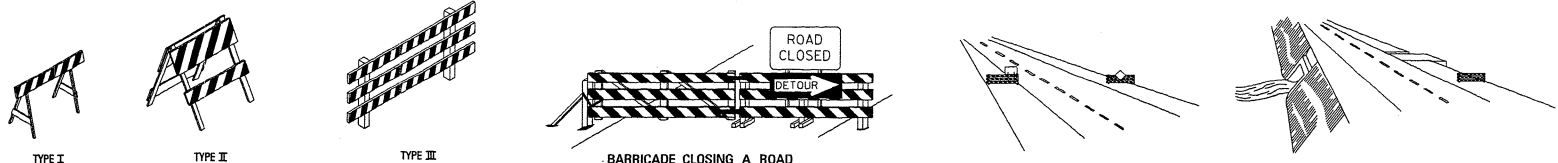

TYPE I                      TYPE II                      TYPE III

BARRICADE CLOSING A ROAD

**STANDARD BARRICADES**

1. A TYPE I BARRICADE CONSISTS OF ONE (1) HORIZONTAL RAIL SUPPORTED BY A DEMOUNTABLE FRAME OR A LIGHT "A" FRAME. A TYPE I BARRICADE NORMALLY WOULD BE USED ON CONVENTIONAL ROADS OR URBAN STREETS AND ARTERIALS.
2. A TYPE II BARRICADE CONSISTS OF TWO (2) HORIZONTAL RAILS ON A LIGHT "A" FRAME. TYPE II BARRICADES ARE INTENDED FOR USE ON EXPRESSWAYS AND FREEWAYS AND OTHER HIGH-SPEED ROADWAYS.
3. TYPE I AND TYPE II BARRICADES ARE INTENDED FOR USE WHERE THE HAZARD IS RELATIVELY SMALL AS, FOR EXAMPLE, ON CITY STREETS, OR FOR THE MORE OR LESS CONTINUOUS DELIMITING OF A RESTRICTED ROADWAY, OR FOR TEMPORARY DAYTIME USE.
4. A TYPE III BARRICADE CONSISTS OF THREE (3) HORIZONTAL RAILS SUPPORTED BY FIXED POSTS, A RIGID SKID, A HEAVY DEMOUNTABLE FRAME OR A HEAVY, HINGED "A" FRAME.
5. TYPE III BARRICADES ARE INTENDED FOR USE ON CONSTRUCTION AND MAINTENANCE PROJECTS AS WING BARRICADES AND AT ROAD CLOSURES, WHERE THEY MUST REMAIN IN PLACE FOR EXTENDED PERIODS.
6. THE MARKING FOR BARRICADE RAILS SHALL BE ORANGE AND WHITE (SLOPING DOWNWARD AT AN ANGLE OF 45° IN THE DIRECTION TRAFFIC IS TO PASS).
7. DO NOT PLACE SANDBAGS OR OTHER DEVICES TO PROVIDE MASS ON THE BOTTOM RAIL THAT WILL BLOCK VIEW OR RAIL FACE.
8. FOR ADDITIONAL INFORMATION OR DETAILS, SEE MUTCD, LATEST EDITION.

**BARRICADE CHARACTERISTICS**

	I	II	III
WIDTH OF RAIL **	8" MIN. - 12" MAX.	8" MIN. - 12" MAX.	8" MIN. - 12" MAX.
LENGTH OF RAIL **	24" MIN.	24" MIN.	48" MIN.
WIDTH OF STRIPE *	6"	6"	6"
HEIGHT	36" MIN.	36" MIN.	60" MIN.
NUMBER OF REFLECTORIZED RAIL FACES	2 (ONE EACH DIRECTION)	4 (TWO EACH DIRECTION)	3 IF FACING TRAFFIC IN ONE DIRECTION 6 IF FACING TRAFFIC IN TWO DIRECTIONS
TYPE OF FRAME	LIGHT	LIGHT "A" FRAME	POST OR SKID

- \* 1. FOR RAILS LESS THAN 36" LONG, 4" WIDE STRIPES MAY BE USED.
- \*\* 2. BARRICADES INTENDED FOR USE ON EXPRESSWAYS, FREEWAYS AND OTHER HIGH SPEED ROADWAYS, SHALL HAVE A MINIMUM OF 270 <sup>1/2</sup>" OF REFLECTIVE AREA FACING TRAFFIC.

**WING BARRICADES**

1. WING BARRICADES ARE TYPE III BARRICADES ERECTED ON THE SHOULDER ON ONE OR BOTH SIDES OF THE PAVEMENT TO GIVE THE SENSATION OF A NARROWING OR RESTRICTED ROADWAY. WING BARRICADES MAY BE USED AS A MOUNTING FOR THE ADVANCE WARNING SIGNS OR FLASHERS.
2. WING BARRICADES SHOULD BE USED:
  - A. IN ADVANCE OF A CONSTRUCTION PROJECT EVEN WHEN NO PART OF THE ROADWAY IS ACTUALLY CLOSED.
  - B. IN ADVANCE OF ALL BRIDGE OR CULVERT WIDENING OPERATIONS.

43

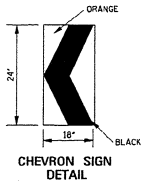

CHEVRON SIGN  
DETAIL

1. A CHEVRON SIGN CONSISTS OF A BLACK CHEVRON TYPE MARKING ON AN ORANGE BACKGROUND AND SHALL POINT IN THE DIRECTION OF TRAFFIC FLOW.
2. THE CHEVRON SIGN SHALL BE MOUNTED ON FIXED POST OR RIGID SKID.
3. CHEVRON SIGNS MAY BE USED TO SUPPLEMENT OTHER STANDARD DEVICES WHERE ONE OR MORE LANES ARE CLOSED FOR CONSTRUCTION OR MAINTENANCE. THEY SHALL BE PLACED APPROXIMATELY 2'-0" BEHIND THE LANE TRANSITION STRIPE.

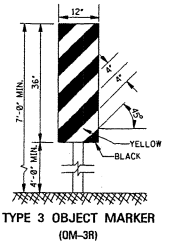

TYPE 3 OBJECT MARKER  
(OM-3R)

1. TYPE 3 OBJECT MARKERS SHALL BE USED AT ALL EXPOSED BRIDGE ABUTMENTS AND AT OTHER LOCATIONS AS DEEMED NECESSARY BY THE ENGINEER.
2. THE OM-3R IS SHOWN. THE OM-3L IS SIMILAR EXCEPT THE STRIPES SLOPE DOWNWARD FROM THE UPPER LEFT SIDE TO THE LOWER RIGHT SIDE AND SHALL BE PLACED ON THE LEFT SIDE OF THE OBJECT.
3. THE INSIDE EDGE OF THE MARKER SHALL BE IN LINE WITH THE INNER EDGE OF THE OBSTRUCTION.

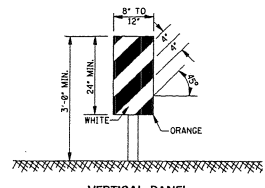

VERTICAL PANEL

1. VERTICAL PANELS CONSIST OF AT LEAST ONE PANEL 8" TO 12" IN WIDTH AND A MINIMUM OF 24" IN HEIGHT.
2. THE DIAGONAL STRIPES SHALL SLOPE DOWNWARD IN THE DIRECTION THAT TRAFFIC IS TO PASS THE PANEL. THE PANELS SHALL BE MOUNTED WITH THE TOP A MINIMUM OF 36" ABOVE THE ROADWAY ON A SINGLE LIGHTMASS POST.
3. VERTICAL PANELS USED ON EXPRESSWAYS, FREEWAYS AND OTHER HIGH-SPEED ROADWAYS SHALL HAVE A MINIMUM OF 270 <sup>1/2</sup>" OF RETROREFLECTIVE AREA FACING TRAFFIC.
4. FOR TWO-WAY TRAFFIC OPERATIONS, BACK-TO-BACK PANELS SHALL BE USED.

- GENERAL NOTES:
1. MARKINGS ON ALL DEVICES SHOWN ON THIS SHEET SHALL BE HIGH INTENSITY REFLECTIVE SHEETING.
  2. THE TRAFFIC CONTROL PLAN WILL LIST THE VARIOUS TRAFFIC CONTROL DEVICES REQUIRED FOR EACH PROJECT.

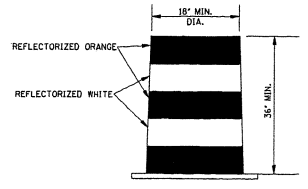

PLASTIC DRUM STRIPING DETAIL

1. PLASTIC DRUMS SHALL BE ON END AND USED AS AN EXPEDIENT METHOD FOR TRAFFIC CHANNELIZATION. THE COLOR AND MARKING OF DRUMS SHALL BE CONSISTENT WITH MARKING STANDARDS FOR BARRICADE. THE PREDOMINANT COLOR ON DRUMS SHALL BE ORANGE WITH FOUR (4) REFLECTORIZED, HORIZONTAL, CIRCUMFERENTIAL STRIPES (2 ORANGE & 2 WHITE) 6" WIDE.
2. DRUMS SHOULD NEVER BE PLACED IN THE ROADWAY WITHOUT WARNING SIGNS.
3. WHERE PRACTICAL PLASTIC DRUMS SHALL BE PLACED NO CLOSER THAN 3'-0" FROM THE EDGE OF TRAVELED LANE.

MISSISSIPPI DEPARTMENT OF TRANSPORTATION ROADWAY DESIGN DIVISION STANDARD PLAN		
<p><b>HIGHWAY SIGN AND BARRICADE DETAILS FOR CONSTRUCTION PROJECTS</b></p>		
DATE	ISSUE DATE: OCTOBER 1, 1998	WORKING NUMBER TCP-10 SHEET NUMBER 259

MOBILE OPERATIONS ON MULTILANE ROAD ▲

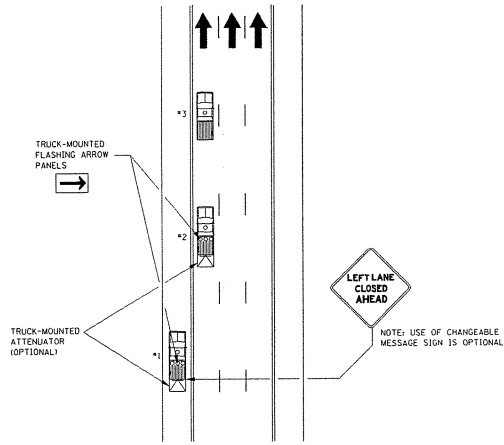

MOBILE OPERATIONS ON MULTILANE ROAD

NOTES:

1. VEHICLES USED FOR THESE OPERATIONS SHOULD BE MADE HIGHLY VISIBLE WITH APPROPRIATE EQUIPMENT, SUCH AS FLASHING LIGHTS, ROTATING BEACONS, FLAGS, SIGNS, OR ARROW PANELS.
2. PROTECTION VEHICLE #1 SHOULD BE EQUIPPED WITH AN ARROW PANEL. AN APPROPRIATE LANE CLOSURE SIGN SHOULD BE PLACED ON PROTECTION VEHICLE #1 SO AS NOT TO OBSCURE THE ARROW PANEL.
3. PROTECTION VEHICLE #2 SHOULD BE EQUIPPED WITH AN ARROW PANEL AND TRUCK-MOUNTED ATTENUATOR (TMA).
4. PROTECTION VEHICLE #1 SHOULD TRAVEL AT A VARYING DISTANCE FROM THE WORK OPERATION SO AS TO PROVIDE ADEQUATE SIGHT DISTANCE FOR TRAFFIC APPROACHING FROM THE REAR.
5. WHEN ADEQUATE SHOULDER WIDTH IS NOT AVAILABLE, PROTECTION VEHICLE #1 SHOULD BE ELIMINATED.
6. ON HIGH-SPEED ROADWAYS, A THIRD PROTECTION VEHICLE SHOULD BE USED (I.E., VEHICLE #1 ON THE SHOULDER IF PRACTICAL), VEHICLE #2 IN THE CLOSED LANE, AND VEHICLE #3 IN THE CLOSED LANE).
7. ARROW PANELS SHALL BE AS A MINIMUM TYPE B, 60" X 38" IN ACCORDANCE WITH THE CRITERIA PRESENTED IN THE MUTCD.
8. WORK SHOULD NORMALLY BE DONE DURING OFF-PEAK HOURS.
9. ALL TRAFFIC CONTROL ITEMS SHOWN ON THIS SHEET WILL NOT BE MEASURED FOR SEPARATE PAYMENT. THIS WORK IS TO BE INCLUDED IN THE PRICE BID FOR MAINTENANCE OF TRAFFIC.

MOBILE OPERATIONS ON TWO-LANE ROAD

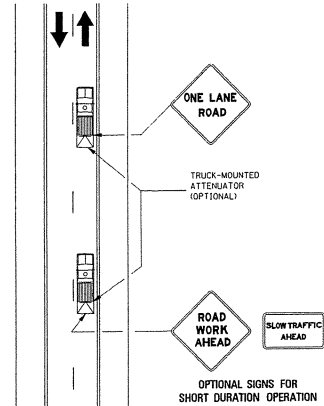

MOBILE OPERATIONS ON TWO-LANE ROAD

NOTES:

1. WHERE PRACTICAL AND WHEN NEEDED, THE WORK AND PROTECTION VEHICLES SHOULD PULL OVER PERIODICALLY TO ALLOW TRAFFIC TO PASS. IF THIS CAN NOT BE DONE FREQUENTLY, AS AN ALTERNATIVE, A "DO NOT PASS" SIGN MAY BE PLACED ON THE REAR OF THE VEHICLE BLOCKING THE LANE.
2. THE DISTANCE BETWEEN THE WORK AND PROTECTION VEHICLES MAY VARY ACCORDING TO TERRAIN, PAINT DRYING TIME, AND OTHER FACTORS. PROTECTION VEHICLES ARE USED TO WARN TRAFFIC OF THE OPERATION AHEAD. WHENEVER ADEQUATE STOPPING SIGHT DISTANCE EXISTS TO THE REAR, THE PROTECTION VEHICLE SHOULD MAINTAIN THE MINIMUM DISTANCE AND PROCEED AT THE SAME SPEED AS THE WORK VEHICLE. THE PROTECTION VEHICLE SHOULD SLOW DOWN IN ADVANCE OF VERTICAL OR HORIZONTAL CURVES THAT RESTRICT SIGHT DISTANCE.
3. ADDITIONAL PROTECTION VEHICLES TO WARN AND REDUCE THE SPEED OF ONCOMING OR OPPOSING TRAFFIC MAY BE USED. POLICE PATROL CARS MAY BE USED FOR THIS PURPOSE.
4. A TRUCK-MOUNTED ATTENUATOR (TMA) SHOULD BE USED ON THE PROTECTION VEHICLE AND MAY BE USED ON THE WORK VEHICLE.
5. THE WORK VEHICLE SHALL BE EQUIPPED WITH BEACONS, AND THE PROTECTION VEHICLES SHALL BE EQUIPPED WITH TWO HIGH-INTENSITY FLASHING LIGHTS MOUNTED ON THE REAR, ADJACENT TO THE SIGN. PROTECTION AND WORK VEHICLES SHOULD DISPLAY FLASHING OR ROTATING BEACONS BOTH FORWARD AND TO THE REAR.
6. VEHICLE-MOUNTED SIGNS SHALL BE MOUNTED WITH THE BOTTOM OF THE SIGN LOCATED AT A MINIMUM HEIGHT OF 48" ABOVE THE PAVEMENT. SIGN LEGENDS SHALL BE COVERED OR TURNED FROM VIEW WHEN WORK IS NOT IN PROGRESS.
7. ALL TRAFFIC CONTROL ITEMS SHOWN ON THIS SHEET WILL NOT BE MEASURED FOR SEPARATE PAYMENT. THIS WORK IS TO BE INCLUDED IN THE PRICE BID FOR MAINTENANCE OF TRAFFIC.

STATE	PROJECT NO.
MISS.	

MISSISSIPPI DEPARTMENT OF TRANSPORTATION ROADWAY DESIGN DIVISION STANDARD PLAN <b>TRAFFIC CONTROL PLAN          MOBILE OPERATIONS          MULTILANE ROADS          AND          TWO-LANE ROADS</b>	
ISSUE DATE: OCTOBER 1, 1998	

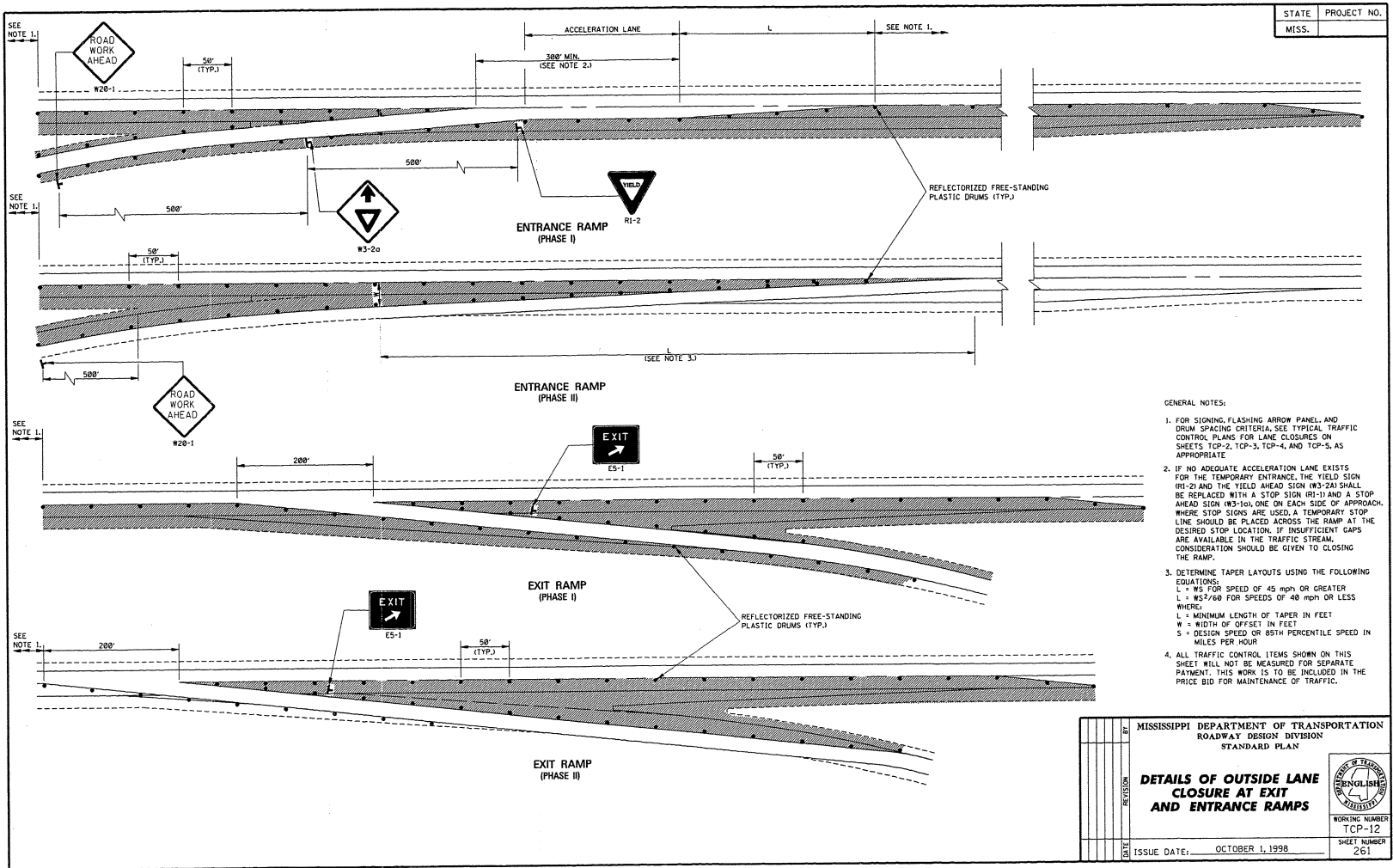

STATE	PROJECT NO.
MISS.	

- GENERAL NOTES:
- FOR SIGNING, FLASHING ARROW PANEL, AND DRUM SPACING CRITERIA, SEE TYPICAL TRAFFIC CONTROL PLANS FOR LANE CLOSURES ON SHEETS TCP-2, TCP-3, TCP-4, AND TCP-5, AS APPROPRIATE.
  - IF NO ADEQUATE ACCELERATION LANE EXISTS FOR THE TEMPORARY ENTRANCE, THE YIELD SIGN (RI-2) AND THE YIELD AHEAD SIGN (W3-2a) SHALL BE REPLACED WITH A STOP SIGN (RI-1) AND A STOP AHEAD SIGN (W3-1a), ONE ON EACH SIDE OF APPROACH. WHERE STOP SIGNS ARE USED, A TEMPORARY STOP LINE SHOULD BE PLACED ACROSS THE RAMP AT THE DESIRED STOP LOCATION. IF INSUFFICIENT GAPS ARE AVAILABLE IN THE TRAFFIC STREAM, CONSIDERATION SHOULD BE GIVEN TO CLOSING THE RAMP.
  - DETERMINE TAPER LAYOUTS USING THE FOLLOWING EQUATIONS:  
 $L = WS$  FOR SPEED OF 45 mph OR GREATER  
 $L = WS^2/60$  FOR SPEEDS OF 40 mph OR LESS WHERE:  
 $L$  = MINIMUM LENGTH OF TAPER IN FEET  
 $W$  = WIDTH OF OFFSET IN FEET  
 $S$  = DESIGN SPEED OR 85TH PERCENTILE SPEED IN MILES PER HOUR
  - ALL TRAFFIC CONTROL ITEMS SHOWN ON THIS SHEET WILL NOT BE MEASURED FOR SEPARATE PAYMENT. THIS WORK IS TO BE INCLUDED IN THE PRICE BID FOR MAINTENANCE OF TRAFFIC.

MISSISSIPPI DEPARTMENT OF TRANSPORTATION ROADWAY DESIGN DIVISION STANDARD PLAN	
<b>DETAILS OF OUTSIDE LANE CLOSURE AT EXIT AND ENTRANCE RAMPS</b>	
WORKING NUMBER TCP-12	ISSUE DATE: OCTOBER 1, 1998
SHEET NUMBER 261	

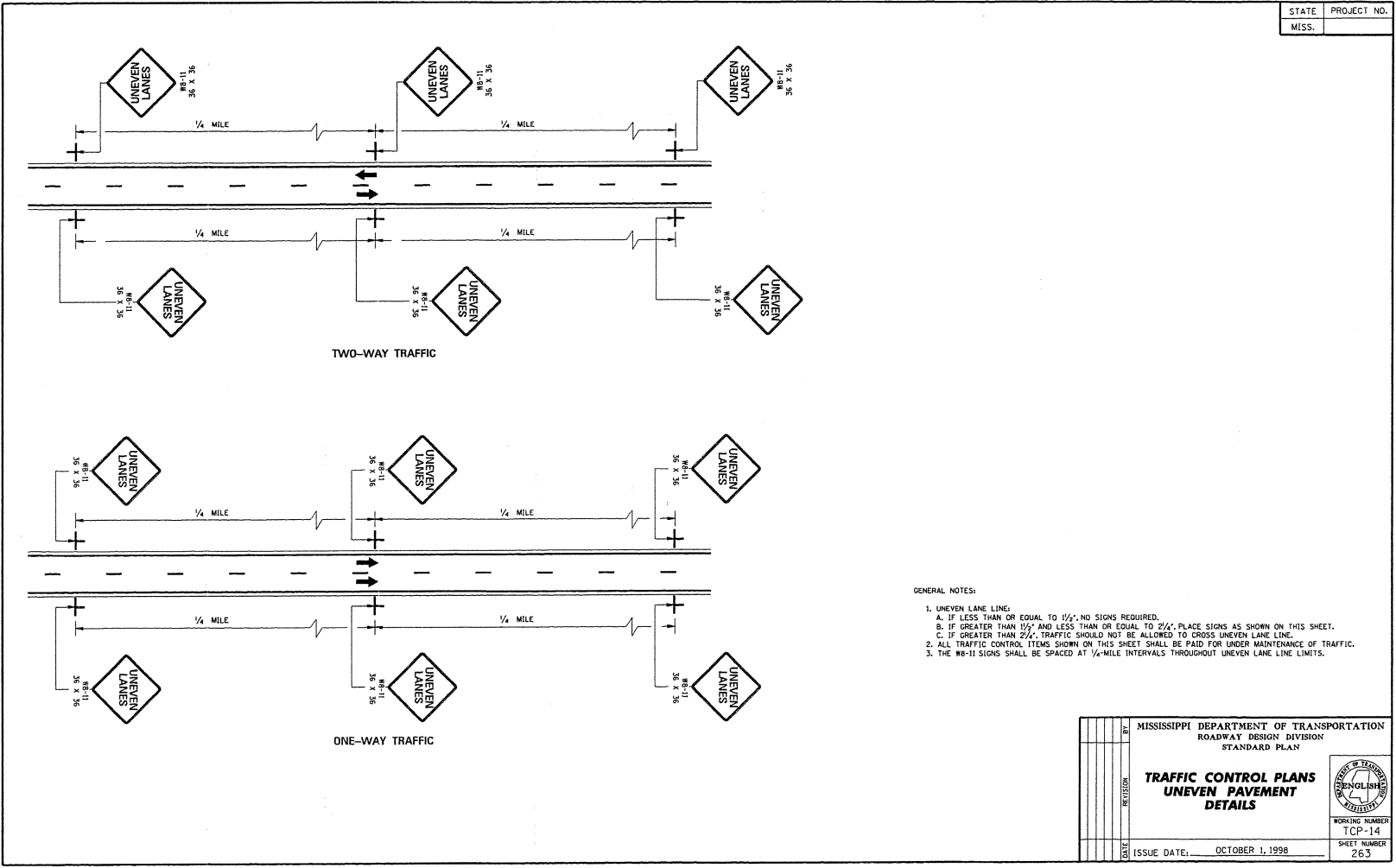



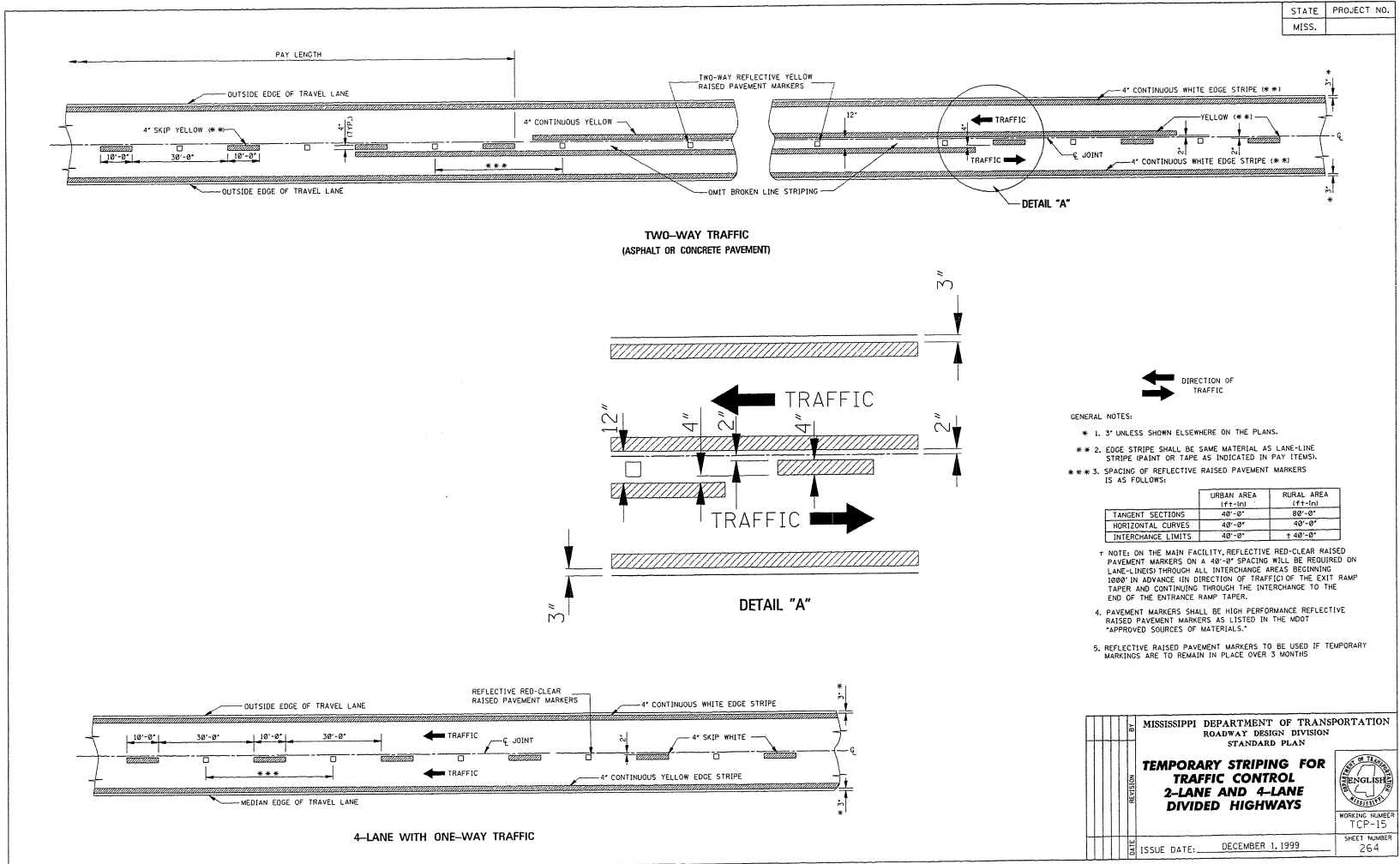

STATE	PROJECT NO.
MISS.	

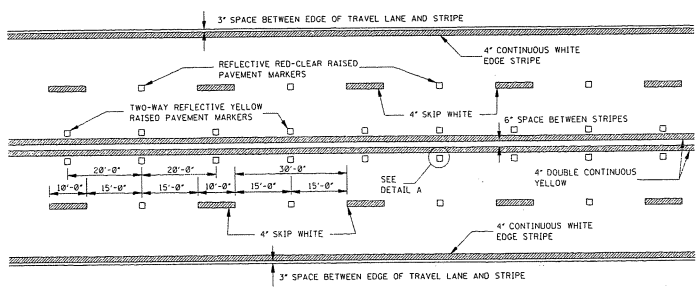

TYPICAL STRIPING AND RAISED PAVEMENT MARKERS FOR 4-LANE SECTION

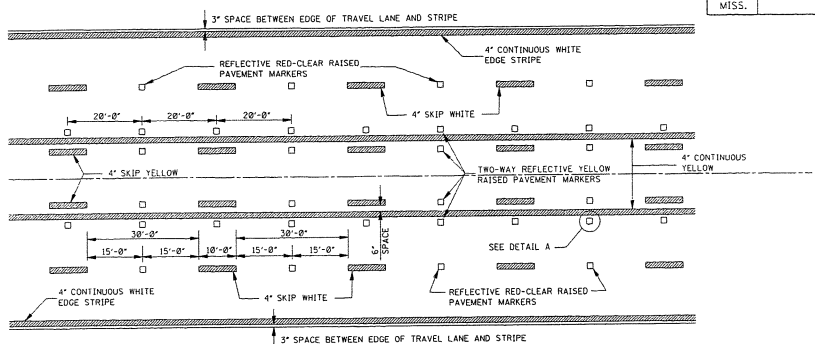

TYPICAL STRIPING AND RAISED PAVEMENT MARKERS FOR 5-LANE SECTION

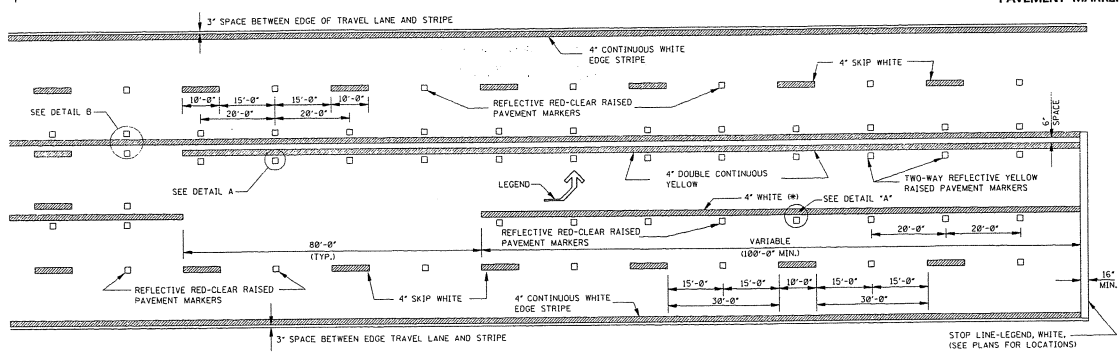

TYPICAL STRIPING AND RAISED PAVEMENT MARKERS AT LEFT TURN LANES

\* NOTE: USE DETAIL STRIPING IF LENGTH  $\leq$  150' AT THIS LOCATION, OTHERWISE USE CONTINUOUS STRIPING.

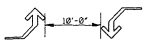

TYPICAL TWO-WAY ARROW INSTALLATION

- NOTES:
1. CONSIDER EACH SEGMENT OF CONTINUOUS TWO-WAY LEFT TURN LANE SEPARATELY.
  2. IF SEGMENT IS LESS THAN 350', PLACE ONE SET OF ARROWS IN CENTER OF SEGMENT.
  3. IF SEGMENT IS GREATER THAN 350', PLACE FIRST SET OF ARROWS 50' TO 100' FROM BEGINNING AND/OR END OF SEGMENT AND SPACE ADDITIONAL SETS OF ARROWS (250' O.C.).

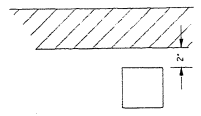

DETAIL A LATERAL PLACEMENT OF PAVEMENT MARKERS

GENERAL NOTES:

1. PAVEMENT MARKERS SHALL BE HIGH PERFORMANCE RAISED PAVEMENT MARKERS AS LISTED IN THE MDT "APPROVED SOURCES OF MATERIALS".
2. REFLECTIVE RAISED PAVEMENT MARKERS TO BE USED IF TEMPORARY MARKINGS ARE TO REMAIN IN PLACE OVER 3 MONTHS.
3. TEMPORARY TURN ARROW TO BE PAID FOR AS TEMPORARY TRAFFIC STRIPE (LEGEND), ESTIMATED AT 10.9 SQ. FT. PER ARROW.

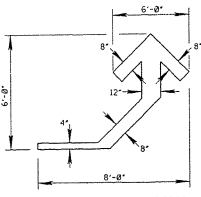

DETAIL OF TEMPORARY TURN ARROW

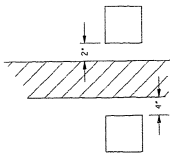

DETAIL B LATERAL PLACEMENT OF PAVEMENT MARKERS

DATE	BY	REVISION	MISSISSIPPI DEPARTMENT OF TRANSPORTATION ROADWAY DESIGN DIVISION STANDARD PLAN	
			<p><b>TEMPORARY STRIPING FOR TRAFFIC CONTROL 4-LANE AND 5-LANE UNDIVIDED ROADWAYS</b></p>	
DATE	ISSUE DATE:	DECEMBER 1, 1999	WORKING NUMBER	TCP-16
			SHEET NUMBER	265

## MISSISSIPPI DEPARTMENT OF TRANSPORTATION

**SECTION 904 - NOTICE TO BIDDERS NO. 2239**

**CODE: (SP)**

**DATE: 01/06/2009**

**SUBJECT: Department of Labor Ruling**

On December 19, 2008 the U.S. Department of Labor issued a final rule revising their regulations in 29 CFR Parts 3 and 5. This rule takes effect for all Federal funded contracts awarded after January 19, 2009.

The primary change in the rule is a provision that requires Contractors to limit the amount of personal information on the weekly payroll submissions. Personal addresses and full social security numbers may no longer be used. Contractors must use an ". . . individually identifying number for each employee (e.g., the last four digits of the employee's social security number)." Form FHWA-1273 - "Required Contract Provisions Federal-aid Construction Contracts" will eventually be revised to reflect this change.

Until the revised is made to FHWA-1273, bidders are advised to disregard any requirement in FHWA-1273 regarding the use of personal addresses and full social security numbers, such as in Section V, Paragraph 2b.

Bidders are also advised that the requirement for maintaining and submitting form FHWA-47, as referenced in FHWA-1273 Section VI, is no longer required on construction projects.

**MISSISSIPPI DEPARTMENT OF TRANSPORTATION**

**SECTION 904 – NOTICE TO BIDDERS NO. 2345**

**CODE: (SP)**

**DATE: 2/9/2009**

**SUBJECT: Petroleum Products Base Prices For Contracts Let in March, 2009**

**REFERENCE: Subsection 109.07**

The following base prices are to be used for adjustment in compensation due to changes in costs of petroleum products:

FUELS

	<u>Per Gallon</u>	<u>Per Liter</u>
Gasoline	\$1.7061	\$0.4507
Diesel	\$1.7690	\$0.4673

MATERIALS OF CONSTRUCTION

<u>ASPHALT CEMENT</u>	<u>Per Gallon</u>	<u>Per Ton</u>	<u>Per Liter</u>	<u>Per Metric Ton</u>
Viscosity Grade AC-5	\$2.0063	\$476.00	\$0.5300	\$524.69
Viscosity Grade AC-10	\$1.9845	\$470.83	\$0.5243	\$518.99
Viscosity Grade AC-20	\$1.9529	\$463.33	\$0.5159	\$510.73
Viscosity Grade AC-30	\$1.9319	\$458.33	\$0.5103	\$505.21
Grade PG 64-22	\$1.9148	\$454.29	\$0.5058	\$500.76
Grade PG 67-22	\$1.8938	\$449.29	\$0.5003	\$495.25
Grade PG 76-22	\$2.5782	\$611.67	\$0.6811	\$674.24
Grade PG 82-22	\$2.8522	\$676.67	\$0.7535	\$745.89

EMULSIFIED ASPHALTS, PRIMES, & TACK COATS

Grade EA-4 (SS-1)	\$2.1594	\$0.5705
Grade RS-2C (CRS-2)	\$2.0109	\$0.5312
Grade CRS-2P	\$2.3810	\$0.6290
Grade EA-1, MC-70 & AE-P	\$2.4823	\$0.6558
Grade SS-1 & 1H	\$2.1950	\$0.5799
Grade CSS-1 & 1H (Undiluted)	\$2.2000	\$0.5812
Grade CSS-1 & 1H (Diluted 1 to 1 Fog Seal)	\$1.3500	\$0.3566

## MISSISSIPPI DEPARTMENT OF TRANSPORTATION

SECTION 904 - NOTICE TO BIDDERS NO. 2361

CODE: (SP)

DATE: 01/26/2009

SUBJECT: Mississippi Resident Agent Requirement

Bidders are advised of new changes in the proposal bond forms and required signatures. Commencing with the February 2009 letting, non-resident agents **WILL NOT** be allowed to sign contract documents, including bonds and insurance. Qualified non-resident agents that were allowed to sign contract documents in the January 2009 letting will not be allowed in future contracts until further notice. Only Mississippi Resident Agents will be allowed to sign contract documents.

Another change for the February 2009 letting is that the new performance bond and new payment bond that was utilized in the January 2009 proposals has been replaced with the one contract bond used by MDOT prior to the January 2009 letting.

## MISSISSIPPI DEPARTMENT OF TRANSPORTATION

| SECTION 904 - NOTICE TO BIDDERS NO. [2382](#)

CODE: (IS)

| DATE: [02/12/2009](#)

| SUBJECT: **Status of Right-of-Way**

Although it is desirable to have acquired all rights-of-way and completed all utility adjustments and work to be performed by others prior to receiving bids, sometimes it is not considered to be in the public interest to wait until each and every such clearance has been obtained. The bidder is hereby advised of possible unacquired rights-of-way, relocatees and utilities which have not been completed.

| The status of right-of-way acquisition, utility adjustments, [encroachments](#), potentially contaminated sites [and asbestos containation](#) are set forth in [the following](#) attachments.

In the event right of entry is not available to ALL parcels of right-of-way and/or all work that is to be accomplished by others on the date set forth in the contract for the Notice to Proceed is not complete, the Department will issue a restricted Notice to Proceed.

**STATUS OF RIGHT-OF-WAY  
STP-2170-00(011)  
105466-301000  
FORREST COUNTY  
February 20, 2009**

All rights of way and legal rights of entry have been acquired **except:**

**NONE.**

ASBESTOS CONTAMINATION STATUS OF BUILDINGS  
TO BE REMOVED BY THE CONTRACTOR  
STP-2170-00(011)  
105466-301000  
FORREST COUNTY  
February 19, 2009

Reference is made to notices to bidders entitled "Asbestos National Emission Standards for Hazardous Air Pollutants (NESHAP)" and "Removal of Obstructions".

The following pertinent information is furnished concerning asbestos containing materials (ACMs), if any, found in buildings to be removed by the Contractor.

There is no Right of Way required for this project. There are no buildings to be removed by the contractor.



STATUS OF POTENTIALLY CONTAMINATED SITES  
STP-2170-00(011)  
105466-301000  
FORREST COUNTY  
February 19, 2009

THERE IS NO RIGHT OF WAY REQUIRED FOR THIS PROJECT. NO INITIAL SITE ASSESSMENT WILL BE PERFORMED. IF CONTAMINATION ON EXISTING RIGHT OF WAY IS DISCOVERED, IT WILL BE HANDLED BY THE DEPARTMENT.

**UTILITY STATUS REPORT**

STP-2170-00(011) / 105466301

Forrest County(ies)

January 12, 2009

This is to certify that the above captioned project has been inspected and there are no known utilities in conflict with the project.

**ENCROACHMENT CERTIFICATION**

STP-2170-00(011) / 105466301

Forrest County(ies)

January 12, 2009

This is to certify that the above captioned project has been inspected and no encroachments were found.

**MISSISSIPPI DEPARTMENT OF TRANSPORTATION**

**SECTION 904 - NOTICE TO BIDDERS NO. 2395**

**CODE: (SP)**

**DATE: 02/18/2009**

**SUBJECT: Contract Time**

**PROJECT: STP-2170-00(011) / 105466301 - Forrest County**

The completion of work to be performed by the Contractor for this project will not be a specified date but shall be when all allowable time units are assessed, or any extension thereto as provided in Subsection 108.06. It is anticipated that the Notice of Award will be issued by not later than **April 14, 2009** and the effective date of the Notice to Proceed / Beginning of Contract Time will be **no later than July 9, 2009**.

Should the Contractor request a Notice to Proceed earlier than **July 9, 2009**, the date the Notice to Proceed is issued will also be the Beginning of Contract Time date.

Allowable Time Units will be **30**.

The contract time has been based on Column **"D"** of the Table of Time Units, in Subsection 108.06.

## MISSISSIPPI DEPARTMENT OF TRANSPORTATION

SECTION 904 - NOTICE TO BIDDERS NO. 2396

DATE: 02/12/2009

SUBJECT: Specialty Items

PROJECT: STP-2171-01(011) / 105466301 - Forrest County

Pursuant to the provisions of Section 108, the following work items are hereby designated as "Specialty Items" for this contract. Bidders are reminded that these items must be subcontracted in order to be considered as specialty items.

### CATEGORY: PAVEMENT STRIPING AND MARKING

---

Line No	Pay Item	Description
0200	627-J001	Two-Way Clear Reflective High Performance Raised Markers
0210	627-L001	Two-Way Yellow Reflective High Performance Raised Markers
0270	907-626-C003	6" Thermoplastic Double Drop Edge Stripe, Continuous White
0280	907-626-D003	6" Thermoplastic Traffic Stripe, Skip Yellow
0290	907-626-E004	6" Thermoplastic Traffic Stripe, Continuous Yellow
0300	907-626-G004	Thermoplastic Detail Stripe, White
0310	907-626-G005	Thermoplastic Detail Stripe, Yellow
0320	907-626-H004	Thermoplastic Legend, White
0330	907-626-H005	Thermoplastic Legend, White

### CATEGORY: TRAFFIC CONTROL - TEMPORARY

---

Line No	Pay Item	Description
0150	619-A1002	Temporary Traffic Stripe, Continuous White
0160	619-A2002	Temporary Traffic Stripe, Continuous Yellow
0170	619-A4006	Temporary Traffic Stripe, Skip Yellow
0180	619-A5001	Temporary Traffic Stripe, Detail
0190	619-A6001	Temporary Traffic Stripe, Legend

**MISSISSIPPI DEPARTMENT OF TRANSPORTATION**

**SECTION 904 - NOTICE TO BIDDERS NO. 2397**

**CODE: (SP)**

**DATE: 02/23/2009**

**SUBJECT: Scope Of Work**

**PROJECT: STP-2170-00(011) / 105466301 - Forrest County**

The contract documents do not include an official set of construction plans but may, by reference, include some Standard Drawings when so specified in a Notice to Bidders entitled, "Standard Drawings". All other references to plans in the contract documents and Standard Specifications for Road and Bridge Construction are to be disregarded.

Work on the project shall consist of the following:

**US HIGHWAY 11  
WIDEN AND OVERLAY APPROXIMATELY 5.017 MILES OF US HWY 11  
FROM GREEN'S CREEK TO FORREST/JONES COUNTY LINE**

**PLACEMENT OF ASPHALT:**

Widen and overlay US 11 from the north side of the Green's Creek bridge at Station 1298+35 (B.O.P.) to the Forrest/Jones County Line at Station 1034+06.5 (E.O.P.) (See Typical Sections).

- Cold mill 100' transition at the Green's Creek Bridge (B.O.P.) from 1" to 0" in 100' transition.
- Trench widen the shoulders 2' and variable at a depth of 3" below the existing asphalt roadway edge. The existing material removed from the trench shall be windrowed along the shoulder and later bladed against the asphalt shoulder edge.
- Overlay each lane with 3/4" and variable 9.5mm MT HMA leveling to correct the cross slope to 2% (See Notes) or superelevation rate in curves. The placement of the leveling asphalt shall include placing asphalt in the trench. The lanes shall be placed at 12' width and the shoulders at a width of 2' for a total roadway width of 28'.
- Overlay each lane with 1.5" of 9.5mm MT HMA to a cross slope to 2% (See Notes) or superelevation rate in curves. The placement of the asphalt shall include the overlay of the previously placed paved shoulder. Each lane shall be placed at 14' width for a total roadway width of 28'.

**ASPHALT NOTES:**

Prior to the overlay, centerline alignment shall be determined by the contractor by measuring the existing roadway at 500 feet intervals in tangent sections, and 100 feet intervals in horizontal curves. The existing pavement edge shall be cut to a smooth and near vertical face with an approved cutting device (Not to be measured for separate pay). The foundation for widening the

base shall be formed by trenching or excavating to the required depth, width, and constructing a smooth, firm compacted foundation using 9.5mm MT asphalt when placing the leveling (See typical drawing). Material excavated from the trench shall be used to raise the existing shoulder to match the new pavement elevation. Surplus material shall be spread along the edge of the shoulders, foreslopes, or other adjacent areas as directed by the Project Engineer, and will be an absorbed item. Any saw cutting needed during the removal of pavement for the islands will not be measured for separate pay. Removal of pavement to construct header curbs in paved islands shall be paid for under pay item 202-B as directed by the Project Engineer.

- 
- Cold mill the roadway at the B.O.P. and E.O.P. as directed by the Project Engineer (See Attached Drawing). Mill a transition of 0” to 1” in 100 feet and 24 feet wide at each tie in.
- Cross slopes shall be increased where practical with contract quantities in an effort to achieve a uniform cross slope of 2%.
- All local roads and driveways shall be overlaid with MT 9.5-mm hot mix asphalt.
- Publicly maintained roads or streets shall be surfaced to the existing R.O.W.; privately owned entrances shall be surfaced a distance of 10 feet & variable from the edge of pavement.
- Any site grading at local roads or drives will not be measured for separate payment but will be considered an absorbed item.
- A paved apron shall be placed around each guardrail location as directed by the Project Engineer.

**PLACEMENT OF GUARD RAIL:**

Guard rail shall be placed on the north and south abutment of the Green’s Creek Bridge at the following locations and as shown on the attached drawings:

<b>Station</b>	<b>Removal of Guardrail</b>	<b>Bridge End Section</b>	<b>Gaurdrail "W" Beam</b>	<b>Terminal End Section</b>
1298+35 Rt.	100 L.F.	1 EACH	50 L.F.	1 EACH
1298+35 Lt.	200 L.F.	1 EACH	162.5 L.F.	1 EACH
1299+35 Lt.	100 L.F.	1 EACH	50 L.F.	1 EACH
1299+35 Rt.	200 L.F.	1 EACH	162.5 L.F.	1 EACH
<b>TOTALS</b>	<b>600 L.F.</b>	<b>4 EACH</b>	<b>425 L.F.</b>	<b>4 EACH</b>

GUARD RAIL NOTES:

- Guard Rail installation shall include furnished and completely erected sections in accordance with Section 606 of the specifications.
- The installation of terminal end sections, installed as per manufacturer's recommendations, shall be National Cooperative Highway Research Program (NCHRP) Report 350 Test Level 3 (TL-3) approved. The SKT-350 Terminal End Section or equivalent shall be used on this project.
- The Contractor shall furnish the Project Engineer two (2) copies of the manufacturer's installation instructions prior to beginning guard rail operations.
- Seeding, fertilizer and vegetative mulch are required on all disturbed areas at the guard rail site and will be considered an absorbed item.
- Application rate for bermuda grass seed will be 25 pounds per acre.
- Application rate for combination fertilizer (13-13-13) will be 1,000 pounds per acre. Application rate for mulch shall be 2 tons per acre.

GENERAL NOTES:

- The Contractor shall mill a 12" rumble strip along the shoulders from Station 1298+35 (B.O.P.) to Station 1034+06.5. The Contractor will place the traffic stripe on the inside 6" of the rumble strip (See Typical Drawings).
- Raise the existing shoulders to match the new pavement elevation by placing Borrow Excavation (Class B7-6) on the shoulders. Placement of the Borrow Material (class B7-6) on the finished surface course shall not be permitted. The material shall be bladed, rolled and compacted to a finished slope of 4%. Shoulders with existing adequate shoulder material in place shall be bladed to a slope of 4%, the cost of which shall be included in the prices of other items bid. The existing material removed from the shoulders should be used where possible.
- Temporary striping shall conform to finished stripe specifications in Section 619.03.2 for alignment, neatness, reflectivity, and straightness. All permanent edge pavement markings on asphalt are to be hot thermoplastic. Edge lines will be placed on the rumble strips at the edge of the original lane. Glass beads applied to thermoplastic shall conform to Section Number – 720.01 (Beads shall be double dropped Class B High-Visibility first and then Class A High-Visibility).
- Raised pavement markers will be placed at 80 feet intervals in tangents and 40 feet intervals in curves, and in urban limits along the centerline of roadway. Any removal of existing raised pavement markers shall be considered an absorbed item. Only flexible adhesive shall be allowed for placement of raised pavement markers meeting the requirements of 720.03.7.7 of the Mississippi Standard Specifications for Road and Bridge Construction.
- The contractor shall erect and maintain construction signing, and provide all signs and traffic handling devices in accordance with the latest edition of the Manual on Uniform



Traffic Control Devices (MUTCD) (the cost is to be included in the price bid for pay item No. 618-A, Maintenance of Traffic).

- Incidental work such as removing vegetation, shaping and compaction of shoulder, removing excess asphalt material, project clean-up, and other incidental work necessary to complete the project will not be measured for separate payment, but will be included in other bid items.
- The contractor shall stripe the west side of railroad crossings along project as directed by the Project Engineer. Striping shall be hot thermoplastic and conform to specifications designated. Layout of railroad striping shall be installed in accordance to standard drawings.

STP - 2171 - 01(011) / 105466301  
FORREST CO.

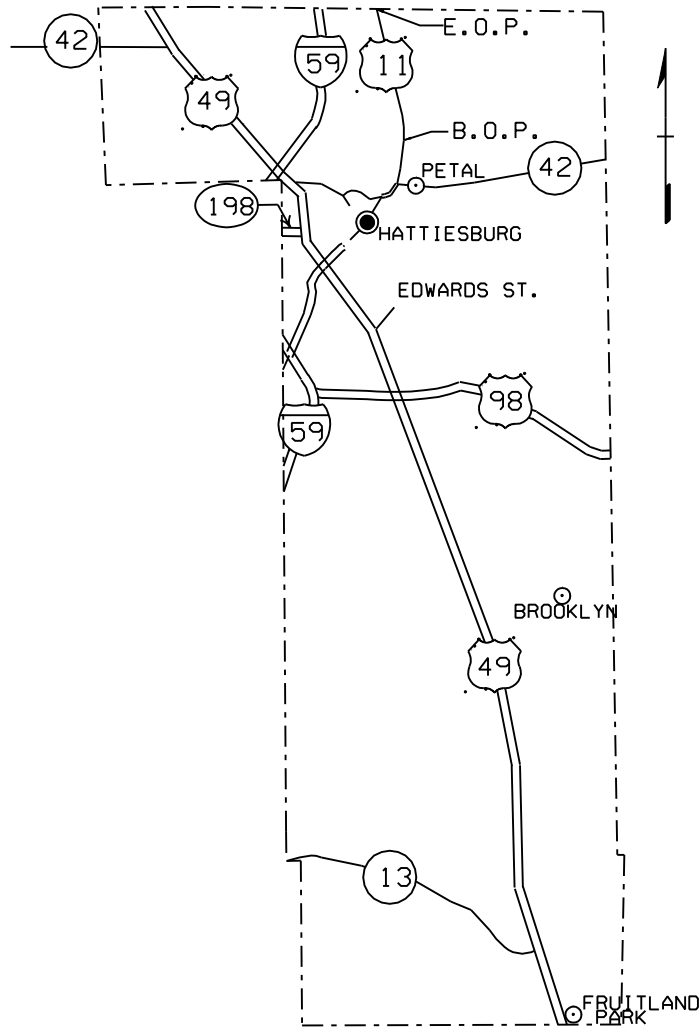

THE ABOVE REFERENCED PROJECT WIDENING  
AND OVERLAYING 5.1 MILES OF US 11 FROM

TYPICAL SECTION  
 1298+35 (B.O.P.) TO 1034+06.5 (E.O.P.)

CL IN DIRECTION OF TRAVEL

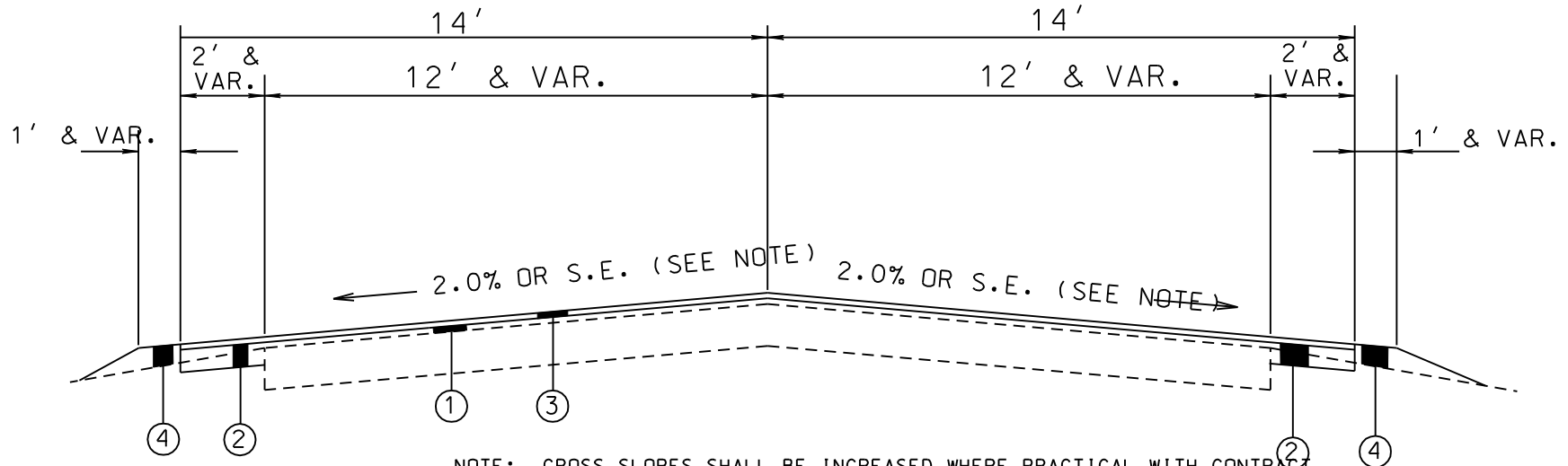

NOTE: CROSS SLOPES SHALL BE INCREASED WHERE PRACTICAL WITH CONTRACT QUANTITIES IN AN EFFORT TO ACHIEVE A UNIFORM CROSS SLOPE OF 2%

- ① 3/4" & VAR. 9.5mm MT HMA
- ② 3" TRENCH WIDENING REQUIRED (9.5mm MT HMA) TO BE PLACED WITH LEVELING
- ③ 1.5" 9.5mm MT HMA
- ④ B7-6 BORROW EXCAVATION 1 3/4" & VARIABLE

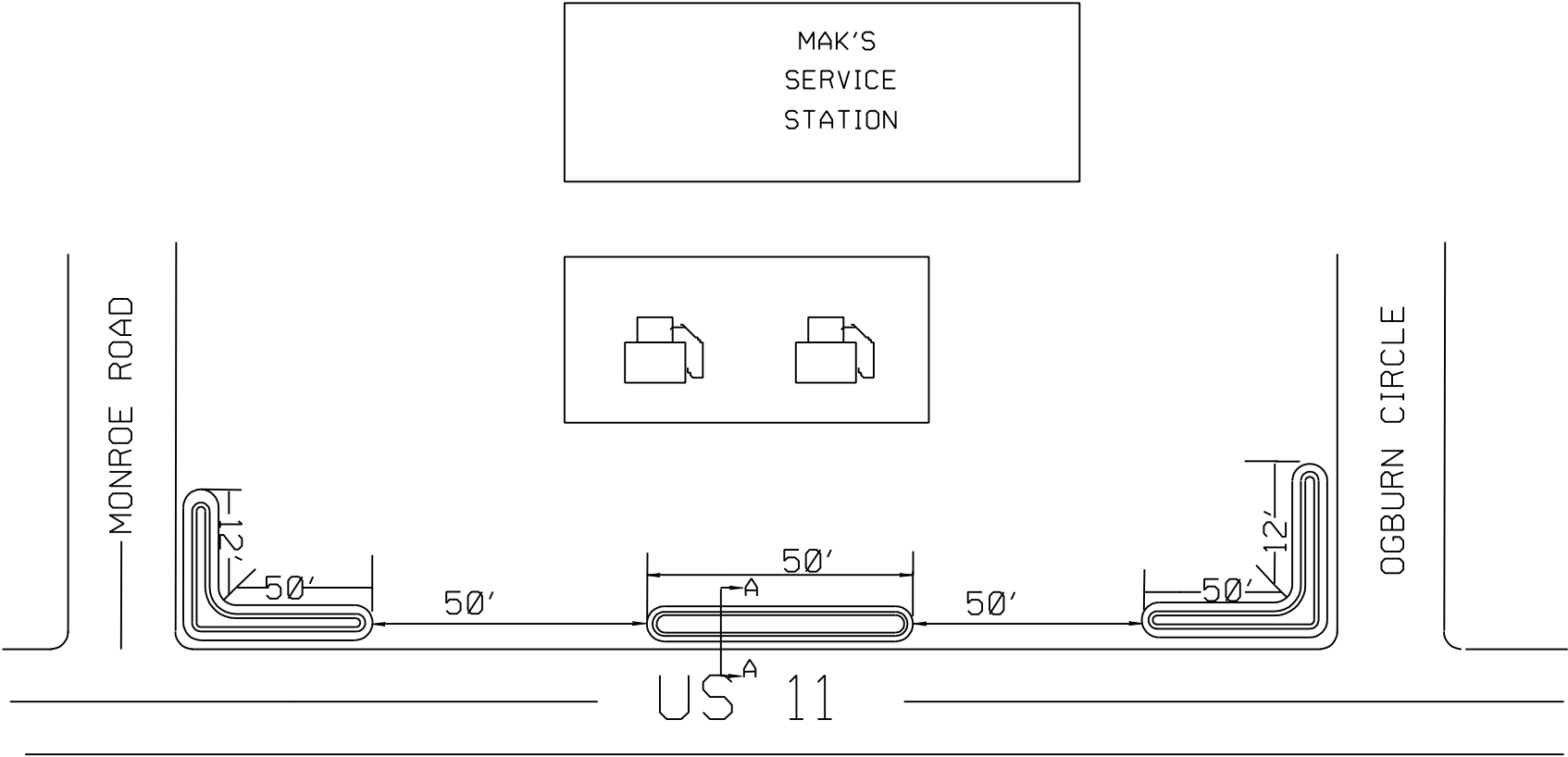

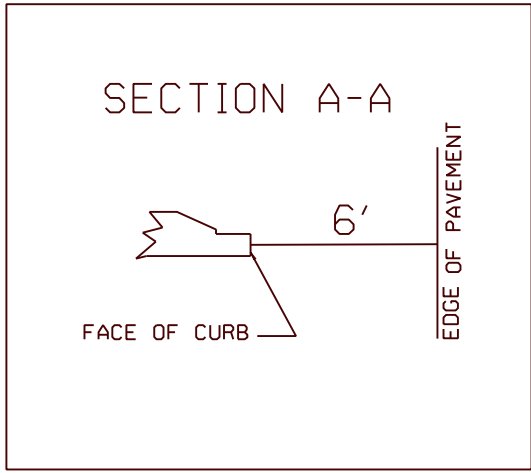

HUB  
CITY  
STEEL

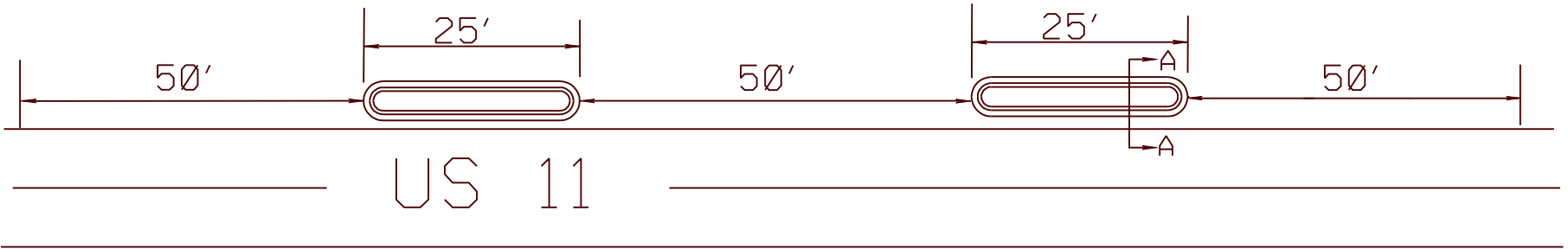

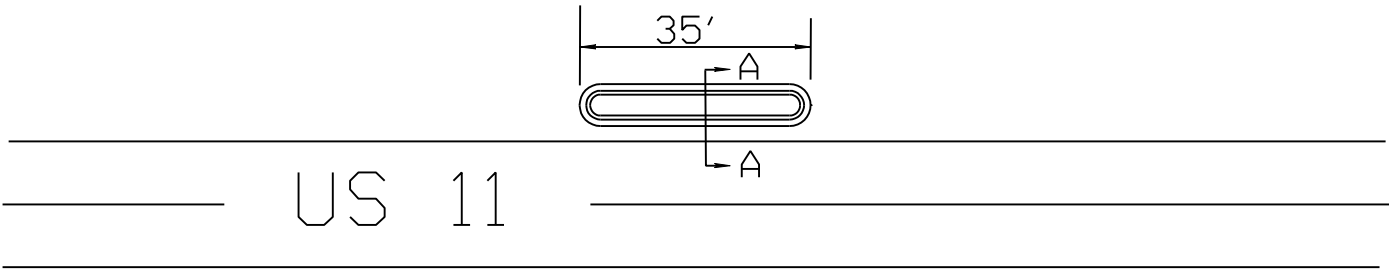
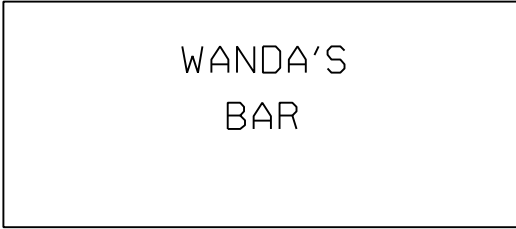
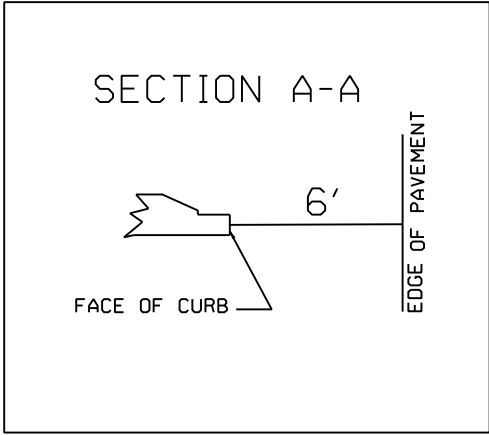

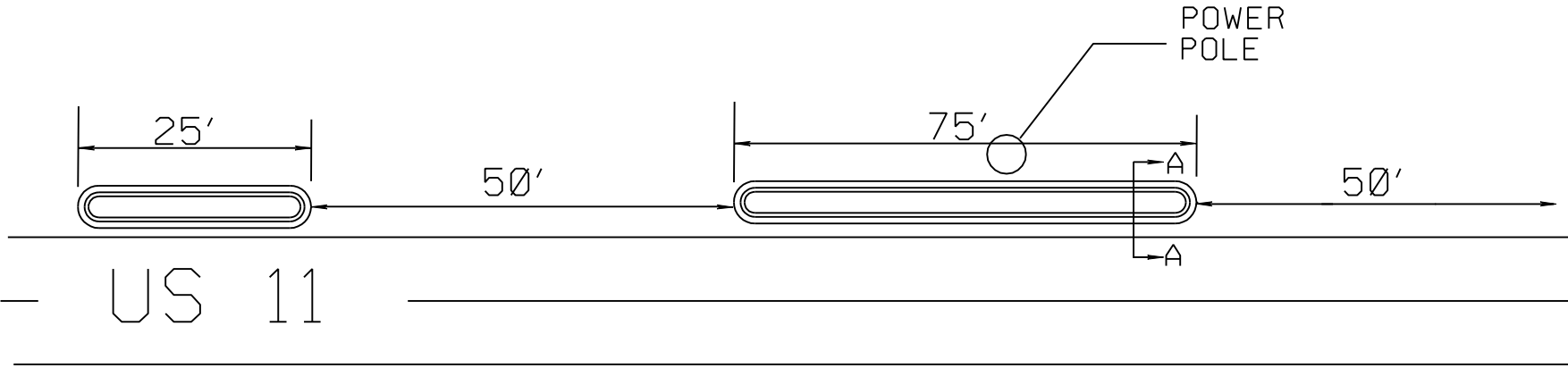
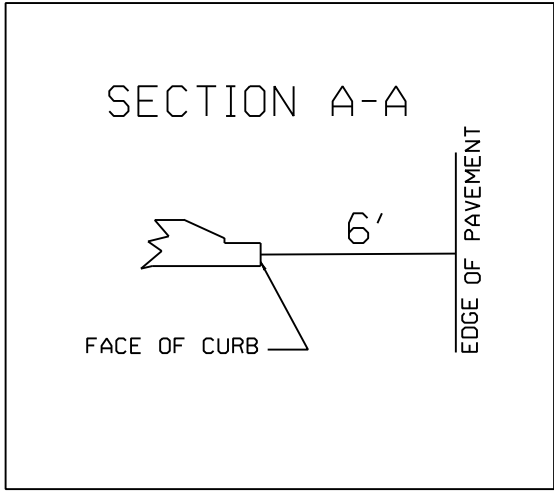

# MILLING REQUIREMENTS

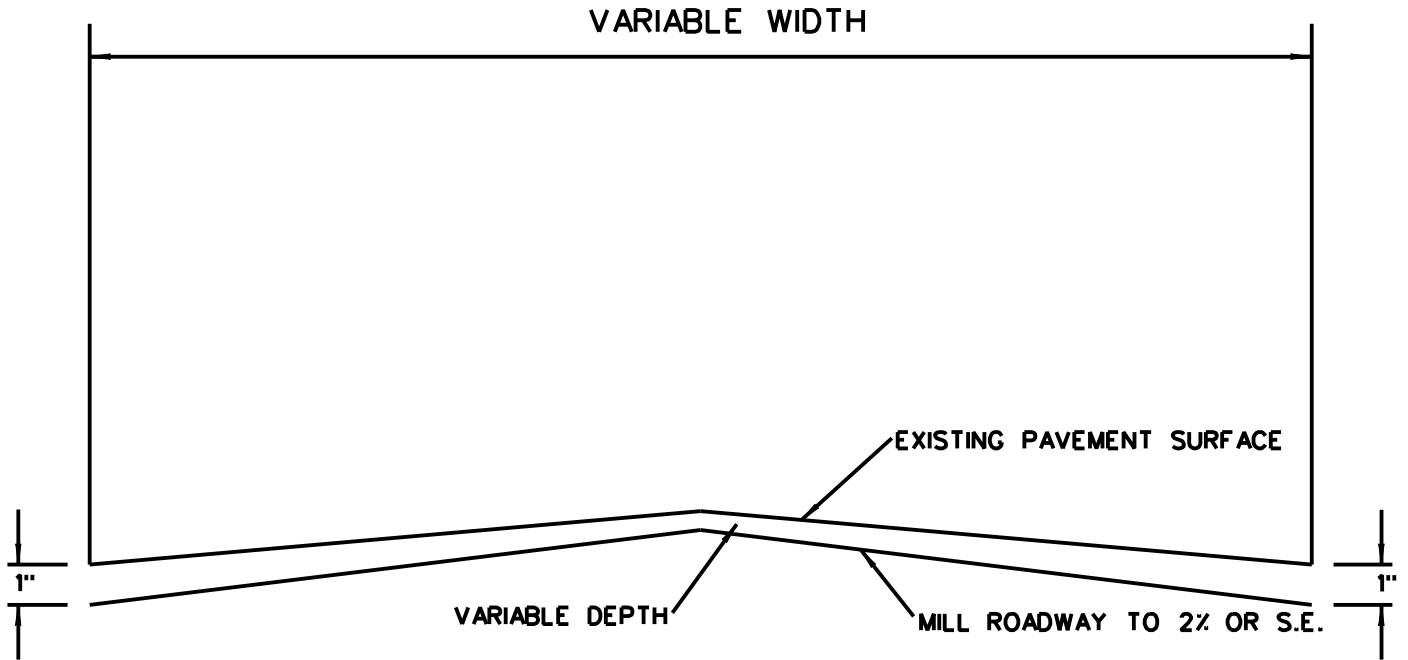

## MILLING TRANSITION AT B.O.P. AND E.O.P.

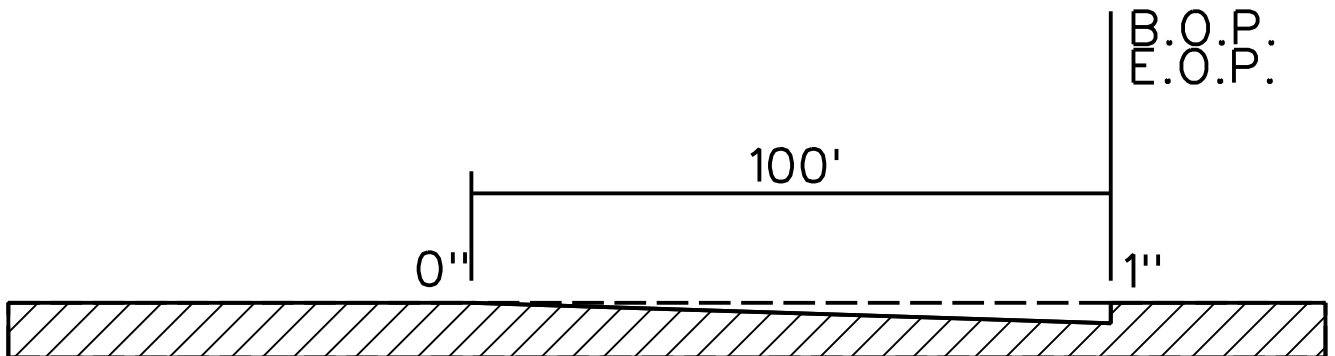



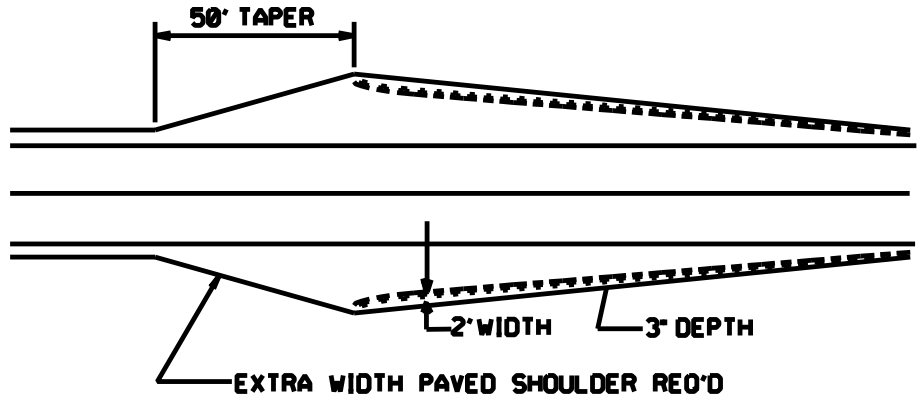

**DETAIL OF INSTALLATION OF EXTRA WIDTH PAVED SHOULDERS AT BRIDGES**

① 3" AND VAR. DEPTH 9.5MM ~~HBF~~ BITUMINOUS PAVEMENT REQ'D

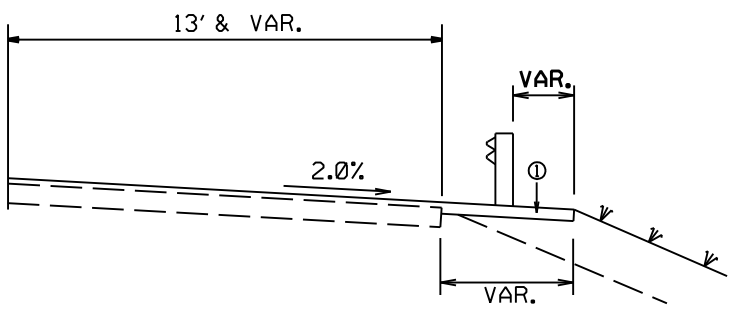

**BOTH SIDES**

**TYPICAL SECTION  
DETAILS OF PAVED SHOULDERS AT  
BRIDGE GUARD RAIL INSTALLATIONS**

# TYPICAL DETAIL OF MONOLITHIC CURB & GUTTER AT ISLAND

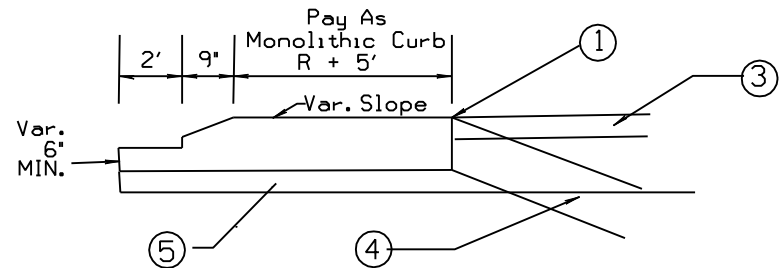
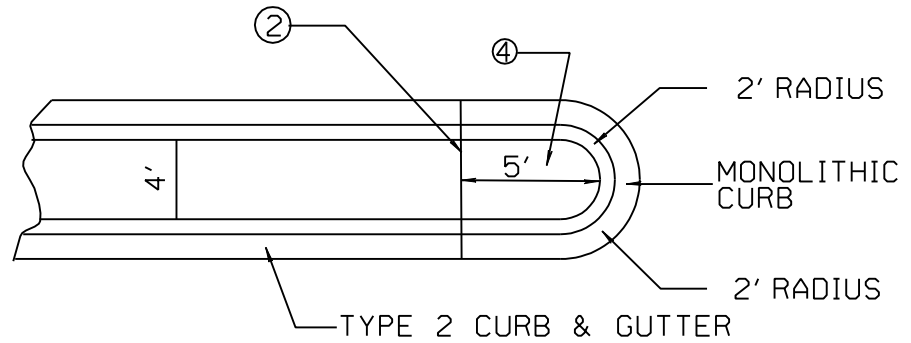

- ① - 1/2" PREMOULDED EXPANSION JOINT ( NOT A PAY ITEM )
- ② - 1/2" TOOLED CONTRACTION JOINT ( NOT A PAY ITEM )
- ③ - 4" CLASS "C" STRUCTURAL CONCRETE ( FOR MEDIAN & ISLAND PAV'T. ) PAY ITEM NO. 616-A
- ④ - 10" & VAR. DEPTH CLASS "C" STRUCTURAL CONCRETE ( FOR MEDIAN & ISLAND PAV'T. )
- ⑤ - 2" MIN. ASPHALT BASE SHALL BE REQUIRED BEFORE PLACING ISLANDS

STATE	PROJECT NO.
MISS.	

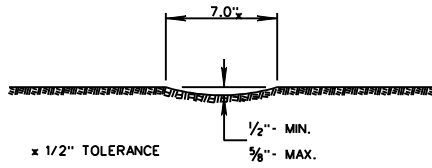

SECTION "A-A"

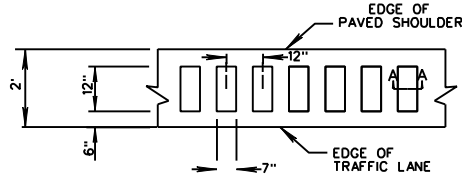

DETAIL "A"

- GENERAL NOTES
1. GROUND-IN RUMBLE STRIPS SHALL BE OMITTED ACROSS PRINCIPAL INTERSECTING ROADWAYS OR OTHER INTERRUPTIONS IN NORMAL SHOULDER WIDTH AS DIRECTED BY THE ENGINEER
  2. GROUND-IN RUMBLE STRIPS SHALL BE APPLIED TO MAINLINE ONLY.

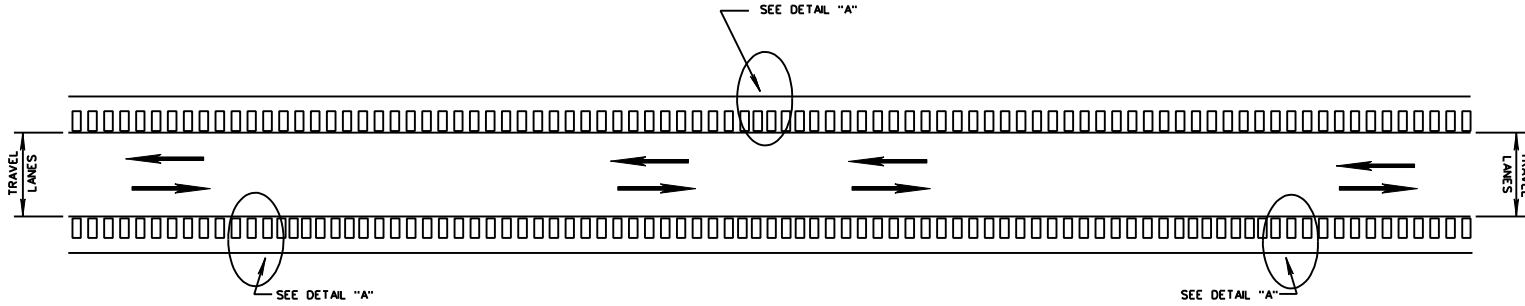

PLAN  
NOT TO SCALE  
DETAIL OF  
RUMBLE STRIPS  
(GROUND-IN)

MISSISSIPPI DEPARTMENT OF TRANSPORTATION	
TYPICAL SECTION	
RUMBLE STRIPS (GROUND-IN)	
WORKING NUMBER	RS 2397
SHEET NUMBER	397
FILENAME:	CHECKED DATE
DESIGN TEAM	

# PRIVATE DRIVEWAY DETAIL

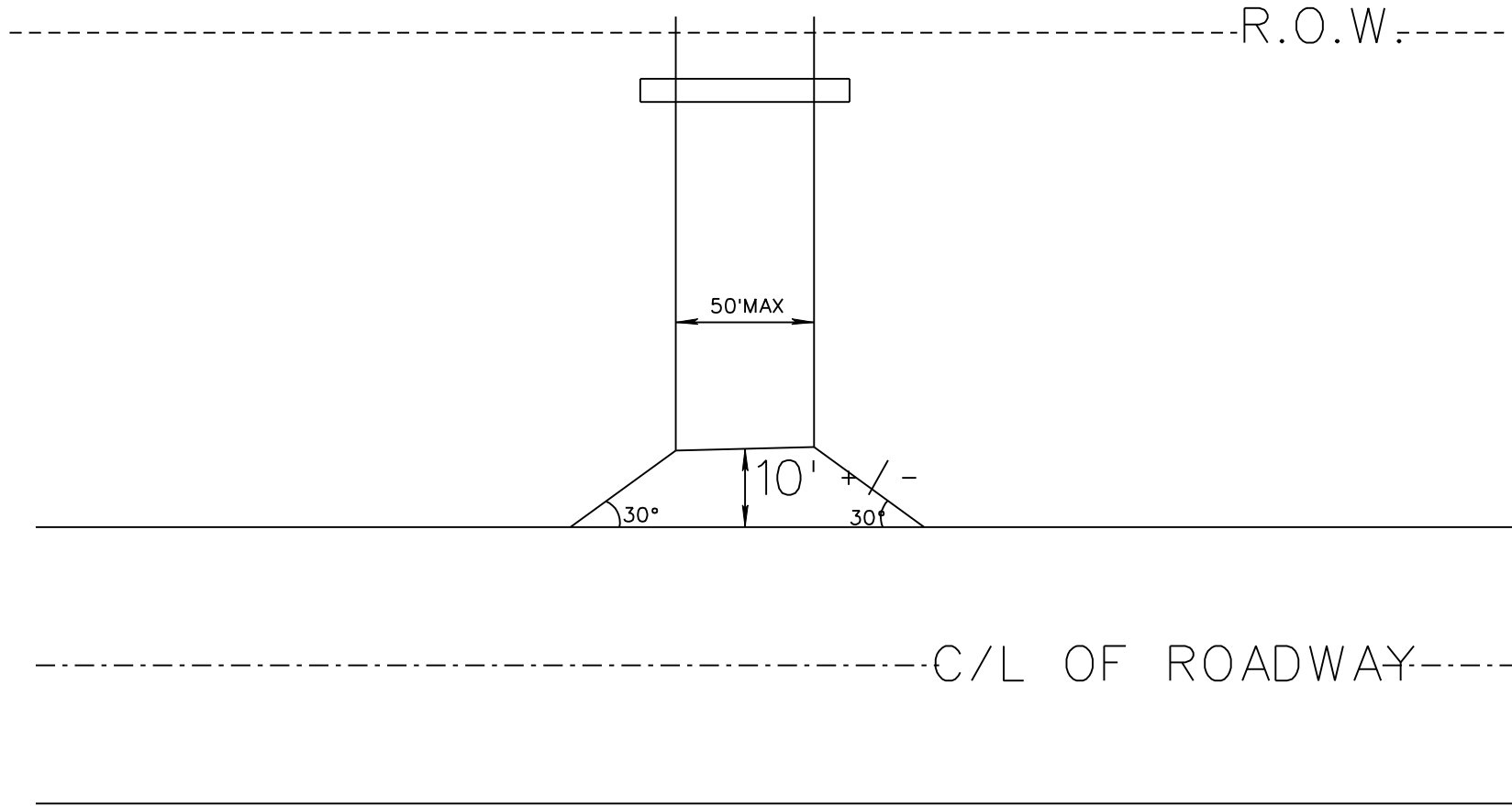

74

# TYPICAL STRIPING FOR SIMPLE INTERSECTION AT LOCAL ROADS

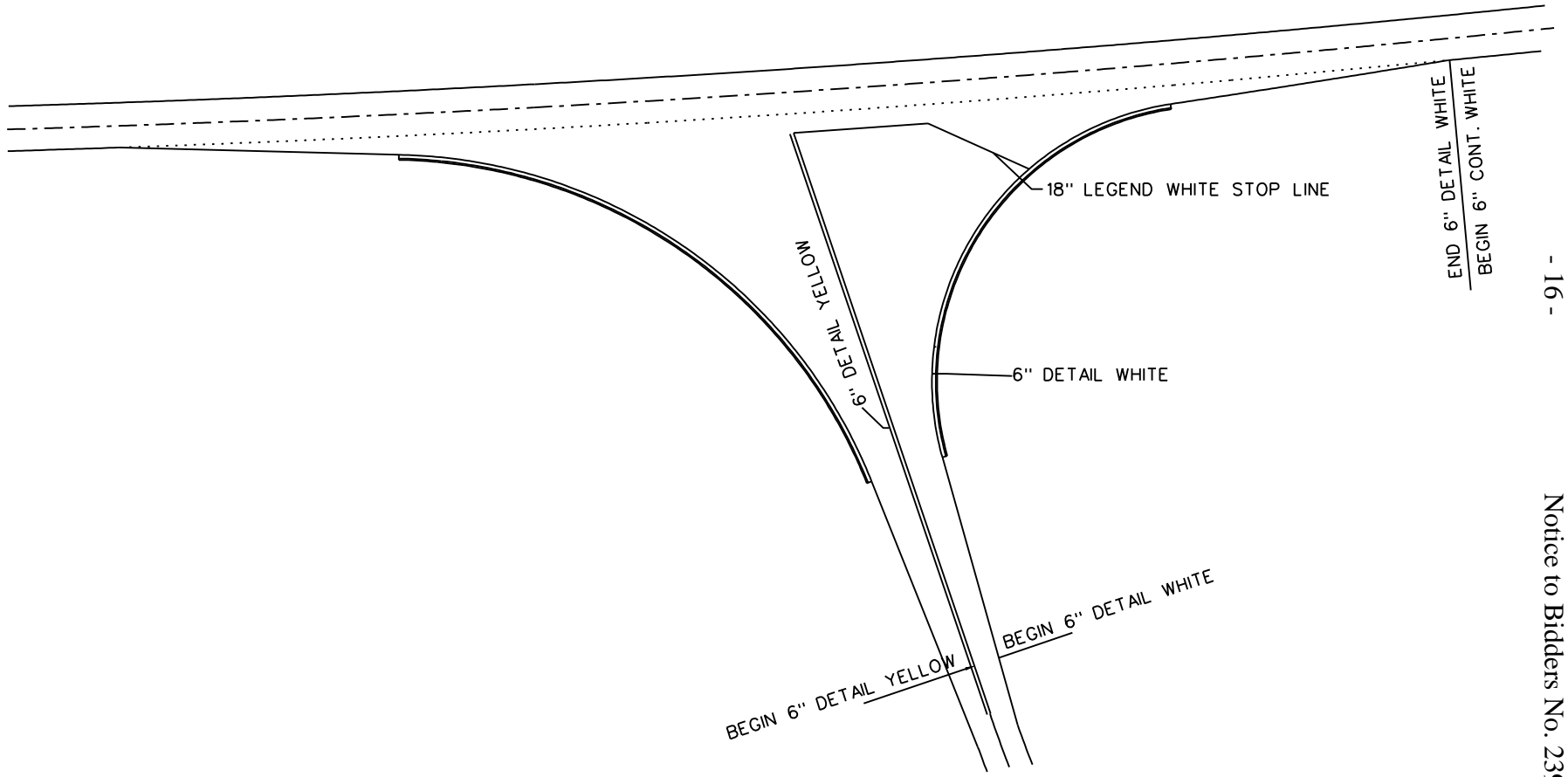

75

# TYPICAL FOR PAVED TAPER AT LOCAL ROADS

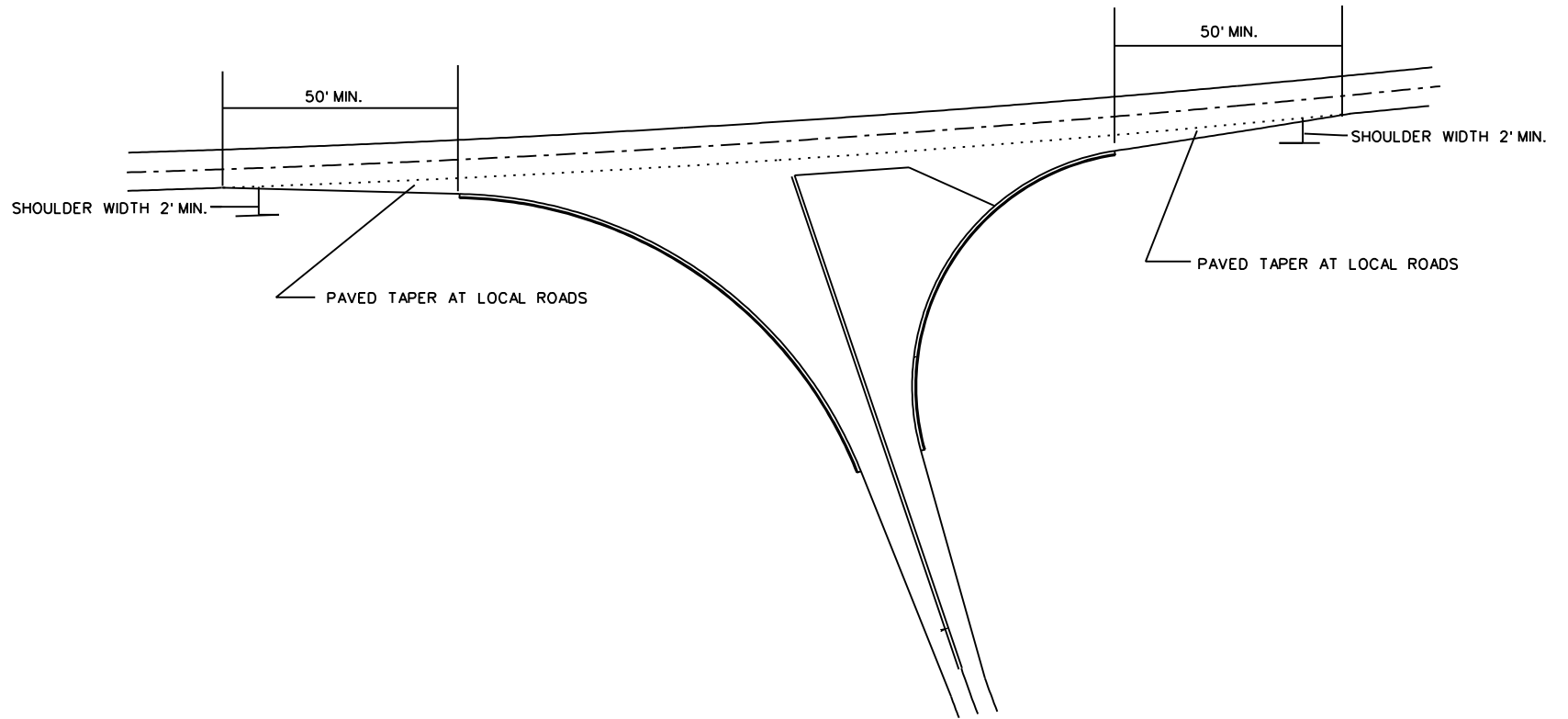

STATE	PROJECT NO.
MISS.	

## TYPICAL FOR RAISED PAVEMENT MARKERS PLACED ON SIDE ROAD RADIUS

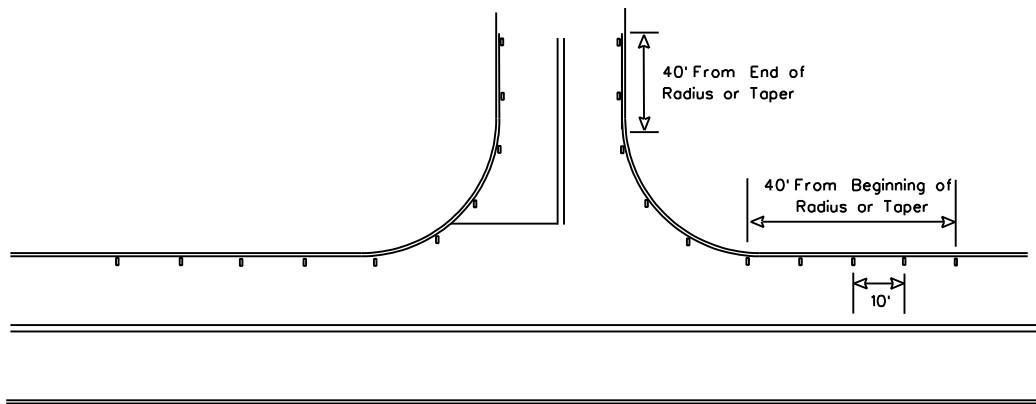

NOTE 1. MARKERS SHALL BE PLACED EVERY 10 FEET.

NOTE 2. MARKERS SHALL BE VISIBLE FROM THE TRAVELING MOTORIST ON STATE DESIGNATED HIGHWAYS.

NOTE 3. MARKERS SHALL BE HIGH PERFORMANCE TWO WAY CLEAR.

NOTE 4. FIVE (5) MARKERS SHALL BE PLACED ALONG MAINLINE EDGE STRIPE.

NOTE 5. MARKERS FOR COUNTY ROADS SHALL CONTINUE DOWN THE EDGE STRIPE A DISTANCE OF 40 FEET.

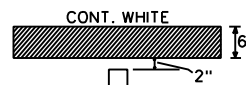

DETAIL A

MISSISSIPPI DEPARTMENT OF TRANSPORTATION	
2-LANE	
2-WAY CLEAR RAISED PAVEMENT MARKERS PLACED ON SIDE ROADS	
DATE	WORKING NUMBER
DESIGN TEAM	CHECKED
DATE	SHEET NUMBER

## MISSISSIPPI DEPARTMENT OF TRANSPORTATION

SECTION 904 - NOTICE TO BIDDERS NO. 2400

CODE: (SP)

DATE: 02/19/2009

SUBJECT: Removal of Haul Permit

Bidders are advised that the Haul Permit that had been previously included in the back of the proposal is no longer included in MDOT contracts. The Contractor, Subcontractors, Suppliers, and others transporting loads exceeding the posted limit on bridges when making deliveries to and from the project will no longer be allowed. Bidders are advised that when a road is open to the traveling public, the posted weight limit will be enforced for everyone, including the successful bidder of the project. Bidders are advised to consider this when preparing their bid.



**MISSISSIPPI DEPARTMENT OF TRANSPORTATION**

**SECTION 904 - NOTICE TO BIDDERS NO. 2415**

**CODE: (SP)**

**DATE: 02/19/2009**

**SUBJECT: Project Number Change**

**PROJECT: STP-2170-00(011) / 105466301 - Forrest County**

Anywhere in the plans, proposal and specifications for the above Project that reference is made to Federal Aid Project No. STP-2171-00(011) / 105466301 - Forrest County, it is understood that Federal Aid Project No. STP-2170-00(011) / 105466301 - Forrest County is the correct project number.

**SUPPLEMENT TO FORM FHWA-1273**

The following MINIMUM HOURLY WAGE RATES have been predetermined by the Secretary of Labor in General Decision No. **MS20080212** dated January 16, 2009.

**FORREST COUNTY**

<b><u>CLASSIFICATION</u></b>	<b><u>MINIMUM HOURLY WAGE RATE</u></b>
Carpenter	13.00
Cement Mason / Concrete Finisher	11.54
Electrician	22.40
Laborer, Common or General	8.34
Laborer, Pipelayer	10.17
Operator, Backhoe	12.57
Operator, Broom	8.00
Operator, Bulldozer	11.63
Operator, Grader / Blade	11.10
Operator, Mechanic	13.00
Operator, Piledriver	12.50
Operator, Roller	9.31
Operator, Scraper	10.00
Truck Driver	10.34

Authorized Payroll Code may be used in lieu of classification titles on weekly payrolls submitted to this Department. Codes or classification titles not conforming to those listed will not be acceptable.

**SUPPLEMENT TO FORM FHWA-1273**

**DATE:** 6/15/94

**SUBJECT: Final Certificate and Contract Provisions for Subcontracts**

All subcontracts shall be in writing and contain all pertinent provisions and requirements of the prime contract.

Each "Request for Permission to Subcontract" (Mississippi Department of Transportation Form CAD-720) shall include a copy of subcontract for review by the Mississippi Department of Transportation. The federal contract provisions may be omitted from the subcontract copy submitted for review provided the Contractor certifies that the provisions will be physically incorporated into the agreement furnished to the Subcontractor.

In lieu of submitting a copy of the subcontract for review, the Contractor may certify that the subcontract agreement is in writing and that it contains all the requirements and pertinent provisions of the prime contract.

Each Subcontractor will be required to provide a copy of the subcontract agreement for contract compliance reviews, along with physical evidence (copy of FHWA-1273) that requirements and pertinent provisions have been provided for review and adherence.

**REQUIRED CONTRACT PROVISIONS  
FEDERAL-AID CONSTRUCTION CONTRACTS**

	Page
I. General -----	1
II. Nondiscrimination -----	1
III. Nonsegregated Facilities -----	3
IV. Payment of Predetermined Minimum Wage -----	3
V. Statements and Payrolls -----	6
VI. Record of Materials, Supplies, and Labor-----	7
VII. Subletting or Assigning the Contract -----	7
VIII. Safety: Accident Prevention -----	7
IX. False Statements Concerning Highway Projects -----	8
X. Implementation of Clean Air Act and Federal Water Pollution Control Act-----	8
XI. Certification Regarding Debarment, Suspension, Ineligibility, and Voluntary Exclusion -----	8
XII. Certification Regarding Use of Contract Funds for Lobbying-----	10

ATTACHMENTS

- A. Employment Preference for Appalachian Contracts  
(included in Appalachian contracts only)

**I. GENERAL**

1. These contract provisions shall apply to all work performed on the contract by the contractor's own organization and with the assistance of workers under the contractor's immediate superintendence and to all work performed on the contract by piecework, station work, or by subcontract.

2. Except as otherwise provided for in each section, the contractor shall insert in each subcontract all of the stipulations contained in these Required Contract Provisions, and further require their inclusion in any lower tier subcontract or purchase order that may in turn be made. The Required Contract Provisions shall not be incorporated by reference in any case. The prime contractor shall be responsible for compliance by any subcontractor or lower tier subcontractor with these Required Contract Provisions.

3. A breach of any of the stipulations contained in these Required Contract Provisions shall be sufficient grounds for termination of the contract.

4. A breach of the following clauses of the Required Contract Provisions may also be grounds for debarment as provided in 29 CFR 5.12:

- Section I, paragraph 2;
- Section IV, paragraphs 1, 2, 3, 4, and 7;
- Section V, paragraphs 1 and 2a through 2g.

5. Disputes arising out of the labor standards provisions of Section IV (except paragraph 5) and Section V of these Required Contract Provisions shall not be subject to the general disputes clause of this contract. Such disputes shall be resolved in accordance with the procedures of the U.S. Department of Labor (DOL) as set forth in 29 CFR 5, 6, and 7. Disputes within the meaning of this clause include disputes between the contractor (or any of its subcontractors) and the contracting agency, the DOL, or the contractor's employees or their representatives.

6. **Selection of Labor:** During the performance of this contract, the contractor shall not:

a. discriminate against labor from any other State, possession, or territory of the United States (except for employment preference for Appalachian contracts, when applicable, as specified in Attachment A), or

b. employ convict labor for any purpose within the limits of the project unless it is labor performed by convicts who are on parole, supervised release, or probation.

**II. NONDISCRIMINATION**

(Applicable to all Federal-aid construction contracts and to all related subcontracts of \$10,000 or more.)

1. **Equal Employment Opportunity:** Equal employment opportunity (EEO) requirements not to discriminate and to take affirmative action to assure equal opportunity as set forth under laws, executive orders, rules, regulations (28 CFR 35, 29 CFR 1630 and 41 CFR 60) and orders of the Secretary of Labor as modified by the provisions prescribed herein, and imposed pursuant to 23 U.S.C. 140 shall constitute the EEO and specific affirmative action standards for the contractor's project activities under this contract. The Equal Opportunity Construction Contract Specifications set forth under 41 CFR 60-4.3 and the provisions of the American Disabilities Act of 1990 (42 U.S.C. 12101 *et seq.*) set forth under 28 CFR 35 and 29 CFR 1630 are incorporated by reference in this contract. In the execution of this contract, the contractor agrees to comply with the following minimum specific requirement activities of EEO:

a. The contractor will work with the State highway agency (SHA) and the Federal Government in carrying out EEO obligations and in their review of his/her activities under the contract.

b. The contractor will accept as his operating policy the following statement:

"It is the policy of this Company to assure that applicants are employed, and that employees are treated during employment, without regard to their race, religion, sex, color, national origin, age or disability. Such action shall include: employment, upgrading, demotion, or transfer; recruitment or recruitment advertising; layoff or termination; rates of pay or other forms of compensation; and selection for training, including apprenticeship, preapprenticeship, and/or on-the-job training."

2. **EEO Officer:** The contractor will designate and make known to the SHA contracting officers an EEO Officer who will have the responsibility for and must be capable of effectively administering and promoting an active contractor program of EEO and who must be assigned adequate authority and responsibility to do so.

3. **Dissemination of Policy:** All members of the contractor's staff who are authorized to hire, supervise, promote, and discharge employees, or who recommend such action, or who are substantially involved in such action, will be made fully cognizant

of, and will implement, the contractor's EEO policy and contractual responsibilities to provide EEO in each grade and classification of employment. To ensure that the above agreement will be met, the following actions will be taken as a minimum:

a. Periodic meetings of supervisory and personnel office employees will be conducted before the start of work and then not less often than once every six months, at which time the contractor's EEO policy and its implementation will be reviewed and explained. The meetings will be conducted by the EEO Officer.

b. All new supervisory or personnel office employees will be given a thorough indoctrination by the EEO Officer, covering all major aspects of the contractor's EEO obligations within thirty days following their reporting for duty with the contractor.

c. All personnel who are engaged in direct recruitment for the project will be instructed by the EEO Officer in the contractor's procedures for locating and hiring minority group employees.

d. Notices and posters setting forth the contractor's EEO policy will be placed in areas readily accessible to employees, applicants for employment and potential employees.

e. The contractor's EEO policy and the procedures to implement such policy will be brought to the attention of employees by means of meetings, employee handbooks, or other appropriate means.

**4. Recruitment:** When advertising for employees, the contractor will include in all advertisements for employees the notation: "An Equal Opportunity Employer." All such advertisements will be placed in publications having a large circulation among minority groups in the area from which the project work force would normally be derived.

a. The contractor will, unless precluded by a valid bargaining agreement, conduct systematic and direct recruitment through public and private employee referral sources likely to yield qualified minority group applicants. To meet this requirement, the contractor will identify sources of potential minority group employees, and establish with such identified sources procedures whereby minority group applicants may be referred to the contractor for employment consideration.

b. In the event the contractor has a valid bargaining agreement providing for exclusive hiring hall referrals, he is expected to observe the provisions of that agreement to the extent that the system permits the contractor's compliance with EEO contract provisions. (The DOL has held that where implementation of such agreements have the effect of discriminating against minorities or women, or obligates the contractor to do the same, such implementation violates Executive Order 11246, as amended.)

c. The contractor will encourage his present employees to refer minority group applicants for employment. Information and procedures with regard to referring minority group applicants will be discussed with employees.

**5. Personnel Actions:** Wages, working conditions, and employee benefits shall be established and administered, and personnel actions of every type, including hiring, upgrading, promotion, transfer, demotion, layoff, and termination, shall be

taken without regard to race, color, religion, sex, national origin, age or disability. The following procedures shall be followed:

a. The contractor will conduct periodic inspections of project sites to insure that working conditions and employee facilities do not indicate discriminatory treatment of project site personnel.

b. The contractor will periodically evaluate the spread of wages paid within each classification to determine any evidence of discriminatory wage practices.

c. The contractor will periodically review selected personnel actions in depth to determine whether there is evidence of discrimination. Where evidence is found, the contractor will promptly take corrective action. If the review indicates that the discrimination may extend beyond the actions reviewed, such corrective action shall include all affected persons.

d. The contractor will promptly investigate all complaints of alleged discrimination made to the contractor in connection with his obligations under this contract, will attempt to resolve such complaints, and will take appropriate corrective action within a reasonable time. If the investigation indicates that the discrimination may affect persons other than the complainant, such corrective action shall include such other persons. Upon completion of each investigation, the contractor will inform every complainant of all of his avenues of appeal.

#### **6. Training and Promotion:**

a. The contractor will assist in locating, qualifying, and increasing the skills of minority group and women employees, and applicants for employment.

b. Consistent with the contractor's work force requirements and as permissible under Federal and State regulations, the contractor shall make full use of training programs, i.e., apprenticeship, and on-the-job training programs for the geographical area of contract performance. Where feasible, 25 percent of apprentices or trainees in each occupation shall be in their first year of apprenticeship or training. In the event a special provision for training is provided under this contract, this subparagraph will be superseded as indicated in the special provision.

c. The contractor will advise employees and applicants for employment of available training programs and entrance requirements for each.

d. The contractor will periodically review the training and promotion potential of minority group and women employees and will encourage eligible employees to apply for such training and promotion.

**7. Unions:** If the contractor relies in whole or in part upon unions as a source of employees, the contractor will use his/her best efforts to obtain the cooperation of such unions to increase opportunities for minority groups and women within the unions, and to effect referrals by such unions of minority and female employees. Actions by the contractor either directly or through a contractor's association acting as agent will include the procedures set forth below:

a. The contractor will use best efforts to develop, in cooperation with the unions, joint training programs aimed toward

qualifying more minority group members and women for membership in the unions and increasing the skills of minority group employees and women so that they may qualify for higher paying employment.

b. The contractor will use best efforts to incorporate an EEO clause into each union agreement to the end that such union will be contractually bound to refer applicants without regard to their race, color, religion, sex, national origin, age or disability.

c. The contractor is to obtain information as to the referral practices and policies of the labor union except that to the extent such information is within the exclusive possession of the labor union and such labor union refuses to furnish such information to the contractor, the contractor shall so certify to the SHA and shall set forth what efforts have been made to obtain such information.

d. In the event the union is unable to provide the contractor with a reasonable flow of minority and women referrals within the time limit set forth in the collective bargaining agreement, the contractor will, through independent recruitment efforts, fill the employment vacancies without regard to race, color, religion, sex, national origin, age or disability; making full efforts to obtain qualified and/or qualifiable minority group persons and women. (The DOL has held that it shall be no excuse that the union with which the contractor has a collective bargaining agreement providing for exclusive referral failed to refer minority employees.) In the event the union referral practice prevents the contractor from meeting the obligations pursuant to Executive Order 11246, as amended, and these special provisions, such contractor shall immediately notify the SHA.

**8. Selection of Subcontractors, Procurement of Materials and Leasing of Equipment:** The contractor shall not discriminate on the grounds of race, color, religion, sex, national origin, age or disability in the selection and retention of subcontractors, including procurement of materials and leases of equipment.

a. The contractor shall notify all potential subcontractors and suppliers of his/her EEO obligations under this contract.

b. Disadvantaged business enterprises (DBE), as defined in 49 CFR 23, shall have equal opportunity to compete for and perform subcontracts which the contractor enters into pursuant to this contract. The contractor will use his best efforts to solicit bids from and to utilize DBE subcontractors or subcontractors with meaningful minority group and female representation among their employees. Contractors shall obtain lists of DBE construction firms from SHA personnel.

c. The contractor will use his best efforts to ensure subcontractor compliance with their EEO obligations.

**9. Records and Reports:** The contractor shall keep such records as necessary to document compliance with the EEO requirements. Such records shall be retained for a period of three years following completion of the contract work and shall be available at reasonable times and places for inspection by authorized representatives of the SHA and the FHWA.

a. The records kept by the contractor shall document the following:

(1) The number of minority and non-minority group members and women employed in each work classification on the project;

(2) The progress and efforts being made in cooperation with unions, when applicable, to increase employment opportunities for minorities and women;

(3) The progress and efforts being made in locating, hiring, training, qualifying, and upgrading minority and female employees; and

(4) The progress and efforts being made in securing the services of DBE subcontractors or subcontractors with meaningful minority and female representation among their employees.

b. The contractors will submit an annual report to the SHA each July for the duration of the project, indicating the number of minority, women, and non-minority group employees currently engaged in each work classification required by the contract work. This information is to be reported on Form FHWA-1391. If on-the-job training is being required by special provision, the contractor will be required to collect and report training data.

### III. NONSEGREGATED FACILITIES

(Applicable to all Federal-aid construction contracts and to all related subcontracts of \$10,000 or more.)

a. By submission of this bid, the execution of this contract or subcontract, or the consummation of this material supply agreement or purchase order, as appropriate, the bidder, Federal-aid construction contractor, subcontractor, material supplier, or vendor, as appropriate, certifies that the firm does not maintain or provide for its employees any segregated facilities at any of its establishments, and that the firm does not permit its employees to perform their services at any location, under its control, where segregated facilities are maintained. The firm agrees that a breach of this certification is a violation of the EEO provisions of this contract. The firm further certifies that no employee will be denied access to adequate facilities on the basis of sex or disability.

b. As used in this certification, the term "segregated facilities" means any waiting rooms, work areas, restrooms and washrooms, restaurants and other eating areas, timeclocks, locker rooms, and other storage or dressing areas, parking lots, drinking fountains, recreation or entertainment areas, transportation, and housing facilities provided for employees which are segregated by explicit directive, or are, in fact, segregated on the basis of race, color, religion, national origin, age or disability, because of habit, local custom, or otherwise. The only exception will be for the disabled when the demands for accessibility override (e.g. disabled parking).

c. The contractor agrees that it has obtained or will obtain identical certification from proposed subcontractors or material suppliers prior to award of subcontracts or consummation of material supply agreements of \$10,000 or more and that it will retain such certifications in its files.

### IV. PAYMENT OF PREDETERMINED MINIMUM WAGE

(Applicable to all Federal-aid construction contracts exceeding \$2,000 and to all related subcontracts, except for projects located on roadways classified as local roads or rural minor collectors, which are exempt.)

**1. General:**

a. All mechanics and laborers employed or working upon the site of the work will be paid unconditionally and not less often than once a week and without subsequent deduction or rebate on any account [except such payroll deductions as are permitted by regulations (29 CFR 3) issued by the Secretary of Labor under the Copeland Act (40 U.S.C. 276c)] the full amounts of wages and bona fide fringe benefits (or cash equivalents thereof) due at time of payment. The payment shall be computed at wage rates not less than those contained in the wage determination of the Secretary of Labor (hereinafter "the wage determination") which is attached hereto and made a part hereof, regardless of any contractual relationship which may be alleged to exist between the contractor or its subcontractors and such laborers and mechanics. The wage determination (including any additional classifications and wage rates conformed under paragraph 2 of this Section IV and the DOL poster (WH-1321) or Form FHWA-1495) shall be posted at all times by the contractor and its subcontractors at the site of the work in a prominent and accessible place where it can be easily seen by the workers. For the purpose of this Section, contributions made or costs reasonably anticipated for bona fide fringe benefits under Section 1(b)(2) of the Davis-Bacon Act (40 U.S.C. 276a) on behalf of laborers or mechanics are considered wages paid to such laborers or mechanics, subject to the provisions of Section IV, paragraph 3b, hereof. Also, for the purpose of this Section, regular contributions made or costs incurred for more than a weekly period (but not less often than quarterly) under plans, funds, or programs, which cover the particular weekly period, are deemed to be constructively made or incurred during such weekly period. Such laborers and mechanics shall be paid the appropriate wage rate and fringe benefits on the wage determination for the classification of work actually performed, without regard to skill, except as provided in paragraphs 4 and 5 of this Section IV.

b. Laborers or mechanics performing work in more than one classification may be compensated at the rate specified for each classification for the time actually worked therein, provided, that the employer's payroll records accurately set forth the time spent in each classification in which work is performed.

c. All rulings and interpretations of the Davis-Bacon Act and related acts contained in 29 CFR 1, 3, and 5 are herein incorporated by reference in this contract.

**2. Classification:**

a. The SHA contracting officer shall require that any class of laborers or mechanics employed under the contract, which is not listed in the wage determination, shall be classified in conformance with the wage determination.

b. The contracting officer shall approve an additional classification, wage rate and fringe benefits only when the following criteria have been met:

(1) the work to be performed by the additional classification requested is not performed by a classification in the wage determination;

(2) the additional classification is utilized in the area by the construction industry;

(3) the proposed wage rate, including any bona fide fringe benefits, bears a reasonable relationship to the wage rates contained in the wage determination; and

(4) with respect to helpers, when such a classification prevails in the area in which the work is performed.

c. If the contractor or subcontractors, as appropriate, the laborers and mechanics (if known) to be employed in the additional classification or their representatives, and the contracting officer agree on the classification and wage rate (including the amount designated for fringe benefits where appropriate), a report of the action taken shall be sent by the contracting officer to the DOL, Administrator of the Wage and Hour Division, Employment Standards Administration, Washington, D.C. 20210. The Wage and Hour Administrator, or an authorized representative, will approve, modify, or disapprove every additional classification action within 30 days of receipt and so advise the contracting officer or will notify the contracting officer within the 30-day period that additional time is necessary.

d. In the event the contractor or subcontractors, as appropriate, the laborers or mechanics to be employed in the additional classification or their representatives, and the contracting officer do not agree on the proposed classification and wage rate (including the amount designated for fringe benefits, where appropriate), the contracting officer shall refer the questions, including the views of all interested parties and the recommendation of the contracting officer, to the Wage and Hour Administrator for determination. Said Administrator, or an authorized representative, will issue a determination within 30 days of receipt and so advise the contracting officer or will notify the contracting officer within the 30-day period that additional time is necessary.

e. The wage rate (including fringe benefits where appropriate) determined pursuant to paragraph 2c or 2d of this Section IV shall be paid to all workers performing work in the additional classification from the first day on which work is performed in the classification.

**3. Payment of Fringe Benefits:**

a. Whenever the minimum wage rate prescribed in the contract for a class of laborers or mechanics includes a fringe benefit which is not expressed as an hourly rate, the contractor or subcontractors, as appropriate, shall either pay the benefit as stated in the wage determination or shall pay another bona fide fringe benefit or an hourly case equivalent thereof.

b. If the contractor or subcontractor, as appropriate, does not make payments to a trustee or other third person, he/she may consider as a part of the wages of any laborer or mechanic the amount of any costs reasonably anticipated in providing bona fide fringe benefits under a plan or program, provided, that the Secretary of Labor has found, upon the written request of the contractor, that the applicable standards of the Davis-Bacon Act have been met. The Secretary of Labor may require the contractor to set aside in a separate account assets for the meeting of obligations under the plan or program.

**4. Apprentices and Trainees (Programs of the U.S. DOL) and Helpers:**

**a. Apprentices:**

(1) Apprentices will be permitted to work at less than the predetermined rate for the work they performed when they are employed pursuant to and individually registered in a bona fide apprenticeship program registered with the DOL, Employment and Training Administration, Bureau of Apprenticeship and Training, or with a State apprenticeship agency recognized by the Bureau, or if a person is employed in his/her first 90 days of probationary employment as an apprentice in such an apprenticeship program, who is not individually registered in the program, but who has been certified by the Bureau of Apprenticeship and Training or a State apprenticeship agency (where appropriate) to be eligible for probationary employment as an apprentice.

(2) The allowable ratio of apprentices to journeyman-level employees on the job site in any craft classification shall not be greater than the ratio permitted to the contractor as to the entire work force under the registered program. Any employee listed on a payroll at an apprentice wage rate, who is not registered or otherwise employed as stated above, shall be paid not less than the applicable wage rate listed in the wage determination for the classification of work actually performed. In addition, any apprentice performing work on the job site in excess of the ratio permitted under the registered program shall be paid not less than the applicable wage rate on the wage determination for the work actually performed. Where a contractor or subcontractor is performing construction on a project in a locality other than that in which its program is registered, the ratios and wage rates (expressed in percentages of the journeyman-level hourly rate) specified in the contractor's or subcontractor's registered program shall be observed.

(3) Every apprentice must be paid at not less than the rate specified in the registered program for the apprentice's level of progress, expressed as a percentage of the journeyman-level hourly rate specified in the applicable wage determination. Apprentices shall be paid fringe benefits in accordance with the provisions of the apprenticeship program. If the apprenticeship program does not specify fringe benefits, apprentices must be paid the full amount of fringe benefits listed on the wage determination for the applicable classification. If the Administrator for the Wage and Hour Division determines that a different practice prevails for the applicable apprentice classification, fringes shall be paid in accordance with that determination.

(4) In the event the Bureau of Apprenticeship and Training, or a State apprenticeship agency recognized by the Bureau, withdraws approval of an apprenticeship program, the contractor or subcontractor will no longer be permitted to utilize apprentices at less than the applicable predetermined rate for the comparable work performed by regular employees until an acceptable program is approved.

**b. Trainees:**

(1) Except as provided in 29 CFR 5.16, trainees will not be permitted to work at less than the predetermined rate for the work performed unless they are employed pursuant to and individually registered in a program which has received prior approval, evidenced by formal certification by the DOL, Employment and Training Administration.

(2) The ratio of trainees to journeyman-level employees on the job site shall not be greater than permitted under the plan approved by the Employment and Training Administration. Any employee listed on the payroll at a trainee rate who is not registered and participating in a training plan approved by the Employment and Training Administration shall be paid not less than the applicable wage rate on the wage determination for the classification of work actually performed. In addition, any trainee performing work on the job site in excess of the ratio permitted under the registered program shall be paid not less than the applicable wage rate on the wage determination for the work actually performed.

(3) Every trainee must be paid at not less than the rate specified in the approved program for his/her level of progress, expressed as a percentage of the journeyman-level hourly rate specified in the applicable wage determination. Trainees shall be paid fringe benefits in accordance with the provisions of the trainee program. If the trainee program does not mention fringe benefits, trainees shall be paid the full amount of fringe benefits listed on the wage determination unless the Administrator of the Wage and Hour Division determines that there is an apprenticeship program associated with the corresponding journeyman-level wage rate on the wage determination which provides for less than full fringe benefits for apprentices, in which case such trainees shall receive the same fringe benefits as apprentices.

(4) In the event the Employment and Training Administration withdraws approval of a training program, the contractor or subcontractor will no longer be permitted to utilize trainees at less than the applicable predetermined rate for the work performed until an acceptable program is approved.

**c. Helpers:**

Helpers will be permitted to work on a project if the helper classification is specified and defined on the applicable wage determination or is approved pursuant to the conformance procedure set forth in Section IV.2. Any worker listed on a payroll at a helper wage rate, who is not a helper under an approved definition, shall be paid not less than the applicable wage rate on the wage determination for the classification of work actually performed.

**5. Apprentices and Trainees (Programs of the U.S. DOT):**

Apprentices and trainees working under apprenticeship and skill training programs which have been certified by the Secretary of Transportation as promoting EEO in connection with Federal-aid highway construction programs are not subject to the requirements of paragraph 4 of this Section IV. The straight time hourly wage rates for apprentices and trainees under such programs will be established by the particular programs. The ratio of apprentices and trainees to journeymen shall not be greater than permitted by the terms of the particular program.

**6. Withholding:**

The SHA shall upon its own action or upon written request of an authorized representative of the DOL withhold, or cause to be withheld, from the contractor or subcontractor under this contract or any other Federal contract with the same prime contractor, or any other Federally-assisted contract subject to Davis-Bacon prevailing wage requirements which is held by the



same prime contractor, as much of the accrued payments or advances as may be considered necessary to pay laborers and mechanics, including apprentices, trainees, and helpers, employed by the contractor or any subcontractor the full amount of wages required by the contract. In the event of failure to pay any laborer or mechanic, including any apprentice, trainee, or helper, employed or working on the site of the work, all or part of the wages required by the contract, the SHA contracting officer may, after written notice to the contractor, take such action as may be necessary to cause the suspension of any further payment, advance, or guarantee of funds until such violations have ceased.

#### **7. Overtime Requirements:**

No contractor or subcontractor contracting for any part of the contract work which may require or involve the employment of laborers, mechanics, watchmen, or guards (including apprentices, trainees, and helpers described in paragraphs 4 and 5 above) shall require or permit any laborer, mechanic, watchman, or guard in any workweek in which he/she is employed on such work, to work in excess of 40 hours in such workweek unless such laborer, mechanic, watchman, or guard receives compensation at a rate not less than one-and-one-half times his/her basic rate of pay for all hours worked in excess of 40 hours in such workweek.

#### **8. Violation:**

Liability for Unpaid Wages; Liquidated Damages: In the event of any violation of the clause set forth in paragraph 7 above, the contractor and any subcontractor responsible thereof shall be liable to the affected employee for his/her unpaid wages. In addition, such contractor and subcontractor shall be liable to the United States (in the case of work done under contract for the District of Columbia or a territory, to such District or to such territory) for liquidated damages. Such liquidated damages shall be computed with respect to each individual laborer, mechanic, watchman, or guard employed in violation of the clause set forth in paragraph 7, in the sum of \$10 for each calendar day on which such employee was required or permitted to work in excess of the standard work week of 40 hours without payment of the overtime wages required by the clause set forth in paragraph 7.

#### **9. Withholding for Unpaid Wages and Liquidated Damages:**

The SHA shall upon its own action or upon written request of any authorized representative of the DOL withhold, or cause to be withheld, from any monies payable on account of work performed by the contractor or subcontractor under any such contract or any other Federal contract with the same prime contractor, or any other Federally-assisted contract subject to the Contract Work Hours and Safety Standards Act, which is held by the same prime contractor, such sums as may be determined to be necessary to satisfy any liabilities of such contractor or subcontractor for unpaid wages and liquidated damages as provided in the clause set forth in paragraph 8 above.

### **V. STATEMENTS AND PAYROLLS**

(Applicable to all Federal-aid construction contracts exceeding \$2,000 and to all related subcontracts, except for projects located on roadways classified as local roads or rural collectors, which are exempt.)

#### **1. Compliance with Copeland Regulations (29 CFR 3):**

The contractor shall comply with the Copeland Regulations of the Secretary of Labor which are herein incorporated by reference.

#### **2. Payrolls and Payroll Records:**

a. Payrolls and basic records relating thereto shall be maintained by the contractor and each subcontractor during the course of the work and preserved for a period of 3 years from the date of completion of the contract for all laborers, mechanics, apprentices, trainees, watchmen, helpers, and guards working at the site of the work.

b. The payroll records shall contain the name, social security number, and address of each such employee; his or her correct classification; hourly rates of wages paid (including rates of contributions or costs anticipated for bona fide fringe benefits or cash equivalent thereof the types described in Section 1(b)(2)(B) of the Davis Bacon Act); daily and weekly number of hours worked; deductions made; and actual wages paid. In addition, for Appalachian contracts, the payroll records shall contain a notation indicating whether the employee does, or does not, normally reside in the labor area as defined in Attachment A, paragraph 1. Whenever the Secretary of Labor, pursuant to Section IV, paragraph 3b, has found that the wages of any laborer or mechanic include the amount of any costs reasonably anticipated in providing benefits under a plan or program described in Section 1(b)(2)(B) of the Davis Bacon Act, the contractor and each subcontractor shall maintain records which show that the commitment to provide such benefits is enforceable, that the plan or program is financially responsible, that the plan or program has been communicated in writing to the laborers or mechanics affected, and show the cost anticipated or the actual cost incurred in providing benefits. Contractors or subcontractors employing apprentices or trainees under approved programs shall maintain written evidence of the registration of apprentices and trainees, and ratios and wage rates prescribed in the applicable programs.

c. Each contractor and subcontractor shall furnish, each week in which any contract work is performed, to the SHA resident engineer a payroll of wages paid each of its employees (including apprentices, trainees, and helpers, described in Section IV, paragraphs 4 and 5, and watchmen and guards engaged on work during the preceding weekly payroll period). The payroll submitted required to be maintained under paragraph 2b of this Section V. This information may be submitted in any form desired. Optional Form WH-347 is available for this purpose and may be purchased from the Superintendent of Documents (Federal stock number 029-005-0014-1), U.S. Government Printing Office, Washington, D.C. 20402. The prime contractor is responsible for the submission of copies of payrolls by all subcontractors.

d. Each payroll submitted shall be accompanied by a "Statement of Compliance," signed by the contractor or subcontractor or his/her agent who pays or supervises the payment of the persons employed under the contract and shall certify the following:

(1) that the payroll for the payroll period contains the information required to be maintained under paragraph 2b of this Section V and that such information is correct and complete;

(2) that such laborer or mechanic (including each helper, apprentice, and trainee) employed on the contract during the payroll period has been paid the full weekly wages earned,

without rebate, either directly or indirectly, and that no deductions have been made either directly or indirectly from the full wages earned, other than permissible deductions as set forth in the Regulations, 29 CFR 3;

(3) that each laborer or mechanic has been paid not less than the applicable wage rate and fringe benefits or cash equivalent for the classification of work performed, as specified in the applicable wage determination incorporated into the contract.

e. The weekly submission of a properly executed certification set forth on the reverse side of Optional Form WH-347 shall satisfy the requirement for submission of the "Statement of Compliance" required by paragraph 2d of this Section V.

f. The falsification of any of the above certifications may subject the contractor to civil or criminal prosecution under 18 U.S.C. 1001 and 31 U.S.C. 231.

g. The contractor or subcontractor shall make the records required under paragraph 2b of this Section V available for inspection, copying, or transcription by authorized representatives of the SHA, the FHWA, or the DOL, and shall permit such representatives to interview employees during working hours on the job. If the contractor or subcontractor fails to submit the required records or to make them available, the SHA, the FHWA, the DOL, or all may, after written notice to the contractor, sponsor, applicant, or owner, take such actions as may be necessary to cause the suspension of any further payment, advance, or guarantee of funds. Furthermore, failure to submit the required records upon request or to make such records available may be grounds for debarment action pursuant to 29 CFR 5.12.

## VI. RECORD OF MATERIALS, SUPPLIES, AND LABOR

1. On all Federal-aid contracts on the National Highway System, except those which provide solely for the installation of protective devices at railroad grade crossings, those which are constructed on a force account or direct labor basis, highway beautification contracts, and contracts for which the total final construction cost for roadway and bridge is less than \$1,000,000 (23 CFR 635) the contractor shall:

a. Become familiar with the list of specific materials and supplies contained in Form FHWA-47, "Statement of Materials and Labor Used by Contractor of Highway Construction Involving Federal Funds," prior to the commencement of work under this contract.

b. Maintain a record of the total cost of all materials and supplies purchased for and incorporated in the work, and also of the quantities of those specific materials and supplies listed on Form FHWA-47, and in the units shown on Form FHWA-47.

c. Furnish, upon the completion of the contract, to the SHA resident engineer on Form FHWA-47 together with the data required in paragraph 1b relative to materials and supplies, a final labor summary of all contract work indicating the total hours worked and the total amount earned.

2. At the prime contractor's option, either a single report covering all contract work or separate reports for the contractor and for each subcontract shall be submitted.

## VII. SUBLETTING OR ASSIGNING THE CONTRACT

1. The contractor shall perform with its own organization contract work amounting to not less than 30 percent (or a greater percentage if specified elsewhere in the contract) of the total original contract price, excluding any specialty items designated by the State. Specialty items may be performed by subcontract and the amount of any such specialty items performed may be deducted from the total original contract price before computing the amount of work required to be performed by the contractor's own organization (23 CFR 635).

a. "Its own organization" shall be construed to include only workers employed and paid directly by the prime contractor and equipment owned or rented by the prime contractor, with or without operators. Such term does not include employees or equipment of a subcontractor, assignee, or agent of the prime contractor.

b. "Specialty Items" shall be construed to be limited to work that requires highly specialized knowledge, abilities, or equipment not ordinarily available in the type of contracting organizations qualified and expected to bid on the contract as a whole and in general are to be limited to minor components of the overall contract.

2. The contract amount upon which the requirements set forth in paragraph 1 of Section VII is computed includes the cost of material and manufactured products which are to be purchased or produced by the contractor under the contract provisions.

3. The contractor shall furnish (a) a competent superintendent or supervisor who is employed by the firm, has full authority to direct performance of the work in accordance with the contract requirements, and is in charge of all construction operations (regardless of who performs the work) and (b) such other of its own organizational resources (supervision, management, and engineering services) as the SHA contracting officer determines is necessary to assure the performance of the contract.

4. No portion of the contract shall be sublet, assigned or otherwise disposed of except with the written consent of the SHA contracting officer, or authorized representative, and such consent when given shall not be construed to relieve the contractor of any responsibility for the fulfillment of the contract. Written consent will be given only after the SHA has assured that each subcontract is evidenced in writing and that it contains all pertinent provisions and requirements of the prime contract.

## VIII. SAFETY: ACCIDENT PREVENTION

1. In the performance of this contract the contractor shall comply with all applicable Federal, State, and local laws governing safety, health, and sanitation (23 CFR 635). The contractor shall provide all safeguards, safety devices and protective equipment and take any other needed actions as it determines, or as the SHA contracting officer may determine, to be reasonably necessary to protect the life and health of employees on the job and the safety of the public and to protect property in connection with the performance of the work covered by the contract.

2. It is a condition of this contract, and shall be made a condition of each subcontract, which the contractor enters into pursuant to this contract, that the contractor and any subcontractor shall not permit any employee, in performance of the contract, to work in surroundings or under conditions which are unsanitary,

hazardous or dangerous to his/her health or safety, as determined under construction safety and health standards (29 CFR 1926) promulgated by the Secretary of Labor, in accordance with Section 107 of the Contract Work Hours and Safety Standards Act (40 U.S.C. 333).

3. Pursuant to 29 CFR 1926.3, it is a condition of this contract that the Secretary of Labor or authorized representative thereof, shall have right of entry to any site of contract performance to inspect or investigate the matter of compliance with the construction safety and health standards and to carry out the duties of the Secretary under Section 107 of the Contract Work Hours and Safety Standards Act (40 U.S.C. 333).

#### **IX. FALSE STATEMENTS CONCERNING HIGHWAY PROJECTS**

In order to assure high quality and durable construction in conformity with approved plans and specifications and a high degree of reliability on statements and representations made by engineers, contractors, suppliers, and workers on Federal-aid highway projects, it is essential that all persons concerned with the project perform their functions as carefully, thoroughly, and honestly as possible. Willful falsification, distortion, or misrepresentation with respect to any facts related to the project is a violation of Federal law. To prevent any misunderstanding regarding the seriousness of these and similar acts, the following notice shall be posted on each Federal-aid highway project (23 CFR 635) in one or more places where it is readily available to all persons concerned with the project:

##### **NOTICE TO ALL PERSONNEL ENGAGED ON FEDERAL-AID HIGHWAY PROJECTS**

18 U.S.C. 1020 reads as follows:

*"Whoever, being an officer, agent, or employee of the United States, or of any State or Territory, or whoever, whether a person, association, firm, or corporation, knowingly makes any false statement, false representation, or false report as to the character, quality, quantity, or cost of the material used or to be used, or the quantity or quality of the work performed or to be performed, or the cost thereof in connection with the submission of plans, maps, specifications, contracts, or costs of construction on any highway or related project submitted for approval to the Secretary of Transportation; or*

*Whoever knowingly makes any false statement, false representation, false report or false claim with respect to the character, quality, quantity, or cost of any work performed or to be performed, or materials furnished or to be furnished, in connection with the construction of any highway or related project approved by the Secretary of Transportation; or*

*Whoever knowingly makes any false statement or false representation as to material fact in any statement, certificate, or report submitted pursuant to provisions of the Federal-aid Roads Act approved July 1, 1916, (39 Stat. 355), as amended and supplemented;*

*Shall be fined not more than \$10,000 or imprisoned not more than 5 years or both."*

#### **X. IMPLEMENTATION OF CLEAN AIR ACT AND FEDERAL WATER POLLUTION CONTROL ACT**

(Applicable to all Federal-aid construction contracts and to all related subcontracts of \$100,000 or more.)

By submission of this bid or the execution of this contract, or subcontract, as appropriate, the bidder, Federal-aid construction contractor, or subcontractor, as appropriate, will be deemed to have stipulated as follows:

1. That any facility that is or will be utilized in the performance of this contract, unless such contract is exempt under the Clean Air Act, as amended (42 U.S.C. 1857 et seq., as amended by Pub.L. 91-604), and under the Federal Water Pollution Control Act, as amended (33 U.S.C. 1251 et seq., as amended by Pub.L. 92-500), Executive Order 11738, and regulations in implementation thereof (40 CFR 15) is not listed, on the date of contract award, on the U.S. Environmental Protection Agency (EPA) List of Violating Facilities pursuant to 40 CFR 15.20.

2. That the firm agrees to comply and remain in compliance with all the requirements of Section 114 of the Clean Air Act and Section 308 of the Federal Water Pollution Control Act and all regulations and guidelines listed thereunder.

3. That the firm shall promptly notify the SHA of the receipt of any communication from the Director, Office of Federal Activities, EPA, indicating that a facility that is or will be utilized for the contract is under consideration to be listed on the EPA List of Violating Facilities.

4. That the firm agrees to include or cause to be included the requirements of paragraph 1 through 4 of this Section X in every nonexempt subcontract, and further agrees to take such action as the government may direct as a means of enforcing such requirements.

#### **XI. CERTIFICATION REGARDING DEBARMENT, SUSPENSION, INELIGIBILITY AND VOLUNTARY EXCLUSION**

##### **1. Instructions for Certification - Primary Covered Transactions:**

(Applicable to all Federal-aid contracts - 49 CFR 29)

a. By signing and submitting this proposal, the prospective primary participant is providing the certification set out below.

b. The inability of a person to provide the certification set out below will not necessarily result in denial of participation in this covered transaction. The prospective participant shall submit an explanation of why it cannot provide the certification set out below. The certification or explanation will be considered in connection with the department or agency's determination whether to enter into this transaction. However, failure of the prospective primary participant to furnish a certification or an explanation shall disqualify such a person from participation in this transaction.

c. The certification in this clause is a material representation of fact upon which reliance was placed when the department or agency determined to enter into this transaction. If it is later determined that the prospective primary participant knowingly rendered an erroneous certification, in addition to other remedies available to the Federal Government, the department or agency may terminate this transaction for cause of default.

d. The prospective primary participant shall provide immediate written notice to the department or agency to whom this proposal is submitted if any time the prospective primary participant learns that its certification was erroneous when submitted or has become erroneous by reason of changed circumstances.

e. The terms "covered transaction," "debarred," "suspended," "ineligible," "lower tier covered transaction," "participant," "person," "primary covered transaction," "principal," "proposal," and "voluntarily excluded," as used in this clause, have the meanings set out in the Definitions and Coverage sections of rules implementing Executive Order 12549. You may contact the department or agency to which this proposal is submitted for assistance in obtaining a copy of those regulations.

f. The prospective primary participant agrees by submitting this proposal that, should the proposed covered transaction be entered into, it shall not knowingly enter into any lower tier covered transaction with a person who is debarred, suspended, declared ineligible, or voluntarily excluded from participation in this covered transaction, unless authorized by the department or agency entering into this transaction.

g. The prospective primary participant further agrees by submitting this proposal that it will include the clause titled "Certification Regarding Debarment, Suspension, Ineligibility and Voluntary Exclusion-Lower Tier Covered Transaction," provided by the department or agency entering into this covered transaction, without modification, in all lower tier covered transactions and in all solicitations for lower tier covered transactions.

h. A participant in a covered transaction may rely upon a certification of a prospective participant in a lower tier covered transaction that is not debarred, suspended, ineligible, or voluntarily excluded from the covered transaction, unless it knows that the certification is erroneous. A participant may decide the method and frequency by which it determines the eligibility of its principals. Each participant may, but is not required to, check the nonprocurement portion of the "Lists of Parties Excluded From Federal Procurement or Nonprocurement Programs" (Nonprocurement List) which is compiled by the General Services Administration.

i. Nothing contained in the foregoing shall be construed to require establishment of a system of records in order to render in good faith the certification required by this clause. The knowledge and information of participant is not required to exceed that which is normally possessed by a prudent person in the ordinary course of business dealings.

j. Except for transactions authorized under paragraph f of these instructions, if a participant in a covered transaction knowingly enters into a lower tier covered transaction with a person who is suspended, debarred, ineligible, or voluntarily excluded from participation in this transaction, in addition to other remedies available to the Federal Government, the department or agency may terminate this transaction for cause or default.

\*\*\*\*\*

#### **Certification Regarding Debarment, Suspension, Ineligibility and Voluntary Exclusion--Primary Covered Transactions**

1. The prospective primary participant certifies to the best of its knowledge and belief, that it and its principals:

a. Are not presently debarred, suspended, proposed for debarment, declared ineligible, or voluntarily excluded from covered transactions by any Federal department or agency;

b. Have not within a 3-year period preceding this proposal been convicted of or had a civil judgement rendered against them for commission of fraud or a criminal offense in connection with obtaining, attempting to obtain, or performing a public (Federal, State or local) transaction or contract under a public transaction; violation of Federal or State antitrust statutes or commission of embezzlement, theft, forgery, bribery, falsification or destruction of records, making false statements, or receiving stolen property;

c. Are not presently indicted for or otherwise criminally or civilly charged by a governmental entity (Federal, State or local) with commission of any of the offenses enumerated in paragraph 1b of this certification; and

d. Have not within a 3-year period preceding this application/proposal had one or more public transactions (Federal, State or local) terminated for cause or default.

2. Where the prospective primary participant is unable to certify to any of the statements in this certification, such prospective participant shall attach an explanation to this proposal.

\*\*\*\*\*

#### **2. Instructions for Certification - Lower Tier Covered Transactions:**

(Applicable to all subcontracts, purchase orders and other lower tier transactions of \$25,000 or more - 49 CFR 29)

a. By signing and submitting this proposal, the prospective lower tier is providing the certification set out below.

b. The certification in this clause is a material representation of fact upon which reliance was placed when this transaction was entered into. If it is later determined that the prospective lower tier participant knowingly rendered an erroneous certification, in addition to other remedies available to the Federal Government, the department, or agency with which this transaction originated may pursue available remedies, including suspension and/or debarment.

c. The prospective lower tier participant shall provide immediate written notice to the person to which this proposal is submitted if at any time the prospective lower tier participant learns that its certification was erroneous by reason of changed circumstances.

d. The terms "covered transaction," "debarred," "suspended," "ineligible," "primary covered transaction," "participant," "person," "principal," "proposal," and "voluntarily excluded," as used in this clause, have the meanings set out in the Definitions and Coverage sections of rules implementing Executive

Order 12549. You may contact the person to which this proposal is submitted for assistance in obtaining a copy of those regulations.

e. The prospective lower tier participant agrees by submitting this proposal that, should the proposed covered transaction be entered into, it shall not knowingly enter into any lower tier covered transaction with a person who is debarred, suspended, declared ineligible, or voluntarily excluded from participation in this covered transaction, unless authorized by the department or agency with which this transaction originated.

f. The prospective lower tier participant further agrees by submitting this proposal that it will include this clause titled "Certification Regarding Debarment, Suspension, Ineligibility and Voluntary Exclusion-Lower Tier Covered Transaction," without modification, in all lower tier covered transactions and in all solicitations for lower tier covered transactions.

g. A participant in a covered transaction may rely upon a certification of a prospective participant in a lower tier covered transaction that is not debarred, suspended, ineligible, or voluntarily excluded from the covered transaction, unless it knows that the certification is erroneous. A participant may decide the method and frequency by which it determines the eligibility of its principals. Each participant may, but is not required to, check the Nonprocurement List.

h. Nothing contained in the foregoing shall be construed to require establishment of a system of records in order to render in good faith the certification required by this clause. The knowledge and information of participant is not required to exceed that which is normally possessed by a prudent person in the ordinary course of business dealings.

i. Except for transactions authorized under paragraph e of these instructions, if a participant in a covered transaction knowingly enters into a lower tier covered transaction with a person who is suspended, debarred, ineligible, or voluntarily excluded from participation in this transaction, in addition to other remedies available to the Federal Government, the department or agency with which this transaction originated may pursue available remedies, including suspension and/or debarment.

\* \* \* \* \*

**Certification Regarding Debarment, Suspension, Ineligibility and Voluntary Exclusion--Lower Tier Covered Transactions:**

1. The prospective lower tier participant certifies, by submission of this proposal, that neither it nor its principals is presently debarred, suspended, proposed for debarment, declared

ineligible, or voluntarily excluded from participation in this transaction by any Federal department or agency.

2. Where the prospective lower tier participant is unable to certify to any of the statements in this certification, such prospective participant shall attach an explanation to this proposal.

\* \* \* \* \*

**XII. CERTIFICATION REGARDING USE OF CONTRACT FUNDS FOR LOBBYING**

(Applicable to all Federal-aid construction contracts and to all related subcontracts which exceed \$100,000 - 49 CFR 20)

1. The prospective participant certifies, by signing and submitting this bid or proposal, to the best of his or her knowledge and belief, that:

a. No Federal appropriated funds have been paid or will be paid, by or on behalf of the undersigned, to any person for influencing or attempting to influence an officer or employee of any Federal agency, a Member of Congress, an officer or employee of Congress, or an employee of a Member of Congress in connection with the awarding of any Federal contract, the making of any Federal grant, the making of any Federal loan, the entering into of any cooperative agreement, and the extension, continuation, renewal, amendment, or modification of any Federal contract, grant, loan, or cooperative agreement.

b. If any funds other than Federal appropriated funds have been paid or will be paid to any person for influencing or attempting to influence an officer or employee of any Federal agency, a Member of Congress, an officer or employee of Congress, or an employee of a Member of Congress in connection with this Federal contract, grant, loan, or cooperative agreement, the undersigned shall complete and submit Standard Form-LLL, "Disclosure Form to Report Lobbying," in accordance with its instructions.

2. This certification is a material representation of fact upon which reliance was placed when this transaction was made or entered into. Submission of this certification is a prerequisite for making or entering into this transaction imposed by 31 U.S.C. 1352. Any person who fails to file the required certification shall be subject to a civil penalty of not less than \$10,000 and not more than \$100,000 for each such failure.

3. The prospective participant also agrees by submitting his or her bid or proposal that he or she shall require that the language of this certification be included in all lower tier subcontracts, which exceed \$100,000 and that all such recipients shall certify and disclose accordingly.

**NOTICE OF REQUIREMENTS FOR AFFIRMATIVE  
ACTION TO ENSURE EQUAL EMPLOYMENT  
OPPORTUNITY (EXECUTIVE ORDER 11246)**

1. The Offeror's or Bidder's attention is called to the "Equal Opportunity Clause" and the "Standard Federal Equal Employment Opportunity Construction Contract Specifications" set forth herein.

2. The goals and timetables for minority and female participation, expressed in percentage terms for the Contractor's aggregate workforce in each trade on all construction work in the covered area, are as follows:

Timetables	Goals for female participation in each trade (percent)
From April 1, 1978 until March 31, 1979	3.1
From April 1, 1979 until March 31, 1980	5.1
From April 1, 1980 until March 31, 1981	6.9

Until further notice	Goals for minority participation for each trade (percent)
----------------------	---

**SHSA Cities:**

Pascagoula - Moss Point -----	16.9
Biloxi - Gulfport -----	19.2
Jackson -----	30.3

**SMSA Counties:**

Desoto -----	32.3
Hancock, Harrison, Stone -----	19.2
Hinds, Rankin -----	30.3
Jackson -----	16.9

**Non-SMSA Counties:**

George, Greene -----	26.4
----------------------	------

Alcorn, Benton, Bolivar, Calhoun, Carroll, Chickasaw, Clay, Coahoma, Grenada, Itawamba, Lafayette, Lee, Leflore, Marshall, Monroe, Montgomery, Panola, Pontotoc, Prentiss, Quitman, Sunflower, Tallahatchie, Tate, Tippah, Tishomingo, Tunica, Union, Washington, Webster, Yalobusha -----	26.5
---	------

Attala, Choctaw, Claiborne, Clarke, Copiah, Covington, Franklin, Holmes, Humphreys, Issaquena, Jasper, Jefferson, Jefferson Davis, Jones Kemper, Lauderdale, Lawrence, Leake, Lincoln, Lowndes, Madison, Neshoba, Newton, Noxubee, Oktibbeha, Scott, Sharkey, Simpson, Smith, Warren, Wayne, Winston, Yazoo -----	32.0
--	------

Forrest, Lamar, Marion, Pearl River, Perry, Pike, Walthall -----	27.7
---	------

Adams, Amite, Wilkinson -----	30.4
-------------------------------	------

These goals are applicable to all the Contractor's construction work (whether or not it is Federal or federally assisted) performed in the covered area. If the contractor performs construction work in a geographical area located outside of the covered area, it shall apply the goals established for such geographical area where the work is actually performed. With regard to this second area, the contractor also is subject to the goals for both its federally involved and nonfederally involved construction.

The Contractor's compliance with the Executive Order and the regulations in CFR Part 60-4 shall be based on its implementation of the Equal Opportunity clause, specific affirmative action obligations required by the specifications set forth in 41 CFR 60-4.3(a), and its efforts to meet the goals. The hours of minority and female employment and training must be substantially uniform throughout the length of the contract, and in each trade, and the Contractor shall make a good faith effort to employ minorities and women evenly on each of its projects. The transfer of minority or female employees or trainees from Contractor to Contractor or from project to project for the sole purpose of meeting the Contractor's goals shall be a violation of the contract, the Executive Order and the regulations in 41 CFR Part 60-4. Compliance with the goals will be measured against the total work hours performed.

3. The Contractor shall provide written notification to the Director of the Office of Federal Contract Compliance Programs within 10 working days of award of any construction subcontract in excess of \$10,000 at any tier for construction work under the contract resulting from this solicitation. The notification shall list the name, address and telephone number of the subcontractor, employer identification number of the subcontractor, estimated dollar amount of the subcontract; estimated starting and completion dates of the subcontract; and the geographical area in which the subcontract is to be performed.

4. As used in this Notice, and in the contract resulting from this solicitation, the "covered area" is to the county and city (if any), stated in the advertisement.

5. The notification required in Paragraph 3 shall be addressed to the following:

Contract Compliance Officer  
Mississippi Department of Transportation  
P.O. Box 1850  
Jackson, Mississippi 39215-1850

**MISSISSIPPI DEPARTMENT OF TRANSPORTATION**

**SUPPLEMENT TO SPECIAL PROVISION NO. 907-105-3**

**DATE: 03/31/2008**

**SUBJECT: Cooperation By Contractor**

Delete the first sentence of the first paragraph under 907-105-05 on page 1, and substitute the following:

On projects that include erosion control pay items, the Contractor shall also designate a responsible person whose primary duty shall be to monitor and maintain the effectiveness of the erosion control plan, including NPDES permit requirements.

## MISSISSIPPI DEPARTMENT OF TRANSPORTATION

SPECIAL PROVISION NO. 907-105-3

CODE: (IS)

DATE: 02/14/2006

SUBJECT: Cooperation By Contractor

Section 105, Control of Work, of the 2004 Edition of the Mississippi Standard Specifications for Road and Bridge Construction is modified as follows:

**907-105.05--Cooperation by Contractor.** In the third sentence of the second paragraph of Subsection 105.05 on page 35, change “Notice to Proceed” to “Notice of Award”.

Delete the fourth paragraph of Subsection 105.05 on page 35, and substitute the following.

The Contractor shall also designate a responsible person whose primary duty shall be to monitor and maintain the effectiveness of the erosion control plan, including NPDES permit requirements. This responsible person must be a Certified Erosion Control Person certified by an organization approved by the Department. Prior to or at the pre-construction conference, the Contractor shall designate in writing the Certified Erosion Control Person to the Project Engineer. The designated Certified Erosion Control Person shall be assigned to only one (1) project. When special conditions exist, such as two (2) adjoining projects or two (2) projects in close proximity, the Contractor may request in writing that the State Construction Engineer approve the use of one (1) Certified Erosion Control Person for both projects. The Contractor may request in writing that the Engineer authorize a substitute Certified Erosion Control Person to act in the absence of the Certified Erosion Control Person. The substitute Certified Erosion Control Person must also be certified by an organization approved by the Department. A copy of the Certified Erosion Control Person's certification must be included in the Contractor's Protection Plan as outlined in Subsection 907-107.22.1. This in no way modifies the requirements regarding the assignment and availability of the superintendent.



**MISSISSIPPI DEPARTMENT OF TRANSPORTATION**

**SUPPLEMENT TO SPECIAL PROVISION NO. 907-107-1**

**DATE:** 03/21/2006

**SUBJECT:** Liability Insurance

In the first sentence of the first paragraph of Subsection 907-107.14.2.1 on page 1, change "\$300,000 each occurrence" to "\$500,000 each occurrence".

## MISSISSIPPI DEPARTMENT OF TRANSPORTATION

SPECIAL PROVISION NO. 907-107-1

CODE: (IS)

DATE: 05/03/2004

SUBJECT: Liability Insurance

Section 107, Legal Relations and Responsibility to Public, of the 2004 Edition of the Mississippi Standard Specifications for Road and Bridge Construction is hereby amended as follows:

**907-107.14.2--Liability Insurance.** Delete in toto Subsection 107.14.2 beginning on page 60 and substitute:

**907-107.14.2.1--General.** The Contractor shall carry Contractor's liability, including subcontractors and contractual, with limits not less than: \$300,000 each occurrence; \$1,000,000 aggregate; automobile liability - \$500,000 combined single limit - each accident; Workers' Compensation and Employers' Liability - Statutory & \$100,000 each accident; \$100,000 each employee; \$500,000 policy limit. Each policy shall be signed or countersigned by a Mississippi Resident Agent of the insurance company.

The Contractor shall have certificates furnished to the Department from the insurance companies providing the required coverage. The certificates shall be on the form furnished by the Department and will show the types and limits of coverage.

**907-107.14.2.2--Railroad Protective.** The following provisions are applicable to all work performed under a contract on, over or under the rights-of-way of each railroad shown on the plans.

The Contractor shall assume all liability for any and all damages to work, employees, servants, equipment and materials caused by railroad traffic.

Prior to starting any work on railroad property, the Contractor shall furnish satisfactory evidence to the Department that insurance of the forms and amounts set out herein in paragraphs (a) and (b) has been obtained. Also, the Contractor shall furnish similar evidence to the Railroad Company that insurance has been obtained in accordance with the Standard Provisions for General Liability Policies and the Railroad Protective Liability Form as published in the Code of Federal Regulations, 23 CFR 646, Subpart A. Evidence to the Railroad Company shall be in the form of a Certificate of Insurance for coverages required in paragraph (b), and the original policy of the Railroad Protective Liability Insurance for coverage required in paragraph (a).

All insurance herein specified shall be carried until the contract is satisfactorily complete as evidenced by a release of maintenance from the Department.

The Railroad Company shall be given at least 30 days notice prior to cancellation of the Railroad Protective Liability Insurance policy.

For work within the limits set out in Subsection 107.18 and this subsection, the Contractor shall provide insurance for bodily injury liability, property damage liability and physical damage to property with coverages and limits no less than shown in paragraphs (a) and (b). Bodily injury shall mean bodily injury, sickness, or disease, including death at anytime resulting therefrom. Property damage shall mean damages because of physical injury to or destruction of property, including loss of use of any property due to such injury or destruction. Physical damage shall mean direct and accidental loss of or damage to rolling stock and their contents, mechanical construction equipment or motive power equipment.

(a) **Railroad Protective Liability Insurance** shall be purchased on behalf of the Railroad Company with limits of \$2,000,000 each occurrence; \$6,000,000 aggregate applying separately to each annual period for lines without passenger trains. If the line carries passenger train(s), railroad protective liability insurance shall be purchased on behalf of the Railroad Company with limits of \$5,000,000 each occurrence; \$10,000,000 aggregate applying separately to each annual period.

Coverage shall be limited to damage suffered by the railroad on account of occurrences arising out of the work of the Contractor on or about the railroad right-of-way, independent of the railroad's general supervision or control, except as noted in paragraph 4 below.

Coverage shall include:

- (1) death of or bodily injury to passengers of the railroad and employees of the railroad not covered by State workmen's compensation laws,
- (2) personal property owned by or in the care, custody or control of the railroads,
- (3) the Contractor, or any of the Contractor's agents or employees who suffer bodily injury or death as a result of acts of the railroad or its agents, regardless of the negligence of the railroads, and
- (4) negligence of only the following classes of railroad employees:
  - (i) any supervisory employee of the railroad at the job site
  - (ii) any employee of the railroad while operating, attached to, or engaged on, work trains or other railroad equipment at the job site which are assigned exclusively to the Contractor, or
  - (iii) any employee of the railroad not within (i) or (ii) above who is specifically loaned or assigned to the work of the Contractor for prevention of accidents or protection or property, the cost of whose services is borne specifically by the Contractor or Governmental authority.

(b) **Regular Contractor's Liability**, including subcontractors, XCU and railroad contractual with limits of \$1,000,000 each occurrence; \$2,000,000 aggregate. **Automobile** with limits of \$1,000,000 combined single limit any one accident; **Workers' Compensation and Employer's Liability** - statutory and \$100,000 each accident; \$100,000 each employee; \$500,000 policy limit. **Excess/Umbrella Liability** \$5,000,000 each occurrence; \$5,000,000 aggregate. All coverage to be issued in the name of the Contractor shall be so written as to furnish protection to the Contractor respecting the Contractor's operations in performing work covered by the contract. Coverage shall include protection from damages arising out of bodily injury or death and damage or destruction of property which may be suffered by persons other than the Contractor's own employees.

In addition, the Contractor shall provide for and on behalf of each subcontractor by means of a separate and individual liability and property damage policy to cover like liability imposed upon the subcontractor as a result of the subcontractor's operations in the same amounts as contained above; or, in the alternative each subcontractor shall provide same.

**MISSISSIPPI DEPARTMENT OF TRANSPORTATION**

**SUPPLEMENT TO SPECIAL PROVISION NO. 907-107-6**

**DATE:** 11/16/2007

**SUBJECT:** Legal Relations and Responsibility to Public

After Subsection 907-107.15 on page 1, add the following:

**907-107.17--Contractor's Responsibility for Work.** Delete the fifth sentence of the fifth paragraph of Subsection 107.17 on page 63 and substitute the following:

The eligible permanent items shall be limited to traffic signal systems, changeable message signs, roadway signs and sign supports, lighting items, guard rail items, delineators, impact attenuators, median barriers, bridge railing or pavement markings. The eligible temporary items shall be limited to changeable message signs, guard rail items, or median barriers.

## MISSISSIPPI DEPARTMENT OF TRANSPORTATION

| SPECIAL PROVISION NO. 907-107-6

CODE: (IS)

| DATE: 07/03/2007

| SUBJECT: **Legal Relations and Responsibility to Public**

Section 107, Legal Relations and Responsibility to Public, of the 2004 Edition of the Mississippi Standard Specifications for Road and Bridge Construction is hereby amended as follows:

**907-107.02--Permits, Licenses and Taxes.** Delete in toto Subsection 107.02 on page 49 and substitute the following:

The Contractor or any Subcontractor shall have the duty to determine any and all permits and licenses required and to procure all permits and licenses, pay all charges, fees and taxes and issue all notices necessary and incidental to the due and lawful prosecution of the work. At any time during the life of this contract, the Department may audit the Contractor's or Subcontractor's compliance with the requirements of this section.

The Contractor or any Subcontractor is advised that the "Mississippi Special Fuel Tax Law", Section 27-55-501, et seq. and the Mississippi Use Tax Law, Section 27-67-1, et seq., and their requirements and penalties, apply to any contract or subcontract for construction, reconstruction, maintenance or repairs, for contracts or subcontracts entered into with the State of Mississippi, any political subdivision of the State of Mississippi, or any Department, Agency, Institute of the State of Mississippi or any political subdivision thereof.

The Contractor or any Subcontractor will be subject to one or more audits by the Department during the life of this contract to make certain that all applicable fuel taxes, as outlined in Section 27-55-501, et seq., and any sales and/or use taxes, as outlined in Section 27-67-1, et seq. are being paid in compliance with the law. The Department will notify the Mississippi State Tax Commission of the names and addresses of any Contractors or Subcontractors.

| **907-107.15--Third Party Beneficiary Clause.** In the first sentence of the first paragraph of Subsection 107.15 on page 61, change "create the public" to "create in the public".

## MISSISSIPPI DEPARTMENT OF TRANSPORTATION

| SPECIAL PROVISION NO. 907-108-17

CODE: (IS)

| DATE: 06/11/2008

SUBJECT: Prosecution and Progress

Section 108, Prosecution and Progress, of the 2004 Edition of the Mississippi Standard Specifications for Road and Bridge Construction is hereby amended as follows:

### **907-108.01--Subletting of Contract.**

**907-108.01.1--General.** At the end of the last paragraph of Subsection 108.01.1 on page 73, add the following:

The Engineer will have the authority to suspend the work wholly or in part and to withhold payments because of the Contractor's failure to make prompt payment within 15 calendar days as required above, or failure to submit the required OCR-484 Form, Certification of Payments to Subcontractors, which is also designed to comply with prompt payment requirements.

**907-108.02--Notice To Proceed.** Delete the fourth paragraph of Subsection 108.02 on page 75 and substitute the following:

Upon written request from the Contractor and if circumstances permit, the Notice to Proceed may be issued at an earlier date subject to the conditions stated therein. The Contractor shall not be entitled to any monetary damages or extension of contract time for any delay claim or claim of inefficiency occurring between the early issuance Notice To Proceed date and the Notice to Proceed date stated in the contract.

### **907-108.06--Determination and Extension of Contract Time.**

#### **907-108.06.1--Based on Time Units.**

**907-108.06.1.2--Contract Time Assessment.** At the end of the eighth paragraph of Subsection 108.06.1.2 on page 81, add the following:

When the approved progress schedule indicates that a controlling phase(s) is to be completed prior to December 1 and the physical features of the phase(s) have not been satisfactorily completed, beginning on December 1 the miscellaneous phase will be shown as the only active phase during the months of December, January, and February. Under this condition, time units, monthly time units divided by monthly calendar days, will be assessed in accordance with the applicable column in the TABLE OF TIME UNITS. If the physical features of the phase(s) have not been completed by March 1, the phase will resume as a controlling phase and time assessment will be made accordingly.

Delete the fourth and fifth sentence of the thirteenth paragraph of Subsection 108.06.1.2 on page 82, and substitute the following:

In the event mutual agreement cannot be reached, the Contractor will be allowed a maximum of 25 calendar days following the Contractor's receipt of the monthly report in question to file a protest Notice of Claim in accordance with the provisions of Subsection 105.17. Otherwise, the Engineer's assessment shall be final unless mathematical errors of assessment are subsequently found to exist.

**907-108.06.2--Based on Calendar Date Completion.** After Subsection 108.06.2.1 on page 85, add the following:

**907-108.06.2.2--Cessation of Contract Time.** When the Engineer by written notice schedules a final inspection, time will be suspended until the final inspection is conducted and for an additional 14 calendar days thereafter. If after the end of the 14-day suspension all necessary items of work have not been completed, time charges will resume. If the specified completion date had not been reached at the time the Contractor called for a final inspection, the calendar day difference between the specified completion date and the date the Contractor called for a final inspection will be added after the 14-day period before starting liquidation damages. If a project is on liquidated damages at the time a final inspection is scheduled, liquidated damages will be suspended until the final inspection is conducted and for seven (7) calendar days thereafter. If after the end of the 7-day suspension all necessary items of work have not been completed, liquidated damages will resume. When final inspection has been made by the Engineer as prescribed in Subsection 105.16 and all items of work have been completed, the daily time charge will cease.



**MISSISSIPPI DEPARTMENT OF TRANSPORTATION**

**SUPPLEMENT TO SPECIAL PROVISION NO. 907-109-3**

**DATE:** 11/21/2006

**SUBJECT:** Changes in Material Costs

After the last paragraph of Subsection 907-109.06.1 on page 1, add the following:

**907-109.07--Changes in Material Costs.** Delete the second sentence of the first paragraph of Subsection 109.07 on page 95, and substitute the following:

When a pay item on the bid sheets indicate that an adjustment is allowed and when a notice to bidders is included in the contract showing current monthly base prices, an adjustment will be provided as follows:

**MISSISSIPPI DEPARTMENT OF TRANSPORTATION**

**SPECIAL PROVISION NO. 907-109-3**

**CODE: (IS)**

**DATE: 04/21/2006**

**SUBJECT: Partial Payment**

Section 109, Measurement and Payment, of the 2004 Edition of the Mississippi Standard Specifications for Road and Bridge Construction is hereby amended as follows:

**907-109.04--Extra and Force Account Work.** Delete the first sentence of the second paragraph of Subsection 109.04 under (d) on page 92 and substitute the following:

In the event an agreement cannot be reached for a particular piece of equipment, the book entitled "Rental Rate Blue Book For Construction Equipment" as published by EquipmentWatch® and is current at the time the force account work is authorized will be used to determine equipment ownership and operating expense rates.

**907-109.06--Partial Payment.**

**907-109.06.1--General.** Delete the fourth and fifth sentences of the third paragraph of Subsection 109.06.1 on page 94, and substitute the following:

In the event mutual agreement cannot be reached, the Contractor will be allowed a maximum of 25 calendar days following the Contractor's receipt of the monthly estimate in question to file in writing, a protest Notice of Claim in accordance with the provisions Subsection 105.17. Otherwise, the Engineer's estimated quantities shall be considered acceptable pending any changes made during the checking of final quantities.

# MISSISSIPPI DEPARTMENT OF TRANSPORTATION

## SUPPLEMENT TO SPECIAL PROVISION NO. 907-401-2

**DATE:** 05/09/2008

**SUBJECT:** Hot Mix Asphalt (HMA)

After Subsection 907-401-02.6.2 on page 2, add the following:

**907-401.02.6.4.1--Roadway Density.** Delete subparagraphs 1., 2., & 3. on page 251 and substitute the following:

1. For all leveling lifts, when full lane width and with a thickness as specified in the table in Subsection 401.02.4, the required lot density shall be 92.0 percent of maximum density.
2. For all single lift overlays, with or without leveling and/or milling, the required lot density shall be 92.0 percent of maximum density.
3. For all multiple lift overlays of two (2) or more lifts excluding leveling lifts, the required lot density of the bottom lift shall be 92.0 percent of maximum density. The required lot density for all subsequent lifts shall be 93.0 percent of maximum density.
4. For all pavements on new construction, the required lot density for all lifts shall be 93.0 percent of maximum density.

**907-401.03.1.2--Tack Coat.** Delete the three sentences of Subsection 401.03.1.2 on page 259, and substitute the following:

Tack coat shall be applied to previously placed HMA and between lifts, unless otherwise directed by the Engineer. Tack coat shall be applied with a distributor spray bar. A hand wand will only be allowed for applying tack coat on ramp pads, irregular shoulder areas, median crossovers, turnouts, or other irregular areas. Bituminous materials and application rates for tack coat shall be as specified in Table 410-A on page 293. Construction requirements shall be in accordance with Subsection 407.03 of the Standard Specifications.

**907-401.03.1.4--Density.** Delete the first sentence of the first paragraph of Subsection 401.03.1.4 on page 259 and substitute the following:

The lot density for all dense graded pavement lifts, except as provided below for preleveling, wedging [less than fifty percent (50%) of width greater than minimum lift thickness], ramp pads, irregular shoulder areas, median crossovers, turnouts, or other areas where the established rolling pattern cannot be performed, shall not be less than the specified percent (92.0% or 93.0%) of the maximum density based on AASHTO Designation: T 209 for the day's production. For all leveling lifts, when full lane width and with a thickness as specified in the table in Subsection 401.02.4, the required lot density shall be 92.0 percent of maximum density.

**907-401.03.9--Material Transfer Equipment.** Delete the paragraph in Subsection 401.03.9 on page 264 and substitute the following:

Excluding the areas mentioned below, the material transferred from the hauling unit when placing the top lift, or the top two (2) lifts of a multi-lift HMA pavement with density requirements, shall be remixed prior to being placed in the paver hopper or insert by using an approved Materials Transfer Device. Information on approved devices can be obtained from the State Construction Engineer. Areas excluded from this requirement include: leveling courses, temporary work of short duration, detours, bridge replacement projects having less than 1,000 feet of pavement on each side of the structure, acceleration and deceleration lanes less than 1,000 feet in length, tapered sections, transition sections for width, shoulders less than 10 feet in width, crossovers, ramps, side street returns and other areas designated by the Engineer.

## MISSISSIPPI DEPARTMENT OF TRANSPORTATION

SPECIAL PROVISION NO. 907-401-2

CODE: (IS)

DATE: 11/04/2005

SUBJECT: Hot Mix Asphalt (HMA)

Section 401, Hot Mix Asphalt (HMA) - General, of the 2004 Edition of the Mississippi Standard Specifications for Road and Bridge Construction is hereby amended as follows:

Delete in toto Subsection 401.02.6.2 on pages 248 and 249, and substitute:

**907-401.02.6.2--Assurance Program for Mixture Quality.** The Engineer will conduct a quality assurance program. The quality assurance program will be accomplished as follows:

- 1) Conducting verification tests.
- 2) Validate Contractor test results.
- 3) Periodically observing Contractor quality control sampling and testing.
- 4) Monitoring required quality control charts and test results.
- 5) Sampling and testing materials at any time and at any point in the production or laydown process.

The rounding of all test results will be in accordance with Subsection 700.04.

The Engineer will conduct verification tests on samples taken by the Contractor under the direct supervision of the Engineer at a time specified by the Engineer. The frequency will be equal to or greater than ten percent (10%) of the tests required for Contractor quality control and the data will be provided to the Contractor within two asphalt mixture production days after the sample has been obtained by the Engineer. At least one sample shall be tested from the first two days of production. All testing and data analysis shall be performed by a Certified Asphalt Technician-I (CAT-I) or by an assistant under the direct supervision of the CAT-I. Certification shall be in accordance with the *MDOT HMA Technician Certification Program* chapter in the Materials Division Inspection, Testing, and Certification Manual. The Department shall post a chart giving the names and telephone numbers for the personnel responsible for the assurance program.

The Engineer shall be allowed to inspect Contractor testing equipment and equipment calibration records to confirm both calibration and condition. The Contractor shall calibrate and correlate all testing equipment in accordance with the latest versions of the Department's Test Methods and AASHTO Designation: R 18.

Random differences between the Engineer's verification tests and the current running average of four quality control tests at the time of obtaining the verification sample will be considered acceptable if within the following limits:

Item	Allowable Differences
Sieve - % Passing	
3/8-inch and above	6.0
No. 4	5.0
No. 8	4.0
No. 16, for 4.75 mm mixtures ONLY	3.5
No. 30	3.5
No. 200	2.0
AC Content	0.4
Specimen Bulk SG, Gmb @ $N_{Design}$	0.030
Maximum SG, Gmm	0.020

If four quality control tests have not been tested prior to the time of the first verification test, the verification test results will be compared to the average of the preceding quality control tests. If the verification test is the first material tested on the project or if a significant process adjustment was made just prior to the verification test, the verification test results will be compared to the average of four subsequent quality control test results. For all other cases after a significant process adjustment, the verification test results will be compared to the average of the preceding quality control tests (taken after the adjustment) as in the case of a new project start-up when four quality control tests are not available.

In the event that; 1) the comparison of the Contractor’s running average quality control data and Engineer’s quality assurance verification test results are outside the allowable differences in the above table, or 2) if a bias exists between the results, such that one of the results is predominately higher or lower than the other, and the Engineer’s results fail to meet the JMF control limits, the Engineer will investigate the reason immediately. As soon as the need for an investigation becomes known, the Engineer will increase the quality assurance sampling rate to the same frequency required for Contractor testing. The additional samples obtained by the Engineer may be used as part of the investigation process or for routine quality assurance verification tests. The Engineer's investigation may include testing of the remaining quality control split samples, review and observation of the Contractor's testing procedures and equipment, and a comparison of split sample test results by the Contractor quality control laboratory, Department quality assurance laboratory and the Materials Division laboratory. The procedures outlined in the latest edition of MDOT’s Field Manual for HMA may be used as a guide for the investigation. In the event that the Contractor’s results are determined to be incorrect, the Engineer's results will be used for the quality control data and the appropriate payment for the mixture will be based on the procedures specified in Subsection 401.02.5.8(j).

The Engineer will periodically witness the sampling and testing being performed by the Contractor. The Engineer, both verbally and in writing, will promptly notify the Contractor of any observed deficiencies. When differences exist between the Contractor and the Engineer which cannot be resolved, a decision will be made by the State Materials Engineer, acting as the referee. The Contractor will be promptly notified in writing of the decision. If the deficiencies are not corrected, the Engineer will stop production until corrective action is taken.

**MISSISSIPPI DEPARTMENT OF TRANSPORTATION**

**SUPPLEMENT TO SPECIAL PROVISION NO. 907-403-4**

**DATE: 03/30/2007**

**SUBJECT: Hot Mix Asphalt (HMA)**

Before Subsection 907-403-05.2 on page 1, add the following:

Delete Subsection 403.03.5.5 on page 273 and substitute the following:

**907-403.03.5.5--Preliminary Leveling.** All irregularities of the existing pavement, such as ruts, cross-slope deficiencies, etc., shall be corrected by spot leveling, skin patching, feather edging or a wedge lift in advance of placing the first overall lift.

**MISSISSIPPI DEPARTMENT OF TRANSPORTATION**

**SPECIAL PROVISION NO. 907-403-4**

**CODE: (IS)**

**DATE: 11/04/2005**

**SUBJECT: Hot Mix Asphalt (HMA)**

Section 403, Hot Bituminous Pavement, of the 2004 Edition of the Mississippi Standard Specifications for Road and Bridge Construction is hereby amended as follows:

**907-403.05.2--Pay Items.** Add the "907" prefix to the pay items listed on page 275 & 276.



**MISSISSIPPI DEPARTMENT OF TRANSPORTATION**

**SPECIAL PROVISION NO. 907-407-1**

**CODE: (SP)**

**DATE: 02/26/2008**

**SUBJECT: Tack Coat**

Section 407, Tack Coat, of the 2004 Edition of the Mississippi Standard Specifications for Road and Bridge Construction is hereby amended as follows:

**907-407.02.1--Bituminous Material.** Delete the second sentence of the first paragraph of Subsection 407.02.1 on page 281, and substitute the following:

When not specified, the materials shall be as specified in Table 410-A on page 293.

**907-407.03.3--Application of Bituminous Material.** Delete the first paragraph of Subsection 407.03.3 on page 281, and substitute the following

Tack coat shall be applied with a distributor spray bar. A hand wand will only be allowed for applying tack coat on ramp pads, irregular shoulder areas, median crossovers, turnouts, or other irregular areas. Bituminous materials and application rates for tack coat shall be as specified in Table 410-A on page 293. Tack coat shall not be applied during wet or cold weather, after sunset, or to a wet surface. Emulsions shall be allowed to "break" prior to superimposed construction.

**907-407.05--Basis of Payment.** Delete the pay item at the end of Subsection 407.05 on page 282, and substitute the following:

907-407-A: Asphalt for Tack Coat \*

- per gallon

\* Grade may be specified

## MISSISSIPPI DEPARTMENT OF TRANSPORTATION

SPECIAL PROVISION NO. 907-413-2

CODE: (SP)

DATE: 05/09/2008

**SUBJECT: Sawing and Sealing Transverse Joints in Asphalt Pavement**

Section 413, Cleaning and Sealing Joints and Cracks, of the 2004 Edition of the Mississippi Standard Specifications for Road and Bridge Construction is hereby amended as follows.

**907-413.03--Construction Requirements.**

**907-413.03.3-- Sawing and Sealing Transverse Joints in Asphalt Pavement.**

**907-413.03.3.1--General.** Delete the first paragraph of Subsection 413.03.3.1 on page 296 and substitute the following:

The Contractor's operation shall be conducted so that sawcutting of transverse joints, cleaning, and sealing is a continuous operation. The entire sawing and sealing operation shall be completed within seven (7) days after the placement of the final wearing course, unless the approved traffic control plan or sequence of operations provide otherwise. Traffic shall not be allowed on sawed unsealed joints in the final wearing course.

When intermediate lifts must be exposed to traffic for over seven (7) days, the Contractor shall be required to make an interim 1/8-inch wide saw cut which is one third (1/3) as deep as the hot mix asphalt layer. This interim saw cut does not require sealing. Costs of this interim cut(s) is to be absorbed the pay item for sawing and sealing transverse joints in asphalt pavement.

**907-413.05--Basis of Payment.** Add the "907" prefix to pay item no. 413-E on page 298.

# MISSISSIPPI DEPARTMENT OF TRANSPORTATION

## SUPPLEMENT TO SPECIAL PROVISION NO. 907-618-1

DATE: 02/19/2009

PROJECT: STP-2170-00(011) / 105466301 - Forrest County

After the first paragraph of Subsection 907-618.01.2 on page 1, add the following:

Additional signs will be required as follows:

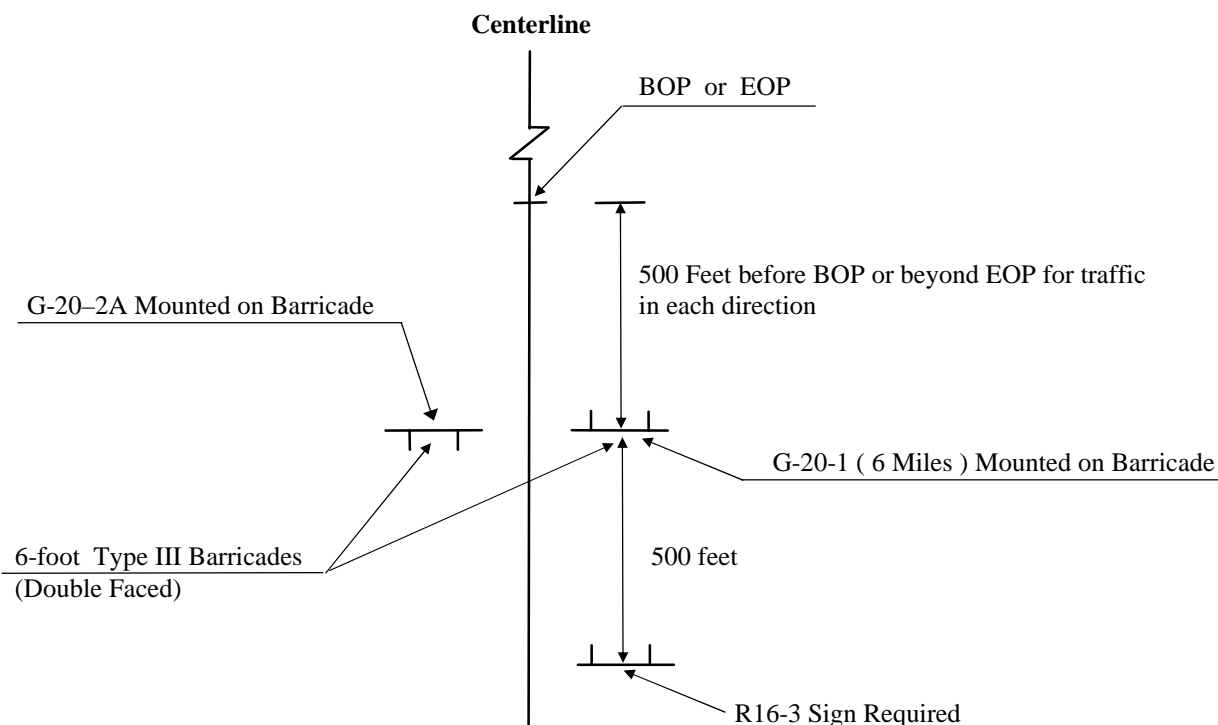

### ADDITIONAL TRAFFIC CONTROL SIGNS REQUIRED:

- 8 - W20-1 (AHEAD) signs required. One (1) W20-1 (AHEAD) sign is required at each local road or street entering the project.
- 2 - R4 -1 "DO NOT PASS" signs required.
- 30 - R4 -2 "PASS WITH CARE" signs required.
- 2 - W14 -3 "NO PASSING ZONE" signs required.
- 2 - R16-3 (SPEEDING FINES DOUBLED) signs required.

R4 -1 " DO NOT PASS ", R4 -2 " PASS WITH CARE" , and W14 -3 "NO PASSING ZONE" signs are required in accordance with Subsection 618.03.3, the attached drawing, and as specified in the Manual on Uniform Traffic Control Devices. If no passing zones are 1,000 feet or more, install additional "DO NOT PASS" signs per attached drawing.

The Contractor shall provide 2 portable R-16 signs in addition to the signs required by the Standard Drawings for Lane Closures and they will be paid for under 618-A Maintenance of Traffic Pay Item.

All Construction signing is included in the bid for Pay Item 618-A, Maintenance of Traffic. Fluorescent orange sheeting shall be used on all construction and traffic control signs except for R16-3, R4-1 and R4-2 signs which shall be black legend and border on white background.

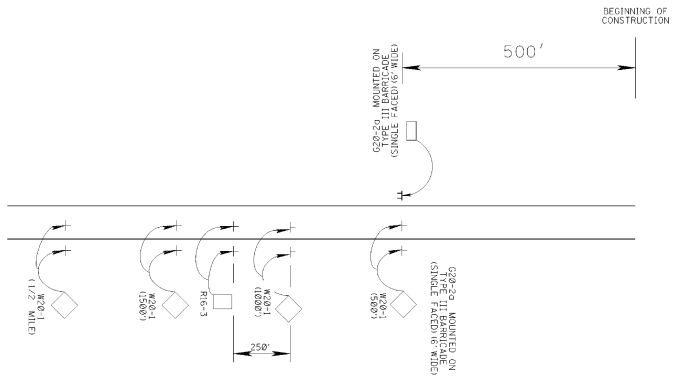

**DIVIDED HIGHWAY  
(PROJECTS LESS THAN 1 MILE LENGTH)**

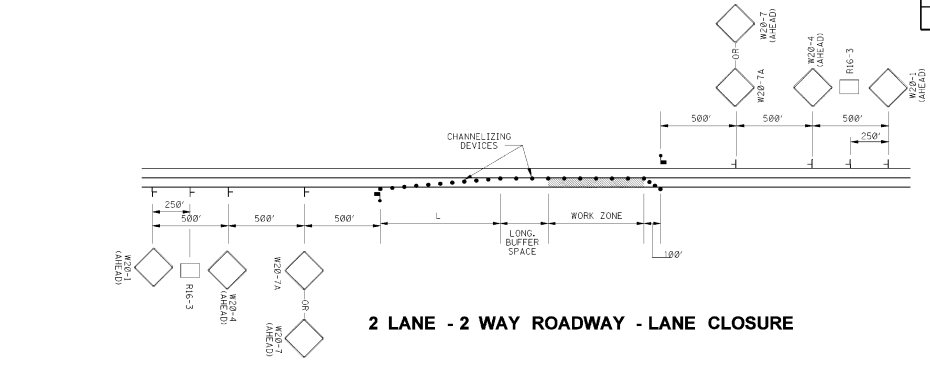

**2 LANE - 2 WAY ROADWAY - LANE CLOSURE**

**NOTES**

- ① R16-3 SIGN TO BE PLACED AS SHOWN OR AS DIRECTED BY THE ENGINEER.
- ② R16-3 SIGN SHALL BE SPACED AT A MAXIMUM OF 2 MILES THROUGHOUT LENGTH OF PROJECT.

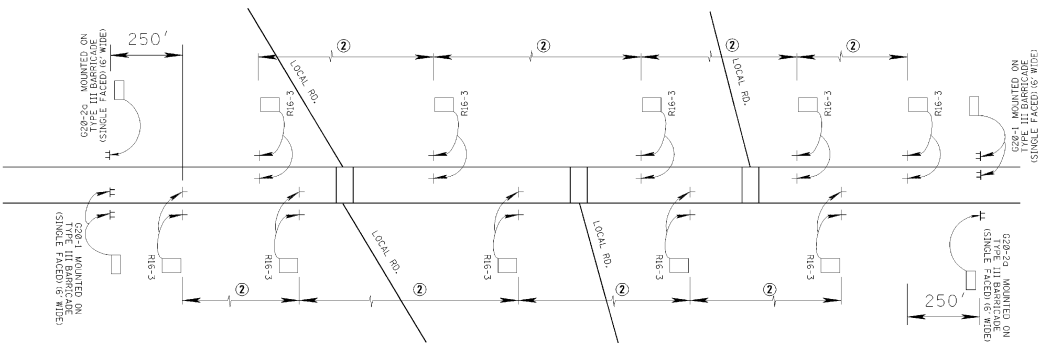

**DIVIDED HIGHWAY SHOWN  
(2 LANE - 2 WAY ROADWAY SIMILAR)  
(PROJECT MORE THAN 1 MILE LENGTH)**

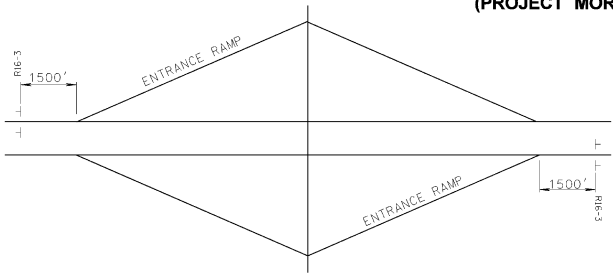

**INTERSTATE DETAIL**

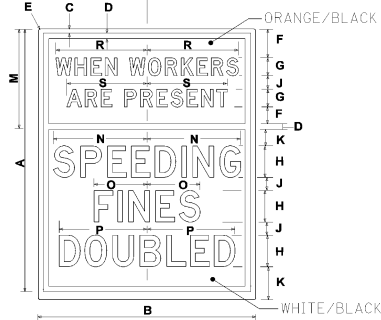

SIGN	DIMENSIONS (INCHES)							
	A	B	C	D	E	F	G	H
STD.	60	48	3/4	1 7/8	3	3 3/4	4 8/16	7 D
STD.	3	6 3/8	22 3/8	21	11 3/8	19 3/8	20 3/8	18

SIGN	DIMENSIONS (INCHES)							
	A	B	C	D	E	F	G	H
STD.	48	36	3/4	1 7/8	3	2 3/4	3 8/16	6 D
STD.	3	4 7/8	14 3/8	14	7 1/8	13 3/8	13 3/8	12

48" x 60"  
(INTERSTATE USE)

36" x 48"  
(ALL OTHER HIGHWAYS)

**R16-3**

MISSISSIPPI DEPARTMENT OF TRANSPORTATION			
<b>LOCATION OF R16-3 SIGNS</b>			
DATE	DESIGNED BY	WORKING NUMBER	
FILENAME: SPEED_SIGN_DETAIL.dgn	CHECKED	DATE: 07-23-04	SHEET NUMBER

MISSISSIPPI DEPARTMENT OF TRANSPORTATION  
 114  
 907.628.2324 SPEED\_SIGN\_DETAIL.dgn

**MISSISSIPPI DEPARTMENT OF TRANSPORTATION**

**SPECIAL PROVISION NO. 907-618-1**

**CODE: (SP)**

**DATE: 04/29/2004**

**SUBJECT: Additional Signing Requirements**

Section 618, Maintenance of Traffic and Traffic Control Plan, of the 2004 Edition of the Mississippi Standard Specifications for Road and Bridge Construction is hereby amended as follows.

**907-618.01.2--Traffic Control Plan.** At the end of Subsection 618.01.2 on page 413, add the following:

For compliance with the traffic control plan, the Contractor will be required to install and maintain construction signs at various location throughout the project. Payment for these signs will be included in the price bid for pay item no. 618-A, Maintenance of Traffic per lump sum.

# MISSISSIPPI DEPARTMENT OF TRANSPORTATION

**SPECIAL PROVISION NO. 907-618-4**

**CODE: (SP)**

**DATE: 12/12/2006**

**SUBJECT: Placement of Temporary Traffic Stripe**

Section 618, Maintenance of Traffic and Traffic Control Plan, of the 2004 Edition of the Mississippi Standard Specifications for Road and Bridge Construction is hereby amended as follows:

**907-618.03.3--Safe Movement of Traffic.** Delete subparagraphs (2) and (3) of Subsection 618.03.3 on pages 415 & 416, and substitute the following:

- (2) Temporary edge lines on projects requiring shoulders constructed of granular material may be delayed for a period not to exceed three (3) days.

Temporary edge lines placed on the final pavement course of projects requiring paved shoulders with surface treatment may be placed on the adjacent shoulder in as near the permanent location as possible until the surface treatment is placed. When the edge lines are obliterated by the placement of the surface treatment, the edge lines shall be placed in the permanent stripe location. The replacement of edge lines may be delayed for a period not to exceed three (3) days for a two or three-lane roads.

**MISSISSIPPI DEPARTMENT OF TRANSPORTATION**

**SPECIAL PROVISION NO. 907-626-14**

**CODE: (SP)**

**DATE: 09/20/2007**

**SUBJECT: Double Drop Thermoplastic Markings**

Section 626, Thermoplastic Traffic Markings, of the 2004 Edition of the Mississippi Standard Specifications for Road and Bridge Construction is hereby amended as follows:

**907-626.03.1.1--Equipment.** After the second paragraph of Subsection 626.03.1.1 on page 444, add the following:

When edge lines are placed over rumble strips, the equipment must be able to apply the markings using the atomization method instead of extrusion / ribbon method.

**907-626.03.1.2--Construction Details.** After the last sentence of the third full paragraph of Subsection 626.03.1.2 on page 445, add the following:

When double drop thermoplastic stripe is called for in the contract, additional beads by the drop-on method shall be applied as follows:

Class A glass beads at a rate of not less than three pounds of beads per 100 feet of six-inch stripe.  
Class B glass beads at a rate of not less than three pounds of beads per 100 feet of six-inch stripe.

The Class B glass beads shall be applied to the newly placed stripe first, followed by the application of the Class A glass beads.

**907-626.05--Basis of Payment.** Add the following to the list of pay items on page 446.

907-626-C: 6” Thermoplastic Double Drop Edge Stripe,  
Continuous White, \* - per linear foot or mile

907-626-F: 6” Thermoplastic Double Drop Edge Stripe,  
Continuous Yellow, \* - per linear foot or mile

\* Thickness may be specified

**MISSISSIPPI DEPARTMENT OF TRANSPORTATION**

**SPECIAL PROVISION NO. 907-626-15**

**CODE: (IS)**

**DATE: 03/17/2008**

**SUBJECT: Thermoplastic Traffic Markings**

Section 626, Thermoplastic Traffic Markings, of the 2004 Edition of the Mississippi Standard Specifications for Road and Bridge Construction is hereby amended as follows:

**907-626.05--Basis of Payment.** Add the “907” prefix to the pay items listed on page 446.



**MISSISSIPPI DEPARTMENT OF TRANSPORTATION**

**SUPPLEMENT TO SPECIAL PROVISION NO. 907-701-3**

**DATE: 10/01/2008**

**SUBJECT: Hydraulic Cement**

In Subsection 907-701.02.2.1 on page 3, delete the line in Table 1 addressing Severe Soluble Sulfate Conditions, and substitute the following:

Severe	0.20 - 2.00	1,500 - 10,000	Type I cement with a replacement by weight of 50% GGBFS, or Type II ** cement with one of the following replacements of cement by weight: 25% Class F fly ash, 50% GGBFS, 10% metakaolin, or 8% silica fume
--------	-------------	----------------	---

## MISSISSIPPI DEPARTMENT OF TRANSPORTATION

**SPECIAL PROVISION NO. 907-701-3**

**CODE: (IS)**

**DATE: 11/30/2007**

**SUBJECT: Hydraulic Cement**

Section 701, Hydraulic Cement, of the 2004 Edition of the Mississippi Standard Specifications for Road and Bridge Construction is hereby amended as follows:

Delete Subsection 701.01 on pages 595 & 596, and substitute the following:

**907-701.01--General.** The following requirements shall be applicable to hydraulic cement:

Only hydraulic cements conforming to Section 701 shall be used. Hydraulic cements shall not be listed or designated as meeting more than one AASHTO or Department type.

Different brands of hydraulic cement, or the same brand of hydraulic cement from different mills, shall not be mixed or used alternately in any one class of construction or structure, without written permission from the Engineer; except that this requirement will not be applicable to hydraulic cement treatment of design soils, or bases.

The Contractor shall provide suitable means for storing and protecting the hydraulic cement against dampness. Hydraulic cement, which for any reason, has become partially set or which contains lumps of caked hydraulic cement will be rejected. Hydraulic cement salvaged from discarded or used bags shall not be used.

The temperature of bulk hydraulic cement shall not be greater than 165°F at the time of incorporation in the mix.

Acceptance of hydraulic cement will be based on the certification program as described in the Department's Materials Division Inspection, Testing, and Certification Manual and job control sampling and testing as established by Department SOP.

Retests of hydraulic cement may be made for soundness and expansion within 28 days of test failure and, if the hydraulic cement passes, it may be accepted. Hydraulic cement shall not be rejected due to failure to meet the fineness requirements if upon retests after drying at 212°F for one hour, it meets such requirements.

Delete Subsection 701.02 on page 596, and substitute the following:

**907-701.02--Portland Cement.**

**907-701.02.1--General.**

**907-701.02.1.1--Types of Portland Cement.** Portland cement (cement) shall be either Type I or Type II conforming to AASHTO Designation: M85 or Type I(MS), as defined by the description below Table 1. Type III cement conforming to AASHTO Designation: M85 or Type III(MS), as defined by the description below Table 1, may be used for the production of precast or precast-prestressed concrete members.

**907-701.02.1.2--Alkali Content.** All cement types in this Subsection shall meet the Equivalent alkali content requirement for low-alkali cements listed in AASHTO Designation: M85, Table 2.

**907-701.02.2--Replacement by Other Cementitious Materials.** The maximum replacement of cement by weight is 25% for fly ash or 50% for ground granulated blast furnace slag (GGBFS). The minimum tolerance for replacement shall be 5% below the maximum replacement content. Replacement contents below this minimum tolerance by fly ash or GGBFS may be used, but shall not be given any special considerations, like the maximum acceptance temperature for Portland cement concrete containing pozzolans. Special considerations shall only apply for replacement of cement by fly ash or GGBFS.

**907-701.02.2.1--Portland Cement Concrete Exposed to Soluble Sulfate Conditions or Seawater.** When Portland cement concrete is exposed to moderate or severe soluble sulfate conditions, or to seawater, cement types and replacement of cement by Class F fly ash, GGBFS, metakaolin, or silica fume shall be as follows in Table 1.

**Table 1- Cementitious Materials for Soluble Sulfate Conditions**

Sulfate Exposure	Water-soluble sulfate (SO <sub>4</sub> ) in soil, % by mass	Sulfate (SO <sub>4</sub> ) in water, ppm	Cementitious material required*
Moderate and Seawater	0.10 - 0.20	150 - 1,500	Type II **, ***, **** cement, or Type I cement with one of the following replacements of cement by weight: 25% Class F fly ash, 50% GGBFS, 10% metakaolin, or 8% silica fume
Severe	0.20 - 2.00	1,500 - 10,000	Type II ** cement with one of the following replacements of cement by weight: 25% Class F fly ash, 50% GGBFS, 10% metakaolin, or 8% silica fume

\* The values listed in this table for replacement of Portland cement by the cementitious materials listed are maximums and shall not be exceeded. The minimum tolerance for replacement shall be 0.5% below the maximum replacement content. Replacement contents below this minimum tolerance by the cementitious materials listed in this table do not meet the requirements for the exposure conditions listed and shall not be allowed.

\*\* Type I cement conforming to AASHTO Designation: M85 with a maximum 8% tricalcium aluminate (C<sub>3</sub>A) may be used in lieu of Type II cement; this cement is given the designation "Type I(MS)". Type III cement conforming to AASHTO Designation: M85 with a maximum 8% tricalcium aluminate (C<sub>3</sub>A) may be used in lieu of Type II cement as allowed in Subsection 907-701.02.1; this cement is given the designation "Type III(MS)".

\*\*\* Blended cement meeting the sulfate resistance requirements of Subsection 907-701.04 may be used in lieu of Type II as allowed in Subsection 907-701.04. No additional cementitious materials shall be added to or as a replacement for blended cement.

\*\*\*\* Class F fly ash or GGBFS may be added as a replacement for cement as allowed in Subsection 907-701.02.2.

Class C fly ash shall not be used as a replacement for cement in any of the sulfate exposure conditions listed above.

**907-701.02.2.2--Cement for Soil Stabilization Exposed to Soluble Sulfate Conditions or Seawater.** When Portland cement for use in soil stabilization is exposed to moderate or severe soluble sulfate conditions, or to seawater, cement types and replacement of cement by Class F fly ash or GGBFS shall meet the requirements of Subsection 907-701.02.2.1. Neither metakaolin nor silica fume shall be used to bring the cementitious materials into compliance with the requirements of Table 1.

Delete Subsection 701.03 on page 596, and substitute the following:

**907-701.03--Masonry Cement.** Masonry cement shall conform to ASTM Designation: C 91 and shall only be used in masonry applications.

Delete Subsection 701.04 on page 596, and substitute the following:

**907-701.04--Blended Hydraulic Cement.**

**907-701.04.1--General.**

**907-701.04.1.1--Types of Blended Cement.** Blended hydraulic cements (blended cements) shall be of the following types and conform to AASHTO Designation: M 240:

- Type I(SM) – Slag-modified Portland cement
- Type IS – Portland blast-furnace slag cement
- Type I(PM) – Pozzolan-modified Portland cement
- Type IP – Portland-pozzolan cement

Blended cement for use in Portland cement concrete or soil stabilization exposed to the moderate soluble sulfate condition or exposure to seawater as defined in Table 1 shall meet the Sulfate resistance requirement listed in AASHTO Designation: M 240, Table 2 and the “(MS)” suffix shall be added to the type designation.

**907-701.04.1.2--Alkali Content.** All blended cement types in this Subsection shall meet the Mortar expansion requirements listed in AASHTO Designation: M 240, Table 2.

**907-701.04.2--Replacement by Other Cementitious Materials.** No additional cementitious materials, such as Portland cement, performance hydraulic cement, fly ash, GGBFS, metakaolin, or others, shall be added to or as a replacement for blended cement.

**907-701.04.3--Exposure to Soluble Sulfate Conditions or Seawater.** When Portland cement concrete or blended cement for soil stabilization is exposed to moderate soluble sulfate conditions or to seawater, where the moderate soluble sulfate condition is defined in Table 1, the

blended cement shall meet the sulfate resistance requirement listed in AASHTO Designation: M 240, Table 2.

When Portland cement concrete or blended cement for soil stabilization is exposed to severe soluble sulfate conditions, where the severe soluble sulfate condition is defined in Table 1, blended cements shall not be used.

MISSISSIPPI DEPARTMENT OF TRANSPORTATION

SPECIAL PROVISION NO. 907-711-3

CODE: (IS)

DATE: 09/26/2005

SUBJECT: Synthetic Structural Fiber Reinforcement

Section 711, Reinforcement and Wire Rope, of the 2004 Edition of the Mississippi Standard Specifications for Road and Bridge Construction is hereby amended as follows:

After Subsection 711.03.4.3 on page 665, add the following:

907-711.04--Synthetic Structural Fiber. Synthetic structural fibers shall meet the requirements of ASTM Designation: C 1116, Section 4.1.3, Note 3. The fibers shall be monofilament made of polypropylene or polypropylene/polyethylene blend meeting the following conditions:

<u>Property</u>	<u>Results</u>
Length, minimum .....	1.5 inches
Aspect Ratio (length / equivalent diameter) .....	90
Breaking tenacity, minimum * .....	530 mN/tex
(Tensile Strength, minimum .....	70 ksi)
Chord modulus, minimum * .....	980 cN/tex
(Modulus of Elasticity, minimum .....	1,300 ksi)

\* When tested in accordance with ASTM Designation: D 3822

The dosage rate for the fibers shall be a minimum of three pounds per cubic yard (3 lb / yd<sup>3</sup>). The dosage rate for the fibers when used in pile encasements shall be a minimum of four pounds per cubic yard (4 lb / yd<sup>3</sup>).

The manufacturer shall furnish the Engineer three copies of the certified test report(s) showing results of all required tests, and certification that the material meets the specifications.

## MISSISSIPPI DEPARTMENT OF TRANSPORTATION

**SPECIAL PROVISION NO. 907-713-1**

**CODE: (IS)**

**DATE: 12/11/2007**

**SUBJECT: Admixtures for Concrete**

Section 713, Concrete Curing Materials and Admixtures, of the 2004 Edition of the Mississippi Standard Specifications for Road and Bridge Construction is hereby amended as follows:

After the second paragraph of Subsection 713.01.2 on page 676, add the following.

Type 1-D compound may be used on bridge rails, median barriers, and other structures requiring a spray finish. When Type 1-D compound is used, it will be the Contractor's responsibility to assure that the compound has dissipated from the structure prior to applying the spray finish and that the spray finish adheres soundly to the structure.

Delete Subsection 713.02 on pages 676 & 677, and substitute the following:

**907-713.02--Admixtures for Portland Cement Concrete.** Admixtures shall only be approved by the Department for classification as a single type following the applicable types from AASTHO Designation: M 154 or M 194, or the definition of a mid-range water reducer listed below with the following exception: when requested by the manufacturer the Department will consider classifying an admixture as both a Type A and a Type D. Admixtures shall only be used in accordance with the manufacturer's recommended dosage range for that type. Where an admixture is classified as both a Type A and Type D, the dosage range for use as a Type A shall not overlap the dosage range for use as a Type D.

Air-entraining admixtures shall comply with AASHTO Designation: M 154. Set-retarding, accelerating, and/or water-reducing admixtures shall comply with AASHTO Designation: M 194. Mid-range water-reducers are classified as water-reducing admixtures that reduce the mix water a minimum of 8% when compared to a control mix with no admixtures when tested in accordance with the requirements in AASHTO Designation: M 194. The type designation for admixtures approved by the Department and classified as meeting the requirements of a mid-range water-reducer shall be "MR".

**907-713.02.1--Source Approval.** In order to obtain approval of an admixture, the Producer/Suppliers shall submit to the State Materials Engineer the following for review: certified test reports, made by an acceptable independent laboratory regularly inspected by the Cement and Concrete Reference Laboratory of the National Institutes of Standards and Technology, which show that the admixture meets all the requirements of the applicable AASHTO or Department Specification for the specific type and the dosage range for the specific type of admixture.

**907-713.02.2--Specific Requirements.** Admixtures containing chlorides will not be permitted.



**907-713.02.3--Acceptance.** The Department reserves the right to sample, for check tests, any shipment or lot of admixture delivered to a project.

The Department reserves the right to require tests of the material to be furnished, using the specific cement and aggregates proposed for use on the project, as suggested in AASHTO Designation: M 154 and outlined in AASHTO Designation: M 194.

Failure to maintain compliance with any requirement of these specifications shall be cause for rejection of any previously approved source or brand of admixture.

With each new lot of material shipped the Contractor shall submit to the State Materials Engineer, a notarized certification from the manufacturer showing that the material complies with the requirements of the applicable AASHTO or Department Specification.

When an admixture is used, it shall be the responsibility of the Contractor to produce satisfactory results.

**MISSISSIPPI DEPARTMENT OF TRANSPORTATION**

**SUPPLEMENT TO SPECIAL PROVISION NO. 907-714-5**

**DATE:** 10/27/2008

**SUBJECT:** Miscellaneous Materials

Delete the second exception under the first paragraph in Subsection 907-714.05.2 regarding the strength activity index.

MISSISSIPPI DEPARTMENT OF TRANSPORTATION

SPECIAL PROVISION NO. 907-714-5

CODE: (IS)

DATE: 06/18/2008

SUBJECT: Miscellaneous Materials

Section 714, Miscellaneous Materials, of the 2004 Edition of the Mississippi Standard Specifications for Road and Bridge Construction is hereby amended as follows:

**907-714.05--Fly Ash.** Delete Subsections 714.05.1 & 714.05.2 on pages 680 & 681, and substitute the following:

**907-714.05.1--General.** The fly ash source must be approved for listing in the Department's "Approved Sources of Materials" prior to use. The acceptance of fly ash shall be based on certified test reports, certification of shipment from the supplier, and tests performed on samples obtained after delivery in accordance with the Department's Materials Division Inspection, Testing, and Certification Manual and Department SOP.

Different classes of fly ash or different sources of the same class shall not be mixed or used in the construction of a structure or unit of a structure without written permission from the Engineer.

The Contractor shall provide suitable means for storing and protecting the fly ash from dampness. Separate storage silos, bins, or containers shall be provided for fly ash. Fly ash which has become partially set or contains lumps of caked fly ash shall not be used.

The temperature of the bulk fly ash shall not be greater than 165°F at the time of incorporation into the work.

All classes of fly ash shall meet the supplementary option chemical requirement for available alkalis listed in AASHTO Designation: M 295, Table 2. **Class F fly ash shall have a calcium oxide (CaO) content of less than 6.0%. Class C fly ash shall have a CaO content of greater than or equal to 6.0%.**

The replacement of Portland cement with fly ash shall be in accordance with the applicable replacement content specified in Subsection 907-701.02.2.

In addition to these requirements, fly ash shall meet the following specific requirements for the intended use.

**907-714.05.2--Fly Ash for Use in Concrete.** When used with Portland cement in the production of concrete or grout, the fly ash shall meet the requirements of AASHTO Designation: M 295, Class C or F, with the following exceptions:

The loss on ignition shall not exceed 6.0 percent.

The strength activity index with Portland cement shall be at least 55 percent of the control mix at seven days.

No additional cementitious materials, such as blended hydraulic cement, GGBFS, metakaolin, or others, shall be added to or as a replacement for Portland cement when used with fly ash.

**907-714.06--Ground Granulated Blast Furnace Slag (GGBFS).** Delete Subsection 714.06.1 on page 681, and substitute the following:

**907-714.06.1--General.** The GGBFS source must be approved for listing in the Department's "Approved Sources of Materials" prior to use. The acceptance of GGBFS shall be based on certified test reports, certification of shipment from the supplier, and tests performed on samples obtained after delivery in accordance with the Department's Materials Division Inspection, Testing, and Certification Manual and Department SOP.

The Contractor shall provide suitable means for storing and protecting the GGBFS against dampness and contamination. Separate storage silos, bins, or containers shall be provided for GGBFS. GGBFS which has become partially set, caked or contains lumps shall not be used.

The State Materials Engineer shall be notified in writing of the nature, amount and identity of any processing or other additions made to the GGBFS during production.

GGBFS from different mills shall not be mixed or used alternately in any one class of construction or structure without written permission from the Engineer; except that this requirement will not be applicable to cement treatment of design soils or bases.

No additional cementitious materials, such as blended hydraulic cement, fly ash, metakaolin, or others, shall be added to or as a replacement for Portland cement when used with GGBFS in the production of concrete. The replacement of Portland cement with GGBFS shall be in accordance with the applicable replacement content specified in Subsection 907-701.02.2.

Delete Subsection 714.07 on page 682, and substitute the following:

**907-714.07--Additional Cementitious Materials.**

**907-714.07.1--Metakaolin.**

**907-714.07.1.1--General.** Metakaolin shall only be used as a supplementary cementitious material in Portland cement concrete for compliance with the requirements for cementitious materials exposed to soluble sulfate conditions. Metakaolin from different sources shall not be mixed or used alternately in any one class of construction or structure without written permission from the Engineer. No additional cementitious materials, such as blended hydraulic cement, fly ash, GGBFS, or others, shall be added to or as a replacement for Portland cement when used with metakaolin in the production of concrete.

The State Materials Engineer shall be notified in writing of the nature, amount and identity of any processing, or other additions made to the metakaolin during production.

**907-714.07.1.2--Source Approval.** The approval of each metakaolin source shall be on a case by case basis as determined by the State Materials Engineer. In order to obtain approval of a metakaolin source, the Producer/Suppliers shall submit to the State Materials Engineer the following for review: certified test reports, made by an acceptable, independent laboratory regularly inspected by the Cement and Concrete Reference Laboratory of the National Institutes of Standards and Technology, which show that the metakaolin meets all the requirements of AASHTO Designation: M295, including the Effectiveness in contributing to sulfate resistance, Procedure A, listed in AASHTO Designation: M295, Table 4 for Supplementary Optional Physical Requirements, and other requirements listed herein.

In order to demonstrate effectiveness in contributing to sulfate resistance, included in this test data shall be results of metakaolin from the proposed source tested in accordance with ASTM Designation: C 1012. There shall be two sets of test specimens per the following:

- a. One set of test specimens shall be prepared using a Type I Portland cement meeting the requirements of AASHTO Designation: M85 and having a tricalcium aluminate ( $C_3A$ ) content of more than 8.0%,
- b. One set of test specimens shall be prepared using a Type II Portland cement meeting the requirements of AASHTO Designation: M85.
- c. The proposed metakaolin shall be incorporated at the rate of 10% cement replacement in each set of test specimens and shall meet both of the acceptance criteria listed below for source approval.

The requirement for acceptance of the test sample using Type I Portland cement is an expansion of 0.10% or less at the end of six months. The requirement for acceptance of the test sample using Type II Portland cement is an expansion of 0.05% or less at the end of six months.

**907-714.07.1.3--Storage.** The Contractor shall provide suitable means for storing and protecting the metakaolin against dampness and contamination. Metakaolin which has become partially set, caked, or contains lumps shall not be used.

**907-714.07.1.4--Specific Requirements.** Metakaolin shall meet the requirements of AASHTO Designation: M 295, Class N with the following modifications:

1. The sum of  $SiO_2 + Al_2O_3 + Fe_2O_3$  shall be at least 85%. The Material Safety Data Sheet shall indicate that the amount of crystalline silica, as measured by National Institute of Occupation Safety and Health (NIOSH) 7500 method, after removal of the mica interference, is less than 1.0%.
2. The loss on ignition shall be less than 3.0%.
3. The available alkalies, as equivalent  $Na_2O$ , shall not exceed 1.0%.
4. The amount of material retained on a No. 325 mesh sieve shall not exceed 1.0%.
5. The strength activity index at seven (7) days shall be at least 85%.

**907-714.07.1.5--Acceptance.** With each new lot of material shipped the Contractor shall submit to the State Materials Engineer a certified test report from the manufacturer showing that the material meets the requirements AASHTO Designation: M295, Class N and the requirements of this Subsection.

The Department reserves the right to sample, for check tests, any shipment or lot of metakaolin delivered to a project.

**907-714.07.2--Silica Fume.**

**907-714.07.2.1--General.** Silica fume shall only be used as a supplementary cementitious material in Portland cement concrete for compliance with the requirements for cementitious materials exposed to soluble sulfate conditions. Silica fume from different sources shall not be mixed or used alternately in any one class of construction or structure without written permission from the Engineer. No additional cementitious materials, such as blended hydraulic cement, performance hydraulic cement, fly ash, GGBFS, or others, shall be added to or as a replacement for Portland cement when used with silica fume in the production of concrete.

The State Materials Engineer shall be notified in writing of the nature, amount and identity of any processing, or other additions made to the silica fume during production.

**907-714.07.2.2--Source Approval.** The approval of each silica fume source shall be on a case by case basis as determined by the State Materials Engineer. In order to obtain approval of a silica fume source, the Producer/Suppliers shall submit to the State Materials Engineer the following for review: certified test reports, made by an acceptable, independent laboratory regularly inspected by the Cement and Concrete Reference Laboratory of the National Institutes of Standards and Technology, which show that the silica fume meets all the requirements of AASHTO Designation: M307, Table 3, including the Sulfate resistance expansion, listed in the table for Optional Physical Requirements, and other requirements listed herein.

In order to demonstrate effectiveness in contributing to sulfate resistance, included in this test data shall be results of silica fume from the proposed source tested in accordance with ASTM Designation: C 1012. There shall be two sets of test specimens per the following:

- a. One set of test specimens shall be prepared using a Type I Portland cement meeting the requirements of AASHTO Designation: M85 and having a tricalcium aluminate ( $C_3A$ ) content of more than 8.0%,
- b. One set of test specimens shall be prepared using a Type II Portland cement meeting the requirements of AASHTO Designation: M85.
- c. The proposed silica fume shall be incorporated at the rate of 8% cement replacement in each set of test specimens and shall meet both of the acceptance criteria listed below for source approval.

The requirement for acceptance of the test sample using Type I Portland cement is an expansion of 0.10% or less at the end of six months. The requirement for acceptance of the test sample using Type II Portland cement is an expansion of 0.05% or less at the end of six months.

**907-714.07.2.3--Storage.** The Contractor shall provide suitable means for storing and protecting the silica fume against dampness and contamination. Silica fume which has become partially set, caked, or contains lumps shall not be used.

**907-714.07.2.4--Acceptance.** With each new lot of material shipped, the Contractor shall submit to the State Materials Engineer a certified test report from the manufacturer showing that the material meets the Chemical and Physical Requirements of AASHTO Designation: M307.

The Department reserves the right to sample, for check tests, any shipment or lot of silica fume delivered to a project.

**907-714.11.6--Rapid Setting Commercial Grouts and Concrete Patching Compounds.** Delete the first sentence of the first paragraph of Subsection 714.11.6 on page 690 and substitute the following:

Rapid setting commercial grouts and concrete patching compounds must be approved for listing in the Department's "Approved Sources of Materials" prior to use. Upon approval, a product must be recertified every four (4) years to remain on the "Approved Sources of Materials" list. Each product shall be pre-measured and packaged dry by the manufacturer.

**907-714.11.7--Commercial Grout for Anchoring Doweled Tie Bars in Concrete.** Before Subsection 714.11.7.1 on page 691, add the following:

Approved Non-"Fast Set" Epoxy anchor systems as specified below may be used for the repair of concrete pavements that do not involve permanent sustained tension applications or overhead applications.

"*Fast Set Epoxy*" may not be used for any Adhesive Anchor Applications. Adhesive Anchor Systems (Fast Set epoxy or otherwise) shall not be used for permanent sustained tension applications or overhead applications. "Fast Set Epoxy" refers to an epoxy produced by the Sika Corporation called Sikadur AnchorFix-3 and repackaged for sale under a variety of names/companies listed at the Federal Highway Administration web site at the following link:

<http://www.fhwa.dot.gov/Bridge/adhesives.cfm>

**907-714.11.7.4--Acceptance Procedure.** After the last sentence of the first paragraph of Subsection 714.11.4 on page 691, add the following:

Upon approval, a product must be recertified every four (4) years to remain on the "Approved Sources of Materials" list.

**907-714.11.8--Epoxy Joint Repair System.**

**907-714.11.8.1--General.** After the last sentence of the first paragraph of Subsection 714.11.8.1 on page 692, add the following:

Upon approval, a product must be recertified every four (4) years to remain on the "Approved Sources of Materials" list.

**MISSISSIPPI DEPARTMENT OF TRANSPORTATION**

**SPECIAL PROVISION NO. 907-720-1**

**CODE: (IS)**

**DATE: 3/17/2008**

**SUBJECT: Pavement Markings Materials**

Section 720, Pavement Marking Materials, of the 2004 Edition of the Mississippi Standard Specifications for Road and Bridge Construction is hereby amended as follows:

**907-720.02--Thermoplastic Pavement Markings.** Delete the first paragraph of Subsection 720.02 on page 730 and substitute the following:

The thermoplastic material shall be lead free and conform to AASHTO Designation: M 249 except the glass beads shall be moisture resistant coated.

After the first sentence of the second paragraph of Subsection 720.02 on page 730, add the following:

In addition, the certification for the thermoplastic material shall state that the material is lead free.



# MISSISSIPPI DEPARTMENT OF TRANSPORTATION

## SUPPLEMENT TO SPECIAL PROVISION NO. 907-804-8

**DATE:** 06/09/2008

**SUBJECT:** Concrete Bridges and Structures

Before the first sentence of 907-804.02.1 on page 1, add the following:

Delete the third and fourth sentences of the first paragraph of Subsection 804.02.1 on page 846, and substitute the following:

For projects with 1000 cubic yards and more, quality control and acceptance shall be achieved through statistical evaluation of test results. For projects of more than 200 but less than 1000 cubic yards, quality control and acceptance shall be achieved by individual test results.

Before the first sentence of Subsection 907-804.02.10 on page 2, add the following:

Delete the first sentence of the first paragraph of Subsection 804.02.10 on page 850 and substitute the following:

At least 30 days prior to production of concrete, the Contractor shall submit to the Engineer proposed concrete mix designs complying with the Department's *Concrete Field Manual*.

Delete the second paragraph of Subsection 907-804.02.11 on page 3 and substitute the following:

For projects with 1000 cubic yards and more, the concrete batch plant shall meet the requirements for an automatic system capable of recording batch weights. It shall also have automatic moisture compensation for the fine aggregate. For projects of more than 200 but less than 1000 cubic yards the plant can be equipped for manual batching with a fine aggregate moisture meter visible to the plant operator.

Delete Subsection 907-804.02.13 on page 4 and substitute the following:

**907-804.02.13--Quality Assurance Sampling and Testing.** Delete subparagraph c) in Subsection 804.02.13 on page 858 and substitute the following:

- c) For concrete, the Contractor's QC and Department's QA testing of concrete compressive strengths compare when using the data comparison computer program with an alpha value of 0.01 for projects with 1000 cubic yards and more; or, strength comparisons are within 990 psi for projects of more than 200 but less than 1000 cubic yards.

In Table 5 of Subsection 804.02.13 on page 858, delete "and FM" from the requirements on line A.3.

After Subsection 907-804.02.13.1.4 on page 4, add the following:

**907-804.02.13.1.5--Compressive Strength.** Delete the heading of the second paragraph of Subsection 804.02.13.1.5 on page 860 and substitute the following:

**Projects with 1000 Cubic Yards and More.**

Delete the second heading in Subsection 804.02.13.1.5 on page 860 and substitute the following:

**Projects of More Than 200 but Less Than 1000 Cubic Yards.**

**MISSISSIPPI DEPARTMENT OF TRANSPORTATION**

**SPECIAL PROVISION NO. 907-804-8**

**CODE: (IS)**

**DATE: 02/05/2008**

**SUBJECT: Concrete Bridges And Structures**

Section 804, Concrete Bridges And Structures, of the 2004 Edition of the Mississippi Standard Specifications for Road and Bridge Construction is hereby amended as follows:

**907-804.02-- Materials.**

**907-804.02.1--General.** Add the following materials to the list of materials in Subsection 804.02.1 on page 847.

Blended Cement..... 907-701.01 and 907-701.04  
 Ground Granulated Blast Furnace Slag (GGBFS)..... 907-714.06  
 Metakaolin ..... 907-714.07  
 Silica Fume ..... 907-714.07.2

**907-804.02.8--Laboratory Accreditation.** In Table 1 of Subsection 804.02.8 on page 849, substitute AASHTO: R 39 - Making and Curing Concrete Test Specimens in the Laboratory for AASHTO: T 126 - Making and Curing Concrete Test Specimens in the Laboratory.

**907-804.02.9--Testing Personnel.** Delete Table 2 in this subsection and replace it with the following.

**Table 2**

<b>Concrete Technician's Tasks</b>	<b>Test Method Required</b>	<b>Certification Required**</b>
Sampling or Testing of Plastic Concrete	AASHTO Designation:T 23, T 119, T 121, T 141, T 152, T 196, and ASTM Designation: C 1064	MDOT Class I certification
Compressive Strength Testing of Concrete Cylinders	AASHTO Designation: T 22 and T 231	MDOT Concrete Strength Testing Technician certification
Sampling of Aggregates	AASHTO Designation: T 2	Work under the supervision of an MDOT Class II certified technician
Testing of Aggregates	AASHTO Designation: T 19, T 27, T 84, T 85, T 248, and T 255	MDOT Class II certification
Proportioning of Concrete Mixtures*	AASHTO Designation: M 157 and R 39	MDOT Class III
Interpretation and Application of Maturity Meter Readings	AASHTO Designation: T 325 and ASTM Designation: C 1074	MDOT Class III or Two hours maturity method training

- \* Technicians making concrete test specimens for meeting the requirements of Subsection 804.02.10.1.2 shall be MDOT Class I certified and under the direct supervision of an MDOT Class III certified technician.
- \*\* MDOT Class I certification encompasses the same test procedures and specifications as ACI Concrete Field Testing Technician Grade I. MDOT Class II certification encompasses the same test procedures and specifications as ACI Aggregate Testing Technician - Level 1. MDOT Concrete Strength Testing Technician encompasses the same test procedures and specifications as ACI Concrete Strength Testing certification.

For specifics about the requirements for each level of certification, please refer to the latest edition of the Department's *Concrete Field Manual*. Technicians holding current MDOT Class I, MDOT Class II and/or MDOT Class III certifications shall be acceptable until those certifications expire. Upon a current certification expiration, recertification with the certifications listed in Table 2 shall be required. Technicians currently performing either specific gravity testing of aggregates or compressive strength tests shall be required to either:

- have the required MDOT certification listed in Table 2, or
- have a current MDOT Class III certification or work under the direct supervision of current MDOT Class III technician, and have demonstrated the specific gravity and/or compressive strength test during the inspection of laboratory equipment by the Materials Division, Concrete Section.

**907-804.02.10--Portland Cement Concrete Mix Design.** Delete the Notes under Table 3 of Subsection 804.02.10 on pages 850 & 851, and substitute the following:

- \* Maximum size aggregate shall conform to the concrete mix design for the specified aggregate.
- \*\* The replacement limits of Portland cement by weight by other cementitious materials (such as fly ash, GGBFS, metakaolin, silica fume, or others) shall be in accordance with the values in Subsection 907-701.02. Other hydraulic cements may be used in accordance with the specifications listed in Section 701.
- \*\*\* The slump may be increased up to six (6) inches with an approved mid-range water reducer or up to eight (8) inches with an approved type F or G high range water reducer, in accordance with 907-713.02. Minus slump requirements shall meet those set forth in Table 3 of AASHTO M157 specifications.
- \*\*\*\* Entrained air is not required except for concrete exposed to seawater. For concrete exposed to seawater, the total air content shall be 3.0 % to 6.0%. For concrete not exposed to seawater, the total air content shall not exceed 6.0%.
- \*\*\*\*\* Class DS Concrete for drilled shafts shall have an  $8\pm 1$ -inch slump.

Delete the last paragraph of Subsection 804.02.10 on page 851 and substitute the following:

Either Type A, D, F, G or mid-range chemical admixture, shall be used in all classes of concrete. Any combinations of water reducing admixtures shall be approved by the Engineer before their use.

**907-804.02.10.1.1--Proportioning on the Basis of Previous Field Experience of Trial Mixtures.** Delete the first sentence of the first paragraph of Subsection 804.02.10.1.1 on page 851, and substitute the following:

Where a concrete production facility has a record, based on at least 10 consecutive strength tests from at least 10 different batches within the past 12 months from a mixture not previously used on Department projects, the standard deviation shall be calculated.

**907-804.02.10.3--Field Verification of Concrete Mix Design.** Delete the third sentence of the third paragraph of Subsection 804.02.10.3 on page 853, and substitute the following:

If the requirements of yield, slump, or total air content are not met within three (3) production days after the first placement, subsequent field verification testing shall not be permitted on department projects, and the mix design shall not be used until the requirements listed above are met

**907-804.02.10.4--Adjustments of Mixture Proportions.** Delete the paragraph in Subsection 804.02.10.4 on page 854, and substitute the following:

The mixture may be adjusted by the Class III Certified Technician representing the Contractor in accordance with the allowable revisions listed in the Department's Concrete Field Manual, paragraph 5.7. Written notification shall be submitted to the Engineer a minimum of seven (7) days prior to any source or brand of material change, aggregate size change, allowable material type change, or decrease in any cementitious material content. Any adjustments of the concrete mixture design shall necessitate repeat of field verification procedure as described in Subsection 804.02.10.3 and approval by the Engineer.

**907-804.02.11--Concrete Batch Plants.** Delete the first three paragraphs of Subsection 804.02.11 on page 854, and substitute the following:

The concrete batch plant shall meet the requirements of the National Ready Mixed Concrete Association *Quality Control Manual, Section 3, Plant Certification Checklist* as outlined in the latest edition of the Department's *Concrete Field Manual*. The Contractor shall submit a copy of the approved checklist along with proof of calibration of batching equipment, i.e., scales, water meter, and admixture dispenser, to the Engineer 30 days prior to the production of concrete.

For large volume projects the concrete batch plant shall meet the requirements for an automatic system capable of recording batch weights. It shall also have automatic moisture compensation for the fine aggregate. For small volume projects, the concrete batch plant can be equipped for manual batching with a fine aggregate moisture meter visible to the plant operator.

The concrete batch plant shall have available adequate facilities to cool concrete during hot weather.

Mixer trucks to be used on the project are to be listed in the checklist and shall meet the requirements of the checklist.

**907-804.02.12--Contractor's Quality Control.** Delete the fourth paragraph of Subsection 804.02.12 on page 854 & 855, and substitute the following:

The Contractor's Quality Control program shall encompass the requirements of AASHTO Designation: M 157 into concrete production and control, equipment requirements, testing, and batch ticket information. The requirement of AASHTO Designation: M 157, Section 11.7 shall

be followed except, on arrival to the job site, a maximum of 1½ gallons per cubic yard is allowed to be added. Water shall not be added at a later time. If the maximum permitted slump is exceeded after the addition of water at the job site, the concrete shall be rejected.

**907-804.02.12.3--Documentation.** After the second sentence of the second paragraph of Subsection 804.02.12.3 on page 856, add the following:

Batch tickets and gradation data shall be documented in accordance with Department requirements. Batch tickets shall contain all the information in AASHTO Designation: M157, Section 16 including the additional information in Subsection 16.2 with the following exception: the information listed in paragraphs 16.2.7 and 16.2.8 is not required. Batch tickets shall also contain the concrete producer's permanent unique mix number assigned to the concrete mix design.

**907-804.02.12.5--Non-Conforming Materials.** In Table 4 of Subsection 804.02.12.5 on page 857, delete “/ FM” from the requirements on line B.3.a.

**907-804.02.13--Quality Assurance Sampling and Testing.** In Table 5 of Subsection 804.02.13 on page 858, delete “and FM” from the requirements on line A.3.

**907-804.02.13.1.4--Temperature.** Delete the first paragraph of Subsection 804.02.13.1.4 on pages 859 & 860, and substitute the following:

Cold weather concreting shall follow the requirements of Subsection 907-804.03.16.1. Hot weather concreting shall follow the requirements of Subsection 804.03.16.2 with a maximum temperature of 95°F for Class DS concrete or for concrete mixes containing cementitious materials meeting the requirements of Subsection 907-701.02.2 as a replacement of Portland cement. For other concrete mixes, the maximum concrete temperature shall be 90°F. Concrete with a temperature more than the maximum allowable temperature shall be rejected and not used in Department work.

**907-804.03--Construction Requirements.**

**907-804.03.15--Removal of Falsework, Forms, and Housing.** Delete the first sentence of the second paragraph of Subsection 804.03.15 on page 871, and substitute the following:

Concrete in the last pour of a continuous superstructure shall have attained a compressive strength of 2,400 psi, as determined by cylinder tests or maturity meter probe, prior to striking any falsework.

Delete the first sentence of the third paragraph of Subsection 804.03.15 on page 871, and substitute the following:

At the Contractor's option and with the approval of the Engineer, the time for removal of forms may be determined by cylinder tests, in accordance with the requirements listed in Table 6, in which case the Contractor shall furnish facilities for testing the cylinders.

Delete the fourth and fifth paragraphs of Subsection 804.03.15 on pages 871 & 872, and substitute the following:

The cylinders shall be cured under conditions which are not more favorable than those existing for the portions of the structure which they represent.

Delete the table in Subsection 804.03.15 on page 872, and substitute the following:

**Table 6  
Minimum Compressive Strength Requirements for Form Removal**

**Forms:**

Columns .....	1000 psi
Side of Beams .....	1000 psi
Walls not under pressure .....	1000 psi
Floor Slabs, overhead .....	2000 psi
Floor Slabs, between beams .....	2000 psi
Slab Spans .....	2400 psi
Other Parts .....	1000 psi

**Centering:**

Under Beams .....	2400 psi
Under Bent Caps .....	2000 psi

**Limitation for Placing Beams on:**

Pile Bents, pile under beam .....	2000 psi
Frame Bents, two or more columns .....	2200 psi
Frame Bents, single column .....	2400 psi

In lieu of using concrete strength cylinders to determine when falsework, forms, and housings can be removed, an approved maturity meter may be used to determine concrete strengths by inserting probes into concrete placed in a structure. The minimum number of maturity meter probes required for each structural component shall be in accordance with Table 7. Falsework, forms, and housings may be removed when maturity meter readings indicate that the required concrete strength is achieved. Procedures for using the maturity meter and developing the strength/maturity relationship shall follow the requirements of AASHTO Designation: T 325 and ASTM Designation: C 1074 specifications. Technicians using the maturity meter or calculating strength/maturity graphs shall be required to have at least two hours of training prior to using the maturity equipment.

**Table 7  
Requirements for use of Maturity Meter Probes**

<b>Structure Component</b>	<b>Quantity of Concrete</b>	<b>No. of Probes</b>
Slabs, beams, walls, & miscellaneous items	0 - 30 yd <sup>3</sup>	2
	> 30 to 60 yd <sup>3</sup>	3
	> 60 to 90 yd <sup>3</sup>	4
	> 90 yd <sup>3</sup>	5
Footings, Columns & Caps	0 - 13 yd <sup>3</sup>	2
	> 13 yd <sup>3</sup>	3
Pavement, Pavement Overlays	1200 yd <sup>2</sup>	2
Pavement Repairs	Per repair or 900 yd <sup>2</sup> Whichever is smaller	2

**907-804.03.16--Cold or Hot Weather Concreting.**

**907-804.03.16.1--Cold Weather Concreting.** After the third paragraph of Subsection 804.03.16.1 on page 873, add the following:

In lieu of the protection and curing of concrete in cold weather, at the option of the Contractor with the approval of the Engineer, when concrete is placed during cold weather and there is a probability of ambient temperatures lower than 40°F, an approved maturity meter may be used to determine concrete strengths by inserting probes into concrete placed in a structure. The minimum number of maturity meter probes required for each structural component shall be in accordance with Table 7. An approved insulating blanketing material shall be used to protect the work when ambient temperatures are less than 40°F and shall remain in place until the required concrete strength in Table 6 is achieved. Procedures for using the maturity meter and developing the strength/maturity relationship shall follow the requirements of AASHTO Designation: T 325 and ASTM Designation: C 1074 specifications. Technicians using the maturity meter or calculating strength/maturity graphs shall be required to have at least two hours of training prior to using the maturity equipment.

Rename the Table in Subsection 804.03.16.1 on page 874 from "Table 6" to "Table 8".

**907-804.03.19--Finishing Concrete Surfaces.**

**907-804.03.19.7--Finishing Bridge Floors.**

**907-804.03.19.7.4--Acceptance Procedure for Bridge Deck Smoothness.** After the first sentence of the second paragraph of Subsection 804.03.19.7.4 on page 886, add the following:

Auxiliary lanes, tapers, shoulders and other areas that are not checked with the profilograph, shall meet a 1/8 inch in 10-foot straightedge check made transversely and longitudinally across the deck or slab.

**907-804.05--Basis of Payment.** Add the "907" prefix to the pay items listed on page 898.



### **SPECIAL PROVISION NO. 906-3**

#### **Training Special Provisions**

This Training Special Provision supersedes subparagraph 7b of the Special Provision entitled "Specific Equal Employment Opportunity Responsibilities," (Attachment 1), and is in implementation of 23 U.S.C. 140(a).

As part of the Contractor's equal employment opportunity affirmative action program training shall be provided as follows:

The Contractor shall provide on-the-job training aimed at developing full journeymen in the type of trade or job classification involved.

The number of trainees to be trained under this special provision will be as indicated in the bid schedule of the contract.

In the event that a Contractor subcontracts a portion of the contract work, he shall determine how many, if any, of the trainees are to be trained by the subcontractor, provided, however, that the Contractor shall retain the primary responsibility for meeting the training requirements imposed by this special provision. The Contractor shall also insure that this training special provision is made applicable to such subcontract. Where feasible, 25 percent of apprentices or trainees in each occupation shall be in their first year of apprenticeship or training.

The number of trainees shall be distributed among the work classifications on the basis of the Contractor's needs and the availability of journeymen in the various classifications within a reasonable area of recruitment. Prior to commencing construction, the Contractor shall submit to the State highway agency for approval the number of trainees to be trained in each selected classification and training program to be used. Furthermore, the Contractor shall specify the starting time for training in each of the classifications. The Contractor will be credited for each trainee employed by him on the contract work who is currently enrolled or becomes enrolled in an approved program and will be reimbursed for such trainees as provided hereinafter.

Training and upgrading of minorities and women toward journeymen status is a primary objective of this Training Special Provision. Accordingly, the Contractor shall make every effort to enroll minority trainees and women (e.g., by conducting systematic and direct recruitment through public and private sources likely to yield minority and women trainees) to the extent that such persons are available within a reasonable area of recruitment. The Contractor will be responsible for demonstrating the steps that he has taken in pursuance thereof, prior to a determination as to whether the Contractor is in compliance with this Training Special Provision. This training commitment is not intended, and shall not be used, to discriminate against any applicant for training, whether a member of a minority group or not.

No employee shall be employed as a trainee in any classification in which he has successfully completed a training course leading to journeyman status or in which he has been employed as a

journeyman. The Contractor should satisfy this requirement by including appropriate questions in the employee application or by other suitable means. Regardless of the method used the Contractor's records should document the findings in each case.

The minimum length and type of training for each classification will be as established in the training program selected by the Contractor and approved by the State highway agency and the Federal Highway Administration. The State highway agency and the Federal Highway Administration shall approve a program if it is reasonably calculated to meet the equal employment opportunity obligations of the Contractor and to qualify the average trainee for journeyman status in the classification concerned by the end of the training period. Furthermore, apprenticeship programs registered with the U.S. Department of Labor, Bureau of Apprenticeship and Training, or with a State apprenticeship agency recognized by the Bureau and training programs approved but not necessarily sponsored by the U.S. Department of Labor, Manpower Administration, Bureau of Apprenticeship and Training shall also be considered acceptable provided it is being administered in a manner consistent with the equal employment obligations of Federal-aid highway construction contracts. Approval or acceptance of a training program shall be obtained from the State prior to commencing work on the classification covered by the program. It is the intention of these provisions that training is to be provided in the construction crafts rather than clerk-typists or secretarial-type positions. Training is permissible in lower level management positions such as office engineers, estimators, timekeepers, etc., where the training is oriented toward construction applications. Training in the laborer classification may be permitted provided that significant and meaningful training is provided and approved by the division office. Some offsite training is permissible as long as the training is an integral part of an approved training program and does not comprise a significant part of the overall training.

Except as otherwise noted below, the Contractor will be reimbursed 80 cents per hour of training given an employee on this contract in accordance with an approved training program. As approved by the engineer, reimbursement will be made for training persons in excess of the number specified herein. This reimbursement will be made even though the Contractor receives additional training program funds from other sources, provided such other does not specifically prohibit the Contractor from receiving other reimbursement. Reimbursement for offsite training indicated above may only be made to the Contractor where he does one or more of the following and the trainees are concurrently employed on a Federal-aid project; contributes to the cost of the training, provides the instruction to the trainee or pays the trainee's wages during the offsite training period.

No payment shall be made to the Contractor if either the failure to provide the required training, or the failure to hire the trainee as a journeyman, is caused by the Contractor and evidences a lack of good faith on the part of the Contractor in meeting the requirements of this Training Special Provision. It is normally expected that a trainee will begin his training on the project as soon as feasible after start of work utilizing the skill involved and remain on the project as long as training opportunities exist in his work classification or until he has completed his training program. It is not required that all trainees be on board for the entire length of the contract. A

Contractor will have fulfilled his responsibilities under this Training Special Provision if he has provided acceptable training to the number of trainees specified. The number trained shall be determined on the basis of the total number enrolled on the contract for a significant period.

Trainees will be paid at least 60 percent of the appropriate minimum journeyman's rate specified in the contract for the first half of the training period, 75 percent for the third quarter of the training period, and 90 percent for the last quarter of the training period, unless apprentices or trainees in an approved existing program are enrolled as trainees on this project. In that case, the appropriate rates approved by the Departments of Labor or Transportation in connection with the existing program shall apply to all trainees being trained for the same classification who are covered by this Training Special Provision.

The Contractor shall furnish the trainee a copy of the program he will follow in providing the training. The Contractor shall provide each trainee with a certification showing the type and length of training satisfactorily completed.

The Contractor will provide for the maintenance of records and furnish periodic reports documenting his performance under this Training Special Provision.

## **SPECIAL PROVISION NO. 906-6**

### **MISSISSIPPI DEPARTMENT OF TRANSPORTATION ON-THE-JOB TRAINING PROGRAM**

#### **ALTERNATE TRAINING SPECIAL PROVISION**

##### **PURPOSE**

The purpose of the On-The-Job Training (OJT) Program is to provide training for minority, female and economically disadvantaged individuals in order that they may develop marketable skills and gain journey status in the skilled craft classifications in which they are being trained.

##### **INTRODUCTION**

This voluntary OJT Program has been developed through the partnering efforts of the Road Builders of Mississippi, the Federal Highway Administration (FHWA) and the Mississippi Department of Transportation (MDOT).

The OJT Program has been designed for use by participating contractors and subcontractors in meeting their training needs. The objective of the OJT Program is to develop skilled workers in the skilled craft trade areas of highway construction who are sufficiently trained to be productive employees in the highway construction industry work force.

The success of the OJT Program will require that contractors and subcontractors take part in the program and follow uniform procedures in training and in tracking trainee's progress.

##### **FUNDING**

MDOT will establish an annual OJT Fund from which, contractors and subcontractors may bill the Department directly for hours worked by trainees. The funding source of this money will be state and federal funds for MDOT's OJT Program.

##### **DISBURSEMENT OF FUNDS**

MDOT will pay \$3.00 per hour toward the trainee's salary for each hour of training performed by each trainee in an approved training program. Program reimbursements will be made directly to the prime or sub contractor. Requests for payment will be submitted to the Office of Civil Rights for approval.

Contractors must provide a signed invoice providing the following information to be reimbursed.

- Contractor's Name
- Mailing Address
- Trainee Name
- Social Security Number

- Race
- Sex
- Project Number
- Job Classification
- Total Number of Hours Completed

### **TRAINING PROGRAM APPROVAL**

A. To use the OJT Program on highway construction projects, the contractor will notify the Department Office of Civil Rights using the On-the-Job Trainee Schedule Form. The notification must include the following information:

- Trainee Starting Date
- Project number (s) trainee starting on
- Training program (classification) to be used; and
- Number of Training Hours Required

B. If a contractor chooses to use a training program different from those listed in the OJT Program Manual, or desires to train in a different classification, the training program must be submitted in its entirety for approval by the Department and FHWA. The training proposal must include the following:

1. The primary objective of the program: To provide training for minority, female and economically disadvantaged individuals for development to full journey status in the work classifications in which they are being trained.
2. The minimum number of hours and type of training the trainee will receive as it relates to each specific task required to achieve journey status.
3. No less than minimum wage.
4. Trainee certification of completion.
5. Records and reports submitted to the Office of Civil Rights on a monthly basis.

### **DEPARTMENT RESPONSIBILITY**

1. Department project staff will monitor trainees on the project. They will monitor payrolls for payment of correct wage rates and fringe benefits. The Office of Civil Rights will maintain a master list by contractor name, project number, trainee name and trainee social security number to aid project staff in monitoring trainees who work on multiple projects.
2. The Office of Civil Rights may elect to interview trainees periodically during the training period to assess their performance and training program.

## **CONTRACTOR RESPONSIBILITY**

1. Trainees must be identified on payrolls (i.e. dragline trainee).
2. When any trainee completes a program, or is terminated for a reason or reasons other than successful completion, the contractor must include the date of completion or an explanation for the termination and date of termination on the OJT Termination Report.
3. The contractor will assign each trainee to a particular person--either a supervisor or a journeyman/woman who is proficient in the craft the trainee is being trained in, to ensure that timely instructional experience is received by the trainee. This person, cooperating with the appropriate company personnel, will see that proper records and the total intended training hours are completed during the allocated number of hours set up in the classification criteria.
4. The contractor has the prerogative of terminating the training period of the trainee and advancing the trainee to journey status. Approval requests must be submitted to the Office of Civil Rights with an explanation (*refer to 2 above*).
5. Upon notification from the contractor, the Department will issue a skill verification card and certificate of training to the trainee.
6. Trainees may be transferred to state-aid highway construction projects in order to complete the training program. If transfers are made the Office of Civil Rights must be notified on the Monthly Trainee Form. All of the training hours completed by trainees will count toward overall program completion.
7. Program reimbursements will be made directly to the prime or sub contractor.

## **WAGE RATE**

The wage rate for all trainees is [the current Minimum Federal Wage Rate](#), during their OJT training program. Trainees shall be paid full fringe benefit amounts, where applicable. At the completion of the training program, the trainee shall receive the wages of a skilled journey.

## **RECRUITMENT AND SELECTION PROCEDURES**

### A. Prerequisites for Trainees

To be qualified for enrollment in the OJT Program, trainees must possess basic physical fitness for the work to be performed, dependability, willingness to learn and ability to follow instructions.

### B. Licenses

Truck driver trainees must possess appropriate driver permits or licenses for the operation of Class A, B and C trucks. However, when an instructional permit is used in lieu of a license, the trainee must be accompanied by an operator who:

1. Holds a license corresponding to the vehicle being operated;
2. Has had at least one year of driving experience; and
3. Is occupying the seat next to the driver.

#### C. Recruitment

1. Notices and posters setting forth the contractor's Equal Employment Opportunity Policy and availability of training programs will be placed in areas readily accessible to employees, applicants for employment and potential employees.
2. The contractor must target minority, female or economically disadvantaged trainees.
3. The contractor will conduct systematic and direct recruitment through public and private employee referral sources. Contractors must submit the trainee's name and completed application form to the Office of Civil Rights for review and approval. Approval must be obtained before the trainee can begin work under the training program.
4. Present employees will be screened for upgrading.

#### D. Selection

1. The selection and employment of a person by participating contractor shall qualify the person for the OJT Program.
  2. Selection will be made without regard to race, color, religion, sex, age or national origin and shall be completely nondiscriminatory.
  3. Employment of trainees will be in accordance with the work force requirements of the contractor. Each contractor will hire and train the trainees for uses in their own organization.
  4. Written certification of individuals under the category of economically disadvantaged can be provided to the contractor at the time of the interview. This certification must then be provided to the Office of Civil Rights with the other required information as part of the approval process for trainees.
- **NOTE:** The OJT Program is to provide training for minority, female and economically disadvantaged individuals in order that they may develop marketable skills and gain journey status in the skilled craft classifications in which they are being trained. However, this program does not exclude trainees that are not members of the above groups.

# SECTION 905 - PROPOSAL

Date \_\_\_\_\_

Mississippi Transportation Commission  
Jackson, Mississippi

Sirs: The following proposal is made on behalf of \_\_\_\_\_  
\_\_\_\_\_ of \_\_\_\_\_  
\_\_\_\_\_

for constructing the following designated project(s) within the time(s) hereinafter specified.

The plans are composed of drawings and blue prints on file in the offices of the Mississippi Department of Transportation, Jackson, Mississippi.

The Specifications are the current Standard Specifications of the Mississippi Department of Transportation approved by the Federal Highway Administration, except where superseded or amended by the plans, Special Provisions and Notice(s) to Bidders attached hereto and made a part thereof.

I (We) certify that I (we) possess a copy of said Standard and Supplemental Specifications.

Evidence of my (our) authority to submit the Proposal is hereby furnished. The proposal is made without collusion on the part of any person, firm or corporation. I (We) certify that I (we) have carefully examined the Plans, the Specifications, including the Special Provisions and Notice(s) to Bidders, herein, and have personally examined the site of the work. On the basis of the Specifications, Special Provisions, Notice(s) to Bidders, and Plans, I (we) propose to furnish all necessary machinery, tools, apparatus and other means of construction and do all the work and furnish all the materials in the manner specified. I (We) understand that the quantities mentioned herein are approximate only and are subject to either increase or decrease, and hereby propose to perform any increased or decreased quantities of work at the unit prices bid, in accordance with the above.

Attached hereto is a certified check, cashier's check or Proposal Guaranty Bond in the amount as required in the Advertisement (or, by law).

**INSTRUCTION TO BIDDERS:** Alternate and Optional Items on Bid Schedule.

1. Two or more items entered opposite a single unit quantity WITHOUT DEFINITE DESIGNATION AS "ALTERNATE ITEMS" are considered as "OPTIONAL ITEMS". Bidders may or may not indicate on bids the Optional Item proposed to be furnished or performed WITHOUT PREJUDICE IN REGARD TO IRREGULARITY OF BIDS.
2. Items classified on the bid schedule as "ALTERNATE ITEMS" and/or "ALTERNATE TYPES OF CONSTRUCTION" must be preselected and indicated on bids. However, "Alternate Types of Construction" may include Optional Items to be treated as set out in Paragraph 1, above.
3. Optional items not preselected and indicated on the bid schedule MUST be designated in accordance with Subsection 102.06 prior to or at the time of execution of the contract.
4. Optional and Alternate items designated must be used throughout the project.

I (We) further propose to perform all "force account or extra work" that may be required of me (us) on the basis provided in the Specifications and to give such work my (our) personal attention in order to see that it is economically performed.



**SECTION 905 -- PROPOSAL (CONTINUED)**

I (We) further propose to execute the attached contract agreement (Section 902) as soon as the work is awarded to me (us), and to begin and complete the work within the time limit(s) provided for in the Specifications and Advertisement. I (We) also propose to execute the attached contract bond (Section 903) in an amount not less than one hundred (100) percent of the total of my (our) part, but also to guarantee the excellence of both workmanship and materials until the work is finally accepted.

I (We) enclose a certified check, cashier's check or bid bond for **five percent (5%) of total bid** and hereby agree that in case of my (our) failure to execute the contract and furnish bond within Ten (10) days after notice of award, the amount of this check (bid bond) will be forfeited to the State of Mississippi as liquidated damages arising out of my (our) failure to execute the contract as proposed. It is understood that in case I am (we are) not awarded the work, the check will be returned as provided in the Specifications.

Respectfully Submitted,

DATE \_\_\_\_\_

\_\_\_\_\_  
Contractor

BY \_\_\_\_\_  
Signature

TITLE \_\_\_\_\_

ADDRESS \_\_\_\_\_

CITY, STATE, ZIP \_\_\_\_\_

PHONE \_\_\_\_\_

FAX \_\_\_\_\_

E-MAIL \_\_\_\_\_

(To be filled in if a corporation)

Our corporation is chartered under the Laws of the State of \_\_\_\_\_ and the names, titles and business addresses of the executives are as follows:

\_\_\_\_\_  
President Address

\_\_\_\_\_  
Secretary Address

\_\_\_\_\_  
Treasurer Address

The following is my (our) itemized proposal.

Widen and Overlay US 11 from Green's Creek Bridge to the Jones County Line, known as Federal Aid Project No. STP-2170-00(011) / 105466301, in the County of Forrest, State of Mississippi.

I (We) agree to complete the entire project within the specified contract time.

**\*\*\* SPECIAL NOTICE TO BIDDERS \*\*\***

**BIDS WILL NOT BE CONSIDERED UNLESS BOTH UNIT PRICES AND ITEM TOTALS ARE ENTERED.  
 BIDS WILL NOT BE CONSIDERED UNLESS THE BID CERTIFICATION LOCATED AT THE END OF THE BID SHEETS IS SIGNED**

**\*\*\*BID SCHEDULE\*\*\***

Line No.	Item Code	Adj Code	Quantity	Units	Description	Unit Price		Item Amount	
						Dollar	Ct	Dollar	Ct
<b>Roadway Items</b>									
0010	202-B078		311	Square Yard	Removal of Pavement, All Types and Depths				
0020	202-B102		600	Linear Feet	Removal of Guard Rail				
0030	203-EX039	(E)	650	Cubic Yard	Borrow Excavation, AH, LVM, Class B7-6				
0040	406-A001		800	Square Yard	Cold Milling of Bituminous Pavement, All Depths				
0050	423-A001		10	Mile	Rumble Strips, Ground In				
0060	606-B005		425	Linear Feet	Guard Rail, Class A, Type 1, 'W' Beam				
0070	606-D004		2	Each	Guard Rail, Bridge End Section, Type E				
0080	606-D005		2	Each	Guard Rail, Bridge End Section, Type F				

Line No.	Item Code	Adj Code	Quantity	Units	Description	Unit Price		Bid Amount	
0090	606-E001		4	Each	Guard Rail, Terminal End Section				
0100	609-D006	(S)	605	Linear Feet	Combination Concrete Curb and Gutter Type 1 Modified				
0110	616-A001	(S)	89	Square Yard	Concrete Median and/or Island Pavement, 4-inch				
0120	616-A003	(S)	28	Square Yard	Concrete Median and/or Island Pavement, 10-inch				
0130	618-A001		1	Lump Sum	Maintenance of Traffic	XXXXXXXX	XXX		
0140	618-B001		1	Square Feet	Additional Construction Signs	10.	00	10.	00
0150	619-A1002		22	Mile	Temporary Traffic Stripe, Continuous White				
0160	619-A2002		2	Mile	Temporary Traffic Stripe, Continuous Yellow				
0170	619-A4006		10	Mile	Temporary Traffic Stripe, Skip Yellow				
0180	619-A5001		800	Linear Feet	Temporary Traffic Stripe, Detail				
0190	619-A6001		360	Linear Feet	Temporary Traffic Stripe, Legend				
0200	627-J001		100	Each	Two-Way Clear Reflective High Performance Raised Markers				

Line No.	Item Code	Adj Code	Quantity	Units	Description	Unit Price		Bid Amount	
0210	627-L001		350	Each	Two-Way Yellow Reflective High Performance Raised Markers				
0220	630-F001		22	Each	Delineators, Guard Rail, White				
0230	907-403-A010 (BA1 )		7,900	Ton	Hot Mix Asphalt, MT, 9.5-mm mixture				
0240	907-403-B006 (BA1 )		5,900	Ton	Hot Mix Asphalt, MT, 9.5-mm mixture, Leveling				
0250	907-413-E001		21,200	Linear Feet	Sawing and Sealing Transverse Joints in Asphalt Pavement				
0260	907-626-C003		11	Mile	6" Thermoplastic Double Drop Edge Stripe, Continuous White				
0270	907-626-D003		5	Mile	6" Thermoplastic Traffic Stripe, Skip Yellow				
0280	907-626-E004		1	Mile	6" Thermoplastic Traffic Stripe, Continuous Yellow				
0290	907-626-G004		1,000	Linear Feet	Thermoplastic Detail Stripe, White				
0300	907-626-G005		800	Linear Feet	Thermoplastic Detail Stripe, Yellow				
0310	907-626-H004		1,225	Linear Feet	Thermoplastic Legend, White				
0320	907-626-H005		325	Square Feet	Thermoplastic Legend, White				

\*\*\* BID CERTIFICATION \*\*\*

TOTAL BID.....\$\_\_\_\_\_

\*\*\* DBE/WBE SECTION \*\*\*

Complete item nos. 1, 2, and/or 3 as appropriate. See Notice to Bidders addressing Disadvantaged Business Enterprises in Highway Construction.

1. I/We agree that no less than \_\_\_\_\_ percent shall be expended with small business concerns owned and controlled by socially and economically disadvantaged individuals (DBE and WBE).
2. Classification of Bidder: Small Business (DBE)\_\_\_\_\_ Small Business (WBE)\_\_\_\_\_
3. A joint venture with a Small Business (DBE/WBE): \_\_\_\_\_

\*\*\* SIGNATURE STATEMENT \*\*\*

BIDDER ACKNOWLEDGES THAT HE/SHE HAS CHECKED ALL ITEMS IN THIS PROPOSAL FOR ACCURACY AND CERTIFIED THAT THE FIGURES SHOWN THEREIN CONSTITUTE THEIR OFFICIAL BID.

\_\_\_\_\_  
BIDDER'S SIGNATURE

\_\_\_\_\_  
BIDDER'S COMPANY

\_\_\_\_\_  
BIDDER'S FEDERAL TAX ID NUMBER

**CONDITIONS FOR COMBINATION BID**

If a bidder elects to submit a combined bid for two or more of the contracts listed for this month's letting, the bidder must complete and execute these sheets of the proposal in each of the individual proposals to constitute a combination bid. In addition to this requirement, each individual contract shall be completed, executed and submitted in the usual specified manner.

Failure to execute this Combination Bid Proposal in each of the contracts combined will be just cause for each proposal to be received and evaluated as a separate bid.

\*\*\*\*\*

**COMBINATION BID PROPOSAL**

I. This proposal is tendered as one part of a Combination Bid Proposal utilizing option \_\_\_\* of Subsection 102.11 on the following contracts:

\* Option to be shown as either (a), (b), or (c).

<u>Project No.</u>	<u>County</u>	<u>Project No.</u>	<u>County</u>
1. _____	_____	6. _____	_____
2. _____	_____	7. _____	_____
3. _____	_____	8. _____	_____
4. _____	_____	9. _____	_____
5. _____	_____	10. _____	_____

A. If option (a) has been selected, then go to II, and sign Combination Bid Proposal.

B. If option (b) has been selected, then complete the following, go to II, and sign Combination Bid Proposal.

SECTION 905 - COMBINATION BID PROPOSAL (Continued)

Project Number	Pay Item Number	Unit	Unit Price Reduction	Total Item Reduction	Total Contract Reduction
1. _____	_____ _____	_____ _____	_____ _____	_____ _____	
2. _____	_____ _____	_____ _____	_____ _____	_____ _____	
3. _____	_____ _____	_____ _____	_____ _____	_____ _____	
4. _____	_____ _____	_____ _____	_____ _____	_____ _____	
5. _____	_____ _____	_____ _____	_____ _____	_____ _____	
6. _____	_____ _____	_____ _____	_____ _____	_____ _____	
7. _____	_____ _____	_____ _____	_____ _____	_____ _____	
8. _____	_____ _____	_____ _____	_____ _____	_____ _____	

SECTION 905 - COMBINATION BID PROPOSAL (Continued)

Project Number	Pay Item Number	Unit	Unit Price Reduction	Total Item Reduction	Total Contract Reduction
9. _____	_____ _____	_____ _____	_____ _____	_____ _____	
10. _____	_____ _____	_____ _____	_____ _____	_____ _____	

C. If option (c) has been selected, then initial and complete one of the following, go to II. and sign Combination Bid Proposal.

\_\_\_\_\_ I (We) desire to be awarded work not to exceed a total monetary value of \$ \_\_\_\_\_.

\_\_\_\_\_ I (We) desire to be awarded work not to exceed \_\_\_\_\_ number of contracts.

II. It is understood that the Mississippi Transportation Commission not only reserves the right to reject any and all proposals, but also the right to award contracts upon the basis of lowest separate bids or combination bids most advantageous to the State.

It is further understood and agreed that the Combination Bid Proposal is for comparison of bids only and that each contract shall operate in every respect as a separate contract in accordance with its proposal and contract documents.

I (We), the undersigned, agree to complete each contract on or before its specified completion date.

SIGNED \_\_\_\_\_  
 \_\_\_\_\_  
 \_\_\_\_\_



**Certification with regard to the Performance of Previous  
Contracts or Subcontracts subject to the Equal Opportunity  
Clause and the filing of Required Reports**

The Bidder \_\_\_\_\_, proposed Subcontractor \_\_\_\_\_, hereby certifies that he has \_\_\_\_\_, has not \_\_\_\_\_, participated in a previous contract or subcontract subject to the Equal Opportunity Clause, as required by Executive Orders 10925, 11114, or 11246, and that he has \_\_\_\_\_, has not \_\_\_\_\_, filed with the Joint Reporting Committee, the Director of the Office of Federal Contract Compliance, a Federal Government contracting or administering agency, or the former President's Committee on Equal Employment Opportunity, all reports due under the applicable filing requirements.

\_\_\_\_\_  
(COMPANY)

BY \_\_\_\_\_

\_\_\_\_\_  
(TITLE)

DATE: \_\_\_\_\_

NOTE: The above certification is required by the Equal Employment Opportunity Regulations of the Secretary of Labor (41 CFR 60-1.7 (b) (1)), and must be submitted by bidders and proposed subcontractors only in connection with contracts and subcontracts which are subject to the Equal Opportunity Clause. Contracts and Subcontracts which are exempt from the Equal Opportunity Clause are set forth in 41 CFR 60-1.5. (Generally only contracts or subcontracts of \$10,000 or under are exempt.)

Currently, Standard Form 100 (EEO-1) is the only report required by the Executive Orders or their implementing regulations.

Proposed prime Contractors and Subcontractors who have participated in a previous contract or subcontract subject to the Executive orders and have not filed the required reports should note that 41 CFR 60-1.7 (b) (1) prevents the award of contracts and subcontracts unless such Contractors submit a report covering the delinquent period or such other period specified by the Federal Highway Administration or by the Director, Office of Federal Contract Compliance, U. S. Department of Labor.

# MISSISSIPPI DEPARTMENT OF TRANSPORTATION

## CERTIFICATION (Execute in duplicate)

I, \_\_\_\_\_,  
(Name of person signing certification)

individually, and in my capacity as \_\_\_\_\_ of  
(Title)

\_\_\_\_\_ do hereby certify under  
(Name of Firm, Partnership, or Corporation)

penalty of perjury under the laws of the United States and the State of Mississippi that \_\_\_\_\_

\_\_\_\_\_, Bidder  
(Name of Firm, Partnership, or Corporation)

on Project No. STP-2170-00(011) / 105466301

in Forrest County(ies), Mississippi, has not either

directly or indirectly entered into any agreement, participated in any collusion; or otherwise taken any action in restraint of free competitive bidding in connection with this contract; nor have any of its corporate officers or principal owners.

Except as noted hereafter, it is further certified that said legal entity and its corporate officers, principal owners, managers, auditors and others in a position of administering federal funds:

- a) Are not presently debarred, suspended, proposed for debarment, declared ineligible, or voluntarily excluded from covered transactions by any Federal department or agency;
- b) Have not within a three-year period preceding this proposal been convicted of or had a civil judgment rendered against them for commission of fraud or a criminal offense in connection with obtaining, attempting to obtain, or performing a public (Federal, State or local) transaction or contract under a public transaction; violation of Federal or State antitrust statutes or commission of embezzlement, theft, forgery, bribery, falsification or destruction of records, making false statements, or receiving stolen property;
- c) Are not presently indicted for or otherwise criminally or civilly charged by a governmental entity (Federal, State or local) with commission of any of the offenses enumerated in (b) above; and
- d) Have not within a three-year period preceding this application/ proposal had one or more public transactions (Federal, State or local) terminated for cause or default.

Initial here "\_\_\_\_\_" if exceptions are attached and made a part thereof. Any exceptions shall address to whom it applies, initiating agency and dates of such action.

Note: Exceptions will not necessarily result in denial of award but will be considered in determining bidder responsibility. Providing false information may result in criminal prosecution or administrative sanctions.

The bidder further certifies that the certification requirements contained in Section XI of Form FHWA 1273, will be or have been included in all subcontracts, material supply agreements, purchase orders, etc. except those procurement contracts for goods or services that are expected to be less than the Federal procurement small purchase threshold fixed at 10 U.S.C. 2304(g) and 41 U.S.C. 253(g) (currently \$25,000) which are excluded from the certification requirements.

The bidder further certifies, to the best of his or her knowledge and belief, that:

- 1) No Federal appropriated funds have been paid or will be paid to any person for influencing or attempting to influence an officer or employee of any Federal agency, a Member of Congress, an officer or employee of Congress, or an employee of a Member of Congress in connection with the awarding of any Federal contract, the making of any Federal grant, the making of any Federal loan, the entering into of any cooperative agreement, and the extension, continuation, renewal, amendment, or modification of any Federal contract, grant, loan, or cooperative agreement.
- 2) If any funds other than Federal appropriated funds have been paid or will be paid to any person for influencing or attempting to influence an officer or employee of any Federal agency, a Member of Congress, an officer or employee of Congress, or an employee of a Member of Congress in connection with this contract, Standard Form-LLL, "Disclosure Form to Report Lobbying," in accordance with its instructions will be completed and submitted.

The certification contained in (1) and (2) above is a material representation of fact upon which reliance is placed and a prerequisite imposed by Section 1352, Title 31, U.S. Code prior to entering into this contract. Failure to comply shall be subject to a civil penalty of not less than \$10,000 and not more than \$100,000. The bidder shall include the language of the certification in all subcontracts exceeding \$100,000 and all subcontractors shall certify and disclose accordingly.

All of the foregoing and attachments (when indicated) is true and correct.

Executed on \_\_\_\_\_  
Signature \_\_\_\_\_

**MISSISSIPPI DEPARTMENT OF TRANSPORTATION**

CERTIFICATION  
(Execute in duplicate)

I, \_\_\_\_\_,  
(Name of person signing certification)

individually, and in my capacity as \_\_\_\_\_ of  
(Title)

\_\_\_\_\_ do hereby certify under  
(Name of Firm, Partnership, or Corporation)

penalty of perjury under the laws of the United States and the State of Mississippi that \_\_\_\_\_

\_\_\_\_\_, Bidder  
(Name of Firm, Partnership, or Corporation)

on Project No. STP-2170-00(011) / 105466301

in Forrest County(ies), Mississippi, has not either

directly or indirectly entered into any agreement, participated in any collusion; or otherwise taken any action in restraint of free competitive bidding in connection with this contract; nor have any of its corporate officers or principal owners.

Except as noted hereafter, it is further certified that said legal entity and its corporate officers, principal owners, managers, auditors and others in a position of administering federal funds:

- a) Are not presently debarred, suspended, proposed for debarment, declared ineligible, or voluntarily excluded from covered transactions by any Federal department or agency;
- b) Have not within a three-year period preceding this proposal been convicted of or had a civil judgment rendered against them for commission of fraud or a criminal offense in connection with obtaining, attempting to obtain, or performing a public (Federal, State or local) transaction or contract under a public transaction; violation of Federal or State antitrust statutes or commission of embezzlement, theft, forgery, bribery, falsification or destruction of records, making false statements, or receiving stolen property;
- c) Are not presently indicted for or otherwise criminally or civilly charged by a governmental entity (Federal, State or local) with commission of any of the offenses enumerated in (b) above; and
- d) Have not within a three-year period preceding this application/ proposal had one or more public transactions (Federal, State or local) terminated for cause or default.

Initial here "\_\_\_\_\_" if exceptions are attached and made a part thereof. Any exceptions shall address to whom it applies, initiating agency and dates of such action.

Note: Exceptions will not necessarily result in denial of award but will be considered in determining bidder responsibility. Providing false information may result in criminal prosecution or administrative sanctions.

The bidder further certifies that the certification requirements contained in Section XI of Form FHWA 1273, will be or have been included in all subcontracts, material supply agreements, purchase orders, etc. except those procurement contracts for goods or services that are expected to be less than the Federal procurement small purchase threshold fixed at 10 U.S.C. 2304(g) and 41 U.S.C. 253(g) (currently \$25,000) which are excluded from the certification requirements.

The bidder further certifies, to the best of his or her knowledge and belief, that:

- 1) No Federal appropriated funds have been paid or will be paid to any person for influencing or attempting to influence an officer or employee of any Federal agency, a Member of Congress, an officer or employee of Congress, or an employee of a Member of Congress in connection with the awarding of any Federal contract, the making of any Federal grant, the making of any Federal loan, the entering into of any cooperative agreement, and the extension, continuation, renewal, amendment, or modification of any Federal contract, grant, loan, or cooperative agreement.
- 2) If any funds other than Federal appropriated funds have been paid or will be paid to any person for influencing or attempting to influence an officer or employee of any Federal agency, a Member of Congress, an officer or employee of Congress, or an employee of a Member of Congress in connection with this contract, Standard Form-LLL, "Disclosure Form to Report Lobbying," in accordance with its instructions will be completed and submitted.

The certification contained in (1) and (2) above is a material representation of fact upon which reliance is placed and a prerequisite imposed by Section 1352, Title 31, U.S. Code prior to entering into this contract. Failure to comply shall be subject to a civil penalty of not less than \$10,000 and not more than \$100,000. The bidder shall include the language of the certification in all subcontracts exceeding \$100,000 and all subcontractors shall certify and disclose accordingly.

All of the foregoing and attachments (when indicated) is true and correct.

Executed on \_\_\_\_\_  
Signature

**S E C T I O N   9 0 2**

CONTRACT FOR STP-2170-00(011) / 105466301

LOCATED IN THE COUNTY(IES) OF Forrest

STATE OF MISSISSIPPI,

COUNTY OF HINDS

This contract entered into by and between the Mississippi Transportation Commission on one hand, and the undersigned contractor, on the other witnesseth;

That, in consideration of the payment by the Mississippi Transportation Commission of the prices set out in the proposal hereto attached, to the undersigned contractor, such payment to be made in the manner and at the time of times specified in the specifications and the special provisions, if any, the undersigned contractor hereby agrees to accept the prices stated in the proposal in full compensation for the furnishing of all materials and equipment and the executing of all the work contemplated in this contract.

It is understood and agreed that the advertising according to law, the Advertisement, the instructions to bidders, the proposal for the contract, the specifications, the revisions of the specifications, the special provisions, and also the plans for the work herein contemplated, said plans showing more particularly the details of the work to be done, shall be held to be, and are hereby made a part of this contract by specific reference thereto and with like effect as if each and all of said instruments had been set out fully herein in words and figures.

It is further agreed that for the same consideration the undersigned contractor shall be responsible for all loss or damage arising out of the nature of the work aforesaid; or from the action of the elements and unforeseen obstructions or difficulties which may be encountered in the prosecution of the same and for all risks of every description connected with the work, exceptions being those specifically set out in the contract; and for faithfully completing the whole work in good and workmanlike manner according to the approved Plans, Specifications, Special Provisions, Notice(s) to Bidders and requirements of the Mississippi Department of Transportation.

It is further agreed that the work shall be done under the direct supervision and to the complete satisfaction of the Executive Director of the Mississippi Department of Transportation, or his authorized representatives, and when Federal Funds are involved subject to inspection at all times and approval by the Federal Highway Administration, or its agents as the case may be, or the agents of any other Agency whose funds are involved in accordance with those Acts of the Legislature of the State of Mississippi approved by the Governor and such rules and regulations issued pursuant thereto by the Mississippi Transportation Commission and the authorized Federal Agencies.

The Contractor agrees that all labor as outlined in the Special Provisions may be secured from list furnished by

It is agreed and understood that each and every provision of law and clause required by law to be inserted in this contract shall be deemed to be inserted herein and this contract shall be read and enforced as though it were included herein, and, if through mere mistake or otherwise any such provision is not inserted, then upon the application of either party hereto, the contract shall forthwith be physically amended to make such insertion.

The Contractor agrees that he has read each and every clause of this Contract, and fully understands the meaning of same and that he will comply with all the terms, covenants and agreements therein set forth.

Witness our signatures this the \_\_\_\_\_ day of \_\_\_\_\_, \_\_\_\_\_.

\_\_\_\_\_  
Contractor (s)

By \_\_\_\_\_

MISSISSIPPI TRANSPORTATION COMMISSION

Title \_\_\_\_\_

By \_\_\_\_\_

Signed and sealed in the presence of:  
(names and addresses of witnesses)

Executive Director

\_\_\_\_\_  
Secretary to the Commission

Award authorized by the Mississippi Transportation Commission in session on the \_\_\_\_ day of \_\_\_\_\_, \_\_\_\_\_, Minute Book No. \_\_\_\_\_, Page No. \_\_\_\_\_.

**S E C T I O N   9 0 3**

CONTRACT BOND FOR: STP-2170-00(011) / 105466301

LOCATED IN THE COUNTY(IES) OF: Forrest

STATE OF MISSISSIPPI,

COUNTY OF HINDS

Know all men by these presents: that we, \_\_\_\_\_

\_\_\_\_\_ Principal, a \_\_\_\_\_

residing at \_\_\_\_\_ in the State of \_\_\_\_\_

and \_\_\_\_\_

residing at \_\_\_\_\_ in the State of \_\_\_\_\_,

authorized to do business in the State of Mississippi, under the laws thereof, as surety, are held and firmly bound unto the State of Mississippi in the sum of \_\_\_\_\_

\_\_\_\_\_ (\$ \_\_\_\_\_) Dollars, lawful money of the United States of America, to be paid to it for which payment well and truly to be made, we bind ourselves, our heirs, administrators, successors, or assigns jointly and severally by these presents.

Signed and sealed this the \_\_\_\_ day of \_\_\_\_\_ A.D. \_\_\_\_\_.

The conditions of this bond are such, that whereas the said \_\_\_\_\_

\_\_\_\_\_ principal, has (have) entered into a contract with the Mississippi Transportation Commission, bearing the date of \_\_\_\_\_ day of \_\_\_\_\_ A.D. \_\_\_\_\_ hereto annexed, for the construction of certain projects(s) in the State of Mississippi as mentioned in said contract in accordance with the Contract Documents therefor, on file in the offices of the Mississippi Department of Transportation, Jackson, Mississippi.

Now therefore, if the above bounden \_\_\_\_\_

\_\_\_\_\_ in all things shall stand to and abide by and well and truly observe, do keep and perform all and singular the terms, covenants, conditions, guarantees and agreements in said contract, contained on his (their) part to be observed, done, kept and performed and each of them, at the time and in the manner and form and furnish all of the material and equipment specified in said contract in strict accordance with the terms of said contract which said plans, specifications and special provisions are included in and form a part of said contract and shall maintain the said work contemplated until its final completion and acceptance as specified in Subsection 109.11 of the approved specifications, and save harmless said Mississippi Transportation Commission from any loss or damage arising out of or occasioned by the negligence, wrongful or criminal act, overcharge, fraud, or any other loss or damage whatsoever, on the part of said principal (s), his (their) agents, servants, or employees in the performance of said work or in any manner connected therewith, and shall be liable and responsible in a civil action instituted by the State at the instance of the Mississippi Transportation Commission or any officer of the State authorized in such cases, for double any amount in money or property, the State may lose or be overcharged or otherwise defrauded of, by reason of wrongful or criminal act, if any, of the Contractor(s), his (their) agents or

**SECTION 903 - CONTINUED**

employees, and shall promptly pay the said agents, servants and employees and all persons furnishing labor, material, equipment or supplies therefor, including premiums incurred, for Surety Bonds, Liability Insurance, and Workmen's Compensation Insurance; with the additional obligation that such Contractor shall promptly make payment of all taxes, licenses, assessments, contributions, damages, any liquidated damages which may arise prior to any termination of said principal's contract, any liquidated damages which may arise after termination of the said principal's contract due to default on the part of said principal, penalties and interest thereon, when and as the same may be due this state, or any county, municipality, board, department, commission or political subdivision: in the course of the performance of said work and in accordance with Sections 31-5-51 et seq. Mississippi Code of 1972, and other State statutes applicable thereto, and shall carry out to the letter and to the satisfaction of the Executive Director of the Mississippi Department of Transportation, all, each and every one of the stipulations, obligations, conditions, covenants and agreements and terms of said contract in accordance with the terms thereof and all of the expense and cost and attorney's fee that may be incurred in the enforcement of the performance of said contract, or in the enforcement of the conditions and obligations of this bond, then this obligation shall be null and void, otherwise to be and remain in full force and virtue.

Witness our signatures and seals this the \_\_\_\_\_ day of \_\_\_\_\_ A.D. \_\_\_\_\_.

_____	_____
(Contractors) Principal	Surety
By _____	By _____
	(Signature) Attorney in Fact
	Address _____
	_____
Title _____	_____
(Contractor's Seal)	Mississippi Resident Agent
	_____
	(Signature) Mississippi Resident Agent
	Address _____
	_____
	_____
	(Surety Seal)





# BID BOND

KNOW ALL MEN BY THESE PRESENTS, that we \_\_\_\_\_

Contractor

Address

City, State ZIP

as Principal, hereinafter called the Principal, and \_\_\_\_\_

a corporation duly organized under the laws of the state of \_\_\_\_\_

as Surety, hereinafter called the Surety, are held and firmly bound unto State of Mississippi, Jackson, Mississippi

As Obligee, hereinafter called Obligee, in the sum of **Five Per Cent (5%) of Amount Bid**

Dollars (\$ \_\_\_\_\_)

for the payment of which sum will and truly to be made, the said Principal and said Surety, bind ourselves, our heirs, executors, administrators, successors and assigns, jointly and severally, firmly by these presents.

WHEREAS, the Principal has submitted a bid for **Widen and Overlay US 11 from Green's Creek Bridge to the Jones County Line, known as Federal Aid Project No. STP-2170-00(011) / 105466301, in the County of Forrest, State of Mississippi.**

NOW THEREFORE, the condition of this obligation is such that if the aforesaid Principal shall be awarded the contract, the said Principal will, within the time required, enter into a formal contract and give a good and sufficient bond to secure the performance of the terms and conditions of the contract, then this obligation to be void; otherwise the Principal and Surety will pay unto the Obligee the difference in money between the amount of the bid of the said Principal and the amount for which the Obligee legally contracts with another party to perform the work if the latter amount be in excess of the former, but in no event shall liability hereunder exceed the penal sum hereof.

Signed and sealed this \_\_\_\_\_ day of \_\_\_\_\_, 2009

\_\_\_\_\_  
(Principal)

\_\_\_\_\_  
(Seal)

By: \_\_\_\_\_

(Title)

\_\_\_\_\_  
(Witness)

\_\_\_\_\_  
(Surety)

\_\_\_\_\_  
(Seal)

By: \_\_\_\_\_

(Attorney-in-Fact)

\_\_\_\_\_  
(Witness)

\_\_\_\_\_  
MS Resident Agent

\_\_\_\_\_  
Mississippi Insurance ID Number

Bid bond must be signed or countersigned by a qualified Mississippi resident agent and the bidder as per Section 102.08 of the Mississippi Standard Specifications for Road and Bridge Construction, 2004 edition.

PROGRESS SCHEDULE

PROJECT NUMBER STP-2170-00(011)/105466301  
COUNTY Forrest County

WORK PHASE		REFERENCE NUMBERS	PHASE VALUE																													NO.	AVTU
NO.	DESCRIPTION			20	40	60	80	100	120	140	160	180	200	220	240	260	280	300	320														
1	Miscellaneous	10,20,40-190,220 & 250	0	[Gantt bar from 0 to 30]																								30					
2	Granular Material & Pavement	30, 230 & 240	5	[Gantt bar from 5 to 26]																								26					
3	Permanent Striping	200,210 & 260-320		[Gantt bar from 26 to 30]																								30					
	LET:	March 24,2009																															
	NOA:	April 14,2009																															
	NTP/BCT:																																
	T.U.:	30																															
	Column:	D GCG																															

This Progress Schedule does not indicate breaks in the contract time during December, January, and February.  
Per Section 108 of the Specifications, during the months of December, January, and February, time will only be assessed in the Miscellaneous Phase.

MISSISSIPPI DEPARTMENT OF TRANSPORTATION  
OFFICE OF CIVIL RIGHTS  
JACKSON, MISSISSIPPI  
**LIST OF FIRMS SUBMITTING QUOTES**

I/we received quotes from the following firms on Project No: **STP-2170-00(011) / 105466301**  
County: **Forrest**

Disadvantaged Business Enterprise (DBE) Regulations as stated in 49 CFR 26.11 require the Mississippi Department of Transportation (MDOT) to create and maintain a comprehensive list of all firms quoting/bidding subcontracts on prime contracts and quoting/bidding subcontracts on federally-funded transportation projects. For every firm, we require the following information:

Firm Name: \_\_\_\_\_  
Contact Name/Title: \_\_\_\_\_  
Firm Mailing Address \_\_\_\_\_  
Phone Number: \_\_\_\_\_  
\_\_\_\_\_ DBE Firm \_\_\_\_\_ Non-DBE Firm

Firm Name: \_\_\_\_\_  
Contact Name/Title: \_\_\_\_\_  
Firm Mailing Address \_\_\_\_\_  
Phone Number: \_\_\_\_\_  
\_\_\_\_\_ DBE Firm \_\_\_\_\_ Non-DBE Firm

Firm Name: \_\_\_\_\_  
Contact Name/Title: \_\_\_\_\_  
Firm Mailing Address \_\_\_\_\_  
Phone Number: \_\_\_\_\_  
\_\_\_\_\_ DBE Firm \_\_\_\_\_ Non-DBE Firm

Firm Name: \_\_\_\_\_  
Contact Name/Title: \_\_\_\_\_  
Firm Mailing Address \_\_\_\_\_  
Phone Number: \_\_\_\_\_  
\_\_\_\_\_ DBE Firm \_\_\_\_\_ Non-DBE Firm

Firm Name: \_\_\_\_\_  
Contact Name/Title: \_\_\_\_\_  
Firm Mailing Address \_\_\_\_\_  
Phone Number: \_\_\_\_\_  
\_\_\_\_\_ DBE Firm \_\_\_\_\_ Non-DBE Firm

\_\_\_\_\_  
**SUBMITTED BY (Signature)**

\_\_\_\_\_  
**FIRM NAME**

Submit this form to **Contract Administration as a part of your bid package**. If this form is not **signed** and included as part of the bid packet, your bid will be deemed irregular. For further information about this form, call Mississippi DOT's Office of Civil Rights at (601) 359-7466; FAX (601) 576-4504.

**Please make copies of this form when needed and also add those copies to the bid package.**