

MDOT Use Only

Checked _____

Loaded _____

Keyed _____

3 -



SM No. CBR0016030201

PROPOSAL AND CONTRACT DOCUMENTS

FOR THE CONSTRUCTION OF
(STATE DELEGATED)

3

Replacing 3 Bridges on SR 8, from Calhoun City to Derma, known as Federal Aid Project No. BR-0016-03(020) / 102160302, in Calhoun County.

Project Completion: October 14, 2013

NOTICE

BIDDERS MUST PURCHASE A BOUND PROPOSAL FROM MDOT CONTRACT ADMINISTRATION DIVISION TO BID THIS PROJECT.

Electronic addendum updates will be posted on www.gomdot.com

SECTION 900
OF THE CURRENT
(1996) STANDARD SPECIFICATIONS
FOR ROAD AND BRIDGE CONSTRUCTION
MISSISSIPPI DEPARTMENT OF TRANSPORTATION
JACKSON, MISSISSIPPI

**BIDDER CHECK LIST
(FOR INFORMATION ONLY)**

- _____ All unit prices and item totals have been entered in accordance with Subsection 102.06 of the Mississippi Standard Specifications for Road and Bridge Construction.
- _____ If the bid sheets were prepared using the Electronic Bid System, proposal sheets have been stapled and inserted into the proposal package.
- _____ First sheet of SECTION 905--PROPOSAL has been completed.
- _____ Second sheet of SECTION 905--PROPOSAL has been completed and signed.
- _____ Addenda, if any, have been acknowledged. Second sheet of Section 905 listing the addendum number has been substituted for the original second sheet of Section 905. Substituted second sheet of Section 905 has been properly completed, signed, and added to the proposal.
- _____ DBE/WBE percentage, when required by contract, has been entered on last sheet of the bid sheets of SECTION 905 - PROPOSAL.
- _____ Form OCR-485, when required by contract, has been completed and signed.
- _____ The last sheet of the bid sheets of SECTION 905--PROPOSAL has been signed.
- _____ Combination Bid Proposal of SECTION 905--PROPOSAL has been completed for each project which is to be considered in combination (See Subsection 102.11).
- _____ Equal Opportunity Clause Certification, when included in contract, has been completed and signed.
- _____ The Certification regarding Non-Collusion, Debarment and Suspension, etc. has been executed in duplicate.
- _____ A certified check, cashier's check or bid bond payable to the State of Mississippi in the principal amount of 5% of the bid has been included with project number identified on same. A bid bond has been signed by the bidder and has also been signed or countersigned by a Mississippi Agent or Qualified Nonresident Agent for the Surety with Power of Attorney attached.
- _____ **ON FEDERAL FUNDED PROJECTS, the Notice To Bidders regarding DUNS Requirements has been completed and included in the contract documents.**
- _____ Non-resident Bidders: ON STATE FUNDED PROJECTS ONLY, a copy of the current laws regarding any preference for local Contractors from State wherein domiciled has been included. See Subsection 103.01, Mississippi Standard Specifications for Road and Bridge Construction, and Section 31-7-47, MCA, 1972 regarding this matter.

Return the proposal and contract documents in its entirety in a sealed envelope. DO NOT remove any part of the contract documents; exception - an addendum requires substitution of second sheet of Section 905. A stripped proposal is considered as an irregular bid and will be rejected.

Failure to complete any or all of the applicable requirements will be cause for the proposal to be considered irregular.

MISSISSIPPI DEPARTMENT OF TRANSPORTATION

TABLE OF CONTENTS

PROJECT: BR-0016-03(020) / 102160302 – Calhoun County

901--Advertisement

904--Notice to Bidders:

- Governing Specs. - # 1M
- Final Cleanup - # 13M
- Selection of Optional Items - # 29M
- Soft Metric Reinforcing Steel - # 32M
- ASTM or AASHTO Designation - # 33M
- Plant Pest Quarantines Information - # 74M
- Concrete Base for Bridge End Pavement - # 432M
- Alterations in Bidding Process - # 526M
- Errata & Modifications to the 1996 Standard Specification Book – # 664M
- Substitution of Cold Plastic Traffic Markings - # 665M
- Placement of Granular Material - # 708M
- Work in Proximity of Overhead High voltage Power Lines - # 741M
- Payment To Subcontractors - # 777M
- Contract Overpayments - # 779M
- Certificate of Traffic Control Devices # 804M
- Removal of Construction Signs - # 853M
- Submittal of Hydrated Lime Shipping Tickets - # 863M
- Fuel Tax Applicability to Bidders and Contractors - # 896M
- Estimated Monthly Quantities - # 900M
- Fiber Reinforced Concrete - # 1041M
- Disadvantaged Business Enterprise, W/Supplement - # 1049M
- Payroll Requirements - # 1082M
- Conversion Factors for MDOT Field Manual for HMA Pavements – # 1102M
- Safety Apparel - # 1129M
- Federal Bridge Formula - # 1144M
- Department of Labor Ruling - # 1162M
- Status of ROW, W/Attachments - # 1170M
- DBE Forms, Participation and Payment - # 1185M
- Non-Quality Control/ Quality Assurance Concrete - # 1215M
- Petroleum Products Base Price - # 1220M
- Reduced Speed Limit Signs - # 1229M
- Alternate Asphalt Mixture Bid Items - # 1238M
- Temporary Traffic Paint - # 1254M
- Warm Mix Asphalt (WMA) - # 1263M
- Detour Bridge Railing - # 1316M
- Questions Regarding Bidding - # 1321M
- Safety Edge - # 1323M
- Storm Water Discharge Associated with Construction Activity
(≥ 2.0 Hectares) - # 1324M
- Additional Erosion Control Requirements - # 1325M
- Contract Time - # 1327M
- Specialty Items - # 1328M

-- CONTINUED ON NEXT PAGE --

Placement of Fill Materials in Federally Regulated Areas - # 1329M
 Removal of Cars - # 1330M
 Property Access - # 1331M
 Silt Fence Reinforcement - # 1332M
 Voided Slab and Curb and Gutter Placement - # 1333M

906: Required Federal Contract Provisions -- FHWA-1273, W/Supplement

907-101-4M: Definitions
 907-102-8M: Bidding Requirements and Conditions
 907-103-7M: Award and Execution of Contract
 907-104-1M: Partnering Process
 907-104-7M: Scope of Work, W/Supplement
 907-105-6M: Control of Work, W/Supplement
 907-106-4M: Control of Materials
 907-107-10M: Environmental Protection
 907-107-18M: Legal Relations & Responsibility to Public, W/Supplement
 907-107-19M: Contractor's Erosion Control Plan, W/Supplement
 907-108-29M: Prosecution & Progress
 907-109-14M: Measurement & Payment
 907-110-2M: Wage Rate Decisions
 907-203-1M: Excavation & Embankment
 907-209-1M: Geotextile Fabric For Stabilization
 907-217-1M: Ditch Liner
 907-223-1M: Mowing
 907-225-4M: Grassing
 907-226-2M: Temporary Grassing
 907-227-5M: Hydroseeding
 907-234-1M: Silt Fence
 907-234-5M: Siltation Barriers
 907-237-3M: Wattles
 907-245-2M: Triangular Silt Dikes
 907-246-3M: Sandbags & Rockbags
 907-304-16M: Granular Courses
 907-310-1M: Stabilizer Aggregate
 907-401-10M: Hot Mix Asphalt (HMA), W/Supplement
 907-403-8M: Hot Mix Asphalt (HMA), W/Supplement
 907-407-1M: Tack Coat
 907-413-1M: Sawing & Sealing Joints in Bituminous Concrete Overlay, W/Supplement
 907-501-12M: Portland Cement Concrete Pavement
 907-601-2M: Structural Concrete
 907-603-4M: Culverts & Storm Drains
 907-605-8M: Underdrains
 907-606-1M: Terminal End Sections
 907-617-3M: Right-Of-Way Markers
 907-618-7M: Placement of Temporary Traffic Stripe
 907-618-8M: Construction and Removal of Detour Bridges
 907-619-5M: Terminal End Sections
 907-619-11M: Traffic Control for Construction Zones

-- CONTINUED ON NEXT PAGE --

- 907-619-13M: Temporary Pavement Markings
- 907-626-12M: Thermoplastic Markings
- 907-626-13M: Inverted Profile Thermoplastic Traffic Stripe
- 907-627-1M: Raised Pavement Markings
- 907-628-9M: Cold Plastic Pavement Markings
- 907-699-2M: Construction Layout & Staking, W/Supplement
- 907-701-4M: Hydraulic Cement
- 907-703-8M: Aggregates, W/Supplement
- 907-703-9M: Aggregates for Hot Mix Asphalt (HMA)
- 907-708-6M: Non-Metal Drainage Structures
- 907-709-1M: Metal Pipe
- 907-710-1M: Fast Drying Acrylic Waterborne Traffic Paint
- 907-710-2M: Fast Drying Solvent Traffic Paint
- 907-711-1M: Reinforcing Steel
- 907-711-6M: Synthetic Structural Fiber Reinforcement
- 907-712-4M: Materials for Guardrail Posts
- 907-713-2M: Admixtures for Concrete
- 907-714-9M: Geotextiles
- 907-714-13M: Miscellaneous Materials
- 907-715-2M: Erosion Control Blanket
- 907-715-6M: Roadside Development Materials
- 907-716-1M: Miscellaneous Materials
- 907-720-3M: High Performance Cold Plastic Pavement Markings
- 907-720-9M: Pavement Marking Materials
- 907-720-10M: Reflective Pav't Markers & Adhesive for Pav't Marker
- 907-721-5M: Flexible Delineators
- 907-721-7M: Materials for Signing
- 907-721-8M: Reflective Sheeting
- 907-803-18M: Deep Foundations
- 907-804-21M: Concrete Bridges & Structures
- 907-815-1M: Sediment Control Stone
- 907-815-4M: Geotextile Fabric for Riprap

SECTION 905 - PROPOSAL, PROPOSAL BID SHEETS
COMBINATION BID PROPOSAL
CERTIFICATION OF PERFORMANCE - PRIOR FEDERAL-AID CONTRACTS
CERTIFICATION REGARDING NON-COLLUSION, DEBARMENT AND SUSPENSION
SECTION 902- CONTRACT FORM, AND SECTION 903 - CONTRACT BOND FORMS
PILE DRIVING FORM
FORM -- OCR-485

REVISIONS TO THE ABOVE WILL BE INDICATED ON THE SECOND SHEET OF SECTION 905
AS ADDENDA)

MISSISSIPPI DEPARTMENT OF TRANSPORTATION

SECTION 901 - ADVERTISEMENT

Sealed bids will be received by the Mississippi Transportation Commission in the Office of the Contract Administration Engineer, Room 1013, Mississippi Department of Transportation Administration Building, 401 North West Street, Jackson, Mississippi, until 10:00 o'clock A.M., Tuesday, October 25, 2011, and shortly thereafter publicly opened on the Sixth Floor for:

Replacing 3 Bridges on SR 8, from Calhoun City to Derma, known as Federal Aid Project No. BR-0016-03(020) / 102160302 in Calhoun County.

The attention of bidders is directed to the Contract Provisions governing selection and employment of labor. Minimum wage rates have been predetermined by the Secretary of Labor and are subject to Public Law 87-58 1, Work Hours Act of 1962, as set forth in the Contract Provisions.

The Mississippi Department of Transportation hereby notifies all bidders that it will affirmatively insure that in any contract entered into pursuant to this advertisement, disadvantaged business enterprises will be afforded full opportunity to submit bids in response to this invitation and will not be discriminated against on the grounds of race, color, sex, age, disability, religion or national origin in consideration for an award.

The award of this contract will be contingent upon the Contractor satisfying the DBE requirements.

Bid proposals must be acquired from the MDOT Contract Administration Division. These proposals are available at a cost of Ten Dollars (\$10.00) per proposal. Specimen proposals are also available at the MDOT Contract Administration Division at a cost of Ten Dollars (\$10.00) per proposal, or can be viewed or downloaded at no cost at www.gomdot.com.

Plans may be acquired on a cost per sheet basis from MDOT Plans Print Shop, MDOT Shop Complex, Building C, Room 114, 2567 North West Street, Jackson, Mississippi 39216, Telephone (601) 359-7460 or e-mail at plans@mdot.state.ms.us or FAX (601) 359-7461. Plans will be shipped upon receipt of payment.

Bid bond, signed or countersigned by a Mississippi Agent or Qualified Nonresident Agent, with Power of Attorney attached or on file with the Contract Administration Engineer of the Department, a Cashier's check or Certified Check for five (5%) percent of bid, payable to STATE OF MISSISSIPPI, must accompany each proposal.

The attention of bidders is directed to the provisions of Subsection 102.07 pertaining to irregular proposals and rejection of bids.

MELINDA L. MCGRATH
INTERIM EXECUTIVE DIRECTOR

MISSISSIPPI DEPARTMENT OF TRANSPORTATION

SECTION 904 - NOTICE TO BIDDERS NO. 1M

CODE: (IS)

DATE: 1/2/96

SUBJECT: Governing Specifications

The current 1996 Metric Edition of the Mississippi Standard Specifications for Road and Bridge Construction adopted by the Mississippi Transportation Commission is made a part hereof fully and completely as if it were attached hereto, except where superseded by special provisions, or amended by revisions of the Specifications contained herein. Copies of the specification book may be purchased from the Construction Division.

A reference in any contract document to controlling requirements in another portion of the contract documents shall be understood to apply equally to any revision or amendment thereof included in the contract.

MISSISSIPPI DEPARTMENT OF TRANSPORTATION

SECTION 904 - NOTICE TO BIDDERS NO. 13M

CODE: (SP)

DATE: 1/2/96

SUBJECT: Final Clean-Up

Immediately prior to final inspection for release of maintenance, the Contractor shall pick up, load, transport and properly dispose of all litter from the entire highway right-of-way that is within the termini of the project.

Litter shall include, but not be limited to, solid wastes such as glass, paper products, tires, wood products, metal, synthetic materials and other miscellaneous debris.

Litter removal is considered incidental to other items of work and will not be measured for separate payment.

MISSISSIPPI DEPARTMENT OF TRANSPORTATION

SECTION 904 - NOTICE TO BIDDERS NO. 29M

CODE: (IS)

DATE: 4/9/96

SUBJECT: Selection of Optional Items

Bidders are hereby advised that, because of a change by the Department in classifying "Optional" items, the bid schedule for this project lists as "Optional" items that formally have been listed as "Alternate".

The summary of quantities sheet(s) in construction plans printed prior to the effective date of this change may list as "Alternate" items that are listed as "Optional" in the bid proposal.

When this contradiction occurs, the listing in the bid schedule is correct and bidders are to disregard the contradicting listing on the summary of quantities sheet(s) in the construction plans.

Bidders should pay close attention to the items classified in the bid schedule as "Optional" items.

With the change by the Department in classifying optional items, a change will be required of the Contractor in the selection of optional items. (Refer to 907-101-2, 907-102-4 and Section 905)

WHEN THE BID SCHEDULE LISTS OPTIONAL ITEMS, THE CONTRACTOR'S SELECTION MAY, BUT IS NOT REQUIRED TO, BE MADE AT THE TIME OF BIDDING. FOR OPTIONAL ITEMS NOT PRE-SELECTED, THE CONTRACTOR'S SELECTION SHALL BE MADE PRIOR TO OR AT THE TIME OF EXECUTION OF THE CONTRACT.

MISSISSIPPI DEPARTMENT OF TRANSPORTATION

SECTION 904 - NOTICE TO BIDDERS NO. 32M

CODE: (IS)

DATE: 5/8/96

SUBJECT: Soft Metric Reinforcing Steel

Anywhere in the plans, proposal or specifications reference is made to Grade 400 or Grade 500 reinforcing steel, it shall be understood that Grade 420 and Grade 520 reinforcing steel are the correct grades.

Anywhere in the plans, proposal or specifications reference is made to AASHTO Designation: M 31M, it shall be understood that AASHTO Designation: M 31M, as amended by special provision, shall apply.

MISSISSIPPI DEPARTMENT OF TRANSPORTATION

SECTION 904 - NOTICE TO BIDDERS NO. 33M

CODE: (IS)

DATE: 5/8/96

SUBJECT: ASTM or AASHTO Designation

Whenever in the specifications reference is made to an ASTM or AASHTO Designation No., the metric edition in effect on the date of advertisement for bids shall apply, provided a metric version exists, regardless of whether or not the Designation No. shown in the specifications carries a "M" to signify metric version.

MISSISSIPPI DEPARTMENT OF TRANSPORTATION

SECTION 904 - NOTICE TO BIDDERS NO. 74M

CODE: (IS)

DATE: 3/31/97

SUBJECT: Plant Pest Quarantines Information

AT THE REQUEST OF THE U. S. DEPARTMENT OF AGRICULTURE, PLANT PEST CONTROL INFORMATION CONCERNING DOMESTIC QUARANTINES IS CITED AS FOLLOWS:

The entire state of Mississippi has been quarantined for the Imported Fire Ants. Soil and soil-moving equipment operating in the state will be subject to plant quarantine regulations. In general, these regulations provide for cleaning soil from equipment before it is moved from the state. Complete information may be secured from the State of Mississippi Department of Agriculture and Commerce, Bureau of Plant Industry, P. O. Box 5207, Mississippi State, Mississippi 39762-5207 - Telephone 325-3390.

IMPORTED FIRE ANT QUARANTINES

THE FOLLOWING REGULATED ARTICLES REQUIRE A CERTIFICATE OR PERMIT FOR MOVEMENT:

1. Soil, separately or with other things, except soil samples shipped to approved laboratories*. Potting soil is exempt, if commercially prepared, packaged and shipped in original containers.
2. Plants with roots with soil attached, except houseplants maintained indoors and not for sale.
3. Grass sod.
4. Baled hay and straw that have been stored in contact with the soil.
5. Used soil-moving equipment.
6. Any other products, articles, or means of conveyance of any character whatsoever not covered by the above, when it is determined by an inspector that they present a hazard of spread of the imported fire ant and the person in possession thereof has been so notified.

* Information as to designated laboratories, facilities, gins, oil mills, and processing plants may be obtained from an inspector.

Imported Fire Ant Quarantines



Conditions of Movement.

Counties entirely colored are completely regulated; Counties partially colored are partially regulated.

Regulated Area.

Restrictions are imposed on the movement of regulated articles as follows:
From colored areas into or through white areas.

Consult your State or Federal plant protection inspector or your County Agent for assistance regarding exact areas under regulation and requirements for moving regulated articles. For detailed information, see 7 CFR 301.81 for quarantine and regulations.

MISSISSIPPI DEPARTMENT OF TRANSPORTATION

SECTION 904 - NOTICE TO BIDDERS NO. 432M

CODE: (IS)

DATE: 11/10/98

SUBJECT: Concrete Base for Bridge End Pavement

The plans specify a certain thickness of hot mix asphalt under the bridge end pavement.

The Contractor may substitute Class "B" Structural Concrete base in lieu of the hot mix asphalt.

The concrete base shall be constructed in one course on a prepared base in accordance with these specifications, and in reasonably close conformity with the lines, grades, thickness, and typical cross-sections as shown on the plans or as directed.

The concrete base will be allowed to cure 24 hours prior to placement of the bridge end pavement. A 25-mm premolded expansion joint will be required along the face of the paving bracket.

The concrete base will be paid for as the hot mix asphalt for which the substitution was made, calculated as follows:

$$\text{Metric tons of hot mix asphalt allowed} = \text{Area} * \text{Thickness} * 0.00235$$

Area = square meters of portland cement concrete bridge end pavement

Thickness = concrete base thickness in millimeters

MISSISSIPPI DEPARTMENT OF TRANSPORTATION

SECTION 904 - NOTICE TO BIDDERS NO. 526M

CODE: (IS)

DATE: 6/11/99

SUBJECT: Alterations In Bidding Process

Bidders are hereby advised that they may either use the traditional method of entering their bid information by hand on Section 905--Proposal, or may insert printed information obtained from the available Electronic Bid System (EBS).

It is the responsibility of every bidder to check for any addendum or modification to the contract document(s) for which they intend to submit a response. It shall be the bidder's responsibility to be sure they are in receipt of all addenda, pre-bid conference information, and/or questions and answers provided at, or subsequent to, the pre-bid conference, if any are issued.

The Mississippi Transportation Commission assumes no responsibility for defects, irregularities or other problems caused by the use of electronic media. Operation of this electronic media is done at the sole risk of the user.

MISSISSIPPI DEPARTMENT OF TRANSPORTATION

| SECTION 904 - NOTICE TO BIDDERS NO. **664M** CODE: (IS)
| DATE: **5/02/2001**
SUBJECT: **ERRATA AND MODIFICATIONS TO 1996 STANDARD SPECIFICATIONS BOOK**

<u>Page</u>	<u>Subsection</u>	<u>Change</u>
101-4	101.02	In the fourth line change the word "six" to "6.1".
104-4	104.02.3	Change the unit of pay item 104-A from "lump um" to "lump sum".
105-4	105.06	In the sixth line of the third paragraph change "Contractor's" to "Contractor".
714-9	714.13.12	In Note 3 of Table I, change "EOS" to "AOS".
721-3	721.03	In the first line of the second paragraph change "banks" to "blanks".
721-3	721.03	In the first line of the third paragraph change "banks" to "blanks".

MISSISSIPPI DEPARTMENT OF TRANSPORTATION

SECTION 904 - NOTICE TO BIDDERS NO. 665M

CODE: (IS)

DATE: 5/02/2001

SUBJECT: Substitution of Cold Plastic Traffic Markings

Bidders are hereby advised that, at their option, cold plastic traffic markings may be used in lieu of hot applied thermoplastic markings. Substitution will only be allowed for pay items 907-626-AA through HH. Substituted cold plastic markings shall be of the same color and width as that required for the hot applied stripe. Unless otherwise specified, the markings, whether hot applied or cold plastic, shall be of the same type material for the entire project. Material and construction requirements for substituted cold plastic traffic markings shall meet the requirements of Section 628 of the Standard Specifications or as amended by special provision. The layout and spacing for substituted cold plastic traffic markings will remain as shown in the plans, or in the contract documents, for hot applied thermoplastic markings. Measurement of substituted cold plastic traffic markings shall be made in accordance with Section 628 of the Standard Specifications or as amended by special provision. Payment for substituted cold plastic traffic markings shall be made at the unit price bid for the appropriate hot applied thermoplastic marking.

MISSISSIPPI DEPARTMENT OF TRANSPORTATION

SECTION 904 - NOTICE TO BIDDERS NO. 708M

CODE: (SP)

DATE: 9/13/2001

SUBJECT: Placement Of Granular Material

The Contractor shall be required to place granular material on the shoulders at any time a differential of fifty five millimeters (55 mm) or more exists between the present pavement edge and the shoulder grade. This condition may exist prior to any preliminary leveling, after the placement of the preliminary leveling, after the placement of the surface course. In any event, whenever or wherever, a 55-mm differential exists between the pavement edge and the shoulder material, this condition shall be corrected by the placement of the shoulder material to correct the differential.

MISSISSIPPI DEPARTMENT OF TRANSPORTATION

SECTION 904 - NOTICE TO BIDDERS NO. 741M

CODE: (IS)

DATE: 02/27/2002

SUBJECT: Work In Proximity Of High Voltage Power Lines

Bidders are hereby advised of Section 45-15-1, et seq., Mississippi Code of 1972, regarding the performance of work in the proximity of high voltage overhead power lines. It is the Contractor's responsibility to comply with those statutory requirements.

MISSISSIPPI DEPARTMENT OF TRANSPORTATION

SECTION 904 - NOTICE TO BIDDERS NO. 777M

CODE: (IS)

DATE: 05/22/2002

SUBJECT: Payments to Subcontractors

Bidders are hereby advised that each month, the Contractor will submit to the Project Engineer form OCR-484 certifying payments to all subcontractors. Form OCR-484 can be obtained from the Office of Civil Rights Division, MDOT Administration Building, 401 North West Street, Jackson, MS, or at the MDOT website under the *Business Section, Construction Contracts and Bidding, Disadvantaged Business Enterprise (DBE), Applications and Forms for the DBE Program.*

MISSISSIPPI DEPARTMENT OF TRANSPORTATION

SECTION 904 - NOTICE TO BIDDERS NO. 779M

CODE: (IS)

DATE: 06/07/2002

SUBJECT: Contract Overpayment(s)

Bidders are hereby advised that by the execution of the contract for this project, the Contractor agrees that it has the duty to and will immediately reimburse the Mississippi Transportation Commission, without any demand therefore, for any overpayment(s) of which it has knowledge, or through due diligence, should have knowledge.

By the execution of the contract for this project, the Contractor also agrees that if the Mississippi Transportation Commission has made any overpayment(s) to the Contractor on any previously executed contract(s), the Mississippi Transportation Commission may notify the Contractor in writing of the nature and the amount of the overpayment(s). If the Contractor fails to remit the overpayment(s) to the Mississippi Transportation Commission within sixty (60) calendar days from the date of such notice, interest shall accrue from the date of such notification until payment is made in full at the rate of one percent (1%) per month until fully paid.

By the execution of the contract for this project, the Contractor also agrees that the Mississippi Transportation Commission may offset and withhold a sum equal to any overpayment(s) on any previously executed contract(s), plus interest, where applicable, against any sums due the Contractor under the terms of this contract or any other active contract(s).

By the execution of the contract for this project, the Contractor also agrees that if any overpayment(s) are made by the Mississippi Transportation Commission to the Contractor under the terms of this contract the Mississippi Transportation Commission shall have the right to offset and withhold that amount, plus interest, where applicable, from any sums which the Mississippi Transportation Commission might owe the Contractor on any other active contract(s) or any contract(s) executed subsequent to the execution of this contract.

MISSISSIPPI DEPARTMENT OF TRANSPORTATION

SECTION 904 - NOTICE TO BIDDERS NO. 804M

CODE: (IS)

DATE: 09/26/2002

SUBJECT: Certification of Traffic Control Devices

Category 1 Traffic Control Devices

Category 1 traffic control devices are defined as low-mass, single-piece traffic cones, tubular markers, single-piece drums, and delineators.

The Contractor shall certify to the Project Engineer by a letter ONLY stating that the Category 1 traffic control devices, furnished and used, either meet the requirements of NCHRP Report 350 or were purchased prior to October 1, 1998.

All documentation supporting the certification is to be kept on file by the Contractor subject to review by the Department at any time. Support documentation shall be kept on file for two years after the completion of the project.

The Contractor may self-certify Category 1 Traffic Control Devices. In order to make the self-certification, the Contractor shall have as a minimum the following support documentation regarding the certification.

1. A title, e.g., "Certification of Crashworthiness";
2. Name and address of vendor making the certification;
3. Unique identification of the certificate (such as serial number) with numbered pages and the total number of pages;
4. Description and unambiguous identification of the item tested;
5. Identification of the basis for self-certification process used and to what test level of NCHRP Report 350. This basis as crash test experience with similar devices or years of demonstrably safe operational performance;
6. A signature and title, or an equivalent identification of the person(s) accepting responsibility for the content of the certification, however produced, and the date of issue;
7. A statement that the certification shall not be reproduced except in full.

All documentation supporting the self-certification is to be kept on file by the Contractor subject to review by the Department at any time. Support documentation shall be kept on file for two years after the completion of the project.

The Contractor's letter to the Project Engineer shall state that all Category 1 traffic control devices, furnished and used, were purchased after October 1, 1998 and met the requirements of NCHRP Report 350, or that the Category 1 traffic control devices, furnished and used, were purchased prior to October 1, 1998.

Category 2 Traffic Control Devices

Category 2 traffic control devices are defined as barricades, intrusion detectors, vertical panel assemblies, portable sign supports, drums with warning lights, and cones with warning lights.

The Contractor shall certify to the Project Engineer by a letter ONLY stating that the Category 2 traffic control devices, furnished and used, either meet the requirements of NCHRP Report 350 or were purchased prior to October 1, 2000. The Contractor's letter shall state that all Category 2 traffic control devices, furnished and used, were purchased after October 1, 2000 and met the requirements of NCHRP Report 350, or that the Category 2 traffic control devices, furnished and used, were purchased prior to October 1, 2000.

Category 3 Traffic Control Devices

Category 3 Traffic Control Devices are items similar to Category 2 but have a mass of more than 45 kilograms. Category 3 Traffic Control Devices include concrete barrier, truck mounted attenuators (TMAs), workzone crash cushions, and fixed sign supports.

Concrete barrier and fixed sign supports, furnished and used, and purchased after October 1, 2002 must meet the requirements of Report 350.

The Contractor shall furnish a letter ONLY certifying that all concrete barrier and fixed sign supports purchased after October 1, 2002 meets the requirements of NCHRP Report 350. Concrete barrier and fixed sign supports purchased prior to October 1, 2002 may be used without written certification until they complete their normal service life.

Work zone crash cushions and truck mounted attenuators (TMAs), furnished and used, and purchased after October 1, 1998 must meet the requirements of Report 350.

The Contractor shall furnish a letter certifying that all work zone crash cushions and TMAs purchased after October 1, 1998 meets the requirements of NCHRP Report 350. Work zone crash cushions and TMAs purchased prior to October 1, 1998 may be used without written certification until they complete their normal service life.

Contractor's Letter to the Project Engineer

The following is an example of a letter to the Project Engineer.

"I, (*Contractor's name*), certify that the Category 1 traffic control devices used on this project and purchased after October 1, 1998 meet the requirements of NCHRP Report 350 and all Category 1 traffic control devices used on this project not meeting NCHRP Report 350 were purchased prior to October 1, 1998.

I also certify that the Category 2 traffic control devices used on this project and purchased after October 1, 2000 meet the requirements on NCHRP Report 350 and all Category 2 traffic control devices used on this project not meeting NCHRP Report 350 were purchased prior to October 1, 2000.

I also certify that except for concrete median barrier, all of the Category 3 traffic control devices crash cushions and truck mounted attenuators used on this project and purchased after October 1, 1998 meet the requirements on NCHRP Report 350 and all Category 3 crash cushions and truck mounted attenuators used on this project not meeting NCHRP Report 350 were purchased prior to October 1, 1998."

MISSISSIPPI DEPARTMENT OF TRANSPORTATION

SECTION 904- NOTICE TO BIDDERS NO. 853M

CODE: (SP)

DATE: 05/12/2003

SUBJECT: Removal of Construction Signs

Bidders are hereby advised that upon receipt of the **Final or Partial** Maintenance Release, as documented in writing by the State Construction Engineer, the Contractor shall have **fifteen (15)** calendar days in which to remove all construction signs on the project. It is agreed that if the signs are not removed within the **fifteen (15)** calendar days the signs shall be considered abandoned and shall become the property of the Mississippi Transportation Commission which may remove, use, and/or dispose of such signs as it sees fit.

The Contractor shall place and maintain appropriate construction signs for any additional work on the project after the Maintenance Release has been issued. These construction signs will not be measured for separate payment. Payment for these signs shall be included in Pay Item No. 618-A, Maintenance of Traffic.

MISSISSIPPI DEPARTMENT OF TRANSPORTATION

SECTION 904 - NOTICE TO BIDDERS NO. 863M

CODE: (SP)

DATE: 6/19/2003

SUBJECT: Submittal of Hydrated Lime Shipping Tickets

In accordance with Subsection 907-401.02.3.1 of the specifications, the Contractor shall provide the District Materials Engineer with a copy of each shipping ticket from the supplier including the project number, date, time and weight of hydrated lime shipped and used in Hot Mix Asphalt (HMA) production.

The Contractor is advised that an amount equal to twenty-five percent (25%) of the total value of HMA items performed during the initial estimate period in which the Contractor fails to submit the hydrated lime shipping tickets to the District Materials Engineer will be withheld from the Contractor's earned work. Non-conformance with this specification for successive estimate period(s) will result in the total value (100%) of HMA items performed during this period(s) being withheld from the Contractor's earned work. Monies withheld for this non-conformance will be released for payment on the next monthly estimate following the date the submittal of hydrated lime shipping tickets to the District Materials Engineer is brought back into compliance with this specification.

MISSISSIPPI DEPARTMENT OF TRANSPORTATION

SECTION 904 - NOTICE TO BIDDERS NO. 896M

CODE: (IS)

DATE: 10/20/2003

SUBJECT: Fuel Tax Applicability to Bidders and Contractors

Bidders are hereby advised that the “Mississippi Special Fuel Tax Law”, Section 27-55-501, et seq. and its requirements and penalties apply to any contract for construction, reconstruction, maintenance or repairs, for contracts entered into with the State of Mississippi, any political subdivision of the State of Mississippi, or any Department, Agency, Institute of the State of Mississippi or any political subdivision thereof.

The Mississippi State Tax Commission will be notified of the name and address of the Contractor that is awarded this contract. The Contractor will be subject to an audit during the life of this contract to make certain that all applicable fuel taxes are being paid promptly as outlined in Section 27-55-501, et seq.

In addition to any audits performed by the Mississippi State Tax Commission, the Department also reserves the right to audit the Contractor’s records during the life of this contract to make certain that all applicable fuel taxes are being paid promptly as outlined in Section 27-55-501, et seq.

MISSISSIPPI DEPARTMENT OF TRANSPORTATION

SECTION 904 - NOTICE TO BIDDERS NO. 900M

CODE: (SP)

DATE: 11/12/2003

SUBJECT: Estimated Monthly Quantities

Bidders are hereby advised that each month the Contractor works, the Engineer furnishes the Contractor with a monthly progress estimate showing the total estimated quantities for each pay item in the contract. The Contractor should review the Engineer's progress estimate as to the accuracy of the quantities. Should the Engineer's estimated quantity for any pay item be greater than a tolerance of plus or minus ten percent ($\pm 10\%$) of the Contractor's estimated quantity, the Contractor should confer with the Resident or Project Engineer to rectify any differences. Each should make a record of the differences, if any, and conclusions reached. In the event mutual agreement cannot be reached, the Contractor will be allowed a maximum of 15 calendar days following the ending date of the monthly estimate in question to file in writing, a protest Notice of Claim in accordance with the provisions Subsection 105.17. Otherwise, the Engineer's estimated quantities shall be considered acceptable pending any changes made during the checking of final quantities.

MISSISSIPPI DEPARTMENT OF TRANSPORTATION

| SECTION 904 - NOTICE TO BIDDERS NO. 1041M

CODE: (IS)

| DATE: 09/26/2005

SUBJECT: Fiber Reinforced Concrete

Bidders are hereby advised that synthetic structural fibers meeting the requirements of Subsection 907-711.04 may be used in lieu of wire mesh in some items of construction. Substitution of fibers for wire mesh will be allowed in the construction of paved ditches, paved flumes, paved inlet apron, driveways, guard rail anchors and pile encasements. Substitution in any other items of work must be approved by the State Construction Engineer prior to use.

SUPPLEMENT TO NOTICE TO BIDDERS NO. 1049M

DATE: 11/06/2009

The goal is 7 percent for the Disadvantaged Business Enterprise. The low bidder is required to submit Form OCR-481 for all DBEs. Bidders are advised to check the bid tabulation link for this project on the MDOT website (<http://www.gomdot.com/applications/bidsystem/currentletting.aspx>) for results. Bid tabulations are usually posted by 3:00 pm on Letting Day.

Form OCR-481 is available at http://www.gomdot.com/Divisions/CivilRights/Resources/Forms/pdf/MDOT_OCR481.pdf or by calling 601-359-7466.

Subparagraph (2) under Award on page 6 indicates that the OCR-481 form is to be submitted to Contract Administration Division. Instead of submitting this form to Contract Administration Division, all OCR-481s must be returned within 10 days following the bid letting to the MDOT Office of Civil Rights, P.O. Box 1850, Jackson, MS 39215-1850.

For answers to questions, contact the MDOT Office of Civil Rights at (601) 359-7466.

The bidder's execution of the signature portion of the proposal shall constitute execution of the following assurance:

The bidder hereby gives assurance pursuant to the applicable requirements of "Safe, Accountable, Flexible, Efficient Transportation Equity Act, A Legacy For Users (SAFETEA-LU)" and "Part 26, Title 49, Code of Federal Regulation" that the bidder has made a good faith effort to meet the contract goal for DBE participation for which this proposal is submitted.

A pre-bid meeting will be held in Amphitheater 1 & 2 of the Hilton Jackson located at I-55 and County Line Road, Jackson, Mississippi at 2:00 P.M. on the day preceding the date of the bid opening.

This meeting is to inform DBE firms of subcontracting and material supply opportunities. Attendance at this meeting is considered of prime importance in demonstrating good faith effort to meet the contract goal.

A list of "Certified DBE Contractors" which have been certified as such by the Mississippi Department of Transportation and other Unified Certification Partners (UPC) can be found on the Mississippi Department of Transportation website at www.gomdot.com. The DBE firm must be on the Department's list of "Certified DBE Contractors" that is posted online at the time the job is let and approved by MDOT to count towards meeting the DBE goal.

MISSISSIPPI DEPARTMENT OF TRANSPORTATION

SECTION 904 - NOTICE TO BIDDERS NO. 1049M

CODE: (IS)

DATE: 12/20/2005

SUBJECT: DISADVANTAGED BUSINESS ENTERPRISES IN FEDERAL-AID HIGHWAY CONSTRUCTION

This contract is subject to the "[Safe, Accountable, Flexible, Efficient Transportation Equity Act, A Legacy For Users \(SAFETEA-LU\)](#)" and applicable requirements of "Part 26, Title 49, Code of Federal Regulations." Portions of the Act are set forth in this Notice as applicable to compliance by the Contractor and all of the Act, and the MDOT DBE Program, is incorporated by reference herein.

The Department has developed a Disadvantaged Business Enterprise Program that is applicable to this contract and is made a part thereof by reference.

Copies of the program may be obtained from:

Office of Civil Rights
Mississippi Department of Transportation
P. O. Box 1850
Jackson, Mississippi 39215-1850

POLICY

It is the policy of the Mississippi Department of Transportation to provide a level playing field, to foster equal opportunity in all federally assisted contracts, to improve the flexibility of the DBE Program, to reduce the burdens on small businesses, and to achieve that amount of participation that would be obtained in a non-discriminatory market place. In doing so, it is the policy of MDOT that there will be no discrimination in the award and performance of federally assisted contracts on the basis of race, color, sex, age, religion, national origin, or any handicap.

ASSURANCES THAT CONTRACTORS MUST TAKE:

MDOT will require that each contract which MDOT signs with a subrecipient or a contractor (and each subcontract the prime contractor signs with a subcontractor) includes the following assurances:

“The contractor, subrecipient or subcontractor shall not discriminate on the basis of race, color, national origin, or sex in the performance of this contract. The contractor shall carry out applicable requirements of 49 CFR 26 in the award and administration of federally assisted contracts. Failure by the contractor to carry out these requirements is a material breach of this contract, which may result in the termination of this contract or such other remedy as MDOT deems appropriate.”

DEFINITIONS

For purposes of this provision the following definitions will apply:

"Disadvantaged Business" means a small business concern: (a) which is at least 51 percent owned by one or more socially and economically disadvantaged individual(s) or in the case of any publicly owned business, at least 51 percent of the stock of which is owned by one or more socially and economically disadvantaged individual(s); and (b) whose management and daily business operations are controlled by one or more of the socially and economically disadvantaged individual(s) who own it. It is important to note that the business owners themselves must control the operations of the business. Absentee ownership or title ownership by an individual who does not take an active role in controlling the business is not consistent with eligibility as a DBE under CFR 49 Part 26.71.

CONTRACTOR'S OBLIGATION

The Contractor and all subcontractors shall take all necessary and reasonable steps to ensure that DBE firms can compete for and participate in the performance of a portion of the work in this contract and shall not discriminate on the basis of race, color, national origin, religion or sex. Failure on the part of the Contractor to carry out the DBE requirements of this contract constitutes a breach of contract and after proper notification the Department may terminate the contract or take other appropriate action as determined by the Department.

When a contract requires a zero percent (0%) DBE goal, the Contractor still has the responsibility to take all necessary and reasonable steps to ensure that DBE firms can compete for and participate in the performance of the work in the contract. **In this case, all work performed by a certified DBE firm is considered to be a “race neutral” measure and the Department will receive DBE credit towards the overall State goals when the DBE firm is paid for their work. If the Prime Contractor is a certified DBE firm, the Department can receive DBE credit only for the work performed by the Prime Contractor’s work force or any work subcontracted to another DBE firm. Work performance by a non-DBE subcontractor is not eligible for DBE credit.**

CONTRACT GOAL

The goal for participation by DBEs is established for this contract in the attached Supplement. The Contractor shall exercise all necessary and reasonable steps to ensure that participation is equal to or exceeds the contract goal.

The percentage of the contract that is proposed for DBEs shall be so stated on the last bid sheet of the proposal.

The apparent lowest responsive bidder shall submit to the Contract Administration Division OCR Form 481, signed by the Prime Contractor and the DBE Subcontractors, no later than the 10th day after opening of the bids.

FORMS ARE AVAILABLE FROM THE CONTRACT ADMINISTRATION DIVISION

The OCR-481 Form must contain the following information:

The name and address of each certified DBE Contractor / supplier;

The Reference Number, percent of work and the dollar amount of each item. If a portion of an item is subcontracted, a breakdown of that item (including quantities and unit price) must be attached, detailing what part of the item the DBE firm is to perform and who will perform the remainder of the item.

If the DBE Commitment shown on the last bid sheet of the proposal, does not equal or exceed the contract goal, the bidder must submit, with the proposal, information to satisfy the Department that adequate good faith efforts have been made to meet the contract goal.

Failure of the lowest bidder to furnish acceptable proof of good faith efforts, submitted with the bid proposal, shall be just cause for rejection of the proposal. Award may then be made to the next lowest responsive bidder or the work may be readvertised.

The following factors are illustrative of matters the Department will consider in judging whether or not the bidder has made adequate good faith effort to satisfy the contract goal.

- (1) Whether the bidder attended the pre-bid meeting that was scheduled by the Department to inform DBEs of subcontracting opportunities;
- (2) whether the bidder advertised in general circulation, trade association, and minority-focus media concerning the subcontracting opportunities;
- (3) whether the bidder provided written notice to a reasonable number of specific DBEs that their interest in the contract is being solicited;
- (4) whether the bidder followed up initial solicitations of interest by contacting DBEs to determine with certainty whether they were interested;
- (5) whether the bidder selected portions of the work to be performed by DBEs in order to increase the likelihood of meeting the contract goal;
- (6) whether the bidder provided interested DBEs with adequate information about the plans, specifications and requirements of the contract;
- (7) whether the bidder negotiated in good faith with interested DBEs and did not reject them as unqualified without sound reasons based on a thorough investigation of their capabilities; and

- (8) whether the bidder made efforts to assist interested DBEs in obtaining any required bonding or insurance.

DIRECTORY

Included with this Bid Proposal is a list of "Certified DBE Contractors" which have been certified as such by the Mississippi Department of Transportation and other Unified Certification Partners (UCP).

The DBE firm must be on the Department's list of "Certified DBE Contractors" that is attached to this proposal and approved by MDOT to count towards meeting the DBE goal.

REPLACEMENT

If a DBE Subcontractor cannot perform satisfactorily, and this causes the OCR-481 commitment to fall below the contract goal, the Contractor shall take all necessary reasonable steps to replace the DBE with another certified DBE Subcontractor or submit information to satisfy the Mississippi Department of Transportation that adequate good faith efforts have been made to replace the DBE. The replacement DBE must be a DBE who was on the Department's list of "Certified DBE Contractors" when the job was awarded, and who is still active. All DBE replacements must be approved by the Department.

Under no circumstances shall the prime or any subcontractor perform the DBE's work (as shown on the OCR-481) without prior written approval from the Department. See "Sanctions" on Page 6 for penalties for performing DBE's work.

When a Contractor proposes to substitute/replace/terminate a DBE that was originally named on the OCR-481, the Contractor must obtain a release (in writing) from the named DBE explaining why the DBE Subcontractor cannot perform the work. A copy of the original DBE's release must be attached to the Contractor's written request to substitute/replace/terminate along with appropriate Subcontract Forms for the substitute/replacement/terminated Subcontractor, all of which must be submitted to the DBE Coordinator and approved, in advance, by MDOT.

GOOD FAITH EFFORTS

To demonstrate good faith efforts to replace any DBE that is unable to perform successfully, the Contractor must document steps taken to subcontract with another certified DBE Contractor. Such documentation shall include no less than the following:

- (a) Proof of written notification to certified DBE Contractors by certified mail that their interest is solicited in subcontracting the work defaulted by the previous DBE or in subcontracting other items of work in the contract.
- (b) Efforts to negotiate with certified DBE Contractors for specific items shall include as a minimum:

- (1) The name, address, and telephone number of each DBE contacted;
 - (2) A description of the information provided about the plans and specifications for those portions of the work to be subcontracted; and
 - (3) A statement of why agreements were not reached.
- (c) For each DBE contacted that was rejected as unqualified, the reasons for such conclusion.
- (d) Efforts made to assist each DBE that needed assistance in obtaining bonding or insurance required by the Contractor.

Failure of the Contractor to demonstrate good faith efforts to replace a DBE Subcontractor that cannot perform as intended with another DBE Subcontractor, when required, shall be a breach of contract and may be just cause to be disqualified from further bidding for a period of up to 12 months after notification by certified mail.

PARTICIPATION / DBE CREDIT

Participation shall be counted toward meeting the goal in this contract as follows:

- (1) If the Prime Contractor is a certified DBE firm, only the value of the work actually performed by the DBE Prime can be counted towards the project goal, along with any work subcontracted to a certified DBE firm.
- (2) If the Contractor is not a DBE, the work subcontracted to a certified DBE Contractor will be counted toward the goal.
- (3) The Contractor may count toward the goal a portion of the total dollar value of a contract with a joint venture eligible under the standards of this provision equal to the percentage of the DBE partner in the joint venture.
- (4) Expenditures to DBEs that perform a commercially useful function may be counted toward the goal. A business is considered to perform a commercially useful function when it is responsible for the execution of a distinct element of the work and carries out its responsibilities by actually performing, managing, and supervising the work involved.
- (5) The Contractor may count 100% of the expenditures for materials and supplies obtained from certified DBE suppliers and manufacturers that produce goods from raw materials or substantially alters them for resale provided the suppliers and manufacturers assume the actual and contractual responsibility for the provision of the materials and supplies. The Contractor may count 60 percent of the expenditures to suppliers that are not manufacturers, provided the supplier performs a commercially useful function in the

supply process. Within 30 days after receipt of the materials, the Contractor shall furnish to the DBE Coordinator invoices from the certified supplier to verify the DBE goal.

- (6) Any work that a certified DBE firm subcontracts or sub-subcontracts to a non-DBE firm will not count towards the DBE goal.
- (7) Only the dollars actually paid to the DBE firm may be counted towards the DBE goal.

AWARD

Award of this contract to the low bidder will be contingent upon the following conditions:

- (1) Concurrence from Federal Highway Administration, when applicable.
- (2) Bidder must submit to the Contract Administration Division for approval, Form OCR-481 (DBE Commitment) no later than the 10th day after opening of the bids, or submit information with the bid proposal to satisfy the Department and that adequate good faith efforts have been made to meet the contract goal.
- (3) Bidder must submit with the bid proposal a list of all firms that submitted quotes for material supplies or items to be subcontracted. This information must be submitted on form OCR-485 in the back of the contract proposal.

Prior to the start of any work, the bidder must notify the Project Engineer, in writing, of the name of the designated "DBE Liaison Officer" for this project. This notification must be posted on the bulletin board at the project site.

DEFAULT

The contract goal established by MDOT in this proposal must be met to fulfill the terms of the contract. The Contractor may list DBE Subcontractors and items that exceed MDOT's contract goal, but should unforeseen problems arise that would prevent a DBE from completing its total commitment percentage, the Contractor will meet the terms of the contract as long as it meets or exceeds MDOT's Contract Goal. For additional information, refer to "Replacement" section of this Notice.

DBE REPORTS

- (1) OCR-481: Refer to "CONTRACT GOAL" section on page no. 2 of this Notice to Bidders for information regarding this form.
- (2) OCR-482: At the conclusion of the project, the Contractor will submit to the Project Engineer for verification of quantities and further handling Form OCR-482 whereby the Contractor certifies to the amounts of payments made to each Contractor/Supplier. The Project Engineer shall submit the completed Form OCR-482 to the DBE Coordinator

(Office of Civil Rights). Final acceptance of the project is dependent upon Contract Administration Division's receipt of completed Form OCR-482 which they will receive from the Office of Civil Rights.

(3) OCR-483: The Project Engineer/Inspector will complete Form OCR-483, the Commercially Useful Function (CUF) Performance Report, in accordance with MDOT S.O.P. No. OCR-03-09-01-483. Evaluations reported on this form are used to determine whether or not the DBE firm is performing a CUF. The Prime Contractor should take corrective action when the report contains any negative evaluations. DBE credit may be disallowed and/or other sanctions imposed if it is determined the DBE firm is not performing a CUF. This form should also be completed and returned to the DBE Coordinator (Office of Civil Rights).

(5) OCR-485: The bidder must submit with the bid proposal a list of all firms that submitted quotes for material supplies or items to be subcontracted.

(6) OCR-487: Only used by Prime Contractors that are certified DBE firms. This form is used in determining the exact percentage of DBE credit for the specified project. It should be returned to MDOT with the OCR-481 form, or can also be returned with the Permission to Subcontract forms (CAD -720 or CAD-725).

SANCTIONS

The Department has the option to enforce any of the following penalties for failure of the prime Contractor to fulfill the DBE goal as stated on the OCR-481 Form or any violations of the DBE program guidelines:

- (1) Disallow credit towards the DBE goal
- (2) Withhold progress estimate payments
- (3) Deduct from the final estimate an amount equal to the unmet portion of the DBE goal
- (4) Recover an amount equal to the unmet contract goal
- (5) Debar the Contractor involved from bidding on Mississippi Department of Transportation projects.
- (6) Deduct from the Contractor's final estimate all or any combination of the following.

<u>Offense</u>	<u>Percentage of the monetary amount disallowed from (1) above</u>	<u>Lump Sum</u>
# 1	10%	\$ 5,000 or both
# 2	20%	\$ 10,000 or both
# 3	40%	\$ 20,000 & debarment

MISSISSIPPI DEPARTMENT OF TRANSPORTATION

SECTION 904 - NOTICE TO BIDDERS NO. 1082M

CODE: (IS)

DATE: 04/28/2006

SUBJECT: Payroll Requirements

Bidders are hereby advised that the Contractor and Subcontractor(s) are required to submit payroll information to the Project Engineers on a weekly basis.

On Federal-Aid Projects, CAD-880, CAD-881 and certified payroll submissions are required each week the Contractor or a Subcontractor performs work on the project. This is addressed in Section V, page 6 of Form FHWA-1273.

On State-Funded Projects, CAD-880 is required each week the Contractor or a Subcontractor performs work on the project.

When no work is performed on either Federal-Aid and State-Funded Projects, the Contractor should only submit CAD-880 showing no work activities.

The Contractor shall make all efforts necessary to submit this information to the Project Engineer in a timely manner. The Engineer will have the authority to suspend the work wholly or in part and to withhold payments because of the Contractor's failure to submit the required information. Submission of forms and payrolls shall be current through the first full week of the month for the estimate period in order for the Project Engineer to process an estimate.

Bidders are advised to review the requirements regarding payroll submissions in Section 110 of the Standard Specifications.

MISSISSIPPI DEPARTMENT OF TRANSPORTATION

SECTION 904 - NOTICE TO BIDDERS NO. 1102M

CODE: (SP)

DATE: 02/21/2007

SUBJECT: Conversion Factors for MDOT Field Manual for HMA Pavements

Bidders are hereby advised that the Field Manual For Hot Mix Asphalt Pavement is only available in the English version.

Any reference in Notice to Bidders, Special Provisions, Plans, and the Mississippi Standard Specifications for Road and Bridge Construction to the latest edition of the MDOT Field Manual for Hot Mix Asphalt shall be understood that the English version of the Field Manual is applicable.

In order to utilize the English version of the Field Manual, conversions will be made in accordance with MDOT's "Metric Criteria Transportation Projects" booklet, copies of which are available in the Planning Division or Construction Division of MDOT. All conversions will be a "soft conversion" from Metric units to English units.

MISSISSIPPI DEPARTMENT OF TRANSPORTATION

SECTION 904 - NOTICE TO BIDDERS NO. 1129M

CODE: (IS)

DATE: 09/09/2008

SUBJECT: Safety Apparel

Bidders are advised that the Code of Federal Regulations CFR 23 Part 634 final rule was adopted November 24, 2006 with an effective date of November 24, 2008. This rule requires that **"All workers within the right-of-way of a Federal-Aid Highway who are exposed either to traffic (vehicles using the highway for the purposes of travel) or to construction equipment within the work area shall wear high-visibility safety apparel"**. High-visibility safety apparel is defined in the CFR as **"personnel protective safety clothing that is intended to provide conspicuity during both daytime and nighttime usage, and that meets the Performance Class 2 or 3 requirements of the ANSI/ISEA 107-2004 publication entitled American National Standard for High-Visibility Safety Apparel and Headwear"**. All workers on Mississippi State Highway right-of-way shall comply with this Federal Regulation. Workers are defined by the CFR as **"people on foot whose duties place them within the right-of way of a Federal-Aid Highway, such as highway construction and maintenance forces, survey crews, utility crews, responders to incidents within the highway right-of-way, and law enforcement personnel when directing traffic, investigating crashes, and handling lane closures, obstructed roadways, and disasters within the right-of-way of a Federal-Aid Highway"**.

You can access this final rule at the following link:

<http://a257.g.akamaitech.net/7/257/2422/01jan20061800/edocket.access.gpo.gov/2006/pdf/E6-19910.pdf>

MISSISSIPPI DEPARTMENT OF TRANSPORTATION

| SECTION 904 - NOTICE TO BIDDERS NO. **1144M**

CODE: (IS)

| DATE: **04/14/2008**

SUBJECT: Federal Bridge Formula

Bidders are hereby advised that Federal Highway Administration Publication No. FHWA-MC-94-007, **BRIDGE FORMULA WEIGHTS**, dated January 1994, is made a part of this contract when applicable.

Prior to the preconstruction conference, the Contractor shall advise the Engineer, in writing, what materials, if any, will be delivered to the jobsite via Interstate route(s).

Copies of the **BRIDGE FORMULA WEIGHTS** publication may be obtained by contacting:

Federal Highway Administration
400 7th Street, SW
Washington, DC 20590
(202) 366-2212

or

| http://ops.fhwa.dot.gov/freight/sw/brdgcalc/calc_page.htm

MISSISSIPPI DEPARTMENT OF TRANSPORTATION

SECTION 904 - NOTICE TO BIDDERS NO. 1162M

CODE: (SP)

DATE: 01/06/2009

SUBJECT: Department of Labor Ruling

On December 19, 2008 the U.S. Department of Labor issued a final rule revising their regulations in 29 CFR Parts 3 and 5. This rule takes effect for all Federal funded contracts awarded after January 19, 2009.

The primary change in the rule is a provision that requires Contractors to limit the amount of personal information on the weekly payroll submissions. Personal addresses and full social security numbers may no longer be used. Contractors must use an ". . . individually identifying number for each employee (e.g., the last four digits of the employee's social security number)." Form FHWA1273 - "Required Contract Provisions Federal-aid Construction Contracts" will eventually be revised to reflect this change.

Until the revised is made to FHWA-1273, bidders are advised to disregard any requirement in FHWA-1273 regarding the use of personal addresses and full social security numbers, such as in Section V, Paragraph 2b.

Bidders are also advised that the requirement for maintaining and submitting form FHWA-47, as referenced in FHWA-1273 Section VI, is no longer required on construction projects.

MISSISSIPPI DEPARTMENT OF TRANSPORTATION

| SECTION 904 - NOTICE TO BIDDERS NO. [1170M](#)

CODE: (IS)

| DATE: [02/12/2009](#)

| SUBJECT: **Status of Right-of-Way**

Although it is desirable to have acquired all rights-of-way and completed all utility adjustments and work to be performed by others prior to receiving bids, sometimes it is not considered to be in the public interest to wait until each and every such clearance has been obtained. The bidder is hereby advised of possible unacquired rights-of-way, relocatees and utilities which have not been completed.

| The status of right-of-way acquisition, utility adjustments, [encroachments](#), potentially contaminated sites [and asbestos containment](#) are set forth in [the following](#) attachments.

In the event right of entry is not available to ALL parcels of right-of-way and/or all work that is to be accomplished by others on the date set forth in the contract for the Notice to Proceed is not complete, the Department will issue a restricted Notice to Proceed.

STATUS OF RIGHT-OF-WAY

BR-0016-03(020)

102160-302000

WIDEN & REPLACE 3 BRIDGES ON SR 8
BETWEEN CALHOUN CITY & DERMA
CALHOUN COUNTY

September 13, 2011

All rights of way and legal rights of entry have been acquired, except:

None.

ASBESTOS CONTAMINATION STATUS OF BUILDINGS
TO BE REMOVED BY THE CONTRACTOR

BR-0016-03(020)

102160/302000

Calhoun County

May 26, 2011

Reference is made to notices to bidders entitled "Asbestos National Emission Standards for Hazardous Air Pollutants (NESHAP)" and "Removal of Obstructions".

The following pertinent information is furnished concerning asbestos containing materials (ACMs), if any, found in buildings to be removed by the Contractor.

There are no buildings in the contract to be removed.

STATUS OF POTENTIALLY CONTAMINATED SITES

BR-0016-03(020)

102160-302000

Calhoun County

May 26, 2011

This project has been inspected and there was no visible indication of potentially contaminated sites within the proposed right of way.

ENCROACHMENT CERTIFICATION

BR-0016-03(020) / 102160302

Calhoun County(ies)

July 19, 2011

This is to certify that the above captioned project has been inspected and no encroachments were found.

UTILITY STATUS REPORT

BR-0016-03(020) / 102160302

Calhoun County(ies)

September 13, 2011

This is to certify that the above captioned project has been inspected and there are no known utilities in conflict with the project.

MISSISSIPPI DEPARTMENT OF TRANSPORTATION

SECTION 904 - NOTICE TO BIDDERS NO. 1185M

CODE: (IS)

DATE: 05/13/2009

SUBJECT: DBE Forms, Participation and Payment

Bidders are hereby advised that the participation of a DBE Firm can not be counted towards the Prime Contractor's DBE goal until the amount being counted towards the goal has been paid to the DBE.

Form OCR-482 has been developed to comply with this requirement. Bidders are hereby advised that at the end of the job, the Prime Contractor will submit this form to the Project Engineer before the final estimate is paid and the project is closed out. This form certifies payments to all DBE Subcontractors over the life of the contract.

Form OCR-484 has also been developed to comply with this requirement. Bidders are hereby advised that each month, the Prime Contractors will submit this form to the Project Engineer no later than the last day of each month. This form certifies payments to all Subcontractors and shows all firms even if the Prime Contractor has paid no monies to the firm during that estimate period (negative report). The Project Engineer will attach this form to the monthly estimate before forwarding the estimate to the Contract Administration Division for processing.

Bidders are also advised that Form OCR-485 will be completed by ALL BIDDERS submitting a bid proposal and must be signed and included in the bid proposal package. Failure to include Form OCR-485 in the bid proposal package will cause the Contractor's bid to be considered irregular.

DBE Forms, including Forms OCR-482, OCR-484 and OCR-485, can be obtained from the Office of Civil Rights Division, MDOT Administration Building, 401 North West Street, Jackson, MS, or at www.gomdot.com under *Business, Disadvantaged Enterprise, Applications and Forms for the DBE Program, MDOT Forms*.

MISSISSIPPI DEPARTMENT OF TRANSPORTATION

SECTION 904 - NOTICE TO BIDDERS NO. 1215M

CODE: (SP)

DATE: 10/01/2009

SUBJECT: Non-Quality Control / Quality Assurance Concrete

Bidders are advised that the following pay items will not be accepted based on the Quality Control / Quality Assurance (QC/QA) requirements of Section 804 of the specifications. The acceptance of these pay items will be based on sampling and testing at the project site by MDOT forces. The Contractor is required to submit mix designs to accomplish this work in accordance with Section 804 and perform normal Quality Control functions at the concrete plant. Acceptance will be in accordance with the requirements of 907-601, Structural Concrete, and TMD-20-04-00-000. At the discretion of the Engineer, the Contractor may request that the concrete be accepted based on QC/QA requirements.

<u>Pay Item</u>	<u>Description</u>
221	Paved Ditches
601	Minor Structures - manholes, inlets, catch basins, junction boxes, pipe headwalls, and pipe collars.
606	Guardrail Anchors
607	Fence Post Footings
608	Sidewalks
609	Curb and Gutter
614	Driveways
616	Median and Island Pavement
630	Sign Footings, except Overhead Sign Supports

MISSISSIPPI DEPARTMENT OF TRANSPORTATION

SECTION 904 - NOTICE TO BIDDERS NO. 1220M

CODE: (SP)

DATE: 12/02/2009

SUBJECT: Petroleum Products Base Prices

Bidders are advised that the Notice To Bidders entitled “Monthly Petroleum Products Base Prices” previously included in the proposal documents will no longer be a printed part of the proposal beginning with the January 2010 letting. Monthly petroleum products base prices will be available at the web site listed below. Current monthly prices will be posted to this web site on or before the 15th of each month. Bidders are advised to use the petroleum base prices on this web site when preparing their bids. The current monthly petroleum products base prices will be acknowledged by the Bidder and become part of the contract during the execution process.

Monthly Petroleum Products Base Prices can be viewed at:

<http://www.gomdot.com/Applications/BidSystem/Home.aspx>

MISSISSIPPI DEPARTMENT OF TRANSPORTATION

SECTION 904 - NOTICE TO BIDDERS NO. 1229M

CODE: (SP)

DATE: 01/11/2010

SUBJECT: Reduced Speed Limit Signs

Bidders are advised that all black and white speed limits signs that are used to reduce the speed limit through construction zones shall be covered or removed during times when the Contractor is not performing work. If the Contractor has a routine daytime operation and is not working at night, the signs shall be covered or removed during the nighttime when there is no work activity.

MISSISSIPPI DEPARTMENT OF TRANSPORTATION

SECTION 904 - NOTICE TO BIDDERS NO. 1238M

CODE: (SP)

DATE: 03/23/2010

SUBJECT: Alternate Asphalt Mixture Bid Items

Bidders are advised that the asphalt mixture used on this project will be bid as an alternate pay item: Hot Mix Asphalt (HMA) or Warm Mix Asphalt (WMA). Bidders must select one of the alternates at the time of bid. **The Contractor must use the selected asphalt mixture, HMA or WMA, throughout the entire project.**

MISSISSIPPI DEPARTMENT OF TRANSPORTATION

SECTION 904 - NOTICE TO BIDDERS NO. 1254M

CODE: (SP)

DATE: 06/24/2010

SUBJECT: Temporary Traffic Paint

Bidders are hereby advised that the temporary traffic paint for this project can be waterborne paint as specified in the 2004 Mississippi Standard Specifications For Road and Bridge Construction or fast dry solvent traffic paint meeting the requirements set out in 907-710-2M (Fast Dry Solvent Traffic Paint).

Payment for all temporary traffic paint shall be paid under the appropriate 619 pay items.

When using fast dry solvent traffic stripe, no paint can be sprayed or placed on the ground during set-up or clean-up.

MISSISSIPPI DEPARTMENT OF TRANSPORTATION

SECTION 904 - NOTICE TO BIDDERS NO. 1263M

CODE: (SP)

DATE: 09/21/2010

SUBJECT: Warm Mix Asphalt

Bidders are advised that MDOT approved products and processes for the production of Warm Mix Asphalt is available at the following MDOT website.

<http://www.gomdot.com/Divisions/Highways/Resources/MPL/Home.aspx>

MISSISSIPPI DEPARTMENT OF TRANSPORTATION

SECTION 904 - NOTICE TO BIDDERS NO. 1316M

CODE: (SP)

DATE: 02/09/2011

SUBJECT: Detour Bridge Railing

Bidders are advised that if the Contractor elects to utilize the Load and Resistance Factor Design (LRFD) designed 5.8-meter or 9.4-meter Precast Concrete Bridge Span Unit Standards as published by the Office of State Aid Road Construction, only the Solid Type Barrier Rail (New Jersey Shape) with the appropriate adjacent connecting exterior span unit will be acceptable for use on MDOT detour bridges. Other railing types published by the Office of State Aid Road Construction **will not** be acceptable for use on MDOT detour bridges.

Bridge railing for use on other type detour bridge designs shall have a minimum LRFD rating of Test Level Two (TL-2) and shall be crash tested to meet the requirements of National Cooperative Highway and Research Program (NCHRP) Report 350. Official certification that the railing meets these requirements shall be included in the detour bridge submittal.

MISSISSIPPI DEPARTMENT OF TRANSPORTATION

SECTION 904 - NOTICE TO BIDDERS NO. 1321M

CODE: (SP)

DATE: 03/01/2011

SUBJECT: Questions Regarding Bidding

Bidders are advised that all questions that arise regarding the contract documents or plans on this project shall be directed to the Construction Division at 601-359-7301.

MISSISSIPPI DEPARTMENT OF TRANSPORTATION

SECTION 904 - NOTICE TO BIDDERS NO. 1323M

CODE: (SP)

DATE: 05/24/2011

SUBJECT: Safety Edge

Bidders are hereby advised that the Shoulder Wedge (Safety Edge) specified in the Supplement to Special Provision 907-401-10M shall only apply to the top two (2) lifts of asphalt. Attached is a drawing showing the safety edge.

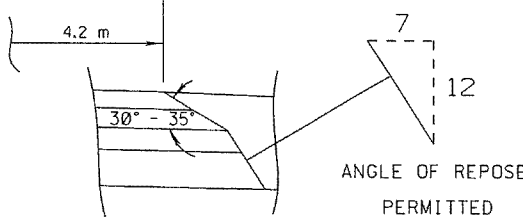
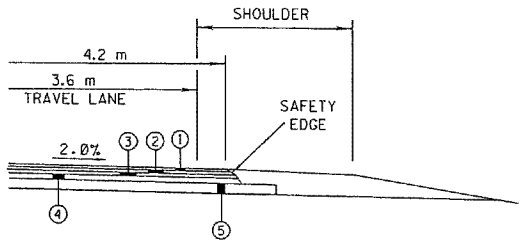

SAFETY EDGE REQ'D
TOP 2 LIFTS ONLY
(NOT A PAY ITEM)

NEW CONSTRUCTION

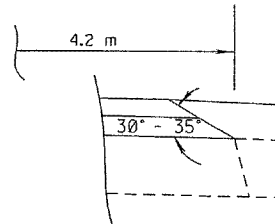
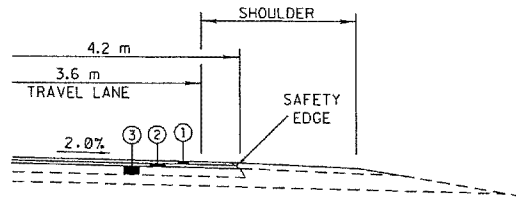

SAFETY EDGE REQ'D
TOP 2 LIFTS ONLY
(NOT A PAY ITEM)

**OVERLAY
4.2 m PAVEMENT**

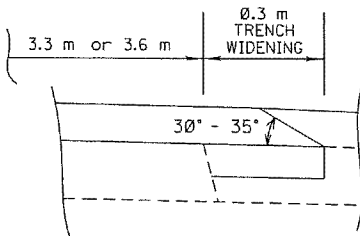
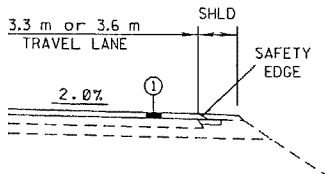

SAFETY EDGE REQ'D
(NOT A PAY ITEM)

**OVERLAY
3.3 m or 3.6 m PAVEMENT
WITH TRENCH WIDENING**

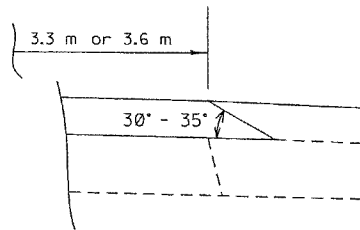
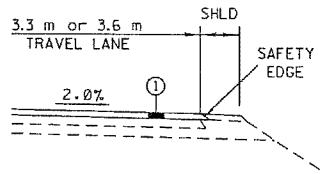

SAFETY EDGE REQ'D
(NOT A PAY ITEM)

**OVERLAY
3.3 m or 3.6 m PAVEMENT
WITHOUT TRENCH WIDENING**

MISSISSIPPI DEPARTMENT OF TRANSPORTATION

SECTION 904 - NOTICE TO BIDDERS NO. 1324M

CODE: (SP)

DATE: 06/10/2011

**SUBJECT: Storm Water Discharge Associated with Construction Activity
(≥ 2.0 Hectares)**

PROJECT: BR-0016-03(020) / 102160302 – Calhoun County

A Construction Storm Water General NPDES Permit to discharge storm water associated with construction activity is required.

The Department has acquired Certificate of Permit Coverage [MSR105954](#) under the Mississippi Department of Environmental Quality's (MDEQ) Storm Water [Large](#) Construction General Permit. Projects issued a certificate of permit coverage are granted permission to discharge treated storm water associated with construction activity into State waters. Copies of said permit, completed Large Construction Notice of Intent (LCNOI), and Storm Water Pollution Prevention Plan (SWPPP) are on file with the Department.

Prior to the execution of the contract, the successful bidder shall execute and deliver to the Executive Director an original signed copy of the completed Prime Contractor Certification Forms.

Failure of the bidder to execute and file the completed Prime Contractor Certification Forms shall be just cause for the cancellation of the award.

The executed Prime Contractor Certification Forms shall be prima facie evidence that the bidder has examined the permit, is satisfied as to the terms and conditions contained therein, and that the bidder has the primary responsibility for meeting all permit terms including, but not limited to, the inspection and reporting requirements. For this project, the Contractor shall furnish, set up and read, as needed, an on-site rain gauge.

The Contractor shall make inspections in accordance with condition No. S-4, page [22](#), and shall furnish the Project Engineer with the results of each weekly inspection as soon as possible following the date of inspection. A copy of the inspection form is provided with the packet. The weekly inspections must be documented monthly on the Inspection and Certification Form. The Contractor's representative and the Project Engineer shall jointly review and discuss the results of the inspections so that corrective action can be taken. The Project Engineer shall retain copies of the inspection reports.

The Engineer will have the authority to suspend all work and/or withhold payments for failure of the Contractor to carry out provisions of MDEQ's Storm Water Construction General Permit, the erosion control plan, updates to the erosion control plan, and /or proper maintenance of the BMPs

Upon successful completion of all permanent erosion and sediment controls, accepted and documented by the full maintenance release, the Construction Division shall submit a completed Notice of Termination (NOT) of Coverage to the Office of Pollution Control.

Securing a permit (s) for storm water discharge associated with the Contractor's activity on any other regulated area the Contractor occupies, shall be the responsibility of the Contractor.

MISSISSIPPI DEPARTMENT OF TRANSPORTATION

SECTION 904 - NOTICE TO BIDDERS NO. 1325M

CODE: (SP)

DATE: 08/10/2011

SUBJECT: Additional Erosion Control Requirements

Bidders are hereby advised of the following requirements that relate to erosion control activities on the project.

THE MAXIMUM TOTAL ACREAGE THAT CAN BE DISTURBED, AT ONE TIME, ON THE PROJECT IS 7.7 HECTARES. THE CONTRACTOR SHALL BE REQUIRED TO STABILIZE DISTURBED AREAS PRIOR TO OPENING UP ADDITIONAL SECTIONS OF THE PROJECT. STABILIZED SHALL BE WHEN THE DISTURBED AREA MEETS ONE OF THE FOLLOWING CRITERIA:

- **THE AREA HAS BEEN GRASSED, EITHER TEMPORARY OR PERMANENT, AND MULCHED ACCORDING TO THE SPECIFICATIONS, OR**
- **A CRUSHED STONE COURSE OR A LIFT OF ASPHALT PAVEMENT HAS BEEN PLACED, OR**
- **THE AREA HAS BEEN CHEMICALLY TREATED USING PORTLAND CEMENT OR LIME-FLY ASH, AND SEALED.**

DISTURBED AREAS INCLUDE THE ROADBED, SLOPES AND REMAINING AREA OUT TO THE ROW LINE.

Clearing and Grubbing: Prior to beginning any clearing and grubbing operations on the project, controls shall be in place to address areas such as drainage structures, wetlands, streams, steep slopes and any other sensitive areas as directed by the Engineer. Clearing and grubbing should be limited to the minimum area necessary to construct the project. Grubbing operations should be minimized in areas outside the construction limits and stumps should be cut off flush with the existing ground elevations. A buffer area of at least 4.5 meters shall be in place adjacent to the right-of-way line and at least 1.5 meters adjacent to stream banks. The buffer area can either be the existing vegetation that is left undisturbed or re-established by planting new vegetation if clearing and grubbing was required.

Unclassified Excavation: Cut sections shall be graded in accordance with the typical sections and plan grades. Permanent erosion control BMP's should be placed as soon as possible after the cut material has been moved. Fill sections that are completed shall have permanent erosion control BMP's placed. Fill sections that are not completed will be either permanently or temporarily grassed until additional material is made available to complete these sections. All unclassified excavation on the project will still be required to be moved prior to incorporating any borrow excavation on the project. The contractor may have to stockpile unclassified excavation in order to comply with the 7.7-hectare requirement. No additional compensation will be made for stockpiling operations.

Disturbed areas that remain inactive for a period of more than fourteen (14) days shall be temporary grassed and mulched. Temporary grassing and mulching shall only be paid one time for a given area.

MISSISSIPPI DEPARTMENT OF TRANSPORTATION

SECTION 904 - NOTICE TO BIDDERS NO. 1327M

CODE: (SP)

DATE: 09/21/2011

SUBJECT: Contract Time

PROJECT: BR-0016-03(020) / 102160302 – Calhoun County

The calendar date for completion of work to be performed by the Contractor for this project shall be **October 14, 2013** which date or extended date as provided in Subsection 907-108.06 shall be the end of contract time. It is anticipated that the Notice of Award will be issued no later than **November 8, 2011** and the effective date of the Notice to Proceed / Beginning of Contract Time will be **March 15, 2012**.

Should the Contractor request a Notice to Proceed earlier than **March 15, 2012**, and it is agreeable with the Department for an early Notice to Proceed, the requested date will become the new Notice to Proceed / Beginning of Contract Time date.

A progress schedule as referenced to in Subsection 907-108.03 will not be required for this contract.

MISSISSIPPI DEPARTMENT OF TRANSPORTATION

SECTION 904 - NOTICE TO BIDDERS NO. 1328M

DATE: 09/22/2011

SUBJECT: Specialty Items

PROJECT: BR-0016-03(020) / 102160302 - Calhoun County

Pursuant to the provisions of Section 108, the following work items are hereby designated as "Specialty Items" for this contract. Bidders are reminded that these items must be subcontracted in order to be considered as specialty items.

CATEGORY: EROSION CONTROL

Line No	Pay Item	Description
0140	211-B001	Topsoil for Slope Treatment(Contractor Furnished) (LVM)
0150	212-B001	Standard Ground Preparation
0160	213-B001	Combination Fertilizer (13-13-13)
0170	213-C001	Superphosphate
0180	216-A001	Solid Sodding
0190	219-A001	Watering
0200	220-A001	Insect Pest Control
0210	221-A001	Portland Cement Concrete Paved Ditch
0220	236-A004	Silt Basin (Type D)
0680	907-217-A001	Ditch Liner
0700	907-225-A001	Grassing
0710	907-225-B001	Agricultural Limestone
0720	907-226-A002	Temporary Grassing
0730	907-234-A002	Temporary Silt Fence
0740	907-234-C002	Super Silt Fence
0750	907-237-A002	Wattles, 500-mm
0760	907-245-A001	Triangular Silt Dike
0770	907-246-A002	Sandbags

CATEGORY: GUARDRAIL, GUIDERAIL

Line No	Pay Item	Description
0390	606-B001	Guard Rail (Class A, Type 1)
0400	606-D012	Guard Rail, Bridge End Section, Type I
0880	907-606-E001	Guard Rail, Terminal End Section

CATEGORY: LANDSCAPING

Line No	Pay Item	Description
0690	907-223-A001	Mowing

CATEGORY: PAVEMENT STRIPING AND MARKING

Line No	Pay Item	Description
0960	907-626-CC002	150-mm Thermoplastic Edge Stripe (Continuous White) (1.50-mm min)
0970	907-626-DD002	150-mm Thermoplastic Traffic Stripe (Skip Yellow) (2.25-mm min)
0980	907-626-EE003	150-mm Thermoplastic Traffic Stripe (Continuous Yellow) (2.25-mm min)
0990	907-626-GG001	Thermoplastic Detail Stripe (150-mm Equivalent Length)(White)(2.25-mm min.)
1000	907-626-GG002	Thermoplastic Detail Stripe (150-mm Equivalent Length)(Yellow)(2.25-mm min.)
1010	907-626-H001	Thermoplastic Legend (White)(3.00-mm min.)
1020	907-626-H002	Thermoplastic Legend (White)(3.00-mm min.)
1030	907-627-K001	Red-Clear Reflective High Performance Raised Markers
1040	907-627-L001	Two-Way Yellow Reflective High Performance Raised Markers
1160	907-628-JJ001	150-mm High Performance Cold Plastic Traffic Stripe (Continuous White)
1170	907-628-LL001	150-mm High Performance Cold Plastic Traffic Stripe (Skip Yellow)
1180	907-628-MM001	150-mm High Performance Cold Plastic Traffic Stripe (Continuous Yellow)
1190	907-626-J003	150-mm Inverted Profile Thermoplastic Traffic Stripe, Continuous White
1200	907-626-K003	150-mm Inverted Profile Thermoplastic Traffic Stripe, Skip Yellow
1210	907-626-L003	150-mm Inverted Profile Thermoplastic Traffic Stripe (Continuous Yellow)

CATEGORY: SURVEY AND STAKING

Line No	Pay Item	Description
0890	907-617-A003	Right-of-Way Marker
1050	907-699-A001	Roadway Construction Stakes

CATEGORY: TRAFFIC CONTROL - PERMANENT

Line No	Pay Item	Description
0610	630-F001	Delineators (Guard Rail)(White)
0620	630-G001	Type 3 Object Markers (OM-3R or OM-3L) Post Mounted

CATEGORY: TRAFFIC CONTROL - TEMPORARY

Line No	Pay Item	Description
0490	619-D1001	Standard Roadside Construction Signs (less than 0.9 square meter)
0500	619-D2001	Standard Roadside Construction Signs (0.9 square meter or more)
0510	619-F3004	Delineators (Guard Rail) (White)
0520	619-G4001	Barricades (Type III) (Single Faced)
0530	619-G4005	Barricades (Type III) (Double Faced)
0540	619-G5001	Free Standing Plastic Drums
0550	619-G7001	Warning Lights (Type "B")
0560	619-K1001	Installation and Removal of Guard Rail (Type I)(Class A)
0570	619-K2003	Installation and Removal of Guard Rail (Type "H" Bridge End Section)
0910	907-619-A1009	Temporary Traffic Stripe (Continuous White)
0920	907-619-A2009	Temporary Traffic Stripe (Continuous Yellow)
0930	907-619-A5005	Temporary Traffic Stripe (Detail)
0940	907-619-C7001	Two-Way Yellow Reflective High Performance Raised Marker
0950	907-619-K4001	Installation and Removal of Guardrail (Terminal End Section)

MISSISSIPPI DEPARTMENT OF TRANSPORTATION

SECTION 904 - NOTICE TO BIDDERS NO. 1329M

CODE (SP)

DATE: 09/14/2011

SUBJECT: Placement of Fill Material in Federally Regulated Areas

PROJECT: BR-0016-03(020) / 102160302 – Calhoun County

A Permit (404, General, Nationwide, etc.) for placing fill material federally regulated sites is required.

The Department has acquired the following permit for permanently filling at regulated sites that are identified during project development:

Nationwide Permit No.23 (Wetlands & Waters of US)

(ID. No. MVK-2011-486 - Site No. 1

Copies of said permit(s) are on file with the Department.

Securing a permit(s) for the filling of any other regulated site, the purpose of which is temporary construction for the convenience of the Contractor, shall be the responsibility of the Contractor.

MISSISSIPPI DEPARTMENT OF TRANSPORTATION

SECTION 904- NOTICE TO BIDDERS NO. 1330M

CODE: (SP)

DATE: 09/21/2011

SUBJECT: Removal of Cars

PROJECT: BR-0016-03(020) / 102160302 – Calhoun County

The Contractor is hereby advised that the project will involve removal of car bodies embedded within the slope at Bridge No. 108.4. The car bodies were previously used to stabilize the slope on the Southeast side of Hurricane Creek. The contractor will be responsible for removal and disposal of the car bodies and said work will be absorbed in the cost bid for removal of obstructions.

MISSISSIPPI DEPARTMENT OF TRANSPORTATION

SECTION 904- NOTICE TO BIDDERS NO. 1331M

CODE: (SP)

DATE: 09/21/2011

SUBJECT: Property Access

PROJECT: BR-0016-03(020) / 102160302 – Calhoun County

The Contractor is hereby advised that full access to the Fire Station for the Town of Derma will be required at all times for emergency purposes. At no times shall construction equipment or construction activities hinder access without approval by the Project Engineer and Fire Station officials. An agreed upon alternate entrance or construction sequencing around this area will be required.

MISSISSIPPI DEPARTMENT OF TRANSPORTATION

SECTION 904- NOTICE TO BIDDERS NO. 1332M

CODE: (SP)

DATE: 09/21/2011

SUBJECT: Silt Fence Reinforcement

PROJECT: BR-0016-03(020) / 102160302 – Calhoun County

The Contractor is hereby advised that all temporary silt fence (234-A001) applications on this project will require wire backing. Standard Drawings in the plans show applications with or without wire backing; however, it will be a requirement to include wire backing on all applications and payment for the wire backing will be considered absorbed in the temporary silt fence pay item.

MISSISSIPPI DEPARTMENT OF TRANSPORTATION

SECTION 904- NOTICE TO BIDDERS NO. 1333M

CODE: (SP)

DATE: 09/21/2011

SUBJECT: Voided Slab and Curb and Gutter Placement

PROJECT: BR-0016-03(020) / 102160302 – Calhoun County

The Contractor is hereby advised that the project will involve use of voided slabs on the bridge deck. Grade control on these slabs to achieve an acceptable finish grade across the bridge deck will require close attention in manufacturing of the voided slabs, forming of the caps, and throughout the process of bridge construction. Therefore, the placement of curb and gutter within 200 LF of the bridge approaches **will not** be permitted until bridge deck finish grades are checked and verified to be acceptable by the Department.

General Decision Number: MS100178 09/16/2011 MS178

Superseded General Decision Number: MS20080178

State: Mississippi

Construction Type: Highway

County: Calhoun County in Mississippi.

HIGHWAY CONSTRUCTION PROJECTS (excluding tunnels, building structures in rest area projects & railroad construction; bascule, suspension & spandrel arch bridges designed for commercial navigation, bridges involving marine construction; and other major bridges).

Modification Number	Publication Date
0	03/12/2010
1	08/13/2010
2	02/11/2011
3	09/16/2011

* ELEC0474-008 07/31/2011

	Rates	Fringes
ELECTRICIAN.....	\$ 24.25	10.41

SUMS2008-096 09/04/2008

	Rates	Fringes
CARPENTER, Includes Form Work....	\$ 12.42	0.87
CEMENT MASON/CONCRETE FINISHER...	\$ 10.75	0.00
IRONWORKER, REINFORCING.....	\$ 9.67	0.00
LABORER: Common or General.....	\$ 7.75	0.00
LABORER: Pipelayer.....	\$ 9.75	0.00
OPERATOR: Backhoe/Excavator.....	\$ 12.36	0.00
OPERATOR: Broom.....	\$ 10.17	0.00
OPERATOR: Bulldozer.....	\$ 11.09	0.00
OPERATOR: Crane.....	\$ 15.04	0.00
OPERATOR: Grader/Blade.....	\$ 13.00	0.00
OPERATOR: Loader.....	\$ 10.48	0.00
OPERATOR: Mechanic.....	\$ 10.60	0.00
OPERATOR: Oiler.....	\$ 12.33	0.48
OPERATOR: Roller.....	\$ 9.65	0.00

OPERATOR: Scraper.....	\$ 11.15	0.00
OPERATOR: Tractor.....	\$ 10.71	0.00
OPERATOR: Asphalt Paver and Asphalt Spreader.....	\$ 10.00	0.00
TRUCK DRIVER.....	\$ 9.68	0.00

WELDERS - Receive rate prescribed for craft performing
operation to which welding is incidental.

=====

Unlisted classifications needed for work not included within
the scope of the
classifications listed may be added after award only as
provided in the labor
standards contract clauses (29 CFR 5.5(a)(1)(ii)).

--

In the listing above, the "SU" designation means that rates
listed under the
identifier do not reflect collectively bargained wage and
fringe benefit
rates. Other designations indicate unions whose rates have
been determined
to be prevailing.

--

WAGE DETERMINATION APPEALS PROCESS

1.) Has there been an initial decision in he matter? This can
be:

- * an existing published wage determination
- * a survey underlying a wage determination
- * a Wage and Hour Division letter setting forth a position on
a wage
determination matter
- * a conformance (additional classification and rate) ruling

On survey related matters, initial contact, including requests
for summaries
of surveys, should be with the Wage and Hour Regional Office
for the area in
which the survey was conducted because those Regional Offices
have
responsibility for the Davis-Bacon survey program. If the
response from this
initial contact is not satisfactory, then the process described
in 2.) and
3.) should be followed.

With regard to any other matter not yet ripe for the formal process described here, initial contact should be with the Branch of Construction Wage Determinations. Write to:

Branch of Construction Wage Determinations
Wage and Hour Division
U.S. Department of Labor
200 Constitution Avenue, N.W.
Washington, DC 20210

2.) If the answer to the question in 1.) is yes, then an interested party (those affected by the action) can request review and reconsideration from the Wage and Hour Administrator (See 29 CFR Part 1.8 and 29 CFR Part 7).
Write to:

Wage and Hour Administrator
U.S. Department of Labor
200 Constitution Avenue, N.W.
Washington, DC 20210

The request should be accompanied by a full statement of the interested party's position and by any information (wage payment data, project description, area practice material, etc.) that the requestor considers relevant to the issue.

3.) If the decision of the Administrator is not favorable, an interested party may appeal directly to the Administrative Review Board (formerly the Wage Appeals Board). Write to:

Administrative Review Board
U.S. Department of Labor
200 Constitution Avenue, N.W.
Washington, DC 20210

4.) All decisions by the Administrative Review Board are final.

END OF GENERAL DECISION

SUPPLEMENT TO FORM FHWA-1273

DATE: 6/15/94

SUBJECT: Final Certificate and Contract Provisions for Subcontracts

All subcontracts shall be in writing and contain all pertinent provisions and requirements of the prime contract.

Each "Request for Permission to Subcontract" (Mississippi Department of Transportation Form CAD-720) shall include a copy of subcontract for review by the Mississippi Department of Transportation. The federal contract provisions may be omitted from the subcontract copy submitted for review provided the Contractor certifies that the provisions will be physically incorporated into the agreement furnished to the Subcontractor.

In lieu of submitting a copy of the subcontract for review, the Contractor may certify that the subcontract agreement is in writing and that it contains all the requirements and pertinent provisions of the prime contract.

Each Subcontractor will be required to provide a copy of the subcontract agreement for contract compliance reviews, along with physical evidence (copy of FHWA-1273) that requirements and pertinent provisions have been provided for review and adherence.

**REQUIRED CONTRACT PROVISIONS
FEDERAL-AID CONSTRUCTION CONTRACTS**

	Page
I. General -----	1
II. Nondiscrimination -----	1
III. Nonsegregated Facilities -----	3
IV. Payment of Predetermined Minimum Wage -----	3
V. Statements and Payrolls -----	6
VI. Record of Materials, Supplies, and Labor-----	7
VII. Subletting or Assigning the Contract -----	7
VIII. Safety: Accident Prevention -----	7
IX. False Statements Concerning Highway Projects -----	8
X. Implementation of Clean Air Act and Federal Water Pollution Control Act-----	8
XI. Certification Regarding Debarment, Suspension, Ineligibility, and Voluntary Exclusion -----	8
XII. Certification Regarding Use of Contract Funds for Lobbying-----	10

ATTACHMENTS

- A. Employment Preference for Appalachian Contracts
(included in Appalachian contracts only)

I. GENERAL

1. These contract provisions shall apply to all work performed on the contract by the contractor's own organization and with the assistance of workers under the contractor's immediate superintendence and to all work performed on the contract by piecework, station work, or by subcontract.

2. Except as otherwise provided for in each section, the contractor shall insert in each subcontract all of the stipulations contained in these Required Contract Provisions, and further require their inclusion in any lower tier subcontract or purchase order that may in turn be made. The Required Contract Provisions shall not be incorporated by reference in any case. The prime contractor shall be responsible for compliance by any subcontractor or lower tier subcontractor with these Required Contract Provisions.

3. A breach of any of the stipulations contained in these Required Contract Provisions shall be sufficient grounds for termination of the contract.

4. A breach of the following clauses of the Required Contract Provisions may also be grounds for debarment as provided in 29 CFR 5.12:

- Section I, paragraph 2;
- Section IV, paragraphs 1, 2, 3, 4, and 7;
- Section V, paragraphs 1 and 2a through 2g.

5. Disputes arising out of the labor standards provisions of Section IV (except paragraph 5) and Section V of these Required Contract Provisions shall not be subject to the general disputes clause of this contract. Such disputes shall be resolved in accordance with the procedures of the U.S. Department of Labor (DOL) as set forth in 29 CFR 5, 6, and 7. Disputes within the meaning of this clause include disputes between the contractor (or any of its subcontractors) and the contracting agency, the DOL, or the contractor's employees or their representatives.

6. **Selection of Labor:** During the performance of this contract, the contractor shall not:

a. discriminate against labor from any other State, possession, or territory of the United States (except for employment preference for Appalachian contracts, when applicable, as specified in Attachment A), or

b. employ convict labor for any purpose within the limits of the project unless it is labor performed by convicts who are on parole, supervised release, or probation.

II. NONDISCRIMINATION

(Applicable to all Federal-aid construction contracts and to all related subcontracts of \$10,000 or more.)

1. **Equal Employment Opportunity:** Equal employment opportunity (EEO) requirements not to discriminate and to take affirmative action to assure equal opportunity as set forth under laws, executive orders, rules, regulations (28 CFR 35, 29 CFR 1630 and 41 CFR 60) and orders of the Secretary of Labor as modified by the provisions prescribed herein, and imposed pursuant to 23 U.S.C. 140 shall constitute the EEO and specific affirmative action standards for the contractor's project activities under this contract. The Equal Opportunity Construction Contract Specifications set forth under 41 CFR 60-4.3 and the provisions of the American Disabilities Act of 1990 (42 U.S.C. 12101 *et seq.*) set forth under 28 CFR 35 and 29 CFR 1630 are incorporated by reference in this contract. In the execution of this contract, the contractor agrees to comply with the following minimum specific requirement activities of EEO:

a. The contractor will work with the State highway agency (SHA) and the Federal Government in carrying out EEO obligations and in their review of his/her activities under the contract.

b. The contractor will accept as his operating policy the following statement:

"It is the policy of this Company to assure that applicants are employed, and that employees are treated during employment, without regard to their race, religion, sex, color, national origin, age or disability. Such action shall include: employment, upgrading, demotion, or transfer; recruitment or recruitment advertising; layoff or termination; rates of pay or other forms of compensation; and selection for training, including apprenticeship, preapprenticeship, and/or on-the-job training."

2. **EEO Officer:** The contractor will designate and make known to the SHA contracting officers an EEO Officer who will have the responsibility for and must be capable of effectively administering and promoting an active contractor program of EEO and who must be assigned adequate authority and responsibility to do so.

3. **Dissemination of Policy:** All members of the contractor's staff who are authorized to hire, supervise, promote, and discharge employees, or who recommend such action, or who are substantially involved in such action, will be made fully cognizant

of, and will implement, the contractor's EEO policy and contractual responsibilities to provide EEO in each grade and classification of employment. To ensure that the above agreement will be met, the following actions will be taken as a minimum:

a. Periodic meetings of supervisory and personnel office employees will be conducted before the start of work and then not less often than once every six months, at which time the contractor's EEO policy and its implementation will be reviewed and explained. The meetings will be conducted by the EEO Officer.

b. All new supervisory or personnel office employees will be given a thorough indoctrination by the EEO Officer, covering all major aspects of the contractor's EEO obligations within thirty days following their reporting for duty with the contractor.

c. All personnel who are engaged in direct recruitment for the project will be instructed by the EEO Officer in the contractor's procedures for locating and hiring minority group employees.

d. Notices and posters setting forth the contractor's EEO policy will be placed in areas readily accessible to employees, applicants for employment and potential employees.

e. The contractor's EEO policy and the procedures to implement such policy will be brought to the attention of employees by means of meetings, employee handbooks, or other appropriate means.

4. Recruitment: When advertising for employees, the contractor will include in all advertisements for employees the notation: "An Equal Opportunity Employer." All such advertisements will be placed in publications having a large circulation among minority groups in the area from which the project work force would normally be derived.

a. The contractor will, unless precluded by a valid bargaining agreement, conduct systematic and direct recruitment through public and private employee referral sources likely to yield qualified minority group applicants. To meet this requirement, the contractor will identify sources of potential minority group employees, and establish with such identified sources procedures whereby minority group applicants may be referred to the contractor for employment consideration.

b. In the event the contractor has a valid bargaining agreement providing for exclusive hiring hall referrals, he is expected to observe the provisions of that agreement to the extent that the system permits the contractor's compliance with EEO contract provisions. (The DOL has held that where implementation of such agreements have the effect of discriminating against minorities or women, or obligates the contractor to do the same, such implementation violates Executive Order 11246, as amended.)

c. The contractor will encourage his present employees to refer minority group applicants for employment. Information and procedures with regard to referring minority group applicants will be discussed with employees.

5. Personnel Actions: Wages, working conditions, and employee benefits shall be established and administered, and personnel actions of every type, including hiring, upgrading, promotion, transfer, demotion, layoff, and termination, shall be

taken without regard to race, color, religion, sex, national origin, age or disability. The following procedures shall be followed:

a. The contractor will conduct periodic inspections of project sites to insure that working conditions and employee facilities do not indicate discriminatory treatment of project site personnel.

b. The contractor will periodically evaluate the spread of wages paid within each classification to determine any evidence of discriminatory wage practices.

c. The contractor will periodically review selected personnel actions in depth to determine whether there is evidence of discrimination. Where evidence is found, the contractor will promptly take corrective action. If the review indicates that the discrimination may extend beyond the actions reviewed, such corrective action shall include all affected persons.

d. The contractor will promptly investigate all complaints of alleged discrimination made to the contractor in connection with his obligations under this contract, will attempt to resolve such complaints, and will take appropriate corrective action within a reasonable time. If the investigation indicates that the discrimination may affect persons other than the complainant, such corrective action shall include such other persons. Upon completion of each investigation, the contractor will inform every complainant of all of his avenues of appeal.

6. Training and Promotion:

a. The contractor will assist in locating, qualifying, and increasing the skills of minority group and women employees, and applicants for employment.

b. Consistent with the contractor's work force requirements and as permissible under Federal and State regulations, the contractor shall make full use of training programs, i.e., apprenticeship, and on-the-job training programs for the geographical area of contract performance. Where feasible, 25 percent of apprentices or trainees in each occupation shall be in their first year of apprenticeship or training. In the event a special provision for training is provided under this contract, this subparagraph will be superseded as indicated in the special provision.

c. The contractor will advise employees and applicants for employment of available training programs and entrance requirements for each.

d. The contractor will periodically review the training and promotion potential of minority group and women employees and will encourage eligible employees to apply for such training and promotion.

7. Unions: If the contractor relies in whole or in part upon unions as a source of employees, the contractor will use his/her best efforts to obtain the cooperation of such unions to increase opportunities for minority groups and women within the unions, and to effect referrals by such unions of minority and female employees. Actions by the contractor either directly or through a contractor's association acting as agent will include the procedures set forth below:

a. The contractor will use best efforts to develop, in cooperation with the unions, joint training programs aimed toward

qualifying more minority group members and women for membership in the unions and increasing the skills of minority group employees and women so that they may qualify for higher paying employment.

b. The contractor will use best efforts to incorporate an EEO clause into each union agreement to the end that such union will be contractually bound to refer applicants without regard to their race, color, religion, sex, national origin, age or disability.

c. The contractor is to obtain information as to the referral practices and policies of the labor union except that to the extent such information is within the exclusive possession of the labor union and such labor union refuses to furnish such information to the contractor, the contractor shall so certify to the SHA and shall set forth what efforts have been made to obtain such information.

d. In the event the union is unable to provide the contractor with a reasonable flow of minority and women referrals within the time limit set forth in the collective bargaining agreement, the contractor will, through independent recruitment efforts, fill the employment vacancies without regard to race, color, religion, sex, national origin, age or disability; making full efforts to obtain qualified and/or qualifiable minority group persons and women. (The DOL has held that it shall be no excuse that the union with which the contractor has a collective bargaining agreement providing for exclusive referral failed to refer minority employees.) In the event the union referral practice prevents the contractor from meeting the obligations pursuant to Executive Order 11246, as amended, and these special provisions, such contractor shall immediately notify the SHA.

8. Selection of Subcontractors, Procurement of Materials and Leasing of Equipment: The contractor shall not discriminate on the grounds of race, color, religion, sex, national origin, age or disability in the selection and retention of subcontractors, including procurement of materials and leases of equipment.

a. The contractor shall notify all potential subcontractors and suppliers of his/her EEO obligations under this contract.

b. Disadvantaged business enterprises (DBE), as defined in 49 CFR 23, shall have equal opportunity to compete for and perform subcontracts which the contractor enters into pursuant to this contract. The contractor will use his best efforts to solicit bids from and to utilize DBE subcontractors or subcontractors with meaningful minority group and female representation among their employees. Contractors shall obtain lists of DBE construction firms from SHA personnel.

c. The contractor will use his best efforts to ensure subcontractor compliance with their EEO obligations.

9. Records and Reports: The contractor shall keep such records as necessary to document compliance with the EEO requirements. Such records shall be retained for a period of three years following completion of the contract work and shall be available at reasonable times and places for inspection by authorized representatives of the SHA and the FHWA.

a. The records kept by the contractor shall document the following:

(1) The number of minority and non-minority group members and women employed in each work classification on the project;

(2) The progress and efforts being made in cooperation with unions, when applicable, to increase employment opportunities for minorities and women;

(3) The progress and efforts being made in locating, hiring, training, qualifying, and upgrading minority and female employees; and

(4) The progress and efforts being made in securing the services of DBE subcontractors or subcontractors with meaningful minority and female representation among their employees.

b. The contractors will submit an annual report to the SHA each July for the duration of the project, indicating the number of minority, women, and non-minority group employees currently engaged in each work classification required by the contract work. This information is to be reported on Form FHWA-1391. If on-the-job training is being required by special provision, the contractor will be required to collect and report training data.

III. NONSEGREGATED FACILITIES

(Applicable to all Federal-aid construction contracts and to all related subcontracts of \$10,000 or more.)

a. By submission of this bid, the execution of this contract or subcontract, or the consummation of this material supply agreement or purchase order, as appropriate, the bidder, Federal-aid construction contractor, subcontractor, material supplier, or vendor, as appropriate, certifies that the firm does not maintain or provide for its employees any segregated facilities at any of its establishments, and that the firm does not permit its employees to perform their services at any location, under its control, where segregated facilities are maintained. The firm agrees that a breach of this certification is a violation of the EEO provisions of this contract. The firm further certifies that no employee will be denied access to adequate facilities on the basis of sex or disability.

b. As used in this certification, the term "segregated facilities" means any waiting rooms, work areas, restrooms and washrooms, restaurants and other eating areas, timeclocks, locker rooms, and other storage or dressing areas, parking lots, drinking fountains, recreation or entertainment areas, transportation, and housing facilities provided for employees which are segregated by explicit directive, or are, in fact, segregated on the basis of race, color, religion, national origin, age or disability, because of habit, local custom, or otherwise. The only exception will be for the disabled when the demands for accessibility override (e.g. disabled parking).

c. The contractor agrees that it has obtained or will obtain identical certification from proposed subcontractors or material suppliers prior to award of subcontracts or consummation of material supply agreements of \$10,000 or more and that it will retain such certifications in its files.

IV. PAYMENT OF PREDETERMINED MINIMUM WAGE

(Applicable to all Federal-aid construction contracts exceeding \$2,000 and to all related subcontracts, except for projects located on roadways classified as local roads or rural minor collectors, which are exempt.)

1. General:

a. All mechanics and laborers employed or working upon the site of the work will be paid unconditionally and not less often than once a week and without subsequent deduction or rebate on any account [except such payroll deductions as are permitted by regulations (29 CFR 3) issued by the Secretary of Labor under the Copeland Act (40 U.S.C. 276c)] the full amounts of wages and bona fide fringe benefits (or cash equivalents thereof) due at time of payment. The payment shall be computed at wage rates not less than those contained in the wage determination of the Secretary of Labor (hereinafter "the wage determination") which is attached hereto and made a part hereof, regardless of any contractual relationship which may be alleged to exist between the contractor or its subcontractors and such laborers and mechanics. The wage determination (including any additional classifications and wage rates conformed under paragraph 2 of this Section IV and the DOL poster (WH-1321) or Form FHWA-1495) shall be posted at all times by the contractor and its subcontractors at the site of the work in a prominent and accessible place where it can be easily seen by the workers. For the purpose of this Section, contributions made or costs reasonably anticipated for bona fide fringe benefits under Section 1(b)(2) of the Davis-Bacon Act (40 U.S.C. 276a) on behalf of laborers or mechanics are considered wages paid to such laborers or mechanics, subject to the provisions of Section IV, paragraph 3b, hereof. Also, for the purpose of this Section, regular contributions made or costs incurred for more than a weekly period (but not less often than quarterly) under plans, funds, or programs, which cover the particular weekly period, are deemed to be constructively made or incurred during such weekly period. Such laborers and mechanics shall be paid the appropriate wage rate and fringe benefits on the wage determination for the classification of work actually performed, without regard to skill, except as provided in paragraphs 4 and 5 of this Section IV.

b. Laborers or mechanics performing work in more than one classification may be compensated at the rate specified for each classification for the time actually worked therein, provided, that the employer's payroll records accurately set forth the time spent in each classification in which work is performed.

c. All rulings and interpretations of the Davis-Bacon Act and related acts contained in 29 CFR 1, 3, and 5 are herein incorporated by reference in this contract.

2. Classification:

a. The SHA contracting officer shall require that any class of laborers or mechanics employed under the contract, which is not listed in the wage determination, shall be classified in conformance with the wage determination.

b. The contracting officer shall approve an additional classification, wage rate and fringe benefits only when the following criteria have been met:

(1) the work to be performed by the additional classification requested is not performed by a classification in the wage determination;

(2) the additional classification is utilized in the area by the construction industry;

(3) the proposed wage rate, including any bona fide fringe benefits, bears a reasonable relationship to the wage rates contained in the wage determination; and

(4) with respect to helpers, when such a classification prevails in the area in which the work is performed.

c. If the contractor or subcontractors, as appropriate, the laborers and mechanics (if known) to be employed in the additional classification or their representatives, and the contracting officer agree on the classification and wage rate (including the amount designated for fringe benefits where appropriate), a report of the action taken shall be sent by the contracting officer to the DOL, Administrator of the Wage and Hour Division, Employment Standards Administration, Washington, D.C. 20210. The Wage and Hour Administrator, or an authorized representative, will approve, modify, or disapprove every additional classification action within 30 days of receipt and so advise the contracting officer or will notify the contracting officer within the 30-day period that additional time is necessary.

d. In the event the contractor or subcontractors, as appropriate, the laborers or mechanics to be employed in the additional classification or their representatives, and the contracting officer do not agree on the proposed classification and wage rate (including the amount designated for fringe benefits, where appropriate), the contracting officer shall refer the questions, including the views of all interested parties and the recommendation of the contracting officer, to the Wage and Hour Administrator for determination. Said Administrator, or an authorized representative, will issue a determination within 30 days of receipt and so advise the contracting officer or will notify the contracting officer within the 30-day period that additional time is necessary.

e. The wage rate (including fringe benefits where appropriate) determined pursuant to paragraph 2c or 2d of this Section IV shall be paid to all workers performing work in the additional classification from the first day on which work is performed in the classification.

3. Payment of Fringe Benefits:

a. Whenever the minimum wage rate prescribed in the contract for a class of laborers or mechanics includes a fringe benefit which is not expressed as an hourly rate, the contractor or subcontractors, as appropriate, shall either pay the benefit as stated in the wage determination or shall pay another bona fide fringe benefit or an hourly case equivalent thereof.

b. If the contractor or subcontractor, as appropriate, does not make payments to a trustee or other third person, he/she may consider as a part of the wages of any laborer or mechanic the amount of any costs reasonably anticipated in providing bona fide fringe benefits under a plan or program, provided, that the Secretary of Labor has found, upon the written request of the contractor, that the applicable standards of the Davis-Bacon Act have been met. The Secretary of Labor may require the contractor to set aside in a separate account assets for the meeting of obligations under the plan or program.

4. Apprentices and Trainees (Programs of the U.S. DOL) and Helpers:

a. Apprentices:

(1) Apprentices will be permitted to work at less than the predetermined rate for the work they performed when they are employed pursuant to and individually registered in a bona fide apprenticeship program registered with the DOL, Employment and Training Administration, Bureau of Apprenticeship and Training, or with a State apprenticeship agency recognized by the Bureau, or if a person is employed in his/her first 90 days of probationary employment as an apprentice in such an apprenticeship program, who is not individually registered in the program, but who has been certified by the Bureau of Apprenticeship and Training or a State apprenticeship agency (where appropriate) to be eligible for probationary employment as an apprentice.

(2) The allowable ratio of apprentices to journeyman-level employees on the job site in any craft classification shall not be greater than the ratio permitted to the contractor as to the entire work force under the registered program. Any employee listed on a payroll at an apprentice wage rate, who is not registered or otherwise employed as stated above, shall be paid not less than the applicable wage rate listed in the wage determination for the classification of work actually performed. In addition, any apprentice performing work on the job site in excess of the ratio permitted under the registered program shall be paid not less than the applicable wage rate on the wage determination for the work actually performed. Where a contractor or subcontractor is performing construction on a project in a locality other than that in which its program is registered, the ratios and wage rates (expressed in percentages of the journeyman-level hourly rate) specified in the contractor's or subcontractor's registered program shall be observed.

(3) Every apprentice must be paid at not less than the rate specified in the registered program for the apprentice's level of progress, expressed as a percentage of the journeyman-level hourly rate specified in the applicable wage determination. Apprentices shall be paid fringe benefits in accordance with the provisions of the apprenticeship program. If the apprenticeship program does not specify fringe benefits, apprentices must be paid the full amount of fringe benefits listed on the wage determination for the applicable classification. If the Administrator for the Wage and Hour Division determines that a different practice prevails for the applicable apprentice classification, fringes shall be paid in accordance with that determination.

(4) In the event the Bureau of Apprenticeship and Training, or a State apprenticeship agency recognized by the Bureau, withdraws approval of an apprenticeship program, the contractor or subcontractor will no longer be permitted to utilize apprentices at less than the applicable predetermined rate for the comparable work performed by regular employees until an acceptable program is approved.

b. Trainees:

(1) Except as provided in 29 CFR 5.16, trainees will not be permitted to work at less than the predetermined rate for the work performed unless they are employed pursuant to and individually registered in a program which has received prior approval, evidenced by formal certification by the DOL, Employment and Training Administration.

(2) The ratio of trainees to journeyman-level employees on the job site shall not be greater than permitted under the plan approved by the Employment and Training Administration. Any employee listed on the payroll at a trainee rate who is not registered and participating in a training plan approved by the Employment and Training Administration shall be paid not less than the applicable wage rate on the wage determination for the classification of work actually performed. In addition, any trainee performing work on the job site in excess of the ratio permitted under the registered program shall be paid not less than the applicable wage rate on the wage determination for the work actually performed.

(3) Every trainee must be paid at not less than the rate specified in the approved program for his/her level of progress, expressed as a percentage of the journeyman-level hourly rate specified in the applicable wage determination. Trainees shall be paid fringe benefits in accordance with the provisions of the trainee program. If the trainee program does not mention fringe benefits, trainees shall be paid the full amount of fringe benefits listed on the wage determination unless the Administrator of the Wage and Hour Division determines that there is an apprenticeship program associated with the corresponding journeyman-level wage rate on the wage determination which provides for less than full fringe benefits for apprentices, in which case such trainees shall receive the same fringe benefits as apprentices.

(4) In the event the Employment and Training Administration withdraws approval of a training program, the contractor or subcontractor will no longer be permitted to utilize trainees at less than the applicable predetermined rate for the work performed until an acceptable program is approved.

c. Helpers:

Helpers will be permitted to work on a project if the helper classification is specified and defined on the applicable wage determination or is approved pursuant to the conformance procedure set forth in Section IV.2. Any worker listed on a payroll at a helper wage rate, who is not a helper under an approved definition, shall be paid not less than the applicable wage rate on the wage determination for the classification of work actually performed.

5. Apprentices and Trainees (Programs of the U.S. DOT):

Apprentices and trainees working under apprenticeship and skill training programs which have been certified by the Secretary of Transportation as promoting EEO in connection with Federal-aid highway construction programs are not subject to the requirements of paragraph 4 of this Section IV. The straight time hourly wage rates for apprentices and trainees under such programs will be established by the particular programs. The ratio of apprentices and trainees to journeymen shall not be greater than permitted by the terms of the particular program.

6. Withholding:

The SHA shall upon its own action or upon written request of an authorized representative of the DOL withhold, or cause to be withheld, from the contractor or subcontractor under this contract or any other Federal contract with the same prime contractor, or any other Federally-assisted contract subject to Davis-Bacon prevailing wage requirements which is held by the

same prime contractor, as much of the accrued payments or advances as may be considered necessary to pay laborers and mechanics, including apprentices, trainees, and helpers, employed by the contractor or any subcontractor the full amount of wages required by the contract. In the event of failure to pay any laborer or mechanic, including any apprentice, trainee, or helper, employed or working on the site of the work, all or part of the wages required by the contract, the SHA contracting officer may, after written notice to the contractor, take such action as may be necessary to cause the suspension of any further payment, advance, or guarantee of funds until such violations have ceased.

7. Overtime Requirements:

No contractor or subcontractor contracting for any part of the contract work which may require or involve the employment of laborers, mechanics, watchmen, or guards (including apprentices, trainees, and helpers described in paragraphs 4 and 5 above) shall require or permit any laborer, mechanic, watchman, or guard in any workweek in which he/she is employed on such work, to work in excess of 40 hours in such workweek unless such laborer, mechanic, watchman, or guard receives compensation at a rate not less than one-and-one-half times his/her basic rate of pay for all hours worked in excess of 40 hours in such workweek.

8. Violation:

Liability for Unpaid Wages; Liquidated Damages: In the event of any violation of the clause set forth in paragraph 7 above, the contractor and any subcontractor responsible thereof shall be liable to the affected employee for his/her unpaid wages. In addition, such contractor and subcontractor shall be liable to the United States (in the case of work done under contract for the District of Columbia or a territory, to such District or to such territory) for liquidated damages. Such liquidated damages shall be computed with respect to each individual laborer, mechanic, watchman, or guard employed in violation of the clause set forth in paragraph 7, in the sum of \$10 for each calendar day on which such employee was required or permitted to work in excess of the standard work week of 40 hours without payment of the overtime wages required by the clause set forth in paragraph 7.

9. Withholding for Unpaid Wages and Liquidated Damages:

The SHA shall upon its own action or upon written request of any authorized representative of the DOL withhold, or cause to be withheld, from any monies payable on account of work performed by the contractor or subcontractor under any such contract or any other Federal contract with the same prime contractor, or any other Federally-assisted contract subject to the Contract Work Hours and Safety Standards Act, which is held by the same prime contractor, such sums as may be determined to be necessary to satisfy any liabilities of such contractor or subcontractor for unpaid wages and liquidated damages as provided in the clause set forth in paragraph 8 above.

V. STATEMENTS AND PAYROLLS

(Applicable to all Federal-aid construction contracts exceeding \$2,000 and to all related subcontracts, except for projects located on roadways classified as local roads or rural collectors, which are exempt.)

1. Compliance with Copeland Regulations (29 CFR 3):

The contractor shall comply with the Copeland Regulations of the Secretary of Labor which are herein incorporated by reference.

2. Payrolls and Payroll Records:

a. Payrolls and basic records relating thereto shall be maintained by the contractor and each subcontractor during the course of the work and preserved for a period of 3 years from the date of completion of the contract for all laborers, mechanics, apprentices, trainees, watchmen, helpers, and guards working at the site of the work.

b. The payroll records shall contain the name, social security number, and address of each such employee; his or her correct classification; hourly rates of wages paid (including rates of contributions or costs anticipated for bona fide fringe benefits or cash equivalent thereof the types described in Section 1(b)(2)(B) of the Davis Bacon Act); daily and weekly number of hours worked; deductions made; and actual wages paid. In addition, for Appalachian contracts, the payroll records shall contain a notation indicating whether the employee does, or does not, normally reside in the labor area as defined in Attachment A, paragraph 1. Whenever the Secretary of Labor, pursuant to Section IV, paragraph 3b, has found that the wages of any laborer or mechanic include the amount of any costs reasonably anticipated in providing benefits under a plan or program described in Section 1(b)(2)(B) of the Davis Bacon Act, the contractor and each subcontractor shall maintain records which show that the commitment to provide such benefits is enforceable, that the plan or program is financially responsible, that the plan or program has been communicated in writing to the laborers or mechanics affected, and show the cost anticipated or the actual cost incurred in providing benefits. Contractors or subcontractors employing apprentices or trainees under approved programs shall maintain written evidence of the registration of apprentices and trainees, and ratios and wage rates prescribed in the applicable programs.

c. Each contractor and subcontractor shall furnish, each week in which any contract work is performed, to the SHA resident engineer a payroll of wages paid each of its employees (including apprentices, trainees, and helpers, described in Section IV, paragraphs 4 and 5, and watchmen and guards engaged on work during the preceding weekly payroll period). The payroll submitted required to be maintained under paragraph 2b of this Section V. This information may be submitted in any form desired. Optional Form WH-347 is available for this purpose and may be purchased from the Superintendent of Documents (Federal stock number 029-005-0014-1), U.S. Government Printing Office, Washington, D.C. 20402. The prime contractor is responsible for the submission of copies of payrolls by all subcontractors.

d. Each payroll submitted shall be accompanied by a "Statement of Compliance," signed by the contractor or subcontractor or his/her agent who pays or supervises the payment of the persons employed under the contract and shall certify the following:

(1) that the payroll for the payroll period contains the information required to be maintained under paragraph 2b of this Section V and that such information is correct and complete;

(2) that such laborer or mechanic (including each helper, apprentice, and trainee) employed on the contract during the payroll period has been paid the full weekly wages earned,

without rebate, either directly or indirectly, and that no deductions have been made either directly or indirectly from the full wages earned, other than permissible deductions as set forth in the Regulations, 29 CFR 3;

(3) that each laborer or mechanic has been paid not less than the applicable wage rate and fringe benefits or cash equivalent for the classification of work performed, as specified in the applicable wage determination incorporated into the contract.

e. The weekly submission of a properly executed certification set forth on the reverse side of Optional Form WH-347 shall satisfy the requirement for submission of the "Statement of Compliance" required by paragraph 2d of this Section V.

f. The falsification of any of the above certifications may subject the contractor to civil or criminal prosecution under 18 U.S.C. 1001 and 31 U.S.C. 231.

g. The contractor or subcontractor shall make the records required under paragraph 2b of this Section V available for inspection, copying, or transcription by authorized representatives of the SHA, the FHWA, or the DOL, and shall permit such representatives to interview employees during working hours on the job. If the contractor or subcontractor fails to submit the required records or to make them available, the SHA, the FHWA, the DOL, or all may, after written notice to the contractor, sponsor, applicant, or owner, take such actions as may be necessary to cause the suspension of any further payment, advance, or guarantee of funds. Furthermore, failure to submit the required records upon request or to make such records available may be grounds for debarment action pursuant to 29 CFR 5.12.

VI. RECORD OF MATERIALS, SUPPLIES, AND LABOR

1. On all Federal-aid contracts on the National Highway System, except those which provide solely for the installation of protective devices at railroad grade crossings, those which are constructed on a force account or direct labor basis, highway beautification contracts, and contracts for which the total final construction cost for roadway and bridge is less than \$1,000,000 (23 CFR 635) the contractor shall:

a. Become familiar with the list of specific materials and supplies contained in Form FHWA-47, "Statement of Materials and Labor Used by Contractor of Highway Construction Involving Federal Funds," prior to the commencement of work under this contract.

b. Maintain a record of the total cost of all materials and supplies purchased for and incorporated in the work, and also of the quantities of those specific materials and supplies listed on Form FHWA-47, and in the units shown on Form FHWA-47.

c. Furnish, upon the completion of the contract, to the SHA resident engineer on Form FHWA-47 together with the data required in paragraph 1b relative to materials and supplies, a final labor summary of all contract work indicating the total hours worked and the total amount earned.

2. At the prime contractor's option, either a single report covering all contract work or separate reports for the contractor and for each subcontract shall be submitted.

VII. SUBLETTING OR ASSIGNING THE CONTRACT

1. The contractor shall perform with its own organization contract work amounting to not less than 30 percent (or a greater percentage if specified elsewhere in the contract) of the total original contract price, excluding any specialty items designated by the State. Specialty items may be performed by subcontract and the amount of any such specialty items performed may be deducted from the total original contract price before computing the amount of work required to be performed by the contractor's own organization (23 CFR 635).

a. "Its own organization" shall be construed to include only workers employed and paid directly by the prime contractor and equipment owned or rented by the prime contractor, with or without operators. Such term does not include employees or equipment of a subcontractor, assignee, or agent of the prime contractor.

b. "Specialty Items" shall be construed to be limited to work that requires highly specialized knowledge, abilities, or equipment not ordinarily available in the type of contracting organizations qualified and expected to bid on the contract as a whole and in general are to be limited to minor components of the overall contract.

2. The contract amount upon which the requirements set forth in paragraph 1 of Section VII is computed includes the cost of material and manufactured products which are to be purchased or produced by the contractor under the contract provisions.

3. The contractor shall furnish (a) a competent superintendent or supervisor who is employed by the firm, has full authority to direct performance of the work in accordance with the contract requirements, and is in charge of all construction operations (regardless of who performs the work) and (b) such other of its own organizational resources (supervision, management, and engineering services) as the SHA contracting officer determines is necessary to assure the performance of the contract.

4. No portion of the contract shall be sublet, assigned or otherwise disposed of except with the written consent of the SHA contracting officer, or authorized representative, and such consent when given shall not be construed to relieve the contractor of any responsibility for the fulfillment of the contract. Written consent will be given only after the SHA has assured that each subcontract is evidenced in writing and that it contains all pertinent provisions and requirements of the prime contract.

VIII. SAFETY: ACCIDENT PREVENTION

1. In the performance of this contract the contractor shall comply with all applicable Federal, State, and local laws governing safety, health, and sanitation (23 CFR 635). The contractor shall provide all safeguards, safety devices and protective equipment and take any other needed actions as it determines, or as the SHA contracting officer may determine, to be reasonably necessary to protect the life and health of employees on the job and the safety of the public and to protect property in connection with the performance of the work covered by the contract.

2. It is a condition of this contract, and shall be made a condition of each subcontract, which the contractor enters into pursuant to this contract, that the contractor and any subcontractor shall not permit any employee, in performance of the contract, to work in surroundings or under conditions which are unsanitary,

hazardous or dangerous to his/her health or safety, as determined under construction safety and health standards (29 CFR 1926) promulgated by the Secretary of Labor, in accordance with Section 107 of the Contract Work Hours and Safety Standards Act (40 U.S.C. 333).

3. Pursuant to 29 CFR 1926.3, it is a condition of this contract that the Secretary of Labor or authorized representative thereof, shall have right of entry to any site of contract performance to inspect or investigate the matter of compliance with the construction safety and health standards and to carry out the duties of the Secretary under Section 107 of the Contract Work Hours and Safety Standards Act (40 U.S.C. 333).

IX. FALSE STATEMENTS CONCERNING HIGHWAY PROJECTS

In order to assure high quality and durable construction in conformity with approved plans and specifications and a high degree of reliability on statements and representations made by engineers, contractors, suppliers, and workers on Federal-aid highway projects, it is essential that all persons concerned with the project perform their functions as carefully, thoroughly, and honestly as possible. Willful falsification, distortion, or misrepresentation with respect to any facts related to the project is a violation of Federal law. To prevent any misunderstanding regarding the seriousness of these and similar acts, the following notice shall be posted on each Federal-aid highway project (23 CFR 635) in one or more places where it is readily available to all persons concerned with the project:

NOTICE TO ALL PERSONNEL ENGAGED ON FEDERAL-AID HIGHWAY PROJECTS

18 U.S.C. 1020 reads as follows:

"Whoever, being an officer, agent, or employee of the United States, or of any State or Territory, or whoever, whether a person, association, firm, or corporation, knowingly makes any false statement, false representation, or false report as to the character, quality, quantity, or cost of the material used or to be used, or the quantity or quality of the work performed or to be performed, or the cost thereof in connection with the submission of plans, maps, specifications, contracts, or costs of construction on any highway or related project submitted for approval to the Secretary of Transportation; or

Whoever knowingly makes any false statement, false representation, false report or false claim with respect to the character, quality, quantity, or cost of any work performed or to be performed, or materials furnished or to be furnished, in connection with the construction of any highway or related project approved by the Secretary of Transportation; or

Whoever knowingly makes any false statement or false representation as to material fact in any statement, certificate, or report submitted pursuant to provisions of the Federal-aid Roads Act approved July 1, 1916, (39 Stat. 355), as amended and supplemented;

Shall be fined not more than \$10,000 or imprisoned not more than 5 years or both."

X. IMPLEMENTATION OF CLEAN AIR ACT AND FEDERAL WATER POLLUTION CONTROL ACT

(Applicable to all Federal-aid construction contracts and to all related subcontracts of \$100,000 or more.)

By submission of this bid or the execution of this contract, or subcontract, as appropriate, the bidder, Federal-aid construction contractor, or subcontractor, as appropriate, will be deemed to have stipulated as follows:

1. That any facility that is or will be utilized in the performance of this contract, unless such contract is exempt under the Clean Air Act, as amended (42 U.S.C. 1857 et seq., as amended by Pub.L. 91-604), and under the Federal Water Pollution Control Act, as amended (33 U.S.C. 1251 et seq., as amended by Pub.L. 92-500), Executive Order 11738, and regulations in implementation thereof (40 CFR 15) is not listed, on the date of contract award, on the U.S. Environmental Protection Agency (EPA) List of Violating Facilities pursuant to 40 CFR 15.20.

2. That the firm agrees to comply and remain in compliance with all the requirements of Section 114 of the Clean Air Act and Section 308 of the Federal Water Pollution Control Act and all regulations and guidelines listed thereunder.

3. That the firm shall promptly notify the SHA of the receipt of any communication from the Director, Office of Federal Activities, EPA, indicating that a facility that is or will be utilized for the contract is under consideration to be listed on the EPA List of Violating Facilities.

4. That the firm agrees to include or cause to be included the requirements of paragraph 1 through 4 of this Section X in every nonexempt subcontract, and further agrees to take such action as the government may direct as a means of enforcing such requirements.

XI. CERTIFICATION REGARDING DEBARMENT, SUSPENSION, INELIGIBILITY AND VOLUNTARY EXCLUSION

1. Instructions for Certification - Primary Covered Transactions:

(Applicable to all Federal-aid contracts - 49 CFR 29)

a. By signing and submitting this proposal, the prospective primary participant is providing the certification set out below.

b. The inability of a person to provide the certification set out below will not necessarily result in denial of participation in this covered transaction. The prospective participant shall submit an explanation of why it cannot provide the certification set out below. The certification or explanation will be considered in connection with the department or agency's determination whether to enter into this transaction. However, failure of the prospective primary participant to furnish a certification or an explanation shall disqualify such a person from participation in this transaction.

c. The certification in this clause is a material representation of fact upon which reliance was placed when the department or agency determined to enter into this transaction. If it is later determined that the prospective primary participant knowingly rendered an erroneous certification, in addition to other remedies available to the Federal Government, the department or agency may terminate this transaction for cause of default.

d. The prospective primary participant shall provide immediate written notice to the department or agency to whom this proposal is submitted if any time the prospective primary participant learns that its certification was erroneous when submitted or has become erroneous by reason of changed circumstances.

e. The terms "covered transaction," "debarred," "suspended," "ineligible," "lower tier covered transaction," "participant," "person," "primary covered transaction," "principal," "proposal," and "voluntarily excluded," as used in this clause, have the meanings set out in the Definitions and Coverage sections of rules implementing Executive Order 12549. You may contact the department or agency to which this proposal is submitted for assistance in obtaining a copy of those regulations.

f. The prospective primary participant agrees by submitting this proposal that, should the proposed covered transaction be entered into, it shall not knowingly enter into any lower tier covered transaction with a person who is debarred, suspended, declared ineligible, or voluntarily excluded from participation in this covered transaction, unless authorized by the department or agency entering into this transaction.

g. The prospective primary participant further agrees by submitting this proposal that it will include the clause titled "Certification Regarding Debarment, Suspension, Ineligibility and Voluntary Exclusion-Lower Tier Covered Transaction," provided by the department or agency entering into this covered transaction, without modification, in all lower tier covered transactions and in all solicitations for lower tier covered transactions.

h. A participant in a covered transaction may rely upon a certification of a prospective participant in a lower tier covered transaction that is not debarred, suspended, ineligible, or voluntarily excluded from the covered transaction, unless it knows that the certification is erroneous. A participant may decide the method and frequency by which it determines the eligibility of its principals. Each participant may, but is not required to, check the nonprocurement portion of the "Lists of Parties Excluded From Federal Procurement or Nonprocurement Programs" (Nonprocurement List) which is compiled by the General Services Administration.

i. Nothing contained in the foregoing shall be construed to require establishment of a system of records in order to render in good faith the certification required by this clause. The knowledge and information of participant is not required to exceed that which is normally possessed by a prudent person in the ordinary course of business dealings.

j. Except for transactions authorized under paragraph f of these instructions, if a participant in a covered transaction knowingly enters into a lower tier covered transaction with a person who is suspended, debarred, ineligible, or voluntarily excluded from participation in this transaction, in addition to other remedies available to the Federal Government, the department or agency may terminate this transaction for cause or default.

Certification Regarding Debarment, Suspension, Ineligibility and Voluntary Exclusion--Primary Covered Transactions

1. The prospective primary participant certifies to the best of its knowledge and belief, that it and its principals:

a. Are not presently debarred, suspended, proposed for debarment, declared ineligible, or voluntarily excluded from covered transactions by any Federal department or agency;

b. Have not within a 3-year period preceding this proposal been convicted of or had a civil judgement rendered against them for commission of fraud or a criminal offense in connection with obtaining, attempting to obtain, or performing a public (Federal, State or local) transaction or contract under a public transaction; violation of Federal or State antitrust statutes or commission of embezzlement, theft, forgery, bribery, falsification or destruction of records, making false statements, or receiving stolen property;

c. Are not presently indicted for or otherwise criminally or civilly charged by a governmental entity (Federal, State or local) with commission of any of the offenses enumerated in paragraph 1b of this certification; and

d. Have not within a 3-year period preceding this application/proposal had one or more public transactions (Federal, State or local) terminated for cause or default.

2. Where the prospective primary participant is unable to certify to any of the statements in this certification, such prospective participant shall attach an explanation to this proposal.

2. Instructions for Certification - Lower Tier Covered Transactions:

(Applicable to all subcontracts, purchase orders and other lower tier transactions of \$25,000 or more - 49 CFR 29)

a. By signing and submitting this proposal, the prospective lower tier is providing the certification set out below.

b. The certification in this clause is a material representation of fact upon which reliance was placed when this transaction was entered into. If it is later determined that the prospective lower tier participant knowingly rendered an erroneous certification, in addition to other remedies available to the Federal Government, the department, or agency with which this transaction originated may pursue available remedies, including suspension and/or debarment.

c. The prospective lower tier participant shall provide immediate written notice to the person to which this proposal is submitted if at any time the prospective lower tier participant learns that its certification was erroneous by reason of changed circumstances.

d. The terms "covered transaction," "debarred," "suspended," "ineligible," "primary covered transaction," "participant," "person," "principal," "proposal," and "voluntarily excluded," as used in this clause, have the meanings set out in the Definitions and Coverage sections of rules implementing Executive

Order 12549. You may contact the person to which this proposal is submitted for assistance in obtaining a copy of those regulations.

e. The prospective lower tier participant agrees by submitting this proposal that, should the proposed covered transaction be entered into, it shall not knowingly enter into any lower tier covered transaction with a person who is debarred, suspended, declared ineligible, or voluntarily excluded from participation in this covered transaction, unless authorized by the department or agency with which this transaction originated.

f. The prospective lower tier participant further agrees by submitting this proposal that it will include this clause titled "Certification Regarding Debarment, Suspension, Ineligibility and Voluntary Exclusion-Lower Tier Covered Transaction," without modification, in all lower tier covered transactions and in all solicitations for lower tier covered transactions.

g. A participant in a covered transaction may rely upon a certification of a prospective participant in a lower tier covered transaction that is not debarred, suspended, ineligible, or voluntarily excluded from the covered transaction, unless it knows that the certification is erroneous. A participant may decide the method and frequency by which it determines the eligibility of its principals. Each participant may, but is not required to, check the Nonprocurement List.

h. Nothing contained in the foregoing shall be construed to require establishment of a system of records in order to render in good faith the certification required by this clause. The knowledge and information of participant is not required to exceed that which is normally possessed by a prudent person in the ordinary course of business dealings.

i. Except for transactions authorized under paragraph e of these instructions, if a participant in a covered transaction knowingly enters into a lower tier covered transaction with a person who is suspended, debarred, ineligible, or voluntarily excluded from participation in this transaction, in addition to other remedies available to the Federal Government, the department or agency with which this transaction originated may pursue available remedies, including suspension and/or debarment.

* * * * *

Certification Regarding Debarment, Suspension, Ineligibility and Voluntary Exclusion—Lower Tier Covered Transactions:

1. The prospective lower tier participant certifies, by submission of this proposal, that neither it nor its principals is presently debarred, suspended, proposed for debarment, declared

ineligible, or voluntarily excluded from participation in this transaction by any Federal department or agency.

2. Where the prospective lower tier participant is unable to certify to any of the statements in this certification, such prospective participant shall attach an explanation to this proposal.

* * * * *

XII. CERTIFICATION REGARDING USE OF CONTRACT FUNDS FOR LOBBYING

(Applicable to all Federal-aid construction contracts and to all related subcontracts which exceed \$100,000 - 49 CFR 20)

1. The prospective participant certifies, by signing and submitting this bid or proposal, to the best of his or her knowledge and belief, that:

a. No Federal appropriated funds have been paid or will be paid, by or on behalf of the undersigned, to any person for influencing or attempting to influence an officer or employee of any Federal agency, a Member of Congress, an officer or employee of Congress, or an employee of a Member of Congress in connection with the awarding of any Federal contract, the making of any Federal grant, the making of any Federal loan, the entering into of any cooperative agreement, and the extension, continuation, renewal, amendment, or modification of any Federal contract, grant, loan, or cooperative agreement.

b. If any funds other than Federal appropriated funds have been paid or will be paid to any person for influencing or attempting to influence an officer or employee of any Federal agency, a Member of Congress, an officer or employee of Congress, or an employee of a Member of Congress in connection with this Federal contract, grant, loan, or cooperative agreement, the undersigned shall complete and submit Standard Form-LLL, "Disclosure Form to Report Lobbying," in accordance with its instructions.

2. This certification is a material representation of fact upon which reliance was placed when this transaction was made or entered into. Submission of this certification is a prerequisite for making or entering into this transaction imposed by 31 U.S.C. 1352. Any person who fails to file the required certification shall be subject to a civil penalty of not less than \$10,000 and not more than \$100,000 for each such failure.

3. The prospective participant also agrees by submitting his or her bid or proposal that he or she shall require that the language of this certification be included in all lower tier subcontracts, which exceed \$100,000 and that all such recipients shall certify and disclose accordingly.

**NOTICE OF REQUIREMENTS FOR AFFIRMATIVE
ACTION TO ENSURE EQUAL EMPLOYMENT
OPPORTUNITY (EXECUTIVE ORDER 11246)**

1. The Offeror's or Bidder's attention is called to the "Equal Opportunity Clause" and the "Standard Federal Equal Employment Opportunity Construction Contract Specifications" set forth herein.

2. The goals and timetables for minority and female participation, expressed in percentage terms for the Contractor's aggregate workforce in each trade on all construction work in the covered area, are as follows:

Timetables	Goals for female participation in each trade (percent)
From April 1, 1978 until March 31, 1979	3.1
From April 1, 1979 until March 31, 1980	5.1
From April 1, 1980 until March 31, 1981	6.9

Until further notice	Goals for minority participation for each trade (percent)
----------------------	---

SHSA Cities:

Pascagoula - Moss Point -----	16.9
Biloxi - Gulfport-----	19.2
Jackson-----	30.3

SMSA Counties:

Desoto-----	32.3
Hancock, Harrison, Stone-----	19.2
Hinds, Rankin-----	30.3
Jackson-----	16.9

Non-SMSA Counties:

George, Greene -----	26.4
----------------------	------

Alcorn, Benton, Bolivar, Calhoun, Carroll, Chickasaw, Clay, Coahoma, Grenada, Itawamba, Lafayette, Lee, Leflore, Marshall, Monroe, Montgomery, Panola, Pontotoc, Prentiss, Quitman, Sunflower, Tallahatchie, Tate, Tippah, Tishomingo, Tunica, Union, Washington, Webster, Yalobusha-----	26.5
--	------

Attala, Choctaw, Claiborne, Clarke, Copiah, Covington, Franklin, Holmes, Humphreys, Issaquena, Jasper, Jefferson, Jefferson Davis, Jones Kemper, Lauderdale, Lawrence, Leake, Lincoln, Lowndes, Madison, Neshoba, Newton, Noxubee, Oktibbeha, Scott, Sharkey, Simpson, Smith, Warren, Wayne, Winston, Yazoo -----	32.0
--	------

Forrest, Lamar, Marion, Pearl River, Perry, Pike, Walthall -----	27.7
---	------

Adams, Amite, Wilkinson-----	30.4
------------------------------	------

These goals are applicable to all the Contractor's construction work (whether or not it is Federal or federally assisted) performed in the covered area. If the contractor performs construction work in a geographical area located outside of the covered area, it shall apply the goals established for such geographical area where the work is actually performed. With regard to this second area, the contractor also is subject to the goals for both its federally involved and nonfederally involved construction.

The Contractor's compliance with the Executive Order and the regulations in CFR Part 60-4 shall be based on its implementation of the Equal Opportunity clause, specific affirmative action obligations required by the specifications set forth in 41 CFR 60-4.3(a), and its efforts to meet the goals. The hours of minority and female employment and training must be substantially uniform throughout the length of the contract, and in each trade, and the Contractor shall make a good faith effort to employ minorities and women evenly on each of its projects. The transfer of minority or female employees or trainees from Contractor to Contractor or from project to project for the sole purpose of meeting the Contractor's goals shall be a violation of the contract, the Executive Order and the regulations in 41 CFR Part 60-4. Compliance with the goals will be measured against the total work hours performed.

3. The Contractor shall provide written notification to the Director of the Office of Federal Contract Compliance Programs within 10 working days of award of any construction subcontract in excess of \$10,000 at any tier for construction work under the contract resulting from this solicitation. The notification shall list the name, address and telephone number of the subcontractor, employer identification number of the subcontractor, estimated dollar amount of the subcontract; estimated starting and completion dates of the subcontract; and the geographical area in which the subcontract is to be performed.

4. As used in this Notice, and in the contract resulting from this solicitation, the "covered area" is to the county and city (if any), stated in the advertisement.

5. The notification required in Paragraph 3 shall be addressed to the following:

Contract Compliance Officer
Mississippi Department of Transportation
P.O. Box 1850
Jackson, Mississippi 39215-1850

MISSISSIPPI DEPARTMENT OF TRANSPORTATION

SPECIAL PROVISION NO. 907-101-4M

CODE: (IS)

DATE: 11/05/2008

SUBJECT: Definitions

Section 101, Definitions and Terms, of the 1996 Metric Edition of the Mississippi Standard Specifications for Road and Bridge Construction is hereby amended as follows:

907-101.02--Definitions. Replace the following definitions in Subsection 101.02 on pages 101-2 through 101-12.

Contract - The written agreement between the Mississippi Transportation Commission and the Contractor setting forth the obligations of the parties thereunder, including but not limited to, the performance of the work, the furnishing of labor and materials, and the basis of payment.

The contract includes the invitation for bids, proposal, contract form and contract bonds, specifications, supplemental specifications, interim specifications, general and detailed plans, special provisions, notices to bidders, notice to proceed, and also any agreements that are required to complete the construction of the work in an acceptable manner, including authorized extensions thereof, all of which constitute one instrument.

Contract Bonds - The approved form of security(ies), executed by the Contractor and the Contractor's Surety(ies), guaranteeing complete execution of the contract and all supplemental agreements pertaining thereto and the payment of all legal debts pertaining to the construction of the project. This term includes Performance and Payment Bonds.

Optional Items - Items listed in the bid schedule of the proposal which are considered to be comparable for the purpose intended, and the Contractor is required to make a selection prior to or at the time of execution of the contract.

Surety - A corporate body, qualified under the laws of Mississippi, which is bound with and for the successful bidder by "contract bonds" to guarantee acceptable performance of the contract and payment of all legal taxes and debts pertaining to the construction of the project, including payment of State Sales Tax as prescribed by law, and any overpayment made to the Contractor.

Add the following to the list of definitions in Subsection 101.02 on pages 101-2 through 101-12.

Performance Bond - The approved form of security, executed by the Contractor and issued by the Contractor's Surety(ies), guaranteeing satisfactory completion of the contract and all supplemental agreements pertaining thereto.

Payment Bond - The approved form of security, executed by the Contractor and issued by the Contractor's Surety(ies), guaranteeing the payment of all legal debts pertaining to the

construction of the project including, but not limited to, the labor and materials of subcontractors and suppliers to the prime contractor.

Wetlands - As defined in EPA and Corps of Engineer's (Corps) regulations and clarified in the Corps 1987 Wetlands Delineation Manual, or sequent Federal wetland delineation manuals.

Delete Figure 1 at the end of Section 101 on page 101-13, and substitute the following:

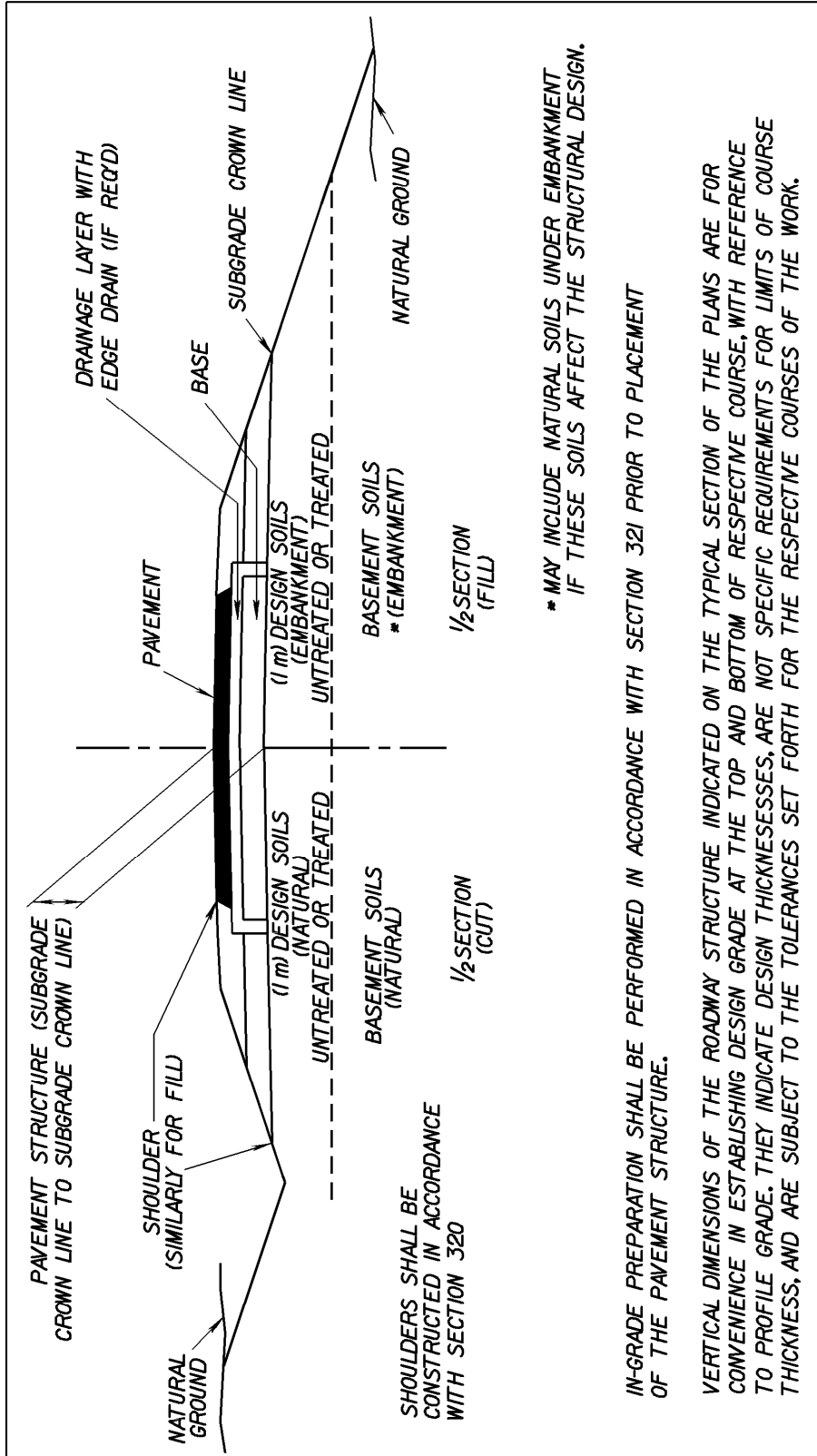

IN-GRADE PREPARATION SHALL BE PERFORMED IN ACCORDANCE WITH SECTION 321 PRIOR TO PLACEMENT OF THE PAVEMENT STRUCTURE.

VERTICAL DIMENSIONS OF THE ROADWAY STRUCTURE INDICATED ON THE TYPICAL SECTION OF THE PLANS ARE FOR CONVENIENCE IN ESTABLISHING DESIGN GRADE AT THE TOP AND BOTTOM OF RESPECTIVE COURSE, WITH REFERENCE TO PROFILE GRADE. THEY INDICATE DESIGN THICKNESSES, ARE NOT SPECIFIC REQUIREMENTS FOR LIMITS OF COURSE THICKNESS, AND ARE SUBJECT TO THE TOLERANCES SET FORTH FOR THE RESPECTIVE COURSES OF THE WORK.

FIGURE 1 - REFERENCE DIVISION 100 - PAGE 101-1

MISSISSIPPI DEPARTMENT OF TRANSPORTATION

| SPECIAL PROVISION NO. 907-102-8M

CODE: (IS)

| DATE: 01/20/2011

SUBJECT: Bidding Requirements and Conditions

Section 102, Bidding Requirements and Conditions, of the 1996 Metric Edition of the Mississippi Standard Specifications for Road and Bridge Construction is hereby amended as follows:

907-102.06--Preparation of Proposal. Delete the fifth paragraph of Subsection 102.06 on page 102-4 and substitute the following:

Bid sheets generated by the Department's Electronic Bid System (Transport Expedite Bid) along with a completed proposal package will constitute the official bid and shall be signed on the last sheet of the Expedite Bid generated bid sheets and delivered to the Department in accordance with the provisions of Subsection 102.09.

Bidders are cautioned that using other versions of the Expedite Bid may result in improperly printed bid sheets. The correct version of Expedite Bid can be obtained at no cost from the MDOT Contract Administration Division or at the MDOT website, www.gomdot.com.

If bidders submit Expedite Bid generated bid sheets, then the bid sheets included in the proposal should not be completed. The Expedite Bid generated bid sheets should be stapled together, signed and included in the bid proposal package in the sealed envelope. If both the forms in the proposal and the Expedite Bid generated bid sheets are completed and submitted, only the Expedite Bid generated sheets will be recognized and used for the official bid. The USB Flash Drive containing the information printed on the Expedite Bid generated bid sheets should be placed in the padded envelope included with the bid proposal package and enclosed in the sealed envelope. Bid sheets printed from Expedite Bid should be a representation of the data returned on the flash drive. To have a true representation of the bid sheets, the Bidder must copy the EBS and EBS amendment files used to prepare the bid sheets to the flash drive. Otherwise, the unit prices bid will not be recorded to the flash drive. Bidders are cautioned that failure to follow proper flash drive handling procedures could result in the Department being unable to process the flash drive. Any modification or manipulation of the data contained on the flash drive, other than entering unit bid prices and completing all required Expedite Bid sections, will not be allowed and will cause the Contractor's bid to be considered irregular.

It is the responsibility of every bidder to check for any addendum or modification to the contract document(s) for which they intend to submit a response. It shall be the bidder's responsibility to be sure they are in receipt of all addenda, pre-bid conference information, and/or questions and answers provided at, or subsequent to, the pre-bid conference, if any are issued.

The Mississippi Transportation Commission has no responsibility for defects, irregularities or

other problems caused by the use of electronic media. Operation of this electronic media is done at the sole risk of the user.

When the bid schedule lists optional items, the Contractor's selection may, but is not required to, be made at the time of bidding. For optional items not pre-selected, the Contractor's selection shall be made prior to or at the time of execution of the contract.

907-102.08--Proposal Guaranty. Delete the first and second paragraphs in Subsection 102.08 on page 102-5 and substitute the following:

No proposal will be considered unless accompanied by certified check, cashier's check or bid bond, made payable to the State of Mississippi, in an amount of not less than five percent (5%) of the total amount of the proposal offered. The guaranty shall be evidence of good faith that, if awarded the contract, the bidder will execute the contract and give performance and payment contract bonds as stipulated in Subsection 907-103.05.1, 907-103.05.2, and as required by law.

If a bid bond is offered as guaranty, the bond must be on a form approved by the Executive Director, made by a Surety acceptable to the Executive Director and signed or countersigned by a Mississippi Agent or Qualified Nonresident Agent and the Bidder. Such bid bond shall also conform to the requirements and conditions stipulated in Subsection 907-103.05.2 as applicable.

MISSISSIPPI DEPARTMENT OF TRANSPORTATION

| SPECIAL PROVISION NO. 907-103-7M

CODE: (SP)

| DATE: 12/15/2009

SUBJECT: Award and Execution of Contract

Section 103, Award and Execution of the Contract, of the 1996 Metric Edition of the Mississippi Standard Specifications for Road and Bridge Construction is hereby amended as follows:

907-103.01-Consideration of Proposals. Delete the third paragraph of Subsection 103.01 on page 103-1, and substitute the following:

In consideration of contract proposals which are equal to or in excess of \$50,000 and financed 100% with State funds, a nonresident bidder domiciled in a state having laws granting preference to local Contractors will be considered for such contracts on the same basis as the nonresident bidder's state awards contracts to Mississippi Contractors bidding under similar circumstances. When a nonresident Contractor submits a bid equal to or in excess of \$50,000 on a contract financed 100% with State funds, a copy of the current laws from the state of domicile and an explanation thereof pertaining to treatment of nonresident Contractors shall be attached. If no preferential treatment is provided for Contractors in the state of domicile and contracts are awarded to the lowest responsible bidder, a statement to this effect shall be attached. Should the attachment not accompany the bid when submitted, the Contractor shall have 10 days following the opening of the bids to furnish the required information to the Contract Administration Engineer for attachment to the bid. As used herein, the term "resident Contractors" includes a nonresident person, firm or corporation that has been qualified to do business in this State and has maintained a permanent full-time office in the State of Mississippi for two years prior to January 1, 1986, and the subsidiaries and affiliates of such a person, firm or corporation.

907-103.04--Return of Proposal Guaranty. Delete the second paragraph of Subsection 103.04 on page 103-2 and substitute the following:

Certified checks or cashier's checks submitted as proposal guaranties, except those of the two lowest bidders, will be returned within 10 days of contract award. The retained proposal guaranty of the unsuccessful of the two lowest bidders will be returned within ten days following the execution of a contract with the successful low bidder. The retained proposal guaranty of the successful bidder will be returned after satisfactory performance and payment bonds have been furnished and the contract has been executed.

In the event all bids are rejected by the Commission, certified checks or cashier's checks submitted as proposal guaranty by all bidders will be returned within 10 days of rejection.

Delete the third paragraph of Subsection 103.04 on page 103-2 and substitute the following:

In the event no award is made within **30 days** after the opening of bids, the Executive Director may permit the successful bidder to replace the certified check or cashier's check with a satisfactory bidder's bond.

Delete Subsection 103.05 on page 103-2 and substitute the following:

907-103.05--Contract Bonds.

907-103.05.1--Requirement of Contract Bonds. Prior to the execution of the contract, the successful bidder shall execute and deliver to the Executive Director a performance and payment bond(s) in a sum equal to the full amount of the contract as a guaranty for complete and full performance of the contract and the protection of the claimants and the Department for materials and equipment and full payment of wages [in accordance with Section 65-1-85 Miss. Code Ann. \(1972 as amended\)](#). In the event of award of a joint bid, each individual, partnership, firm or corporation shall assume jointly the full obligations under the contract and the contract bond(s).

907-103.05.2--Form of Bonds. The form of bonds shall be that provided by or acceptable to the Department. These bonds shall be executed by a [Mississippi agent](#) or [qualified](#) nonresident agent and shall be accompanied by a certification as to authorization of the attorney-in-fact to commit the Surety company. A power of attorney [exhibiting the Surety's original seal](#) supporting the [Mississippi agent](#) or [the qualified](#) nonresident agent's signature shall be furnished with each bond. The Surety company shall be currently authorized and licensed in good standing to conduct business in the State of Mississippi with a minimum rating by A.M. Best of (A-) in the latest printing "Best's Key Rating Guide" to write individual bonds up to ten percent of the policy holders' surplus or listed on the current list of "Companies Holding Certificates of Authority as Acceptable Sureties on Federal Bonds and as Acceptable Reinsuring Companies" as published by the United States Department of the Treasury, Financial Management Service, Circular 570 (latest revision as published and supplemented on the Financial Management Service Web site and in the Federal Register) within the underwriting limits listed for that Surety. All required signatures on the bond(s) and certifications shall be original signatures, in ink, and not mechanical reproductions or facsimiles. The [Mississippi agent](#) or [qualified](#) nonresident agent shall be in good standing and currently licensed by the Insurance Commissioner of the State of Mississippi to represent the Surety company(ies) executing the bonds.

Surety bonds shall continue to be acceptable to the Commission throughout the life of the Contract and shall not be canceled by the Surety without the consent of the Department. In the event the Surety fails or becomes financially insolvent, the Contractor shall file a new Bond in the amount designated by the Executive Director within thirty (30) days of such failure, insolvency, or bankruptcy. Subsequent to award of Contract, the Commission or the Department may [require additional security for any supplemental agreements executed under the contract or replacement security in the event of the surety\(ies\) loss of the ratings](#) required above. Suits concerning bonds shall be filed in the State of Mississippi.

Delete in toto Subsection 103.07 on page 103-2, and substitute the following:

907-103.07--Execution and Approval of Contract. The successful bidder to whom the contract has been awarded shall sign and file with the Director the contract and all documents required by the contract within **10 days** after the contract has been mailed to the bidder. The contract may require certain documents be submitted at an earlier date, in which case, those documents shall be submitted within the time frame specified. If the contract is not executed by the Department within 15 days following receipt of the signed contract and all necessary documents, the bidder shall have the right to withdraw his bid without penalty. No contract is in effect until it is executed by all parties.

907-103.08--Failure to Execute Contract. Delete in toto Subsection 103.08 on page 103-2, and substitute the following:

Failure of the bidder to execute the contract and file acceptable performance and payment bonds within **10 days** shall be just cause for the cancellation of the award and forfeiture of the proposal guaranty which shall become the property of the Department, not as a penalty but in liquidation of damages sustained. Award may then be made to the next lowest responsible bidder, or the work may be readvertised at the discretion of the Department.

MISSISSIPPI DEPARTMENT OF TRANSPORTATION

SPECIAL PROVISION NO. 907-104-1M

CODE: (IS)

DATE: 1/2/96

SUBJECT: Partnering Process

Section 104, Scope of Work, of the 1996 Metric Edition of the Mississippi Standard Specifications for Road and Bridge Construction is hereby amended as follows:

907-104.01--Intent of Contract.

After the end of Subsection 104.01 on page no. 104-1, add the following:

907-104.01.1--Partnering Process.

COVENANT OF GOOD FAITH AND FAIR DEALING:

This contract imposes an obligation of good faith and fair dealing in its performance and enforcement.

The contractor and the Department, with a positive commitment to honesty and integrity, agree to the following mutual duties:

- A. Each will function within the laws and statutes applicable to their duties and responsibilities.
- B. Each will assist in the other's performance.
- C. Each will avoid hindering the other's performance.
- D. Each will proceed to fulfill its obligations diligently.
- E. Each will cooperate in the common endeavor of the contract.

VOLUNTARY PARTNERING:

The Mississippi Department of Transportation intends to encourage the foundation of a cohesive partnership with the contractor and its principal subcontractors and suppliers. This partnership will be structured to draw on the strengths of each organization to identify and achieve reciprocal goals. The objectives are effective and efficient contract performance and completion within budget, on schedule, and in accordance with plans and specifications.

This partnership will be bilateral in make-up, and participation will be totally voluntary. Any cost associated with effectuating this partnering will be agreed to by both parties and will be shared equally.

To implement this partnering initiative prior to starting of work in accordance with the requirements of Subsection 108.02 Notice to Proceed and prior to the preconstruction conference, the contractor's management personnel and MDOT's District Engineer will initiate a partnering development seminar/team building workshop. The Contractor working with the assistance of the District and the State Construction Engineer will make arrangements to

determine attendees for the workshop, agenda of the workshop, duration, and location. Persons required to be in attendance will be the MDOT key project personnel, the contractor's on-site project manager and key project supervision personnel of both the prime and principal subcontractors and suppliers. The project design engineers, FHWA and key local government personnel will be also be invited to attend as necessary. The contractors and MDOT will also be required to have Regional/District and Corporate/State level managers on the project team.

Follow-up workshops may be held periodically throughout the duration of the contract as agreed by the contractor and Mississippi Department of Transportation.

The establishment of a partnership charter on a project will not change the legal relationship of the parties to the contract nor relieve either party from any of the terms of the contract.

MISSISSIPPI DEPARTMENT OF TRANSPORTATION

SUPPLEMENT TO SPECIAL PROVISION NO. 907-104-7M

DATE: 03/01/2011

SUBJECT: Removal and Disposal of Materials

Delete the second sentence of the fourth paragraph of Subsection 907-104.05 on page 2 and substitute the following:

The Contractor shall also furnish the Engineer a certified letter stating that the area of disposal is not in a wetland or in Waters of the U.S.

MISSISSIPPI DEPARTMENT OF TRANSPORTATION

SPECIAL PROVISION NO. 907-104-7M

CODE: (IS)

DATE: 01/20/2011

SUBJECT: Scope of Work

Section 104, Scope of Work, of the 1996 Metric Edition of the Mississippi Standard Specifications for Road and Bridge Construction is hereby amended as follows:

907-104.02.2--Differing Site Conditions. Delete the first, second and third paragraphs of Subsection 104.02.2 on page 104-3, and substitute the following:

During the progress of the work, if subsurface or latent physical conditions are encountered at the site differing materially from those indicated in the contract or if unknown physical conditions of an unusual nature, differing materially from those ordinarily encountered and generally recognized as inherent in the work provided for in the contract, are encountered at the site, the Contractor shall promptly notify the Engineer in writing of the specific differing conditions before the affected work is performed.

Upon written notification by the Contractor, the Engineer will investigate the conditions, and if it is determined that the conditions materially differ and cause an increase or decrease in the cost or time required for the performance of any work under the contract, an adjustment, excluding anticipated profits, will be made and the contract modified in writing accordingly. The Engineer will notify the Contractor of the determination whether or not an adjustment of the contract is warranted.

No contract adjustment which results in a benefit to the Contractor will be allowed unless the Contractor has provided the required written notice. The written notice shall be submitted upon the forms provided and required by the Department.

Delete in toto Subsection 104.02.3 on pages 104-3 and 104-4, and substitute the following:

907-104.02.3--Minor Alterations to the Contract. When the Department makes alterations in the details of construction or specifications that are minor in nature, the Resident or Project Engineer may elect to make an equitable adjustment to the contract under the provisions of this subsection. Minor alterations shall be defined as those alterations to the contract that are not addressed in the Standard Specifications, or supplements thereto, and are valued at less than \$10,000.00. The District Engineer shall designate, in writing, the Resident or Project Engineer authorized to execute the Class I Supplemental Agreement. The Resident or Project Engineer and Contractor shall agree upon the scope of work and a lump sum amount, within the above stated limit, for the work to be performed. The agreement shall be reflected in a Class I Supplemental Agreement signed by the Resident or Project Engineer and the Contractor's authorized representative, which, when it bears both the signature of the Resident or Project Engineer and Contractor, shall constitute the scope of work and basis of payment under the item "Minor Alterations to the Contract." Work shall not proceed until both parties sign the agreement.

Any adjustment of contract time due to Minor Alterations will be in accordance with Subsection 108.06 of the Standard Specifications.

Payment will be made under:

907-104-A S/A: Minor Alterations to the Contract - lump sum

(This pay item is not to be included on the plans or in the contract proposal)

907-104.05--Removal and Disposal of Structures and Obstructions. Change the title of Subsection 104.05 on page 104-6 to the following:

907-104.05--Removal and Disposal of All Materials From the Project.

At the end of the fourth paragraph of Subsection 104.05 on page 104-6, remove the period at the end of the sentence and add the following:

, but any such delays shall not entitle the Contractor to nor shall such delays justify or be the basis for any monetary damages against the Commission, Department or any of its officers or employees.

Delete the eighth and ninth paragraphs of Subsection 104.05 on page 104-6 and substitute the following:

When the contract documents indicate certain materials or other matter for removal or removal from the right-of-way permitted and disposed of at locations provided by the Contractor, the Contractor shall furnish the Engineer a copy of a release from each property owner for the servitude of the land. The Contractor shall also furnish the Engineer a certified letter stating that the area of disposal is not in a wetland. The State, the Commission, the Department, or any of its officers or employees will have no ownership or liability whatsoever for materials or matter removed thus from the right-of-way.

All removals by the Contractors are to be made in accordance with the provisions of Section 201, Section 202 and Section 203.

MISSISSIPPI DEPARTMENT OF TRANSPORTATION

SUPPLEMENT TO SPECIAL PROVISION NO. 907-105-6M

DATE: 03/01/2011

SUBJECT: Maintenance During Construction

Before Subsection 907-105.17 on page 2, add the following.

907-105.14--Maintenance During Construction. Before the first sentence Subsection 105.14 on page 105-8, add the following:

The Contractor will be responsible for the maintenance of existing roadways within the limits of this project starting on the date of the Notice To Proceed / Beginning of Contract Time. Anytime work is performed in a travel lane, the Contractor shall install portable lane closure signs meeting the requirement of the MDOT Standard Drawing or MUTCD.

MISSISSIPPI DEPARTMENT OF TRANSPORTATION

SPECIAL PROVISION NO. 907-105-6M

CODE: (IS)

DATE: 02/09/2011

SUBJECT: Control of Work

Section 105, Control of the Work, of the 1996 Metric Edition of the Mississippi Standard Specifications for Road and Bridge Construction is hereby amended as follows:

907-105.04--Coordination of Plans, Specifications, Interim Specifications, Special Provisions and Notice to Bidders. After subparagraph f) on page 105-3, add the following:

Any reference in the plans or contract documents to a particular Section or Subsection shall mean that Section or Subsection of the Mississippi Standard Specifications for Road and Bridge Construction, Supplement to the Mississippi Standard Specifications for Road and Bridge Construction, or that Section or Subsection as modified by the contract.

907-105.05--Cooperation by Contractor. In the third sentence of the second paragraph of Subsection 105.05 on page 105-3, change “Notice to Proceed” to “Notice of Award”.

After the last paragraph of Subsection 105.05 on page 105-4, add the following:

On projects that include erosion control pay items, the Contractor shall also designate a responsible person whose primary duty shall be to monitor and maintain the effectiveness of the erosion control plan, including NPDES permit requirements. This responsible person must be a Certified Erosion Control Person certified by an organization approved by the Department. Prior to or at the pre-construction conference, the Contractor shall designate in writing the Certified Erosion Control Person to the Project Engineer. The designated Certified Erosion Control Person shall be assigned to only one (1) project. When special conditions exist, such as two (2) adjoining projects or two (2) projects in close proximity, the Contractor may request in writing that the State Construction Engineer approve the use of one (1) Certified Erosion Control Person for both projects. The Contractor may request in writing that the Engineer authorize a substitute Certified Erosion Control Person to act in the absence of the Certified Erosion Control Person. The substitute Certified Erosion Control Person must also be certified by an organization approved by the Department. A copy of the Certified Erosion Control Person's certification must be included in the Contractor's Protection Plan as outlined in Subsection 907-107.22.1. This in no way modifies the requirements regarding the assignment and availability of the superintendent.

907-105.13--Load and Speed Restrictions. Delete the first paragraph of Subsection 105.13 on page 105-7, and substitute the following:

The Contractor shall determine and comply with all legal load restrictions in the hauling of materials on public roads beyond the limits of the project. The Department shall not have any

obligations to determine or inform the Contractor of any legal load limitations of any municipality, county or the State of Mississippi. A special permit will not relieve the Contractor of liability for damages which may result from the moving of material or equipment.

907-105.17--Claims for Adjustments and Disputes. Delete the first paragraph of Subsection 105.17 on page 105-10, and substitute the following:

It is in the public interest that the Department have early or prior knowledge of an existing or impending claim of any nature by the Contractor so that the Department may appropriately consider modifying the details of the work or other actions of the Department which might result in mitigation or elimination of the effect of the act or conditions objected to by the Contractor and so that the Department may institute appropriate procedures, as required, to keep strict account of actual costs and to verify, at the time, facts upon which a claim is made. Therefore, if in any case the Contractor deems that additional compensation is due for work or materials not covered in the contract or not ordered by the Engineer as Extra Work, or if the Contractor deems that adjustment in the contract time should be made because of any of the reasons provided for in the contract as a basis for an extension of time, the Contractor shall immediately notify the Engineer in writing of an intention to make such claim for additional compensation before beginning the work on which the Contractor bases the claim. If the nature of the claim is such that the Contractor can not fully identify all aspects of the claim, the Contractor shall have 30 calendar days from the date of the incident to provide the Engineer with written documentation clearly identifying the claim issue(s) and all other logically related work items or phases. If such written notification is not given by the Contractor in accordance with these specifications and the Engineer and the Department's Audit Division, or other authorized persons, are not afforded proper facilities by the Contractor for keeping strict account of actual costs or verification at the time of facts upon which a claim for contract adjustment is made, the Contractor hereby agrees that failure to provide written notice has denied the Department the prerogative of verifying additional time, materials, equipment, labor and making adjustments in the work which might remove or alleviate the conditions for which a claim might be made, and the Contractor further agrees that such failure on the Contractor's part shall be a conclusive waiver of any claim, or part thereof, including the waiver of any such claim for damages before a court of law.

Delete the third paragraph of Subsection 105.17 on pages 105-10 and 105-11, and substitute the following:

Any such notice shall be in writing on a form provided by the Department for such purpose and shall describe in detail any act of omission or commission by the Department or its agents that allegedly caused or contributed to the condition for which a claim may be made and the nature of the claim and shall provide all documentation to support any such claim. The Contractor shall deliver or mail the notice to the Project Engineer and retain proof of such delivery.

Delete the fifteenth paragraph of Subsection 105.17 on pages 105-12, and substitute the following:

Any part of a claim based on after-the-fact general statements of costs such as "Normal cost of such work", "computed as a percentage of etc." or other such indefinite statements shall not

justify or be the basis for the payment of or award of any damages and will be denied or returned to the Contractor without action.

MISSISSIPPI DEPARTMENT OF TRANSPORTATION

| SPECIAL PROVISION NO. 907-106-4M

CODE: (IS)

| DATE: 01/20/2011

| SUBJECT: Control of Materials

Section 106, Control of Materials, of the 1996 Metric Edition of the Mississippi Standard Specifications for Road and Bridge Construction is hereby amended as follows:

| **907-106.02.2--Contractor Furnished Sources.** Delete the fourth and fifth paragraphs of Subsection 106.02.2 on pages 106-1 and 106-2, and substitute the following:

All pits and quarry sites are subject to approval from the Mississippi Department of Environmental Quality, Office of Geology, as set forth in Subsection 907-107.23.

| After Subsection 106.12 on page 106-5, add the following:

| **907-106.13--Convict Produced Materials.** Materials produced after July 1, 1991, by convict labor may only be incorporated in a Federal-aid highway construction project if such materials have been:

1. Produced by convicts who are on parole, supervised release, or probation from a prison
or
2. Produced in a qualified prison facility and the cumulative annual production amount of such materials for use in Federal-aid highway construction does not exceed the amount of such materials produced in such facility for use in Federal-aid highway construction during the 12-month period ending July 1, 1987.

Qualified prison facility means any prison facility in which convicts, during the 12-month period ending July 1, 1987, produced materials for use in Federal-aid highway construction projects.

MISSISSIPPI DEPARTMENT OF TRANSPORTATION

SPECIAL PROVISION NO. 907-107-10M

CODE: (IS)

DATE: 06/11/2004

SUBJECT: Environmental Protection

Section 107, Legal Relations and Responsibility to Public, of the 1996 Metric Edition of the Mississippi Standard Specifications for Road and Bridge Construction is hereby amended as follows:

907-107.22.3--Pit Operations. Delete the second paragraph of Subsection 107.22.3 on page 107-19.

907-107.22.5--Special Temporary Erosion Control. Delete the first and second paragraphs of Subsection 107.22.5 on page 107-20, and substitute the following:

The plans may designate special temporary erosion control work such as fast growing grasses or other designated temporary features for problem areas during grading, paving or other construction work. Unless otherwise provided, quantities for such temporary features shown on the plans will be included in items for which bids are to be received. The Contractor shall perform all designated temporary work as indicated on the plans or provided in the contract or as directed by the Engineer at the time and in the manner deemed to provide the most effective deterrent to siltation.

Any emergency temporary erosion control will be authorized and used only under conditions or causes created solely by the State or unforeseeable causes beyond the control of the Contractor. The Engineer shall be the sole judge as to the use and payment of emergency temporary erosion control work. Unforeseen special emergency erosion control features not contemplated in the plans or contract documents and determined by the Engineer to be essential for the prevention of siltation and pollution for conditions or causes created solely by the State or unforeseeable causes beyond the control of the Contractor shall be performed as Extra Work.

907-107.23--Material Pits. Delete the second paragraph of Subsection 107.23 on page 107-21, and substitute the following:

Prior to opening a new pit or enlarging an existing pit, the Contractor will furnish the Engineer either a copy of the "Notification of Exempt Operations" or a copy of the (permanent or temporary) Class II Permit approval from the Mississippi Department of Environmental Quality, Office of Geology. The Contractor shall also obtain a letter stating that the pit site is satisfactory from an archaeological and historical standpoint from the Mississippi Department of Archives and History, Historic Preservation Division, Jackson, Mississippi. All costs involved in obtaining clearance shall be borne by the Contractor. Delays encountered in obtaining clearance will not be a reason for extension of contract time. This requirement is not applicable to

commercial sources.

When the contract requires the Contractor to dispose of excavated material, the Contractor shall, prior to removal, furnish the Engineer with a copy of a letter from the land owner stating that the Contractor has the right to place material on the said property. The Contractor shall also furnish the Engineer with a letter stating that the property is not in a wetland. Delays encountered in obtaining this information will not be a reason for extension of contract time. This requirement is not applicable to commercial sources.

The Contractor is further reminded of and shall comply with the requirements of the Clean Water Act Amendments requiring National Pollutant Discharge Elimination System (NPDES) permits for discharges composed entirely of storm water from active or inactive surface mining operations, excluding work areas covered by a U. S. Army Corps of Engineers Clean Water Act Section 404 Permit. Questions or problems concerning NPDES permits should be directed to the Mississippi Department of Environmental Quality (MDEQ), Office of Pollution Control, Industrial Branch, Jackson, Mississippi.

The Contractor shall, before a regulated area is opened or enlarged as a material pit, obtain from MDEQ the necessary Mining Storm Water NPDES Permit(s) authorizing the discharge of storm water subject to the terms and conditions of said permit. All costs involved in obtaining the permit(s) shall be borne by the Contractor. Delays encountered in obtaining the permit(s) will not be a reason for extension of contract time.

For regulated commercial sources, the owner(s) shall bear the responsibility for meeting the requirements of the NPDES permitting process.

MISSISSIPPI DEPARTMENT OF TRANSPORTATION

SUPPLEMENT TO SPECIAL PROVISION NO. 907-107-18M

DATE: 08/23/2011

SUBJECT: Legal Relations and Responsibility to Public

907-107.14.2.2--Railroad Protective. After subparagraph (a) of Subsection 107.14.2.2 on page 2, add the following.

Delete the first sentence of subparagraph (b) of Subsection 907-107.14.2.2 on page 107-14 and substitute the following.

(b) **Contractor's Liability - Railroad**, including subcontractors, XCU and railroad contractual with limits of \$1,000,000 each occurrence; \$2,000,000 aggregate.

After Subsection 907-107.17 on page 3, add the following:

907-107.18--Contractor's Responsibility for Utility Property and Services. After the first sentence of Subsection 107.18 on page 107-16, add the following:

Prior to any excavation on the project, the Contractor shall contact MS 811 and advise them to mark all known utilities in the area of the excavation.

MISSISSIPPI DEPARTMENT OF TRANSPORTATION

| SPECIAL PROVISION NO. 907-107-18M

CODE: (IS)

| DATE: 01/20/2011

SUBJECT: Legal Relations and Responsibility to Public

Section 107, Legal Relations and Responsibility to Public, of the 1996 Metric Edition of the Mississippi Standard Specifications for Road and Bridge Construction is hereby amended as follows

907-107.02--Permits, Licenses and Taxes. Delete in toto Subsection 107.02 on page 107-1 and substitute the following:

The Contractor or any Subcontractor shall have the duty to determine any and all permits and licenses required and to procure all permits and licenses, pay all charges, fees and taxes and issue all notices necessary and incidental to the due and lawful prosecution of the work. At any time during the life of this contract, the Department may audit the Contractor's or Subcontractor's compliance with the requirements of this section.

The Contractor or any Subcontractor is advised that the "Mississippi Special Fuel Tax Law", Section 27-55-501, et seq. and the Mississippi Use Tax Law, Section 27-67-1, et seq., and their requirements and penalties, apply to any contract or subcontract for construction, reconstruction, maintenance or repairs, for contracts or subcontracts entered into with the State of Mississippi, any political subdivision of the State of Mississippi, or any Department, Agency, Institute of the State of Mississippi or any political subdivision thereof.

The Contractor or any Subcontractor will be subject to one or more audits by the Department during the life of this contract to make certain that all applicable fuel taxes, as outlined in Section 27-55-501, et seq., and any sales and/or use taxes, as outlined in Section 27-67-1, et seq. are being paid in compliance with the law. The Department will notify the Mississippi State Tax Commission of the names and addresses of any Contractors or Subcontractors.

907-107.09--Construction Over or Adjacent to Navigable Waters and Wetlands. Delete the fourth paragraph of Subsection 107.09 on page 107-8 and substitute the following:

The permits will only cover work shown on the plans. Should temporary construction be proposed for the Contractor's convenience in the areas set out in the permits, the Contractor shall apply for and furnish a copy of the required permits to the Engineer before proceeding with the temporary construction.

907-107.11--Use of Explosives. Delete the first paragraph of Subsection 107.11 on page 107-10 and substitute the following:

The use of explosives is not permissible under any condition or on any project unless approved in writing by the Engineer. When using explosives, the Contractor shall exercise utmost care not to endanger life and property including the new work. The Contractor shall be responsible for all damage resulting from the use of explosives and shall indemnify and hold harmless the Commission, the Department, and any of its officers or employees.

907-107.14--Damage Claims and Insurance.

907-107.14.2--Liability Insurance. Delete Subsection 107.14.2.1 on page 107-12 and substitute the following:

907-107.14.2.1--General. The Contractor shall carry contractor's liability (including subcontractors and contractual) with limits not less than: \$500,000 each occurrence; \$1,000,000 aggregate; automobile liability - \$500,000 combined single limit - each accident; Workers' Compensation and Employers' Liability - Statutory & \$100,000 each accident; \$100,000 each employee; \$500,000 policy limit. **Each policy shall be signed or countersigned by a Mississippi Agent or Qualified Nonresident Agent of the Insurance Company.**

The Contractor shall have certificates furnished to the Department from the insurance companies providing the required coverage. The certificates shall be on the form furnished by the Department and will show the types and limits of coverage.

Delete the third and fourth paragraphs of Subsection 107.14.2.2 on pages 107-12 & 107-13 and substitute the following:

Prior to starting any work on railroad property, the Contractor shall furnish satisfactory evidence to the Department that insurance of the forms and amounts set out herein in paragraphs (a) and (b) has been obtained. Also, the Contractor shall furnish similar evidence to the Railroad Company that insurance has been obtained in accordance with the Standard Provisions for General Liability Policies and the Railroad Protective Liability Form as published in the Code of Federal Regulations, 23 CFR 646, Subpart A. Evidence to the Railroad Company shall be in the form of a Certificate of Insurance for coverages required in paragraph (b), and the original policy of the Railroad Protective Liability Insurance for coverage required in paragraph (a).

Delete the first paragraph of subparagraph (a) in Subsection 107.14.2.2 on page 107-13 and substitute the following:

- (a) **Railroad Protective Liability Insurance** shall be purchased on behalf of the Railroad Company with limits of \$2,000,000 each occurrence; \$6,000,000 aggregate applying separately to each annual period for lines without passenger trains. If the line carries passenger train(s), railroad protective liability insurance shall be purchased on behalf of the Railroad Company with limits of \$5,000,000 each occurrence; \$10,000,000 aggregate applying separately to each annual period.

907-107.15--Third Party Beneficiary Clause. In the first sentence of the first paragraph of Subsection 107.15 on page 107-14, change “create the public” to “create in the public”.

907-107.17--Contractor's Responsibility For Work. After the second paragraph of Subsection 107.17 on page 107-15, add the following:

Damage to items of construction, caused by the traveling public on a project or section(s) of a project open to traffic, shall be repaired by the Contractor. The Contractor will be paid for repairing such damage to certain acceptably installed items of construction at the contract unit price(s) for the applicable item(s) used in the repair. An acceptably installed item shall be complete-in-place meeting the requirements of the specifications. The acceptably installed items of construction eligible to receive payment for repair of damage caused by the traveling public shall be items used for signing, safety and traffic control. The eligible permanent items shall be limited to traffic signal systems, changeable message signs, roadway signs and sign supports, lighting items, guard rail items, delineators, impact attenuators, median barriers, bridge railing or pavement markings. The eligible temporary items shall be limited to changeable message signs, guard rail items, or median barriers. If damage to the above items necessitate only minor repairs, in lieu of total replacement, the work shall be performed in accordance with Subsection 109.04, or as directed by the Engineer. Damage not meeting the requirements to qualify for repair payment shall be repaired at no additional cost to the State.

MISSISSIPPI DEPARTMENT OF TRANSPORTATION

SUPPLEMENT TO SPECIAL PROVISION NO. 907-107-19M

DATE: 9/23/2011

SUBJECT: Contractor's Erosion Control Plan

Delete the second paragraph of Subsection 907-107.22.1 on page 1, and substitute the following:

The time allowed for submittal and concurrence of the Contractor's erosion control plan, MDOT's review of the plan and any revisions that may be necessary shall be the time between the Notice of Award and the Notice to Proceed/Beginning of Contract Time. The original contract time shall not be adjusted unless delays are caused solely by the Department for the submission, review and concurrence of the Contractor's erosion control plan.

MISSISSIPPI DEPARTMENT OF TRANSPORTATION

SPECIAL PROVISION NO. 907-107-19M

CODE: (SP)

DATE: 03/14/2011

SUBJECT: Contractor's Erosion Control Plan

Section 107, Legal Relations and Responsibility to Public, of the 1996 Metric Edition of the Mississippi Standard Specifications for Road and Bridge Construction is hereby amended as follows:

Delete in toto Subsection 107.22.1 on page 107-18 and substitute:

907-107.22.1--Contractor's Erosion Control Plan. At the preconstruction conference or prior to starting any work on the project, the Contractor shall submit to the Project Engineer for concurrence a comprehensive erosion and siltation control plan utilizing temporary measures and permanent erosion control features to provide acceptable controls during all stages of construction.

The contract time for this project has allowed 60 calendar days for the submittal and concurrence of the Contractor's erosion control plan, MDOT's review of the plan, and any revisions that may be necessary. The original contract time shall not be adjusted unless delays are caused solely by the Department for the submission, review, and concurrence of the Contractor's erosion control plan.

As a minimum, the plan shall include the following:

1. Erosion Control Plan (ECP) sheets or the plan profile sheets, 11" x 17" or larger, of all areas within the rights-of-way from the Beginning of the Project (BOP) to the End of the Project (EOP) showing the location of all temporary erosion control devices. Erosion control devices should be identified by exact type, temporary or permanent, configuration, and placement of each item to prevent erosion and siltation. [A narrative of the Contractor's temporary erosion control plan shall be submitted in a format similar to the form attached to this special provision, but must include the heading and sub-heading information. As a minimum, the narrative shall include the following:](#)
 - A detailed description, including locations (station numbers) of the Contractor's proposed sequence of operations including, but not limited to, clearing and grubbing, excavation, drainage, and structures.
 - A detailed description, including locations, and best management practices (BMP) that will be used to prevent siltation and erosion from occurring during the Contractor's proposed sequence of operations.
2. A copy of the certification for the Contractor's Certified Erosion Control Person whose primary duty shall be monitoring and maintaining the effectiveness of the erosion control plan, BMPs, and compliance with the NPDES permit requirements.

3. A plan for the disposal of waste materials on the project right-of-way which shall include but not be limited to the following:
 - containment and disposal of materials resulting from the cleaning (washing out) of concrete trucks that are delivering concrete to the project site.
 - containment and disposal of fuel / petroleum materials at staging areas on the project.

The erosion and siltation control plan shall be maintained on the project site at all times, updated as work progresses to show changes due to revisions in the sequences of construction operations, replacement of inadequate BMPs, and the maintenance of BMPs. Work shall not be started until an erosion control plan has been concurred with by the MDOT. The Engineer will have the authority to suspend all work and/or withhold payments for failure of the Contractor to carry out provisions of MDEQ's Storm Water Construction General Permit, the erosion control plan, updates to the erosion control plan, and /or proper maintenance of the BMPs.

907-107.22.2--Clearing and Grubbing, Haul Roads, Waste Areas, Plant Sites or Other Areas Occupied by the Contractor. Delete the fourth paragraph of Subsection 107.22.2 on page 107-18 and substitute the following:

Unless otherwise determined by the Engineer from a study of overall job conditions, the exposed surface area of erodible material at any one time for each of the separate operations of this subsection shall not exceed 7.7 hectares without prior approval by the Engineer.

EXAMPLE
MISSISSIPPI DEPARTMENT OF TRANSPORTATION
Storm Water Pollution Prevention Plan (SWPPP)
Narrative

General Permit Coverage No: MSR _____

Project Number: _____

County: _____

Route: _____

SITE INFORMATION

This project consists of grading and installing drainage structures necessary to construct approximately 6 miles of parallel lanes on SR 31 between the Hinds County Line and the Rankin County Line.

SEDIMENT AND EROSION CONTROLS

VEGETATIVE CONTROLS: Clearing and grubbing areas will be minimized to comply with the buffer zones (minimum of 4.5 meters along the ROW lines and 1.5 meters along creeks) as per the contract documents. A combination of temporary and permanent grassing will be used to protect slopes as construction progresses. **Should a disturbed area be left undisturbed for 14 days or more, temporary or permanent vegetation will be placed within 7 calendar days.**

STRUCTURAL CONTROLS: Gravel construction entrance/exit will be installed near Stations 145+500, 159+500, 164+500 & 172+500. Riprap ditch checks will be constructed at Stations 144+500, 151+750, 162+000 & 166+250. The Concrete washout area will be at Stations 140+250, 152+000 & 168+500.

HOUSEKEEPING PRACTICES: Structural BPM's will be cleaned out when sediment reaches 1/3 to 1/2 of the height of the BMP. Maintenance and repair of equipment will be performed off-site, material wash out will occur either off-site or within designated wash out areas.

POST-CONSTRUCTION CONTROL MEASURES: As construction is completed, permanent vegetative growth will be established on disturbed soils to improve soil stability and provide a buffer zone for loose material. Paved ditches and flumes will be placed as specified in the ECP to reduce erosion in concentrated flow areas and rip rap will be placed as specified to dissipate flow energy and reduce flow velocity.

IMPLEMENTATION SEQUENCE

Perimeter controls will be installed first. Clearing and grubbing will be performed in 7.7-hectare sections beginning at the BOP and temporary grassing will be installed as needed. Temporary erosion control BMP's will be installed at the drainage structures prior/during construction of the drainage structures. Grading activities will commence at the BOP and proceed towards the EOP, fill slopes will be permanently grassed in stages for fill heights that exceed 1.5 meters. Base materials will be installed on completed grading sections with the paving to follow.

MAINTENANCE PLAN

All erosion and sediment control practices will be checked for stability and operation following every rainfall but in no case less than once every week. Any needed repairs will be made immediately to maintain all practices as designed. Sediment basins will be cleaned out when the level of sediment reaches 600 millimeters below the top of the riser. Sediment will be removed from behind BMP's when it becomes about 1/3 to 1/2 height of BMP.

Prime Contractor's Signature

Date

Printed Name

Title

MISSISSIPPI DEPARTMENT OF TRANSPORTATION

| SPECIAL PROVISION NO. 907-108-29M

CODE: (PS)

| DATE: 03/15/2011

SUBJECT: Prosecution and Progress

Section 108, Prosecution and Progress, of the 1996 Metric Edition of the Mississippi Standard Specifications for Road and Bridge Construction is hereby amended as follows:

907-108.01--Subletting of Contract.

907-108.01.1--General. At the end of the last paragraph of Subsection 108.01.1 on page 108-1, add the following:

The Contractor must pay subcontractor(s) for satisfactory performance of their contracts no later than 15 calendar days from receipt of payment from the Department. Within 15 calendar days after receiving payment from the Department for work satisfactorily performed, the Contractor shall make prompt payment to all sub-contractors or material suppliers for all monies due. Within 15 calendar days after receiving payment from the Department for work satisfactorily completed, the Contractor shall promptly return all retainage monies due to all sub-contractors or material suppliers. The Engineer will have the authority to suspend the work wholly or in part and to withhold payments because of the Contractor's failure to make prompt payment within 15 calendar days as required above, or failure to submit the required OCR-484 Form, Certification of Payments to Subcontractors, which is also designed to comply with prompt payment requirements.

907-108.02--Notice To Proceed. Delete the second, third and fourth paragraphs of Subsection 108.02 on page 108-3, and substitute the following:

The anticipated date of the Notice to Proceed (NTP) / Beginning of Contract Time (BCT) will be specified in the proposal.

If the Department delays the issuance of the Notice to Proceed, the Beginning of Contract Time will automatically be adjusted equal to the number of calendar days of the delay. When the revised date falls on Sunday or a holiday the following day will be the Beginning of Contract Time. The contract time will be extended automatically as provided in Subsection 907-108.06, and the Department will furnish the Contractor a revised progress schedule as provided in Subsection 108.03.1.

Upon written request from the Contractor and if circumstances permit, the Notice to Proceed may be issued at an earlier date subject to the conditions stated therein. The Contractor shall not be entitled to any monetary damages or extension of contract time for any delay claim or claim of inefficiency occurring between the early issuance Notice To Proceed date and the Notice to Proceed date stated in the contract.

907-108.03--Prosecution and Progress. Delete Subsection 108.03.1 on pages 108-3 & 108-4, and substitute the following:

907-108.03.1--Progress Schedule. Prior to or at the Pre-Construction Conference, the Contractor shall furnish a progress schedule and be prepared to discuss both its proposed methodologies for fulfilling the scheduling requirements and its sequence of operations. The Engineer will review the schedule and approve the schedule as it relates to compliance with the specifications and logic. The progress schedule must be approved by the Engineer prior to commencing work. The schedule shall be a bar-chart type schedule submitted on 11"x17" paper meeting the below minimum requirements. These activities shall be significantly detailed enough to communicate the Contractor's understanding of the construction sequencing and phasing of the project.

When preparing the progress schedule, the Contractor shall include the following:

- Show a time scale to graphically show the completion of the work within contract time.
- Define and relate activities to the contract pay items.
- Show all activities in the order the work is to be performed including submittals, submittal reviews, fabrication and delivery.
- Show all activities that are controlling factors in the completion of the work.
- Show the time needed to perform each activity and its relationship in time to other activities.

Should the schedule not include the above requirements or becomes unrealistic during construction, the Contractor should immediately submit a revised, more realistic schedule for approval.

907-108.03.2--Preconstruction Conference. Delete the first paragraph of Subsection 108.03.2 on page 108-4 and substitute the following:

Prior to commencement of the work, a preconstruction conference shall be held for the purpose of discussing with the Contractor essential matters pertaining to the prosecution and satisfactory completion of the work. The Contractor will be responsible for scheduling the preconstruction conference. The Contractor will advise the Project Engineer in writing 14 days prior to the requested date that a conference is requested. When the contract requires the Contractor to have a certified erosion control person, the Contractor's certified erosion control person shall be at the preconstruction conference. The Department will arrange for utility representatives and other affected parties to be present.

Delete the third paragraph of Subsection 108.03.2 on page 108-4.

907-108.04.3--Temporary Suspension of Work. Delete the last sentence of the second paragraph of Subsection 108.04.3 on page 108-6, and substitute the following:

The failure of the Contractor to submit the written report within the seven-day period officially constitutes a waiver of any claims for additional time or damages. The request shall set forth the reasons and support for such adjustment.

907-108.06--Determination and Extension of Contract Time. Delete Subsections 108.06.1, 108.06.2, 108.06.3 and 108.06.4 on pages 108-7 thru 108-11 and substitute the following:

907-108.06.1--Blank.

907-108.06.2--Based on Calendar Date Completion.

907-108.06.2.1--General. Contract Time will be established on the basis of a Completion Date, as indicated in the contract. The span of time allowed for the completion of the work included in the contract will be indicated in the contract documents and will be known as "Contract Time".

The span of time allowed in the contract as awarded is based on the quantities used for comparison of bids. If satisfactory fulfillment of the contract requires performance of work in greater quantities than those set forth in the proposal, the time allowed for completion shall be increased in Calendar Days in the same ratio that the cost of such added work, exclusive of the cost of work altered by Supplemental Agreement for which a time adjustment is made for such altered work in the Supplemental Agreement, bears to the total value of the original contract unless it can be established that the extra work was of such character that it required more time than is indicated by the money value.

The Contractor shall provide sufficient materials, equipment and labor to guarantee the completion of the work in the contract in accordance with the plans and specifications within the Contract Time.

907-108.06.2.2--Contract Time. The following TABLE OF ANTICIPATED PRODUCTIVE DAYS indicates an average/anticipated number of productive days per month.

TABLE OF ANTICIPATED PRODUCTIVE DAYS

Month	Available Productive Days
January	6
February	7
March	11
April	15
May	19
June	20
July	21
August	21
September	20
October	16
November	11
December	5
Calendar Year	172

Allocation of anticipated productive days for a fractional part of the month will be computed as a proportion of the listed anticipated productive days for the applicable month.

An available productive day will be assessed (a) any day of the week, Monday through Friday, exclusive of legal holidays recognized by the Department in Subsection 108.04.1, in which the Contractor works or could have worked for more than six (6) consecutive hours on the controlling items of work, as determined by the Engineer, or (b) any Saturday, exclusive of legal holidays recognized by the Department in Subsection 108.04.1, in which the Contractor works for more than six (6) consecutive hours on the controlling items of work, as determined by the Engineer. When the Contractor works less than four consecutive hours during the day, no time will be charged for that day. When the Contractor works more than four but less than six consecutive hours, one-half (0.5) of an available work day will be charged for that day. When he Contractor works six or more consecutive hours during the day, one (1.0) available work day will be charged for that day.

Should the weather or other conditions be such that four (4) consecutive satisfactory hours are not available prior to noon (for daytime operations) or midnight (for nighttime operations), no time will be assessed for that day regardless of the above conditions. However, if the Contractor elects to work, time will be assessed in accordance with the previous paragraph.

Weather delays will not be considered for Saturdays, Sundays or legal holidays recognized by the Department in Subsection 108.04.1.

Available productive days will be based on soil and weather conditions and other specific conditions cited in the contract. The Engineer will determine on each applicable day the extent to which work in progress could have been productive, regardless of whether the Contractor actually worked.

Each month the Engineer will complete, and furnish to the Contractor, an "Assessment Report for Available Productive Days" (CSD-765). This report shows the number of available productive days during the estimate period and the cumulative available productive days to date. The Contractor should review the Engineer's report as to the accuracy of the assessment and confer with the Resident or Project Engineer to rectify any differences. Each should make a record of the differences, if any, and conclusions reached. In the event mutual agreement cannot be reached, the Contractor will be allowed a maximum of 15 calendar days following the ending date of the monthly report in question to file a protest Notice of Claim in accordance with the provisions of Subsection 105.17. Otherwise, the Engineer's assessment shall be final unless mathematical errors of assessment are subsequently found to exist, and any claim of the Contractor as to such matter shall be waived.

At any given date, the ratio of the accumulated monetary value of that part of the work actually accomplished to the total contract bid amount adjusted to reflect approved increases or decreases shall determine the "percent complete" of the work.

The "percentage of elapsed time" shall be calculated as a direct ratio of the expired calendar days

to the total calendar days between the Beginning of Contract Time and the Specified Completion Date in the contract.

When the "percent complete" lags more than 20 percent behind the "percentage of elapsed time", the Contractor shall immediately submit a written statement and revised progress schedule indicating any additional equipment, labor, materials, etc. to be assigned to the work to ensure completion within the specified contract time. When the "percent complete" lags more than 40 percent behind the "percentage of elapsed time", the contract may be terminated.

907-108.06.2.3--Extension of Time. The Contractor may, prior to the expiration of the Contract Time, make a written request to the Engineer for an extension of time with a valid justification for the request. The Contractor's plea that insufficient time was specified is not a valid reason for extension of time.

No extension of the specified completion date will be granted except as provided herein. An extension of contract time may be granted for unusually severe weather, abnormal delays caused solely by the State or other governmental authorities, or unforeseeable disastrous phenomena of nature of the magnitude of earthquakes, hurricanes, tornadoes, or flooded essential work areas which are deemed to unavoidably prevent prosecuting the work.

Unusually severe weather is defined as when the actual available productive days for the contract time are less than the number of available productive days shown in the Table of Anticipated Productive Days.

Any extension of contract time will be based on a calendar days basis, excluding Saturdays, Sundays or legal holidays recognized by the Department in Subsection 108.04.1. No proration of contract time will be made. Any extension of contract time will be made on or after the specified completion date. No extension of contract time will be made on a monthly basis.

Any revision of the specified completion date provided in the contract will be made automatically on the specified completion date as established in the contract, and at a later date if additional conditions so warrant.

If the completion of the project is extended into a season of the year in which completion of certain items of work would be prohibited or delayed because of seasonal or temperature limitations, the Engineer may waive the limitations provided the completion of the work will not result in a reduction in quality. When determined that the completion of the out-of-season items will cause a reduction in the quality of the work, the completion of the project will be further extended so the items may be completed under favorable weather conditions. In either case, the Engineer will notify the Contractor in writing.

Liquidated damages as set forth in Subsection 108.07 under the heading "Daily Charge Per Calendar Day" in the Table titled "Schedule of Deductions for Each Day of Overrun in Contract Time", shall be applicable to each calendar day after the specified completion date, or authorized extension thereof, and until all work under the contract is completed.

907-108.06.2.4--Cessation of Contract Time. When the Engineer by written notice schedules a final inspection, time will be suspended until the final inspection is conducted and for an additional 14 calendar days thereafter. If after the end of the 14-day suspension all necessary items of work have not been completed, time charges will resume. If the specified completion date had not been reached at the time the Contractor called for a final inspection, the calendar day difference between the specified completion date and the date the Contractor called for a final inspection will be added after the 14-day period before starting liquidation damages. If a project is on liquidated damages at the time a final inspection is scheduled, liquidated damages will be suspended until the final inspection is conducted and for seven (7) calendar days thereafter. If after the end of the 7-day suspension all necessary items of work have not been completed, liquidated damages will resume. When final inspection has been made by the Engineer as prescribed in Subsection 105.16 and all items of work have been completed, the daily time charge will cease.

907-108.07--Failure to Complete the Work on Time. Delete the table in Subsection 108.07 on page 108-12, and substitute the following:

Schedule of Deductions for Each Day of Overrun in Contract Time

Original Contract Amount		Daily Charge
From More	To and	Per
Than	Including	Calendar Day
\$ 0	\$ 100,000	\$ 140
100,000	500,000	200
500,000	1,000,000	300
1,000,000	2,000,000	450
2,000,000	5,000,000	650
5,000,000	10,000,000	750
10,000,000	-----	1,400

907-108.10--Termination of Contractor's Responsibility. In the last sentence of Subsection 108.10 on page 108-14, change “bond” to “performance and payment bonds”.

MISSISSIPPI DEPARTMENT OF TRANSPORTATION

SPECIAL PROVISION NO. 907-109-14M

CODE: (IS)

DATE: 01/20/2011

SUBJECT: Measurement and Payment

Section 109, Measurement and Payment, of the 1996 Metric Edition of the Mississippi Standard Specifications for Road and Bridge Construction is hereby amended as follows:

907-109.01--Measurement of Quantities. Delete the second full paragraph of Subsection 109.01 on page 109-3 and substitute the following.

When requested by the Contractor, material specified to be measured by the cubic yard or ton may be converted to the other measure as appropriate. Factors for this conversion will be determined by the District Materials Engineer and agreed to by the Contractor. The conversion of the materials along with the conversion factor will be incorporated into the contract by supplemental agreement. The supplemental agreement must be executed before such method of measurement is used.

907-109.04--Extra and Force Account Work. In the last sentence of subparagraph (b) in Subsection 109.04 on page 109-4, change "bond" to "bonds".

Delete the first sentence of the second paragraph of Subsection 109.04 under (d) on page 109-4 and substitute the following:

In the event an agreement cannot be reached for a particular piece of equipment, the book entitled "Rental Rate Blue Book For Construction Equipment" as published by EquipmentWatch® and is current at the time the force account work is authorized will be used to determine equipment ownership and operating expense rates.

Delete the fourth and fifth sentences of the first paragraph of Subsection 907-109.06.1 on page 1, and substitute the following:

In the event mutual agreement cannot be reached, the Contractor will be allowed a maximum of 25 calendar days following the Contractor's receipt of the monthly estimate in question to file in writing, a protest Notice of Claim in accordance with the provisions Subsection 105.17. Otherwise, the Engineer's estimated quantities shall be considered acceptable pending any changes made during the checking of final quantities.

907-109.06--Partial Payment.

907-109.06.1--General. After the second paragraph of Subsection 109.06.1 on page 109-6, add the following:

Each month the Contractor receives a monthly progress estimate, the Contractor shall review the Engineer's progress estimate as to the accuracy of the quantities. Should the Engineer's estimated quantity for any pay item be greater than a tolerance of plus or minus ten percent ($\pm 10\%$) of the Contractor's estimated quantity, the Contractor shall confer with the Resident or Project Engineer to rectify any differences. Each should make a record of the differences, if any, and conclusions reached. In the event mutual agreement cannot be reached, the Contractor will be allowed a maximum of 15 calendar days following the ending date of the monthly estimate in question to file in writing, a protest Notice of Claim in accordance with the provisions Subsection 105.17. Otherwise, the Engineer's estimated quantities shall be considered acceptable pending any changes made during the checking of final quantities and any claim by the Contractor shall be considered to have been waived.

907-109.06.2--Advancement on Materials. Delete the fourth sentence of the first paragraph of Subsection 109.06.2 on page 109-7, and substitute:

To qualify for advance payment, materials must be stored or stockpiled on or near the project or at other locations approved by the Engineer; or in the case of prestressed concrete members that may require being produced at an out-of-state location, the prestress members shall be produced and may be stored at the commercial manufacturer's yard provided it is a PCI certified plant on the Department's List of Approved Prestress & Precast Plants and it is located within the continental United States; or in the case of structural steel members that may require fabrication at an out-of-state location, the fabricated members may be stored at the location of the commercial fabricator's yard provided it is located within the continental United States.

Delete the second paragraph of Subsection 109.06.2 on pages 109-6 & 109-7, and substitute the following:

Advancements will not be allowed until the Project Engineer has received triplicate copies of material invoices and certified test reports or acceptable certificates of conformance, and in the case of materials stored at the commercial producer's/fabricator's yard, the material shall be positively identified for the specific project and a Certificate of Storage issued by the State Materials Engineer, another designated Department employee or a designated representative of the Department. Requests for advancements on fabricated structural steel members and prestress concrete members stored out-of-state will be denied when the Department does not have available a designated representative to issue a Certificate of Storage.

Delete the first sentence of the third paragraph of Subsection 109.06.2 on page 109-7, and substitute the following:

The Contractor shall make suitable arrangements to the satisfaction of the Engineer for storage and protection at approved sites or, in the case of materials stored at the commercial producer's yard located in Mississippi or, in the case of fabricated structural steel members stored at the commercial fabricator's yard or prestress concrete members stored at a commercial manufacturer's yard located within the continental United States, the Contractor shall make arrangements with the producer/fabricator for suitable storage and protection.

Delete the third full paragraph on page 109-7, and substitute:

Unless specifically provided for in the contract, advance payment will not be made on materials, except for fabricated structural steel members or prestress concrete members, stored or stockpiled outside of the State of Mississippi.

Delete in toto Subsection 109.06.3 on pages 109-7 and 109-8, and substitute the following:

907-109.06.3--Retainage. Regardless of the value of the earned work based on the value of work scheduled for completion by the approved progress schedule, no deduction for retainage will be made from payments and advancement of materials due to the Contractor. Likewise, the Contractor shall not withhold any retainage from any payments due to a Subcontractor or Supplier.

Delete Subsection 109.07 on page 109-8 and substitute the following:

907-109.07--Changes in Material Costs. Because of the uncertainty in estimating the costs of petroleum products that will be required during the life of a contract, an adjustment in compensation for certain materials may be allowed when provisions are included in the contract. [When a pay item on the bid sheets indicate that an adjustment is allowed, an adjustment will be provided as follows:](#)

Bituminous Products--Each month the Department will acquire unit prices from producers or suppliers who supply the State highway construction industry with bituminous products. The average of all quotes for each product will serve as the base price for contracts let in the subsequent month.

Fuels--Selected cash price quotations for bulk gasoline and diesel fuel will be taken from Platt's Oilgram PAD 2 and PAD 3. The appropriate adjustment per liter for gasoline and diesel fuel will be added to the quotations to allow for taxes and markups. The prices thus determined will serve as the base prices for contracts let in the subsequent month.

[A link to the established base prices for bituminous products and fuels will be included in the contract documents under a Notice to Bidders entitled "Petroleum Products Base Prices."](#)

Each month thereafter, the Engineer will be furnished with the current monthly prices. Adjustments for change in cost will be determined from the difference in the contract base prices and the prices for the period that the work is performed and for the quantities completed. Adjustments may increase or decrease compensation depending on the difference between the base prices and prices for the estimate period.

The adjustments will be determined for the quantities of bituminous products and the average fuel requirements for processing a unit of work as set forth herein.

COST ADJUSTMENT FACTORS FOR FUEL USAGE

<u>Item of Work</u>	<u>Units</u>	<u>Code</u>	<u>Diesel</u>	<u>Gasoline</u>
Excavation & Embankment (Except Structure and Foundation)	liters/cubic meter	(E)	1.44	0.74
Granular Materials, Stabilizer Aggregates or Coarse & Seal Aggregates	liters/cubic meter	(GM)	4.36	2.82
	or liters/metric ton	(GT)	2.59	1.67
Subgrade & Base Mixing Items	liters/square meter	(M)	0.199	0.127
Hot Mix Asphalt (HMA)	liters/metric ton	(B)	10.72	3.25
Asphalt Drainage Course	liters/square meter	(D)	2.20	0.67
Portland Cement Concrete Base & Pavement	liters/square meter	(C)	0.50	0.68
Bridge Items, Structural Concrete, Pipe Culverts, (Including Foundation & Structure Excavation and all other Concrete related items)	liters/\$1000	(S)	41.6	49.2

CONSTRUCTION MATERIALS

The items and quantities subject to compensation adjustment:

ADJUSTMENT CODE

- (A1) Asphalt for HMA mixture -- theoretical liters based on job mix formula and unit mass of 1.010 kilograms per liter (new asphalt only for recycled HMA mixture).
- (A2) Asphalt for Surface Treatment -- pay quantity in liters.
- (A3) Asphalt for Prime -- pay quantity in liters.
- (A4) Asphalt for Curing Seal -- 1.13 liters per square meter.
- (A5) Asphalt for Bituminous Treated Roving -- 2.26 liters per square meter.
- (A6) Asphalt for Asphalt Drainage Course -- theoretical gallons per square meter based on job mix formula and unit mass of 1.010 kilograms per liter.

Any difference between checked final quantity and the sum of quantities shown on the monthly estimates for any item will be adjusted by the following formula:

FA = (FCQ - PRQ) x EA
Where: FA = Final Adjustment
FCQ = Final Checked Quantity
PRQ = Total Quantity Previously Reported on Monthly Estimate
EA = Total Adjustment Shown on Monthly Estimate

The final adjustment is to consider any error(s) that may have been made in the computations of monthly adjustments.

After the expiration of contract time, including all authorized extensions, adjustments will be computed using fuel and material prices that are in effect at the expiration of contract time.

907-109.10--Payment of Withheld Funds. Delete in toto Subsection 109.10 on page 109-8, and substitute the following:

907-109.10--Blank.

MISSISSIPPI DEPARTMENT OF TRANSPORTATION

| **SPECIAL PROVISION NO. 907-110-2M**

CODE: (SP)

| **DATE: 04/02/2010**

SUBJECT: Wage Rates

Section 110, Required Contract Provisions, of the 1996 Metric Edition of the Mississippi Standard Specifications for Road and Bridge Construction is hereby amended as follows:

907-110.02--Application. Delete Subsection 110.02.2 on page 110-1 and substitute the following.

907-110.02.2--Wage Rates. All persons employed or working upon the site of the work will be paid at wage rates not less than those contained in the wage determination decision of the Secretary of Labor in effect 10 days prior to taking bids.

| **Bidders are advised that regardless of the wage rates listed in the Supplement to FHWA 1273 in the contract, minimum federal wage rates must be paid.**

MISSISSIPPI DEPARTMENT OF TRANSPORTATION

SPECIAL PROVISION NO. 907-203-1M

CODE: (IS)

DATE: 11/26/2002

SUBJECT: Excavation and Embankment

Section 203, Excavation and Embankment, of the 1996 Metric Edition of Mississippi Standard Specifications for Road and Bridge Construction, is hereby amended as follows:

907-203.03--Construction Requirements.

907-203.03.8.7--Compaction of Embankments. Delete the fifth paragraph of Subsection 203.03.8.7 on page 203-11 and substitute the following:

For basement and design soils, the required density shall be 95.0 percent and 98.0 percent, respectively. If a density test fails within minus two percent (-2.0%), 93.0 to 95.0% or 96.0 to 98.0%, of the required density, a verification test will be performed and the average of the two tests will be the test value for the lot. If this test value does not meet the required density (95.0 or 98.0%), the lot shall be rejected. If the original test value exceeds minus two percent (-2%) of the required density, no verification test will be performed and the lot shall be rejected.

907-203.05--Basis of Payment. Delete the first, fifth, and ninth pay item, description and unit of measure shown on page 203-13, and substitute the following:

907-203-A: Unclassified Excavation (_____) - per cubic meter
FM or LVM

907-203-E: Borrow Excavation (_____) (Class _____) - per cubic meter
FM, FME or LVM

907-203-EX: Borrow Excavation (AH)(_____) (Class _____) - per cubic meter
FME or LVM

MISSISSIPPI DEPARTMENT OF TRANSPORTATION

SPECIAL PROVISION NO. 907-209-1M

CODE: (IS)

DATE: 12/10/2001

SUBJECT: Geotextile Fabric for Stabilization

Section 907-209, Geotextile Fabric Stabilization, of the 1996 Metric Edition of the Mississippi Standard Specifications for Road and Bridge Construction is hereby modified as follows:

907-209.05--Basis of Payment. Add the "907" prefix to the pay item listed on page 209-2.

MISSISSIPPI DEPARTMENT OF TRANSPORTATION

SPECIAL PROVISION NO. 907-217-1M

CODE: (SP)

DATE: 12/10/99

SUBJECT: Ditch Liner

Section 217, Ditch Liner, of the 1996 Metric Edition of the Mississippi Standard Specifications for Road and Bridge Construction is hereby amended as follows:

907-217.05--Basis of Payment. Add the "907" prefix to pay item number 217-A in Subsection 217.05 on page 217-2.

MISSISSIPPI DEPARTMENT OF TRANSPORTATION

SPECIAL PROVISION NO. 907-223-1M

CODE: (SP)

DATE: 9/29/98

SUBJECT: Mowing

Section 907-223, Mowing, is added to and made a part of the 1996 Metric Edition of the Standard Specifications for Road and Bridge Construction as follows:

907-223.01--Description. When the contract includes a pay item for mowing, the Contractor shall perform litter removal and mowing of obnoxious vegetation or excess growth as directed by the Engineer in accordance with the provisions contained herein. Mowing shall also be required, when necessary, for the safe and convenient passage of traffic, as required in Subsection 104.04, Maintenance of Traffic. The importance of public safety and workplace safety can not be overemphasized. Special attention is made to Subsections 107.06, 107.07 and 107.10 of the Standard Specifications.

Prior to mowing, the Contractor shall pick up and properly dispose of all trash and debris within the area to be mowed and along any adjacent roadway shoulders. Trash and debris picked up and piled or bagged on the roadside must be removed from the right-of-way by the close of the work day. Piles or bags will not be allowed to remain on the roadside overnight. All trash and debris is defined as all trash, debris, litter, junk, rubbish, paper, cardboard, glass, cans, styrofoam cups, discarded items, garbage, old tires, treads, etc. The Contractor will not be required to pick up such items as cigarette butts, tiny chips of grass or other small items not readily visible to the traveling public.

The Engineer will advise the Contractor of the area to be mowed and the time to begin the mowing operations. The Engineer may delay mowing of lespedezas or crimson clover until after these plants have gone to seed. Mowing may be delayed to retain and promote desirable wildflower growth.

Mowing will be to a height of not more than 150 millimeters and will include trimming adjacent to culvert ends, guard rail, sign posts or other appurtenances. Trimming adjacent to objects inaccessible by mower shall be performed by hand mowers, weed-eaters, sling blades, or any acceptable means necessary to complete the work. Care shall be taken not to damage trees, plants, shrubs, delineators or other fixtures which are part of the facility. Any damages by the Contractor's operations to signs, delineators, other traffic control devices or other appurtenances shall be corrected immediately at no additional cost to the State.

The quantity of mowing will be affected by actual conditions which occur during construction and may be eliminated entirely at the direction of the Engineer.

907-223.02--Blank.

907-223.03--Construction Requirements.

907-223.03.1--General. The Contractor shall perform the work throughout the entire project on those areas directed by the Engineer. The Contractor shall take full advantage of weather and soil conditions, and no attempt shall be made to mow while the areas are deemed to be wet enough to cause damage to the soil or vegetation. Care shall be taken to use methods and mowers that will provide even, uniform mowed areas, and not damage adjacent vegetation and structures. Excessive clippings of sufficient magnitude to smother or retard grass growth shall be removed to allow growth of existing or new grass.

The Contractor shall begin mowing operations within two weeks after receipt of the Engineers order to begin mowing. If the Contractor fails to begin the work within that time period the Engineer shall notify the Contractor in writing that the work is not being prosecuted properly, and therefore, future progress payments may be withheld in accordance with Subsection 105.01 of the Standard Specifications.

907-223.03.2--Equipment. Equipment used for mowing operations shall be of sufficient size, type and condition to perform the work satisfactorily. Mowers may be rotary, flail, sickle or combination thereof as necessary to efficiently accomplish the work. Rotary mowers shall be equipped with safety chains or other devices to prevent flying stones, rocks, cans, etc. from striking persons or property. Change or adjustment of the equipment or operator may be required if at any time during the mowing operation, the Engineer determines that the equipment, or operators of the equipment, are not performing satisfactorily.

When required for the Contractor's mowing operations, appropriate traffic control devices shall be installed in accordance with the MUTCD.

907-223.04--Method of Measurement. Mowing, complete and accepted, will be measured by the hectare. Litter removal and any required traffic control devices will not be measured for separate payment, but will be included in the fixed contract price for mowing.

907-223.05--Basis of Payment. When ordered by the Engineer, mowing, except as required in Subsection 213.03, will be paid for at the fixed contract unit price per hectare indicated in the bid schedule, which price shall be full compensation for removing and disposing of litter, all equipment, tools, labor, traffic control devices and incidentals necessary to complete the work.

Payment will be made under:

907-223-A: Mowing - per hectare

MISSISSIPPI DEPARTMENT OF TRANSPORTATION

SPECIAL PROVISION NO. 907-225-4M

CODE: (SP)

DATE: 03/02/2010

SUBJECT: Grassing

Section 907-225, Grassing, is hereby added to the 1996 Metric Edition of the Mississippi Standard Specifications for Road and Bridge Construction as follows:

SECTION 907-225 - GRASSING

907-225.01--Description. This work consists of furnishing, transporting, placing, plant establishment and all work necessary to produce a satisfactory and acceptable growth of grass. This work includes ground preparation, fertilizing and seeding necessary to establish a satisfactory growth of grass.

Ground preparation, light or standard, consists of plowing, loosening, and pulverizing the soil to form suitable beds for erosion control items in reasonably close conformity with the established lines and grades without appreciable humps or depressions.

Fertilizing work consists of furnishing, transporting, spreading, and incorporating fertilizers.

Seeding consists of furnishing and planting seeds in a prepared seedbed; covering the seeds and compacting the seedbed; and providing plant establishment on all areas seeded. All the work shall be in accordance with the plans and these specifications.

907-225.02--Materials.

907-225.02.1--Fertilizers. Fertilizers for purposes of these specifications shall be understood to include standard manufactured products consisting of single or combination ingredients and agricultural limestone.

All fertilizer shall comply with the State fertilizer laws and the requirements of these specifications.

Fertilizers shall meet the requirements of Subsection 715.02.

907-225.02.2--Seeds. Seeds shall meet the requirements of Subsection 715.03, subject to the provisions of this subsection. The Contractor shall acquire seed from persons registered with the Mississippi Department of Agriculture and Commerce.

Except for the germination requirements, bags of seeds properly labeled or tagged according to law and indicating characteristics meeting or exceeding the requirements of Subsection 715.03 will be acceptable for planting.

The Contractor should provide adequate dry storage facilities for seeds, and shall furnish access to the storage for sampling stored seed.

907-225.02.3--Blank.

907-225.03--Construction Requirements.

907-225.03.1--Ground Preparation.

907-225.03.1.1--General. Any equipment used for ground preparation shall be approved units suitable to perform the work and subject to the requirements of 108.05.

The Contractor shall take full advantage of weather and soil conditions, and no attempt shall be made to prepare soil when it is wet or in an otherwise non-tillable condition.

Light ground preparation should be used on areas where seeding is required to improve the coverage of partially vegetated areas.

Standard ground preparation should be used on areas designated to be solid sodded and unvegetated areas designated to be seeded.

907-225.03.1.2--Light Ground Preparation. Light ground preparation consists of scratching the surface with a close-tooth harrow, disk-harrow, or similar equipment. The depth of scratching should be at least 20 millimeters but not deep enough to damage existing grasses of the type being planted.

907-225.03.1.3--Standard Ground Preparation. Standard ground preparation consists of plowing or disk-harrowing and thoroughly pulverizing the areas immediately before the application of erosion control (vegetative) items. Unless otherwise specified, the pulverized and prepared seedbed should be at least 100 millimeters deep and shall be reasonably free of large clods, earthballs, boulders, stumps, roots and other objectionable matter. Incorporation of fertilizer and ground preparation may be performed simultaneously.

Aerating, moistening, or otherwise bringing the soil to a suitable condition for ground preparation shall be considered as incidental to the work and will not be measured for separate payment.

907-225.03.2--Fertilizing. The Contractor shall furnish all equipment necessary to properly handle, store, uniformly spread, and incorporate the specified application of fertilizer.

Unless otherwise approved by the Engineer, the Contractor shall incorporate bag fertilizer at a rate of one (1) metric ton per hectare of 13-13-13 commercial fertilizer. The equivalent rate of other type fertilizers will be allowed if the equivalent percentages of Nitrogen, Phosphorus and Potassium are obtained. The Contractor shall incorporate agricultural limestone at a rate of 5600

kilograms per hectare. Fertilization shall be applied uniformly on the areas to be planted or seeded and uniformly incorporated into the soil.

Fertilizers should be applied on individual areas of not more than three acres.

All fertilizer should be incorporated within 24 hours following spreading.

907-225.03.3--Seeding.

907-225.03.3.1--General. Prior to planting the seeds, ground preparation and fertilizing should have been satisfactorily performed.

Seeding may be required for temporary protection or for establishment of permanent ground cover. The plans will indicate temporary seeding.

The required type of seeds, minimum rates of application and planting dates of seeds are shown in the vegetation schedule on the plans. It is the Contractor's responsibility to apply an ample amount of each type of seed to produce a satisfactory growth of grass and of the seed type required. At the completion of the project, a satisfactory growth of grass will be required. Reference Subsection 210 for satisfactory growth and coverage of dormant seed.

Legume seeds should be treated in accordance with Subsection 715.03.4 immediately before sowing. Seeds should be uniformly sown over the entire area with mechanical seeders. Seeds of different sizes may necessitate separate sowing. When legume seeds become dry, they should be reinoculated.

Seeding should not be done during windy weather or when the ground is frozen, extremely wet, or in an untillable condition.

All seeds should be covered lightly with soil by raking, rolling, or other approved methods, and the area compacted with a cultipacker.

Mulching should be performed as soon as practicable.

907-225.03.3.2--Plant Establishment. The Contractor should provide plant establishment on all areas seeded until release of maintenance.

Plant establishment should be provided for a minimum period of 45 calendar days after completion of seeding. In the event satisfactory growth and coverage has not been attained by the end of the 45-day period, plant establishment should be continued until a satisfactory growth and coverage is provided for at least one kind of plant (reference is made to Section 210). The Contractor shall perform plant establishment on all areas of temporary seeding until the Engineer determines that the temporary seeding has served its purpose.

Plant establishment shall consist of preserving, protecting, watering, reseeding, mowing, and other work necessary to keep the seeded areas in satisfactory condition.

Areas requiring reseeding should be prepared and seeded and all other work performed as if the reseeding was the initial seeding. The types and application rates of fertilizer will be at the discretion of the Contractor.

907-225.03.3.3--Growth and Coverage. It shall be the Contractor's responsibility to provide satisfactory growth and coverage of grasses, legumes, or combination produced from the specified seeding.

Growth and coverage on seeded areas will be considered to be in reasonably close conformity with the intent of the contract when the type of vegetation specified, exclusive of that from seeds not expected to have germinated and shows growth at that time, has reached a point of maturity where stems or runners overlap adjacent similar growth in each direction over the entire area.

907-225.04--Method of Measurement. Grassing, complete and accepted, will be measured by the hectare. Acceptance will be based on a satisfactory growth and coverage of seeds planted.

Acceptable quantities of agricultural limestone will be measured by the metric ton.

907-225.05--Basis of Payment. Grassing, measured as prescribed above, will be paid for at the contract unit price per hectare, which will be full compensation for all required materials, equipment, labor, testing and all work necessary to establish a satisfactory growth of grass.

Hard rock agricultural limestone will be paid for at the contract unit price per metric ton. Hard rock agricultural limestone with a relative neutralizing value (RNV), determined in accordance with Subsection 907-715-02.2.1.3, of between 60.0% and 62.9% will be paid for at half (1/2) the contract unit price per metric ton. No payment will be made for hard rock agricultural limestone with an RNV less than 60.0%.

Payment will be made under:

907-225-A: Grassing - per hectare

907-225-B: Agricultural Limestone - per metric ton

MISSISSIPPI DEPARTMENT OF TRANSPORTATION

SPECIAL PROVISION NO. 907-226-2M

CODE: (IS)

DATE: 05/13/2011

SUBJECT: Temporary Grassing

Section 907-226, Temporary Grassing, is hereby added to and made part of the 1996 Metric Edition of the Mississippi Standard Specifications for Road and Bridge Construction as follows:

SECTION 907-226 -- TEMPORARY GRASSING

907-226.01--Description. This work consists of furnishing, transporting, placing, plant establishment and all work necessary to produce rapid-growing grasses, grains or legumes to provide an initial, temporary cover of grass. This work includes ground preparation, fertilizing, seeding and mulching necessary to establish a satisfactory growth of temporary grass. The Contractor may elect to place temporary grassing using the hydroseeding method as set out in Special Provision No. 907-227, as modified by this special provision.

The Engineer or the plans will designate areas to be temporarily grassed. Any other areas the Contractor desires to grass will be measured for payment only if agreed upon by the Engineer.

907-226.02--Materials.

907-226.02.1--Fertilizers. Fertilizers for purposes of these specifications shall be understood to include standard manufactured products consisting of a combination of ingredients.

All fertilizer shall comply with the State fertilizer laws and Subsection 715.02.

Agricultural limestone will not be requirement for temporary grassing.

907-226.02.2--Seeds. Seeds shall meet the requirements of Subsection 715.03, subject to the provisions of this subsection. The Contractor shall acquire seed from persons registered with the Mississippi Department of Agriculture and Commerce.

Except for the germination requirements, bags of seeds properly labeled or tagged according to law and indicating characteristics meeting or exceeding the requirements of Subsection 715.03 will be acceptable for planting.

The Contractor should provide adequate dry storage facilities for seeds, and shall furnish access to the storage for sampling stored seed.

907-226.02.3--Mulching. The vegetative materials for mulch shall meet the requirements of Subsection 715.05.

When used, bituminous material for mulch shall be Emulsified Asphalt, Grade SS-1, meeting the requirement of Subsection 702.07.

907-226.03--Construction Requirements. The rates of application shall not exceed the rates shown on the temporary vegetation schedule, unless otherwise approved by the Engineer. Any unauthorized overage due to increased application rates will not be measured for payment.

907-226.03.1--Ground Preparation. Any equipment used for ground preparation shall be approved units suitable to perform the work and subject to the requirements of Subsection 108.05.

Light ground preparation should be used on areas where seeding is required.

Light ground preparation consists of scratching the surface with a close-tooth harrow, disk-harrow, or similar equipment. The depth of scratching should be at least 20 millimeters but not deep enough to damage existing grasses of the type being planted.

Aerating, moistening, or otherwise bringing the soil to a suitable condition for ground preparation shall be considered as incidental to the work and will not be measured for separate payment.

907-226.03.2--Fertilizing. The Contractor shall furnish all equipment necessary to properly handle, store, uniformly spread, and incorporate the specified application of fertilizer.

The Contractor shall incorporate fertilizer at a rate of 560 kilograms per hectare of 13-13-13 commercial fertilizer. The equivalent rate of other type fertilizers will be allowed if the equivalent percentages of Nitrogen, Phosphorus and Potassium are obtained. Fertilization shall be applied uniformly on the areas to be seeded and uniformly incorporated into the soil.

Fertilizer should be applied on individual areas of not more than 1.2 hectares.

All fertilizer should be incorporated within 24 hours following spreading.

907-226.03.3--Seeding.

907-226.03.3.1--General. Prior to planting the seeds, ground preparation and fertilizing should have been satisfactorily performed.

The required type of seeds, recommended rates of application and recommended planting dates of seeds are shown in the vegetation schedule in the plans.

When a temporary vegetation schedule is not shown in the plans, the following types of seed and application rates should be used.

Spring & Summer

Browntop Millet ----- 22 kilograms per hectare - April 1 to August 31

Fall & Winter

Rye Grass ----- 28 kilograms per hectare - September 1 to March 31

Oats ----- 100 kilograms per hectare - September 1 to December 15

It is the Contractor's responsibility to apply an ample amount of each type of seed to produce a satisfactory growth of grass and of the seed type required.

Legume seeds should be treated in accordance with Subsection 715.03.4 immediately before sowing. Seeds should be uniformly sown over the entire area with mechanical seeders. Seeds of different sizes may necessitate separate sowing. When legume seeds become dry, they should be reinoculated.

Seeding should not be done during windy weather or when the ground is frozen, extremely wet, or in an untillable condition.

All seeds should be covered lightly with soil by raking, rolling, or other approved methods, and the area compacted with a cultipacker.

907-226.03.3.2--Plant Establishment. Plant establishment shall consist of preserving, protecting, watering, reseeding, and other work necessary to keep the seeded areas in satisfactory condition.

Areas requiring reseeding should be prepared and seeded and all other work performed as if the reseeding was the initial seeding. The types and application rates of fertilizer will be at the discretion of the Contractor. **No additional measurement and payment will be made for re-seeding when payment was made for the initial seeding.**

907-226.03.3.3--Growth and Coverage. It shall be the Contractor's responsibility to provide satisfactory growth and coverage of grasses, legumes, or combination produced from the specified seeding.

Growth and coverage on seeded areas will be considered to be in reasonably close conformity with the intent of the contract when the type of vegetation specified, exclusive of that from seeds not expected to have germinated and shows growth at that time, has reached a point of maturity where stems or runners overlap adjacent similar growth in each direction over the entire area.

907-226.03.4--Mulching.

907-226.03.4.1--Equipment. Mulching equipment should be capable of maintaining a constant air stream which will blow or eject controlled quantities of mulch in a uniform pattern. If asphalt is used, a jet or spray nozzle for applying uniform, controlled amounts of asphalt to the vegetative material as it is ejected should be located at or near the discharge spout.

Mulch stabilizers should consist of dull blades or disks without camber and approximately 500 millimeters in diameter. The disks should be notched, should be spaced at approximately 200-millimeter intervals, and should be equipped with scrapers. The stabilizer should have a mass of approximately 450 to 550 kilograms, should have a working width of no more than 2.5 meters, and should be equipped with a ballast compartment, so that mass can be increased.

907-226.03.4.2--Placement of Vegetative Mulch. If required, mulching should be placed uniformly on designated areas within 24 hours following seeding unless weather conditions are such that mulching cannot be performed. Placement should begin on the windward side of areas and from tops of slopes. In its final position, the mulch should be loose enough to allow air to circulate but compact enough to partially shade the ground and reduce erosion.

The baled material should be loosened and broken thoroughly before it is fed into the machine to avoid placement of unbroken clumps.

907-226.03.4.3--Rates of Application and Anchoring Mulch. The recommended rate of application of vegetative mulch shall be as shown in the vegetation schedule in the plans. The mulch should be anchored by either the use of a mulch stabilizer or by tacking with bituminous material. If a mulch stabilizer is used, the mulch should be punched into the soil for a minimum depth of 25 millimeters. If bituminous material is used, the rate of application should be 1400 liters per hectare.

Where steep slopes or other conditions are such that anchoring cannot be performed satisfactory with a mulch stabilizer, the Contractor may elect to use bituminous material applied at the time or immediately following the mulch placement.

When mulch stabilizers are used, anchoring the mulch should be performed along the contour of the ground surface.

907-226.03.4.4--Protection and Maintenance. The Contractor should take every precaution to prevent unnecessary foot and vehicular traffic.

907-226.04--Method of Measurement. Temporary grassing will be measured by the hectare. Acceptance will be based on a satisfactory growth and coverage of seeds planted.

907-226.05--Basis of Payment. Temporary grassing, measured as prescribed above, will be paid for at the contract unit price per hectare, which will be full compensation for all required materials, equipment, labor, testing and all work necessary to establish a satisfactory growth of grass.

Payment will be made under:

907-226-A: Temporary Grassing

- per hectare

MISSISSIPPI DEPARTMENT OF TRANSPORTATION

SPECIAL PROVISION NO. 907-227-5M

CODE: (IS)

DATE: 05/13/2011

SUBJECT: Hydroseeding

Section 907-227, Hydroseeding, is hereby added to and made a part of the 1996 Metric Edition of the Mississippi Standard Specifications for Road and Bridge Construction as follows:

SECTION 907-227--HYDROSEEDING

907-227.01--Description. This work consists of furnishing, transporting, placing, plant establishment and all work necessary to produce a satisfactory and acceptable growth of grass. The seeds, fertilizers, tackifier, and mulch shall be incorporated using the hydroseeding process. These items shall be combined into a mixture and force-applied to the areas to be grassed. Prior to placement of the hydroseeding, agricultural limestone shall be incorporated into the area in accordance with Section 213 of the Standard Specifications.

907-227.02--Materials. The Contractor shall, prior to application, furnish the Engineer with invoices of all materials used in the grassing operation.

907-227.02.1--Fertilizers. Fertilizers for purposes of these specifications shall be understood to include standard manufactured products consisting of single or combination ingredients.

All fertilizers shall comply with the State fertilizer laws and Subsection 715.02.

907-227.02.2--Seeds. Seeds shall meet the requirements of Subsection 715.03, subject to the provisions of this subsection. The Contractor shall acquire seed from persons registered with the Mississippi Department of Agriculture and Commerce.

Except for the germination requirements, bags of seeds properly labeled or tagged according to law and indicating characteristics meeting or exceeding the requirements of Subsection 715.03 will be acceptable for planting.

The Contractor should provide adequate dry storage facilities for seeds, and shall furnish access to the storage for sampling stored seed.

907-227.02.3--Mulching. The rate of application of fiber mulch shall be as recommended by the manufacture of the fibers mulch.

907-227.02.3.1--Wood Fiber Mulch. Wood fiber mulch shall be made from wood chip particles manufactured particularly for discharging uniformly on the ground surface when dispersed by a hydraulic water sprayer. It shall remain in uniform suspension in water under agitation and blend with grass seed and fertilizer to form a homogeneous slurry. The fibers shall

intertwine physically to form a strong moisture-holding mat on the ground surface and allow rainfall to percolate the underlying soil. The fiber material shall be heat processed so as to contain no germination or growth-inhibiting factors. The mulch shall be dyed an appropriate color to facilitate the application of material using non-toxic dye.

907-227.02.3.2--Cellulose Fiber Mulch. Cellulose fiber mulch consist of recycled paper stock products which are shredded into small pieces particular for application by hydraulic seeding equipment. It shall mix readily and uniformly under agitation with water and blend with grass seed and fertilizer to form a homogeneous slurry. When applied to the ground surface, the material shall form a strong moisture-holding mat, allow rainfall to percolate the underlying soil, and remain in place until the grass root system is established. The material shall contain no growth inhibiting characteristic or organisms. The mulch shall be dyed an appropriate color to facilitate the application of material using non-toxic dye.

907-227.02.3.3--Wood/Cellulose Fiber Mulch. Wood/cellulose fiber mix hydroseeding mulch shall consist of a combination of the above wood and cellulose fibers at a ratio recommended by the manufacturer of the products.

907-227.02.3.4--Straw Mulch. Straw mulch shall consist of a natural straw fiber. This material shall be a minimum 90% straw and essentially free from plastic materials or other non-bio degradable substances. The material shall be disperse into a uniform mulch slurry when mixed with water.

907-227.02.4--Tackifier. The tackifier will serve the purpose of an adhesive to form a bond between the soil, fiber, and seed particles. It will also allow the soil to retain moisture.

The tackifier shall be of the organic or synthetic variety.

907-227.03--Construction Requirements.

907-227.03.1--Ground Preparation. Light ground preparation consists of plowing, loosening, and pulverizing the soil to form suitable beds for seeding items in reasonably close conformity with the established lines and grades without appreciable humps or depressions. Unless otherwise specified, the pulverized and prepared seedbed should be at least four inches deep and shall be reasonably free of large clods, earthballs, boulders, stumps, roots and other objectionable matter. The Engineer may eliminate or alter the requirements for ground preparation due to site conditions.

907-227.03.2--Fertilizing. The Contractor shall furnish all equipment necessary to properly handle, store, uniformly spread, and incorporate the specified application of fertilizer.

The Contractor shall incorporate bag fertilizer at a rate of 1120 kilograms per hectare of 13-13-13 commercial fertilizer. The equivalent rate of other type fertilizers will be allowed if the equivalent percentages of Nitrogen, Phosphorus and Potassium are obtained. Any changes in the type or rate of application of the fertilizers shall be approved by the Engineer prior to being incorporated.

Agricultural limestone will be incorporated into the area and paid for in accordance with Section 213 of the Standard Specifications.

907-227.03.3--Seeding.

907-227.03.3.1--General. The Contractor shall use the vegetation schedule in the plan for the correct types of seed and application rates, unless otherwise noted or approved by the Engineer.

When a vegetation schedule for permanent grass is not shown in the plans, the following types of seed and application rates shall be used, unless otherwise approved by the Engineer.

Bermudagrass -----	22 kilograms per hectare
Bahiagrass -----	28 kilograms per hectare
Tall Fescue -----	17 kilograms per hectare
Crimson Clover -----	22 kilograms per hectare

At the completion of the project, a satisfactory growth of grass will be required. The Contractor should reference Subsection 210 for satisfactory growth and coverage of dormant seed.

907-227.03.3.2--Plant Establishment. The Contractor should provide plant establishment on all areas seeded until release of maintenance. Plant establishment shall consist of preserving, protecting, watering, reseeding, mowing, and other work necessary to keep the seeded areas in satisfactory condition.

Plant establishment should be provided for a minimum period of 45 calendar days after completion of seeding. In the event satisfactory growth and coverage has not been attained by the end of the 45-day period, plant establishment should be continued until a satisfactory growth and coverage is provided for at least one kind of plant. The Contractor should reference Section 210 of the Standard Specifications for more information.

907-227.03.3.3--Growth and Coverage. It shall be the Contractor's responsibility to provide satisfactory growth and coverage of grasses, legumes, or combination produced from the specified seeding.

Growth and coverage on seeded areas will be considered to be in reasonably close conformity with the intent of the contract when the type of vegetation specified, exclusive of that from seeds not expected to have germinated and shows growth at that time, has reached a point of maturity where stems or runners overlap adjacent similar growth in each direction over the entire area.

Final acceptance of the project will not be made until a satisfactory growth of grass has been acknowledged by the Engineer.

907-227.03.4--Mulching. At the Contractor's option, mulch may be wood fiber, cellulose fiber, a mixture of wood and cellulose fibers, or straw fiber. The mulch shall be applied at the rate

recommended by the manufacturer in a mixture of water, seed and fertilizer. Any changes in the rate of application of the mulch shall be approved by the Engineer prior to its use.

907-227.03.5--Equipment. Hydraulic equipment shall be used for the application of fertilizers, seeds and slurry of the prepared mulch. This equipment shall have a built-in agitation system with an operating capacity sufficient to agitate, suspend, and homogeneously mix slurry of the specified amount of fiber, fertilizer, seed and water. The slurry distribution lines shall be large enough to prevent stoppage. The discharge line shall be equipped with a set of hydraulic spray nozzles, which will provide even distribution of the slurry on the various areas to be seeded.

The seed, fertilizer, mulch and water shall all be combined into the slurry tank for distribution of all ingredients in one operation as specified herein. The materials shall be combined in a manner recommended by the manufacturer. The slurry mixture shall be so regulated that the amounts and rates of application shall result in a uniform application of all materials at rates not less than the amounts specified. Using the color of the mulch as a guide, the equipment operator shall spray the prepared seedbed with a uniform visible coat. The slurry shall be applied in a sweeping motion, in an arched stream, so as to fall like rain, allowing the mulch to build upon each other until an even coat is achieved.

907-227.03.6--Protection and Maintenance. The Contractor should maintain and protect seeded areas until release of maintenance of the project. The Contractor should take every precaution to prevent unnecessary foot and vehicular traffic.

The Contractor should mow or otherwise remove or destroy any undesirable growth on all areas mulched to prevent competition with the desired plants and to prevent reseeding of undesirable growth.

907-227.04--Method of Measurement. Hydroseeding, complete and accepted, will be measured by the hectare. No separate payment will be made for ground preparation, seeds, fertilizers, or mulch. Acceptance will be based on a satisfactory growth and coverage of seeds planted.

Agricultural limestone shall be measured and paid for under Section 213 of the Standard Specifications.

907-227.05--Basis of Payment. Hydroseeding, measured as prescribed above, will be paid for at the contract unit price per hectare, which will be full compensation for all required materials, equipment, labor, testing and all work necessary to establish a satisfactory growth of grass.

Payment will be made under:

907-227-A: Hydroseeding - per hectare

MISSISSIPPI DEPARTMENT OF TRANSPORTATION

SPECIAL PROVISION NO. 907-234-1M

CODE: (IS)

DATE: 12/10/2001

SUBJECT: Silt Fence

Section 907-234, Silt Fence, of the 1996 Metric Edition of the Mississippi Standard Specifications for Road and Bridge Construction is hereby modified as follows:

907-234.05--Basis of Payment. Add the "907" prefix to the pay items listed on page 234-2.

MISSISSIPPI DEPARTMENT OF TRANSPORTATION

| SPECIAL PROVISION NO. 907-234-5M

CODE: (SP)

| DATE: 09/23/2010

SUBJECT: Siltation Barriers

Section 234, Silt Fence, of the 1996 Metric Edition of the Mississippi Standard Specifications for Road and Bridge Construction is hereby amended as follows.

907-234.01--Description. Delete the first paragraph of Subsection 234.01 on page 234-1 and substitute the following:

This work consists of furnishing, constructing and maintaining a water permeable filter type fence, inlet siltation guard or turbidity barrier for the purpose of removing suspended soil particles from the water passing through it in accordance with the requirements shown on the plans, directed by the Engineer and these specifications. Fence, inlet siltation guards and turbidity barriers measured and paid as temporary shall be removed when no longer needed or permanent devices are installed.

Delete the first sentence of the second paragraph of Subsection 234.01 on page 234-1 and substitute the following:

It is understood that measurement and payment for silt fence, inlet siltation guards, and turbidity barriers will be made when a pay item is included in the proposal.

907-234.02--Materials. After the first paragraph of Subsection 234.02 on page 234-1, add the following:

Inlet siltation guards shall be listed on the Department's "Approved Sources of Materials".

Turbidity barriers shall be one of the following, or an approved equal.

1. SiltMax Turbidity Barrier by Dawg, Inc., 1-800-935-3294, www.dawginc.com
2. Turbidity Barrier by IWT Cargo-Guard, Inc., 1-609-971-8810, www.iwtcargoguard.com
3. Turbidity Curtain by Abasco, LLC, 1-281-214-0300, www.abasco.net

| Chain link fence and hardware for super silt fence shall meet the requirements of Section 607, as applicable. Geotextile for super silt fence shall meet the requirements of Subsection 714.13 for a Type II Woven fabric.

| **907-234.03--Construction Requirements.** After the last paragraph of Subsection 234.03.1 on page 234-1, add the following:

Super Silt Fence. Super silt fence shall be constructed in accordance with the plans and these specifications.

All posts shall be installed/driven so that at least 850 millimeters of the post will protrude above the ground. The chain link wire and geotextile shall be stretched taut and securely fastened to the posts as shown on the plans. The bottom edge of the fence and geotextile shall be buried at least 200 millimeters below ground surface to prevent undermining. When splicing of the geotextile is necessary, the fabric shall be overlapped approximately 450 millimeters.

907-234.03.1.1--Placement of Inlet Siltation Guards and Turbidity Barriers. The inlet siltation guards and turbidity barriers shall be constructed at the locations shown on the erosion control plans. Inlet siltation guards and turbidity barriers shall be installed in accordance with the erosion control drawings in the plans. A copy of the manufacturer's instructions for placement of inlet siltation guards and turbidity barriers shall be provided to the Engineer prior to construction.

907-234.03.2--Maintenance and Removal. At the end of the first paragraph of Subsection 234.03.2 on page 234.2, add the following:

The Contractor shall maintain the inlet siltation guards. The geotextile shall be removed and replaced when deteriorated to such extent that it reduces the effectiveness of the guard. Replacement geotextile shall be the same type and manufacture as the original. Excessive accumulations against the guard shall be removed and disposed of at a location approved by the Engineer.

The Contractor shall maintain the turbidity barriers. Excessive accumulations against the turbidity barrier shall be removed and disposed of as directed by the Engineer.

Delete the second paragraph of Subsection 234.03.2 on page 234-2 and substitute the following:

Unless otherwise directed, all temporary silt fences, inlet guards and turbidity barriers shall be removed. Upon removal, the Contractor shall remove and dispose of any excess silt accumulations, shape the area to the line, grade, and cross section shown on the plans and vegetate all bare areas in accordance with the contract requirements. The temporary fence, inlet guard materials and turbidity barriers will remain the property of the Contractor and may be used at other locations provided the materials are acceptable to the Engineer.

After Subsection 234.03.2 on page 234-2, insert the following:

907-234.03.3--Resetting Inlet Siltation Guards and Turbidity Barriers. When inlet siltation guards and turbidity barriers are no longer needed at one location, they may be removed and reset at other needed locations. The Engineer may allow the resetting of siltation guards and turbidity barriers upon an inspection and determination that the siltation guards (frame and geotextile) and turbidity barriers are adequate for their intended purpose. When they have to be stored until needed at another location, payment for resetting will not be made until they are reset at their needed location.

907-234.04--Method of Measurement. Delete the sentence in Subsection 234.04 on page 234-2, add the following:

Silt fence and super silt fence will be measured by the meter.

Inlet siltation guard and resetting siltation guards will be measured per each. Turbidity barrier will be measured per meter.

907-234.05--Basis of Payment. Delete the sentence in Subsection 234.05 on page 234-2, add the following:

Silt fence and super silt fence, measured as prescribed above, will be paid for at the contract unit price per meter which shall be full compensation for completing the work.

Inlet siltation guard, resetting inlet siltation guards, and turbidity barrier, measured as prescribed above, will be paid for at the contract unit price per each or meter, which shall be full compensation for furnishing, constructing, and maintaining the work and for the removal and disposal of, all items comprising the devices.

After the last pay item listed on page 234-2, add the following:

- 907-234-C: Super Silt Fence - per meter
- 907-234-D: Inlet Siltation Guard - per each
- 907-234-E: Reset Inlet Siltation Guard - per each
- 907-234-F: Turbidity Barrier - per meter

MISSISSIPPI DEPARTMENT OF TRANSPORTATION

SPECIAL PROVISION NO. 907-237-3M

CODE: (SP)

DATE: 01/14/2010

SUBJECT: Wattles

Section 907-237, Wattles, is hereby added to and made a part of the 1996 Metric Edition of the Mississippi Standard Specifications for Road and Bridge Construction as follows.

SECTION 907-237 - WATTLES

907-237.01--Description. This work consists of furnishing, constructing and maintaining wattles for the retention of soil around inlets, swale areas, small ditches, sediment basins and other areas as necessary. Also, the work includes removing and disposing of the wattles checks and silt accumulations.

Measurement and payment for wattles will be made only when a pay item is included in the bid schedule of the proposal. The quantity is estimated for bidding purposes only and will be dependent upon actual conditions which occur during construction of the project.

907-237.02--Materials. Wattles used around inlets shall have a minimum diameter of 300 millimeters and a length adequate to meet field conditions. Wattles used at other locations shall have a minimum diameter of 500 millimeters and a length adequate to meet field conditions. The stakes used in securing the wattles in place shall be placed approximately one meters apart throughout the length of the wattle. Stakes shall be wooden and of adequate size to stabilize the wattles to the satisfaction of the Engineer.

In addition to the requirements of this specifications, wattles shall be listed on the Department's "Approved Sources of Materials".

907-237.03--Construction Requirements.

907-237.03.1--General. The wattles shall be constructed at the locations and according to the requirements shown on the erosion control plans.

907-237.03.2--Maintenance and Removal. The Contractor shall maintain the wattles and remove and dispose of silt accumulations.

When the wattles are no longer needed, they shall be removed and the Contractor shall dispose of silt accumulations and treat the disturbed areas in accordance with the contract requirements.

907-237.04--Method of Measurement. Wattles of the size specified will be measured per meter.

907-237.05--Basis of Payment. Wattles, measured as prescribed above, will be paid for at the contract unit price per meter, which price shall be full compensation for installation, maintaining and removal of the wattles, the removal and disposal of silt accumulations and any required restoration of the disturbed areas.

Payment will be made under:

907-237-A: Wattles, [Size](#)

- per meter

MISSISSIPPI DEPARTMENT OF TRANSPORTATION

| SPECIAL PROVISION NO. 907-245-2M

CODE: (SP)

| DATE: 03/23/2010

SUBJECT: Triangular Silt Dike

Section 907-245, Triangular Silt Dike, is hereby added to and made a part of the 1996 Metric Edition of the Mississippi Standard Specifications for Road and Bridge Construction as follows.

SECTION 907-245 -- TRIANGULAR SILT DIKE

907-245.01--Description. This work consists of furnishing, installing, maintaining and removing temporary triangular silt dikes. The dike consists of a triangular-shaped inner material made of foam rubber or urethane foam. The outer cover is a woven geotextile fabric placed around the inner material with aprons that extend from both sides of the triangle. The dike aprons are entrenched at the upstream side and anchored to the ground at downstream end using staples. This device can be used on surfaces that do not allow for trenching by securing the aprons with sand or gravel bags. The device can be easily removed for maintenance and is considered to be reusable.

| **907-245.02--Materials.** Triangular silt dikes shall be triangular in shape, having a height of at least 250 millimeters in the center. The triangular-shaped inner material shall be foam rubber or urethane foam. The outer cover shall be a woven geotextile fabric placed around the inner triangular plane and allowed to extend beyond both sides of the triangle for 600 millimeters to form an apron.

907-245.03--Construction Requirements. The flexibility of the materials in triangular silt dikes allows them to conform to various channel configurations.

The dikes shall be attached to the ground with wire staples. The staples shall be No. 11 gauge wire and be at least 150 millimeters long. As a minimum, the staples shall be placed as recommended by the manufacture.

The geotextile filter material shall be attached to the triangular frame by using wire ties or staples. The ties shall be placed evenly on 300-mm centers.

Prior to placement of the triangular silt dikes, the Contractor shall make sure the surface on which the dike is to be placed is flat. The triangular silt dikes shall be placed in ditch, keeping excess fabric extended up and downstream of the dam. Excess material shall be trenched into the ground on the upstream end and stapled on the downstream end. A minimum 150-mm overlap between end sections shall be required should the width require multiple triangular silt dikes to be installed. The overlapped end sections shall be connected with wire wraps or staples every 300 millimeters on center.

The Contractor shall be required to remove and dispose of all sediment that is accumulated adjacent to the dike.

907-245.04--Method of Measurement. Triangular silt dike will be measured by the meter.

907-245.05--Basis of Payment. Triangular silt dike, measured as prescribed above, will be paid for by the meter, which price shall be full compensation for all cost of equipment, labor, materials, installation, cleaning and removal, and all incidental necessary to complete the work.

Payment will be made under:

907-245-A: Triangular Silt Dike - per meter

MISSISSIPPI DEPARTMENT OF TRANSPORTATION

SPECIAL PROVISION NO. 907-246-3M

CODE: (SP)

DATE: 11/08/2010

SUBJECT: Sandbags and Rockbags

Section 907-246, Sandbags and Rockbags, is hereby added to and made a part of the 1996 Metric Edition of the Mississippi Standard Specifications for Road and Bridge Construction as follows.

SECTION 907-246 -- SANDBAGS AND ROCKBAGS

907-246.01--Description. This item of work shall consist of the furnishing, installing, and maintaining sandbags and rockbags for the purpose of temporary erosion control by intercepting and slowing the flow of sediment-laden runoff water, or for use as a temporary dam.

907-246.02--Materials. The filler material for sandbags shall consist of a fine aggregate meeting the requirements of Subsection 703.02. The filler material for rockbags shall consist of a size 57 aggregate meeting the requirements of Subsection 703.03.

The bag material shall be woven polypropylene, polyethylene or polyamide fabric with a minimum unit mass of 542 grams per square meter. The bags shall be a minimum of 525 millimeters in length, 300 millimeters in width, and 100 millimeters in thickness when filled.

907-246.03--Construction Requirements. Sandbags and rockbags shall be used to construct a berm/dam which will intercept sediment-laden storm water runoff from disturbed areas, create a retention pond, detain sediment, and release water in sheet flow. Sand or rock shall be placed in the bag so that at least the top 150 millimeters of the bag is unfilled to allow for proper tying of the open end. Any subsequent rows of bags shall be offset one-half the length of the preceding row to provide a layered brick-type arrangement.

The sandbag and rockbag berm/dam installation shall be maintained in good condition by the Contractor. All necessary work and materials to maintain the integrity of the installation shall be provided until earthwork construction is complete and permanent erosion-control features are in place. The maintenance of the bags will not be paid for separately and will be included in the cost for sandbags or rockbags.

907-246.04--Method of Measurement. Sandbags and rockbags will be measured per meter or each.

Sandbags and rockbags measured by the meter shall be in accordance with the details in the erosion control drawing. The length of the sandbag or rockbag berm/dam will be measured end-to-end along the cross-section of the ditch in accordance with the erosion control drawing.

907-246.05--Basic of Payment. Sandbags and rockbags, measured as prescribed above, will be

paid for per meter or each, which prices shall be full compensation for furnishing bags, fine aggregate, size 57 aggregate, placement of bags, maintenance of the installation, removal and disposal of the sediment deposits and removal after construction has been completed, and for all labor, tools, equipment and incidentals necessary to complete the work.

Payment will be made under:

907-246-A: Sandbags - per meter or each

907-246-B: Rockbags - per meter or each

MISSISSIPPI DEPARTMENT OF TRANSPORTATION

SPECIAL PROVISION NO. 907-304-16M

CODE: (IS)

DATE: 06/01/2009

SUBJECT: Granular Courses

Section 907-304, Granular Courses, of the 1996 Metric Edition of the Mississippi Standard Specifications for Road and Bridge Construction is hereby amended as follows:

907-304.02--Materials. After the first paragraph of Subsection 304.02.1 on page 304-1, add the following:

When the contract includes pay item 907-304-I, Granular Material (RAP) (LVM), it shall be milled recycled asphalt pavement and shall be visually inspected by the Engineer to insure it is free from chunks and deleterious materials.

Crushed concrete meeting the requirements of Subsection 907-703.04.4 may be used in lieu of other crushed courses specified in the contract.

907-304.03--Construction Requirements.

907-304.03.5--Shaping, Compacting and Finishing. Delete the sixth paragraph of Subsection 304.03.6 on page 304-3.

Delete the remainder of Subsection 304.03.5 beginning with the last paragraph on page 304-3, and substitute the following:

The lot will be divided into five approximately equal sublots with one density test taken at random in each subplot. The individual tests and the average of the five tests shall equal or exceed the values as shown in the table below.

Granular Material	Lot	Individual
<u>Class</u>	<u>Average</u>	<u>Test</u>
7,8,9 or 10	97.0	93.0
5 or 6	99.0	95.0
3 or 4	100.0	96.0
1 or 2	102.0	98.0
Crushed Courses*	99.0	95.0

* When placed on filter fabric on untreated subgrade, the individual tests and the average of the five (5) tests shall equal or exceed the following values:

<u>Lot Average</u>	<u>Individual Test</u>
96.0	92.0

When pavement is not required, the required density for the top course will be as shown in the table below.

Granular Material Class	Lot Average	Individual Test
10	94.0	90.0
7,8 or 9	95.0	91.0
5 or 6	96.0	92.0
3 or 4	97.0	93.0
1 or 2	98.0	94.0
Crushed Stone Courses	96.0	92.0

No density tests will be required for granular or crushed stone courses used for temporary work such as maintaining temporary ramps and driveways.

Unless otherwise specified, density for granular material RAP or crushed stone used for driveway, etc. maintenance, shall be achieved by two passes of an approved roller and density tests will not be required.

A finished course shall be continually maintained until a subsequent course is placed thereon or the work is released from maintenance.

907-304.05--Basis of Payment. Delete the pay items listed on page 304-5, and substitute the following:

- 907-304-A: Granular Material (LVM) (Class____, Group____) - per cubic meter
- 907-304-B: Granular Material (Class____, Group____) - per metric ton
- 907-304-C: Granular Material (AEA) (Class____, Group____) - per cubic meter
- 907-304-D: 20-mm and Down Crushed Stone - per metric ton
- 907-304-E: 50-mm to 20-mm Crushed Stone - per metric ton
- 907-304-F: 100-mm to 50-mm Crushed Stone - per metric ton
- 907-304-G: 20-mm and Down Crushed Stone (AEA) - per cubic meter
- 907-304-H: 20-mm and Down Crushed Stone (LVM) - per cubic meter
- 907-304-I: Crushed Stone Base (Size _____) - per metric ton
- 907-304-I: Crushed Stone Base (Size _____) (LVM) - per cubic meter
- 907-304-I: Granular Material (_____) - per metric ton
- 907-304-I: Granular Material (_____) (LVM) - per cubic meter

MISSISSIPPI DEPARTMENT OF TRANSPORTATION

SPECIAL PROVISION NO. 907-310-1M

CODE: (SP)

DATE: 03/01/2011

SUBJECT: Stabilizer Aggregate

Section 907-310, Mechanically Stabilized Courses, of the 2004 Edition of the Mississippi Standard Specifications for Road and Bridge Construction is hereby amended as follows:

907-304.05--Basis of Payment. Add the “907” prefix to pay item 310-B on page 222.

MISSISSIPPI DEPARTMENT OF TRANSPORTATION

SUPPLEMENT TO SPECIAL PROVISION NO. 907-401-10M

DATE: 07/19/2011

SUBJECT: Hot Mix Asphalt (HMA) and Warm Mix Asphalt (WMA)

907-401.01--Description. Delete the first sentence of Subsection 907-401.01 on page 1, and substitute the following:

These specifications include general requirements that are applicable to all types of Hot Mix Asphalt (HMA) or Warm Mix Asphalt (WMA) along with the specific requirements for each particular mixture when deviations from the general requirements are necessary.

907-401.02--Materials. Delete Subsection 907-401.02.2 on page 4, and substitute the follows:

907-401.02.2--WMA Products and Processes. The Department will maintain a list of qualified WMA products and processes. No product or process shall be used unless it appears on this list.

The Contractor may propose other products or processes for approval by the Product Evaluation Committee. Documentation shall be provided to demonstrate laboratory performance, field performance, and construction experience.

907-401.02.4--Substitution of Mixture. Delete the table in Subsection 907-401.02.4 on page 7, and substitute the following:

Mixture	Single Lift Laying Thickness millimeters	
	Minimum	Maximum
25 mm	75	100
19 mm	55	90
12.5 mm	40	65
9.5 mm	25	40
4.75 mm	12.5	20

In Subsection 907-401.02.6.4.1 on pages 15 & 16, delete subparagraphs 1., 2., & 3. and substitute the following:

1. For all leveling lifts, when full lane width and with a thickness as specified in the table in Subsection 401.02.4, the required lot density shall be 92.0 percent of maximum density.
2. For all single lift overlays, with or without leveling and/or milling, the required lot density shall be 92.0 percent of maximum density.
3. For all multiple lift overlays of two (2) or more lifts excluding leveling lifts, the required

lot density of the bottom lift shall be 92.0 percent of maximum density. The required lot density for all subsequent lifts shall be 93.0 percent of maximum density.

- 4. For all pavements on new construction, the required lot density for all lifts shall be 93.0 percent of maximum density.

907-401.02.6.5--Acceptance Procedure for Pavement Smoothness. Delete the third sentence of the sixth paragraph of Subsection 907-401.02.6.5 on page 19, and substitute the following.

The wheel paths shall be designated as being located 0.9 meter and 2.7 meters from centerline or longitudinal joint, respectively.

907-401.03--Construction Requirements.

907-401.03.1.1--Weather Limitations. After the last paragraph of Subsection 907-401.03.1.1 on page 23, add the follows:

NOTE: When WMA products and processes are utilized, the air and pavement temperature at the time of placement shall equal or exceed 4°C, regardless of compacted lift thickness.

907-401.03.1.2--Tack Coat. Delete the three sentences of Subsection 907-401.03.1.2 on page 23, and substitute the following:

Tack coat shall be applied to previously placed HMA and between lifts, unless otherwise directed by the Engineer. Tack coat shall be applied with a distributor spray bar. A hand wand will only be allowed for applying tack coat on ramp pads, irregular shoulder areas, median crossovers, turnouts, or other irregular areas. Bituminous materials and application rates for tack coat shall be as specified in Table 410-A on page 410-8. Construction requirements shall be in accordance with Subsection 407.03 of the Standard Specifications.

907-401.03.1.4--Density. Delete the first sentence of the first paragraph of Subsection 907-401.03.1.4 on page 23 and substitute the following:

The lot density for all dense graded pavement lifts, except as provided below for preleveling, wedging [less than fifty percent (50%) of width greater than minimum lift thickness], ramp pads, irregular shoulder areas, median crossovers, turnouts, or other areas where the established rolling pattern cannot be performed, shall not be less than the specified percent (92.0% or 93.0%) of the maximum density based on AASHTO Designation: T 209 for the day's production. For all leveling lifts, when full lane width and with a thickness as specified in the table in Subsection 907-401.02.4, the required lot density shall be 92.0 percent of maximum density.

907-401.03.8--Preparation of Mixture. Delete the sentence in Subsection 907-401.03.8 on page 28, and substitute the following:

The temperature of the HMA mixture, when discharged from the mixer, shall not exceed 171°C.

Warm mix asphalt is defined as a plant produced asphalt mixture that can be produced and constructed at lower temperatures than typical hot mix asphalt. Typical temperature ranges of non-polymer modified, WMA produced by foaming the asphalt binder at the plant are typically

270°F to 295°F at the point of discharge of the plant. Typical temperature ranges of polymer modified, WMA produced by foaming the asphalt binder at the plant are typically 280°F to 305°F at the point of discharge of the plant. WMA produced by addition of a terminal blended additive may allow the producer to reduce the temperatures below 270°F as long as all mixture quality and field density requirements are met. Production temperatures at the plant may need to be increased or decreased due to factors such as material characteristics, environmental conditions, and haul time to achieve mixture temperatures at the time of compaction in which uniform mat density can be achieved.

907-401.03.9--Material Transfer Equipment. Delete the paragraph in Subsection 907-401.03.9 on page 28 and substitute the following:

Excluding the areas mentioned below, the material transferred from the hauling unit when placing the top lift, or the top two (2) lifts of a multi-lift HMA pavement with density requirements, shall be remixed prior to being placed in the paver hopper or insert by using an approved Materials Transfer Device. Information on approved devices can be obtained from the State Construction Engineer. Areas excluded from this requirement include: leveling courses, temporary work of short duration, detours, bridge replacement projects having less than 300 meters of pavement on each side of the structure, acceleration and deceleration lanes less than 300 meters in length, tapered sections, transition sections for width, shoulders less than three meters in width, crossovers, ramps, side street returns and other areas designated by the Engineer.

After Subsection 907-401.03.13 on page 29, add the following:

907-401.03.14--Shoulder Wedge. The Contractor shall attach a device to the screed of the paver that confines the material at the end gate and extrudes the asphalt material in such a way that results in a compacted wedge shape pavement edge of approximately 30 degrees, but not steeper than 35 degrees. The device shall maintain contact between itself and the road shoulder surface and allow for automatic transition to cross roads, driveways, and obstructions. The device shall be used to constrain the asphalt head reducing the area by 10% to 15% increasing the density of the extruded profile. Conventional single plate strike off shall not be used.

The device shall be TransTech Shoulder Wedge Maker, the Advant-Edge, or a similar approved equal device that produces the same wedge consolidation results. Contact information for these wedge shape compaction devices is the following:

1. TransTech Systems, Inc.
1594 State Street
Schenectady, NY 12304
800-724-6306
www.transtechsys.com

2. Advant-Edge Paving Equipment, LLC
P.O. Box 9163
Niskayuna, NY 12309-0163
518-280-6090
Contact; Gary D. Antonelli
Cell: 518-368-5699

email: garya@nycap.rr.com

Website: www.advantedgepaving.com

Before using a similar device, the Contractor shall provide proof that the device has been used on previous projects with acceptable results, or construct a test section prior to the beginning of work and demonstrate wedge compaction to the satisfaction of the Engineer. Short sections of handwork will be allowed when necessary for transitions and turnouts, or otherwise authorized by the Engineer.

MISSISSIPPI DEPARTMENT OF TRANSPORTATION

| SPECIAL PROVISION NO. 907-401-10M

CODE: (IS)

| DATE: 11/04/2005

SUBJECT: Hot Mix Asphalt (HMA)

Section 401, Plant Mix Pavements-General, of the 1996 Metric Edition of the Mississippi Standard Specifications for Road and Bridge Construction is deleted in toto and replaced as follows:

SECTION 907-401 - HOT MIX ASPHALT (HMA) - GENERAL

907-401.01--Description. These specifications include general requirements that are applicable to all types of HMA along with the specific requirements for each particular mixture when deviations from the general requirements are necessary.

This work consists of the construction of one or more lifts of HMA in accordance with these specifications and the specific requirements for the mixture to be produced and in reasonably close conformity with the lines, grades, thicknesses and typical sections shown on the plans or established by the Engineer.

907-401.01.1--Definitions.

Maximum Sieve Size - Maximum sieve size is the smallest sieve size at which 100 percent of the aggregate passes.

Nominal Maximum Sieve Size - The nominal maximum sieve size is one sieve size larger than the first sieve to retain more than 10 percent of the aggregate.

Maximum Density Line - The maximum density line is a straight line plot on the FHWA 0.45 power gradation chart which extends from the zero origin point of the chart through the plotted point of the combined aggregate gradation curve on the nominal maximum sieve size.

Mechanically Fractured Face - An angular, rough, or broken surface of an aggregate particle created by crushing as determined by ASTM Designation: D 5821.

907-401.02--Materials.

907-401.02.1--Component Materials.

907-401.02.1.1--General. Component materials will be conditionally accepted at the plant subject to later rejection if incorporated in a mixture or in work which fails to meet contract requirements.

907-401.02.1.2--Aggregates. The source of aggregates shall meet the applicable requirements of Section 907-703.

907-401.02.1.2.1--Coarse Aggregate Blend. Mechanically fractured faces by mass of the combined mineral aggregate coarser than the 4.75 mm sieve:

<u>Mixture</u>	<u>Percent Fractured Faces, minimum</u>
25 mm	70 (one face)
19 mm*	80 (one face)
12.5 mm	90 (two face)
9.5 mm	90 (two face)
4.75 mm	90 (two face)

* When used on routes requiring polymer modified asphalt, the top intermediate lift (19 mm mixture), including travel lane and adjacent lane, shall have at least 90 percent two fractured faces minimum. When placed on an existing portland cement concrete surface, all intermediate lifts (19 mm mixture) shall have at least 90 percent fractured two faces minimum.

The maximum percentage by mass of flat and elongated particles, for all mixes other than 4.75 mm, maximum to minimum dimension greater than 5, shall not exceed 10% for all mixtures. This shall be determined in accordance with ASTM D 4791, Section 8.4, on the combined mineral aggregate retained on the 4.75 mm sieve.

907-401.02.1.2.2--Fine Aggregate Blend. Of all the material passing the 2.36 mm sieve and retained on the 75 µm sieve, not more than 60 percent shall pass the 600 µm sieve.

Uncrushed natural sand shall pass the 9.5 mm sieve and may be used, excluding the content in RAP, in the percentages of the total mineral aggregate by mass set out in the following table:

Mixture	Maximum Percentage of Natural Sand by Total Mass of Mineral Aggregate		
	HT	MT	ST
25 mm	10	10	20
19 mm	10	10	20
12.5 mm	10	10	20
9.5 mm	10	10	10
4.75 mm	25	30	30

907-401.02.1.2.3--Combined Aggregate Blend.**Design Master Range**

Mixture:	25 mm	19 mm	12.5 mm	9.5 mm	4.75 mm
Nominal Maximum Sieve Size	<u>25.0 mm</u>	<u>19.0 mm</u>	<u>12.5 mm</u>	<u>9.5 mm</u>	<u>4.75 mm</u>
Sieve Size	<u>Percent Passing</u>				
37.5 mm	100				
25.0 mm	90-100	100			
19.0 mm	89 max.	90-100	100		
12.5 mm	-	89 max.	90-100	100	100
9.5 mm	-	-	89 max.	90-100	95-100
4.75 mm	-	-	-	89 max.	90-100
2.36 mm	16-50	18-55	20-60	22-70	-
1.18 mm	-	-	-	-	30-60
75 µm	4.0-9.0	4.0-9.0	4.0-9.0	4.0-9.0	6.0-12.0

For MT and HT mixtures, the combined aggregate gradation of the job mix formula, when plotted on FHWA 0.45 power chart paper, shall fall entirely below the Maximum Density Line on all sieve sizes smaller than the 4.75 mm sieve. However, MT and HT mixtures having a minimum fine aggregate angularity index of 44.0 (ASTM C1252, Method A) may be designed above the maximum density line.

The 9.5 mm mixtures shall have a minimum fine aggregate angularity of 44.0 for HT and MT mixtures and 40.0 for ST mixtures when tested on combined aggregate in accordance with ASTM C1252, Method A. The 4.75 mm mixtures shall have a minimum fine aggregate angularity of 45.0 for all design levels when tested on combined aggregate in accordance with ASTM C 1252, Method A.

The minus 425 µm fraction of the combined aggregate shall be non-plastic when tested according to AASHTO T 90. The clay content for the combined aggregate used in underlying layers shall not exceed 1.0 percent, and when used in top layers shall not exceed 0.5 percent by mass of the total mineral aggregate when tested according to AASHTO T 88.

907-401.02.1.3--Bituminous Materials. Bituminous materials shall meet the applicable requirements of Section 907-702 for the grade specified.

Tack coat shall be the same neat grade asphalt cement used in the mixture being placed or those materials specified for tack coat in Table 410-A on the last page of Section 410. Emulsified asphalt shall not be diluted without approval of the Engineer.

907-401.02.1.4--Blank.

907-401.02.1.5--Hydrated Lime. Hydrated lime shall meet the requirements of 714.03.2 for lime used in soil stabilization.

907-401.02.1.6--Asphalt Admixtures. Additives for liquid asphalt, when required or permitted, shall meet the requirements of Subsection 702.08.

907-401.02.1.7--Polymers. Polymers for use in polymer modified HMA pavements shall meet the requirements of Subsection 907-702.08.3.

907-401.02.2--Blank.

907-401.02.3--Composition of Mixtures.

907-401.02.3.1--General. Unless otherwise specified or permitted, the HMA shall consist of a uniform mixture of asphalt, aggregate, hydrated lime and, when required or necessary to obtain desired properties, antistripping agent and/or other materials.

The total amount of crushed limestone aggregate for mixtures, excluding 4.75 mm mixtures, when used in the top lift, shall not exceed 50 percent of the total combined aggregate by mass.

Hydrated lime shall be used in all HMA at the rate of one percent (1%) by mass of the total dry aggregate including aggregate in RAP, if used. The aggregate, prior to the addition of the hydrated lime, shall contain sufficient surface moisture. If necessary, the Contractor shall add moisture to the aggregate according to the procedures set out in Subsection 907-401.03.2.1.2.

The Contractor shall obtain a shipping ticket for each shipment of hydrated lime. The Contractor shall provide the District Materials Engineer with a copy of each shipping ticket from the supplier, including the date, time and weight of hydrated lime shipped and used in hot mix asphalt production. An amount equal to twenty-five percent (25%) of the total value of HMA items performed during the initial estimate period in which the Contractor fails to submit the hydrated lime shipping tickets to the District Materials Engineer will be withheld from the Contractor's earned work. Non-conformance with this specification for successive estimate period(s) will result in the total value (100%) of HMA items performed during this period(s) being withheld from the Contractor's earned work. Monies withheld for this non-conformance will be released for payment on the next monthly estimate following the date the submittal of hydrated lime shipping tickets to the District Materials Engineer is brought back into compliance with this specification.

Mixtures will require the addition of an antistripping agent when the Tensile Strength Ratio (MT-63M) and/or the Boiling Water Test (MT-59M) fail to meet the following criteria.

Tensile Strength Ratio (TSR - MT-63M)	
Wet Strength / Dry Strength	85 percent minimum
Interior Face Coating	95 percent minimum
Boiling Water Test (MT-59M)	
Particle Coating	95 percent minimum

Reclaimed asphalt pavement (RAP) materials may be used in the production of HMA in the percentages of the total mix by mass set out in the following table:

HMA Mixture	Maximum percent RAP by total mass of mix
4.75 mm	0
9.5 mm	15
12.5 mm Top Lift	15
12.5 mm Underlying Lift	30
19 mm	30
25 mm	30

During HMA production, the RAP shall pass through a maximum 50-mm square sieve located in the HMA plant after the RAP cold feed bin and prior to the RAP mass determining system.

Crushed reclaimed concrete pavement may be used as an aggregate component of all HMA pavements. When crushed reclaimed concrete pavement is used as an aggregate component, controls shall be implemented to prevent segregation. Crushed reclaimed concrete pavement aggregate shall be separated into coarse and fine aggregate stockpiles using the 9.5 mm or 12.5 mm sieve as a break-point unless otherwise approved by the Engineer in writing.

907-401.02.3.1.1--Mixture Properties.

ALL MIXTURES

Percent of Maximum Specific Gravity (Gmm)

N_{Design}	96.0
N_{Initial}	Less than 90.0
N_{Maximum}	Less than 98.0

VMA CRITERIA

Minimum percent

25 mm mixture	12.0
19 mm mixture	13.0
12.5 mm mixture	14.0
9.5 mm mixture	15.0
4.75 mm mixture	16.0

Mixtures with VMA more than two percent higher than the minimum may be susceptible to flushing and rutting; therefore, unless satisfactory experience with high VMA mixtures is available, mixtures with VMA greater than two percent above the minimum should be avoided.

The specified VFA range for 4.75 mm nominal maximum size mixtures for design traffic levels >3 million ESAL's (HT Mixtures) shall be 75 to 78 percent, for design traffic levels of 1.0 to 3

million ESAL's (MT mixtures) 65 to 78 percent, and for design traffic levels of <1.0 million ESAL's (ST mixtures) 65 to 78 percent.

DUST/BINDER RATIO (4.75 mm)

(Percent Passing 75µm / Effective Binder Percent) 0.9 to 2.0

DUST/BINDER RATIO (9.5 mm, 12.5 mm, 19 mm & 25mm)

(Percent Passing 75µm / Effective Binder Percent) 0.8 to 1.6

907-401.02.3.2--Job Mix Formula. The job mix formula shall be established in accordance with Mississippi Test Method: MT-78M, where N represents the number of revolutions of the gyratory compactor.

Compaction Requirements:	N _{Initial}	N _{Design}	N _{Maximum}
High Type (HT) Mixtures (19 mm, 12.5 mm, 9.5 mm & 4.75 mm)	7	85	130
Medium Type (MT) Mixtures (19 mm, 12.5 mm, 9.5 mm & 4.75 mm)	7	65	100
All Standard Type (ST) Mixtures; 25 mm HT & MT Mixtures	6	50	75

At least 10 working days prior to the proposed use of each mixture, the Contractor shall submit in writing to the Engineer a proposed job-mix formula or request the transfer of a verified job-mix formula as set forth in the latest edition of MDOT's Field Manual for HMA and TMD-11-78-00-000M. The job-mix formula shall be signed by a Certified Mixture Design Technician (CMDT).

The Department will perform the tests necessary for review of a proposed job-mix formula for each required mixture free of charge one time only. A charge will be made for additional job-mix formulas submitted by the Contractor for review.

Review of the proposed job-mix formula will be based on percent maximum specific gravity at N_{Initial}, N_{Design}, and N_{Maximum}, VMA @ N_{Design}, resistance to stripping, and other criteria specified for the mixture.

The mixture shall conform thereto within the range of tolerances specified for the particular mixture. No change in properties or proportion of any component of the job-mix formula shall be made without permission of the Engineer. The job-mix formula for each mixture shall be in effect until revised in writing by the Engineer.

A job-mix formula may be transferred to other contracts in accordance with conditions set forth in the Department's Field Manual for HMA.

The Contractor shall not place any HMA prior to receiving “tentative” approval and a MDOT design number from the Central Laboratory.

When a change in source of materials, unsatisfactory mixture production results (such as segregation, bleeding, shoving, rutting over 3 millimeters, raveling & cracking) or changed conditions make it necessary, a new job-mix formula will be required. The conditions set out herein for the original job-mix formula are applicable to the new job-mix formula.

907-401.02.4--Substitution of Mixture. The substitution of a one (1) size finer mixture for an underlying lift shall require written permission of the State Construction Engineer, except no substitution of a 4.75 mm mixture will be allowed. A 9.5 mm mixture may be substituted for the 12.5 mm mixture designated on the plans as the top lift or pre-leveling. The 19 mm mixture may be substituted for the 25 mm mixture in trench widening work. Any substitution of mixtures shall be of the same type. No other substitutions will be allowed. The quantity of substituted mixture shall be measured and paid for at the contract unit price for the mixture designated on the plans. The substitution of any mixture will be contingent on meeting the required total structure thickness and maintaining the minimum and/or maximum laying thickness for the particular substituted mixture as set out in the following table.

Mixture	Single Lift Laying Thickness (millimeters)	
	Minimum	Maximum
25 mm	75	100
19 mm	55	75
12.5 mm	40	50
9.5 mm	25	40
4.75 mm	12.5	20

907-401.02.5--Contractor's Quality Management Program.

907-401.02.5.1--General. The Contractor shall have full responsibility for quality management and maintain a quality control system that will furnish reasonable assurance that the mixtures and all component materials incorporated in the work conform to contract requirements. The Contractor shall have responsibility for the initial determination and all subsequent adjustments in proportioning materials used to produce the specified mixture. Adjustments to plant operation and spreading and compaction procedures shall be made immediately when results indicate that they are necessary. Mixture produced by the Contractor without the required testing or personnel on the project shall be subject to removal and replacement by the Contractor at no additional cost to the State.

907-401.02.5.2--Personnel Requirements. The Contractor shall provide at least one Certified Asphalt Technician-I (CAT-I) full-time during HMA production at each plant site used to furnish material to the project. Sampling shall be conducted by a certified technician or by plant personnel under the direct observation of a certified technician. All testing, data analysis and data posting will

be performed by the CAT-I or by an assistant under the direct supervision of the CAT-I. The Contractor shall have a Certified Asphalt Technician-II (CAT-II) available to make any necessary process adjustments. Technician certification shall be in accordance with MDOT SOP TMD-22-10-00-000M, MDOT HMA Technician Certification Program. An organizational chart, including names, telephone numbers and current certification, of all those responsible for the quality control program shall be posted in the contractor's laboratory while the asphaltic paving work is in progress.

907-401.02.5.3--Testing Requirements. As a minimum, the Contractor's quality management program shall include the following:

- (a) Bituminous Material. Provide Engineer with samples in a sealed one liter metal container at the frequency given in MDOT SOP TMD-20-04-00-000M.
- (b) Mechanically Fractured Face. Determine mechanically fractured face content of aggregates retained on the 4.75 mm sieve, at a minimum of one test per day of production.
- (c) Mixture Gradation. Conduct extraction tests for gradation determination on the mixture. Sample according to the frequency in paragraph (i) and test according to Mississippi Test Method MT-31M.
- (d) Total Voids and VMA. Determine total voids and voids in mineral aggregate (VMA), at N_{Design} , from the results of bulk specific gravity tests on laboratory compacted specimens. Sample according to the sampling frequency in paragraph (i) and test according to the latest edition of MDOT's Field Manual for HMA.
- (e) Asphalt Content. Sample according to the sampling frequency in paragraph (i). Determine the asphalt content using one of the following procedures.
 - (1) Nuclear gauge. (Mississippi Test Method MT-6M)
 - (2) Incinerator oven. (AASHTO T 308, Method A)
- (f) Stripping Tests. Conduct a minimum of one stripping test at the beginning of each job-mix production and thereafter, at least once per each two weeks of production according to Mississippi Test Method: MT-63M and one stripping test per day of production according to Mississippi Test Method: MT-59M. Should either the TSR (MT-63M) or the boiling water (MT-59M) stripping tests fail, a new antistrip additive or rate shall be established or other changes made immediately that will result in a mixture which conforms to the specifications; otherwise, production shall be suspended until corrections are made.
- (g) Density Tests. For 25 mm, 19.5 mm, 12.5 mm & 9.5 mm mixtures, conduct density tests as necessary to control and maintain required compaction according to Mississippi Test Method: MT-16M, Method C (nuclear gauge), or AASHTO T 166.

(Note - The nuclear gauge may be correlated, at the Contractor's option, with the average of a minimum of five pavement sample densities.) For 4.75 mm mixtures, conduct density tests as necessary to control and maintain required compaction according to AASHTO Designation: T 166.

- (h) Quality Control Charts. Plot the individual test data, the average of the last four tests and the control limits for the following items as a minimum:

Mixture Gradation (Percent Passing) Sieves:

12.5 mm, 9.5 mm , 2.36 mm, 1.18 mm, 600 μm and 75 μm.

Asphalt Content, Percent

Maximum Specific Gravity, G_{mm}

Total Voids @ N_{Design}, Percent

VMA @ N_{Design}, Percent

NOTE: For 4.75 mm mixtures, Quality Control Charts for mixture gradation are not required on the 2.36 mm and 600 μm sieves. For 4.75 mm mixtures, as a minimum, Quality Control Charts for mixture gradation shall be kept on the 9.5 mm, 1.18 mm and 75 μm sieves. For all mixtures other than 4.75 mm, Quality Control Charts for mixture gradation are not required on the 1.18 mm sieve.

Keep charts up-to-date and posted in a readily observable location. Charts may be kept on a computer, however, the charts shall be printed out a minimum of once each production day and displayed in the laboratory. Note any process changes or adjustments on the Air Voids chart.

- (i) Sampling Frequency. Conduct those tests as required above at the following frequency for each mixture produced based on the estimated plant tonnage at the beginning of the day.

<u>Total Estimated Production,</u> <u>metric tons</u>	<u>Number of Tests</u>
50-800	1
801-1700	2
1701-2700	3
2701+	4

- (j) Sample Requirements. Obtain the asphalt mixture samples from trucks at the plant. Obtain aggregate samples from cold feed bins or aggregate stockpile. Save a split portion of all mixture samples at the laboratory site in a dry and protected location for 14 calendar days. At the completion of the project, the remaining samples may be disposed of with the approval of the Engineer.

NOTE: Material placed in a storage silo from a previous day's production shall be randomly sampled and tested when removed for placement on the roadway. Such sample(s) shall be independent of the day's production sampling frequency and shall be used in calculating the four (4) sample running average.

The above testing frequencies are for the estimated plant production for the day. If production is discontinued or interrupted, the tests will be conducted at the previously established sample tonnage points for the materials that are actually produced. If the production exceeds the estimated tonnage, sampling and testing will continue at the testing increments previously established for the day. A testing increment is defined as the estimated daily tonnage divided by the required number of tests from the table in 907-401.02.5.3 paragraph (i).

In addition to the above program, the following tests shall be conducted on the first day of production and once for every eight production samples thereafter, with a minimum of one test per production week.

Aggregate Stockpile Gradations (AASHTO T-11 and T-27)

Reclaimed Asphalt Pavement (RAP) Gradation (Mississippi Test Method MT-31M)

Fine Aggregate Angularity for all 4.75 mm and 9.5 mm mixtures and all MT and HT mixtures designed above the maximum density line. (ASTM C 1252, Method A)

Testing of the aggregate and RAP stockpiles during production will be waived provided the Contractor provides the Engineer with gradation test results for the materials in the stockpile determined during the building of the stockpiles. The test results provided shall represent a minimum frequency of one per one thousand metric tons of material in the stockpile. If the Contractor continues to add materials to the stockpile during HMA production, the requirements for gradation testing during production are not waived.

907-401.02.5.4--Documentation. The Contractor shall document all observations, records of inspection, adjustments to the mixture, and test results on a daily basis. All tests conducted by the Contractor in accordance with 907-401.02.5.3(h) shall be included in the running average calculations. If single tests are performed as a check on individual HMA properties, between regular samples, without performing all tests required in 907-401.02.5.3(h), the results of those individual tests shall not be included in the running average calculations for that particular property. The Contractor shall record the results of observations and records of inspection as they occur in a permanent field record. The Contractor shall record all process adjustments and job mix formula (JMF) changes on the air void charts. The Contractor shall provide copies of all test data sheets and the daily summary reports on the appropriate Mississippi DOT forms to the Engineer on a daily basis. The Contractor shall provide a written description of any process change (including blend proportions) to the Engineer as they occur. Information provided to the Engineer must be received in the Engineer's office by no later than 9:00 AM the day after the HMA is produced. Fourteen days after the completion of the placement of the HMA, the

Contractor shall provide the Engineer with the original testing records and control charts in a neat and orderly manner.

907-401.02.5.5--Control Limits. The following control limits for the job mix formula (JMF) and warning limits are based on a running average of the last four data points.

<u>Item</u>	<u>JMF Limits</u>	<u>Warning Limits</u>
Sieve - % Passing		
12.5 mm	± 5.5	± 4.0
9.5 mm	± 5.5	± 4.0
2.36 mm	± 5.0	± 4.0
1.18 mm (For 4.75 mm mixtures ONLY)	± 4.0	± 3.0
600 µm	± 4.0	± 3.0
75 µm	± 1.5	± 1.0
Asphalt Content, %	-0.3 to +0.5	-0.2 to + 0.4
Total Voids @ N _{Design} , %	± 1.3	± 1.0
VMA @ N _{Design} , %	- 1.5	- 1.0

907-401.02.5.6--Warning Bands. Warning bands are defined as the area between the JMF limits and the warning limits.

907-401.02.5.7--Job Mix Formula Adjustments. A request for a JMF adjustment signed by a CAT-II may be made to the Engineer by the Contractor. Submit sufficient testing data with the request to justify the change. The requested change will be reviewed by the State Materials Engineer for the Department. If current production values meet the mixture design requirements, a revised JMF will be issued. Adjustments to the JMF shall conform to the latest edition of MDOT's Field Manual for HMA. Adjustments to the JMF to conform to actual production shall not exceed the tolerances specified for the JMF limits. Regardless of such tolerances, any adjusted JMF gradation shall be within the design master range for the mixture specified. **The JMF asphalt content may only be reduced if the production VMA meets or exceeds the minimum design VMA requirements for the mixture being produced.**

907-401.02.5.8--Actions and Adjustments. Based on the process control test results for any property in question, the following actions shall be taken or adjustments made when appropriate:

- (a) When the running average trends toward the warning limits, the Contractor shall consider taking corrective action. The corrective action, if any, shall be documented. All tests shall be part of the contract files and shall be included in the running average calculations.
- (b) The Contractor shall notify the Engineer whenever the running average exceeds the warning limits.
- (c) If two consecutive running averages exceed the warning limit, the Contractor shall stop production and make adjustments. Production shall only be restarted after notifying the Engineer of the adjustments made.

- (d) If the adjustment made under (c) improves the process such that the running average after four additional tests is within the warning limits, the Contractor may continue production with no reduction in payment.
- (e) If the adjustment made under (c) does not improve the process and the running average after four additional tests stays in the warning band, the mixture will be considered unsatisfactory. Reduced payment for unsatisfactory mixtures will be applied starting from the stop point to the point when the running average is back within the warning limits in accordance with Subsection 907-401.02.6.3.
- (f) Failure to stop production and make adjustments when required shall subject all mixture produced from the stop point to the point when the running average is back within the warning limits to be considered unsatisfactory. Reduced payment for unsatisfactory mixtures will be applied in accordance with Subsection 907-401.02.6.3.
- (g) If the running average exceeds the JMF limits, the Contractor shall stop production and make adjustments. Production shall only be restarted after notifying the Engineer of the adjustments made.
- (h) All materials for which the running average exceeds the JMF limits will be considered unacceptable and shall be removed and replaced by the Contractor at no additional cost to the State. The Engineer will determine the quantity of material to be replaced based on a review of the individual testing data which make up the running average in question and an inspection of the completed pavement. If the Engineer decides to leave the mixture in place because of special circumstances, the quantity of mixture, as defined above, will be paid for in accordance with Subsection 907-401.02.6.3.
- (i) Single test results shall be compared to 1.7 times the warning and JMF limits. If the test results verified by QA testing (within allowable differences in Subsection 907-401.02.6.2) exceed these limits, the pay factor provided in Subsection 907-401.02.6.3 will apply for the quantity of material represented by the test(s). Single test limits will be used for the acceptance of projects when insufficient tonnage is produced to require four (4) Contractor's tests.
- (j) The above corrective action will also apply for a mixture when the Contractor's testing data has been proven incorrect. The Contractor's data will be considered incorrect when;
1) the Contractor's tests and the Engineer's tests do not agree within the allowable differences given in Subsection 907-401.02.6.2 and the difference can not be resolved, or
2) the Engineer's tests indicates that production is outside the JMF limits and the results have been verified by the Materials Division. The Engineer's data will be used in place of the Contractor's data to determine the appropriate pay factor.

907-401.02.6--Standards of Acceptance.

907-401.02.6.1--General. Acceptance for mixture quality (VMA and total voids @ N_{Design} , gradation, and asphalt content) will be based on random samples tested in accordance with the latest edition of MDOT's Field Manual for HMA. Pavement densities and smoothness will be accepted by lots as set out in 907-401.02.6.4 and 907-401.02.6.5.

907-401.02.6.2--Assurance Program for Mixture Quality. The Engineer will conduct a quality assurance program. The quality assurance program will be accomplished as follows:

- 1) Conducting verification tests.
- 2) Validate Contractor test results.
- 3) Periodically observing Contractor quality control sampling and testing.
- 4) Monitoring required quality control charts and test results.
- 5) Sampling and testing materials at any time and at any point in the production or laydown process.

The rounding of all test results will be in accordance with Subsection 700.04.

The Engineer will conduct verification tests on samples taken by the Contractor under the direct supervision of the Engineer at a time specified by the Engineer. The frequency will be equal to or greater than ten percent (10%) of the tests required for Contractor quality control and the data will be provided to the Contractor within two asphalt mixture production days after the sample has been obtained by the Engineer. At least one sample shall be tested from the first two days of production. All testing and data analysis shall be performed by a Certified Asphalt Technician-I (CAT-I) or by an assistant under the direct supervision of the CAT-I. Certification shall be in accordance with the *MDOT HMA Technician Certification Program* chapter in the Materials Division Inspection, Testing, and Certification Manual. The Department shall post a chart giving the names and telephone numbers for the personnel responsible for the assurance program.

The Engineer shall be allowed to inspect Contractor testing equipment and equipment calibration records to confirm both calibration and condition. The Contractor shall calibrate and correlate all testing equipment in accordance with the latest versions of the Department's Test Methods and AASHTO Designation: R 18.

Random differences between the Engineer's verification tests and the current running average of four quality control tests at the time of obtaining the verification sample will be considered acceptable if within the following limits:

Item	Allowable Differences
Sieve - % Passing	
9.5 mm and above	6.0
4.75 mm	5.0
2.36 mm	4.0
1.18 mm (For 4.75 mm mixtures ONLY)	3.5
600 μm	3.5
75 μm	2.0
AC Content	0.4
Specimen Bulk SG (Gmb) @ N_{Design}	0.030
Maximum SG (Gmm)	0.020

If four quality control tests have not been tested prior to the time of the first verification test, the verification test results will be compared to the average of the preceding quality control tests. If the verification test is the first material tested on the project or if a significant process adjustment was made just prior to the verification test, the verification test results will be compared to the average of four subsequent quality control test results. For all other cases after a significant process adjustment, the verification test results will be compared to the average of the preceding quality control tests (taken after the adjustment) as in the case of a new project start-up when four quality control tests are not available.

In the event that; 1) the comparison of the Contractor's running average quality control data and Engineer's quality assurance verification test results are outside the allowable differences in the above table, or 2) if a bias exists between the results, such that one of the results is predominately higher or lower than the other, and the Engineer's results fail to meet the JMF control limits, the Engineer will investigate the reason immediately. As soon as the need for an investigation becomes known, the Engineer will increase the quality assurance sampling rate to the same frequency required for Contractor testing. The additional samples obtained by the Engineer may be used as part of the investigation process or for routine quality assurance verification tests. The Engineer's investigation may include testing of the remaining quality control split samples, review and observation of the Contractor's testing procedures and equipment, and a comparison of split sample test results by the Contractor quality control laboratory, Department quality assurance laboratory and the Materials Division laboratory. The procedures outlined in the latest edition of MDOT's Field Manual for HMA may be used as a guide for the investigation. In the event that the Contractor's results are determined to be incorrect, the Engineer's results will be used for the quality control data and the appropriate payment for the mixture will be based on the procedures specified in Subsection 401.02.5.8(j).

The Engineer will periodically witness the sampling and testing being performed by the Contractor. The Engineer, both verbally and in writing, will promptly notify the Contractor of any observed deficiencies. When differences exist between the Contractor and the Engineer which cannot be resolved, a decision will be made by the State Materials Engineer, acting as the referee. The Contractor will be promptly notified in writing of the decision. If the deficiencies are not corrected, the Engineer will stop production until corrective action is taken.

907-401.02.6.3--Acceptance Procedure for Mixture Quality. All obviously defective material or mixture will be subject to rejection by the Engineer. Such defective material or mixture shall not be incorporated into the finished work. If the defective material has already been placed in the work, the material shall be removed and replaced at no additional cost to the State.

The Engineer will base final acceptance of the asphalt mixture production on the results of the Contractor's testing for total voids and VMA @ N_{Design} , gradation, and asphalt content as verified by the Engineer in the manner hereinbefore described and the uniformity and condition of the completed pavement. Areas of pavement that exhibit nonuniformity or failures (materials or construction related) such as but not limited to segregation, bleeding, shoving, rutting over 3 millimeters, raveling, slippage, or cracking will not be accepted. Such areas will be removed and replaced at no additional cost to the State.

Bituminous mixture placed prior to correction for deficiencies in VMA and total voids @ N_{Design} , gradation, or asphalt content, as required in 907-401.02.5.8 and determined by the Engineer satisfactory to remain in place will be paid for in accordance with the following pay factors times the contract unit price per metric ton.

Pay Factor for Mixture Quality *

Item	Produced in Warning Bands	Produced Outside JMF Limits (Allowed to Remain in Place)
Gradation	0.90	0.75
Asphalt Content	0.85	0.75
Total Voids @ N_{Design}	0.70	0.50
VMA @ N_{Design}	0.90	0.75

* The minimum single payment will apply.

907-401.02.6.4--Acceptance Procedure for Density. Each completed lift will be accepted with respect to compaction on a lot to lot basis from density tests performed by the Department. For normal production days, divide the production into approximately equal lots as shown in the following table. When cores are being used for the compaction evaluation, randomly obtain one core from each lot. When the nuclear density gauge is being used for compaction evaluation, obtain two random readings from each lot and average the results (see Chapter 7 of the latest edition of MDOT’s Field Manual for HMA). Additional tests may be required by the Engineer to determine acceptance of work appearing deficient. The Contractor shall furnish and maintain traffic control for all compaction evaluations (including coring) required in satisfying specified density requirements.

Lot Determination

<u>Daily Production - Metric Tons</u>	<u>Number of Lots</u>
0-300	1
301-600	2
601-1000	3
1001-1500	4
1501-2100	5
2101-2800	6
2801+	7

907-401.02.6.4.1--Roadway Density. The density requirement for each completed lift on a lot to lot basis from density tests performed by the Department shall be as follows:

1. For all single lift overlays, with or without leveling and/or milling, the required lot density shall be 92.0 percent of maximum density.

- 2. For all multiple lift overlays (two (2) or more lifts, excluding leveling lifts), the required lot density of the bottom lift shall be 92.0 percent of maximum density. The required lot density for all subsequent lifts shall be 93.0 percent of maximum density.
- 3. For all pavements on new construction, the required lot density for all lifts shall be 93.0 percent of maximum density.

When it is determined that the density for a lot is below the required density (93.0 percent or 92.0 percent) but not lower than 91.0 or 90.0 percent of maximum density, respectively, the Contractor will have the right to remove and replace the lot(s) not meeting the specified density requirements in lieu of accepting reduced payment for the lot(s).

When it is determined that the density for a lot is above 96.0 percent, the Engineer shall notify the Contractor who will make plant adjustments to resolve the problem.

When it is determined that the density for a lot is below 91.0 or 90.0 percent, respectively, the lot(s), or portions thereof shall be removed and replaced in accordance with Chapter 7 of the latest edition of MDOT's Field Manual for HMA at no additional cost to the State. A corrected lot will be retested for approval. No resampling will be performed when pavement samples are used for determining density.

At any time the average daily compaction (the total of the percent compaction for the lots produced in one day divided by the total number of lots for the day) does not meet the required percent compaction or more for two consecutive days, the Contractor shall notify the Engineer of proposed changes to the compactive effort. If the average daily compaction does not meet the required percent compaction or more for a third consecutive day, the Contractor shall stop production until compaction procedures are established to meet the specified density requirements.

Each lot of work found not to meet the density requirement of 92.0 percent of maximum density may remain in place with a reduction in payment as set out in the following tables:

**PAYMENT SCHEDULE FOR COMPACTION
OF 92.0 PERCENT OF MAXIMUM DENSITY**

<u>Pay Factor</u>	<u>Lot Density ** % of Maximum Density</u>
1.00	92.0 and above
0.90	91.0 - 91.9
0.70	90.0 - 90.9

** Any lot or portion thereof with a density of less than 90.0 percent of maximum density shall be removed and replaced at no additional cost to the State.

PAYMENT SCHEDULE FOR COMPACTION OF 93.0 PERCENT OF MAXIMUM DENSITY

<u>Pay Factor</u>	<u>Lot Density ***</u> <u>% of Maximum Density</u>
1.00	93.0 and above
0.90	92.0 - 92.9
0.70	91.0 - 91.9

*** Any lot or portion thereof with a density of less than 91.0 percent of maximum density shall be removed and replaced at no additional cost to the State.

The compaction pay factors and mixture quality pay factor (Subsection 907-401.02.6.3) will each apply separately. However, the combined pay factor shall not be less than 0.50 for any mixture allowed to remain in place.

907-401.02.6.4.2--Trench Widening Density. The density for trench widening on a lot to lot basis shall be determined from density tests performed by the Department using pavement samples (cores).

When it is determined that the density for a trench widening lot is below 89.0 percent but not lower than 88.0 percent of maximum density, the Contractor will have the right to remove and replace the lot(s) not meeting the specified density requirements in lieu of accepting reduced payment for the lot(s).

When it is determined that the density for a trench widening lot is above 95.0 percent, the Engineer shall notify the Contractor who will make plant adjustments to resolve the problem.

When it is determined that the density for a trench widening lot is below 88.0 percent, the lot(s), or portions thereof shall be removed and replaced in accordance with Chapter 7 of the latest edition of MDOT's Field Manual for HMA at no additional cost to the State. A corrected lot will be retested for approval. No resampling will be performed when pavement samples are used for determining density.

At any time the daily compaction (the total of the percent compaction for the lots produced in one day divided by the total number of lots for the day) does not meet 89.0 percent compaction or more for two consecutive days, the Contractor shall notify the Engineer of proposed changes to the compactive effort. If the average daily compaction does not meet 89.0 percent compaction or more for a third consecutive day, the Contractor shall stop production until compaction procedures are established to meet the specified density requirement.

Each lot of trench widening work found not to meet the density requirement of 91.0 percent of maximum density may remain in place with a reduction in payment as set out in the following table:

**PAYMENT SCHEDULE FOR COMPACTION
(TRENCH WIDENING WORK)**

	Lot Density ***
<u>Pay Factor</u>	<u>% of Maximum Density</u>
1.00	89.0 and above
0.50	88.0 - 88.9

*** Any lot or portion thereof with a density of less than 88.0 percent of maximum density shall be removed and replaced at no additional cost to the State.

The compaction pay factors and mixture quality pay factor (Subsection 907-401.02.6.3) will each apply separately. However, the combined pay factor shall not be less than 0.50 for any mixture allowed to remain in place.

907-401.02.6.5--Acceptance Procedure for Pavement Smoothness. When compaction is completed, the lift shall have a uniform surface and be in reasonably close conformity with the line, grade and cross section shown on the plans.

The smoothness of each applicable lift will be determined by using a California Profilograph to produce a profilogram (profile trace) at each designated location. The surface shall be tested and corrected to a smoothness index as described herein with the exception of those locations or specific projects that are excluded from a smoothness test with the profilograph.

The profilograph, furnished and operated by the Contractor under supervision of the Engineer, shall consist of a frame at least 7.5 meters in length supported upon multiple wheels having no common axle. The wheels shall be arranged in a staggered pattern so that no two wheels will simultaneously cross the same bump. A profile is to be recorded from the vertical movement of a sensing mechanism. This profile is in reference to the mean elevation of the contact points established by the support wheels. The sensing mechanism, located at the mid-frame, may consist of a single bicycle-type wheel or a dual-wheel assembly consisting of either a bicycle-type (pneumatic tire) or solid rubber tire vertical sensing wheel and a separate bicycle-type (pneumatic tire) longitudinal sensing wheel. The wheel(s) shall be of such circumference(s) to produce a profilogram recorded on a scale of 1:300 longitudinally and 1:1 (full scale) vertically. Motive power may be provided manually or by the use of a propulsion unit attached to the center assembly. In operation, the profilograph shall be moved longitudinally along the pavement at a speed no greater than 5 KPH so as to reduce bounce as much as possible. The testing equipment and procedure shall comply with the requirements of Department SOP.

The Contractor may elect to use a computerized version of the profilograph in lieu of the standard profilograph. If the computerized version of the profilograph is used, it shall meet the requirements of Subsection 907-401.02.6.6.

The smoothness of each applicable lift will be determined for traffic lanes, auxiliary lanes, climbing lane and two-way turn lanes. Areas excluded from a smoothness test with the profilograph are acceleration and deceleration lanes, tapered sections, transition sections (for width), shoulders, crossovers, ramps, side street returns, etc. The roadway pavement on bridge replacement projects having 300 meters or less of pavement on each side of the structure will be excluded from a test with the profilograph. Pavement on horizontal curves having a radius of less than 300 meters at the centerline and pavement within the superelevation transition of such curves are excluded from a test with the profilograph. The profilogram shall terminate five meters from each transverse joint that separates the pavement from a bridge deck, bridge approach slab or existing pavement not constructed under the contract.

A profilogram will be made for each applicable lift. The measurements will be made in the outside wheel path of exterior lanes and either wheel path of interior lanes. The wheel path is designated as being located 0.9 meter from the edge of pavement or longitudinal joint. The testing will be limited to a single profilogram for each lift of a lane except that a new profilogram will be made on segments that have been surface corrected. When surface corrections are required and/or made, a new profilogram will be made. The new profilogram shall meet the requirements of Subsection 907-403.03.2.

Each applicable lift will be accepted on a segment to segment basis for pavement smoothness. When the profile index requirement of the lift is 475.0 millimeters per kilometer, no segment of the lift with a profile index greater than 475.0 millimeters per kilometer shall be allowed to remain in place without correction. For the purpose of determining pavement smoothness and contract price adjustment for rideability (Subsection 907-403.03.2), each day's production will be sub-divided into sections which terminate at bridges, transverse joints or other interruptions. Each section will be sub-divided into segments of 0.1 kilometer. Where a segment less than 0.1 kilometers occurs at the end of a section, it will be combined with the preceding 0.1-kilometer segment for calculation of the profile index. The last five meters of a day's lift may not be obtainable until the lift is continued and for this reason may be included in the subsequent segment.

A profile index will be determined for each segment as millimeters per kilometer in excess of the "Zero" blanking band which is simply referred to as the "Profile Index". From the profilogram of each segment, the scallops above and below the "Zero" blanking band are totaled in millimeters. The totaled count of millimeters is converted to millimeters per kilometer to establish a smoothness profile index for that segment.

Individual bumps and/or dips that are identified on the profilogram by locating vertical deviations that exceed 10 millimeters when measured from a chord length of 7.5 meters or less shall be corrected regardless of the profile index value of the segment. Surface correction by grinding shall be in accordance with Subsection 907-401.02.6.7. The Contractor shall also make other necessary surface corrections to ensure that the final profile index of the segment meets the requirements of Subsection 907-403.03.2.

Segment(s) exceeding the accepted profile index value shall be corrected as specified in Subsection 907-403.03.4. All such corrections shall be at the expense of the Contractor.

Scheduling will be the responsibility of the Contractor with approval of the Engineer, and the tests shall be conducted within 72 hours after each day's production unless authorized otherwise by the Engineer. The Contractor will be responsible for traffic control associated with this testing operation.

907-401.02.6.6--Computerized Profilograph.

907-401.02.6.6.1--General The computerized profilograph, furnished and operated by the Contractor under the supervision of the Engineer, shall be equipped with an on-board computer capable of meeting the following conditions.

Vertical displacement shall be sampled every 75 millimeters or less along the roadway. The profile data shall be bandpass filtered in the computer to remove all spatial wavelengths shorter than 0.6 meter. This shall be accomplished by a third order, low pass Butterworth filter. The resulting band limited profile will then be computer analyzed according to the California Profilograph reduction process to produce the required millimeters per kilometer index. This shall be accomplished by fitting a linear regression line to each 0.1 kilometer of continuous pavement section. This corresponds to the perfect placement of the blanking band bar by a human trace reducer. Scallops above and below the blanking band are then detected and totaled according to the California protocol. Bump/Dip analysis shall take place according to the California Profilograph reduction process.

The computerized profilograph shall be capable of producing a plot of the profile and a printout which will give the following data: Stations every 7.5 meters, bump/dip height and bump/dip length of specification (10.0 millimeters and 7.5 meters respectively), the blanking band width, date of measurement, total profile index in millimeters per kilometer for the measurement, total length of the measurement, and the raw millimeters for each 0.1-kilometer segment.

907-401.02.6.6.2--Mechanical Requirements. The profilograph shall consists of a frame 7.5 meters long supported at each end by multiple wheels. The frame shall be constructed to be easily dismantled for transporting. The profilograph shall be constructed from aluminum, stainless steel and chromed parts. The end support wheels shall be arranged in a staggered pattern such that no two wheels cross a transverse joint at the same time. The relative smoothness shall be measured by the vertical movement of an 200 millimeters or larger diameter sensing wheel at the midpoint of the 7.5-meter frame. The horizontal distance shall be measured by a 500-mm or larger diameter pneumatic wheel. This profile shall be the mean elevation referenced to the twelve points of contact with the pavement established by the support wheels. Recorded graphical trace of the profile shall be on a scale of 1:1 (full scale) vertical motion of the sensing wheel and 1:300 horizontal motion of the profilograph.

907-401.02.6.6.3--Computer Requirements. The computer shall have the ability to produce output on sight for verification. The computerized output shall indicate the profile index for each

specified section of roadway. Variable low and high pass third-order Butterworth filtering options shall be available. The printout shall be capable of showing station marks automatically on the output. Blanking band positioning for each specified section of the roadway shall be placed according to the least squares fit line of the collected data. Variable bump and dip tests shall be available to show "must correct" locations on the printout. The computer must have the ability to display on screen "must correct" conditions and alert the user with an audible warning when a must correct location has been located. The computer must have the ability to store profile data for later reanalysis. The measurement program must be menu driven and IBM compatible. User selected options, identification, calibration factors, and time and date stamps shall be printed at the top of each printed report for verification. The control software must be upgradeable. A power source shall be included for each profilograph and be capable of supplying all power needs for a full days testing.

907-401.02.6.7--Surface Correction. Corrective work to bumps shall consist of diamond grinding in accordance with these specifications or methods approved by the Engineer. All surface areas corrected by grinding shall be sealed with a sealant approved by the Engineer.

907-401.02.6.7.1--Diamond Grinding. Grinding of asphalt surfaces shall consist of diamond grinding the existing asphalt pavement surface to remove surface distortions to achieve the specified surface smoothness requirements.

907-401.02.6.7.2--Equipment. The grinding equipment shall be a power driven, self-propelled machine that is specifically designed to smooth and texture pavement surfaces with diamond blades. The effective wheel base of the machine shall not be less than 3.6 meters. It shall have a set of pivoting tandem bogey wheels at the front of the machine and the rear wheels shall be arranged to travel in the track of the fresh cut pavement. The center of the grinding head shall be no further than 0.9 meter forward from the center of the back wheels.

The equipment shall be of a size that will cut or plane at least 0.6 meter wide. It shall also be of a shape and dimension that does not encroach on traffic movement outside of the work area. The equipment shall be capable of grinding the surface without causing spalls at joints, or other locations.

907-401.02.6.7.3--Construction. The construction operation shall be scheduled and proceed in a manner that produces a uniform finish surface. Grinding will be accomplished in a manner to provide positive lateral drainage by maintaining a constant cross-slope between grinding extremities in each lane.

The operation shall result in pavement that conforms to the typical cross-section and the requirements specified in 907-401.02.6.7.4. It is the intent of this specification that the surface smoothness characteristics be within the limits specified.

The Contractor shall establish positive means for removal of grinding residue. Solid residue shall be removed from pavement surfaces before it is blown by traffic action or wind. Residue

shall not be permitted to flow across lanes used by public traffic or into gutters or drainage facilities, but may be allowed to flow into adjacent ditches.

907-401.02.6.7.4--Finished Pavement Surface. The grinding process shall produce a pavement surface that is smooth and uniform in appearance with a longitudinal line type texture. The line type texture shall contain parallel longitudinal corrugations that present a narrow ridge corduroy type appearance. The peaks of the ridges shall not be more than two millimeters higher than the bottoms of the grooves.

The finished pavement surface will be measured for riding quality. The grinding shall produce a riding surface which does not exceed either the specified profile index or the specified bump and dip limit.

907-401.02.7--Nuclear Gauges.

907-401.02.7.1--Nuclear Moisture-Density Gauge. The nuclear gauge unit used to monitor density shall contain a full data processor which holds all calibration constants necessary to compute and directly display wet density, moisture, and dry density in kilograms per cubic meter. The data processor shall compute and display the percent moisture and percent density based on dry mass.

907-401.02.7.2--Nuclear Asphalt Content Gauge. The Contractor shall furnish and calibrate, unless designated otherwise in the contract, a Troxler Nuclear Asphalt Content Gauge (Model 3241 or updated model) or a Campbell Nuclear Asphalt Content Gauge (Model AC-2) or an approved equal.

907-401.03--Construction Requirements. Mississippi DOT has adopted the “Hot-Mix Asphalt Paving Handbook” as the guideline for acceptable HMA construction practices.

907-401.03.1--Specific Requirements.

907-401.03.1.1--Weather Limitations. The mixture shall not be placed when weather conditions prevent the proper handling and finishing or the surface on which it is to be placed is wet or frozen. At the time of placement, the air and pavement surface temperature limitations shall be equal to or exceed that specified in the following table:

TEMPERATURE LIMITATIONS

Compacted Thickness	Temperature
Less than 40 millimeters	13°C
40 millimeters to 50 millimeters	10°C
55 millimeters to 75 millimeters	7°C
Greater than 75 millimeters	5°C

When paving operations are discontinued because of rain, the mixture in transit shall be protected until the rain ceases. The surface on which the mixture is to be placed shall be swept to remove as much moisture as possible and the mixture may then be placed subject to removal and replacement at no additional cost to the State if contract requirements are not met.

907-401.03.1.2--Tack Coat. Tack coat shall be applied to previously placed HMA and between lifts, unless otherwise directed by the Engineer. The tack coat shall be applied as a spray coating, fog coating, or "spider webbing". Construction requirements shall be in accordance with Subsection 407.03.

907-401.03.1.3--Blank.

907-401.03.1.4--Density. The lot density for all dense graded pavement lifts, except as provided below for preleveling, wedging [less than fifty percent (50%) of width greater than minimum lift thickness], ramp pads, irregular shoulder areas, median crossovers, turnouts, or other areas where the established rolling pattern cannot be performed, shall not be less than 92.0 percent of the maximum density based on AASHTO Designation: T 209 for the day's production. If a job-mix formula adjustment is made during the day which affects the maximum specific gravity, calculate a new average maximum density for the lot(s) placed after the change.

Pavement core samples obtained for determining density which have a thickness less than two times the maximum size aggregate permitted by the job-mix formula will not be used as a representative sample.

Preleveling, wedging [less than fifty percent (50%) of width greater than minimum lift thickness], ramp pads, irregular shoulder areas, median crossovers, turnouts, and other areas where an established rolling pattern cannot be obtained shall be compacted to refusal densification.

907-401.03.2--Bituminous Mixing Plants.

907-401.03.2.1--Plant Requirements.

907-401.03.2.1.1--Cold Aggregate Storage. The cold storage for hydrated lime shall be a separate bulk storage bin with a vane feeder or other approved feeder system which can readily be calibrated. The system shall provide a means for easy sampling of the hydrated lime additive and verifying the quantity of lime dispensed. The feeder system shall require a totalizer.

The hydrated lime additive equipment shall be interlocked and synchronized with the cold feed controls to operate concurrently with the cold feed operation which will automatically adjust the hydrated lime feed to variations in the cold aggregate feed. A positive signal system shall be installed which will automatically shut the plant down when malfunctions cause an improper supply of hydrated lime or water.

The plant shall not operate unless the entire hydrated lime system is functioning properly.

907-401.03.2.1.2--Cold Aggregate Feed. The hydrated lime shall be dispensed dry or as a slurry (1 part hydrated lime to 3 parts water) directly onto the composite aggregate between the cold feed and the dryer.

When hydrated lime is introduced dry, a spray bar or other approved system capable of spraying all aggregate with water shall be installed in order to maintain all aggregate at the moisture condition set out in Subsection 907-401.02.3.1 prior to addition of the hydrated lime. An alternate system for spraying the coarse aggregate stockpiles may be allowed when approved by the Engineer. The approved equipment and methods shall consistently maintain the aggregate in a uniform, surface wet condition. The moisture content of the aggregate-hydrated lime mixture, following spraying and mixing, shall be introduced into the automatic moisture controls of the plant.

The aggregate-hydrated lime mixture shall be uniformly blended by some mechanical means such as a motorized "on the belt" mixer or pug mill located between the cold feed and the dryer. Other mixing devices may be used subject to approval by the Engineer.

A maximum of forty five (45) percent of the total aggregate blend may be fed through any single cold feed bin. If the JMF calls for more than forty five (45) percent of a specific aggregate, that aggregate must be fed through two (2) or more separate cold feed bins.

907-401.03.2.1.3--Dryer. The efficiency of drying aggregates shall be such that the moisture content of the top HMA mixture shall not exceed 0.50 percent by mass of the total mixture, and the moisture content of all the underlying mixtures shall not exceed 0.75 percent by mass of the total mixture being produced.

907-401.03.2.1.4--Blank.

907-401.03.2.1.5--Control of Bituminous Material and Antistripping Agent. Specified bituminous materials from different manufacturers or from different refineries of a single manufacturer shall not be mixed in the plant's asphalt cement supply system storage tank and used in the work without prior written approval of the Engineer. Approval is contingent upon the Engineer's receipt of three copies of the manufacturer's certified test report(s) from the Contractor showing that the bituminous material blend conforms to the specifications.

A satisfactory method of determining the mass or metering shall be provided to ensure the specified quantity of bituminous material. Provisions shall be provided for checking the quantity or rate of flow. Mass determining or metering devices shall be accurate within plus or minus one-half percent.

The antistripping agent shall be injected into the bituminous material immediately prior to the mixing operation with an approved in-line injector system capable of being calibrated so as to ensure the prescribed dosage.

An in-line spigot for sampling of asphalt shall be located between the asphalt storage tank and the antistripping agent in-line injector.

907-401.03.2.1.6--Thermometric Equipment. An armored thermometer of adequate range and calibrated in 2°C increments shall be fixed at a suitable location in the bituminous line near the charging valve of the mixer unit.

The plant shall be equipped with an approved dial-scale, mercury-actuated thermometer, pyrometer or other approved thermometric instrument placed at the discharge chute of the dryer to measure the temperature of the material.

When the temperature control is unsatisfactory, the Engineer may require an approved temperature-recording apparatus for better regulation of the temperature.

907-401.03.2.1.7--Screens. A scalping screen shall be used.

907-401.03.2.1.8--Dust Collector. The plant shall be equipped with a dust collector constructed to waste or return collected material. When collected material is returned, it shall be returned through a controlling device which will provide a uniform flow of material into the aggregate mixture.

907-401.03.2.1.9--Safety Requirements. A platform or other suitable device shall be provided so the Engineer will have access to the truck bodies for sampling and mixture temperature data.

907-401.03.2.1.10--Blank.

907-401.03.2.1.11--Truck Scales. The specifications, tolerances and regulations for commercial mass determining and measuring devices as recommended by the National Bureau of Standards [National Institute of Standards and Technology (NIST) Handbook 44] shall govern truck scales used in the State of Mississippi, except mass determining devices with a capacity of 4536 kilograms or more used to determine the mass of road construction materials (i.e. sand, gravel, asphalt, fill dirt, topsoil and concrete) shall have a tolerance of one-half of one percent (1/2 of 1%) in lieu of the requirements of Handbook 44 and shall be regulated by the Mississippi Department of Transportation.

Scales shall be checked and certified by a scale company certified in heavy truck masses by the Mississippi Department of Agriculture and Commerce. In the case of scales used for measurement of materials on Department of Transportation projects, certification shall be performed in the presence of an authorized representative of the Department or a copy of the certification may be furnished for scales that have been checked and certified within the last six months for use on other Department of Transportation projects and are still in the position where previously tested. Scales that have not been checked and certified under NIST Handbook 44 guidelines, except for the herein modified tolerances allowed, shall be so checked and certified prior to use for measurement of materials on Department of Transportation projects. Tests shall

be continued on six month intervals with the test conducted in the presence of an authorized representative of the Department.

Truck scales shall be accurate to one-half of one percent of the applied load, shall be sensitive to 10 kilograms, and shall have a graduation of not more than 10 kilograms.

The Contractor may use an electronic mass determining system approved by the Engineer in lieu of truck scales. The system shall be equipped with an automatic print out system which will print a ticket for each load with the following information:

MDOT, Contractor's name, project number, county, ticket number, load number, pay item number, item description of the material delivered, date, time of day, haul vehicle number, gross mass, tare mass, net mass and total daily net mass.

When approved by the Engineer and materials are measured directly from a storage bin equipped with load cells, exceptions may be made to the gross and tare mass requirements.

The ticket shall also have a place for recording the temperature of HMA mixtures, if applicable, and the signatures of MDOT's plant and roadway inspectors. The load numbers for each project shall begin with load number one (1) for the first load of the day and shall be numbered consecutively without a break until the last load of the day. The Contractor shall provide MDOT with an original and one copy of each ticket. When the ticket information provided by the Contractor proves to be unsatisfactory, MDOT will use imprinter(s) and imprinter tickets to record load information. All recorded masses shall be in kilograms and shall be accurate to within one-half of one percent of the true mass, and the system shall be sensitive to 10 kilograms. The Engineer will require random loads to be checked on certified platform scales at no cost to the Department.

When an electronic mass determining system utilizes the plant scales of a batch plant, the system may be used only in conjunction with a fully automatic batching and control system.

907-401.03.2.2--Additional Requirements for Batching Plants.

907-401.03.2.2.1--Plant Scales. The plant batch scale mass shall not exceed the platform scale mass by more than one percent (1%).

907-401.03.2.3--Additional Requirements for Drum Mixing Plants.

907-401.03.2.3.1--Plant Controls. The plant shall be operated with all the automatic controls as designed and provided by the plant manufacturer. If the automatic controls malfunction, brief periods of manual operations to complete the day's work or to protect the work already placed may be conducted with the approval of the Engineer. During manual operation, the Contractor must continue to produce a uniform mixture meeting all contract requirements.

907-401.03.2.3.2--Aggregate Handling and Proportioning. A screening unit shall be placed between the bins and the mixer to remove oversized aggregate, roots, clayballs, etc.

907-401.03.2.4--Surge or Storage Bins. Surge and/or storage systems may be used at the option of the Contractor provided each system is approved by the Department prior to use. Surge bins shall be emptied at the end of each day's operation. Storage silos may be used to store mixtures as follows:

- 19-mm & 25-mm mixtures ----- 24 hours
- 9.5-mm & 12.5-mm mixtures ----- 36 hours

The storage silos must be well sealed, completely heated and very well insulated. The mixture when removed from the storage silo shall be tested to ensure that it meets all the same specifications and requirements as the mixture delivered directly to the paving site. See Subsection 907-401.02.5.3, subparagraph (i) for sampling and testing requirements.

907-401.03.3--Hauling Equipment. The inside surfaces of each vehicle bed shall be coated with a light application of water and thin oil, soap solution, lime water solution or other approved material to prevent the mixture from sticking. Diesel fuel or gasoline shall not be used to lubricate vehicle beds. Truck beds shall be raised to drain excessive lubricants before placing mixture in the bed. An excess of lubricant will not be permitted.

907-401.03.4--Bituminous Pavers. The screed or strikeoff assembly shall be capable of vibrating and heating the full width of the mixture being placed and shall lay the lift with an automatic control device to the specified slope and grade without tearing, pulling or gouging the mixture surface.

907-401.03.5--Rollers. All rollers shall be self-propelled units capable of maintaining a smooth and uniform forward and reverse speed as required for proper compaction. They shall be equipped with adjustable scrapers, water tanks, mats and a device for wetting the wheels or tires to prevent the mixture from sticking. Adhesion of the mixture to the rollers will not be permitted. The use of diesel fuel or gasoline for cleaning roller wheels or tires or to aid in preventing the mixture from sticking to the wheels or tires is prohibited.

All rollers shall be in good mechanical condition, free from leaking fuels and lubricants, loose link motion, faulty steering mechanism, worn king bolts and bearings. They shall be operational at slow speeds to avoid displacement of the mixture and capable of reversing direction smoothly and without backlash.

907-401.03.6--Preparation of Grade. The foundation upon which HMA pavement is to be placed shall be prepared in accordance with the applicable Section of the Standard Specification.

Unless otherwise directed, tack coat shall be applied to the underlying surface on which the mixture is to be placed. Emulsions, if used, must be allowed to "break" prior to placement of the bituminous mixture.

Bituminous mixture shall not be placed against the edge of pavements, curbs, gutters, manholes and other structures until sprayed with a thin uniform tack coating. The tack coat shall be protected until the mixture has been placed.

Existing HMA pavements that require preliminary leveling or patching in advance of placing the bituminous mixture shall be sprayed with a tack coat material and then brought as nearly as practicable to uniform grade and cross section. The material shall be placed by hand or machine in one or more compacted layers approximately 50 millimeters or less in compacted thickness.

907-401.03.7--Blank.

907-401.03.8--Preparation of Mixture. The temperature of the mixture, when discharged from the mixer, shall not exceed 170°C.

907-401.03.9--Material Transfer Equipment. Except for the areas mentioned below, when placing the top intermediate lift and/or the top lift of HMA pavements, the material transferred from the hauling unit shall be remixed prior to being placed in the paver hopper or insert by using an approved Materials Transfer Device. Information on approved devices can be obtained from the State Construction Engineer. Areas excluded from this requirement include: temporary work of short duration, detours, bridge replacement projects having less than 300 meters of pavement on each side of the structure, acceleration and deceleration lanes less than 300 meters in length, tapered sections, transition sections (for width), shoulders less than three meters in width, crossovers, ramps, side street returns and other areas designated by the Engineer.

907-401.03.10--Spreading and Finishing. Grade control for HMA pavements shall be established by stringline at least 150 meters ahead of spreading, unless placement is adjacent to curb and gutter, concrete pavement, or other allowed grade control.

The mixture shall be spread to the depth and width that will provide the specified compacted thickness, line, grade and cross section. Placing of the mixture shall be as continuous as possible. On areas where mechanical spreading and finishing is impracticable, the mixture may be spread, raked and luted by hand tools.

Immediately after screeding and prior to compaction, the surface shall be checked by the Contractor and irregularities adjusted. When the edge is feathered as in a wedge lift, it may be sealed by rolling. Irregularities in alignment and grade along the edges shall be corrected before the edges are rolled.

Hauling, spreading and finishing equipment shall be furnished that is capable of and operated in such a manner that the rolling operation will satisfactorily correct any surface blemishes.

The longitudinal joint in the subsequent lift shall offset that in the underlying lift by approximately 150 millimeters. However, the joint in the top lift shall be at the centerline or lane line.

907-401.03.11--Compaction. After the mixture has been spread and surface irregularities corrected, it shall be thoroughly and uniformly compacted to the required line, grade, cross section and density.

907-401.03.12--Joints. Joints between previously placed pavement and pavement being placed shall be so formed as to insure thorough and continuous bond.

Transverse construction joints shall be formed by cutting the previously placed mixture to expose the full depth of the lift.

The contact surface of transverse joints and longitudinal joints, except hot joints, shall be sprayed with a thin uniform tack coating before additional mixture is placed against the previously placed material.

Longitudinal joints shall be formed by overlapping the screed on the previously placed material for a width of at least 25 millimeters and depositing the quantity of mixture to form a smooth, tight joint.

907-401.03.13--Pavement Samples. The Contractor shall cut samples from each lift of HMA at the time and locations designated by the Engineer. The samples shall be taken for the full depth of each lift and shall be of a size approved by the Engineer but not to exceed 77 500 square millimeters. Tools used for cutting or coring of samples shall be of the revolving blade type such as saw or core drill. Cores shall be taken using a 75.0 to 100.0-mm inside diameter coring bit. The sample hole shall be filled, compacted and finished by the Contractor to conform with the surrounding area. No additional compensation will be allowed for furnishing samples and repairing the areas with new pavement.

MISSISSIPPI DEPARTMENT OF TRANSPORTATION

SUPPLEMENT TO SPECIAL PROVISION NO. 907-403-8M

DATE: 07/19/2011

SUBJECT: Hot Mix Asphalt (HMA) and Warm Mix Asphalt (WMA)

907-403.01--Description. Delete the first sentence of Subsection 907-403.01 on page 1, and substitute the following:

This work consists of constructing one or more lifts of HMA or WMA pavement meeting the requirements of Section 401 on a prepared surface in accordance with the requirements of this section and in reasonably close conformity with the lines, grade, thicknesses, and typical cross sections shown on the plans or established by the Engineer.

Delete the last paragraph of Subsection 907-403.03.2 at the bottom of page 3 and the table at the top of page 4, and substitute the following:

Regardless of the Surface Profile Index requirement, when the Profile Index for the final surface lift is less than or equal to three thousand and forty seven millimeters per kilometer (347.0 millimeters / kilometer) per segment, a unit price increase will be added. The following schedule lists the Profile Index range and the corresponding contract price adjustment:

Profile Index millimeters / kilometer / segment	Contract Price Adjustment percent of unit bid price
less than 158.0	108
158.1 to 221.0	106
221.1 to 284.0	104
284.1 to 347.0	102
347.1 to Required P.I.	100
over Required P.I.	100 (with correction to Required P.I.)

Delete the first full paragraph after the table on page 4 and substitute the following:

Contract price adjustments for rideability shall only be applicable to the surface lift and furthermore to only the segment(s) or portions of the segments(s) of the surface lift that require smoothness be determined by using a profilograph.

Delete the third full paragraph of Subsection 907-403.03.2 on page 4 and substitute the following:

Any contract price adjustment for rideability will be applied on a segment to segment basis on the theoretical tonnage based on 3.6-meter lanes, determined in accordance with Subsections 907-401.02.6.5 and 907-403.04, for the segment(s) or portions thereof for which an adjustment is warranted.

Delete Subsection 907-403.03.5.5 on page 8 and substitute the following:

907-403.03.5.5--Preliminary Leveling. All irregularities of the existing pavement, such as ruts, cross-slope deficiencies, etc., shall be corrected by spot leveling, skin patching, feather edging or a wedge lift in advance of placing the first overall lift.

907-403.05--Basis of Payment.

907-403.05.2--Pay Items. After the last pay item listed on page 10, add the following:

907-403-M: Warm Mix Asphalt, (1), (2) - per metric ton
Type Mixture

907-403-N: Warm Mix Asphalt, (1), (3), Leveling - per metric ton
Type Mixture

907-403-O: Warm Mix Asphalt, (1), (4), Trench Widening - per metric ton
Type Mixture

907-403-P: Warm Mix Asphalt, HT, (3), Polymer Modified - per metric ton
Mixture

907-403-Q: Warm Mix Asphalt, HT, (3), Polymer Modified, Leveling - per metric ton
Mixture

MISSISSIPPI DEPARTMENT OF TRANSPORTATION

SPECIAL PROVISION NO. 907-403-8M

CODE: (SP)

DATE: 11/04/2005

SUBJECT: Hot Mix Asphalt (HMA)

Section 403, Hot Bituminous Pavement, of the 1996 Metric Edition of the Mississippi Standard Specifications for Road and Bridge Construction is deleted in toto and replaced as follows:

SECTION 907-403 - HOT MIX ASPHALT PAVEMENT

907-403.01--Description. This work consists of constructing one or more lifts of HMA pavement meeting the requirements of Section 907-401 on a prepared surface in accordance with the requirements of this section and in reasonably close conformity with the lines, grades, thicknesses, and typical cross sections shown on the plans or established by the Engineer. This work shall also include applicable in-grade preparation of the underlying course in accordance with Section 321.

907-403.02--Material Requirements. Materials and their use shall conform to the applicable requirements of 907-401.02.

907-403.03--Construction Requirements.

907-403.03.1--General. Construction requirements shall be as specified in 907-401.03 except as otherwise indicated in this section or applicable special provisions.

907-403.03.2--Smoothness Tolerances. Except as noted herein, the finished smoothness of each lift shall conform to the designated grade and cross section within the following tolerances from grade stakes or other grade reference points set at 10-meter intervals:

	Lower* & Leveling Lifts	Lower* Intermediate Lift	Top Intermediate Lift	Surface Lift
Maximum deviation from grade and cross section at any point	13 mm	10 mm	6 mm	6 mm
Maximum deviation from a three-meter straight edge	10 mm	6 mm	3 mm	3 mm
Profile Index (PI) (millimeters/kilometer)	-	-	710	475

Note: Where more than four (4) lifts of HMA are required, all lifts, excluding the top three (3) lifts, shall meet the requirements of the lower lift.

- * When tested longitudinally from a stringline located equidistant above points 15 meters apart, the distance from the stringline to the surface at any two points located approximately four meters apart shall not vary one from the other more than the maximum deviation allowed above from a three-meter straight edge.

Where only one intermediate lift is required, it shall meet the smoothness requirements for lower intermediate lifts and shall have a Profile Index of not more than 945 millimeters per kilometer. The surface lift shall have a Profile Index of not more than 475 millimeters per kilometer.

Where only a leveling lift and a surface lift are required, the surface lift shall meet the smoothness requirements for lower intermediate lifts, and shall have a Profile Index of not more than 945 millimeters per kilometer.

Where only a surface lift is required, the Contractor shall determine the existing surface profile index at no additional cost to the State. The finished surface lift shall have a profile index of sixty percent (60%) of the profile index of the existing surface or 945 millimeters per kilometer, whichever is greater.

Where milling is required to remove undesirable material and/or correction of the cross-slope and only one (1) lift is required, the lift shall have a Profile Index of not more than 710 millimeters per kilometer

Where milling is required to remove undesirable material and/or correction of the cross-slope and a leveling lift and a surface lift are required, the surface lift shall have a Profile Index of not more than 710 millimeters per kilometer.

Where milling is required to remove undesirable material and/or correction of the cross-slope and two (2) lifts are required, the lower lift shall have a Profile Index of not more than 710 millimeters per kilometer and the surface lift shall have a Profile Index of not more than 475 millimeters per kilometer

In the placement of full depth HMA pavement, where the chemically treated base is constructed, graded and/or trimmed, full lane width, to a surface tolerance of ± 10 millimeters from design grade, stringline grade controls may be eliminated for the placement of the asphalt drainage course and all HMA lifts. In addition, where the base course is crushed stone or crushed concrete and is constructed to a surface tolerance of ± 10 millimeters from design grade using a stringline controlled spreader, stringline grade controls may be eliminated for the placement of the asphalt drainage course and all HMA lifts.

All other tolerances as specified in Section 907-321 are applicable, except for bases, when tested longitudinally, the maximum deviation when measured at the 4-meter midpoint shall be ± 10 millimeters.

Acceptance and payment of HMA will be determined on a lot to lot basis by cores taken from the completed pavement as outlined in Subsection 907-403.03.3.

Grade stakes or other grade reference points set at 10-meter intervals and maximum deviation from grade and cross section will not be required provided an approved profile averaging device with extreme contact points with surface at least nine meters apart is furnished and properly used for the four conditions set forth herein; however, all other surface requirements are applicable.

- (a) Overlays with one overall lift.
- (b) Overlays with two or more overall lifts -- for each lift above the first overall lift provided each underlying overall lift is within the allowable tolerances.
- (c) Surface lift of new construction provided the underlying lift is within the allowable tolerances.
- (d) Full-depth asphalt construction for lifts above the lower lift provided the lower lift is within the specified tolerances for the lower intermediate lift.

Approved contacting type profile averaging devices are those devices capable of working in conjunction with a taut string or wire set to grade, or ski-type device with extreme contact points with the surface at least 10 meters apart. Approved non-contacting type profile averaging devices are laser type ski devices with at least four referencing mobile stations at a minimum length of 7.3 meters, or an approved equal.

When approved by the Engineer, a short ski or shoe may be substituted for a long ski on the second paving operation working in tandem.

During the finishing and compacting of pavement lifts, it shall be the responsibility of the Contractor to check the surface and joints for progress toward conformance to surface requirements set forth herein. Variations from surface requirements exceeding the allowable tolerances shall be corrected at the Contractor's expense.

When a portland cement concrete pavement is to be placed on a HMA lift, the finished top of the HMA lift shall meet the requirements of Sections 321 and 501.

When the Profile Index for the final surface lift is less than or equal to three hundred and forty seven millimeters per kilometer (347 mm / km), per segment, a unit price increase will be added. The following schedule lists the Profile Index range and the corresponding contract price adjustment:

Profile Index millimeters / kilometer / segment	Contract Price Adjustment percent of HMA unit bid price
less than 158.0	108
158.1 to 221.0	106
221.1 to 284.0	104
284.1 to 347.0	102
347.1 to 475.0	100
over 475.0	100 (with correction of PI = 475.0)

Contract price adjustments for rideability shall only be applicable to the surface lift and furthermore to only the segment(s) or portions of the segment(s) of the surface lift that require smoothness be determined by using a profilograph and then only when the surface tolerance requirements include a profile index of 475 mm / km.

Segment(s) or portions thereof representing areas excluded from a smoothness test with the profilograph shall also be excluded from consideration for a contract price adjustment for rideability.

Any contract price adjustment for rideability will be applied on a segment to segment basis to the pay tonnage, determined in accordance with Subsections 907-401.02.6.5 and 907-403.04, for the segment(s) or portions thereof for which an adjustment is warranted.

907-403.03.3--Thickness Requirements. Hot mix asphalt overlay lifts shall be constructed as nearly in accordance with the thickness shown on the plans as the underlying pavement and foundation will permit. Periodic and cumulative yield tests will be made to determine practicable conformity to the thickness of each lift. The Engineer may order modifications in placement thicknesses to prevent unwarranted variations in plan quantities.

When the paver is operating off an established grade line, no thickness determination will be required for the various lifts of pavement. It is understood that the tolerances from design grade will control the thickness requirements.

When grade stakes are eliminated by Notice To Bidders or as outlined in 907-403.03.2(d) and where resulting in the placement of two (2) or more lifts, acceptance and payment will be determined on a lot to lot basis by cores taken from the completed pavement. Lots will be coincidental with acceptance lots for the surface lift as provided in 907-401.02.6.4, except that only lots resulting from the placement of mainline surface lift will be used for thickness assessment. One core will be obtained at random from each lot. Irregular areas will not be cored.

When the average thickness of all the cores from the lots representing a day's production (excluding any discarded by the Engineer for justifiable reason) is within 10 millimeters of the total pavement thickness shown on the plans, excluding lift(s) placed using an established grade line, corrective action will not be required and a price adjustment will not be made for non-conformity to specified thickness.

When the average thickness of all cores from the lots representing a day's production is deficient in thickness by more 10 millimeters of the total pavement thickness shown on the plans, excluding lift(s) placed using an established grade line, the deficiency shall be corrected by overlaying the entire length of the day's production. The thickness of the overlay shall be equal to the thickness deficiency but no less than the minimum single lift laying thickness for the specified mixture.

When the thickness of any core from the lots representing a day's production is more than 10 millimeters thicker than the total thickness shown on the plans, excluding lift(s) placed using an established grade line, a price adjustment will be made in accordance with 907-403.05.1.

The cores shall be cut and removed by the Contractor in the presence of the Engineer's representative and turned over to the Engineer's representative for further handling. The Contractor shall fill each core hole with surface lift mixture and compact to the satisfaction of the Engineer within 24 hours after coring.

907-403.03.4--Lift Corrections. Pavement exceeding the allowable surface tolerances shall be corrected at the Contractor's expense by the following methods:

Lower, Leveling and Lower Intermediate Lifts:

- (a) Removal or addition of mixture by skin patching, feather edging, wedge lift construction or full depth patching where appropriate and can be completed in a satisfactory manner.
- (b) Superimposing an additional layer which shall be an approved grade raise for the full roadway width and length of the area to be corrected.

Top Intermediate Lift:

- (a) Removal and the addition of sufficient mixture to provide the specified thickness. Corrections by this method shall be square or rectangular in shape and shall completely cover the area to be corrected.
- (b) Superimposing an additional layer (minimum lift thickness for mixture being used) which shall be an approved grade raise for full roadway width of the area to be corrected. Transverse joints shall be perpendicular to the centerline of the pavement.

Surface Lift:

- (a) Removal and the addition of sufficient mixture to provide new material of at least minimum single lift laying thickness for full lane width of the area to be corrected. Transverse joints shall be perpendicular to the centerline of the lane.
- (b) Superimposing an additional layer (minimum lift thickness for mixture being used) which shall be an approved grade raise for full roadway width of the area to be corrected. Transverse joints shall be perpendicular to the centerline of the pavement.

All mixtures used in the correction of unacceptable pavement shall be approved by the Engineer prior to use.

907-403.03.5--Overlays or Widening and Overlays. In addition to the requirements of 907-403.03.1 through 907-403.03.4 the following requirements will be applicable when an existing pavement is to be overlaid or widened and overlaid.

907-403.03.5.1--Blank.

907-403.03.5.2--Sequence of Operations. In order to expedite the safe movement of traffic and to protect each phase of the work as it is performed, a firm sequence of operations is essential. Unless otherwise provided in the traffic control plan and/or the contract, the following appropriate items of work shall be begun and continually prosecuted in the order listed:

- (a) In sections designated by the Engineer, trim the shoulders along the pavement edges to provide drainage from the pavement.
- (b) Perform prerolling to locate areas of pavement with excessive movement (Section 411).
- (c) Perform selective undercutting and patching as directed (Subsection 907-403.03.5.4).
- (d) Perform pressure grouting as specified (Section 412).
- (e) Clean and seal joints (Section 413).
- (f) Complete preparation on one side of roadway to be widened and place widening materials.
- (g) Reconstruct shoulders to elevation necessary to assure traffic safety.
- (h) Open the widened section to traffic.
- (i) Complete above work for other side of roadway.

- (j) Perform preliminary leveling as directed.
- (k) Apply interlayer as specified.
- (l) Place the first overall leveling lift.
- (m) After the first overall leveling lift, reconstruct shoulders as necessary to eliminate vertical differentials which may be hazardous to traffic.
- (n) Place first intermediate lift.
- (o) Construct shoulders to the contiguous elevation of the first intermediate lift.
- (p) Place remaining intermediate lift (if required).
- (q) Place surface lift.
- (r) Complete construction of shoulders.
- (s) Apply permanent traffic marking.
- (t) Final cleanup.

The above operations shall be performed in such a manner that traffic will be maintained on a paved surface at all times. Two-lane, two-way highways should not be restricted to a single lane in excess of a 1000-meter section.

907-403.03.5.3--Widening of Pavement. The foundation for widening shall be formed by trenching or excavating to the required depth and constructing a smooth, firm and compacted foundation. It shall have sufficient density and stability to withstand the placement and compaction of subsequent lifts. Soft, yielding and other unsuitable material which the Engineer determines will not compact readily shall be removed and backfilled with granular material or hot mix asphalt as directed.

Except as provided herein, excavation for widening, undercutting or other required excavation shall be spread along the edge of the shoulders, foreslopes or other adjacent areas as directed and will be an absorbed item. When the quantity is in excess of what may be used satisfactorily on adjacent areas, the Engineer may direct that the material be loaded, hauled and spread uniformly on other designated areas. In this case, compensation for handling surplus material will be in accordance with the appropriate pay items as provided in the contract or as extra work.

If the plans require widening of the shoulders or embankment with contractor furnished material, all suitable material obtained from widening excavation may be used and will be measured and paid for as Contractor furnished materials. No measurement for payment of haul will be made.

Removal and disposal of old stakes, forms and other debris encountered in excavating shall be in accordance with Section 201 and shall be considered as incidental to and included in the unit prices bid for other items. No separate measurement will be made therefor. Pavement edges and surfaces shall be cleaned prior to final shaping and compaction of adjacent trenching or undercut areas.

Granular material for widening shall be placed on a previously prepared, smooth, firm and unyielding foundation in accordance with the typical section. Density of the granular material shall be as specified.

Hot mix asphalt for widening, including trench widening, shall meet the applicable requirements of this section and Section 401 and shall be placed in one or more layers as shown on the plans or directed. The surface of the mixture shall be finished as a continuation of the adjacent pavement slope.

Trench rollers or other compaction equipment shall be used to compact the foundation, granular material and bituminous mixtures for widening when standard width rolling equipment cannot be used.

907-403.03.5.4--Patching. Existing pavement which has failed or unsatisfactorily stabilized shall be removed as directed. Removal of pavement will be measured and paid for under the appropriate pay items as provided in the contract.

Backfill shall consist of hot mix asphalt or a combination of compacted layers of granular material and hot mix asphalt. Unless otherwise specified, the Engineer will make this determination based on depth and field conditions.

Hot mix asphalt used for backfilling will be measured and paid for at the contract unit price for the mixture designated on the plans as the lowest lift. Granular material will be measured and paid for under the appropriate pay item as provided in the contract or as extra work.

907-403.03.5.5--Preliminary Leveling. All irregularities of the existing pavement that result in a thickness greater than approximately 65 millimeters for the first overall leveling lift shall be corrected by skin patching, feather edging or a wedge lift and shall be approved by the Engineer in advance of placing the first overall lift.

907-403.03.5.6--Placement of Lifts. The leveling lift shall be placed in a layer (or layers) not exceeding approximately 65 millimeters compacted thickness.

When single lane construction is required, placement of a lift on the adjacent lane may be performed by an approved profile averaging device provided the lane previously placed is within the allowable tolerances for all surface requirements. When any of the tolerances are exceeded, the contractor shall reestablish the control stringline for laying the adjacent lane should he elect to perform this work prior to correcting the deficiencies of the lane previously placed. In no case shall a "matching shoe" be used to control the grade of an adjacent lane.

In instances where there are only minor deviations from the allowable tolerances in the first overall lift, the Engineer may permit the Contractor to place the next higher lift by graded stringline in lieu of making the corrections.

Single lane placement of leveling, intermediate and surface lifts shall be limited to the distance covered in one and one-half days in advance of that placed in the adjacent lane.

907-403.03.5.7--Protection of Pavement. The pavement shall be protected and properly maintained until it has been compacted and cooled sufficiently for use by traffic.

907-403.04--Method of Measurement. HMA pavement, complete in place and accepted, will be measured by the metric ton. The mass of the composite mixture shall be determined in accordance with the provisions of 907-401.03.2.1.11.

Unless shown as a separate pay item, the furnishing and application of the tack coat will not be measured for payment. When payment is provided, tack coat will be measured as set out in Subsection 407.04.

The quantity of bituminous mixture required to correct the work, when made at the expense of the Contractor, will not be measured for payment.

Any trenching required for widening will not be measured for payment; the cost thereof shall be included in other items of work.

Undercut required by the Engineer will be measured for payment under the appropriate excavation item as provided in the contract or as extra work. Pavement removal and any required trenching will not be included in the measurement for undercut.

907-403.05--Basis of Payment. Subject to the adjustments set out in 907-401.02.6.3, 907-401.02.6.4, 907-401.02.6.5 & 907-403.03.2, hot mix asphalt pavement, complete-in-place, accepted, and measured as prescribed above, will be paid for at the contract unit price per metric ton for each lift of pavement specified in the bid schedule and shall be full compensation for completing the work.

907-403.05.1--Price Adjustment for Thickness Requirement. When grade stakes are eliminated as provided in 907-403.03.3 and the average thickness of all cores from lots representing a day's production is more than 10 millimeters thicker than the total specified thickness of the pavement, excluding lift(s) placed using an established grade line, a lump sum reduction in payment for the surface lift of lots representing a day's production will be made as follows:

$$\text{Individual Day's L.S. Reduction} = \frac{\text{Monetary Value of the Day's Surface Lift Production}}{\text{Surface Lift Production}} \times \frac{(\text{D} - 10)}{\text{ST}}$$

Where:

D = The day's average deviation from total pavement thickness shown on the plans, excluding lift(s) placed using an established grade line.

ST = Specified thickness for surface lift.

The total L.S. reduction for the project is the summation of the individual day's reductions in payment.

907-403.05.2--Pay Items.

Payment will be made under:

907-403-A: Hot Mix Asphalt, $\frac{(1)}{\text{Type}}, \frac{(2)}{\text{Mixture}}$ - per metric ton

907-403-B: Hot Mix Asphalt, $\frac{(1)}{\text{Type}}, \frac{(3)}{\text{Mixture}}$, Leveling - per metric ton

907-403-C: Hot Mix Asphalt, $\frac{(1)}{\text{Type}}, \frac{(4)}{\text{Mixture}}$, Trench Widening - per metric ton

907-403-D: Hot Mix Asphalt, HT, $\frac{(3)}{\text{Mixture}}$, Polymer Modified - per metric ton

907-403-E: Hot Mix Asphalt, HT, $\frac{(3)}{\text{Mixture}}$, Polymer Modified, Leveling - per metric ton

- (1) ST, MT or HT
- (2) 4.75 mm mixture, 9.5 mm mixture, 12.5 mm mixture, 19 mm mixture or 25 mm mixture
- (3) 4.75 mm mixture, 9.5 mm mixture, 12.5 mm mixture or 19 mm mixture
- (4) 19 mm mixture or 25 mm mixture

MISSISSIPPI DEPARTMENT OF TRANSPORTATION

SPECIAL PROVISION NO. 907-407-1M

CODE: (SP)

DATE: 02/26/2008

SUBJECT: Tack Coat

Section 407, Tack Coat, of the 1996 Metric Edition of the Mississippi Standard Specifications for Road and Bridge Construction is hereby amended as follows:

907-407.02.1--Bituminous Material. Delete the second sentence of the first paragraph of Subsection 407.02.1 on page 407-1, and substitute the following:

When not specified, the materials shall be as specified in Table 410-A on page 410-8.

907-407.03.3--Application of Bituminous Material. Delete the first paragraph of Subsection 407.03.3 on page 407-1, and substitute the following

Tack coat shall be applied with a distributor spray bar. A hand wand will only be allowed for applying tack coat on ramp pads, irregular shoulder areas, median crossovers, turnouts, or other irregular areas. Bituminous materials and application rates for tack coat shall be as specified in Table 410-A on page 410-8. Tack coat shall not be applied during wet or cold weather, after sunset, or to a wet surface. Emulsions shall be allowed to "break" prior to superimposed construction.

907-407.05--Basis of Payment. Delete the pay item at the end of Subsection 407.05 on page 407-2, and substitute the following:

907-407-A: Asphalt for Tack Coat *

- per liter

* Grade may be specified

MISSISSIPPI DEPARTMENT OF TRANSPORTATION

SUPPLEMENT TO SPECIAL PROVISION NO. 907-413-1M

DATE: 05/09/2008

SUBJECT: Sawing and Sealing Transverse Joints in Asphalt Pavement

907-413.03.3--General. Delete the first and second paragraphs of Subsection 907-413.03.3.1 on page 1 and substitute the following:

The Contractor's operation shall be conducted so that sawcutting of transverse joints, cleaning, and sealing is a continuous operation. The entire sawing and sealing operation shall be completed within seven (7) days after the placement of the final wearing course, unless the approved traffic control plan or sequence of operations provide otherwise. Traffic shall not be allowed on sawed unsealed joints of the final wearing course.

When intermediate lifts must be exposed to traffic for over seven (7) days, the Contractor shall be required to make an interim 1/8-inch wide saw cut which is one third (1/3) as deep as the hot mix asphalt layer. This interim saw cut does not require sealing. Costs of this interim cut(s) is to be absorbed the pay item for sawing and sealing transverse joints in asphalt pavement.

Saw cutting shall be done only after the hot mix asphalt has cooled to ambient temperature.

MISSISSIPPI DEPARTMENT OF TRANSPORTATION

SPECIAL PROVISION NO. 907-413-1M

CODE: (IS)

DATE: 1/2/96

SUBJECT: Sawing and Sealing Joints in Bituminous Concrete Overlays

Section 413, Cleaning and Sealing Joints and Cracks, of the 1996 Metric Edition of the Mississippi Standard Specifications for Road and Bridge Construction is amended as follows:

907-413.01--Description. At the end of Subsection 413.01 on page 413-1, insert the following:

When called for on the plans, this work shall also consist of saw cutting, cleaning and sealing transverse joints in new bituminous concrete overlays. Bituminous concrete pavement joints shall be constructed over, and in line with, the existing underlying transverse portland cement concrete joints in accordance with plans, specifications, and as directed by the Engineer.

907-413.02--Materials. At the end of Subsection 413.02 on page 413-1, insert the following:

The joint sealing material for sealing transverse joints in new bituminous pavement shall be a hot-poured elastic type conforming to the requirements of 707.02.1.3. The bond breaker tape shall consist of regular masking tape or a suitable bond breaker tape designed for use with hot-poured sealants. The width of the tape may be equal to but not more than three millimeters narrower than the width of the saw cut.

After Subsection 413.03.2 on page 413-1, add the following:

907-413.03.3--Construction Methods for Sawing and Sealing Transverse Joints in Asphalt Pavement.

907-413.03.3.1--General. On sections of bituminous overlay designated to receive sawed and sealed joints, the overlay, once begun, shall be completed through the surface course without undue delay between courses. Failure to comply may require saw cuts in an underlying course as directed by the Engineer and at no additional cost to the State.

The Contractor's operations shall be conducted so that sawcutting of transverse joints, cleaning, and sealing is a continuous operation. Traffic shall not be allowed to knead together or damage the sawed joints. Sawed joints should be filled and cured prior to opening to traffic. Sawed joints not sealed before traffic is allowed on the overlay shall be resawed when sawing and sealing operations resume at no additional cost to the State. Sawcutting, cleaning and sealing shall be performed within seven days after placement of the top course of asphalt pavement.

907-413.03.3.2--Sawcutting of Transverse Joints. The Contractor shall sawcut transverse joints in the pattern and to the dimensions shown on the plans or as directed by the Engineer. The

sawcut joints shall be directly over the existing portland cement concrete pavement joints and shall be accurately located by a method employing pins and stringline. The pins shall be accurately located prior to paving. Details of the Contractor's method for locating the sawcuts shall be subject to the approval of the Engineer.

The blade or blades shall be of such size and configuration that the desired dimensions of each sawcut can be made with one pass. No spacers between blades will be allowed. Either dry or wet cutting will be allowed.

The transverse sawcut joints shall normally extend the full width of the pavement unless otherwise shown on the plans or directed by the Engineer. Existing transverse joints that are offset at the longitudinal joint by more than 25 millimeters, measured between the centers of the joint cavities, shall require separate sawcuts terminating at the longitudinal joint.

907-413.03.3.3--Cleaning. Dry sawed joints shall be thoroughly cleaned with a stream of air sufficient to remove dirt, dust or deleterious matter adhering to the joint walls or remaining in the joint cavity. Wet sawed joints shall be thoroughly cleaned with a water blast (345 kPa minimum) immediately after sawing to remove any sawing slurry, dirt or deleterious matter adhering to the joint walls or remaining in the joint cavity. Wet sawed joints shall be blown with air to provide dry joint surfaces prior to sealing.

All sawing slurry from the wet sawing process shall be immediately flushed from the pavement surface. Dry dust and material from the dry sawing process shall be blown or brushed off the pavement surface.

The Contractor shall be required to provide protective screening, subject to the approval of the Engineer, if cleaning operations are capable of causing damage to or interference with traffic in adjacent lanes.

907-413.03.3.4--Sealing. Just prior to sealing, each joint shall be thoroughly cleaned of all foreign material and the joint faces shall be clean and surface dry when the seal is applied.

After cleaning, and just prior to sealing, a bond breaker tape shall be placed in the bottom of the sawcut joint.

Sealant material shall be at the pouring temperature recommended by the manufacturer when applied to the joints. Hot applied sealant material shall be stirred during heating so that localized overheating does not occur.

The sealant shall fill the joint such that, after cooling, the sealed joint conforms to the details shown on the plans or as directed by the Engineer. The pouring shall be performed in such a manner that the material will not be spilled on the exposed surfaces of the asphalt pavement. Any excess material on the surface of the asphalt pavement shall be removed immediately and the pavement surface cleaned. The use of sand or similar material as a cover for the seal will not

be permitted. Poured joint sealing material shall not be placed when the air temperature in the shade is less than 10°C, unless approved by the Engineer.

907-413.04--Method of Measurement. At the end of Subsection 413.04 on page 413-2, insert the following:

Sawed and sealed joints in new asphalt pavement will be measured by the meter of joint complete in place and accepted by the Engineer. Sawing, bond breaker tape and joint sealant material will not be paid for as separate items but will be included in the unit price per meter for sawing and sealing transverse joints in asphalt pavement.

907-413.05--Basis of Payment. After the first paragraph of Subsection 413.05 on page 413-2, insert the following:

Sawing and sealing transverse joints in new asphalt pavement, accepted and measured as prescribed, will be paid for at the contract unit price per meter; which price shall be full compensation for locating and transferring the location of existing joints to establish new joint locations, for all required sawing, for furnishing all materials, including bond breaker tape and joint sealant materials, for all cleaning, pouring, trimming, cleanup and disposal of all excess and waste, for protective screening; for all pertinent operations necessary and incidental to the construction as indicated herein, and for all equipment, tools, labor, and incidentals necessary to complete the work.

The price for sawing and sealing transverse joints in asphalt pavement shall include the cost of continuous maintenance of traffic and protective services as required by the Department's Traffic Control Plan. This shall include all required individual traffic control devices.

After the last pay item listed in Subsection 413.05 on page 413-2, add the following:

Payment will be made under:

907-413-H: Sawing and Sealing Transverse Joints in Asphalt Pavement - per meter

MISSISSIPPI DEPARTMENT OF TRANSPORTATION

SPECIAL PROVISION NO. 907-501-12M

CODE: (SP)

DATE: 09/05/2007

SUBJECT: Portland Cement Concrete Pavement

Section 907-501, Portland Cement Concrete Pavement, of the 1996 Metric Standard Specifications for Road and Bridge Construction is hereby amended as follows:

907-501.01--Description. After the last sentence of Subsection 501.01 on page 501-1, add the following:

This work also consist of replacing or repairing damaged or deteriorated dowels and wooden joint filler boards.

907-501.02--Materials. Add the following to the table in Subsection 501.02 on page 501-1.

Coarse Aggregate	703.01 and 907-703.03
Dowel Adhesive	714.11

907-501.02.1--Composition of Concrete. Delete Subsections 501.02.1.1 & 501.02.1.2 on pages 501-1 & 501-2 and substitute the following:

907-501.02.1.1--General. The concrete mix design shall be submitted by the Contractor to the Engineer for approval prior to production. The mix proportions shall be based on a laboratory batch as described below.

- a) The combination of materials shall be those intended for use in the proposed work. Materials shall be from approved sources. Aggregate gradations, specific gravities and bulk densities shall be reported.
- b) Trial mixtures having proportions and consistencies suitable for the proposed work shall be made using the ACI 211.1 as a guide to proportion the mix design.
- c) Trial mixtures shall be designed to produce a slump within ± 20 mm of the maximum permitted, and for air-entrained concrete, 6.0 ± 0.5 percent total air content. The temperature of freshly mixed concrete in trial mixtures shall be reported.
- d) For each proposed mixture, at least three compressive test cylinders shall be made and cured in accordance with AASHTO Designation: T 126. Each change of water-cement ratio shall be considered a new mixture. The cylinders shall be tested for strength in accordance with AASHTO Designation: T 22 and shall meet the required 28 day strength.

- e) The strength of laboratory trial mixes shall exceed 33 MPa.
- f) The laboratory trial batch mixtures shall have been made within the last three months before being submitted for approval.

907-501.02.1.2--Design of Mix. The mix shall be designed to meet the requirements as set out in the following table.

Design Property	Requirements
Minimum Coarse Aggregate Volume / Cubic Meter Of Concrete, %	72
Coarse Aggregate Size	467 or 57
Maximum Water / Cementitious Ratio	0.48
Maximum Slump, millimeters	75
Total Air Content, %	3 - 6
Minimum Compressive Strength, MPa	25

907-501.03--Construction Requirements. Delete Subsections 501.03.1, 501.03.2, 501.03.3 & 501.03.4 on pages 501-3 thru 501-6, and substitute the following:

907-501.03.1--Batching Plant and Equipment. Concrete batching and handling equipment shall meet the applicable requirements of AASHTO Designation: M 157.

907-501.03.2--Blank.

907-501.03.3--Blank.

907-501.03.4--Blank.

Delete Subsection 501.03.5.5 on page 501-7 and substitute the following:

907-501.03.5.5--Transverse Texturing Device. Transverse texturing shall be produced by either tining or grooving as indicated in the plans or in the contract documents.

Other types of texturing equipment may be approved by the Department provided it produces a texture equivalent to that specified.

907-501.03.5.5.1--Transverse Tining. This equipment shall be a metal tine finishing device having flat steel wire tines capable of being operated to produce uniform, parallel grooves in newly placed pavement.

907-501.03.5.5.2--Transverse Grooving. This equipment shall be a self-propelled mechanical sawing device using diamond blades. The blades shall be arranged in such a manner to produce grooves three millimeters and five millimeters spaced in the following sequence: 20-mm, 28-mm, 15-mm, 28-mm, 20-mm in 150-millimeter repetitions across the width of the sawing device.

907-501.03.6--Miscellaneous Equipment.

907-501.03.6.1--Concrete Saw. Delete the first paragraph of Subsection 501.03.6.1 on page 501-7, and substitute the following:

When sawing joints is elected or specified, the Contractor shall provide sawing equipment adequate in number of units and power to complete the sawing to the required dimensions using a water-cooled diamond edge saw blade, abrasive wheel, “early entry dry cut” type blade, or other device approved by the Engineer.

907-501.03.16--Joints. After the first paragraph of Subsection 501.03.16 on page 501-14, add the following:

Sawing of joints shall commence as possible after the concrete has hardened and before uncontrolled shrinkage cracking occurs. The saw blades, and skid plates if early entry method is used, shall be changed as often as necessary to control and minimize spalling/raveling. A sufficient number of saws, replacement blades and skid plates shall be available at the project site to insure that the sawing operations will proceed until completion without interruption.

Any damage to the concrete resulting from the sawing operations shall be corrected immediately after the sawing is complete at no additional costs to the State.

At the end of Subsection 501.03.16 on page 501-16, add the following:

907-501.03.16.6--Dowel Replacement. When designated on the plans, dowel replacement work shall consist of replacing damaged or deteriorated dowels in reconstructed contraction joints and both dowels and wooden joint filler boards in reconstructed expansion joints.

Dowel bars shall be the size and length designated on the plans. **Wooden joint filler board shall conform to the dimensions shown on the plans.**

New expansion boards shall be drilled to fit the new dowels installed. Special care shall be taken to ensure that all dowels in the joint remain parallel to the surface of the concrete.

907-501.03.17--Final Strike-Off, Consolidation and Finishing.

907-501.03.17.1--Sequence. After the first paragraph of Subsection 501.03.17.1 on page 501-16, add the following:

Concrete, as soon as placed, shall be struck off and screeded. An approved portable screed shall be used. A second screed shall be provided for striking off the bottom layer of concrete if reinforcement is used and the pavement is placed in two layers.

The screed for the surface shall be at least 600 millimeters longer than the maximum width of the slab to be struck off. It shall be of approved design, sufficiently rigid to retain its shape, and be constructed of metal or of other suitable material shod with metal.

Consolidation shall be attained by the use of a suitable vibrator or other approved equipment.

In operation the screed shall be moved forward with a combined longitudinal and transverse shearing motion, and manipulated so that neither end is raised from the side forms during the striking off process. If necessary, this shall be repeated until the surface is of uniform texture, true to grade and cross section, and free from porous areas.

Delete Subsection 501.03.17.4 on page 501-17, and substitute the following:

907-501.03.17.4--Hand Finishing. Unless otherwise specified, hand finishing methods, other than the hand floating method described below, will not be permitted except under the following conditions:

In the event of breakdown of the mechanical equipment, hand methods may be used to finish the concrete already deposited on the grade when the breakdown occurs.

Narrow widths or areas where operation of mechanical equipment is impractical may be finished by hand methods.

After Subsection 501.03.18.4 on page 501-20, add the following:

907-501.03.18.6--Transverse Grooved Finish. After the concrete has cured for a minimum of seven (7) days, areas to be transverse grooved shall be grooved with a sawing device meeting the requirements of Subsection 907-501.03.5.5.2. Grooves shall be perpendicular to the centerline of the roadway and extend as close as possible to the edge but in no case more than 600 millimeters from the edge, gutter line, etc. The tolerance for the width of the groove is +2 to -0 millimeters and the tolerance for the depth and spacing of the grooves is ± 2 millimeters.

Change Subsection 501.03.18.5 on page 501-20 to "**907-501.03.18.6--Edging at Forms and Joints**".

Delete Subsection 501.03.19 on pages 501-21 thru 501-23, and substitute the following:

907-501.03.19--Surface Test. It is the intent of these specifications that the finished surface will have good riding qualities.

Profiles of the mainline pavement surface will be established, evaluated and the pavement surface corrected, as necessary, so that the final surface variances shall not exceed a profile index of 475 millimeters per kilometer per segment. Mainline pavement is defined as all pavements other than shoulders, parking lanes, ramps, tapers, acceleration and deceleration lanes, bridge decks, and bridge approach slabs. Determination of the profile index will be in accordance with test methods established by the Department.

A California profilograph meeting the requirements as set out in Section 907-401 shall be furnished and operated by the Contractor under supervision of the Engineer to provide recorded

data to establish the profile index and identify locations requiring correction. Surface profile shall be obtained in the wheel path of each travel lane.

During initial paving operations, either when starting up or after a long shut down period, the pavement surface will be tested with profilograph as soon as the concrete has cured sufficiently to allow testing. Membrane curing damaged during the testing operation shall be repaired by the Contractor. The purpose of this testing is to aid the Contractor and the Engineer in evaluating the paving methods and equipment. For the purpose of determining pavement smoothness and contract price adjustment for rideability, each day's production will be sub-divided into sections which terminate at bridges, transverse joints or other interruptions. Each section will be sub-divided into segments of 0.1 kilometer. Where a segment less than 0.1 kilometer occurs at the end of a section, it will be combined with the preceding 0.1-kilometer segment for calculation of the profile index. The last 4.5 meters of a day's production may not be obtainable until the paving operation is continued and for this reason may be included in the subsequent segment. If a day's paving is less than 15 meters, it shall be tested using the three-meter straightedge, and shall be included in the subsequent day's production profile.

A profile index will be determined for each segment as millimeters per kilometer in excess of the "Zero" blanking band which is simply referred to as the "Profile Index". From the profilogram of each segment, the scallops above and below the "Zero" blanking band are totaled in millimeters. The totaled count of millimeters is converted to millimeters per kilometer to establish a smoothness profile index for that segment.

In addition to the above requirements for the profile index, all areas represented by high points having deviations in excess of 7.5 millimeters in 7.5 meters shall be removed by the Contractor utilizing grinding methods and equipment specified. Deviations in excess of 7.5 millimeters will be determined from the profilogram in accordance with Department test methods.

After correcting individual deviations in excess of 7.5 millimeters in 7.5 meters, corrective action shall be made to reduce the profile index to 475 millimeters per kilometer per segment or less.

On those segments where corrections are made, the pavement will be tested to verify that corrections have produced a profile index of 475 millimeters per kilometer per segment or less.

Corrections shall be made using an approved profiling device or by removing and replacing the pavement as directed by the Engineer. Corrective work shall be performed at no additional cost to the State.

Each area or section of pavement removed shall be at least three meters in length and at least the full width of the lane involved. When it is necessary to remove and replace a section of pavement, any remaining portion of the slab adjacent to the joints that is less than three meters in length shall also be removed and replaced. The new surface shall be textured as specified in the contract.

Where surface corrections are made, the Contractor shall reestablish the surface texture to a uniform texture equal in roughness to the surrounding uncorrected pavement. This work shall be

at no additional cost to the State.

Corrective work shall be completed prior to determining pavement thickness.

907-501.03.19.1--Diamond Grinding. Grinding of concrete surfaces shall consist of diamond grinding the existing portland cement concrete surface to remove surface distortions to achieve the specified surface smoothness requirements.

907-501.03.19.1.1--Equipment. The grinding equipment shall be a power driven, self-propelled machine that is specifically designed to smooth and texture portland cement concrete surfaces with diamond blades. The effective wheel base of the machine shall not be less than 3.6 meters. It shall have a set of pivoting tandem bogey wheels at the front of the machine and the rear wheels shall be arranged to travel in the track of the fresh cut pavement. The center of the grinding head shall be no further than 0.9 meter forward from the center of the back wheels.

The equipment shall be of a size that will cut or plane at least 0.9 meter wide. It shall also be of a shape and dimension that does not encroach on traffic movement outside of the work area. The equipment shall be capable of grinding the surface without causing spalls at cracks, joints, or other locations.

907-501.03.19.1.2--Construction. The construction operation shall be scheduled and proceed in a manner that produces a uniform finish surface. Grinding will be accomplished in a manner to provide positive lateral drainage by maintaining a constant cross-slope between grinding extremities in each lane.

The operation shall result in pavement that conforms to the typical cross-section and the requirements specified in Subsection 907-501.03.19.1.3. It is the intent of this specification that the surface smoothness characteristics be within the limits specified.

The Contractor shall establish positive means for removal of grinding residue. Solid residue shall be removed from pavement surfaces before it is blown by traffic action or wind. Residue shall not be permitted to flow across lanes used by public traffic or into gutters or drainage facilities, but may be allowed to flow into adjacent ditches.

907-501.03.19.1.3--Finished Concrete Surface. The grinding process shall produce a pavement surface that is smooth and uniform in appearance with a longitudinal line type texture. The line type texture shall contain parallel longitudinal corrugations that present a narrow ridge corduroy type appearance. The peaks of the ridges shall not be more than two millimeters higher than the bottoms of the grooves.

The finished pavement surface will be measured for riding quality. The grinding shall produce a mainline riding surface which does not exceed either the specified profile index or the specified bump and dip limit.

907-501.03.24.1--Thickness Determination. Delete the third sentence of the fifth paragraph of Subsection 501.03.24.1 on page 501-27, and substitute the following:

If the Engineer determines that the deficient areas do not warrant removal, the pavement may be left in place with no payment to the Contractor, or may be removed and replaced at the Contractor's option.

907-501.03.24.2--Alternate to Coring. Delete the second paragraph of Subsection 501.03.24.2 on page 501-28, and substitute the following:

For such contracts, the Project Engineer's measurements will be used to determine the pavement thickness as follows:

907-501.04--Method of Measurement. After the last paragraph of Subsection 501.04 on page 501-28, add the following:

When rehabilitating existing pavement, dowels will be measured per each and wooden joint filler board shall be measured by the meter. All concrete removed will be measured by the square meter under pay item 202-B.

When a pay item is included in the contract, transverse grooving will be measured by the square meter, complete in place and accepted. For bridge decks, the quantity will be computed by measuring the limits of transverse grooving shown in the plans. When not shown, the quantity will be computed by measuring the bound area between the face of barrier rail and the length of the span. For concrete and bridge end pavements, the quantity will be computed by measuring by the limits of transverse grooving shown in the plan. When not shown, the quantity will be computed by measuring the bound area between the edge of pavement and the length of the pavement.

907-501.05-- Basis of Payment.

907-501.05.1--General. Delete the first paragraph of Subsection 501.05.1 on page 501-28, and substitute the following:

Concrete pavement will be paid for at the contract unit price per square meter, adjusted when applicable in accordance with Subsections 907-501.05.2 and 907-501.05.3.

After the third paragraph of Subsection 501.05 on page 501-28, add the following:

Transverse grooving, measured as prescribed above , will be paid for at the contract unit price per square meter, which price shall be full compensation for all grinding, cleaning and sweeping; and for all labor, equipment, tools and incidentals necessary to complete the work.

When rehabilitating existing pavement , dowel bars and expansion board will be paid for at the contract unit price per each and meter, respectively, which shall be full compensation for furnishing all labor, equipment, tools and materials to complete the work. No separate payment will be made for cutting off dowel bars left in the existing pavement. Unless otherwise noted, the price for dowel replacement work shall include the cost of continuous maintenance of traffic

and protective services as required by the Department's Traffic Control Plan. This shall include all required individual traffic control devices.

Delete pay item nos. 501-A, 501-B & 501-C on page 501-29 and substitute the following:

907-501-A: ___-mm Reinforced Cement Concrete Pavement, _____ Finish - per square meter

907-501-B: ___-mm Plain Cement Concrete Pavement, _____ Finish - per square meter

907-501-C: ___-mm Continuously Reinforced Cement Concrete Pavement, _____ Finish - per square meter

After pay item 501-F on page 501-29, add the following:

907-501-G: Dowels, Drilled and Installed - per each

907-501-H: Dowels, Installed - per each

907-501-I: Joint Filler, Wooden Board - per meter

907-501-K: Transverse Grooving - per square meter

Change Subsection 501.05.2 on page 501-29 to “907-501.05.2--Price Adjustment for Thickness.”.

Delete the **Concrete Pavement Deficiency** table on page 501-29 and substitute the following:

<u>Thickness Deficiency In Millimeters</u>	<u>Proportional Part of Contract Price Allowed</u>
0 to 5	100 percent
6, 7, 8	80 percent
9, 10	72 percent
11, 12, 13	68 percent
14 to 19	57 percent
20 to 25	50 percent

At the end of Subsection 501.05 on page 501-30, add the following:

501.05.3--Price Adjustments for Smoothness. When the profile index is less than or equal to three hundred and forty seven millimeters per kilometer (347.0 mm / km) per segment, a unit price increase will be added. The following schedule lists the Profile Index range and the corresponding contract price adjustment.

Profile Index Millimeters Per Kilometer Per Segment	Adjustment Price Per Square Meter Of PCC Pavement
less than 158.0	plus \$ 0.31
158.1 to 221.0	plus \$ 0.24
221.1 to 284.0	plus \$ 0.16
274.1 to 347.0	plus \$ 0.08
347.1 to 475.0	\$ 0.00
Over 475.0	\$ 0.00 (With Correction of $PI \leq 475.0$)

The adjusted unit price will be computed using the contract unit price of the portland cement concrete pavement. This adjusted unit price will apply to the total area of the 0.1-kilometer segment for the lane width represented by the profilogram.

For concrete pavement other than main-line pavement, the surface will be tested using a 3-meter straightedge at locations selected by the Engineer. The variation of the surface from the testing edge of the straightedge between any two contacts, longitudinal or transverse with the surface, shall not exceed six millimeters. Irregularities exceeding the specified tolerances shall be corrected, at no additional cost to the State, by the Contractor with an approved profiling device or by other means as directed by the Engineer. Following correction, the area will be retested to verify compliance with the specified tolerances.

MISSISSIPPI DEPARTMENT OF TRANSPORTATION

SPECIAL PROVISION NO. 907-601-2M

CODE: (IS)

DATE: 08/29/2007

SUBJECT: Structural Concrete

Section 601, Concrete Structures, of the 1996 Metric Edition of the Mississippi Standard Specifications for Road and Bridge Construction is hereby amended as follows:

After the heading **DIVISION 600 - INCIDENTAL CONSTRUCTION**, add the following:

Unless otherwise specified, all testing of Portland cement concrete in Division 600 shall be in accordance with the requirements of Subsection 907-601.02.1.

907-601.02--Materials.

907-601.02.1--General. Delete the second and third sentence of the first paragraph of Subsection 601.02.1 on page 601-1, and substitute the following:

Sampling and testing will be in accordance with TMD-20-04-00-000 or TMD-20-05-00-000, as applicable.

907-601.03.6.3--Removal of Falsework, Forms, and Housing. Delete the first paragraph, the table and second paragraph of Subsection 601.03.6.3 on page 601-2, and substitute the following:

The removal of falsework, forms, and the discontinuance of heating, shall be in accordance with the provisions and requirements of Subsection 907-804.03.15, except that the concrete shall conform to the following compressive strength requirements:

Wingwall and Wall Forms not Under Stress	7 MPa
Wall Forms under Stress	16 MPa
Backfill and Cover clear	17 MPa

In lieu of using concrete strength cylinders to determine when falsework, forms, and housings can be removed, an approved maturity meter may be used to determine concrete strengths by inserting probes into concrete placed in a structure. The minimum number of maturity meter probes required for each structural component shall be in accordance with Subsection 907-804.03.15. Procedures for using the maturity meter and developing the strength/maturity relationship shall follow the requirements of Subsection 907-804.03.15. Technicians using the maturity meter or calculating strength/maturity graphs shall meet the requirements of Subsection 907-804.03.15.

907-601.05--Basis of Payment. Add the “907” prefix to the pay items listed on page 601-4.

MISSISSIPPI DEPARTMENT OF TRANSPORTATION

SPECIAL PROVISION NO. 907-603-4M

CODE: (SP)

DATE: 05/12/2008

SUBJECT: Culverts and Storm Drains

Section 603, Culverts and Storm Drains, of the 1996 Metric Edition of the Mississippi Standard Specifications for Road and Bridge Construction is hereby amended as follows:

907-603.01--Description. At the end of Subsection 603.01 on page 603-1, add the following:

When alternate pipe is shown in the contract, the Contractor may select an alternate pipe from the alternate pipe group (type) shown in the plans or contract documents. The type of pipe used for alternate pipe shall meet the material requirements of Subsection 603.02 for the type of pipe selected.

907-603.02--Materials. Delete the entry for “Corrugated Polyethylene Pipe” and add the following material to the list contained in Subsection 603.02, pages 603-1 and 603-2:

Corrugated Polyethylene Pipe,	907-708.17
Corrugated Poly (Vinyl Chloride) (PVC) Pipe	907-708.17

907-603.03--Construction Requirements.

907-603.03.2--Bedding. After the first paragraph of the Subsection 603.03.2 on page 603-2, add the following:

Non-rigid pipe used in cross drains and storm drains shall have a Class B bedding. Non-rigid pipe used in side drains shall have a Class C bedding. No separate measurement will be made for pipe bedding. Costs associated with pipe bedding shall be included in the cost of the pipe.

907-603.03.4--Joining Conduit.

907-603.03.4.1--Storm Drainage. Delete the first sentence of the seventh paragraph of Subsection 603.03.4.1 on page 603-4, and substitute the following:

Flexible steel conduits shall be firmly joined by coupling bands.

Delete the last paragraph of Subsection 603.03.4.1 on page 603-5, and substitute the following:

In lieu of the preceding requirements and in addition to being supplied or recommended by the pipe manufacturer, coupling bands for joining corrugated polyethylene pipe shall be in accordance with AASHTO Designation: M 294 and shall meet or exceed the soil-tightness

requirements of the AASHTO Standard Specifications for Highway Bridges, Section 26, paragraph 26.4.2.4 (e).

Corrugated polyethylene pipe may also be furnished with bell & spigot type joints with O-ring rubber gasket meeting ASTM Designation: F477 placed on the spigot end. At least two (2) corrugations of the spigot end must insert into the bell end.

Joints and fittings for poly (vinyl chloride) (PVC) pipe shall meet the requirements of ASTM Designation: F 949.

907-603.03.7--Backfilling. After the first paragraph of the Subsection 603.03.7 on page 603-6, add the following:

Backfill of non-rigid corrugated polyethylene and poly (vinyl chloride) (PVC) pipe used in cross drains and storm drains shall be performed using one of the following methods:

1. Flowable fill meeting the requirements of Section 907-631. If flowable fill is used, care shall be taken to prevent the pipe from "floating".
2. Crushed stone aggregate meeting the requirements of Subsection 907-703.04.3.

No separate measurement will be made for backfilling pipe. Costs associated with backfilling pipe will be included in the cost of the pipe.

907-603.05--Basis of Payment. Add the "907" prefix to pay item nos. 603-MA thru 603-MH and 603-NA thru 603-NL on pages 603-11 and 603-12.

Delete the heading, pay item number description and unit for Corrugated Polyethylene Pipe on page 603-13, and add the following headings, pay item numbers, descriptions and units to the list contained in Subsection 603.05, pages 603-9 thru 603-13:

ALTERNATE PIPE

907-603-ALT: ___-mm Type ___ Alternate Pipe - per meter

CORRUGATED POLYETHYLENE

907-603-PE: ___-mm Corrugated Polyethylene Pipe - per meter

CORRUGATED POLY (VINYL CHLORIDE)

907-603-PVC: ___-mm Corrugated Poly (Vinyl Chloride) Pipe - per meter

MISSISSIPPI DEPARTMENT OF TRANSPORTATION

SPECIAL PROVISION NO. 907-605-8M

CODE: (SP)

DATE: 05/05/2008

SUBJECT: Underdrains

Section 605, Underdrains, of the 1996 Metric Edition of the Mississippi Standard Specifications for Road and Bridge Construction, is hereby amended as follows.

907-605.01--Description. After the first paragraph of Subsection 605.01 on page 605-1, add the following:

This work consists of furnishing and installing plastic pipe edge drains and edge drain outlets, vents and miscellaneous appurtenances as shown on the drawings in the plans (or contract documents) and as specified in the standard specifications and this special provision. This work also includes the video inspection and reporting of edge drain system installation.

907-605.02--Materials.

907-605.02.4--Edge Drain Pipe and Pipe Fittings.

907-605.02.4.1--General. Pipe for edge drains and fittings shall be size DN 100, and shall be either Schedule 40 or Schedule 80 polyvinyl chloride (PVC) plastic pipe conforming to the requirements of ASTM Designation: D 1785.

Fittings, except for "Y" fittings, shall be socket-type fittings conforming to the requirements of ASTM Designation: D 2467 for Schedule 80 pipe and ASTM Designation: D 2466 for Schedule 40 pipe.

The Contractor may elect to furnish one of the following perforated pipe in lieu of the pipe mentioned above. Regardless of the pipe used, it shall be DN 100 nominal size.

- a) Pipe conforming to Subsection 708.18 of the Standard Specifications with SDR number ranging from 23.5 to 35 and shall have a minimum pipe stiffness value of 345 kPa.
- b) Corrugated polyethylene drainage tubing or corrugated high density polyethylene (HDPE) pipe conforming to the requirements of AASHTO Designation: M 252, Type SP with the stipulation that the minimum pipe stiffness value shall be 345 kPa. The pipe and fittings shall be made of virgin polyethylene compounds which conform with the requirements of cell class 324420C as defined and described in ASTM Designation: D 3350, except that the carbon black content shall not exceed 5%. Compounds that have higher cell classifications in one or more properties are acceptable provided product requirements are met.

Pipe used for the edge drain outlet/vents shall be either PVC or corrugated high density polyethylene (HDPE) pipe. PVC pipe shall meet the requirements of ASTM Designation: D 1785 as stated above, and HDPE pipe shall meet the requirements of AASHTO Designation: M 252 as stated above.

All "Y" fittings shall be smooth interior wall fittings fabricated from pipe conforming to the requirements for edge drain outlet pipe. The fitting shall provide an unobstructed passageway through both legs of the "Y".

Edge drain outlet and vent covers shall consist of commercial quality 75-mm x 75-mm galvanized hardware cloth, 1.6-millimeter wire or equal. The outlet and vent covers shall be installed at the end of each outlet pipe and vent pipe.

The Contractor shall furnish to the Engineer three copies of the manufacturer's certified test reports and certification covering each shipment of pipe stating the amount furnished and that the pipe, fittings, couplings, etc. comply with the requirements of the specifications.

907-605.02.4.2--Untreated Permeable Material. The untreated permeable material used to backfill the edge drain pipe and outlet/vent trench shall be Type 57 filter material and shall conform to the requirements of Subsection 703.03, Coarse Aggregate for Portland Cement Concrete, for Size 57 coarse aggregate. The type of aggregate may also be slag or granite. Mixing of different types of aggregate will not be permitted.

907-605.02.4.3--Geotextile. The geotextile used with edge drains and edge drain outlets shall be Type V geotextile meeting the requirements of Subsection 714.13.

907-605.02.4.4--Miscellaneous. Concrete for aprons shall be Class "C" concrete meeting the requirements of Subsection 804.02.7.2.

Mortar placed where edge drain outlets and vents connect to drainage pipes and existing drainage inlets shall conform to the provisions of Subsection 714.11.5, Masonry Mortar, except that the sand and cement shall be commercial quality.

907-605.03--Construction Requirements. [After Subsection 605.03.4 on page 605-3, add the following:](#)

907-605.03.5--Installation Edge drains, edge drain outlets, vents, untreated permeable material, and geotextile shall be installed in accordance with the details shown on the plans or in the contract documents, as specified herein and applicable Special Provisions. The vertical tolerance (height) for the trench shall be plus or minus 13 millimeters. The horizontal tolerance (width) shall be plus 25 millimeters.

Immediately prior to placement, surfaces to receive geotextile shall be free of loose or extraneous material and sharp objects that may damage the geotextile during installation.

The geotextile shall be stretched, aligned and placed in a wrinkle-free manner.

Adjacent rolls of the geotextile shall be overlapped from 300 to 450 millimeters. The preceding roll shall overlap the following roll in the direction the material is being spread.

Should the geotextile be damaged during placing, the torn or punctured section shall be either completely replaced or shall be repaired by placing a piece of geotextile that is large enough to cover the damaged area and to meet the overlap requirement.

Damage to the geotextile resulting from the Contractor's vehicles, equipment or operations shall be replaced or repaired by the Contractor at no additional cost to the State.

Pipe and fittings shall be joined by solvent cementing with commercial quality solvent cement and primer specifically manufactured for use with rigid PVC plastic pipe and fittings. The solvent cement and primer used shall be made by the same manufacturer. The color of the primer shall contrast with the color of the pipe and fittings. The solvent cement and primer shall be used in accordance with the manufacturer's printed instructions.

When corrugated polyethylene drainage tubing is used, joints shall be made with [snap-on or split couplings](#), corrugated to engage the pipe corrugations, and shall engage a minimum of four corrugations, two on each side of the pipe joint.

When poly (vinyl chloride) corrugated sewer pipe is used, joints shall be made in accordance with the pipe manufacturer's recommendations and ASTM Designation: F 949.

The backfill of the trench along the pavement edge, across the shoulder and outside the shoulder shall be as shown in the details of the drawings.

The Contractor may dispose of the trenched materials on the slopes provided all material passes a 75-millimeter ring and blends into the existing or reconstructed roadway slopes. Otherwise, the material must be disposed of outside the right-of-way.

The edge drain and edge drain outlets and vents shall be clean at the time of installation and shall be free of obstructions after installation.

907-605.03.6--Inspection. The edge drain system shall be inspected by the Contractor after all roadway construction items are completed within a given section of roadway. A video record and written report for each line inspected shall be furnished to the Engineer. The line location (station number), distance traversed by the camera, and pipe deficiency shall be recorded on a standard VHS video tape and in a written report. As a minimum, fifty percent (50%) of the entire edge drain system shall be video inspected. Video inspection shall be performed in the presence of the Engineer or the Engineer's representative.

Video equipment used for inspecting the edge drain system shall be capable of the following minimum requirements:

- (1) Providing color video inspection of pipelines for 100-mm inside diameter pipe in a wet, corrosive environment and negotiating a 90° bend in a smooth bore or corrugated pipe. The color camera must have a minimum 400-line horizontal resolution.
- (2) Video inspecting up to 100 meters of edge drain pipe, by pushing, pull cabling, jetting or tractoring the camera through the line and recording the condition on video tape.
- (3) Equipped with a video monitor capable of allowing live viewing of the video inspection.
- (4) Displaying and recording on the video tape, the date, line identification, footage and type of pipe deficiency.
- (5) Recording the distance traversed by the camera to within 150 millimeters, allowing for overlapping of distances if a reversal is required to permit full-length inspection.

A written report of the drain system inspection shall be completed on the attached form.

Any foreign materials that restricts the movement of the inspection equipment or impairs the quality of the video within the drain system shall be flushed from the system. Flushing of the drain system will be by water jetting or other methods approved by the Engineer. Costs associated with flushing the system will not be made under separate payment. The system shall be re-inspected after flushing in the same manner as the initial inspection as described above. Re-inspection of the system shall be at no additional cost to the State.

Any drain system pipe that can not be cleared from obstructions, damaged or does not conform to the lines and grades shown on the plans shall be replaced at no additional cost to the State.

907-605.04--Method of Measurement. [After the last paragraph of Subsection 605.04, add the following:](#)

Edge drains and edge drain outlets/vents, complete in place, will be measured by the meter along the line of the trench. On slopes, the length to be paid for will be the slope length of the trench.

Edge drain inspection will be measured by the meter of edge drain and edge drain outlet/vent inspected. The length to be paid for will be the slope length of the trench.

The Class "C" Concrete for concrete aprons shall be measured by the cubic meter.

Wire mesh covers, pipe and pipe fittings, couplings, untreated permeable material, geotextile, granular material, bituminous pavement mixture, trenching, disposal of trenched materials and other miscellaneous appurtenances will not be measured separately for payment.

907-605.05--Basis of Payment. Before the last paragraph of subsection 605.05, add the following:

The contract unit prices paid for edge drain and edge drain outlets/vents shall be full compensation for furnishing all labor, materials, tools, equipment, and incidentals and for doing all the work involved in constructing edge drains and edge drain outlets/vents complete in place, including wire mesh covers, pipe and pipe fittings, couplings, untreated permeable material, geotextile, granular material, bituminous pavement mixture, trenching, disposal of trenched materials and other miscellaneous appurtenances as shown on the plans and as specified in the standard specifications and in this special provision.

Edge drain inspection, completed and accepted, will be paid for at the contract unit price per meter of edge drain and edge drain outlet/vent inspected, which price shall be full compensation for furnishing all labor, equipment, VHS tapes, tools and incidentals necessary to complete the work.

Class "C" concrete for aprons, as shown on the plans and as specified herein, shall be paid for under Pay Item No. 221-A, Portland Cement Concrete Paved Ditch.

Add the following to the list of pay items at the end of Subsection 605.05.

- 907-605-FF: Edge Drain, Complete-in-Place - per meter
- 907-605-GG: Edge Drain Outlets/Vents, Complete-in-Place - per meter
- 907-605-HH: Edge Drain & Edge Drain Outlet/Vent Inspection - per meter

Add the "907" prefix to pay item nos. 605-Q, 605-R and 605-AA.

MISSISSIPPI DEPARTMENT OF TRANSPORTATION

SPECIAL PROVISION NO. 907-606-1M

CODE: (IS)

DATE: 4/24/98

SUBJECT: Terminal End Sections

Section 606, Guard Rail, of the 1996 Metric Edition of Standard Specifications for Road and Bridge Construction is hereby amended as follows:

907-606.02--Materials. After the second paragraph of Subsection 606.02 on page 606-1 add the following:

Terminal end sections, installed as per manufacturer's recommendations, shall be National Cooperative Highway Research Program (NCHRP) Report 350 Test Level 3 (TL-3) approved. The following is a list of the current devices that have met NCHRP Report 350.

1. BEST
2. ET-2000
3. FLEAT-350
4. SKT-350
5. SRT-350

Terminal end sections shall be one of the above listed devices or an approved equal.

The Contractor shall furnish the Project Engineer two (2) copies of the manufacturer's installation instructions prior to beginning guard rail operations.

907-606.05--Basis of Payment. Add the following pay item to the list on page 606-4:

907-606-E: Guard Rail (Terminal End Section)

- per each

MISSISSIPPI DEPARTMENT OF TRANSPORTATION

| SPECIAL PROVISION NO. 907-617-3M

CODE: (IS)

| DATE: 08/12/2005

SUBJECT: Right-Of-Way Markers

Section 617, Right-Of-Way Markers, of the 1996 Metric Edition of the Mississippi Standard Specifications for Road and Bridge Construction is deleted in toto and replaced as follows:

SECTION 907-617 - RIGHT-OF-WAY MARKERS

907-617.01--Description. This work consists of furnishing and placing right-of-way markers in accordance with the plans and these specifications and at points designated on the plans, or as directed. The work also shall include the removal of right-of-way markers from their original locations and resetting at new locations as specified or established.

Generally, Type “A” markers shall be placed in the ground and Type “B” markers shall be placed in concrete areas. The estimated quantity of markers will be shown on the plans, and it is the Contractor’s responsibility to verify the type and number of markers required.

907-617.02--Materials. The right-of-way marker shall be constructed using a reinforcement bar of the size indicated and a brass or bronze cap as indicated on the plan sheet. The cap shall be Mark-It® model C/M-HS-3-1/4B, Berntsen® 6000 Series, or approved equal. The cap shall be stamped with information indicated on the plans. The rebar shall meet the requirement of Section 711 of the Standard specifications.

Right-of-way markers for placement in concrete shall be Mark-It® model C/M-SS-3-1/4B, Berntsen® C Series, or approved equal brass or bronze stem designed marker. The cap shall be stamped with information indicated on the plans.

The witness post shall be made of fiberglass or Poly Vinyl Chloride (PVC) and shall not rust, rot or corrode within the service temperature range of -40°C to 60°C. It shall be of the color and size indicated in the plans or contract documents. The color shall not be painted on the marker but shall be pigmented into the material composition of the post. The post shall feature ultra violet (U.V.) inhibitors to eliminate cracking, peeling and deterioration of the post.

907-617.03--Construction Requirements.

907-617.03.1--General. Markers shall be manufactured in accordance with the details shown on the plans and the requirements of this section.

| Prior to installation, the rebar shall be checked to assure there are no large burrs or mushrooming on the end that will receive the brass cap. Any burrs shall be filed or ground off before installation. The Contractor shall use rebar drivers to eliminate mushrooming of the rebar during

the driving operations.

Type "B" markers may be installed in freshly placed concrete or placed in cured concrete by drilling and anchoring. The marker shall be anchored using a bonding material recommended by the manufacturer of the marker.

The Contractor shall use specially designed post drivers or other means necessary to eliminate damage to the witness posts during installation. The Contractor will not be required to place witness posts in concrete.

All letters, symbols, and other markings shall be as shown on the plans and shall be neatly imprinted in the caps.

The markers shall be set at the locations designated on the plans, or as directed by the Engineer with assistance as needed by the District Surveyor. The markers shall be set to within six millimeters of the lines indicated or established and a minimum of 50 millimeters below to a maximum of 150 millimeters below the natural ground elevation.

The layout and placement of right-of-way markers shall be performed by, or under the supervision of, or directed by, a Licensed Professional Surveyor who is duly licensed and entitled to practice as a Professional Surveyor in the State of Mississippi and shall have responsible charge for these duties. The duties performed by said Professional shall conform to the definitions under the practice of "land surveying" in Mississippi Law. The location of the markers shall be as shown in the plans. Accuracy standards for placement of markers shall be 15 millimeters relative to the project control established by MDOT using either state plane coordinate monuments or centerline control monuments used for construction; or those accuracies as listed in the Mississippi State Board of Licensure for Professional Engineers and Land Surveyors publication entitled "Standards of Practice for Surveying in the State of Mississippi". The more stringent of these two accuracy standards will apply and shall be used. The Contractor shall not engage the services of any person in the employ of the Department for the performance of any of the work covered by this Section or any person who has been employed by the Department within the past six months, except those who have legitimately retired from service with the Department during this period.

The Department will establish, one time only, State Plane Coordinate System horizontal control monuments. It shall be the responsibility of the Contractor to establish additional control as may be required to facilitate the staking of the right-of-way. Control monuments set by the Contractor shall meet the minimum standards of surveying as required by the Mississippi State Board of Licensure for Professional Engineers and Surveyors. The accuracy of the control established by the Contractor shall be not less than 1:20,000 relative to the control provided by the Department. The Contractor shall reference, guard and protect control points from damage and obliteration. The Contractor shall verify the accuracy of the control points before proceeding with the installation.

907-617.03.2--Removal of Existing Markers. Existing right-of-way markers which are specified to be removed shall be removed in accordance with the plans or as directed by the

Engineer without additional compensation.

907-617.03.3—Certification. After all the markers are installed, the Licensed Professional Surveyor **tasked with responsible charge for this** installation shall submit a written certification to the Engineer certifying that all right of way markers were set at the locations designated on the plans, or otherwise directed by MDOT, and to the specified tolerances. The certification shall also include a copy of the right-of-way plan sheets with the right-of-way marker table completed for all locations in which the Licensed Professional Surveyor installed right-of-way markers. The table shall be completed showing the as-built (in-place) northing and easting location based on the State Plane **Coordinate** System. Each right-of-way plan sheet shall be signed and stamped by the Licensed Professional Surveyor.

The Licensed Professional Surveyor **tasked with responsible charge** will furnish a signed and stamped Final Right-of-Way Plat meeting the minimum standards of surveying **for a Class A, B, or C survey** as required by the Mississippi State Board of **Licensure** for Professional Engineers and Surveyors. **In no incidence shall the standards for surveying be less accurate than a Class C survey.**

The Final Right-of-Way Plat shall show all horizontal control points, whether provided by the Department or by the Contractor. **In addition, the as-built project alignment shall be shown with stationing, curve data, and State Plane Coordinates for the BOP, PC's, PT's, and EOP.**

907-617.04--Method of Measurement. Right-of-way markers will be measured by the unit. Such measurements shall include all the components and imprinting necessary for the right-of-way marker, the witness post and surveying decals, all labor, materials and incidentals necessary to furnish a complete in-place right-of-way marker.

907-617.05--Basis of Payment. Right-of-way markers will be paid for at the contract unit price per each, which shall be full compensation for completing the work.

Payment will be made under:

907-617-A: Right-of-Way Marker - per each

MISSISSIPPI DEPARTMENT OF TRANSPORTATION

SPECIAL PROVISION NO. 907-618-7M

CODE: (IS)

DATE: 11/10/98

SUBJECT: Placement of Temporary Traffic Stripe

Section 618, Maintenance of Traffic and Traffic Control Plan, of the 1996 Metric Edition of the Mississippi Standard Specifications for Road and Bridge Construction is hereby amended as follows:

907-618.03 -- Construction Requirements.

907-618.03.3 -- Safe Movement of Traffic. Delete the third paragraph of Subsection 618.03.3 on page 618-3 and substitute the following:

A longitudinal pavement edge that traffic is expected to move across should have an elevation difference of not more than 55 millimeters. If the pavement edge is more than 40 millimeters and less than or equal to 55 millimeters, uneven pavement signs will be required as shown in the plans or contract documents. If the pavement edge is less than or equal to 40 millimeters, no uneven pavement signs will be required. Transverse pavement joints shall be sufficiently tapered to allow for the safe movement of traffic.

When a paving operation produces a longitudinal pavement edge that traffic is expected to move across, the adjacent lane shall be constructed to eliminate any uneven pavement edge within 48 hours, unless prohibited by weather conditions or an emergency arises.

Delete the sixth paragraph of Subsection 618.03.3 on page nos. 618-3 and 618-4 and substitute:

All centerline, lane lines, edge lines and no-passing stripes that have been covered or removed during the day's operations shall be replaced with temporary stripe before work is discontinued for the day or as soon thereafter as weather conditions will permit, except that:

- (1) Replacement of no-passing stripes may be delayed for a period not to exceed three (3) days for a two or three lane road.
- (2) Temporary edge lines may be eliminated on projects requiring shoulders constructed of granular material.
- (3) Temporary edge lines placed on the final pavement course of projects requiring paved shoulders without surface treatment shall be placed in the permanent stripe location, otherwise temporary edge lines on projects requiring paved shoulders may be placed on the adjacent shoulder in as near the permanent location as possible.

Temporary no-passing stripe is not considered a major item of work and such stripe which is eliminated because of placing the next course prior to expiration of the 3-day period shall not result in a monetary adjustment to the Contractor as provided in 104.02. All temporary stripe shall be placed in accordance with the plans and Subsection 907-619.03.2.

Delete the first sentence of the first full paragraph on page 618-4 under Subsection 618.03.3 and substitute the following:

In addition to the temporary no-passing stripe, the Contractor shall erect standard "DO NOT PASS," "NO-PASSING ZONE," and "PASS WITH CARE" signs in accordance with plan details or as specified in the MUTCD.

Delete the last sentence of the third full paragraph on page 618-4 under Subsection 618.03.3 and substitute the following:

All temporary stripe shall be maintained in good order until placement of the permanent pavement markings or placement of the next pavement course or until removed. Maintenance of temporary stripe may require more than one application over the life of the project. Payment will be made for one application only.

MISSISSIPPI DEPARTMENT OF TRANSPORTATION

SPECIAL PROVISION NO. 907-618-8M

CODE: (SP)

DATE: 03/08/2011

SUBJECT: Construction and Removal of Detour Bridges

Section 618, Maintenance of Traffic and Traffic Control Plan, of the 1996 Metric Edition of the Mississippi Standard Specifications for Road and Bridge Construction is modified as follows:

907-618.01--Description. After the last paragraph of Subsection 618.01.1 on page 618-1, add the following:

When specified in the plans, the Contractor will construct, maintain and remove all detour bridges as indicated in the plans and contract documents. The work shall consist of the furnishing of materials, construction, maintenance and removal of bridges with payment as described herein.

Unless otherwise shown in the plan, through and local traffic shall be maintained throughout the project at all times on existing facility, detours and completed permanent facility indicated on the plans and as necessary to carry out construction within the intent of the plans and contract. Minimum requirements of the Traffic Control Plan are shown on the plans.

907-618.04--Method of Measurement. After the last paragraph of Subsection 618.04 on page 618-5, add the following:

Construction and removal of detour bridges will be measured as a lump sum quantity, consisting of furnishing all labor and materials, construction, repair and replacement as deemed necessary during the life of the project and removal as follows:

After the permanent bridge is opened to traffic, the detour bridge shall be removed. All Contractor furnished material shall remain the property of the Contractor and shall be removed from the site.

Percentages for construction and removal of each detour bridge commensurate with the magnitude of the work will be applied as follows:

Construction of Detour Bridge	80%
Removal of Detour Bridge	20%

Each month the Engineer will estimate the percentage of construction and removal of each detour bridge and apply the percentage as indicated herein.

907-618.05--Basis of Payment. After the [third](#) paragraph of Subsection 618.05 on page 618-5, add the following:

Construction and removal of detour bridges, measured as provided in Subsection 907-618.04, will be paid for at the contract lump sum bid price bid, which price shall be full compensation for furnishing all labor and materials, construction, repair, replacement and removal when ordered by the Engineer.

Additional maintenance responsibilities covering maintenance of the embankment, base and paving on detour roads will be measured and paid for as set out in Section 618.

Payment will be made under:

907-618-C: Construction and Removal of Detour Bridge - [lump sum](#)

MISSISSIPPI DEPARTMENT OF TRANSPORTATION

SPECIAL PROVISION NO. 907-619-5M

CODE: (SP)

DATE: 6/15/98

SUBJECT: Terminal End Sections

Section 619, Traffic Control for Construction Zones, of the 1996 Metric Edition of the Mississippi Standard Specifications for Road and Bridge Construction is hereby amended as follows:

907-619.02--Materials. After of Subsection 619.02.11 on page 619-3 add the following:

907-619.02.12--Terminal End Section. Terminal end sections, installed as per manufacturer's recommendations, shall be National Cooperative Highway Research Program (NCHRP) Report 350 Test Level 3 (TL-3) approved. The following is a list of the current devices that have met NCHRP Report 350.

1. BEST
2. ET-2000
3. FLEAT-350
4. SKT-350
5. SRT-350

Terminal end sections shall be one of the above listed devices or an approved equal.

The Contractor shall furnish the Project Engineer two (2) copies of the manufacturer's installation instructions prior to beginning guard rail operations.

907-619.05--Basis of Payment.

Payment will be made under:

907-619-K4: Installation and Removal of Guard Rail (Terminal End Section) - per each

MISSISSIPPI DEPARTMENT OF TRANSPORTATION

SPECIAL PROVISION NO. 907-619-11M

CODE: (IS)

DATE: 06/18/2003

SUBJECT: Traffic Control for Construction Zones

Section 619, Traffic Control for Construction Zones, of the 1996 Metric Edition of the Mississippi Standard Specifications for Road and Bridge Construction is hereby amended as follows:

907-619.02.4--Construction Signs. Delete the fourth sentence of the second paragraph of Subsection 619.02.4 on page 619-1 and substitute:

Standards for height of construction signs shall be those shown for roadside signs in Chapter 6F of the Manual of Uniform Traffic Control Devices (MUTCD).

Delete the third paragraph of Subsection 619.02.4 on page 619-1 and substitute the following:

Unless specified otherwise, fluorescent orange reflective sheeting, meeting the requirements of Subsection 721.06, shall be used on all construction signs regardless of whether used during daytime or nighttime hours.

Delete the fourth paragraph of Subsection 619.02.4 on page 619-1 and substitute the following:

Unless otherwise specified on the plans, the material on which the reflective sheeting is to be applied shall be 1.52-millimeter (minimum) steel, 2.03-millimeter (minimum) aluminum, or 15-millimeter (minimum) high density overlaid plywood. Ungalvanized steel, exterior grade plywood and lumber shall have a minimum of two coats of paint on front, back, and edges. High density overlaid plywood shall have the edges painted. The material to which reflective sheeting is to be applied shall be prepared in accordance with the recommendations of the sheeting manufacturer.

Delete the third sentence of the first paragraph of Subsection 619.02.4 on page 619-2 and substitute the following:

If tested by the Central Laboratory, the reflective sheeting shall have at least 50 percent of the reflectivity specified for new sheeting.

907-619.02.5--Advance Warning Flashing Arrow Panels. Delete in toto Subsection 619.02.5 on page 619-2 and substitute:

907-619.02.5--Advance Warning Flashing Arrow Panels. Flashing arrow panels shall meet the requirements of Section 6F.53 of the MUTCD.

907-619.02.6--Concrete Median Barrier and Delineators. Delete in toto Subsection 619.02.6 on pages 619-2 & 619-3, and substitute:

907-619.02.6--Concrete Median Barrier and Delineators. Precast concrete median barrier shall meet the requirements of the plans, contract documents, and Section 615 except the surface may be a Class 1 ordinary surface finish unless designated otherwise. When precast concrete median barriers are no longer needed at one location, as determined by the Engineer, the barriers shall be removed and reset at other designated locations. When barriers have to be stored until needed at another location, payment for removing and resetting will not be made until they are reset at their designated location. The Contractor shall furnish the storage area.

The Engineer may allow the installation of used barriers for temporary traffic control upon an inspection and determination that the barrier units are structurally adequate for their intended purpose. Barriers with small chips or fractures not affecting their integrity may be accepted.

Precast concrete barriers used on this project which were purchased or manufactured after October 1, 2002 must meet the requirements of NCHRP Report 350. Precast median barriers purchased or manufactured prior to October 1, 2002 may be used until they complete their normal service life.

Certification of precast concrete barriers shall be as required in the Notice to Bidders titled "Certification of Traffic Control Devices".

Delineators shall be listed on the Department's "Approved Sources of Materials" and meet the requirements of the plans and Section 6F.68 of the MUTCD.

Delete in toto Subsection 619.02.7 on page 619-3 and substitute:

907-619.02.7--Channelization Devices, Barricades, and Warning Lights. Channelization devices, vertical panels, tubular markers, cones, drums, barricades and temporary raised islands shall meet the requirements of the plans and Sections 6F.55 through 6F.64 of the MUTCD. Drums shall be constructed of lightweight, deformable material capable of retaining reflective sheeting. Reflective sheeting for drums shall be Type III meeting the requirements of 721.06. Warning lights shall meet the requirements of Section 6F.72 of the MUTCD.

907-619.02.8--Traffic Signals and Flashers. Delete in toto Subsection 619.02.8 on page 619-3 and substitute:

907-619.02.8--Traffic Signals and Flashers. Traffic signals and flashers shall meet the requirements of the plans and Sections 6F.71 & 6F.74 of the MUTCD.

907-619.02.9--Impact Attenuators. Delete in toto Subsection 619.02.9 on page 619-3 and substitute:

907-619.02.9--Impact Attenuators. Impact attenuators must be listed on the Department's "Approved Sources of Materials".

MISSISSIPPI DEPARTMENT OF TRANSPORTATION

| SPECIAL PROVISION NO. 907-619-13M

CODE: (IS)

| DATE: 04/27/2004

SUBJECT: Temporary Pavement Markings

Section 619, Traffic Control for Construction Zones, of the 1996 Metric Edition of the Mississippi Standard Specifications for Road and Bridge Construction is hereby amended as follows:

907-619.03--Construction Requirements.

907-619.03.2--Temporary Stripe. Delete in toto Subsection 619.03.2 on page 619-4 and substitute the following:

Temporary stripes are pavement markings, temporary in nature, such as those used to direct traffic from its customary path or those to be removed from the pavement course under use for further temporary traffic control or those to be covered by the next pavement course and/or those to be replaced by permanent stripes. Temporary stripes shall be paint or preformed tape as designated on the plans or when not designated, the use of paint or tape will be at the Contractor's option. Temporary stripes on surface treatments shall be paint.

All temporary stripe shall be placed in accordance with the plans and the requirements set out in Section 625, except that alignment of temporary stripe placed on underlying courses shall have a tolerance of 100 millimeters in 15 meters from true alignment for skip stripes and edge lines and 25 millimeters in 15 meters from true alignment for no-passing stripes and lane lines. When preformed tape is used on the final pavement course for temporary traffic markings, it shall be removed at no additional cost to the State.

Temporary paint stripe requiring removal shall be removed by carefully controlled blast cleaning, approved grinding or other approved methods in such a manner that the surface to which the stripe was applied will not be unnecessarily marred or damaged. Preformed tape is to be removed in accordance with the manufacturer's recommendations.

Temporary paint stripe which has been placed on the final pavement course may be left in place and covered with permanent stripe of the same color provided the temporary stripe has been satisfactorily placed in the proper location. Under this condition, any remaining temporary paint stripe not covered by the permanent stripe shall be removed at no additional cost to the State.

Painted traffic stripe which has been removed from the final asphalt pavement surface shall be sealed with an approved sealant. The Engineer may wave the sealant requirement when the area to be sealed is insignificant. This sealing operation shall be performed at no additional costs to the State.

All temporary pavement markings placed and measured for payment under this section shall include any required removal. Removal of all temporary stripe will not be measured for separate payment.

Existing pavement markings conflicting with temporary markings shall be removed. Removal of such materials (paint, tape, marker, etc.) will be measured and payment made under Section 202. When measuring removal of pavement markings for payment, the skips will not be included in the measurement.

907-619.03.3--Short-term Stripe. Delete in toto Subsection 619.03.3 on pages 619-4 and 619-5.

907-619.04--Method of Measurement. Delete the third paragraph on page 619-7 and substitute the following:

Temporary stripe, completed and removed in accordance with the requirements of this Section, will be measured as provided for painted traffic markings in 625.04, except as follows: Detail traffic stripe will be measured by the meter from end-to-end of individual stripes. Measurement will be made along the surface of each stripe and will exclude nominal skip intervals where specified. Stripes more than 100 millimeters in width will be converted to equivalent lengths of 100-mm widths. Legend, which is to include railroad markings, pedestrian crosswalks and stop lines, will be measured by the square meter or meter. Pay areas of individual letters and symbols will usually be shown on the plans and measured by the square meter. Transverse railroad bands, pedestrian crosswalks and stop lines will generally be measured by the meter, in which case, stripes more than 100 millimeters in width will be converted to equivalent lengths of 100-mm widths.

907-619.05--Basis of Payment. Add the "907" prefix to pay item numbers 619-A1, 619-A2, 619-A5 and 619-A6 in Subsection 619.05 on page numbers 619-7 and 619-8.

Delete pay item numbers 619-A3 and 619-A4 on page 619-8 and substitute the following:

- 619-A3: Temporary Traffic Stripe (Skip White) (_____ * _____) - per meter or kilometer
Description
- 619-A4: Temporary Traffic Stripe (Skip Yellow) (_____ * _____) - per meter or kilometer
Description

Delete in toto the pay item numbers, descriptions and units for pay item numbers 619-B1, 619-B2, 619-B3, 619-B4, 619-B5 and 619-B6 from Subsection 619.05 on pages 619-8 and 619-9.

After pay item number 619-C5 on page 619-9 add the following:

- 907-619-C6: Red-Clear Reflective High Performance Raised Marker
- per each

- 907-619-C7: Two-Way Yellow Reflective High Performance Raised Marker - per each
- 907-619-C8: One-Way Clear Reflective High Performance Raised Marker - per each
- 907-619-C9: One-Way Yellow Reflective High Performance Raised Marker - per each
- 907-619-C10: Yellow Clear Reflective High Performance Raised Marker - per each

Delete the last paragraph of Subsection 619.05 on page 619-10 and substitute the following:

- * The description for temporary traffic stripe will be shown as "paint" or "tape". In the case of "tape" the type will also be designated. When the description is not designated, the use of "paint" or "tape" will be at the Contractor's option.

MISSISSIPPI DEPARTMENT OF TRANSPORTATION

SPECIAL PROVISION NO. 907-626-12M

CODE: (IS)

DATE: 04/27/2004

SUBJECT: Thermoplastic Markings

Section 626, Thermoplastic Traffic Markings, of the 1996 Metric Edition of the Mississippi Standard Specifications for Road and Bridge Construction is hereby amended as follows:

907-626.03--Construction Requirements.

907-626.03.2--Construction Details. Delete the first paragraph on page 626-2 under Subsection 626.03.2 and substitute the following:

Unless otherwise directed by the Engineer, traffic stripes that are coincidental with the thermoplastic stripe shall be removed prior to placement of the thermoplastic material, except that temporary paint stripe may be left in place when satisfactorily placed in the proper location. Any temporary stripe not covered shall be removed. Payment for removal of stripe, except temporary stripe, will be made under Section 202.

907-626.04--Method of Measurement. Delete the last sentence of the second paragraph of Subsection 626.04 on page 626-3 and substitute the following:

Stripes more than 150 millimeters in width will be converted to equivalent lengths of 150-mm stripe.

Delete the last sentence of Subsection 626.04 on Page 626-3 and substitute the following:

Transverse railroad bands, pedestrian crosswalks and stop lines will generally be measured by the meter, in which case, stripes more than 150 millimeters in width will be converted to equivalent lengths of 150-mm widths.

907-626.05--Basis of Payment. After the last pay item listed on page 626-3, add the following:

907-626-AA: 150-mm Thermoplastic Traffic Stripe (Skip White)

()
Thickness

- per meter or kilometer

907-626-BB: 150-mm Thermoplastic Traffic Stripe (Continuous White)

()
Thickness

- per meter or kilometer

907-626-CC: 150-mm Thermoplastic Edge Stripe (Continuous White)
()
Thickness - per meter or kilometer

907-626-DD: 150-mm Thermoplastic Traffic Stripe (Skip Yellow)
()
Thickness - per meter or kilometer

907-626-EE: 150-mm Thermoplastic Traffic Stripe (Continuous Yellow)
()
Thickness - per meter or kilometer

907-626-FF: 150-mm Thermoplastic Edge Stripe (Continuous Yellow)
()
Thickness - per meter or kilometer

907-626-GG: Thermoplastic Detail Stripe
(150-mm Equivalent Length) () ()
Color Thickness - per meter

907-626-HH: Thermoplastic Legend (White)
()
Thickness - per meter or square meter

MISSISSIPPI DEPARTMENT OF TRANSPORTATION

SPECIAL PROVISION NO. 907-626-13M

CODE: (SP)

DATE: 09/15/2004

SUBJECT: Inverted Profile Thermoplastic Traffic Stripe

Section 626, Thermoplastic Traffic Markings, of the 1996 Metric Edition of the Mississippi Standard Specifications for Road and Bridge Construction as amended by this special provision is applicable for inverted profile thermoplastic traffic stripe only:

907-626.01--Description. Inverted profile thermoplastic pavement markings consists of furnishing materials and placing inverted profile thermoplastic pavement markings in reasonably close conformity with these specifications and the details shown on the plans or established.

Inverted profile thermoplastic pavement markings, high contract, shall consist of furnishing materials and placing inverted profile thermoplastic pavement markings over a black thermoplastic pavement marking in order to enhance the marking's visibility.

907-626.02--Materials.

907-626.02.1--General. The inverted profile thermoplastic marking material shall consist of an alkyd/maleic or hydrocarbon based formulation. The material shall be so manufactured as to be applied to the pavement in a molten form, with internal and surface application of glass spheres, and upon cooling to normal pavement temperature, shall produce an adherent, reflectorized pavement marking of specified thickness and width, capable of resisting deformation.

Materials shall be obtained from approved sources as listed on the Department's "List of Approved Sources" for Inverted Profile Thermoplastic Pavement Marking Materials. The material shall not scorch, break down, discolor, or deteriorate when held at the application temperature for four hours or when reheated four times to the application temperature. Temperature-vs-viscosity characteristics of the plastic material shall remain constant when reheated four times, and shall be the same from batch to batch.

The thermoplastic material shall be a product especially compounded for pavement markings. The pavement markings shall maintain their original dimension and shall not smear or spread under normal traffic at temperatures below 60°C. The markings shall have a uniform cross section. Pigment shall be evenly dispersed throughout its thickness. The exposed surface shall be free from tack and shall not be slippery when wet. The material shall not lift from pavement in freezing weather. Cold ductility of the material shall be such as to permit normal movement with the pavement surface without chipping or cracking.

Black thermoplastic compound for the placement of inverted profile thermoplastic pavement markings, high contract, shall consist of a hydrocarbon or alkyd/maleic based formulation.

The manufacturers of the thermoplastic compound, glass beads and epoxy primer sealer shall furnish to the Engineer three copies of certified test reports showing results of all tests specified herein and shall further certify that the materials meet all requirements. The Contractor shall provide the warranty as specified herein to the Engineer.

907-626.02.2--Inverted Profile Thermoplastic Material. The thermoplastic material shall consist of homogeneously mixed pigments, fillers, resins and glass beads, and shall be available in both white and yellow. The material shall be free from all skins, dirt, and foreign objects. Materials shall conform to AASHTO Designation: M 249 with the following modifications:

907-626.02.2.1--Intermixed Glass Beads. The thermoplastic material shall contain a minimum of 40 percent Class H glass beads by mass. Class H glass beads shall meet the requirements of ASTM Designation: D 1155, and shall be coated with an adhesion promoting coating which shall also provide moisture resistance as tested by AASHTO Designation: M 247, Section 4.4.2. Class H beads shall have a minimum of 70 percent true spheres and the +850µm sieve shall be tested visually.

The gradation of the Class H beads shall meet the following:

<u>U. S. Standard Sieve</u>	<u>% Passing</u>
1.70 mm	100
1.40 mm	95 - 100
1.18 mm	80 - 100
1.00 mm	30 - 100
850 µm	15 - 100
600 µm	10 - 100
300 µm	0 - 50
150 µm	0 - 5

907-626.02.2.2--Binder Content. The binder content of the thermoplastic material shall be 19 percent minimum.

907-626.02.2.3--Titanium Dioxide. The titanium dioxide shall meet ASTM Designation: D 476, Type II, Rutile grade - 10 percent minimum titanium content.

907-626.02.2.4--Yellow Pigment. The yellow pigment for the yellow thermoplastic material shall be five (5) percent minimum.

907-626.02.2.5--Specific Gravity. The specific gravity of the thermoplastic pavement marking material shall not exceed 2.35.

907-626.02.2.6--Flow Characteristics.

907-626.02.2.6.1--Flowability. After heating the thermoplastic material for four (4) hours ±5 minutes at 218 ±2°C and testing flowability, the white thermoplastic shall have a maximum percent residue of 22 percent and the yellow thermoplastic shall have a maximum residue of 24 percent.

907-626.02.2.6.2--Flow Resistance. The material shall exhibit a maximum flow of 10%. The material's ability to form ribs on the markings shall be evaluated by casting a disc of material approximately 90 millimeters wide by 25 millimeters long by and 15 millimeters deep. After the material is cooled to ambient temperature, measure the exact height. The material shall then be stored at 88°C for four (4) hours. After the material is cooled to ambient temperature, re-measure the exact height and express the flow resistance as a flow percentage.

907-626.02.2.7--Reflectivity. The initial reflectance for the in-place marking shall have a minimum reflectance value of 450 mcd/lux/m² for white and 350 mcd/ lux/m² for yellow, when measured with a Mirolux 30 retroreflectometer, or approved equal.

907-626.02.2.8--Wet Reflectivity. The initial reflectance for the in-place marking when wet shall have a minimum reflectance value of 200 mcd/ lux/m² for white and 175 mcd/ lux/m² for yellow, when measured with an approved retroreflectometer. The stripe shall be wetted utilizing a pump type sprayer for five (5) seconds. After 30 seconds, place the retroreflectometer on the stripe and measure the reflectance.

907-626.02.2.9--Inverted Profile. The thermoplastic pavement marking material shall be applied to have individual profiles having a minimum height of 3.55 millimeters with the recessed inverted profiles having a thickness of 0.65 to 1.25 millimeters. The profiles shall be well defined, spaced approximately 25 millimeters apart, and not excessively run back together.

907-626.02.3--Black Pavement Marking Material for High Contrast Inverted Profile Pavement Markings.

907-626.02.3.1--General. In the molten state, the material shall not give off fumes that are toxic or otherwise injurious to persons or property. The manufacturer shall provide material safety data sheets for the product.

The temperature versus viscosity characteristic of the plastic material shall remain constant and the material shall not deteriorate in any manner during three reheating processes. There shall be no obvious change in color of the material as a result of up to three reheatings, or in maintaining the material at application temperature up to an aggregate time of four (4) hours, or from batch to batch. The maximum elapsed time after application at which normal traffic will leave no impression or imprint on the new stripe shall be 30 seconds when the air and road surface temperature is approximately 20 ±3°C. The applied stripe shall remain free from tack and shall not lift from the pavement under normal traffic conditions within a road temperature range of -29°C to 66°C. The stripe shall maintain its original dimensions and placement. Cold ductility of the material shall be such as to permit normal dimensional distortion as a result of tire impact within the temperature range specified.

The material shall provide a stripe that has a uniform thickness throughout its cross section.

907-626.02.3.2--Binder. The binder shall be hydrocarbon or alkyd/maleic based. The binder shall consist of a homogeneous mixture of pigment, fillers, resins, waxes and plasticizers. The total binder content shall be well distributed throughout the compound. The binder shall be free

from all foreign objects or ingredients that would cause bleeding, staining or discoloration. The binder shall be 19 percent minimum by mass of the thermoplastic compound.

907-626.02.3.3--Pigment. The pigment used for black pavement marking compound shall be as required and shall be uniformly distributed throughout the marking compound.

907-626.02.3.4--Filler. The filler to be incorporated with the resins shall be a white calcium carbonate, silica or any approved substitute.

907-626.02.3.5--Specific Gravity. The specific gravity of the marking compound shall not exceed 2.0.

907-626.02.3.6--Softening Point. After heating the marking compound for 4 hours ± 5 minutes at $190 \pm 2^\circ\text{C}$ and testing in accordance with ASTM Designation: E 28, the material shall have a minimum softening point of 82°C as measured by the ring and ball method.

907-626.02.3.7--Tensile Bond Strength. After heating the marking compound for 4 hours ± 5 minutes at $190 \pm 2^\circ\text{C}$, the tensile bond strength shall exceed 1.2 MPa when tested in accordance with ASTM Designation: D 4806. The material shall be applied to unprimed, sandblasted Portland cement concrete block at a thickness of two millimeters and at a temperature of $190 \pm 2^\circ\text{C}$. The test shall be conducted at room temperature.

907-626.02.3.8--Impact Resistance. After heating the marking compound for 4 hours ± 5 minutes at $190 \pm 2^\circ\text{C}$, the impact resistance shall be a minimum of 5.6 Newton-meters minimum when tested in accordance with ASTM Designation: D 2794. No cracks or bond loss shall occur when a 2-mm thick film drawdown is made at $190 \pm 2^\circ\text{C}$ on an unprimed sandblasted Portland cement concrete block. The sample is tested with a male indenter 15 millimeters and no female Die at room temperature.

907-626.02.3.9--Identification. Each package of material shall be stenciled with the manufacturer's name, the type of material and specification number, the month and year the material was packaged and lot number. The letters and numbers used in the stencils shall be a minimum of 12 millimeters in height.

907-626.02.3.10--Packaging. The material shall be packaged in suitable containers that will not adhere to the product during shipment and storage. The container of pavement marking material shall weigh approximately 22 kilograms. Each container shall designate the color, type of resin, type of application and user information. The label shall warn the user that the material shall be heated in the range of $176 \pm 2^\circ\text{C}$.

907-626.02.3.11--Storage Life. The material shall meet the requirements of this specification for a period of one year. The material must also meet uniformly with no evidence of skins or unmelted particles for this one-year period. The manufacturer shall replace any material not meeting the above requirements.

907-626.02.3.12--Certifications. The material manufacturer shall furnish a certified copy of material test reports to the Engineer.

907-626.02.4--Drop-On Glass Beads. Drop-on glass beads shall be separated into two (2) classes, as follows:

907-626.02.4.1--Class G Glass Beads. Class G glass beads shall be coated with an adhesion promoting coating which shall also provide moisture resistance as tested by AASHTO Designation: M 247, Section 4.4.2 and shall exhibit the following characteristics:

- **Color and Clarity:** The glass beads shall be colorless and clear, and shall be free of carbon residues.
- **Index of Refraction:** minimum 1.50
- **Roundness:** The glass beads shall have a minimum of 80% true spheres per screen for the two highest sieve quantities, determined visually, and a maximum of 3% angular particles per sieve, determined visually. The remaining sieves shall have a minimum of 75% true spheres, determined visually per aspect ratio using microfiche reader.
- **Air Inclusions:** 10% maximum
- **Specific Gravity:** The specific gravity of the glass beads shall be a minimum of 2.50.
- **Gradation:** The gradation of Class G glass beads shall be as follows:

<u>U. S. Standard Sieve</u>	<u>% Passing</u>
1.70 mm	100
1.40 mm	100 - 95
1.18 mm	100 - 80
1.00 mm	100 - 20
850 μm	90 - 20
600μm	100 - 50
Pan	100 - 90

All Class G glass beads shall be coated with an adhesion promoting coating.

907-626.02.4.2--Class H Glass Beads. Class H glass beads shall meet the requirements of ASTM Designation: D 1155, and shall be coated with an adhesion promoting coating which shall also provide moisture resistance as tested by AASHTO Designation: M 247, Section 4.4.2. Class H beads shall have a minimum of 70 percent true spheres and the +20 sieve shall be tested visually.

The gradation of the Class H beads shall meet the following:

<u>U. S. Standard Sieve</u>	<u>% Passing</u>
1.18 mm	99 - 100
850 μm	75 - 100
600 μm	55 - 95
300 μm	10 - 35
150 μm	0 - 5

907-626.03--Construction Requirements.

907-626.03.1--Equipment. The application equipment shall be specifically designed for placing thermoplastic material in a hot molten state on the pavement surface utilizing a pressure type application method. The thermoplastic stripe shall be formed by a die that is allowed to drag along in proximity with the pavement surface. The die is pulled forward by a special linkage that will allow it to automatically level itself as to float and remain parallel with the pavement surface. The traffic stripe shall be formed by reason that the hot thermoplastic material is forced under pressure through four sides to the die onto the pavement surface. The top of the die shall be enclosed and provide entry means for the hot molten thermoplastic material to enter the die cavity. The bottom of the die shall contain a movable door that is remote controlled so as to start or stop the flow of thermoplastic material onto the pavement surface. When the movable door is open, thermoplastic material can flow through the die and will apply a thermoplastic stripe that will be formed rearward of the advancing die. The pavement surface shall be at the bottom of the die enclosure. Thermoplastic material shall be fed to the die under pressure through flexible oil-jacketed stainless steel hoses. The thermoplastic material must be either pumped or fed from a pressure vessel to the die under pressure in order to obtain the proper adhesion with the pavement surface.

The system shall consist of a low pressure drop-on type glass bead gun, (bead coat #1). The thermoplastic die shall be oil-jacketed on four (4) sides and is formed from a single solid block of steel. The glass bead gun shall dispense glass beads onto the hot thermoplastic stripe from a height of approximately 25 millimeters above the pavement surface. The point at which the glass beads strike the surface of the stripe shall be approximately 75 millimeters behind the strike point of the thermoplastic material itself. This reflective bead coat #1 shall utilize Class G glass beads as specified herein, and shall provide a surface coating of 50 percent of the thermoplastic stripe surface. Of this 50 percent stripe coverage, at least 50 percent of the beads shall be embedded to a depth of 60 percent of their diameter.

A second curtain coater, low pressure drop-on type glass bead gun capable of applying a continuous sheet or ribbon of glass beads, shall follow at an interval of approximately 250 millimeters behind the first bead gun. This second glass bead gun shall apply bead coat #2 which will form a continuous drop-on coat of Class H glass beads immediately in front of the profiling device. This second curtain of glass beads shall have a low impact speed so that they are not forced into the stripe under pressure.

A special rotatable wheel profiling device shall be located approximately 200 millimeters behind bead gun #2. This rotatable wheel device shall be approximately 175 millimeters in diameter and shall have a plurality of spaced projections located around its circumference. The profiling device shall be wider than the stripe being applied in order that the stripe shall be adequately covered. The projections on the rotatable profiling device shall have an angular profiling surface set at an angle to the pavement surface. The rotatable profile device shall be mounted with an automatic leveling device to the same carriage assembly as the thermoplastic gun. This is required so that a traffic stripe of accurate and uniform definition can be obtained. The inverted profile grooves shall be pressed into the hot molten thermoplastic stripe within one (1) second of the thermoplastic material application in order to insure proper bead adhesion to the stripe. Using rollers to place grooves in the traffic stripe utilizing a separate vehicle or grooves that are not pressed within one (1) second of the thermoplastic material application will not be allowed. To insure that no thermoplastic material adheres to the wheel as it rotates and profiles the stripe, a small air atomizer water jet shall apply a thin mist coat of water to the rotatable profile wheel. It is the intent of this specification that a minimum amount of water be used and that no water puddles greater than six millimeters in diameter be allowed to accumulate on the pavement surface in proximity to the freshly placed stripe. Excess water on the pavement surface can cause bond failure of the thermoplastic material.

All parts of the thermoplastic holding tank including manifolds, hoses, pipes, dies, etc., shall be oil-jacketed to insure accurate temperature control. The thermoplastic material shall be preheated in kettles designed specifically for that purpose. Each kettle of preheated thermoplastic material shall be properly mixed and heated to the correct application temperature. The preheated material shall then be fed to the thermoplastic gun for application.

The striping machine shall contain enough glass beads and water to apply one full kettle of thermoplastic material.

907-626.03.2--Cleaning of Pavement Surface. Immediately before application, the areas to receive markings shall be cleaned thoroughly using equipment capable of cleaning without damaging the pavement surface. This will include, but not be limited to, all vegetation, loose soil, oils, and other debris. On areas of pavement cured with compound, the membrane shall be removed completely by "shot" blasting, sand blasting or other approved method. Striping shall follow as closely as practical after the pavement surface has been cleaned.

907-626.03.3--Application Over Existing Striping. Where shown on the plans or directed by the Engineer, the existing traffic stripe shall be removed by grinding or sandblasting. When placing inverted profile thermoplastic pavement markings on existing pavement that has more than one light coat (pavement not showing through stripe) of striping material, the existing stripe shall be removed to the point that 80 percent of the pavement surface is visible.

Removal of existing stripe will be paid for as a separate item of work.

Where unsatisfactory striping performed by the Contractor must be removed and replaced in accordance with these specifications, the Contractor shall use the removal method described above. No payment will be made for removal or replacement of the Contractor's unsatisfactory striping.

907-626.03.4--Surface Conditions. When placing inverted profile thermoplastic pavement markings, no striping shall be permitted when the pavement surface temperature is less than 16°C. A non-contact infrared pyrometer shall be furnished by the Contractor for use by the Engineer for verification of the temperature. Striping shall not be performed when there is moisture on the pavement surface or when winds exceed 19 kph. When unseen moisture is suspected to be present, a moisture test shall be performed. The test shall be as follows:

- 1) Place a piece of roofing felt on the pavement surface.
- 2) Pour two liters of thermoplastic material at application temperature onto the paper.
- 3) After two (2) minutes, lift the paper and inspect to see if moisture has been drawn from the pavement.
- 4) If moisture is present, striping is not to begin until the surface is moist free.

Documentation of weather and pavement conditions shall be recorded as part of completing the MDOT Inverted Profile Thermoplastic Pavement Marking Inspectors Report.

907-626.03.5--Application. Prior to the placement of pavement markings, the Contractor shall furnish the Engineer three copies of the manufacturer's warranty stating that the manufacturer will guarantee the pavement marking to meet the requirements of this specification.

The thermoplastic material shall be preheated and thoroughly mixed. The application temperature of the thermoplastic material shall be between 205°C and 220°C. A digital thermometer complete with a 600-mm probe shall be furnished by the Contractor for use by the Engineer for verification of the temperature.

When measured at the highest point of the profile, the cold thickness of the in-place thermoplastic stripe shall be a minimum of 3.55 millimeters for Inverted Profile Thermoplastic Pavement Markings. The thickness of the thermoplastic material in the bottom of the profiles shall range from 0.65 to 1.25 millimeters. The individual profiles shall be located transversely across the stripe at intervals of approximately 25 millimeters. The bottoms of these intervals shall be between 2.4 to 8.0 millimeters wide. In order to drain water and to reflect light, it is normal for the top surface of the inverted profiles to be irregular. The application rate of thermoplastic material for Inverted Profile Thermoplastic Pavement Markings shall be a minimum of 760± kilograms per kilometer for a continuous 150-mm stripe.

The application rate for Class G glass beads (bead coat #1) shall be 85± kilograms per kilometer for 150-mm continuous stripe.

The application rate for Class H glass beads (bead coat #2) shall be 85± kilograms per kilometer for 150-mm continuous stripe.

The thickness of the striping materials shall be verified periodically (at least every 400 meters) and any thickness more than five (5) percent under the designated thickness shall be reworked. A consistent, uncorrected under-run will not be allowed and the Contractor will be required to install the specified minimum thickness of 3.55 millimeters. A wet thickness gauge and cold

thickness gauge shall be furnished by the Contractor for use by the Engineer for the verification of film thickness.

When striping over existing painted stripe (one light coat), on old oxidized asphalt, on all concrete surfaces or on asphalt surfaces when ambient temperatures are below 21°C, a two component epoxy primer sealer shall be used and installed as recommended in writing by the thermoplastic material manufacturer. The epoxy primer sealer shall be EX255/EX256 as manufactured by Crown Paint Company of Oklahoma City, Oklahoma, or approved equal. The Contractor shall furnish certification of compatibility of the epoxy primer sealer to be used with the thermoplastic material supplied. If an alternate epoxy primer sealer to the EX255/EX256 is used, the Contractor shall furnish a mill analysis and proof of adequate performance of the alternate epoxy primer sealer when used with thermoplastic pavement markings.

907-626.03.6--Inverted Profile Thermoplastic Traffic Stripe, High Contrast. Before applying the black pavement marking material, the Contractor shall remove any dirt, glaze, grease or any other material that would reduce the adhesion of the thermoplastic to the pavement.

The pavement marking material shall be installed in a molten state by the spray method at a minimum temperature of 176°C and a maximum temperature of 218°C. Scorching or discoloration of material shall be cause for rejection by the Engineer. The machinery shall be constructed so that all mixing and conveying parts, up to and including the thermoplastic gun, maintain the material in the molten state.

The pavement marking materials shall not be applied when air and pavement surface temperatures are below 16°C or when the surface of the pavement contains any evidence of moisture.

The pavement marking material shall be applied at a thickness of not less than 10 millimeters.

The equipment used to install hot applied pavement marking material shall provide continuous mixing and agitation of the material while maintaining a minimum temperature exceeding 205°C. A strainer shall be in place between the main material reservoir and the gun to prevent accumulation and clogging. The equipment shall be constructed for easy accessibility to parts requiring cleaning and maintenance.

After the black thermoplastic pavement markings are applied, inverted profile thermoplastic markings shall be placed over the black thermoplastic pavement markings in accordance with the specifications and to the dimensions and details shown on the plans or established.

907-626.03.7--Warranty. The manufacturer shall warrant that the inverted profile thermoplastic markings will meet the minimum performance level of 150 mcd/lux/m² dry and 75 mcd/ lux/m² wet for a period of 48 months from the date of final inspection when exposed to normal roadway conditions regardless of the average daily traffic. Failure to meet this requirement will result in the total replacement of the portion of the stripe shown to be below these minimums. All costs of labor, material and other incidentals necessary for the replacement of unacceptable pavement markings shall be at no additional costs to the State.

Compliance will be determined by an average brightness reading over a minimum zone marking length of 100 meters, using an approved reflectometer. The zone of measurement referred to includes centerline stripe, edge lines and skip lines.

Performance Requirements:	White		Yellow	
	<u>Dry</u>	<u>Wet</u>	<u>Dry</u>	<u>Wet</u>
Initial Reflectivity, mcd/ lux/m ²	450	200	350	175
48-Month Retained Reflectivity	150	75	150	75

The measurement procedure for this warranty will entail a visual night inspection by a manufacturer representative and a MDOT representative to identify areas of the installation, which appear to be below the specified minimum, warranted reflectance value. All reflectance measurements for dry conditions shall be made on a clean dry surface at a minimum temperature of 4°C. All reflectance measurements for wet conditions shall be made using the setting conditions of Subsection 907-626.02.2.8 at a minimum temperature of 4°C.

Measurement intervals for installations with areas less than, or equal to, five (5) kilometers shall be at a minimum of three (3) check points for each zone. These check points should include the start point, approximate mid-point and the end point.

Measurement intervals for installations with areas greater than five (5) kilometers shall be at a minimum of three (3) check points, one at the start point, one at the end point and additional measurements spaced at 5-kilometer intervals between the start and end points of the area in question.

The number of measurements at each check point for each zone will be as follows:

- (A) Skip Lines: Eighteen (18) measurements, distributed over six (6) skip lines, shall be made at each check point.
- (B) Center Lines and/or Edge Lines: Eighteen (18) measurements shall be made over 100 meters of continuous stripe.

When taking reflectivity measurements, the value of the measurement shall be determined by averaging three measurements; one at the left edge of the stripe, one at the center of the stripe and one at the right edge of the stripe.

In addition, the reflectance values measured at each check point shall be averaged by zone to determine conformance to the minimum warranted reflective values.

907-626.04--Method of Measurement. Inverted profile thermoplastic traffic stripe of the type specified will be measured by the meter by the kilometer, as indicated, from end-to-end of individual stripes. In the case of skip lines the measurement will include skips. The length used to measure centerline and edge stripes will be the horizontal length computed along the stationed control line. Inverted profile thermoplastic detail traffic stripe will be measured by the meter from end-to-end of individual stripes. Measurements will be made along the surface of each

stripe and will exclude skip intervals where skips are specified. Stripes more than 150 millimeters in width will be converted to equivalent lengths of 150-mm widths.

907-626.05--Basis of Payment. Inverted profile thermoplastic traffic stripe, measured as prescribed above, will be paid for at the contract unit price per meter or kilometer, as applicable, which shall be full compensation for completing the work.

Payment will be made under:

907-626-I:	150-mm Inverted Profile Thermoplastic Traffic Stripe, Skip White	- per kilometer or meter
907-626-J:	150-mm Inverted Profile Thermoplastic Traffic Stripe, Continuous White	- per kilometer or meter
907-626-K:	150-mm Inverted Profile Thermoplastic Traffic Stripe, Skip Yellow	- per kilometer or meter
907-626-L:	150-mm Inverted Profile Thermoplastic Traffic Stripe, Continuous Yellow	- per kilometer or meter
907-626-M:	Inverted Profile Thermoplastic Detail Traffic Stripe, <u>Color</u>	- per meter
907-626-II:	150-mm Inverted Profile Thermoplastic Traffic Stripe, High Contrast, Skip White	- per kilometer or meter
907-626-JJ:	150-mm Inverted Profile Thermoplastic Traffic Stripe, High Contrast, Continuous White	- per kilometer or meter
907-626-KK:	150-mm Inverted Profile Thermoplastic Traffic Stripe, High Contrast, Skip Yellow	- per kilometer or meter
907-626-LL:	150-mm Inverted Profile Thermoplastic Traffic Stripe, High Contrast, Continuous Yellow	- per kilometer or meter
907-626-MM:	Inverted Profile Thermoplastic Detail Traffic Stripe, High Contrast, <u>Color</u>	- per meter

MISSISSIPPI DEPARTMENT OF TRANSPORTATION

SPECIAL PROVISION NO. 907-627-1M

CODE: (IS)

DATE: 4/25/2000

SUBJECT: Raised Pavement Markers

Section 627, Raised Pavement Markers, of the 1996 Metric Edition of the Mississippi Standard Specifications for Road and Bridge Construction is hereby amended as follows:

907-627.02--Materials. Delete the second paragraph of Subsection 627.02 on page 627-1 and substitute:

Type B through G High Performance reflective markers shall be listed on the Department's "Approved Sources of Materials" for high performance raised pavement markers.

907-627.05--Basis of Payment. Add the "907" prefix to pay items 627-J, 627-K, 627-L, 627-M, 627-N, and 627-O at the end of Subsection 627.05 on page 627-3.

MISSISSIPPI DEPARTMENT OF TRANSPORTATION

| SPECIAL PROVISION NO. 907-628-9M

CODE: (IS)

| DATE: 04/27/2004

SUBJECT: Cold Plastic Pavement Markings

Section 628, Cold Plastic Pavement Markings, of the 1996 Metric Edition of the Mississippi Standard Specifications for Road and Bridge Construction, is hereby amended as follows:

Delete in toto Subsection 628.01 on page 628-1 and substitute the following:

907-628.01--Description. This work consists of furnishing materials and installing cold plastic pavement markings of the type specified in reasonably close conformity with the plans and these specifications.

907-628.02--Materials. After the first sentence of Subsection 628.02 on page 628-1, add the following:

High performance cold plastic marking material shall meet the requirements of 907-720.07.

907-628.03--Construction Requirements.

907-628.03.1--Equipment. After the first sentence of Subsection 628.03.1 on page 628-1, insert the following:

When high performance cold plastic pavement markings for lane lines are used, the manufacturer shall provide application equipment, manual or automatic as necessary for the job requirements. These applicators shall be capable of applying markings to the required alignment and dimensions shown on the plans or in the contract documents.

907-628.05--Basis of Payment. After the last pay item listed in Subsection 628.05 on page 628-2, substitute the following:

| 907-628-AA: 150-mm Cold Plastic Traffic Stripe (Skip White) - per meter or kilometer

| 907-628-BB: 150-mm Cold Plastic Traffic Stripe (Continuous White) - per meter or kilometer

| 907-628-CC: 150-mm Cold Plastic Edge Stripe (Continuous White) - per meter or kilometer

| 907-628-DD: 150-mm Cold Plastic Traffic Stripe (Skip Yellow) - per meter or kilometer

907-628-EE: 150-mm Cold Plastic Traffic Stripe (Continuous Yellow) - per meter or kilometer

- 907-628-FF: 150-mm Cold Plastic Edge Stripe (Continuous Yellow) - per meter or kilometer
- 907-628-GG: Cold Plastic Detail Stripe
(150-mm Equivalent Length) (Color) - per meter
- 907-628-HH: Cold Plastic Legend (White) - per meter or square meter
- 907-628-II: 150-mm High Performance Cold Plastic Traffic Stripe
(Skip White) - per meter or kilometer
- 907-628-JJ: 150-mm High Performance Cold Plastic Traffic Stripe
(Continuous White) - per kilometer or meter
- 907-628-KK: 150-mm High Performance Cold Plastic Edge Stripe
(Continuous White) - per meter or kilometer
- 907-628-LL: 150-mm High Performance Cold Plastic Traffic Stripe
(Skip Yellow) - per meter or kilometer
- 907-628-MM: 150-mm High Performance Cold Plastic Traffic Stripe
(Continuous Yellow) - per meter or kilometer
- 907-628-NN: 150-mm High Performance Cold Plastic Edge Stripe
(Continuous Yellow) - per meter or kilometer
- 907-628-OO: High Performance Cold Plastic Detail Stripe
(150-mm Equivalent Length) (Color) - per meter
- 907-628-PP: High Performance Cold Plastic Legend (White) - per meter or square meter

MISSISSIPPI DEPARTMENT OF TRANSPORTATION

SUPPLEMENT TO SPECIAL PROVISION NO. 907-699-2M

DATE: 06/07/2011

Delete the first sentence of Subsection 907-699.03 on page 1 and substitute the following:

The Department will establish, one time only, secondary control points with elevations at distances not to exceed 450 meters or that minimum distance necessary to maintain inter-visibility.

MISSISSIPPI DEPARTMENT OF TRANSPORTATION

| SPECIAL PROVISION NO. 907-699-2M

CODE: (IS)

| DATE: 7/03/2003

SUBJECT: Construction Layout and Staking

Section 699, Construction Stakes, of the 1996 Metric Edition of the Mississippi Standard Specifications for Road and Bridge Construction is hereby amended as follows:

Delete in toto Section 699 on page nos. 699-1 thru 699-3 and substitute the following:

SECTION 907-699--CONSTRUCTION STAKES

907-699.01--Description. This work consists of performing all calculations and other work necessary to establish and/or verify all horizontal and vertical control data; and furnishing, placing and maintaining roadway construction stakes or bridge construction stakes, or both, necessary for the proper prosecution of all features and items of the work under contract. This shall include, but not be limited to, grades and drainage structure locations, lengths, elevations and skews. When the contract includes a pay item for roadway construction stakes as provided herein, any references in other sections of the Standard Specifications to establishment of control points or construction staking "by the Department" shall be construed to mean "by the Contractor".

907-699.02--Materials. The Contractor shall furnish all personnel, materials, equipment and devices necessary for determining, establishing, setting, checking and maintaining points, lines, grades and layout of the work. All surveying equipment shall be properly adjusted and suited for performing the work required. Traffic control necessary for the proper execution of the work shall be furnished by the Contractor without separate measurement for payment. Stakes shall be of sufficient length, thickness and quality to serve the purpose for which they are being used.

907-699.03--Construction Requirements. The Department will establish, one time only, reference points and bench marks at distances not to exceed 300 meters for roadway work. For bridge work, the Engineer's field control will consist of a stationed baseline reference point near each end of the bridge(s) and one accessible bench mark near each bridge site. For the purpose of determining responsibility for construction stakes, lines and grades, a box bridge will not be considered as a bridge. The Contractor shall verify the accuracy of the control points before proceeding with the layout for construction.

When errors are discovered and control points do not agree with the plans, the Contractor shall promptly notify the Engineer in writing, and explain the problem in detail. The Engineer will advise the Contractor within five (5) working days of any corrective actions which may be deemed necessary.

The Contractor will be responsible for verifying and modifying, as necessary to best fit existing field conditions, lengths, locations, elevations and skew angles of all drainage structures shown on the construction plans. All junction box and inlet locations and heights shall also be verified and modified as necessary to fit existing field conditions. Modifications to the plans shall not be made without the consent of the Project Engineer. The Contractor will not be responsible for determining the size of drainage structures, but should immediately report any suspected error to the Engineer. Heights of fill over drainage structures shall be checked to verify class of pipe, bedding and the appropriate standard and/or modified standard drawing(s) required in the construction with any differences from the plans being reported to the Engineer.

The Contractor shall perform work necessary to verify alignment and plan grades on all roadway intersections and tie-ins. Any discrepancies in grades, alignment, location and or dimension detected by the Contractor shall immediately be brought to the attention of the Project Engineer.

The Contractor shall employ sufficient qualified personnel experienced in highway surveying and layout to complete the work accurately. The Contractor shall also determine and provide all additional grade controls and staking operations necessary to secure a correct layout and construction of the work. All minor variations in layout and grades required to meet field conditions shall be resolved with the Engineer and shall not be considered justification for adjusting contract price or time.

Examples of minor variations in layout and grades are:

- (a) Adjustment of drainage or other structure length, alignment, and flow line elevation.
- (b) The adjustment of grades and alignment at roadway intersections, cross-overs, railroad crossings, interchanges, existing bridges and roadways.
- (c) Adjustment of curve data.

The Contractor will be responsible for **calculating and laying out** all **additional** lines, grades, elevations and dimensions **necessary to construct the work required in the plans**. All grades and other layout data computed by the Contractor shall be recorded and a copy of this data shall be furnished, with sufficient time for checking, to the Engineer before field work is started. The originals of all data shall be furnished to the Engineer on or before final inspection for the Department's permanent file. The Contractor shall also furnish personnel to assist the Engineer in taking stringline or other notes to determine whether specified tolerances are met. Any inspection or checking of the Contractor's layout by the Engineer and the approval of all or any part of it will not relieve the Contractor of the responsibility to secure proper dimensions, grades, and elevations of the several parts of the work.

Prior to beginning construction on any structure which is referenced to an existing structure or topographical feature, the Contractor shall check the pertinent location and grades of the existing structures or topographical features to determine whether the location and grade shown on the plans are correct.

The Contractor shall stake centerline control at each station, BOP, EOP, PC, PT, SC, CS, TS, ST, and equations just before field cross sectioning by the Department for both original and final cross sections.

The Contractor shall furnish "as built" finish centerline elevations to the Project Engineer prior to final inspection of the project.

The Contractor shall set stakes and/or flags on the right-of-way line at each station and right-of-way break or as directed by the Engineer before clearing operations are started on any section of roadway.

On grading projects, the Contractor shall set slope stakes at each station and at the beginning and end of spirals and curves. Closer intervals will be required for sharp changes in grades or alignment, widening and certain other geometric details.

The Contractor shall set subgrade blue tops on centerline, break points and at the left and right subgrade shoulder lines at intervals of not more than 30 meters on tangents and intervals of not more than 15 meters in curves. Closer intervals will be required for sharp changes in grades or alignment, widening, or super elevation.

On paving contracts, the Contractor shall set subgrade, base and paving blue tops. The base and pavement blue tops shall be set on intervals in accordance with the appropriate applicable requirements of Sections 321, 403 and 501.

The Contractor shall exercise care in the preservation of stakes and bench marks and shall reset them when they are damaged, lost, displaced or removed. The Contractor shall use competent personnel and suitable equipment for the layout work required and shall provide that it be performed under the supervision of, or directed by, a Registered Professional Engineer or Registered Land Surveyor who is duly registered and entitled to practice as a Professional Engineer or Professional Land Surveyor in the State of Mississippi. The duties performed by said Registrant shall conform to the definitions under the "practice of engineering" and practice of "land surveying" in Mississippi Law. The Contractor shall not engage the services of any person in the employ of the Department for the performance of any of the work covered by this Section or any person who has been employed by the Department within the past six months except those who have legitimately retired from service with the Department during this period.

All cross sections, measurements, and tickets required for determining pay quantities will be the responsibility of the Department.

The Department reserves the right to check for accuracy any or all of the Contractor's layout work and shall be assisted by the Contractor's personnel in such checking. When errors or discrepancies are found, the Contractor will take measures necessary to correct, at no expense to the State, any construction that has been performed using the improper layout. Any inspection, checking and approval thereof by the Engineer of work for which the Contractor is responsible will not relieve the Contractor of responsibility to secure correct dimensions, grades, elevations, alignments and locations of the work for satisfactory completion of the project and as a condition for final acceptance by the Department.

907-699.04--Method of Measurement. Construction stakes will be measured as a lump sum quantity. When Pay Item No. 907-699-A, Roadway Construction Stakes, is provided in the contract, measurement shall include the staking of all bridges, including detour bridges, which are a part of the contract.

907-699.04.1--Roadway Construction Stakes. Measurement for payment will be in accordance with the following schedule:

- (a) When one percent of the original contract amount is earned from all direct pay items, 10 percent of the amount bid for Roadway Construction Stakes will be paid.
- (b) When five percent of the original contract amount is earned from all direct pay items, 25 percent of the amount bid for Roadway Construction Stakes will be paid.
- (c) When 20 percent of the original contract amount is earned from all direct pay items, 50 percent of the amount bid for Roadway Construction Stakes will be paid.
- (d) After the Contractor has earned 50 percent of the original value of all direct pay items, the amount paid will be based on the contract percent complete.

907-699.04.2--Bridge Construction Stakes. Measurement for payment will be in accordance with the following schedule:

- (a) When one percent of the original contract value of all bridge items is earned, 10 percent of the amount bid for Bridge Construction Stakes will be paid.
- (b) When five percent of the original contract value of all bridge items is earned, 25 percent of the amount bid for Bridge Construction Stakes will be paid.
- (c) When 20 percent of the original contract value of all bridge items is earned, 50 percent of the amount bid for Bridge Construction Stakes will be paid.
- (d) After the Contractor has earned 50 percent of original contract value of all bridge items, the amount paid will be based on the percentage of work completed on all bridge items.

907-699.05--Basis of Payment. Construction stakes, measured as prescribed in Subsection 907-699.04, will be paid for at the contract lump sum price, which shall be full compensation for completing the work.

Payment will be made under:

- 907-699-A: Roadway Construction Stakes - lump sum
- 907-699-B: Bridge Construction Stakes - lump sum

MISSISSIPPI DEPARTMENT OF TRANSPORTATION

| SPECIAL PROVISION NO. 907-701-4M

CODE: (IS)

| DATE: 11/09/2010

SUBJECT: Hydraulic Cement

Section 701, Hydraulic Cement, of the 1996 Metric Edition of the Mississippi Standard Specifications for Road and Bridge Construction is hereby amended as follows:

Delete Subsection 701.01 on page 701-1, and substitute the following:

907-701.01--General. The following requirements shall be applicable to hydraulic cement:

Only hydraulic cements conforming to Section 701 shall be used. Hydraulic cements shall not be listed or designated as meeting more than one AASHTO or Department type.

Different brands of hydraulic cement, or the same brand of hydraulic cement from different mills, shall not be mixed or used alternately in any one class of construction or structure, without written permission from the Engineer; except that this requirement will not be applicable to hydraulic cement treatment of design soils, or bases.

The Contractor shall provide suitable means for storing and protecting the hydraulic cement against dampness. Hydraulic cement, which for any reason, has become partially set or which contains lumps of caked hydraulic cement will be rejected. Hydraulic cement salvaged from discarded or used bags shall not be used.

The temperature of bulk hydraulic cement shall not be greater than 74°C at the time of incorporation in the mix.

Acceptance of hydraulic cement will be based on the certification program as described in the Department's Materials Division Inspection, Testing, and Certification Manual and job control sampling and testing as established by Department SOP.

Retests of hydraulic cement may be made for soundness and expansion within 28 days of test failure and, if the hydraulic cement passes, it may be accepted. Hydraulic cement shall not be rejected due to failure to meet the fineness requirements if upon retests after drying at 100°C for one hour, it meets such requirements.

Delete Subsection 701.02 on pages 701-1 & 701-2, and substitute the following:

907-701.02--Portland Cement.

907-701.02.1--General.

907-701.02.1.1--Types of Portland Cement. Portland cement (cement) shall be either Type I or Type II conforming to AASHTO Designation: M85 or Type I(MS), as defined by the description below Table 1. Type III cement conforming to AASHTO Designation: M85 or Type III(MS), as defined by the description below Table 1, may be used for the production of precast or precast-prestressed concrete members.

907-701.02.1.2--Alkali Content. All cement types in this Subsection shall meet the Equivalent alkali content requirement for low-alkali cements listed in AASHTO Designation: M85, Table 2.

907-701.02.2--Replacement by Other Cementitious Materials. The maximum replacement of cement by weight is 25% for fly ash or 50% for ground granulated blast furnace slag (GGBFS). The minimum tolerance for replacement shall be 5% below the maximum replacement content. Replacement contents below this minimum tolerance by fly ash or GGBFS may be used, but shall not be given any special considerations, like the maximum acceptance temperature for Portland cement concrete containing pozzolans. Special considerations shall only apply for replacement of cement by fly ash or GGBFS.

907-701.02.2.1--Portland Cement Concrete Exposed to Soluble Sulfate Conditions or Seawater. When Portland cement concrete is exposed to moderate or severe soluble sulfate conditions, or to seawater, cement types and replacement of cement by Class F fly ash, GGBFS, or silica fume shall be as follows in Table 1.

Table 1- Cementitious Materials for Soluble Sulfate Conditions

Sulfate Exposure	Water-soluble sulfate (SO4) in soil, % by mass	Sulfate (SO4)in water, ppm	Cementitious material required*
Moderate and Seawater	0.10 - 0.20	150 - 1,500	Type II **, ***, **** cement, or Type I cement with one of the following replacements of cement by mass: 25% Class F fly ash, 50% GGBFS, or 8% silica fume
Severe	0.20 - 2.00	1,500 - 10,000	Type I cement with a replacement by weight of 50% GGBFS, or Type II ** cement with one of the following replacements of cement by weight: 25% Class F fly ash, 50% GGBFS, or 8% silica fume

- * The values listed in this table for replacement of Portland cement by the cementitious materials listed are maximums and shall not be exceeded. The minimum tolerance for replacement shall be 0.5% below the maximum replacement content. Replacement contents below this minimum tolerance by the cementitious materials listed in this table do not meet the requirements for the exposure conditions listed and shall not be allowed.
- ** Type I cement conforming to AASHTO Designation: M85 with a maximum 8% tricalcium aluminate (C3A) may be used in lieu of Type II cement; this cement is given the designation "Type I(MS)". Type III cement conforming to AASHTO Designation: M85 with a maximum 8% tricalcium aluminate (C3A) may be used in lieu of Type II cement as allowed in Subsection 907-701.02.1; this cement is given the designation "Type III(MS)".
- *** Blended cement meeting the sulfate resistance requirements of Subsection 907-701.04 may be used in lieu of Type II as allowed in Subsection 907-701.04. No additional cementitious materials shall be added to or as a replacement for blended cement.
- **** Class F fly ash or GGBFS may be added as a replacement for cement as allowed in Subsection 907-701.02.2.

Class C fly ash shall not be used as a replacement for cement in any of the sulfate exposure conditions listed above.

907-701.02.2.2--Cement for Soil Stabilization Exposed to Soluble Sulfate Conditions or Seawater. When Portland cement for use in soil stabilization is exposed to moderate or severe soluble sulfate conditions, or to seawater, cement types and replacement of cement by Class F fly ash or GGBFS shall meet the requirements of Subsection 907-701.02.2.1. Neither metakaolin nor silica fume shall be used to bring the cementitious materials into compliance with the requirements of Table 1.

Delete Subsection 701.03 on page 701-2, and substitute the following:

907-701.03--Masonry Cement. Masonry cement shall conform to ASTM Designation: C 91 and shall only be used in masonry applications.

Delete Subsection 701.04 on page 701-2, and substitute the following:

907-701.04--Blended Hydraulic Cement.

907-701.04.1--General.

907-701.04.1.1--Types of Blended Cement. Blended hydraulic cements (blended cements) shall be of the following types and conform to AASHTO Designation: M 240:

- Type I(SM) – Slag-modified Portland cement
- Type IS – Portland blast-furnace slag cement
- Type I(PM) – Pozzolan-modified Portland cement
- Type IP – Portland-pozzolan cement

Blended cement for use in Portland cement concrete or soil stabilization exposed to the moderate soluble sulfate condition or exposure to seawater as defined in Table 1 shall meet the Sulfate resistance requirement listed in AASHTO Designation: M 240, Table 2 and the "(MS)" suffix shall be added to the type designation.

907-701.04.1.2--Alkali Content. All blended cement types in this Subsection shall meet the Mortar expansion requirements listed in AASHTO Designation: M 240, Table 2.

907-701.04.2--Replacement by Other Cementitious Materials. No additional cementitious materials, such as Portland cement, performance hydraulic cement, fly ash, GGBFS, metakaolin, or others, shall be added to or as a replacement for blended cement.

907-701.04.3--Exposure to Soluble Sulfate Conditions or Seawater. When Portland cement concrete or blended cement for soil stabilization is exposed to moderate soluble sulfate conditions or to seawater, where the moderate soluble sulfate condition is defined in Table 1, the blended cement shall meet the sulfate resistance requirement listed in AASHTO Designation: M 240, Table 2.

When Portland cement concrete or blended cement for soil stabilization is exposed to severe soluble sulfate conditions, where the severe soluble sulfate condition is defined in Table 1, blended cements shall not be used.

MISSISSIPPI DEPARTMENT OF TRANSPORTATION

SUPPLEMENT TO SPECIAL PROVISION NO. 907-703-8M

DATE: 03/01/2011

SUBJECT: Aggregates

Delete the first paragraph of Subsection 907-703.04.1 on page 1, and substitute the following:

Coarse aggregate, defined as material retained on the 2.36-mm sieve, shall be either crushed stone, slag, granite, shell, concrete, or combination thereof.

Delete the first sentence of the first paragraph of Subsection 907-703.04.2 on page 1, and substitute the following:

Fine aggregate, defined as material passing the 2.36-mm sieve, shall consist of hard, durable particles of naturally disintegrated rock, or material obtained by crushing stone, slag, concrete, or combination thereof.

After the last paragraph on page 4, add the following:

907-703.20.3--Gradation. Delete the table and notes in Subsection 703.20.3 on page 703.23, and substitute the following

PERCENT PASSING BY MASS

Square Mesh Sieves	Shell	Coarse			Medium	Fine
		Size I	Size II Note (1)	Size III Note (3)		
75-mm	90-100			100		
63-mm				90-100		
50-mm		100				
37.5-mm		90-100	100	25-60		
25.0-mm		80-100	97-100			
19.0-mm		55-100	55-100	0-10		
12.5-mm		35-85	35-85	0-5	100	
9.5-mm		12-65	12-65		97-100	
4.75-mm, Note (2)		0-30	0-30		92-100	
2.00-mm		0-8	0-8		80-100	100
425- μ m				10-40	80-100	
250- μ m				0-20	30-100	
150- μ m					15-80	
75- μ m	0-5	0-4	0-4	0-5	0-30	
PI Material Passing 4.75-mm				6 or less	0	

Note (1): Size II is intended for use in bases in which portland cement is used.

Note (2): Ground shell shall contain at least 97% passing the 4.75-mm sieve.

Note (3): Size III is intended for use in stabilized construction entrances.

MISSISSIPPI DEPARTMENT OF TRANSPORTATION

SUPPLEMENT TO SPECIAL PROVISION NO. 907-703-8M

DATE: 06/10/2010

SUBJECT: Aggregates

Delete the first paragraph of Subsection 907-703.04.1 on page 1, and substitute the following:

Coarse aggregate, defined as material retained on the 2.36-mm sieve, shall be either crushed stone, slag, granite, shell, concrete, or combination thereof.

Delete the first sentence of the first paragraph of Subsection 907-703.04.2 on page 1, and substitute the following:

Fine aggregate, defined as material passing the 2.36-mm sieve, shall consist of hard, durable particles of naturally disintegrated rock, or material obtained by crushing stone, slag, concrete, or combination thereof.

MISSISSIPPI DEPARTMENT OF TRANSPORTATION

SPECIAL PROVISION NO. 907-703-8M

CODE: (IS)

DATE: 06/01/2009

SUBJECT: Aggregates

Section 703, Aggregates, of the 1996 Metric Edition of the Mississippi Standard Specifications for Road and Bridge Construction is amended as follows:

907-703.04--Aggregate for Crushed Stone Courses. Delete in toto Subsection 703.04 on page 703-5 & 6, and substitute the following.

907-703.04--Aggregate for Crushed Stone Courses.

907-703.04.1--Coarse Aggregate. Coarse aggregate, defined as material retained on the 2.36-mm sieve, shall be either crushed stone, slag, granite, shell, gravel, concrete, or combination thereof. When the required properties of the mix are not obtained with uncrushed gravel, the addition of crushed gravel or other approved material is required.

Individual sources of coarse aggregate shall conform to the following quality requirements:

Percentage of wear shall not exceed 45 when tested in accordance with AASHTO Designation: T 96.

The coarse aggregate shall have a minimum dry rodded unit mass of 1120 kilograms per cubic meter when tested in accordance with AASHTO Designation: T 19.

907-703.04.2--Fine Aggregate. Fine aggregate, defined as material passing the 2.36-mm sieve, shall consist of hard, durable particles of naturally disintegrated rock, or material obtained by crushing stone, slag, concrete, gravel or combination thereof. Fine aggregate, when manufactured, shall be manufactured from material meeting the quality requirements for coarse aggregate, and it shall be free of lumps of clay and friable particles, loam, organic or foreign matter.

Individual sources of fine aggregate shall be non-plastic when tested in accordance with AASHTO Designation: T 90.

Natural deposits of fine aggregate shall contain no more than 10 percent by mass passing the 75µm sieve when tested in accordance with AASHTO Designation: T 11.

Fly ash, when used as a portion of the fine aggregate to obtain desired properties of the mixture, shall be from an approved source.

When the fine aggregate is combined with other aggregate fractions in the proper proportion, the resultant mixture shall meet the requirements of the job-mix formula.

907-703.04.3--Gradation. Aggregates for crushed stone shall be well-graded from coarse to fine, and shall conform to the following:

TABLE OF SIZES AND GRADATION OF CRUSHED STONE AGGREGATE

Sieve Size	Percent Passing By Mass						Crushed Stone
	Size 100-mm to 50-mm	Size 50-mm to 20-mm	Size 20-mm and Down	Size No. 610	Size No. 825 B	Size No. 825	
100 mm	100						
90 mm	90 - 100						
63 mm	25 - 60	100					
50 mm	0 - 5	95 - 100				100	100
37.5 mm		35 - 70	100	100	90 - 100	90 - 100	90 - 100
25.0 mm				70 - 100		75 - 98	90 - 100
19.0 mm				62 - 90		60 - 85	62 - 90
12.5 mm				50 - 80		40 - 70	30 - 65
9.5 mm		0 - 5	50 - 85	40 - 65		28 - 54	30 - 65
4.75 mm			35 - 65			19 - 42	15 - 40
2.36 mm			25 - 50				
2.00 mm			15 - 30	12 - 26			
1.18 mm			5 - 15	5 - 12			
425 µm						9 - 32	9 - 27
300 µm						4 - 18	4 - 18
75 µm							3 - 16

907-703.04.4--Crushed Concrete. Crushed reclaimed concrete shall also be allowed as a crushed aggregate course provided it meets the requirements of Subsection 907-703.04 and the following.

Crushed Concrete

Sieve Size	Percent Passing By Mass
50 mm	
37.5 mm	100
25.0 mm	90 - 100
19.0 mm	
12.5 mm	60 - 85
9.5 mm	
4.75 mm	40 - 65
2.36 mm	28 - 54
2.00 mm	
1.18 mm	19 - 42
425 µm	
300 µm	9 - 27
75 µm	2 - 18

MISSISSIPPI DEPARTMENT OF TRANSPORTATION

SPECIAL PROVISION NO. 907-703-9M

CODE: (IS)

DATE: 11/09/2010

SUBJECT: Aggregates for Hot Mix Asphalt (HMA)

Section 703, Aggregates, of the 1996 Metric Edition of the Mississippi Standard Specifications for Road and Bridge Construction is hereby amended as follows:

Delete Subsections 703.04, 703.05, 703.09, 703.10, 703.11, and 703.12 in toto, and substitute -

907-703.06--Aggregates for Hot Mix Asphalt.

907-703.06.1--General.

907-703.06.1.1--Coarse Aggregates. Coarse aggregate, material retained on the 2.36 mm sieve, shall be either crushed stone, slag, or granite; shell; expanded clay; expanded shale; crushed gravel or combination thereof. Crushed reclaimed concrete pavement shall also be allowed as a coarse aggregate provided it meets the quality requirements below and the final product produced therefrom meets all other specification requirements.

The percentage of wear shall not exceed 45 when tested in accordance with AASHTO Designation: T 96.

When tested in accordance with AASHTO Designation: T 19, the dry rodded unit mass of all aggregates except expanded clay and shale shall not be less than 1120 kilograms per cubic meter, and crushed slag used in the surface course shall have a dry rodded unit mass of not more than 1440 kilograms per cubic meter except the maximum unit mass is waived for chromium slag.

The coarse aggregate shall be free of any injurious coating which will prohibit the adherence of asphalt to the aggregate particles.

The percentage of loss shall not exceed 20 when tested for soundness using magnesium sulfate in accordance with AASHTO T 104.

Shell shall consist of durable, washed particles of dead clam or dead reef oyster shell, or combination thereof. The shell shall be free of objectionable matter such as sticks, mud, clay lumps, cannery or live shell, or other deleterious matter. Not more than five percent by mass of the dredged material shall pass the 75 μ m sieve; any such material shall be dispersed throughout the mass.

907-703.06.1.2--Fine Aggregates. Fine aggregate, material passing the 2.36 mm sieve, shall consist of hard, durable particles of naturally disintegrated rock, or material obtained by crushing stone, slag, gravel, reclaimed concrete pavement, or combinations thereof. Fine aggregate produce from crushing reclaimed concrete pavement shall be manufactured from material meeting the quality requirements for coarse aggregate.

Fine aggregate shall be free of lumps of clay and friable particles, loam, organic or foreign matter.

Fine aggregate produced by crushing stone, slag or gravel shall be manufactured from aggregate meeting the quality requirements of coarse aggregate.

Individual sources of fine aggregate shall be non-plastic when tested in accordance with AASHTO Designation: T 90.

Natural deposits of fine aggregate shall contain no more than 10 percent by mass passing the 75 μm sieve when tested in accordance with AASHTO Designation: T 11.

Individual fine aggregate components shall be of such consistency and dryness that a uniform and even flow from the cold feed will be provided.

MISSISSIPPI DEPARTMENT OF TRANSPORTATION

SPECIAL PROVISION NO. 907-708-6M

CODE: (IS)

DATE: 07/25/2008

SUBJECT: Non-Metal Drainage Structures

Section 708, Non-Metal Structures and Cattlepasses, of the 1996 Metric Edition of the Mississippi Standard Specifications for Road and Bridge Construction is hereby amended as follows:

907-708.02.1.2--Fly Ash. In the first sentence of Subsection 708.02.1.2 on page 708-1, change “20 percent” to “25%”.

907-708.02.3.2--Marking. Delete the second sentence of Subsection 708.02.3.2 on page 708-2, and substitute the following:

Machine made pipe shall be marked in accordance with one of the following methods: 1) the pipe shall be inscribed on the outside of the pipe and stenciled on the inside of the pipe, or 2) the pipe shall be inscribed on the inside of the pipe, only. All other pipe may be stenciled.

Delete in toto Subsection 708.17 on page no. 708-7 and substitute the following:

907-708.17--Corrugated Plastic Pipe Culverts.

907-708.17.1--Corrugated Polyethylene Pipe Culverts. Corrugated polyethylene pipe shall conform to the requirements of AASHTO Designation: M 294, Type S and/or SP, as applicable, and shall have soil tight joints, unless otherwise specified.

The Contractor shall furnish to the Engineer three copies of the manufacturer's certified test reports and certification covering each shipment of pipe stating the amount furnished and that the pipe, fittings, couplings, etc. comply with the requirements of the specifications.

907-708.17.1.1--Inspection and Final Acceptance of Corrugated Polyethylene Pipe Culverts. Approximately 50% of the installed length of corrugated polyethylene pipe shall be inspected for excess deflection no sooner than 30 days after the embankment material over the pipe is placed to the required subgrade elevation or the maximum required fill height. The inspection shall be performed using either electronic deflectometers, calibrated television or video cameras, or a “go, no-go” mandrel that has an effective diameter of 95% of the nominal inside diameter of the pipe.

Pipe found to have deflection values greater than 5% shall be removed and replaced at no cost to the State.

907-708.17.2--Corrugated Poly (Vinyl Chloride) (PVC) Pipe Culverts. Corrugated poly

(vinyl chloride) (PVC) pipe shall conform to the requirements of AASHTO Designation: M 304 and shall have soil tight joints, unless otherwise specified. Non-perforated PVC pipe used in underdrains shall either be manufactured with an ultra-violet light inhibitor or be fully coated with an ultra-violet light inhibitor.

The Contractor shall furnish to the Engineer three copies of the manufacturer's certified test reports and certification covering each shipment of pipe stating the amount furnished and that the pipe, fittings, etc. comply with the requirements of the specifications.

907-708.17.2.1--Inspection and Final Acceptance of Poly (Vinyl Chloride) (PVC) Pipe Culverts. Approximately 50% of the installed length of PVC pipe shall be inspected for excess deflection no sooner than 30 days after the embankment material over the pipe is placed to the required subgrade elevation or the maximum required fill height. The inspection shall be performed using either electronic deflectometers, calibrated television or video cameras, or a “go, no-go” mandrel that has an effective diameter of 95% of the nominal inside diameter of the pipe.

Pipe found to have deflection values greater than 5% shall be removed and replaced at no cost to the State.

907-708.18--Sewer Pipe Used for Underdrains.

907-708.18.1--General. After the second paragraph of Subsection 708.18.1 on page 708-7 add the following:

In lieu of the pipe listed in this subsection, pipe meeting the requirements of Subsection 708.19 may also be used for plastic underdrain pipe.

907-708.18.3--Type PSM Poly (Vinyl Chloride) (PVC) Sewer Pipe. After the first sentence of Subsection 708.18.3 on page 708-7, add the following.

Non-perforated PVC pipe shall either be manufactured with an ultra-violet light inhibitor or be fully coated with an ultra-violet light inhibitor.

907-708.18.4--Poly (Vinyl Chloride) (PVC) Corrugated Sewer Pipe. Delete the paragraph in Subsection 708.18.4 on page 708-7 and substitute the following.

This pipe shall conform to the following requirements. For pipe sizes less than or equal to 150 millimeters, the pipe shall be Class PS46 meeting the requirements of AASHTO Designation: M 278. For pipe sizes greater than 150 millimeters, the pipe shall meet the requirements of AASHTO Designation: M 304. Non-perforated PVC pipe shall either be manufactured with an ultra-violet light inhibitor or be fully coated with an ultra-violet light inhibitor.

Delete Subsection 708.19 on page 708-8 and substitute the following:

907-708.19--Corrugated Polyethylene Pipe. This pipe shall be high density polyethylene pipe or drainage tubing meet the requirements of AASHTO Designation: M 294, Type S or SP, or AASHTO Designation: M 252, Type S or Type SP, as applicable.

907-708.22.2--Exceptions to AASHTO. Delete the sixth paragraph of Subsection 708.22.2 on page 708-10.

MISSISSIPPI DEPARTMENT OF TRANSPORTATION

SPECIAL PROVISION NO. 907-709-1M

CODE: (SP)

DATE: 05/05/2008

SUBJECT: Metal Pipe

Section 709, Metal Pipe, of the 1996 Metric Edition of the Mississippi Standard Specifications for Road and Bridge Construction is hereby amended as follows:

After Subsection 709.02 on page 709-1, add the following:

907-709.02.1--Aluminized Corrugated Metal Culvert Pipe and Pipe Arches. All aluminized metal pipe and arches shall be manufactured from Type 2 corrugated metal pipe and arches in accordance with the requirements of Subsection 709.02.

907-709.03--Bituminous Coated Corrugated Metal pipe and Pipe Arches.

907-709.03.1--Materials. Delete the first sentence of the first paragraph of Subsection 709.03.1 on page 709-1, and substitute the following:

Bituminous coated corrugated metal pipe and arches shall conform to the requirements of AASHTO Designation: M 190 and be completely coated inside and out with an asphalt cement which will meet the performance requirements hereinafter set forth.

907-709.05--Polymer Coated Corrugated Metal Pipe and Pipe Arches. Delete the first sentence of the first paragraph of Subsection 709.05 on page 709-2, and substitute the following:

Polymer coated corrugated metal pipe and arches shall conform to the requirements of AASHTO Designation: M 245, except the minimum gauge thickness shall be as shown on the plans or in the contract; however, corrugated metal pipe manufactured from sheets thicker than that specified will be acceptable when approved by the Engineer. The internal diameter of corrugated metal pipe will be determined by inside measurement between the crests of the corrugations. Corrugations greater than 75 mm x 25 mm will not be allowed in arch pipe.

907-709.06--Corrugated Metal Pipe for Underdrains. Delete the sentence in Subsection 709.06 on page 709-2, and substitute the following:

Corrugated metal pipe shall conform to AASHTO Designation: M 36, Type III. Type I pipe which has been perforated to permit the in-flow or out-flow of water may be used in lieu of Type III pipe.

907-709.06.1--Aluminized Corrugated Metal Culvert Pipe For Underdrains. All aluminized corrugated metal pipe for underdrains shall be manufactured from Type 2 corrugated metal pipe and arches in accordance with the requirements of AASHTO Designation: M 36, Type III.

Manufacturer must repair any damaged coating caused from perforating the pipe.

907-709.07--Bituminous Coated Corrugated Metal Pipe for Underdrains. Delete the sentence in Subsection 709.07 on page 709-2, and substitute the following:

Bituminous coated corrugated metal pipe shall conform to the requirements of AASHTO Designation: M 190, Type A with a bituminous coating applied in accordance with the requirements of Subsection 709.03. Manufacturer must repair any damaged coating caused from perforating the pipe.

907-709.08--Polymer Coated Corrugated Metal Pipe for Underdrains. Delete the sentence in Subsection 709.08 on page 709-2, and substitute the following:

The metal pipe for underdrains shall conform to the requirements of AASHTO Designation: M 245, Type III and the polymer coating shall conform to the requirements of Subsection 709.05. Type I pipe which has been perforated to permit the in-flow or out-flow of water may be used in lieu of Type III pipe. Manufacturer must repair any damaged coating caused from perforating the pipe.

907-709.09--Corrugated Aluminum Alloy Culvert Pipe and Arches. Delete the first sentence in Subsection 709.09 on page 709-2, and substitute the following:

Corrugated aluminum culvert pipe and arches shall conform to the requirements of AASHTO Designation: M 196, Type IA.

907-709.10--Corrugated Aluminum Alloy Pipe for Underdrains. Delete the first sentence in Subsection 709.10 on page 709-2, and substitute the following:

Corrugated aluminum pipe underdrains shall conform to the requirements of AASHTO Designation: M 196, Type III. Type I pipe which has been perforated to permit the in-flow or out-flow of water may be used in lieu of Type III pipe.

907-709.11--Bituminous Coated Corrugated Aluminum Alloy Culvert Pipe and Arches. Delete the sentence in Subsection 709.11 on page 709-2, and substitute the following:

Bituminous coated aluminum culvert pipe and arches shall conform to AASHTO Designation: M 196, Type IA, and in addition shall be coated inside and out as specified in Subsection 709.03. Manufacturer must repair any damaged coating caused from perforating the pipe.

907-709.13--Bituminous Coated Corrugated Aluminum Alloy Pipe for Underdrains. Delete the sentence in Subsection 709.13 on page 709-2, and substitute the following:

This pipe shall conform to AASHTO Designation: M 196, Type III, and shall be coated with bituminous material conforming to AASHTO Designation: M 190, type coating as specified. Manufacturer must repair any damaged coating caused from perforating the pipe.

MISSISSIPPI DEPARTMENT OF TRANSPORTATION

SPECIAL PROVISION NO. 907-710-1M

CODE: (IS)

DATE: 5/7/96

SUBJECT: Fast Drying Acrylic Waterborne Traffic Paint

Section 710, Paint, of the 1996 Metric Edition of the Mississippi Standard Specifications for Road and Construction is hereby amended as follows:

907-710.02.2.1--Composition of Formulation. Delete the first paragraph of Subsection 710.02.2.1 on pages 710-2 and insert the following:

The composition of the paint shall be left to the discretion of the manufacturer as long as the finished product is composed of 100% acrylic emulsion, Rohm and Haas Emulsion E-2706 or Dow Chemical Emulsion DT 211NA, and meets the requirements of this specification and of any applicable Federal, State or Local regulations for products of this type.

907-710.02.2.1.3--Non-Volatile Vehicle. Delete the first sentence of Subsection 710.02.2.1.3 on pages 710-2 and substitute the following:

The non-volatile portion of the vehicle shall be composed of a 100% acrylic polymer (Rohm and Haas Emulsion E-2706 or Dow Chemical Emulsion DT 211NA) and shall not be less than 44% by mass.

MISSISSIPPI DEPARTMENT OF TRANSPORTATION

SPECIAL PROVISION NO. 907-710-2M

CODE: (SP)

DATE: 06/24/10

SUBJECT: Fast Dry Solvent Traffic Paint

Section 710, Paint, of the 2004 Edition of the Mississippi Standard Specifications for Road and Bridge Construction is amended as follows:

After Subsection 710.05 on Page 661, add the following:

907-710.06—Fast Dry Solvent Traffic Paint. Fast dry solvent traffic paints intended for use under this specification shall include products that are single packaged and ready mixed. Upon curing, these materials shall produce an adherent, reflective pavement marking capable of resisting deformation by traffic. The manufacturer shall have the option of formulating the material according to their own specifications. However, the requirements delineated in this specification, Section 619 and Section 710 shall apply regardless of the formulation used. The material shall be free from all skins, dirt and foreign objects.

907-710.06.1—Composition.

907-710.06.1.1—Percent Pigment. The percent pigment by weight shall be not less than 51% nor more than 58% when tested in accordance with ASTM D 3723.

907-710.06.1.2—Viscosity. The consistency of the paint shall be not less than 75 nor more than 95 Krebs Units (KU) when tested in accordance with ASTM D 562.

907-710.06.1.3—Weight per Gallon. The paint shall weigh a minimum 11.8 pounds per gallon and the weight of the production batches shall not vary more than +/- 0.5 pounds per gallon from the weight of the qualification samples when tested in accordance with ASTM D 1475.

907-710.06.1.4—Total Solids. The percent of total solids shall not be less than 70% by weight when tested in accordance with ASTM D 2369.

907-710.06.1.5—Dry Time (No pick-up). The paint shall dry to a no tracking condition in a maximum of 10 minutes.

907-710.06.1.6—Volatile Organic Content. The volatile organic content (VOC) shall contain a maximum of 1.25 pounds of volatile organic matter per gallon of total non-volatile paint material when tested in accordance with ASTM D 3960.

907-710.06.1.7—Bleeding. The paint shall have a minimum bleeding ratio of 0.95 when tested in accordance with Federal Specification TT-P-115D.

907-710.06.1.8—Color. The initial daytime chromaticity for yellow materials shall fall within the box created by the following coordinates:

Daytime Chromaticity Coordinates (Corner Points)

	1	2	3	4
x	0.53	0.51	0.455	0.472
y	0.456	0.485	0.444	0.4

The initial daytime chromaticity of white materials shall fall within the box created by the following coordinates:

Daytime Chromaticity Coordinates (Corner Points)

	1	2	3	4
x	0.355	0.305	0.285	0.355
y	0.355	0.305	0.325	0.375

907-710.06.2—Environmental Requirements. All yellow materials using lead chromate pigments shall meet the criteria of non-hazardous waste as defined by 40 CFR 261.24 when tested in accordance with EPA Test Method 1311, Toxicity Characteristics Leaching Procedures (TCLP). The striping and marking material, upon preparation and installation, shall not exude fumes which are toxic, or detrimental to persons or property. All material using lead free pigments shall NOT contain either lead or other Resource Conservation and Recovery Act (RCCA) materials in excess of the standard defined by EPA Method 3050 and 6010.

907-710.06.3—Acceptance Procedures. Acceptance of all fast dry solvent based traffic paint will be based on the Manufacturer’s Certification and Certified Test Results. The Contractor shall furnish the Engineer with three copies of the manufacturer’s certification stating that each lot of material in a shipment complies with the requirements of this contract. In addition, the Contractor shall provide Certified Test Reports for all tests required by this specification. The test results shall be representative of the material contained with the shipment.

MISSISSIPPI DEPARTMENT OF TRANSPORTATION

SPECIAL PROVISION NO. 907-711-1M

CODE: (IS)

DATE: 5/8/96

SUBJECT: Reinforcing Steel

Section 711, Reinforcement and Wire Rope, of the 1996 Metric Edition of the Mississippi Standard Specifications for Road and Bridge Construction is amended as follows:

907-711.02--Reinforcing Steel.

Delete the first paragraph of Subsection 711.02.1 on page 711-1 and substitute:

907-711.02.1--Bar Reinforcement. Bar reinforcement shall conform to the requirements of AASHTO Designation: M 31M, as herein amended, (Grade 420) for billet steel bars.

AASHTO Designation: M 31M is hereby amended as follows:

1. Sections 1.2 and 1.3, and Note 2 shall be replaced in their entirety with:

1.2 Bars are of three minimum yield levels: namely, 300, 420, and 520 MPa, designated as Grades 300, 420, and 520, respectively.

1.3 Hot-rolled plain rounds, in sizes up to and including 50.8 mm in diameter in coils or cut lengths, when specified for dowels, spirals, and structural ties or supports, shall be furnished under the specification in Grades 300, 420, and 520 (Note 2). For bending properties, test provisions of the nearest nominal diameter deformed bar size shall apply. Those requirements providing for deformations and marking shall not be applicable.

NOTE 2 - The mass for plain rounds smaller than 9.5 mm in diameter shall be computed on the basis of the size in ASTM A 510M.

2. Note 4 shall be replaced in its entirety with:

NOTE 4 - A typical ordering description is as follows: 19 metric tons, deformed and plain billet-steel bars for concrete reinforcement, No. 25, 18.3 m long, deformed, Grade 420 in secured lifts, to AASHTO M 31M as herein amended. Certified mill test reports are required.

3. Section 11.1 shall be replaced in its entirety by:

11.1 The permissible variation in mass shall not exceed 6 percent under nominal mass, except for bars smaller than 9.5 mm plain round, the permissible variation in mass shall be computed on the basis of the permissible variation in diameter in Specification ASTM A 510M. Reinforcing bars are evaluated on the basis of nominal mass. In no case shall the overmass of any bar be the cause for rejection.

4. *Section 14 shall be replaced in its entirety with:*

14. NUMBER OF TESTS

14.1 For bar sizes No. 10 to 36, inclusive, one tension test and one bend test shall be made of the largest size rolled from each heat. If, however, material from one heat differs by three or more designation numbers, one tension and one bend test shall be made from both the highest and lowest designation number of the deformed bars rolled.

14.2 In the case of No. 43 and 57 bars, one tension test and one bend test shall be made of each size from each heat.

5. *Replace Section 20.3.4 in its entirety with:*

20.3.4 Minimum Yield Designation - For Grade 420 bars, either the number 4 or a single continuous longitudinal line through at least 5 spaces offset from the center of the bar side. For Grade 520 bars, either the number 5 or two continuous longitudinal lines through at least 5 spaces offset each direction from the center of the bar. (No marking designation for Grade 300 bars.)

6. *Table 1 shall be replaced in its entirety by:*

TABLE 1 Deformed Bar Designation Numbers, Nominal Masses, Nominal Dimensions, and Deformation Requirements

Bar Designation No. ^B	Nominal Mass, kg/m	Nominal Dimensions ^A			Deformation Requirements, mm		
		Diameter, mm	Cross-Sectional Area, mm ²	Perimeter, mm	Maximum Average Spacing	Minimum Average Height	Maximum Gap (Chord of 12.5% of Nominal Perimeter)
10	0.560	9.5	71	29.9	6.7	0.38	3.6
13	0.994	12.7	129	39.9	8.9	0.51	4.9
16	1.552	15.9	199	49.9	11.1	0.71	6.1
19	2.235	19.1	284	59.8	13.3	0.97	7.3
22	3.042	22.2	387	69.8	15.5	1.12	8.5
25	3.973	25.4	510	79.8	17.8	1.27	9.7
29	5.060	28.7	645	90.0	20.1	1.42	10.9
32	6.404	32.3	819	101.3	22.6	1.63	12.4
36	7.907	35.8	1006	112.5	25.1	1.80	13.7
43	11.38	43.0	1452	135.1	30.1	2.16	16.5
57	20.24	57.3	2581	180.1	40.1	2.59	21.9

^A The nominal dimensions of a deformed bar are equivalent to those of a plain round bar having the same mass per meter as the deformed bar.

^B Bar designation numbers approximate the number of millimeters of the nominal diameter of the bar.

7. *Table 2 shall be replaced in its entirety with:*

TABLE 2 Tensile Requirements

	Grade 300 ^A	Grade 420	Grade 520 ^B
Tensile strength, min, MPa	500	620	690
Yield strength, min, MPa	300	420	520
Elongation in 203.2 mm, min, %:			
Bar Designation No.			
10	11	9	-
13, 16	12	9	-
19	12	9	7
22, 25	-	8	7
29, 32, 36	-	7	6
43, 57	-	7	6

^A Grade 300 bars are furnished only in sizes 10 through 19.

^B Grade 520 bars are furnished only in sizes 19 through 57.

8. *Table 3 shall be replaced in its entirety with:*

TABLE 3 Bend Test Requirements

Bar Designation No.	Pin Diameter for Bend Tests ^A		
	Grade 300	Grade 420	Grade 520
10,13,16	$3\frac{1}{2}d$ ^B	$3\frac{1}{2}d$	-
19	$5d$	$5d$	$5d$
22, 25	-	$5d$	$5d$
29, 32, 36	-	$7d$	$7d$
43, 57 (90°)	-	$9d$	$9d$

^A Test bends 180° unless noted otherwise.

^B d = nominal diameter of specimen.

Delete the Standard Reinforcing Bars table on page 711-1 and substitute:

STANDARD REINFORCING BARS

Bar Designation No.(2)	Nominal Mass, kg/m	Nominal Dimensions (1)		
		Diameter, mm	Cross-Sectional Area, mm ²	Perimeter, mm
10	0.560	9.5	71	29.9
13	0.994	12.7	129	39.9
16	1.552	15.9	199	49.9
19	2.235	19.1	284	59.8
22	3.042	22.2	387	69.8
25	3.973	25.4	510	79.8
29	5.060	28.7	645	90.0
32	6.404	32.3	819	101.3
36	7.907	35.8	1006	112.5
43	11.38	43.0	1452	135.1
57	20.24	57.3	2581	180.1

Delete in toto Subsection 711.02.2 on page 711-2 and substitute:

907-711.02.2--Bar Mats. Bar mats for concrete pavement reinforcement shall be Grade 420 billet steel, AASHTO Designation: M 31M, as amended by special provision, and shall conform to the requirements of AASHTO Designation: M 54.

Delete the first paragraph of Subsection 711.02.4 on page 711-2 and substitute:

907-711.02.4--Dowel Bars and Marginal Bars. Unless otherwise indicated, dowel bars used to span transverse joints and marginal bars shall be plain round bars. They shall be Grade 420 billet steel, AASHTO Designation: M 31M, as amended by special provision.

MISSISSIPPI DEPARTMENT OF TRANSPORTATION

SPECIAL PROVISION NO. 907-711-6M

CODE: (IS)

DATE: 06/26/2009

SUBJECT: Synthetic Structural Fiber Reinforcement

Section 711, Reinforcement and Wire Rope, of the 1996 Metric Edition of the Mississippi Standard Specifications for Road and Bridge Construction is hereby amended as follows:

After Subsection 711.03.4.3 on page 711-5, add the following:

907-711.04--Synthetic Structural Fiber. The synthetic structural fibers shall be approved for listing in the Department's "Approved Sources of Materials" prior to use. The synthetic structural fibers shall be added to the concrete and mixed in accordance with the manufacturer's recommended methods.

907-711.04.1--Material Properties. The fibers shall meet the requirements of ASTM Designation: C 1116, Section 4.1.3. The fibers shall be made of polypropylene, polypropylene/polyethylene blend, nylon, or polyvinyl alcohol (PVA).

907-711.04.2--Minimum Dosage Rate. The dosage rate shall be such that the average residual strength ratio ($R_{150,3.0}$) of fiber reinforced concrete beams is a minimum of 20.0 percent when the beams are tested in accordance with ASTM Designation: C 1609. The dosage rate for fibers shall be determined by the following.

The fiber manufacturer shall have the fibers tested by an acceptable, independent laboratory acceptable to the Department and regularly inspected by the Cement and Concrete Reference Laboratory of the National Institutes of Standards and Technology and approved to perform ASTM Designations: C 39, C 78, and C192.

The laboratory shall test the fibers following the requirements of ASTM Designation: C 1609 in a minimum of three (3) test specimens cast from the same batch of concrete, molded in 150 x 150 x 450-mm standard beam molds meeting the requirements of ASTM Designation: C 31. The beams shall be tested on a 450-mm span. The tests for $R_{150,3.0}$ shall be performed when the average compressive strength of concrete used to cast the beams is between 25 and 30 MPa. The tests for compressive strength shall follow the requirements of ASTM Designation: C 39. The average compressive strength shall be determined from a minimum of two (2) compressive strength cylinders.

The value for $R_{150,3}$ shall be determined using the following equation:

$$R_{150,3.0} = \frac{f_{150,3.0}}{f_1} \times 100$$

The residual flexural strength ($f_{150,3.0}$) shall be determined using the following equation:

$$f_{150,3.0} = \frac{P_{150,3.0} \times L}{b \times d^2}$$

where:

$f_{150,3.0}$ is the residual flexural strength at the midspan deflection of $L/150$, (MPa),

$P_{150,3.0}$ is the residual load capacity at the midspan deflection of $L/150$, (MPa),

L is the span, (mm),

b is the width of the specimen at the fracture, (mm), and

d is the depth of the specimen at the fracture, (mm).

For a 150 x 150 x 450-mm beam, the $P_{150,3.0}$ shall be measured at a midspan deflection of 3.0 millimeters.

Additionally, $R_{150,3.0}$, $f_{150,3.0}$, and $P_{150,3.0}$ may also be referred to as R_{150}^{150} , f_{150}^{150} , and P_{150}^{150} , respectively.

At the dosage rate required to achieve the minimum $R_{150,3}$, the mixture shall both be workable and the fibers shall not form clumps.

The manufacturer shall submit to the State Materials Engineer certified test reports from the independent laboratory showing the test results of each test specimen.

907-711.04.3--Job Control Requirements. The synthetic structural fibers shall be one from the Department's "Approved Sources of Materials."

At the required dosage rate, the mixture shall both be workable and the fibers shall not form clumps to the satisfaction of the Engineer. If the mixture is determined by the Engineer to not be workable or have clumps of fibers, the mixture may be rejected.

MISSISSIPPI DEPARTMENT OF TRANSPORTATION

SPECIAL PROVISION NO. 907-712-4M

CODE: (IS)

DATE: 05/01/2002

SUBJECT: Materials for Guardrail Posts

Section 712, Fence and Guardrail, of the 1996 Metric Edition of the Mississippi Standard Specifications for Road and Bridge Construction, is hereby amended as follows:

907-712.06--Guard and Guardrail Posts.

Delete Subsection 712.06.4 on Page 712-6 and substitute the following:

907-712.06.4--Steel Posts. Steel posts shall be of the section and length as shown on the plans and shall conform to the requirements of ASTM Designation: A 36.

907-712.06.5--Treated Wood Blocks For Use With Metal Guardrail Posts. Treated wood blocks for use with metal guardrail posts shall be within ± 10 -mm of the size and dimensions shown on the plans, except that a minus tolerance shall not be allowed for the slotted width in which the metal post must fit. Preservative treatment shall be in accordance with AWPA Standard C14.

The blocks must be obtained from approved manufacturers listed on MDOT's "List of Approved Suppliers of Treated Wood Products". The manufacturer's approval will be based on their Quality Control Program for material certification. The manufacturer shall employ a certified material grader and treatment inspector who will be responsible for grading and inspecting the treated material. The inspector's certification shall be from an approved industrial organization such as AWPA, SPIB or American Lumber Standard. The manufacturer's certification shall be based on satisfactory grading, dimensional measurements, and treatment results. The manufacturer shall provide the Contractor two copies of their material certification and treatment report for each charge of material delivered. Also, a copy of these documents shall be mailed to the State Materials Engineer for all blocks shipped for use on MDOT projects.

The manufacturer shall brand each block with the following information:

- (1) manufacturer's logo or initials (XYZ)
- (2) manufacturer's plant location
- (3) species of wood (SYP)
- (4) treatment type (CCA-C)
- (5) minimum preservative retention by assay (10)

The Contractor, prior to installation of the blocks, shall furnish a copy of the manufacturer's certification and treatment report covering the blocks to be installed to the Department's representative.

The Project Engineer, or the Project Engineer's designated representative, will inspect each block prior to installation for proper dimensions, identification and damage or other deficiency prior to

permitting installation of the blocks. The Project Engineer will notify the State Materials Engineer when blocks are delivered to the project and report any deficiencies found. The State Materials Engineer will, at the State Materials Engineer's discretion, dispatch an inspector to the project for inspecting and boring the blocks for an assay test. Final acceptance of the blocks will be based on satisfactory field inspection and satisfactory test results when field sampling is performed.

MISSISSIPPI DEPARTMENT OF TRANSPORTATION

SPECIAL PROVISION NO. 907-713-2M

CODE: (IS)

DATE: 11/09/2010

SUBJECT: Admixtures for Concrete

Section 713, Concrete Curing Materials and Admixtures, of the 1996 Metric Edition of the Mississippi Standard Specifications for Road and Bridge Construction is hereby amended as follows:

After the second paragraph of Subsection 713.01.2 on page 713-1, add the following.

Type 1-D compound may be used on bridge rails, median barriers, and other structures requiring a spray finish. When Type 1-D compound is used, it will be the Contractor's responsibility to assure that the compound has dissipated from the structure prior to applying the spray finish and that the spray finish adheres soundly to the structure.

Delete Subsection 713.02 on pages 713-1 & 713-2, and substitute the following:

907-713.02--Admixtures for Concrete. Air-entraining admixtures used in Portland cement concrete shall comply with AASHTO Designation: M 154. Set-retarding, accelerating, and/or water-reducing admixtures shall comply with AASHTO Designation: M 194. Water-reducing admixture shall meet the minimum requirements for Type A. Set-retarding admixtures shall meet the minimum requirements for Type D.

In order to obtain approval of an admixture, the State Materials Engineer shall have been furnished certified test reports, made by an acceptable independent laboratory regularly inspected by the Cement and Concrete Reference Laboratory of the National Institutes of Standards and Technology, which show that the admixture meets all the requirements of the applicable AASHTO Standard Specification.

The Department reserves the right to sample, for check tests, any shipment or lot of admixture delivered to a project.

The Department reserves the right to require tests of the material to be furnished, using the specific cement and aggregates proposed for use on the project, as suggested in AASHTO Designation: M 154 and outlined in AASHTO Designation: M 194.

After an admixture has been approved, the Contractor shall submit to the State Materials Engineer, with each new lot of material shipped, a certification from the manufacturer in accordance with the requirements of Subsection 700.05.1 and stating the material is of the same composition as originally approved and has not been changed or altered in any way. The requirement in Subsection 700.05.1(b) is not required on the certification from the manufacturer.

Admixtures containing chlorides will not be permitted.

Failure to maintain compliance with any requirement of these specifications shall be cause for rejection of any previously approved source or brand of admixture.

Admixtures shall only be used in accordance with the manufacturer's recommended dosage range as set forth in the manufacturer's approval request correspondence. When an admixture is used in Portland cement concrete, it shall be the responsibility of the Contractor to produce satisfactory results.

907-713.02.1--Source Approval. In order to obtain approval of an admixture, the Producer/Suppliers shall submit to the State Materials Engineer the following for review: certified test reports, made by an acceptable independent laboratory regularly inspected by the Cement and Concrete Reference Laboratory of the National Institutes of Standards and Technology, which show that the admixture meets all the requirements of the applicable AASHTO or Department Specification for the specific type and the dosage range for the specific type of admixture.

907-713.02.2--Specific Requirements. Admixtures containing chlorides will not be permitted.

907-713.02.3--Acceptance. The Department reserves the right to sample, for check tests, any shipment or lot of admixture delivered to a project.

The Department reserves the right to require tests of the material to be furnished, using the specific cement and aggregates proposed for use on the project, as suggested in AASHTO Designation: M 154 and outlined in AASHTO Designation: M 194.

Failure to maintain compliance with any requirement of these specifications shall be cause for rejection of any previously approved source or brand of admixture.

With each new lot of material shipped the Contractor shall submit to the State Materials Engineer, a notarized certification from the manufacturer showing that the material complies with the requirements of the applicable AASHTO or Department Specification.

When an admixture is used, it shall be the responsibility of the Contractor to produce satisfactory results.

MISSISSIPPI DEPARTMENT OF TRANSPORTATION

SPECIAL PROVISION NO. 907-714-9M

CODE: (IS)

DATE: 12/11/2003

SUBJECT: Geotextiles

Section 714, Miscellaneous Materials, of the 1996 Metric Edition of the Mississippi Standard Specifications for Road and Bridge Construction is hereby amended as follows:

Delete in toto Subsection 714.13 beginning on page 714-15 and substitute the following:

907-714.13--Geotextiles.

907-714.13.1--General. Unless specified otherwise, the geotextile may be woven or non-woven. The fibers used in the manufacture of the geotextiles and the threads used in joining geotextiles by sewing, shall consist of long-chain synthetic polymers, composed of at least 95% by mass polyolefins, polyesters, or polyamides. They shall be formed into a network such that the filaments or yarns retain dimensional stability relative to each other, including selvages. The geotextile shall be mildew resistant and inert to biological degradation and naturally encountered chemicals, alkalines and acids. Geotextile which is not protected from sunlight after installation shall contain stabilizers and/or inhibitors to make it resistant to deterioration from direct sunlight, ultraviolet rays, and heat.

The edges of the geotextile shall be selvaged or finished in such a manner to prevent the outer yarn of filaments from raveling. The geotextile shall be free of defects or flaws, which affect the required physical properties.

Geotextile for silt fence shall be manufactured in widths of not less than 900 millimeters, and geotextile for other applications shall be manufactured in widths of not less than 1800 millimeters. Sheets of geotextile may be sewn or bonded together at the factory or other approved locations, but deviation from the physical requirements will not be permitted.

Acceptance testing, except geotextile for silt fence, will be conducted with geotextile samples from each lot shipped to the project, as per Subsection 907-714.13.10.

907-714.13.2--Geotextile for Silt Fence. The geotextile shall conform to the physical requirements of Type I or II as shown in Table I. Unless a specific type is specified in the plans or contract documents, the Contractor may select Type I or II.

907-714.13.2.1--Woven Wire Backing. Except as provided herein, silt fence shall be reinforced with a woven wire backing. The wire backing shall be at least 800 millimeters high and have no less than six horizontal wires. Vertical wires shall be spaced no more than 300 millimeters apart. The top and bottom wire shall be 3.43-mm diameter or larger. All other wire shall be no smaller than 2.51-mm diameter.

907-714.13.2.2--Posts. Wood or steel posts may be used. Wood posts shall have a minimum diameter of 75 millimeters and length of 1.5 meters and shall be straight enough to provide a fence without noticeable misalignment. Steel tee posts shall be 1.5 meters long, approximately 35 millimeters wide, 35 millimeters deep, and three millimeters thick with a nominal mass of 1.98 kilograms per meter prior to fabrication. The posts shall have projections, notches or holes for fastening the wire backing or [geotextile](#) to the posts.

907-714.13.2.3--Staples. Staples shall be made of 3.76-mm wire with a minimum length of 25 millimeters after bending.

907-714.13.3--Geotextile for Subsurface Drainage. For normal drainage applications, the [geotextile](#) shall conform to the physical requirements of Type III as shown in Table I.

907-714.13.3.1--Geotextile for Edge Drains. The [geotextile](#) shall conform to the physical requirements of Type V as shown in Table I, except the AOS for the woven [geotextile](#) shall have a range of 0.15 mm to 0.43 mm.

907-714.13.4--Geotextile Underseal. The [geotextile](#) shall be non-woven polyester or polypropylene, which is satisfactory for use with asphalt cements. Unless otherwise specified, the [geotextile](#) shall conform to the physical requirements of Type IV in Table I.

907-714.13.5--Geotextile for Use Under Riprap. Unless otherwise specified, the [geotextile](#) shall conform to the physical requirements of Type V in Table I. The requirements for grab tensile, puncture, and trapezoidal tear strengths may be reduced 50 percent when the [geotextile](#) is cushioned from rock placement by a 150-mm minimum layer of sand.

907-714.13.6--Geotextile Stabilization. The [geotextile](#) shall meet the physical requirements as shown in Table I for the Type specified in the plans or contract documents.

907-714.13.7--Securing Pins. Steel pins used for anchoring the [geotextile](#) shall be five millimeters in diameter, minimum length of 375 millimeters, pointed at one end and fabricated with a head for retaining a steel washer. A minimum 38-mm diameter washer shall be installed on each pin.

907-714.13.8--Identification. Each roll of [geotextile](#) or container shall be visibly labeled with the name of the manufacturer, type of [geotextile](#) or trade name, lot number, and quantity of material.

907-714.13.9--Shipment and Storage. During shipment and storage, the [geotextile](#) shall be protected from direct sunlight, ultraviolet rays, temperatures greater than 60°C, mud, dirt, dust, and debris. The [geotextile](#) shall be wrapped and maintained in a heavy-duty protective covering, including ends of roll.

907-714.13.10--Certification, Acceptance Sampling and Testing. The Contractor shall furnish to the Engineer three copies of the manufacturer's certification that each lot in a shipment

complies with the requirements of the contract. Certification of geotextile for silt fence shall include a material conformance statement, as per Subsection 700.05.1, that the geotextile meets or exceeds the minimum average roll values specified in Table 1. All fabric, steel pins, washers, fence posts, woven wire and wire staples are subject to approval by the Engineer upon delivery to the work site.

Acceptance testing shall be completed prior to incorporating in the work. Acceptance of geotextile to be used in the work, except geotextile for silt fence, will be based on the results of tests performed by the Department on verification samples submitted from the project. The Engineer will select one roll at random, from each lot in a shipment, for sampling. A sample extending full width of the randomly selected roll and containing at least five square meters of geotextile will be obtained and submitted by the Engineer. The sample shall be provided at no additional cost to the State.

TABLE I
GEOTEXTILES

Type Designation	I ^a	II ^a	III	IV	V	VI	VII	Test Method
Application	Sediment Control		Drainage	Paving	Separation & Drainage	Separation, Stabilization & Reinforcement		
Physical Properties								
Grab Strength (N)	225	400	490	400	900	W 1250	NW 800	ASTM D 4632
Elongation %	----	50% max @ 200 N	20% min	50% min @ break	50% min	50% max min	50% max min	ASTM D 4632
Seam Strength (N)	----	----	310	----	800	1070	710	ASTM D 4632
Puncture Strength (N)	----	----	175	----	360	490	330	ASTM D 4883
Trapezoidal Tear (N)	----	----	175	----	360	445	310	ASTM D 4533
Asphalt Retention (L/m ²)	----	----	----	0.9	----	----	----	ASTM D 6140
Permittivity (Sec ⁻¹)	0.05	0.05	0.5	----	0.15	0.2	0.2	ASTM D 4491
AOS Woven (mm)	0.15 - 0.84	0.15 - 0.84	0.15 - 0.43	----	0.21 - 0.43	0.15 - 0.21	----	ASTM D 4751
AOS Non-Woven (mm)	<0.84	<0.84	<0.43	----	<0.43	----	<0.43	ASTM D 4751
Tensile Strength after UV (% Retained)	70@500 Hr.	70 @ 500 Hr.	70 @ 150 Hr.	----	70 @ 150 Hr.	70 @ 150 Hr.	70 @ 150 Hr.	ASTM D 4355
Melting Point (°C)	----	----	----	165°F	----	----	----	ASTM D 276

a. All property values, with the exception of apparent opening size (AOS), represent minimum average roll values in the weakest principal direction. Values for AOS represent the maximum average roll values.

MISSISSIPPI DEPARTMENT OF TRANSPORTATION

| SPECIAL PROVISION NO. 907-714-13M

CODE: (IS)

| DATE: 11/09/2010

SUBJECT: Miscellaneous Materials

Section 714, Miscellaneous Materials, of the 1996 Metric Edition of the Mississippi Standard Specifications for Road and Bridge Construction is hereby amended as follows:

907-714.05--Fly Ash. Delete Subsections 714.05.1 & 714.05.2 on pages 714-3 & 714-4, and substitute the following:

907-714.05.1--General. The fly ash source must be approved for listing in the Department's "Approved Sources of Materials" prior to use. The acceptance of fly ash shall be based on certified test reports, certification of shipment from the supplier, and tests performed on samples obtained after delivery in accordance with the Department's Materials Division Inspection, Testing, and Certification Manual and Department SOP.

Different classes of fly ash or different sources of the same class shall not be mixed or used in the construction of a structure or unit of a structure without written permission from the Engineer.

The Contractor shall provide suitable means for storing and protecting the fly ash from dampness. Separate storage silos, bins, or containers shall be provided for fly ash. Fly ash which has become partially set or contains lumps of caked fly ash shall not be used.

The temperature of the bulk fly ash shall not be greater than 74°C at the time of incorporation into the work.

All classes of fly ash shall meet the supplementary option chemical requirement for available alkalis listed in AASHTO Designation: M 295, Table 2. Class F fly ash shall have a calcium oxide (CaO) content of less than 6.0%. Class C fly ash shall have a CaO content of greater than or equal to 6.0%.

The replacement of Portland cement with fly ash shall be in accordance with the applicable replacement content specified in Subsection 907-701.02.2.

In addition to these requirements, fly ash shall meet the following specific requirements for the intended use.

907-714.05.2--Fly Ash for Use in Concrete. When used with Portland cement in the production of concrete or grout, the fly ash shall meet the requirements of AASHTO Designation: M 295, Class C or F, with the following exception:

The loss on ignition shall not exceed 6.0 percent.

No additional cementitious materials, such as blended hydraulic cement, GGBFS, metakaolin, or others, shall be added to or as a replacement for Portland cement when used with fly ash.

Delete Subsection 714.06 on page 714-4, and substitute the following:

907-714.06--Ground Granulated Blast Furnace Slag (GGBFS).

907-714.06.1--General. The GGBFS source must be approved for listing in the Department's "Approved Sources of Materials" prior to use. The acceptance of GGBFS shall be based on certified test reports, certification of shipment from the supplier, and tests performed on samples obtained after delivery in accordance with the Department's Materials Division Inspection, Testing, and Certification Manual and Department SOP.

The Contractor shall provide suitable means for storing and protecting the GGBFS against dampness and contamination. Separate storage silos, bins, or containers shall be provided for GGBFS. GGBFS which has become partially set, caked or contains lumps shall not be used.

The State Materials Engineer shall be notified in writing of the nature, amount and identity of any processing or other additions made to the GGBFS during production.

GGBFS from different mills shall not be mixed or used alternately in any one class of construction or structure without written permission from the Engineer; except that this requirement will not be applicable to cement treatment of design soils or bases.

No additional cementitious materials, such as blended hydraulic cement, fly ash, metakaolin, or others, shall be added to or as a replacement for Portland cement when used with GGBFS in the production of concrete. The replacement of Portland cement with GGBFS shall be in accordance with the applicable replacement content specified in Subsection 907-701.02.2.

907-714.06.2--Specific Requirements. GGBFS shall meet the requirements of AASHTO Designation: M 302, Grade 100 or 120. GGBFS shall contain no chlorides.

Delete Subsection 714.07 on page 714-4, and substitute the following:

907-714.07--Additional Cementitious Materials.

907-714.07.1--Metakaolin.

907-714.07.1.1--General. Metakaolin shall only be used as a supplementary cementitious materials in Portland cement concrete for compliance with the requirements for cementitious materials exposed to soluble sulfate conditions. Metakaolin from different sources shall not be mixed or used alternately in any one class of construction or structure without written permission from the Engineer. No additional cementitious materials, such as blended hydraulic cement, fly ash, GGBFS, or others, shall be added to or as a replacement for Portland cement when used with metakaolin in the production of concrete.

The State Materials Engineer shall be notified in writing of the nature, amount and identity of any processing, or other additions made to the metakaolin during production.

907-714.07.1.2-- Source Approval. The approval of each metakaolin source shall be on a case by case basis as determined by the State Materials Engineer. In order to obtain approval of a metakaolin source, the Producer/Suppliers shall submit to the State Materials Engineer the following for review: certified test reports, made by an acceptable, independent laboratory regularly inspected by the Cement and Concrete Reference Laboratory of the National Institutes of Standards and Technology, which show that the metakaolin meets all the requirements of AASHTO Designation: M295, including the Effectiveness in contributing to sulfate resistance, Procedure A, listed in AASHTO Designation: M295, Table 4 for Supplementary Optional Physical Requirements, and other requirements listed herein.

In order to demonstrate effectiveness in contributing to sulfate resistance, included in this test data shall be results of metakaolin from the proposed source tested in accordance with ASTM Designation: C 1012. There shall be two sets of test specimens per the following:

- a. One set of test specimens shall be prepared using a Type I Portland cement meeting the requirements of AASHTO Designation: M85 and having a tricalcium aluminate (C_3A) content of more than 8.0%,
- b. One set of test specimens shall be prepared using a Type II Portland cement meeting the requirements of AASHTO Designation: M85.
- c. The proposed metakaolin shall be incorporated at the rate of 10% cement replacement in each set of test specimens and shall meet both of the acceptance criteria listed below for source approval.

The requirement for acceptance of the test sample using Type I Portland cement is an expansion of 0.10% or less at the end of six months. The requirement for acceptance of the test sample using Type II Portland cement is an expansion of 0.05% or less at the end of six months.

907-714.07.1.3--Storage. The Contractor shall provide suitable means for storing and protecting the metakaolin against dampness and contamination. Metakaolin which has become partially set, caked, or contains lumps shall not be used.

907-714.07.1.4--Specific Requirements. Metakaolin shall meet the requirements of AASHTO Designation: M 295, Class N with the following modifications:

- 1. The sum of $SiO_2 + Al_2O_3 + Fe_2O_3$ shall be at least 85%. The Material Safety Data Sheet shall indicate that the amount of crystalline silica, as measured by National Institute of Occupation Safety and Health (NIOSH) 7500 method, after removal of the mica interference, is less than 1.0%.
- 2. The loss on ignition shall be less than 3.0%.
- 3. The available alkalies, as equivalent Na_2O , shall not exceed 1.0%.
- 4. The amount of material retained on a No. 325 mesh sieve shall not exceed 1.0%.
- 5. The strength activity index at seven (7) days shall be at least 85%.

907-714.07.1.5--Acceptance. With each new lot of material shipped the Contractor shall submit to the State Materials Engineer a certified test report from the manufacturer showing that the material meets the requirements AASHTO Designation: M295, Class N and the requirements of this Subsection.

The Department reserves the right to sample, for check tests, any shipment or lot of metakaolin delivered to a project.

907-714.07.2--Silica Fume.

907-714.07.2.1--General. Silica fume shall only be used as a supplementary cementitious material in Portland cement concrete for compliance with the requirements for cementitious materials exposed to soluble sulfate conditions. Silica fume from different sources shall not be mixed or used alternately in any one class of construction or structure without written permission from the Engineer. No additional cementitious materials, such as blended hydraulic cement, performance hydraulic cement, fly ash, GGBFS, or others, shall be added to or as a replacement for Portland cement when used with silica fume in the production of concrete.

The State Materials Engineer shall be notified in writing of the nature, amount and identity of any processing, or other additions made to the silica fume during production.

907-714.07.2.2--Source Approval. The approval of each silica fume source shall be on a case by case basis as determined by the State Materials Engineer. In order to obtain approval of a silica fume source, the Producer/Suppliers shall submit to the State Materials Engineer the following for review: certified test reports, made by an acceptable, independent laboratory regularly inspected by the Cement and Concrete Reference Laboratory of the National Institutes of Standards and Technology, which show that the silica fume meets all the requirements of AASHTO Designation: M307, Table 3, including the Sulfate resistance expansion, listed in the table for Optional Physical Requirements, and other requirements listed herein.

In order to demonstrate effectiveness in contributing to sulfate resistance, included in this test data shall be results of silica fume from the proposed source tested in accordance with ASTM Designation: C 1012. There shall be two sets of test specimens per the following:

- a. One set of test specimens shall be prepared using a Type I Portland cement meeting the requirements of AASHTO Designation: M85 and having a tricalcium aluminate (C_3A) content of more than 8.0%,
- b. One set of test specimens shall be prepared using a Type II Portland cement meeting the requirements of AASHTO Designation: M85.
- c. The proposed silica fume shall be incorporated at the rate of 8% cement replacement in each set of test specimens and shall meet both of the acceptance criteria listed below for source approval.

The requirement for acceptance of the test sample using Type I Portland cement is an expansion of 0.10% or less at the end of six months. The requirement for acceptance of the test sample using Type II Portland cement is an expansion of 0.05% or less at the end of six months.

907-714.07.2.3--Storage. The Contractor shall provide suitable means for storing and protecting the silica fume against dampness and contamination. Silica fume which has become partially set, caked, or contains lumps shall not be used.

907-714.07.2.4--Acceptance. With each new lot of material shipped, the Contractor shall submit to the State Materials Engineer a certified test report from the manufacturer showing that the material meets the Chemical and Physical Requirements of AASHTO Designation: M307.

The Department reserves the right to sample, for check tests, any shipment or lot of silica fume delivered to a project.

Delete Subsection 714.11.6 on pages 714-12 and 714-13, and substitute the following:

907-714.11.6--Rapid Setting Commercial Grouts and Concrete Patching Compounds.

Rapid setting commercial grouts and concrete patching compounds must be approved for listing in the Department's "Approved Sources of Materials" prior to use. Upon approval, a product must be recertified every four (4) years to remain on the "Approved Sources of Materials" list. Each product shall be pre-measured and packaged dry by the manufacturer. All liquid solutions included by the manufacturer as components of the packaged material shall be packaged in a watertight container. The manufacturer may include aggregates in the packaged material or recommend the addition of Contractor furnished aggregates.

The type, size and quantity of aggregates, if any, to be added at the job site shall be in accordance with the manufacturer's recommendations and shall meet the requirements of Subsection 703.02 for fine aggregate and Subsection 703.03 for coarse aggregate. Required mixing water to be added at the job site shall meet the requirements of Subsection 714.01.2.

Only those bonding agents, if any, recommended by the manufacturer of the grout or patching compounds may be used for increasing the bond to old concrete or mortar surfaces.

Grout or patching compounds containing chlorides will not be permitted when in contact with steel.

Site preparation, proportioning of materials, mixing, placing and curing shall be performed in accordance with the manufacturer's recommendation for the specific type of application, and the Contractor shall furnish a copy of these recommendations to the Engineer.

Rapid setting non-shrink commercial grouts and concrete patching compounds, including components to be added at the job site, shall conform to the following physical requirements:

Non-shrink cementitious grouts shall not be permitted for use.

Compressive strength shall equal or exceed 20.7 MPa in 24 hours when tested in accordance with Mississippi Test Method MT-4.

Bond strength shall equal or exceed 690 kPa in 24 hours when tested in accordance with Mississippi Test Method MT-4.

The material shall not shrink, and the increase in length at 28 days shall not be greater than 0.3% when tested in accordance with Mississippi Test Method MT-4.

The Contractor shall furnish to the Engineer three copies of the manufacturer's certified test report(s) showing results of all required tests and certification that the material meets the specifications when mixed and placed in accordance with the manufacturer's instructions. When the mixture is to be placed in contact with steel, the certification shall further state that the packaged material contains no chlorides. Certified test report(s) and certification shall be furnished for each lot in a shipment.

The proportioning of materials must be approved by the State Materials Engineer and any subsequent change in proportioning must also be approved. A sample of each component shall be submitted to the Engineer along with the quantity or percentage of each to be blended. At least 45 days must be allowed for initial approval.

The proportioning of materials for subsequent lots may be approved by the State Materials Engineer upon receipt of certification from the manufacturer that the new lot of material is the same composition as that originally approved by the Department and that the material has not been changed or altered in any way.

907-714.11.7--Commercial Grout for Anchoring Doweled Tie Bars in Concrete. Before Subsection 714.11.7.1 on page 714-13, add the following:

Approved Non-“Fast Set” Epoxy anchor systems as specified below may be used for the repair of concrete pavements that do not involve permanent sustained tension applications or overhead applications.

“*Fast Set Epoxy*” may not be used for any Adhesive Anchor Applications. Adhesive Anchor Systems (Fast Set epoxy or otherwise) shall not be used for permanent sustained tension applications or overhead applications. “Fast Set Epoxy” refers to an epoxy produced by the Sika Corporation called Sikadur AnchorFix-3 and repackaged for sale under a variety of names/companies listed at the Federal Highway Administration web site at the following link:

<http://www.fhwa.dot.gov/Bridge/adhesives.cfm>

907-714.11.7.4--Acceptance Procedure. After the last sentence of the first paragraph of Subsection 714.11.4 on page 714-13, add the following:

Upon approval, a product must be recertified every four (4) years to remain on the “Approved Sources of Materials” list.

907-714.11.8--Epoxy Joint Repair System.

907-714.11.8.1--General. After the last sentence of the first paragraph of Subsection 714.11.8.1 on page 714-14, add the following:

Upon approval, a product must be recertified every four (4) years to remain on the “Approved Sources of Materials” list.

MISSISSIPPI DEPARTMENT OF TRANSPORTATION

SPECIAL PROVISION NO. 907-715-2M

CODE: (IS)

DATE: 12/10/99

SUBJECT: Erosion Control Blanket

Section 715, Roadside Development Materials, of the 1996 Metric Edition of the Mississippi Standard Specifications for Road and Bridge Construction is hereby amended as follows:

907-715.09.3--Erosion Control Blanket. Delete the third line of the first paragraph of Subsection 715.09.3 and substitute:

The top side of the blanket shall be covered with a photodegradable plastic mesh having 20-mm x 20-mm maximum openings which shall be substantially adhered to the straw by a knitting process using degradable thread.

MISSISSIPPI DEPARTMENT OF TRANSPORTATION

SPECIAL PROVISION NO. 907-715-6M

CODE: (IS)

DATE: 01/25/2008

SUBJECT: Roadside Development Materials

Section 715, Roadside Development Materials, of the 1996 Metric Edition of the Mississippi Standard Specifications for Road and Bridge Construction is hereby amended as follows:

Delete the first sentence of Subsection 715.02.2 on page 715-1 and substitute the following:

Combination or manufactured fertilizer shall be "standard commercial products" and shall contain not less than the percentages by mass of the ingredients set out in Table A, except for agricultural limestone which shall meet the requirements of Subsection 907-715-.02.2.1.

In Table A of Subsection 715.02.2 on page 715-2, delete the column titled "Agricultural Limestone" and the row titled "Calcium and Magnesium Carbonate**".

Delete the third paragraph on page 715-3.

At the end of Subsection 715.02.2 on page 715-3, add the following:

907-715-02.2.1--Agricultural Limestone. Agricultural limestone shall be either a hard-rock limestone material or a marl or chalk agricultural liming material as addressed in the latest amendment to the Mississippi Agricultural Liming Material Act of 1993, published by the Mississippi Department of Agriculture and Commerce.

907-715-02.2.1.1--Screening Requirements. Marl or chalk lining material shall not have less than 90% of the material passing the 2.00 mm sieve.

907-715-02.2.1.2--Calcium Carbonate Equivalent. Marl or chalk liming material shall not have less than 70% calcium and magnesium carbonate calculated as calcium carbonate equivalent when expressed on a dry weight basis.

907-715-02.2.1.3--Neutralizing Values. Hard-rock limestone material shall have a minimum Relative Neutralizing Value (RNV) of 63.0%, which is determined as follows:

$$\% \text{ RNV} = \text{CCE} \times (\% \text{ passing \#10 mesh} + \% \text{ passing \#50 mesh})/2$$

Where: CCE = Calcium Carbonate Equivalent

907-715.03--Seed.

907-715.03.2--Germination and Purity Requirements. Add the following to Table B on page 715-4.

Name (Kind)	Name (Variety)	Percent Germination	Percent Purity
GRASSES Rye Grass	Annual	80	98

MISSISSIPPI DEPARTMENT OF TRANSPORTATION

SPECIAL PROVISION NO. 907-716-1M

CODE: (IS)

DATE: 05/16/2002

SUBJECT: Miscellaneous Materials

Section 716, Miscellaneous Metals, of the 1996 Metric Edition of the Mississippi Standard Specifications for Road and Bridge Construction is hereby amended as follows:

Delete Subsection 716.04 on page 716-1 and substitute the following:

907-716.04--Gray Iron Casings. Gray iron castings shall conform to AASHTO Designation: M 105. Class 30B shall be furnished unless otherwise specified. For testing purposes a lot size shall be defined as the lesser of either a total of 15 875 kilograms or one week's production for the Department. The test bars shall be made from a melt of iron used in production of units for the Department. The test bar length shall be a minimum of 400 millimeters.

907-716.07--Copper Bearings and Sheet Copper.

Delete Subsection 716.07.1 on page 716-1 and substitute the following:

907-716.07.1--Rolled Copper-Alloy Bearings and Expansion Plates. Rolled copper-alloy bearings and expansion plates shall conform to ASTM Designation: B 100. Alloy UNS No. C51000 shall be furnished unless otherwise specified.

Delete Subsections 716.10 on page 716-2 and substitute the following:

907-716.10--Lead Plates, Pipes, Etc. Lead used for plates, pipes, etc. shall conform to ASTM Designation: B 29, Grade: Pure Lead.

907-716.14--Bar Grates.

Delete Subsection 716.14.1 starting on page 716-2 and substitute the following:

907-716.14.1--Material Requirements. Plain round steel bars and strap bars shall conform to the following requirements:

B-9 Grates and Bar Grates:	AASHTO Designation M 270M, Grade 250.
MI, GI, & SS-3 Grates:	AASHTO Designation: M270M, Grade 345W, or as specified in the plans.

Delete the last paragraph of Subsection 716.14.2 on page 716-3 and substitute the following:

After fabrication, the bar grate shall be coated with an approved commercial quality coating designed for coating steel castings and fabricated units. The State Materials Engineer shall approve the coating material prior to application.

MISSISSIPPI DEPARTMENT OF TRANSPORTATION

| SPECIAL PROVISION NO. 907-720-3M

CODE: (IS)

| DATE: 10/7/97

SUBJECT: High Performance Cold Plastic Pavement Markings

Section 720, Pavement Marking Materials, of the 1996 Metric Edition of the Mississippi Standard Specifications for Road and Bridge Construction, is hereby amended as follows:

At the end of Section 720 on page 720-15, add the following:

| 907-720.07--High Performance Cold Plastic Pavement Markings.

| 907-720.07.1--General. The preformed high performance pavement markings shall consist of white or yellow films with ceramic beads incorporated to provide immediate and continuing retroreflection.

| Preformed high performance cold plastic pavement markings shall be listed on the Department's list of "Approved Sources of Materials" for Preformed High Performance Profile Cold Plastic Pavement Marking Tape. Prior to use, the Contractor shall furnish the Engineer three copies of the manufacturer's certification for each shipment stating that the material furnished is of the same composition as that originally approved by the Department and that the material has not been changed or altered in any way.

The preformed pavement markings shall be capable of being adhered to the pavement by a pre-coated pressure sensitive adhesive. A primer may be used to precondition the pavement surface. When a primer is specified by the manufacturer, it shall be installed as recommended by the manufacturer at no additional cost to the State. The preformed pavement markings shall conform to pavement contours by the action of traffic. After application, the markings shall be immediately ready for traffic. A representative of the manufacturer shall be present to identify proper solvents and/or primers (where necessary) to be applied at the time of application, to identify all equipment necessary for proper application, and to make recommendations for application that will assure effective product performance.

907-720.07.2--Classification. The preformed pavement markings shall be highly durable retroreflective pliant polymer materials designed for longitudinal markings subjected to high traffic volumes.

907-720.07.3--Requirements.

907-720.07.3.1--Composition. The retroreflective pliant polymer pavement marking film shall consist of a mixture of high quality polymeric materials, pigments and glass beads distributed throughout its base cross-sectional area, with a reflective layer of ceramic beads bonded to a durable polyurethane top surface. The surface shall have approximately 50% ($\pm 15\%$) of the surface area raised and presenting a near vertical face (angle of 0° to 60°) to traffic from any direction. The channels between the raised areas shall be substantially free of exposed beads or particles.

907-720.07.3.2--Retroreflectance. The white and yellow markings shall have the following initial minimum retroreflectance values as measured in accordance with the testing procedures of

ASTM Designation: D 4061. The photometric quantity to be measured shall be coefficient of retroreflected luminance (R_L), and shall be expressed as millicandelas per square meter per lux ($\text{mcd}/\text{m}^2/\text{lx}$).

INITIAL MINIMUM RETROREFLECTANCE VALUES

	White		Yellow	
	86.0°	86.5° *	86.0°	86.5° *
Entrance Angle	86.0°	86.5° *	86.0°	86.5° *
Observation Angle	0.2°	1.0°	0.2°	1.0°
Retroreflected Luminance R_L ($\text{mcd}/\text{m}^2/\text{lx}$)	1100	700	800	500

* These retroreflectance values are based on dark room photometric readings per ASTM D 4061. The Ecolux™ Retroreflectometer measurement geometry is an 86.5° entrance angle and a 1.0° observation angle.

907-720.07.3.3--Glass Beads. The size and quality of the beads shall be such that the performance requirements for the retroreflective pliant polymer shall be met.

907-720.07.3.3.1--Index of Refraction. All ceramic beads bonded to the polyurethane coated patterned surface of the material shall have a minimum index of refraction of 1.70 when tested using the liquid oil immersion method. The glass beads mixed into the pliant polymer shall have a minimum index of refraction of 1.5 when tested by the liquid oil immersion method.

TESTING PROCEDURE FOR REFRACTIVE INDEX OF BEADS BY LIQUID IMMERSION

EQUIPMENT REQUIRED:

- A. Microscope (minimum 100X magnification).
- B. Light Source - preferably sodium light or other monochromatic source, but not absolutely essential.
- C. Refractive Index Liquids.*
- D. Microscope Slide and Slide Cover.
- E. Mortar and Pestle.

* Available from R.P. Cargille Laboratories, Inc., Cedar Grove, NJ.

PROCEDURE:

- A. Using the mortar and pestle, crush a few representative beads and place a few of these crushed particles on a microscope slide.
- B. Place a drop of a refractive index liquid, with an index as close to that of the glass as can be estimated, on the crushed bead particles.

- C. Cover the slide with a microscope slide cover and view the crushed particles by transmitted light normal to the slide surface (illuminated from the bottom).
- D. Adjust the microscope mirror to allow a minimum light intensity for viewing. This is important when sodium light is not used.
- E. Bring a relatively flat and transparent particle into focus.
- F. By slightly raising and lowering the microscope tube, look for one or both of the following:
 - 1. Becke Line - This light line will appear to move either into the particle or away from it. In general, when the microscope tube is raised, the line will move toward the material of higher refractive index; when the microscope tube is lowered, the line will move toward the material of lower index.
 - 2. Variation in Particle Brightness - When raising the microscope tube from sharp focus, the particle will appear to get brighter or darker than the surrounding field. If it becomes brighter, the glass has a higher refractive index than the liquid. If it becomes darker, the glass has a lower refractive index than the liquid. In both cases, the opposite will be true when the microscope tube is lowered.
- G. This test can be used to confirm that the beads are above or below a specified index. It can also be used to give an accurate determination of the index (± 0.001). This is done by using several refractive index liquids until a match or near match of indices occurs. The index of the glass will equal that of the liquid when no Becke line and no variation in bead brightness can be observed.

907-720.07.3.3.2--Acid Resistance. The beads shall show resistance to corrosion of their surface after exposure to a 1% solution (by mass) of sulfuric acid. The 1% acid solution shall be made by adding 5.7 mL of concentrated acid into 1000 mL of distilled water. **CAUTION:** Always add the concentrated acid into the water, not the reverse. The test shall be performed as follows:

Take a 25-mm x 50-mm sample, adhere it to the bottom of a glass tray and place just enough acid solution to completely immerse the sample. Cover the tray with a piece of glass to prevent evaporation and allow the sample to be exposed for 24 hours under these conditions. Then decant the acid solution (do not rinse, touch, or otherwise disturb the bead surfaces) and dry the sample while adhered to the glass tray in a 66°C oven for approximately 15 minutes.

Microscopic examination (20X) shall show no more than 15% of the beads having a formation of a very distinct opaque white (corroded) layer on their entire surface.

907-720.07.3.4--Color. The preformed pavement markings shall consist of white and yellow films with pigments selected and blended to conform to standard highway colors.

907-720.07.3.5--Skid Resistance. The patterned surface of the retroreflective pliant polymer shall provide an initial average skid resistance value of 45 BPN when tested according to ASTM Designation: E 303, except values will be taken at downweb and at a 45 degree angle from downweb. These two values will then be averaged to find the skid resistance of the patterned surface.

907-720.07.3.6--Patchability. The pavement marking material shall be capable of use for patching worn areas of the same type in accordance with manufacturer's instructions.

907-720.07.3.7--Thickness. The patterned material, without adhesive, shall have a minimum caliper of 1.651 mm at the thickest portion of the patterned cross-section and a minimum caliper of 0.508 mm at the thinnest portion of the cross-section.

907-720.07.4--Effective Performance Life. The film, when applied according to the recommendations of the manufacturer, shall provide a neat, durable marking that will not flow or distort due to temperature if the pavement surface remains stable. The film shall be weather resistant and, through normal traffic wear, shall show no appreciable fading, lifting or shrinkage throughout the useful life of the marking, and shall show no significant tearing, roll back, or other signs of poor adhesion.

907-720.07.5--Manufacturer's Certification. The Contractor shall furnish the Engineer three copies of the manufacturer's certification stating that each lot in a shipment complies with the requirements of the contract.

907-720.07.6--Acceptance Sampling and Testing. Final acceptance of each lot will be based on results of tests performed by the Department on verification samples submitted from each lot shipped to the project. The Engineer will select one sample at random from each lot in the shipment for testing. A sample extending full width of the randomly selected sample and 1.5 meters in length will be obtained and submitted by the Engineer. The sample from each shipment shall be provided at no cost to the State.

907-720.07.7--Warranty. All manufacturer's standard warranties and guarantees on high performance cold plastic pavement marking material, which are provided as customary trade practice, shall be delivered to the Engineer at the final inspection. All warranties and guarantees shall be made out to the Mississippi Department of Transportation.

MISSISSIPPI DEPARTMENT OF TRANSPORTATION

| SPECIAL PROVISION NO. 907-720-9M

CODE: (IS)

| DATE: 03/17/2008

| SUBJECT: Pavement Markings Materials

Section 720, Pavement Marking Materials, of the 1996 Metric Edition of the Mississippi Standard Specifications for Road and Bridge Construction is hereby amended as follows:

907-720.01.3--Packaging and Marking. Delete the first sentence of Subsection 720.01.3 on page 720-1 and substitute the following:

The beads shall be packaged in 22.7-kilogram or 25-kilogram moisture proofed bags.

| **907-720.02--Thermoplastic Pavement Markings.** Delete the first paragraph of Subsection 720.02 on page 720-2 and substitute the following:

The thermoplastic material shall be lead free and conform to AASHTO Designation: M 249 except the glass beads shall be moisture resistant coated.

| After the first sentence of the second paragraph of Subsection 720.02 on page 720-2, add the following:

Additional beads by the drop-on method shall be applied at a rate of not less than 45 grams of beads per meter of 150-mm stripe.

| Delete the third paragraph of Subsection 720.02 on page 720-2 and substitute the following:

The manufacturer/producers of the thermoplastic compound, glass beads, epoxy resin, and primer/sealer shall furnish to the Engineer three copies of certified test reports showing results of all tests specified therein and shall further certify that the materials meet all requirements. In addition, the certification for the thermoplastic material shall state that the material is lead free.

MISSISSIPPI DEPARTMENT OF TRANSPORTATION

| SPECIAL PROVISION NO. 907-720-10M

CODE: (IS)

| DATE:

SUBJECT: Reflective Pavement Markers and Adhesive for Pavement Markers

| Section 720, Pavement Marking Materials, of the 1996 Metric Edition of the Mississippi Standard Specifications for Road and Bridge Construction is hereby amended as follows:

Delete Subsection 720.03.3.1.1 on page 720-3 and substitute:

907-720.03.3.2--Marker Type B through G. The Contractor shall furnish the Engineer three copies of the manufacturer's certification covering all pavement markers shipped to the project. The certification shall state that the raised pavement markers meet the applicable requirements of ASTM Designation: D 4280.

The pavement markers will be tentatively accepted on the basis of the manufacturer's certification. The Department reserves the right to obtain check samples as deemed necessary for determining compliance with this specification.

Change the number of Subsection 720.03.3.2 on page 720-3 to "**907-720.03.3.3**".

Delete Subsection 720.03.4.2 on page 720-4 and substitute the following:

907-720.03.4.2--Tolerances.

907-720.03.4.2.1--Tolerances For Marker Type A, H & I. At least 90% of the original sampling of each lot of markers shall pass all tests with the following exceptions:

When less than 90% but more than 70% pass all tests, a resample of that lot will be allowed at the request of the Contractor. When less than 70% of the markers from the original sample comply with the requirements, the lot represented by the samples will be rejected and no resample will be allowed. Tolerances for resamples shall be in the same ratio as specified above.

At least two of three specimens, randomly selected for strength, water absorption, and autoclave, and also the averages of the three, must pass the stated requirements; otherwise, three additional markers selected at random shall be tested, and if the same conditions for passing are not met for these latter three markers, the lot will be rejected.

907-720.03.4.2.2--Tolerances For Marker Type B through G. At least 90% of the check sampling of each lot of markers shall pass the strength test required in the Physical Properties Section of ASTM Designation: D 4280 with the following exceptions:

When less than 90% but more than 70% pass the test, a resample of that lot will be allowed at the request of the Contractor. When less than 70% of the markers from the check sample comply with the requirements, the lot represented by the samples will be rejected and no resample will be allowed. Tolerances for resamples shall be in the same ratio as specified above.

Delete in toto Subsection 720.03.6 on pages 720-6 & 720-7 and substitute the following:

907-720.03.6--Reflective Pavement Markers. Reflective pavement markers shall be listed on the Department's "Approved Sources of Materials" and shall meet the applicable requirements of ASTM Designation: D 4280.

MISSISSIPPI DEPARTMENT OF TRANSPORTATION

SPECIAL PROVISION NO. 907-721-5M

CODE: (SP)

DATE: 1/09/2001

SUBJECT: Flexible Delineators

Section 721, Materials for Signing, of the 1996 Metric Edition of the Mississippi Standard Specifications for Road and Bridge Construction is hereby amended as follows:

Delete in toto Subsection 721.07.1 beginning on page 721-12 and substitute the following:

907-721.07.1--Flexible Posts. Flexible posts for delineators shall be composed of high impact fiberglass reinforced composite, engineering blended plastic or thermosetting polymers which is reasonably unaffected by long term U.V. exposure.

Flexible posts for delineators must be one from the Department's "Approved Sources of Materials". Prior to use, the Contractor shall furnish the Engineer three copies of the manufacturer's certification for each shipment stating that the material furnished is of the same composition as that originally approved by the Department and that the material has not been changed or altered in any way.

MISSISSIPPI DEPARTMENT OF TRANSPORTATION

SPECIAL PROVISION NO. 907-721-7M

CODE: (IS)

DATE: 05/01/2002

SUBJECT: Materials for Signing

Section 721, Materials for Signing, of the 1996 Metric Edition of the Mississippi Standard Specifications for Road and Bridge Construction is hereby amended as follows:

Delete the sixth paragraph of Subsection 721.02.2.1 on page 721-1 and substitute the following:

Structural steel shapes, bars, and plates used for bracing, framing and other accessories, including base plates for steel posts, per ASTM Designation: A 36.

Delete the fourth paragraph of Subsection 721.02.2.2 on page 721-2 and substitute the following:

Structural shapes, plates, and bars per ASTM Designation: A 36.

Delete the first paragraph of Subsection 721.02.5 beginning on page 721-2 and substitute the following:

907-721.02.5--Bolts, Nuts, Washers, Screws, and other Hardware. Except as otherwise specified, all bolts, nuts, washers, sheet metal screws, and machine screws shall be coated by the zinc chromate process. The zinc chromate process shall be in accordance with the requirements of ASTM Designation: B633. Bolts shall have a 13 millimeter head and shall meet the requirements of ASTM Designation: A307, Grade A. Nuts shall be self-locking and shall meet the requirements of ASTM Designation: A563. Flat washers shall be installed between the sign support and the self-locking nut and shall meet the requirements of ANSI Designation: B27.2. Sheet metal screws shall meet the requirements of ANSI Designation: B18.6.4. Machine screws shall meet the requirements of ANSI Designation: B18.6.3. Vinyl spacers shall be installed between the bolt head and the sign face and shall meet the following maximum dimensions: 22 mm outside diameter by 10 mm inside diameter by 1.5 mm thickness.

At the end of Subsection 721 on page 721-13, add the following:

907-721.10--Direct Applied Copy. Direct applied copy which is to be provided on guide directional signs, ground mounted or overhead, shall be directly applied to the sign face. Direct applied copy shall include letters, numerals, symbols and borders. The designs for capital and lower case shall be as required by the plans. All type of copy other than caps and lower case shall be as required by the plans. All type faces (fonts) shall conform to the recommendations contained in standards published by the Federal Highway Administration. All direct applied copy shall be attached to the sign face by means of pressure sensitive adhesive meeting the requirements of Subsection 721.06.5--Adhesive. Direct applied copy shall consist of encapsulated lens silver retroreflective sheeting meeting the requirements of Subsection 721.06--Reflective Sheeting.

All signs shall be delivered to the site of their erection in one piece with all bolts, rivets, moldings, extrusions, copy, and other required appurtenances thereto attached, complete and ready to be mounted to the sign support structure. Any required supplemental (temporary) supports required for stability during transport shall be firmly attached but easily removed prior to erection.

MISSISSIPPI DEPARTMENT OF TRANSPORTATION

SPECIAL PROVISION NO. 907-721-8M

CODE: (IS)

DATE: 01/18/2002

SUBJECT: Reflective Sheeting

Section 721, Materials for Signing, of the 1996 Metric Edition of the Mississippi Standard Specifications for Road and Bridge Construction is hereby amended as follows:

Delete in toto Subsection 721.06 beginning on page 721-4 and ending on page 721-12, and substitute the following:

907-721.06--Reflective Sheeting.

907-721.06.1--General. Retroreflective sheeting materials shall comply with all applicable requirements of ASTM Designation: D 4956, except as specifically modified herein, and be listed on the Department's "Approved Sources of Materials".

Reflective sheeting shall be one of the following types.

Type III A high-intensity retroreflective sheeting. This shall be an encapsulated glass-bead or unmetallized microprismatic retroreflective material. This sheeting shall have a protected, pre-coated, pressure-sensitive adhesive backing.

Type VII A super high-intensity retroreflective sheeting. This shall be an unmetallized microprismatic retroreflective material. This sheeting shall have a protected, pre-coated, pressure sensitive adhesive backing.

Type VIII A super high-intensity retroreflective sheeting. This shall be an unmetallized microprismatic retroreflective material. This sheeting shall have a protected, pre-coated, pressure sensitive adhesive backing.

Type IX A very-high intensity retroreflective sheeting. This shall be an unmetallized, microprismatic retroreflective material. This sheeting shall have a protected, pre-coated, pressure sensitive, adhesive backing.

All other retroreflective sheeting shall be as shown in the plans.

907-721.06.2--Performance Requirements. The retroreflective sheeting shall have the following minimum brightness values at 0.2° and 0.5° observation angle (in addition 1.0° for Type IX sheeting) expressed as average candelas per lux per square meter of material.

Sheetings and inks processed and applied in accordance with the manufacturer's recommendations, shall perform effectively for the number of years stated below. The sheeting will be considered unsatisfactory if it has deteriorated due to natural causes to the extent that: (1) the sign is ineffective for its intended purpose when viewed from a moving vehicle under normal day and night driving conditions or (2) the coefficient of retroreflection

is less than the minimum specified for that sheeting during the periods listed below. For screen printed transparent colored areas on white sheeting, the coefficients of retroreflection shall not be less than 70% of the values for the corresponding color in the table.

Type III Sheeting Retain 85% of initial values listed in Table 1 through 7 years
Retain 80% of initial values listed in Table 1 between 7 & 10 years

Type VII Sheeting Retain 85% of initial values listed in Table 2 through 7 years
Retain 80% of initial values listed in Table 2 between 7 & 10 years
Retain 50% of initial values listed in Table 2 through 3 years (Fluorescent Orange)

Type VIII Sheeting Retain 85% of initial values listed in Table 3 through 7 years
Retain 80% of initial values listed in Table 3 between 7 & 10 years
Retain 50% of initial values listed in Table 3 through 3 years (Fluorescent Orange)
Retain 80% of initial values listed in Table 3 through 7 years (Fluorescent Yellow/Green) (Fluorescent Yellow)

Type IX Sheeting Retain 85% of initial values listed in Table 4 through 7 years
Retain 80% of initial values listed in Table 4 between 7 & 10 years
Retain 80% of initial values listed in Table 4 for 7 years (Fluorescent Yellow/Green)(Fluorescent Yellow)

MINIMUM COEFFICIENTS OF RETROREFLECTION

(Candela per lux per square meter) - cd/lx/m²

(Per ASTM E 810)

**TABLE 1
Type III Sheeting**

Observation Angle	Entrance Angle	White	Orange	Yellow	Green	Red	Blue	Brown
0.2°	-4°	250	10	170	45	45	20	12
0.2°	+30°	150	60	100	25	25	11	8.5
0.5°	-4°	95	30	62	15	15	7.5	5.0
0.5°	+30°	65	25	45	10	10	5.0	3.5

**TABLE 2
Type VII Sheeting**

Observation Angle	Entrance Angle	White	Yellow	Green	Red	Blue	Brown	Fluorescent Orange
0.2°	-4°	750	560	75	150	34	23	200
0.2°	+30°	430	320	43	86	20	10	85
0.5°	-4°	240	180	24	48	11	8	90
0.5°	+30°	135	100	14	27	6.0	4	50

TABLE 3
Type VIII Sheeting

Observation Angle	Entrance Angle	White	Yellow	Green	Red	Blue	Brown	Fluorescent Orange	Fluorescent Yellow/Green	Fluorescent Yellow
0.2°	-4°	700	525	70	105	42	21	200	480	375
0.2°	+30°	325	245	33	49	20	10	85	240	170
0.5°	-4°	250	190	25	38	15	7.5	90	235	165
0.5°	+30°	115	86	12	17	7	3.5	50	110	85

TABLE 4
Type IX Sheeting

Observation Angle	Entrance Angle	White	Yellow	Green	Red	Blue	Fluorescent Yellow/Green	Fluorescent Yellow
0.2°	-4.0°	380	285	38	76	17	325	240
0.2°	+30.0°	215	162	22	43	10	205	150
0.5°	-4.0°	240	180	24	48	11	240	165
0.5°	+30.0°	135	100	14	27	6.0	110	75
1.0°	-4.0°	80	60	8	16	3.6	65	45
1.0°	+30.0°	45	34	4.5	9	2.0	35	25

907-721.06.3--Certification. The Contractor shall require the supplier to furnish certified evidence and/or samples to the Engineer showing conformance to these requirements. Manufacturer's warranties or guarantees provided as customary trade practice shall be furnished the Department.

907-721.06.4--Color. Reflective sheeting shall meet the color requirements of ASTM Designation: D 4956. See Table 5 below for color specifications for fluorescent yellow green, fluorescent orange, and fluorescent yellow sheeting.

TABLE 5
Color Specification Limits for New Sheeting (Daytime)

Color	Chromaticity Coordinate 1		Chromaticity Coordinate 2		Chromaticity Coordinate 3		Chromaticity Coordinate 4		Total Luminance Factor Limit Y? Min.
	x	y	x	y	x	y	x	y	
Fluorescent Yellow Green	0.387	0.610	0.460	0.540	0.438	0.508	0.376	0.568	60%
Fluorescent Orange	0.562	0.350	0.645	0.355	0.570	0.429	0.506	0.404	30%
Fluorescent Yellow	0.521	0.424	0.557	0.442	0.479	0.520	0.454	0.491	40%

907-721.06.5--Adhesive. The retroreflective sheeting shall include a pre-coated pressure sensitive adhesive (ASTM Designation: D 4956, Class I) applied without the necessity of additional adhesive coats on the retroreflective sheeting or application surface.

The Class I adhesive shall be a pressure sensitive adhesive of the aggressive tack type requiring no heat solvent or other preparation for adhesion to smooth clean surfaces.

The protective liner attached to the adhesive shall be removed by peeling without soaking in water or other solutions and shall be easily removed after accelerated storage for four hours at 70°C under a mass of 1750 kilograms per square meter.

907-721.06.6--Additional Contract Requirements. In addition to the above requirements, the following requirements are applicable only when the sheeting material is being purchased for use in the MDOT Sign Shop.

907-721.06.6.1--Sheeting Manufacturer's Replacement Obligation Where it can be shown that retroreflective traffic signs with Type III, Type VII, Type VIII, or Type IX sheeting supplied and used according to the sheeting manufacturer's recommendations have not met the performance requirements, the sheeting manufacturer shall replace the sheeting required to restore the sign surface to its original effectiveness during the entire 10 years. In addition, during the first seven (7) years the manufacturer of Type III, Type VII, Type VIII, or Type IX sheeting shall cover the cost of restoring the sign surface to its original effectiveness at no cost to the Department for materials and labor for both sign manufacture and installation.

907-721.06.6.2--Technical Assistance Requirements.

Instruction and Training. The manufacturer supplying the retroreflective sheeting shall provide at no additional cost the services of a qualified technician for instruction and training at the sign manufacturing facility. This instruction shall be provided bi-annually or when requested, and shall include but not be limited to training films, material application, equipment operation, silk screening techniques, packaging, storage, and other proven sign shop practices as they apply to the retroreflective sheeting supplied by the manufacturer, and to assure that the resulting signs can comply with the applicable specifications.

Technical Service. The sheeting manufacturer shall, without additional cost to the Department, provide the sign shop with competent technical service and product information including service on screen printing problems with the inks furnished by the manufacturer.

Equipment. The manufacturer supplying the retroreflective sheeting shall provide technical assistance for the recommended sheeting application equipment and certify that trained personnel shall be available on 72 hours notice to render such service necessary to adjust ink consistency or otherwise modify the application of silk screen equipment to accommodate use of manufacturer's sheeting. "Service" is understood to mean the capability of calibration and trouble shooting, as well as the training and retaining of personnel as required.

907-721.06.6.3--Warranty. Any warranties prepared by the manufacturer shall be included with the bid documents.

MISSISSIPPI DEPARTMENT OF TRANSPORTATION

SPECIAL PROVISION NO. 907-803-18M

CODE: (IS)

DATE: 02/05/2008

SUBJECT: Deep Foundations

Section 803, Bearing Piles, of the 1996 Metric Edition of the Mississippi Standard Specifications for Road and Bridge Construction is hereby deleted in toto and replaced as follows:

SECTION 907-803 - DEEP FOUNDATIONS

907-803.01--General.

907-803.01.1--Description. This work consists of furnishing and installing deep foundations in accordance with these specifications and in reasonable conformance with the lines, elevations, and spacings shown on the plans. It shall also consist of furnishing all required labor, tools, and equipment to determine the bearing value of the deep foundation by static load testing, by dynamic load testing, and/or by driving of the specified test piles.

907-803.01.2--Order Lists for Deep Foundations. Lengths found in the plans are estimated lengths for bid purposes. Unless otherwise specified or authorized in writing by the Bridge Engineer, all permanent deep foundations shall be installed within the prescribed tolerances specified herein and to the depths and/or lengths indicated on the itemized Order List furnished by the Engineer. The Order List shall be furnished after bearing has been verified either through static load testing, dynamic load testing, and/or driving of the specified test piles.

The Contractor shall furnish or install driven piles and/or drilled shafts in accordance with an itemized list furnished by the Engineer. The Order List will show the required length of the piles or drilled shafts for each bridge bent or footing.

907-803.02--Materials. All materials shall conform to the applicable requirements set forth in Sections 710, 711, 719, 804, and 814, or supplements thereto.

Driven piles shall conform to all applicable requirements set forth in Section 719 and the plans. Paint for steel piles or steel shells shall conform to the applicable requirements of Sections 710 and 814.

Drilled shaft concrete shall conform to the requirements of Section 804 for Class "DS" concrete. All reinforcing steel shall conform to the requirements of Section 907-711 of the Specifications.

907-803.03--Construction Requirement. This work shall consist of furnishing all labor, materials, equipment and services necessary to install driven piles of the prescribed type in accordance with these specifications and in conformance with the lines, elevations, and spacings shown on the plans.

This work shall also consist of furnishing all labor, materials, equipment and services necessary to perform all operations to complete the drilled shaft installations in accordance with these specifications and with the details and dimensions shown on the plans. Drilled shafts shall consist of reinforced or nonreinforced concrete with or without concrete bell footings.

907-803.03.1--Driven Piles.

907-803.03.1.1--General. Unless otherwise specified or authorized by the Bridge Engineer, all permanent production piles shall be driven in a continuous operation, to the full lengths indicated on the itemized order list furnished by the Bridge Engineer.

907-803.03.1.2--Accuracy of Installation. Driven piles in trestle bents shall be driven to within a tolerance of 20 millimeters per meter from the vertical or from the batter shown on the plans. Piles to be incorporated into a cap or footing shall not be out of the position shown on the plans by more than 150 millimeters. In all cases, piles shall be driven so that they will not be excessively stressed to place them in the proper location in the cap or footing. Excessive manipulation of the piles will not be permitted, and the Contractor shall redrive or use other satisfactory methods to avoid such manipulations. No shimming on tops of piles will be permitted.

907-803.03.1.3--Extensions, Build-ups and Splices. If determined by the Engineer to be necessary, production piles that are extended below cut-off shall be extended, built-up, or spliced in accordance with the plans to the extent established by the Bridge Engineer. Extensions or build-ups will not be measured for payment as such, but will be included in the total length of piling in the finished structure.

907-803.03.1.4--Cut-Offs. If it is determined by the Engineer that the pile has reached practical refusal above pile cut-off elevation but below the prescribed minimum tip elevation shown in the plans then the Contractor will be allowed to cut off the pile at the cut-off elevation.

907-803.03.1.5--Driven Pile Types. Driven piles shall be of the type listed below unless otherwise specified in the plans.

907-803.03.1.5.1--Concrete Piles. Concrete piles shall be the size and shape specified. Reinforcement, unless otherwise designated, shall have a clear distance of at least 50 millimeters from the face of the pile. When the piles are for use in salt water or alkali soils this clear distance shall be at least three inches.

907-803.03.1.5.2--Steel Piles. Full-length piles shall be used unless splicing is approved in writing by the Bridge Engineer. When permitted, splicing shall be in accordance with the notes and details shown on the plans.

907-803.03.1.5.3--Timber Piles. Specified timber piles or timber piles used for temporary construction shall meet the requirements set forth in Section 820.

907-803.03.1.5.4--Special Piles. Piles not of the type specified above, but called for in the plans or additional specifications shall meet the general requirements contained therein.

907-803.03.1.6--Preparation for Driving.

907-803.03.1.6.1--Excavation. When a pile cap is located below the ground line, piles shall not be driven until the required excavation is completed. All material forced up between the piles shall be removed to the correct elevation at the Contractor's expense before concrete for the foundation is placed.

907-803.03.1.6.2--Pile Cushions. Suitable cushioning material shall be used between the driving helmet and the top of the pile. This is especially critical for concrete piles. The Contractor should submit the type material, cross-sectional area and total thickness of the pile cushion. This information shall be submitted to the Engineer for approval on the completed *Pile Driving Equipment Data Form*. The pile cushion shall be approved with the pile driving system and is subject to satisfactory field performance.

907-803.03.1.7--Method of Installation and Driving System.

907-803.03.1.7.1--General. The pile driving system shall be defined as all equipment necessary to install the specified piles to the required minimum tip elevations specified in the plans. The pile driving system shall include the pile hammer, hammer leads, followers, water jets, drilling equipment for pre-formed pile holes, and templates, if necessary.

907-803.03.1.7.2--Submittal of Pile Driving System Data. The Contractor shall submit to the Engineer all technical specifications and operating instructions relating to the pile driving system that is to be used to drive the piling. The Contractor shall also submit a completed *Pile and Driving Equipment Data Form* to the Engineer at the pre-construction conference or no later than 14 days prior to the anticipated driving date. The Contractor will not be allowed to install any piling until the driving system has been approved in writing by the Engineer. The Department will use the submitted information to perform wave equation analysis and prepare a summary report of the wave equation results. The wave equation analysis and other data shall be used to assess the ability of the proposed systems to install the piles to the desired penetration depth within the AASHTO standards for driving stresses.

The Engineer will notify the Contractor of any additional information required and/or changes that may be necessary to meet the project requirements. Any parts of the driving system that are unacceptable will be rejected and the Contractor will submit changes. Review of these changes will be completed within seven (7) days and the Contractor notified of their acceptance or rejection. Approval of the proposed driving system by the Engineer for driving of test piles shall be based upon the wave equation analysis indicating that the proposed driving system is acceptable.

All production piles shall be driven with the hammer bearing the same Serial Number submitted on the *Pile and Driving Equipment Data Form* and used to drive the test piles. In the event multiple hammers of differing type are used on the same bridge, the Contractor shall submit to

the Engineer for approval a completed *Pile and Driving Equipment Data Form* for each hammer and specify the bridge bents in which each hammer will be used. This will allow the Department the opportunity to develop appropriate driving and acceptance criteria specific to each hammer.

A different pile driving system, modifications to the existing system, or different pile installation procedures shall be proposed by the Contractor if the pile installation stresses predicted by the wave equation analysis or calculated by the PDA are not within the AASHTO values. All approvals are conditional and subject to trial and satisfactory performance in the field. Unless otherwise permitted by the Bridge Engineer in writing, test piles and permanent piles shall be driven with the approved driving system.

907-803.03.1.7.3--Pile Hammers. Piles may be driven with an approved single-acting or double-acting pile hammer in combination with water jets or pre-formed pile holes. The pile driving system shall be constructed so as to afford freedom of movement of the pile hammer and to drive the piles to the required depth within the tolerances specified without undue injury to the piles.

The pile hammer shall be in good working condition and produce the energy required to install piles to the depth or penetration required in the plans. Single or double-acting Steam/Air, Diesel/Internal Combustion, or Hydraulic hammers may be submitted for review and approval.

In no case shall a gravity or drop hammer be used to drive concrete or steel piles supporting the permanent bridge structure. A drop hammer may be used to install timber or steel piles for temporary construction, but in no case shall a gravity or drop hammer be used to drive concrete piles.

907-803.03.1.7.4--Driving Appurtenances.

907-803.03.1.7.4.1--Pile Hammer Leads. Either fixed leads or swinging leads may be used. Swinging leads shall be used in combination with rigid templates approved by the Engineer. Battered piles shall be driven in inclined leads or multiple rigid templates capable of holding the pile in the proper position during driving.

907-803.03.1.7.4.2--Pile Cushions. Suitable cushioning material shall be used between the driving cap and the top of the pile. The cushion material shall protect the pile top during driving and shall be constructed such that the hammer energy is uniformly distributed to the pile top. The pile cushion shall be changed prior to driving each pile. In addition, if the cushion material becomes highly compressed, or chars or burns during the driving operations or damage occurs at the pile top, it shall be replaced. The type of material and dimensions of the pile cushion shall be included in the appropriate place on the *Pile and Driving Equipment Data Form*.

907-803.03.1.7.4.3--Water Jets. Water jets may be used in conjunction with the pile hammer to install piles to the required depth or penetration called for in the plans. The use of water jets, where the stability of embankments or other improvements would be endangered, will not be permitted. When water jets are used, the number of jets and the volume and pressure of water shall be sufficient to adequately facilitate driving without undue damage to the pile or the soil

adjacent to or below the pile. Unless otherwise specified, water jets shall not be used within five feet of the final tip elevation of the pile. In addition, it shall be the Contractor's responsibility to withdraw the water jets sufficiently above the 1.5 meters requirement to obtain the specified bearing at the required cut off elevation.

In the event a jetted pile fails to obtain the specified bearing at the required penetration and a determination is made by the Engineer that the Contractor has failed to properly control the jetting operation, the Contractor should submit detailed corrective measures for founding the pile to the Engineer for approval. Any required corrective measures to the pile due to the Contractor's operation shall be performed at no additional cost to the State.

907-803.03.1.7.4.4--Followers. Followers are considered to be part of the Driving System and should be included for approval with the *Pile and Driving Equipment Data Form*. Included with the submittal should be a dimensioned sketch of the follower. Also, the type(s) of materials that the follower is made of and the mass of the follower should be included as well as cushion information.

907-803.03.1.7.4.5--Pre-formed Pile Holes. The Bridge Engineer will make all determinations as to the necessity for pre-formed pile holes and the size and maximum depth of each hole required or permitted.

If it is determined from the Geotechnical Investigation or from the site survey that pre-formed pile holes are necessary, a pay item and estimated quantities will be included on the plans, and the Bridge Engineer will furnish the Contractor with an itemized list showing the location, size and bottom elevation of each hole.

If the plans do not specify pre-formed pile holes and the Bridge Engineer, with the concurrence of the Construction Engineer, determines during construction that subsurface conditions are encountered that necessitate pre-formed pile holes, at certain locations, an adjustment in the contract unit price for furnishing and driving piling at these locations may be made under the provisions of Subsection 104.02.

If in the judgment of the Engineer pre-formed pile holes are not required and the Contractor desires to use them, the Contractor may be permitted to do so under conditions prescribed by the Bridge Engineer and at no additional cost to the State.

907-803.03.1.7.4.6--Additional Equipment. When a minimum penetration is indicated on the plans and is not obtained by the use of an approved hammer, the Contractor shall submit to the Engineer for approval a completed *Pile and Driving Equipment Data Form* for a heavier hammer or resort to jetting at no additional cost to the State.

907-803.03.1.8--Defective Piles. Prior to driving, piles shall not be subjected to handling that causes damage either through bending, crushing or spalling of concrete, or deformation of the steel. All piles damaged because of internal defects or by improper driving, driven out of the proper location or driven below the specified elevation shall be corrected at the Contractor's expense by one of the following methods approved by the Engineer for the pile in question:

- 1) The pile shall be withdrawn and replaced by a new and, if necessary, a longer pile.
- 2) A second pile shall be driven adjacent to the defective or low pile.
- 3) The pile shall be spliced or built up or a sufficient portion of the footing shall be extended to properly embed the pile. All piles pushed up by the driving of adjacent piles or by any other cause shall be driven down to grade.

907-803.03.1.9--Determination of Bearing Value of Piling.

907-803.03.1.9.1--General. The ability of the pile to transfer load to the ground will be determined to the satisfaction of the Bridge Engineer. Such determination will be made by the Geotechnical Engineer and Foundation Engineer from a subsurface investigation conducted by the Geotechnical Branch of Materials Division and test piles that are driven out-of-position or driven to be incorporated in the structure as permanent piles.

907-803.03.1.9.2--Determination of Bearing Value by Pile Hammer Formulas. When load testing, either static or dynamic, is not called for in the plans, the safe bearing values will be determined by the following formulas or as directed by the Engineer.

$$P = \frac{1634WH}{S+5.08} \quad \text{for single-acting steam/air hammers and open cylinder diesel hammers}$$

$$P = \frac{217H(W+Ap)}{S+2.54} \quad \text{for double-acting steam hammers}$$

- Where
- P = safe bearing value in kilonewtons (kN)
 - W = mass, in kilograms, of striking parts of hammer
 - H = height of fall in meters
 - A = area of piston in square millimeters
 - p = steam/air pressure in Pascals at the hammer
 - S = the average penetration in 10 blows for gravity hammers and the last 10 to 20 blows for steam/air hammers.

These formulas are applicable for the following conditions only:

- The hammer has a free fall.
- The pile head is not crushed.
- The penetration is reasonably quick and uniform.
- There is no appreciable bounce after the blow.
- A follower is not used.

Where there is appreciable bounce of the hammer, twice the height of the bounce shall be deducted from “H” to determine its value in the formula.

When water jets are used, the bearing value shall be determined by the above formulas from the results of driving after the jets have been withdrawn, or a static or dynamic load test has been conducted.

Formulas for pile hammers not covered herein must be approved by the Bridge Engineer.

907-803.03.1.9.3--Determination of Bearing Value by PDA Monitoring (Dynamic Load Testing).

907-803.03.1.9.3.1--Description. This work consists of furnishing all labor, materials, equipment and services necessary to perform all operations to complete the determination of bearing value of piling by Department forces using a Pile Driving Analyzer (PDA) and associated equipment. The dynamic load testing measurements will be performed in accordance with the plans and the guidelines given herein.

907-803.03.1.9.3.2--Scope and Sequence of Construction. The dynamic measurements will be performed on the piles as detailed below for the purpose of obtaining ultimate pile bearing capacity, pile driving stresses, pile integrity, and the pile driving system efficiency. Unless otherwise directed in the plans, the sequence of construction outlined below shall not be deviated from unless an alternate sequence of construction is approved in writing by the Engineer.

- 1) When called for in the plans, Load Testing With Special Instrumentation and/or Conventional Static Load Testing will be performed on piles as detailed. Piles to be load tested shall be driven in the location shown in the plans with PDA monitoring under initial drive and have restrikes performed.
- 2) When called for in the plans, PDA Test Piles will be driven with PDA monitoring under initial drive and have restrikes performed as detailed below. The test piles will be used as production piles and be incorporated into the bridge structure.
- 3) Any production piles determined by the Engineer to require PDA monitoring during initial drive or require PDA restrikes.

907-803.03.1.9.3.3--PDA Monitored Driving and/or Restrike of Piling.

907-803.03.1.9.3.3.1--General. When called for in the plans or the Engineer, a Pile Driving Analyzer (PDA) and instrumentation will be used to obtain dynamic measurements during pile driving and pile restrikes. The analysis of the monitoring will be the responsibility of the Department. The Contractor shall give notice to the State Geotechnical Engineer at least 14 calendar days before the scheduled date of driving piles to be monitored. The Contractor shall confirm the driving date three calendar days prior to the scheduled driving date.

907-803.03.1.9.3.3.2--Contractor Requirements. The Contractor shall be responsible for furnishing the following:

- 1) A power supply providing at least 1800 watts of 115-volt AC power with a frequency of 60 Hz at the driving site.
- 2) Prepare the driving site.

- 3) Supply the labor necessary for attaching the dynamic monitoring instrumentation to the piles. The Contractor shall make one of their personnel available to place the transducers on the piles after the piles have been placed in the leads.
- 4) Drive the piles as directed by the Engineer.

The Contractor shall make the piles available prior to driving for drilling and tapping of holes that are necessary for attachment of instrumentation. The expected delay for attaching the instruments to the pile will be approximately one (1) hour. The Contractor shall use reasonable care when working with piles when instruments are installed and shall replace any damaged equipment caused by Contractor error at no additional cost to the State.

907-803.03.1.9.3.3--Driving Requirements. Piles to be used in the determination of pile bearing by PDA monitoring shall be driven with PDA instrumentation attached to the pile and shall have a PDA monitored 1-day and 7-day restrrike performed after the initial pile driving. The Engineer may modify the waiting periods that are required before the restrikes are performed. When a static load test is to be performed, the 7-day restrrike should be eliminated and a PDA monitored restrrike done within 24 hours of completion of the static load test. When deemed necessary by the Engineer, permanent piles may have PDA monitored restrikes performed to confirm or supplement design requirements.

Restrikes shall be performed with a warm hammer operating at normal efficiency. A warm hammer is defined as a hammer that has applied a minimum of 20 blows to another pile or a dummy block immediately before being used in a restrrike. The restrrike shall consist of striking the pile for 50 blows or until the pile penetrates an additional 75 millimeters, whichever occurs first. In the event the pile movement is less than 25 millimeters after 15 blows during the restrrike, the restrrike may be terminated.

907-803.03.1.9.4--Determination of Bearing Value by Static Load Testing. When called for in the plans or directed by the Engineer, static load testing will be conducted to determine the ultimate bearing capacity of piles. Depending upon the conditions encountered in the field, the Bridge Engineer may increase or decrease the number of static load tests required.

907-803.03.1.9.4.1--Load Testing of Piling With Special Instrumentation.

907-803.03.1.9.4.1.1--General. When called for in the plans, out-of-position test piles shall be driven with special instrumentation attached for the purpose of conducting a load test as directed by the plans. A waiting period of seven (7) calendar days shall be observed beginning after the out-of-position test pile is driven. After the waiting period, the pile shall be load tested to failure as directed by the plans. The Contractor will be responsible for furnishing all materials, equipment, labor, and incidentals necessary for conducting the load test. The Contractor shall subcontract and supply all instrumentation, conducting, and reporting of the load test to the company supplying the instrumentation, with the cost included in prices bid for items contained in the contract. Reaction systems and extra pile installations as required in the plans shall be absorbed in the cost for the load test on the pile.

907-803.03.1.9.4.1.2--Materials. When called for in the plans, instrumentation shall be supplied to meet the requirements set forth in the plans. Instrumentation required in the plans are subject to prior approval by the State Geotechnical Engineer. Additional equipment that may be required are as follows.

- 1) Materials sufficient to construct a stable reference beam system for monitoring deflection of the pile during testing, supported at a minimum distance of three (3) diameters from the center of the pile to prevent disturbance of the reference system.
- 2) Materials sufficient to construct a protected work area including provisions such as a tent or shed for protection from inclement weather for the load test equipment. The work area shall be of size and type required by the Engineer.
- 3) In the case of an out-of-position pile, the pile shall be removed or broken-off such that the remaining pile is at least 600 millimeters below the ground or mud line.

Materials supplied, which do not become a part of the finished structure, shall be removed from the job site.

907-803.03.1.9.4.2--Conventional Static Load Testing of Piling.

907-803.03.1.9.4.2.1--General. When called for in the plans or directed by the Engineer, the pile to be load tested shall be installed as indicated in the plans to the specified tip elevation or as directed by the Engineer. Once the pile is in place, a static load test will be conducted to determine the ultimate bearing capacity of the pile. A waiting period of seven (7) calendar days shall be observed beginning after all the reaction piles have been driven but prior to static load testing.

907-803.03.1.9.4.2.2--Contractor Requirements. The Contractor shall be responsible for furnishing the following:

- 1) A reaction load frame capable of resisting a total load of at least five (5) times the design load called for in the plans. The frame shall consist of a beam or girder that will carry the above load while sustaining only minor deflections in the reaction system. The beam or girder shall be attached to a system of anchor piles. The anchor piles shall not be closer to the test pile than five times the diameter (width) of the pile to be tested. See Figure 1 for additional reaction load frame requirements.
- 2) A hydraulic jack that has been calibrated for the full range of anticipated loads in accordance with AASHTO Designation: T 67 (ASTM Designation: E 4) at least once. The maximum anticipated load shall be assumed to be five (5) times the design load called for in the plans. The pressure gauge shall be calibrated within one year preceding the time of use and whenever there is a reason to doubt the accuracy of the results. The Contractor shall furnish a certificate of calibration for the hydraulic jack at the time of static load testing.
- 3) A measuring frame or reference beam for measuring the movement of the pile during testing. Two dial gauges, supplied by the Department, will be attached to the pile as indicated on Figure 1. Each dial gauge shall be actuated by its stem or by a stem attachment resting on the measuring frame. The supports for the measuring frame shall be placed the maximum practical distance from the test pile and the anchor piles for the

reaction load frame. In no case should the measuring frame be affected by movement of the test pile or the anchor piles.

- 4) In the case of an out-of-position pile, the pile shall be removed or broken-off such that the remaining pile is at least two (2) feet below the ground or mud line.

907-803.03.1.9.4.2.3--Methods and Equipment. Personnel from the Geotechnical Branch of MDOT will assist in the setup and will be responsible for the running of the test. The Department will be responsible for providing the load cell, dial gauges and associated equipment. The static load test will be performed using ASTM Designation: D 1143, quick test methods. A waiting period of seven (7) calendar days shall be observed beginning after all the reaction piles have been driven but prior to static load testing.

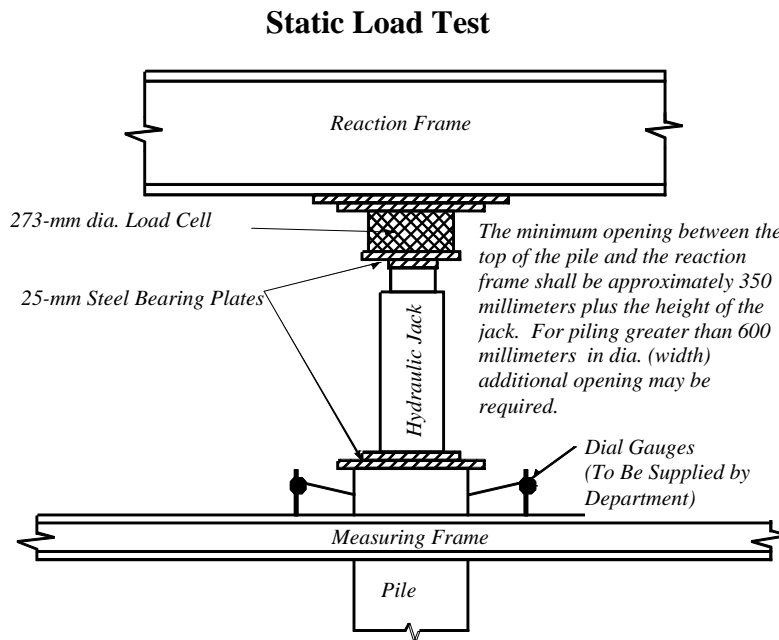

Figure 1

907-803.03.1.10--Pile Acceptance. The safe allowable load for each type, size, and length of pile will be determined by the Bridge Engineer. Acceptance criteria for permanent production piles will be supplied by the Bridge Engineer with the final order list.

907-803.03.1.11--Test Piles. When required in the plans, the Contractor shall furnish and install test piles of the sizes, types, and lengths at the locations shown on the plans. The number of test piles may be increased or decreased by the Bridge Engineer as field conditions warrant. If determined by the Engineer to be necessary, test piles shall be extended, built-up, or spliced and in the case of steel piles driven further if deemed necessary, to the depths established by the Bridge Engineer. Similarly, the Contractor may be required to drive test piles below cut-off and extended as necessary.

907-803.03.2--Drilled Shafts.

907-803.03.2.1--Submittals.

907-803.03.2.1.1--Qualification of Contractor. The person(s) or firm directing the work described in this specification shall be knowledgeable of drilled shaft installation procedures and shall have installed drilled shafts of both diameter and length similar to those shown in the plans in accordance with the following minimum experience requirements:

- 1) A drilled shaft Contractor shall have a minimum of three (3) years of drilled shaft installation experience prior to the bid date for this project; or,
- 2) A Contractor without prior drilled shaft experience shall employ a superintendent with a minimum of fifteen years of drilled shaft experience prior to the bid date of this project.

A Contractor with limited drilled shaft installation experience may use a combination of their experience and the superintendent's experience, with each five years of experience of the superintendent counting as equivalent to one year's experience of the Contractor. A signed statement listing the applicable work experience of the drilled shaft Contractor shall be submitted to the Engineer at the Preconstruction Conference, or no later than 45 calendar days prior to drilled shaft construction.

At the Preconstruction Conference, or no later than 45 calendar days prior to beginning drilled shaft construction, the Contractor shall furnish the Engineer evidence of the following:

- 1) A signed statement from the drilled shaft superintendent responsible for the drilled shaft installation that the project site has been visited, and that all the subsurface information has been inspected. This information includes the soil profiles and/or boring logs furnished in the plans, soil samples and rock cores, and the Geotechnical Investigation. All the above information may be obtained from the Geotechnical Branch of Materials Division.
- 2) A signed statement from the drilled shaft Contractor detailing their ability to complete a project of this type. This shall be supported by a list containing a detailed description of at least three (3) projects completed in the last three (3) years on which the drilled shaft Contractor and/or superintendent has installed or supervised installation of drilled shafts similar in size to those shown in the plans, and utilized excavation methods similar to those anticipated for this project. This list of projects shall contain names and phone numbers of the project owner's representatives who can verify the drilled shaft Contractor's participation on the project, and the names of the superintendents who were in charge of the drilled shaft operations.
- 3) Name and experience records of the drilled shaft superintendent and driller who will perform the required work.

The Engineer will evaluate the evidence of qualifications submitted for conformance with these specifications. Should the information submitted be incomplete or not conform to the project specifications, the information will be rejected and the Contractor shall submit changes for reevaluation.

If the Contractor wishes to replace the drilled shaft superintendent or the driller during the life of the project, the name and experience record of their replacement shall be submitted to the Engineer for approval.

907-803.03.2.1.2--Drilled Shaft Installation Plan. At the Preconstruction Conference, or no later than 45 calendar days before drilled shaft construction begins, the Contractor shall submit to the Engineer an installation plan for review. This plan shall provide information on the following:

- 1) A copy of the proposed drilled shaft concrete mix design as submitted with the Contractor's Concrete Quality Control Plan. Construction of the trial shaft(s) will not commence until the drilled shaft concrete mix design has been approved in accordance with Section 804, Concrete for Bridges and Structures.
- 2) List and size of proposed equipment including cranes, drill rigs, augers, bits, bailing buckets, digging buckets, final cleaning equipment, slurry tanks, desanding equipment, slurry pumps, tremies, pump lines, concrete pumps, casings, etc.
- 3) Details of the method of exploration including the equipment, if required.
- 4) Details of the sequence of construction operations and sequence of shaft construction within bents or shaft groups.
- 5) Details of shaft excavation method(s).
- 6) Details of slurry type and usage, including proposed methods to mix, circulate and desand slurry when slurry is required.
- 7) Details of proposed methods to clean the drilled shaft excavation upon reaching the minimum required tip elevation.
- 8) Details of reinforcement placement including the method of support while aligning the cage for placement into the drilled shaft excavation and the centering devices to be used to center the cage and assure minimum outside clear space shown in the plans.
- 9) Details of concrete placement including proposed operational procedures for concrete tremie or pump, including initial placement, raising during placement, and overfilling of the shaft concrete, and the ability of the concrete supplier to provide a continuous pour for the anticipated volumes.
- 10) Details of casing installation and removal, when required.
- 11) Details of any required load tests including equipment and recent calibrations for any jacks supplied by the Contractor.

The Engineer will evaluate the Contractor's *Drilled Shaft Installation Plan* for conformance with the plans and specifications, after which the Engineer will notify the Contractor within 14 calendar days of any additional information and/or changes that may be required. Any part of the plan that is unacceptable will be rejected and the Contractor shall submit changes for reevaluation.

All approvals given by the Engineer shall be subject to trial and satisfactory field performance, and shall not relieve the Contractor of the responsibility to satisfactorily complete the work as detailed on the plans and in the specifications.

907-803.03.2.2--Trial Shaft Construction. The Contractor shall demonstrate the adequacy of the methods and equipment during construction of an out of position trial shaft. This trial shaft shall be positioned as far as practical from the production shafts, in the position shown on the plans or as directed by the Engineer, and shall be drilled to the minimum tip elevation as required on the plans. When shown on the plans, the reaming of bells at specified trial shafts will be required to establish the feasibility of bell in a specific soil strata. Failure to demonstrate the adequacy of the Contractor's methods and equipment to construct the trial shaft shall be cause for the Engineer to require alterations in equipment and/or method by the Contractor, to eliminate unsatisfactory results. Backfilling of unsuccessful excavations and any additional trial shafts required to demonstrate the adequacy of altered methods of construction or equipment shall be performed by the Contractor at no additional cost to the State. Once the Contractor has completed the excavation for the trial shaft to the satisfaction of the Engineer, the Contractor shall set the reinforcement and pour the concrete to finish construction of the trial shaft. This shall be demonstration that the entire plan for drilled shaft construction is satisfactory. Failure to successfully construct the trial shaft shall be cause for rejection of the trial shaft, and shall be reason for the Engineer to require alterations necessary to eliminate unsatisfactory results. Additional trial shafts to demonstrate correction of deficiencies shall be at the Contractor's expense.

If differing soil conditions require two (2) or more methods for construction of production shafts, said methods shall be demonstrated by trial shaft prior to construction of any production shaft.

After the successful trial shaft has been completed, the Contractor shall submit in writing for review the successful methods and equipment used. This submittal, once reviewed, will serve as the approved method of construction for all the production shafts covered by that successful trial shaft. Once approval has been given to construct production shafts, no changes will be permitted in the methods, equipment, drilled shaft superintendent, or driller from those used during the construction of the trial shaft without written approval of the Engineer.

Trial shafts shall be cut off 600 millimeters below finish grade or 600 millimeters below the mudline and left in place. The portions of the shafts cut off and removed shall remain the property of the Contractor. The disturbed areas in the vicinity of the trial shaft shall be restored as nearly as practical to their original condition.

907-803.03.2.3--Construction Methods and Equipment.

907-803.03.2.3.1--General.

907-803.03.2.3.1.1--Protection of Existing Structures. When the plans require drilled shaft excavations within close proximity to existing structures or utilities, the Contractor shall take all reasonable precautions to prevent damage to such structures. This shall include newly constructed shafts. If not otherwise provided for in the plans, the Contractor shall be solely responsible for evaluating the need for, design of, and providing all reasonable precautionary features to prevent damage. These measures shall include, but are not limited to, selecting construction methods and procedures that will prevent caving of the shaft excavation, and monitoring and controlling the vibrations from construction activities, including the driving of

casings, driving of sheeting, or from blasting, when permitted. Advancing an uncased drilled shaft excavation or the use of a vibratory hammer to install casings within nine (9) meters of a newly constructed shaft will not be permitted unless the concrete in that shaft has attained a compressive strength of 17 MPa, as determined by cylinder tests, or maturity meter probe when maturity meter readings indicate that the required concrete strength is achieved. Based upon observations, the Engineer may adjust this distance accordingly. During shaft construction, the Contractor shall take into account and make provisions for vibrations caused by activities other than the Contractor's, such as adjacent traffic.

If a maturity meter probe is used, it shall be located in the last concrete placed. Procedures for using the maturity meter and developing the strength/maturity relationship shall follow the requirements of AASHTO Designation: T 325 and ASTM Designation: C 1074 specifications. Technicians using the maturity meter or calculating strength/maturity graphs shall be required to have at least two hours of training prior to using the maturity equipment.

Such structures shall be monitored for settlement in an approved manner, recording elevations to the millimeter (0.001 m). The number and location of monitoring points shall be as approved by the Engineer. Elevations shall be taken before construction begins, during the driving of any required casings, and during excavation or blasting as directed by the Engineer.

When shown on the plans, or as directed by the Engineer, the Contractor shall monitor and record vibration levels during the driving of casings, sheeting, or during blasting operations. Vibration monitoring equipment shall be capable of detecting particle velocities of 2.5 millimeters per second or less.

At any time the Contractor detects settlement of nine millimeters (9 mm), vibration levels reaching 38 millimeters per second, or damage to the structure, the Contractor shall immediately stop the source of vibrations, backfill the excavation, and contact the Engineer for instructions.

907-803.03.2.3.1.2--Construction Sequence for Site Preparation. Excavation to the plan footing elevation, if required, shall be completed before shaft construction begins. Any disturbance to the footing area caused by shaft installation shall be repaired by the Contractor prior to the footing pour.

When drilled shafts are to be installed in conjunction with embankment placement, the Contractor shall construct the drilled shafts after placement of the embankment material.

907-803.03.2.3.1.3--General Methods and Equipment. The Contractor shall perform the excavations required for the shafts and bell footings, through whatever materials encountered to the dimensions and elevations shown on the plans, or otherwise required by the specifications, at no additional cost to the State. The Contractor's methods and equipment shall be suited for the intended purpose and the materials encountered.

Drilled shafts shall be constructed by either the dry method, wet method, casing method, or permanent casing method, as necessary to produce a sound, durable, concrete foundation free of defects. The permanent casing method shall be used only when required by the plans or

authorized by the Engineer. When the plans describe a particular method of construction, this method shall be used unless otherwise permitted by the Engineer. The Engineer may permit an alternate method than designated on the plans, only after successful construction of an out of position trial shaft. When the plans do not describe a particular method, the Contractor shall utilize a method on the basis of its suitability to the site conditions. Blasting shall only be permitted if specifically stated on the plans or approved by the Engineer.

Once approval is given to construct production shafts, no changes will be permitted in the methods or equipment from those used in constructing the accepted trial shaft without written approval of the Engineer.

907-803.03.2.3.2--Dry Construction Method. The dry construction method shall be used only at sites where the groundwater level and soil conditions are suitable to permit construction of the shaft in a relatively dry excavation, and where the sides and bottom of the shaft may be visually inspected by the Engineer prior to placing the concrete. The dry method consists of drilling the shaft excavation, placing the reinforcing cage, and concreting the shaft in a relatively dry excavation.

The dry construction method shall be used only when the trial shaft excavation demonstrates that: concrete can be placed with less than 75 millimeters of accumulated water in the bottom of the shaft; the sides and bottom of the hole remain stable without caving, sloughing, or swelling over a two-hour period immediately following completion of the excavation; and any loose material and excess water can be satisfactorily removed prior to inspection and prior to concrete placement.

907-803.03.2.3.3--Wet Construction Method. The wet construction method shall be used at all sites where it is impractical to provide a dry excavation for placement of the shaft concrete.

The wet construction method consists of drilling the shaft excavation below the water table, keeping the shaft filled with water or mineral slurry, not a separate pay item, desanding or cleaning the slurry, final cleaning of the excavation by means of a bailing bucket, air lift, submersible pump or other approved devices, and placing the rebar cage and the shaft concrete, with a tremie or concrete pump beginning at the shaft bottom, which displaces the water or slurry as the shaft is concreted. Temporary surface casings shall be provided to aid shaft alignment and position and to prevent sloughing of the top of the shaft, except when the Contractor demonstrates to the satisfaction of the Engineer that the surface casing is not required.

Where drilled shafts are located in open water areas, the shafts shall be constructed by the wet method using casings extending from above the water elevation into the ground to protect the shaft concrete from water action during placement and curing of the concrete. The casing shall be installed in a manner that will produce a positive seal at the bottom of the casing so that there is no intrusion or extrusion of water or other materials into or from the shaft excavation. Casings for this application may include multiple casings, temporary casings, and/or designed permanent casings.

The wet construction method may be used in combination with the dry method and temporary or permanent casing methods.

907-803.03.2.3.4--Casing Construction Method. The casing construction method may be used at sites when the dry or wet construction methods are inadequate to prevent hole caving or excessive deformation of the hole. In this method, the casing may be either placed in a predrilled hole if no caving, swelling, or yielding occurs, or advanced through the ground by twisting, driving, or vibration before being cleaned out.

When a formation is reached that is nearly impervious, a casing shall be placed in the hole and seated in the nearly impervious formation. Drilling may proceed as with the dry method to the projected depth. If seepage occurs at this point, temporary casing may be advanced further to create the dry condition. In the event seepage conditions prevent use of the dry method, excavation shall be completed using wet methods. The placement of the concrete shall proceed as with the wet or dry method, except that the casing shall be withdrawn after the concrete is placed.

When caving soils occur near the ground surface and/or if the top of the concrete for the drilled shaft is below the ground surface, the Contractor shall set a suitable temporary removable surface casing. The minimum surface casing length shall be the length required to prevent caving of the surface soils and to aid in maintaining shaft position and alignment. Predrilling with slurry and/or overreaming to the outside diameter of the casing may be acceptable if required to install the surface casing at some sites.

Where drilling is through materials having a tendency to cave, the drilling shall be advanced by drilling in a mineral slurry. In the event that a caving layer or layers are encountered that cannot be controlled by slurry, the Contractor shall install temporary removable casing through such caving layer or layers. Overreaming to the outside diameter of the casing may be required. However, the final dimensions of the drilled shaft shall not be altered to accommodate these construction practices unless approved by the Engineer. The Contractor shall take whatever steps are required to prevent caving during shaft excavation including installation of deeper casings. If the Contractor elects to remove a casing and replace it with a longer casing through caving soils, the Contractor shall adequately stabilize the excavation with slurry or backfill the excavation. Other approved methods which will control the size of the excavation and protect the integrity of the foundation soils may be used to excavate through caving layers.

907-803.03.2.3.5--Permanent Casing Method. The permanent casing method shall be used when required by the plans. In this method, a casing is driven to the prescribed depth before excavation begins. If full penetration cannot be attained, the Contractor may excavate material from inside the casing and the casing may be driven again until reaching the desired penetration. In some cases overreaming to the outside diameter of the casing may be required before driving the casing.

The casing shall be cut off at the prescribed elevation upon reaching the proper construction sequence, and the remainder of the casing is left in place.

907-803.03.2.3.6--Excavation and Drilling Equipment. The excavation and drilling equipment shall have adequate capacity including power, torque, and down thrust to excavate a hole of both the maximum diameter and to a depth 20 percent greater than the longest shaft shown on the plans.

The excavation and overreaming tools shall be of adequate design, size, and strength to perform the work shown on the plans or described herein. When the material encountered cannot be drilled using conventional earth augers with soil or rock teeth, drill buckets, and/or underreaming tools, the Contractor shall provide special drilling equipment including but not limited to: rock core barrels, rock tools, air tools, blasting materials, and other equipment as necessary to construct the shaft excavation to size and depth required. Approval of the Engineer is required before excavation by blasting is permitted.

Sidewall overreaming shall be required when the sidewall of the hole is determined by the Engineer to have either softened due to excavation methods or delays in excavation completion, swelled due to delays in concreting, or degraded because of slurry cake build-up. Overreaming thickness shall be a minimum of 13 millimeters and a maximum of 75 millimeters beyond the shaft radius. Overreaming may be accomplished with a grooving tool, overreaming bucket, or other approved equipment. The thickness and elevation of sidewall overreaming shall be as directed by the Engineer. The Contractor shall bear all costs associated with both sidewall overreaming and additional shaft concrete placement.

907-803.03.2.3.7--Excavations.

907-803.03.2.3.7.1--General. Shaft excavations shall be made at locations and to the top of shaft elevations, estimated bottom of shaft elevations, shaft geometry and dimensions shown in the plans. The Contractor shall extend drilled shaft tip elevations when the Geotechnical Engineer determines that the material encountered during excavation is unsuitable and/or differs from that anticipated in the design of the drilled shaft.

The Contractor shall maintain a drilling log during shaft excavation. The log shall contain information such as: the description and approximate top and bottom elevation of each soil or rock strata, seepage or groundwater, and remarks. Three (3) copies of the final Contractor's log shall be furnished to the Engineer with a copy to the Geotechnical Engineer at the time the drilled shaft is completed and accepted.

When shown on the plans, bells shall be excavated to form the height and bearing area of the size and shape shown. The bell shall be excavated by mechanical methods. Any drilled shaft concrete over the theoretical amount required to fill any excavations for the bells and shafts dimensioned on the plans shall be furnished at no additional cost to the State.

The Contractor shall not permit workmen to enter a shaft excavation for any reason unless: both a suitable size casing has been installed and the water level has been lowered and stabilized below the level to be occupied, and adequate safety equipment and procedures have been provided to workmen entering the excavation. The Contractor is responsible for complying with all State and Federal safety regulations.

907-803.03.2.3.7.2--Obstructions. Surface and subsurface obstructions at drilled shaft locations shall be removed by the Contractor. Such obstructions may include man-made materials such as old concrete foundations, and natural materials such as boulders. Special procedures and/or tools shall be employed by the Contractor after the hole cannot be advanced using conventional augers fitted with soil or rock teeth, drilling buckets and/or underreaming tools. Such special procedures/tools may include but are not limited to: chisels, boulder breakers, core barrels, air tools, hand excavation, temporary casing, and increasing the hole diameter. Blasting shall not be permitted unless specifically approved in writing by the Engineer.

Drilling tools which are lost in the excavation shall be promptly removed by the Contractor at no cost to the State. All costs due to lost tool removal shall be borne by the Contractor including, but not limited to, costs associated with hole degradation due to removal operations or the time the hole remains open.

907-803.03.2.3.7.3--Exploration. When directed by the Engineer, the Contractor shall take soil samples or rock cores to determine the character of the material directly below the completed shaft excavation. The soil samples shall be extracted with a standard penetration test split spoon sampler or undisturbed sample (Shelby) tube. Rock cores, if required, shall be cut with an approved double or triple tube core barrel to a minimum of 1.5 meters below the bottom of the drilled shaft excavation at the time the shaft excavation is approximately complete. Rock core, undisturbed tube, and/or standard penetration test samples shall be measured, visually identified, and described on the Contractor's log. The samples shall be placed in suitable containers, identified by shaft location, elevation, and project number, and delivered with the Contractor's field log to the Engineer within 24 hours after the exploration is completed. The Engineer will inspect the samples, or cores, and determine the final depth of required excavation based on the evaluation of the material.

907-803.03.2.3.7.4--Excavation Completion. Concrete placement must begin within two (2) hours of completion of shaft excavation. If the drilled shafts are five (5) feet in diameter or larger and in excess of sixty (60) feet in length, the elapsed time from completion of the drilled shaft excavation until beginning concrete placement may extend past two hours provided the excavation remains stable and the extended time is demonstrated on the trial shaft. Completion of shaft excavation is defined as the time at which the specified tip elevation is initially achieved. Before concrete placement begins, bottom cleaning operations, any necessary slurry desanding, and placement of the reinforcing steel must be completed. These operations are included in the two hour time limit.

When it becomes apparent, as the excavation of the shaft is nearing completion, that it will not be feasible or possible to place concrete within the specified limit, the Contractor shall halt excavation operations a minimum of 1.5 meters above the specified tip elevation. In the event that the wet construction method is being used, the slurry should be desanded at this point so that the remaining excavation will not cause the slurry to be too heavily contaminated and delay concrete placement due to final desanding operations.

In no case shall any excavation within the bearing zone(s) be allowed to remain open and idle for more than 24 hours. The bearing zone(s) are considered as those soil strata below the scour line, in the case of hydraulic structures, or those 1.5 meters below the ground line, whichever is greatest in depth. In no instance shall any uncased excavation, except for trial shafts, be allowed to remain open and idle for more than 24 hours. For partially completed excavations which stand idle for more than six (6) hours but less than 24 hours, sidewall overreaming may still be required by the Engineer.

If completion of shaft excavation has been achieved, and concrete placement has not begun within the specified limit, the Contractor shall backfill and/or stabilize the excavation. The Engineer shall then direct the Contractor as to the additional shaft excavation that will be required to produce a sound drilled shaft due to shaft wall and bottom degradation. The cost of the additional excavation, concrete, reinforcing steel, and other incidentals will be borne by the Contractor at no additional cost to the State.

907-803.03.2.3.7.5--Casings.

907-803.03.2.3.7.5.1--General. Casings shall be steel, smooth, clean, watertight, and of ample strength to withstand both handling and driving stresses and the pressure of both concrete and the surrounding earth materials. The outside diameter of casing shall not be less than the specified size of shaft. No extra compensation will be allowed for concrete required to fill an oversized casing or oversized excavations. All casings, except permanent casing, shall be removed from the shaft excavation. Any length of permanent casing installed below the shaft cutoff elevations shall remain in place.

When the shaft is to extend above the ground or through a body of water, the portion exposed above the ground or through a body of water may be formed with removable casing, except when permanent casing is specified. Removable casing shall be stripped from the shaft in a manner that will not damage the concrete. Casings can be removed when the concrete is cured for a full 72 hours; the shaft concrete is not exposed to salt water or moving water for seven (7) days; and the concrete reaches a compressive strength of at least 17 MPa as determined from concrete cylinder tests.

907-803.03.2.3.7.5.2--Temporary Casing. All subsurface casing shall be considered temporary unless specifically shown as permanent in the contract documents. All temporary casing shall be removed. Telescoping, predrilling with slurry, and/or overreaming to beyond the outside diameter of the casing may be required to install the casing. When temporary casing larger than called for on the plans is used for telescoping or overreaming, no additional compensation will be made.

If the Contractor elects to remove a casing and substitute a longer or larger diameter casing through caving soils, the excavation shall be either stabilized with slurry or backfilled before the new casing is installed, as directed in Subsection 907-803.03.5.4. Other methods, as approved by the Engineer, may be used to control the stability of the excavation and protect the integrity of the foundation soils.

When temporary casings which are to be removed become fouled or bound in the shaft excavation and cannot be practically removed, and concreting has not yet begun, the Engineer may direct that the shaft excavation be drilled deeper to compensate for the loss of capacity due to the presence of the casing. No additional compensation will be paid for the casing left in the excavation. No additional length of shaft will be paid for beyond the current depth of excavation or the plan tip elevation of the production shaft, whichever is lower.

Temporary casings which become bound or fouled during concreting of the shaft, and cannot be practically removed before the concrete begins to set up, shall constitute a defect in the drilled shaft. When the Engineer, in writing, notifies the Contractor of a defective shaft, the Contractor shall be responsible for improving such defective shafts to the satisfaction of the Engineer. Improvements may consist of, but are not limited to, removing the shaft concrete and extending the shaft deeper to compensate for loss of frictional capacity in the cased zone, providing straddle shafts to compensate for capacity loss, proof load testing or providing replacement shafts. All corrective measures, including redesign of footings or drilled shaft caps, shall be performed to the satisfaction of the Engineer by the Contractor without either additional compensation or extension of Contract Time. No compensation will be paid for casing remaining in place. Any redesigns submitted must be approved in writing by the Bridge Engineer.

Temporary casing extraction shall be slow and uniform, pulling along the axis of the shaft. The elevation of the concrete in the casing shall be maintained high enough to displace the drilling slurry between the outside of the casing and the edge of the hole as the casing is removed. Temporary casings shall be removed while the concrete remains workable. No temporary casings will be removed if the concrete slump is less than 100 millimeters. Should this condition occur, the shaft will be designated as defective, and corrections to the situation shall be as described above.

Special casing systems may be used in open water areas, when approved, which are designed to permit removal after the concrete has hardened. Special casings shall be designed so that no damage occurs to the drilled shaft concrete during their removal. Any defects either cosmetic or structural that are apparent after removal of the casing or are due to the removal of the casing shall be repaired to the satisfaction of the Engineer at no additional cost to the State.

In the event that permanent casing is not specified in the plans, and the Contractor elects to use a temporary casing and leave it in place, it shall be cut off at a maximum of 300 millimeters above the low water elevation as shown on the plans, or painted. Written approval from the Engineer is required in this event, and payment for the temporary casing left in place will be at the contract bid price for temporary casing.

907-803.03.2.3.7.5.3--Permanent Casings. Permanent casing shall be used when shown on the plans. The casing shall be continuous between top and bottom elevations prescribed on the plans or as directed by the Engineer. Exterior surfaces of permanent casing shall be painted in accordance with the plans unless otherwise noted. After installation is complete, the permanent casing shall be cut off at the prescribed elevation and the shaft completed.

In general, permanent casing shall not be placed in an overreamed shaft hole.

907-803.03.2.3.8--Slurry. Mineral slurries shall be employed when slurry is used in the drilling process, unless other drilling fluids are approved in writing by the Engineer. The slurry shall have both a mineral grain size that will remain in suspension and sufficient viscosity and gel characteristics to transport excavated material to a suitable screening system. The percentage and specific gravity of the material used to make the suspension shall be sufficient to maintain the stability of the excavation and to allow proper concrete placement. During construction, the level of the slurry shall be maintained at a height sufficient to prevent caving of the hole. In the event there is a sudden, significant loss of slurry within the drilled shaft excavation, the construction of the drilled shaft shall be stopped until a method to stop slurry loss or an alternate construction procedure has been approved by the Engineer.

Mineral slurry shall be premixed thoroughly with clean, fresh water, and an adequate time (as prescribed by the mineral manufacturer) shall be allotted for hydration, prior to introduction into the shaft excavation. Slurry tanks of adequate capacity will be required for slurry circulation, storage, and treatment. No excavated slurry pits will be allowed in lieu of slurry tanks, without the written permission of the Engineer. Desanding equipment shall be provided by the Contractor as necessary to control slurry sand content to less than two percent (2%) by volume at any point in the borehole. Desanding will not be required for setting sign post or lighting mast foundations unless shown on the plans. The Contractor shall take all steps necessary to prevent the slurry from "setting up" in the shaft. Such methods may include, but are not limited to: agitation, circulation, and/or adjusting the properties of the slurry. Disposal of all slurry shall be performed offsite in suitable areas by the Contractor, and subject to all environmental regulations pertaining to slurry disposal.

Control tests using suitable apparatus shall be carried out on the mineral slurry mixture by a qualified individual or qualified professional testing laboratory approved by the Engineer. Tests to be conducted will be density, sand content, viscosity, and pH. The acceptable range of values for those physical properties is as shown in the following table:

MINERAL SLURRY
Sodium Montmorillonite (Commercial Bentonite)
Acceptable Range of Values

Property Units	At Time of Slurry Introduction	In Hole at Time of Concreting	Test Method
Density, kg/m ³	1030** - 1105**	1030** - 1200**	Density Balance
Viscosity, seconds/liter	30 - 48	30 - 48	Marsh Cone
pH	8 - 11	8 - 11	pH paper pH meter

**Increase by 30 kg/m^3 in salt water

Notes: a. Tests should be performed when the slurry temperature is above 5°C .

- b. If desanding is required, sand content shall not exceed two percent (2%) by volume at any point in the borehole as determined by the American Petroleum Institute sand content test.

The limits in the above table may be adjusted when field conditions warrant, as successfully demonstrated on the trial shaft or as directed by the Engineer. All changes must be approved in writing by the Engineer before continued use.

Tests to determine density, viscosity, and pH value shall be performed during the shaft excavation to establish a consistent working pattern. A minimum of four (4) sets of tests shall be made during the first eight (8) hours of slurry use. When the results show consistent behavior, the testing frequency may be decreased to one set every four (4) hours of slurry use.

The Contractor shall insure that heavily contaminated slurry suspension, which could impair the free flow of concrete, has not accumulated in the bottom of the shaft. Prior to placing concrete in any shaft excavation, the Contractor shall take slurry samples using a sampling tool approved by the Engineer or similar to that shown in Figure 2. Slurry samples shall be extracted from the base of the shaft and at intervals not exceeding 3 meters up the shaft, until two consecutive samples produce acceptable values for density, viscosity, pH, and sand content.

When any slurry samples are found to be unacceptable, the Contractor shall take whatever action is necessary to bring the mineral slurry within specification requirements. Concrete shall not be poured until resampling and testing produce acceptable results.

Reports of all tests required above, signed by an authorized representative of the Contractor, shall be furnished to the Engineer on completion of each drilled shaft. Representatives of the Department may perform comparison tests as determined necessary during mineral slurry operations.

During construction, the level of mineral slurry in the shaft excavation shall be maintained at a level not less than 1.2 meters above the highest expected piezometric pressure head along the depth of the shaft. If at any time the slurry construction method fails to produce the desired final results, the Contractor shall discontinue this method and propose an alternate method for approval by the Engineer.

Drilling tools should contain vents to stabilize hydrostatic pressure above and below the tool during extraction. The rate of tool extraction should not cause any noticeable turbulence in the hole.

In locations where saline or chemically contaminated groundwater exists, the slurry should be adjusted with appropriate chemical additives, or developed with a mineral material not affected by such conditions.

907-803.03.2.4--Excavation Inspection. The Contractor shall provide equipment for checking the dimensions and alignment of each drilled shaft excavation. The dimensions and alignment shall be determined by the Contractor in the presence of the Engineer or the Engineer's inspector. Final shaft depths shall be measured with a weighted tape or other approved methods after final cleaning. Unless otherwise stated on the plans, a minimum of 50 percent of the base of each shaft shall have less than 13 millimeters of sediment at the time of placement of the concrete. Shaft cleanliness will be determined by the Engineer, by visual inspection for dry shafts, or other methods deemed appropriate to the Engineer for wet shafts. In addition, for dry excavations, the maximum depth of water shall not exceed 75 millimeters prior to concrete pour.

SLURRY SAMPLER

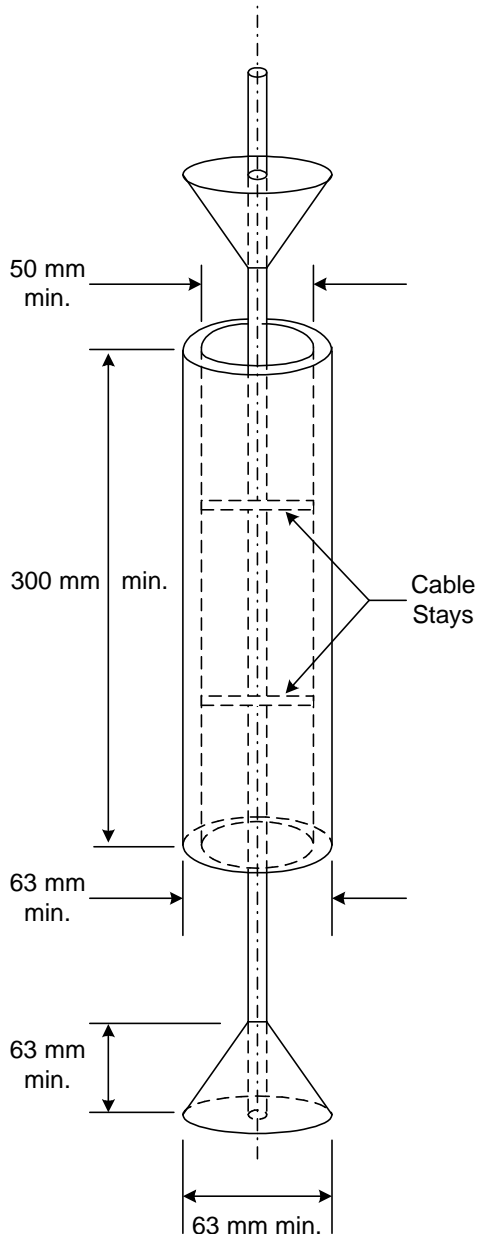

The sampler consists of three components:

1. Cable with weighted cone-shaped stopper.
2. Cylindrical sampler center stayed for alignment.
3. Top stopper with hole drilled through the center.

SAMPLING PROCEDURE

1. Lower cable with stopper to desired sampling elevation.
2. Slide cable through aligning guides of sampler.
3. Let sampler drop down the cable and seat onto bottom cone-shaped stopper.
4. Slide cable through hole in top stopper and let drop to seat on top of sampler.
5. Withdraw entire assembly from shaft.
6. Sample may be emptied into separate container and used as necessary to perform required testing.

Figure 2

907-803.03.2.5--Construction Tolerances. The following construction tolerances apply to drilled shafts unless otherwise stated in the contract documents.

- 1) The drilled shaft shall be within 75 millimeters of plan position in the horizontal plan at the plan elevation for the top of the shaft.
- 2) The vertical alignment of a vertical shaft excavation shall not vary from the plan alignment by more than 25 millimeters per meter of depth.
- 3) After all the concrete is placed, the top of the reinforcing steel cage shall be not more than 75 millimeters below plan elevation.
- 4) All casing diameters shown on the plans refer to O.D. (outside diameter) dimensions. The dimensions of casings are subject to American Pipe Institute tolerances applicable to regular steel pipe. When approved, the Contractor may elect to provide a casing larger in diameter than shown on the plans.
- 5) Bells shall be excavated to the plan bearing area and height shown on the plans as a minimum. The actual diameter of the bells shall not exceed three (3) times the specified shaft diameter. All other plan dimensions shown for the bells may be varied, when approved, to accommodate the Contractor's equipment.
- 6) Top elevation of the shaft shall have a tolerance of plus 25 millimeters or minus 75 millimeters from the plan top of shaft elevation.
- 7) Excavation equipment and methods shall be designed so that the completed shaft excavation will have a planar bottom. The cutting edges of excavation equipment shall be normal to the vertical axis of the equipment within a tolerance of ± 30 millimeters per meter of shaft diameter.

Drilled shaft excavations and completed shafts not constructed within the required tolerances are unacceptable. The Contractor shall be responsible for correcting all unacceptable shaft excavations and completed shafts to the satisfaction of the Engineer. Materials and work necessary, including engineering analysis and redesign, to complete corrections for out of tolerance drilled shaft excavations shall be furnished without either cost to the State or an extension of the completion dates of the project. Any redesign shall be performed by a professional engineer, registered in the State of Mississippi and engaged by the Contractor. Redesign drawings and computations prepared by the Contractor's engineer shall be signed and sealed.

Out of tolerance shaft holes shall be backfilled in an approved manner, when directed by the Engineer, until the redesign is complete and approved.

907-803.03.2.6--Reinforcing Steel Construction and Placement. The reinforcing steel cage, consisting of longitudinal bars, ties, cage stiffener bars, spacers, centralizers, and other necessary appurtenances, shall be completely assembled and placed as a unit immediately after the shaft excavation is inspected and accepted, and prior to concrete placement. Details of reinforcing steel will be as shown in the plans.

The reinforcing steel in the shaft shall be double-wire tied at all junctions and supported so that the reinforcing steel will remain within allowable tolerances given in Subsection 907-803.03.7. Stiff tie wire may be required for long reinforcing steel cages. Free-rolling concrete centralizers or other approved noncorrosive rolling centralizer devices shall be used at sufficient intervals. The centralizers shall be attached to the reinforcing steel cage near the bottom, and at intervals not exceeding three meters up the shaft for shaft lengths less than 18 meters, and intervals not exceeding two meters for shaft lengths greater than 18 meters, to insure concentric spacing for the entire cage length. Centralizers shall be constructed of approved material equal in quality and durability to the concrete specified for the shaft. The centralizers shall be of adequate dimension to insure a minimum 125 millimeters annular space between the outside of the reinforcing cage and the side of the excavated hole. Approved cylindrical feet (bottom supports) shall be provided to insure that the bottom of the cage is maintained the proper distance above the base.

The elevation of the top of the steel cage shall be checked before and after the concrete is placed. If the rebar cage is not maintained within the specified tolerances, corrections shall be made by the Contractor to the satisfaction of the Engineer. No additional shafts shall be constructed until the Contractor has modified the rebar cage support in a manner satisfactory to the Engineer.

If the bottom of the excavated shaft elevation is lower than the bottom of the shaft elevation shown on the plans, all reinforcement required in the upper portion of the shaft shall be achieved by splicing the additional length at the bottom of the cage, to avoid congestion in the upper portion of the shaft.

907-803.03.2.7--Concrete Placement.

907-803.03.2.7.1--General. Drilled Shaft concrete shall meet the requirements in Section 907-804.

Concrete placement during cold weather shall be allowed when ambient air conditions are at or expected to drop below 5°C, but protection of the fresh concrete shall be in accordance with the provisions stated in Sections 804 and 501. The Contractor shall assume all responsibility for protection of fresh concrete in cold weather.

Concrete shall be placed as soon as possible after reinforcing steel placement. Concrete placement shall be continuous from the bottom to the top elevation of the shaft. Concrete placement shall continue after the shaft excavation is full until good quality concrete is evident at the top of the shaft. Concrete shall be placed either through a tremie, concrete pump or free fall. Free fall placement shall require prior written approval of the Engineer and shall be restricted for use in dry excavations only.

For tremied or pumped concrete, the elapsed time from the beginning of concrete placement in the shaft to the completion of the placement shall not exceed four (4) hours, except as noted below. Retarders and/or water reducers in the concrete mix shall be adjusted as approved for the conditions encountered on the job, so that the concrete remains in a workable plastic state throughout the four hour placement limit. This is defined as a minimum slump of 100 millimeters existing everywhere within the concrete shaft after placement has been completed. Prior to concrete placement, the Contractor shall provide test results of a trial mix, set time test per AASHTO Designation: T 197, and a slump loss test using approved methods, to demonstrate that the concrete meets this four hour requirement. These tests shall be conducted by an approved testing laboratory at least 30 days prior to initial concrete placement, with the Department's Central Laboratory personnel present, at temperatures and conditions similar to those at the job site at the time of the shaft pour. However, the Contractor may request a longer placement time, provided a concrete mix is supplied that will maintain a slump of 100 millimeters or greater over the longer placement time, as demonstrated by trial mix, set time, and slump loss tests. A slump loss test shall be conducted from the concrete at the site for verification of slump loss requirements, using a sample from a minimum batch size of four cubic meters of concrete.

In the event that free-fall concrete placement is approved and used, the 100-mm slump in four hours requirement will be waived.

The Contractor shall place the concrete within the approved time and temperature limitations determined by the trial mix demonstration.

Before the casing is withdrawn, the level of fresh concrete shall be at such a level that the fluid trapped behind the casing is displaced upward. As the casing is withdrawn, care shall be exercised to maintain the level of concrete within the casing so that the fluid trapped behind the casing is displaced upward out of the shaft excavation without mixing with or displacing the shaft concrete.

907-803.03.2.7.2--Tremies. Tremies used for concrete placement in either wet or dry excavations shall consist of a tube of sufficient length, mass, and diameter to discharge concrete at the shaft base elevation. The tremie shall not contain aluminum parts which will have contact with the concrete. The tremie inside diameter shall be at least six (6) times the maximum size of aggregate used in the concrete mix but shall not be less than 250 millimeters. The inside and outside surfaces of the tremie shall be clean and smooth to permit both flow of concrete and unimpeded withdrawal during concreting. The wall thickness of the tremie shall be adequate to prevent crimping or sharp bends which restrict concrete placement.

The tremie used for wet excavation concrete placement shall be watertight. Underwater placement shall not begin until the tremie is placed at the bottom of the excavation. Valves, bottom plates, or plugs may be used only if concrete discharge can begin within one tremie diameter of the base. Plugs and plates shall either be removed from the excavation or be of a material, approved by the Engineer, which will not cause a defect in the shaft if not removed. The discharge end of the tremie shall be constructed to permit the free radial flow of concrete

during placement operations. The tremie discharge end shall remain at the excavation bottom as long as possible, and thereafter be immersed at least two shaft diameters but not less than three meters in concrete at all times after starting the flow of concrete. The flow of concrete shall be continuous. The concrete in the tremie shall be maintained at a positive pressure differential at all times to prevent water or slurry intrusion into the shaft concrete.

If, at any time during the concrete pour in a wet excavation, the tremie line orifice is removed from the fluid concrete column and discharges concrete above the rising concrete level, the shaft shall be considered defective. In such case, the Contractor shall remove the reinforcing cage and concrete, complete all necessary sidewall removal directed by the Engineer and repour the shaft. All costs of replacement of defective shafts shall be the responsibility of the Contractor.

907-803.03.2.7.3--Pumping Concrete. Concrete pumps and lines may be used for concrete placement in either wet or dry excavations. All pump lines shall have a minimum 125 millimeters diameter and be constructed with watertight joints. The use of aluminum pipe as a conveyance for the concrete will not be permitted. Concrete placement shall not begin until the pump line discharge orifice is at the bottom of the excavation.

For wet excavations, a plug or similar device shall be used to separate the concrete from the fluid in the hole until pumping begins. The plug shall either be removed from the excavation or be of a material, approved by the Engineer, which will not cause a defect in the shaft if not removed.

The discharge orifice shall remain at least two shaft diameters but not less than three meters below the surface of the fluid concrete at all times after starting the flow of concrete. When lifting the pump line during concreting, the Contractor shall temporarily reduce the line pressure until the orifice has been repositioned at a higher level in the excavation.

If, at any time during the concrete pour, the pump line orifice is removed from the fluid concrete column and discharges concrete above the rising level, the shaft shall be considered defective. In such case, the Contractor shall remove the reinforcing cage and concrete, complete all necessary sidewall removal directed by the Engineer and repour the shaft. All costs of replacement of defective shafts shall be the responsibility of the Contractor.

907-803.03.2.7.4--Free Fall Method. Placement of concrete by the free fall method will be permitted only when approved in writing by the Engineer. Approval of concrete placement by the free fall method shall be contingent upon the following conditions:

- 1) The clear opening inside the reinforcing cage is not less than 600 millimeters in diameter.
- 2) The dry construction method is used in constructing the drilled shafts.
- 3) The height of free fall placement shall not exceed 20 meters.
- 4) Concrete shall fall directly to the placement location without contacting either the reinforcing cage or shaft walls.

- 5) A hopper shall be used at the top of the shaft to center and direct free fall placement.
- 6) The Engineer will observe the falling of the concrete within the shaft. The Contractor shall reduce the rate of concrete placement or reduce the height of free fall as directed by the Engineer when the concrete strikes the reinforcing cage or shaft sidewalls, when there is excessive spatter from the impact of the falling concrete, or when concrete placement causes the shaft excavation to cave or slough.
- 7) When in the opinion of the Engineer, placement cannot be satisfactorily accomplished by the free fall method, the Contractor shall change to either the tremie or pumping method to accomplish the pour.

907-803.03.2.8--Drilled Shaft Load Tests. The methods required for the load testing of drilled shafts shall be Static and/or Static with Special Instrumentation. Load testing of drilled shafts shall be completed before construction of any production drilled shafts, and the results used by the Bridge Engineer to determine the drilled shaft lengths given on the order list. The method, number, and locations of load tests shall be as shown on the plans or as designated by the Engineer.

After completion of any load test, the order list providing the final production lengths will be provided within two weeks of receiving the load test results. The production shaft lengths provided by the Bridge Engineer may differ from the individual shaft lengths shown on the plans. Requests for adjustment to the contract due to changes in shaft lengths shall be subject to the provisions of Subsection 104.02.1. Before any consideration will be given for an adjustment to the contract, it must be determined that a significant change in the character of the work has occurred.

907-803.03.2.8.1--Static Load Tests. Static load testing shall not begin until the concrete has attained a compressive strength of 20 MPa as determined from cylinder tests, or maturity meter probe in accordance with Subsection 907-803.03.2.3.1.1. If a maturity meter probe is used, it shall be located the last concrete placed. During the curing time, no other construction or operations which will induce excessive vibration levels, as previously discussed, shall be performed.

Static axial load tests shall be performed by personnel of the Geotechnical Branch of MDOT assisted by the Contractor's personnel using the procedures as described in ASTM Designation: D 1143, quick test method. No weighted platforms to totally supply the axial load are allowed.

The Contractor shall be responsible for furnishing the following:

- 1) A reaction frame capable of resisting a total load of at least four (4) times the design load of the test shaft shall be provided. The frame shall consist of a beam(s) or girder(s) that will carry the required load while sustaining only minor deflections in the reaction system. The beam or girder shall be attached to a system of anchor shafts or piles. The anchor piles shall not be closer than three (3) diameters measured from the center of the test shaft.

- 2) A hydraulic jack that has been calibrated for the full range of anticipated loads in accordance with AASHTO Designation: T 67 (ASTM Designation: E 4) at least once. The maximum anticipated load shall be assumed to be four (4) times the design load for the test shaft. The pressure gauge shall be calibrated within one year preceding time of use. The Contractor shall furnish a certificate of calibration for the hydraulic jack at the time of load testing.
- 3) A measuring frame or reference beam for measuring the movement of the test shaft during testing. Two dial gauges, supplied by the Department, will be attached to the test shaft during testing to monitor downward movement. Each dial gauge will be actuated by its stem or by a stem attachment resting on the measuring frame. The supports for the measuring frame shall be placed the maximum practical distance from the test pile and the anchor shafts or piles. In no case shall the measuring frame be affected by movement of the test shaft or the anchor shafts or piles.

The Geotechnical Branch will furnish the load cell, gages, any needed details of the shaft gauge locations and personnel to run the test. The Geotechnical Branch shall also be responsible for reviewing and submitting the results to the Bridge Engineer. The Contractor shall submit a detailed plan for any jacks and load frame to the Engineer for evaluation. This plan should include the following:

- 1) Size and type of the reaction beam or beams.
- 2) Size, type, number, and length of reaction piles or shafts.
- 3) Type and capacity of any jacks and their most recent calibration documents.
- 4) A plan sheet shop drawing showing plan and profile of load frame details. Details should be shown for of how the reaction beam will be connected to the reaction piles or shafts. A detail showing how the jack, load cell (150-mm height, 275-mm diameter, supplied by MDOT), and bearing plates are to be arranged between the shaft top and the bottom of the reaction beam.
- 5) Details of a protected work area, including provisions such as a tent or shed for protection from inclement weather for the testing equipment, of a size and type required by the Engineer.

After testing is completed, the test shafts and any anchor shafts shall be cut off at an elevation 600 millimeters below the finished ground surface. The portion of the shafts cut off and removed shall remain the property of the Contractor.

907-803.03.2.8.2--Load Testing of Drilled Shafts With Special Instrumentation.

907-803.03.2.8.2.1--General. When designated on the plans, a dedicated test shaft shall be constructed as detailed in the plans with instrumentation and hydraulic jack(s) cast in the concrete of the drilled shaft. The Contractor will be required to furnish all materials, equipment,

labor, and incidentals necessary for conducting the load test and reporting the results. The Contractor shall subcontract the instrumenting, conducting, and reporting of the load test to the company supplying the instrumentation with the cost included in prices bid for test shaft.

No reaction systems and extra drilled shaft installations such as anchor shafts are required for conducting the load test. The load test is a non-destructive test, and if the test shaft designated on the plans is a production shaft, it shall be left in a condition suitable for use as a production shaft in the finished structure.

907-803.03.2.8.2.2--Materials. When called for in the plans, instrumentation shall be supplied to meet the requirements set forth in the plans. Instrumentation required in the plans are subject to prior approval by the State Geotechnical Engineer. Additional equipment that may be required is as follows.

- 1) Materials sufficient to construct a stable reference beam system for monitoring deflection of the shaft during testing, supported at a minimum distance of three (3) diameters from the center of the shaft to prevent disturbance of the reference system.
- 2) Materials sufficient to construct a protected work area, including provisions such as a tent or shed for protection from inclement weather for the load test equipment, of size and type required by the Engineer.

Materials supplied which do not become a part of a finished structure shall be removed from the job site at the conclusion of the load test.

907-803.03.2.8.2.3--Equipment. The Contractor shall supply any additional equipment required to install the testing instrumentation and conduct the load test, remove the load test apparatus, and, if the test shaft is to become a production shaft at the conclusion of the test, restore the shaft to a condition suitable for use in the finished structure. This equipment includes, but is not limited to:

- 1) Electric power and welding equipment, as required, to assemble the test equipment, instrumentation, and prepare the work area.
- 2) A suitable pressurized gas source consisting either of an approved air compressor or of compressed nitrogen, i.e. four 6.5 cubic-meter cylinders of nitrogen per load test.
- 3) Equipment and operators for handling the instrumentation and reinforcing cage, if required, during the installation of the test shaft and during the test. This shall include, but is not limited to, a crane or other lifting device, manual labor, and hand tools.
- 4) Equipment and labor sufficient to erect the protected work area and monitoring reference beam system, to be constructed to the requirements of the Engineer and instrumentation supplier.

- 5) Approved small piston type power grout pump with experienced operator, for grouting the cell upon completion of the test if required. Successful demonstration that the grout pumping system works as intended will be required before placing the instrumentation in the test shaft hole.
- 6) Approved small power mortar mixer with suitable mortar box to discharge grout, if required, with an experienced operator.
- 7) Screen with an approximately six millimeters mesh to screen grout prior to placement in the grout pump to prevent clogging of the grout pump or the piping.
- 8) Suitable operating and reference level platforms, as required by the Engineer and/or instrumentation supplier, for testing over water or in otherwise unstable foundation conditions.

907-803.03.2.8.2.4--Procedure. The test shaft shall be constructed by the shaft construction technique approved by the Engineer after trial shaft construction. The test shaft shall then be constructed in accordance with the plans and at the direction of the Engineer.

The instrumentation shall be assembled and made ready for installation under the direction of the instrumentation supplier, in a suitable area, adjacent to the test shaft, to be provided by the Contractor. When a reinforcing cage is required for the test shaft, the instrumentation shall be placed as directed in the plans.

When the test shaft excavation has been completed and accepted by the Engineer, the Contractor shall then install the instrumentation and, if required, the reinforcing cage assembly in the test shaft under the direction of the Engineer. The Contractor shall use the utmost care in handling the reinforcing cage and test equipment assembly so as not to damage the instrumentation during installation.

After the installation of the instrumentation, the test shaft shall be concreted in the manner approved from the trial shaft construction. Load testing shall not begin until the concrete has attained a compressive strength of 20 MPa as determined from cylinder tests. During the curing period, no other construction or operations which will induce excessive vibration levels shall be performed.

After completion of the load test, and at the direction of the Engineer, the Contractor shall remove any equipment, material, etc. which are not to be a part of the finished structure.

The Contractor shall supply the Engineer with six (6) copies of the final load test report.

907-803.04--Method of Measurement.

907-803.04.1--Test Piles. Test piles will be measured per each complete-in-place. Piles measured as test piles will not be included in the measurement of pay length for permanent piles.

Test piles constructed in accordance with the lengths indicated on the plans and which are required to be extended or built up will be measured as a percentage, calculated by dividing the sum of the plan length plus the length of the ordered extension or build-up, by the plan length. Splices required for the extension(s) will not be measured for payment.

No measurement for payment will be made for cut-off of a test pile.

907-803.04.2--Conventional Static Pile Load Tests. Conventional static pile load tests will be measured by the actual number of static load tests conducted on either a test pile or permanent production pile in accordance with these specifications.

In the event a pile is reloaded in accordance with these specifications, the reloading will be measured for payment as 50 percent of a separate conventional static pile load test.

907-803.04.3--Pile Shoes. Pile shoes of approved design, ordered and used, will be measured and paid as set out in Subsection 907-803.05.3.

907-803.04.4--Piling. Piling, exclusive of those measured as test piles, will be measured by the meter for each class and size of piling furnished and installed in accordance with lengths shown on the plans or approved by the Bridge Engineer. Cut-offs for each individual pile will be measured and deducted as set forth in Subsection 907-803.04.5.

Pile lengths in excess of those shown on the plans or approved by the Bridge Engineer will not be measured for payment unless such additional lengths below cut-off are approved in writing by the Bridge Engineer for incorporation in the structure.

907-803.04.5--Cut-Off. The summation of all cut-offs shall be deducted at 40 percent to determine the length for payment of in-place permanent piling.

The summation of all cut-offs for pile lengths in excess of those shown on the plans or approved by the Bridge Engineer will be deducted at 100 percent to determine the length for payment of in-place permanent piling.

An allowance will be made for prestressed concrete piling cut-offs in accordance with the provisions of Subsection 907-803.05.5. Cut-offs shall be measured for payment per each for each pile requiring cut-off.

All piling cut-offs shall become the property of and shall be disposed of by the Contractor.

907-803.04.6--Extensions or Build-Ups. Extensions or build-ups will not be measured for payment as such, but will be included in the length of piling remaining in the finished structure. In determining the amount to be included in piling lengths, no allowance will be made for cut-offs necessary to accomplish the extensions or build-ups.

907-803.04.7--Falsework and Defective Piles. No allowance will be made for furnishing or driving of falsework piles, for piles driven out of place, for defective piles, or for piles which are damaged by handling or driving.

907-803.04.8--Splices. Splices necessary for extensions or build-ups on bearing piles will be measured by the meter. For prestressed concrete piles, the length will be determined by allowing 2.1 meters of piling for each splice. For other piles, the length will be determined by allowing four linear feet of piling for each splice. The total length of piling to be paid for shall be determined by adding 2.1 meters or 1.2 meters, as applicable, to the net length of piling for each splice in place in the finished structure.

No measurement or payment will be made for splices except those made at the direction and under the supervision of the Engineer.

907-803.04.9--Pre-formed Pile Holes. Pre-formed pile holes, when included as a pay item on the plans, will be measured by the meter. For trestle type bents, the length for each hole will be determined by subtracting the elevation of the bottom of the hole shown on the itemized list from the elevation of the natural ground at the pile site or from the elevation of the excavated section, whichever is lower. For foundations and end bents, the length will be determined by subtracting the elevation of the bottom of the hole as shown on the itemized list from the elevation of the bottom of the footing or the bottom of the end bent caps, as applicable.

907-803.04.10--PDA Test Piles, Special Instrumentation Load Test. PDA test piles, special instrumentation load test will be measured per each, which shall include a static load test with special instrumentation. Piles paid for as PDA test piles, special instrumentation load test, will not be included in the measurement of pay lengths for permanent piles.

Completion of this pay item shall include the 1-day restrike after the initial pile driving, the special instrumentation load test, and the restrike within 24 hours after the static load test and the individual components will not be considered separately. Any additional restrike required by the Engineer on this type test pile will be paid for as a PDA Restrike.

907-803.04.11--PDA Test Piles, Conventional Load Test. PDA test piles, conventional load test, will be measured per each, which shall include a static load test. Piles paid for as PDA test piles, conventional load test will not be included in the measurement of pay lengths for permanent piles.

Completion of this pay item shall include the 1-day restrike after the initial pile driving, the conventional static load test, and the restrike within 24 hours after the static load test and the individual components will not be considered separately. Any additional restrike required by the Engineer on this type test pile will be paid for as a PDA Restrike.

907-803.04.12--PDA Test Pile. PDA test pile will be measured per each. Piles paid for as PDA test piles will not be included in the measurement of pay lengths for permanent piles.

Completion of this pay item shall include the 1-day and 7-day restrrike after initial driving and individual components will not be considered separately. Any additional restrrike required by the Engineer on this type test pile will be paid for as a PDA restrrike.

907-803.04.13--Pile Restrike. Pile restrrike will be measured per each actually performed on permanent piles or test piles as directed by the Engineer. The pile restrrike will be conducted as directed by the Engineer for bearing determination and may be conducted either with or without PDA monitoring.

907-803.04.14--Drilled Shaft. Drill shaft will be measured per meter. Measurement shall be the authorized length in meters of the completed concrete drilled shaft, including bells, of the diameter and containing the reinforcement shown on the plans. The length shall be determined as the difference between the plan top of shaft elevation and the final bottom of shaft elevation.

907-803.04.15--Test Shaft. Test shaft of the specified diameter will be measured per each. Such measurement shall be full compensation for excavating the test shaft through whatever materials are encountered to the bottom of the shaft elevation shown on the plans or as authorized by the Engineer, concrete, reinforcement, required casings, special instrumentation load cell when required, conducting and reporting load test results, restoring the site as required, and all other expenses to complete the work.

907-803.04.16--Trial Shaft. Trial shaft of the specified diameter will be measured per meter. Such measurement shall be full compensation for excavating the trial shaft hole through whatever materials are encountered to the bottom of shaft elevation shown on the plans or as authorized by the Engineer, using mineral slurry as necessary, utilizing temporary casing as necessary which is not a separate pay item, providing inspection facilities, backfilling the holes, setting reinforcement and placing concrete as required, restoring the site, and all other expenses necessary to complete the work.

907-803.04.17--Exploration. Exploration will be measured per meter of soil samples and/or rock cores of the diameter and length required and authorized by the Engineer. Such measurement shall be full compensation for drilling, extracting, packaging and classifying the samples or cores, delivering them to the Department, furnishing concrete to fill the core hole, and all other expenses necessary to complete the work.

907-803.04.18--Casing. Casing shall be measured per meter. Such measurement shall be full compensation for furnishing, placing, and removing when required, the casing in the shaft excavation.

907-803.05--Basis of Payment.

907-803.05.1--Test Piles. Test piles, measured as prescribed above, will be paid for at the contract unit price per each.

907-803.05.2--Conventional Static Pile Load Tests. Conventional static pile load tests, measured as prescribed above, will be paid for at the contract unit price per each.

907-803.05.3--Pile Shoes. If not covered by a contract item or otherwise required by the plans, metal shoes ordered by the Engineer will be paid for at double the invoice cost of the shoe. The cost of placing the pile shoes and driving piling with these additional requirements will not be paid for directly, and the cost thereof shall be considered incidental to the respective pile driving pay item.

907-803.05.4--Piling. Piling of the type specified will be paid for at the contract unit price per meter.

907-803.05.5--Cut-Offs. For permanent prestressed concrete piles required to be cut off and the cut-offs are not necessitated by damage to the pile or as a result of a pile furnished in a length greater than that established by the pile list on the plans or furnished by the Bridge Engineer, the Contractor will be paid \$60.00 per each pile cut-off for sizes smaller than 500 millimeters and \$80.00 per each pile cut-off for sizes 500 millimeters and larger.

907-803.05.6--Extensions or Build-Ups. Extensions or Build-ups will not be paid for directly, but will be included in payment for piling. No payment will be made for extensions or build-ups for test piles.

907-803.05.7--Blank.

907-803.05.8--Splices. Splices, measured as prescribed above, will be paid for at the contract unit price per meter for the particular type pile splices.

907-803.05.9--Pre-formed Pile Holes. Pre-formed pile holes of the sizes specified will be paid for at the contract unit price per meter.

907-803.05.10--PDA Test Piles, Special Instrumentation Load Test. PDA test piles, special instrumentation load test, measured as prescribed above, will be paid for at the contract unit price per each.

907-803.05.11--PDA Test Piles, Conventional Load Test. PDA test piles, conventional load test, measured as prescribed above, will be paid for at the contract unit price per each.

907-803.05.12--PDA Test Piles. PDA test piles, measured as prescribed above, will be paid for at the contract unit price per each.

907-803.05.13--Pile Restrike. Pile restrikes, measured as prescribed above, will be paid for at the contract unit price per each.

907-803.05.14--Drilled Shafts. Drilled shafts of the type specified, measured as prescribed above, will be paid for at the contract unit price per meter, which price shall include the cost of concrete, reinforcing steel, and all labor, materials including mineral slurry, equipment, and incidentals necessary to complete the drilled shaft.

907-803.05.15--Test Shafts. Test shafts of the type specified, measured as prescribed above, will be paid for at the contract unit price per each, which price shall be full compensation for excavating the test shaft through whatever materials are encountered to the bottom of the shaft elevation shown on the plans or as authorized by the Engineer, concrete, reinforcement, required casings, special instrumentation load cell if required, conducting and reporting load test results, restoring the site as required, and all other expenses to complete the work.

907-803.05.16--Trial Shaft. Trial shafts of the type specified, measured as prescribed above, will be paid for at the contract unit price per meter, which price shall be full compensation for excavating the trial shaft through whatever materials are encountered to the bottom of the shaft elevation shown on the plans or as authorized by the Engineer, concrete, reinforcement, required casings, special instrumentation if required, conducting and reporting load test results, restoring the site as required, and all other expenses to complete the work.

907-803.05.17--Exploration. Exploration, measured as prescribed above, will be paid for at the contract unit price per meter, which price shall be full compensation for drilling, extracting, packaging and classifying the samples or cores, delivering them to the Department, furnishing concrete to fill the core hole, and all other expenses necessary to complete the work.

907-803.05.18--Casings. Casings, measured as prescribed above, will be paid for at the contract price per meter, which price shall be full compensation for furnishing, placing, and removing (when required) the casing in the shaft excavation.

The prices thus paid shall be full compensation for all materials, tools, equipment, labor, and incidentals required to complete work.

Payment will be made under:

- 907-803-A: Test Pile - per each
- 907-803-B: Conventional Static Pile Load Test - per each
- 907-803-C: ___-mm Prestressed Concrete Piling - per meter
- 907-803-D: ___ Steel Piling -per meter
- 907-803-E: Concrete Piling Cut-off, Size - per each
- 907-803-F: ___-mm Pre-formed Pile Hole - per meter
- 907-803-G: PDA Test Pile, Special Instrumentation Load Test - per each
- 907-803-H: PDA Test Pile, Conventional Load Test - per each
- 907-803-I: PDA Test Pile - per each

907-803-J: Pile Restrike	- per each
907-803-M: Drilled Shaft, ___-mm Diameter	- per meter
907-803-N: Test Shaft, ___-mm Diameter	- per each
907-803-O: Trial Shaft, ___-mm Diameter	- per meter
907-803-P: Exploration	- per meter
907-803-R: ___* Casing, ___-mm Diameter	- per meter

* Temporary or Permanent

MISSISSIPPI DEPARTMENT OF TRANSPORTATION

SPECIAL PROVISION NO. 907-804-21M

CODE: (IS)

DATE: 11/09/2010

SUBJECT: Concrete Bridges and Structures

Section 804, Concrete Bridges and Structures, of the 1996 Metric Edition of the Mississippi Standard Specifications for Road and Bridge Construction is deleted in toto and replaced as follows:

SECTION 907-804--CONCRETE BRIDGES AND STRUCTURES

907-804.01--Description. This work consists of constructing concrete bridges and structures in accordance with these specifications and in reasonably close conformity with the dimensions, designs, lines, and grades indicated on the plans or established.

Construction of box bridges shall be in accordance with Sections 601 and 602.

907-804.02--Materials.

907-804.02.1--General. Concrete produced and controlled from this specification shall be accepted upon proper certification of concrete production through an approved quality control program and verification by job site acceptance criteria. The Contractor shall develop and implement a quality control program that will be used to maintain the required properties of concrete. For projects with 765 cubic meters and more, quality control and acceptance shall be achieved through statistical evaluation of test results. For projects of more than 150 but less than 765 cubic meters, quality control and acceptance shall be achieved by individual test results. For projects less than or equal to 152 cubic meters, refer to the requirements of TMD-20-05-00-000M "Sampling and Testing of Small Quantities of Miscellaneous Materials".

The materials for concrete bridges and structures, when sampled and tested in accordance with Subsection 700.03, shall meet the requirements of the following Subsections:

Portland Cement	907-701.01 and 907-701.02
Admixtures	713.02
Fly Ash	714.05
Water	714.01.1 and 714.01.2
Fine Aggregate	703.02
Coarse Aggregate	703.03
Curing Materials	713.01
Joint Materials	707.01, 707.02, and 707.07
Structural Steel Joints and Bearing Devices	717.01
Sheet Copper	716.07.2
Bronze Bearing Devices	716.06

Copper-Alloy Bearing Devices	716.07.1
Self-Lubricating Bearing Plates	716.08
Bearing Pads	714.10
Wire Rope or Wire Cable for Prestressed Concrete	700.01 and 711.03
Sprayed Finish for Concrete Surface	714.12
Reinforcing Steel	711.02
Ground Granulated Blast Furnace Slag (GGBFS).....	907-714.06
Silica Fume	907-714.07.2

907-804.02.2--Use, Care and Handling. The use, care and handling of materials shall conform to the applicable requirements of Subsection 501.03.10 and the specific requirements of Subsections 907-804.02.4 and 907-804.02.5. Unless otherwise authorized, only fine aggregate or coarse aggregate of one type and from the same source shall be used in the construction of any one unit of a structure. Should the Contractor, with written permission of the Engineer, elect to substitute high early strength cement for cement of the type specified, the Contractor will not receive additional compensation for the substitution.

907-804.02.3--Sampling & Testing. Sampling and testing shall meet the requirements of these specifications.

907-804.02.4--Care and Storage of Concrete Aggregates. The handling and storage of aggregates shall be such as to prevent segregation or contamination with foreign materials. The Engineer may require that aggregates be stored on separate platforms at satisfactory locations.

When specified, coarse aggregates shall be separated into two or more sizes in order to secure greater uniformity of the concrete mixture. Different sizes of aggregate shall be stored in separate stock piles sufficiently removed from each other to prevent the material at the edges of the piles from becoming intermixed.

907-804.02.5--Storage of Cement. All cement shall be stored in suitable weather-proof buildings or bins. These buildings or bins shall be placed in locations approved by the Engineer. Provision for storage shall be ample, and the shipments of cement as received shall be stored separately or other provisions made to the satisfaction of the Engineer for easy access for the identification, inspection, and sampling of each shipment as deemed desirable. Stored cement shall meet the test requirements at any time after storage when a retest is ordered by the Engineer.

On small jobs, open storage consisting of a raised platform and ample waterproof covering may be permitted by written authorization from the Engineer.

When specified, the Contractor shall keep accurate records of deliveries of cement and of its use in the work. Copies of these records shall be supplied in the form required by the Engineer.

907-804.02.6--Classification and Uses of Concrete. When a specific class of concrete is not specified on the plans or in the contract documents, the structure or parts thereof shall be constructed with the class of concrete as directed by the Engineer.

The classes and their uses are as follows:

- (1) Class AA - Concrete for bridge construction and concrete exposed to seawater.
- (2) Class A - Concrete for use where indicated.
- (3) Class B - General use, heavily reinforced sections, cast-in-place concrete piles, and conventional concrete piles.
- (4) Class C - Massive sections or lightly reinforced sections.
- (5) Class D - Massive unreinforced sections and riprap.
- (6) Class F - Concrete for prestressed members.
- (7) Class FX - Extra strength concrete for prestressed members, as shown on plans.
- (8) Class S - For all seal concrete deposited under water.
- (9) Class DS - Drilled Shaft Concrete

907-804.02.7--Composition of Concrete. The composition of concrete mixtures shall meet the requirements of these specifications.

907-804.02.8--Laboratory Accreditation. The Contractor shall be responsible for furnishing the laboratory used to perform concrete quality control tests. The laboratory may be the Contractor’s facility, the concrete producer’s facility, or a certified independent testing laboratory.

Only laboratories certified by the Mississippi Department of Transportation are qualified to perform material testing. Certification by AASHTO Accreditation Program (AAP) will be acceptable if the laboratory is listed in the latest AASHTO Accreditation Program publication and maintains accreditation to completion of concrete work.

The Contractor’s laboratory designated for quality control testing shall have equipment necessary to test aggregates and concrete for the test methods listed in Table 1.

Table 1

AASHTO: T 2	Sampling Aggregates
AASHTO: T 19	Bulk Density (“Unit Weight”) and Voids in Aggregates
AASHTO: T 22	Compressive Strength of Cylindrical Concrete Specimens
AASHTO: T 23	Making and Curing Concrete Test Specimens in the Field
AASHTO: T 27	Sieve Analysis of Fine and Coarse Aggregates
AASHTO: T 84	Specific Gravity and Absorption of Fine Aggregate
AASHTO: T 85	Specific Gravity and Absorption of Coarse Aggregate
AASHTO: T 119	Slump of Hydraulic Cement Concrete
AASHTO: T 121	Mass per Cubic Meter (Cubic Foot), Yield, and Air Content (Gravimetric) of Concrete
AASHTO: R 39	Making and Curing Concrete Test Specimens in the Laboratory
AASHTO: T 141	Sampling Freshly Mixed Concrete
AASHTO: T 152	Air Content of Freshly Mixed Concrete by Pressure Method *
AASHTO: T 196	Air Content of Freshly Mixed Concrete by the Volumetric Method *
AASHTO: T 231	Capping Cylindrical Concrete Specimens
AASHTO: T 248	Reducing Field Samples of Aggregate to Testing Size

AASHTO: T 255	Total Evaporable Moisture Content of Aggregate by Drying
ASTM: C 1064	Temperature of Freshly Mixed Portland Cement Concrete

* Equipment necessary for either pressure or volumetric air content.

Testing equipment shall have been inspected by the Department or through AAP. Testing equipment calibration files shall be made available upon request by the Department.

907-804.02.9--Testing Personnel. Technicians testing Portland cement concrete, for either acceptance or production control purposes, shall be certified by an accepted certification program. Recertification is required for each Class after five years. Certification requirements are listed in Table 2.

Table 2

Concrete Technician's Tasks	Test Method Required	Certification Required**
Sampling or Testing of Plastic Concrete	AASHTO Designation: T 23, T 119, T 121, T 141, T 152, T 196, and ASTM Designation: C 1064	MDOT Class I certification
Compressive Strength Testing of Concrete Cylinders	AASHTO Designation: T 22 and T 231	MDOT Concrete Strength Testing Technician certification
Sampling of Aggregates	AASHTO Designation: T 2	Work under the supervision of an MDOT Class II certified technician
Testing of Aggregates	AASHTO Designation: T 19, T 27, T 84, T 85, T 248, and T 255	MDOT Class II certification
Proportioning of Concrete Mixtures*	AASHTO Designation: M 157 and R 39	MDOT Class III
Interpretation and Application of Maturity Meter Readings	AASHTO Designation: T 325 and ASTM Designation: C 1074	MDOT Class III or Two hours maturity method training

* Technicians making concrete test specimens for meeting the requirements of Subsection 804.02.10.1.2 shall be MDOT Class I certified and under the direct supervision of an MDOT Class III certified technician.

** MDOT Class I certification encompasses the same test procedures and specifications as ACI Concrete Field Testing Technician Grade I. MDOT Class II certification encompasses the same test procedures and specifications as ACI Aggregate Testing Technician - Level 1. MDOT Concrete Strength Testing Technician encompasses the same test procedures and specifications as ACI Concrete Strength Testing certification.

For specifics about the requirements for each level of certification, please refer to the latest edition of the Department’s *Concrete Field Manual*. Technicians holding current MDOT Class I, MDOT Class II and/or MDOT Class III certifications shall be acceptable until those certifications expire. Upon a current certification expiration, recertification with the certifications listed in Table 2 shall be required. Technicians currently performing either specific gravity testing of aggregates or compressive strength tests shall be required to either:

- have the required MDOT certification listed in Table 2, or
- have a current MDOT Class III certification or work under the direct supervision of current MDOT Class III technician, and have demonstrated the specific gravity and/or compressive strength test during the inspection of laboratory equipment by the Materials Division, Concrete Section.

907-804.02.10--Portland Cement Concrete Mixture Design. At least 30 days prior to production of concrete, the Contractor shall submit to the Engineer proposed concrete mixture designs complying with the Department’s *Concrete Field Manual*. Materials shall be from approved sources meeting the requirements of the Standard Specifications. Proportions for the mixture designs shall be for the class concrete required by the contract plans and shall meet the requirements of the “Master Proportion Table for Structural Concrete Design” listed in Table 3. The concrete producer shall assign a permanent unique mixture number to each mixture design. Each mixture design shall be field verified as required in Subsection 907-804.02.10.3. Acceptable field verification data shall be required for final approval of a mixture design. All concrete mixture designs will be reviewed by the Central Laboratory prior to use. Concrete mixture designs disapproved will be returned to the Contractor with a statement explaining the disapproval.

**Table 3
MASTER PROPORTION TABLE FOR STRUCTURAL CONCRETE DESIGN**

CLASS	COARSE AGGREGATE SIZE NO. *	MAXIMUM WATER/CEMENTITIOUS ** RATIO	SPECIFIED COMPRESSIVE STRENGTH (f'_c) MPa	MAXIMUM SLUMP *** millimeters	TOTAL AIR CONTENT %
AA	57 or 67	0.45	30	75	3.0 to 6.0
A	57 or 67	0.45	30	75	3.0 to 6.0
B	57 or 67	0.50	25	100	3.0 to 6.0
C	57 or 67	0.55	20	100	3.0 to 6.0
D	57 or 67	0.70	15	100	3.0 to 6.0
F	67	0.40	35	75	****
FX	67	(As required by special provisions)		75	****
S	57 or 67	0.45	20	200	3.0 to 6.0
DS	67	0.45	30	*****	****

* Maximum size aggregate shall conform to the concrete mixture design for the specified aggregate.

** The replacement limits of Portland cement by weight by other cementitious materials (such as fly ash, GGBFS, silica fume, or others) shall be in accordance with the values

in Subsection 907-701.02. Other hydraulic cements may be used in accordance with the specifications listed in Section 701.

*** The slump may be increased up to 200 millimeters with :

- an approved water-reducing admixture,
- an approved water-reducing/set-retarding admixture, or
- a combination of an approved water-reducing admixture and an approved set-retarding admixture, in accordance with Subsection 907-713.02. Minus slump requirements shall meet those set forth in Table 3 of AASHTO Designation: M157.

**** Entrained air is not required except for concrete exposed to seawater. For concrete exposed to seawater, the total air content shall be 3.0 % to 6.0%. For concrete not exposed to seawater, the total air content shall not exceed 6.0%.

***** Class DS Concrete for drilled shafts shall have a 200±25-millimeter slump. In the event the free fall method of concrete placement is used, the slump shall be 188±38 millimeters.

At least one water-reducing admixture shall be used in all classes of concrete in accordance with the manufacturer’s recommended dosage range. Any combinations of admixtures shall be approved by the Engineer before their use.

907-804.02.10.1--Proportioning of Portland Cement Concrete Mixture Design.

Proportioning of Portland cement concrete shall be based on an existing mixture of which the producer has field experience and documentation or based on a recently batched laboratory mixture tested according to the required specifications.

907-804.02.10.1.1--Proportioning on the Basis of Previous Field Experience of Trial Mixtures.

Where a concrete production facility has a record, based on at least 10 consecutive strength tests from at least 10 different batches within the past 12 months from a mixture not previously used on Department projects, the standard deviation shall be calculated. The record of tests from which the standard deviation is calculated shall:

- a) Represent similar materials and conditions to those expected. Changes in materials and proportions within the test record shall not have been more closely restricted than those for the proposed work.
- b) Represent concrete produced to meet a specified strength.
- c) Consist of 10 consecutive tests, average of two cylinders per test, tested at 28 days.

The standard deviation, *s* , shall be calculated as:

$$s = \left[\sum (X_i - \bar{X})^2 \div (N - 1) \right]^{1/2}$$

where:

X_i = the strength result of an individual test

\bar{X} = the average of individual tests in the series
 N = number of tests in the series

When the concrete production facility does not have a record of tests for calculation of standard deviation, as required in the above formula, the requirements of Subsection 907-804.02.10.1.2 shall govern.

The required average compressive strength (f'_{cr}) used as the basis for selection of concrete proportions shall conform to the inequality listed below, while using a standard deviation, s , calculated as shown above.

$$\bar{X} \geq f'_{cr}$$

where:

$$f'_{cr} = f'_c + 1.43s$$

where:

f'_c = specified compressive strength of concrete, MPa

f'_{cr} = required average compressive strength of concrete, MPa

s = standard deviation, MPa

1.43 represents the Lower Quality Index necessary to assure that 93% of compressive strength tests are above f'_c .

907-804.02.10.1.2--Proportioning on the Basis of Laboratory Trial Mixtures. When an acceptable record of field test results is not available, concrete proportions shall be established based on laboratory trial mixtures meeting the following restrictions:

- a) The combination of materials shall be those intended for use in the proposed work.
- b) Trial mixtures having proportions and consistencies suitable for the proposed work shall be made using the ACI 211.1 as a guide to proportion the [mixture](#) design.
- c) Trial mixtures shall be designed to produce a slump within ± 20 mm of the maximum permitted, and for air-entrained concrete, 6.0 ± 0.5 percent total air content. The temperature of freshly mixed concrete in trial mixtures shall be reported.
- d) For each proposed mixture, at least three compressive test cylinders shall be made and cured in accordance with AASHTO Designation: T 126. Each change of water-cement ratio shall be considered a new mixture. The cylinders shall be tested for strength in accordance with AASHTO Designation: T 22 and shall meet the required 28 day strength.

- e) The required average strength of laboratory trial mixes shall exceed f'_c by 8.3 MPa for concrete **mixture** designs less than 35 MPa and by 9.7 MPa for concrete **mixture** designs of 35 MPa or more.
- f) The laboratory trial batch mixtures shall have been made within the previous 12 months before being submitted for approval and shall not have been previously used on Department projects.

907-804.02.10.2--Documentation of Average Strength. Documentation that the proposed concrete proportions will produce an average strength equal to or greater than the required average shall consist of the strength test records from field tests or results from laboratory trial mixtures.

907-804.02.10.3--Field Verification of Concrete **Mixture Design.** Concrete **mixture** designs will only be tentatively approved pending field verification. **Mixture** designs may be transferred to other projects without additional field verification testing, once the **mixture** design has passed the field verification process.

The Contractor's Certified Quality Control Technicians shall test each concrete **mixture** design upon the first placement of the mix. Aggregates and concrete tests during the first placement shall be as follows:

<u>Aggregates</u>	<u>Concrete</u>
Bulk Specific Gravity	Water Content
Moisture	Slump
Gradation	Air Content
	Unit Weight
	Yield

For all Classes of concrete, the mixture shall be verified to yield within 2.0% of the correct volume when all the mix water is added to the batch.

For all Classes of concrete other than DS, F, and FX, the mixture shall produce a slump within a minus 38-mm tolerance of the maximum permitted for mixtures with a maximum permitted slump of 150 millimeters or less or within a minus 62-mm tolerance of the maximum permitted for mixtures with a maximum permitted slump of greater than 75 millimeters, and producing a total air content within a minus 1½ percent tolerance of the maximum allowable air content in Table 3.

For Class DS, the slump shall be within the requirements in Note ***** below Table 3. For Class DS exposed to seawater, the total air content shall be within a minus 1½ percent tolerance of the maximum allowable air content in Note ***** below Table 3. For Class DS not exposed to seawater the total air content shall be within the requirements of Note ***** in below Table 3.

For Classes F and FX, the slump shall be within a minus 38-mm tolerance of the maximum permitted for mixtures with a maximum permitted slump of 75 millimeters or less or within a

minus 62-mm tolerance of the maximum permitted for mixtures with a maximum permitted slump of greater than 75 millimeters. For Classes F and FX exposed to seawater, the total air content shall be within a minus 1½ percent tolerance of the maximum allowable air content in Note **** below Table 3. For Classes F and FX not exposed to seawater the total air content shall be within the requirements in Note **** below Table 3. The mixture shall be adjusted and retested, if necessary, on subsequent placements until the above mentioned properties are met. If the requirements of yield, slump, or total air content are not met within three (3) production days after the first placement, subsequent field verification testing shall not be permitted on department projects, and the mixture design shall not be used until the requirements listed above are met. Any mixture design adjustments, changes in the mixture proportions, are to be made by a Class III Certified Technician representing the Contractor. After the mixture design has been verified and adjustments made, verification test results will be reviewed by the Engineer.

907-804.02.10.4--Adjustments of Mixtures Proportions. The mixture may be adjusted by the Class III Certified Technician representing the Contractor in accordance with the allowable revisions listed in the Department's Concrete Field Manual, paragraph 5.7. Written notification shall be submitted to the Engineer a minimum of seven (7) days prior to any source or brand of material change, aggregate size change, allowable material type change, or decrease in any cementitious material content. Any adjustments of the concrete mixture design shall necessitate repeat of field verification procedure as described in Subsection 907-804.02.10.3 and approval by the Engineer.

907-804.02.11--Concrete Batch Plants. The concrete batch plant shall meet the requirements of the National Ready Mixed Concrete Association *Quality Control Manual, Section 3, Plant Certification Checklist* as outlined in the latest edition of the Department's *Concrete Field Manual*. The Contractor shall submit a copy of the approved checklist along with proof of calibration of batching equipment, i.e., scales, water meter, and admixture dispenser, to the Engineer 30 days prior to the production of concrete.

For projects with 765 cubic meters and more, the concrete batch plant shall meet the requirements for an automatic system capable of recording batch weights. It shall also have automatic moisture compensation for the fine aggregate. For projects of more than 150 but less than 765 cubic meters the plant can be equipped for manual batching with a fine aggregate moisture meter visible to the plant operator.

The concrete batch plant shall have available adequate facilities to cool concrete during hot weather.

Mixer trucks to be used on the project are to be listed in the checklist and shall meet the requirements of the checklist.

907-804.02.12--Contractor's Quality Control. The Contractor shall provide and maintain a quality control program that will provide reasonable assurance that all materials and products submitted to the Department for acceptance will conform to the contract requirements, whether manufactured or processed by the Contractor or procured from suppliers, subcontractors, or vendors.

The Contractor's Quality Control program shall implement the minimum quality control requirements shown in Table 4, "CONTRACTOR'S MINIMUM REQUIREMENTS FOR QUALITY CONTROL". The quality control activities shown in the table are considered to be normal activities necessary to control the production and placing of a given product or material at an acceptable quality level. To facilitate the Department's activities, all completed gradation samples shall be retained for a maximum of sixty (60) days by the Contractor until further disposition is designated by the Department.

The Contractor shall perform, or have performed, the inspections and tests required to substantiate product conformance to contract document requirements and shall also perform, or have performed, all inspections and tests otherwise required.

The Contractor's Quality Control program shall encompass the requirements of AASHTO Designation: M 157 into concrete production and control, equipment requirements, testing, and batch ticket information. The requirement of AASHTO Designation: M 157, Section 11.7 shall be followed except, on arrival to the job site, a maximum of seven (7) liters per cubic meter is allowed to be added. Water shall not be added at a later time. If the maximum permitted slump is exceeded after the addition of water at the job site, the concrete shall be rejected.

The Contractor's quality control inspections and tests shall be documented and shall be available for review by the Engineer throughout the life of the contract.

As set out in these specifications, quality control sampling and testing performed by the Contractor will be used by the Department for determination of acceptability of the concrete.

The Contractor shall maintain standard equipment and qualified personnel as required to assure conformance to contract requirements.

907-804.02.12.1--Quality Control Plan. The Contractor shall prepare a Quality Control Plan which shall identify the personnel responsible for the Contractor's quality control including the company official who will act as liaison with Department personnel. The Quality Control Plan shall be submitted in writing to the Engineer for approval 30 days prior to the production of concrete.

The class(es) of concrete involved will be listed separately. If an existing **mixture** design(s) is to be used, the **mixture** design number(s) as previously approved shall be listed.

It is intended that sampling and testing be in accordance with standard methods and procedures, and that measuring and testing equipment be standard and properly calibrated. If alternative sampling methods and procedures, and inspection equipment are to be used, they shall be detailed in the Quality Control Plan.

907-804.02.12.1.1--Elements of Plan. The Plan shall address all elements that affect the quality of the structural concrete including, but not limited to, the following:

- 1) Stockpile Management

- 2) Procedures for Corrective Actions for Non Compliance of Specifications
- 3) Procedure for Controlling Concrete Temperatures

907-804.02.12.2--Personnel Requirements. The Contractor's Designated Certified Technician shall perform and use quality control tests and other quality control practices to assure that delivered materials and proportioning meet the requirements of the **mixture** design including temperature, slump, air content, and strength and shall periodically inspect all equipment used in transporting, proportioning, and mixing.

The Contractor's Designated Technician shall periodically inspect all equipment used placing, consolidating, finishing, and curing to assure it is operating properly and that placement, consolidation, finishing, and curing conform to the **mixture** design and other contract requirements.

907-804.02.12.3--Documentation. The Contractor shall maintain adequate records of all inspections and tests. The records shall indicate the nature and number of observations made, the number and type of deficiencies found, date and time of samples taken, the quantities approved and rejected, and the nature of corrective action taken as appropriate. The Contractor's documentation procedures will be subject to approval of the Department prior to the start of the work and to compliance checks during the progress of the work.

All conforming and non-conforming inspections and test results shall be kept complete and shall be available at all times to the Department during the performance of the work. Forms shall be on a computer-acceptable medium. Batch tickets and gradation data shall be documented in accordance with Department requirements. Batch tickets shall contain all the information in AASHTO Designation: M157, Section 16 including the additional information in Subsection 16.2 with the following exception: the information listed in paragraphs 16.2.7 and 16.2.8 is not required. Batch tickets shall also contain the concrete producer's permanent unique **mixture** number assigned to the concrete **mixture** design. Batch tickets and gradation data shall be documented in accordance with Department requirements. Copies shall be submitted to the Department as the work progresses.

Test data for Portland cement concrete, including gradation, shall be charted in accordance with the applicable requirements.

The Contractor may use additional control charts as deemed appropriate. It is normally expected that testing and charting will be completed within 24 hours after sampling.

All charts and records documenting the Contractor's quality control inspections and tests shall become the property of the Department upon completion of the work.

907-804.02.12.4--Corrective Action. The Contractor shall take prompt action to correct conditions that have resulted, or could result, in the submission to the Department of materials and products that do not conform to the requirements of the contract documents. All corrective actions shall be documented.

907-804.02.12.5--Non-Conforming Materials. The Contractor shall establish and maintain an effective and positive system for controlling non-conforming material, including procedures for its identification, isolation and disposition. Reclaiming or reworking of non-conforming materials shall be in accordance with procedures acceptable to the Department.

All non-conforming materials and products shall be positively identified to prevent use, shipment, and intermingling with conforming materials and products. Holding areas, mutually agreeable to the Department and the Contractor, shall be provided by the Contractor.

**TABLE 4
CONTRACTOR'S MINIMUM REQUIREMENTS FOR QUALITY CONTROL**

Portland Cement Concrete		
Control Requirement	Frequency	AASHTO/ASTM Designation
A. PLANT AND TRUCKS		
1. Mixer Blades	Monthly	
2. Scales		
a. Tared	Daily	
b. Calibrate	Every 6 months	
c. Check Calibration	Weekly	
3. Gauges & Meters - Plant & Truck		
a. Calibrate	Every 6 months	
b. Check Calibration	Weekly	
4. Admixture Dispenser		
a. Calibrate	Every 6 months	
b. Check Operation & Calibration	Daily	
B. AGGREGATES		
1. Sampling		T 2
2. Fine Aggregate		
a. Gradation / FM	200 m ³ Concrete	T 27
b. Moisture	Check Meter Against Test Results Weekly	T 255
c. Specific Gravity / Absorption	2000 m ³ Concrete	T 84
3. Coarse Aggregates		
a. Gradation	200 m ³ Concrete	T 27
b. Moisture	Minimum of once daily or more as needed to control production	T 255
c. Specific Gravity / Absorption	2000 m ³ Concrete	T 85
C. PLASTIC CONCRETE		
1. Sampling		T 141
2. Air Content	First load then one per 40 m ³	T 152 or T 196
3. Slump	First load then one per 40 m ³	T 119
4. Compressive Strength	A minimum of one set (two cylinders) for each 75 m³, and one set for each additional 75 m³ or fraction thereof for each class concrete delivered and placed on a calendar day from a single supplier. A test shall be the average of two cylinders.	T 22, T 23, T 231
5. Yield	Each 300 m ³	T 121
6. Temperature	With each sample	C 1064

907-804.02.13--Quality Assurance Sampling and Testing. Quality Assurance (QA) inspection and testing will be provided by the Department to assure that the Contractor's Quality Control (QC) testing meets the requirements of these specifications.

Acceptance of the material is based on the inspection of the construction, monitoring of the Contractor's quality control program, QC test results, and the comparison of the QA test results with the QC test results. The Department may use the results of the Contractor's QC tests as a part of the acceptance procedures instead of the results of QA tests, provided:

- a) The Department's inspection and monitoring activities indicate that the Contractor is following the approved Quality Control program and, respectively,
- b) For aggregates, the results from the Contractor's QC and the Department's QA testing of aggregate gradations compare by both meeting the aggregate type's gradation requirements;
- c) For concrete, the Contractor's QC and Department's QA testing of concrete compressive strengths compare when using the data comparison computer program with an alpha value of 0.01 for projects with 765 cubic meters and more; or, strength comparisons are within 6.8 MPa for projects of more than 150 but less than 765 cubic meters.

The minimum frequency for QA testing of aggregate and plastic concrete by the Department will follow the frequencies listed in Table 5, "DEPARTMENT'S MINIMUM REQUIREMENTS FOR QUALITY ASSURANCE".

**TABLE 5
DEPARTMENT'S MINIMUM REQUIREMENTS FOR QUALITY ASSURANCE**

Quality Assurance Tests	Frequency	AASHTO/ASTM Designation
A. AGGREGATES		
1. Sampling	200 m ³ Concrete	T 2
2. Fine Aggregate Gradation and FM		T 27
3. Coarse Aggregates Gradation	200 m ³ Concrete	T 27
B. PLASTIC CONCRETE		
1. Sampling	Every 75 m ³	T 141
2. Air Content		T 152 or T 196
3. Slump	Every 75 m ³	T 119
4. Compressive Strength	One set (two cylinders) for every 75 m ³ inclusive. A test shall be the average of two cylinders.	T 22, T 23, T 231
5. Temperature	With each sample	C 1064

Periodic inspection by the Department of the Contractor's QC testing and production will continue through the duration of the project. Weekly reviews will be made of the Contractor's QC records and charts.

For aggregates, comparison of data of the Contractor's QC aggregate gradation test results to those of the Department's QA aggregate gradation test results will be made monthly during concrete production periods according to Department Standard Operating Procedures. When it is determined that the Contractor's QC test results of aggregate gradations are comparative to

that of the Department's QA test results, then the Department will use the Contractor's QC results as a basis for acceptance of the aggregates and the Department's QA testing frequency of aggregates may be reduced to a frequency of no less than three QA tests to every 10 QC tests. If the Contractor's QC aggregate gradation test results fail to compare to those of the Department's QA aggregate gradation test results, Department testing for aggregate gradations will revert to the frequency shown in Table 5 for aggregates until the Contractor's and Department's aggregate gradation test data compare.

For concrete compressive strength, comparison of data of the Contractor's QC compressive strength test results to those of the Department's QA compressive strength test results will be made monthly during concrete production periods according to Department Standard Operating Procedures. When it is determined that the Contractor's QC test results of concrete compressive strengths are comparative to that of the Department's QA test results, then the Department will use the Contractor's QC results as a basis for acceptance of the concrete and the Department's QA testing frequency of concrete compressive strengths may be reduced to a frequency of no less than three QA tests to every 10 QC tests. If the Contractor's QC compressive strength test results fail to compare to those of the Department's QA compressive strength test results, Department testing will revert to the frequency shown in Table 5 for plastic concrete until the Contractor's and Department's compressive strength test data compare.

907-804.02.13.1--Basis of Acceptance.

907-804.02.13.1.1--Sampling. Sampling of concrete mixture shall be performed in accordance with the latest edition of the Department's *Concrete Field Manual*.

907-804.02.13.1.2--Slump. Slump of plastic concrete shall meet the requirements of Table 3: MASTER PROPORTION TABLE FOR STRUCTURAL CONCRETE DESIGN. A check test shall be made on another portion of the sample before rejection of any load.

907-804.02.13.1.3--Air. Total air content of concrete shall be within the specified range for the class of concrete listed in Table 3: MASTER PROPORTION TABLE FOR STRUCTURAL CONCRETE DESIGN. A check test shall be made on another portion of the sample before rejection of any load.

907-804.02.13.1.4--Yield. If the yield of the concrete mixture design is more than plus or minus 3% of the designed volume, the mixture shall be adjusted by a Class III Certified Technician representing the Contractor to yield the correct volume plus or minus three percent ($\pm 3\%$). If batching of the proportions of the mixture design varies outside the batching tolerance range of the originally approved proportions by more than the tolerances allowed in Subsection 907-804.02.12.1, the new proportions shall be field verified per Subsection 907-804.02.10.3.

907-804.02.13.1.5--Temperature. Cold weather concreting shall follow the requirements of Subsection 907-804.03.16.1. Hot weather concreting shall follow the requirements of Subsection 907-804.03.16.2 with a maximum temperature of 35°C for Class DS concrete or for concrete mixes containing cementitious materials meeting the requirements of Subsection 907-701.02.2 as a replacement of Portland cement. For other concrete mixes, the maximum concrete

temperature shall be 32°C. Concrete with a temperature more than the maximum allowable temperature shall be rejected and not used in Department work.

907-804.02.13.1.6--Compressive Strength. Laboratory cured concrete compressive strength tests shall conform to the specified strength (f'_c) listed in the specifications. Concrete represented by compressive strength test below the specified strength (f'_c) may be removed and replaced by the Contractor. If the Contractor elects not to remove the material, it will be evaluated by the Department as to the adequacy for the use intended. All concrete evaluated as unsatisfactory for the intended use shall be removed and replaced by the Contractor at no additional cost to the Department. For concrete allowed to remain in place, reduction in payment will be as follows:

Projects with 765 Cubic Meters and More. When the evaluation indicates that the work may remain in place, a statistical analysis will be made of the QC and QA concrete test results. If this statistical analysis indicates at least 93% of the material would be expected to have a compressive strength equal to or greater than the specified strength (f'_c) and 99.87% of the material would be expected to have a compressive strength at least one standard deviation above the allowable design stress (f_c), the work will be accepted. If the statistical analysis indicates that either of the two criteria are not met, the Engineer will provide for an adjustment in pay as follows for the material represented by the test result.

Total Pay on Material in Question = Unit Price - (Unit Price x % Reduction)

$$\% \text{ Reduction} = \frac{(f'_c - X)}{f'_c - (f_c + s)} \times 100$$

where:

- f'_c = Specified 28-day compressive strength, MPa
- X = Individual compressive strength below f'_c , MPa
- s = standard deviation, MPa*
- f_c = allowable design stress, MPa

* Standard deviation used in the above reduction of pay formula shall be calculated from the applicable preceding compressive strengths test results plus the individual compressive strength below f'_c . If below f'_c strengths occur during the project's first ten compressive strength tests, the standard deviation shall be calculated from the first ten compressive strength tests results.

Projects of More Than 150 but Less Than 2000 Cubic Meters. When the evaluation indicates that the work may remain in place, a percent reduction in pay will be assessed based on a comparison of the deficient 28-day test result to the specified strength. The Engineer will provide for an adjustment in pay as follows for the material represented by the test result.

Total Pay on Material in Question = Unit Price - (Unit Price x % Reduction)

$$\% \text{ Reduction} = \frac{(f'_c - X)}{f'_c} \times 100$$

where:

f'_c = Specified 28-day compressive strength, MPa

X = Individual compressive strength below f'_c , MPa

907-804.02.14--Dispute Resolution. Disputes over variations between Contractor’s QC test results and the Department’s QA test results shall be resolved at the lowest possible level. When there are significant discrepancies between the QC test results and the QA test results, the Contractor’s Quality Control Manager, the Project Engineer, and/or the District Materials Engineer shall look for differences in the procedures, and correct the inappropriate procedure before requesting a third party resolution.

If the dispute cannot be resolved at the project or District level, the Department’s Central Laboratory will serve as a third party to resolve the dispute. The Central Laboratory’s decision shall be binding.

The Contractor shall be responsible for the cost associated with the third party resolution if the final decision is such that the Department’s QA test results were correct. Likewise, the Department will be responsible for the cost when the final decision is such that the Contractor’s QC test results were correct.

907-804.03--Construction Requirements.

907-804.03.1--Measurement of Materials.

907-804.03.1.1--General. The accuracy for measuring materials shall be in accordance with AASHTO Designation: M 157.

907-804.03.1.2--Measurement by Mass Determination. Except when otherwise specified or authorized, materials shall be measured by determining their mass. The apparatus provided for determining the mass shall be suitably designed and constructed for this purpose. The mass of cement and aggregates shall be determined separately. The mass of cement in standard bags need not be determined, but the mass of bulk cement shall be determined. The mixing water shall be measured by volume or by determining its mass. All measuring devices shall be subject to approval.

907-804.03.2--Blank.

907-804.03.3--Blank.

907-804.03.4--Hand Mixing. Hand mixing of concrete will not be allowed.

907-804.03.5--Delivery. The plant supplying concrete shall have sufficient capacity and transporting apparatus to insure continuous delivery at the rate required. The rate of delivery

shall be such as to provide for the proper continuity in handling, placing, and furnishing of the concrete. The rate shall be such that the interval between batches shall not exceed 20 minutes. The methods of delivering and handling the concrete shall be that which will facilitate placing with minimum rehandling and without damage to the structure or the concrete.

907-804.03.6--Handling and Placing Concrete.

907-804.03.6.1--General. Prior to placing concrete, all reinforcement shall have been accurately placed in the position shown on the plans and fastened as set out in Section 805. All sawdust, chips, and other construction debris and extraneous matter shall have been removed from the interior of the forms. Temporary struts, braces, and stays holding the forms in correct shape and alignment shall be removed when the concrete placing has reached an elevation rendering their service unnecessary. These temporary members shall be entirely removed from the forms and shall not be buried in the concrete.

No concrete shall be placed until the forms and reinforcement have been inspected.

Except as provided for truck mixers and truck agitators, concrete shall be placed in the forms within 30 minutes after the time that the cement is first added to the mix.

Concrete shall be placed so as to avoid segregation of materials and displacement of reinforcement. The use of troughs, chutes, and pipes over eight meters in length for gravity conveyance of concrete to the forms, will not be permitted except when authorized by the Engineer and subject to the production of quality concrete.

Only approved mechanical conveyors will be permitted.

Open troughs and chutes shall be metal or metal lined. The use of aluminum pipes, chutes, or other devices made of aluminum that come into direct contact with the concrete shall not be used. Where steep slopes are required, the chutes shall be equipped with baffles or be in short sections that change the direction of movement.

All chutes, troughs, and pipes shall be kept clean and free from coatings of hardened concrete by thoroughly flushing with water after each run. Water used for flushing shall be discharged clear of the structure.

When placing operations involve dropping the concrete more than 1.5 meters, it shall be deposited through sheet metal or other approved pipes to prevent segregation and unnecessary splashing. The pipes shall be made in sections to permit discharging and raising as the placement progresses. A non-jointed pipe may be used if sufficient openings of the proper size are provided to allow for the flow of the concrete into the shaft. As far as practicable, the pipes shall be kept full of concrete during placing, and their ends shall be kept buried in the newly placed concrete.

Except as hereinafter provided, concrete shall be placed in horizontal layers not more than 300 millimeter thick. When, with the Engineer's approval, less than the complete length of a layer is

placed in one operation, it shall be terminated in a vertical bulkhead. Each layer shall be placed and compacted before the preceding layer has taken its initial set and shall be compacted so as to avoid the formation of a construction joint with the preceding layer.

907-804.03.6.2--Consolidation. Concrete, during and immediately after depositing, shall be thoroughly consolidated by the use of approved mechanical vibrators and suitable spading tools. Hand spading alone will be permitted on small structural members such as railing and small culvert headwalls. Mechanical vibration of concrete shall be subject to the following:

- A. The vibration shall be internal unless special authorization of other methods is given by the Engineer or as provided herein.
- B. In general, vibrators shall be a type and design approved by the Engineer. They shall be capable of vibration frequencies of at least 4500 impulses per minute.
- C. The intensity of vibration shall be such as to visibly affect a mass of concrete of 25-mm slump over a radius of at least 450 millimeters.
- D. The Contractor shall provide sufficient vibrators to properly compact each batch immediately after it is placed in the forms.
- E. Vibrators shall be manipulated so as to thoroughly work the concrete around the reinforcement and embedded fixtures and into the corners and angles of the forms.

Vibration shall be applied at the point of deposit and in the area of freshly deposited concrete. The vibrators shall be inserted into and withdrawn out of the concrete slowly. The vibration shall be of sufficient duration and intensity to thoroughly compact the concrete, but shall not be continued so as to cause segregation. Vibration shall not be continued at any one point to the extent that localized areas of grout are formed. Application of vibrators shall be at points uniformly spaced and not farther apart than twice the radius over which the vibration is visibly effective.

- F. Vibration shall not be applied directly or through the reinforcement to sections or layers of concrete which have taken initial set. It shall not be used to make concrete flow in the forms over distances so great as to cause segregation, and vibrators shall not be used to transport concrete in the forms.
- G. Vibration shall be supplemented by spading as necessary to insure smooth surfaces and dense concrete along form surfaces, in corners, and in locations impossible to reach with vibrators.
- H. These provisions shall apply to the filler concrete for steel grid floors except that the vibrator shall be applied to the steel.

- I. These provisions shall apply to precast piling, concrete cribbing, and other precast members except that, if approved by the Engineer, the manufacturer's methods of vibrations may be used.

When hand spading is used for consolidation, a sufficient number of workmen with spading tools shall be provided. They will be required to flush a thin layer of mortar to all the surfaces and thoroughly and satisfactorily consolidate the concrete.

The entire operation of depositing and consolidating the concrete shall be conducted so that the concrete shall be smooth and dense and free from honeycomb or pockets of segregated aggregate.

If the Department determines that there is an excessive number of projections, swells, ridges, depressions, waves, voids, holes, honeycombs or other defects in the completed structure, removal of the entire structure may be required as set out in Subsection 105.12.

907-804.03.6.3--Discontinuance of Placing. When placing is temporarily discontinued, the concrete, after becoming firm enough to retain its form, shall be cleaned of laitance and other objectionable material to a sufficient depth to expose sound concrete. To avoid visible joints insofar as possible upon exposed faces, the top surface of the concrete adjacent to the forms shall be smoothed with a trowel. Where a "feather edge" might be produced at a construction joint, such as in the sloped top surface of a wing wall, an inset form work shall be used in the preceding layer to produce a blocked out portion that will provide an edge thickness of at least 150 millimeters in the succeeding layer. Work shall not be discontinued within 450 millimeters of the top of any face unless provision has been made for a coping less than 450 millimeters thick. In this case and if permitted by the Engineer, the construction joint may be made at the under side of the coping.

Immediately following the discontinuance of placing concrete, all accumulations of mortar splashed on the reinforcement and the surface of forms shall be removed. Dried mortar chips and dust shall not be puddled into the unset concrete. If the accumulations are not removed prior to the concrete becoming set, care shall be exercised not to break or injure the concrete-steel bond at and near the surface of the concrete while cleaning the reinforcement. After initial set the forms shall not be jarred, and no strain shall be placed on the ends of projecting reinforcement until the concrete has sufficiently set to insure against any damage by such jarring or strain.

907-804.03.6.4--Placing Bridge Concrete. The method and sequence of placing concrete shall conform to the provisions and requirements set forth for the particular type of construction.

907-804.03.6.4.1--Foundations and Substructures. Concrete seals shall be placed in accordance with Subsection 907-804.03.9. All other concrete for foundations shall be poured in the dry unless otherwise stipulated or authorization is given in writing by the Engineer to do otherwise. Concrete shall not be placed in foundations until the foundation area has been inspected and approved.

Unless otherwise specified, the placement of concrete in the substructure shall be in accordance with the general requirements of Subsection 907-804.03.6.

Unless otherwise directed, concrete in columns shall be placed in one continuous operation, and shall be allowed to set at least 12 hours before the caps are placed.

907-804.03.6.4.2--Superstructure. For simple spans, concrete shall preferably be deposited by beginning at the center of the span and working toward the ends. For continuous spans, concrete shall be deposited as shown on the plans. Concrete in girders shall be uniformly deposited for the full length of the girder and brought up evenly in horizontal layers.

Unless otherwise permitted by the Engineer, concrete shall not be placed in the superstructure until the column forms have been stripped sufficiently to determine the character of the concrete in the columns. Unless otherwise permitted by the Engineer, the load of the superstructure shall not be placed on pile bents until the caps have been in place at least seven days and shall not be placed on other types of bents until the bents have been in place at least 14 days.

In placing concrete around steel shapes, it shall be placed on one side of the shape until it flushes up over the bottom flange of the shape on the opposite side, after which it shall be placed on both sides to completion.

Concrete in girder haunches less than three feet in height shall be placed at the same time as that in the girder stem. Whenever a haunch or fillet has a height of three feet or more at the abutment or columns, the haunch and the girder shall be poured in three successive stages: first, up to the lower side of the haunch; second, to the lower side of the girder; and third, to completion.

Except when intermediate construction joints are specified, concrete in slab, T-beam, or deck-girder spans shall be placed in one continuous operation for each span.

The floors and girders of through-girder superstructures shall be placed in one continuous operation unless otherwise specified, in which case special shear anchorage shall be provided to insure monolithic action between girder and floor.

Concrete in box girders shall be placed as shown on the plans.

Concrete shall not be chuted directly into the forms of the span and shall be placed continuously with sufficient speed to be monolithic and to allow for finishing before initial set.

907-804.03.7--Pneumatic Placing. Pneumatic placing of concrete will be permitted only if specified in the contract or if authorized by the Engineer. The equipment shall be so arranged that no vibrations result which might damage freshly placed concrete.

Where concrete is conveyed and placed by pneumatic means the equipment shall be suitable in kind and adequate in capacity for the work. The machine shall be located as close as practicable to the place of deposit. The position of the discharge end of the line shall not be more than 10

feet from the point of deposit. The discharge lines shall be horizontal or inclined upwards from the machine. At the conclusion of placement the entire equipment shall be thoroughly cleaned.

907-804.03.8--Pumping Concrete. Placement of concrete by pumping will be permitted only if specified in the contract or if authorized in writing by the Engineer. If used, the equipment shall be arranged so that no vibrations result which might damage freshly placed concrete.

Where concrete is conveyed and placed by mechanically applied pressure, the equipment shall be suitable in kind and adequate in capacity for the work. The operation of the pump shall be such that a continuous stream of concrete without air pockets is produced. When pumping is completed, the concrete remaining in the pipe line, if it is to be used, shall be ejected in such a manner that there will be no contamination of the concrete or separation of the ingredients. After this operation, the entire equipment shall be thoroughly cleaned.

The use of aluminum pipe as a conveyance for the concrete will not be permitted.

907-804.03.9--Depositing Concrete Under Water. Concrete shall not be deposited in water except with the approval of the Engineer.

Concrete deposited under water shall be Class S.

Concrete deposited under water shall be carefully placed in a compact mass in its final position by means of a tremie, a bottom dump bucket, or other approved method and shall not be disturbed after being deposited. Special care shall be exercised to maintain still water at the point of deposit. No concrete shall be placed in running water and all form work designed to retain concrete under water shall be water-tight. The consistency of the concrete shall be carefully regulated, and special care shall be exercised to prevent segregation of materials.

Concrete seals shall be placed continuously from start to finish, and the surface of the concrete shall be kept as nearly horizontal as practicable at all times. To insure thorough bonding, each succeeding layer of a seal shall be placed before the preceding layer has taken initial set.

When a tremie is used, it shall consist of a tube having a diameter of at least 250 millimeters and constructed in sections having flanged couplings fitted with gaskets. The means of supporting the tremie shall be such as to permit the free movement of the discharge over the entire top surface of the work and to permit it to be lowered rapidly when necessary to choke off or retard the flow of concrete. The discharge end shall be closed at the start of the work so as to prevent water entering the tube and shall be entirely sealed. The tremie tube shall be kept full to the bottom of the hopper. When a batch is dumped into the hopper, the flow of concrete shall be induced by slightly raising the discharge end, always keeping it in the deposited concrete. The flow is then stopped by lowering the tremie. The flow shall be continuous until the work is completed.

Depositing of concrete by the drop bottom bucket method shall conform to the following: The top of the bucket shall be open. The bottom doors shall open freely downward and outward when tripped. The bucket shall be completely filled and slowly lowered to avoid backwash. It

shall not be dumped until it rests on the surface upon which the concrete is to be deposited and when discharged shall be withdrawn slowly until well above the concrete.

Dewatering may proceed when the concrete seal is sufficiently hard and strong. As a general rule, this time will be 48 hours for concrete made with high-early-strength cement and three days for concrete made with other types of cement. All laitance and other unsatisfactory material shall be removed from the exposed surface by scraping, chipping, or other means which will not injure the surface of the concrete.

907-804.03.10--Construction Joints.

907-804.03.10.1--General. Unless otherwise approved by the Engineer, construction joints shall be made only where located on the plans or shown in the pouring schedule. If not detailed on the plans, or in the case of emergency, construction joints shall be placed as directed by the Engineer. Shear keys or inclined reinforcement shall be used where necessary to transmit shear or to bond the two sections together.

For continuous spans, bridge deck concrete shall be deposited as shown on the plans. Deviation from the pouring schedule shown in the plans is not permitted.

907-804.03.10.2--Bonding. Before depositing new concrete on or against concrete which has hardened, the forms shall be retightened. The surface of the hardened concrete shall be roughened as required by the Engineer and in a manner that will not leave loosened particles of aggregate or damaged concrete at the surface. It shall be thoroughly cleaned of foreign matter and laitance and saturated with water. When directed by the Engineer, the cleaned and saturated surfaces, including vertical and inclined surfaces, shall first be thoroughly covered with a coating of mortar or neat cement grout against which the new concrete shall be placed before the grout has attained its initial set.

The placing of concrete shall be carried continuously from joint to joint. The face edges of all joints which are exposed to view shall be carefully finished, true to line and elevation.

In order to bond successive courses suitable depressed or raised keys of the designated size shall be constructed. Raised keys shall be monolithic with the concrete of the lower course.

907-804.03.11--Concrete Exposed to Seawater. Unless otherwise specifically provided, concrete for structures exposed to seawater shall be Class AA concrete as referenced in Subsection 907-804.02.10. The clear distance from the face of the concrete to the nearest face of reinforcing steel shall be at least 100 millimeters. The mixing time and the water content shall be carefully controlled and regulated so as to produce concrete of maximum impermeability. The concrete shall be thoroughly compacted, and stone pockets shall be avoided. No construction joints shall be formed between the levels of extreme low water and extreme high water as determined by the Engineer. Between these levels, seawater shall not come in direct contact with the new concrete until at least 30 days have elapsed. The surface concrete as left by the forms shall be left undisturbed.

907-804.03.12--Blank.

907-804.03.13--Falsework. The Contractor shall submit to the Engineer four copies of structural design analysis and detail drawings, which show the method of falsework or centering. These designs and detail plans shall be prepared and bear the seal of a Registered Professional Engineer with experience in falsework design.

Falsework plans shall include falsework elevations together with all other dimensions and details which is considered necessary for the construction.

Other pertinent data needed is size and spacing of all falsework members and minimum bearing requirements for false piles.

Upon completion of falsework erection, the Registered Professional Engineer shall certify that the erected falsework is capable of supporting the load for construction.

Falsework piling shall be spaced and driven so that the bearing value of each pile is sufficient to support the load that will be imposed upon it. The bearing value of the piles should be calculated according to the appropriate formula given in Section 803.

For designing falsework and centering, a mass of 2400 kilograms per cubic meter shall be assumed for green concrete. All falsework shall be designed and constructed to provide the necessary rigidity and to support the loads without appreciable settlement or deformation. The Contractor may be required to employ screw jacks or hardwood wedges to take up slight settlement in the falsework either before or during the placing of concrete. An allowance shall be made for anticipated compressibility of falsework and for the placement of shims, wedges, or jacks to produce the permanent structural camber shown on the plans. If during construction, any weakness develops and the falsework shows any undue settlement or distortion, the work shall be stopped, the part of the structure affected removed, and the falsework strengthened before work is resumed. Falsework which cannot be founded on a satisfactory footing shall be supported on piling, which shall be spaced, driven, and removed, as referenced in Subsection 907-804.03.15, in a manner approved by the Engineer.

All structures built across a public street or highway on which maintenance of traffic is required, shall have falsework so arranged that a vertical clearance of at least 3.8 meters is provided. Unless otherwise specified, a horizontal clearance of at least the width of the traveled way shall be provided at all times. If the vertical clearance is less than 4.1 meters or the horizontal clearance is less than the full crown width of the roadway, the Contractor shall install and maintain appropriate safety devices, clearance signs and warning lights, and shall notify the Engineer sufficiently in advance of restricting the clearance for the Engineer to advise both the Traffic Engineering and the Maintenance Divisions. All traffic control and safety devices shall be in accordance with the Manual on Uniform Traffic Control Devices (MUTCD).

907-804.03.14--Forms.

907-804.03.14.1--General. Forms shall be wood, metal, or other material approved by the Engineer. All forms shall be built mortar-tight and sufficiently rigid to prevent distortion due to

pressure of the concrete and other loads incident to the construction operations. Forms shall be constructed and maintained so as to prevent warping and the opening of joints due to shrinkage. The forms shall be substantial and unyielding and shall be so designed that the finished concrete will conform to the proper dimensions and contours. The design of the forms shall take into account the effect of vibration of concrete as it is placed.

Minimum requirements for slab overhang forms shall be 20-mm plywood supported on 50-mm x 150-mm S4S wood timbers placed flatwise on 400-mm centers.

Adjustable brackets for support of slab overhang forms shall be spaced at a maximum distance of 0.9 meter center to center unless specifically approved otherwise. Grade points for forms shall coincide with the location of the adjustable form brackets.

Forms for surfaces exposed to view shall be of uniform thickness with a smooth inside surface of an approved type. Joints in forms for exposed surfaces shall be closely fitted to eliminate fins, stone pockets, or other variations in the surface of the concrete which would mar a smooth and uniform texture.

Forms shall be filleted at all sharp corners and shall be given a bevel or draft in the case of all projections, such as girders and copings, to insure easy removal.

Metal ties or anchorages within the forms shall be so constructed as to permit their removal, without injury to the concrete, to a depth of at least the reinforcing steel clearance shown on the plans. In case ordinary wire ties are permitted, all wires, upon removal of the forms, shall be cut back at least six millimeters from the face of the concrete with chisels or nippers. Nippers shall be used for green concrete. All fittings for metal ties shall be designed so that upon their removal the cavities which are left will be the smallest practicable size. The cavities shall be filled with cement mortar and the surface left sound, smooth, even, and uniform in color.

Forms shall be set and maintained to the lines designated until the concrete is sufficiently cured for form removal. Forms shall remain in place for periods which shall be determined as hereinafter specified. If forms are deemed to be unsatisfactory in any way, either before or during the placing of concrete, the Engineer will order the work stopped until the defects have been corrected.

The shape, strength, rigidity, water-tightness, and surface smoothness of reused forms shall be maintained at all times. Warped or bulged lumber shall be resized before being reused. Forms which are unsatisfactory in any respect shall not be reused.

Access to the lower portions of forms for narrow walls and columns shall be provided for cleaning out extraneous material immediately before placing the concrete.

All forms shall be treated with an approved oil or saturated with water immediately before placing the concrete. For rail members or other members with exposed faces, the forms shall be treated only with an approved oil to prevent the adherence of concrete. Any material which will adhere to or discolor the concrete shall not be used.

When metal forms are used they shall be kept free from rust, grease, or other foreign matter which will discolor the concrete. They shall be of sufficient thickness and so connected that they will remain true to shape and line, and shall conform in all respects as herein prescribed for mortar tightness, filleted corners, beveled projections, etc. They shall be constructed so as to insure easy removal without injury to concrete. All inside bolt and rivet heads shall be countersunk.

All chamfer strips shall be dressed, straight, and of uniform width and shall be maintained as such at all times.

907-804.03.14.2--Stay-In-Place Metal Forms. The use of stay-in-place metal forms will not be allowed.

907-804.03.15--Removal of Falsework, Forms, and Housing. In the determination of the time for the removal of falsework, forms, and housing and the discontinuance of heating, consideration shall be given to the location and character of the structure, the weather and other conditions influencing the setting of the concrete, and the materials used in the mix. No forms or supports shall be removed prior to approval by the Engineer. During cold weather, removal of housing and the discontinuance of heating shall be in accordance with Subsection 907-804.03.16.1.

Concrete in the last pour of a continuous superstructure shall have attained a compressive strength of 16.55 MPa, as determined by cylinder tests or maturity meter probe, prior to striking any falsework.

At the Contractor's option and with the approval of the Engineer, the time for removal of forms may be determined by cylinder tests, in accordance with the requirements listed in Table 6, in which case the Contractor shall furnish facilities for testing the cylinders. The facilities shall include an approved concrete testing machine of sufficient capacity and calibrated by an acceptable commercial laboratory. Tests shall be conducted in the presence of a Department representative to witness and record strengths obtained on each break or performed by a Department certified technician in an approved testing laboratory.

The cylinders shall be cured under conditions which are not more favorable than those existing for the portions of the structure which they represent.

Table 6
Minimum Compressive Strength Requirements for Form Removal

Forms:

Columns	7 MPa
Side of Beams	7 MPa
Walls not under pressure	7 MPa
Floor Slabs, overhead	14 MPa
Floor Slabs, between beams	14 MPa
Slab Spans	17 MPa
Other Parts	7 MPa

Centering:

Under Beams	17 MPa
Under Bent Caps	14 MPa

Limitation for Placing Beams on:

Pile Bents, pile under beam	14 MPa
Frame Bents, two or more columns	16 MPa
Frame Bents, single column	17 MPa

In lieu of using concrete strength cylinders to determine when falsework, forms, and housings can be removed, an approved maturity meter may be used to determine concrete strengths by inserting probes into concrete placed in a structure. The minimum number of maturity meter probes required for each structural component shall be in accordance with Table 7. Falsework, forms, and housings may be removed when maturity meter readings indicate that the required concrete strength is achieved. Procedures for using the maturity meter and developing the strength/maturity relationship shall follow the requirements of AASHTO Designation: T 325 and ASTM Designation: C 1074 specifications. Technicians using the maturity meter or calculating strength/maturity graphs shall be required to have at least two hours of training prior to using the maturity equipment.

Table 7
Requirements for use of Maturity Meter Probes

Structure Component	Quantity of Concrete	No. of Probes
Slabs, beams, walls, & miscellaneous items	0 - 23 m ³	2
	> 23 to 46 m ³	3
	> 46 to 69 m ³	4
	> 69 m ³	5
Footings, Columns & Caps	0 - 10 m ³	2
	> 10 m ³	3
Pavement, Pavement Overlays	112 m ²	2
Pavement Repairs	Per repair or 84 m ² Whichever is smaller	2

Methods of form removal likely to cause overstressing of the concrete shall not be used. Forms and supports shall be removed in a manner that will permit the concrete to uniformly and gradually take the stresses due to its own weight. Centers shall be gradually and uniformly lowered in a manner that will avoid injurious stresses in any part of the structure.

As soon as concrete for railings, ornamental work, parapets and vertical faces which require a rubbed finish has attained a safe strength, the forms shall be carefully removed without marring the surfaces and corners, the required finishing performed, and the required curing continued.

Prior to final inspection of the work, the Contractor shall remove all falsework, forms, excavated material or other material placed in the stream channel during construction. Falsework piles may be cut or broken off at least 300 millimeters below the mudline or ground line unless the plans specifically indicate that they are to be pulled and completely removed from the channel.

907-804.03.16--Cold or Hot Weather Concreting.

907-804.03.16.1--Cold Weather Concreting. In cold weather, the temperature of the concrete when delivered to the job site shall conform to the temperature limitations of “Temperature Limitations on Concrete when Delivered to Job Site” listed in Table 6 below.

When the Contractor proposes to place concrete during seasons when there is a probability of ambient temperatures lower than 5°C, the Contractor shall have available on the project the approved facilities necessary to enclose uncured concrete and to keep the temperature of the air inside the enclosure within the ranges and for the minimum periods specified herein.

In lieu of the protection and curing of concrete in cold weather, at the option of the Contractor with the approval of the Engineer, when concrete is placed during cold weather and there is a probability of ambient temperatures lower than 5°C, an approved maturity meter may be used to determine concrete strengths by inserting probes into concrete placed in a structure. The minimum number of maturity meter probes required for each structural component shall be in accordance with Table 7. An approved insulating blanketing material shall be used to protect the work when ambient temperatures are less than 5°C and shall remain in place until the required concrete strength in Table 6 is achieved. Procedures for using the maturity meter and developing the strength/maturity relationship shall follow the requirements of AASHTO Designation: T 325 and ASTM Designation: C 1074 specifications. Technicians using the maturity meter or calculating strength/maturity graphs shall be required to have at least two hours of training prior to using the maturity equipment.

One or more of the aggregates and/or mixing water may be heated. The aggregates may be heated by steam, dry heat, or by placing in the mixing water which has been heated. Frozen aggregates shall not be used. When either aggregates or water are heated above 38°C, the aggregates and water shall be combined first in the mixer before the cement is added to avoid flash set. Cement shall not be mixed with water or with a mixture of water and aggregate having a temperature greater than 38°C.

The use of salt or other chemical admixtures in lieu of heating will not be permitted.

Before placing concrete, all ice or frost shall be removed from the forms and reinforcement.

In the case of concrete placed directly on or in the ground, such as for footings or bottom slabs, protection and curing during cold weather may be provided as set for concrete pavement under Subsection 501.03.20.3.

The Contractor shall assume all risk and added cost connected with the placing and protecting of concrete during cold weather. Permission given by the Engineer to place concrete during such time will in no way relieve the Contractor of responsibility for satisfactory results. Should it be determined at any time that the concrete placed under such conditions is unsatisfactory, it shall be removed and replaced with satisfactory concrete by the Contractor without extra compensation.

**TABLE 8
COLD WEATHER TEMPERATURE LIMITATIONS ON CONCRETE WHEN
DELIVERED TO JOB SITE**

Ambient Temperature °C	Minimum Concrete Temperature °C	
	For sections with least dimension less than 300 mm	For sections with least dimensions 300 mm or greater
-1 to 7	16	10
-18 to -1	18	13
Below -18	21	16

907-804.03.16.2--Hot Weather Concreting. The manufacture, placement, and protection of concrete during hot weather requires special attention to insure that uniform slump ranges and satisfactory placement qualities are maintained, that surface cracking is held to a minimum, and that design strengths are produced.

907-804.03.17--Curing Concrete. Concrete surfaces shall be protected from premature drying by covering as soon as possible with a satisfactory curing material. When wetted burlap is used, it shall be not less than two thicknesses of Class 3 burlap or its equivalent, and the burlap shall be kept continuously and thoroughly wet. Careful attention shall be given to the proper curing and protection of concrete, and curing by the wetting method shall continue for a period of at least seven days after placing the concrete. If high-early-strength cement is used, this period may be reduced to four days.

Surfaces to have a Class 2 rubbed or sprayed finish and bridge deck surfaces when the atmospheric temperature is 32°C or above shall be cured only by wetting methods. The curing of concrete bridges with membrane curing will be permitted only under the conditions specified herein.

Surfaces on which curing is to be by liquid membrane shall be given the required surface finish prior to the application of curing compound. During the finishing period the concrete shall be

protected by the water method of curing. Concrete surfaces cured by the liquid membrane method shall receive two applications of curing compound. The first application shall be applied immediately after the finishing is completed and accepted. Prior to applying the first application, the concrete shall be thoroughly wetted with water and the liquid membrane applied just as the surface film of water disappears. The second application shall be applied immediately after the first application has set. The rate of application of curing compound will be as prescribed by the Engineer with a minimum spreading rate per application of one liter per five square meters of concrete surface. The coating shall be protected against marring for at least 10 days after the application of the curing compound. The coating on bridge decks shall receive extra attention and may require additional protection as required by the Engineer. All membrane marred or otherwise disturbed shall be given an additional coating. Should the surface coating be subjected repeatedly to injury, the Engineer may require that the water curing method be applied at once.

When using curing compound, the compound should be thoroughly mixed within an hour before use. If the use of curing compound results in a streaked or blotched appearance, the method shall be stopped and water curing applied until the cause of defective appearance is corrected.

Other precautions to insure the development of strength shall be taken as directed.

Adequate tarpaulins of ample size shall be on the project and used as necessary to protect the work in case of rain or other emergencies.

Conditions governing the placement of concrete and the requirements for the placement, protection, and curing of concrete during cold or hot weather shall conform to the limitations, conditions, and requirements stipulated in Subsection 907-804.03.16 as applicable.

907-804.03.18--Expansion and Fixed Joints, Bearings, Anchor Bolts, Plates, Castings, Pipes, Drains, Conduits, Etc. All joints shall be constructed according to details shown on the plans. The edges of the concrete at open or filled joints shall be chamfered or edged as indicated on the plans.

907-804.03.18.1--Open Joints. Open joints shall be placed in the locations shown on the plans and shall be constructed by the insertion and subsequent removal of a wood strip, metal plate, or other approved material. The insertion and removal of the template shall be accomplished without chipping or breaking the corners of the concrete. Reinforcement shall not extend across an open joint unless so specified on the plans.

907-804.03.18.2--Filled Joints. Poured expansion joints and joints to be sealed with premolded materials shall be constructed similar to open joints. When premolded types are specified, the filler shall be placed in correct position as the concrete on one side of the joint is placed. When the form is removed, the concrete on the other side shall be placed. Adequate water stops of metal, rubber, or plastic shall be carefully placed as shown on the plans.

907-804.03.18.3--Premolded and Preformed Joint Seals. When preformed elastomeric compressive joint seals are specified, the previously formed and cured open joint shall be

thoroughly cleaned of all foreign matter, the required adhesive uniformly applied, and the seal installed in accordance with the recommendations of the manufacturer of the seal.

When premolded filler is used for the joints in the roadway slab, the tops shall be adequately sealed with poured joint filler in accordance with details on the plans. Premolded filler shall be permanently fastened to an adjacent concrete surface by appropriate use of copper wire, copper nails, or galvanized nails.

907-804.03.18.4--Steel Joints. The plates, angles, or other structural shapes shall be accurately shaped at the shop to conform to the section of the concrete floor. Fabrication and painting shall conform to the specifications covering those items. When called for on the plans or in the special provisions, the material shall be galvanized in lieu of painting. Care shall be taken to insure that the surface in the finished plane is true and free of warping. Positive methods shall be employed in placing the joints to keep them in correct position during the placing of the concrete. The opening at expansion joints shall be that designated on the plans at normal temperature, and care shall be taken to avoid impairment of the clearance in any manner.

907-804.03.18.5--Water Stops. Adequate water stops of metal, rubber, or plastic shall be placed as shown on the plans. Where movement at the joint is provided for, the water stops shall be of a type permitting movement without injury. They shall be spliced, welded, or soldered to form continuous watertight joints.

907-804.03.18.6--Bearing Devices. Bearing plates, rockers, and other bearing devices shall be constructed according to details shown on the plans. Unless otherwise specified or set in plastic concrete, they shall be set in grout to insure uniform bearing. Structural steel and painting shall conform to the requirements of Sections 810 and 814. When specified, the material shall be galvanized in lieu of painting. The rockers or other expansion bearing devices shall be set, considering the temperature at the time of erection, so that the required position of the device is provided.

At all points of bearing contact, concrete members shall be separated from underlying members by dimensioned bearing pads or by methods and/or materials specified on the plans.

When not otherwise specifically provided, contact areas between concrete super-structures and substructures shall be separated by three layers of No. 15, Type I, roofing felt.

907-804.03.18.7--Friction Joints. Metal friction joints shall consist of plates as indicated on the plans and shall be securely anchored in correct position. All sliding surfaces shall be thoroughly coated with an approved graphite grease. Movement shall not be impeded by the concrete in which the plates are embedded.

907-804.03.18.8--Placing Anchor Bolts, Plates, Castings, Grillage, Conduits, Etc. All anchor bolts, plates, castings, grillage, conduits, etc. indicated on the plans to be placed in or on the concrete shall be placed, set, or embedded as indicated or as directed. These items of the construction shall be set in portland cement mortar as referenced in Subsection 714.11.5, except that anchor bolts may, as permitted by the Engineer, be built into the masonry, set in drilled

holes, or placed as the concrete is being constructed by inserting encasing pipe or oiled wooden forms of sufficient size to allow for adjustment of the bolts. After removal of the pipe or forms, the space around the bolts shall be filled with portland cement mortar completely filling the holes. The bolt shall be set accurately and perpendicular to the plane of the seat.

Anchor bolts which are to be set in the masonry prior to the erection of the superstructure shall be carefully set to proper location and elevation with a template or by other suitable means.

When bed plates are set in mortar, no superstructure or other load shall be placed thereon until this mortar has been allowed to set for a period of at least 96 hours, subject to the restrictions for cold weather concreting in Subsection 907-804.03.16.1. The mortar shall be kept well moistened during this period.

Weep hole drains shall be installed in abutments and retaining walls, and roadway drains or scuppers shall be installed in the roadway slabs in accordance with the details shown on the plans.

Where backfill is to be made at weep holes or openings in the structure, sand or stone chimneys or French drains shall be constructed as specified and shall extend through the portion of the backfill to be drained. Except as otherwise provided, the sand, stone, or slag used in this construction shall meet the requirements of Subsection 704.04.

907-804.03.19--Finishing Concrete Surfaces.

907-804.03.19.1--Classes of Finishes. Surface finishes of exposed concrete surfaces shall be classified as follows:

- Class 1 - Ordinary Surface Finish
- Class 2 - Rubbed or spray Finish
- Class 3 - Tooled Finish
- Class 4 - Sand-Blast Finish
- Class 5 - Wirebrush or Scrubbed Finish
- Class 6 - Floated Surface Finish

907-804.03.19.2--Class 1, Ordinary Surface Finish. Immediately following the removal of forms, all fins and irregular projections shall be removed from all surfaces except from those which are not to be exposed or not to be waterproofed. On all surfaces, the cavities produced by form ties and all other holes, honeycomb spots, broken corners or edges, and other defects shall be thoroughly cleaned, and after having been kept saturated with water for at least three hours shall be carefully pointed and trued with a mortar of cement and fine aggregate mixed in the proportions used in the class of the concrete being finished. Mortar used in pointing shall be not more than one hour old. The mortar patches shall be cured as specified under Subsection 907-804.03.17. All construction and expansion joints shall be left carefully tooled and free of mortar and concrete. The joint filler shall be left exposed for its full length with clean and true edges.

The resulting surfaces shall be true and uniform. All surfaces which cannot be repaired to the satisfaction of the Engineer shall be given a Class 2 rubbed finish.

907-804.03.19.3--Class 2, Rubbed or Spray Finish.

907-804.03.19.3.1--Rubbed Finish. After removal of forms, the Class 1 finish shall be completed and the rubbing of concrete shall be started as soon as its condition will permit. Immediately before starting this work, the concrete shall be kept thoroughly saturated with water for at least three hours. Surfaces shall be rubbed with a medium course Carborundum stone using a small amount of mortar on its face. The mortar shall be composed of cement and sand mixed in the proportions used in the concrete being finished. Rubbing shall be continued until all form marks, projections, and irregularities have been removed, all voids are filled, and a uniform surface has been obtained. The paste produced by this rubbing shall be left in place at this time.

After all concrete above the surface being treated has been cast, the final finish shall be obtained by rubbing with a fine Carborundum stone and water. This rubbing shall continue until the entire surface is of a smooth texture and uniform color.

After the final rubbing is completed and the surface has dried, it shall be rubbed with burlap to remove loose powder and objectionable marks.

907-804.03.19.3.2--Spray Finish. Prior to the spray finish, the concrete shall be given a Class 1 finish in accordance with Subsection 907-804.03.19.2, supplemented if necessary with a grout meeting the requirements of Subsection 714.11 with fine aggregate modified to require 100 percent passing the 1.18-mm Sieve.

Grout shall be applied with burlap pads or float sponges, and as soon as the grout has dried the surface shall be brushed to remove all loose grout and the surface left smooth and free of air holes. Surfaces to be sprayed shall be free of efflorescence, flaking coatings, dirt, oil, and other foreign substances. Prior to application of the spray finish, the surfaces shall be free of moisture, as determined by sight and touch, and in a condition consistent with the manufacturer's published recommendations.

The spray finish material shall meet the requirements of Subsection 714.12 and shall be listed on of Approved Sources of Materials. The spray finish shall be applied with heavy duty spray equipment capable of maintaining a constant pressure as necessary for proper application. The material shall be applied as recommended by the manufacturer except the rate of application shall not be less than one liter per 1.2 square meters of surface area without prior written approval of the Engineer.

The completed finish shall be tightly bonded to the structure and present a uniform appearance and texture equal to or better than a rubbed finish. If necessary, additional coats shall be sprayed to produce the desired surface texture and uniformity. Upon failure to adhere positively to the structure without chipping or cracking or to attain the desired surface appearance, the coatings shall be completely removed and the surface given a rubbed finish in accordance with Subsection

907-804.03.19.3.1, or other approved methods shall be used to obtain the desired surface finish to the satisfaction of the Engineer without additional cost to the State.

907-804.03.19.4--Classes 3, 4, and 5 Finishes. If required, specifications for these finishes will be contained in the special provisions.

907-804.03.19.5--Class 6, Floated Surface Finish. After the concrete has been deposited in place, it shall be consolidated and the surface shall be struck off by means of a strike board and floated with a wooden or cork float. An edging tool shall be used on edges and expansion joints. The surface shall not vary more than three millimeters under a 3-meter straightedge. The surface shall have a granular or matte texture which will not be slick when wet.

907-804.03.19.6--Required Finishes for Various Surfaces.

907-804.03.19.6.1--General. Unless otherwise specified, the top surface of sidewalks, the top horizontal surfaces of footings, and top slabs of box bridges, box culverts, or other structures shall be given a Class 6 finish. All formed concrete surfaces shall be given a Class 1 finish, except on surfaces which are completely enclosed, such as the inside surfaces of cells of box girders, the removal of fins and form marks and the rubbing of mortared surfaces to a uniform color will not be required.

In reference to finishing, exposed surfaces are surfaces or faces which may be seen after all backfill has been placed. Exposed surfaces requiring a Class 2 finish shall be finished at least 300 millimeters below the ground line or the low water elevation, whichever is higher.

The Class 2 finish shall be made upon a Class 1 finish. After the removal of forms the Class 1 finish shall be completed and the rubbing of concrete shall be started as soon as the condition of the concrete will permit.

Bridge floors shall be finished in accordance with Subsection 907-804.03.19.7.

907-804.03.19.6.2--Finishing Formed Concrete Surfaces of Box Bridges, Box Culverts, Pipe Headwalls, and Minor Structures. The exposed surfaces of wing walls and parapets of box bridges and box culverts to be used as vehicular or pedestrian underpasses shall be given a Class 2 finish. Exposed surfaces of other box culverts or box bridges, pipe culvert headwalls, and other minor structures shall be given a Class 1 finish unless otherwise indicated on the plans.

The exposed surfaces of retaining walls including copings and parapets shall receive a Class 2 finish.

907-804.03.19.6.3--Finishing Formed Concrete Surface of Bridges. All formed concrete bridge surfaces which are exposed shall have a Class 1 or 2 finish as set forth herein unless designated otherwise on the plans.

Bridges with designated surfaces for Class 2 finish are classified as follows:

- Group A - Bridges over highways, roads and streets.
- Group B - Bridges over waterways and railroads.
- Group BB - Twin or adjacent bridges of Group B category.

When a Group B or BB bridge also spans a highway, road or street, exposed concrete surfaces shall be finished in accordance with Group A requirements.

(A) Superstructures. Concrete surfaces to be given a Class 2 finish shall be the exposed surfaces of wings and rails and other exposed surfaces indicated by a double line in Figures 804-1, 804-2, and 804-3.

When a Group B or BB also spans a highway, road or street, the superstructure of spans over and extending one span in each direction beyond the lower level highway, road or street shall be given a Class 2 finish as shown for Group A.

(B) Substructures. Concrete surfaces to be given a Class 2 finish are as follows:

Group A. Exposed surfaces of abutments, end bents, end bent posts, wing walls, railing, retaining walls, parapets, copings, piers, columns, piles, caps, struts or walls between columns or piles, encasement of steel piles, arch rings and spandrel walls.

Group B and BB. Exposed surfaces of abutments, wing walls, end bent posts, railing, retaining walls, parapets and copings.

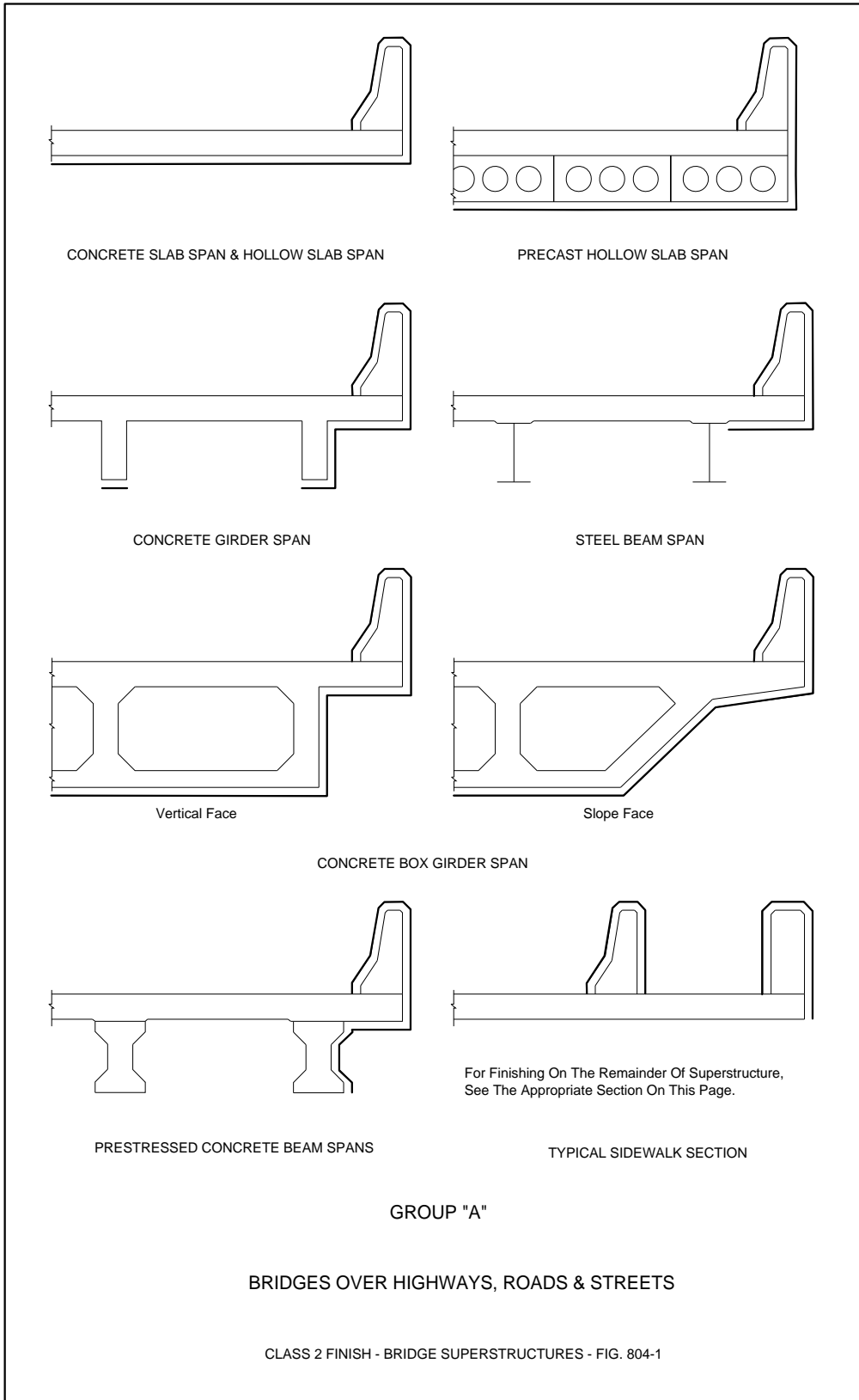

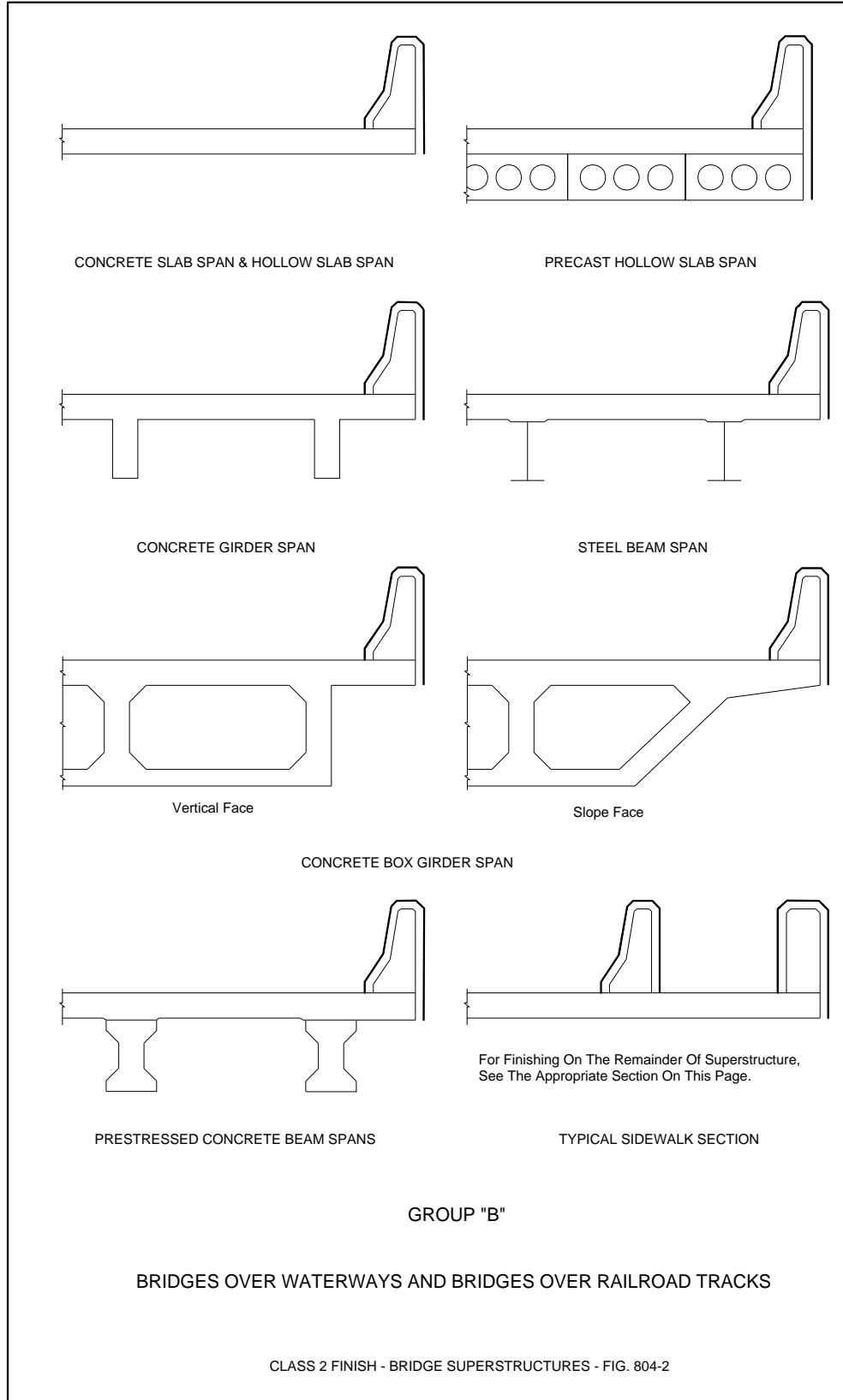

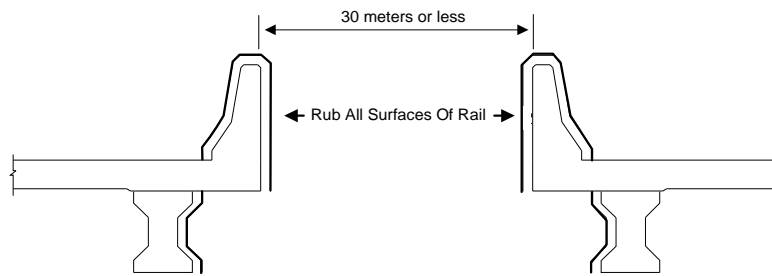

GROUP "B B" - ADJACENT BRIDGES

TYPICAL FOR OTHER BRIDGE SPAN TYPES

GROUP "B B"

TWIN or DUAL BRIDGES

CLASS 2 FINISH - BRIDGE SUPERSTRUCTURES - FIG. 804-3

907-804.03.19.7--Finishing Bridge Floors.

907-804.03.19.7.1--General. Concrete bridge decks shall be struck off and finished by the method(s) designated on the plans.

In the event a method is not designated, the Contractor may use either the longitudinal or transverse method subject to the requirements contained in these specifications.

Except when indicated otherwise on the plans, the final surface texture of the bridge floor shall be either a drag, belt, or broom finish. The surface texture specified and surface requirements shall be in accordance with the applicable requirements of Subsections 501.03.17 and 501.03.18 modified only as the Engineer deems necessary for bridge deck construction operations.

907-804.03.19.7.2--Longitudinal Method. The longitudinal method requires that the strike-off screed be supported on accurately graded and supported bulkheads or templates placed across the full width at the end(s) of the pour. Before the concrete is placed, approved fixed templates or wooden bulkheads of not less than 31-mm lumber shall be placed perpendicular to the centerline of the roadway, or in the case of skew bridges at the angle of skew. The upper surface of the template or bulkheads shall be accurately set to conform to the required grade and crown.

Special attention shall be given to the gutter lines where the strike-off screed cannot reach. The gutters shall be finished by hand and tested with the straight edge. Floor drains shall be set lower than the finished gutter line and finished over. After initial set, the concrete shall be dished out and finished around the drains to form an outlet.

After the concrete has been deposited and rough graded, it shall be struck off by means of a strike-off screed resting on the bulkheads or fixed templates. The strike-off screed shall be of a type satisfactory to the Engineer and shall have sufficient strength to retain its shape under all working conditions. The final surface shall comply with the applicable requirements of Subsections 501.03.17.6 and 501.03.18, and unless otherwise specified in the contract, the final finish under this method shall be the belt finish.

In general, the overall strike-off screed should be trussed, with bracing heavy enough to support the weight of a man without deflecting, and should be adjustable for camber and correction of sag.

The strike-off screed will ride on the bulkheads or fixed templates at the ends of the section being finished. Care shall be taken to see that the bulkhead or fixed template elevations are accurately set since the entire span surface will be controlled by them. The manipulation of the screed shall be such that neither end is raised from the bulkheads or templates during the process.

The concrete shall be struck off by beginning at one curb and proceeding entirely across the span. A slight excess of concrete shall be kept in front of the cutting edge at all times. This operation shall be repeated at least three times. In each case, the strike-off screed shall be picked up and carried back to the point of beginning. No backward strokes will be allowed. The strike-off screed shall be moved along the bulkheads or fixed templates with a combined longitudinal

and transverse motion. This operation may be manual or mechanical. Standing or walking in the fresh concrete ahead of the strike-off screed will not be permitted.

907-804.03.19.7.3--Transverse Method. The transverse method requires that the screeding equipment be supported on accurately graded and supported rails placed beyond the gutter lines and parallel with the centerline of the bridge.

The machine shall be so constructed and operated as to produce a bridge floor of uniform density with minimum manipulation of the fresh concrete and achieved in the shortest possible time. Manual transverse methods of screeding will not be permitted.

The finishing machine shall be supported on vertically adjustable rails set a sufficient distance from the gutter line to allow free movement of the screed from gutter line to gutter line. Satisfactory means of load distribution with minimum rail deflection shall be provided. The screed rails for a deck pour shall be completely in place for the full length of the pour and shall be firmly secured prior to placing concrete. The screed rails shall be adjusted as necessary to compensate for settlement and deflection occurring during the screeding operations. Supports for the screed rail shall be located directly over slab overhang support brackets as referenced in Subsection 907-804.03.14.1.

At least one dry run shall be made the length of each pour with a "tell-tail" device attached to the screed carriage to assure the specified clearance to the reinforcing steel.

The screed shall be equipped with a metal cutting edge or other approved mechanical means for accurately fine grading the plastic concrete to the required grade and surface smoothness and shall be supported by a bridging structure sufficiently rigid and heavy to perform operations satisfactorily on concrete of minimum slump without vibration, distortion, and wrecking of forms. The screed shall be mechanically actuated to deliver the screeding action and for travel in a longitudinal direction at a uniform rate along the bridge floor.

The screed shall complete sufficient passes to strike off all of the excess concrete with ample mortar along the entire leading edge to assure filling of low spots. Care shall be taken to remove all objectionable material from the gutters where final hand finishing will be required.

The selection of the transverse method may require the Contractor to furnish bridge deck concrete which contains an approved water-reducing set retarding admixture in the quantities approved by the Engineer at no additional cost to the State. See Subsection 713.02 for more information.

Other finishing requirements shall be in accordance with the general requirements in Subsection 907-804.03.19.7.1 and as specified on the plans.

907-804.03.19.7.4--Acceptance Procedure for Bridge Deck Smoothness. After the bridge decks and bridge end slabs are completed and preferably before the construction of the bridge railing, they shall be tested for ride quality using a Contractor furnished profilograph. Profile Index Values shall be determined in accordance with Department SOPs and these specifications.

The profilograph shall meet the requirements of Subsection 401.02.6.5. Profiles will be obtained in the wheel paths of the main thru lanes and, where conditions allow, in the wheel paths of any auxiliary lanes or tapers. Profile Index Values for bridge decks and bridge end slabs shall be obtained for all state roads with four lanes or more, on state roads three lanes or less where the current traffic count is 2,000 ADT or higher, or as designated on the plans. Ride quality tests will begin at a point where the rearmost wheel of the profilograph is as close to the beginning of the bridge end slab as possible and shall proceed forward across the remainder of the bridge end slab, across the bridge deck and continue across the next bridge end slab to a point where the front-most wheel of the profilograph reaches the far-most edge of the bridge end slab. Bridges and bridge end slabs not requiring a ride quality test must meet a 3.0 millimeters in 3-meter straightedge requirement in longitudinal and transverse directions. Bridges in horizontal curves having a radius of less than 300 meters at the centerline and bridges within the superelevation transition of such curves are excluded from a test with the profilograph.

The Profile Index Value for bridge decks including the bridge end slabs shall be averaged for the left and right wheel path for each lane and where applicable, each auxiliary lane and taper, and shall not exceed 1025 millimeters per kilometer for each lane. Auxiliary lanes, tapers, shoulders and other areas that are not checked with the profilograph, shall meet a 3.0 millimeter in 3-meter straightedge check made transversely and longitudinally across the deck or slab. In addition, individual bumps or depressions exceeding 8.0 millimeters, when measured from a chord length of 7.5 meters, shall be corrected and the surface shall meet a 3.0 millimeters in 3-meter straightedge check made transversely across the deck or slab.

Bridge decks and bridge end slabs not meeting the preceding requirements shall be corrected. Corrective work shall be done at no additional cost to the Department. Corrective work shall consist of grinding the bridge deck in accordance with this specification. All corrective work shall precede final surface texturing. After completion of final surface texturing, all surface areas corrected by grinding shall be sealed with a nonstaining 40% minimum alkylalkoxysilane penetrating sealant applied per the manufacturer's directions.

In case the bridge end slabs are to be constructed on a future project, the bridge deck(s) alone shall be tested for ride quality using the acceptance procedure outlined above, except that the ride quality test will begin at a point where the rearmost wheel of the profilograph is as close to the beginning of the bridge as possible and shall proceed forward across the bridge deck to a point where the front-most wheel of the profilograph reaches the far-most edge of the bridge.

Expansion joint installation shall be delayed and the joint temporarily bridged to facilitate operation of the profilograph and grinding equipment across the joint wherever feasible.

It shall be the Contractor's responsibility to schedule profilograph testing. The Contractor shall notify the Department at least five (5) days in advance of profilograph testing. The Contractor shall ensure that the area to be tested has been cleaned and cleared of all obstructions. Profilograph testing of bridge decks and bridge end slabs shall be performed by the Contractor under supervision of the Engineer. All profilograph testing shall be performed at no additional cost to the Department. The Contractor will be responsible for traffic control associated with this testing operation.

907-804.03.19.7.4.1--Grinding Bridge Decks.

907-804.03.19.7.4.1.1--Equipment. The grinding equipment shall be a power driven, self-propelled machine that is specifically designed to smooth and texture Portland cement concrete pavement with diamond blades. The effective wheel base of the machine shall not be less than 3.6 meters. It shall have a set of pivoting tandem bogey wheels at the front of the machine and the rear wheels shall be arranged to travel in the track of the fresh cut pavement. The center of the grinding head shall be no further than 0.9 meter forward from the center of the back wheels.

The equipment shall be of a size that will cut or plane at least 0.9 meter wide. It shall also be of a shape and dimension that does not encroach on traffic movement outside of the work area. The equipment shall be capable of grinding the surface without causing spalls at cracks, joints, or other locations.

907-804.03.19.7.4.1.2--Grinding. The grinding areas will be determined by the Contractor and approved by the Engineer. The Contractor shall develop and submit to the Engineer for approval a Grinding Plan. The Contractor shall allow up to 45 days for the Department to review the Plan prior to starting any grinding operations. This plan shall include as a minimum:

- 1) Name of the project superintendent in responsible charge of the grinding operation.
- 2) List and description of all equipment to be used.
- 3) Maximum depth of each pass allowed by the grinding equipment.
- 4) Maximum width of each pass allowed by the grinding equipment.
- 5) Details of a sequence of the grinding operation.
- 6) Complete data from Profilograph runs, based on a 8.0-mm bump height, for each wheel path over the entire bridge including bridge end slabs, which shall include profile index, bump locations (in stations), bump heights and proposed final cross-slopes. When a computerized profilograph is used, a complete printout of the profile including the header information for each wheel path will be required.
- 7) Data showing reinforcing steel clearance in all areas to be ground.
- 8) A detailed drawing of the deck showing areas to be ground with station numbers and grinding depths clearly indicated.
- 9) A description of grinding in areas where drains are in conflict with grind areas.
- 10) Details of any changes in deck drainage, anticipated ponding, etc.

The Engineer will evaluate the grinding plan for conformance with the plans and specifications, after which the Engineer will notify the Contractor of any additional information required and/or changes that may be needed. Any part of the plan that is unacceptable will be rejected and the Contractor shall submit changes for reevaluation. All approvals given by the Engineer shall be subject to trial and satisfactory performance in the field, and shall not relieve the Contractor of the responsibility to satisfactorily complete the work.

The construction operation shall be scheduled and proceed in a manner that produces a uniform finished surface. Grinding will be accomplished in a manner that eliminates joint or crack faults while providing positive lateral drainage by maintaining a constant cross-slope between grinding

extremities in each lane. Auxiliary or ramp lane grinding shall transition as required from the mainline edge to provide positive drainage and acceptable riding surface.

The operation shall result in a finished surface that conforms as close as possible to the typical cross-section and the requirements specified in Subsection 907-804.03.19.7.4.1.3.

The Contractor shall establish positive means for removal of grinding residue. Residue shall not be permitted to flow across lanes used by public traffic or into gutters or drainage facilities.

907-804.03.19.7.4.1.3--Final Surface Finish. The grinding process shall produce a finish surface that is as close as possible to grade and uniform in appearance with a longitudinal line type texture. The line type texture shall contain parallel longitudinal corrugations that present a narrow ridge corduroy type appearance. The peaks of the ridges shall be approximately 2.0 millimeters higher than the bottoms of the grooves with approximately 173 to 187 evenly spaced grooves per meter. Grinding chip thickness shall be a minimum of 2.0 millimeters thick.

The finished bridge decks and bridge end slabs shall be retested for riding quality using a Contractor furnished profilograph meeting the requirements of 401.02.6.5. The finished results shall meet the following conditions:

- (a) Individual bumps or depressions shall not exceed 8.0 millimeters when measured from a chord length of 7.5 meters.
- (b) The final index value for the bridge deck and bridge end slabs shall be an average of both the right and left wheel paths of each lane and shall not exceed 1025 millimeters per kilometer.

The final profilogram will be furnished to the Engineer for informational purposes.

907-804.03.19.8--Finishing Horizontal Surfaces of Footings or Top Slabs of Box Bridges, Culverts, or Other Structures. The finishing of horizontal surfaces of footing or top slabs of box bridges, culverts, or other structures shall be achieved by placing an excess of material in the form and removing or striking off the excess with a template, forcing the coarse aggregate below the mortar surface. After the concrete has been struck off the surface shall be given a Class 6 finish.

907-804.03.19.9--Finishing Exposed Surfaces of Sidewalks. After the concrete has been deposited in place it shall be consolidated and the exposed surface shall be given a Class 6 finish. An edging tool of the required radius shall be used on all edges and at all expansion joints. The surface shall have a granular texture which will not be slick when wet.

Sidewalk surfaces shall be laid out in blocks with an approved grooving tool as shown on the plans or as directed.

907-804.03.20--Opening Bridges.

907-804.03.20.1--Public Traffic. Unless otherwise specified, concrete bridge floors shall be closed to public highway traffic for a period of at least 21 days after placing concrete.

907-804.03.20.2--Construction Traffic. Unless otherwise specified, concrete bridge floors shall be closed to construction traffic for a period of seven days after placing concrete and the minimum required compressive strength for the concrete placed is obtained.

907-804.03.21--Final Cleanup. Upon completion of the work all equipment, surplus materials, forms, and waste material shall be removed, the bridge cleaned, and the site of the work given a final cleanup.

907-804.03.22--Precast-Prestressed Concrete Bridge Members.

907-804.03.22.1--General. All installations and plants for the manufacture of precast-prestressed bridge members shall be PCI (Prestressed Concrete Institute) Certified. Bridge members manufactured in plants or installations not so approved will not be accepted for use in the work. The Contractor or other manufacturer shall employ a technician skilled in the adopted system of prestressing to supervise the manufacturing operations. This technician shall be certified according to the guidelines of this specification. The Contractor shall develop and implement a Quality Control Program as per Division I of PCI Quality Control Manual, 4th Edition. The Quality Control Program shall be submitted to the District Materials Engineer for approval.

907-804.03.22.2--Stressing Requirements. The jacks for stressing shall be equipped with accurate calibrated gauges for registering the jacking pressure. Means shall be provided for measuring elongation of strands to at least the nearest millimeter.

Prior to beginning work, the Contractor or manufacturer shall have all jacks to be used, together with their gauges, calibrated by an approved laboratory. All jacks and gauges shall have an accuracy of reading within two percent. The testing agency shall furnish the Engineer a statement certifying that the jacks and gauges meet this requirement. During the progress of the work, if a gauge appears to be giving erratic results or if the gauge pressure and elongations indicate materially differing stresses, recalibration will be required.

Calibration of jacks and gauges shall be repeated at intervals deemed necessary by the Engineer. These intervals for calibration shall not exceed one year.

Shop drawings of prestressed beams, including an erection plan, shall be submitted in duplicate to the Bridge Engineer for approval prior to manufacture of members.

907-804.03.22.2.1--Methods. Plans for the particular bridge members will show prestressing by one of the following methods:

(A) Pretensioning. The prestressing strands are stressed initially. After the concrete is placed, cured, and has attained the compressive strength shown on the plans, the stress is transferred to

the member. The method used for pretensions shall be in accordance to Division V of PCI Quality Control Manual, 4th Edition.

(B) Posttensioning. The posttensioning tendons are installed in voids or ducts and are stressed and anchored after development of the compressive strength specified on the plans. The voids or ducts are then pressure grouted.

(C) Combined Method. Part of the reinforcing is pretensioned and part posttensioned. Under this method all applicable requirements for the two methods specified shall apply to the respective stressing elements being used.

907-804.03.22.2.2--Alternate Details for Prestressed Members. In the event that the Contractor / Manufacturer desires to use materials or methods that differ in any respect from those shown on the plans or described in these specifications, the Contractor shall submit for approval full plan details on acceptable tracings suitable for reproduction and specifications which shall become the property of the Department. In order for alternate materials and/or methods to be considered, they will be required to comply fully with the following:

- A. Provisions equal to those stipulated in these specifications.
- B. Current AASHTO Specifications.
- C. Recommendations of materials manufacturer.
- D. Camber tolerance of beams and spans shown on plans.

Note: Alternate materials and methods will not be authorized on Federal-Aid Projects.

The Engineer shall be the sole judge as to the adequacy and propriety of any variation of materials or methods.

907-804.03.22.2.3--Stressing Procedure.

(A) General. Stressing shall be performed by suitable jacks working against unyielding anchorages and capable of maintaining the required stress for an indefinite period without movement or yielding. Strands may be stressed singularly or in a group.

The tension to be applied to each strand shall be as shown on the plans. The tension shall be measured by both jacking gauges and elongations in the strands and the result shall check within close limits.

It is anticipated that there will possibly be a difference in indicated tension between jack pressure and elongation of about five (5) percent. In this event, the discrepancy shall be placed on the side of slight overstress rather than understress.

In the event of an apparent discrepancy between gauge pressure and elongation of as much as five (5) percent, the entire operation shall be carefully checked, and the source of error determined before proceeding further.

Elongation is to be measured after the strands have been suitably anchored, and all possible slippage at the anchorages has been eliminated.

In all stressing operations, the stressing force shall be kept as nearly symmetrical about the vertical axis of the member as practicable.

(B) Pretensioning. All strands to be prestressed shall be brought to a uniform initial tension prior to being given their full pretensioning. This uniform initial tension of approximately 4450 to 8900 Newtons shall be measured by suitable means such as a dynamometer so that its value can be used as a check against elongation computed and measured.

After the initial tensioning, the strand or group shall be stressed until the required elongation and jacking pressure is within the limits specified.

When the strands are stressed in accordance with the plan requirements and these specifications and all other reinforcing is in place, the concrete shall be placed in the prepared forms.

Strand stress shall be maintained until the concrete between anchorages has attained the required compressive strength as determined by cylinder tests, after which the strands shall be cut off flush with the ends of column members, and cut as shown on the plans for beams, girders, etc. Strands shall be cut or released in such a manner that eccentricity of prestress will be kept to a minimum and no damage to the member will result. The strand cutting pattern shall be as shown on the plans or as approved by the Bridge Engineer.

(C) Posttensioning. For all posttensioning tendons/bars the anchor plates shall set exactly normal in all directions to the axis of the tendon/bar. Parallel wire anchorage cones shall be recessed within the beams. Tensioning shall not take place until the concrete has reached the compressive strength shown on the plans.

Elongation and jacking pressures shall make appropriate allowance for all possible slippage or relaxation of the anchorage. Posttensioning tendons/bars shall be stressed in the order and manner shown on the plans.

The units shall be tensioned until the required elongations and jacking pressures are attained and reconciled within the limits specified in Subsection 907-804.03.22.2.3(A) with such overstresses as approved by the Engineer for anchorage relaxation.

Independent references shall be established adjacent to each anchorage to indicate any yielding or slippage that may occur between the time of initial stressing and final release of the strands.

Straight tendons/bars may be tensioned from one end. Unless otherwise specified, curved tendons shall be stressed by jacking from both ends of the tendons.

(D) Combined Method. In the event that girders are manufactured with part of the reinforcement pretensioned and part posttensioned, the applicable portions of the requirements listed herein shall apply to each type.

907-804.03.22.3--Manufacture.

907-804.03.22.3.1--Forms. The forms used for precast-prestressed bridge members shall meet the requirements of Division II of the PCI Quality Control Manual, 4th Edition.

907-804.03.22.3.2--Placing and Fastening Steel. Placing and fastening of all steel used for precast-prestressed bridge members shall meet the requirements of Division V of the PCI Quality Control Manual, 4th Edition.

907-804.03.22.3.3--Holes for Prestressing Tendons/Bars. Holes provided in girders for prestressing tendons/bars shall be formed by means of inflatable rubber tubing, flexible metal conduit, metal tubing, or other approved means.

907-804.03.22.4--Placing and Curing Concrete.

907-804.03.22.4.1--Placing. The placing of concrete shall meet the applicable requirements of Division III of PCI Quality Control Manual, 4th Edition.

907-804.03.22.4.2--Curing. Initial and accelerated curing of all members shall meet the applicable requirements of Division IV of PCI Quality Control Manual, 4th Edition except for the following listed requirements.

The source of heat for accelerated cure shall be steam. Calibrated thermocouples shall be implanted into the concrete members to monitor areas expected to have maximum and minimum heat. Curing methods and procedures listed in the prestress producer's PCI Quality System Manual shall be approved by the Department before their implementation.

907-804.03.22.4.3--Removal of Side Forms. Side forms may be removed after the concrete has attained sufficient strength to maintain a true section. In order to obtain "sufficient strength", it may be necessary to cure members for 12 hours or more as prescribed in Subsection 907-804.03.22.4.2, or to attain a minimum compressive strength of 7 MPa.

If high-early-strength concrete is obtained by use of low slump (0 to 38 millimeters) concrete, vacuum process, or other approved methods, side forms may be removed earlier; however, approval of the methods and revision from normal schedules will be made only after inspections by the District and Jackson Laboratories have determined that satisfactory results will be attained by the methods and schedules proposed.

907-804.03.22.4.4--Grouting. The holes through posttensioned members in which the tendons are installed shall be equipped with approved grouting vents. All prestressing tendons to be bonded shall be free of dirt, loose rust, grease, or other deleterious substances. Before grouting, the ducts shall be free of water, dirt, and other foreign substances. The ducts shall be blown out with compressed air until no water comes through the ducts. For long members with draped tendons an open tap at low points may be necessary. After completion of stressing, the annular

space between sides of tendon and sides of hole shall be grouted as set in the following paragraphs.

With the grouting vent open at one end of the core hole, grout shall be applied continuously under moderate pressure at the other end until all entrapped air is forced out through the open grout vent, as evidenced by a steady stream of grout at the vent. Whereupon, the open vent shall be closed under pressure. The grouting pressure shall be gradually increased to a refusal of at least 520kPa and held at this pressure for approximately 10 seconds, and the vent shall then be closed under this pressure.

Portland cement grout shall consist of a mixture of:

- 1 part Type 1 Portland cement
- 1/4 part fly ash
- 3/4 part washed sand *
- 0.35 to 0.54 kilograms of water per kilogram of cement

* all passing 1.18-mm sieve and not more than 5% retained on the 600- μ m sieve

A plasticizing admixture, subject to approval by the Engineer, shall be used in accordance with the manufacturer's recommendations.

The grout shall be mixed in a mechanical mixer, shall have the consistency of heavy paint, and shall be kept agitated until placed.

Members shall not be moved before the grout has set, ordinarily at least 24 hours at 26°C or higher.

907-804.03.22.5--Finishing and Marking. Units shall be given a Class 1 finish at the plant and shall be given a Class 2 finish after erection when required.

Recesses in girders at end of diaphragm bars, holes left by form ties, and other surface irregularities shall be carefully cleaned and patched with an approved non-shrink commercial grout or a non-shrinkage mortar of the following composition:

- 1 part Type 1 cement
- 1 1/2 to 2 parts fine sand
- 033 to 049 grams of aluminum powder per kilogram of cement
- Approved admixture per Subsection 713.02.
- Sufficient water to produce a workable but rather stiff mix.

The units shall be clearly marked in accordance with Department SOP.

907-804.03.22.6--Handling, Storage, and Installation. Posttensioned members may be handled immediately after completion of stressing and grout has set. Pretensioned members may be handled immediately after release of tensioning. In either case, the members shall have developed a minimum compressive strength of 28 MPa prior to handling. In the event stressing is not done in a continuous operation, members shall not be handled before they are sufficiently

stressed, as determined by the Engineer, to sustain all forces and bending moments due to handling. In the handling, storage, and transporting of beams or girders, they shall be maintained in an upright position (position as cast) at all times and shall be picked up from points within distance from beam ends equal to beam depth or at pick-up points designated on the plans. Disregard of this requirement and dropping of units may be cause for rejection, whether or not injury to the unit is apparent. Piles shall be picked up and loaded for shipment at points shown by the suspension diagram on the plans. Extreme care shall be used in handling and storing piles to prevent damage. The dropping of a pile may be cause for rejection of same, whether or not there is apparent injury to the member.

Care shall be exercised during the storage, hoisting, and handling of precast units to prevent damage. Damaged units shall be replaced by the Contractor at no additional costs to the State.

When members are stacked for storage, each layer shall be supported at or near the pick-up points. Supports shall be carefully placed in a vertical line in order that the weight of any member will not stress an underlying member. To prevent damage in moving members it is suggested that rigid supports be covered with a cushion of wood or other resilient material.

Members shall not be transported until at least one day after the concrete has reached a compressive strength of 35 MPa or greater strength when shown on the plans.

Piles used in salt water shall not be driven until concrete is seven days old, and air-entrained concrete shall be used in such piles.

After prestressed concrete voided slab units are set, doweled and bolted in their final position the keyways and dowel holes shall be filled with an approved non-shrink grout. Traffic shall not be permitted on the spans for 24 hours after grouting, and heavy construction equipment exceeding 13.6 metric tons will not be permitted on the spans for a period of 72 hours after grouting.

Adjacent slab units that mismatch more than six millimeters shall be adjusted prior to grouting of the shear keys. The maximum deviation from cross-section and grade (exclusive of camber) at any point shall not exceed six millimeters; and when the surface is checked with a 3-meter straightedge applied both parallel and perpendicular to the centerline, the variance shall not exceed six millimeters.

In addition to the requirements set out in this section, the applicable requirements of Section 803 shall apply.

907-804.03.22.7--Tolerances for Accepting Precast Prestressed Concrete. Member shall meet the dimension tolerances set by Division VII of PCI Quality Control Manual, 4th Edition.

907-804.03.22.8--Testing of Materials. Concrete and aggregate testing shall meet the requirements of Division VI of PCI Quality Control Manual, 4th Edition, except that the concrete **mixture** design shall meet the requirements of Subsection 907-804.02.10 “Portland Cement Concrete **Mixture** Design”. Also, in addition to concrete compressive tests samples made for detensioning and 28-day strength, test samples shall be made and tested in order to prove

compliance to the requirements of Subsection 907-804.03.22.6 for handling and shipping prestressed members. Compressive strength test cylinders for detensioning, handling and shipping shall receive the same type curing as the prestressed members for which they represent. Compressive strength samples shall be made each day for each prestress casting bed.

907-804.03.22.9--Testing Personnel. Technicians testing Portland cement concrete used in the production of precast-prestressed members shall be PCI Quality Control Technician/Inspector Certified. Each producer of precast-prestressed members shall have at least one PCI Level II certified technician on site during production for Department projects.

907-804.03.22.10--Documentation. The Precast-Prestressed Producer for each Precast-Prestressed concrete bridge member shall maintain documentation as set forth in Department SOPs. Testing and inspection record forms shall be approved by the Central Laboratory and as a minimum contain information listed in Division VI of PCI Quality Control Manual, 4th Edition.

907-804.03.22.11--Use in the Work. Before any Precast-Prestressed member is incorporated into the work, documentation as described in Subsection 907-804.03.22.10 is required along with visual inspection of the member at the bridge construction site. Project Office personnel as per Department SOP will make visual inspection of the prestressed member at the bridge construction site.

907-804.04--Method of Measurement. Concrete, complete and accepted, will be measured in cubic meter. The concrete volume will be computed from the neat dimensions shown on the plans, except for such variations as may be ordered in writing by the Engineer. The quantity of concrete involved in fillets, scorings, and chamfers 645 square millimeters or less in cross-sectional area will be neglected. Deductions shall be made for the following:

- (1) The volume of structural steel, including steel piling encased in concrete.
- (2) The volume of timber piles encased in concrete, assuming the volume to be 0.075 cubic meter per meter of pile.
- (3) The volume of concrete piles encased in concrete.

No deduction will be made for the volume of concrete displaced by steel reinforcement, floor drains, or expansion joint material that is 25 millimeters or less in width normal to the centerline of the joint. Where railing is bid as a separate item, that portion of the railing above the top of the curb, above the surface of the sidewalk, or above the bridge roadway, as the case may be, will not be included in the measurement of concrete, but will be measured as railing. Massive pylons or posts which are to be excepted from payment for railing and are intended to be measured for as concrete will be so noted on the plans.

When shown on the plans or directed by the Engineer, concrete placed as a seal for cofferdams will be measured by the cubic meter actually in place, except that no measurement will be made of seal concrete placed outside of an area bounded by vertical planes 450 millimeters outside the neat lines of the footing as shown on the plans or as directed and parallel thereto.

Reinforcing steel will be measured and paid for in kilogram as set out in Section 805.

Unless otherwise specified, structural steel will be measured and paid for as set out in Section 810.

Excavation for bridges will be measured and paid for as in Section 801.

Piling will be measured and paid for as set out in Sections 802 and 803.

Railing will be measured and paid for as set out in Section 813.

Prestressed concrete beams and plank will be measured by the meter.

Prestressed concrete voided slab units, interior and exterior with railing, and precast concrete caps, intermediate and end cap with winged abutment wall, of the size and type specified will be measured by the unit complete in place and accepted. Railing, winged abutment walls, grout, tie rods, nuts, washers, bearing pads and other appurtenances will not be measured for separate payment.

907-804.05--Basis of Payment. Concrete will be paid for at the contract unit price per cubic meter for the class or classes specified, complete in place. Prestressed concrete beams and plank will be paid for at the contract unit per meter of specified size and type.

Prestressed concrete voided slab units and precast caps will be paid for at the contract unit price per each for the specified types and sizes, complete in place and accepted; which price shall be full compensation for furnishing, hauling and erecting the members; including all prestressing reinforcement and other reinforcement in the members. Payment at the contract unit prices bid shall be full compensation for furnishing all materials, equipment, tools, labor and incidentals necessary to complete the work.

Payment will be made under:

- 907-804-A: Bridge Concrete (Class ____) - per cubic meter
- 907-804-B: Box Bridge Concrete (Class ____) - per cubic meter
- 907-804-C: Length Prestressed Concrete Beam (Type ____) - per meter
- 907-804-D: Length Prestressed Concrete Plank - per meter
- 907-804-E: Length Prestressed Concrete Voided Slab (Size Interior) - per each
- 907-804-F: Length Prestressed Concrete Voided Slab (Size Exterior) - per each
- 907-804-G: Length Precast Concrete Caps (End Unit with Wall) - per each
- 907-804-H: Length Precast Concrete Caps (Intermediate Unit) - per each

MISSISSIPPI DEPARTMENT OF TRANSPORTATION

SPECIAL PROVISION NO. 907-815-1M

CODE: (SP)

DATE: 8/6/97

SUBJECT: Sediment Control Stone

Section 815, Riprap and Slope Paving, of the 1996 Metric Edition of the Mississippi Standard Specifications for Road and Bridge Construction is hereby amended as follows:

907-815.02--Materials. After the last paragraph of Subsection 815.02 on page 815-1, add the following:

Material used for sediment control stone shall be crushed stone meeting the requirements of Subsection 703.03 for Size No. 57.

907-815.04--Method of Measurement. After the first sentence of the first paragraph of Subsection 815.04 on page 815-4, insert the following:

Sediment control stone complete in place and accepted will be measured by the cubic meter (LVM) or metric ton, as specified.

907-815.05--Basis of Payment. After the first sentence of the first paragraph of Subsection 815.05 on page 815-5, insert the following:

Sediment control stone will be paid for at the contract unit price per cubic meter or metric ton.

After the last pay item listed on page 815-5, add the following:

907-815-F: Sediment Control Stone

- per cubic meter
or metric ton

MISSISSIPPI DEPARTMENT OF TRANSPORTATION

SPECIAL PROVISION NO. 907-815-4M

CODE: (IS)

DATE: 12/10/2001

SUBJECT: Geotextile for RipRap

Section 907-815, RipRap and Slope Paving, of the 1996 Metric Edition of the Mississippi Standard Specifications for Road and Bridge Construction is hereby modified as follows:

907-815.05--Basis of Payment. Delete the last pay item number, description and unit in Subsection 815.05 on page 815-5 and substitute the following:

907-815-E: Geotextile Fabric under _____

Description

(Type ___*) (AOS ___*)

- per square meter

* When not designated, see 714.13.

S E C T I O N 9 0 5 - P R O P O S A L

Date _____

Mississippi Transportation Commission
Jackson, Mississippi

Sirs: The following proposal is made on behalf of _____
_____ of _____

for constructing the following designated project(s) within the time(s) hereinafter specified.

The plans are composed of drawings and blue prints on file in the offices of the Mississippi Department of Transportation, Jackson, Mississippi.

The Specifications are the current Standard Specifications of the Mississippi Department of Transportation approved by the Federal Highway Administration, except where superseded or amended by the plans, Special Provisions and Notice(s) to Bidders attached hereto and made a part thereof.

I (We) certify that I (we) possess a copy of said Standard and Supplemental Specifications.

Evidence of my (our) authority to submit the Proposal is hereby furnished. The proposal is made without collusion on the part of any person, firm or corporation. I (We) certify that I (we) have carefully examined the Plans, the Specifications, including the Special Provisions and Notice(s) to Bidders, herein, and have personally examined the site of the work. On the basis of the Specifications, Special Provisions, Notice(s) to Bidders, and Plans, I (we) propose to furnish all necessary machinery, tools, apparatus and other means of construction and do all the work and furnish all the materials in the manner specified. I (We) understand that the quantities mentioned herein are approximate only and are subject to either increase or decrease, and hereby propose to perform any increased or decreased quantities of work at the unit prices bid, in accordance with the above.

Attached hereto is a certified check, cashier's check or Proposal Guaranty Bond in the amount as required in the Advertisement (or, by law).

INSTRUCTION TO BIDDERS: Alternate and Optional Items on Bid Schedule.

1. Two or more items entered opposite a single unit quantity WITHOUT DEFINITE DESIGNATION AS "ALTERNATE ITEMS" are considered as "OPTIONAL ITEMS". Bidders may or may not indicate on bids the Optional Item proposed to be furnished or performed WITHOUT PREJUDICE IN REGARD TO IRREGULARITY OF BIDS.
2. Items classified on the bid schedule as "ALTERNATE ITEMS" and/or "ALTERNATE TYPES OF CONSTRUCTION" must be preselected and indicated on bids. However, "Alternate Types of Construction" may include Optional Items to be treated as set out in Paragraph 1, above.
3. Optional items not preselected and indicated on the bid schedule MUST be designated in accordance with Subsection 102.06 prior to or at the time of execution of the contract.
4. Optional and Alternate items designated must be used throughout the project.

I (We) further propose to perform all "force account or extra work" that may be required of me (us) on the basis provided in the Specifications and to give such work my (our) personal attention in order to see that it is economically performed.

SECTION 905 -- PROPOSAL (CONTINUED)

I (We) further propose to execute the attached contract agreement (Section 902) as soon as the work is awarded to me (us), and to begin and complete the work within the time limit(s) provided for in the Specifications and Advertisement. I (We) also propose to execute the attached contract bond (Section 903) in an amount not less than one hundred (100) percent of the total of my (our) part, but also to guarantee the excellence of both workmanship and materials until the work is finally accepted.

I (We) enclose a certified check, cashier's check or bid bond for **five percent (5%) of total bid** and hereby agree that in case of my (our) failure to execute the contract and furnish bond within Ten (10) days after notice of award, the amount of this check (bid bond) will be forfeited to the State of Mississippi as liquidated damages arising out of my (our) failure to execute the contract as proposed. It is understood that in case I am (we are) not awarded the work, the check will be returned as provided in the Specifications.

Respectfully Submitted,

DATE _____

Contractor

BY _____
Signature

TITLE _____

ADDRESS _____

CITY, STATE, ZIP _____

PHONE _____

FAX _____

E-MAIL _____

(To be filled in if a corporation)

Our corporation is chartered under the Laws of the State of _____ and the names, titles and business addresses of the executives are as follows:

President Address

Secretary Address

Treasurer Address

The following is my (our) itemized proposal.

Replacing 3 Bridges on SR 8, from Calhoun City to Derma, known as Federal Aid Project No. BR-0016-03(020) / 102160302, in Calhoun County.

I (We) agree to complete the entire project within the specified contract time.

***** SPECIAL NOTICE TO BIDDERS *****

**BIDS WILL NOT BE CONSIDERED UNLESS BOTH UNIT PRICES AND ITEM TOTALS ARE ENTERED.
 BIDS WILL NOT BE CONSIDERED UNLESS THE BID CERTIFICATION LOCATED AT THE END OF THE BID SHEETS IS SIGNED**

*****BID SCHEDULE*****

Line No.	Item Code	Adj Code	Quantity	Units	Description	Unit Price		Item Amount	
						Dollar	Ct	Dollar	Ct
Roadway Items									
0010	201-A001		1	Lump Sum	Clearing and Grubbing	XXXXXXXX	XXX		
0020	201-B001		1	Hectare	Clearing and Grubbing				
0030	202-A001		1	Lump Sum	Removal of Obstructions	XXXXXXXX	XXX		
0040	202-B005		7,330	Square Meter	Removal of Asphalt Pavement (All Depths)				
0050	202-B018		4,139	Square Meter	Removal of Concrete Driveways (All Depths)				
0060	202-B024		206	Square Meter	Removal of Concrete Median & Island Pavement (All Depths)				
0070	202-B035		70	Square Meter	Removal of Concrete Sidewalk				
0080	202-B039		235	Meter	Removal of Curb (All Types)				

Line No.	Item Code	Adj Code	Quantity	Units	Description	Unit Price		Bid Amount	
0090	202-B059		6	Each	Removal of Inlets (All Sizes)				
0100	202-B076		300	Meter	Removal of Traffic Stripe				
0110	202-B107		383	Meter	Removal of Pipe (All Sizes)				
0120	203-G003	(E)	7,678	Cubic Meter	Excess Excavation (FM) (AH)				
0130	206-A001	(S)	1,073	Cubic Meter	Structure Excavation				
0140	211-B001	(E)	4,578	Cubic Meter	Topsoil for Slope Treatment(Contractor Furnished) (LVM)				
0150	212-B001		135	Square Meter	Standard Ground Preparation				
0160	213-B001		1	Metric Ton	Combination Fertilizer (13-13-13)				
0170	213-C001		6	Metric Ton	Superphosphate				
0180	216-A001		135	Square Meter	Solid Sodding				
0190	219-A001		9	thousand liter	Watering	6.	00	54.	00
0200	220-A001		3	Hectare	Insect Pest Control	75.	00	225.	00

Line No.	Item Code	Adj Code	Quantity	Units	Description	Unit Price		Bid Amount	
0210	221-A001	(S)	14	Cubic Meter	Portland Cement Concrete Paved Ditch				
0220	236-A004		6	Each	Silt Basin (Type D)				
0230	406-A001		1,000	Square Meter	Cold Milling of Bituminous Pavement (All Depths)				
0240	501-E001		78	Meter	Expansion Joints (Without Dowels)				
0250	502-A001	(C)	467	Square Meter	Reinforced Cement Concrete Bridge End Pavement				
0260	602-A001	(S)	4,473	Kilogram	Reinforcing Steel				
0270	603-C-A002	(S)	658	Meter	450-mm Reinforced Concrete Pipe, Class III				
0280	603-C-A003	(S)	46	Meter	600-mm Reinforced Concrete Pipe, Class III				
0290	603-C-A005	(S)	13	Meter	900-mm Reinforced Concrete Pipe, Class III				
0300	603-C-A007	(S)	199	Meter	1200-mm Reinforced Concrete Pipe, Class III				
0310	603-C-B001	(S)	4	Each	450-mm Reinforced Concrete End Section				
0320	603-C-B002	(S)	3	Each	600-mm Reinforced Concrete End Section				

Line No.	Item Code	Adj Code	Quantity	Units	Description	Unit Price		Bid Amount	
0330	603-C-B004	(S)	2	Each	900-mm Reinforced Concrete End Section				
0340	604-A001		1,289	Kilogram	Castings				
0350	605-O003	(S)	150	Meter	150-mm Perforated Sewer Pipe for Underdrains (SDR 23.5)				
0360	605-P003	(S)	75	Meter	150-mm Non-perforated Sewer Pipe for Underdrains (SDR 23.5)				
0370	605-W001	(GM)	187	Cubic Meter	Filter Material for Combination Storm Drain &/or Underdrains, Type A (FM)				
0380	605-W002	(GM)	456	Cubic Meter	Filter Material for Combination Storm Drain &/or Underdrains, Type B (FM)				
0390	606-B001		225	Meter	Guard Rail (Class A, Type 1)				
0400	606-D012		11	Each	Guard Rail, Bridge End Section, Type I				
0410	608-A001	(S)	95	Square Meter	Concrete Sidewalk (Without Reinforcement)				
0420	609-B001	(S)	224	Meter	Concrete Curb, Type Header				
0430	609-D004	(S)	594	Meter	Combination Concrete Curb and Gutter Type 3A Modified				
0440	609-D007	(S)	103	Meter	Combination Concrete Curb and Gutter Type 2 Modified				

Line No.	Item Code	Adj Code	Quantity	Units	Description	Unit Price		Bid Amount	
0450	614-B001	(S)	3,104	Square Meter	Concrete Driveway (With Reinforcement)				
0460	615-A015	(S)	37	Meter	Concrete Bridge End Barrier, 810-mm				
0470	616-A001	(S)	1,044	Square Meter	Concrete Median and/or Island Pavement (100-mm)				
0480	618-A001		1	Lump Sum	Maintenance of Traffic	XXXXXXXXX	XXX		
0490	619-D1001		29	Square Meter	Standard Roadside Construction Signs (less than 0.9 square meter)				
0500	619-D2001		64	Square Meter	Standard Roadside Construction Signs (0.9 square meter or more)				
0510	619-F3004		18	Each	Delineators (Guard Rail) (White)				
0520	619-G4001		178	Meter	Barricades (Type III) (Single Faced)				
0530	619-G4005		7	Meter	Barricades (Type III) (Double Faced)				
0540	619-G5001		165	Each	Free Standing Plastic Drums				
0550	619-G7001		4	Each	Warning Lights (Type "B")				
0560	619-K1001		92	Meter	Installation and Removal of Guard Rail (Type I)(Class A)				

Line No.	Item Code	Adj Code	Quantity	Units	Description	Unit Price		Bid Amount	
0570	619-K2003		12	Each	Installation and Removal of Guard Rail (Type "H" Bridge End Section)				
0580	620-A001		1	Lump Sum	Mobilization	XXXXXXXX	XXX		
0590	621-A001		1	Each	Field Laboratory				
0600	629-A004		1	Each	Vehicular Impact Attenuator (112 kph)				
0610	630-F001		50	Each	Delineators (Guard Rail)(White)				
0620	630-G001		12	Each	Type 3 Object Markers (OM-3R or OM-3L) Post Mounted				
0630	815-A005	(S)	94	Metric Ton	Loose Riprap, (Size 45 kg)				
0640	815-A007	(S)	3,345	Metric Ton	Loose Riprap, (Size 136 kg)				
0650	907-203-A002	(E)	11,373	Cubic Meter	Unclassified Excavation (FM) (AH)				
0660	907-203-EX004	(E)	21,683	Cubic Meter	Borrow Excavation (AH)(FME) (Class B9)				
0670	907-209-A004		9,865	Square Meter	Geotextile Fabric Stabilization (Type V Non-Woven)				
0680	907-217-A001		72	Square Meter	Ditch Liner				

Line No.	Item Code	Adj Code	Quantity	Units	Description	Unit Price		Bid Amount	
0690	907-223-A001		8	Hectare	Mowing	100.	00	800.	00
0700	907-225-A001		8	Hectare	Grassing				
0710	907-225-B001		41	Metric Ton	Agricultural Limestone				
0720	907-226-A002		8	Hectare	Temporary Grassing				
0730	907-234-A002		2,800	Meter	Temporary Silt Fence				
0740	907-234-C002		400	Meter	Super Silt Fence				
0750	907-237-A002		900	Meter	Wattles, 500-mm				
0760	907-245-A001		11	Meter	Triangular Silt Dike				
0770	907-246-A002		175	Each	Sandbags				
0780	907-304-B001	(GT)	13,806	Metric Ton	Granular Material (Class 3, Group D)				
0790	907-304-I004	(GT)	5,557	Metric Ton	Crushed Stone Base (Size 610)				
0800	907-310-B002	(GT)	24	Metric Ton	Size III Stabilizer Aggregate, Coarse				

Line No.	Item Code	Adj Code	Quantity	Units	Description	Unit Price		Bid Amount	
0810	907-407-A001	(A2)	14,753	Liter	Asphalt for Tack Coat				
0820	907-413-H001		74	Meter	Sawing and Sealing Transverse Joints in Asphalt Pavment				
0830	907-501-K001		452	Square Meter	Transverse Grooving				
0840	907-601-B001	(S)	82	Cubic Meter	Class "B" Structural Concrete, Minor Structures				
0850	907-603-ALT01	(S)	359	Meter	450-mm Type A Alternate Pipe				
0860	907-603-ALT05	(S)	117	Meter	600-mm Type A Alternate Pipe				
0870	907-605-AA004	(S)	2,512	Square Meter	Geotextile for Subsurface Drainage, Type III				
0880	907-606-E001		11	Each	Guard Rail, Terminal End Section				
0890	907-617-A003		49	Each	Right-of-Way Marker				
0900	907-618-C001		1	Lump Sum	Construction & Removal of Detour Bridge	XXXXXXXXX	XXX		
0910	907-619-A1009		5,216	Meter	Temporary Traffic Stripe (Continuous White)				
0920	907-619-A2009		5,511	Meter	Temporary Traffic Stripe (Continuous Yellow)				

Line No.	Item Code	Adj Code	Quantity	Units	Description	Unit Price		Bid Amount	
0930	907-619-A5005		2,021	Meter	Temporary Traffic Stripe (Detail)				
0940	907-619-C7001		110	Each	Two-Way Yellow Reflective High Performance Raised Marker				
0950	907-619-K4001		12	Each	Installation and Removal of Guardrail (Terminal End Section)				
0960	907-626-CC002		2,622	Meter	150-mm Thermoplastic Edge Stripe (Continuous White) (1.50-mm min)				
0970	907-626-DD002		1,151	Meter	150-mm Thermoplastic Traffic Stripe (Skip Yellow) (2.25-mm min)				
0980	907-626-EE003		2,437	Meter	150-mm Thermoplastic Traffic Stripe (Continuous Yellow) (2.25-mm min)				
0990	907-626-GG001		542	Meter	Thermoplastic Detail Stripe (150-mm Equivalent Length)(White)(2.25-mm min.)				
1000	907-626-GG002		764	Meter	Thermoplastic Detail Stripe (150-mm Equivalent Length)(Yellow)(2.25-mm min.)				
1010	907-626-H001		21	Square Meter	Thermoplastic Legend (White)(3.00-mm min.)				
1020	907-626-H002		180	Meter	Thermoplastic Legend (White)(3.00-mm min.)				
1030	907-627-K001		11	Each	Red-Clear Reflective High Performance Raised Markers				
1040	907-627-L001		486	Each	Two-Way Yellow Reflective High Performance Raised Markers				

Line No.	Item Code	Adj Code	Quantity	Units	Description	Unit Price		Bid Amount	
1050	907-699-A001		1	Lump Sum	Roadway Construction Stakes	XXXXXXXXX	XXX		
1060	907-815-E001	(S)	3,683	Square Meter	Geotextile Fabric under Riprap				
1070	907-815-F002	(S)	20	Metric Ton	Sediment Control Stone				
ALTERNATE GROUP AA NUMBER 1									
1080	907-403-A005	(BA1)	2,311	Metric Ton	Hot Mix Asphalt, MT, 9.5-mm mixture				
1090	907-403-A006	(BA1)	3,803	Metric Ton	Hot Mix Asphalt, MT, 12.5-mm mixture				
1100	907-403-A007	(BA1)	2,525	Metric Ton	Hot Mix Asphalt, MT, 19-mm mixture				
1110	907-403-C003	(BA1)	153	Metric Ton	Hot Mix Asphalt, MT, 19-mm mixture, Trench Widening				
ALTERNATE GROUP AA NUMBER 2									
1120	907-403-M001	(BA1)	2,311	Metric Ton	Warm Mix Asphalt, MT, 9.5-mm mixture				
1130	907-403-M002	(BA1)	2,525	Metric Ton	Warm Mix Asphalt, MT, 19-mm mixture				
1140	907-403-M007	(BA1)	3,803	Metric Ton	Warm Mix Asphalt, MT, 12.5-mm mixture				
1150	907-403-O001	(BA1)	153	Metric Ton	Warm Mix Asphalt, MT, 19-mm mixture, Trench Widening				
ALTERNATE GROUP BB NUMBER 1									

Line No.	Item Code	Adj Code	Quantity	Units	Description	Unit Price		Bid Amount	
1160	907-628-JJ001		461	Meter	150-mm High Performance Cold Plastic Traffic Stripe (Continuous White)				
1170	907-628-LL001		315	Meter	150-mm High Performance Cold Plastic Traffic Stripe (Skip Yellow)				
1180	907-628-MM001		461	Meter	150-mm High Performance Cold Plastic Traffic Stripe (Continuous Yellow)				
ALTERNATE GROUP BB NUMBER 2									
1190	907-626-J003		461	Meter	150-mm Inverted Profile Thermoplastic Traffic Stripe, Continuous White				
1200	907-626-K003		315	Meter	150-mm Inverted Profile Thermoplastic Traffic Stripe, Skip Yellow				
1210	907-626-L003		461	Meter	150-mm Inverted Profile Thermoplastic Traffic Stripe (Continuous Yellow)				
Bridge Items									
1220	805-A001	(S)	14,880	Kilogram	Reinforcement				
1230	813-A001	(S)	390	Meter	Concrete Railing				
1240	815-A007	(S)	1,327	Metric Ton	Loose Riprap, (Size 136 kg)				
1250	907-803-A001	(S)	9	Each	Test Pile				
1260	907-803-B002	(S)	9	Each	Conventional Static Pile Load Test	5,000.	00	45,000.	00

Line No.	Item Code	Adj Code	Quantity	Units	Description	Unit Price		Bid Amount	
1270	907-803-D001	(S)	474	Meter	HP 310 x 79 Steel Piling				
1280	907-803-D002	(S)	801	Meter	HP 360 x 108 Steel Piling				
1290	907-803-J001	(S)	6	Each	Pile Restrike				
1300	907-804-A001	(S)	189	Cubic Meter	Bridge Concrete (Class AA)				
1310	907-804-E001	(S)	144	Each	12.192-m Prestressed Concrete Voided Slab (1.219-m Interior)				
1320	907-804-F008	(S)	32	Each	12.192-m Prestressed Concrete Voided Slab (1.042-m Exterior)				
1330	907-815-E001	(S)	1,256	Square Meter	Geotextile Fabric under Riprap				

*** BID CERTIFICATION ***

TOTAL BID.....\$_____

*** DBE/WBE SECTION ***

Complete item nos. 1, 2, and/or 3 as appropriate. See Notice to Bidders addressing Disadvantaged Business Enterprises in Highway Construction.

1. I/We agree that no less than _____ percent shall be expended with small business concerns owned and controlled by socially and economically disadvantaged individuals (DBE and WBE).
2. Classification of Bidder: Small Business (DBE)_____ Small Business (WBE)_____
3. A joint venture with a Small Business (DBE/WBE): _____

*** SIGNATURE STATEMENT ***

BIDDER ACKNOWLEDGES THAT HE/SHE HAS CHECKED ALL ITEMS IN THIS PROPOSAL FOR ACCURACY AND CERTIFIED THAT THE FIGURES SHOWN THEREIN CONSTITUTE THEIR OFFICIAL BID.

BIDDER'S SIGNATURE

BIDDER'S COMPANY

BIDDER'S FEDERAL TAX ID NUMBER

CONDITIONS FOR COMBINATION BID

If a bidder elects to submit a combined bid for two or more of the contracts listed for this month's letting, the bidder must complete and execute these sheets of the proposal in each of the individual proposals to constitute a combination bid. In addition to this requirement, each individual contract shall be completed, executed and submitted in the usual specified manner.

Failure to execute this Combination Bid Proposal in each of the contracts combined will be just cause for each proposal to be received and evaluated as a separate bid.

COMBINATION BID PROPOSAL

I. This proposal is tendered as one part of a Combination Bid Proposal utilizing option ___* of Subsection 102.11 on the following contracts:

* Option to be shown as either (a), (b), or (c).

<u>Project No.</u>	<u>County</u>	<u>Project No.</u>	<u>County</u>
1. _____	_____	6. _____	_____
2. _____	_____	7. _____	_____
3. _____	_____	8. _____	_____
4. _____	_____	9. _____	_____
5. _____	_____	10. _____	_____

A. If option (a) has been selected, then go to II, and sign Combination Bid Proposal.

B. If option (b) has been selected, then complete the following, go to II, and sign Combination Bid Proposal.

SECTION 905 - COMBINATION BID PROPOSAL (Continued)

Project Number	Pay Item Number	Unit	Unit Price Reduction	Total Item Reduction	Total Contract Reduction
1. _____	_____ _____	_____ _____	_____ _____	_____ _____	
2. _____	_____ _____	_____ _____	_____ _____	_____ _____	
3. _____	_____ _____	_____ _____	_____ _____	_____ _____	
4. _____	_____ _____	_____ _____	_____ _____	_____ _____	
5. _____	_____ _____	_____ _____	_____ _____	_____ _____	
6. _____	_____ _____	_____ _____	_____ _____	_____ _____	
7. _____	_____ _____	_____ _____	_____ _____	_____ _____	
8. _____	_____ _____	_____ _____	_____ _____	_____ _____	

SECTION 905 - COMBINATION BID PROPOSAL (Continued)

Project Number	Pay Item Number	Unit	Unit Price Reduction	Total Item Reduction	Total Contract Reduction
9. _____	_____ _____	_____ _____	_____ _____	_____ _____	
10. _____	_____ _____	_____ _____	_____ _____	_____ _____	

C. If option (c) has been selected, then initial and complete one of the following, go to II. and sign Combination Bid Proposal.

_____ I (We) desire to be awarded work not to exceed a total monetary value of \$ _____.

_____ I (We) desire to be awarded work not to exceed _____ number of contracts.

II. It is understood that the Mississippi Transportation Commission not only reserves the right to reject any and all proposals, but also the right to award contracts upon the basis of lowest separate bids or combination bids most advantageous to the State.

It is further understood and agreed that the Combination Bid Proposal is for comparison of bids only and that each contract shall operate in every respect as a separate contract in accordance with its proposal and contract documents.

I (We), the undersigned, agree to complete each contract on or before its specified completion date.

SIGNED _____

**Certification with regard to the Performance of Previous
Contracts or Subcontracts subject to the Equal Opportunity
Clause and the filing of Required Reports**

The Bidder _____, proposed Subcontractor _____, hereby certifies that he has _____, has not _____, participated in a previous contract or subcontract subject to the Equal Opportunity Clause, as required by Executive Orders 10925, 11114, or 11246, and that he has _____, has not _____, filed with the Joint Reporting Committee, the Director of the Office of Federal Contract Compliance, a Federal Government contracting or administering agency, or the former President's Committee on Equal Employment Opportunity, all reports due under the applicable filing requirements.

(COMPANY)

BY _____

(TITLE)

DATE: _____

NOTE: The above certification is required by the Equal Employment Opportunity Regulations of the Secretary of Labor (41 CFR 60-1.7 (b) (1)), and must be submitted by bidders and proposed subcontractors only in connection with contracts and subcontracts which are subject to the Equal Opportunity Clause. Contracts and Subcontracts which are exempt from the Equal Opportunity Clause are set forth in 41 CFR 60-1.5. (Generally only contracts or subcontracts of \$10,000 or under are exempt.)

Currently, Standard Form 100 (EEO-1) is the only report required by the Executive Orders or their implementing regulations.

Proposed prime Contractors and Subcontractors who have participated in a previous contract or subcontract subject to the Executive orders and have not filed the required reports should note that 41 CFR 60-1.7 (b) (1) prevents the award of contracts and subcontracts unless such Contractors submit a report covering the delinquent period or such other period specified by the Federal Highway Administration or by the Director, Office of Federal Contract Compliance, U. S. Department of Labor.

MISSISSIPPI DEPARTMENT OF TRANSPORTATION

CERTIFICATION
(Execute in duplicate)

I, _____,
(Name of person signing certification)

individually, and in my capacity as _____ of
(Title)

_____ do hereby certify under
(Name of Firm, Partnership, or Corporation)

penalty of perjury under the laws of the United States and the State of Mississippi that _____

_____, Bidder
(Name of Firm, Partnership, or Corporation)

on Project No. **BR-0016-03(020) / 102160302**

in **Calhoun** County(ies), Mississippi, has not either

directly or indirectly entered into any agreement, participated in any collusion; or otherwise taken any action in restraint of free competitive bidding in connection with this contract; nor have any of its corporate officers or principal owners.

Except as noted hereafter, it is further certified that said legal entity and its corporate officers, principal owners, managers, auditors and others in a position of administering federal funds:

- a) Are not presently debarred, suspended, proposed for debarment, declared ineligible, or voluntarily excluded from covered transactions by any Federal department or agency;
- b) Have not within a three-year period preceding this proposal been convicted of or had a civil judgment rendered against them for commission of fraud or a criminal offense in connection with obtaining, attempting to obtain, or performing a public (Federal, State or local) transaction or contract under a public transaction; violation of Federal or State antitrust statutes or commission of embezzlement, theft, forgery, bribery, falsification or destruction of records, making false statements, or receiving stolen property;
- c) Are not presently indicted for or otherwise criminally or civilly charged by a governmental entity (Federal, State or local) with commission of any of the offenses enumerated in (b) above; and
- d) Have not within a three-year period preceding this application/ proposal had one or more public transactions (Federal, State or local) terminated for cause or default.

Initial here "_____" if exceptions are attached and made a part thereof. Any exceptions shall address to whom it applies, initiating agency and dates of such action.

Note: Exceptions will not necessarily result in denial of award but will be considered in determining bidder responsibility. Providing false information may result in criminal prosecution or administrative sanctions.

The bidder further certifies that the certification requirements contained in Section XI of Form FHWA 1273, will be or have been included in all subcontracts, material supply agreements, purchase orders, etc. except those procurement contracts for goods or services that are expected to be less than the Federal procurement small purchase threshold fixed at 10 U.S.C. 2304(g) and 41 U.S.C. 253(g) (currently \$25,000) which are excluded from the certification requirements.

The bidder further certifies, to the best of his or her knowledge and belief, that:

- 1) No Federal appropriated funds have been paid or will be paid to any person for influencing or attempting to influence an officer or employee of any Federal agency, a Member of Congress, an officer or employee of Congress, or an employee of a Member of Congress in connection with the awarding of any Federal contract, the making of any Federal grant, the making of any Federal loan, the entering into of any cooperative agreement, and the extension, continuation, renewal, amendment, or modification of any Federal contract, grant, loan, or cooperative agreement.
- 2) If any funds other than Federal appropriated funds have been paid or will be paid to any person for influencing or attempting to influence an officer or employee of any Federal agency, a Member of Congress, an officer or employee of Congress, or an employee of a Member of Congress in connection with this contract, Standard Form-LLL, "Disclosure Form to Report Lobbying," in accordance with its instructions will be completed and submitted.

The certification contained in (1) and (2) above is a material representation of fact upon which reliance is placed and a prerequisite imposed by Section 1352, Title 31, U.S. Code prior to entering into this contract. Failure to comply shall be subject to a civil penalty of not less than \$10,000 and not more than \$100,000. The bidder shall include the language of the certification in all subcontracts exceeding \$100,000 and all subcontractors shall certify and disclose accordingly.

All of the foregoing and attachments (when indicated) is true and correct.

Executed on _____
Signature

MISSISSIPPI DEPARTMENT OF TRANSPORTATION

CERTIFICATION
(Execute in duplicate)

I, _____,
(Name of person signing certification)

individually, and in my capacity as _____ of
(Title)

_____ do hereby certify under
(Name of Firm, Partnership, or Corporation)

penalty of perjury under the laws of the United States and the State of Mississippi that _____

_____, Bidder
(Name of Firm, Partnership, or Corporation)

on Project No. **BR-0016-03(020) / 102160302**

in **Calhoun** County(ies), Mississippi, has not either

directly or indirectly entered into any agreement, participated in any collusion; or otherwise taken any action in restraint of free competitive bidding in connection with this contract; nor have any of its corporate officers or principal owners.

Except as noted hereafter, it is further certified that said legal entity and its corporate officers, principal owners, managers, auditors and others in a position of administering federal funds:

- a) Are not presently debarred, suspended, proposed for debarment, declared ineligible, or voluntarily excluded from covered transactions by any Federal department or agency;
- b) Have not within a three-year period preceding this proposal been convicted of or had a civil judgment rendered against them for commission of fraud or a criminal offense in connection with obtaining, attempting to obtain, or performing a public (Federal, State or local) transaction or contract under a public transaction; violation of Federal or State antitrust statutes or commission of embezzlement, theft, forgery, bribery, falsification or destruction of records, making false statements, or receiving stolen property;
- c) Are not presently indicted for or otherwise criminally or civilly charged by a governmental entity (Federal, State or local) with commission of any of the offenses enumerated in (b) above; and
- d) Have not within a three-year period preceding this application/ proposal had one or more public transactions (Federal, State or local) terminated for cause or default.

Initial here "_____" if exceptions are attached and made a part thereof. Any exceptions shall address to whom it applies, initiating agency and dates of such action.

Note: Exceptions will not necessarily result in denial of award but will be considered in determining bidder responsibility. Providing false information may result in criminal prosecution or administrative sanctions.

The bidder further certifies that the certification requirements contained in Section XI of Form FHWA 1273, will be or have been included in all subcontracts, material supply agreements, purchase orders, etc. except those procurement contracts for goods or services that are expected to be less than the Federal procurement small purchase threshold fixed at 10 U.S.C. 2304(g) and 41 U.S.C. 253(g) (currently \$25,000) which are excluded from the certification requirements.

The bidder further certifies, to the best of his or her knowledge and belief, that:

- 1) No Federal appropriated funds have been paid or will be paid to any person for influencing or attempting to influence an officer or employee of any Federal agency, a Member of Congress, an officer or employee of Congress, or an employee of a Member of Congress in connection with the awarding of any Federal contract, the making of any Federal grant, the making of any Federal loan, the entering into of any cooperative agreement, and the extension, continuation, renewal, amendment, or modification of any Federal contract, grant, loan, or cooperative agreement.
- 2) If any funds other than Federal appropriated funds have been paid or will be paid to any person for influencing or attempting to influence an officer or employee of any Federal agency, a Member of Congress, an officer or employee of Congress, or an employee of a Member of Congress in connection with this contract, Standard Form-LLL, "Disclosure Form to Report Lobbying," in accordance with its instructions will be completed and submitted.

The certification contained in (1) and (2) above is a material representation of fact upon which reliance is placed and a prerequisite imposed by Section 1352, Title 31, U.S. Code prior to entering into this contract. Failure to comply shall be subject to a civil penalty of not less than \$10,000 and not more than \$100,000. The bidder shall include the language of the certification in all subcontracts exceeding \$100,000 and all subcontractors shall certify and disclose accordingly.

All of the foregoing and attachments (when indicated) is true and correct.

Executed on _____

Signature

S E C T I O N 9 0 2

CONTRACT FOR BR-0016-03(020) / 102160302

LOCATED IN THE COUNTY(IES) OF Calhoun

STATE OF MISSISSIPPI,
COUNTY OF HINDS

This contract entered into by and between the Mississippi Transportation Commission on one hand, and the undersigned contractor, on the other witnesseth;

That, in consideration of the payment by the Mississippi Transportation Commission of the prices set out in the proposal hereto attached, to the undersigned contractor, such payment to be made in the manner and at the time of times specified in the specifications and the special provisions, if any, the undersigned contractor hereby agrees to accept the prices stated in the proposal in full compensation for the furnishing of all materials and equipment and the executing of all the work contemplated in this contract.

It is understood and agreed that the advertising according to law, the Advertisement, the instructions to bidders, the proposal for the contract, the specifications, the revisions of the specifications, the special provisions, and also the plans for the work herein contemplated, said plans showing more particularly the details of the work to be done, shall be held to be, and are hereby made a part of this contract by specific reference thereto and with like effect as if each and all of said instruments had been set out fully herein in words and figures.

It is further agreed that for the same consideration the undersigned contractor shall be responsible for all loss or damage arising out of the nature of the work aforesaid; or from the action of the elements and unforeseen obstructions or difficulties which may be encountered in the prosecution of the same and for all risks of every description connected with the work, exceptions being those specifically set out in the contract; and for faithfully completing the whole work in good and workmanlike manner according to the approved Plans, Specifications, Special Provisions, Notice(s) to Bidders and requirements of the Mississippi Department of Transportation.

It is further agreed that the work shall be done under the direct supervision and to the complete satisfaction of the Executive Director of the Mississippi Department of Transportation, or his authorized representatives, and when Federal Funds are involved subject to inspection at all times and approval by the Federal Highway Administration, or its agents as the case may be, or the agents of any other Agency whose funds are involved in accordance with those Acts of the Legislature of the State of Mississippi approved by the Governor and such rules and regulations issued pursuant thereto by the Mississippi Transportation Commission and the authorized Federal Agencies.

The Contractor agrees that all labor as outlined in the Special Provisions may be secured from list furnished by

It is agreed and understood that each and every provision of law and clause required by law to be inserted in this contract shall be deemed to be inserted herein and this contract shall be read and enforced as though it were included herein, and, if through mere mistake or otherwise any such provision is not inserted, then upon the application of either party hereto, the contract shall forthwith be physically amended to make such insertion.

The Contractor agrees that he has read each and every clause of this Contract, and fully understands the meaning of same and that he will comply with all the terms, covenants and agreements therein set forth.

Witness our signatures this the _____ day of _____, _____.

Contractor (s)

By _____

MISSISSIPPI TRANSPORTATION COMMISSION

Title _____

By _____

Signed and sealed in the presence of:
(names and addresses of witnesses)

Executive Director

Secretary to the Commission

Award authorized by the Mississippi Transportation Commission in session on the ____ day of _____, _____, Minute Book No. _____, Page No. _____.

S E C T I O N 9 0 3
PERFORMANCE AND PAYMENT BOND

CONTRACT BOND FOR: BR-0016-03(020) / 102160302

LOCATED IN THE COUNTY(IES) OF: Calhoun

STATE OF MISSISSIPPI,

COUNTY OF HINDS

Know all men by these presents: that we, _____
(Contractor)

_____ Principal, a _____

residing at _____ in the State of _____

and _____
(Surety)

residing at _____ in the State of _____,

authorized to do business in the State of Mississippi, under the laws thereof, as surety, are held and firmly bound unto the State of Mississippi in the sum of _____

_____ Dollars, lawful money of the United States of America, to be paid to it for which payment well and truly to be made, we bind ourselves, our heirs, administrators, successors, or assigns jointly and severally by these presents.

Signed and sealed this the _____ day of _____ A.D. _____.

The conditions of this bond are such, that whereas the said _____

principal, has (have) entered into a contract with the Mississippi Transportation Commission, bearing the date of _____ day of _____ A.D. _____ hereto annexed, for the construction of certain projects(s) in the State of Mississippi as mentioned in said contract in accordance with the Contract Documents therefor, on file in the offices of the Mississippi Department of Transportation, Jackson, Mississippi.

Now therefore, if the above bounden _____

_____ in all things shall stand to and abide by and well and truly observe, do keep and perform all and singular the terms, covenants, conditions, guarantees and agreements in said contract, contained on his (their) part to be observed, done, kept and performed and each of them, at the time and in the manner and form and furnish all of the material and equipment specified in said contract in strict accordance with the terms of said contract which said plans, specifications and special provisions are included in and form a part of said contract and shall maintain the said work contemplated until its final completion and acceptance as specified in Subsection 109.11 of the approved specifications, and save harmless said Mississippi Transportation Commission from any loss or damage arising out of or occasioned by the negligence, wrongful or criminal act, overcharge, fraud, or any other loss or damage whatsoever, on the part of said principal (s), his (their) agents, servants, or employees in

SECTION 903 - CONTINUED

the performance of said work or in any manner connected therewith, and shall be liable and responsible in a civil action instituted by the State at the instance of the Mississippi Transportation Commission or any officer of the State authorized in such cases, for double any amount in money or property, the State may lose or be overcharged or otherwise defrauded of, by reason of wrongful or criminal act, if any, of the Contractor(s), his (their) agents or employees, and shall promptly pay the said agents, servants and employees and all persons furnishing labor, material, equipment or supplies therefor, including premiums incurred, for Surety Bonds, Liability Insurance, and Workmen's Compensation Insurance; with the additional obligation that such Contractor shall promptly make payment of all taxes, licenses, assessments, contributions, damages, any liquidated damages which may arise prior to any termination of said principal's contract, any liquidated damages which may arise after termination of the said principal's contract due to default on the part of said principal, penalties and interest thereon, when and as the same may be due this state, or any county, municipality, board, department, commission or political subdivision: in the course of the performance of said work and in accordance with Sections 31-5-51 et seq. Mississippi Code of 1972, and other State statutes applicable thereto, and shall carry out to the letter and to the satisfaction of the Executive Director of the Mississippi Department of Transportation, all, each and every one of the stipulations, obligations, conditions, covenants and agreements and terms of said contract in accordance with the terms thereof and all of the expense and cost and attorney's fee that may be incurred in the enforcement of the performance of said contract, or in the enforcement of the conditions and obligations of this bond, then this obligation shall be null and void, otherwise to be and remain in full force and virtue.

Witness our signatures and seals this the _____ day of _____ A.D. _____.

_____	_____
(Contractors) Principal	Surety
By _____	By _____
	(Signature) Attorney in Fact
	Address _____

Title _____	_____
(Contractor's Seal)	(Printed) MS Agent

	(Signature) MS Agent
	Address _____

	(Surety Seal)

	Mississippi Insurance ID Number



BID BOND

KNOW ALL MEN BY THESE PRESENTS, that we _____

Contractor

Address

City, State ZIP

as Principal, hereinafter called the Principal, and _____

Surety

a corporation duly organized under the laws of the state of _____

as Surety, hereinafter called the Surety, are held and firmly bound unto State of Mississippi, Jackson, Mississippi

As Obligee, hereinafter called Obligee, in the sum of **Five Per Cent (5%) of Amount Bid**

Dollars (\$ _____)

for the payment of which sum will and truly to be made, the said Principal and said Surety, bind ourselves, our heirs, executors, administrators, successors and assigns, jointly and severally, firmly by these presents.

WHEREAS, the Principal has submitted a bid for **Replacing 3 Bridges on SR 8, from Calhoun City to Derma, known as Federal Aid Project No. BR-0016-03(020) / 102160302, in Calhoun County.**

NOW THEREFORE, the condition of this obligation is such that if the aforesaid Principal shall be awarded the contract, the said Principal will, within the time required, enter into a formal contract and give a good and sufficient bond to secure the performance of the terms and conditions of the contract, then this obligation to be void; otherwise the Principal and Surety will pay unto the Obligee the difference in money between the amount of the bid of the said Principal and the amount for which the Obligee legally contracts with another party to perform the work if the latter amount be in excess of the former, but in no event shall liability hereunder exceed the penal sum hereof.

Signed and sealed this _____ day of _____, 20__

(Principal)

(Seal)

(Witness)

By: _____

(Name)

(Title)

(Surety)

(Seal)

(Witness)

By: _____

(Attorney-in-Fact)

MS Agent

Mississippi Insurance ID Number

MISSISSIPPI DEPARTMENT OF TRANSPORTATION PILE AND DRIVING EQUIPMENT DATA FORM

Project No.: _____ Bridge No.: _____

Termini: _____ Pile Driving Contractor: _____

County: _____

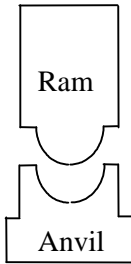

Manufacture: _____ Model No.: _____

Hammer Type: _____ Serial No.: _____

Manufacturers Maximum Rated Energy: _____ (Joules)

Hammer Stroke at Maximum Rated Energy: _____ (m)

Range in Operating Energy: _____ to _____ (Joules)

Range in Operating Stroke: _____ to _____ (m)

Modifications: _____

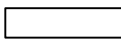

Striker Weight: _____ (N) Diameter: _____ (mm)

Plate Thickness: _____ (mm)

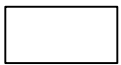

Material #1

Material #2

Name: _____ Name: _____

Hammer Area: _____ (mm²) Area: _____ (mm²)

Cushion Thickness/Plate: _____ (mm) Thickness/Plate: _____ (mm)

No. of Plates: _____ No. of Plates: _____

Total Thickness of Hammer Cushion: _____ (mm)

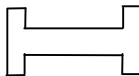

Helmet
(Drive Head) Weight: _____ (kN)

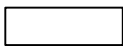

Pile Material: _____

Cushion Area: _____ (mm²) Total Thickness: _____ (mm)



Pile

Submitted By: _____ **Date:** _____

Telephone No.: _____

