



SM No. CMP6018310101

# PROPOSAL AND CONTRACT DOCUMENTS

FOR THE CONSTRUCTION OF  
(STATE DELEGATED)

17  
Overlay approximately 9 miles East of SR 18 from Smith County Line, known as  
State Project No. MP-6018-31(010) / 304810301 in Jasper County.  
Project Completion: Flexible

## NOTICE

**BIDDERS MUST PURCHASE A BOUND PROPOSAL  
FROM MDOT CONTRACT ADMINISTRATION DIVISION  
TO BID THIS PROJECT.**

Electronic addendum updates will be posted on [www.gomdot.com](http://www.gomdot.com)

**SECTION 900  
OF THE CURRENT  
2004 STANDARD SPECIFICATIONS  
FOR ROAD AND BRIDGE CONSTRUCTION  
MISSISSIPPI DEPARTMENT OF TRANSPORTATION  
JACKSON, MISSISSIPPI**

**BIDDER CHECK LIST  
(FOR INFORMATION ONLY)**

- | \_\_\_\_\_ All unit prices have been entered **into Expedite Bid** in accordance with Subsection 102.06 of the Mississippi Standard Specifications for Road and Bridge Construction.
- | \_\_\_\_\_ **Expedite bid** sheets have been stapled and inserted into the proposal package.
- \_\_\_\_\_ First sheet of SECTION 905--PROPOSAL has been completed.
- \_\_\_\_\_ Second sheet of SECTION 905--PROPOSAL has been completed and signed.
- \_\_\_\_\_ Addenda, if any, have been acknowledged. Second sheet of Section 905 listing the addendum number has been substituted for the original second sheet of Section 905. Substituted second sheet of Section 905 has been properly completed, signed, and added to the proposal.
- \_\_\_\_\_ DBE/WBE percentage, when required by contract, has been entered on last sheet of the bid sheets of SECTION 905 - PROPOSAL.
- \_\_\_\_\_ Form OCR-485, when required by contract, has been completed and signed.
- | \_\_\_\_\_ The last sheet of the **Expedite** bid sheets of SECTION 905--PROPOSAL has been signed.
- \_\_\_\_\_ Combination Bid Proposal of SECTION 905--PROPOSAL has been completed for each project which is to be considered in combination (See Subsection 102.11).
- \_\_\_\_\_ Equal Opportunity Clause Certification, when included in contract, has been completed and signed.
- \_\_\_\_\_ The Certification regarding Non-Collusion, Debarment and Suspension, etc. has been executed in duplicate.
- \_\_\_\_\_ A certified check, cashier's check or bid bond payable to the State of Mississippi in the principal amount of 5% of the bid has been included with project number identified on same. A bid bond has been signed by the bidder and has also been signed or countersigned by a Mississippi Agent or Qualified Nonresident Agent for the Surety with Power of Attorney attached.
- \_\_\_\_\_ ON FEDERAL FUNDED PROJECTS, the Notice To Bidders regarding DUNS Requirements has been completed and included in the contract documents.
- \_\_\_\_\_ Non-resident Bidders: ON STATE FUNDED PROJECTS ONLY, a copy of the current laws regarding any preference for local Contractors from State wherein domiciled has been included. See Subsection 103.01, Mississippi Standard Specifications for Road and Bridge Construction, and Section 31-7-47, MCA, 1972 regarding this matter.
- | Return the **MDOT flash drive with completed EBS file**, proposal and contract documents in its entirety in a sealed envelope. DO NOT remove any part of the contract documents; exception - an addendum requires substitution of second sheet of Section 905. A stripped proposal is considered as an irregular bid and will be rejected.

Failure to complete any or all of the applicable requirements will be cause for the proposal to be considered irregular.

# MISSISSIPPI DEPARTMENT OF TRANSPORTATION

## TABLE OF CONTENTS

### PROJECT: MP-6018-31(010) / 304810301 – Jasper County

901--Advertisement

904--Notice to Bidders:      Governing Specifications - # 1  
   Final Cleanup - # 3  
   Fiber Reinforced Concrete - # 640  
   Payroll Requirements - # 883  
   Errata & Modifications to 2004 Standard Specifications - # 1405  
   Federal Bridge Formula - # 1928  
   Non-Quality Control / Quality Assurance Concrete - # 2818  
   Reduced Speed Limit Signs - # 2937  
   Alternate Asphalt Mixture Bid Items - # 3039  
   Temporary Traffic Paint - # 3131  
   Safety Edge - #3585  
   Type III Barricade Rails - #3655  
   Petroleum Products Base Price - # 3893  
   Questions Regarding Bidding - # 3980  
   Standard Drawings - # 4100  
   Rumble Stripe - # 4189  
   Safety Apparel - # 4214  
   Terminal End Sections - # 4308  
   Alternate Crushed Stone Base Bid Items - # 4473  
   Contract Time - # 4500  
   Scope of Work - # 4501  
   Warm Mix Asphalt (WMA) - # 4524

907-101-4:      Definitions  
907-102-8:      Bidding Requirements and Conditions, w/ Supplement  
907-103-8:      Award and Execution of Contract  
907-104-4:      Disposal of Materials  
907-105-6:      Control of Work, w/ Supplement  
907-107-9:      Legal Relations & Responsibility to Public, w/ Supplement  
907-108-31:     Prosecution and Progress  
907-109-5:      Measurement and Payment, w/ Supplement  
907-304-13:     Granular Courses  
907-401-2:      Hot Mix Asphalt (HMA),w/ Supplement  
907-401-6:      Warm Mix Asphalt (WMA)  
907-403-4:      Hot Mix Asphalt (HMA), w/ Supplement  
907-403-12:     Warm Mix Asphalt (WMA)  
907-407-1:      Tack Coat  
907-618-1:      Additional Signing Requirements, w/ Supplement

- CONTINUED ON NEXT PAGE -

- 907-618-9: Placement of Temporary Traffic Stripe
- 907-626-25: Thermoplastic Traffic Markings
- 907-701-4: Hydraulic Cement
- 907-702-3: Polyphosphoric Acid (PPA) Modification of Petroleum Asphalt Cement
- 907-703-10: Aggregates, w/ Supplement
- 907-710-1: Fast Dry Solvent Traffic Paint
- 907-711-4: Synthetic Structural Fiber Reinforcement
- 907-713-2: Admixtures for Concrete, w/ Supplement
- 907-714-6: Miscellaneous Materials, w/ Supplement
- 907-720-1: Pavement Marking Materials, w/ Supplement
- 907-804-13: Concrete Bridges and Structures, w/ Supplement

SECTION 905 - PROPOSAL, PROPOSAL BID ITEMS  
COMBINATION BID PROPOSAL  
STATE BOARD OF CONTRACTORS REQUIREMENTS  
STATE CERTIFICATION REGARDING NON-COLLUSION, DEBARMENT AND SUSPENSION  
SECTION 902- CONTRACT FORM, AND SECTION 903 - CONTRACT BOND FORMS

(REVISIONS TO THE ABOVE WILL BE INDICATED ON THE SECOND SHEET  
OF SECTION 905 AS ADDENDA)

# MISSISSIPPI DEPARTMENT OF TRANSPORTATION

## SECTION 901 - ADVERTISEMENT

Sealed bids will be received by the Mississippi Transportation Commission in the Office of the Contract Administration Engineer, Room 1013, Mississippi Department of Transportation Administration Building, 401 North West Street, Jackson, Mississippi, until 10:00 o'clock A.M., Tuesday, June 25, 2013, and shortly thereafter publicly opened on the Sixth Floor for:

Overlay SR 18 from Smith County Line East approximately 9 miles, known as State Project No. MP-6018-31(010) / 304810301 in Jasper County.

The attention of bidders is directed to the predetermined minimum wage rate set by the U. S. Department of Labor under the Fair Labor Standards Act.

The Mississippi Department of Transportation hereby notifies all bidders that it will affirmatively insure that in any contract entered into pursuant to this advertisement, disadvantaged business enterprises will be afforded full opportunity to submit bids in response to this invitation and will not be discriminated against on the grounds of race, color, sex, age, disability, religion or national origin in consideration for an award.

The specifications are on file in the offices of the Mississippi Department of Transportation.

Bid proposals must be purchased online at <https://shopmdot.ms.gov>. Specimen proposals may be viewed and downloaded online at no cost at <http://mdot.ms.gov> or purchased online. Proposals are available at a cost of Ten Dollars (\$10.00) per proposal plus a small convenience fee. Cash or checks will not be accepted as payment.

Bid bond, signed or countersigned by a Mississippi Agent or Qualified Nonresident Agent, with Power of Attorney attached, a Cashier's check or Certified Check for five (5%) percent of bid, payable to STATE OF MISSISSIPPI, must accompany each proposal.

The attention of bidders is directed to the provisions of Subsection 102.07 pertaining to irregular proposals and rejection of bids.

MELINDA L. MCGRATH  
EXECUTIVE DIRECTOR

# MISSISSIPPI DEPARTMENT OF TRANSPORTATION

**SECTION 904 - NOTICE TO BIDDERS NO. 1**

**CODE: (IS)**

**DATE: 05/03/2004**

**SUBJECT: Governing Specifications**

The current (2004) Edition of the Standard Specifications for Road and Bridge Construction adopted by the Mississippi Transportation Commission is made a part hereof fully and completely as if it were attached hereto, except where superseded by special provisions, or amended by revisions of the Specifications contained herein. Copies of the specification book may be purchased from the MDOT Construction Division.

A reference in any contract document to controlling requirements in another portion of the contract documents shall be understood to apply equally to any revision or amendment thereof included in the contract.

In the event the plans or proposal contain references to the 1990 Edition of the Standard Specifications for Road and Bridge Construction, it is to be understood that such references shall mean the comparable provisions of the 2004 Edition of the Standard Specifications.

## MISSISSIPPI DEPARTMENT OF TRANSPORTATION

**SECTION 904 - NOTICE TO BIDDERS NO. 3**

**CODE: (SP)**

**DATE: 05/03/2004**

**SUBJECT: Final Clean-Up**

Immediately prior to final inspection for release of maintenance, the Contractor shall pick up, load, transport and properly dispose of all litter from the entire highway right-of-way that is within the termini of the project.

Litter shall include, but not be limited to, solid wastes such as glass, paper products, tires, wood products, metal, synthetic materials and other miscellaneous debris.

Litter removal is considered incidental to other items of work and will not be measured for separate payment.

## MISSISSIPPI DEPARTMENT OF TRANSPORTATION

| SECTION 904 - NOTICE TO BIDDERS NO. 640

CODE: (IS)

| DATE: 09/26/2005

SUBJECT: Fiber Reinforced Concrete

Bidders are hereby advised that synthetic structural fibers meeting the requirements of Subsection 907-711.04 may be used in lieu of wire mesh in some items of construction. Substitution of fibers for wire mesh will be allowed in the construction of paved ditches, paved flumes, paved inlet apron, driveways, guard rail anchors and pile encasements. Substitution in any other items of work must be approved by the State Construction Engineer prior to use.



## MISSISSIPPI DEPARTMENT OF TRANSPORTATION

**SECTION 904 - NOTICE TO BIDDERS NO. 883**

**CODE: (IS)**

**DATE: 04/28/2006**

**SUBJECT: Payroll Requirements**

Bidders are hereby advised that the Contractor and Subcontractor(s) are required to submit payroll information to the Project Engineers on a weekly basis.

On Federal-Aid Projects, CAD-880, CAD-881 and certified payroll submissions are required each week the Contractor or a Subcontractor performs work on the project. This is addressed in Section V, page 6 of Form FHWA-1273.

On State-Funded Projects, CAD-880 is required each week the Contractor or a Subcontractor performs work on the project.

When no work is performed on either Federal-Aid and State-Funded Projects, the Contractor should only submit CAD-880 showing no work activities.

The Contractor shall make all efforts necessary to submit this information to the Project Engineer in a timely manner. The Engineer will have the authority to suspend the work wholly or in part and to withhold payments because of the Contractor's failure to submit the required information. Submission of forms and payrolls shall be current through the first full week of the month for the estimate period in order for the Project Engineer to process an estimate.

Bidders are advised to review the requirements regarding payroll submissions in Section 110 of the Standard Specifications.

## MISSISSIPPI DEPARTMENT OF TRANSPORTATION

SECTION 904 - NOTICE TO BIDDERS NO. 1405

CODE: (IS)

DATE: 03/15/2007

SUBJECT: ERRATA AND MODIFICATIONS TO THE 2004 STANDARD SPECIFICATIONS

<u>Page</u>	<u>Subsection</u>	<u>Change</u>
101	201.01	In the second sentence of the first paragraph, change “salvable” to “salvageable”.
107	202.04	In the fourth sentence of the fourth paragraph, change “yard” to “feet”.
107	202.05	In the list of units measurements for 202-B, add “square foot”.
132	211.03.4	In the second sentence of the second paragraph, change “planted” to “plated”.
192	306.02.4	In the first line of the first paragraph, delete the word “be”.
200	307.03.7	In the fourth sentence of the second paragraph, change “lime-fly ash” to “treated”.
236	401.01	Change the header from “Section 403” to “Section 401”.
242	401.02.3.2	In the first sentence of the third full paragraph, add “1/8” in the blank before the inch mark.
250	401.02.6.3	In the second sentence of the first paragraph on page 250, change “rutting over ”” to “rutting over 1/8" ”.
253	401.02.6.4.2	In the paragraph preceding the table, change “91.0” to “89.0”.
259	401.03.1.4	In the first paragraph, change “92.0 percent” to “the specified percentage (92.0 or 93.0)”.
269	403.03.2	In the table at the top of page 269, change the PI requirement from “= ” to “≤ ”.

- 278 404.04 In the second sentence, change the subsection from “401.04” to “403.04”.
- 283 409.02.2 Change “PG 64-22” to “PG 67-22”.
- 294 413.02 In the first sentence of the second paragraph, change “707.02.1.3” to “Subsection 707.02.1.3”.
- 340 511.04 In the second sentence of the second paragraph, change “412” to “512”.
- 349 601.03.3 In the first sentence, change “804.03.2” to “804.03.5”.
- 355 603.02 Change the subsection reference for Joint mortar from “707.03” to “714.11”.
- 369 604.04 In the first sentence, change “601.04” to “Subsection 601.04”.
- 427 619.04 Delete the second paragraph.
- 442 625.04 In the third paragraph, change “626.04” to “Subsection 626.04”.
- 444 626.03.1.2 Delete the third sentence of the first paragraph.
- 464 631.02 Change the subsection reference for Water from “714.01.0” to “714.01.1”.
- 570 682.03 Change the subsection number from “682-03” to “682.03”.
- 575 683.10.4 Change the subsection number from “683.10.4” to “683.04”.
- 575 683.10.5 Change the subsection number from “683.10.5” to “683.05”.
- 596 701.02 In the table under the column titled “Cementations material required”, change Class F, FA” to “Class F FA,”.
- 603 702.11 In the first sentence, change “702.12” to “Subsection 702.12”.
- 612 703.04.2 In the fifth paragraph, delete “Subsection 703.11 and”.
- 616 703.07.2 In the Percentage By Weight Passing Square Mesh Sieves table, change the No. 10 requirement for Class 7 material from “30 - 10” to “30 - 100”.

- 618 703.13.1 In the first sentence of the first paragraph, change “703.09” to “703.06”.
- 618 703.13.2 In the first sentence, change “703.09” to “703.06”.
- 671 712.06.2.2 In the first sentence, change “712.05.1” to “Subsection 712.05.1”.
- 689 714.11.2 In the first sentence, change “412” to “512”.
- 709 715.09.5 In the first sentence of the first paragraph, change “guage” to “gauge”.
- 717 717.02.3.4 In the top line of the tension table, change “1 1/2” to “1 1/8” and change “1 1/8” to “1 1/2”.
- 741 720.05.2.2 In the last sentence of this subsection, change “720.05.2.1” to “Subsection 720.05.2.1”.
- 827 803.03.2.3.7.5.2 In the first sentence of the second paragraph, change “803.03.5.4” to “803.03.2.3.4”.
- 833 803.03.2.6 In the first sentence, change “803.03.7” to “803.03.2.5”.
- 854 804.02.11 In the last sentence of the first paragraph, change “automatically” to “automatic”.
- 859 804.02.13.1.3 In the last sentence, change Subsection “804.02.12.1” to “804.02.12”.
- 879 804.03.19.3.2 In the first sentence of the third paragraph, change “listed on of Approved” to “listed on the Approved”.
- 879 804.03.19.3.2 In the last sentence of the last paragraph, change “804.03.19.3.1” to “Subsection 804.03.19.3.1”.
- 962 814.02.3 In the first sentence, change “710.03” to “Subsection 710.03”.
- 976 820.03.2.1 In the first sentence, change “803.02.6” to “803.03.1.7”.
- 976 820.03.2.2 In the first sentence, change “803.03.9.6” to “803.03.1.9.2”.
- 985 Index Change the subsection reference for Petroleum Asphalt Cement from “702.5” to “702.05”.

985	Index	Change the subsection reference for the Definition of Asphaltic Cement or Petroleum Asphalt from “700.2” to “700.02”.
985	Index	Change the subsection reference for Automatic Batchers from “501.03.2.4” to “804.02.10.4”.
986	Index	Delete “501.03.2” as a subsection reference for Batching Plant & Equipment.
988	Index	Change the subsection reference for the Central Mixed Concrete from “501.03.3.2” to “804.02.11”.
988	Index	Change the subsection reference for the Concrete Batching Plant & Equipment from “501.03.2” to “804.02.11”.
999	Index	Delete “501.03.3.3” as a subsection reference for Truck Mixers.
1001	Index	Change the subsection reference for Edge Drain Pipes from “605.3.5” to “605.03.5”.
1002	Index	Change the subsection reference for Metal Posts from “713.05.2” to “712.05.2”.
1007	Index	Change the subsection reference for Coarse Aggregate of Cement Concrete Table from “703.3” to “703.03”.
1007	Index	Change the subsection reference for Composite Gradation for Mechanically Stabilized Courses Table from “703.8” to “703.08”.
1009	Index	Delete “501.03.3.3” as a subsection reference for Truck Mixers and Truck Agitators.
1010	Index	Delete reference to “Working Day, Definition of”.

**MISSISSIPPI DEPARTMENT OF TRANSPORTATION**

| **SECTION 904 - NOTICE TO BIDDERS NO. 1928**

**CODE: (IS)**

| **DATE: 04/14/2008**

**SUBJECT: Federal Bridge Formula**

Bidders are hereby advised that Federal Highway Administration Publication No. FHWA-MC-94-007, **BRIDGE FORMULA WEIGHTS**, dated January 1994, is made a part of this contract when applicable.

Prior to the preconstruction conference, the Contractor shall advise the Engineer, in writing, what materials, if any, will be delivered to the jobsite via Interstate route(s).

Copies of the **BRIDGE FORMULA WEIGHTS** publication may be obtained by contacting:

Federal Highway Administration  
400 7<sup>th</sup> Street, SW  
Washington, DC 20590  
(202) 366-2212

or

| [http://ops.fhwa.dot.gov/freight/sw/brdgcalf/calf\\_page.htm](http://ops.fhwa.dot.gov/freight/sw/brdgcalf/calf_page.htm)

**MISSISSIPPI DEPARTMENT OF TRANSPORTATION**

**SECTION 904 - NOTICE TO BIDDERS NO. 2818**

**CODE: (SP)**

**DATE: 10/01/2009**

**SUBJECT: Non-Quality Control / Quality Assurance Concrete**

Bidders are advised that the following pay items will not be accepted based on the Quality Control / Quality Assurance (QC/QA) requirements of Section 804 of the specifications. The acceptance of these pay items will be based on sampling and testing at the project site by MDOT forces. The Contractor is required to submit mix designs to accomplish this work in accordance with Section 804 and perform normal Quality Control functions at the concrete plant. Acceptance will be in accordance with the requirements of 907-601, Structural Concrete, and TMD-20-04-00-000. At the discretion of the Engineer, the Contractor may request that the concrete be accepted based on QC/QA requirements.

<u>Pay Item</u>	<u>Description</u>
221	Paved Ditches
601	Minor Structures - manholes, inlets, catch basins, junction boxes, pipe headwalls, and pipe collars.
606	Guardrail Anchors
607	Fence Post Footings
608	Sidewalks
609	Curb and Gutter
614	Driveways
616	Median and Island Pavement
630	Sign Footings, except Overhead Sign Supports

**MISSISSIPPI DEPARTMENT OF TRANSPORTATION**

**SECTION 904 - NOTICE TO BIDDERS NO. 2937**

**CODE: (SP)**

**DATE: 01/11/2010**

**SUBJECT: Reduced Speed Limit Signs**

Bidders are advised that all black and white speed limits signs that are used to reduce the speed limit through construction zones shall be covered or removed during times when the Contractor is not performing work. If the Contractor has a routine daytime operation and is not working at night, the signs shall be covered or removed during the nighttime when there is no work activity.



**MISSISSIPPI DEPARTMENT OF TRANSPORTATION**

**SECTION 904 - NOTICE TO BIDDERS NO. 3039**

**CODE: (SP)**

**DATE: 03/23/2010**

**SUBJECT: Alternate Asphalt Mixture Bid Items**

Bidders are advised that the asphalt mixture used on this project will be bid as an alternate pay item: Hot Mix Asphalt (HMA) or Warm Mix Asphalt (WMA). Bidders must select one of the alternates at the time of bid. **The Contractor must use the selected asphalt mixture, HMA or WMA, throughout the entire project.**

**MISSISSIPPI DEPARTMENT OF TRANSPORTATION**

**SECTION 904 - NOTICE TO BIDDERS NO. 3131**

**CODE: (SP)**

**DATE: 06/24/2010**

**SUBJECT: Temporary Traffic Paint**

Bidders are hereby advised that the temporary traffic paint for this project can be waterborne paint as specified in the 2004 Mississippi Standard Specifications For Road and Bridge Construction or fast dry solvent traffic paint meeting the requirements set out in 907-710-1 (Fast Dry Solvent Traffic Paint).

Payment for all temporary traffic paint shall be paid under the appropriate 619 pay items.

When using fast dry solvent traffic stripe, no paint can be sprayed or placed on the ground during set-up or clean-up.

**MISSISSIPPI DEPARTMENT OF TRANSPORTATION**

**SECTION 904 - NOTICE TO BIDDERS NO. 3585**

**CODE: (SP)**

**DATE: 06/22/2011**

**SUBJECT: Safety Edge**

Bidders are hereby advised that the Shoulder Wedge (Safety Edge) specified in the Supplement to Special Provision 907-401-2 shall only apply to the top two (2) lifts of asphalt. Attached is a drawing showing the safety edge.

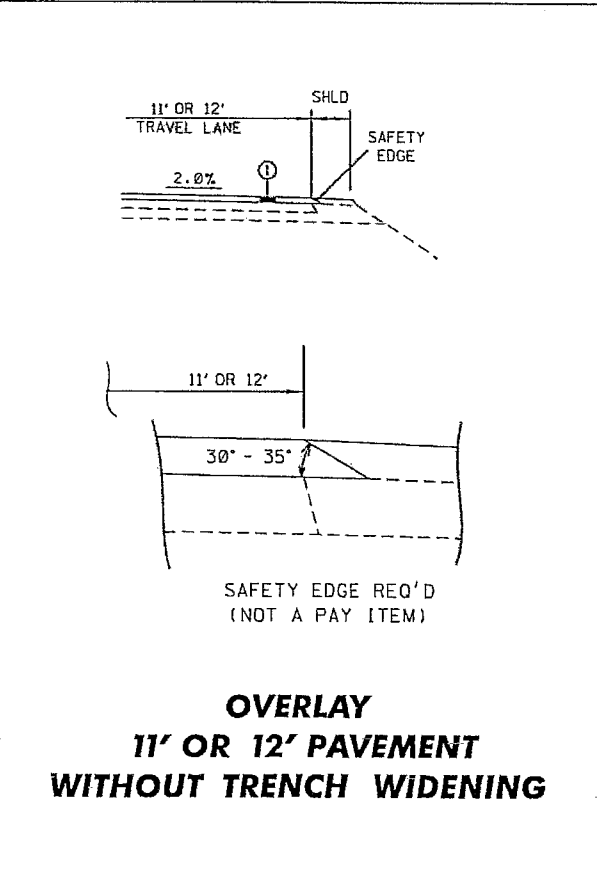
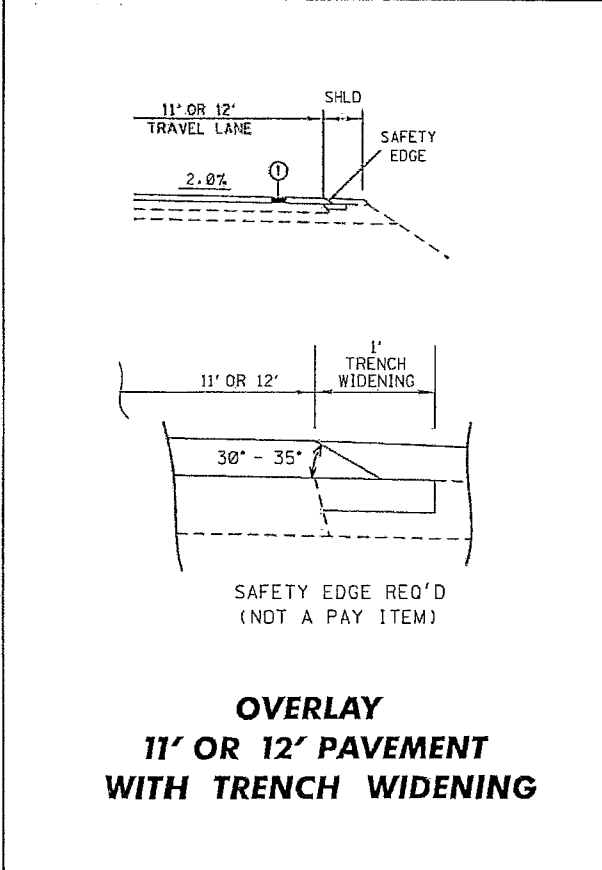
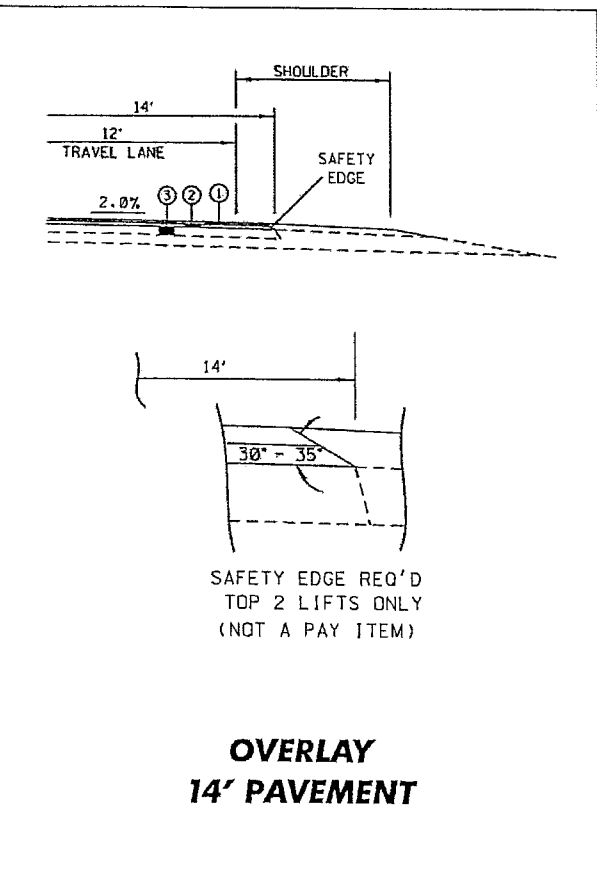
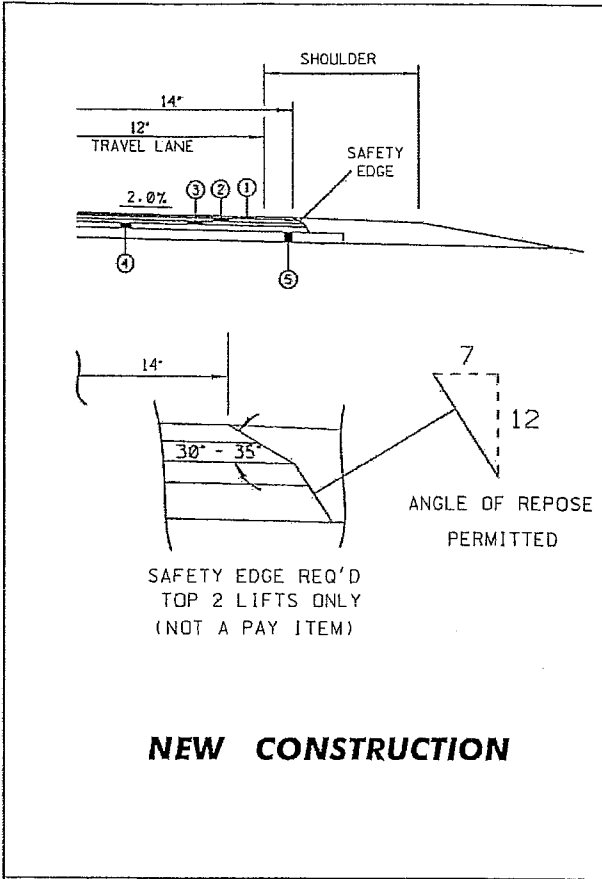

## MISSISSIPPI DEPARTMENT OF TRANSPORTATION

SECTION 904 - NOTICE TO BIDDERS NO. 3655

CODE: (SP)

DATE: 10/04/2011

SUBJECT: Type III Barricade Rails

Bidders are advised that the use of 2-inch nominal thickness timber for rails on Type III barricades has not been approved by NCHRP as a crashworthy device. Therefore, the use of 2-inch nominal thickness timbers will not be allowed for rails on Type III Barricades. Timber rails for Type III Barricades shall be as follows.

- For barricades up to four feet (4') wide, the maximum thickness of timber rails shall be one inch (1") and the material shall be pine timber or ¾-inch ACX plywood.
- For barricades more than four feet (4') wide, timber rails shall be constructed of ¾-inch ACX plywood.

A list of crashworthy Type III Barricades can be found at the below FHWA website.

[http://safety.fhwa.dot.gov/roadway\\_dept/policy\\_guide/road\\_hardware/wzd/](http://safety.fhwa.dot.gov/roadway_dept/policy_guide/road_hardware/wzd/)

## MISSISSIPPI DEPARTMENT OF TRANSPORTATION

**SECTION 904 - NOTICE TO BIDDERS NO. 3893**

**CODE: (SP)**

**DATE: 04/10/2012**

**SUBJECT: Petroleum Products Base Prices**

Bidders are advised that monthly petroleum products base prices will be available at the web site listed below. Current monthly prices will be posted to this web site on or before the 15<sup>th</sup> of each month. Bidders are advised to use the petroleum base prices on this web site when preparing their bids. The current monthly petroleum products base prices will be acknowledged by the Bidder and become part of the contract during the execution process.

Monthly Petroleum Products Base Prices can be viewed at:

<http://sp.gomdot.com/Contract%20Administration/BidSystems/Pages/letting%20calendar.aspx>

## MISSISSIPPI DEPARTMENT OF TRANSPORTATION

**SECTION 904 - NOTICE TO BIDDERS NO. 3980**

**CODE: (SP)**

**DATE: 07/25/2012**

**SUBJECT: Questions Regarding Bidding**

Bidders are advised that all questions that arise regarding the contract documents (proposal) or plans on this project shall be directed to the [www.gomdot.com](http://www.gomdot.com) current letting webpage. Click on the call number for this project to open an email form to submit your question. Questions must be submitted by 8:00 a.m. on Monday prior to the letting on Tuesday. Answers to questions will be posted by 6:00 p.m. on Monday prior to the letting on Tuesday. Answers can be viewed by clicking on Q&A link under the Proposal Addenda column.

It shall be the Bidders responsibility to familiarize themselves with the questions and answers that have been submitted on this project.

**MISSISSIPPI DEPARTMENT OF TRANSPORTATION**

**SECTION 904 – NOTICE TO BIDDERS NO. 4100**

**CODE: (SP)**

**DATE: 09/05/2012**

**SUBJECT: Standard Drawings**

Standard Drawings attached hereto shall govern appropriate items of required work.

Larger copies of Standard Drawings may be purchased from:

MDOT Plans Print Shop  
MDOT Shop Complex, Building C, Room 114  
2567 North West Street  
P.O. Box 1850  
Jackson, MS 39215-1850  
Telephone: (601) 359-7460  
or FAX: (601) 359-7461  
or e-mail: [plans@mdot.state.ms.us](mailto:plans@mdot.state.ms.us)



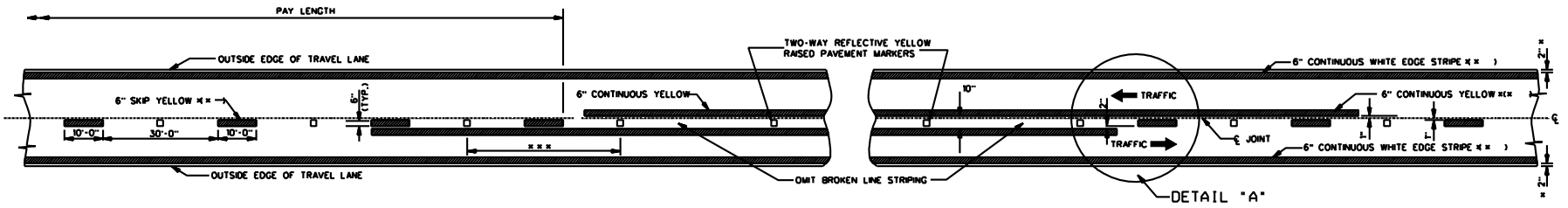

TWO-WAY TRAFFIC  
(ASPHALT OR CONCRETE PAVEMENT)

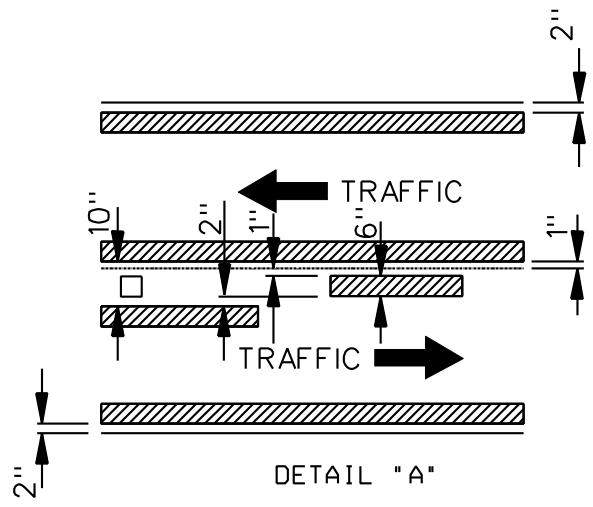

DETAIL "A"



- GENERAL NOTES:
- \* 1. 2" UNLESS SHOWN ELSEWHERE ON THE PLANS.
  - \*\* 2. EDGE STRIPE SHALL BE SAME MATERIAL AS LANE-LINE STRIPE (PAINT OR PLASTIC AS INDICATED IN PAY ITEMS).
  - \*\*\* 3. SPACING OF REFLECTIVE RAISED PAVEMENT MARKERS IS AS FOLLOWS:

	URBAN AREA (ft-in)	RURAL AREA (ft-in)
TANGENT SECTIONS	40'-0"	80'-0"
HORIZONTAL CURVES	40'-0"	40'-0"
INTERCHANGE LIMITS	40'-0"	40'-0"

1 NOTE: ON THE MAIN FACILITY, REFLECTIVE RED-CLEAR RAISED PAVEMENT MARKERS ON A 40'-0" SPACING WILL BE REQUIRED ON LANE-LINE(S) THROUGH ALL INTERCHANGE AREAS BEGINNING 1000' IN ADVANCE (IN DIRECTION OF TRAFFIC) OF THE EXIT RAMP TAPER AND CONTINUING THROUGH THE INTERCHANGE TO THE END OF THE ENTRANCE RAMP TAPER.

4. PAVEMENT MARKERS SHALL BE HIGH PERFORMANCE REFLECTIVE RAISED PAVEMENT MARKERS AS LISTED IN THE MOOT "APPROVED SOURCES OF MATERIALS."

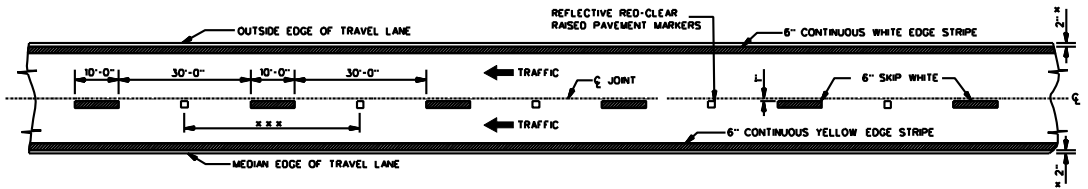

4-LANE WITH ONE-WAY TRAFFIC

MISSISSIPPI DEPARTMENT OF TRANSPORTATION ROADWAY DESIGN DIVISION STANDARD PLAN	
PAVEMENT MARKING DETAILS FOR 2-LANE AND 4-LANE DIVIDED HIGHWAYS	
WORKING NUMBER PM-1	SHEET NUMBER 2 of 2
ISSUE DATE: OCTOBER 1, 1998	

Notice To Bidders No. 23  
23 m'd.

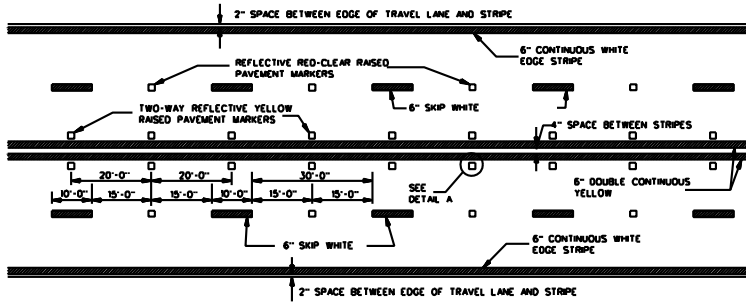

TYPICAL STRIPING AND RAISED PAVEMENT MARKERS FOR 4-LANE SECTION

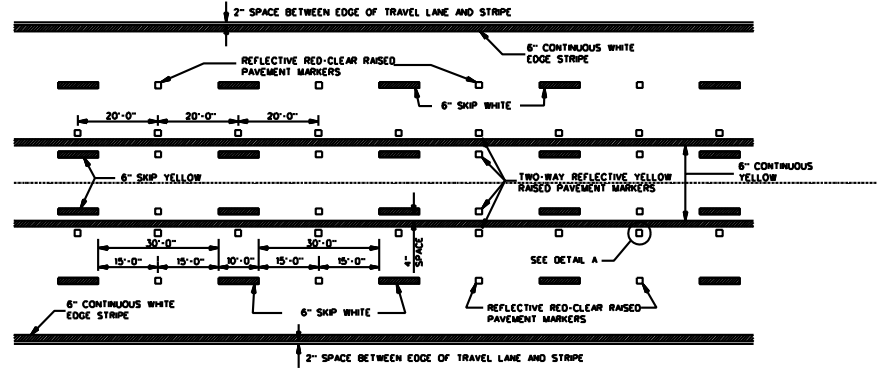

TYPICAL STRIPING AND RAISED PAVEMENT MARKERS FOR 5-LANE SECTION

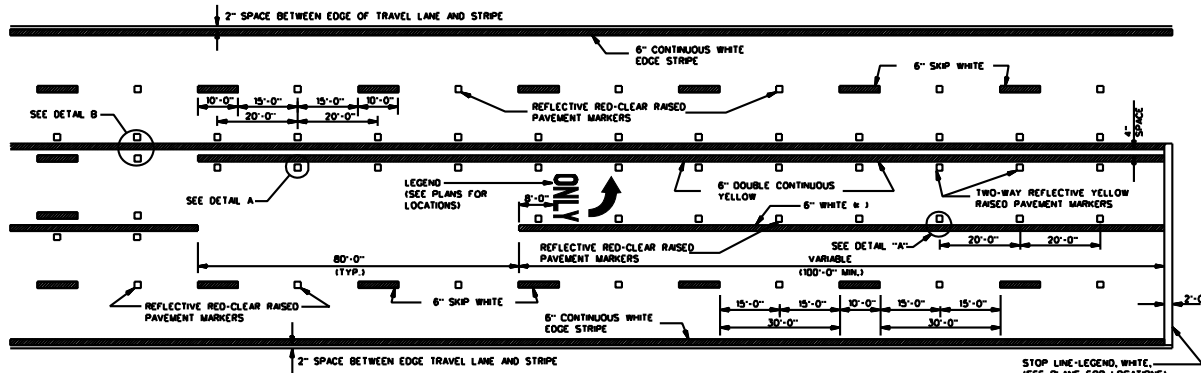

TYPICAL STRIPING AND RAISED PAVEMENT MARKERS AT LEFT TURN LANES

= NOTE: USE DETAIL STRIPING IF LENGTH  $\leq$  150' AT THIS LOCATION, OTHERWISE USE CONTINUOUS STRIPING.

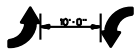

TYPICAL TWO-WAY ARROW INSTALLATION

- NOTES:
1. CONSIDER EACH SEGMENT OF CONTINUOUS TWO-WAY LEFT TURN LANE SEPARATELY.
  2. IF SEGMENT IS LESS THAN 350', PLACE ONE SET OF ARROWS IN CENTER OF SEGMENT.
  3. IF SEGMENT IS GREATER THAN 350', PLACE FIRST SET OF ARROWS 50' TO 100' FROM BEGINNING AND/OR END OF SEGMENT AND SPACE ADDITIONAL SETS OF ARROWS (250' O.C.).

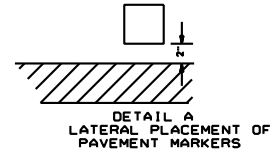

DETAIL A LATERAL PLACEMENT OF PAVEMENT MARKERS

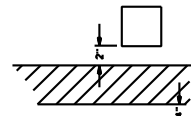

DETAIL B LATERAL PLACEMENT OF PAVEMENT MARKERS

GENERAL NOTE:

1. PAVEMENT MARKERS SHALL BE HIGH PERFORMANCE RAISED PAVEMENT MARKERS AS LISTED IN THE MOOT "APPROVED SOURCES OF MATERIALS".

MISSISSIPPI DEPARTMENT OF TRANSPORTATION	
PAVEMENT MARKING DETAILS FOR 4-LANE AND 5-LANE UNDIVIDED ROADWAYS	
DESIGN TEAM	DATE: 10/18/10
DESIGNER	CHECKED
DATE	DATE
REVISION	REVISION
NO.	NO.
DESCRIPTION	DESCRIPTION

WORKING NUMBER  
SDPM-2  
SHEET NUMBER  
1

STATE	PROJECT NO.
MSS.	

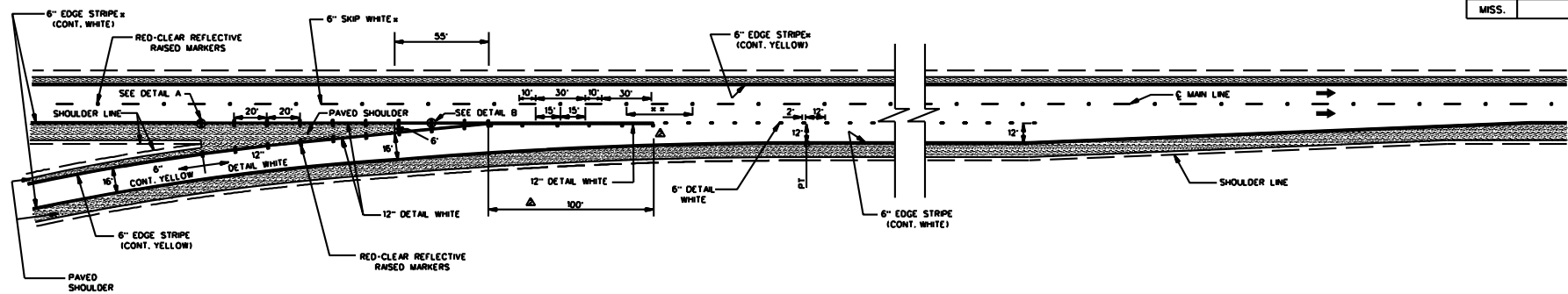

PARALLEL ENTRANCE RAMP

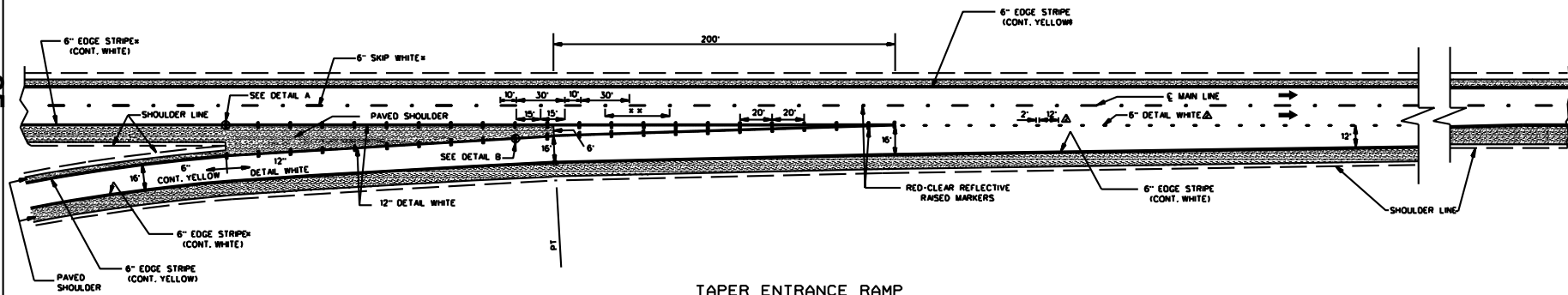

TAPER ENTRANCE RAMP

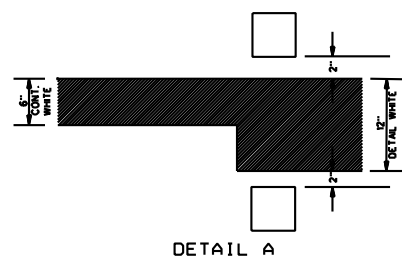

DETAIL A

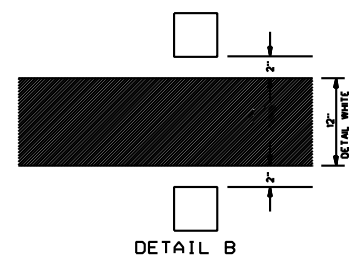

DETAIL B

- GENERAL NOTES:
- \* 1. SEE SHEET PM-1 FOR THE PLACEMENT OF LANE-LINE STRIPE WITH RESPECT TO THE PAVEMENT JOINT AND FOR THE PLACEMENT OF THE EDGE LINE WITH RESPECT TO THE OUTSIDE EDGE OF THE TRAVELED WAY.
  - \* 2. ON THE MAIN FACILITY, PLACE REFLECTIVE RED-CLEAR RAISED PAVEMENT MARKERS AT A 40' SPACING ON ALL LANE-LINE(S) THROUGHOUT THE INTERCHANGE AREA BEGINNING 1000' IN ADVANCE (IN DIRECTION OF TRAFFIC) OF THE EXIT RAMP TAPER AND CONTINUING THROUGH THE INTERCHANGE TO THE END OF THE ENTRANCE RAMP TAPER.
  - \* 3. PAVEMENT MARKERS SHALL BE HIGH PERFORMANCE REFLECTIVE RAISED PAVEMENT MARKERS AS LISTED IN THE MOOT "APPROVED SOURCES OF MATERIALS."

MISSISSIPPI DEPARTMENT OF TRANSPORTATION ROADWAY DESIGN DIVISION PROJECT NO. _____ SHEET NO. _____	<b>MISSISSIPPI DEPARTMENT OF TRANSPORTATION</b> ROADWAY DESIGN DIVISION		 WORKING NUMBER <b>SDPM-3</b> SHEET NUMBER _____
	<b>PAVEMENT MARKING</b> <b>DETAILS FOR</b> <b>INTERCHANGE</b> <b>ENTRANCE RAMPS</b> <b>(PARALLEL AND TAPER)</b>		
	ISSUE DATE: <b>OCTOBER 1, 1998</b>		
	APPROVED BY: _____ DATE: _____		

25

Pavement Marking - interchange ramps\PM-3.DGN

- 4 -

Notice To Bidder No. 4100 -- Cont'd.

STATE	PROJECT NO.
MISS.	

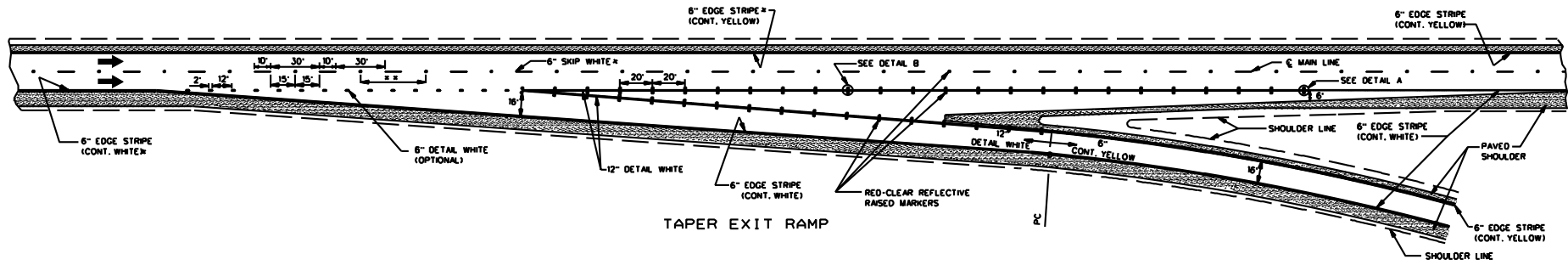

TAPER EXIT RAMP

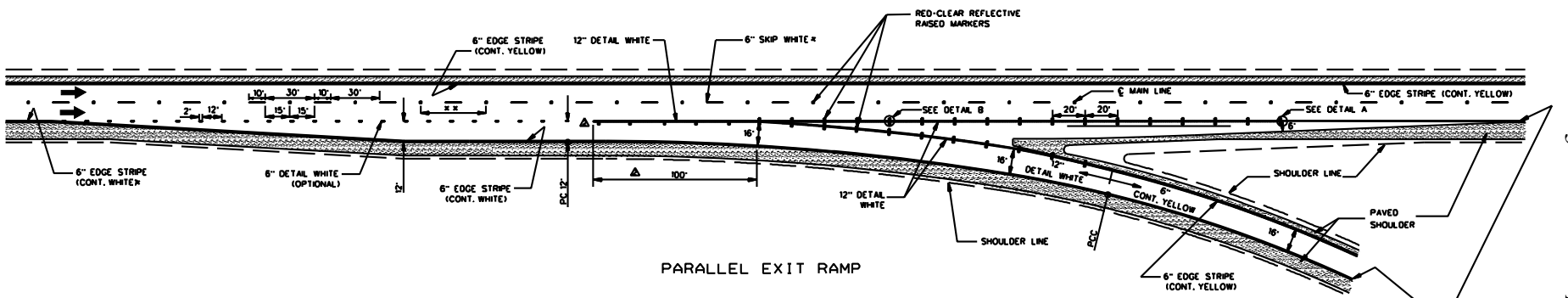

PARALLEL EXIT RAMP

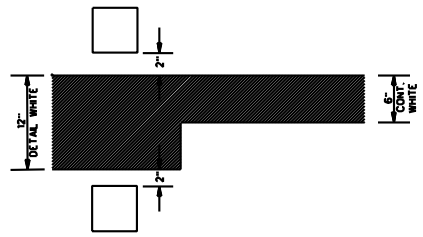

DETAIL A

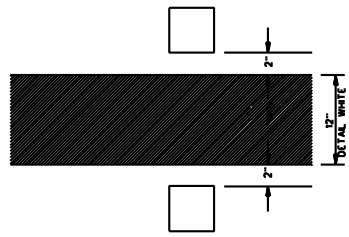

DETAIL B

- GENERAL NOTES:
- \* 1. SEE SHEET PM-1 FOR THE PLACEMENT OF LANE-LINE STRIPE WITH RESPECT TO THE PAVEMENT JOINT AND FOR THE PLACEMENT OF THE EDGE LINE WITH RESPECT TO THE OUTSIDE EDGE OF THE TRAVELED WAY.
  - \* 2. ON THE MAIN FACILITY, PLACE REFLECTIVE RED-CLEAR RAISED PAVEMENT MARKERS AT A 40' SPACING ON ALL LANE-LINES THROUGHOUT THE INTERCHANGE AREA BEGINNING 1000' IN ADVANCE (IN DIRECTION OF TRAFFIC) OF THE EXIT RAMP TAPER AND CONTINUING THROUGH THE INTERCHANGE TO THE END OF THE ENTRANCE RAMP TAPER.
  - 3. PAVEMENT MARKERS SHALL BE HIGH PERFORMANCE REFLECTIVE RAISED PAVEMENT MARKERS AS LISTED IN THE MDT "APPROVED SOURCES OF MATERIALS."

DATE DRAWN CHECKED APPROVED SCALE SHEET NO.	MISSISSIPPI DEPARTMENT OF TRANSPORTATION ROADWAY DESIGN DIVISION
	<b>PAVEMENT MARKING          DETAILS FOR          INTERCHANGE          EXIT RAMP          (PARALLEL AND TAPER)</b>
	WORKING NUMBER <b>SDPM-4</b>
	SHEET NUMBER

ISSUE DATE: OCTOBER 1, 1998

26

Pavement Marking - interchange ramps PM-4.DGN

Notice To Bidder No. 4400 Cont'd.

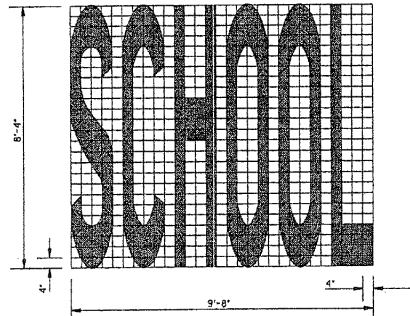
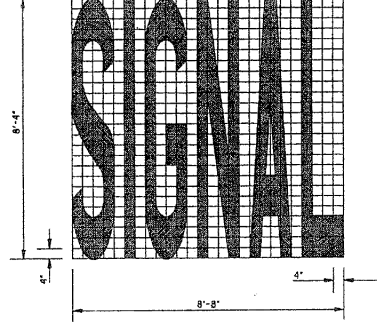
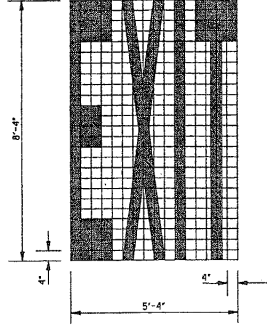
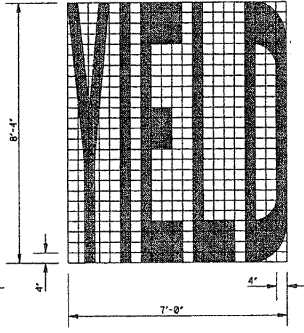
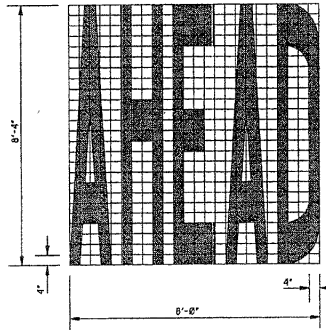
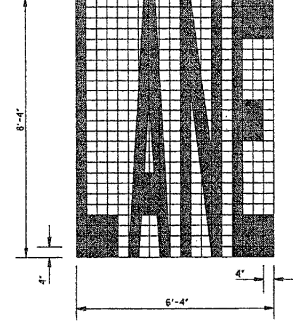
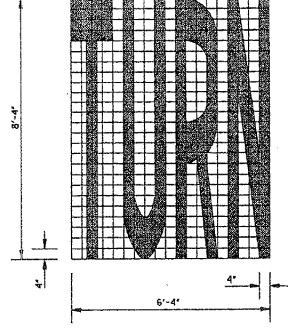
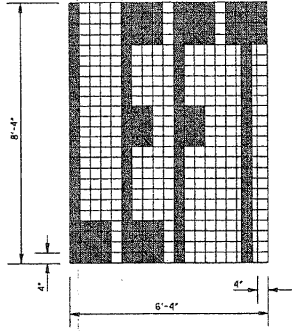
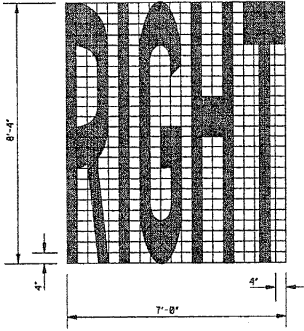
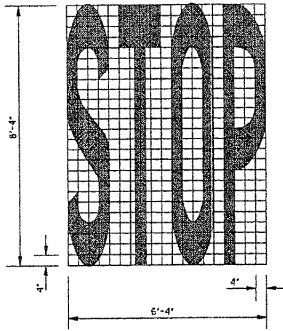

- GENERAL NOTES:
- UNLESS OTHERWISE SHOWN ON THE PLANS, ALL PAVEMENT MARKING LEGENDS SHALL BE APPLIED USING HIGH PERFORMANCE MATERIALS.
  - TWO HORIZONTAL GAPS (CAUSED BY TEMPLATE CONNECTORS) OF 1/4" OR LESS AND EXTENDING THE FULL WIDTH ARE PERMITTED IN EACH LETTER.
  - FOR OTHER DETAILS, SEE THE MANUAL ON UNIFORM TRAFFIC CONTROL DEVICES.
  - PAY QUANTITIES FOR PAVEMENT MARKING LEGENDS ARE AS FOLLOWS:

LEGEND	AREA (ft <sup>2</sup> )
STOP	24.6
RIGHT	26.6
LEFT	19.5
TURN	27.3
LANE	22.7
AHEAD	32.3
YIELD	28.9
EXIT	18.5
SIGNAL	32.5
SCHOOL	38.5

MISSISSIPPI DEPARTMENT OF TRANSPORTATION  
ROADWAY DESIGN DIVISION  
STANDARD PLAN

**PAVEMENT MARKING  
LEGEND DETAILS**

ISSUE DATE: OCTOBER 1, 1998

WORKING NUMBER: PM-5  
SHEET NUMBER: 124

STATE	PROJECT NO.
MISS.	

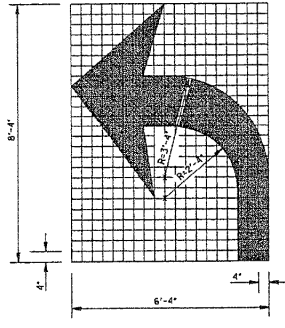
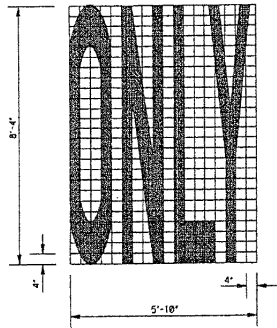

TURN ARROW

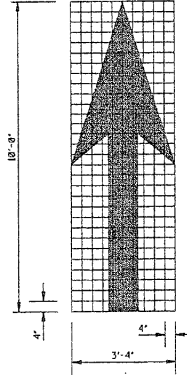

THRU ARROW

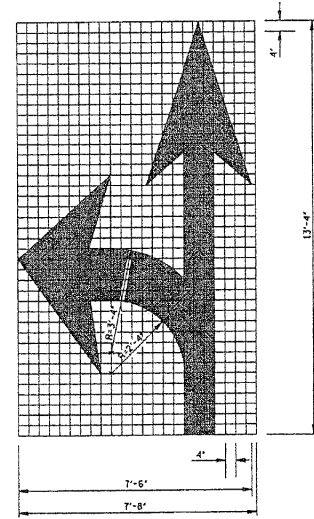

COMBINATION ARROW

GENERAL NOTES:

1. UNLESS OTHERWISE SHOWN ON THE PLANS, ALL PAVEMENT MARKING LEGENDS, INCLUDING TURN ARROWS, SHALL BE APPLIED USING HIGH PERFORMANCE MATERIALS.
2. TWO HORIZONTAL GAPS (CAUSED BY TEMPLATE CONNECTORS) OF 1/2" OR LESS AND EXTENDING THE FULL WIDTH ARE PERMITTED IN EACH LETTER.
3. FOR OTHER DETAILS, SEE THE MANUAL ON UNIFORM TRAFFIC CONTROL DEVICES.
4. PAY QUANTITIES FOR PAVEMENT MARKING LEGENDS ARE AS FOLLOWS:

PAY QUANTITIES	
LEGEND/SYMBOL	AREA (ft <sup>2</sup> )
ONLY	22.0
TURN ARROW	16.4
THRU ARROW	32.3
COMB. ARROW	27.5
1-WAY ARROW	24.3

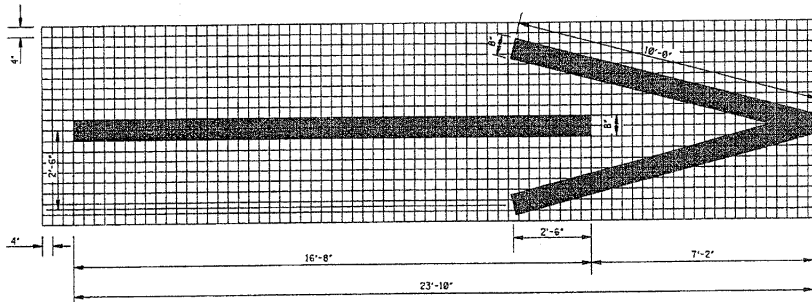

1-WAY ARROW

BY	MISSISSIPPI DEPARTMENT OF TRANSPORTATION ROADWAY DESIGN DIVISION STANDARD PLAN
REVISION	
DATE	ISSUE DATE: OCTOBER 1, 1998

**PAVEMENT MARKING  
LEGEND DETAILS**



WORKING NUMBER  
PM-6  
SHEET NUMBER  
125

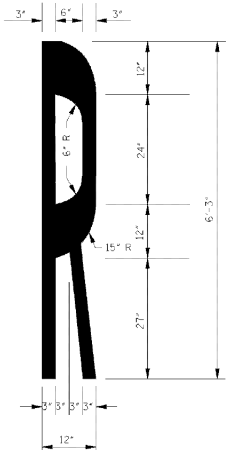
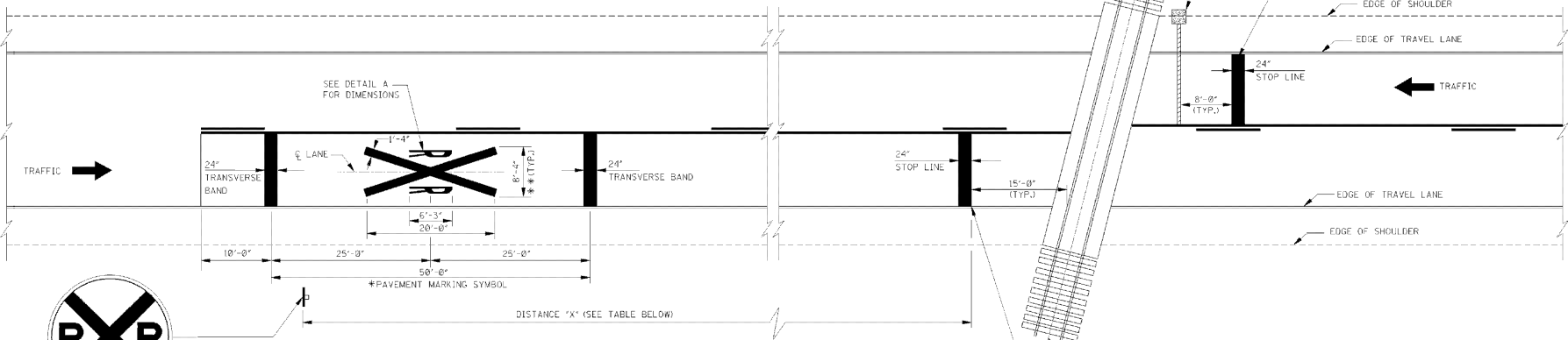
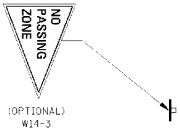

DETAIL A  
STANDARD "R" PAVEMENT MARKING  
FOR R X R SYMBOL

ADVANCE WARNING SIGN PLACEMENT DISTANCE

POSTED SPEED (mph)	① DISTANCE "X" (ft)	
	RURAL	URBAN
20	175	100
25	250	100
30	325	100
35	400	② 150
40	475	② 225
45	550	300
50	625	375
55	700	450
60	775	550

NOTES:  
 ① DISTANCE "X" MAY BE ADJUSTED IF PROHIBITIVE PHYSICAL CONDITIONS EXIST AT THE DESIGNATED DISTANCE.  
 ② THESE DISTANCES MAY BE ADJUSTED TO A MINIMUM OF 100' IN RESIDENTIAL AREAS OR BUSINESS DISTRICTS WHERE LOW SPEEDS ARE PREVALENT.

- GENERAL NOTES:
- \* 1. A PORTION OF THE PAVEMENT MARKING SYMBOL SHOULD BE DIRECTLY OPPOSITE THE ADVANCE WARNING SIGN (W10-1).
  - \* \* 2. WIDTH OF R X R SYMBOL MAY VARY ACCORDING TO LANE WIDTH. HOWEVER, ON MULTI-LANE ROADS, THE TRANSVERSE BANDS AND STOP LINE SHOULD EXTEND ACROSS ALL APPROACH LANES, AND INDIVIDUAL R X R SYMBOLS SHOULD BE USED IN EACH APPROACH LANE.
  - △ 3. R X R SYMBOL (63.0 ft<sup>2</sup>), TRANSVERSE BANDS AND STOP LINE SHALL BE PAID FOR AS LEGEND, WHITE (PLASTIC), (MATERIAL OPTIONAL FOR OTHER AGENCIES).
  - \* \* \* 4. REFER TO THE "MANUAL ON UNIFORM TRAFFIC CONTROL DEVICES" FOR LOCATION OF PROPOSED WARNING DEVICES AT RAILROAD-HIGHWAY GRADE CROSSINGS.

APPROVED FOR	DATE	ISSUE DATE: OCTOBER 1, 1998
REVISION	BY	
DATE	BY	

MISSISSIPPI DEPARTMENT OF TRANSPORTATION  
ROADWAY DESIGN DIVISION  
STANDARD PLAN

**TYPICAL PLACEMENT OF WARNING SIGNS AND PAVEMENT MARKINGS AT RAILROAD HIGHWAY GRADE CROSSINGS**

WORKING NUMBER: 4109  
SHEET NUMBER: 12

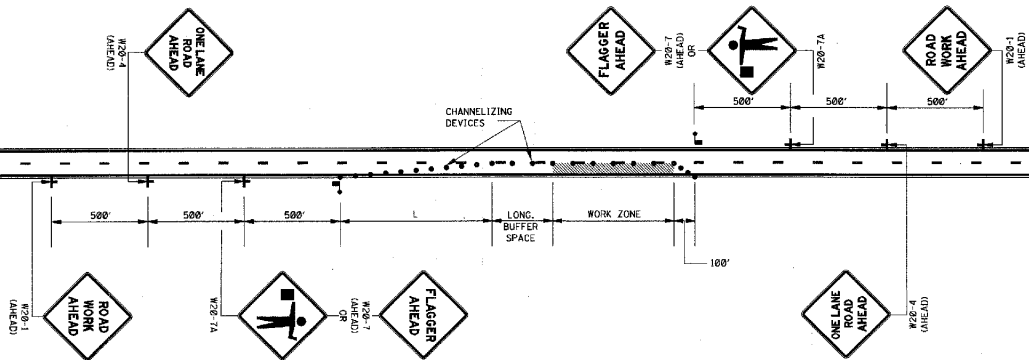

LEGEND  
 ■ FLAGGER  
 ● CHANNELIZING DEVICES

GENERAL NOTES:

1. THE LOCATION OF CHANNELIZING DEVICES AND THE WORK AREA LAYOUT SHALL BE BASED ON THE CRITERIA IN THE FOLLOWING TABLE:

POSTED SPEED AND/OR DESIGN SPEED	MAXIMUM CHANNELIZING DEVICE SPACING (FT)		MINIMUM LONGITUDINAL BUFFER SPACE (FT)	TAPER † RATES
	TAPER	ALONG LANE LINE & WORK ZONE		
20	40	60	170	27:1
45	45	90	220	45:1
50	50	100	260	50:1
55	55	110	335	55:1
60	60	120	415	60:1
65	65	130	485	65:1
70	70	140	575	70:1

† NOTE: TAPER RATES ARE DETERMINED USING THE FOLLOWING EQUATIONS:  
 $L = WS$  FOR SPEEDS OF 45 mph OR GREATER  
 $L = WS^2/60$  FOR SPEEDS OF 40 mph OR LESS  
 WHERE: L = MINIMUM LENGTH OF TAPER IN FEET  
 W = WIDTH OF OFFSET (USUALLY LANE WIDTH) IN FEET  
 S = DESIGN SPEED OR 85TH PERCENTILE SPEED IN MILES PER HOUR

2. ALL CHANNELIZING DEVICES SHALL BE A MINIMUM OF 24" IN HEIGHT.
3. ALL TRAFFIC CONTROL ITEMS SHOWN ON THIS SHEET WILL NOT BE MEASURED FOR SEPARATE PAYMENT. THIS WORK IS TO BE INCLUDED IN THE PRICE BID FOR MAINTENANCE OF TRAFFIC.
4. DIAMOND SHAPED TRAFFIC CONTROL SIGNS SHALL BE A MINIMUM OF 48" x 48".
5. WHEN THERE IS NO EXISTING HAZARD OR AT THE END OF THE WORK DAY, ALL SIGNS SHALL BE COVERED OR REMOVED AND ALL CHANNELIZING DEVICES SHALL BE MOVED TO THE SHOULDER EDGE.
6. WHERE THE WORK ZONE IS STATIONARY, THE W20-7 (500 FT.) SIGN OR THE W20-7A SIGN TOGETHER WITH THE W20-1 (500 FT.) SUPPLEMENTAL PLATE SHOULD BE USED TO INDICATE THE DISTANCE TO THE FLAGGER.

MISSISSIPPI DEPARTMENT OF TRANSPORTATION  
 ROADWAY DESIGN DIVISION  
 STANDARD PLAN

**TRAFFIC CONTROL PLAN  
 WITH FLAGGER  
 (ONE-LANE CLOSURE OF  
 TWO-WAY TRAFFIC)**

WORKING NUMBER  
 TCP-1  
 SHEET NUMBER  
 250

ISSUE DATE: OCTOBER 1, 1998



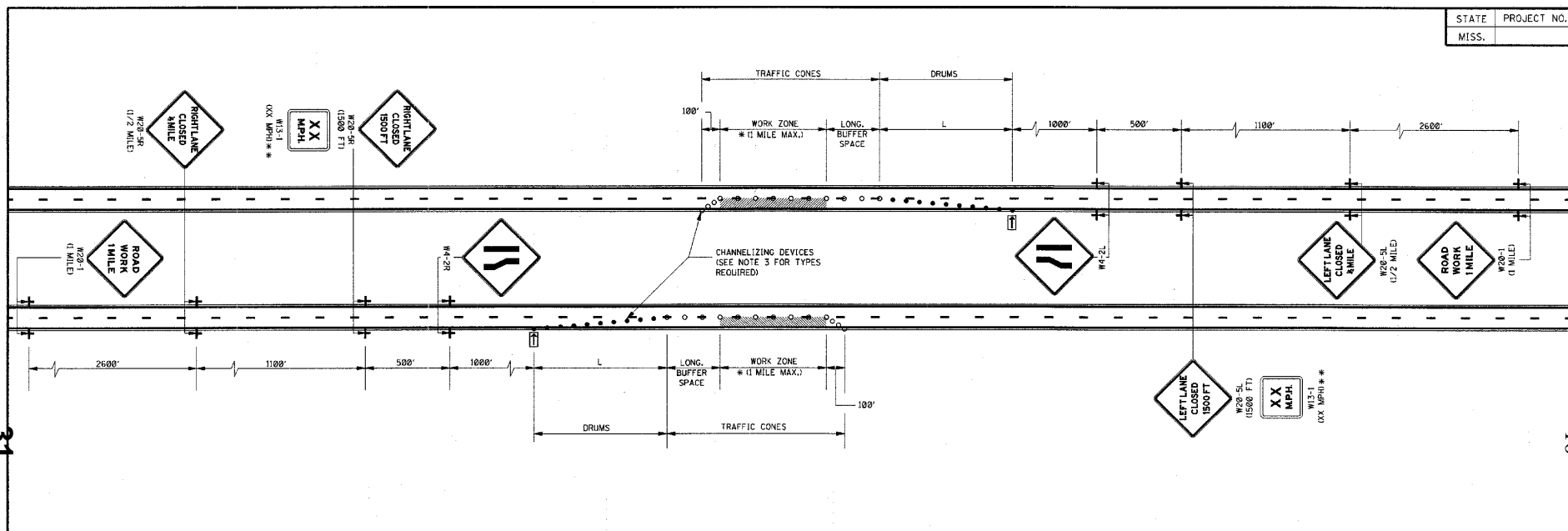

GENERAL NOTES:

1. THE LOCATION OF CHANNELIZING DEVICES AND THE WORK AREA LAYOUT SHALL BE BASED ON THE CRITERIA IN THE FOLLOWING TABLE:

POSTED SPEED AND/OR DESIGN SPEED	MAXIMUM CHANNELIZING DEVICE SPACING (ft)		MINIMUM LONGITUDINAL BUFFER SPACE (ft)	TAPER † RATES
	TAPER	ALONG LANE LINE & WORK ZONE		
≤40	40	80	170	27:1
45	45	90	220	45:1
50	50	100	280	50:1
55	55	110	335	55:1
60	60	120	415	60:1
65	65	130	485	65:1
70	70	140	575	70:1

† NOTE: TAPER RATES ARE DETERMINED USING THE FOLLOWING EQUATIONS:  
 $L = WS$  FOR SPEEDS OF 45 mph OR GREATER  
 $L = WS^2/60$  FOR SPEEDS OF 40 mph OR LESS  
 WHERE: L = MINIMUM LENGTH OF TAPER IN FEET  
 W = WIDTH OF OFFSET (USUALLY LANE WIDTH) IN FEET  
 S = DESIGN SPEED OR 85TH PERCENTILE SPEED IN MILES PER HOUR

- FLASHING ARROW PANEL SHALL BE AS LEVEL AS POSSIBLE AS APPROVED BY THE ENGINEER. FLASHING ARROW PANEL SHOULD BE LOCATED AT THE BEGINNING OF THE TAPER OR, IF THE SHOULDER IS TOO NARROW, BEHIND THE CHANNELIZING DEVICES IN THE CLOSED LANE.
- CHANNELIZING DEVICE TYPES FOR:  
 A. APPROACH TAPER- REFLECTORIZED PLASTIC DRUMS  
 B. ALONG LANE LINE AND WORK ZONE- TRAFFIC CONES (28" HEIGHT)  
 C. EXIT TAPER- TRAFFIC CONES (28" HEIGHT)
- WHEN THERE IS NO EXISTING HAZARD, ALL SIGNS SHALL BE COVERED OR REMOVED AND THE DRUMS SHALL BE MOVED TO THE SHOULDER EDGE AT THE END OF THE WORK DAY.
- FOR MOVING OPERATIONS (PAVING) THE CONTRACTOR SHALL HAVE TWO (2) SETS OF ADVANCE WARNING SIGNS, PLASTIC DRUMS, AND ARROW BOARD, WHEN THE CONSTRUCTION ZONE IS MOVED AHEAD, ALL SIGNS, PLASTIC DRUMS AND ARROW BOARD SHALL BE IN PLACE ON THE SECOND ZONE BEFORE REMOVING ANY SIGNS, PLASTIC DRUMS OR ARROW BOARD ON THE FIRST ZONE.
- ALL TRAFFIC CONTROL ITEMS SHOWN ON THIS SHEET WILL NOT BE MEASURED FOR SEPARATE PAYMENT. THIS WORK IS TO BE INCLUDED IN THE PRICE BID FOR MAINTENANCE OF TRAFFIC.
- DIAMOND SHAPED TRAFFIC CONTROL SIGNS SHALL BE A MINIMUM OF 48" X 48".

LEGEND

- \* OR AS SHOWN ELSEWHERE OF THE PLANS.
- \*\* THE LEGEND ON W13-1 (XX MPH) SUPPLEMENTAL PLATE SHALL BE 10 MPH LESS THAN THE POSTED SPEED LIMIT.
- ◻ FLASHING ARROW PANEL (TYPE 'C')
- REFLECTORIZED FREE-STANDING PLASTIC DRUMS
- TRAFFIC CONES (28" HEIGHT)

31

10

Notice To Bidder No. 4100 Cont'd

MISSISSIPPI DEPARTMENT OF TRANSPORTATION  
 ROADWAY DESIGN DIVISION  
 STANDARD PLAN

**TRAFFIC CONTROL PLAN  
 FOR POSTED SPEED LIMIT  
 LESS THAN 65 MPH  
 (4-LANE, MEDIAN LANE  
 OR OUTSIDE LANE CLOSURE)  
 (WORK DAY ONLY)**

WORKING NUMBER: TCP-2  
 SHEET NUMBER: 251

ISSUE DATE: OCTOBER 1, 1998

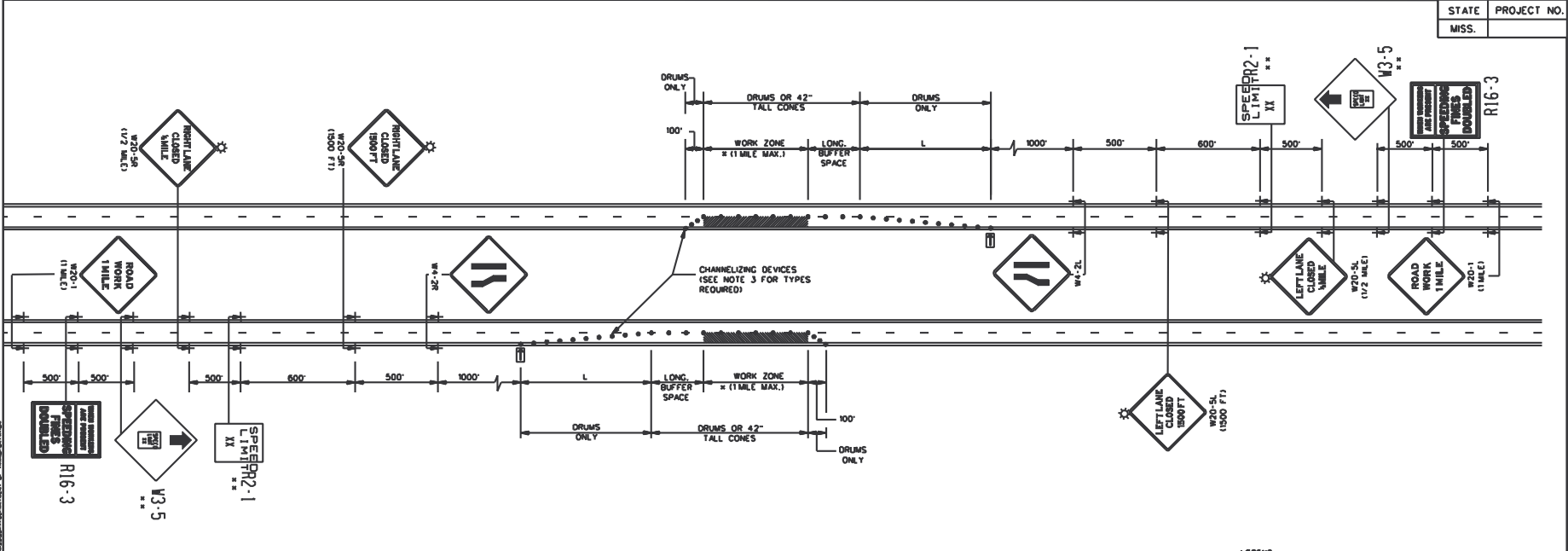

GENERAL NOTES:

1. THE LOCATION OF CHANNELIZING DEVICES AND THE WORK AREA LAYOUT SHALL BE BASED ON THE CRITERIA IN THE FOLLOWING TABLE:

POSTED SPEED AND/OR DESIGN SPEED	MAXIMUM CHANNELIZING DEVICE SPACING (1)		MINIMUM LONGITUDINAL BUFFER SPACE (1)	TAPER RATES
	TAPER	ALONG BUFFER SPACE & WORK ZONE		
40	40	80	170	27:1
45	45	90	220	45:1
50	50	100	280	50:1
55	55	110	335	55:1
60	60	120	415	60:1
65	65	130	485	65:1
70	70	140	575	70:1

1 NOTE: TAPER RATES ARE DETERMINED USING THE FOLLOWING EQUATIONS:  
 $L = WS$  FOR SPEEDS OF 45 mph OR GREATER  
 $L = WS^2/60$  FOR SPEEDS OF 40 mph OR LESS  
 WHERE: L = MINIMUM LENGTH OF TAPER IN FEET  
 W = WIDTH OF OFFSET (USUALLY LANE WIDTH) IN FEET  
 S = DESIGN SPEED OR 85TH PERCENTILE SPEED IN MILES PER HOUR

- FLASHING ARROW PANEL SHALL BE AS LEVEL AS POSSIBLE AS APPROVED BY THE ENGINEER. FLASHING ARROW PANEL SHOULD BE LOCATED AT THE BEGINNING OF THE TAPER OR, IF THE SHOULDER IS TOO NARROW, BEHIND THE CHANNELIZING DEVICES IN THE CLOSED LANE.
- CHANNELIZING DEVICES:
  - ALL CHANNELIZING DEVICES IN TAPERS SHALL BE REFLECTORIZED FREE STANDING PLASTIC DRUMS.
  - CHANNELIZING DEVICES IN TANGENTS MAY BE EITHER REFLECTORIZED FREE STANDING PLASTIC DRUMS OR 42" TALL CONES.
  - FOR NIGHTTIME USE, ALL CHANNELIZING DEVICES SHALL BE RETRORFLECTIVE.
  - RETRORFLECTORIZATION SHALL BE IN ACCORDANCE WITH THE LATEST EDITION OF THE M.U.T.C.D.
- FOR MOVING OPERATIONS (PAVING) THE CONTRACTOR SHALL HAVE TWO (2) SETS OF ADVANCE WARNING SIGNS, PLASTIC DRUMS, AND ARROW BOARD. WHEN THE CONSTRUCTION ZONE IS MOVED AHEAD, ALL SIGNS, PLASTIC DRUMS AND ARROW BOARD SHALL BE IN PLACE ON THE SECOND ZONE BEFORE REMOVING ANY SIGNS, PLASTIC DRUMS OR ARROW BOARD ON THE FIRST ZONE.
- ALL TRAFFIC CONTROL ITEMS SHOWN ON THIS SHEET WILL NOT BE MEASURED FOR SEPARATE PAYMENT. THIS WORK IS TO BE INCLUDED IN THE PRICE BID FOR MAINTENANCE OF TRAFFIC.
- DIAMOND SHAPED TRAFFIC CONTROL SIGNS SHALL BE A MINIMUM OF 48" X 48".

LEGEND

- OR AS SHOWN ELSEWHERE OF THE PLANS.
- \*\* THE LEGEND ON R2-1 & W3-5 SPEED LIMIT SIGNS SHALL BE 10 MPH LESS THAN THE ORIGINAL POSTED SPEED LIMIT.
- FLASHING ARROW PANEL (TYPE "C")
- REFLECTORIZED FREE-STANDING PLASTIC DRUMS
- TYPE "B" WARNING LIGHTS

MISSISSIPPI DEPARTMENT OF TRANSPORTATION  
 TRAFFIC CONTROL PLAN  
 FOR POSTED SPEED LIMIT  
 LESS THAN 65 MPH  
 (4-LANE MEDIAN OR  
 OUTSIDE LANE CLOSURE)  
 (EXTENDED PERIOD)

WORKING NUMBER: SDTCP-3  
 SHEET NUMBER: 3

DATE: FILENAME: OVERNIGHTCLOS\SDTCP-3  
 DESIGN TEAM: CHECKED: DATE:

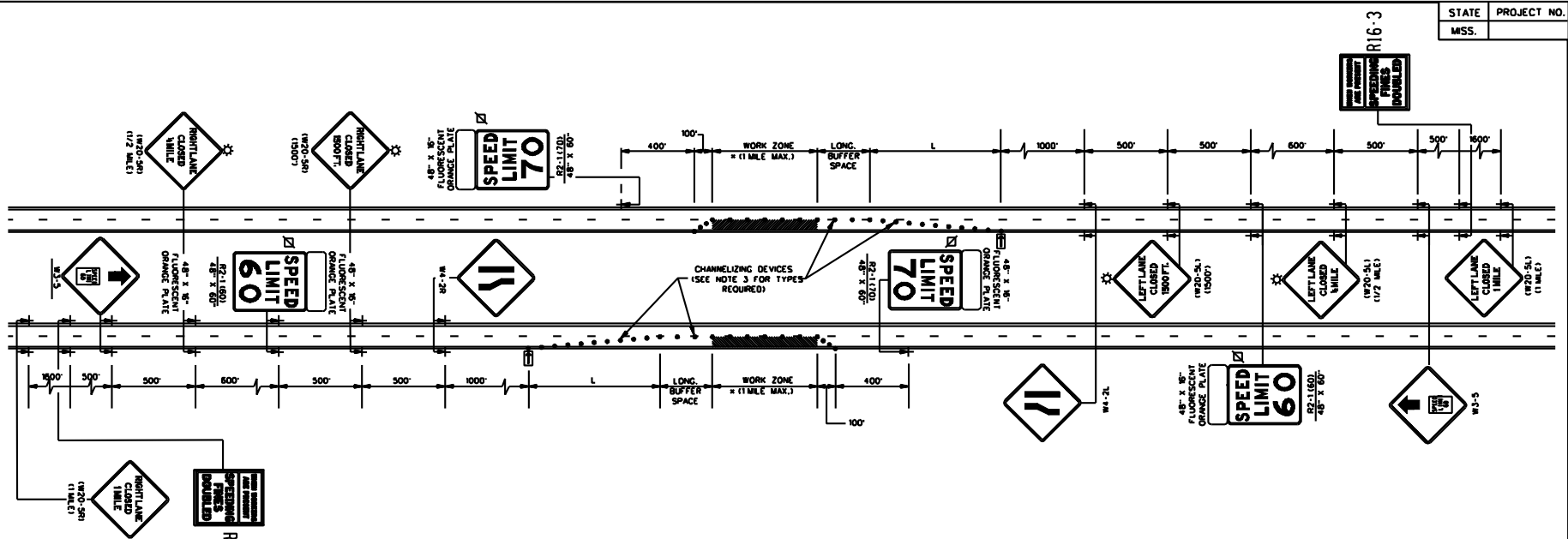

**GENERAL NOTES:**

1. THE LOCATION OF CHANNELIZING DEVICES AND THE WORK AREA LAYOUT SHALL BE BASED ON THE CRITERIA IN THE FOLLOWING TABLE:

POSTED SPEED AND/OR DESIGN SPEED	MAXIMUM CHANNELIZING DEVICE SPACING (1)		MINIMUM LONGITUDINAL BUFFER SPACE (1)	TAPER RATES
	TAPER	ALONG BUFFER SPACE & WORK ZONE		
40	40	80	170	27:1
45	45	90	220	45:1
50	50	100	280	50:1
55	55	110	335	55:1
60	60	120	415	60:1
65	65	130	485	65:1
70	70	140	575	70:1

1. NOTE: TAPER RATES ARE DETERMINED USING THE FOLLOWING EQUATIONS:  
 L = WS FOR SPEEDS OF 45 MPH OR GREATER  
 L = WS<sup>2</sup>/60 FOR SPEEDS OF 40 MPH OR LESS  
 WHERE: L = MINIMUM LENGTH OF TAPER IN FEET  
 W = WIDTH OF OFFSET (USUALLY LANE WIDTH) IN FEET  
 S = DESIGN SPEED OR 85TH PERCENTILE SPEED IN MILES PER HOUR

2. FLASHING ARROW PANEL SHALL BE AS LEVEL AS POSSIBLE AS APPROVED BY THE ENGINEER. FLASHING ARROW PANEL SHOULD BE LOCATED AT THE BEGINNING OF THE TAPER OR, IF THE SHOULDER IS TOO NARROW, BEHIND THE CHANNELIZING DEVICES IN THE CLOSED LANE.

**3. CHANNELIZING DEVICES:**

- A. ALL CHANNELIZING DEVICES IN TAPERS SHALL BE REFLECTORIZED FREE STANDING PLASTIC DRUMS.
- B. CHANNELIZING DEVICES IN TANGENTS MAY BE EITHER REFLECTORIZED FREE STANDING PLASTIC DRUMS OR 42" TALL CONES.
- C. FOR NIGHTTIME USE, ALL CHANNELIZING DEVICES SHALL BE RETROREFLECTIVE.
- D. RETROREFLECTORIZATION SHALL BE IN ACCORDANCE WITH THE LATEST EDITION OF THE M.U.T.C.D.
- 4. ALL TRAFFIC CONTROL ITEMS SHOWN ON THIS SHEET WILL NOT BE MEASURED FOR SEPARATE PAYMENT. THIS WORK IS TO BE INCLUDED IN THE PRICE BID FOR MAINTENANCE OF TRAFFIC.
- 5. DIAMOND SHAPED TRAFFIC CONTROL SIGNS SHALL BE A MINIMUM OF 48" X 48".
- 6. ALL EXISTING SPEED LIMIT SIGNS WHICH ARE INFLUENCED BY OR CONFLICT WITH THE SPEED ZONE REDUCTION SHALL BE COVERED AS DIRECTED BY THE ENGINEER WHILE THE REDUCED SPEED LIMIT IS IN EFFECT. TAPE SHALL NOT BE USED ON FACE OF SIGN.
- 7. ADDITIONAL REDUCED SPEED LIMIT SIGNS ARE REQUIRED AT EACH ENTRANCE RAMP WITHIN THE SPEED ZONE. A MINIMUM OF TWO (2) WILL BE REQUIRED FOR EACH RAMP. LOCATION AND NUMBER REQUIRED WILL BE DETERMINED BY THE ENGINEER.
- 8. THIS TRAFFIC CONTROL PLAN, WITH SPEED ZONE, MAY NOT BE USED ON ANY FACILITY WHERE THE POSTED SPEED LIMIT IS BELOW 65 MPH WITHOUT A COMMISSION ORDER REQUESTING A SPEED LIMIT REDUCTION.
- 9. LAYOUT SHOWN ABOVE IS FOR AN INTERSTATE WITH A POSTED SPEED LIMIT OF 70 MPH. FOR POSTED SPEED LIMIT OF 65 MPH, THE REDUCED SPEED LIMIT WILL BE 55 MPH.
- 10. A FLUORESCENT ORANGE PLATE IS REQUIRED WITH ALL REGULATORY SPEED LIMIT SIGNS REQUIRED FOR LANE CLOSURE.

- LEGEND**
- \* OR AS SHOWN ELSEWHERE OF THE PLANS.
  - ◻ FLASHING ARROW PANEL (TYPE "C")
  - ◻ BLACK LEGEND AND BORDER ON WHITE BACKGROUND
  - ☆ TYPE "B" WARNING LIGHTS
  - REFLECTORIZED FREE-STANDING PLASTIC DRUMS

MISSISSIPPI DEPARTMENT OF TRANSPORTATION TRAFFIC CONTROL PLAN FOR POSTED SPEED LIMIT OF 65 OR 70 MPH (INTERSTATES AND OTHER 4-LANE DIVIDED HIGHWAYS) (MEDIAN LANE OR OUTSIDE LANE CLOSURE) (EXTENDED PERIOD)		WORKING NUMBER SDTCP - 4
		SHEET NUMBER
FILENAME: OVERNIGHTCLOS\SDTCP-4	DESIGN TEAM	ORDER DATE



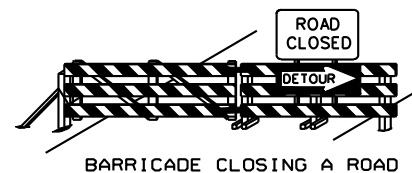
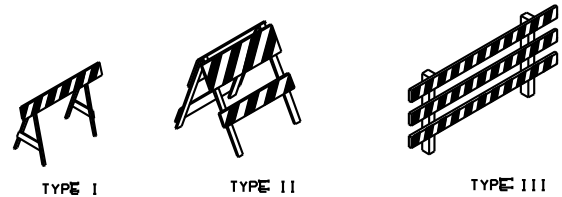

### STANDARD BARRICADES

1. A TYPE I BARRICADE CONSISTS OF ONE (1) HORIZONTAL RAIL SUPPORTED BY A DEMOUNTABLE FRAME OR A LIGHT "A" FRAME. A TYPE I BARRICADE NORMALLY WOULD BE USED ON CONVENTIONAL ROADS OR URBAN STREETS AND ARTERIALS.
2. A TYPE II BARRICADE CONSISTS OF TWO (2) HORIZONTAL RAILS ON A LIGHT "A" FRAME. TYPE II BARRICADES ARE INTENDED FOR USE ON EXPRESSWAYS AND FREEWAYS AND OTHER HIGH-SPEED ROADWAYS.
3. TYPE I AND TYPE II BARRICADES ARE INTENDED FOR USE WHERE THE HAZARD IS RELATIVELY SMALL AS, FOR EXAMPLE, ON CITY STREETS, OR FOR THE MORE OR LESS CONTINUOUS DELIMITING OF A RESTRICTED ROADWAY, OR FOR TEMPORARY DAYTIME USE.
4. A TYPE III BARRICADE CONSISTS OF THREE (3) HORIZONTAL RAILS SUPPORTED BY FIXED POSTS, A RIGID SKID, A HEAVY DEMOUNTABLE FRAME OR A HEAVY, HINGED "A" FRAME.
5. TYPE III BARRICADES ARE INTENDED FOR USE ON CONSTRUCTION AND MAINTENANCE PROJECTS AS WING BARRICADES AND AT ROAD CLOSURES, WHERE THEY MUST REMAIN IN PLACE FOR EXTENDED PERIODS.
6. THE MARKING FOR BARRICADE RAILS SHALL BE ORANGE AND WHITE (SLOPING DOWNWARD AT AN ANGLE OF 45° IN THE DIRECTION TRAFFIC IS TO PASS).
7. DO NOT PLACE SANDBAGS OR OTHER DEVICES TO PROVIDE MASS ON THE BOTTOM RAIL THAT WILL BLOCK VIEW OR RAIL FACE.
8. FOR ADDITIONAL INFORMATION OR DETAILS, SEE MUTCD, LATEST EDITION.

### BARRICADE CHARACTERISTICS

	I	II	III
WIDTH OF RAIL * #	8" MIN. - 12" MAX.	8" MIN. - 12" MAX.	8" MIN. - 12" MAX.
LENGTH OF RAIL * #	24" MIN.	24" MIN.	48" MIN.
WIDTH OF STRIPE #	6"	6"	6"
HEIGHT	36" MIN.	36" MIN.	60" MIN.
NUMBER OF REFLECTORIZED RAIL FACES	2 (ONE EACH DIRECTION)	4 (TWO EACH DIRECTION)	3 IF FACING TRAFFIC IN ONE DIRECTION 6 IF FACING TRAFFIC IN TWO DIRECTIONS
TYPE OF FRAME	LIGHT	LIGHT "A" FRAME	POST OR SKID

- \* 1. FOR RAILS LESS THAN 36" LONG, 4" WIDE STRIPES MAY BE USED.
- \*\* 2. BARRICADES INTENDED FOR USE ON EXPRESSWAYS, FREEWAYS AND OTHER HIGH SPEED ROADWAYS, SHALL HAVE A MINIMUM OF 270 sq OF REFLECTIVE AREA FACING TRAFFIC.

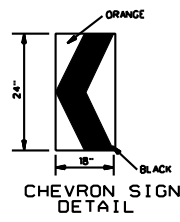

CHEVRON SIGN DETAIL

1. A CHEVRON SIGN CONSISTS OF A BLACK CHEVRON TYPE MARKING ON AN ORANGE BACKGROUND AND SHALL POINT IN THE DIRECTION OF TRAFFIC FLOW.
2. THE CHEVRON SIGN SHALL BE MOUNTED ON FIXED POST OR RIGID SKID.
3. CHEVRON SIGNS MAY BE USED TO SUPPLEMENT OTHER STANDARD DEVICES WHERE ONE OR MORE LANES ARE CLOSED FOR CONSTRUCTION OR MAINTENANCE. THEY SHALL BE PLACED APPROXIMATELY 2'-0" BEHIND THE LANE TRANSITION STRIPE.

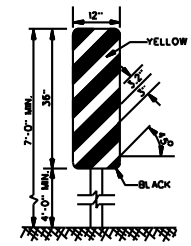

TYPE 3 OBJECT MARKER (OM-3R)

1. TYPE 3 OBJECT MARKERS SHALL BE USED AT ALL EXPOSED BRIDGE ABUTMENTS AND AT OTHER LOCATIONS AS DEEMED NECESSARY BY THE ENGINEER.
2. THE OM-3R IS SHOWN. THE OM-3L IS SIMILAR EXCEPT THE STRIPES SLOPE DOWNWARD FROM THE UPPER LEFT SIDE TO THE LOWER RIGHT SIDE AND SHALL BE PLACED ON THE LEFT SIDE OF THE OBJECT.
3. THE INSIDE EDGE OF THE MARKER SHALL BE IN LINE WITH THE INNER EDGE OF THE OBSTRUCTION.

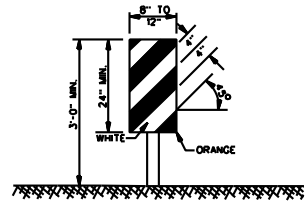

VERTICAL PANEL

1. VERTICAL PANELS CONSIST OF AT LEAST ONE PANEL 8" TO 12" IN WIDTH AND A MINIMUM OF 24" IN HEIGHT.
2. THE DIAGONAL STRIPES SHALL SLOPE DOWNWARD IN THE DIRECTION THAT TRAFFIC IS TO PASS THE PANEL. THE PANELS SHALL BE MOUNTED WITH THE TOP A MINIMUM OF 36" ABOVE THE ROADWAY ON A SINGLE LIGHTMASS POST.
3. VERTICAL PANELS USED ON EXPRESSWAYS, FREEWAYS AND OTHER HIGH-SPEED ROADWAYS SHALL HAVE A MINIMUM OF 270 sq OF RETROREFLECTIVE AREA FACING TRAFFIC.
4. FOR TWO-WAY TRAFFIC OPERATIONS, BACK-TO-BACK PANELS SHALL BE USED.

- GENERAL NOTES:
1. MARKINGS ON ALL DEVICES SHOWN ON THIS SHEET SHALL BE HIGH INTENSITY REFLECTIVE SHEETING.
  2. THE TRAFFIC CONTROL PLAN WILL LIST THE VARIOUS TRAFFIC CONTROL DEVICES REQUIRED FOR EACH PROJECT.

### WING BARRICADES

1. WING BARRICADES ARE TYPE II BARRICADES ERECTED ON THE SHOULDER ON ONE OR BOTH SIDES OF THE PAVEMENT TO GIVE THE SENSATION OF A NARROWING OR RESTRICTED ROADWAY. WING BARRICADES MAY BE USED AS A MOUNTING FOR THE ADVANCE WARNING SIGNS OR FLASHERS.
2. WING BARRICADES SHOULD BE USED:
  - A. IN ADVANCE OF A CONSTRUCTION PROJECT EVEN WHEN NO PART OF THE ROADWAY IS ACTUALLY CLOSED.
  - B. IN ADVANCE OF ALL BRIDGE OR CULVERT WIDENING OPERATIONS.

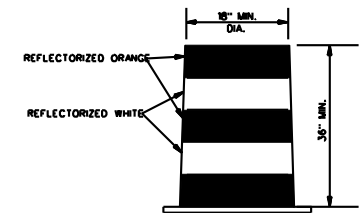

### PLASTIC DRUM STRIPING DETAIL

1. PLASTIC DRUMS SHALL BE ON END AND USED AS AN EXPEDIENT METHOD FOR TRAFFIC CHANNELIZATION. THE COLOR AND MARKING OF DRUMS SHALL BE CONSISTENT WITH MARKING STANDARDS FOR BARRICADE. THE PREDOMINANT COLOR ON DRUMS SHALL BE ORANGE WITH FOUR (4) REFLECTORIZED, HORIZONTAL, CIRCUMFERENTIAL STRIPES (2 ORANGE & 2 WHITE) 6" WIDE.
2. DRUMS SHOULD NEVER BE PLACED IN THE ROADWAY WITHOUT WARNING SIGNS.
3. WHERE PRACTICAL PLASTIC DRUMS SHALL BE PLACED NO CLOSER THAN 3'-0" FROM THE EDGE OF TRAVELED LANE.

MISSISSIPPI DEPARTMENT OF TRANSPORTATION

HIGHWAY SIGN AND BARRICADE DETAIL FOR CONSTRUCTION PROJECTS

WORKING NUMBER SDTCP-10

SHEET NUMBER

FILENAME: SDTCP-10\_06012012.DGN

DESIGN TEAM CHECKER DATE: 8/21/2012

- 14 - Notice To Bidders

MOBILE OPERATIONS ON MULTILANE ROAD ▲

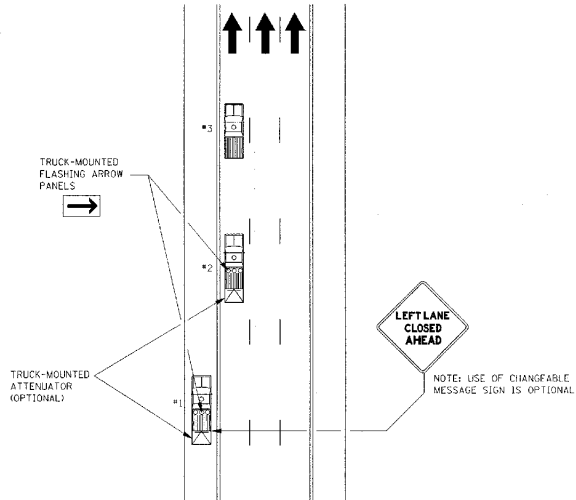

MOBILE OPERATIONS ON MULTILANE ROAD

NOTES:

- VEHICLES USED FOR THESE OPERATIONS SHOULD BE MADE HIGHLY VISIBLE WITH APPROPRIATE EQUIPMENT, SUCH AS FLASHING LIGHTS, ROTATING BEACONS, FLAGS, SIGNS, OR ARROW PANELS.
- PROTECTION VEHICLE #1 SHOULD BE EQUIPPED WITH AN ARROW PANEL. AN APPROPRIATE LANE CLOSURE SIGN SHOULD BE PLACED ON PROTECTION VEHICLE #1 SO AS NOT TO OBSCURE THE ARROW PANEL.
- PROTECTION VEHICLE #2 SHOULD BE EQUIPPED WITH AN ARROW PANEL AND TRUCK-MOUNTED ATTENUATOR (TMA).
- PROTECTION VEHICLE #1 SHOULD TRAVEL AT A VARYING DISTANCE FROM THE WORK OPERATION SO AS TO PROVIDE ADEQUATE SIGHT DISTANCE FOR TRAFFIC APPROACHING FROM THE REAR.
- WHEN ADEQUATE SHOULDER WIDTH IS NOT AVAILABLE, PROTECTION VEHICLE #1 SHOULD BE ELIMINATED.
- ON HIGH-SPEED ROADWAYS, A THIRD PROTECTION VEHICLE SHOULD BE USED (I.E., VEHICLE #1 ON THE SHOULDER IF PRACTICALLY, VEHICLE #2 IN THE CLOSED LANE, AND VEHICLE #3 IN THE CLOSED LANE).
- ARROW PANELS SHALL BE AS A MINIMUM TYPE B, 60" X 30" IN ACCORDANCE WITH THE CRITERIA PRESENTED IN THE MUTCD.
- WORK SHOULD NORMALLY BE DONE DURING OFF-PEAK HOURS.
- ALL TRAFFIC CONTROL ITEMS SHOWN ON THIS SHEET WILL NOT BE MEASURED FOR SEPARATE PAYMENT. THIS WORK IS TO BE INCLUDED IN THE PRICE BID FOR MAINTENANCE OF TRAFFIC.

MOBILE OPERATIONS ON TWO-LANE ROAD

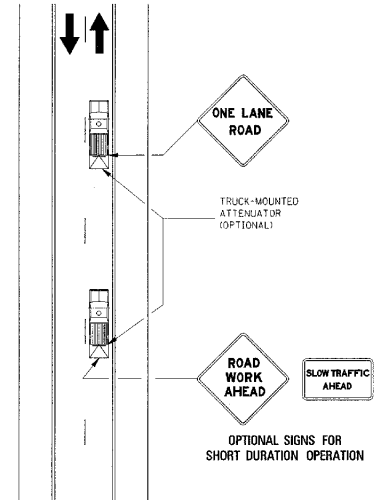

MOBILE OPERATIONS ON TWO-LANE ROAD

NOTES:

- WHERE PRACTICAL AND WHEN NEEDED, THE WORK AND PROTECTION VEHICLES SHOULD PULL OVER PERIODICALLY TO ALLOW TRAFFIC TO PASS. IF THIS CAN NOT BE DONE FREQUENTLY, AS AN ALTERNATIVE, A "DO NOT PASS" SIGN MAY BE PLACED ON THE REAR OF THE VEHICLE BLOCKING THE LANE.
- THE DISTANCE BETWEEN THE WORK AND PROTECTION VEHICLES MAY VARY ACCORDING TO TERRAIN, PAINT DRYING TIME, AND OTHER FACTORS. PROTECTION VEHICLES ARE USED TO WARN TRAFFIC OF THE OPERATION AHEAD. WHENEVER ADEQUATE STOPPING SIGHT DISTANCE EXISTS TO THE REAR, THE PROTECTION VEHICLE SHOULD MAINTAIN THE MINIMUM DISTANCE AND PROCEED AT THE SAME SPEED AS THE WORK VEHICLE. THE PROTECTION VEHICLE SHOULD SLOW DOWN IN ADVANCE OF VERTICAL OR HORIZONTAL CURVES THAT RESTRICT SIGHT DISTANCE.
- ADDITIONAL PROTECTION VEHICLES TO WARN AND REDUCE THE SPEED OF ONCOMING OR OPPOSING TRAFFIC MAY BE USED. POLICE PATROL CARS MAY BE USED FOR THIS PURPOSE.
- A TRUCK-MOUNTED ATTENUATOR (TMA) SHOULD BE USED ON THE PROTECTION VEHICLE AND MAY BE USED ON THE WORK VEHICLE.
- THE WORK VEHICLE SHALL BE EQUIPPED WITH BEACONS, AND THE PROTECTION VEHICLES SHALL BE EQUIPPED WITH TWO HIGH-INTENSITY FLASHING LIGHTS MOUNTED ON THE REAR, ADJACENT TO THE SIGN. PROTECTION AND WORK VEHICLES SHOULD DISPLAY FLASHING OR ROTATING BEACONS BOTH FORWARD AND TO THE REAR.
- VEHICLE-MOUNTED SIGNS SHALL BE MOUNTED WITH THE BOTTOM OF THE SIGN LOCATED AT A MINIMUM HEIGHT OF 48" ABOVE THE PAVEMENT. SIGN LEGENDS SHALL BE COVERED OR TURNED FROM VIEW WHEN WORK IS NOT IN PROGRESS.
- ALL TRAFFIC CONTROL ITEMS SHOWN ON THIS SHEET WILL NOT BE MEASURED FOR SEPARATE PAYMENT. THIS WORK IS TO BE INCLUDED IN THE PRICE BID FOR MAINTENANCE OF TRAFFIC.

STATE	PROJECT NO.
MISS.	

MISSISSIPPI DEPARTMENT OF TRANSPORTATION ROADWAY DESIGN DIVISION STANDARD PLAN	
<b>TRAFFIC CONTROL PLAN MOBILE OPERATIONS MULTILANE ROADS AND TWO-LANE ROADS</b>	
DATE	ISSUE DATE: OCTOBER 1, 1998
WORKING NUMBER TCP-11	SHEET NUMBER 260

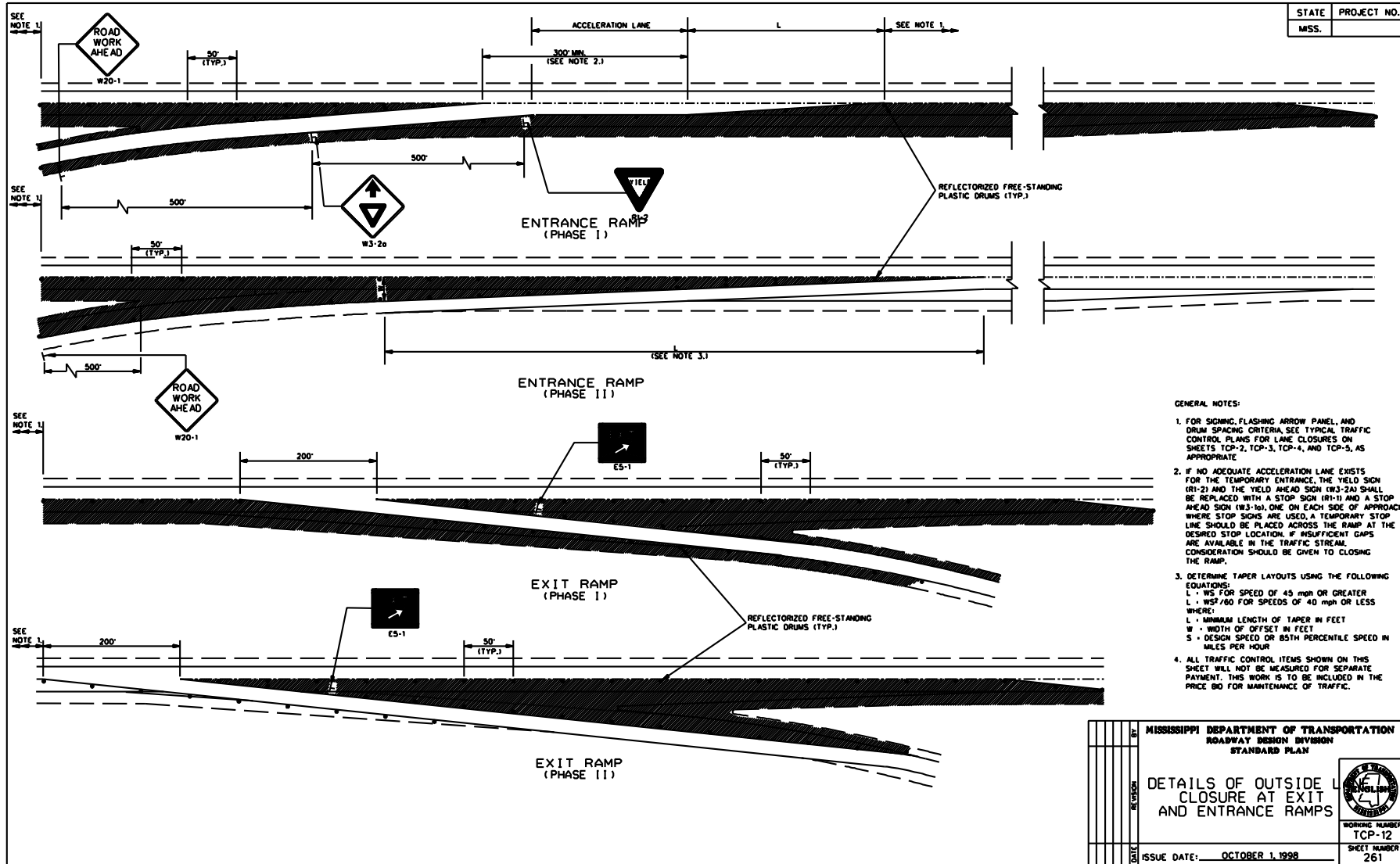

STATE	PROJECT NO.
MISS.	

- GENERAL NOTES:
1. FOR SIGNING, FLASHING ARROW PANEL, AND DRUM SPACING CRITERIA, SEE TYPICAL TRAFFIC CONTROL PLANS FOR LANE CLOSURES ON SHEETS TCP-2, TCP-3, TCP-4, AND TCP-5, AS APPROPRIATE.
  2. IF NO ADEQUATE ACCELERATION LANE EXISTS FOR THE TEMPORARY ENTRANCE, THE YIELD SIGN (R1-2) AND THE YIELD AHEAD SIGN (R3-2A) SHALL BE REPLACED WITH A STOP SIGN (R1-1) AND A STOP AHEAD SIGN (W3-1a), ONE ON EACH SIDE OF APPROACH. WHERE STOP SIGNS ARE USED, A TEMPORARY STOP LINE SHOULD BE PLACED ACROSS THE RAMP AT THE DESIRED STOP LOCATION. IF INSUFFICIENT GAPS ARE AVAILABLE IN THE TRAFFIC STREAM, CONSIDERATION SHOULD BE GIVEN TO CLOSING THE RAMP.
  3. DETERMINE TAPER LAYOUTS USING THE FOLLOWING EQUATIONS:  
 $L = WS$  FOR SPEED OF 45 mph OR GREATER  
 $L = WS^2/600$  FOR SPEEDS OF 40 mph OR LESS  
 WHERE:  
 L = MINIMUM LENGTH OF TAPER IN FEET  
 W = WIDTH OF OFFSET IN FEET  
 S = DESIGN SPEED OR 85TH PERCENTILE SPEED IN MILES PER HOUR
  4. ALL TRAFFIC CONTROL ITEMS SHOWN ON THIS SHEET WILL NOT BE MEASURED FOR SEPARATE PAYMENT. THIS WORK IS TO BE INCLUDED IN THE PRICE BID FOR MAINTENANCE OF TRAFFIC.

MISSISSIPPI DEPARTMENT OF TRANSPORTATION ROADWAY DESIGN DIVISION STANDARD PLAN	
DETAILS OF OUTSIDE LANE CLOSURE AT EXIT AND ENTRANCE RAMP	
WORKING NUMBER TCP-12	ISSUE DATE: OCTOBER 1, 1998
SHEET NUMBER 261	

STATE	PROJECT NO.
MISS.	

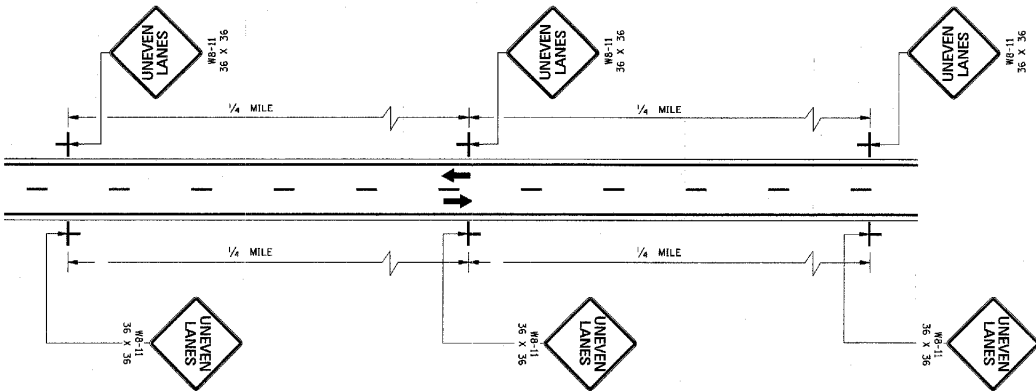

TWO-WAY TRAFFIC

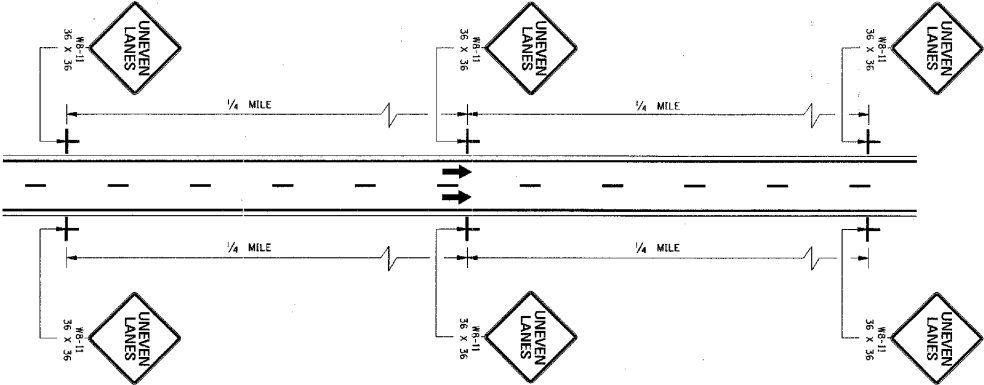

ONE-WAY TRAFFIC

- GENERAL NOTES:
1. UNEVEN LANE LINE.
  - A. IF LESS THAN OR EQUAL TO 1 1/2", NO SIGNS REQUIRED.
  - B. IF GREATER THAN 1 1/2" AND LESS THAN OR EQUAL TO 2 1/4", PLACE SIGNS AS SHOWN ON THIS SHEET.
  - C. IF GREATER THAN 2 1/4", TRAFFIC SHOULD NOT BE ALLOWED TO CROSS UNEVEN LANE LINE.
  2. ALL TRAFFIC CONTROL ITEMS SHOWN ON THIS SHEET SHALL BE PAID FOR UNDER MAINTENANCE OF TRAFFIC.
  3. THE WB-11 SIGNS SHALL BE SPACED AT 1/4-MILE INTERVALS THROUGHOUT UNEVEN LANE LINE LIMITS.

BY		MISSISSIPPI DEPARTMENT OF TRANSPORTATION	
REVISION		ROADWAY DESIGN DIVISION	
DATE		STANDARD PLAN	
		<b>TRAFFIC CONTROL PLANS UNEVEN PAVEMENT DETAILS</b>	
			
		WORKING NUMBER TCP-14	
ISSUE DATE: OCTOBER 1, 1998		SHEET NUMBER 263	



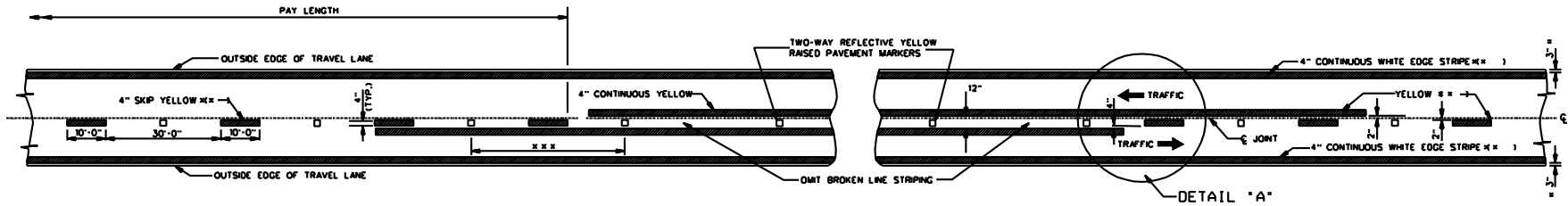

TWO-WAY TRAFFIC  
(ASPHALT OR CONCRETE PAVEMENT)

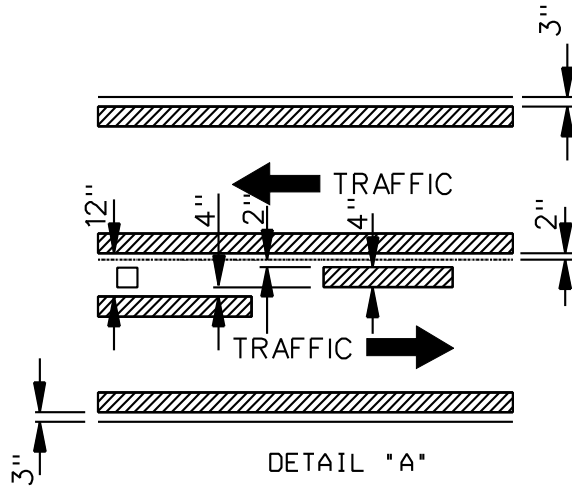

DETAIL "A"



GENERAL NOTES:

- \*\* 1. 3" UNLESS SHOWN ELSEWHERE ON THE PLANS.
- \*\* 2. EDGE STRIPE SHALL BE SAME MATERIAL AS LANE-LINE STRIPE (PAINT OR TAPE AS INDICATED IN PAY ITEMS).
- \*\*\* 3. SPACING OF REFLECTIVE RAISED PAVEMENT MARKERS IS AS FOLLOWS:

	URBAN AREA (11-in)	RURAL AREA (11-in)
TANGENT SECTIONS	40'-0"	80'-0"
HORIZONTAL CURVES	40'-0"	40'-0"
INTERCHANGE LANES	40'-0"	140'-0"

- 1 NOTE: ON THE MAIN FACILITY, REFLECTIVE RED-CLEAR RAISED PAVEMENT MARKERS ON A 40'-0" SPACING WILL BE REQUIRED ON LANE-LINE(S) THROUGH ALL INTERCHANGE AREAS BEGINNING 1000' IN ADVANCE (IN DIRECTION OF TRAFFIC) OF THE EXIT RAMP TAPER AND CONTINUING THROUGH THE INTERCHANGE TO THE END OF THE ENTRANCE RAMP TAPER.
- 4. PAVEMENT MARKERS SHALL BE HIGH PERFORMANCE REFLECTIVE RAISED PAVEMENT MARKERS AS LISTED IN THE MOOT "APPROVED SOURCES OF MATERIALS."
- 5. REFLECTIVE RAISED PAVEMENT MARKERS TO BE USED IF TEMPORARY MARKINGS ARE TO REMAIN IN PLACE OVER 3 MONTHS

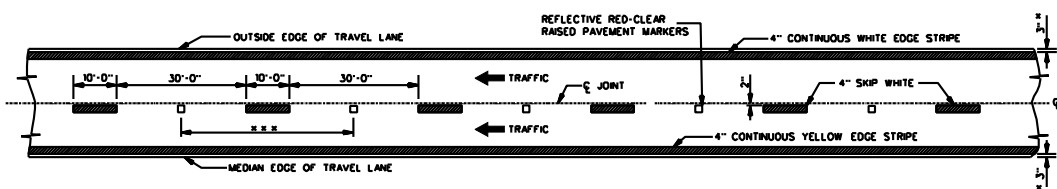

4-LANE WITH ONE-WAY TRAFFIC

DATE	DESIGNED BY	MISSISSIPPI DEPARTMENT OF TRANSPORTATION ROADWAY DESIGN DIVISION STANDARD PLAN <b>TEMPORARY STRIPING FOR          TRAFFIC CONTROL          2-LANE AND 4-LANE          DIVIDED HIGHWAYS</b>	
	CHECKED BY		
	APPROVED BY		
	ISSUE DATE: DECEMBER 1, 1999		
		WORKING NUMBER TCP-15	SHEET NUMBER 264

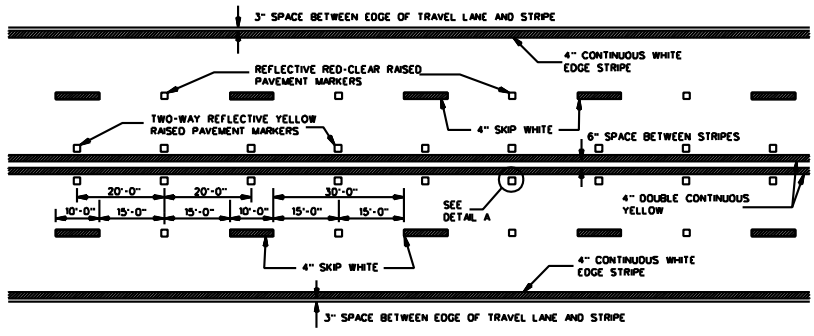

TYPICAL STRIPING AND RAISED PAVEMENT MARKERS FOR 4-LANE SECTION

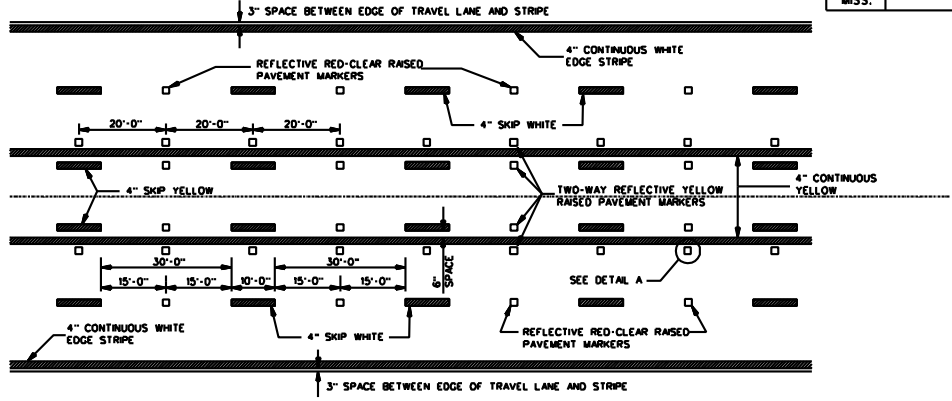

TYPICAL STRIPING AND RAISED PAVEMENT MARKERS FOR 5-LANE SECTION

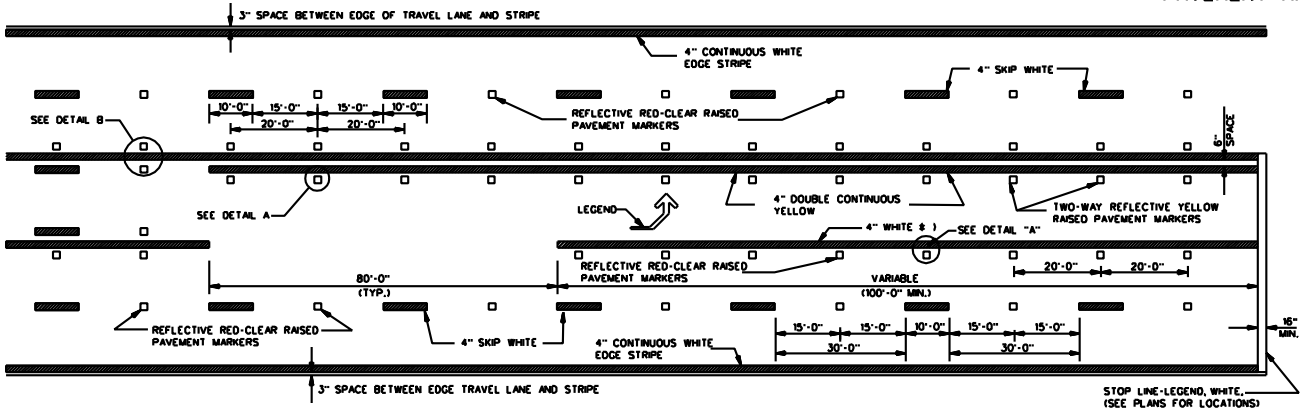

TYPICAL STRIPING AND RAISED PAVEMENT MARKERS AT LEFT TURN LANES

\* NOTE: USE DETAIL STRIPING IF LENGTH ≤ 150' AT THIS LOCATION, OTHERWISE USE CONTINUOUS STRIPING.

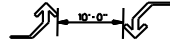

TYPICAL TWO-WAY ARROW INSTALLATION

- NOTES: 1. CONSIDER EACH SEGMENT OF CONTINUOUS TWO-WAY LEFT TURN LANE SEPARATELY.  
 2. IF SEGMENT IS LESS THAN 350', PLACE ONE SET OF ARROWS IN CENTER OF SEGMENT.  
 3. IF SEGMENT IS GREATER THAN 350', PLACE FIRST SET OF ARROWS 50' TO 100' FROM BEGINNING AND/OR END OF SEGMENT AND SPACE ADDITIONAL SETS OF ARROWS (250' O.C.).

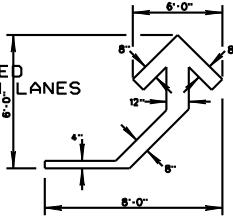

DETAIL OF TEMPORARY TURN ARROW

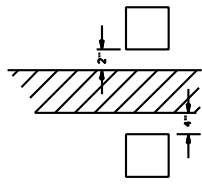

DETAIL B LATERAL PLACEMENT OF PAVEMENT MARKERS

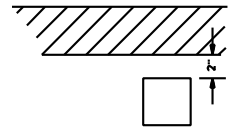

DETAIL A LATERAL PLACEMENT OF PAVEMENT MARKERS

GENERAL NOTE:

1. PAVEMENT MARKERS SHALL BE HIGH PERFORMANCE RAISED PAVEMENT MARKERS AS LISTED IN THE MDT "APPROVED SOURCES OF MATERIALS".
2. REFLECTIVE RAISED PAVEMENT MARKERS TO BE USED IF TEMPORARY MARKINGS ARE TO REMAIN IN PLACE OVER 3 MONTHS
3. TEMPORARY TURN ARROW TO BE PAID FOR AS TEMPORARY TRAFFIC STRIPE (LEGEND), ESTIMATED AT 10.9 SO. FT. PER ARROW

BY	REVISION	MISSISSIPPI DEPARTMENT OF TRANSPORTATION ROADWAY DESIGN DIVISION STANDARD PLAN	
		TEMPORARY STRIPING FOR TRAFFIC CONTROL 4-LANE AND 5-LANE UNDIVIDED ROADWAYS	
DATE	ISSUE DATE: DECEMBER 1, 1999	WORKING NUMBER TCP-16	SHEET NUMBER 265

40

19

Notice to Bidders No. 99001

**MISSISSIPPI DEPARTMENT OF TRANSPORTATION**

**SECTION 904 - NOTICE TO BIDDERS NO. 4189**

**CODE: (SP)**

**DATE: 11/08/2012**

**SUBJECT: Rumble Stripe**

Bidders are hereby advised that when edge lines are placed over rumble strips, the pavement marking stripe must be applied using the atomization/spray method instead of extrusion / ribbon method. To ensure the proper alignment of the rumble stripes, the Contractor will be required to place a layout line to be followed during installation of the edge lines over the rumble strips.

## MISSISSIPPI DEPARTMENT OF TRANSPORTATION

SECTION 904 - NOTICE TO BIDDERS NO. 4214

CODE: (IS)

DATE: 11/29/2012

SUBJECT: Safety Apparel

Bidders are advised that the Code of Federal Regulations CFR 23 Part 634 final rule was adopted November 24, 2006 with an effective date of November 24, 2008. This rule requires that "All workers within the right-of-way of a Federal-Aid Highway who are exposed either to traffic (vehicles using the highway for the purposes of travel) or to construction equipment within the work area shall wear high-visibility safety apparel". High-visibility safety apparel is defined in the CFR as "personnel protective safety clothing that is intended to provide conspicuity during both daytime and nighttime usage, and that meets the Performance Class 2 or 3 requirements of the ANSI/ISEA 107-2004 publication entitled American National Standard for High-Visibility Safety Apparel and Headwear". All workers on Mississippi State Highway right-of-way shall comply with this Federal Regulation. Workers are defined by the CFR as "people on foot whose duties place them within the right-of way of a Federal-Aid Highway, such as highway construction and maintenance forces, survey crews, utility crews, responders to incidents within the highway right-of-way, and law enforcement personnel when directing traffic, investigating crashes, and handling lane closures, obstructed roadways, and disasters within the right-of-way of a Federal-Aid Highway".

More information regarding high visibility safety apparel can be found at the following sites.

<http://www.gpo.gov/fdsys/pkg/CFR-2008-title23-vol1/pdf/CFR-2008-title23-vol1-sec634-1.pdf>

<http://ops.fhwa.dot.gov/wz/resources/policy.htm#hv>

## MISSISSIPPI DEPARTMENT OF TRANSPORTATION

NOTICE TO BIDDERS NO. 4308

CODE: (SP)

DATE: 02/07/2013

SUBJECT: Terminal End Sections

Guard rail terminal end sections shall be construction in accordance with the plans, specifications, and the following.

### **Flared.**

Flared terminal end sections shall be FLEAT-350, REGENT, SRT-350, ROSS-350 or approved flared equal and installed in accordance with the manufacturer's recommendation. The Contractor shall provide two copies of the manufacturer's installation details to the Project Engineer. The Project Engineer will keep one copy in the project file and provide one copy to the District Maintenance Engineer. The installation details shall be engineering drawings, a minimum of 11" X 17" in size. Reflective adhesive sheeting with alternating black and yellow stripes (sloping downward at an angle of 45 degrees in the direction traffic is to pass) shall be required on the end of the terminal section. The type of terminal section installed shall be written on the device with a Permanent Marking Stick or some other means of permanent identification.

### **Non-Flared.**

Non-Flared terminal end sections shall be ET-2000, SKT-350, or approved non-flared equal and installed in accordance with the manufacturer's recommendation. The Contractor shall provide two copies of the manufacturer's installation details to the Project Engineer. The Project Engineer will keep one copy in the project file and provide one copy to the District Maintenance Engineer. The installation details shall be engineering drawings, a minimum of 11" X 17" in size. Reflective adhesive sheeting with alternating black and yellow stripes (sloping downward at an angle of 45 degrees in the direction traffic is to pass) shall be required on the end of the terminal section. The type of terminal section installed shall be written on the device with a Permanent Marking Stick or some other means of permanent identification.

Likewise, impact attenuators shall be construction in accordance with the plans, specifications, and the following.

Approved impact attenuator systems shall meet standardized testing defined in Manual for Assessing Safety Hardware (MASH) or NCHRP Report 350. In addition, these devices shall have an acceptance letter from FHWA that documents the device meets the appropriate crash test criteria and can be used on the National Highway System (NHS). The Contractor shall provide two copies of the manufacturer's installation details to the Project Engineer. The Project Engineer shall keep one copy in project file and provide one copy to District Maintenance Engineer. The installation details shall be engineering drawings, a minimum of 11"x17" in size. Reflective adhesive sheeting with alternating black and yellow stripes (sloping downward at an angle of 45 degrees in the direction traffic is to pass) shall be required on the end of the attenuator section. The type of system installed shall be written on the device with a Permanent Marking Stick or some other means of permanent identification.

**MISSISSIPPI DEPARTMENT OF TRANSPORTATION**

**SECTION 904- NOTICE TO BIDDERS NO. 4473**

**CODE: (SP)**

**DATE: 04/08/2013**

**SUBJECT: Alternate Crushed Stone Base Bid Items**

Bidders are advised that the Crushed Stone Base used on this project will be bid as an alternate pay item:  $\frac{3}{4}$ " and Down Crushed Stone Base, Size 825B Crushed Stone Base, or Size 610 Crushed Stone Base. Bidders must select one of the alternates at the time of bid. **The Contractor must use the selected crushed stone base throughout the entire project.**

**MISSISSIPPI DEPARTMENT OF TRANSPORTATION**

**SECTION 904 - NOTICE TO BIDDERS NO. 4500**

**CODE: (SP)**

**DATE: 05/14/2013**

**SUBJECT: Contract Time**

**PROJECT: MP-6018-31(010) / 304810301 -- Jasper County**

The calendar date for completion of work to be performed by the Contractor for this project will be determined as follows, which date or extended date as provided in Subsection 907-108.06 shall be the end of contract time. It is anticipated that the Notice of Award will be issued no later than **July 9, 2013** and the effective date of the Notice to Proceed / Beginning of Contract Time will be between **Execution of Contract and September 12, 2013**.

The Contractor shall request a Notice to Proceed / Beginning of Contract Time date between the date of **Execution of Contract and September 12, 2013**.

The calendar date for completion of work will be determined by adding **56 Calendar Days** to the effective date of the Notice to Proceed / Beginning of Contract Time.

Should the Contractor not request a Notice to Proceed by **September 12, 2013**, the date for the Notice to Proceed / Beginning of Contract Time will be **September 12, 2013**.

# MISSISSIPPI DEPARTMENT OF TRANSPORTATION

SECTION 904 - NOTICE TO BIDDERS NO. 4501

CODE: (SP)

DATE: 05/01/2013

SUBJECT: Scope of Work

PROJECT: MP-6018-31(010) / 304810301 -- Jasper County

The contract documents do not include an official set of construction plans but may, by reference, include some Standard Drawings when so specified in a Notice to Bidders entitled, "Standard Drawings". All other references to plans in the contract documents and Standard Specifications for Road and Bridge Construction are to be disregarded.

Work on the project shall consist of the following.

**SR 18**  
**LEVEL AND OVERLAY FROM SMITH COUNTY LINE EAST 8.3 MILES**  
**10+00 – 116+08 (R1) 10+00 – 348+00 (R2)**

(A) Prior to the overlay, centerline alignment shall be determined by the Contractor by measuring the existing roadway at 500-foot intervals in tangent sections, and 100-foot intervals in horizontal curves. The existing shoulders shall be clipped and surplus material shall be spread along the edge of the shoulders, fore slopes, or other adjacent areas as directed by the Project Engineer, and will be an absorbed item. The brick section in at the intersection of SR 18 and 3<sup>rd</sup> Street (Station 15+85 to Station 16+57) shall be omitted.

(B) Cold Mill 1.5" & Variable on SR 18 at all the transitions including E.O.P., B.O.P., bridge approaches, and all tie-ins. Cold Mill 1.5" for the entire road width from station 110+04 (R1) thru the city of Bay Springs to station 23+00 (R2). Vehicle Assembly Loops shall be placed in the underlying layer of asphalt prior to placing the surface lift. Work performed within the city limits of Bay Springs shall be performed between the hours of 7:00 PM and 6:00 AM. All milled areas shall be backfilled with asphalt within 48 hours of milling.

(C) Overlay SR 18 with 1.5" of 9.5-mm, MT, asphalt mixture from the Smith County line 8.3 miles east. Prior to the overlay, a leveling course of ¾" & variable of 9.5-mm, MT, asphalt shall be required. Leveling will not be performed thru the milling limits within the City of Bay Springs. Smoothness incentive/disincentive will be governed by special provision for MRI (mean roughness index). All incentive/disincentive will be based on theoretical tonnage placed on a 12-foot travel lane. Remove any failed areas on the main facility and repair by backfilling with 19-mm, MT, asphalt as directed by the Project Engineer. Removal areas will be marked by MDOT personnel and include, but are not limited to, areas included in Table 1. Approximately 550 tons of 19-mm, MT, asphalt will be used for backfill in all removal sections. Publicly maintained roads or streets shall be surfaced to the existing R.O.W.; privately owned entrances shall be surfaced a distance of 10 feet & variable from edge of pavement. Any site grading at



local roads or drives will not be measured for separate payment but will be considered an absorbed item. Cross slopes shall be maintained to achieve a uniform cross slope of 2% where practical with plan quantities. The Contractor will mill a 12-inch rumble strip along the inside of the shoulders and place the traffic stripe on the inside six inches (6") of the rumble strip. If water stands when project is complete, the contractor shall correct at no additional cost to the State.

(D) Raise the existing shoulders to match the new pavement elevation by placing 2.25" & variable depth crushed stone on the shoulders. Placement of the crushed stone on the finished surface course shall not be permitted. The material shall be bladed, rolled and compacted to a finished slope of 4% where practical. Shoulders with existing adequate shoulder material in place shall be bladed to a slope of 4%, the cost of which shall be included in the prices of other items bid.

(E) Temporary striping shall conform to finished stripe specifications for alignment, neatness, reflectivity, and straightness. All permanent pavement markings are to be hot thermoplastic. Edge lines will be placed so as to maintain the original lane width. Glass beads applied to thermoplastic shall conform to Subsection 720.01. On all bridges and concrete sections of highway, old traffic stripe shall be removed and replaced with High Performance Thermoplastic. Special care should be taken for the placement of Thermoplastic Detail Stripe along the edge of pavement at turn-outs on all local roads and along tapers where Detail Stripe is required as per Typical PMD-1.

(F) Raised pavement markers will be placed as per sheet PM-1 of the Standard Drawings. Any removal of existing raised pavement markers or rumble bars shall be considered an absorbed item. Only flexible adhesive shall be allowed for placement of raised pavement markers meeting the requirements of Subsection 720.03.7.7 of the 2004 Mississippi Standard Specifications for Road and Bridge.

(G) Approximately 33 SY of 10-inch island pavement, 179 SY of 4-inch island pavement and 1302 LF of Type 2 Combination Curb and Gutter shall be placed as specified in typical drawings. Final location and dimension of concrete islands shall be directed by the Project Engineer. Concrete shall be Class B and an approved mix design shall be obtained prior to beginning work on any paved islands. Islands shall be backfilled with crushed stone. Removal of existing pavement and excavation for islands will be paid for under Removal of Pavement, All Types and Depths. Concrete testing shall be performed by MDOT personnel.

(H) The installation of terminal end sections, installed as per manufactures recommendations, shall be National Cooperative Highway Research Program (NCHRP) Report 350 Test Level 3 (TL-3) approved. The flared Terminal End Section or equivalent shall be used at each of the bridge locations on this project. All terminal end sections shall be marked with a Samford Mean Streak grease pen to identify type installed. The Contractor shall furnish the Project Engineer two (2) copies of the manufacture's installation instructions prior to beginning guardrail operations. Any site grading and all fill material necessary at the guardrail locations will not be measured for separate payment but will be absorbed in other guardrail pay items. Guard rail pads shall be overlaid prior to placing guardrail and will be paid for under 907-403, 9.5-mm,

MT, asphalt mixture. Seeding, fertilizer and vegetative mulch are required on all disturbed areas at the guardrail site and will be considered an absorbed item. Application rate for Bermuda grass seed will be 25 pounds per acre. Application rate for combination fertilizer (13-13-13) will be 1,000 pounds per acre. Application rate for mulch shall be two (2) tons per acre.

Pay Item 907-824-PP008 shall be used on Bridge Locations 127.4 and 127.8 (See attached detail).

The Contractor shall erect and maintain construction signing, and provide all signs and traffic handling devices, and shall provide two portable R16-3 signs per work zone or lane closure in addition to signs required by standard drawings in accordance with Manual Uniform Traffic Control Devices (MUTCD) (the cost is to be included in the price bid for pay item No. 618-A, Maintenance of Traffic).

Incidental work such as removing vegetation, shaping and compaction of shoulder, removing excess asphalt material, project clean-up, and other incidental work necessary to complete the project will not be measured for separate payment, but will be included in other bid items, and must be performed during the operating hours for this project.

If pavement section marking tape is encountered on this project, it shall be located prior to overlaying and placed back in same location after paving operations have ceased. The section marking shall be eight inch high performance cold plastic detail stripe and shall be four feet in length. The marking shall be centered across the centerline stripe. The cost of this item shall be absorbed in other bid items.

MP - 6018 - 31(010) / 304810301  
JASPER COUNTY

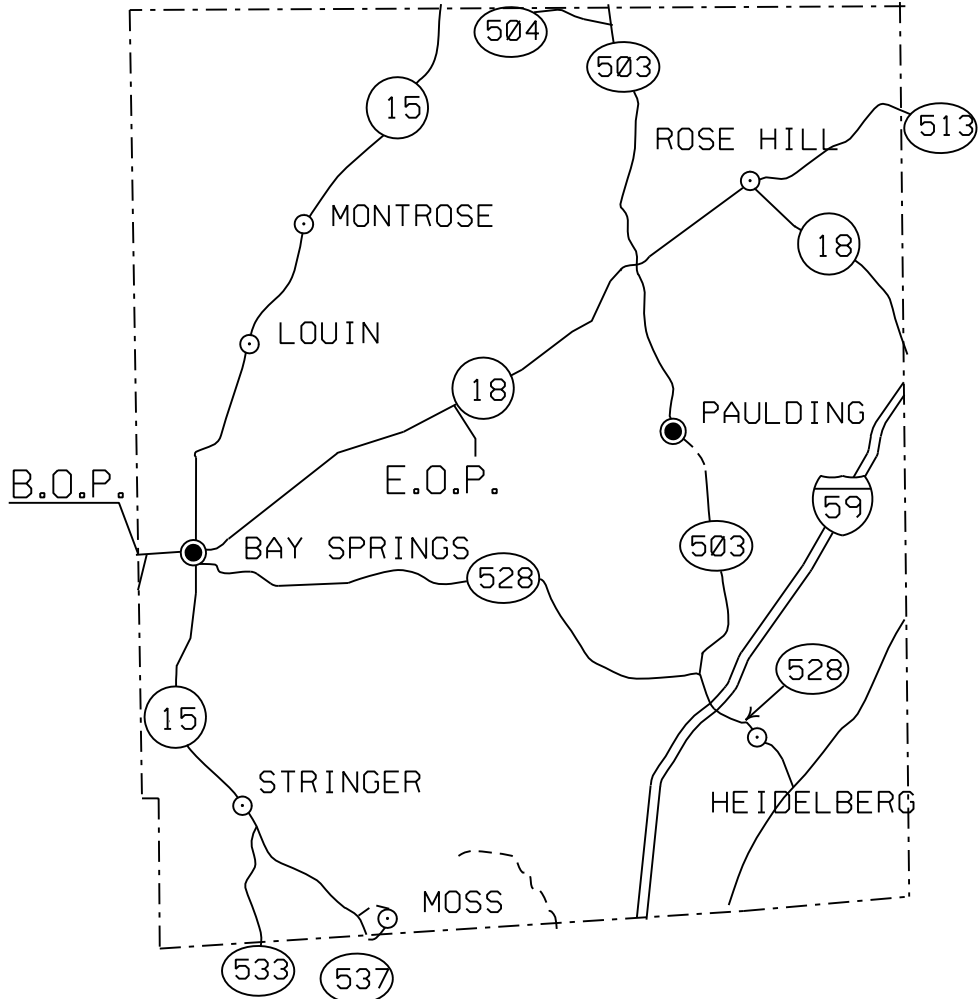

THE ABOVE REFERENCED PROJECT IS FOR LEVELING  
AND OVERLAYING HWY 18 FROM THE SMITH COUNTY  
LINE EAST 8.25 MILES

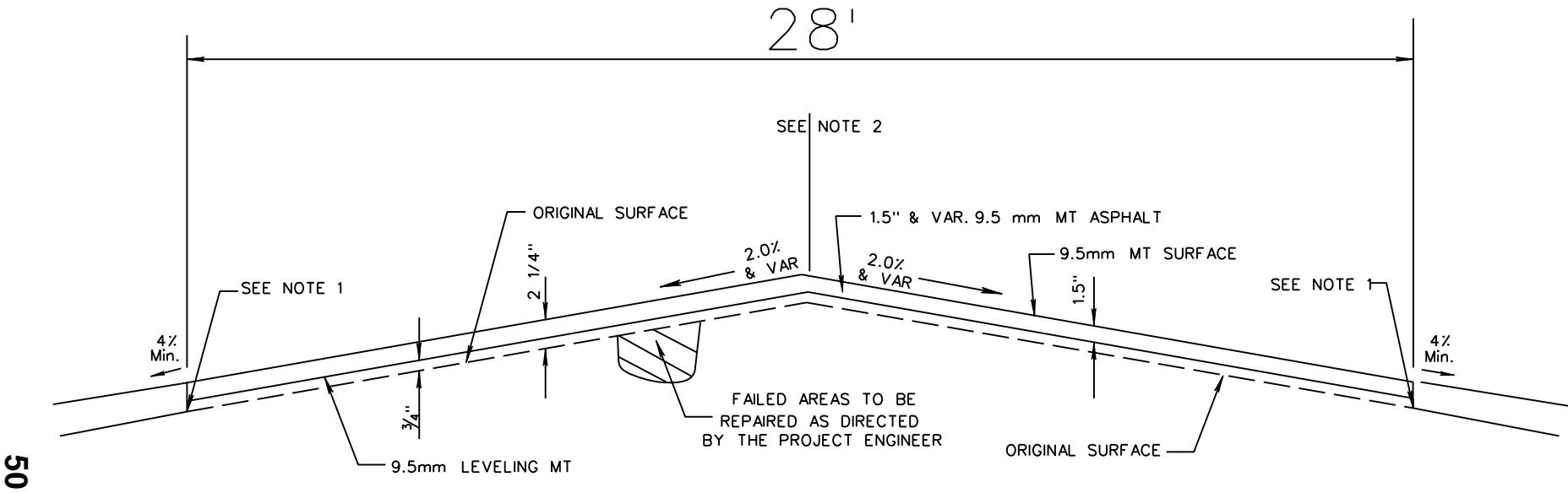

TYPICAL FOR  
STATION 10+00(R1) TO 110+00 (R1)

NOTES:

(1) THE EXISTING PAVEMENT EDGE SHALL BE CUT TO A SMOOTH AND NEAR VERTICAL FACE WITH AN APPROVED CUTTING DEVICE. (NOT TO BE MEASURED FOR SEPARATE PAY.)

(2) TRUE CENTERLINE PAVEMENT ALIGNMENT SHALL BE DETERMINED BY THE CONTRACTOR BY MEASURING THE EXISTING ROADWAY AT 500ft. INTERVALS IN TANGENT SECTIONS, AND 100ft. INTERVALS IN HORIZONTAL CURVES.

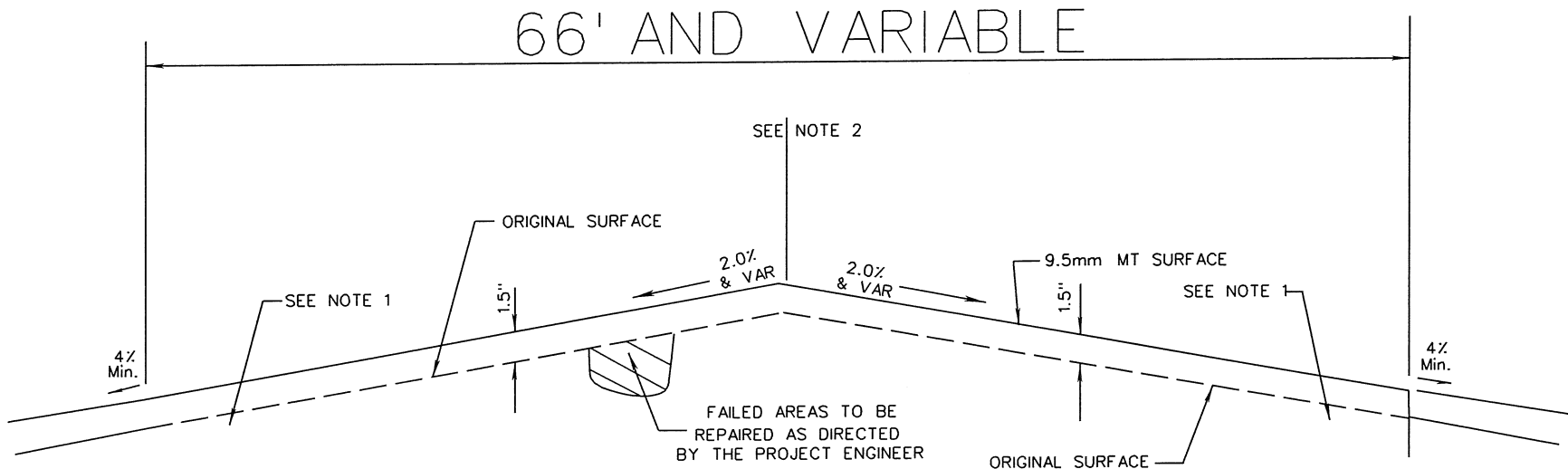

51

- 6 -

## TYPICAL FOR STATION 110+00(R1) TO 23+00 (R2)

NOTES:

(1) THE EXISTING PAVEMENT EDGE SHALL BE CUT TO A SMOOTH AND NEAR VERTICAL FACE WITH AN APPROVED CUTTING DEVICE. (NOT TO BE MEASURED FOR SEPARATE PAY.)

(2) TRUE CENTERLINE PAVEMENT ALIGNMENT SHALL BE DETERMINED BY THE CONTRACTOR BY MEASURING THE EXISTING ROADWAY AT 500ft. INTERVALS IN TANGENT SECTIONS, AND 100ft. INTERVALS IN HORIZONTAL CURVES.

MILL AND REPLACE 1.5" OF 9.5MM

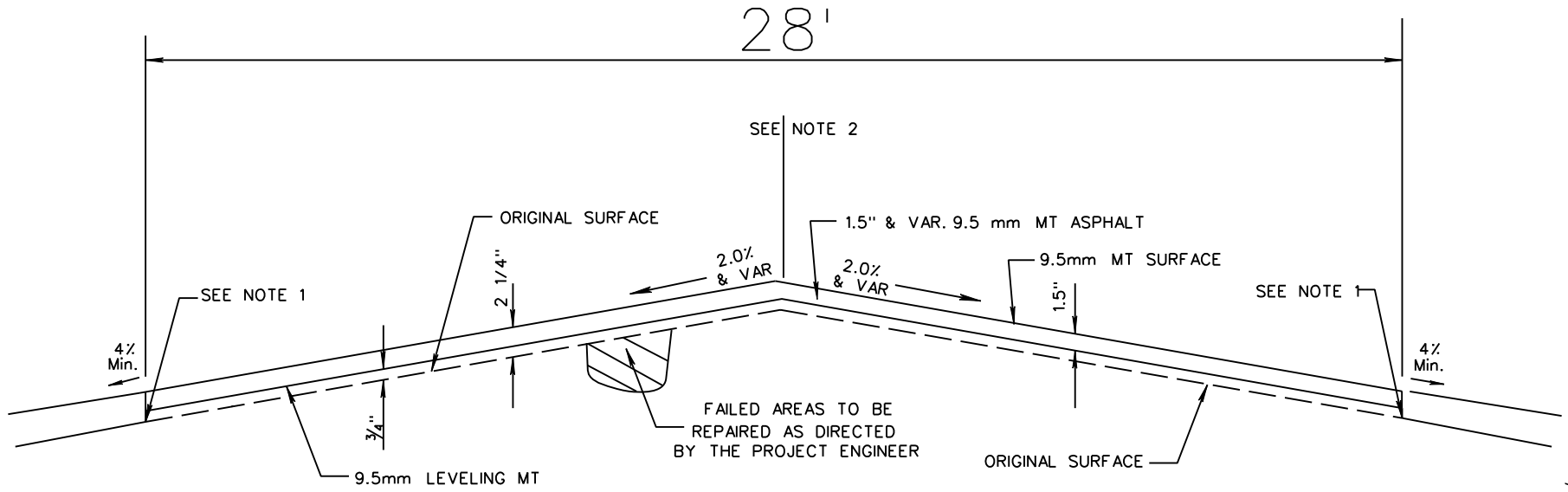

TYPICAL FOR  
STATION 23+00(R2) TO 348+00(R2)

NOTES:

- (1) THE EXISTING PAVEMENT EDGE SHALL BE CUT TO A SMOOTH AND NEAR VERTICAL FACE WITH AN APPROVED CUTTING DEVICE. ( NOT TO BE MEASURED FOR SEPARATE PAY.)
- (2) TRUE CENTERLINE PAVEMENT ALIGNMENT SHALL BE DETERMINED BY THE CONTRACTOR BY MEASURING THE EXISTING ROADWAY AT 500ft. INTERVALS IN TANGENT SECTIONS, AND 100ft. INTERVALS IN HORIZONTAL CURVES.

# TYPICAL MILLING DIAGRAM

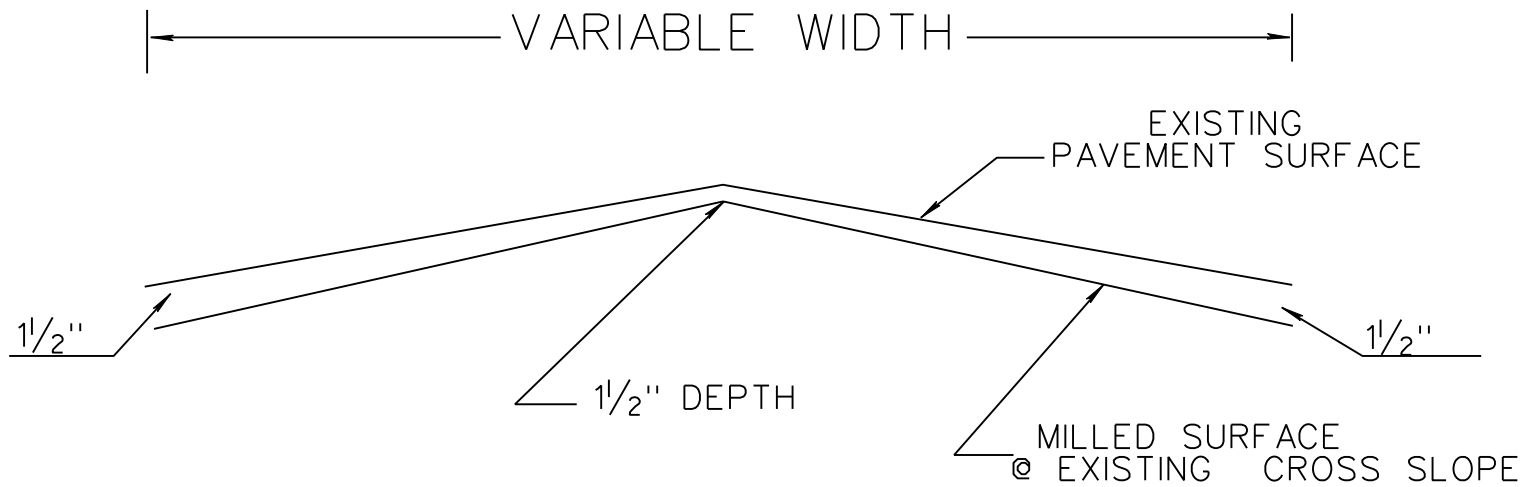

# TYPICAL MILLED TRANSITION AT BRIDGE ABUT. OR PAVEMENT IN PLACE

54

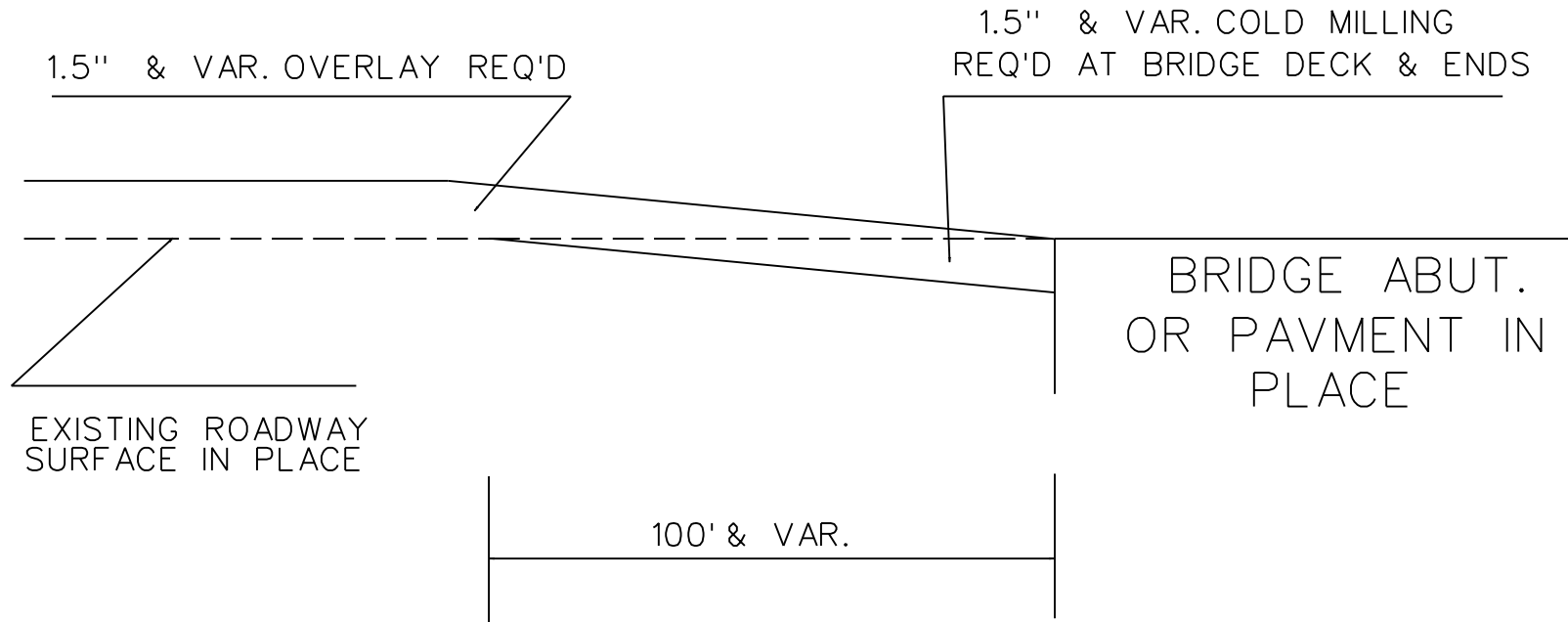



# TYPICAL FOR PAVED TAPER AT LOCAL ROADS

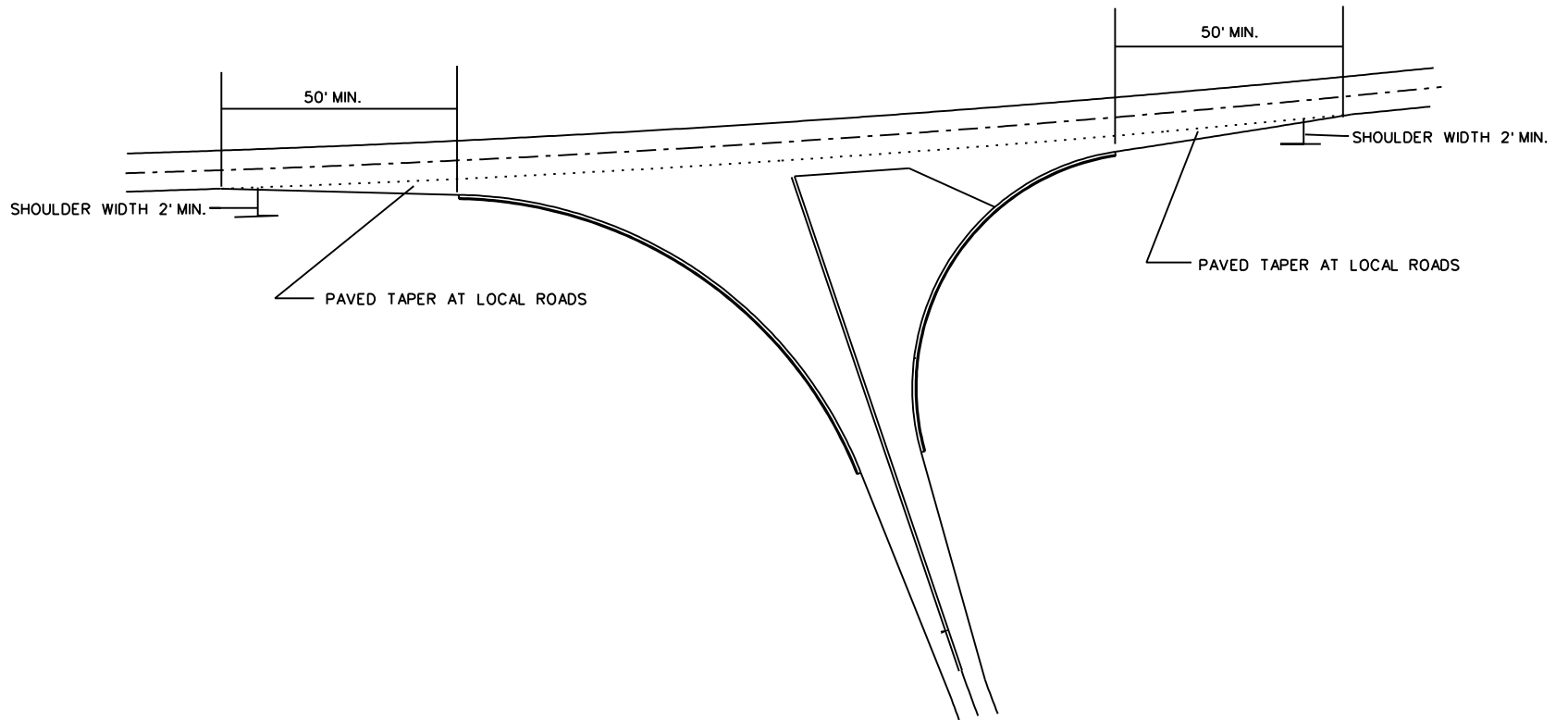

55

# PRIVATE DRIVEWAY DETAIL

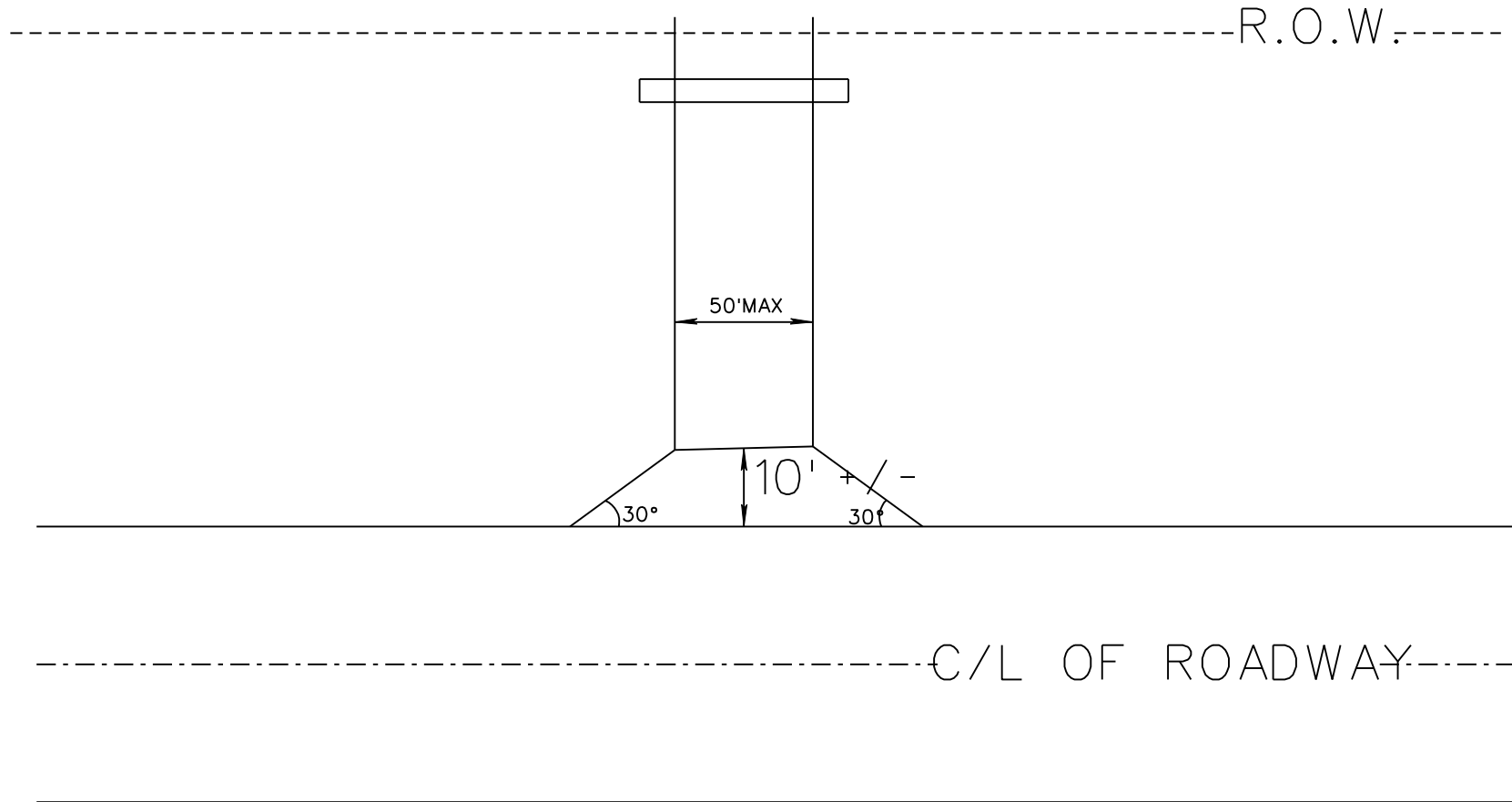

56

# TYPICAL DETAIL OF MONOLITHIC CURB & GUTTER AT ISLAND

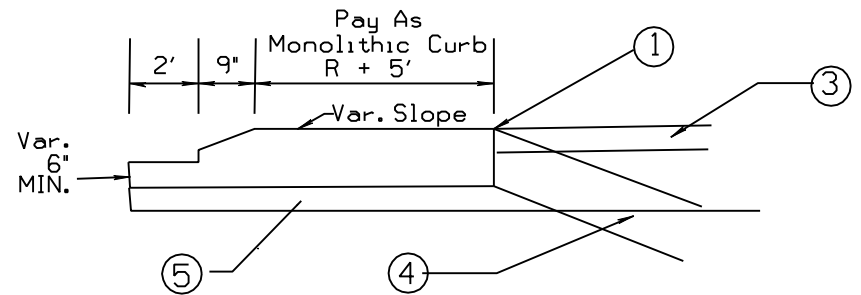
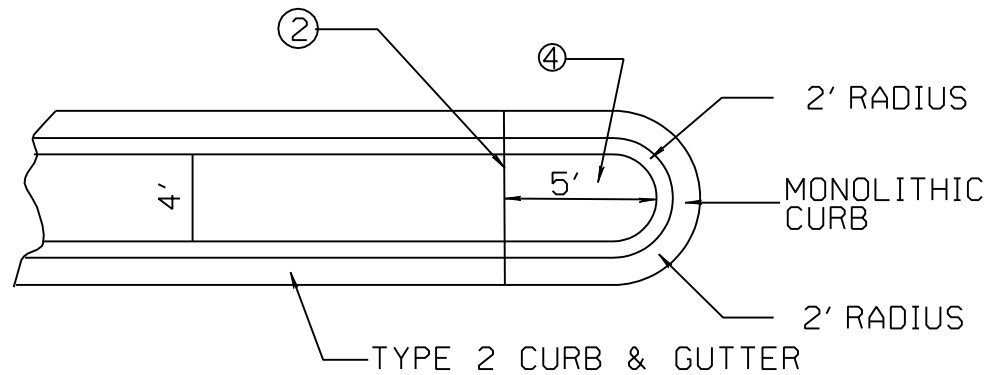

- ① - 1/2" PREMOULDED EXPANSION JOINT ( NOT A PAY ITEM )
- ② - 1/2" TOOLED CONTRACTION JOINT ( NOT A PAY ITEM )
- ③ - 4" CLASS "C" STRUCTURAL CONCRETE ( FOR MEDIAN & ISLAND PAV'T. ) PAY ITEM NO. 616-A
- ④ - 10" & VAR. DEPTH CLASS "C" STRUCTURAL CONCRETE (FOR MEDIAN & ISLAND PAV'T.)
- ⑤ - 2" MIN. ASPHALT BASE SHALL BE REQUIRED BEFORE PLACING ISLANDS

SR 18

11+50 R2

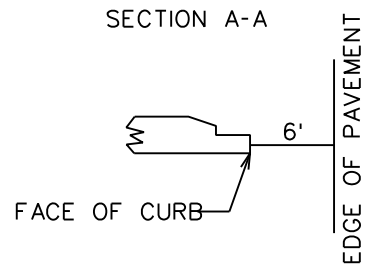
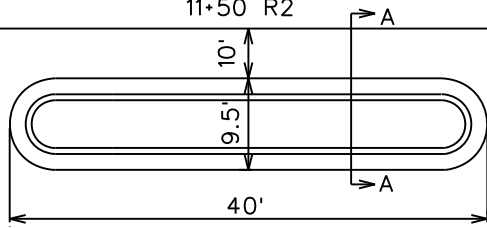

SR 18

108+54 R1

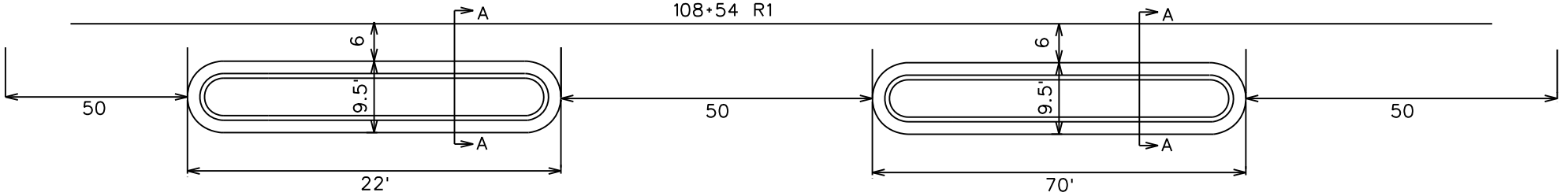

59

FIRST BAPTIST  
CHRUCH

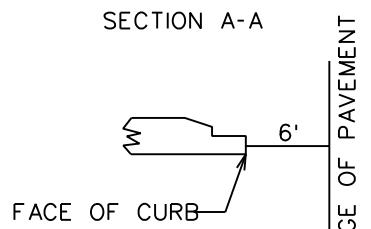

- 14 -

Notice To Bidder No. 4501-- Cont'd.

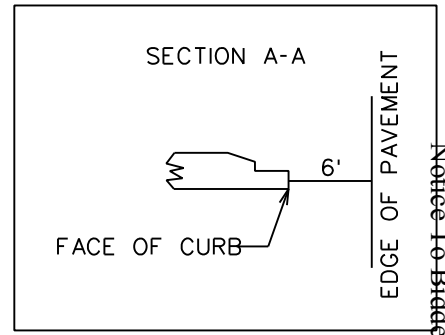
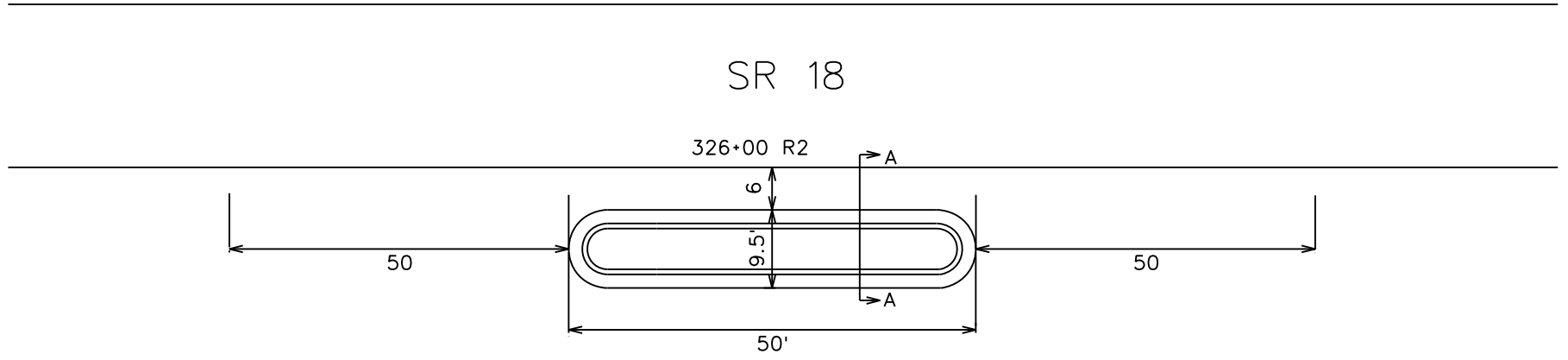

SR 18

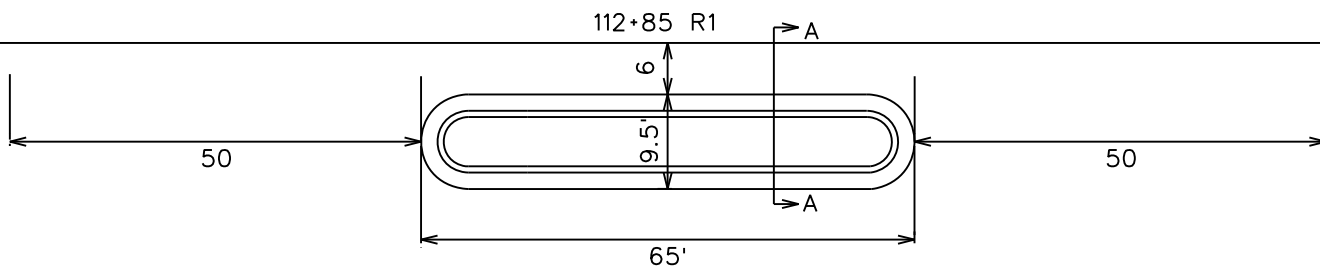

METHODIST  
CHRUCH

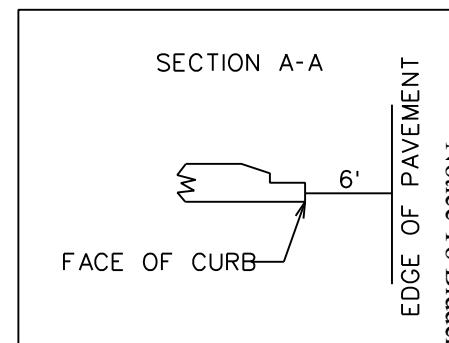

61

SR 18

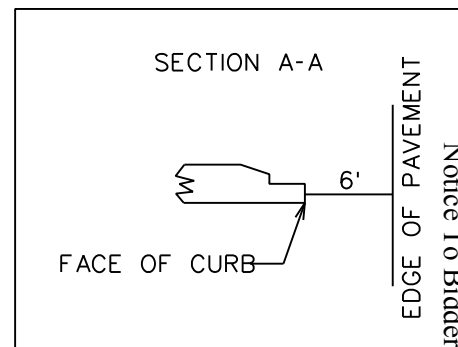
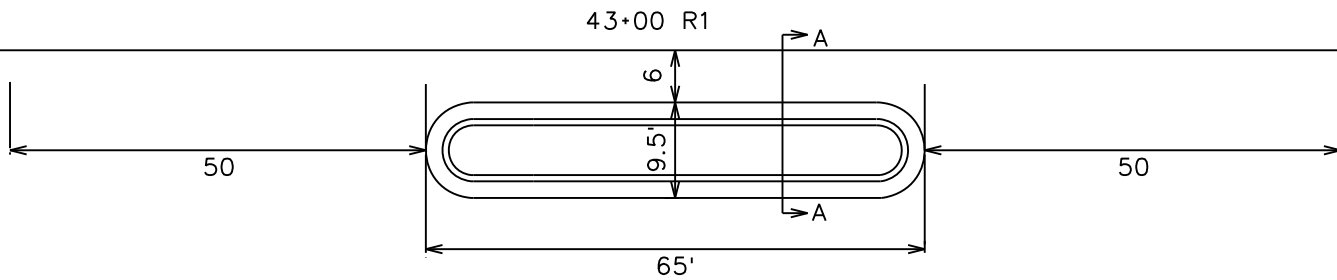

62



SR 18

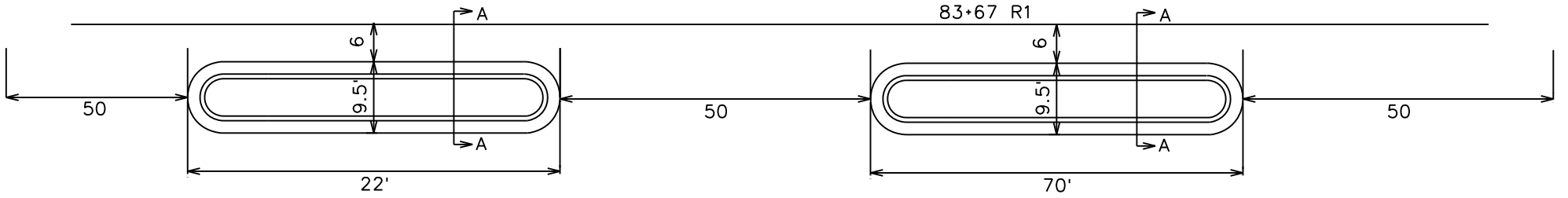

63

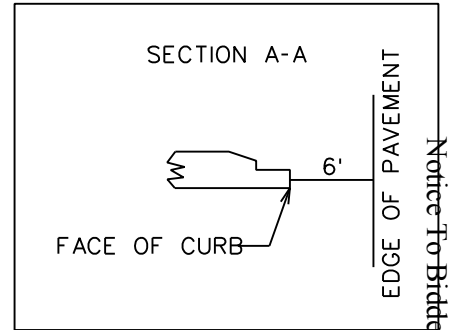

- 18 -

Notice To Bidder No. 4501 -- Cont'd.

STATE	PROJECT NO.
MISS.	

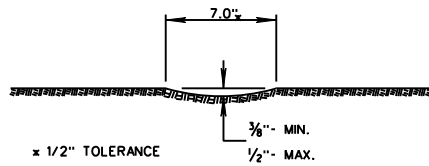

SECTION "A-A"

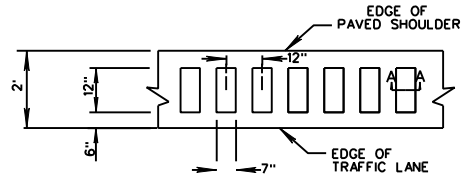

DETAIL "A"

- GENERAL NOTES
1. GROUND-IN RUMBLE STRIPS SHALL BE OMITTED ACROSS PRINCIPAL INTERSECTING ROADWAYS OR OTHER INTERRUPTIONS IN NORMAL SHOULDER WIDTH AS DIRECTED BY THE ENGINEER
  2. GROUND-IN RUMBLE STRIPS SHALL BE APPLIED TO MAINLINE ONLY.

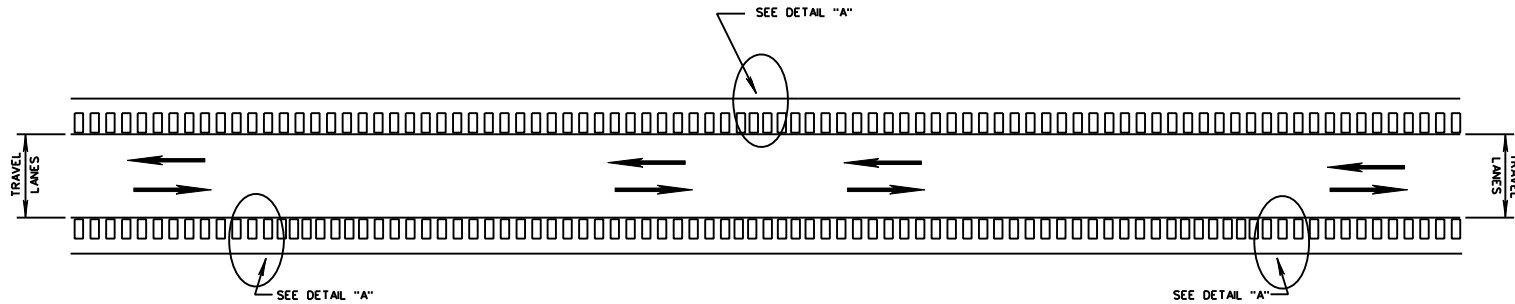

PLAN  
NOT TO SCALE  
DETAIL OF  
RUMBLE STRIPS  
(GROUND-IN)

MISSISSIPPI DEPARTMENT OF TRANSPORTATION	
TYPICAL SECTION	
RUMBLE STRIPS (GROUND-IN)	
DATE	DESIGN TEAM
FILENAME:	CHECKED DATE
WORKING NUMBER	SHEET NUMBER
RS-1	

WOODY: 08/15/2011 10:00 AM

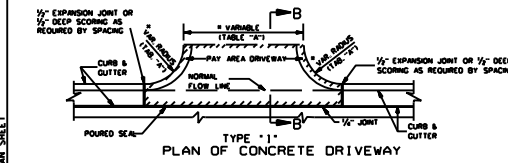
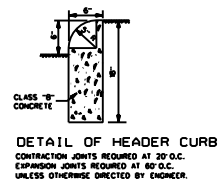
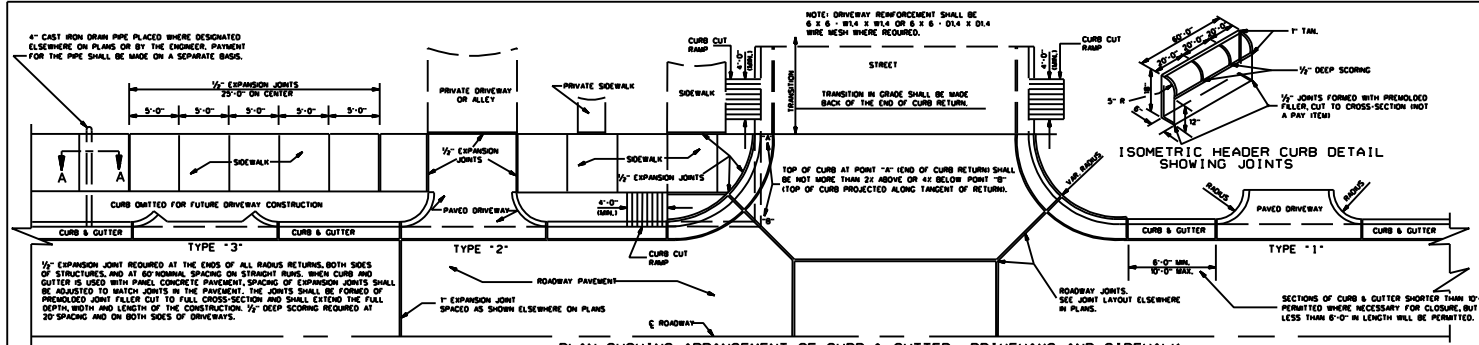

11.08 sq ft FOR DRIVEWAY 18'-0" IN WIDTH.  
0.374 sq ft FOR EACH ADDED OR SUBTRACTED FOOT OF WIDTH.  
NOTE: THIS DRIVEWAY AREA EXAMPLE IS COMPUTED ON THE BASIS OF 3'-0" RADIUS. PAYMENT FOR CURB RADIUS SHALL BE INCLUDED IN COMPENSATION FOR DRIVEWAY.

TABLE "A"		
DRIVEWAY TYPE	DRIVEWAY WIDTH (ft)	CURB RETURN RADIUS (ft)
RESIDENTIAL	18'	3' - 10"
COMMERCIAL/INDUSTRIAL	30' - 50'	5' - 30"

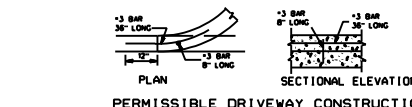
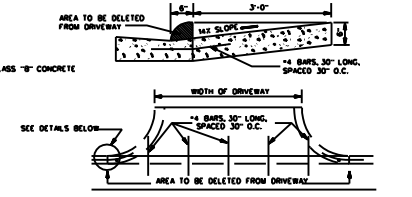
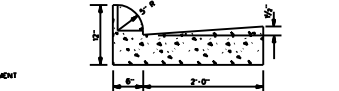
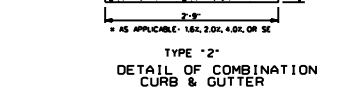
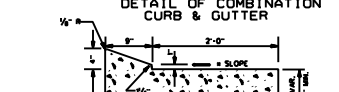
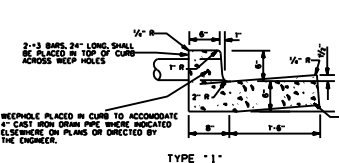
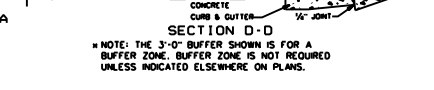
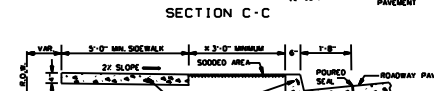
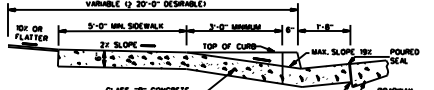
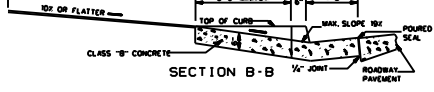
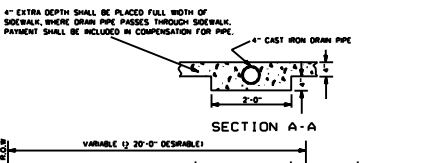

MISSISSIPPI DEPARTMENT OF TRANSPORTATION  
ROADWAY DESIGN DIVISION  
STANDARD PLAN

DRIVEWAYS, CURB & GUTTER & SIDEWALK

WORKING NUMBER SD-1  
SHEET NUMBER 287

ISSUE DATE: OCTOBER 1, 1998

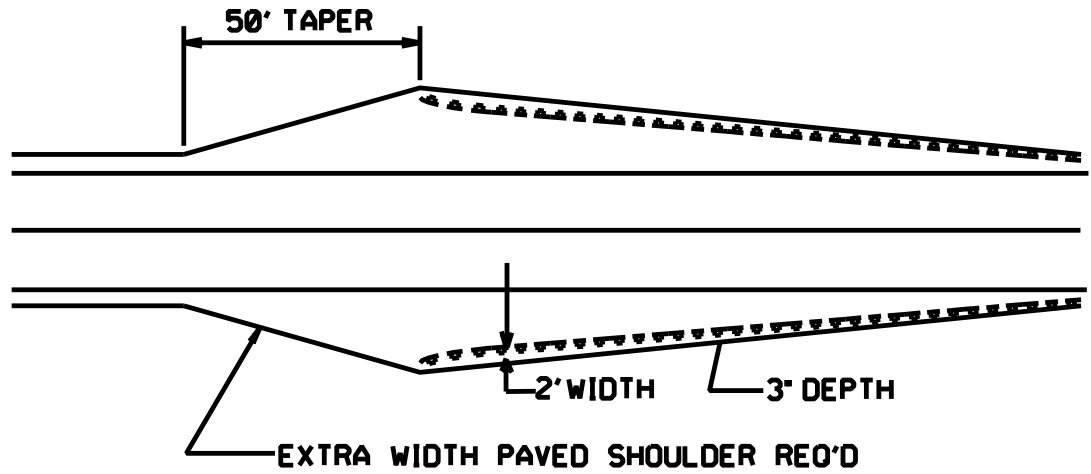

**DETAIL OF INSTALLATION OF EXTRA WIDTH PAVED SHOULDERS AT BRIDGES**

66

1. 3" AND VAR. DEPTH 9.5MM HOT BITUMINOUS PAVEMENT REQ'D

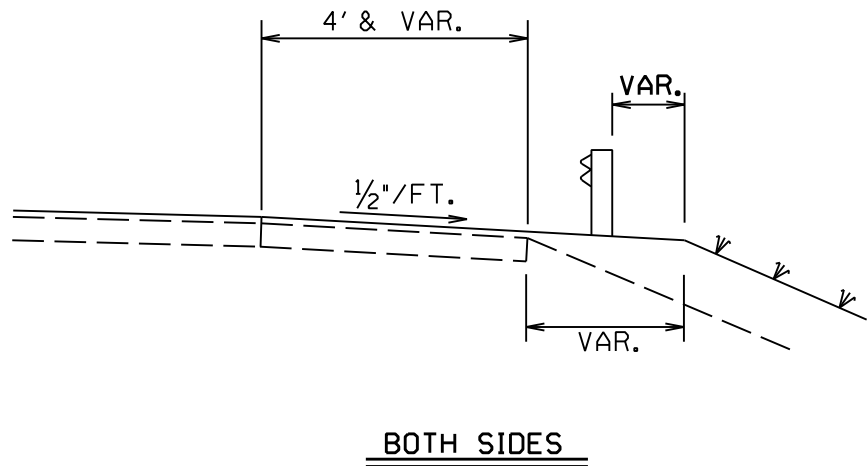

**TYPICAL SECTION  
DETAILS OF PAVED SHOULDERS AT  
BRIDGE GUARD RAIL INSTALLATIONS**

- 21 -  
Notice To Bidder No.4501-- Cont'd.

STATE	PROJECT NO.
MISS.	

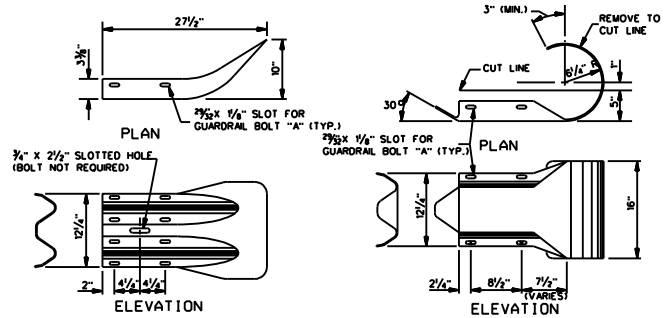

**TYPE "1" "W" BEAM END SECTION**  
 NOTE: THE TYPE "1" END SECTION IS THE STANDARD FLARED "W" BEAM END SECTION AND IS USED WITH THE TYPE "A" AND TYPE "E" BRIDGE END SECTIONS. THE CROSS-SECTIONAL DIMENSIONS OF THIS PART ARE IDENTICAL TO THOSE OF THE STANDARD "W" BEAM GUARDRAIL.

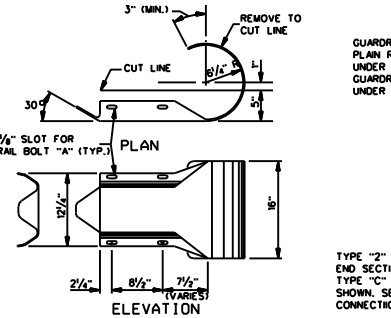

**TYPE "2" "W" BEAM END SECTION**  
 NOTE: THE TYPE "2" END SECTION IS A MODIFICATION OF THE STANDARD ROUNDED "W" BEAM END SECTION AND IS USED EXCLUSIVELY WITH THE TYPE "C" BRIDGE END SECTION. THE CROSS-SECTIONAL DIMENSIONS OF THIS PART ARE IDENTICAL TO THOSE OF THE STANDARD "W" BEAM GUARDRAIL.

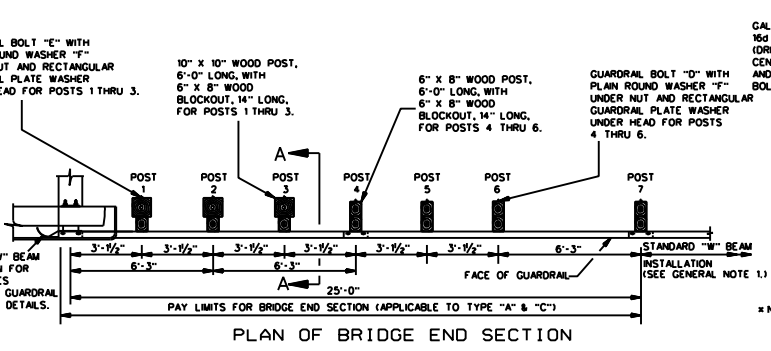

**PLAN OF BRIDGE END SECTION**  
 \* NOTE: UNLESS OTHERWISE SPECIFIED ON THE PLANS.

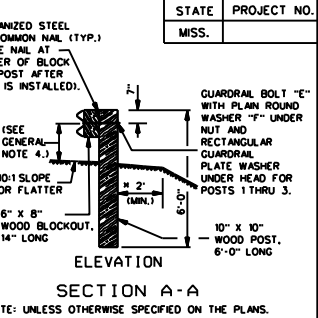

**SECTION A-A**  
 \* NOTE: UNLESS OTHERWISE SPECIFIED ON THE PLANS.

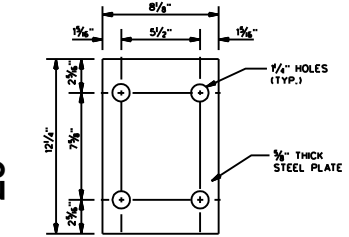

**DETAIL OF PLATE "B"**

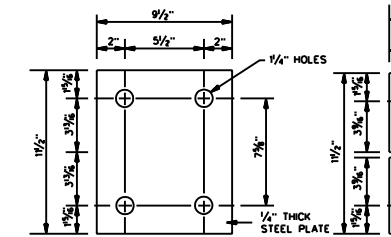

**STANDARD ALTERNATIVE**

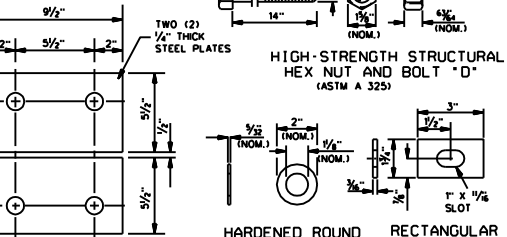

**FASTENER DETAILS**

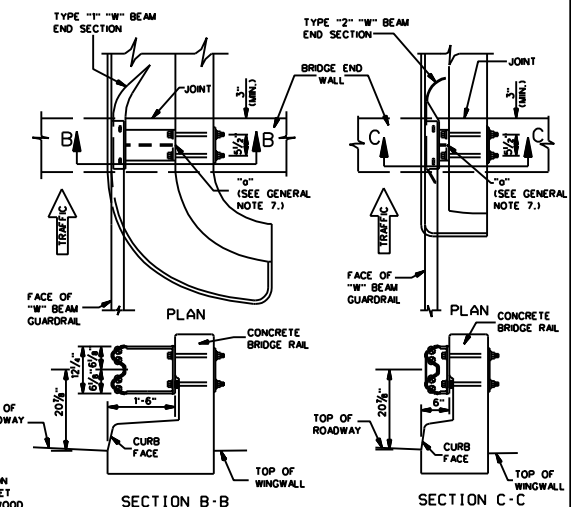

**SECTION B-B SECTION C-C**

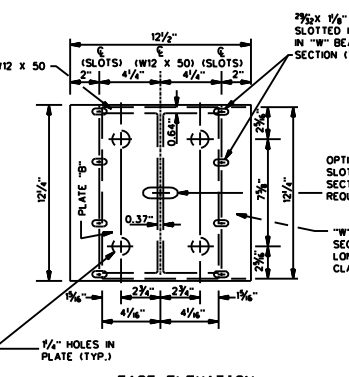

**FACE ELEVATION**

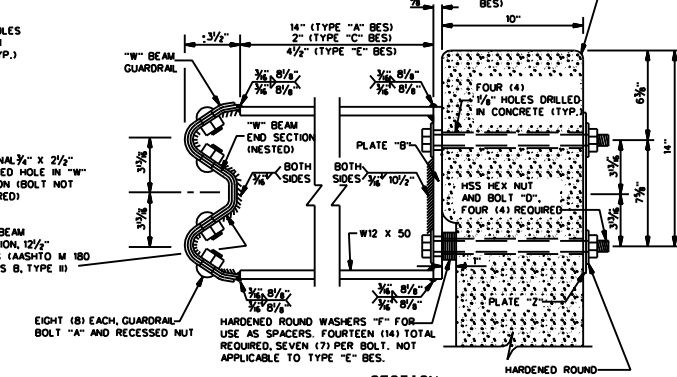

**SECTION**

- GENERAL NOTES:**
- ALL NOTES AND DETAILS PERTAINING TO NORMAL "W" BEAM GUARDRAIL INSTALLATION NOT SPECIFICALLY MODIFIED ON THIS SHEET WILL BE FOUND ON EITHER SHEET GR-1 (WOOD POSTS) OR GR-1B (STEEL POSTS).
  - WOOD POSTS ARE SHOWN ON THIS SHEET. WHEN STEEL POSTS ARE INSTALLED, A SOLID BEARING PLATE IS PLACED ON THE STANDARD SIZE STEEL POST FOR POSTS 1 THRU 3 AND A RECTANGULAR GUARDRAIL PLATE WASHER IS PLACED UNDER THE STANDARD POST BOLT HEAD FOR POSTS 1 THRU 6. SEE DETAILS FOR STEEL POST INSTALLATIONS ON SHEET GR-1B.
  - FOR INFORMATION PERTAINING TO THE INSTALLATION OF THE TYPE "E" BRIDGE END SECTION, SEE SHEET GR-2A.
  - THE HEIGHT OF RAIL AT THE BRIDGE END IS 20" AND WILL BE TRANSITIONED TO 22" AT POST 7. THIS TRANSITION WILL BE A LINEAR TRANSITION IN THE VERTICAL PLANE.
  - ALL GUARDRAIL ELEMENTS SHALL BE LAPPED IN THE DIRECTION OF TRAFFIC.
  - THE APPLICATION OF THIS STANDARD IS FOR ONE-WAY TRAFFIC DIRECTION ONLY.
  - POINT "a", WHICH IS AT THE CENTERLINE BETWEEN THE ANCHOR BOLTS, WILL BE CENTERED OVER THE CENTERLINE OF THE BRIDGE END WALL EXCEPT IN SKEWED BRIDGE ENDS WHERE THE BOLT NEAREST THE JOINT WILL BE A MINIMUM OF 3" FROM THE JOINT.

MISSISSIPPI DEPARTMENT OF TRANSPORTATION  
 ROADWAY DESIGN DIVISION  
 STANDARD PLAN

**GUARDRAIL: BRIDGE END SECTION TYPE "A" & "C"**

WORKING NUMBER GR-2  
 SHEET NUMBER 184

ISSUE DATE: OCTOBER 1, 1998

PAVEMENT MARKING			
SYMBOL	DESCRIPTION	TYPE	QUANTITY
(1)	LEFT TURN ARROW AND ONLY (TAPE & )	PAINT	
(2)	RED-CLEAR REFLECTIVE RAISED MARKERS	EACH	
(3)	TWO-WAY YELLOW REFLC. RAISED MARKER	EACH	
(4)	6" TRAFFIC SKIP WHITE (10'-30')	PLASTIC	
(5)	6" CONTINUOUS EDGE WHITE (SOLID)	PLASTIC	
(6)	6" CONTINUOUS TRAFFIC YELLOW	PLASTIC	
(7)	6" CONTINUOUS EDGE YELLOW (SOLID)	PLASTIC	
(8)	6" CONTINUOUS TRAFFIC WHITE	PLASTIC	
(9)	6" DETAIL STRIPE WHITE (SOLID)	PLASTIC	
(10)	6" DETAIL STRIPE YELLOW (SOLID)	PLASTIC	
(11)	6" DETAIL SKIP WHITE (2'-12')	PLASTIC	
(12)	12" DETAIL STRIPE WHITE (SOLID)	PLASTIC	
(13)	18" THERMO LEGEND (WHITE/STOP BAR)		

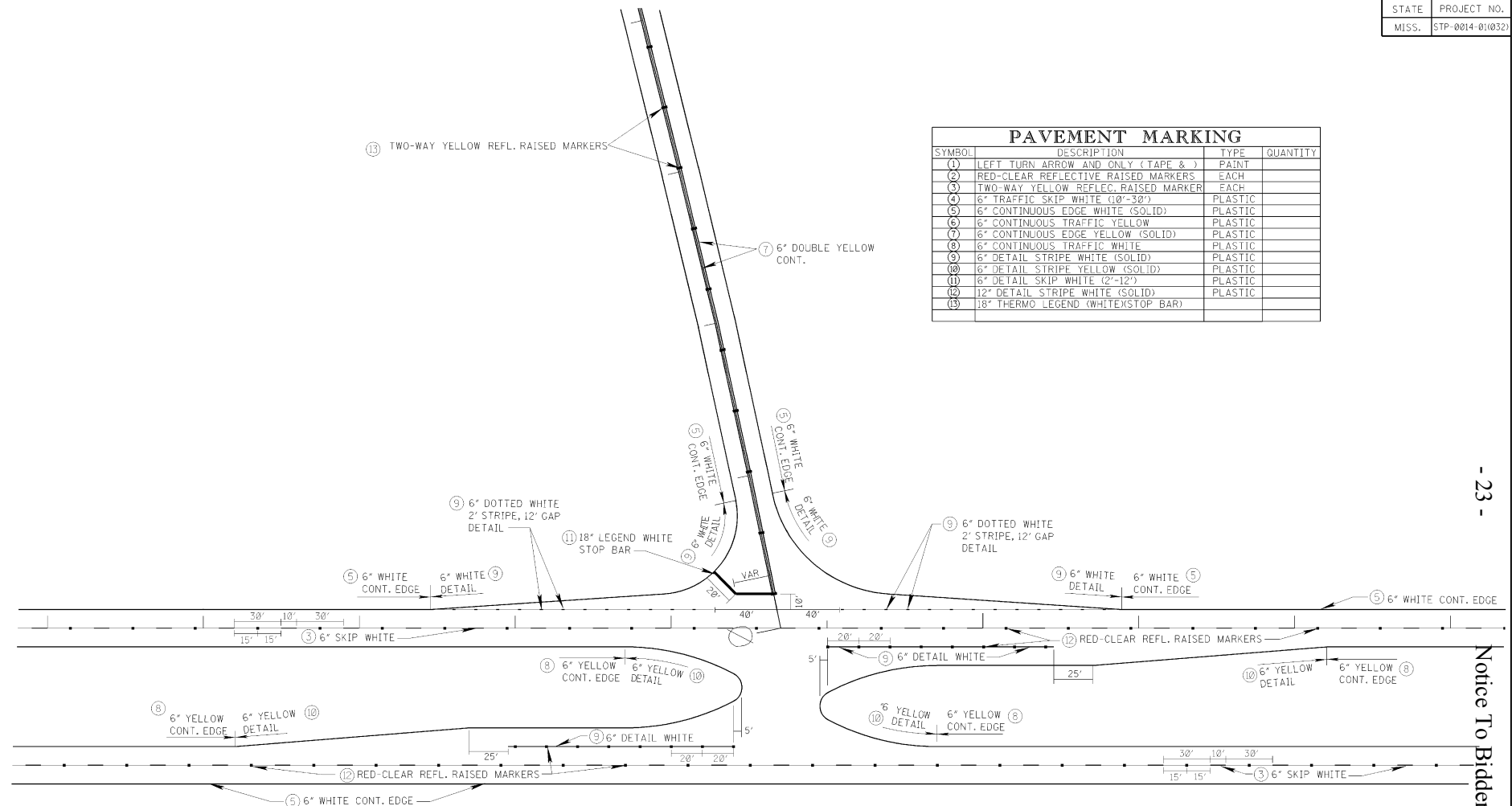

68

- 23 -

Notice To Bidder No. 4501 -- Cont'd.

MISSISSIPPI DEPARTMENT OF TRANSPORTATION	
<b>DETAIL OF STRIPING</b>	
PROJECT NO: STP-0014-01(032)	
COUNTY: PIKE	
FILENAME:	WORKING NUMBER
DESIGN TEAM	PN 1
CHECKED	SHEET NUMBER
DATE	

1/20/2013 2:53:43 PM C:\1.dwg

# TYPICAL STRIPING FOR SIMPLE INTERSECTION AT LOCAL ROADS

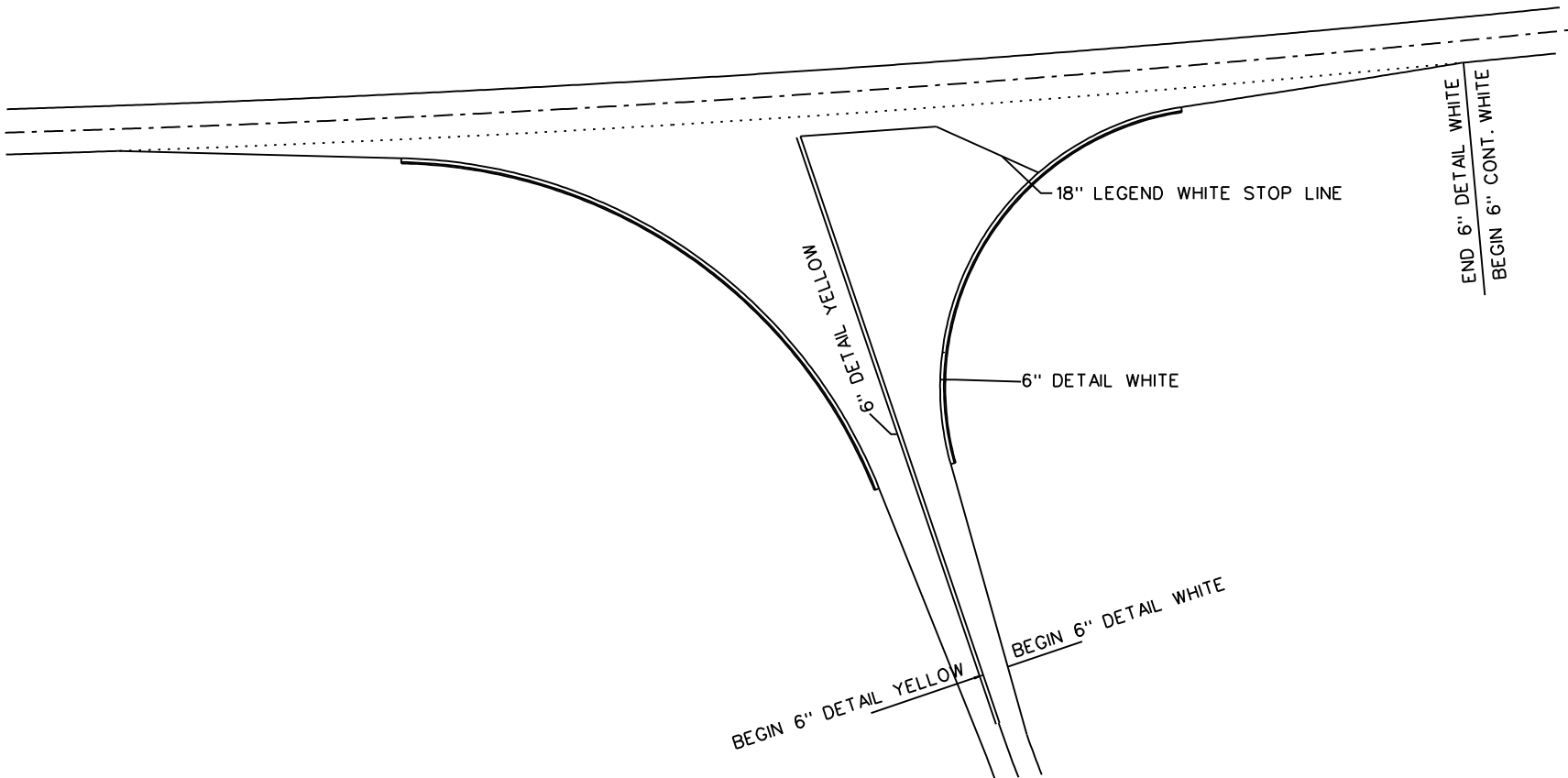

69

TYPICAL FOR RAISED PAVEMENT MARKERS  
PLACED ON SIDE ROAD RADIUS

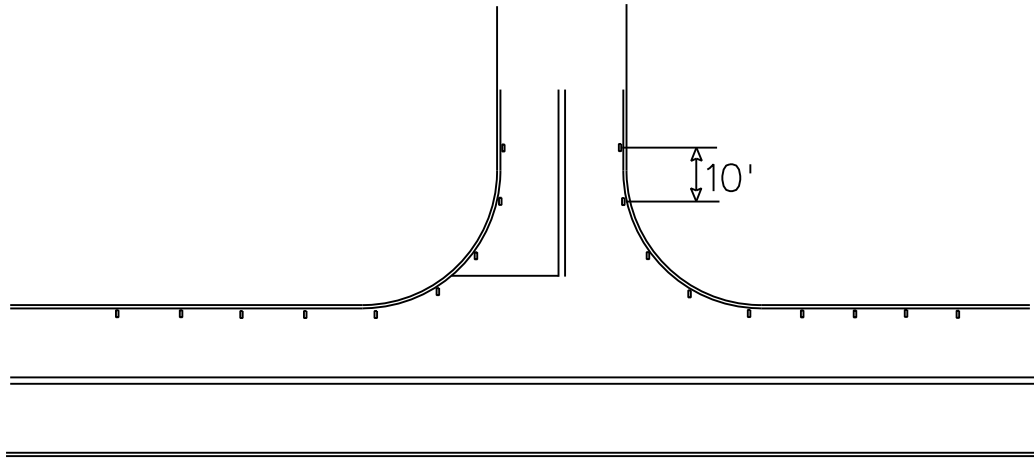

- NOTE 1. MARKERS SHALL BE PLACED EVERY 10 FEET.  
 NOTE 2. MARKERS SHALL BE VISIBLE FROM THE TRAVELING MOTORIST  
ON STATE DESIGNATED HIGHWAYS.  
 NOTE 3. MARKERS SHALL BE HIGH PERFORMANCE TWO WAY CLEAR.

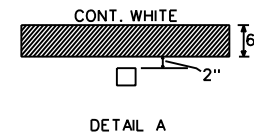

MISSISSIPPI DEPARTMENT OF TRANSPORTATION	
2-LANE	
RAISED PAVEMENT MARKERS PLACED ON SIDE ROADS	
BY	REVISION
DATE	FILE NAME:
DESIGN TEAM	CHECKED DATE
WORKING NUMBER	SHEET NUMBER

70

25

Notice To Bidder No. 4501 Cont'd.



**JOINT REPAIR NOTES:**

1. THE INTENT OF THE CONTRACT IS TO REMOVE ALL JOINT ARMOR EXISTING AT THE TIME THE CONTRACT IS LET THAT IS DAMAGED, LOOSE, AND/OR HAS BEEN PREVIOUSLY REMOVED IN PART. ANY JOINT ARMOR THAT EXTENDS THE FULL WIDTH OF THE BRIDGE AND IS INTACT AND IN GOOD CONDITION WILL REMAIN.  
REPAIR JOINTS WITH EPOXY MORTAR AND SEAL JOINTS WITH A SILICONE JOINT SEALANT. IT IS POSSIBLE THAT BETWEEN PLAN PREPARATION AND LETTING TIME, JOINT ARMOR SHOWN TO BE REMOVED MAY HAVE BEEN REMOVED EARLIER BY DEPARTMENT PERSONNEL. ALSO, THE NUMBER OF JOINTS REQUIRING SAWCUTTING MAY CHANGE DUE TO TEMPERATURE CHANGES. QUANTITIES SHALL BE ADJUSTED ACCORDINGLY.
2. PAYMENT FOR JOINT PREPARATION, JOINT REPAIR AND REMOVAL OF JOINT ARMOR SHALL BE PAID FOR AS THE LENGTH ALONG THE BRIDGE DECK ON EACH SIDE OF THE CENTERLINE OF JOINT.
3. SAWCUTTING THE JOINT IS REQUIRED AT EXISTING JOINTS THAT HAVE LESS THAN 1 INCH OF OPENING.
4. SILICONE SEALED JOINTS ARE REQUIRED AT ALL JOINTS.
5. PAYMENT FOR SILICONE SEALED JOINTS AND SAWCUTTING THE JOINTS SHALL BE PAID FOR AS THE LENGTH ALONG THE CENTERLINE OF JOINT ONLY AND NOT EACH SIDE OF THE JOINT.
6. REMOVAL OF EXISTING JOINT SEALANTS WILL NOT BE PAID FOR DIRECTLY AND THEREFOR SHALL BE CONSIDERED AS AN ABSORBED ITEM OF WORK.

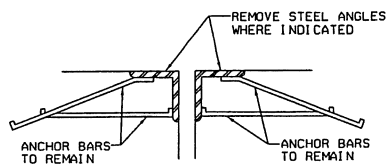

**TYPICAL SECTION AT JOINT REPAIR**  
SHOWING EXISTING JOINT ARMOR TO BE REMOVED

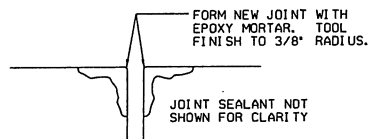

**TYPICAL SECTION AT JOINT REPAIR**  
SHOWING JOINT AFTER EPOXY MORTAR REPAIR

**JOINT REPAIR MORTAR NOTES:**

1. JOINT REPAIR MORTAR SHALL BE ONE OF THE FOLLOWING PRODUCTS:
  - A. 'HP-BINDER' SHALL BE AS MANUFACTURED BY HUNT PROCESS CORPORATION, P. O. BOX 688, RIDGELAND, MS 39158, TELEPHONE NO. (601) 856-8811, AND INSTALLED ACCORDING TO THE MANUFACTURER'S RECOMMENDATIONS.
  - B. 'POLYMER CONCRETE' SHALL BE AS MANUFACTURED BY POLYMER CONCRETE, INC. P. O. BOX 610, CAMDEN, AL 36726, (205) 682-4296, AND INSTALLED ACCORDING TO THE MANUFACTURER'S RECOMMENDATIONS.
  - C. 'CERATECH PAVEMENT VR' SHALL BE AS MANUFACTURED BY CERATECH, INC., 3037 TUGGLE IVES DR., BUFORD, GA 30519, TELEPHONE NO. (770) 831-0794, AND INSTALLED ACCORDING TO THE MANUFACTURER'S RECOMMENDATIONS.

**GENERAL NOTES:**

1. SPECIFICATIONS: MISSISSIPPI STANDARD SPECIFICATIONS FOR ROAD AND BRIDGE CONSTRUCTION, 2004.
2. NO CHANGE OF PLANS WILL BE PERMITTED EXCEPT BY WRITTEN APPROVAL OF THE BRIDGE ENGINEER. MINOR CHANGES OF DETAIL OF DESIGN OR CONSTRUCTION PROCEDURE MAY BE AUTHORIZED BY THE BRIDGE ENGINEER PROVIDED SUCH CHANGES WILL NOT BE CAUSE FOR CONTRACT PRICE ADJUSTMENT.
3. WORK FOR WHICH NO PAY ITEM IS PROVIDED IN THE PROPOSAL WILL NOT BE PAID FOR DIRECTLY AND COMPENSATION THEREFOR WILL BE INCLUDED IN THE PRICES AND PAYMENTS FOR BID ITEMS.

**NOTE:**  
SEALANT SHALL BE ON THE MOUT LIST OF APPROVED SILICONE JOINT SEALING COMPOUNDS FOR BRIDGE JOINTS APPLIED ACCORDING TO THE MANUFACTURER'S DIRECTIONS.

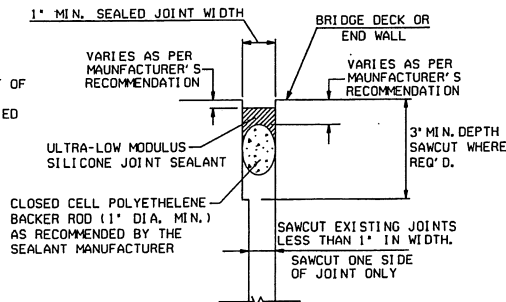

**TYPICAL SECTION AT SAWCUT & SEALED JOINT**  
SHOWING SILICONE SEALED JOINT AFTER SAWCUT AND REPAIR WITH EPOXY MORTAR

MISSISSIPPI DEPARTMENT OF TRANSPORTATION	
<b>DETAILS OF BRIDGE DECK JOINT REPAIR</b>	
DESIGNER	WORKING NUMBER
BRIDGE ENGINEER	BR-1
DATE	SHEET NUMBER
DESIGN TEAM	FILED
CHECKED	DATE

**MISSISSIPPI DEPARTMENT OF TRANSPORTATION**

**SECTION 904 - NOTICE TO BIDDERS NO. 4524**

**CODE: (SP)**

**DATE: 05/13/2013**

**SUBJECT: Warm Mix Asphalt**

Bidders are advised that MDOT approved products and processes for the production of Warm Mix Asphalt are available at the following MDOT website.

<http://sp.mdot.ms.gov/Materials/Pages/MPL.aspx>

## MISSISSIPPI DEPARTMENT OF TRANSPORTATION

SPECIAL PROVISION NO. 907-101-4

CODE: (IS)

DATE: 11/05/2008

SUBJECT: Definitions

Section 101, Definitions and Terms, of the 2004 Edition of the Mississippi Standard Specifications for Road and Bridge Construction is hereby amended as follows:

**907-101.02--Definitions.** Replace the following definitions in Subsection 101.02 on pages 3 through 13.

**Contract** - The written agreement between the Mississippi Transportation Commission and the Contractor setting forth the obligations of the parties thereunder, including but not limited to, the performance of the work, the furnishing of labor and materials, and the basis of payment.

The contract includes the invitation for bids, proposal, contract form and contract bonds, specifications, supplemental specifications, interim specifications, general and detailed plans, special provisions, notices to bidders, notice to proceed, and also any agreements that are required to complete the construction of the work in an acceptable manner, including authorized extensions thereof, all of which constitute one instrument.

**Contract Bonds** - The approved form of security, executed by the Contractor and the Contractor's Surety(ies), guaranteeing complete execution of the contract and all supplemental agreements pertaining thereto and the payment of all legal debts pertaining to the construction of the project. This term includes Performance and Payment Bond(s).

**Surety** - A corporate body, qualified under the laws of Mississippi, which is bound with and for the successful bidder by "contract bond(s)" to guarantee acceptable performance of the contract and payment of all legal taxes and debts pertaining to the construction of the project, including payment of State Sales Tax as prescribed by law, and any overpayment made to the Contractor.

Add the following to the list of definitions in Subsection 101.02 on pages 3 through 13.

**Performance Bond** - The approved form of security, executed by the Contractor and issued by the Contractor's Surety(ies), guaranteeing satisfactory completion of the contract and all supplemental agreements pertaining thereto.

**Payment Bond** - The approved form of security, executed by the Contractor and issued by the Contractor's Surety(ies), guaranteeing the payment of all legal debts pertaining to the construction of the project including, but not limited to, the labor and materials of subcontractors and suppliers to the prime contractor.

# MISSISSIPPI DEPARTMENT OF TRANSPORTATION

## SUPPLEMENT TO SPECIAL PROVISION NO. 907-102-8

**DATE:** 04/24/2013

**SUBJECT:** Bidding Requirements and Conditions

Delete Subsection 907-102.06 on page 1, and substitute the following.

**907-102.06--Preparation of Proposal.** Delete the first paragraph of Subsection 102.06 on page 17, and substitute the following.

The bidder's complete original proposal shall be submitted upon the forms (Certification of Performance, Certification Regarding Non-Collusion, etc.) furnished by the Department and shall include Expedite Bid printed bid sheets along with the bid data on the MDOT-supplied USB Flash Drive. Expedite Bid System (EBS) files shall be downloaded from the Department's website <http://mdot.ms.gov>. In case of discrepancy between a unit price and the extension, the unit price will govern and the extension along with the total amount of the proposal will be corrected.

Delete the fifth, sixth, and seventh paragraphs of Subsection 102.06 on page 18, and substitute the following.

Bid sheets generated by the Department's Electronic Bid System (Transport Expedite Bid) along with a completed proposal package (with all forms completed and signed) will constitute the official bid and shall be signed on the last sheet of the Expedite Bid generated bid sheets and delivered to the Department in accordance with the provisions of Subsection 102.09. Bids submitted using any other form, format or means will result in an irregular bid. The bidder's bid data shall be saved on the MDOT-supplied USB Flash Drive and submitted with the bid. Failure to return the USB Flash Drive with bid data will result in an irregular bid. [If a Bidder is submitting bids on multiple proposals, the bid data for all proposals can be included on one flash drive and submitted with any of the bid envelopes.](#)

Bidders are cautioned that using other versions of the Expedite Bid may result in improperly printed bid sheets. The correct version of Expedite Bid can be obtained at no cost from the MDOT Contract Administration Division or at the MDOT website, <http://mdot.ms.gov>. The current version of Expedite Bid is also included on the MDOT-supplied USB Flash Drive.

The Expedite Bid generated bid sheets should be stapled together in order beginning with page 1, signed and included in the bid proposal package in the sealed envelope. Only the Expedite Bid generated sheets will be recognized as the official bid. The MDOT-provided USB Flash Drive containing the information printed on the Expedite Bid generated bid sheets should be placed in the padded envelope included with the bid proposal package and enclosed in the sealed envelope. Bid sheets printed from Expedite Bid should be a representation of the data returned on the flash

drive. To have a true representation of the bid sheets, the Bidder must copy the EBS and EBS amendment files used to prepare the bid sheets to the flash drive. Otherwise, the unit prices bid will not be recorded to the flash drive. Bidders are cautioned that failure to follow proper flash drive handling procedures could result in the Department being unable to process the flash drive. Any modification or manipulation of the data contained on the flash drive, other than entering unit bid prices and completing all required Expedite Bid sections, will not be allowed and will cause the Contractor's bid to be considered irregular.

## MISSISSIPPI DEPARTMENT OF TRANSPORTATION

| SPECIAL PROVISION NO. 907-102-8

CODE: (IS)

| DATE: 01/20/2011

**SUBJECT: Bidding Requirements and Conditions**

**907-102.06--Preparation of Proposal.** Delete the fifth, sixth, and seventh paragraphs of Subsection 102.06 on page 18 and substitute the following:

Bid sheets generated by the Department's Electronic Bid System (Transport Expedite Bid) along with a completed proposal package will constitute the official bid and shall be signed on the last sheet of the Expedite Bid generated bid sheets and delivered to the Department in accordance with the provisions of Subsection 102.09.

Bidders are cautioned that using other versions of the Expedite Bid may result in improperly printed bid sheets. The correct version of Expedite Bid can be obtained at no cost from the MDOT Contract Administration Division or at the MDOT website, [www.gomdot.com](http://www.gomdot.com).

If bidders submit Expedite Bid generated bid sheets, then the bid sheets included in the proposal should not be completed. The Expedite Bid generated bid sheets should be stapled together, signed and included in the bid proposal package in the sealed envelope. If both the forms in the proposal and the Expedite Bid generated bid sheets are completed and submitted, only the Expedite Bid generated sheets will be recognized and used for the official bid. The USB Flash Drive containing the information printed on the Expedite Bid generated bid sheets should be placed in the padded envelope included with the bid proposal package and enclosed in the sealed envelope. Bid sheets printed from Expedite Bid should be a representation of the data returned on the flash drive. To have a true representation of the bid sheets, the Bidder must copy the EBS and EBS amendment files used to prepare the bid sheets to the flash drive. Otherwise, the unit prices bid will not be recorded to the flash drive. Bidders are cautioned that failure to follow proper flash drive handling procedures could result in the Department being unable to process the flash drive. Any modification or manipulation of the data contained on the flash drive, other than entering unit bid prices and completing all required Expedite Bid sections, will not be allowed and will cause the Contractor's bid to be considered irregular.

**907-102.08--Proposal Guaranty.** Delete the first and second paragraphs in Subsection 102.08 on page 20 and substitute the following:

No proposal will be considered unless accompanied by certified check, cashier's check or bid bond, made payable to the State of Mississippi, in an amount of not less than five percent (5%) of the total amount of the proposal offered. The guaranty shall be evidence of good faith that, if awarded the contract, the bidder will execute the contract and give performance and payment contract bond(s) as stipulated in Subsection 907-103.05.1, 907-103.05.2, and as required by law.

If a bid bond is offered as guaranty, the bond must be on a form approved by the Executive Director, made by a Surety acceptable to the Executive Director and signed or countersigned by a Mississippi Agent or Qualified Nonresident Agent and the Bidder. Such bid bond shall also conform to the requirements and conditions stipulated in Subsection 907-103.05.2 as applicable.

## MISSISSIPPI DEPARTMENT OF TRANSPORTATION

SPECIAL PROVISION NO. 907-103-8

CODE: (SP)

DATE: 12/15/2009

SUBJECT: Award and Execution of Contract

Section 103, Award and Execution of Contract, of the 2004 Edition of the Mississippi Standard Specifications for Road and Bridge Construction is hereby amended as follows:

**907-103.04--Return of Proposal Guaranty.** Delete the second paragraph of Subsection 103.04 on page 23 and substitute the following:

Certified checks or cashier's checks submitted as proposal guaranties, except those of the two lowest bidders, will be returned within 10 days of contract award. The retained proposal guaranty of the unsuccessful of the two lowest bidders will be returned within ten days following the execution of a contract with the successful low bidder. The retained proposal guaranty of the successful bidder will be returned after satisfactory performance and payment bonds have been furnished and the contract has been executed.

In the event all bids are rejected by the Commission, certified checks or cashier's checks submitted as proposal guaranty by all bidders will be returned within 10 days of rejection.

Delete Subsection 103.05 on page 23 and substitute the following:

**907-103.05--Contract Bonds.**

**907-103.05.1--Requirement of Contract Bonds.** Prior to the execution of the contract, the successful bidder shall execute and deliver to the Executive Director a performance and payment bond(s), in a sum equal to the full amount of the contract as a guaranty for complete and full performance of the contract and the protection of the claimants and the Department for materials and equipment and full payment of wages in accordance with Section 65-1-85 Miss. Code Ann. (1972 as amended). In the event of award of a joint bid, each individual, partnership, firm or corporation shall assume jointly the full obligations under the contract and the contract bond(s).

**907-103.05.2--Form of Bonds.** The form of bond(s) shall be that provided by or acceptable to the Department. These bonds shall be executed by a Mississippi agent or qualified nonresident agent and shall be accompanied by a certification as to authorization of the attorney-in-fact to commit the Surety company. A power of attorney exhibiting the Surety's original seal supporting the Mississippi agent or the qualified nonresident agent's signature shall be furnished with each bond. The Surety company shall be currently authorized and licensed in good standing to conduct business in the State of Mississippi with a minimum rating by A.M. Best of (A-) in the latest printing "Best's Key Rating Guide" to write individual bonds up to ten percent of the policy holders' surplus or listed on the current list of "Companies Holding Certificates of Authority as Acceptable Sureties on Federal Bonds and as Acceptable Reinsuring Companies" as



published by the United States Department of the Treasury, Financial Management Service, Circular 570 (latest revision as published and supplemented on the Financial Management Service Web site and in the Federal Register) within the underwriting limits listed for that Surety. All required signatures on the bond(s) and certifications shall be original signatures, in ink, and not mechanical reproductions or facsimiles. The [Mississippi agent](#) or [qualified nonresident agent](#) shall be in good standing and currently licensed by the Insurance Commissioner of the State of Mississippi to represent the Surety company(ies) executing the bonds.

Surety bonds shall continue to be acceptable to the Commission throughout the life of the Contract and shall not be canceled by the Surety without the consent of the Department. In the event the Surety fails or becomes financially insolvent, the Contractor shall file a new Bond in the amount designated by the Executive Director within thirty (30) days of such failure, insolvency, or bankruptcy. Subsequent to award of Contract, the Commission or the Department may [require additional security for any supplemental agreements executed under the contract or replacement security in the event of the surety\(ies\) loss of the ratings required above](#). Suits concerning bonds shall be filed in the State of Mississippi and adjudicated under its laws without reference to conflict of laws principles.

**907-103.08--Failure to Execute Contract.** In the first sentence of Subsection 103.08 on page 24, change “bond” to “performance and payment bonds”.

**MISSISSIPPI DEPARTMENT OF TRANSPORTATION**

**SPECIAL PROVISION NO. 907-104-4**

**CODE: (SP)**

**DATE: 03/01/2011**

**SUBJECT: Disposal of Materials**

Section 104, Scope of Work, of the 2004 Edition of the Mississippi Standard Specifications for Road and Bridge Construction is hereby amended as follows:

**907-104.05--Removal and Disposal of All Materials From the Project.** Delete the second sentence of the first full paragraph of Subsection 104.05 on page 30 and substitute the following:

The Contractor shall also furnish the Engineer a certified letter stating that the area of disposal is not in a wetland or in Waters of the U.S.

**MISSISSIPPI DEPARTMENT OF TRANSPORTATION**

**SUPPLEMENT TO SPECIAL PROVISION NO. 907-105-6**

**DATE:** 12/12/2011

**SUBJECT:** Control of Work

After Subsection 907-105.05 on page 1, add the following.

**907-105.14--Maintenance During Construction.** Before the first sentence Subsection 105.14 on page 39, add the following:

The Contractor will be responsible for the maintenance of existing roadways within the limits of this project starting on the date of the Notice To Proceed / Beginning of Contract Time. Anytime work is performed in a travel lane, the Contractor shall install portable lane closure signs meeting the requirement of the MDOT Standard Drawing or MUTCD.

## MISSISSIPPI DEPARTMENT OF TRANSPORTATION

| SPECIAL PROVISION NO. 907-105-6

CODE: (IS)

| DATE: 01/20/2011

| SUBJECT: Control of Work

Section 105, Control of Work, of the 2004 Edition of the Mississippi Standard Specifications for Road and Bridge Construction is modified as follows:

**907-105.05--Cooperation by Contractor.** In the third sentence of the second paragraph of Subsection 105.05 on page 35, change “Notice to Proceed” to “Notice of Award”.

Delete the fourth paragraph of Subsection 105.05 on page 35, and substitute the following.

On projects that include erosion control pay items, the Contractor shall also designate a responsible person whose primary duty shall be to monitor and maintain the effectiveness of the erosion control plan, including NPDES permit requirements. This responsible person must be a Certified Erosion Control Person certified by an organization approved by the Department. Prior to or at the pre-construction conference, the Contractor shall designate in writing the Certified Erosion Control Person to the Project Engineer. The designated Certified Erosion Control Person shall be assigned to only one (1) project. When special conditions exist, such as two (2) adjoining projects or two (2) projects in close proximity, the Contractor may request in writing that the State Construction Engineer approve the use of one (1) Certified Erosion Control Person for both projects. The Contractor may request in writing that the Engineer authorize a substitute Certified Erosion Control Person to act in the absence of the Certified Erosion Control Person. The substitute Certified Erosion Control Person must also be certified by an organization approved by the Department. A copy of the Certified Erosion Control Person's certification must be included in the Contractor's Protection Plan as outlined in Subsection 907-107.22.1. This in no way modifies the requirements regarding the assignment and availability of the superintendent.

**MISSISSIPPI DEPARTMENT OF TRANSPORTATION**

**SUPPLEMENT TO SPECIAL PROVISION NO. 907-107-9**

**DATE: 08/23/2011**

**SUBJECT: Legal Relations and Responsibility to Public**

**907-107.14.2.2--Railroad Protective.** Delete the first sentence of subparagraph (b) of Subsection 907-107.14.2.2 on page 3 and substitute the following.

(b) **Contractor's Liability - Railroad**, including subcontractors, XCU and railroad contractual with limits of \$1,000,000 each occurrence; \$2,000,000 aggregate.

After Subsection 907-107.17 on page 4, add the following:

**907-107.18--Contractor's Responsibility for Utility Property and Services.** After the first sentence of Subsection 107.18 on page 63, add the following:

Prior to any excavation on the project, the Contractor shall contact MS 811 and advise them to mark all known utilities in the area of the excavation.

## MISSISSIPPI DEPARTMENT OF TRANSPORTATION

| SPECIAL PROVISION NO. 907-107-9

CODE: (IS)

| DATE: 01/20/2011

SUBJECT: Legal Relations and Responsibility to Public

Section 107, Legal Relations and Responsibility to Public, of the 2004 Edition of the Mississippi Standard Specifications for Road and Bridge Construction is hereby amended as follows:

**907-107.02--Permits, Licenses and Taxes.** Delete in toto Subsection 107.02 on page 49 and substitute the following:

The Contractor or any Subcontractor shall have the duty to determine any and all permits and licenses required and to procure all permits and licenses, pay all charges, fees and taxes and issue all notices necessary and incidental to the due and lawful prosecution of the work. At any time during the life of this contract, the Department may audit the Contractor's or Subcontractor's compliance with the requirements of this section.

The Contractor or any Subcontractor is advised that the "Mississippi Special Fuel Tax Law", Section 27-55-501, et seq. and the Mississippi Use Tax Law, Section 27-67-1, et seq., and their requirements and penalties, apply to any contract or subcontract for construction, reconstruction, maintenance or repairs, for contracts or subcontracts entered into with the State of Mississippi, any political subdivision of the State of Mississippi, or any Department, Agency, Institute of the State of Mississippi or any political subdivision thereof.

The Contractor or any Subcontractor will be subject to one or more audits by the Department during the life of this contract to make certain that all applicable fuel taxes, as outlined in Section 27-55-501, et seq., and any sales and/or use taxes, as outlined in Section 27-67-1, et seq. are being paid in compliance with the law. The Department will notify the Mississippi State Tax Commission of the names and addresses of any Contractors or Subcontractors.

| **907-107.14--Damage Claims and Insurance.**

**907-107.14.2--Liability Insurance.** Delete Subsection 107.14.2 beginning on page 60 and substitute:

**907-107.14.2.1--General.** The Contractor shall carry Contractor's liability, including subcontractors and contractual, with limits not less than: \$500,000 each occurrence; \$1,000,000 aggregate; automobile liability - \$500,000 combined single limit - each accident; Workers' Compensation and Employers' Liability - Statutory & \$100,000 each accident; \$100,000 each employee; \$500,000 policy limit. Each policy shall be signed or countersigned by a Mississippi Agent or Qualified Nonresident Agent of the Insurance Company.

The Contractor shall have certificates furnished to the Department from the insurance companies providing the required coverage. The certificates shall be on the form furnished by the Department and will show the types and limits of coverage.

**907-107.14.2.2--Railroad Protective.** The following provisions are applicable to all work performed under a contract on, over or under the rights-of-way of each railroad shown on the plans.

The Contractor shall assume all liability for any and all damages to work, employees, servants, equipment and materials caused by railroad traffic.

Prior to starting any work on railroad property, the Contractor shall furnish satisfactory evidence to the Department that insurance of the forms and amounts set out herein in paragraphs (a) and (b) has been obtained. Also, the Contractor shall furnish similar evidence to the Railroad Company that insurance has been obtained in accordance with the Standard Provisions for General Liability Policies and the Railroad Protective Liability Form as published in the Code of Federal Regulations, 23 CFR 646, Subpart A. Evidence to the Railroad Company shall be in the form of a Certificate of Insurance for coverages required in paragraph (b), and the original policy of the Railroad Protective Liability Insurance for coverage required in paragraph (a).

All insurance herein specified shall be carried until the contract is satisfactorily complete as evidenced by a release of maintenance from the Department.

The Railroad Company shall be given at least 30 days notice prior to cancellation of the Railroad Protective Liability Insurance policy.

For work within the limits set out in Subsection 107.18 and this subsection, the Contractor shall provide insurance for bodily injury liability, property damage liability and physical damage to property with coverages and limits no less than shown in paragraphs (a) and (b). Bodily injury shall mean bodily injury, sickness, or disease, including death at anytime resulting therefrom. Property damage shall mean damages because of physical injury to or destruction of property, including loss of use of any property due to such injury or destruction. Physical damage shall mean direct and accidental loss of or damage to rolling stock and their contents, mechanical construction equipment or motive power equipment.

(a) **Railroad Protective Liability Insurance** shall be purchased on behalf of the Railroad Company with limits of \$2,000,000 each occurrence; \$6,000,000 aggregate applying separately to each annual period for lines without passenger trains. If the line carries passenger train(s), railroad protective liability insurance shall be purchased on behalf of the Railroad Company with limits of \$5,000,000 each occurrence; \$10,000,000 aggregate applying separately to each annual period.

Coverage shall be limited to damage suffered by the railroad on account of occurrences arising out of the work of the Contractor on or about the railroad right-of-way, independent of the railroad's general supervision or control, except as noted in paragraph 4 below.

Coverage shall include:

- (1) death of or bodily injury to passengers of the railroad and employees of the railroad not covered by State workmen's compensation laws,
- (2) personal property owned by or in the care, custody or control of the railroads,
- (3) the Contractor, or any of the Contractor's agents or employees who suffer bodily injury or death as a result of acts of the railroad or its agents, regardless of the negligence of the railroads, and
- (4) negligence of only the following classes of railroad employees:
  - (i) any supervisory employee of the railroad at the job site
  - (ii) any employee of the railroad while operating, attached to, or engaged on, work trains or other railroad equipment at the job site which are assigned exclusively to the Contractor, or
  - (iii) any employee of the railroad not within (i) or (ii) above who is specifically loaned or assigned to the work of the Contractor for prevention of accidents or protection or property, the cost of whose services is borne specifically by the Contractor or Governmental authority.

(b) **Regular Contractor's Liability**, including subcontractors, XCU and railroad contractual with limits of \$1,000,000 each occurrence; \$2,000,000 aggregate. **Automobile** with limits of \$1,000,000 combined single limit any one accident; **Workers' Compensation and Employer's Liability** - statutory and \$100,000 each accident; \$100,000 each employee; \$500,000 policy limit. **Excess/Umbrella Liability** \$5,000,000 each occurrence; \$5,000,000 aggregate. All coverage to be issued in the name of the Contractor shall be so written as to furnish protection to the Contractor respecting the Contractor's operations in performing work covered by the contract. Coverage shall include protection from damages arising out of bodily injury or death and damage or destruction of property which may be suffered by persons other than the Contractor's own employees.

In addition, the Contractor shall provide for and on behalf of each subcontractor by means of a separate and individual liability and property damage policy to cover like liability imposed upon the subcontractor as a result of the subcontractor's operations in the same amounts as contained above; or, in the alternative each subcontractor shall provide same.

**907-107.15--Third Party Beneficiary Clause.** In the first sentence of the first paragraph of Subsection 107.15 on page 61, change "create the public" to "create in the public".

**907-107.17--Contractor's Responsibility for Work.** Delete the fifth sentence of the fifth paragraph of Subsection 107.17 on page 63 and substitute the following:



The eligible permanent items shall be limited to traffic signal systems, changeable message signs, roadway signs and sign supports, lighting items, guard rail items, delineators, impact attenuators, median barriers, bridge railing or pavement markings. The eligible temporary items shall be limited to changeable message signs, guard rail items, or median barriers.

## MISSISSIPPI DEPARTMENT OF TRANSPORTATION

| SPECIAL PROVISION NO. 907-108-31

CODE: (SP)

| DATE: 05/28/2013

**SUBJECT: Prosecution and Progress**

Section 108, Prosecution and Progress, of the 2004 Edition of the Mississippi Standard Specifications for Road and Bridge Construction is hereby amended as follows.

### **907-108.01--Subletting of Contract.**

**907-108.01.1--General.** At the end of the last paragraph of Subsection 108.01.1 on page 73, add the following.

The Engineer will have the authority to suspend the work wholly or in part and to withhold payments because of the Contractor's failure to make prompt payment within 15 calendar days as required above, or failure to submit the required OCR-484 Form, Certification of Payments to Subcontractors, which is also designed to comply with prompt payment requirements.

**907-108.02--Notice To Proceed.** Delete the second paragraph of Subsection 108.02 on page 75 and substitute the following.

The anticipated date of the Notice to Proceed (NTP) / Beginning of Contract Time (BCT) will be specified in the proposal.

Delete the fourth paragraph of Subsection 108.02 on page 75 and substitute the following.

Upon written request from the Contractor and if circumstances permit, the Notice to Proceed may be issued at an earlier date subject to the conditions stated therein. The Contractor shall not be entitled to any monetary damages or extension of contract time for any delay claim or claim of inefficiency occurring between the early issuance Notice To Proceed date and the Notice to Proceed date stated in the contract.

**907-108.03--Prosecution and Progress.** Delete Subsection 108.03.1 on pages 75 & 76, and substitute the following.

**907-108.03.1--Progress Schedule.** Prior to or at the Pre-Construction Conference, the Contractor shall furnish a progress schedule and be prepared to discuss both its proposed methodologies for fulfilling the scheduling requirements and its sequence of operations. The Engineer will review the schedule and approve the schedule as it relates to compliance with the specifications and logic. The progress schedule must be approved by the Engineer prior to commencing work. The schedule shall be a bar-chart type schedule submitted on 11"x17" paper meeting the below minimum requirements. These activities shall be significantly detailed enough to communicate the Contractor's understanding of the construction sequencing and phasing of the project.

When preparing the progress schedule, the Contractor shall include the following:

- Show a time scale to graphically show the completion of the work within contract time.
- Define and relate activities to the contract pay items.
- Show all activities in the order the work is to be performed including submittals, submittal reviews, fabrication and delivery.
- Show all activities that are controlling factors in the completion of the work.
- Show the time needed to perform each activity and its relationship in time to other activities.

Should the schedule not include the above requirements or becomes unrealistic during construction, the Contractor should immediately submit a revised, more realistic schedule for approval.

**907-108.03.2--Preconstruction Conference.** Delete the first paragraph of Subsection 108.03.2 on page 76 and substitute the following.

Prior to commencement of the work, a preconstruction conference shall be held for the purpose of discussing with the Contractor essential matters pertaining to the prosecution and satisfactory completion of the work. The Contractor will be responsible for scheduling the preconstruction conference. The Contractor will advise the Project Engineer in writing 14 days prior to the requested date that a conference is requested. When the contract requires the Contractor to have a certified erosion control person, the Contractor's certified erosion control person shall be at the preconstruction conference. The Department will arrange for utility representatives and other affected parties to be present.

Delete the third paragraph of Subsection 108.03.2 on page 76.

**907-108.06--Determination and Extension of Contract Time.** Delete Subsections 108.06.1 and 108.06.2 on pages 79 thru 85 and substitute the following.

**907-108.06.1--Blank.**

**907-108.06.2--Based on Calendar Date Completion.**

**907-108.06.2.1--General.** Contract Time will be established on the basis of a Completion Date, as indicated in the contract. The span of time allowed for the completion of the work included in the contract will be indicated in the contract documents and will be known as "Contract Time".

The span of time allowed in the contract as awarded is based on the quantities used for comparison of bids. If satisfactory fulfillment of the contract requires performance of work in greater quantities than those set forth in the proposal, the time allowed for completion shall be increased in Calendar Days in the same ratio that the cost of such added work, exclusive of the cost of work altered by Supplemental Agreement for which a time adjustment is made for such altered work in the Supplemental Agreement, bears to the total value of the original contract unless it can be established that the extra work was of such character that it required more time

than is indicated by the money value.

The Contractor shall provide sufficient materials, equipment and labor to guarantee the completion of the work in the contract in accordance with the plans and specifications within the Contract Time.

**907-108.06.2.2--Contract Time.** The following TABLE OF ANTICIPATED PRODUCTIVE DAYS indicates an average/anticipated number of productive days per month.

**TABLE OF ANTICIPATED PRODUCTIVE DAYS**

Month	Available Productive Days
January	6
February	7
March	11
April	15
May	19
June	20
July	21
August	21
September	20
October	16
November	11
December	5
Calendar Year	172

Allocation of anticipated productive days for a fractional part of the month will be computed as a proportion of the listed anticipated productive days for the applicable month.

Available productive days will start being assessed at the original Notice to Proceed/Beginning of Contract Time date shown in the contract documents, regardless of whether or not the Contractor has been issued an early Notice to Proceed.

Available productive days will be based on soil and weather conditions and other specific conditions cited in the contract. The Engineer will determine on each applicable day the extent to which work in progress could have been productive, regardless of whether the Contractor actually worked.

An available productive day will be assessed as follows:

- (a) any day of the week, Monday through Friday, exclusive of legal holidays recognized by the Department in Subsection 108.04.1, in which the Contractor works or could have worked for more than six (6) consecutive hours on the controlling item(s) of work, as determined by the

Engineer from the Contractor's approved progress schedule. When the Contractor works or could work more than four but less than six consecutive hours, one-half (0.5) of an available work day will be charged for that day. When the Contractor works or could work six or more consecutive hours during the day, one (1.0) available work day will be charged for that day, or

(b) any Saturday, exclusive of legal holidays recognized by the Department in Subsection 108.04.1, in which the Contractor works for more than six (6) consecutive hours on the controlling item(s) of work, as determined by the Engineer from the Contractor's approved progress schedule. When the Contractor works less than four consecutive hours during the day, no time will be charged for that day. When the Contractor works more than four but less than six consecutive hours, one-half (0.5) of an available work day will be charged for that day. When the Contractor works six or more consecutive hours during the day, one (1.0) available work day will be charged for that day.

Should the weather or other conditions be such that four (4) consecutive satisfactory hours are not available prior to noon (for daytime operations) or midnight (for nighttime operations), no time will be assessed for that day regardless of the above conditions. However, if the Contractor elects to work, time will be assessed in accordance with the previous paragraph.

Weather delays will not be considered for Saturdays, Sundays or legal holidays recognized by the Department in Subsection 108.04.1.

Each month the Engineer will complete, and furnish to the Contractor, an "Assessment Report for Available Productive Days" (CSD-765). This report shows the number of available productive days during the estimate period and the cumulative available productive days to date. The Contractor should review the Engineer's report as to the accuracy of the assessment and confer with the Resident or Project Engineer to rectify any differences. Each should make a record of the differences, if any, and conclusions reached. In the event mutual agreement cannot be reached, the Contractor will be allowed a maximum of 15 calendar days following the ending date of the monthly report in question to file a protest Notice of Claim in accordance with the provisions of Subsection 105.17. Otherwise, the Engineer's assessment shall be final unless mathematical errors of assessment are subsequently found to exist, and any claim of the Contractor as to such matter shall be waived.

The Contractor's progress will be determined monthly at the time of each progress estimate and will be based on the percentage of money earned by the Contractor compared to the percentage of elapsed time.

The percentage of money earned will be determined by comparing the total money earned to-date by the Contractor, minus any payment for advancement of materials, to the total dollar amount of the contract. The percentage of time elapsed will be determined by comparing the available productive days assessed to-date on Form CSD-765 to the total available productive days for the contract.

When the "percent complete" lags more than 20 percent behind the "percentage of elapsed time", the Contractor shall immediately submit a written statement and revised progress schedule

indicating any additional equipment, labor, materials, etc. to be assigned to the work to ensure completion within the specified contract time. When the "percent complete" lags more than 40 percent behind the "percentage of elapsed time", the contract may be terminated.

**907-108.06.2.3--Extension of Time.** The Contractor may, prior to the expiration of the Contract Time, make a written request to the Engineer for an extension of time with a valid justification for the request. The Contractor's plea that insufficient time was specified is not a valid reason for extension of time.

No extension of the specified completion date will be granted except as provided herein. An extension of contract time may be granted for unusually severe weather, abnormal delays caused solely by the State or other governmental authorities, or unforeseeable disastrous phenomena of nature of the magnitude of earthquakes, hurricanes, tornadoes, or flooded essential work areas which are deemed to unavoidably prevent prosecuting the work.

Unusually severe weather is defined as when the actual available productive days for the contract time are less than the number of available productive days shown in the Table of Anticipated Productive Days. Any extension of contract time will be based on a calendar days basis, excluding Saturdays, Sundays or legal holidays recognized by the Department in Subsection 108.04.1. Any extension of contract time will be made on or after the specified completion date. No extension of contract time will be made on a monthly basis.

If the **specified completion date** of the project is extended into a season of the year in which completion of certain items of work would be prohibited or delayed because of seasonal or temperature limitations, the Engineer may waive the limitations provided the completion of the work will not result in a reduction in quality. When determined that the completion of the out-of-season items will cause a reduction in the quality of the work, the completion of the project will be further extended so the items may be completed under favorable weather conditions. In either case, the Engineer will notify the Contractor in writing.

Liquidated damages as set forth in Subsection 108.07 under the heading "Daily Charge Per Calendar Day" in the Table titled "Schedule of Deductions for Each Day of Overrun in Contract Time", shall be applicable to each calendar day after the specified completion date, or authorized extension thereof, and until all work under the contract is completed.

**907-108.06.2.4--Cessation of Contract Time.** When the Engineer by written notice schedules a final inspection, time will be suspended until the final inspection is conducted and for an additional 14 calendar days thereafter. If after the end of the 14-day suspension all necessary items of work have not been completed, time charges will resume. If the specified completion date had not been reached at the time the Contractor called for a final inspection, the calendar day difference between the specified completion date and the date the Contractor called for a final inspection will be added after the 14-day period before starting liquidation damages. If a project is on liquidated damages at the time a final inspection is scheduled, liquidated damages will be suspended until the final inspection is conducted and for seven (7) calendar days thereafter. If after the end of the 7-day suspension all necessary items of work have not been completed, liquidated damages will resume. When final inspection has been made by the

Engineer as prescribed in Subsection 105.16 and all items of work have been completed, the daily time charge will cease.

**907-108.07--Failure to Complete the Work on Time.** Delete the Schedule of Deductions table in Subsection 108.07 on page 85, and substitute the following.

**Schedule of Deductions for Each Day of Overrun in Contract Time**

<b>Original Contract Amount</b>		<b>Daily Charge Per Calendar Day</b>
<b>From More Than</b>	<b>To and Including</b>	
\$ 0	100,000	\$ 150
100,000	500,000	360
500,000	1,000,000	540
1,000,000	5,000,000	830
5,000,000	10,000,000	1,200
10,000,000	20,000,000	1,800
20,000,000	-----	3,500

**907-108.10--Termination of Contractor's Responsibility.** In the last sentence of Subsection 108.10 on page 88, change “bond” to “performance and payment bond(s)”.

**MISSISSIPPI DEPARTMENT OF TRANSPORTATION**

**SUPPLEMENT TO SPECIAL PROVISION NO. 907-109-5**

**DATE: 05/15/2012**

**SUBJECT: Measurement and Payment**

After the last paragraph of Subsection 907-109.01 on page 1, add the following.

After the second sentence of the fourth full paragraph of Subsection 109.01 on page 90, add the following.

Where loose vehicle measurement (LVM) is used, the capacity will be computed to the nearest one-tenth cubic yard and paid to the whole cubic yard. Measurements greater than or equal to nine-tenths of a cubic yard will be rounded to the next highest number. Measurements less than nine-tenths of a cubic yard will not be rounded to the next highest number. Example: A vehicle measurement of 9.9 cubic yards will be classified as a 10-cubic yard vehicle. A vehicle measurement of 9.8 cubic yards will be classified as a 9-cubic yard vehicle.



## MISSISSIPPI DEPARTMENT OF TRANSPORTATION

| SPECIAL PROVISION NO. 907-109-5

CODE: (IS)

| DATE: 1/20/2011

SUBJECT: Measurement and Payment

Section 109, Measurement and Payment, of the 2004 Edition of the Mississippi Standard Specifications for Road and Bridge Construction is hereby amended as follows:

907-109.01--Measurement of Quantities. Delete the third full paragraph of Subsection 109.01 on page 90 and substitute the following.

When requested by the Contractor, material specified to be measured by the cubic yard or ton may be converted to the other measure as appropriate. Factors for this conversion will be determined by the District Materials Engineer and agreed to by the Contractor. The conversion of the materials along with the conversion factor will be incorporated into the contract by supplemental agreement. The supplemental agreement must be executed before such method of measurement is used.

907-109.04--Extra and Force Account Work. In the last sentence of subparagraph (b) in Subsection 109.04 on page 91, change “bond” to “bond(s)”.

Delete the first sentence of the second paragraph of subparagraph (d) in Subsection 109.04 on page 92 and substitute the following:

In the event an agreement cannot be reached for a particular piece of equipment, the book entitled "Rental Rate Blue Book For Construction Equipment" as published by EquipmentWatch® and is current at the time the force account work is authorized will be used to determine equipment ownership and operating expense rates.

907-109.06--Partial Payment.

907-109.06.1--General. Delete the fourth and fifth sentences of the third paragraph of Subsection 109.06.1 on page 94, and substitute the following:

In the event mutual agreement cannot be reached, the Contractor will be allowed a maximum of 25 calendar days following the Contractor's receipt of the monthly estimate in question to file in writing, a protest Notice of Claim in accordance with the provisions Subsection 105.17. Otherwise, the Engineer's estimated quantities shall be considered acceptable pending any changes made during the checking of final quantities.

907-109.07--Changes in Material Costs. Delete the third full paragraph of Subsection 109.07 on page 96 and substitute the following:

A link to the established base prices for bituminous products and fuels will be included in the contract documents under a Notice to Bidders entitled "Petroleum Products Base Prices."

MISSISSIPPI DEPARTMENT OF TRANSPORTATION

SPECIAL PROVISION NO. 907-304-13

CODE: (SP)

DATE: 06/06/2012

SUBJECT: Granular Courses

Section 907-304, Granular Courses, of the 2004 Edition of the Mississippi Standard Specifications for Road and Bridge Construction is hereby amended as follows.

**907-304.02--Materials.** After the first paragraph of Subsection 304.02.1 on page 183, add the following.

Crushed concrete meeting the requirements of Subsection 907-703.04.3 may be used in lieu of granular courses or crushed stone courses specified in the contract. This applies to base courses, shoulders, or other required construction on a prepared foundation.

**907-304.03--Construction Requirements.**

**907-304.03.5--Shaping, Compacting and Finishing.** Delete the sixth paragraph of Subsection 304.03.5 on page 185.

Delete the first table in Subsection 304.03.5 on page 186 and substitute the following.

Granular Material Class	Lot Average	Individual Test
7,8,9 or 10	97.0	93.0
5 or 6	99.0	95.0
3 or 4	100.0	96.0
1 or 2	102.0	98.0
Crushed Courses*	99.0	95.0

\* When placed on filter fabric on untreated subgrade, the individual tests and the average of the five (5) tests shall equal or exceed the following values.

Lot Average	Individual Test
96.0	92.0

**907-304.05--Basis of Payment.** Add the “907” prefix to the pay items listed on page 187.

# MISSISSIPPI DEPARTMENT OF TRANSPORTATION

## SUPPLEMENT TO SPECIAL PROVISION NO. 907-401-2

**DATE:** 05/14/2013

**SUBJECT:** Hot Mix Asphalt (HMA)

Add the following before 907-401.02.6.2 on page 1.

**907-401.02.4--Substitution of Mixture.** Delete the table in Subsection 401.02.4 on page 242, and substitute the following.

Mixture	Single Lift Laying Thickness Inches	
	Minimum	Maximum
25 mm	3	4
19 mm	2¼	3½
12.5 mm	1½	2½
9.5 mm	1	1½
4.75 mm	½	¾

After Subsection 907-401-02.6.2 on page 2, add the following.

**907-401.02.6.4.1--Roadway Density.** Delete subparagraphs 1., 2., & 3. on page 251 and substitute the following.

1. For all leveling lifts, when full lane width and with a thickness as specified in the table in Subsection 401.02.4, the required lot density shall be 92.0 percent of maximum density.
2. For all single lift overlays, with or without leveling and/or milling, the required lot density shall be 92.0 percent of maximum density.
3. For all multiple lift overlays of two (2) or more lifts excluding leveling lifts, the required lot density of the bottom lift shall be 92.0 percent of maximum density. The required lot density for all subsequent lifts shall be 93.0 percent of maximum density.
4. For all pavements on new construction, the required lot density for all lifts shall be 93.0 percent of maximum density.

Delete Subsections 401.02.6.5 and 401.02.6.6 on pages 253 thru 257 and substitute the following.

**907-401.02.6.5--Blank.**

**907-401.02.6.6--Blank.**

**907-401.02.6.7--Surface Correction.** Delete the paragraph in Subsection 401.02.6.7 on page 257, and substitute the following.

Corrective work to sections exceeding short continuous interval thresholds reported by ProVal, as described in Subsection 907-403.03.2.1, shall consist of diamond grinding in accordance with these specifications or methods approved by the Engineer. All surface areas corrected by grinding shall be sealed with a sealant approved by the Engineer.

**907-401.02.6.8--Acceptance Procedure for Pavement Smoothness Using Mean Roughness Index (MRI).** When compaction is completed, the lift shall have a uniform surface and be in reasonably close conformity with the line, grade and cross section shown on the plans.

The smoothness of the surface lift will be determined by using an Inertial Profiling System (IPS) to measure and record roughness data in each designated location. Roughness data for each longitudinal profile will be reported as a Mean Roughness Index (MRI). MRI is calculated by averaging the International Roughness Index (IRI) values from the two individual wheelpath profiles. The surface shall be tested and corrected to a smoothness index as described herein with the exception of those locations or specific projects that are excluded from smoothness testing with an IPS.

The smoothness of the surface lift will be determined for traffic lanes, auxiliary lanes, climbing lane and two-way turn lanes. Areas excluded from a smoothness test with the IPS are acceleration and deceleration lanes, tapered sections, transition sections for width, shoulders, crossovers, ramps, side street returns, etc. The roadway pavement on bridge replacement projects having 1,000 feet or less of pavement on each side of the structure will be excluded from a smoothness test. Pavement on horizontal curves having a radius of less than 1,000 feet at the centerline and pavement within the super elevation transition of such curves are excluded from smoothness testing. Smoothness testing shall terminate 15 feet from each transverse joint that separates the pavement from a bridge deck, bridge approach slab or existing pavement not constructed under the contract.

Initial smoothness measurements shall take place no more than 72 hours following placement of surface and must be performed at the posted speed limit or 50 miles per hour ( $\pm 5$  mile per hour), whichever is lower. This speed requirement will be waived for all lightweight profilers. Measurements will be made in both wheel paths of exterior and interior lanes. The wheel paths shall be designated as being located three feet (3') and nine feet (9') from centerline or longitudinal joint, respectively. Beginning and ending latitude and longitude coordinates shall be required on each smoothness surface test. Testing will also be required on sections that have been surface corrected. No smoothness testing shall be performed when there is moisture of any kind on the pavement surface. Any additional testing shall meet the requirements of Subsection 907-403.03.2.

The surface lift will be accepted on a continuous basis for pavement smoothness. Continuous reporting is based upon all MRI values for a specified running interval. These values are averaged and presented at the midpoint of the specified running interval. The last 15 feet of a day's lift may not be obtainable until the lift is continued and for this reason may be included in the subsequent section.

Areas of localized roughness exceeding the continuous 25-foot interval thresholds described in Subsection 907-403.03.2.1 shall be corrected regardless of the 528-foot interval MRI value of the section. Surface correction by grinding shall be performed in accordance with Subsection 401.02.6.7. The Contractor shall also make other necessary surface corrections to ensure that the final mean roughness index of the section meets the requirements of Subsection 907-403.03.2.

Continuous sections exceeding the accepted long interval MRI value shall be corrected as specified in Subsection 403.03.4. All such corrections shall be performed at no additional costs to the State. Scheduling and traffic control will be the responsibility of the Contractor with approval of the Engineer. All tests and corrections shall be in accordance with AASHTO R 54-10, Accepting Pavement Ride Quality When Measured Using Inertial Profiling Systems.

**907-401.02.6.9--High Speed Inertial Profiling System.**

**907-401.02.6.9.1--General.** The IPS, furnished and operated by the Contractor under the supervision of the Engineer or the Engineer's representative, shall meet the requirements of AASHTO M 328-10, Standard Specification for Inertial Profiler.

**907-401.02.6.9.2--Mechanical Requirements.** The IPS should function independent of vehicle suspension and speed with an operational range of 15-70 mph (for high speed profilers only) and must collect data at a sample interval of no more than three inches (3"). All IPSs, operators, and combinations thereof shall be verified in accordance with AASHTO R 56-10, Standard Practice for Certification of Inertial Profiler Systems and AASHTO R 57-10, Operating Inertial Profiler Systems.

**907-401.02.6.9.3--Computer Requirements.** The computer measurement program must be menu driven, Windows compatible, and able to produce profiler runs in University of Michigan's Transportation Research Institute's (UMTRI) Engineering Research Division (.erd) file format. The computer shall have the ability to display and print data on sight for verification and shall have the ability to save and transfer data via Universal Serial Bus (USB) flash drive, which shall be provided by the Contractor.

In addition to manufacturers software; the latest version of FHWA's ProVAL software shall be installed on the IPS computer. ProVAL software is available for free download at <http://www.roadprofile.com>.

**907-401.03.1.2--Tack Coat.** Delete the three sentences of Subsection 401.03.1.2 on page 259, and substitute the following.

Tack coat shall be applied to previously placed HMA and between lifts, unless otherwise directed by the Engineer. Tack coat shall be applied with a distributor spray bar. A hand wand will only be allowed for applying tack coat on ramp pads, irregular shoulder areas, median crossovers, turnouts, or other irregular areas. Bituminous materials and application rates for tack coat shall be as specified in Table 410-A on page 293. Construction requirements shall be in accordance with Subsection 407.03 of the Standard Specifications.

**907-401.03.1.4--Density.** Delete the first sentence of the first paragraph of Subsection 401.03.1.4 on page 259 and substitute the following.

The lot density for all dense graded pavement lifts, except as provided below for preleveling, wedging [less than fifty percent (50%) of width greater than minimum lift thickness], ramp pads, irregular shoulder areas, median crossovers, turnouts, or other areas where the established rolling pattern cannot be performed, shall not be less than the specified percent (92.0% or 93.0%) of the maximum density based on AASHTO Designation: T 209 for the day's production. For all leveling lifts, when full lane width and with a thickness as specified in the table in Subsection 401.02.4, the required lot density shall be 92.0 percent of maximum density.

**907-401.03.9--Material Transfer Equipment.** Delete the paragraph in Subsection 401.03.9 on page 264 and substitute the following.

Excluding the areas mentioned below, the material transferred from the hauling unit when placing the top lift, or the top two (2) lifts of a multi-lift HMA pavement with density requirements, shall be remixed prior to being placed in the paver hopper or insert by using an approved Materials Transfer Device. Information on approved devices can be obtained from the State Construction Engineer. Areas excluded from this requirement include: leveling courses, temporary work of short duration, detours, bridge replacement projects having less than 1,000 feet of pavement on each side of the structure, acceleration and deceleration lanes less than 1,000 feet in length, tapered sections, transition sections for width, shoulders less than 10 feet in width, crossovers, ramps, side street returns and other areas designated by the Engineer.

After Subsection 401.03.13 on page 266, add the following.

**907-401.03.14--Shoulder Wedge.** The Contractor shall attach a device to the screed of the paver that confines the material at the end gate and extrudes the asphalt material in such a way that results in a compacted wedge shape pavement edge of approximately 30 degrees, but not steeper than 35 degrees. The device shall maintain contact between itself and the road shoulder surface and allow for automatic transition to cross roads, driveways, and obstructions. The device shall be used to constrain the asphalt head reducing the area by 10% to 15% increasing the density of the extruded profile. Conventional single plate strike off shall not be used.

The device shall be TransTech Shoulder Wedge Maker, the Advant-Edge, or a similar approved equal device that produces the same wedge consolidation results. Contact information for these wedge shape compaction devices is the following:

1. TransTech Systems, Inc.  
1594 State Street  
Schenectady, NY 12304  
800-724-6306  
[www.transtechsys.com](http://www.transtechsys.com)
2. Advant-Edge Paving Equipment, LLC  
P.O. Box 9163  
Niskayuna, NY 12309-0163  
518-280-6090  
Contact; Gary D. Antonelli  
Cell: 518-368-5699  
email: [garya@nycap.rr.com](mailto:garya@nycap.rr.com)

Website: [www.advantedgepaving.com](http://www.advantedgepaving.com)

Before using a similar device, the Contractor shall provide proof that the device has been used on previous projects with acceptable results, or construct a test section prior to the beginning of work and demonstrate wedge compaction to the satisfaction of the Engineer. Short sections of handwork will be allowed when necessary for transitions and turnouts, or otherwise authorized by the Engineer.



## MISSISSIPPI DEPARTMENT OF TRANSPORTATION

**SPECIAL PROVISION NO. 907-401-2**

**CODE: (IS)**

**DATE: 11/04/2005**

**SUBJECT: Hot Mix Asphalt (HMA)**

Section 401, Hot Mix Asphalt (HMA) - General, of the 2004 Edition of the Mississippi Standard Specifications for Road and Bridge Construction is hereby amended as follows:

Delete in toto Subsection 401.02.6.2 on pages 248 and 249, and substitute:

**907-401.02.6.2--Assurance Program for Mixture Quality.** The Engineer will conduct a quality assurance program. The quality assurance program will be accomplished as follows:

- 1) Conducting verification tests.
- 2) Validate Contractor test results.
- 3) Periodically observing Contractor quality control sampling and testing.
- 4) Monitoring required quality control charts and test results.
- 5) Sampling and testing materials at any time and at any point in the production or laydown process.

The rounding of all test results will be in accordance with Subsection 700.04.

The Engineer will conduct verification tests on samples taken by the Contractor under the direct supervision of the Engineer at a time specified by the Engineer. The frequency will be equal to or greater than ten percent (10%) of the tests required for Contractor quality control and the data will be provided to the Contractor within two asphalt mixture production days after the sample has been obtained by the Engineer. At least one sample shall be tested from the first two days of production. All testing and data analysis shall be performed by a Certified Asphalt Technician-I (CAT-I) or by an assistant under the direct supervision of the CAT-I. Certification shall be in accordance with the *MDOT HMA Technician Certification Program* chapter in the Materials Division Inspection, Testing, and Certification Manual. The Department shall post a chart giving the names and telephone numbers for the personnel responsible for the assurance program.

The Engineer shall be allowed to inspect Contractor testing equipment and equipment calibration records to confirm both calibration and condition. The Contractor shall calibrate and correlate all testing equipment in accordance with the latest versions of the Department's Test Methods and AASHTO Designation: R 18.

Random differences between the Engineer's verification tests and the current running average of four quality control tests at the time of obtaining the verification sample will be considered acceptable if within the following limits:

Item	Allowable Differences
Sieve - % Passing	
3/8-inch and above	6.0
No. 4	5.0
No. 8	4.0
No. 16, for 4.75 mm mixtures ONLY	3.5
No. 30	3.5
No. 200	2.0
AC Content	0.4
Specimen Bulk SG, Gmb @ $N_{Design}$	0.030
Maximum SG, Gmm	0.020

If four quality control tests have not been tested prior to the time of the first verification test, the verification test results will be compared to the average of the preceding quality control tests. If the verification test is the first material tested on the project or if a significant process adjustment was made just prior to the verification test, the verification test results will be compared to the average of four subsequent quality control test results. For all other cases after a significant process adjustment, the verification test results will be compared to the average of the preceding quality control tests (taken after the adjustment) as in the case of a new project start-up when four quality control tests are not available.

In the event that; 1) the comparison of the Contractor's running average quality control data and Engineer's quality assurance verification test results are outside the allowable differences in the above table, or 2) if a bias exists between the results, such that one of the results is predominately higher or lower than the other, and the Engineer's results fail to meet the JMF control limits, the Engineer will investigate the reason immediately. As soon as the need for an investigation becomes known, the Engineer will increase the quality assurance sampling rate to the same frequency required for Contractor testing. The additional samples obtained by the Engineer may be used as part of the investigation process or for routine quality assurance verification tests. The Engineer's investigation may include testing of the remaining quality control split samples, review and observation of the Contractor's testing procedures and equipment, and a comparison of split sample test results by the Contractor quality control laboratory, Department quality assurance laboratory and the Materials Division laboratory. The procedures outlined in the latest edition of MDOT's Field Manual for HMA may be used as a guide for the investigation. In the event that the Contractor's results are determined to be incorrect, the Engineer's results will be used for the quality control data and the appropriate payment for the mixture will be based on the procedures specified in Subsection 401.02.5.8(j).

The Engineer will periodically witness the sampling and testing being performed by the Contractor. The Engineer, both verbally and in writing, will promptly notify the Contractor of any observed deficiencies. When differences exist between the Contractor and the Engineer which cannot be resolved, a decision will be made by the State Materials Engineer, acting as the referee. The Contractor will be promptly notified in writing of the decision. If the deficiencies are not corrected, the Engineer will stop production until corrective action is taken.

## MISSISSIPPI DEPARTMENT OF TRANSPORTATION

**SPECIAL PROVISION NO. 907-401-6**

**CODE: (SP)**

**DATE: 08/21/2012**

**SUBJECT: Warm Mix Asphalt (WMA)**

Section 401, Hot Mix Asphalt (HMA) - General, of the 2004 Edition of the Mississippi Standard Specifications for Road and Bridge Construction as amended by this special provision is applicable to Warm Mix Asphalt Only.

### **907-401.01--Description.**

These specifications include general requirements that are applicable to Warm Mix Asphalt (WMA).

This work consists of the construction of one or more lifts of WMA in accordance with Section 401 for Hot Mix Asphalt, with the exceptions set forth in this special provision. The WMA shall meet the specific requirements for the mixture to be produced and placed in reasonably close conformity with the lines, grades, thicknesses and typical sections shown on the plans or established by the Engineer.

### **907-401.02--Materials.**

**907-401.02.2--WMA Products and Processes.** The Department will maintain a list of qualified WMA products and processes. No product or process shall be used unless it appears on this list.

The Contractor may propose other products or processes for approval by the Product Evaluation Committee. Documentation shall be provided to demonstrate laboratory performance, field performance, and construction experience.

### **907-401.03--Construction Requirements.**

**907-401.03.1.1--Weather Limitations.** The air and pavement temperature at the time of placement shall equal or exceed 40°F, regardless of compacted lift thickness.

**907-401.03.8--Preparation of Mixture.** Warm mix asphalt is defined as a plant produced asphalt mixture that can be produced and constructed at lower temperatures than typical hot mix asphalt. Typical temperature ranges of non-polymer modified, WMA produced by foaming the asphalt binder at the plant are typically 270°F to 295°F at the point of discharge of the plant. Typical temperature ranges of polymer modified, WMA produced by foaming the asphalt binder at the plant are typically 280°F to 305°F at the point of discharge of the plant. WMA produced by addition of a terminal blended additive may allow the producer to reduce the temperatures below 270°F as long as all mixture quality and field density requirements are met. Production temperatures at the plant may need to be increased or decreased due to factors such as material

characteristics, environmental conditions, and haul time to achieve mixture temperatures at the time of compaction in which uniform mat density can be achieved.

**MISSISSIPPI DEPARTMENT OF TRANSPORTATION**

**SUPPLEMENT TO SPECIAL PROVISION NO. 907-403-4**

**DATE: 05/15/2013**

**SUBJECT: Hot Mix Asphalt (HMA)**

Before Subsection 907-403.05.2 on page 1, add the following:

**907-403.03--Construction Requirements.**

**907-403.03.2--Smoothness Tolerances.** Delete the table, footnotes, and first six paragraphs of Subsection 403.03.2 on page 266 & 267, and substitute the following.

	Lower* & Leveling Lifts	Lower* Intermediate Lift	Top Intermediate Lift	Surface Lift
Maximum deviation from grade and cross section at any point .....	1/2"	3/8"	1/4"	1/4"
Maximum deviation from A 10 foot straight edge.....	3/8"	1/4"	1/8"	1/8"

Note: Where more than four (4) lifts of HMA are required, all lifts, excluding the top three (3) lifts, shall meet the requirements of the lower lift.

\* When tested longitudinally from a stringline located equidistant above points 50 feet apart, the distance from the stringline to the surface at any two points located 12 1/2 feet apart shall not vary one from the other more than the maximum deviation allowed above from a 10-foot straight edge.

Delete the last paragraph of Subsection 403.03.2 at the bottom of page 268, the table at the top of page 269, and the first, second and third full paragraphs on page 269, and substitute the following.

Sections(s) or portions thereof representing areas excluded from a smoothness test with the High Speed Inertial Profiling System (IPS) shall also be excluded from consideration for a contract price adjustment for rideability.

Any contract price adjustment for rideability will be applied on a continuous basis to the pay tonnage, determined in accordance with Subsections 907-401.02.6.8 and 403.04, for the section(s) or portions thereof for which an adjustment is warranted.

Contract price adjustments for rideability shall only be applicable to the surface lift and furthermore to only the long continuous section(s) or portions of the long continuous section(s) of the surface lift that require smoothness be determined by using a profiling device.

**907-403.03.2.1--Smoothness Tolerances for Mean Roughness Index (MRI).** Smoothness tolerances shall be applied to asphalt pavements based on the following pavement categories.

**Category A** applies to the following pavement constructions:

- New construction
- Construction with three (3) or more lifts
- Mill and two (2) or more lifts

**Category B** applies to the following pavement constructions:

- Mill and one (1) lift
- Two (2) lift overlays without milling

**Category C** applies to the following pavement constructions:

- Single lift overlay without milling

**NOTE: Spot Leveling does not count as a lift. Full width / continuous leveling courses will be considered a lift.**

For all projects, the surface lift smoothness data shall be reported by two MRI methods:

1. A continuous 528-foot long interval MRI report
2. A continuous 25-foot short interval MRI report

**Category A** projects shall have a long interval surface MRI of not more than 60 inches per mile. Areas of the surface lift with localized roughness greater than 130 inches per mile as determined by the continuous short interval report will be identified for correction by the Project Engineer.

**Category B** projects shall have a long interval surface MRI of not more than 70 inches per mile. Areas of the surface lift with localized roughness greater than 140 inches per mile as determined by the continuous short interval report will be identified for correction by the Project Engineer.

**Category C** projects shall have the existing surface profiled at no additional cost to the State. The finished surface lift shall meet the following requirements:

- A 50% improvement in MRI from the existing surface
- or
- 80 inches per mile long interval surface MRI value whichever value is higher.

Additionally, areas of the surface lift with localized roughness greater than 150 inches per mile, as determined by the continuous short interval report, will be identified for correction by the Project Engineer. In the case that 50% of the existing surface MRI is greater than 80 inches per mile, the short continuous threshold shall be increased from 150 inches per mile by the difference between 50% of the existing surface MRI and 80 inches per mile.

No incentive will be allowed if the MRI value from the newly paved surface is greater than the existing surface.

When a project has multiple lifts, all lifts preceding the surface lift shall have a MRI of no more than 10 inches/mile (or one Project Category) more than the surface lift threshold for both long and short continuous intervals. Corrective action must be taken on those segments that do not meet this requirement. No unit price adjustment will be applied on any underlying lift.

For Category A and B projects, a unit price increase will be added when the MRI for the final surface lift, following all required localized roughness (short interval) corrective action, is less than or equal to forty-five inches per mile (45.0 inches / mile) on the long interval report. These Projects will be considered for incentive pay based on the following guidelines for the long interval surface lift MRI.

Mean Roughness Index inches / mile	Contract Price Adjustment percent of HMA unit bid price
Less than 30.0	108
30.0 to 35.0	106
35.1 to 40.0	104
40.1 to 45.0	102
45.1 to Required Surface MRI	100

For Category C projects, a unit price increase will be added when the MRI for the final surface lift, following all required localized roughness (short interval) corrective action, is less than or equal to forty-five inches per mile (45.0 inches / mile) on the long interval report. These Projects will be considered for incentive pay based on the following guidelines for the long interval surface lift MRI.

Mean Roughness Index inches / mile	Contract Price Adjustment percent of HMA unit bid price
Less than or equal to 45.0	103
45.1 to Required Surface MRI	100

In addition to the above pay incentive factors, a project may be subject to a disincentive when the Long Continuous Interval MRI for the surface exceeds the allowable tolerance. This applies to all project categories and will correlate to the maximum allowed Long Continuous Interval MRI.

Mean Roughness Index inches / mile	Contract Price Adjustment percent of HMA unit bid price
Above 20.0 Over	Remove And Replace
15.1 to 20.0 Over	80
10.1 to 15.0 Over	85
5.1 to 10.0 Over	90
0.1 to 5.0 Over	95
Required Surface MRI	100

Note: All incentives and disincentives will be based on a single smoothness test, following all required localized roughness (short interval) corrective action, of the newly paved surface.

Corrective action must be taken on those sections that exceed the 'Remove and Replace' threshold on the Long Continuous Interval as directed by the Project Engineer. Sections that fall into this requirement may also need corrective action on both the preceding and following 264-foot sections as to conform to a complete 528-foot Long Continuous Interval. The minimum remove and replace length will be 528 feet (0.1 mile). Additional smoothness testing shall be required on sections following replacement and will be required to meet *at least* the maximum surface MRI short of 'Remove and Replace'.

The above pay factors will be applied in conjunction with the Long Continuous Histogram Chart from ProVAL's Smoothness Assurance Module. The price adjustments for rideability will be tabulated in MDOT's Pay Incentive spreadsheet on the basis of a theoretical tonnage of 110 lbs/yd<sup>2</sup>\*inch thickness (pounds per square yard \* inch thickness) and 12-foot travel lanes, determined in accordance with Subsections 401.02.6.5 and 403.04, for the segment(s) or portions thereof for which an adjustment is warranted.

Delete Subsection 403.03.5.5 on page 273 and substitute the following.

**907-403.03.5.5--Preliminary Leveling.** All irregularities of the existing pavement, such as ruts, cross-slope deficiencies, etc., shall be corrected by spot leveling, skin patching, feather edging or a wedge lift in advance of placing the first overall lift.

**907-403.04--Method of Measurement.** After the first paragraph of Subsection 403.04 on page 274, add the following.

The pay quantities for each individual job mix formula (JMF) will be calculated using the approved JMF maximum specific gravity (Gmm) and the following formulas.

When the composite mixture has a maximum specific gravity of 2.540 or less,

$$T_p = T_w$$

When the composite mixture has a maximum specific gravity greater than 2.540,



$$T_p = T_w \left( \frac{100 - \left( \frac{G_{mm} \cdot A \cdot B - C}{G_{mm} \cdot A \cdot B} \right) \cdot 100}{100} \right)$$

Where:

- $T_p$  = Total tonnage for payment
- $T_w$  = Total tonnage weighed, used and accepted
- $G_{mm}$  = Maximum Specific Gravity of the approved composite asphalt mixture
- $A$  = 46.725 lbs/yd<sup>2</sup>/in
- $B$  = 0.93 = 93% density
- $C$  = 110.374 lbs/yd<sup>2</sup>/in = Theoretical density at 2.540 Gmm

**MISSISSIPPI DEPARTMENT OF TRANSPORTATION**

**SPECIAL PROVISION NO. 907-403-4**

**CODE: (IS)**

**DATE: 11/04/2005**

**SUBJECT: Hot Mix Asphalt (HMA)**

Section 403, Hot Bituminous Pavement, of the 2004 Edition of the Mississippi Standard Specifications for Road and Bridge Construction is hereby amended as follows:

**907-403.05.2--Pay Items.** Add the "907" prefix to the pay items listed on page 275 & 276.

MISSISSIPPI DEPARTMENT OF TRANSPORTATION

SPECIAL PROVISION NO. 907-403-12

CODE: (SP)

DATE: 08/21/2012

SUBJECT: Warm Mix Asphalt (WMA)

Section 403, Hot Bituminous Pavement, of the 2004 Edition of the Mississippi Standard Specifications for Road and Bridge Construction as amended by this special provision is applicable to Warm Mix Asphalt Only.

**907-403.01--Description.** This work consists of constructing one or more lifts of Warm Mix Asphalt (WMA) pavement in accordance with the requirements of Section 403 for Hot Mix Asphalt, with the exceptions set forth in this special provision. The WMA shall meet the requirements of this section and placed in reasonably close conformity with the lines, grade, thicknesses, and typical cross sections shown on the plans or established by the Engineer.

**907-403.04--Method of Measurement.** Warm mix asphalt will be measured by the ton. The weight of the composite mixture shall be determined in accordance with the provisions of Subsection 401.03.2.1.11.

**907-403.05--Basis of Payment.** Subject to the adjustments set out in Subsections 401.02.6.3, 401.02.6.4, 401.02.6.5, 401.02.6.6 & 403.03.2, warm mix asphalt, measured as prescribed above, will be paid for at the contract unit price per ton for each lift of pavement specified in the bid schedule and shall be full compensation for completing the work.

**907-403.05.2--Pay Items.** After the last pay item listed on page 276, add the following:

907-403-M: Warm Mix Asphalt, (1), (2) - per ton  
Type Mixture

907-403-N: Warm Mix Asphalt, (1), (3), Leveling - per ton  
Type Mixture

907-403-O: Warm Mix Asphalt, (1), (4), Trench Widening - per ton  
Type Mixture

907-403-P: Warm Mix Asphalt, HT, (3), Polymer Modified - per ton  
Mixture

907-403-Q: Warm Mix Asphalt, HT, (3), Polymer Modified, Leveling - per ton  
Mixture

**MISSISSIPPI DEPARTMENT OF TRANSPORTATION**

**SPECIAL PROVISION NO. 907-407-1**

**CODE: (SP)**

**DATE: 02/26/2008**

**SUBJECT: Tack Coat**

Section 407, Tack Coat, of the 2004 Edition of the Mississippi Standard Specifications for Road and Bridge Construction is hereby amended as follows:

**907-407.02.1--Bituminous Material.** Delete the second sentence of the first paragraph of Subsection 407.02.1 on page 281, and substitute the following:

When not specified, the materials shall be as specified in Table 410-A on page 293.

**907-407.03.3--Application of Bituminous Material.** Delete the first paragraph of Subsection 407.03.3 on page 281, and substitute the following.

Tack coat shall be applied with a distributor spray bar. A hand wand will only be allowed for applying tack coat on ramp pads, irregular shoulder areas, median crossovers, turnouts, or other irregular areas. Bituminous materials and application rates for tack coat shall be as specified in Table 410-A on page 293. Tack coat shall not be applied during wet or cold weather, after sunset, or to a wet surface. Emulsions shall be allowed to "break" prior to superimposed construction.

**907-407.05--Basis of Payment.** Delete the pay item at the end of Subsection 407.05 on page 282, and substitute the following:

907-407-A: Asphalt for Tack Coat \*

- per gallon

\* Grade may be specified

# MISSISSIPPI DEPARTMENT OF TRANSPORTATION

## SUPPLEMENT TO SPECIAL PROVISION NO. 907-618-1

**DATE:** 05/01/2013

**PROJECT:** MP-6018-31(010) / 304810301 -- Jasper County

After the first paragraph of Subsection 907-618.01.2 on page 1, add the following.

Additional signs will be required as follows.

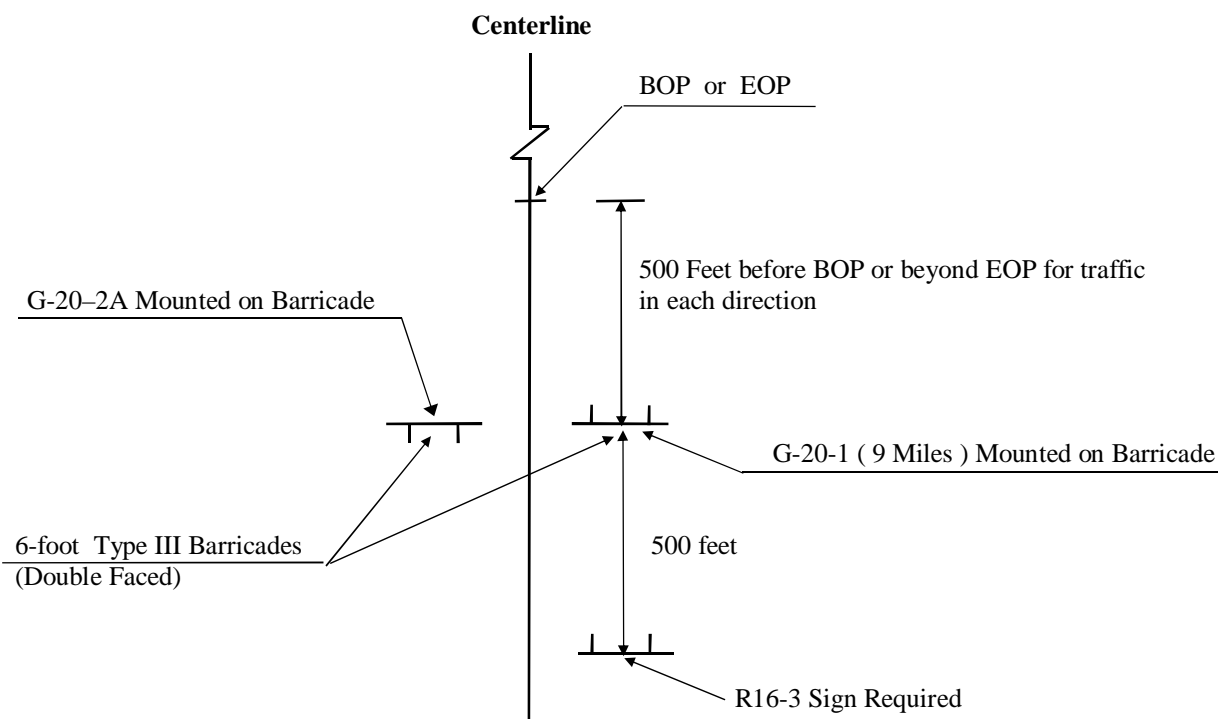

### ADDITIONAL TRAFFIC CONTROL SIGNS REQUIRED:

- 32 - W20-1 "AHEAD" signs required. One (1) W20-1 "AHEAD" sign is required at each local road or street entering the project.
- 75 - R4-1 "DO NOT PASS" signs required.
- 18 - R4-2 "PASS WITH CARE" signs required.
- 22 - W14-3 "NO PASSING ZONE" signs required.
- 8 - R16-3 "SPEEDING FINES DOUBLED" signs required.

R4-1 "DO NOT PASS", R4-2 "PASS WITH CARE", and W14-3 "NO PASSING ZONE" signs are required in accordance with Subsection 618.03.3, this drawing, and as specified in the Manual on Uniform Traffic Control Devices. If no passing zones are 1,000 feet or more, additional "DO NOT PASS" signs shall be installed.

R16-3 signs shall be spaced in accordance with sheet titled "Location of R16-3 Signs".

All Construction signing is included in the bid for Pay Item 618-A, Maintenance of Traffic. Fluorescent orange sheeting shall be used on all construction and traffic control signs except for R16-3, R4-1 and R4-2 signs which shall be black legend and border on white background.

STATE	PROJECT NO.
MISS.	

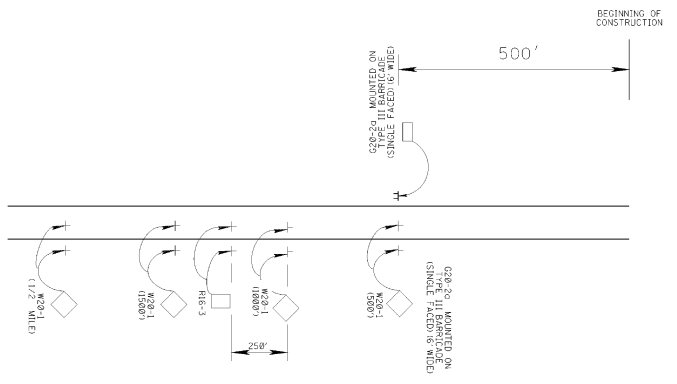

**DIVIDED HIGHWAY  
(PROJECTS LESS THAN 1 MILE LENGTH)**

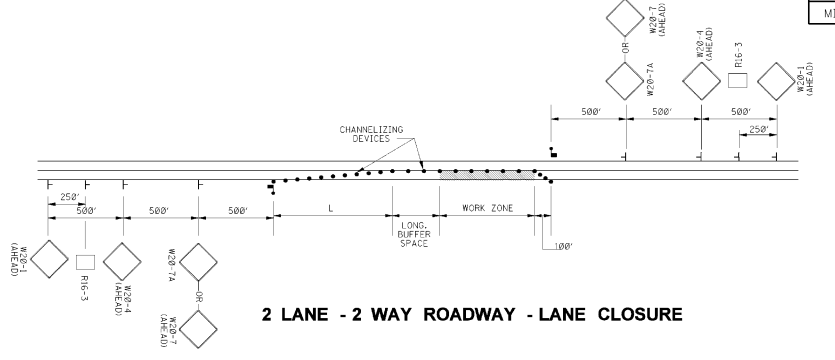

**2 LANE - 2 WAY ROADWAY - LANE CLOSURE**

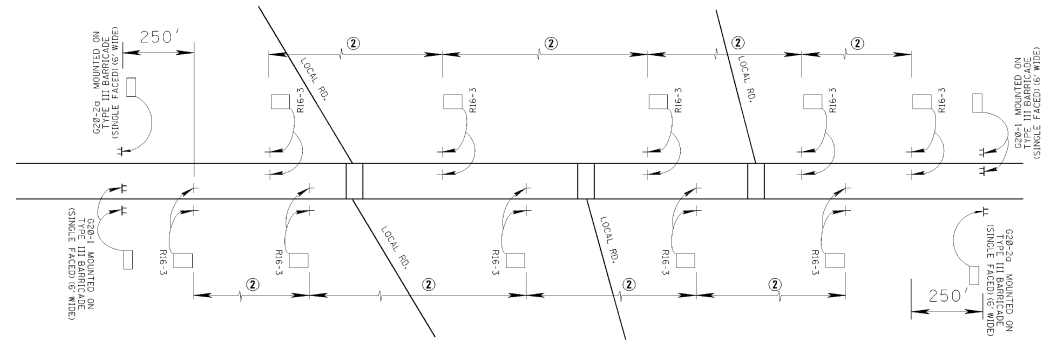

**DIVIDED HIGHWAY SHOWN  
(2 LANE - 2 WAY ROADWAY SIMILAR)  
(PROJECT MORE THAN 1 MILE LENGTH)**

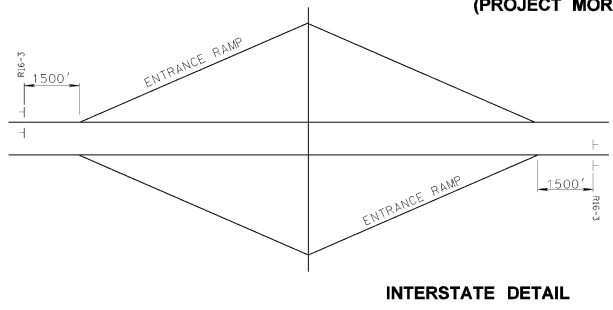

**INTERSTATE DETAIL**

**NOTES**

R16-3 SIGN TO BE PLACED AS SHOWN OR AS DIRECTED BY THE ENGINEER.  
R16-3 SIGN SHALL BE SPACED AT A MAXIMUM OF 2 MILES THROUGHOUT LENGTH OF PROJECT.

**146**

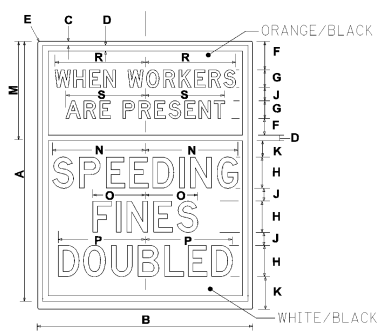

SIGN		DIMENSIONS (INCHES)							
	A	B	C	D	E	F	G	H	
STD.	60	48	3/4	1 7/8	3	3 3/4	4 0m	7 D	
	J	K	M	N	O	P	R	S	
STD.	3	4 1/2	22 3/8	21	11 7/8	19 3/4	20 3/8	18	

48" x 60"  
(INTERSTATE USE)

36" x 48"  
(ALL OTHER HIGHWAYS)

**R16-3**

MISSISSIPPI DEPARTMENT OF TRANSPORTATION			
<b>LOCATION OF R16-3 SIGNS</b>		WORKING NUMBER	
FILENAME:	SPFED_SIGN_DFTAIL.dgn	SHEET NUMBER	
DESIGN TEAM:	CHECKED:	DATE:	07-23-04

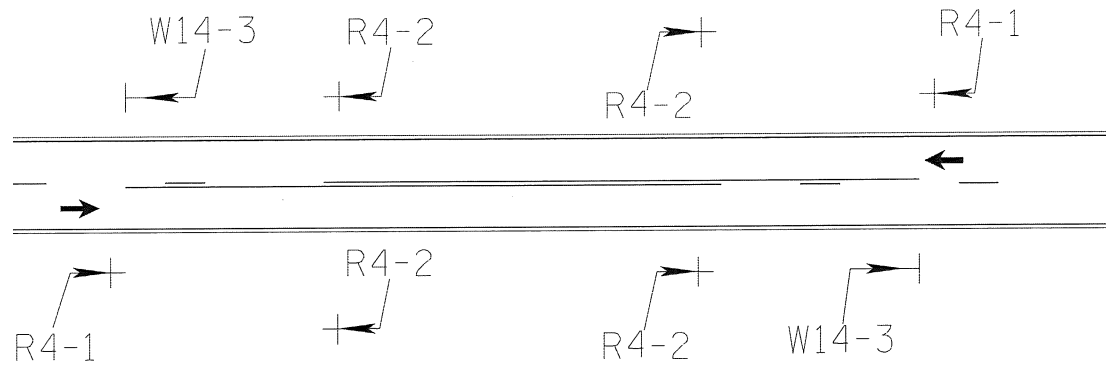

- ① THE R4-1, DO NOT PASS SIGNS, SHALL BE PLACED ON THE RIGHT SIDE OF THE ROAD AT THE BEGINNING OF THE NO PASSING ZONE. ADDITIONAL R4-1 SIGNS SHALL BE PLACED RIGHT AND LEFT IN INCREMENTS OF 750' TO 1000'. THROUGHOUT THE LENGTH OF THE NO PASSING ZONE.
- ② THE R4-2, PASS WITH CARE SIGN, SHALL BE PLACED ON THE RIGHT AND LEFT SIDE OF THE ROAD AT THE END OF THE NO PASSING ZONE & IN INCREMENTS OF 750' TO 1000' UNTIL THE NEXT NO PASSING ZONE.
- ③ THE W14-3, NO PASSING ZONES SIGNS, SHALL BE PLACED ON THE LEFT SIDE OF THE ROAD AT THE BEGINNING OF EACH NO PASSING ZONE.
- ④ THE R4-1, R4-2 AND W14-3 SIGNS ARE TO BE USED WHEN STANDARD PAVEMENT MARKINGS ARE NOT IN PLACE. SIGNS MAY ALSO BE USED TO EMPHASIZE PAVEMENT MARKINGS.

**MISSISSIPPI DEPARTMENT OF TRANSPORTATION**

**SPECIAL PROVISION NO. 907-618-1**

**CODE: (SP)**

**DATE: 04/29/2004**

**SUBJECT: Additional Signing Requirements**

Section 618, Maintenance of Traffic and Traffic Control Plan, of the 2004 Edition of the Mississippi Standard Specifications for Road and Bridge Construction is hereby amended as follows.

**907-618.01.2--Traffic Control Plan.** At the end of Subsection 618.01.2 on page 413, add the following:

For compliance with the traffic control plan, the Contractor will be required to install and maintain construction signs at various location throughout the project. Payment for these signs will be included in the price bid for pay item no. 618-A, Maintenance of Traffic per lump sum.



**MISSISSIPPI DEPARTMENT OF TRANSPORTATION**

**SPECIAL PROVISION NO. 907-618-9**

**CODE: (IS)**

**DATE: 11/08/2012**

**SUBJECT: Placement of Temporary Traffic Stripe**

Section 618, Maintenance of Traffic and Traffic Control Plan, of the 2004 Edition of the Mississippi Standard Specifications for Road and Bridge Construction is hereby amended as follows.

**907-618.03.3--Safe Movement of Traffic.** Delete subparagraphs (2) and (3) of Subsection 618.03.3 on page 416, and substitute the following.

- (2) Temporary edge lines on projects requiring shoulders constructed of granular material may be delayed for a period not to exceed three (3) days.

Temporary edge lines placed on the final pavement course of projects requiring paved shoulders with surface treatment may be placed on the adjacent shoulder in as near the permanent location as possible until the surface treatment is placed. When the edge lines are obliterated by the placement of the surface treatment, the edge lines shall be placed in the permanent stripe location. The replacement of edge lines may be delayed for a period not to exceed three (3) days for a two or three-lane roads.

Delete the first sentence of next to last paragraph of Subsection 618.03.3 on page 416 and substitute the following.

Permanent pavement markings are to be applied no sooner than 10 days nor later than 45 days after placement of the final lift of pavement.

MISSISSIPPI DEPARTMENT OF TRANSPORTATION

SPECIAL PROVISION NO. 907-626-25

CODE: (IS)

DATE: 11/13/2012

SUBJECT: Thermoplastic Traffic Markings

Section 626, Thermoplastic Traffic Markings, of the 2004 Edition of the Mississippi Standard Specifications for Road and Bridge Construction is hereby amended as follows.

**907-626.01--Description.** After the last sentence of the first paragraph of Subsection 626.01 on page 443, add the following.

All pavement marking material, excluding edge lines over rumble strips, shall be applied using the extrusion/ribbon method. Edge lines placed over rumble strips shall be applied using the atomization/spray method.

**907-626.03.1.1--Equipment.** After the second paragraph of Subsection 626.03.1.1 on page 444, add the following.

When edge lines are placed over rumble strips, the equipment must be able to apply the marking material using the atomization/spray method instead of extrusion/ribbon method.

**907-626.03.1.2--Construction Details.** Delete the second sentence of the first full paragraph of Subsection 626.03.1.2 on page 445, and substitute the following.

Unless otherwise specified in the plans or contract documents, the thickness shall be 90 mils for edge lines, center lines, lane lines, barrier lines and detail stripe including gore markings, and 120 mils for crosswalks, stop lines, and railroad, word and symbol markings.

After the last sentence of the third full paragraph of Subsection 626.03.1.2 on page 445, add the following.

When double drop thermoplastic stripe is called for in the contract, additional beads by the drop-on method shall be applied as follows.

Class A glass beads at a rate of not less than three pounds of beads per 100 feet of six-inch stripe.  
Class B glass beads at a rate of not less than three pounds of beads per 100 feet of six-inch stripe.

The Class B glass beads shall be applied to the newly placed stripe first, followed by the application of the Class A glass beads.

**907-626.05--Basis of Payment.** Delete the pay items listed on page 446 and substitute the following.

907-626-A: 6" Thermoplastic* Traffic Stripe, Skip White	- per linear foot or mile
907-626-B: 6" Thermoplastic* Traffic Stripe, Continuous White	- per linear foot or mile
907-626-C: 6" Thermoplastic* Edge Stripe, Continuous White	- per linear foot or mile
907-626-D: 6" Thermoplastic* Traffic Stripe, Skip Yellow	- per linear foot or mile
907-626-E: 6" Thermoplastic* Traffic Stripe, Continuous Yellow	- per linear foot or mile
907-626-F: 6" Thermoplastic* Edge Stripe, Continuous Yellow	- per linear foot or mile
907-626-G: Thermoplastic* Detail Stripe, <u>Color</u>	- per linear foot
907-626-H: Thermoplastic* Legend, White	- per linear foot or square foot

\* Indicate Double Drop if applicable

## MISSISSIPPI DEPARTMENT OF TRANSPORTATION

| SPECIAL PROVISION NO. 907-701-4

CODE: (IS)

| DATE: 11/09/2010

**SUBJECT: Hydraulic Cement**

Section 701, Hydraulic Cement, of the 2004 Edition of the Mississippi Standard Specifications for Road and Bridge Construction is hereby amended as follows:

Delete Subsection 701.01 on pages 595 & 596, and substitute the following:

**907-701.01--General.** The following requirements shall be applicable to hydraulic cement:

Only hydraulic cements conforming to Section 701 shall be used. Hydraulic cements shall not be listed or designated as meeting more than one AASHTO or Department type.

Different brands of hydraulic cement, or the same brand of hydraulic cement from different mills, shall not be mixed or used alternately in any one class of construction or structure, without written permission from the Engineer; except that this requirement will not be applicable to hydraulic cement treatment of design soils, or bases.

The Contractor shall provide suitable means for storing and protecting the hydraulic cement against dampness. Hydraulic cement, which for any reason, has become partially set or which contains lumps of caked hydraulic cement will be rejected. Hydraulic cement salvaged from discarded or used bags shall not be used.

The temperature of bulk hydraulic cement shall not be greater than 165°F at the time of incorporation in the mix.

Acceptance of hydraulic cement will be based on the certification program as described in the Department's Materials Division Inspection, Testing, and Certification Manual and job control sampling and testing as established by Department SOP.

Retests of hydraulic cement may be made for soundness and expansion within 28 days of test failure and, if the hydraulic cement passes, it may be accepted. Hydraulic cement shall not be rejected due to failure to meet the fineness requirements if upon retests after drying at 212°F for one hour, it meets such requirements.

Delete Subsection 701.02 on page 596, and substitute the following:

**907-701.02--Portland Cement.**

**907-701.02.1--General.**

**907-701.02.1.1--Types of Portland Cement.** Portland cement (cement) shall be either Type I or Type II conforming to AASHTO Designation: M85 or Type I(MS), as defined by the description below Table 1. Type III cement conforming to AASHTO Designation: M85 or Type III(MS), as defined by the description below Table 1, may be used for the production of precast or precast-prestressed concrete members.

**907-701.02.1.2--Alkali Content.** All cement types in this Subsection shall meet the Equivalent alkali content requirement for low-alkali cements listed in AASHTO Designation: M85, Table 2.

**907-701.02.2--Replacement by Other Cementitious Materials.** The maximum replacement of cement by weight is 25% for fly ash or 50% for ground granulated blast furnace slag (GGBFS). The minimum tolerance for replacement shall be 5% below the maximum replacement content. Replacement contents below this minimum tolerance by fly ash or GGBFS may be used, but shall not be given any special considerations, like the maximum acceptance temperature for Portland cement concrete containing pozzolans. Special considerations shall only apply for replacement of cement by fly ash or GGBFS.

**907-701.02.2.1--Portland Cement Concrete Exposed to Soluble Sulfate Conditions or Seawater.** When Portland cement concrete is exposed to moderate or severe soluble sulfate conditions, or to seawater, cement types and replacement of cement by Class F fly ash, GGBFS, or silica fume shall be as follows in Table 1.

**Table 1- Cementitious Materials for Soluble Sulfate Conditions**

Sulfate Exposure	Water-soluble sulfate (SO <sub>4</sub> ) in soil, % by mass	Sulfate (SO <sub>4</sub> ) in water, ppm	Cementitious material required*
Moderate and Seawater	0.10 - 0.20	150 - 1,500	Type II **, ***, **** cement, or Type I cement with one of the following replacements of cement by weight: 25% Class F fly ash, 50% GGBFS, or 8% silica fume
Severe	0.20 - 2.00	1,500 - 10,000	Type I cement with a replacement by weight of 50% GGBFS, or Type II ** cement with one of the following replacements of cement by weight: 25% Class F fly ash, 50% GGBFS, or 8% silica fume

- \* The values listed in this table for replacement of Portland cement by the cementitious materials listed are maximums and shall not be exceeded. The minimum tolerance for replacement shall be 0.5% below the maximum replacement content. Replacement contents below this minimum tolerance by the cementitious materials listed in this table do not meet the requirements for the exposure conditions listed and shall not be allowed.
- \*\* Type I cement conforming to AASHTO Designation: M85 with a maximum 8% tricalcium aluminate (C<sub>3</sub>A) may be used in lieu of Type II cement; this cement is given the designation "Type I(MS)". Type III cement conforming to AASHTO Designation: M85 with a maximum 8% tricalcium aluminate (C<sub>3</sub>A) may be used in lieu of Type II cement as allowed in Subsection 907-701.02.1; this cement is given the designation "Type III(MS)".
- \*\*\* Blended cement meeting the sulfate resistance requirements of Subsection 907-701.04 may be used in lieu of Type II as allowed in Subsection 907-701.04. No additional cementitious materials shall be added to or as a replacement for blended cement.
- \*\*\*\* Class F fly ash or GGBFS may be added as a replacement for cement as allowed in Subsection 907-701.02.2.

Class C fly ash shall not be used as a replacement for cement in any of the sulfate exposure conditions listed above.

**907-701.02.2.2--Cement for Soil Stabilization Exposed to Soluble Sulfate Conditions or Seawater.** When Portland cement for use in soil stabilization is exposed to moderate or severe soluble sulfate conditions, or to seawater, cement types and replacement of cement by Class F fly ash or GGBFS shall meet the requirements of Subsection 907-701.02.2.1. Neither metakaolin nor silica fume shall be used to bring the cementitious materials into compliance with the requirements of Table 1.

Delete Subsection 701.03 on page 596, and substitute the following:

**907-701.03--Masonry Cement.** Masonry cement shall conform to ASTM Designation: C 91 and shall only be used in masonry applications.

Delete Subsection 701.04 on page 596, and substitute the following:

**907-701.04--Blended Hydraulic Cement.**

**907-701.04.1--General.**

**907-701.04.1.1--Types of Blended Cement.** Blended hydraulic cements (blended cements) shall be of the following types and conform to AASHTO Designation: M 240:

- Type I(SM) – Slag-modified Portland cement
- Type IS – Portland blast-furnace slag cement
- Type I(PM) – Pozzolan-modified Portland cement
- Type IP – Portland-pozzolan cement

Blended cement for use in Portland cement concrete or soil stabilization exposed to the moderate soluble sulfate condition or exposure to seawater as defined in Table 1 shall meet the Sulfate resistance requirement listed in AASHTO Designation: M 240, Table 2 and the “(MS)” suffix shall be added to the type designation.

**907-701.04.1.2--Alkali Content.** All blended cement types in this Subsection shall meet the Mortar expansion requirements listed in AASHTO Designation: M 240, Table 2.

**907-701.04.2--Replacement by Other Cementitious Materials.** No additional cementitious materials, such as Portland cement, performance hydraulic cement, fly ash, GGBFS, metakaolin, or others, shall be added to or as a replacement for blended cement.

**907-701.04.3--Exposure to Soluble Sulfate Conditions or Seawater.** When Portland cement concrete or blended cement for soil stabilization is exposed to moderate soluble sulfate conditions or to seawater, where the moderate soluble sulfate condition is defined in Table 1, the blended cement shall meet the sulfate resistance requirement listed in AASHTO Designation: M 240, Table 2.

When Portland cement concrete or blended cement for soil stabilization is exposed to severe soluble sulfate conditions, where the severe soluble sulfate condition is defined in Table 1, blended cements shall not be used.

**MISSISSIPPI DEPARTMENT OF TRANSPORTATION**

**SPECIAL PROVISION NO. 907-702-3**

**CODE: (SP)**

**DATE: 05/08/2012**

**SUBJECT: Polyphosphoric Acid (PPA) Modification of Petroleum Asphalt Cement**

Section 702.05, Petroleum Asphalt Cement, of the 2004 Edition of the Mississippi Standard Specifications for Road and Bridge Construction is hereby amended as follows:

**907-702.05--Petroleum Asphalt Cement.** Delete the third paragraph of Subsection 702.05 on page 598, and substitute the following.

The bituminous material used in all types of asphalt mixtures shall conform to AASHTO Designation: M 320, Performance Grade PG 67-22, as modified in the table below, except that Polyphosphoric Acid (PPA) may be used at low dosage rates as a modifier to enhance the physical properties of a base binder to meet the requirements for Performance Grade PG 67-22. In addition, PPA may be used as a catalyst or mixing agent at low dosage rates in the production of Polymer Modified, Performance Grade PG 76-22.

When PPA is used as a modifier, in no case shall the PPA modifier be used to adjust the physical properties of the binder a full binder grade. For example: the base binder (unmodified) is graded as a PG 64-22 and should only be modified by the addition of PPA to a modified binder grade of PG 67-22.

When petroleum asphalt cement is modified by PPA, the following dosage limits shall be applied.

<b>Grade</b>	<b>Dosage Limit</b>
PG 67-22	0.75% by weight of binder
PG 76-22	0.50% by weight of binder



# MISSISSIPPI DEPARTMENT OF TRANSPORTATION

## SUPPLEMENT TO SPECIAL PROVISION NO. 907-703-10

**DATE:** 05/14/2013

**SUBJECT:** Aggregates

Before Subsection 907-703.06.1.2 on page 1, add the following.

**907-703.06.1--Coarse Aggregates.** Delete the third paragraph of Subsection 703.06.1 on page 613, and substitute the following.

When tested in accordance with AASHTO Designation: T 19, the dry rodded unit weight of all aggregates except expanded clay and shale shall not be less than 70 pounds per cubic foot.

Before Subsection 907-703.20.3 on page 2, add the following.

**907-703.14--Aggregates for Bituminous Surface Treatments.**

**907-703.14.2--Detail Requirements.**

**907-703.14.2.1--Gradation.** In the table entitled “Gradation Requirements For Cover Aggregate” in Subsection 703.14.2.1 on page 622, delete the requirement for the No. 16 sieve for Size No. 7 under the column “Slag or Expanded Clay”.

## MISSISSIPPI DEPARTMENT OF TRANSPORTATION

| SPECIAL PROVISION NO. 907-703-10

CODE: (SP)

| DATE: 06/06/2012

SUBJECT: Aggregates

Section 703, Aggregates, of the 2004 Edition of the Mississippi Standard Specifications for Road and Bridge Construction is hereby amended as follows.

**907-703.03.2.4--Gradation.** Delete the last sentence of the last paragraph of Subsection 703.03.2.4 on page 611.

**907-703.04--Aggregate for Crushed Stone Courses.**

**907-703.04.1--Coarse Aggregate.** Delete the first paragraph of Subsection 703.04.1 on page 611, and substitute the following.

Coarse aggregate, defined as material retained on No. 8 sieve, shall be either crushed limestone, steel slag, granite, concrete, or combination thereof. Crushed concrete is defined as recycled concrete pavement, structural concrete, or other concrete sources that can be crushed to meet the gradation requirements for Size No. 825 B as modified below. In no case shall waste from concrete production (wash-out) be used as a crushed stone base.

**907-703.04.2--Fine Aggregate.** Delete the first sentence of the first paragraph of Subsection 703.04.2 on page 612, and substitute the following.

Fine aggregate, defined as material passing No. 8 sieve, shall be material resulting from the crushing of limestone, steel slag, granite, concrete, or combination thereof.

Delete the third paragraph of Subsection 703.04.2 on page 612.

**907-703.04.3--Gradation.** After the table in Subsection 703.04.3 on page 613, add the following.

If crushed concrete is used, the crushed material shall meet the gradation requirements of Size No. 825 B with the exception that the percent passing by weight of the No. 200 sieve shall be 2 – 18.

**907-703.06--Aggregates for Hot Mix Asphalt.**

**907-703.06.1.2--Fine Aggregates.** Delete the last sentence of Subsection 703.06.1.2 on page 614.

**907-703.20.3--Gradation.** Delete the table and notes in Subsection 703.20.3 at the top of page 626, and substitute the following.

**PERCENT PASSING BY WEIGHT**

Square Mesh Sieves	Shell	Coarse			Medium	Fine
		Size I	Size II Note (1)	Size III Note (3)		
3 inch	90-100			100		
2 1/2 inch				90-100		
2 inch		100				
1 1/2 inch		90-100	100	25-60		
1 inch		80-100	97-100			
3/4 inch		55-100	55-100	0-10		
1/2 inch		35-85	35-85	0-5	100	
3/8 inch	12-65	12-65		97-100		
No. 4, Note (2)	0-30	0-30		92-100		
No. 10	0-8	0-8		80-100	100	
No. 40				10-40	80-100	
No. 60				0-20	30-100	
No. 100					15-80	
No. 200	0-5	0-4	0-4	0-5	0-30	
PI Material Passing No. 40				6 or less	0	

Note (1): Size II is intended for use in bases in which portland cement is used.

Note (2): Ground shell shall contain at least 97% passing the No. 4 sieve.

Note (3): Size III is intended for use in stabilized construction entrances.

## MISSISSIPPI DEPARTMENT OF TRANSPORTATION

SPECIAL PROVISION NO. 907-710-1

CODE: (SP)

DATE: 06/24/10

SUBJECT: Fast Dry Solvent Traffic Paint

Section 710, Paint, of the 2004 Edition of the Mississippi Standard Specifications for Road and Bridge Construction is amended as follows:

After Subsection 710.05 on Page 661, add the following:

**907-710.06--Fast Dry Solvent Traffic Paint.** Fast dry solvent traffic paints intended for use under this specification shall include products that are single packaged and ready mixed. Upon curing, these materials shall produce an adherent, reflective pavement marking capable of resisting deformation by traffic. The manufacturer shall have the option of formulating the material according to their own specifications. However, the requirements delineated in this specification, Section 619 and Section 710 shall apply regardless of the formulation used. The material shall be free from all skins, dirt and foreign objects.

**907-710.06.1--Composition.**

**907-710.06.1.1--Percent Pigment.** The percent pigment by weight shall be not less than 51% nor more than 58% when tested in accordance with ASTM D 3723.

**907-710.06.1.2--Viscosity.** The consistency of the paint shall be not less than 75 nor more than 95 Krebs Units (KU) when tested in accordance with ASTM D 562.

**907-710.06.1.3--Weight per Gallon.** The paint shall weigh a minimum 11.8 pounds per gallon and the weight of the production batches shall not vary more than +/- 0.5 pounds per gallon from the weight of the qualification samples when tested in accordance with ASTM D 1475.

**907-710.06.1.4--Total Solids.** The percent of total solids shall not be less than 70% by weight when tested in accordance with ASTM D 2369.

**907-710.06.1.5--Dry Time (No pick-up).** The paint shall dry to a no tracking condition in a maximum of 10 minutes.

**907-710.06.1.6--Volatile Organic Content.** The volatile organic content (VOC) shall contain a maximum of 1.25 pounds of volatile organic matter per gallon of total non-volatile paint material when tested in accordance with ASTM D 3960.

**907-710.06.1.7--Bleeding.** The paint shall have a minimum bleeding ratio of 0.95 when tested in accordance with Federal Specification TT-P-115D.

**907-710.06.1.8--Color.** The initial daytime chromaticity for yellow materials shall fall within the box created by the following coordinates:

**Initial Daytime Chromaticity Coordinates (Corner Points)**

	<b>1</b>	<b>2</b>	<b>3</b>	<b>4</b>
<b>x</b>	<b>0.53</b>	<b>0.51</b>	<b>0.455</b>	<b>0.472</b>
<b>y</b>	<b>0.456</b>	<b>0.485</b>	<b>0.444</b>	<b>0.4</b>

The initial daytime chromaticity of white materials shall fall within the box created by the following coordinates:

**Initial Daytime Chromaticity Coordinates (Corner Points)**

	<b>1</b>	<b>2</b>	<b>3</b>	<b>4</b>
<b>x</b>	<b>0.355</b>	<b>0.305</b>	<b>0.285</b>	<b>0.355</b>
<b>y</b>	<b>0.355</b>	<b>0.305</b>	<b>0.325</b>	<b>0.375</b>

**907-710.06.2--Environmental Requirements.** All yellow materials using lead chromate pigments shall meet the criteria of non-hazardous waste as defined by 40 CFR 261.24 when tested in accordance with EPA Test Method 1311, Toxicity Characteristics Leaching Procedures (TCLP). The striping and marking material , upon preparation and installation, shall not exude fumes which are toxic, or detrimental to persons or property. All material using lead free pigments shall NOT contain either lead or other Resource Conservation and Recovery Act (RCCA) materials in excess of the standard defined by EPA Method 3050 and 6010.

**907-710.06.3--Acceptance Procedures.** Acceptance of all fast dry solvent based traffics paint will be based on the Manufacturer's Certification and Certified Test Results. The Contractor shall furnish the Engineer with three copies of the manufacturer's certification stating that each lot of material in a shipment complies with the requirements of this contract. In addition, the Contractor shall provide Certified Test Reports for all tests required by this specification. The test results shall be representative of the material contained with the shipment.

## MISSISSIPPI DEPARTMENT OF TRANSPORTATION

SPECIAL PROVISION NO. 907-711-4

CODE: (IS)

DATE: 06/26/2009

SUBJECT: Synthetic Structural Fiber Reinforcement

Section 711, Reinforcement and Wire Rope, of the 2004 Edition of the Mississippi Standard Specifications for Road and Bridge Construction is hereby amended as follows:

After Subsection 711.03.4.3 on page 665, add the following:

**907-711.04--Synthetic Structural Fiber.** The synthetic structural fibers shall be approved for listing in the Department's "Approved Sources of Materials" prior to use. The synthetic structural fibers shall be added to the concrete and mixed in accordance with the manufacturer's recommended methods.

**907-711.04.1--Material Properties.** The fibers shall meet the requirements of ASTM Designation: C 1116, Section 4.1.3. The fibers shall be made of polypropylene, polypropylene/polyethylene blend, nylon, or polyvinyl alcohol (PVA).

**907-711.04.2--Minimum Dosage Rate.** The dosage rate shall be such that the average residual strength ratio ( $R_{150,3.0}$ ) of fiber reinforced concrete beams is a minimum of 20.0 percent when the beams are tested in accordance with ASTM Designation: C 1609. The dosage rate for fibers shall be determined by the following.

The fiber manufacturer shall have the fibers tested by an acceptable, independent laboratory acceptable to the Department and regularly inspected by the Cement and Concrete Reference Laboratory of the National Institutes of Standards and Technology and approved to perform ASTM Designations: C 39, C 78, and C192.

The laboratory shall test the fibers following the requirements of ASTM Designation: C 1609 in a minimum of three (3) test specimens cast from the same batch of concrete, molded in 6 x 6 x 20-inch standard beam molds meeting the requirements of ASTM Designation: C 31. The beams shall be tested on an 18-inch span. The tests for  $R_{150,3.0}$  shall be performed when the average compressive strength of concrete used to cast the beams is between 3500 and 4500 psi. The tests for compressive strength shall follow the requirements of ASTM Designation: C 39. The average compressive strength shall be determined from a minimum of two (2) compressive strength cylinders.

The value for  $R_{150,3}$  shall be determined using the following equation:

$$R_{150,3.0} = \frac{f_{150,3.0}}{f_1} \times 100$$

The residual flexural strength ( $f_{150,3.0}$ ) shall be determined using the following equation:

$$f_{150,3.0} = \frac{P_{150,3.0} \times L}{b \times d^2}$$

where:

$f_{150,3.0}$  is the residual flexural strength at the midspan deflection of  $L/150$ , (psi),

$P_{150,3.0}$  is the residual load capacity at the midspan deflection of  $L/150$ , (lbf),

$L$  is the span, (in),

$b$  is the width of the specimen at the fracture, (in), and

$d$  is the depth of the specimen at the fracture, (in).

For a 6 x 6 x 20-inch beam, the  $P_{150,3.0}$  shall be measured at a midspan deflection of 0.12 inch.

Additionally,  $R_{150,3.0}$ ,  $f_{150,3.0}$ , and  $P_{150,3.0}$  may also be referred to as  $R_{150}^{150}$ ,  $f_{150}^{150}$ , and  $P_{150}^{150}$  respectively.

At the dosage rate required to achieve the minimum  $R_{150,3}$ , the mixture shall both be workable and the fibers shall not form clumps.

The manufacturer shall submit to the State Materials Engineer certified test reports from the independent laboratory showing the test results of each test specimen.

**907-711.04.3--Job Control Requirements.** The synthetic structural fibers shall be one from the Department's "Approved Sources of Materials."

At the required dosage rate, the mixture shall both be workable and the fibers shall not form clumps to the satisfaction of the Engineer. If the mixture is determined by the Engineer to not be workable or have clumps of fibers, the mixture may be rejected.

**MISSISSIPPI DEPARTMENT OF TRANSPORTATION**

**SUPPLEMENT TO SPECIAL PROVISION NO. 907-713-2**

**DATE: 04/04/2012**

**SUBJECT: Admixtures for Concrete**

After the last sentence of the first paragraph of Subsection 907-713.02 on page 1, add the following.

Admixtures providing a specific performance characteristic(s) other than those of water reduction or set retardation shall meet the minimum requirements for Type S. For admixtures meeting the requirements for Type S, the manufacturer shall provide data to substantiate the specific performance characteristic(s) to the satisfaction of the State Materials Engineer.



## MISSISSIPPI DEPARTMENT OF TRANSPORTATION

| SPECIAL PROVISION NO. 907-713-2

CODE: (IS)

| DATE: 11/09/2010

SUBJECT: Admixtures for Concrete

Section 713, Concrete Curing Materials and Admixtures, of the 2004 Edition of the Mississippi Standard Specifications for Road and Bridge Construction is hereby amended as follows:

After the second paragraph of Subsection 713.01.2 on page 676, add the following.

Type 1-D compound may be used on bridge rails, median barriers, and other structures requiring a spray finish. When Type 1-D compound is used, it will be the Contractor's responsibility to assure that the compound has dissipated from the structure prior to applying the spray finish and that the spray finish adheres soundly to the structure.

Delete Subsection 713.02 on pages 676 & 677, and substitute the following:

**907-713.02--Admixtures for Concrete.** Air-entraining admixtures used in Portland cement concrete shall comply with AASHTO Designation: M 154. Set-retarding, accelerating, and/or water-reducing admixtures shall comply with AASHTO Designation: M 194. Water-reducing admixture shall meet the minimum requirements for Type A. Set-retarding admixtures shall meet the minimum requirements for Type D.

In order to obtain approval of an admixture, the State Materials Engineer shall have been furnished certified test reports, made by an acceptable independent laboratory regularly inspected by the Cement and Concrete Reference Laboratory of the National Institutes of Standards and Technology, which show that the admixture meets all the requirements of the applicable AASHTO Standard Specification.

The Department reserves the right to sample, for check tests, any shipment or lot of admixture delivered to a project.

The Department reserves the right to require tests of the material to be furnished, using the specific cement and aggregates proposed for use on the project, as suggested in AASHTO Designation: M 154 and outlined in AASHTO Designation: M 194.

After an admixture has been approved, the Contractor shall submit to the State Materials Engineer, with each new lot of material shipped, a certification from the manufacturer in accordance with the requirements of Subsection 700.05.1 and stating the material is of the same composition as originally approved and has not been changed or altered in any way. The requirement in Subsection 700.05.1(b) is not required on the certification from the manufacturer.

Admixtures containing chlorides will not be permitted.

Failure to maintain compliance with any requirement of these specifications shall be cause for rejection of any previously approved source or brand of admixture.

Admixtures shall only be used in accordance with the manufacturer's recommended dosage range as set forth in the manufacturer's approval request correspondence. When an admixture is used in Portland cement concrete, it shall be the responsibility of the Contractor to produce satisfactory results.

**907-713.02.1--Source Approval.** In order to obtain approval of an admixture, the Producer/Suppliers shall submit to the State Materials Engineer the following for review: certified test reports, made by an acceptable independent laboratory regularly inspected by the Cement and Concrete Reference Laboratory of the National Institutes of Standards and Technology, which show that the admixture meets all the requirements of the applicable AASHTO or Department Specification for the specific type and the dosage range for the specific type of admixture.

**907-713.02.2--Specific Requirements.** Admixtures containing chlorides will not be permitted.

**907-713.02.3--Acceptance.** The Department reserves the right to sample, for check tests, any shipment or lot of admixture delivered to a project.

The Department reserves the right to require tests of the material to be furnished, using the specific cement and aggregates proposed for use on the project, as suggested in AASHTO Designation: M 154 and outlined in AASHTO Designation: M 194.

Failure to maintain compliance with any requirement of these specifications shall be cause for rejection of any previously approved source or brand of admixture.

With each new lot of material shipped the Contractor shall submit to the State Materials Engineer, a notarized certification from the manufacturer showing that the material complies with the requirements of the applicable AASHTO or Department Specification.

When an admixture is used, it shall be the responsibility of the Contractor to produce satisfactory results.

**MISSISSIPPI DEPARTMENT OF TRANSPORTATION**

**SUPPLEMENT TO SPECIAL PROVISION NO. 907-714-6**

**DATE: 04/11/2013**

**SUBJECT: Miscellaneous Materials**

In the fifth paragraph of Subsection 907-714.05.1 on page 1, change “6.0%” to “8.0%”.

## MISSISSIPPI DEPARTMENT OF TRANSPORTATION

| SPECIAL PROVISION NO. 907-714-6

CODE: (IS)

| DATE: 11/09/2010

SUBJECT: Miscellaneous Materials

Section 714, Miscellaneous Materials, of the 2004 Edition of the Mississippi Standard Specifications for Road and Bridge Construction is hereby amended as follows:

**907-714.05--Fly Ash.** Delete Subsections 714.05.1 & 714.05.2 on pages 680 & 681, and substitute the following:

**907-714.05.1--General.** The fly ash source must be approved for listing in the Department's "Approved Sources of Materials" prior to use. The acceptance of fly ash shall be based on certified test reports, certification of shipment from the supplier, and tests performed on samples obtained after delivery in accordance with the Department's Materials Division Inspection, Testing, and Certification Manual and Department SOP.

Different classes of fly ash or different sources of the same class shall not be mixed or used in the construction of a structure or unit of a structure without written permission from the Engineer.

The Contractor shall provide suitable means for storing and protecting the fly ash from dampness. Separate storage silos, bins, or containers shall be provided for fly ash. Fly ash which has become partially set or contains lumps of caked fly ash shall not be used.

The temperature of the bulk fly ash shall not be greater than 165°F at the time of incorporation into the work.

All classes of fly ash shall meet the supplementary option chemical requirement for available alkalis listed in AASHTO Designation: M 295, Table 2. Class F fly ash shall have a calcium oxide (CaO) content of less than 6.0%. Class C fly ash shall have a CaO content of greater than or equal to 6.0%.

The replacement of Portland cement with fly ash shall be in accordance with the applicable replacement content specified in Subsection 907-701.02.2.

In addition to these requirements, fly ash shall meet the following specific requirements for the intended use.

**907-714.05.2--Fly Ash for Use in Concrete.** When used with Portland cement in the production of concrete or grout, the fly ash shall meet the requirements of AASHTO Designation: M 295, Class C or F, with the following exception:

| The loss on ignition shall not exceed 6.0 percent.

No additional cementitious materials, such as blended hydraulic cement, GGBFS, metakaolin, or others, shall be added to or as a replacement for Portland cement when used with fly ash.

**907-714.06--Ground Granulated Blast Furnace Slag (GGBFS).** Delete Subsection 714.06.1 on page 681, and substitute the following:

**907-714.06.1--General.** The GGBFS source must be approved for listing in the Department's "Approved Sources of Materials" prior to use. The acceptance of GGBFS shall be based on certified test reports, certification of shipment from the supplier, and tests performed on samples obtained after delivery in accordance with the Department's Materials Division Inspection, Testing, and Certification Manual and Department SOP.

The Contractor shall provide suitable means for storing and protecting the GGBFS against dampness and contamination. Separate storage silos, bins, or containers shall be provided for GGBFS. GGBFS which has become partially set, caked or contains lumps shall not be used.

The State Materials Engineer shall be notified in writing of the nature, amount and identity of any processing or other additions made to the GGBFS during production.

GGBFS from different mills shall not be mixed or used alternately in any one class of construction or structure without written permission from the Engineer; except that this requirement will not be applicable to cement treatment of design soils or bases.

No additional cementitious materials, such as blended hydraulic cement, fly ash, metakaolin, or others, shall be added to or as a replacement for Portland cement when used with GGBFS in the production of concrete. The replacement of Portland cement with GGBFS shall be in accordance with the applicable replacement content specified in Subsection 907-701.02.2.

Delete Subsection 714.07 on page 682, and substitute the following:

**907-714.07--Additional Cementitious Materials.**

**907-714.07.1--Metakaolin.**

**907-714.07.1.1--General.** Metakaolin shall only be used as a supplementary cementitious material in Portland cement concrete for compliance with the requirements for cementitious materials exposed to soluble sulfate conditions. Metakaolin from different sources shall not be mixed or used alternately in any one class of construction or structure without written permission from the Engineer. No additional cementitious materials, such as blended hydraulic cement, fly ash, GGBFS, or others, shall be added to or as a replacement for Portland cement when used with metakaolin in the production of concrete.

The State Materials Engineer shall be notified in writing of the nature, amount and identity of any processing, or other additions made to the metakaolin during production.

**907-714.07.1.2--Source Approval.** The approval of each metakaolin source shall be on a case by case basis as determined by the State Materials Engineer. In order to obtain approval of a metakaolin source, the Producer/Suppliers shall submit to the State Materials Engineer the

following for review: certified test reports, made by an acceptable, independent laboratory regularly inspected by the Cement and Concrete Reference Laboratory of the National Institutes of Standards and Technology, which show that the metakaolin meets all the requirements of AASHTO Designation: M295, including the Effectiveness in contributing to sulfate resistance, Procedure A, listed in AASHTO Designation: M295, Table 4 for Supplementary Optional Physical Requirements, and other requirements listed herein.

In order to demonstrate effectiveness in contributing to sulfate resistance, included in this test data shall be results of metakaolin from the proposed source tested in accordance with ASTM Designation: C 1012. There shall be two sets of test specimens per the following:

- a. One set of test specimens shall be prepared using a Type I Portland cement meeting the requirements of AASHTO Designation: M85 and having a tricalcium aluminate ( $C_3A$ ) content of more than 8.0%,
- b. One set of test specimens shall be prepared using a Type II Portland cement meeting the requirements of AASHTO Designation: M85.
- c. The proposed metakaolin shall be incorporated at the rate of 10% cement replacement in each set of test specimens and shall meet both of the acceptance criteria listed below for source approval.

The requirement for acceptance of the test sample using Type I Portland cement is an expansion of 0.10% or less at the end of six months. The requirement for acceptance of the test sample using Type II Portland cement is an expansion of 0.05% or less at the end of six months.

**907-714.07.1.3--Storage.** The Contractor shall provide suitable means for storing and protecting the metakaolin against dampness and contamination. Metakaolin which has become partially set, caked, or contains lumps shall not be used.

**907-714.07.1.4--Specific Requirements.** Metakaolin shall meet the requirements of AASHTO Designation: M 295, Class N with the following modifications:

1. The sum of  $SiO_2 + Al_2O_3 + Fe_2O_3$  shall be at least 85%. The Material Safety Data Sheet shall indicate that the amount of crystalline silica, as measured by National Institute of Occupation Safety and Health (NIOSH) 7500 method, after removal of the mica interference, is less than 1.0%.
2. The loss on ignition shall be less than 3.0%.
3. The available alkalies, as equivalent  $Na_2O$ , shall not exceed 1.0%.
4. The amount of material retained on a No. 325 mesh sieve shall not exceed 1.0%.
5. The strength activity index at seven (7) days shall be at least 85%.

**907-714.07.1.5--Acceptance.** With each new lot of material shipped the Contractor shall submit to the State Materials Engineer a certified test report from the manufacturer showing that the material meets the requirements AASHTO Designation: M295, Class N and the requirements of this Subsection.

The Department reserves the right to sample, for check tests, any shipment or lot of metakaolin delivered to a project.

**907-714.07.2--Silica Fume.**

**907-714.07.2.1--General.** Silica fume shall only be used as a supplementary cementitious material in Portland cement concrete for compliance with the requirements for cementitious materials exposed to soluble sulfate conditions. Silica fume from different sources shall not be mixed or used alternately in any one class of construction or structure without written permission from the Engineer. No additional cementitious materials, such as blended hydraulic cement, performance hydraulic cement, fly ash, GGBFS, or others, shall be added to or as a replacement for Portland cement when used with silica fume in the production of concrete.

The State Materials Engineer shall be notified in writing of the nature, amount and identity of any processing, or other additions made to the silica fume during production.

**907-714.07.2.2--Source Approval.** The approval of each silica fume source shall be on a case by case basis as determined by the State Materials Engineer. In order to obtain approval of a silica fume source, the Producer/Suppliers shall submit to the State Materials Engineer the following for review: certified test reports, made by an acceptable, independent laboratory regularly inspected by the Cement and Concrete Reference Laboratory of the National Institutes of Standards and Technology, which show that the silica fume meets all the requirements of AASHTO Designation: M307, Table 3, including the Sulfate resistance expansion, listed in the table for Optional Physical Requirements, and other requirements listed herein.

In order to demonstrate effectiveness in contributing to sulfate resistance, included in this test data shall be results of silica fume from the proposed source tested in accordance with ASTM Designation: C 1012. There shall be two sets of test specimens per the following:

- a. One set of test specimens shall be prepared using a Type I Portland cement meeting the requirements of AASHTO Designation: M85 and having a tricalcium aluminate ( $C_3A$ ) content of more than 8.0%,
- b. One set of test specimens shall be prepared using a Type II Portland cement meeting the requirements of AASHTO Designation: M85.
- c. The proposed silica fume shall be incorporated at the rate of 8% cement replacement in each set of test specimens and shall meet both of the acceptance criteria listed below for source approval.

The requirement for acceptance of the test sample using Type I Portland cement is an expansion of 0.10% or less at the end of six months. The requirement for acceptance of the test sample using Type II Portland cement is an expansion of 0.05% or less at the end of six months.

**907-714.07.2.3--Storage.** The Contractor shall provide suitable means for storing and protecting the silica fume against dampness and contamination. Silica fume which has become partially set, caked, or contains lumps shall not be used.

**907-714.07.2.4--Acceptance.** With each new lot of material shipped, the Contractor shall submit to the State Materials Engineer a certified test report from the manufacturer showing that the material meets the Chemical and Physical Requirements of AASHTO Designation: M307.

The Department reserves the right to sample, for check tests, any shipment or lot of silica fume

delivered to a project.

Delete Subsection 714.11.6 on pages 690 and 691, and substitute the following:

**907-714.11.6--Rapid Setting Cementitious Patching Compounds for Concrete Repair.**

Rapid setting concrete patching compounds must be approved for listing in the Department's "Approved Sources of Materials" prior to use. Upon approval, a product must be recertified every four (4) years to remain on the "Approved Sources of Materials" list. Each product shall be pre-measured and packaged dry by the manufacturer. All liquid solutions included by the manufacturer as components of the packaged material shall be packaged in a watertight container. The manufacturer may include aggregates in the packaged material or recommend the addition of Contractor furnished aggregates.

The type, size and quantity of aggregates, if any, to be added at the job site shall be in accordance with the manufacturer's recommendations and shall meet the requirements of Subsection 703.02 for fine aggregate and Subsection 703.03 for coarse aggregate. Required mixing water to be added at the job site shall meet the requirements of Subsection 714.01.2.

Only those bonding agents, if any, recommended by the manufacturer of the grout or patching compounds may be used for increasing the bond to old concrete or mortar surfaces.

Patching compounds containing soluble chlorides will not be permitted when in contact with steel.

Site preparation, proportioning of materials, mixing, placing and curing shall be performed in accordance with the manufacturer's recommendation for the specific type of application, and the Contractor shall furnish a copy of these recommendations to the Engineer.

Rapid setting cementitious concrete patching compounds, including components to be added at the job site, shall conform to the following physical requirements:

Non-shrink cementitious grouts shall not be permitted for use.

Compressive strength shall equal or exceed 3000 psi in 24 hours in accordance with ASTM C 928 for Type R2 concrete or mortar.

Bond strength shall equal or exceed 1000 psi in 24 hours in accordance with ASTM C 928 for Type R2 concrete or mortar.

The material shall have a maximum length change of  $\pm 0.15\%$  in accordance with ASTM C 928 for Type R2 concrete or mortar.

The Contractor shall furnish to the Engineer three copies of the manufacturer's certified test report(s) showing results of all required tests and certification that the material meets the specifications when mixed and placed in accordance with the manufacturer's instructions. When the mixture is to be placed in contact with steel, the certification shall further state that the packaged material contains no chlorides. Certified test report(s) and certification shall be furnished for each lot in a shipment.



The proportioning of materials must be approved by the State Materials Engineer and any subsequent change in proportioning must also be approved. A sample of each component shall be submitted to the Engineer along with the quantity or percentage of each to be blended. At least 45 days must be allowed for initial approval.

The proportioning of materials for subsequent lots may be approved by the State Materials Engineer upon receipt of certification from the manufacturer that the new lot of material is the same composition as that originally approved by the Department and that the material has not been changed or altered in any way.

**907-714.11.7--Commercial Grout for Anchoring Doweled Tie Bars in Concrete.** Before Subsection 714.11.7.1 on page 691, add the following:

Approved Non-“Fast Set” Epoxy anchor systems as specified below may be used for the repair of concrete pavements that do not involve permanent sustained tension applications or overhead applications.

“*Fast Set Epoxy*” may not be used for any Adhesive Anchor Applications. Adhesive Anchor Systems (Fast Set epoxy or otherwise) shall not be used for permanent sustained tension applications or overhead applications. “Fast Set Epoxy” refers to an epoxy produced by the Sika Corporation called Sikadur AnchorFix-3 and repackaged for sale under a variety of names/companies listed at the Federal Highway Administration web site at the following link:

<http://www.fhwa.dot.gov/Bridge/adhesives.cfm>

**907-714.11.7.4--Acceptance Procedure.** After the last sentence of the first paragraph of Subsection 714.11.4 on page 691, add the following:

Upon approval, a product must be recertified every four (4) years to remain on the “Approved Sources of Materials” list.

**907-714.11.8--Epoxy Joint Repair System.**

**907-714.11.8.1--General.** After the last sentence of the first paragraph of Subsection 714.11.8.1 on page 692, add the following:

Upon approval, a product must be recertified every four (4) years to remain on the “Approved Sources of Materials” list.

**MISSISSIPPI DEPARTMENT OF TRANSPORTATION**

**SUPPLEMENT TO SPECIAL PROVISION NO. 907-720-1**

**DATE:** 10/04/2012

**SUBJECT:** Pavement Marking Material

Before Subsection 907-720.02 on page 1, add the following.

**907-720.01--Glass Beads.** After the first sentence of Subsection 720.01 on page 729, add the following.

The glass beads shall contain no more than 200 ppm (mg/kg) total concentration for lead, arsenic, or antimony. The manufacture shall furnish the Engineer with a certified test report indicating that the glass beads meet the above requirement.

**MISSISSIPPI DEPARTMENT OF TRANSPORTATION**

**SPECIAL PROVISION NO. 907-720-1**

**CODE: (IS)**

**DATE: 3/17/2008**

**SUBJECT: Pavement Markings Materials**

Section 720, Pavement Marking Materials, of the 2004 Edition of the Mississippi Standard Specifications for Road and Bridge Construction is hereby amended as follows:

**907-720.02--Thermoplastic Pavement Markings.** Delete the first paragraph of Subsection 720.02 on page 730 and substitute the following:

The thermoplastic material shall be lead free and conform to AASHTO Designation: M 249 except the glass beads shall be moisture resistant coated.

After the first sentence of the second paragraph of Subsection 720.02 on page 730, add the following:

In addition, the certification for the thermoplastic material shall state that the material is lead free.

# MISSISSIPPI DEPARTMENT OF TRANSPORTATION

## SUPPLEMENT TO SPECIAL PROVISION NO. 907-804-13

| **DATE:** 04/23/2013

**SUBJECT:** Concrete Bridges And Structures

After the second paragraph of Subsection 907-804.02.10 on page 2, add the following.

After the first paragraph of Subsection 804.02.10 on page 850, add the following.

If the Contractor chooses to cure the concrete in accordance with the requirements listed under **Length of Time Defined by Development of Compressive Strength** in Subsection 907-804.03.17, the compressive strength/maturity relationship shall be developed for the mixture design for a minimum of 28 days following the requirements of Subsection 907-804.03.15. The compressive strength/maturity relationship information shall be submitted with the mixture design information.

In the \*\* Note of Subsection 907-804.02.10 on page 2, delete “metakaolin” from the list of other cementitious materials.

After the first sentence of the last paragraph of Subsection 907-804.02.10 on page 3, add the following.

Mixture designs containing accelerating admixtures will not be approved. Admixtures providing a specific performance characteristic other than those of water reduction or set retardation may be used in accordance with the manufacturer’s recommended dosage range.

After Subsection 907-804.02.10.1.1 on page 3, add the following.

**907-804.02.10.1.2--Proportioning on the Basis of Laboratory Trial Mixtures.** Delete subparagraph d) of Subsection 804.02.10.1.2 on pages 852 & 853, and substitute the following.

- d) For each proposed mixture, at least three compressive test cylinders shall be made and cured in accordance with AASHTO Designation: T 126. Each change of water-cementitious ratio shall be considered a new mixture. The cylinders shall be tested for strength in accordance with AASHTO Designation: T 22 and shall be tested at 28 days.

After Subsection 907-804.02.10.3 on page 4, add the following.

After Subsection 804.02.10.3 on page 853, add the following.

**907-804.02.10.3.1--Slump Retention of Class DS Concrete Mixture Designs.** Prior to concrete placement, the Contractor shall provide test results of a slump loss test using approved methods to demonstrate that the mixture meets the four hour requirement in Subsection 907-803.02.7.1. These tests shall be conducted successfully by an approved testing laboratory within

30 days prior to installation of the trial shaft, with personnel from the Department's Central Laboratory present. The slump loss test shall be conducted at temperatures and conditions similar to those expected at the job site at the time of the installation of the trial shaft. The sample for the slump loss test shall be from a minimum batch size of four cubic yards of concrete. If the time between the previous successful slump loss test and the installation of the trial shaft exceeds 30 days, another successful slump loss test shall be performed on the first truckload of concrete as part of the installation of the trial shaft. This requirement limiting the time between the previous slump loss test and an installation of the trial shaft also applies to Class DS concrete mixture designs being transferred from another project. During any shaft installation a slump loss test shall be conducted by the Contractor at the direction of the Engineer from the concrete at the site for verification of slump loss requirements using a sample from a minimum batch size of four cubic yards of concrete.

Before Subsection 907-804.02.12.3 on page 5, add the following.

**907-804.02.12.1.1--Elements of Plan.** After item 3) in Subsection 804.02.12.1.1 on page 855, add the following.

4) Job Site Batch Adjustments by Addition of Chemical Admixtures:

The Plan shall address if the Contractor intends to adjust either the slump and/or total air content of a batch on the job site by adding chemical admixture(s) to a batch. The Contractor shall include the names of the personnel designated to perform this batch adjustment, the equipment used to add the chemical admixture(s), and the procedure by which the batch adjustment will be accomplished. Only the Contractor's designated personnel shall adjust a batch. Only calibrated dispensing equipment shall be used to add chemical admixture(s) to a batch. Only the procedure described in section of the Plan shall be utilized.

If the maximum permitted slump or total air content is exceeded after the addition of admixtures at the job site, the concrete shall be rejected.

If the Contractor elects to utilize Job Site Batch Adjustments by Addition of Chemical Admixture within Item 2, Procedures for Corrective Actions for Non Compliance of Specifications, to adjust batches which do not meet the minimum specification requirements for slump and/or total air content, no more than three batches on any one project shall be allowed to be adjusted.

5) Construction of Concrete Bridge Decks, including the following:

- the description of the equipment used for placing concrete on the bridge deck in accordance with Subsection 907-804.03.6 and, as applicable, Subsections 907-804.03.7 and 907-804.03.8 including any accessories added to the pump to ensure the entrained air in the concrete mixture remains entrained during pumping and depositing of the concrete mixture,
- the description of and the number of pieces of equipment used to consolidate the concrete in accordance with Subsection 907-804.03.6.2,

- the description of the equipment used to finish the bridge deck in accordance with Subsection 907-804.03.19.7,
- the plan for ensuring a continuous rate of finishing the bridge deck without delaying the application of curing materials within the time specified in Subsection 907-804.03.17, including ensuring a continuous supply of concrete throughout the placement with an adequate quantity of concrete to complete the deck and filling diaphragms and end walls in advance of deck placement,
- the plan for applying the curing materials within the time specified in Subsection 907-804.03.17,
- the description of the powered fogging equipment in accordance with Subsection 907-804.03.17,
- a sample of the documentation used as the daily inspection report for ensuring maintenance of the continuous wet curing in accordance with Subsection 907-804.03.17, as required,
- the description of the equipment used to apply the liquid membrane, including but not limited to, the nozzles, pumping/pressurization equipment, and liquid membrane tanks, in accordance with Subsection 907-804.03.17,
- the method for determining the rate of applied liquid membrane meets the application rate requirements in accordance with Subsection 907-804.03.17,
- a sample of the documentation used for the application rate verification of the liquid membrane in accordance with Subsection 907-804.03.17.

After Subsection 907-804.03.6.2 on page 7, add the following.

**907-804.03.8--Pumping Concrete.** Delete the second paragraph of Subsection 804.03.8 on page 866, and substitute the following.

Where concrete mixture is conveyed and placed by mechanically applied pressure (pumping), the equipment shall be suitable in kind and adequate in capacity for the work. The Contractor shall select concrete mixture proportions such that the concrete mixture is pumpable and placeable with the selected equipment.

The pumping equipment shall be thoroughly cleaned prior to concrete placement. Excess form release agent shall be removed from the concrete pump hopper. The Contractor shall prime the pump at no additional cost to the Department by pumping and discarding enough concrete mixture to produce a uniform mixture exiting the pump. At least 0.25 cubic yard of concrete mixture shall be pumped and discarded to prime the pump. This shall be accomplished by using the pump to fill a commercially-available six (6) cubic foot wheelbarrow to overflowing or filling a commercially-available eight (8) cubic foot wheel barrow to level. Only concrete mixture shall be added directly into the concrete pump hopper after placement has commenced. If anything other than concrete mixture is added to the concrete pump hopper, all concrete mixture in the concrete pump hopper and pump line shall be discarded and the pump re-primed at no additional cost to the Department.

The discharge end of the pump shall be of such a configuration that the concrete does not move in the pump line under its own weight. The intent of this requirement is to ensure that entrained air in the concrete mixture remains entrained during pumping and depositing the concrete mixture. This shall be accomplished with one or both of the following:

- a minimum 10-foot flexible hose attached to the discharge end of a steel reducer having a minimum length of three (3) feet and a minimum reduction in area of 20% which is attached to the discharge end of the pump line, or
- a flexible reducing hose to the discharge end of the pumpline with a minimum reduction in area of 20% over a minimum 10-foot hose length.

Regardless of the configuration chosen, the Contractor shall ensure that the concrete is pumped and does not free-fall more than five (5) feet within the entire length of pump line and after discharge from the end of pump line.

The Contractor shall not have any type of metal elbow, metal pipe, or other metal fitting within five (5) feet of any person during discharge of concrete mixture.

Boom pumps shall have a current Concrete Pump Manufacturers Association's ASME/ANSI B30.27 certification. Equipment added to the boom and pump line shall meet the pump manufacturer's specifications and shall not exceed the manufacturer's maximum recommended weight limit for equipment added to the boom and pump line.

The operation of the pump shall be such that a continuous stream of concrete without air pockets is produced. When pumping is completed, the concrete remaining in the pipe line, if it is to be used, shall be ejected in such a manner that there will be no contamination of the concrete or separation of the ingredients. After this operation, the entire equipment shall be thoroughly cleaned.

Before Subsection 907-804.03.15 on page 7, add the following.

**907-804.03.14.2--Stay-In-Place Metal Forms.** Delete the sentence in Subsection 804.03.14.2 on page 871 and substitute the following.

Stay-in-place (SIP) metal forms are corrugated metal sheets permanently installed between the supporting superstructure members. After the concrete has cured, these forms shall remain in place as permanent, non-structural members of the bridge.

Pay quantities for bridge deck concrete will be computed from the dimensions shown in the Contract Plans with no allowance for changes in deflection and /or changes in dimensions necessary to accommodate the SIP metal forms.

There will be no direct payment for the cost of the forms and form supports, or any material, tools, equipment, or labor incidental thereto, but the cost shall be considered absorbed in the contract unit price for bridge deck concrete.

Before fabricating any material, three (3) complete sets of SIP metal form shop drawings and design calculations, bearing the Design Engineer's Seal, shall be submitted to the Director of Structures, State Bridge Engineer, through the Project Engineer, for review. The Contractor's SIP metal form Design Engineer shall be a MS Registered Professional Engineer who is knowledgeable in the field of structural design.

In no case shall additional dead load produced by the use of SIP metal forms overstress any bridge component. Design calculations shall indicate any additional dead load from SIP metal form self-weight, form support hangers, concrete in flutes, concrete due to form deflection, etc. not included in the Contract Plans. The additional dead loads shall be clearly labeled and tabulated on the shop drawings. Bridge Division will evaluate the additional load for overstress of the bridge components. In the event that the additional dead load produces an overstress in any bridge component, Bridge Division will reject the Contractor's design. Deflection and loads produced by deflection of the SIP metal forms shall be considered and indicated in the design calculations.

The cambers and deflections provided in the Contract Plans do not consider the effects of SIP metal forms. The Contractor's Engineer shall take into account the weight of the forms and any additional dead load when developing the "Bridge Superstructure Construction Plan".

For the purpose of reducing any additional dead load produced by the SIP metal forms, the flutes of SIP metal forms may be filled with polystyrene foam. When polystyrene foam is used to fill the forms, the form flutes shall be filled completely; no portion of the polystyrene foam shall extend beyond the limits of the flutes. The Contractor shall ensure that the polystyrene foam remains in its required position within flutes during the entire concrete placement process. The Contractor shall not use reinforcing steel supports or other accessories in such a manner as to cause damage to the polystyrene foam. All damaged polystyrene foam shall be replaced to the satisfaction of the Project Engineer. All welding of formwork shall be completed prior to placement of polystyrene foam.

For bridges not located in horizontal curves, the Contractor may reduce the additional dead load by matching the flute spacing with the transverse steel spacing of the bottom layer. The bottom longitudinal layer of steel shall have one (1) inch of minimum concrete cover measured from the bottom of the reinforcing to the top of the flute. The Contractor will not be allowed to vary the reinforcing steel spacing or size from the Contract Plans for the purpose of matching flute spacing.

**907-804.03.14.2.1--Materials.** SIP metal forms and supports shall meet the requirements of ASTM Designation: A653 having a coating designation G165. Form materials that are less than 0.03-inch uncoated thickness shall not be allowed.

**907-804.03.14.2.2--Certification.** The Contractor shall provide written certification from the manufacturer stating the product meets the requirements of this specification to the Project Engineer along with the delivery of the coated forms to the job site.

All welds shall be performed by certified welders meeting the requirements of the approved shop drawings.

**907-804.03.14.2.3--Polystyrene Foam.** The polystyrene foam shall be comprised of expanded polystyrene manufactured from virgin resin of sufficient density to support the weight of concrete without deformation. The polystyrene foam shall be extruded to match the geometry of the flutes and provide a snug fit. The polystyrene foam shall have a density of not less than 0.8 pounds per cubic foot. The polystyrene foam shall have water absorption of less than 2.6% when tested according to ASTM Designation: C272. The Contractor shall provide written certification



from the manufacturer stating the polystyrene foam product meets the requirements of this specification to the Project Engineer along with the delivery of the coated forms to the job site.

**907-804.03.14.2.4--Design.** The design of the SIP metal forms shall meet the following criteria.

1. The maximum self-weight of the stay in place metal forms, plus the weight of the concrete or expanded polystyrene required to fill the form flutes (where used), shall not exceed 20 psf.
2. The forms shall be designed on the basis of dead load of form, reinforcement, and plastic concrete plus 50 pounds per square foot for construction loads. The design shall use a unit working stress in the steel sheet of not more than 0.725 of the specified minimum yield strength of the material furnished, but not to exceed 36,000 psi.
3. Deflection under the weight of the forms, reinforcement, and plastic concrete shall not exceed 1/180 of the form span or 1/2 inch, whichever is less, for form spans of 10 feet or less, or 1/240 of the form span or 3/4 inch, whichever is less, for form spans greater than 10 feet.
4. The design span of the form shall equal the clear span of the form plus two (2) inches. The span shall be measure parallel to the form flutes.
5. Physical design properties shall be computed in accordance with requirements of the AISI Specifications for the Design of Cold Formed Steel Structural Members, latest published edition.
6. The design concrete cover required by the plans shall be maintained for all reinforcement.
7. The plan dimensions of both layers of primary deck reinforcement from the top surface of the concrete deck shall be maintained.
8. The SIP metal form shall not be considered as lateral bracing for compression flanges of supporting structural members.
9. SIP metal forms shall not be used under closure pours or in bays where longitudinal slab construction joints are located. SIP metal forms shall not be used under cantilevered slabs such as the overhang outside of fascia members.
10. Forms shall be secured to the supporting members by means other than welding directly to the member. Welding to the top flanges of steel stringers and/or girders shall not be allowed. Alternate installation procedures shall be submitted addressing this condition.

**907-804.03.14.2.5--Construction.** SIP metal form sheets shall not rest directly on the top of the stringer or floor beam flanges. Sheets shall be fastened securely to form supports, and maintain a minimum bearing length of one (1) inch at each end for metal forms. Form supports shall be placed in direct contact with the flange of the stringer or floor beam. All attachments for coated metal forms shall be made by bolts, clips, screws, or other approved means.

**907-804.03.14.2.6--Form Galvanizing Repairs.** Where forms or their installation are unsatisfactory in the opinion of the Project Engineer, either before or during placement of the concrete, the Contractor shall correct the defects before proceeding with the construction work. The cost of such corrective work shall be at the sole expense of the Contractor. Minor heat discoloration in areas of welds shall not be touched up.

**907-804.03.14.2.7--Placing of Concrete.** The Contractor shall insure that concrete placement does not damage the SIP metal forms. The concrete shall be vibrated to avoid honeycomb and voids, especially at construction joints, expansion joints, valleys and ends of form sheets. Approved pouring sequences shall be used. Calcium chloride or any other admixture containing chloride salts shall not be used in the concrete. The completed SIP metal form system shall be sufficiently tight to prevent leakage of mortar or concrete.

**907-804.03.14.2.8--Inspection.** The Project Engineer will observe the Contractor's method of construction during all phases of the construction of the bridge deck slab, including the installation of the SIP metal form system; location and fastening of the reinforcement; composition of concrete items; mixing procedures, concrete placement, and vibration; and finishing of the bridge deck. Should the Project Engineer determine that the procedures used during the placement of the concrete warrant inspection of the underside of the deck, at least one section of the metal forms shall be removed in each span for this purpose. This shall be done as soon after placing the concrete as practical in order to provide visual evidence that the concrete mix and the procedures are obtaining the desired results. An additional section shall be removed in any span if the Project Engineer determines that there has been any change in the concrete mix or in the procedures warranting additional inspection.

If, in the Project Engineer's judgment, inspection is needed to check for defects in the bottom of the deck or to verify soundness, the SIP metal forms shall be sounded with a hammer after the deck concrete has been in place a minimum of two days. If sounding discloses areas of doubtful soundness to the Project Engineer, the SIP metal forms shall be removed from such areas for visual inspection after the concrete has attained adequate strength. The SIP metal bridge deck forms shall be removed at no expense to the State.

At locations where sections of the metal forms have been removed, the Project Engineer will not require the Contractor to replace the metal forms. The adjacent metal forms and supports shall be repaired to present a neat appearance and to ensure their satisfactory retention. As soon as the form is removed, the Project Engineer will examine the concrete surfaces for cavities, honeycombing, and other defects. If irregularities are found and the Project Engineer determines that these irregularities do not justify rejection of the work, the concrete shall be repaired as directed by the Project Engineer. If the Project Engineer determines that the concrete where the form is removed is unsatisfactory, additional metal forms as necessary shall be removed to inspect and repair the slab, and the Contractor's method of construction shall be modified as required to obtain satisfactory concrete in the slab. All unsatisfactory concrete shall be removed and replaced as directed at no expense to the State.

If the method of construction and the results of the inspections as outlined above indicate that sound concrete has been obtained throughout the slabs, the amount of sounding and form removal may be reduced when approved by the Project Engineer.

The Contractor shall provide a safe and convenient means of conducting of the inspection.

Delete Table 6 of Subsection 907-804.03.15 on page 8, and substitute the following.

**Table 6**  
**Minimum Compressive Strength Requirements for Form Removal**

**Forms:**

Columns .....	1000 psi
Side of Beams .....	1000 psi
Walls not under pressure .....	1000 psi
Other Parts .....	1000 psi

**Centering:**

Under Beams .....	2400 psi
Under Bent Caps .....	2000 psi

**Limitation for Placing Beams on:**

Pile Bents, pile under beam .....	2000 psi
Frame Bents, two or more columns .....	2200 psi
Frame Bents, single column .....	2400 psi

Forms for bridge deck slabs overhead and bridge deck slabs between beams shall be removed with the approval of the Engineer, between two weeks and four weeks after the removal of the wet burlap applied in accordance with Subsection 907-804.03.17.1, or application of liquid membrane applied in accordance with Subsection 907-804.03.17.2.

Delete the second paragraph of Subsection 907-804.03.16.1 on page 9, and substitute the following.

At the option of the Contractor with the approval of the Engineer, when concrete is placed during cold weather and there is a probability that the ambient temperatures will be lower than 40°F, an approved maturity meter may be used to determine concrete strengths by inserting probes into concrete placed in a structure. The minimum number of maturity meter probes required for each structural component shall be in accordance with Table 7. An approved insulating blanketing material shall be used to protect the work when ambient temperatures are less than 40°F and shall remain in place until the required concrete strength in Table 6 is achieved. Within 30 minutes of removal of the insulating blanketing material in any area, the Contractor shall have curing of the concrete established in accordance with the requirements in Subsection 907-804.03.17. Procedures for using the maturity meter and developing the strength/maturity relationship shall follow the requirements of AASHTO Designation: T 325 and ASTM Designation: C 1074 specifications. Technicians using the maturity meter or calculating strength/maturity graphs shall be required to have at least two hours of training prior to using the maturity equipment.

Before Subsection 907-804.03.19 on page 9, add the following.

**907-804.03.17--Curing Concrete.** Delete Subsection 804.03.17 on pages 874 & 875, and substitute the following.

Curing is defined as all actions taken to ensure the moisture and temperature conditions of freshly placed concrete exist so the concrete may develop its potential properties. Curing shall take place from the time of placement until its potential properties have developed. The Contractor shall use the guidance in ACI 308R-01 to:

- a) cure the concrete in such a manner as to prevent premature moisture loss from the concrete,
- b) supply additional moisture to the concrete as required in order to ensure sufficient moisture within the concrete, and
- c) maintain a concrete temperature beneficial to the concrete.

Curing in accordance with the requirements in either Subsection 907-804.03.17.1 or Subsection 907-804.03.17.2 shall be completely established within 20 minutes after finishing, except as noted for bridge decks. Finishing is complete when the pan drag, burlap drag, or other is complete.

The length of time for curing shall be maintained in accordance with either of the following:

**1. Prescribed Length of Time:**

- a) Curing following the requirements of Subsection 804.03.17.1 shall continue uninterrupted for at least 14 days.
- b) Curing following the requirements of Subsection 804.03.17.2 shall continue uninterrupted for at least 10 days.

OR

**2. Length of Time Defined by Development of Compressive Strength:**

Curing following the application requirements of Subsection 907-804.03.17.1 or Subsection 907-804.03.17.2 shall continue uninterrupted for each day's production until the compressive strength of the concrete exceeds 75% of the 28-day compressive strength submitted as the Basis of Proportioning per Subsection 907-804.02.10.1. Therefore, if an area is being cured in accordance with Subsection 907-804.03.17.1, the curing by wet burlap shall continue until the concrete in that area has attained a minimum of 75% of the 28-day compressive strength submitted as the Basis of Proportioning per Subsection 907-804.02.10.1. Likewise, if an area is being cured in accordance with Subsection 907-804.03.17.2, the curing by liquid membrane shall continue until the concrete in that area has attained a minimum of 75% of the 28-day compressive strength submitted as the Basis of Proportioning per Subsection 907-804.02.10.1.

The compressive strength of the concrete may be determined by the use of maturity meter in accordance with Subsection 907-804.03.15.

**907-804.03.17.1--Water With Waterproof Cover.** All burlap shall be completely saturated and wet prior to placing it on the concrete. The burlap shall have been fully soaked in water for a minimum of 12 hours prior to placement on the concrete.

For bridge decks, the Contractor shall apply one (1) layer of saturated burlap within 20 minutes of the initial strike-off for bridges without a skew and 25 minutes of the initial strike-off for bridges with a skew. For all other concrete, the Contractor shall apply one (1) layer of saturated burlap within 20 minutes of completing finishing.

Following the first layer of burlap, the Contractor shall apply a second layer of saturated burlap within five (5) minutes of applying the first layer. The concrete surface shall not be allowed to dry after strike-off or at any time during the curing period.

The Contractor shall maintain the burlap in a fully wet condition using powered fogging equipment capable of producing a fog spray of atomized droplets of water until the concrete has gained sufficient strength to allow foot traffic without the foot traffic marring the surface of the concrete. Burlap shall not be maintained in the fully wet condition using equipment which does not produce a fog spray of atomized droplets of water or by use of manually pressurized sprayers. For bridge decks, once the concrete has gained sufficient strength to allow foot traffic which does not mar the surface of the concrete, soaker hoses shall be placed on the burlap. The soaker hoses shall then be supplied with running water continuously to maintain continuous saturation of all burlap and the entire concrete surface.

If there is a delay in the placement of the first layer of saturated burlap outside the time limit, the struck-off and finished concrete shall be kept wet by use of the powered fogging equipment used to keep the burlap wet.

White polyethylene sheets shall be placed on top of the wet burlap and, as applicable, soaker hoses covering the entire concrete surface as soon as practical and not more than 12 hours after the placement of the concrete. White polyethylene sheets of the widest practical width shall be used, overlapping adjacent sheets a minimum of six inches (6") and tightly sealed with an adhesive like pressure sensitive tape, mastic, glue, or other approved methods to form a complete waterproof cover of the entire concrete surface. White polyethylene sheets which overlap a minimum of two feet (2') may be held in place using means other than an adhesive. The white polyethylene sheets shall be secured so that wind will not displace them. The Contractor shall immediately repair the broken or damaged portions or replace sections that have lost their waterproof qualities.

If burlap and/or white polyethylene sheets are temporarily removed for any reason during the curing period, the Contractor shall keep the entire exposed area continuously wet. The saturated burlap and white polyethylene sheets shall be replaced, resuming the specified curing conditions, as soon as possible.

The Contractor shall inspect the concrete surface once every 8 hours for the entirety of the curing period, so that all areas remain wet for the entire curing period and all curing requirements are satisfied and document the inspection in accordance with Subsection 907-804.03.17.1.1.

At the end of the curing period, one coating of liquid membrane shall be applied following the requirements of Subsection 907-804.03.17.1.2. The purpose of the coating of liquid membrane is

to allow for slow drying of the concrete. The application of liquid membrane to any area shall be complete within 30 minutes of the beginning of removal of the white polyethylene sheets, soaker hoses, and burlap from this area.

**907-804.03.17.1.1--Documentation.** The Contractor shall provide the Engineer with a daily inspection report that includes:

- documentation that identifies any deficiencies found (including location of deficiency);
- documentation of corrective measures taken;
- a statement of certification that all areas are wet and all curing material is in place on the entire bridge deck;
- documentation showing the time and date of all inspections and the inspector's signature;
- documentation of any temporary removal of curing materials including location, date and time, length of time curing was removed, and means taken to ensure exposed area was kept continuously wet.

**907-804.03.17.1.2--Liquid Membrane.** At the end of the 14-day wet curing period the wet burlap and polyethylene sheets shall be removed and within 30 minutes, the Contractor shall apply white liquid membrane to the deck. The liquid membrane shall be thoroughly mixed within the time recommended by the liquid membrane producer but no more than an hour before use. If the use of liquid membrane results in a streaked or blotched appearance, the method shall be stopped and water curing applied until the cause of defective appearance is corrected.

The liquid membrane shall be applied when no free water remains on the surface but while the surface is still wet. The liquid membrane shall be applied according to the manufacturer's instructions with a minimum spreading rate per coat of one (1) gallon per 200 square feet of concrete surface. If the concrete is dry or becomes dry, the Contractor shall thoroughly wet it with water applied as a fog spray by means of approved equipment.

The application of liquid membrane shall be accomplished by the use of power applied spray equipment using nozzles and other equipment recommended by the liquid membrane producer. Manually pressurized or manual pump-up type sprayers shall not be used to apply the first application of liquid membrane.

As a visual guide, the color of concrete covered with the required amount of liquid membrane should be indistinguishable from a sheet of commercially available standard "letter" size white copier paper placed on top of it when viewed from a distance of about five feet (5') away horizontally if standing on the same grade as the concrete. The appearance of the concrete does not supersede applying the minimum spreading rate.

The coating shall be protected against marring for at least seven (7) days after the application of the curing compound. The coating on bridge decks shall receive extra attention and may require additional protection as required by the Engineer. All membrane marred or otherwise disturbed shall be given an additional coating. Manually pressurized or manual pump-up type sprayers may be used for giving marred areas the required additional application of liquid membrane. Should the surface coating be subjected repeatedly to injury, the Engineer may require that the water curing method be applied at once.

The 7-day period during which the liquid membrane is applied and protected shall not be reduced even if the period of wet curing is extended past the required 14 days.

**907-804.03.17.1.2.1--Liquid Membrane Documentation.** The Contractor shall make available to the Engineer an application rate verification method and any information necessary during application of the liquid membrane to verify that the rate of application meets the prescribed rate for the various surfaces of the concrete, including, but not limited to, the top surface of the bridge deck and exposed sides of the bridge deck after any forms are removed. The Contractor shall submit this application verification method to the Engineer in accordance with Subsection 907-804.02.12.1.1.

One method of verifying the rate of application is as follows:

1. Determine the volume of liquid membrane in the container. For a container with a uniform cross-sectional area, for example a 55-gallon drum, determine the area of the cross-section. Determine the height of the surface of the liquid membrane from the bottom of the container. This may be accomplished by inserting a sufficiently long, clean dip-stick parallel with the axis of the container into the liquid membrane until the inserted end of the dip-stick contacts the bottom of the container. On removing the dip-stick, measure the length from the end which was inserted to the point on the dip-stick where the liquid membrane ceases to coat the dip-stick. Multiply the area of the cross-section by the height of the level of liquid membrane, maintaining consistent units, to determine the volume.
2. Perform step 1 prior to beginning applying the liquid membrane to establish the initial volume.
3. During the period of application, perform step 1 each 100 square feet of bridge deck.
4. In order to meet the required application rate of one (1) gallon per 200 square feet, the amount in the container shall be at least 0.5 gallon less than the previous volume in the previous 100 square feet. Other changes in volume may apply depending on the manufacturer's recommended application rate.
5. Additional applications to an area shall be applied until the required rate is satisfied. Areas which are not visually satisfactory to the Engineer shall have additional liquid membrane applied as directed by the Engineer.

The amount of liquid membrane applied shall be determined each day using the application verification method. This information shall be submitted to the Engineer within 24 hours of applying the liquid membrane.

**907-804.03.17.2--Liquid Membrane Method.** Surfaces on which curing is to be by liquid membrane shall be given the required surface finish prior to the application of liquid membrane. Concrete surfaces cured by liquid membrane shall receive two applications of white liquid membrane. Neither application shall be made from a position supported by or in contact with the freshly placed concrete. Both applications shall be applied perpendicularly to the surface of the concrete.

When using liquid membrane, the liquid membrane shall be thoroughly mixed within the time recommended by the liquid membrane producer but no more than an hour before use. If the use of liquid membrane results in a streaked or blotched appearance, the method shall be stopped and water curing applied until the cause of defective appearance is corrected.

The application of liquid membrane shall be accomplished by the use of power applied spray equipment using nozzles and other equipment recommended by the liquid membrane producer. Manually pressurized or manual pump-up type sprayers shall not be used to apply the first two applications of liquid membrane.

The liquid membrane shall be applied when no free water remains on the surface but while the surface is still wet. The liquid membrane shall be applied according to the manufacturer's instructions with a minimum spreading rate per coat of one (1) gallon per 200 square feet of concrete surface. If the concrete is dry or becomes dry, the Contractor shall thoroughly wet it with water applied as a fog spray by means of approved equipment.

The first application of the liquid membrane shall be made as the work progresses. For bridge decks, the first application shall be completed in each area of the deck within 20 minutes of initial strike-off for bridges with no skew and within 25 minutes of initial strike-off for bridges with skew. For all other concrete, the first application of the liquid membrane shall be completed within 20 minutes of finishing.

The second application shall be applied within 30 minutes after the first application. The liquid membrane shall be uniformly applied to all exposed concrete surfaces.

As a visual guide, the color of concrete covered with the required amount of liquid membrane should be indistinguishable from a sheet of commercially available standard "letter" size white copier paper placed on top of it when viewed from a distance of about five feet (5') away horizontally if standing on the same grade as the concrete. The appearance of the concrete does not supersede applying the minimum spreading rate.

The Contractor shall make available to the Engineer an application rate verification in accordance with Subsection 907-804.03.17.1.2.1.

The coating shall be protected against marring for at least 10 days after the application of the curing compound. The coating on bridge decks shall receive extra attention and may require additional protection as required by the Engineer. All membrane marred or otherwise disturbed shall be given an additional coating. Manually pressurized or manual pump-up type sprayers may be used for giving marred areas the required additional application of liquid membrane. Should the surface coating be subjected repeatedly to injury, the Engineer may require that the water curing method be applied at once.

Delete Subsection 907-804.19.7 on page 9, and substitute the following.

**907-804.03.19.7--Finishing Bridge Decks.**

**907-804.03.19.7.1--General.** Delete the third paragraph of Subsection 804.03.19.7.1 on page 884, and substitute the following.

Except when indicated otherwise on the plans, the finish of the bridge deck shall be either a belt finish, a broom finish, or one of the following drag methods: pan, double pan, burlap, or pan and burlap. Manual finishing of the bridge deck shall be performed only in areas inaccessible by the



finishing equipment mounted to the strike-off screed, but shall not hinder the requirements for curing in accordance with Subsection 907-804.03.17.1. The surface texture specified and surface requirements shall be in accordance with the applicable requirements of Subsections 501.03.17 and 501.03.18 modified only as the Engineer deems necessary for bridge deck construction operations.

At no time shall water on the surface of the concrete from bleeding, fogging, curing, or other sources be worked into the concrete or used as an aid for finishing.

Regardless of the method of finishing selected, requirements for curing per Subsection 907-804.03.17 shall be completed within the specified time limits. If the requirements in Subsection 907-804.03.17 are not completed within the specific time limits, the Contractor shall cease operations, revise his operations up to and including acquiring new or additional equipment or additional personnel in order to satisfy the requirements in Subsection 907-804.03.17, and, on approval from the Engineer, resume operations

**907-804.03.19.7.2--Longitudinal Method.** Before the first paragraph of Subsection 804.03.19.7.2 on page 884, add the following.

The longitudinal method may be used for repairs to bridge decks or bridge widening projects. For bridge widening projects, the time for establishing curing in accordance with Subsections 907-804.03.17 shall be increased to within 30 minutes for bridges without skew and within 35 minutes for bridges with skew.

**907-804.03.19.7.3--Transverse Method.** Delete the first sentence of the second paragraph of Subsection 804.03.19.7.3 on page 885, and substitute the following.

The machine shall be so constructed and operated as to produce a bridge deck of uniform density with minimum manipulation of the fresh concrete and achieved in the shortest possible time.

Delete the fourth paragraph of Subsection 804.03.19.7.3 on page 885, and substitute the following.

At least one dry run shall be made the length of each pour with a "tell-tale" device attached to the screed carriage to assure the specified clearance to the reinforcing steel.

Delete the last sentence of the fifth paragraph of Subsection 804.03.19.7.3 on page 885, and substitute the following.

The screed shall be mechanically actuated to deliver the screeding action and for travel in a longitudinal direction at a uniform rate along the bridge deck.

Delete the last paragraph of Subsection 804.03.19.7.3 on page 886, and substitute the following.

Other finishing requirements shall be in accordance with the general requirements in Subsection 907-804.03.19.7.1 and as specified on the plans.

Regardless of the finish, the requirements for curing per Subsection 907-804.03.17 shall be completed within the specified time limits.

**907-804.03.19.7.4--Acceptance Procedure for Bridge Deck Smoothness.** Delete the third sentence of the first paragraph of Subsection 804.03.19.7.4 on page 886, and substitute the following.

The profilograph shall meet the requirements of Subsection 907-804.03.19.7.5.

After the fourth sentence of the first paragraph of Subsection 804.03.19.7.4 on page 886, add the following.

The wheel paths shall be designated as being located three feet (3') and nine feet (9') from centerline or longitudinal joint, respectively.

After the first sentence of the second paragraph of Subsection 804.03.19.7.4 on page 886, add the following.

Auxiliary lanes, tapers, shoulders and other areas that are not checked with the profilograph, shall meet a 1/8 inch in 10-foot straightedge check made transversely and longitudinally across the deck or slab.

After Subsection 907-804.03.19.7.4 on page 9, add the following.

Delete the title of Subsection 804.03.19.7.4.1.3 on page 888, and substitute the following.

**907-804.03.19.7.4.1.3--Final Surface Texture.**

Delete the first sentence of the second paragraph of Subsection 804.03.19.7.4.1.3 on page 889 and substitute the following.

The finished bridge decks and bridge end slabs shall be retested for riding quality using a Contractor furnished profilograph meeting the requirements of Subsection 907-804.03.19.7.5.

After Subsection 804.03.19.7.4.1.3 on page 889, add the following.

**907-804.03.19.7.5--Profilograph Requirements.** The smoothness of the bridge deck will be determined by using a California Profilograph to produce a profilogram (profile trace) at each designated location. The surface shall be tested and corrected to a smoothness index as described herein with the exception of those locations or specific projects that are excluded from a smoothness test with the profilograph.

The profilograph, furnished and operated by the Contractor under supervision of the Engineer, shall consist of a frame at least 25 feet in length supported upon multiple wheels having no common axle. The wheels shall be arranged in a staggered pattern so that no two wheels will simultaneously cross the same bump. A profile is to be recorded from the vertical movement of a sensing mechanism. This profile is in reference to the mean elevation of the contact points established by the support wheels. The sensing mechanism, located at the mid-frame, may

consist of a single bicycle-type wheel or a dual-wheel assembly consisting of either a bicycle-type (pneumatic tire) or solid rubber tire vertical sensing wheel and a separate bicycle-type (pneumatic tire) longitudinal sensing wheel. The wheel(s) shall be of such circumference(s) to produce a profilogram recorded on a scale of one (1) inch equal to 25 feet longitudinally and one (1) inch equal to one (1) inch (full scale) vertically. Motive power may be provided manually or by the use of a propulsion unit attached to the center assembly. In operation, the profilograph shall be moved longitudinally along the pavement at a speed no greater than 3 MPH so as to reduce bounce as much as possible. The testing equipment and procedure shall comply with the requirements of Department SOP.

The Contractor may elect to use a computerized version of the profilograph in lieu of the standard profilograph. If the computerized version of the profilograph is used, it shall meet the requirements of Subsection 907-804.03.19.7.5.1.

**907-804.03.19.7.5.1--Computerized Profilograph.**

**907-804.03.19.7.5.1.1--General** The computerized profilograph, furnished and operated by the Contractor under the supervision of the Engineer, shall be equipped with an on-board computer capable of meeting the following conditions.

Vertical displacement shall be sampled every three (3) inches or less along the bridge deck. The profile data shall be bandpass filtered in the computer to remove all spatial wavelengths shorter than two (2) feet. This shall be accomplished by a third order, low pass Butterworth filter. The resulting band limited profile will then be computer analyzed according to the California Profilograph reduction process to produce the required inches per mile index. This shall be accomplished by fitting a linear regression line to the length of bridge. This corresponds to the perfect placement of the blanking band bar by a human trace reducer. Scallops above and below the blanking band are then detected and totaled according to the California protocol. Bump/Dip analysis shall take place according to the California Profilograph reduction process.

The computerized profilograph shall be capable of producing a plot of the profile and a printout which will give the following data: Stations every twenty five (25) feet, bump/dip height and bump/dip length of specification (3/10 of an inch and 25 feet respectively), the blanking band width, date of measurement, total profile index in inches per mile for the measurement, total length of the measurement, and the raw inches for each segment.

**907-804.03.19.7.5.1.2--Mechanical Requirements.** The profilograph shall consist of a frame twenty five (25) feet long supported at each end by multiple wheels. The frame shall be constructed to be easily dismantled for transporting. The profilograph shall be constructed from aluminum, stainless steel and chromed parts. The end support wheels shall be arranged in a staggered pattern such that no two wheels cross a transverse joint at the same time. The relative smoothness shall be measured by the vertical movement of an eight (8) inch or larger diameter sensing wheel at the midpoint of the 25-foot frame. The horizontal distance shall be measured by a twenty (20) inch or larger diameter pneumatic wheel. This profile shall be the mean elevation referenced to the twelve points of contact with the pavement established by the support wheels. Recorded graphical trace of the profile shall be on a scale of one inch equals one inch (full scale) vertical motion of the sensing wheel and one inch equals 25 feet horizontal motion of the profilograph.

**907-804.03.19.7.5.1.3--Computer Requirements.** The computer shall have the ability to produce output on sight for verification. The computerized output shall indicate the profile index for each specified section of bridge deck. Variable low and high pass third-order Butterworth filtering options shall be available. The printout shall be capable of showing station marks automatically on the output. Blanking band positioning for each specified section of the bridge deck shall be placed according to the least squares fit line of the collected data. Variable bump and dip tests shall be available to show “must correct” locations on the printout. The computer must have the ability to display on screen “must correct” conditions and alert the user with an audible warning when a “must correct” location has been located. The computer must have the ability to store profile data for later reanalysis. The measurement program must be menu driven and PC compatible. User selected options, identification, calibration factors, and time and date stamps shall be printed at the top of each printed report for verification. The control software must be upgradeable. A power source shall be included for each profilograph and be capable of supplying all power needs for a full days testing.

**907-804.03.20--Opening Bridges.**

**907-804.03.20.2--Construction Traffic.** Delete the paragraph in Subsection 804.03.20.2 on page 889, and substitute the following:

Unless otherwise specified, the concrete bridge decks shall be closed to construction traffic for the time required for curing in Subsection 907-804.03.17 and until the required compressive strength for the concrete is obtained.

**MISSISSIPPI DEPARTMENT OF TRANSPORTATION**

**SPECIAL PROVISION NO. 907-804-13**

**CODE: (IS)**

**DATE: 11/09/2010**

**SUBJECT: Concrete Bridges And Structures**

Section 804, Concrete Bridges And Structures, of the 2004 Edition of the Mississippi Standard Specifications for Road and Bridge Construction is hereby amended as follows:

**907-804.02-- Materials.**

**907-804.02.1--General.** Delete the third and fourth sentences of the first paragraph of Subsection 804.02.1 on page 846, and substitute the following:

For projects with 1000 cubic yards and more, quality control and acceptance shall be achieved through statistical evaluation of test results. For projects of more than 200 but less than 1000 cubic yards, quality control and acceptance shall be achieved by individual test results.

Add the following materials to the list of materials in Subsection 804.02.1 on page 847.

Blended Cement..... 907-701.01 and 907-701.04  
 Ground Granulated Blast Furnace Slag (GGBFS)..... 907-714.06  
 Silica Fume ..... 907-714.07.2

**907-804.02.8--Laboratory Accreditation.** In Table 1 of Subsection 804.02.8 on page 849, substitute AASHTO: R 39 - Making and Curing Concrete Test Specimens in the Laboratory for AASHTO: T 126 - Making and Curing Concrete Test Specimens in the Laboratory.

**907-804.02.9--Testing Personnel.** Delete Table 2 in this subsection and replace it with the following.

**Table 2**

<b>Concrete Technician's Tasks</b>	<b>Test Method Required</b>	<b>Certification Required**</b>
Sampling or Testing of Plastic Concrete	AASHTO Designation:T 23, T 119, T 121, T 141, T 152, T 196, and ASTM Designation: C 1064	MDOT Class I certification
Compressive Strength Testing of Concrete Cylinders	AASHTO Designation: T 22 and T 231	MDOT Concrete Strength Testing Technician certification
Sampling of Aggregates	AASHTO Designation: T 2	Work under the supervision of an MDOT Class II certified technician

Testing of Aggregates	AASHTO Designation: T 19, T 27, T 84, T 85, T 248, and T 255	MDOT Class II certification
Proportioning of Concrete Mixtures*	AASHTO Designation: M 157 and R 39	MDOT Class III
Interpretation and Application of Maturity Meter Readings	AASHTO Designation: T 325 and ASTM Designation: C 1074	MDOT Class III or Two hours maturity method training

- \* Technicians making concrete test specimens for meeting the requirements of Subsection 804.02.10.1.2 shall be MDOT Class I certified and under the direct supervision of an MDOT Class III certified technician.
- \*\* MDOT Class I certification encompasses the same test procedures and specifications as ACI Concrete Field Testing Technician Grade I. MDOT Class II certification encompasses the same test procedures and specifications as ACI Aggregate Testing Technician - Level 1. MDOT Concrete Strength Testing Technician encompasses the same test procedures and specifications as ACI Concrete Strength Testing certification.

For specifics about the requirements for each level of certification, please refer to the latest edition of the Department’s *Concrete Field Manual*. Technicians holding current MDOT Class I, MDOT Class II and/or MDOT Class III certifications shall be acceptable until those certifications expire. Upon a current certification expiration, recertification with the certifications listed in Table 2 shall be required. Technicians currently performing either specific gravity testing of aggregates or compressive strength tests shall be required to either:

- have the required MDOT certification listed in Table 2, or
- have a current MDOT Class III certification or work under the direct supervision of current MDOT Class III technician, and have demonstrated the specific gravity and/or compressive strength test during the inspection of laboratory equipment by the Materials Division, Concrete Section.

**907-804.02.10--Portland Cement Concrete Mix Design.** Delete the first sentence of the first paragraph of Subsection 804.02.10 on page 850 and substitute the following:

At least 30 days prior to production of concrete, the Contractor shall submit to the Engineer proposed concrete mixture designs complying with the Department’s *Concrete Field Manual*.

Delete the Notes under Table 3 of Subsection 804.02.10 on pages 850 & 851, and substitute the following:

- \* Maximum size aggregate shall conform to the concrete mix design for the specified aggregate.
- \*\* The replacement limits of Portland cement by weight by other cementitious materials (such as fly ash, GGBFS, metakaolin, silica fume, or others) shall be in accordance with the values in Subsection 907-701.02. Other hydraulic cements may be used in accordance with the specifications listed in Section 701.

\*\*\* The slump may be increased up to eight (8) inches with :

- an approved water-reducing admixture,
- an approved water-reducing/set-retarding admixture, or
- a combination of an approved water-reducing admixture and an approved set-retarding admixture, in accordance with 907-713.02. Minus slump requirements shall meet those set forth in Table 3 of AASHTO Designation: M157.

\*\*\*\* Entrained air is not required except for concrete exposed to seawater. For concrete exposed to seawater, the total air content shall be 3.0 % to 6.0%. For concrete not exposed to seawater, the total air content shall not exceed 6.0%.

\*\*\*\*\* Class DS Concrete for drilled shafts shall have an 8±1-inch slump.

Delete the last paragraph of Subsection 804.02.10 on page 851 and substitute the following:

At least one water-reducing admixture shall be used in all classes of concrete in accordance with the manufacturer's recommended dosage range. Any combinations of admixtures shall be approved by the Engineer before their use.

**907-804.02.10.1.1--Proportioning on the Basis of Previous Field Experience of Trial Mixtures.** Delete the first sentence of the first paragraph of Subsection 804.02.10.1.1 on page 851, and substitute the following:

Where a concrete production facility has a record, based on at least 10 consecutive strength tests from at least 10 different batches within the past 12 months from a mixture not previously used on Department projects, the standard deviation shall be calculated.

**907-804.02.10.3--Field Verification of Concrete Mix Design.** Delete the first sentence of the third paragraph of Subsection 804.02.10.3 on page 853 and substitute the following:

For all Classes of concrete, the mixture shall be verified to yield within 2.0% of the correct volume when all the mix water is added to the batch.

For all Classes of concrete other than DS, F, and FX, the mixture shall produce a slump within a minus 1½-inch tolerance of the maximum permitted for mixtures with a maximum permitted slump of three inches (3") or less or within a minus 2½-inch tolerance of the maximum permitted for mixtures with a maximum permitted slump of greater than three inches (3"), and producing a total air content within a minus 1½ percent tolerance of the maximum allowable air content in Table 3.

For Class DS, the slump shall be within the requirements in Note \*\*\*\*\* below Table 3. For Class DS exposed to seawater, the total air content shall be within a minus 1½ percent tolerance of the maximum allowable air content in Note \*\*\*\* below Table 3. For Class DS not exposed to seawater the total air content shall be within the requirements in Note \*\*\*\* below Table 3.

For Classes F and FX, the slump shall be within a minus 1½-inch tolerance of the maximum permitted for mixtures with a maximum permitted slump of three inches (3") or less or within a minus 2½-inch tolerance of the maximum permitted for mixtures with a maximum permitted

slump of greater than three inches (3"). For Classes F and FX exposed to seawater, the total air content shall be within a minus 1½ percent tolerance of the maximum allowable air content in Note \*\*\*\* below Table 3. For Classes F and FX not exposed to seawater the total air content shall be within the requirements in Note \*\*\*\* below Table 3.

Delete the third sentence of the third paragraph of Subsection 804.02.10.3 on page 853, and substitute the following:

If the requirements of yield, slump, or total air content are not met within three (3) production days after the first placement, subsequent field verification testing shall not be permitted on department projects, and the mix design shall not be used until the requirements listed above are met

**907-804.02.10.4--Adjustments of Mixture Proportions.** Delete the paragraph in Subsection 804.02.10.4 on page 854, and substitute the following:

The mixture may be adjusted by the Class III Certified Technician representing the Contractor in accordance with the allowable revisions listed in the Department's Concrete Field Manual, paragraph 5.7. Written notification shall be submitted to the Engineer a minimum of seven (7) days prior to any source or brand of material change, aggregate size change, allowable material type change, or decrease in any cementitious material content. Any adjustments of the concrete mixture design shall necessitate repeat of field verification procedure as described in Subsection 804.02.10.3 and approval by the Engineer.

**907-804.02.11--Concrete Batch Plants.** Delete the first three paragraphs of Subsection 804.02.11 on page 854, and substitute the following:

The concrete batch plant shall meet the requirements of the National Ready Mixed Concrete Association *Quality Control Manual, Section 3, Plant Certification Checklist* as outlined in the latest edition of the Department's *Concrete Field Manual*. The Contractor shall submit a copy of the approved checklist along with proof of calibration of batching equipment, i.e., scales, water meter, and admixture dispenser, to the Engineer 30 days prior to the production of concrete.

For projects with 1000 cubic yards and more, the concrete batch plant shall meet the requirements for an automatic system capable of recording batch weights. It shall also have automatic moisture compensation for the fine aggregate. For projects of more than 200 but less than 1000 cubic yards the plant can be equipped for manual batching with a fine aggregate moisture meter visible to the plant operator.

The concrete batch plant shall have available adequate facilities to cool concrete during hot weather.

Mixer trucks to be used on the project are to be listed in the checklist and shall meet the requirements of the checklist.

**907-804.02.12--Contractor's Quality Control.** Delete the fourth paragraph of Subsection 804.02.12 on page 854 & 855, and substitute the following:



The Contractor's Quality Control program shall encompass the requirements of AASHTO Designation: M 157 into concrete production and control, equipment requirements, testing, and batch ticket information. The requirement of AASHTO Designation: M 157, Section 11.7 shall be followed except, on arrival to the job site, a maximum of 1½ gallons per cubic yard is allowed to be added. Water shall not be added at a later time. If the maximum permitted slump is exceeded after the addition of water at the job site, the concrete shall be rejected.

**907-804.02.12.3--Documentation.** After the second sentence of the second paragraph of Subsection 804.02.12.3 on page 856, add the following:

Batch tickets and gradation data shall be documented in accordance with Department requirements. Batch tickets shall contain all the information in AASHTO Designation: M157, Section 16 including the additional information in Subsection 16.2 with the following exception: the information listed in paragraphs 16.2.7 and 16.2.8 is not required. Batch tickets shall also contain the concrete producer's permanent unique mix number assigned to the concrete mix design.

**907-804.02.12.5--Non-Conforming Materials.** In Table 4 of Subsection 804.02.12.5 on page 857, delete “/ FM” from the requirements on line B.3.a.

In Table 4 of Subsection 804.02.12.5 on page 857, replace “One set ( two cylinders ) for 0-100 yd<sup>3</sup> inclusive” with “A minimum of one set (two cylinders) for each 100 yd<sup>3</sup>,”

**907-804.02.13--Quality Assurance Sampling and Testing.** Delete subparagraph c) in Subsection 804.02.13 on page 858 and substitute the following:

- c) For concrete, the Contractor's QC and Department's QA testing of concrete compressive strengths compare when using the data comparison computer program with an alpha value of 0.01 for projects with 1000 cubic yards and more; or, strength comparisons are within 990 psi for projects of more than 200 but less than 1000 cubic yards.

In Table 5 of Subsection 804.02.13 on page 858, delete “and FM” from the requirements on line A.3.

Delete Subsection 907-804.02.13.1 beginning on page 859 and substitute the following:

**907-804.02.13.1--Basis of Acceptance.**

**907-804.02.13.1.1--Sampling.** Sampling of concrete mixture shall be performed in accordance with the latest edition of the Department's *Concrete Field Manual*.

**907-804.02.13.1.2--Slump.** Slump of plastic concrete shall meet the requirements of Table 3: MASTER PROPORTION TABLE FOR STRUCTURAL CONCRETE DESIGN. A check test shall be made on another portion of the sample before rejection of any load.

**907-804.02.13.1.3--Air.** Total air content of concrete shall be within the specified range for the class of concrete listed in Table 3: MASTER PROPORTION TABLE FOR STRUCTURAL CONCRETE DESIGN. A check test shall be made on another portion of the sample before rejection of any load.

**907-804.02.13.1.4--Yield.** If the yield of the concrete mix design is more than plus or minus 3% of the designed volume, the mix shall be adjusted by a Class III Certified Technician representing the Contractor to yield the correct volume plus or minus three percent (±3%). If batching of the proportions of the mix design varies outside the batching tolerance range of the originally approved proportions by more than the tolerances allowed in Subsection 804.02.12.1, the new proportions shall be field verified per Subsection 804.02.10.3.

**907-804.02.13.1.5--Temperature.** Cold weather concreting shall follow the requirements of Subsection 907-804.03.16.1. Hot weather concreting shall follow the requirements of Subsection 804.03.16.2 with a maximum temperature of 95°F for Class DS concrete or for concrete mixes containing cementitious materials meeting the requirements of Subsection 907-701.02.2 as a replacement of Portland cement. For other concrete mixes, the maximum concrete temperature shall be 90°F. Concrete with a temperature more than the maximum allowable temperature shall be rejected and not used in Department work.

**907-804.02.13.1.6--Compressive Strength.** Laboratory cured concrete compressive strength tests shall conform to the specified strength ( $f'_c$ ) listed in the specifications. Concrete represented by compressive strength test below the specified strength ( $f'_c$ ) may be removed and replaced by the Contractor. If the Contractor elects not to remove the material, it will be evaluated by the Department as to the adequacy for the use intended. All concrete evaluated as unsatisfactory for the intended use shall be removed and replaced by the Contractor at no additional cost to the Department. For concrete allowed to remain in place, reduction in payment will be as follows:

**Projects with 1000 Cubic Yards and More.** When the evaluation indicates that the work may remain in place, a statistical analysis will be made of the QC and QA concrete test results. If this statistical analysis indicates at least 93% of the material would be expected to have a compressive strength equal to or greater than the specified strength ( $f'_c$ ) and 99.87% of the material would be expected to have a compressive strength at least one standard deviation above the allowable design stress ( $f_c$ ), the work will be accepted. If the statistical analysis indicates that either of the two criteria are not met, the Engineer will provide for an adjustment in pay as follows for the material represented by the test result.

Total Pay on Material in Question = Unit Price - (Unit Price x % Reduction)

$$\% \text{ Reduction} = \frac{(f'_c - X)}{f'_c - (f_c + s)} \times 100$$

where:

$f'_c$  = Specified 28-day compressive strength, psi

- $X$  = Individual compressive strength below  $f'_c$ , psi
- $s$  = standard deviation, psi\*
- $f_c$  = allowable design stress, psi

\* Standard deviation used in the above reduction of pay formula shall be calculated from the applicable preceding compressive strengths test results plus the individual compressive strength below  $f'_c$ . If below  $f'_c$  strengths occur during the project's first ten compressive strength tests, the standard deviation shall be calculated from the first ten compressive strength tests results.

**Projects of More Than 200 but Less Than 1000 Cubic Yards.** When the evaluation indicates that the work may remain in place, a percent reduction in pay will be assessed based on a comparison of the deficient 28-day test result to the specified strength. The Engineer will provide for an adjustment in pay as follows for the material represented by the test result.

Total Pay on Material in Question = Unit Price - (Unit Price x % Reduction)

$$\% \text{ Reduction} = \frac{(f'_c - X)}{f'_c} \times 100$$

where:

- $f'_c$  = Specified 28-day compressive strength, psi
- $X$  = Individual compressive strength below  $f'_c$ , psi

**907-804.03--Construction Requirements.**

**907-804.03.6--Handling and Placing Concrete.**

**907-804.03.6.2--Consolidation.** After the last sentence of Subsection 804.03.6.2 on page 864, add the following:

If the Department determines that there is an excessive number of projections, swells, ridges, depressions, waves, voids, holes, honeycombs or other defects in the completed structure, removal of the entire structure may be required as set out in Subsection 105.12.

**907-804.03.15--Removal of Falsework, Forms, and Housing.** Delete the first sentence of the second paragraph of Subsection 804.03.15 on page 871, and substitute the following:

Concrete in the last pour of a continuous superstructure shall have attained a compressive strength of 2,400 psi, as determined by cylinder tests or maturity meter probe, prior to striking any falsework.

Delete the first sentence of the third paragraph of Subsection 804.03.15 on page 871, and substitute the following:

At the Contractor's option and with the approval of the Engineer, the time for removal of forms may be determined by cylinder tests, in accordance with the requirements listed in Table 6, in which case the Contractor shall furnish facilities for testing the cylinders.

Delete the fourth and fifth paragraphs of Subsection 804.03.15 on pages 871 & 872, and substitute the following:

The cylinders shall be cured under conditions which are not more favorable than those existing for the portions of the structure which they represent.

Delete the table in Subsection 804.03.15 on page 872, and substitute the following:

**Table 6**  
**Minimum Compressive Strength Requirements for Form Removal**

**Forms:**

Columns .....	1000 psi
Side of Beams .....	1000 psi
Walls not under pressure .....	1000 psi
Floor Slabs, overhead .....	2000 psi
Floor Slabs, between beams .....	2000 psi
Slab Spans .....	2400 psi
Other Parts .....	1000 psi

**Centering:**

Under Beams .....	2400 psi
Under Bent Caps .....	2000 psi

**Limitation for Placing Beams on:**

Pile Bents, pile under beam .....	2000 psi
Frame Bents, two or more columns .....	2200 psi
Frame Bents, single column .....	2400 psi

In lieu of using concrete strength cylinders to determine when falsework, forms, and housings can be removed, an approved maturity meter may be used to determine concrete strengths by inserting probes into concrete placed in a structure. The minimum number of maturity meter probes required for each structural component shall be in accordance with Table 7. Falsework, forms, and housings may be removed when maturity meter readings indicate that the required concrete strength is achieved. Procedures for using the maturity meter and developing the strength/maturity relationship shall follow the requirements of AASHTO Designation: T 325 and ASTM Designation: C 1074 specifications. Technicians using the maturity meter or calculating strength/maturity graphs shall be required to have at least two hours of training prior to using the maturity equipment.

**Table 7  
Requirements for use of Maturity Meter Probes**

<b>Structure Component</b>	<b>Quantity of Concrete</b>	<b>No. of Probes</b>
Slabs, beams, walls, & miscellaneous items	0 - 30 yd <sup>3</sup>	2
	> 30 to 60 yd <sup>3</sup>	3
	> 60 to 90 yd <sup>3</sup>	4
	> 90 yd <sup>3</sup>	5
Footings, Columns & Caps	0 - 13 yd <sup>3</sup>	2
	> 13 yd <sup>3</sup>	3
Pavement, Pavement Overlays	1200 yd <sup>2</sup>	2
Pavement Repairs	Per repair or 900 yd <sup>2</sup> Whichever is smaller	2

**907-804.03.16--Cold or Hot Weather Concreting.**

**907-804.03.16.1--Cold Weather Concreting.** After the third paragraph of Subsection 804.03.16.1 on page 873, add the following:

In lieu of the protection and curing of concrete in cold weather, at the option of the Contractor with the approval of the Engineer, when concrete is placed during cold weather and there is a probability of ambient temperatures lower than 40°F, an approved maturity meter may be used to determine concrete strengths by inserting probes into concrete placed in a structure. The minimum number of maturity meter probes required for each structural component shall be in accordance with Table 7. An approved insulating blanketing material shall be used to protect the work when ambient temperatures are less than 40°F and shall remain in place until the required concrete strength in Table 6 is achieved. Procedures for using the maturity meter and developing the strength/maturity relationship shall follow the requirements of AASHTO Designation: T 325 and ASTM Designation: C 1074 specifications. Technicians using the maturity meter or calculating strength/maturity graphs shall be required to have at least two hours of training prior to using the maturity equipment.

Rename the Table in Subsection 804.03.16.1 on page 874 from “Table 6” to “Table 8”.

**907-804.03.19--Finishing Concrete Surfaces.**

**907-804.03.19.7--Finishing Bridge Floors.**

**907-804.03.19.7.4--Acceptance Procedure for Bridge Deck Smoothness.** After the first sentence of the second paragraph of Subsection 804.03.19.7.4 on page 886, add the following:

Auxiliary lanes, tapers, shoulders and other areas that are not checked with the profilograph, shall meet a 1/8 inch in 10-foot straightedge check made transversely and longitudinally across the deck or slab.

**907-804.05--Basis of Payment.** Add the "907" prefix to the pay items listed on page 898.

# SECTION 905 - PROPOSAL

Date \_\_\_\_\_

Mississippi Transportation Commission  
Jackson, Mississippi

Sirs: The following proposal is made on behalf of \_\_\_\_\_  
\_\_\_\_\_ of \_\_\_\_\_

\_\_\_\_\_ for constructing the following designated project(s) within the time(s) hereinafter specified.

The plans are composed of drawings and blue prints on file in the offices of the Mississippi Department of Transportation, Jackson, Mississippi.

The Specifications are the current Standard Specifications of the Mississippi Department of Transportation approved by the Federal Highway Administration, except where superseded or amended by the plans, Special Provisions and Notice(s) to Bidders attached hereto and made a part thereof.

I (We) certify that I (we) possess a copy of said Standard and any Supplemental Specifications.

Evidence of my (our) authority to submit the Proposal is hereby furnished. The proposal is made without collusion on the part of any person, firm or corporation. I (We) certify that I (we) have carefully examined the Plans, the Specifications, including the Special Provisions and Notice(s) to Bidders, herein, and have personally examined the site of the work. On the basis of the Specifications, Special Provisions, Notice(s) to Bidders, and Plans, I (we) propose to furnish all necessary machinery, tools, apparatus and other means of construction and do all the work and furnish all the materials in the manner specified. I (We) understand that the quantities mentioned herein are approximate only and are subject to either increase or decrease, and hereby propose to perform any increased or decreased quantities of work at the unit prices bid, in accordance with the above.

Attached hereto is a certified check, cashier's check or Proposal Guaranty Bond in the amount as required in the Advertisement (or, by law).

**INSTRUCTION TO BIDDERS:** Alternate and Optional Items on Bid Schedule.

1. Two or more items entered opposite a single unit quantity WITHOUT DEFINITE DESIGNATION AS "ALTERNATE ITEMS" are considered as "OPTIONAL ITEMS". Bidders may or may not indicate on bids the Optional Item proposed to be furnished or performed WITHOUT PREJUDICE IN REGARD TO IRREGULARITY OF BIDS.
2. Items classified on the bid schedule as "ALTERNATE ITEMS" and/or "ALTERNATE TYPES OF CONSTRUCTION" must be preselected and indicated on bids. However, "Alternate Types of Construction" may include Optional Items to be treated as set out in Paragraph 1, above.
3. Optional items not preselected and indicated on the bid schedule MUST be designated in accordance with Subsection 102.06 prior to or at the time of execution of the contract.
4. Optional and Alternate items designated must be used throughout the project.

I (We) further propose to perform all "force account or extra work" that may be required of me (us) on the basis provided in the Specifications and to give such work my (our) personal attention in order to see that it is economically performed.

**SECTION 905 -- PROPOSAL (CONTINUED)**

I (We) further propose to execute the attached contract agreement (Section 902) as soon as the work is awarded to me (us), and to begin and complete the work within the time limit(s) provided for in the Specifications and Advertisement. I (We) also propose to execute the attached contract bond (Section 903) in an amount not less than one hundred (100) percent of the total of my (our) part, but also to guarantee the excellence of both workmanship and materials until the work is finally accepted.

I (We) enclose a certified check, cashier's check or bid bond for **five percent (5%) of total bid** and hereby agree that in case of my (our) failure to execute the contract and furnish bond within Ten (10) days after notice of award, the amount of this check (bid bond) will be forfeited to the State of Mississippi as liquidated damages arising out of my (our) failure to execute the contract as proposed. It is understood that in case I am (we are) not awarded the work, the check will be returned as provided in the Specifications.

Respectfully Submitted,

DATE \_\_\_\_\_

\_\_\_\_\_  
Contractor

BY \_\_\_\_\_  
Signature

TITLE \_\_\_\_\_

ADDRESS \_\_\_\_\_

CITY, STATE, ZIP \_\_\_\_\_

PHONE \_\_\_\_\_

FAX \_\_\_\_\_

E-MAIL \_\_\_\_\_

(To be filled in if a corporation)

Our corporation is chartered under the Laws of the State of \_\_\_\_\_ and the names, titles and business addresses of the executives are as follows:

\_\_\_\_\_  
President Address

\_\_\_\_\_  
Secretary Address

\_\_\_\_\_  
Treasurer Address

The following is my (our) itemized proposal.

Overlay SR 18 from Smith County Line East approximately 9 miles, known as State Project No. MP-6018-31(010) / 304810301 in Jasper County.

Line No.	Item Code	Adj Code	Quantity	Units	Description [Fixed Unit Price]
					Roadway Items
0010	202-B053		1,974	Linear Feet	Removal of Guard Rail Including Post, Blockouts & Hardware
0020	202-B076		906	Linear Feet	Removal of Traffic Stripe
0030	202-B078		1,750	Square Yard	Removal of Pavement, All Types and Depths
0040	202-B093		219	Linear Feet	Removal of Curb & Gutter, All Types
0050	406-A001		20,668	Square Yard	Cold Milling of Bituminous Pavement, All Depths
0060	423-A001		16	Mile	Rumble Strips, Ground In
0070	606-B005		1,294	Linear Feet	Guard Rail, Class A, Type 1, 'W' Beam
0080	606-D015		8	Each	Guard Rail, Bridge End Section
0090	606-E002		8	Each	Guard Rail, Terminal End Section, Flared
0100	606-E003		10	Each	Guard Rail, Terminal End Section, Non-Flared
0110	609-D002	(S )	1,302	Linear Feet	Combination Concrete Curb and Gutter Type 2
0120	616-A001	(S )	179	Square Yard	Concrete Median and/or Island Pavement, 4-inch
0130	616-A003	(S )	33	Square Yard	Concrete Median and/or Island Pavement, 10-inch
0140	618-A001		1	Lump Sum	Maintenance of Traffic
0150	618-B001		1	Square Feet	Additional Construction Signs [\$10.00]
0160	619-A1002		32	Mile	Temporary Traffic Stripe, Continuous White
0170	619-A2002		22	Mile	Temporary Traffic Stripe, Continuous Yellow
0180	619-A4006		9	Mile	Temporary Traffic Stripe, Skip Yellow
0190	619-A5001		3,400	Linear Feet	Temporary Traffic Stripe, Detail
0200	619-A6001		3,100	Linear Feet	Temporary Traffic Stripe, Legend
0210	619-A6002		242	Square Feet	Temporary Traffic Stripe, Legend
0220	627-J001		493	Each	Two-Way Clear Reflective High Performance Raised Markers
0230	627-K001		27	Each	Red-Clear Reflective High Performance Raised Markers
0240	627-L001		816	Each	Two-Way Yellow Reflective High Performance Raised Markers
0250	630-F001		44	Each	Delineators, Guard Rail, White
0260	630-G001		4	Each	Type 3 Object Markers, OM-3R, Post Mounted
0270	630-G003		4	Each	Type 3 Object Markers, OM-3L, Post Mounted
0280	635-A001		934	Linear Feet	Vehicle Loop Assemblies
0290	907-407-A001	(A2 )	16,100	Gallon	Asphalt for Tack Coat
0300	907-626-C003		16	Mile	6" Thermoplastic Double Drop Edge Stripe, Continuous White
0310	907-626-D003		5	Mile	6" Thermoplastic Traffic Stripe, Skip Yellow
0320	907-626-E004		11	Mile	6" Thermoplastic Traffic Stripe, Continuous Yellow



Line No.	Item Code	Adj Code	Quantity	Units	Description [Fixed Unit Price]
0330	907-626-G001		272	Linear Feet	Thermoplastic Detail Stripe, Blue-ADA
0340	907-626-G004		6,200	Linear Feet	Thermoplastic Detail Stripe, White
0350	907-626-G005		2,400	Linear Feet	Thermoplastic Detail Stripe, Yellow
0360	907-626-H002		2	Each	Thermoplastic Legend, Blue-ADA Handicap Symbol
0370	907-626-H004		3,100	Linear Feet	Thermoplastic Legend, White
0380	907-626-H005		313	Square Feet	Thermoplastic Legend, White
0390	907-824-PP008		585	Linear Feet	Bridge Repair, Silicone Sealed Joint, Per Plans
<b>ALTERNATE GROUP AA NUMBER 1</b>					
0400	907-304-F002	(GT )	3,600	Ton	Size 610 Crushed Stone Base
<b>ALTERNATE GROUP AA NUMBER 2</b>					
0410	907-304-F003	(GT )	3,600	Ton	3/4" and Down Crushed Stone Base
<b>ALTERNATE GROUP AA NUMBER 3</b>					
0420	907-304-F004	(GT )	3,600	Ton	Size 825B Crushed Stone Base
<b>ALTERNATE GROUP BB NUMBER 1</b>					
0430	907-403-A007	(BA1 )	550	Ton	Hot Mix Asphalt, MT, 19-mm mixture
<b>ALTERNATE GROUP BB NUMBER 2</b>					
0440	907-403-M007	(BA1 )	550	Ton	Warm Mix Asphalt, MT, 19-mm mixture
<b>ALTERNATE GROUP CC NUMBER 1</b>					
0450	907-403-A010	(BA1 )	14,715	Ton	Hot Mix Asphalt, MT, 9.5-mm mixture
<b>ALTERNATE GROUP CC NUMBER 2</b>					
0460	907-403-M006	(BA1 )	14,715	Ton	Warm Mix Asphalt, MT, 9.5-mm mixture
<b>ALTERNATE GROUP DD NUMBER 1</b>					
0470	907-403-B006	(BA1 )	6,000	Ton	Hot Mix Asphalt, MT, 9.5-mm mixture, Leveling
<b>ALTERNATE GROUP DD NUMBER 2</b>					
0480	907-403-N005	(BA1 )	6,000	Ton	Warm Mix Asphalt, MT, 9.5-mm mixture, Leveling

**CONDITIONS FOR COMBINATION BID**

If a bidder elects to submit a combined bid for two or more of the contracts listed for this month's letting, the bidder must complete and execute these sheets of the proposal in each of the individual proposals to constitute a combination bid. In addition to this requirement, each individual contract shall be completed, executed and submitted in the usual specified manner.

Failure to execute this Combination Bid Proposal in each of the contracts combined will be just cause for each proposal to be received and evaluated as a separate bid.

\*\*\*\*\*

**COMBINATION BID PROPOSAL**

I. This proposal is tendered as one part of a Combination Bid Proposal utilizing option \_\_\_\* of Subsection 102.11 on the following contracts:

\* Option to be shown as either (a), (b), or (c).

<u>Project No.</u>	<u>County</u>	<u>Project No.</u>	<u>County</u>
1. _____	_____	6. _____	_____
2. _____	_____	7. _____	_____
3. _____	_____	8. _____	_____
4. _____	_____	9. _____	_____
5. _____	_____	10. _____	_____

A. If option (a) has been selected, then go to II, and sign Combination Bid Proposal.

B. If option (b) has been selected, then complete the following, go to II, and sign Combination Bid Proposal.

SECTION 905 - COMBINATION BID PROPOSAL (Continued)

Project Number	Pay Item Number	Unit	Unit Price Reduction	Total Item Reduction	Total Contract Reduction
1. _____	_____ _____	_____ _____	_____ _____	_____ _____	
2. _____	_____ _____	_____ _____	_____ _____	_____ _____	
3. _____	_____ _____	_____ _____	_____ _____	_____ _____	
4. _____	_____ _____	_____ _____	_____ _____	_____ _____	
5. _____	_____ _____	_____ _____	_____ _____	_____ _____	
6. _____	_____ _____	_____ _____	_____ _____	_____ _____	
7. _____	_____ _____	_____ _____	_____ _____	_____ _____	
8. _____	_____ _____	_____ _____	_____ _____	_____ _____	

SECTION 905 - COMBINATION BID PROPOSAL (Continued)

Project Number	Pay Item Number	Unit	Unit Price Reduction	Total Item Reduction	Total Contract Reduction
9. _____	_____ _____	_____ _____	_____ _____	_____ _____	
10. _____	_____ _____	_____ _____	_____ _____	_____ _____	

C. If option (c) has been selected, then initial and complete one of the following, go to II. and sign Combination Bid Proposal.

\_\_\_\_\_ I (We) desire to be awarded work not to exceed a total monetary value of \$ \_\_\_\_\_.

\_\_\_\_\_ I (We) desire to be awarded work not to exceed \_\_\_\_\_ number of contracts.

II. It is understood that the Mississippi Transportation Commission not only reserves the right to reject any and all proposals, but also the right to award contracts upon the basis of lowest separate bids or combination bids most advantageous to the State.

It is further understood and agreed that the Combination Bid Proposal is for comparison of bids only and that each contract shall operate in every respect as a separate contract in accordance with its proposal and contract documents.

I (We), the undersigned, agree to complete each contract on or before its specified completion date.

SIGNED \_\_\_\_\_  
 \_\_\_\_\_  
 \_\_\_\_\_

TO: EXECUTIVE DIRECTOR, MISSISSIPPI DEPARTMENT OF TRANSPORTATION  
JACKSON, MISSISSIPPI

**CERTIFICATE**

If awarded this contract, I (we) contemplate that portions of the contract will be sublet. I (we) certify that those subcontracts which are equal to or in excess of fifty thousand dollars (\$50,000.00) will be in accordance with regulations promulgated and adopted by the Mississippi State Board of Contractors on January 13, 1999.

I (we) agree that this notification of intent DOES NOT constitute APPROVAL of the subcontracts.

NOTE: Insert name and address of subcontractors. (Subcontracts equal to or in excess of fifty thousand dollars (\$50,000.00) ONLY.)

_____	_____
(Individual or Firm)	(Address)
_____	_____
(Individual or Firm)	(Address)
_____	_____
(Individual or Firm)	(Address)
_____	_____
(Individual or Firm)	(Address)

NOTE: Failure to complete the above DOES NOT preclude subsequent subcontracts. Subsequent subcontracts, if any, equal to or in excess of fifty thousand dollars (\$50,000.00) will be in accordance with regulations promulgated and adopted by the Mississippi State Board of Contractors on January 13, 1999.

Contractor \_\_\_\_\_

By \_\_\_\_\_

Title \_\_\_\_\_

**CERTIFICATE MUST BE EXECUTED**

**MISSISSIPPI DEPARTMENT OF TRANSPORTATION**

CERTIFICATION  
(Execute in duplicate)

I, \_\_\_\_\_,  
(Name of person signing certification)

individually, and in my capacity as \_\_\_\_\_ of  
(Title)

\_\_\_\_\_ do hereby certify under  
(Name of Firm, Partnership, or Corporation)

penalty of perjury under the laws of the United States and the State of Mississippi that  
\_\_\_\_\_, Bidder  
(Name of Firm, Partnership, or Corporation)

on Project No. **MP-6018-31(010) / 304810301** \_\_\_\_\_.

in **Jasper** \_\_\_\_\_ County(ies), Mississippi, has not either directly or indirectly entered into any agreement, participated in any collusion; or otherwise taken any action in restraint of free competitive bidding in connection with this contract; nor have any of its corporate officers or principal owners.

Except as noted hereafter, it is further certified that said legal entity and its corporate officers, principal owners, managers, auditors and others in a position of administering federal funds are not currently under suspension, debarment, voluntary exclusion or determination of ineligibility; nor have a debarment pending; nor been suspended, debarred, voluntarily excluded or determined ineligible within the past three years by the Mississippi Transportation Commission, the State of Mississippi, any other State or a federal agency; nor been indicted, convicted or had a civil judgment rendered by a court of competent jurisdiction in any matter involving fraud or official misconduct within the past three years.

Initial here "\_\_\_\_\_" if exceptions are attached and made a part thereof. Any exceptions shall address to whom it applies, initiating agency and dates of such action.

Note: Exceptions will not necessarily result in denial of award but will be considered in determining bidder responsibility. Providing false information may result in criminal prosecution or administrative sanctions.

All of the foregoing and attachments (when indicated) is true and correct.

Executed on \_\_\_\_\_  
Signature

(5/29/2008S)

**MISSISSIPPI DEPARTMENT OF TRANSPORTATION**

CERTIFICATION  
(Execute in duplicate)

I, \_\_\_\_\_,  
(Name of person signing certification)

individually, and in my capacity as \_\_\_\_\_ of  
(Title)

\_\_\_\_\_ do hereby certify under  
(Name of Firm, Partnership, or Corporation)

penalty of perjury under the laws of the United States and the State of Mississippi that  
\_\_\_\_\_, Bidder  
(Name of Firm, Partnership, or Corporation)

on Project No. **MP-6018-31(010) / 304810301** \_\_\_\_\_.

in **Jasper** \_\_\_\_\_ County(ies), Mississippi, has not either directly or indirectly entered into any agreement, participated in any collusion; or otherwise taken any action in restraint of free competitive bidding in connection with this contract; nor have any of its corporate officers or principal owners.

Except as noted hereafter, it is further certified that said legal entity and its corporate officers, principal owners, managers, auditors and others in a position of administering federal funds are not currently under suspension, debarment, voluntary exclusion or determination of ineligibility; nor have a debarment pending; nor been suspended, debarred, voluntarily excluded or determined ineligible within the past three years by the Mississippi Transportation Commission, the State of Mississippi, any other State or a federal agency; nor been indicted, convicted or had a civil judgment rendered by a court of competent jurisdiction in any matter involving fraud or official misconduct within the past three years.

Initial here "\_\_\_\_\_" if exceptions are attached and made a part thereof. Any exceptions shall address to whom it applies, initiating agency and dates of such action.

Note: Exceptions will not necessarily result in denial of award but will be considered in determining bidder responsibility. Providing false information may result in criminal prosecution or administrative sanctions.

All of the foregoing and attachments (when indicated) is true and correct.

Executed on \_\_\_\_\_  
Signature

(5/29/2008S)

**S E C T I O N   9 0 2**

CONTRACT FOR MP-6018-31(010) / 304810301

LOCATED IN THE COUNTY(IES) OF Jasper

STATE OF MISSISSIPPI,  
COUNTY OF HINDS

This contract entered into by and between the Mississippi Transportation Commission on one hand, and the undersigned contractor, on the other witnesseth;

That, in consideration of the payment by the Mississippi Transportation Commission of the prices set out in the proposal hereto attached, to the undersigned contractor, such payment to be made in the manner and at the time of times specified in the specifications and the special provisions, if any, the undersigned contractor hereby agrees to accept the prices stated in the proposal in full compensation for the furnishing of all materials and equipment and the executing of all the work contemplated in this contract.

It is understood and agreed that the advertising according to law, the Advertisement, the instructions to bidders, the proposal for the contract, the specifications, the revisions of the specifications, the special provisions, and also the plans for the work herein contemplated, said plans showing more particularly the details of the work to be done, shall be held to be, and are hereby made a part of this contract by specific reference thereto and with like effect as if each and all of said instruments had been set out fully herein in words and figures.

It is further agreed that for the same consideration the undersigned contractor shall be responsible for all loss or damage arising out of the nature of the work aforesaid; or from the action of the elements and unforeseen obstructions or difficulties which may be encountered in the prosecution of the same and for all risks of every description connected with the work, exceptions being those specifically set out in the contract; and for faithfully completing the whole work in good and workmanlike manner according to the approved Plans, Specifications, Special Provisions, Notice(s) to Bidders and requirements of the Mississippi Department of Transportation.

It is further agreed that the work shall be done under the direct supervision and to the complete satisfaction of the Executive Director of the Mississippi Department of Transportation, or his authorized representatives, and when Federal Funds are involved subject to inspection at all times and approval by the Federal Highway Administration, or its agents as the case may be, or the agents of any other Agency whose funds are involved in accordance with those Acts of the Legislature of the State of Mississippi approved by the Governor and such rules and regulations issued pursuant thereto by the Mississippi Transportation Commission and the authorized Federal Agencies.

The Contractor agrees that all labor as outlined in the Special Provisions may be secured from list furnished by

It is agreed and understood that each and every provision of law and clause required by law to be inserted in this contract shall be deemed to be inserted herein and this contract shall be read and enforced as though it were included herein, and, if through mere mistake or otherwise any such provision is not inserted, then upon the application of either party hereto, the contract shall forthwith be physically amended to make such insertion.

The Contractor agrees that he has read each and every clause of this Contract, and fully understands the meaning of same and that he will comply with all the terms, covenants and agreements therein set forth.

Witness our signatures this the \_\_\_\_\_ day of \_\_\_\_\_, \_\_\_\_\_.

\_\_\_\_\_  
Contractor (s)

By \_\_\_\_\_

MISSISSIPPI TRANSPORTATION COMMISSION

Title \_\_\_\_\_

By \_\_\_\_\_

Signed and sealed in the presence of:  
(names and addresses of witnesses)

Executive Director

\_\_\_\_\_  
Secretary to the Commission

Award authorized by the Mississippi Transportation Commission in session on the \_\_\_\_ day of \_\_\_\_\_, \_\_\_\_\_, Minute Book No. \_\_\_\_\_, Page No. \_\_\_\_\_.



**S E C T I O N 9 0 3**  
**PERFORMANCE AND PAYMENT BOND**

CONTRACT BOND FOR: MP-6018-31(010) / 304810301

LOCATED IN THE COUNTY(IES) OF: Jasper

STATE OF MISSISSIPPI,

COUNTY OF HINDS

Know all men by these presents: that we, \_\_\_\_\_  
( Contractor )

\_\_\_\_\_ Principal, a \_\_\_\_\_

residing at \_\_\_\_\_ in the State of \_\_\_\_\_

and \_\_\_\_\_  
( Surety )

residing at \_\_\_\_\_ in the State of \_\_\_\_\_,

authorized to do business in the State of Mississippi, under the laws thereof, as surety, are held and firmly bound unto the State of Mississippi in the sum of \_\_\_\_\_

\_\_\_\_\_ Dollars, lawful money of the United States of America, to be paid to it for which payment well and truly to be made, we bind ourselves, our heirs, administrators, successors, or assigns jointly and severally by these presents.

Signed and sealed this the \_\_\_\_\_ day of \_\_\_\_\_ A.D. \_\_\_\_\_.

The conditions of this bond are such, that whereas the said \_\_\_\_\_

principal, has (have) entered into a contract with the Mississippi Transportation Commission, bearing the date of \_\_\_\_\_ day of \_\_\_\_\_ A.D. \_\_\_\_\_ hereto annexed, for the construction of certain projects(s) in the State of Mississippi as mentioned in said contract in accordance with the Contract Documents therefor, on file in the offices of the Mississippi Department of Transportation, Jackson, Mississippi.

Now therefore, if the above bounden \_\_\_\_\_

\_\_\_\_\_ in all things shall stand to and abide by and well and truly observe, do keep and perform all and singular the terms, covenants, conditions, guarantees and agreements in said contract, contained on his (their) part to be observed, done, kept and performed and each of them, at the time and in the manner and form and furnish all of the material and equipment specified in said contract in strict accordance with the terms of said contract which said plans, specifications and special provisions are included in and form a part of said contract and shall maintain the said work contemplated until its final completion and acceptance as specified in Subsection 109.11 of the approved specifications, and save harmless said Mississippi Transportation Commission from any loss or damage arising out of or occasioned by the negligence, wrongful or criminal act, overcharge, fraud, or any other loss or damage whatsoever, on the part of said principal (s), his (their) agents, servants, or employees in

**SECTION 903 - CONTINUED**

the performance of said work or in any manner connected therewith, and shall be liable and responsible in a civil action instituted by the State at the instance of the Mississippi Transportation Commission or any officer of the State authorized in such cases, for double any amount in money or property, the State may lose or be overcharged or otherwise defrauded of, by reason of wrongful or criminal act, if any, of the Contractor(s), his (their) agents or employees, and shall promptly pay the said agents, servants and employees and all persons furnishing labor, material, equipment or supplies therefor, including premiums incurred, for Surety Bonds, Liability Insurance, and Workmen's Compensation Insurance; with the additional obligation that such Contractor shall promptly make payment of all taxes, licenses, assessments, contributions, damages, any liquidated damages which may arise prior to any termination of said principal's contract, any liquidated damages which may arise after termination of the said principal's contract due to default on the part of said principal, penalties and interest thereon, when and as the same may be due this state, or any county, municipality, board, department, commission or political subdivision: in the course of the performance of said work and in accordance with Sections 31-5-51 et seq. Mississippi Code of 1972, and other State statutes applicable thereto, and shall carry out to the letter and to the satisfaction of the Executive Director of the Mississippi Department of Transportation, all, each and every one of the stipulations, obligations, conditions, covenants and agreements and terms of said contract in accordance with the terms thereof and all of the expense and cost and attorney's fee that may be incurred in the enforcement of the performance of said contract, or in the enforcement of the conditions and obligations of this bond, then this obligation shall be null and void, otherwise to be and remain in full force and virtue.

Witness our signatures and seals this the \_\_\_\_\_ day of \_\_\_\_\_ A.D. \_\_\_\_\_.

_____	_____
(Contractors) Principal	Surety
By _____	By _____
	(Signature) Attorney in Fact
	Address _____
	_____
Title _____	_____
(Contractor's Seal)	(Printed) MS Agent
	_____
	(Signature) MS Agent
	Address _____
	_____
	_____
	(Surety Seal)
	_____
	Mississippi Insurance ID Number



# BID BOND

KNOW ALL MEN BY THESE PRESENTS, that we \_\_\_\_\_  
Contractor

\_\_\_\_\_  
Address

\_\_\_\_\_  
City, State ZIP

as Principal, hereinafter called the Principal, and \_\_\_\_\_  
Surety

a corporation duly organized under the laws of the state of \_\_\_\_\_

as Surety, hereinafter called the Surety, are held and firmly bound unto State of Mississippi, Jackson, Mississippi

As Obligee, hereinafter called Obligee, in the sum of **Five Per Cent (5%) of Amount Bid**  
Dollars (\$ \_\_\_\_\_)

for the payment of which sum will and truly to be made, the said Principal and said Surety, bind ourselves, our heirs, executors, administrators, successors and assigns, jointly and severally, firmly by these presents.

WHEREAS, the Principal has submitted a bid for **Overlay Sr 18 from Smith County Line East approximately 9 miles, known as State Project No. MP-6018-31(010) / 304810301 in Jasper County.**

NOW THEREFORE, the condition of this obligation is such that if the aforesaid Principal shall be awarded the contract, the said Principal will, within the time required, enter into a formal contract and give a good and sufficient bond to secure the performance of the terms and conditions of the contract, then this obligation to be void; otherwise the Principal and Surety will pay unto the Obligee the difference in money between the amount of the bid of the said Principal and the amount for which the Obligee legally contracts with another party to perform the work if the latter amount be in excess of the former, but in no event shall liability hereunder exceed the penal sum hereof.

Signed and sealed this \_\_\_\_\_ day of \_\_\_\_\_, 20\_\_

\_\_\_\_\_  
(Principal) (Seal)

\_\_\_\_\_  
(Witness)

By: \_\_\_\_\_  
(Name) (Title)

\_\_\_\_\_  
(Surety) (Seal)

\_\_\_\_\_  
(Witness)

By: \_\_\_\_\_  
(Attorney-in-Fact)

\_\_\_\_\_  
MS Agent

\_\_\_\_\_  
Mississippi Insurance ID Number