



# PROPOSAL AND CONTRACT DOCUMENTS

FOR THE CONSTRUCTION OF  
(STATE DELEGATED)

2

Mill and Overlay approximately 4 miles of US 84 from SR 28 to SR 15, known as Federal Aid Project No. NH-0015-02(096) / 106755301 in Jones County.

Project Completion: Flexible

## NOTICE

**BIDDERS MUST PURCHASE A BOUND PROPOSAL  
FROM MDOT CONTRACT ADMINISTRATION DIVISION  
TO BID THIS PROJECT.**

Electronic addendum updates will be posted on [www.gomdot.com](http://www.gomdot.com)

**SECTION 900  
OF THE CURRENT  
2004 STANDARD SPECIFICATIONS  
FOR ROAD AND BRIDGE CONSTRUCTION  
MISSISSIPPI DEPARTMENT OF TRANSPORTATION  
JACKSON, MISSISSIPPI**

**BIDDER CHECK LIST  
(FOR INFORMATION ONLY)**

- | \_\_\_\_\_ All unit prices have been entered **into Expedite Bid** in accordance with Subsection 102.06 of the Mississippi Standard Specifications for Road and Bridge Construction.
- | \_\_\_\_\_ **Expedite bid** sheets have been stapled and inserted into the proposal package.
- \_\_\_\_\_ First sheet of SECTION 905--PROPOSAL has been completed.
- \_\_\_\_\_ Second sheet of SECTION 905--PROPOSAL has been completed and signed.
- \_\_\_\_\_ Addenda, if any, have been acknowledged. Second sheet of Section 905 listing the addendum number has been substituted for the original second sheet of Section 905. Substituted second sheet of Section 905 has been properly completed, signed, and added to the proposal.
- \_\_\_\_\_ DBE/WBE percentage, when required by contract, has been entered on last sheet of the bid sheets of SECTION 905 - PROPOSAL.
- \_\_\_\_\_ Form OCR-485, when required by contract, has been completed and signed.
- | \_\_\_\_\_ The last sheet of the **Expedite** bid sheets of SECTION 905--PROPOSAL has been signed.
- \_\_\_\_\_ Combination Bid Proposal of SECTION 905--PROPOSAL has been completed for each project which is to be considered in combination (See Subsection 102.11).
- \_\_\_\_\_ Equal Opportunity Clause Certification, when included in contract, has been completed and signed.
- \_\_\_\_\_ The Certification regarding Non-Collusion, Debarment and Suspension, etc. has been executed in duplicate.
- \_\_\_\_\_ A certified check, cashier's check or bid bond payable to the State of Mississippi in the principal amount of 5% of the bid has been included with project number identified on same. A bid bond has been signed by the bidder and has also been signed or countersigned by a Mississippi Agent or Qualified Nonresident Agent for the Surety with Power of Attorney attached.
- \_\_\_\_\_ ON FEDERAL FUNDED PROJECTS, the Notice To Bidders regarding DUNS Requirements has been completed and included in the contract documents.
- \_\_\_\_\_ Non-resident Bidders: ON STATE FUNDED PROJECTS ONLY, a copy of the current laws regarding any preference for local Contractors from State wherein domiciled has been included. See Subsection 103.01, Mississippi Standard Specifications for Road and Bridge Construction, and Section 31-7-47, MCA, 1972 regarding this matter.
- | Return the **MDOT flash drive with completed EBS file**, proposal and contract documents in its entirety in a sealed envelope. DO NOT remove any part of the contract documents; exception - an addendum requires substitution of second sheet of Section 905. A stripped proposal is considered as an irregular bid and will be rejected.

Failure to complete any or all of the applicable requirements will be cause for the proposal to be considered irregular.

# MISSISSIPPI DEPARTMENT OF TRANSPORTATION

## TABLE OF CONTENTS

### PROJECT: NH-0015-02(096) / 106755301 – Jones County

901--Advertisement

904--Notice to Bidders:

- Governing Specs. - # 1
- Final Cleanup - # 3
- Gopher Tortoises - # 151
- Errata & Modifications to 2004 Standard Specifications - # 1405
- Federal Bridge Formula - # 1928
- Status of ROW, W/Attachments - # 2382
- Reduced Speed Limit Signs - # 2937
- Alternate Asphalt Mixture Bid Items - # 3039
- Temporary Traffic Paint - # 3131
- Safety Edge - # 3585
- Type III Barricade Rails - # 3655
- Petroleum Products Base Price - # 3893
- Questions Regarding Bidding - # 3980
- Standard Drawings - # 4100
- Disadvantaged Business Enterprise, W/Supplement - # 4103
- Rumble Stripe - # 4189
- Safety Apparel - # 4214
- Terminal End Sections - # 4308
- Alternate Crushed Stone Base Bid Items - # 4473
- DBE Forms, Participation, and Payment - # 4488
- Warm Mix Asphalt (WMA) - # 4524
- Electronic Addendum Process - # 4526
- Manual on Uniform Traffic Control Devices (MUTCD) - # 4565
- DUNS Requirement for Federal Funded Projects - # 4566
- Adjustments for Bituminous Materials - # 4612
- Payroll Requirements - # 4661
- Contract Time - # 4812
- Specialty Items - # 4813
- Scope of Work - # 4814

906: Required Federal Contract Provisions -- FHWA-1273, W/ Supplements

907-101-4: Definitions

907-102-10: Bidding Requirements and Conditions

907-103-8: Award and Execution of Contract

907-104-5: Scope of Work

907-105-7: Control of Work

907-107-13: Legal Relations & Responsibility to Public

907-108-30: Prosecution and Progress

907-109-6: Measurement and Payment, W/ Supplement

907-110-2: Wage Rates

907-304-13: Granular Courses

-- CONTINUED ON NEXT PAGE --

- 907-401-2: Hot Mix Asphalt (HMA), W/ Supplement
- 907-401-6: Warm Mix Asphalt (WMA)
- 907-403-4: Hot Mix Asphalt (HMA), W/ Supplement
- 907-403-12: Warm Mix Asphalt (WMA)
- 907-407-1: Tack Coat
- 907-413-5: Sawing & Sealing Transverse Joints in Asphalt
- 907-618-1: Additional Signing Requirements, W/ Supplement
- 907-618-9: Placement of Temporary Traffic Stripe
- 907-626-25: Thermoplastic Traffic Markings
- 907-702-3: Polyphosphoric Acid (PPA) Modification of Petroleum Asphalt Cement
- 907-703-11: Aggregates
- 907-710-1: Fast Dry Solvent Traffic Paint
- 907-720-2: Pavement Marking Materials

SECTION 905 - PROPOSAL,  
PROPOSAL BID ITEMS,  
COMBINATION BID PROPOSAL,  
CERTIFICATION OF PERFORMANCE - PRIOR FEDERAL-AID CONTRACTS,  
CERTIFICATION REGARDING NON-COLLUSION, DEBARMENT AND SUSPENSION,  
SECTION 902 - CONTRACT FORM, AND SECTION 903 - CONTRACT BOND FORMS,  
OCR-485.

(REVISIONS TO THE ABOVE WILL BE INDICATED ON THE SECOND SHEET  
OF SECTION 905 AS ADDENDA)

# MISSISSIPPI DEPARTMENT OF TRANSPORTATION

## SECTION 901 - ADVERTISEMENT

Sealed bids will be received by the Mississippi Transportation Commission in the Office of the Contract Administration Engineer, Room 1013, Mississippi Department of Transportation Administration Building, 401 North West Street, Jackson, Mississippi, until 10:00 o'clock A.M., Tuesday, February 25, 2014, and shortly thereafter publicly opened on the Sixth Floor for:

Mill and Overlay approximately 4 miles of US 84 from SR 28 to SR 15, known as Federal Aid Project No. NH-0015-02(096) / 106755301 in Jones County.

The attention of bidders is directed to the Contract Provisions governing selection and employment of labor. Minimum wage rates have been predetermined by the Secretary of Labor and are subject to Public Law 87-581, Work Hours Act of 1962, as set forth in the Contract Provisions.

The Mississippi Department of Transportation hereby notifies all bidders that it will affirmatively insure that in any contract entered into pursuant to this advertisement, disadvantaged business enterprises will be afforded full opportunity to submit bids in response to this invitation and will not be discriminated against on the grounds of race, color, sex, age, disability, religion or national origin in consideration for an award.

**The award of this contract will be contingent upon the Contractor satisfying the DBE requirements.**

The specifications are on file in the offices of the Mississippi Department of Transportation.

Bid proposals must be purchased online at <https://shopmdot.ms.gov>. Specimen proposals may be viewed and downloaded online at no cost at <http://mdot.ms.gov> or purchased online. Proposals are available at a cost of Ten Dollars (\$10.00) per proposal plus a small convenience fee. Cash or checks will not be accepted as payment.

Bid bond, signed or countersigned by a Mississippi Agent or Qualified Nonresident Agent, with Power of Attorney attached, a Cashier's check or Certified Check for five (5%) percent of bid, payable to STATE OF MISSISSIPPI, must accompany each proposal.

The attention of bidders is directed to the provisions of Subsection 102.07 pertaining to irregular proposals and rejection of bids.

MELINDA L. MCGRATH  
EXECUTIVE DIRECTOR

# MISSISSIPPI DEPARTMENT OF TRANSPORTATION

**SECTION 904 - NOTICE TO BIDDERS NO. 1**

**CODE: (IS)**

**DATE: 05/03/2004**

**SUBJECT: Governing Specifications**

The current (2004) Edition of the Standard Specifications for Road and Bridge Construction adopted by the Mississippi Transportation Commission is made a part hereof fully and completely as if it were attached hereto, except where superseded by special provisions, or amended by revisions of the Specifications contained herein. Copies of the specification book may be purchased from the MDOT Construction Division.

A reference in any contract document to controlling requirements in another portion of the contract documents shall be understood to apply equally to any revision or amendment thereof included in the contract.

In the event the plans or proposal contain references to the 1990 Edition of the Standard Specifications for Road and Bridge Construction, it is to be understood that such references shall mean the comparable provisions of the 2004 Edition of the Standard Specifications.

## MISSISSIPPI DEPARTMENT OF TRANSPORTATION

**SECTION 904 - NOTICE TO BIDDERS NO. 3**

**CODE: (SP)**

**DATE: 05/03/2004**

**SUBJECT: Final Clean-Up**

Immediately prior to final inspection for release of maintenance, the Contractor shall pick up, load, transport and properly dispose of all litter from the entire highway right-of-way that is within the termini of the project.

Litter shall include, but not be limited to, solid wastes such as glass, paper products, tires, wood products, metal, synthetic materials and other miscellaneous debris.

Litter removal is considered incidental to other items of work and will not be measured for separate payment.

## MISSISSIPPI DEPARTMENT OF TRANSPORTATION

**SECTION 904 - NOTICE TO BIDDERS NO. 151**

**CODE: (IS)**

**DATE: 06/18/2004**

**SUBJECT: Gopher Tortoises**

Bidders are hereby advised that the Contractor will be required to make special considerations regarding gopher tortoises on this project. In addition to the normal required documentation associated with borrow pits, the Contractor shall, for each site used to obtain or dispose of materials associated with this project, provide the Engineer with a letter from a qualified biologist certifying that the site was inspected prior to any clearing of vegetation or disposal of project materials and that the site is not inhabited by gopher tortoises, or appropriate avoidance measures have been installed. No individual lacking the proper State or Federal license shall touch or otherwise harass a gopher tortoise.



# MISSISSIPPI DEPARTMENT OF TRANSPORTATION

SECTION 904 - NOTICE TO BIDDERS NO. 1405

CODE: (IS)

DATE: 03/15/2007

SUBJECT: ERRATA AND MODIFICATIONS TO THE 2004 STANDARD SPECIFICATIONS

<u>Page</u>	<u>Subsection</u>	<u>Change</u>
101	201.01	In the second sentence of the first paragraph, change “salvable” to “salvageable”.
107	202.04	In the fourth sentence of the fourth paragraph, change “yard” to “feet”.
107	202.05	In the list of units measurements for 202-B, add “square foot”.
132	211.03.4	In the second sentence of the second paragraph, change “planted” to “plated”.
192	306.02.4	In the first line of the first paragraph, delete the word “be”.
200	307.03.7	In the fourth sentence of the second paragraph, change “lime-fly ash” to “treated”.
236	401.01	Change the header from “Section 403” to “Section 401”.
242	401.02.3.2	In the first sentence of the third full paragraph, add “1/8” in the blank before the inch mark.
250	401.02.6.3	In the second sentence of the first paragraph on page 250, change “rutting over ” to “rutting over 1/8” ”.
253	401.02.6.4.2	In the paragraph preceding the table, change “91.0” to “89.0”.
259	401.03.1.4	In the first paragraph, change “92.0 percent” to “the specified percentage (92.0 or 93.0)”.
269	403.03.2	In the table at the top of page 269, change the PI requirement from “=” to “≤”.

- 278 404.04 In the second sentence, change the subsection from “401.04” to “403.04”.
- 283 409.02.2 Change “PG 64-22” to “PG 67-22”.
- 294 413.02 In the first sentence of the second paragraph, change “707.02.1.3” to “Subsection 707.02.1.3”.
- 340 511.04 In the second sentence of the second paragraph, change “412” to “512”.
- 349 601.03.3 In the first sentence, change “804.03.2” to “804.03.5”.
- 355 603.02 Change the subsection reference for Joint mortar from “707.03” to “714.11”.
- 369 604.04 In the first sentence, change “601.04” to “Subsection 601.04”.
- 427 619.04 Delete the second paragraph.
- 442 625.04 In the third paragraph, change “626.04” to “Subsection 626.04”.
- 444 626.03.1.2 Delete the third sentence of the first paragraph.
- 464 631.02 Change the subsection reference for Water from “714.01.0” to “714.01.1”.
- 570 682.03 Change the subsection number from “682-03” to “682.03”.
- 575 683.10.4 Change the subsection number from “683.10.4” to “683.04”.
- 575 683.10.5 Change the subsection number from “683.10.5” to “683.05”.
- 596 701.02 In the table under the column titled “Cementations material required”, change “Class F, FA” to “Class F FA,”.
- 603 702.11 In the first sentence, change “702.12” to “Subsection 702.12”.
- 612 703.04.2 In the fifth paragraph, delete “Subsection 703.11 and”.
- 616 703.07.2 In the Percentage By Weight Passing Square Mesh Sieves table, change the No. 10 requirement for Class 7 material from “30 - 10” to “30 - 100”.

- 618 703.13.1 In the first sentence of the first paragraph, change “703.09” to “703.06”.
- 618 703.13.2 In the first sentence, change “703.09” to “703.06”.
- 671 712.06.2.2 In the first sentence, change “712.05.1” to “Subsection 712.05.1”.
- 689 714.11.2 In the first sentence, change “412” to “512”.
- 709 715.09.5 In the first sentence of the first paragraph, change “guage” to “gauge”.
- 717 717.02.3.4 In the top line of the tension table, change “1 1/2” to “1 1/8” and change “1 1/8” to “1 1/2”.
- 741 720.05.2.2 In the last sentence of this subsection, change “720.05.2.1” to “Subsection 720.05.2.1”.
- 827 803.03.2.3.7.5.2 In the first sentence of the second paragraph, change “803.03.5.4” to “803.03.2.3.4”.
- 833 803.03.2.6 In the first sentence, change “803.03.7” to “803.03.2.5”.
- 854 804.02.11 In the last sentence of the first paragraph, change “automatically” to “automatic”.
- 859 804.02.13.1.3 In the last sentence, change Subsection “804.02.12.1” to “804.02.12”.
- 879 804.03.19.3.2 In the first sentence of the third paragraph, change “listed on of Approved” to “listed on the Approved”.
- 879 804.03.19.3.2 In the last sentence of the last paragraph, change “804.03.19.3.1” to “Subsection 804.03.19.3.1”.
- 962 814.02.3 In the first sentence, change “710.03” to “Subsection 710.03”.
- 976 820.03.2.1 In the first sentence, change “803.02.6” to “803.03.1.7”.
- 976 820.03.2.2 In the first sentence, change “803.03.9.6” to “803.03.1.9.2”.
- 985 Index Change the subsection reference for Petroleum Asphalt Cement from “702.5” to “702.05”.

985	Index	Change the subsection reference for the Definition of Asphaltic Cement or Petroleum Asphalt from “700.2” to “700.02”.
985	Index	Change the subsection reference for Automatic Batchers from “501.03.2.4” to “804.02.10.4”.
986	Index	Delete “501.03.2” as a subsection reference for Batching Plant & Equipment.
988	Index	Change the subsection reference for the Central Mixed Concrete from “501.03.3.2” to “804.02.11”.
988	Index	Change the subsection reference for the Concrete Batching Plant & Equipment from “501.03.2” to “804.02.11”.
999	Index	Delete “501.03.3.3” as a subsection reference for Truck Mixers.
1001	Index	Change the subsection reference for Edge Drain Pipes from “605.3.5” to “605.03.5”.
1002	Index	Change the subsection reference for Metal Posts from “713.05.2” to “712.05.2”.
1007	Index	Change the subsection reference for Coarse Aggregate of Cement Concrete Table from “703.3” to “703.03”.
1007	Index	Change the subsection reference for Composite Gradation for Mechanically Stabilized Courses Table from “703.8” to “703.08”.
1009	Index	Delete “501.03.3.3” as a subsection reference for Truck Mixers and Truck Agitators.
1010	Index	Delete reference to “Working Day, Definition of”.

## MISSISSIPPI DEPARTMENT OF TRANSPORTATION

| SECTION 904 - NOTICE TO BIDDERS NO. 1928

CODE: (IS)

| DATE: 04/14/2008

SUBJECT: Federal Bridge Formula

Bidders are hereby advised that Federal Highway Administration Publication No. FHWA-MC-94-007, **BRIDGE FORMULA WEIGHTS**, dated January 1994, is made a part of this contract when applicable.

Prior to the preconstruction conference, the Contractor shall advise the Engineer, in writing, what materials, if any, will be delivered to the jobsite via Interstate route(s).

Copies of the **BRIDGE FORMULA WEIGHTS** publication may be obtained by contacting:

Federal Highway Administration  
400 7<sup>th</sup> Street, SW  
Washington, DC 20590  
(202) 366-2212

or

| [http://ops.fhwa.dot.gov/freight/sw/brdgcalf/calf\\_page.htm](http://ops.fhwa.dot.gov/freight/sw/brdgcalf/calf_page.htm)

## MISSISSIPPI DEPARTMENT OF TRANSPORTATION

| SECTION 904 - NOTICE TO BIDDERS NO. 2382

CODE: (IS)

| DATE: 02/12/2009

| SUBJECT: Status of Right-of-Way

Although it is desirable to have acquired all rights-of-way and completed all utility adjustments and work to be performed by others prior to receiving bids, sometimes it is not considered to be in the public interest to wait until each and every such clearance has been obtained. The bidder is hereby advised of possible unacquired rights-of-way, relocatees and utilities which have not been completed.

| The status of right-of-way acquisition, utility adjustments, encroachments, potentially contaminated sites and asbestos containation are set forth in the following attachments.

In the event right of entry is not available to ALL parcels of right-of-way and/or all work that is to be accomplished by others on the date set forth in the contract for the Notice to Proceed is not complete, the Department will issue a restricted Notice to Proceed.

**STATUS OF RIGHT-OF-WAY**

NH-0015-02(096)

106755-301000

Jones County

**November 12, 2013**

All rights of way and legal rights of entry have been acquired **except:**

**None.**

ASBESTOS CONTAMINATION STATUS OF BUILDINGS  
TO BE REMOVED BY THE CONTRACTOR  
NH-0015-02(096)  
106755-301000  
Jones County  
November 12, 2013

Reference is made to notices to bidders entitled "Asbestos National Emission Standards for Hazardous Air Pollutants (NESHAP)" and "Removal of Obstructions".

The following pertinent information is furnished concerning asbestos containing materials (ACMs), if any, found in buildings to be removed by the Contractor.

There is no Right of Way required for this project. There are no buildings to be removed by the contractor.



STATUS OF POTENTIALLY CONTAMINATED SITES  
NH-0015-02(096)  
106755-301000  
Jones County  
November 12, 2013

THERE IS NO RIGHT OF WAY REQUIRED FOR THIS PROJECT. NO INITIAL SITE ASSESSMENT WILL BE PERFORMED. IF CONTAMINATION ON EXISTING RIGHT OF WAY IS DISCOVERED, IT WILL BE HANDLED BY THE DEPARTMENT.

**ENCROACHMENT CERTIFICATION**

NH-0015-02(096) / 106755301

Jones County(ies)

November 7, 2013

This is to certify that the above captioned project has been inspected and no encroachments were found.

**UTILITY STATUS REPORT**

NH-0015-02(096) / 106755301

Jones County(ies)

November 7, 2013

This is to certify that the above captioned project has been inspected and there are no known utilities in conflict with the project.

**MISSISSIPPI DEPARTMENT OF TRANSPORTATION**

**SECTION 904 - NOTICE TO BIDDERS NO. 2937**

**CODE: (SP)**

**DATE: 01/11/2010**

**SUBJECT: Reduced Speed Limit Signs**

Bidders are advised that all black and white speed limits signs that are used to reduce the speed limit through construction zones shall be covered or removed during times when the Contractor is not performing work. If the Contractor has a routine daytime operation and is not working at night, the signs shall be covered or removed during the nighttime when there is no work activity.

**MISSISSIPPI DEPARTMENT OF TRANSPORTATION**

**SECTION 904 - NOTICE TO BIDDERS NO. 3039**

**CODE: (SP)**

**DATE: 03/23/2010**

**SUBJECT: Alternate Asphalt Mixture Bid Items**

Bidders are advised that the asphalt mixture used on this project will be bid as an alternate pay item: Hot Mix Asphalt (HMA) or Warm Mix Asphalt (WMA). Bidders must select one of the alternates at the time of bid. **The Contractor must use the selected asphalt mixture, HMA or WMA, throughout the entire project.**

**MISSISSIPPI DEPARTMENT OF TRANSPORTATION**

**SECTION 904 - NOTICE TO BIDDERS NO. 3131**

**CODE: (SP)**

**DATE: 06/24/2010**

**SUBJECT: Temporary Traffic Paint**

Bidders are hereby advised that the temporary traffic paint for this project can be waterborne paint as specified in the 2004 Mississippi Standard Specifications For Road and Bridge Construction or fast dry solvent traffic paint meeting the requirements set out in 907-710-1 (Fast Dry Solvent Traffic Paint).

Payment for all temporary traffic paint shall be paid under the appropriate 619 pay items.

When using fast dry solvent traffic stripe, no paint can be sprayed or placed on the ground during set-up or clean-up.

**MISSISSIPPI DEPARTMENT OF TRANSPORTATION**

**SECTION 904 - NOTICE TO BIDDERS NO. 3585**

**CODE: (SP)**

**DATE: 06/22/2011**

**SUBJECT: Safety Edge**

Bidders are hereby advised that the Shoulder Wedge (Safety Edge) specified in the Supplement to Special Provision 907-401-2 shall only apply to the top two (2) lifts of asphalt. Attached is a drawing showing the safety edge.

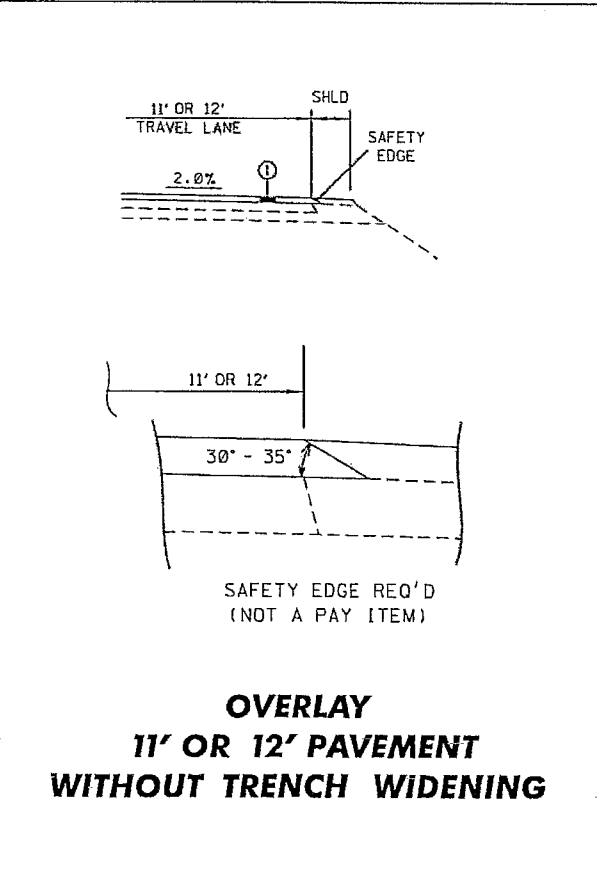
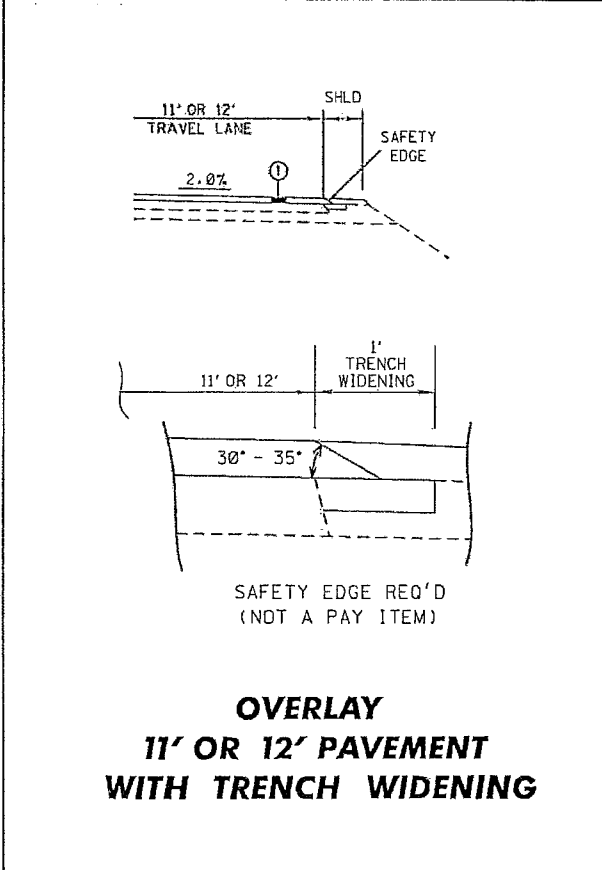
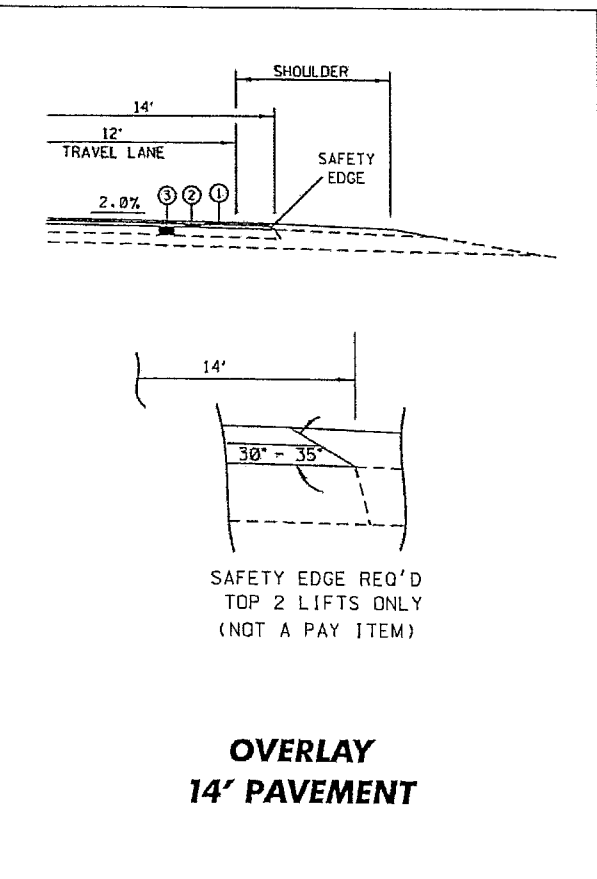
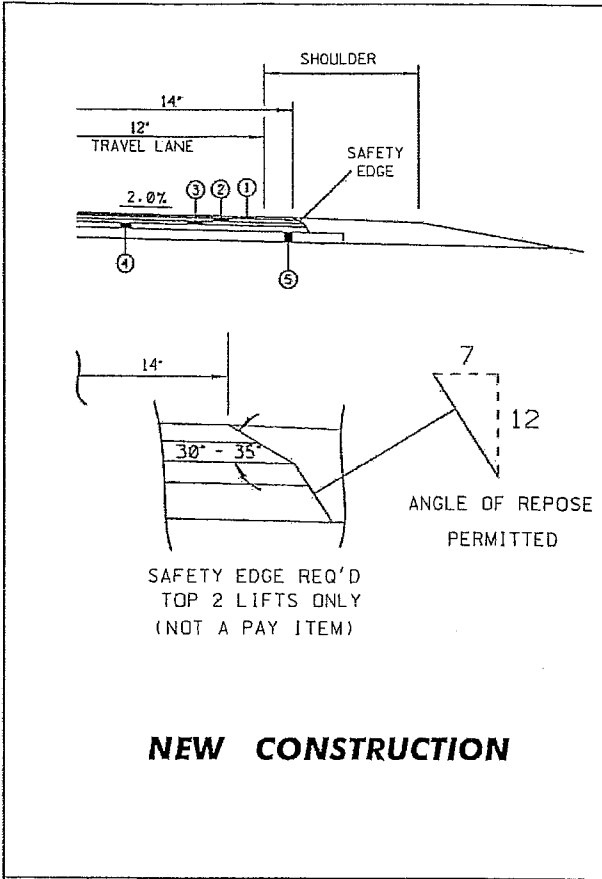



## MISSISSIPPI DEPARTMENT OF TRANSPORTATION

SECTION 904 - NOTICE TO BIDDERS NO. 3655

CODE: (SP)

DATE: 10/04/2011

SUBJECT: Type III Barricade Rails

Bidders are advised that the use of 2-inch nominal thickness timber for rails on Type III barricades has not been approved by NCHRP as a crashworthy device. Therefore, the use of 2-inch nominal thickness timbers will not be allowed for rails on Type III Barricades. Timber rails for Type III Barricades shall be as follows.

- For barricades up to four feet (4') wide, the maximum thickness of timber rails shall be one inch (1") and the material shall be pine timber or ¾-inch ACX plywood.
- For barricades more than four feet (4') wide, timber rails shall be constructed of ¾-inch ACX plywood.

A list of crashworthy Type III Barricades can be found at the below FHWA website.

[http://safety.fhwa.dot.gov/roadway\\_dept/policy\\_guide/road\\_hardware/wzd/](http://safety.fhwa.dot.gov/roadway_dept/policy_guide/road_hardware/wzd/)

## MISSISSIPPI DEPARTMENT OF TRANSPORTATION

**SECTION 904 - NOTICE TO BIDDERS NO. 3893**

**CODE: (SP)**

**DATE: 04/10/2012**

**SUBJECT: Petroleum Products Base Prices**

Bidders are advised that monthly petroleum products base prices will be available at the web site listed below. Current monthly prices will be posted to this web site on or before the 15<sup>th</sup> of each month. Bidders are advised to use the petroleum base prices on this web site when preparing their bids. The current monthly petroleum products base prices will be acknowledged by the Bidder and become part of the contract during the execution process.

Monthly Petroleum Products Base Prices can be viewed at:

<http://sp.gomdot.com/Contract%20Administration/BidSystems/Pages/letting%20calendar.aspx>

## MISSISSIPPI DEPARTMENT OF TRANSPORTATION

**SECTION 904 - NOTICE TO BIDDERS NO. 3980**

**CODE: (SP)**

**DATE: 07/25/2012**

**SUBJECT: Questions Regarding Bidding**

Bidders are advised that all questions that arise regarding the contract documents (proposal) or plans on this project shall be directed to the [www.gomdot.com](http://www.gomdot.com) current letting webpage. Click on the call number for this project to open an email form to submit your question. Questions must be submitted by 8:00 a.m. on Monday prior to the letting on Tuesday. Answers to questions will be posted by 6:00 p.m. on Monday prior to the letting on Tuesday. Answers can be viewed by clicking on Q&A link under the Proposal Addenda column.

It shall be the Bidders responsibility to familiarize themselves with the questions and answers that have been submitted on this project.

**MISSISSIPPI DEPARTMENT OF TRANSPORTATION**

**SECTION 904 – NOTICE TO BIDDERS NO. 4100**

**CODE: (SP)**

**DATE: 09/05/2012**

**SUBJECT: Standard Drawings**

Standard Drawings attached hereto shall govern appropriate items of required work.

Larger copies of Standard Drawings may be purchased from:

MDOT Plans Print Shop  
MDOT Shop Complex, Building C, Room 114  
2567 North West Street  
P.O. Box 1850  
Jackson, MS 39215-1850  
Telephone: (601) 359-7460  
or FAX: (601) 359-7461  
or e-mail: [plans@mdot.state.ms.us](mailto:plans@mdot.state.ms.us)

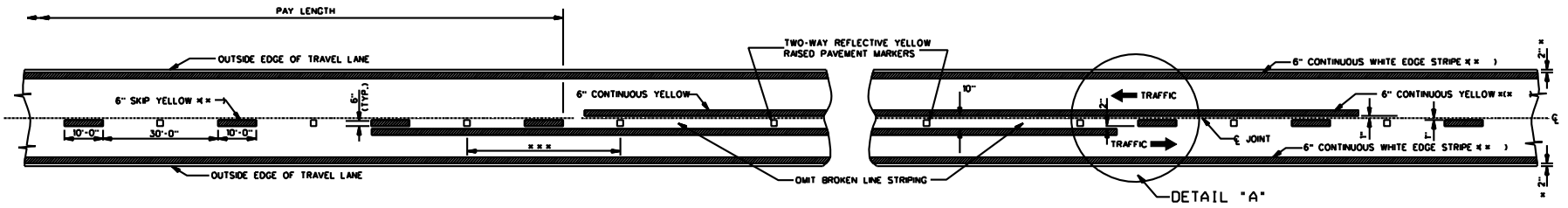

TWO-WAY TRAFFIC  
(ASPHALT OR CONCRETE PAVEMENT)

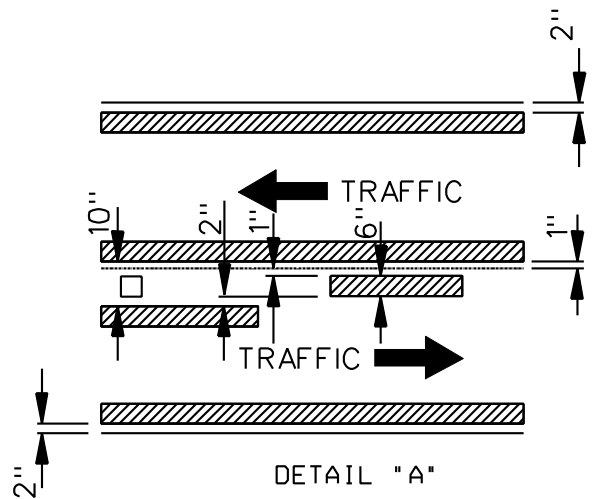

DETAIL "A"

- GENERAL NOTES:
- \* 1. 2" UNLESS SHOWN ELSEWHERE ON THE PLANS.
  - \*\* 2. EDGE STRIPE SHALL BE SAME MATERIAL AS LANE-LINE STRIPE (PAINT OR PLASTIC AS INDICATED IN PAY ITEMS).
  - \*\*\* 3. SPACING OF REFLECTIVE RAISED PAVEMENT MARKERS IS AS FOLLOWS:

	URBAN AREA (ft-in)	RURAL AREA (ft-in)
TANGENT SECTIONS	40'-0"	80'-0"
HORIZONTAL CURVES	40'-0"	40'-0"
INTERCHANGE LIMITS	40'-0"	40'-0"

1. NOTE: ON THE MAIN FACILITY, REFLECTIVE RED-CLEAR RAISED PAVEMENT MARKERS ON A 40'-0" SPACING WILL BE REQUIRED ON LANE-LINE(S) THROUGH ALL INTERCHANGE AREAS BEGINNING 1000' IN ADVANCE (IN DIRECTION OF TRAFFIC) OF THE EXIT RAMP TAPER AND CONTINUING THROUGH THE INTERCHANGE TO THE END OF THE ENTRANCE RAMP TAPER.

4. PAVEMENT MARKERS SHALL BE HIGH PERFORMANCE REFLECTIVE RAISED PAVEMENT MARKERS AS LISTED IN THE MOOT "APPROVED SOURCES OF MATERIALS."

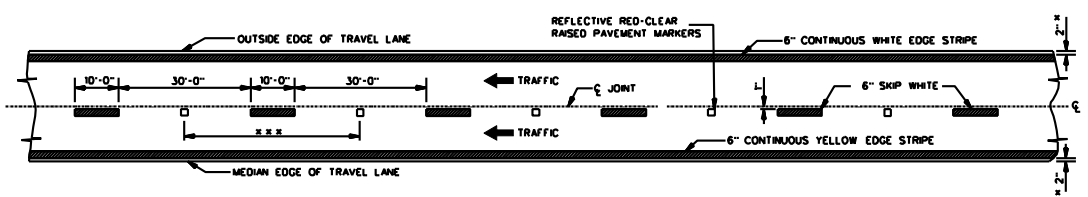

4-LANE WITH ONE-WAY TRAFFIC

MISSISSIPPI DEPARTMENT OF TRANSPORTATION ROADWAY DESIGN DIVISION STANDARD PLAN	
PAVEMENT MARKING DETAILS FOR 2-LANE AND 4-LANE DIVIDED HIGHWAYS	
ISSUE DATE: OCTOBER 1, 1998	WORKING NUMBER PM-1
	SHEET NUMBER

Notice To Bidders No. 27  
27 m'd.

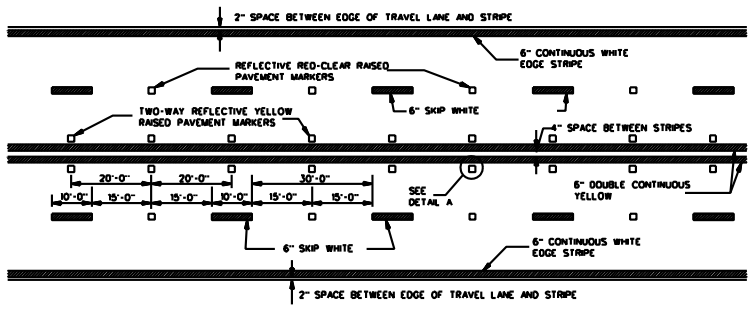

TYPICAL STRIPING AND RAISED PAVEMENT MARKERS FOR 4-LANE SECTION

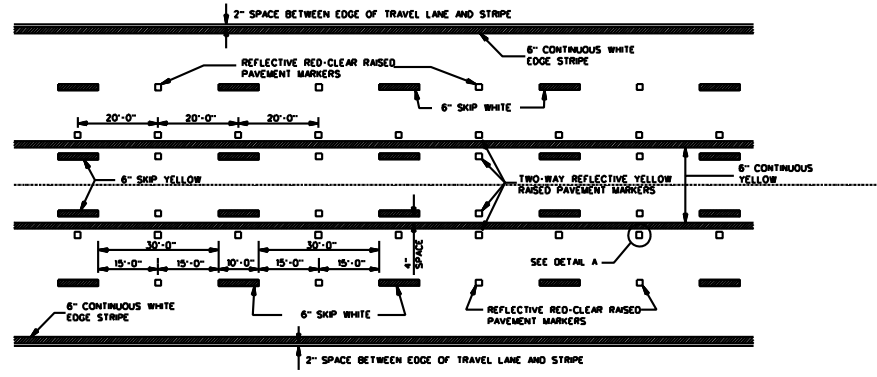

TYPICAL STRIPING AND RAISED PAVEMENT MARKERS FOR 5-LANE SECTION

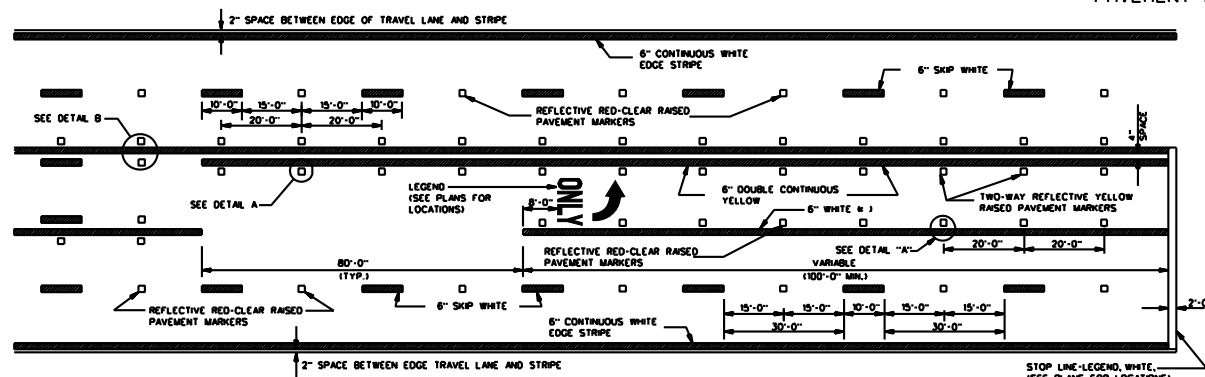

TYPICAL STRIPING AND RAISED PAVEMENT MARKERS AT LEFT TURN LANES

= NOTE: USE DETAIL STRIPING IF LENGTH  $\leq$  150' AT THIS LOCATION, OTHERWISE USE CONTINUOUS STRIPING.

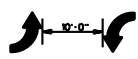

TYPICAL TWO-WAY ARROW INSTALLATION

- NOTES:
1. CONSIDER EACH SEGMENT OF CONTINUOUS TWO-WAY LEFT TURN LANE SEPARATELY.
  2. IF SEGMENT IS LESS THAN 350', PLACE ONE SET OF ARROWS IN CENTER OF SEGMENT.
  3. IF SEGMENT IS GREATER THAN 350', PLACE FIRST SET OF ARROWS 50' TO 100' FROM BEGINNING AND/OR END OF SEGMENT AND SPACE ADDITIONAL SETS OF ARROWS (250' O.C.).

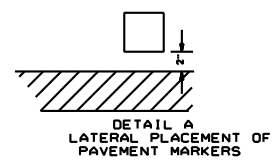

DETAIL A LATERAL PLACEMENT OF PAVEMENT MARKERS

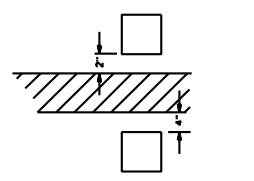

DETAIL B LATERAL PLACEMENT OF PAVEMENT MARKERS

GENERAL NOTE:

1. PAVEMENT MARKERS SHALL BE HIGH PERFORMANCE RAISED PAVEMENT MARKERS AS LISTED IN THE MOOT "APPROVED SOURCES OF MATERIALS".

MISSISSIPPI DEPARTMENT OF TRANSPORTATION	
PAVEMENT MARKING	
DETAILS FOR	
4-LANE AND 5-LANE	
UNDIVIDED ROADWAYS	
DESIGN TEAM	DATE: 10/13/10
DESIGNER	CHECKED

WORKING NUMBER  
SDPM-2  
SHEET NUMBER  
1

28

- 3 -

Notice To Bidder No. 4100 -- C-5

STATE	PROJECT NO.
MSS.	

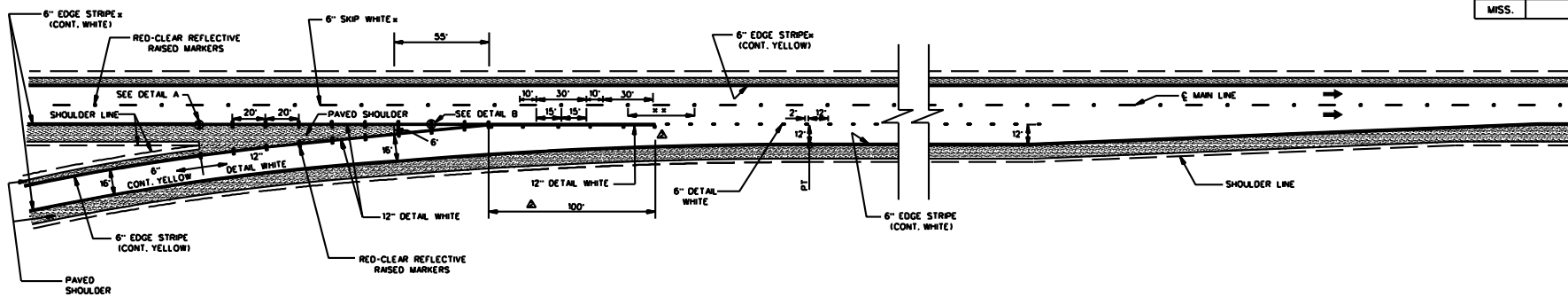

PARALLEL ENTRANCE RAMP

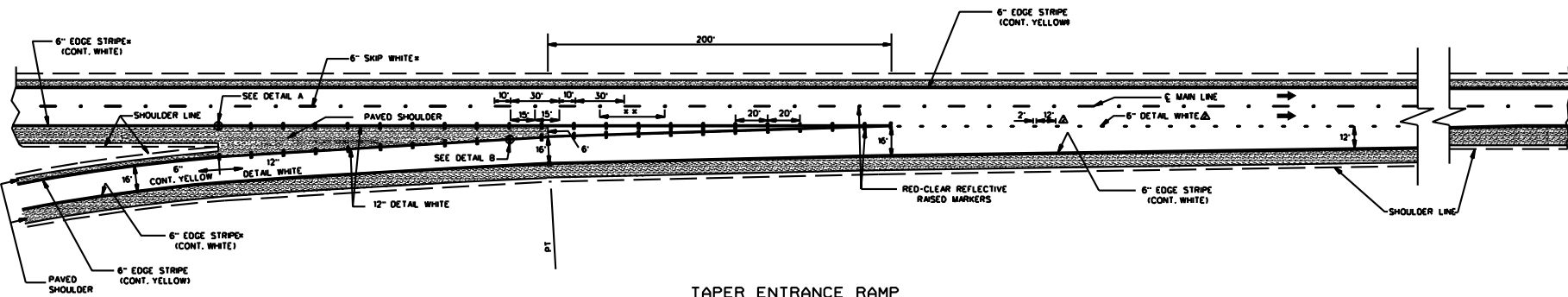

TAPER ENTRANCE RAMP

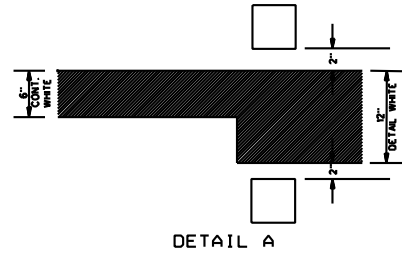

DETAIL A

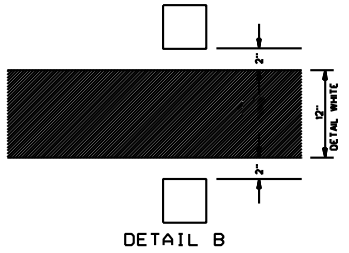

DETAIL B

- GENERAL NOTES:
- \* 1. SEE SHEET PM-1 FOR THE PLACEMENT OF LANE-LINE STRIPE WITH RESPECT TO THE PAVEMENT JOINT AND FOR THE PLACEMENT OF THE EDGE LINE WITH RESPECT TO THE OUTSIDE EDGE OF THE TRAVELED WAY.
  - \* 2. ON THE MAIN FACILITY, PLACE REFLECTIVE RED-CLEAR RAISED PAVEMENT MARKERS AT A 40' SPACING ON ALL LANE-LINE(S) THROUGHOUT THE INTERCHANGE AREA BEGINNING 1000' IN ADVANCE (IN DIRECTION OF TRAFFIC) OF THE EXIT RAMP TAPER AND CONTINUING THROUGH THE INTERCHANGE TO THE END OF THE ENTRANCE RAMP TAPER.
  - \* 3. PAVEMENT MARKERS SHALL BE HIGH PERFORMANCE REFLECTIVE RAISED PAVEMENT MARKERS AS LISTED IN THE MOOT "APPROVED SOURCES OF MATERIALS."

MISSISSIPPI DEPARTMENT OF TRANSPORTATION ROADWAY DESIGN DIVISION PROJECT NO. SHEET NO. DATE	<b>MISSISSIPPI DEPARTMENT OF TRANSPORTATION</b> ROADWAY DESIGN DIVISION		 WORKING NUMBER <b>SDPM-3</b> SHEET NUMBER
	<b>PAVEMENT MARKING</b> <b>DETAILS FOR</b> <b>INTERCHANGE</b> <b>ENTRANCE RAMPS</b> <b>(PARALLEL AND TAPER)</b>		
	ISSUE DATE: <b>OCTOBER 1, 1998</b>		
	PROJECT NO. _____ SHEET NO. _____		

29

Pavement Marking - interchange ramps\PM-3.DGN

- 4 -

Notice To Bidder No. 4100 -- Cont'd.

STATE	PROJECT NO.
MISS.	

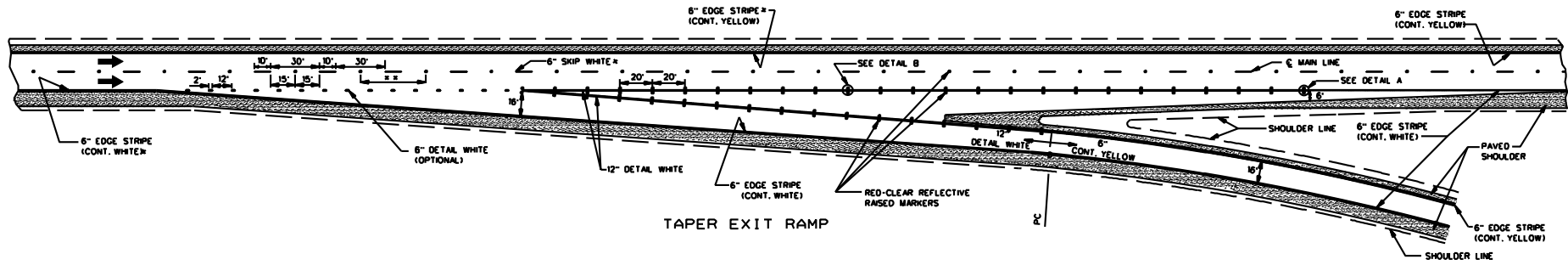

TAPER EXIT RAMP

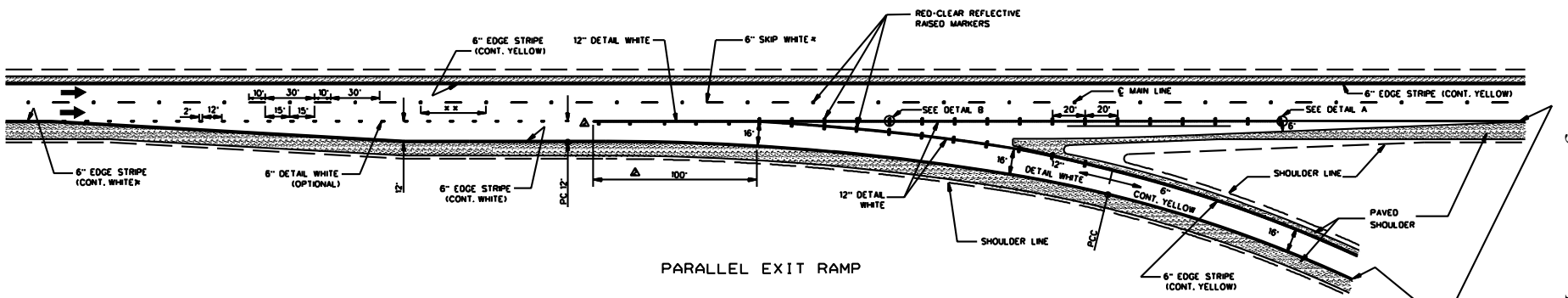

PARALLEL EXIT RAMP

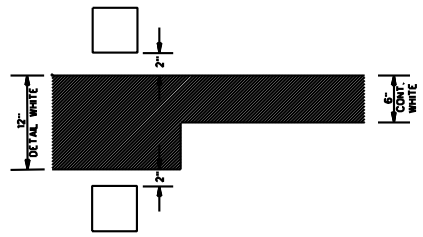

DETAIL A

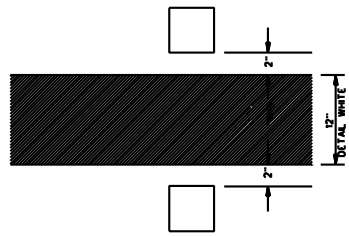

DETAIL B

- GENERAL NOTES:
- \* 1. SEE SHEET PM-1 FOR THE PLACEMENT OF LANE-LINE STRIPE WITH RESPECT TO THE PAVEMENT JOINT AND FOR THE PLACEMENT OF THE EDGE LINE WITH RESPECT TO THE OUTSIDE EDGE OF THE TRAVELED WAY.
  - \* 2. ON THE MAIN FACILITY, PLACE REFLECTIVE RED-CLEAR RAISED PAVEMENT MARKERS AT A 40' SPACING ON ALL LANE-LINES THROUGHOUT THE INTERCHANGE AREA BEGINNING 1000' IN ADVANCE (IN DIRECTION OF TRAFFIC) OF THE EXIT RAMP TAPER AND CONTINUING THROUGH THE INTERCHANGE TO THE END OF THE ENTRANCE RAMP TAPER.
  - 3. PAVEMENT MARKERS SHALL BE HIGH PERFORMANCE REFLECTIVE RAISED PAVEMENT MARKERS AS LISTED IN THE MDT "APPROVED SOURCES OF MATERIALS."

DATE DRAWN CHECKED APPROVED SCALE SHEET NO.	MISSISSIPPI DEPARTMENT OF TRANSPORTATION ROADWAY DESIGN DIVISION
	<b>PAVEMENT MARKING          DETAILS FOR          INTERCHANGE          EXIT RAMP          (PARALLEL AND TAPER)</b>
	WORKING NUMBER SDPM-4
	SHEET NUMBER

ISSUE DATE: OCTOBER 1, 1998

30

Pavement Marking - interchange ramps PM-4.DGN

Notice To Bidder No. 4100 Cont'd.



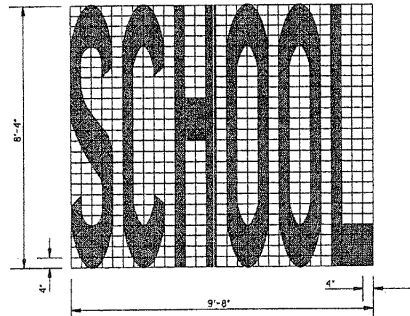
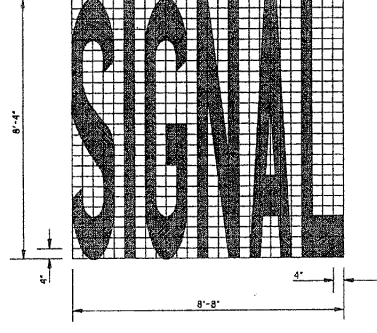
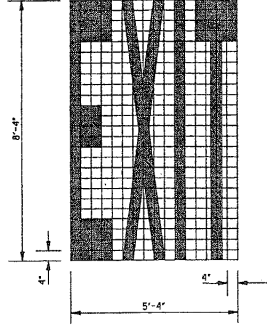
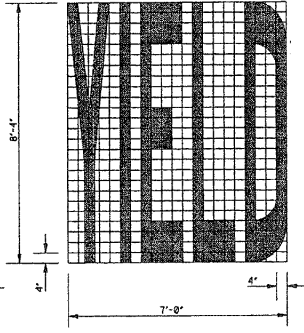
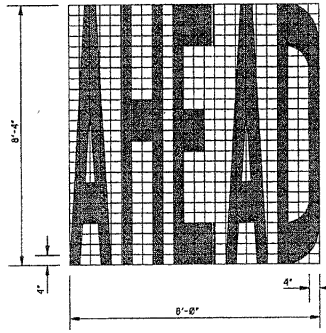
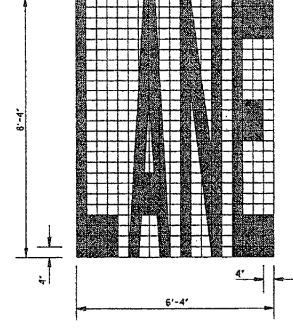
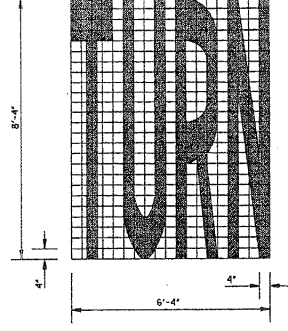
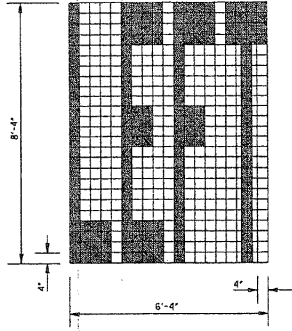
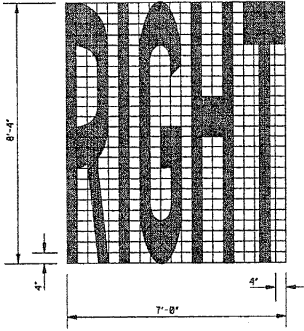
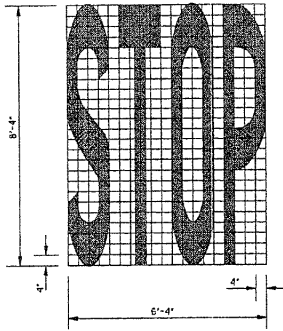

- GENERAL NOTES:
- UNLESS OTHERWISE SHOWN ON THE PLANS, ALL PAVEMENT MARKING LEGENDS SHALL BE APPLIED USING HIGH PERFORMANCE MATERIALS.
  - TWO HORIZONTAL GAPS (CAUSED BY TEMPLATE CONNECTORS) OF 1/4" OR LESS AND EXTENDING THE FULL WIDTH ARE PERMITTED IN EACH LETTER.
  - FOR OTHER DETAILS, SEE THE MANUAL ON UNIFORM TRAFFIC CONTROL DEVICES.
  - PAY QUANTITIES FOR PAVEMENT MARKING LEGENDS ARE AS FOLLOWS:

LEGEND	AREA (ft <sup>2</sup> )
STOP	24.6
RIGHT	26.6
LEFT	19.5
TURN	27.3
LANE	22.7
AHEAD	32.3
YIELD	28.9
EXIT	18.5
SIGNAL	32.5
SCHOOL	35.5

MISSISSIPPI DEPARTMENT OF TRANSPORTATION  
ROADWAY DESIGN DIVISION  
STANDARD PLAN

**PAVEMENT MARKING  
LEGEND DETAILS**

ISSUE DATE: OCTOBER 1, 1998

WORKING NUMBER: PM-5  
SHEET NUMBER: 124

STATE	PROJECT NO.
MISS.	

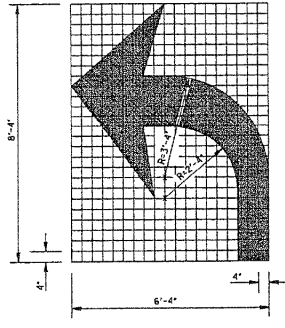
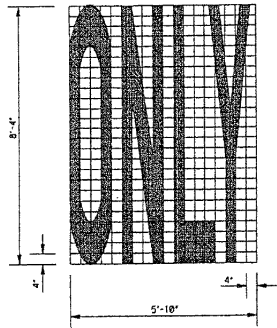

TURN ARROW

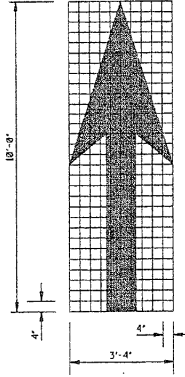

THRU ARROW

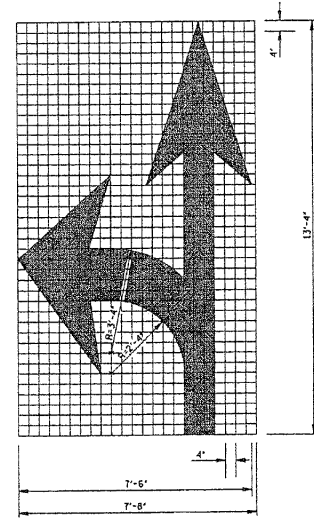

COMBINATION ARROW

GENERAL NOTES:

1. UNLESS OTHERWISE SHOWN ON THE PLANS, ALL PAVEMENT MARKING LEGENDS, INCLUDING TURN ARROWS, SHALL BE APPLIED USING HIGH PERFORMANCE MATERIALS.
2. TWO HORIZONTAL GAPS (CAUSED BY TEMPLATE CONNECTORS) OF 1/2" OR LESS AND EXTENDING THE FULL WIDTH ARE PERMITTED IN EACH LETTER.
3. FOR OTHER DETAILS, SEE THE MANUAL ON UNIFORM TRAFFIC CONTROL DEVICES.
4. PAY QUANTITIES FOR PAVEMENT MARKING LEGENDS ARE AS FOLLOWS:

PAY QUANTITIES	
LEGEND/SYMBOL	AREA (ft <sup>2</sup> )
ONLY	22.0
TURN ARROW	16.4
THRU ARROW	12.3
COMB. ARROW	27.5
1-WAY ARROW	24.3

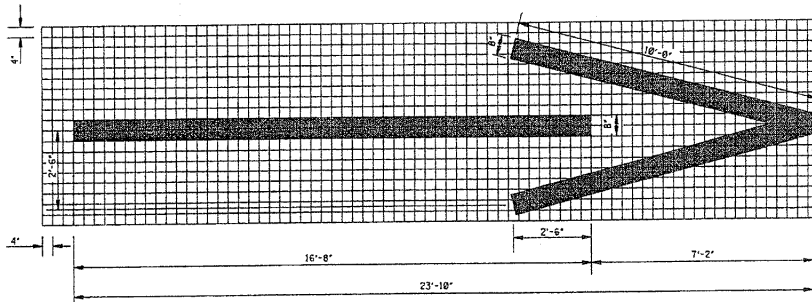

1-WAY ARROW

BY	MISSISSIPPI DEPARTMENT OF TRANSPORTATION ROADWAY DESIGN DIVISION STANDARD PLAN
REVISION	
DATE	ISSUE DATE: OCTOBER 1, 1998

**PAVEMENT MARKING  
LEGEND DETAILS**



WORKING NUMBER  
PM-6  
SHEET NUMBER  
125

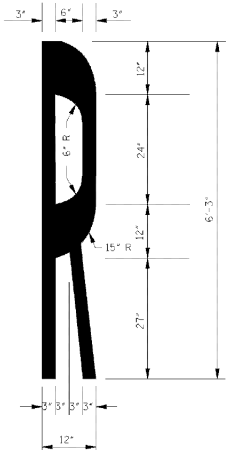
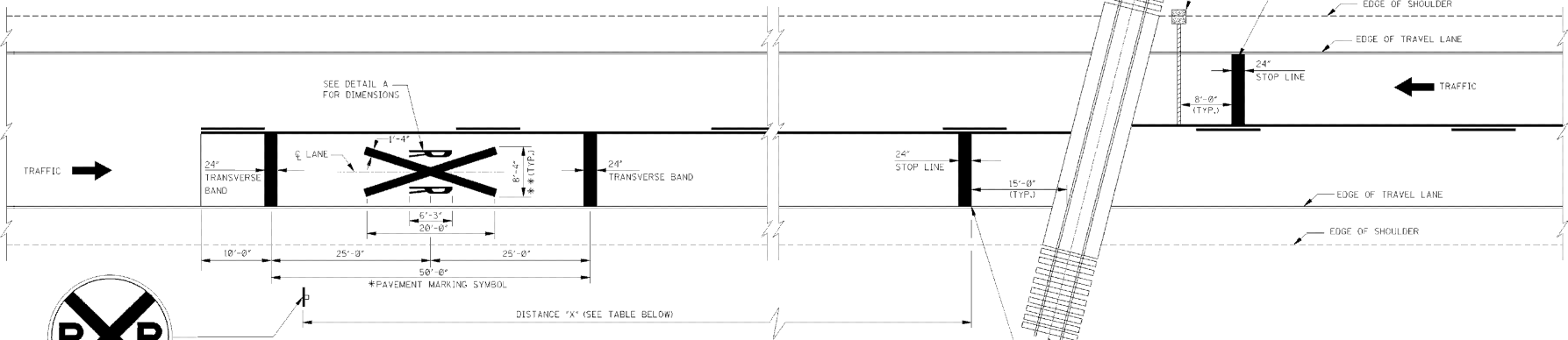
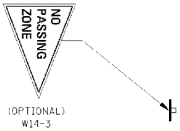

DETAIL A  
STANDARD "R" PAVEMENT MARKING  
FOR R X R SYMBOL

ADVANCE WARNING SIGN PLACEMENT DISTANCE

POSTED SPEED (mph)	① DISTANCE "X" (ft)	
	RURAL	URBAN
20	175	100
25	250	100
30	325	100
35	400	② 150
40	475	② 225
45	550	300
50	625	375
55	700	450
60	775	550

NOTES:  
 ① DISTANCE "X" MAY BE ADJUSTED IF PROHIBITIVE PHYSICAL CONDITIONS EXIST AT THE DESIGNATED DISTANCE.  
 ② THESE DISTANCES MAY BE ADJUSTED TO A MINIMUM OF 100' IN RESIDENTIAL AREAS OR BUSINESS DISTRICTS WHERE LOW SPEEDS ARE PREVALENT.

- GENERAL NOTES:
- \* 1. A PORTION OF THE PAVEMENT MARKING SYMBOL SHOULD BE DIRECTLY OPPOSITE THE ADVANCE WARNING SIGN (W10-1).
  - \* \* 2. WIDTH OF R X R SYMBOL MAY VARY ACCORDING TO LANE WIDTH. HOWEVER, ON MULTI-LANE ROADS, THE TRANSVERSE BANDS AND STOP LINE SHOULD EXTEND ACROSS ALL APPROACH LANES, AND INDIVIDUAL R X R SYMBOLS SHOULD BE USED IN EACH APPROACH LANE.
  - △ 3. R X R SYMBOL (63.0 ft<sup>2</sup>), TRANSVERSE BANDS AND STOP LINE SHALL BE PAID FOR AS LEGEND, WHITE (PLASTIC), (MATERIAL OPTIONAL FOR OTHER AGENCIES).
  - \* \* \* 4. REFER TO THE "MANUAL ON UNIFORM TRAFFIC CONTROL DEVICES" FOR LOCATION OF PROPOSED WARNING DEVICES AT RAILROAD-HIGHWAY GRADE CROSSINGS.

DESIGNED BY	DATE	REVISION	DATE

MISSISSIPPI DEPARTMENT OF TRANSPORTATION  
ROADWAY DESIGN DIVISION  
STANDARD PLAN

**TYPICAL PLACEMENT OF WARNING SIGNS AND PAVEMENT MARKINGS AT RAILROAD HIGHWAY GRADE CROSSINGS**

ISSUE DATE: OCTOBER 1, 1998

WORKING NUMBER: 4109  
SHEET NUMBER: 12

33

- 8 -

Notice To Bidder No. 4109

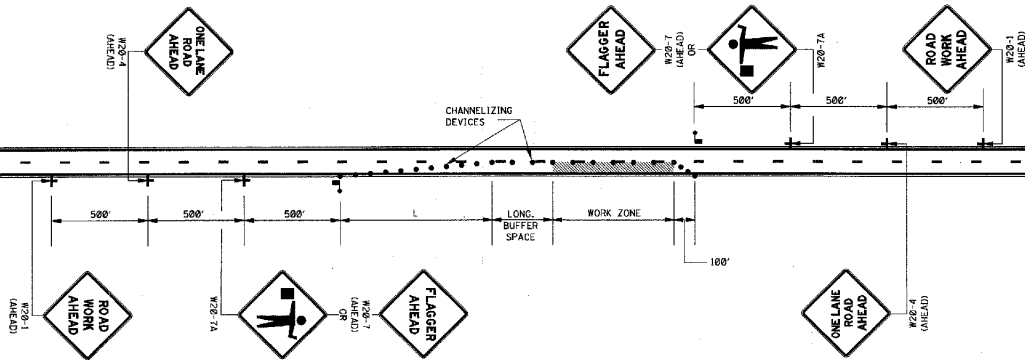

LEGEND  
 ■ FLAGGER  
 ● CHANNELIZING DEVICES

GENERAL NOTES:

1. THE LOCATION OF CHANNELIZING DEVICES AND THE WORK AREA LAYOUT SHALL BE BASED ON THE CRITERIA IN THE FOLLOWING TABLE:

POSTED SPEED AND/OR DESIGN SPEED	MAXIMUM CHANNELIZING DEVICE SPACING (FT)		MINIMUM LONGITUDINAL BUFFER SPACE (FT)	TAPER † RATES
	TAPER	ALONG LANE LINE & WORK ZONE		
20	40	60	170	27:1
45	45	90	220	45:1
50	50	100	260	50:1
55	55	110	335	55:1
60	60	120	415	60:1
65	65	130	485	65:1
70	70	140	575	70:1

† NOTE: TAPER RATES ARE DETERMINED USING THE FOLLOWING EQUATIONS:  
 $L = WS$  FOR SPEEDS OF 45 mph OR GREATER  
 $L = WS^2/60$  FOR SPEEDS OF 40 mph OR LESS  
 WHERE: L = MINIMUM LENGTH OF TAPER IN FEET  
 W = WIDTH OF OFFSET (USUALLY LANE WIDTH) IN FEET  
 S = DESIGN SPEED OR 85TH PERCENTILE SPEED IN MILES PER HOUR

2. ALL CHANNELIZING DEVICES SHALL BE A MINIMUM OF 24" IN HEIGHT.
3. ALL TRAFFIC CONTROL ITEMS SHOWN ON THIS SHEET WILL NOT BE MEASURED FOR SEPARATE PAYMENT. THIS WORK IS TO BE INCLUDED IN THE PRICE BID FOR MAINTENANCE OF TRAFFIC.
4. DIAMOND SHAPED TRAFFIC CONTROL SIGNS SHALL BE A MINIMUM OF 48" x 48".
5. WHEN THERE IS NO EXISTING HAZARD OR AT THE END OF THE WORK DAY, ALL SIGNS SHALL BE COVERED OR REMOVED AND ALL CHANNELIZING DEVICES SHALL BE MOVED TO THE SHOULDER EDGE.
6. WHERE THE WORK ZONE IS STATIONARY, THE W20-7 (500 FT.) SIGN OR THE W20-7A SIGN TOGETHER WITH THE W20-1 (500 FT.) SUPPLEMENTAL PLATE SHOULD BE USED TO INDICATE THE DISTANCE TO THE FLAGGER.

MISSISSIPPI DEPARTMENT OF TRANSPORTATION  
 ROADWAY DESIGN DIVISION  
 STANDARD PLAN

**TRAFFIC CONTROL PLAN  
 WITH FLAGGER  
 (ONE-LANE CLOSURE OF  
 TWO-WAY TRAFFIC)**

WORKING NUMBER  
 TCP-1

SHEET NUMBER  
 250

ISSUE DATE: OCTOBER 1, 1998

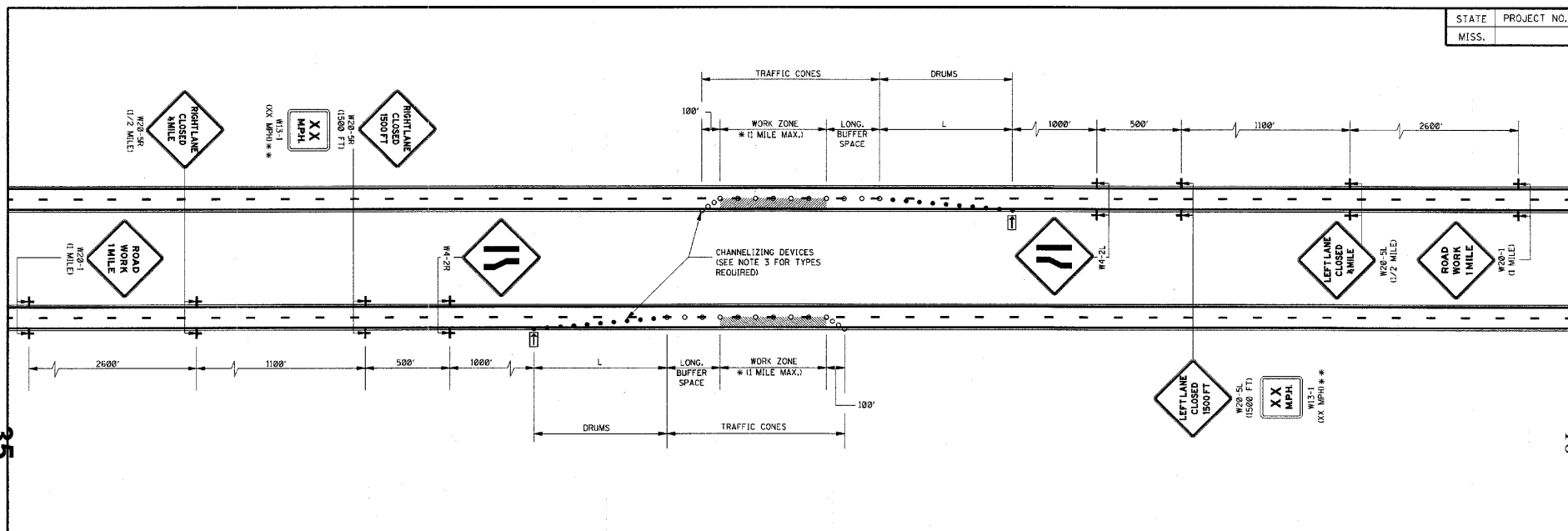

GENERAL NOTES:

1. THE LOCATION OF CHANNELIZING DEVICES AND THE WORK AREA LAYOUT SHALL BE BASED ON THE CRITERIA IN THE FOLLOWING TABLE:

POSTED SPEED AND/OR DESIGN SPEED	MAXIMUM CHANNELIZING DEVICE SPACING (ft)		MINIMUM LONGITUDINAL BUFFER SPACE (ft)	TAPER † RATES
	TAPER	ALONG LANE LINE & WORK ZONE		
≤40	40	80	170	27:1
45	45	90	220	45:1
50	50	100	280	50:1
55	55	110	335	55:1
60	60	120	415	60:1
65	65	130	485	65:1
70	70	140	575	70:1

† NOTE: TAPER RATES ARE DETERMINED USING THE FOLLOWING EQUATIONS:  
 $L = WS$  FOR SPEEDS OF 45 mph OR GREATER  
 $L = WS^2/60$  FOR SPEEDS OF 40 mph OR LESS  
 WHERE: L = MINIMUM LENGTH OF TAPER IN FEET  
 W = WIDTH OF OFFSET (USUALLY LANE WIDTH) IN FEET  
 S = DESIGN SPEED OR 85TH PERCENTILE SPEED IN MILES PER HOUR

- FLASHING ARROW PANEL SHALL BE AS LEVEL AS POSSIBLE AS APPROVED BY THE ENGINEER. FLASHING ARROW PANEL SHOULD BE LOCATED AT THE BEGINNING OF THE TAPER OR, IF THE SHOULDER IS TOO NARROW, BEHIND THE CHANNELIZING DEVICES IN THE CLOSED LANE.
- CHANNELIZING DEVICE TYPES FOR:  
 A. APPROACH TAPER- REFLECTORIZED PLASTIC DRUMS  
 B. ALONG LANE LINE AND WORK ZONE- TRAFFIC CONES (28" HEIGHT)  
 C. EXIT TAPER- TRAFFIC CONES (28" HEIGHT)
- WHEN THERE IS NO EXISTING HAZARD, ALL SIGNS SHALL BE COVERED OR REMOVED AND THE DRUMS SHALL BE MOVED TO THE SHOULDER EDGE AT THE END OF THE WORK DAY.
- FOR MOVING OPERATIONS (PAVING) THE CONTRACTOR SHALL HAVE TWO (2) SETS OF ADVANCE WARNING SIGNS, PLASTIC DRUMS, AND ARROW BOARD, WHEN THE CONSTRUCTION ZONE IS MOVED AHEAD, ALL SIGNS, PLASTIC DRUMS AND ARROW BOARD SHALL BE IN PLACE ON THE SECOND ZONE BEFORE REMOVING ANY SIGNS, PLASTIC DRUMS OR ARROW BOARD ON THE FIRST ZONE.
- ALL TRAFFIC CONTROL ITEMS SHOWN ON THIS SHEET WILL NOT BE MEASURED FOR SEPARATE PAYMENT. THIS WORK IS TO BE INCLUDED IN THE PRICE BID FOR MAINTENANCE OF TRAFFIC.
- DIAMOND SHAPED TRAFFIC CONTROL SIGNS SHALL BE A MINIMUM OF 48" X 48".

LEGEND

- \* OR AS SHOWN ELSEWHERE OF THE PLANS.
- \*\* THE LEGEND ON W13-1 (XX MPH) SUPPLEMENTAL PLATE SHALL BE 10 MPH LESS THAN THE POSTED SPEED LIMIT.
- ◻ FLASHING ARROW PANEL (TYPE 'C')
- REFLECTORIZED FREE-STANDING PLASTIC DRUMS
- TRAFFIC CONES (28" HEIGHT)

35

10

Notice To Bidder No. 4100 Cont'd

MISSISSIPPI DEPARTMENT OF TRANSPORTATION  
 ROADWAY DESIGN DIVISION  
 STANDARD PLAN

**TRAFFIC CONTROL PLAN  
 FOR POSTED SPEED LIMIT  
 LESS THAN 65 MPH  
 (4-LANE-MEDIAN LANE  
 OR OUTSIDE LANE CLOSURE)  
 (WORK DAY ONLY)**

WORKING NUMBER: TCP-2  
 SHEET NUMBER: 251

ISSUE DATE: OCTOBER 1, 1998

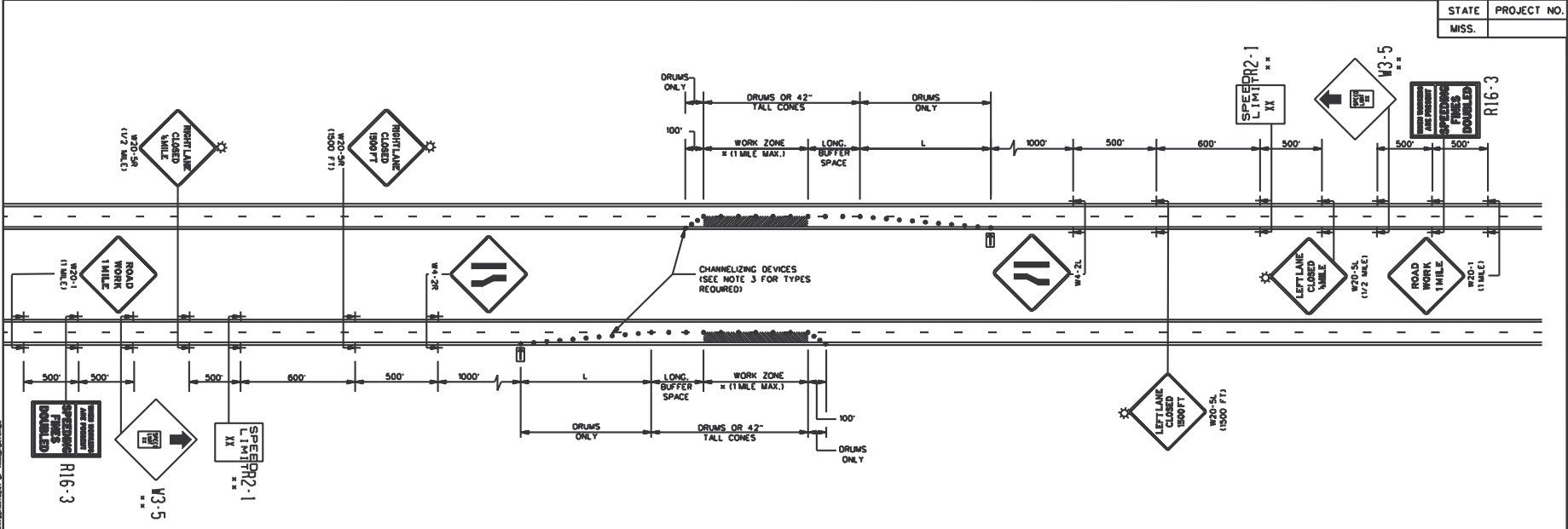

GENERAL NOTES:

1. THE LOCATION OF CHANNELIZING DEVICES AND THE WORK AREA LAYOUT SHALL BE BASED ON THE CRITERIA IN THE FOLLOWING TABLE:

POSTED SPEED AND/OR DESIGN SPEED	MAXIMUM CHANNELIZING DEVICE SPACING (1)		MINIMUM LONGITUDINAL BUFFER SPACE (1)	TAPER RATES
	TAPER	ALONG BUFFER SPACE & WORK ZONE		
40	40	80	170	27:1
45	45	90	220	45:1
50	50	100	280	50:1
55	55	110	335	55:1
60	60	120	415	60:1
65	65	130	485	65:1
70	70	140	575	70:1

1 NOTE: TAPER RATES ARE DETERMINED USING THE FOLLOWING EQUATIONS:  
 $L = WS$  FOR SPEEDS OF 45 mph OR GREATER  
 $L = WS^2/60$  FOR SPEEDS OF 40 mph OR LESS  
 WHERE: L = MINIMUM LENGTH OF TAPER IN FEET  
 W = WIDTH OF OFFSET (USUALLY LANE WIDTH) IN FEET  
 S = DESIGN SPEED OR 85TH PERCENTILE SPEED IN MILES PER HOUR

- FLASHING ARROW PANEL SHALL BE AS LEVEL AS POSSIBLE AS APPROVED BY THE ENGINEER. FLASHING ARROW PANEL SHOULD BE LOCATED AT THE BEGINNING OF THE TAPER OR, IF THE SHOULDER IS TOO NARROW, BEHIND THE CHANNELIZING DEVICES IN THE CLOSED LANE.
- CHANNELIZING DEVICES:
  - ALL CHANNELIZING DEVICES IN TAPERS SHALL BE REFLECTORIZED FREE STANDING PLASTIC DRUMS.
  - CHANNELIZING DEVICES IN TANGENTS MAY BE EITHER REFLECTORIZED FREE STANDING PLASTIC DRUMS OR 42" TALL CONES.
  - FOR NIGHTTIME USE, ALL CHANNELIZING DEVICES SHALL BE RETRORFLECTIVE.
  - RETRORFLECTORIZATION SHALL BE IN ACCORDANCE WITH THE LATEST EDITION OF THE M.U.T.C.D.
- FOR MOVING OPERATIONS (PAVING) THE CONTRACTOR SHALL HAVE TWO (2) SETS OF ADVANCE WARNING SIGNS, PLASTIC DRUMS, AND ARROW BOARD. WHEN THE CONSTRUCTION ZONE IS MOVED AHEAD, ALL SIGNS, PLASTIC DRUMS AND ARROW BOARD SHALL BE IN PLACE ON THE SECOND ZONE BEFORE REMOVING ANY SIGNS, PLASTIC DRUMS OR ARROW BOARD ON THE FIRST ZONE.
- ALL TRAFFIC CONTROL ITEMS SHOWN ON THIS SHEET WILL NOT BE MEASURED FOR SEPARATE PAYMENT. THIS WORK IS TO BE INCLUDED IN THE PRICE BID FOR MAINTENANCE OF TRAFFIC.
- DIAMOND SHAPED TRAFFIC CONTROL SIGNS SHALL BE A MINIMUM OF 48" X 48".

LEGEND

- OR AS SHOWN ELSEWHERE OF THE PLANS.
- \*\* THE LEGEND ON R2-1 & W3-5 SPEED LIMIT SIGNS SHALL BE 10 MPH LESS THAN THE ORIGINAL POSTED SPEED LIMIT.
- FLASHING ARROW PANEL (TYPE "C")
- REFLECTORIZED FREE-STANDING PLASTIC DRUMS
- TYPE "B" WARNING LIGHTS

MISSISSIPPI DEPARTMENT OF TRANSPORTATION  
 TRAFFIC CONTROL PLAN  
 FOR POSTED SPEED LIMIT  
 LESS THAN 65 MPH  
 (4-LANE MEDIAN OR  
 OUTSIDE LANE CLOSURE)  
 (EXTENDED PERIOD)

WORKING NUMBER: SDTCP-3  
 SHEET NUMBER: 3

DATE: FILENAME: OVERNIGHTCLOS\SDTCP-3  
 DESIGN TEAM: CHECKED: DATE:

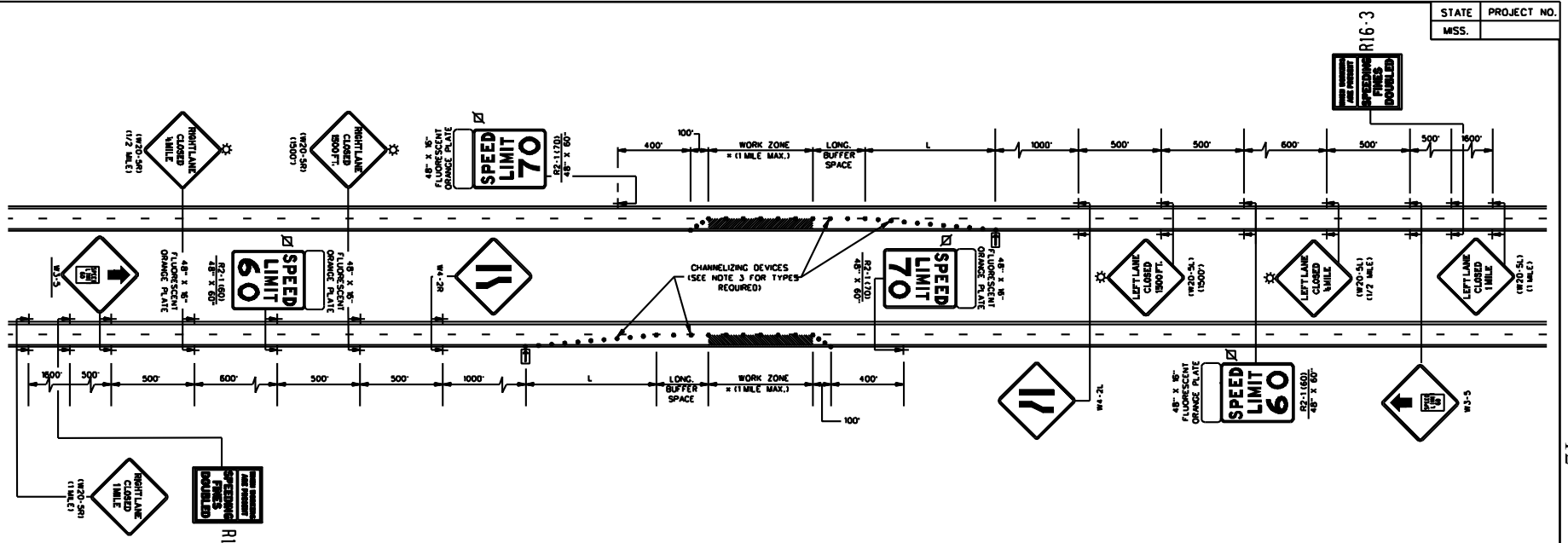

GENERAL NOTES:

1. THE LOCATION OF CHANNELIZING DEVICES AND THE WORK AREA LAYOUT SHALL BE BASED ON THE CRITERIA IN THE FOLLOWING TABLE:

POSTED SPEED AND/OR DESIGN SPEED	MAXIMUM CHANNELIZING DEVICE SPACING (1)		MINIMUM LONGITUDINAL BUFFER SPACE (1)	TAPER RATES
	TAPER	ALONG BUFFER SPACE & WORK ZONE		
40	40	80	170	27:1
45	45	90	220	45:1
50	50	100	280	50:1
55	55	110	335	55:1
60	60	120	415	60:1
65	65	130	485	65:1
70	70	140	575	70:1

1. NOTE: TAPER RATES ARE DETERMINED USING THE FOLLOWING EQUATIONS:  
 L = WS FOR SPEEDS OF 45 MPH OR GREATER  
 L = WS<sup>2</sup>/60 FOR SPEEDS OF 40 MPH OR LESS  
 WHERE: L = MINIMUM LENGTH OF TAPER IN FEET  
 W = WIDTH OF OFFSET (USUALLY LANE WIDTH) IN FEET  
 S = DESIGN SPEED OR 85TH PERCENTILE SPEED IN MILES PER HOUR

2. FLASHING ARROW PANEL SHALL BE AS LEVEL AS POSSIBLE AS APPROVED BY THE ENGINEER. FLASHING ARROW PANEL SHOULD BE LOCATED AT THE BEGINNING OF THE TAPER OR, IF THE SHOULDER IS TOO NARROW, BEHIND THE CHANNELIZING DEVICES IN THE CLOSED LANE.

3. CHANNELIZING DEVICES:

- A. ALL CHANNELIZING DEVICES IN TAPERS SHALL BE REFLECTORIZED FREE STANDING PLASTIC DRUMS.
- B. CHANNELIZING DEVICES IN TANGENTS MAY BE EITHER REFLECTORIZED FREE STANDING PLASTIC DRUMS OR 42" TALL CONES.
- C. FOR NIGHTTIME USE, ALL CHANNELIZING DEVICES SHALL BE RETROREFLECTIVE.
- D. RETROREFLECTORIZATION SHALL BE IN ACCORDANCE WITH THE LATEST EDITION OF THE M.U.T.C.D.
- 4. ALL TRAFFIC CONTROL ITEMS SHOWN ON THIS SHEET WILL NOT BE MEASURED FOR SEPARATE PAYMENT. THIS WORK IS TO BE INCLUDED IN THE PRICE BID FOR MAINTENANCE OF TRAFFIC.
- 5. DIAMOND SHAPED TRAFFIC CONTROL SIGNS SHALL BE A MINIMUM OF 48" X 48".
- 6. ALL EXISTING SPEED LIMIT SIGNS WHICH ARE INFLUENCED BY OR CONFLICT WITH THE SPEED ZONE REDUCTION SHALL BE COVERED AS DIRECTED BY THE ENGINEER WHILE THE REDUCED SPEED LIMIT IS IN EFFECT. TAPE SHALL NOT BE USED ON FACE OF SIGN.
- 7. ADDITIONAL REDUCED SPEED LIMIT SIGNS ARE REQUIRED AT EACH ENTRANCE RAMP WITHIN THE SPEED ZONE. A MINIMUM OF TWO (2) WILL BE REQUIRED FOR EACH RAMP. LOCATION AND NUMBER REQUIRED WILL BE DETERMINED BY THE ENGINEER.
- 8. THIS TRAFFIC CONTROL PLAN, WITH SPEED ZONE, MAY NOT BE USED ON ANY FACILITY WHERE THE POSTED SPEED LIMIT IS BELOW 65 MPH WITHOUT A COMMISSION ORDER REQUESTING A SPEED LIMIT REDUCTION.
- 9. LAYOUT SHOWN ABOVE IS FOR AN INTERSTATE WITH A POSTED SPEED LIMIT OF 70 MPH. FOR POSTED SPEED LIMIT OF 65 MPH, THE REDUCED SPEED LIMIT WILL BE 55 MPH.
- 10. A FLUORESCENT ORANGE PLATE IS REQUIRED WITH ALL REGULATORY SPEED LIMIT SIGNS REQUIRED FOR LANE CLOSURE.

- LEGEND
- \* OR AS SHOWN ELSEWHERE OF THE PLANS.
  - ◻ FLASHING ARROW PANEL (TYPE "C")
  - ◻ BLACK LEGEND AND BORDER ON WHITE BACKGROUND
  - ☆ TYPE "B" WARNING LIGHTS
  - REFLECTORIZED FREE-STANDING PLASTIC DRUMS

MISSISSIPPI DEPARTMENT OF TRANSPORTATION  
 TRAFFIC CONTROL PLAN  
 FOR POSTED SPEED LIMIT  
 OF 65 OR 70 MPH  
 (INTERSTATES AND OTHER 4-LANE  
 DIVIDED HIGHWAYS)  
 (MEDIAN LANE OR OUTSIDE  
 LANE CLOSURE) (EXTENDED PERIOD)

WORKING NUMBER  
SDTCP - 4

FILE NAME: OVERNIGHTCLOS\SDTCP-4  
 DESIGN TEAM: \_\_\_\_\_ CHECKED: \_\_\_\_\_ DATE: \_\_\_\_\_

SHEET NUMBER

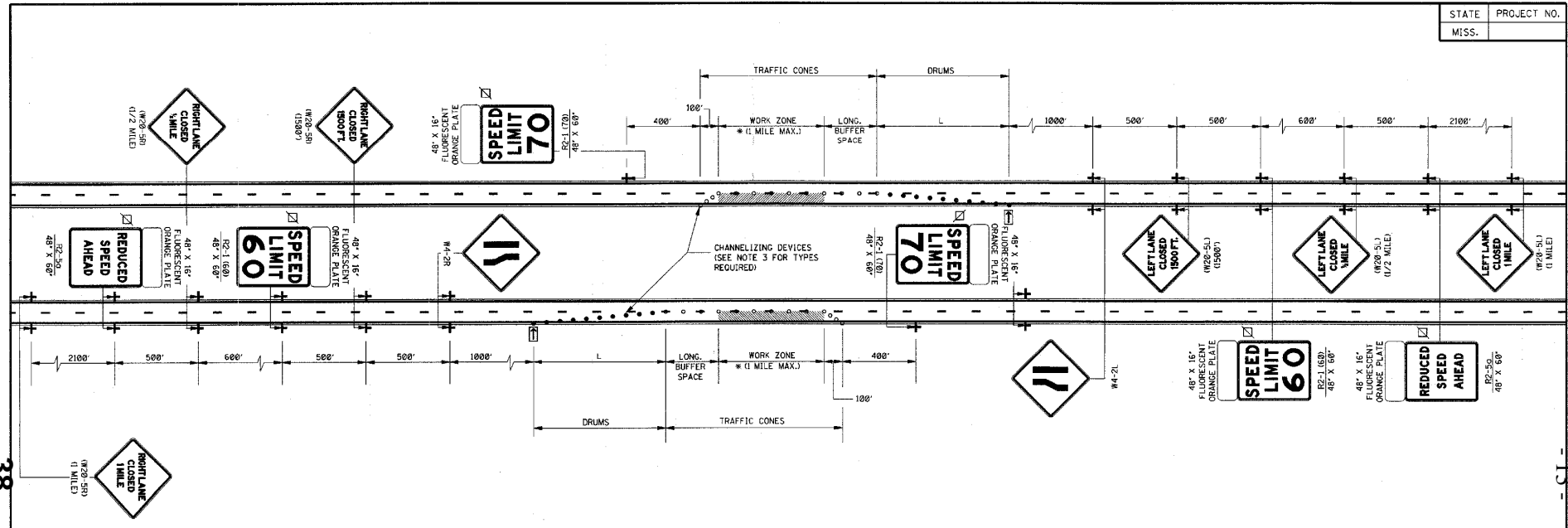

38

GENERAL NOTES:

1. THE LOCATION OF CHANNELIZING DEVICES AND THE WORK AREA LAYOUT SHALL BE BASED ON THE CRITERIA IN THE FOLLOWING TABLE:

POSTED SPEED AND/OR DESIGN SPEED	MAXIMUM CHANNELIZING DEVICE SPACING (ft)		MINIMUM LONGITUDINAL BUFFER SPACE (ft)	TAPER RATES
	TAPER	ALONG LANE LINE & WORK ZONE		
40	40	80	170	27:1
45	45	90	220	45:1
50	50	100	280	50:1
55	55	110	335	55:1
60	60	120	415	60:1
65	65	130	485	65:1
70	70	140	575	70:1

† NOTE: TAPER RATES ARE DETERMINED USING THE FOLLOWING EQUATIONS:  
 $L = WS$  FOR SPEEDS OF 45 MPH OR GREATER  
 $L = WS^2/60$  FOR SPEEDS OF 40 MPH OR LESS  
 WHERE: L = MINIMUM LENGTH OF TAPER IN FEET  
 W = WIDTH OF OFFSET (USUALLY LANE WIDTH) IN FEET  
 S = DESIGN SPEED OR 85TH PERCENTILE SPEED IN MILES PER HOUR

- FLASHING ARROW PANEL SHALL BE AS LEVEL AS POSSIBLE AS APPROVED BY THE ENGINEER. FLASHING ARROW PANEL SHOULD BE LOCATED AT THE BEGINNING OF THE TAPER OR, IF THE SHOULDER IS TOO NARROW, BEHIND THE CHANNELIZING DEVICES IN THE CLOSED LANE.
- CHANNELIZING DEVICE TYPES FOR:
  - APPROACH TAPER- REFLECTORIZED PLASTIC DRUMS
  - ALONG LANE LINE AND WORK ZONE- TRAFFIC CONES (28" HEIGHT)
  - EXIT TAPER- TRAFFIC CONES (28" HEIGHT)

- WHEN THERE IS NO EXISTING HAZARD, ALL SIGNS SHALL BE COVERED OR REMOVED AND THE DRUMS SHALL BE MOVED TO THE SHOULDER EDGE AT THE END OF THE WORK DAY.
- FOR MOVING OPERATIONS (PAVING) THE CONTRACTOR SHALL HAVE TWO (2) SETS OF ADVANCE WARNING AND REGULATORY SIGNS, PLASTIC DRUMS, AND ARROW BOARD. WHEN THE CONSTRUCTION ZONE IS MOVED AHEAD, ALL SIGNS, PLASTIC DRUMS AND ARROW BOARD SHALL BE IN PLACE ON THE SECOND ZONE BEFORE REMOVING ANY SIGNS, PLASTIC DRUMS OR ARROW BOARD ON THE FIRST ZONE.
- ALL TRAFFIC CONTROL ITEMS SHOWN ON THIS SHEET WILL NOT BE MEASURED FOR SEPARATE PAYMENT, THIS WORK IS TO BE INCLUDED IN THE PRICE BID FOR MAINTENANCE OF TRAFFIC.
- DIAMOND SHAPED TRAFFIC CONTROL SIGNS SHALL BE A MINIMUM OF 48" X 48".
- ALL EXISTING SPEED LIMIT SIGNS WHICH ARE INFLUENCED BY OR CONFLICT WITH THE SPEED ZONE REDUCTION SHALL BE COVERED AS DIRECTED BY THE ENGINEER WHILE THE REDUCED SPEED LIMIT IS IN EFFECT. TAPE SHALL NOT BE USED ON THE FACE OF SIGN.
- ADDITIONAL REDUCED SPEED LIMIT SIGNS ARE REQUIRED AT EACH ENTRANCE RAMP WITHIN THE SPEED ZONE. A MINIMUM OF TWO (2) WILL BE REQUIRED FOR EACH RAMP. LOCATION AND NUMBER REQUIRED WILL BE DETERMINED BY THE ENGINEER.
- THIS TRAFFIC CONTROL PLAN WITH SPEED ZONE, MAY NOT BE USED ON ANY FACILITY WHERE THE POSTED SPEED LIMIT IS BELOW 65 MPH WITHOUT A COMMISSION ORDER REQUESTING A SPEED LIMIT REDUCTION.
- LAYOUT SHOWN ABOVE IS FOR AN INTERSTATE WITH A POSTED SPEED LIMIT OF 70 MPH, FOR POSTED SPEED LIMIT OF 65 MPH, THE REDUCED SPEED LIMIT WILL BE 55 MPH.
- A FLUORESCENT ORANGE PLATE IS REQUIRED WITH ALL REGULATORY SPEED LIMIT SIGNS AND "REDUCED SPEED AHEAD" SIGNS REQUIRED FOR LANE CLOSURE.

LEGEND

- \* OR AS SHOWN ELSEWHERE OF THE PLANS.
- ◻ FLASHING ARROW PANEL (TYPE "C")
- ◻ BLACK LEGEND AND BORDER ON WHITE BACKGROUND
- REFLECTORIZED FREE-STANDING PLASTIC DRUMS
- TRAFFIC CONES (28" HEIGHT)

MISSISSIPPI DEPARTMENT OF TRANSPORTATION	
ROADWAY DESIGN DIVISION	
STANDARD PLAN	
<b>TRAFFIC CONTROL PLAN</b>	
<b>FOR POSTED SPEED LIMIT</b>	
<b>OF 65 OR 70 MPH</b>	
<b>(INTERSTATES AND OTHER 4-LANE</b>	
<b>DIVIDED HIGHWAYS)</b>	
<b>(MEDIAN LANE OR OUTSIDE</b>	
<b>LANE CLOSURE) (WORK DAY ONLY)</b>	
WORKING NUMBER	TCP-5
SHEET NUMBER	254
DATE	ISSUE DATE: OCTOBER 1, 1998

- 13 -

Notice To Bidder No. 4100-1-10-98



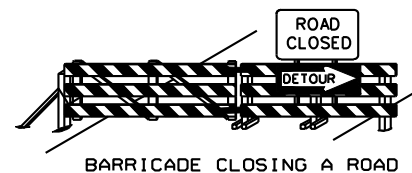
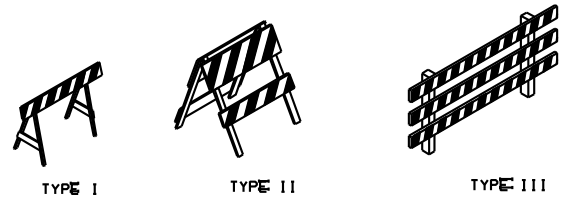

### STANDARD BARRICADES

1. A TYPE I BARRICADE CONSISTS OF ONE (1) HORIZONTAL RAIL SUPPORTED BY A DEMOUNTABLE FRAME OR A LIGHT "A" FRAME. A TYPE I BARRICADE NORMALLY WOULD BE USED ON CONVENTIONAL ROADS OR URBAN STREETS AND ARTERIALS.
2. A TYPE II BARRICADE CONSISTS OF TWO (2) HORIZONTAL RAILS ON A LIGHT "A" FRAME. TYPE II BARRICADES ARE INTENDED FOR USE ON EXPRESSWAYS AND FREEWAYS AND OTHER HIGH-SPEED ROADWAYS.
3. TYPE I AND TYPE II BARRICADES ARE INTENDED FOR USE WHERE THE HAZARD IS RELATIVELY SMALL AS, FOR EXAMPLE, ON CITY STREETS, OR FOR THE MORE OR LESS CONTINUOUS DELIMITING OF A RESTRICTED ROADWAY, OR FOR TEMPORARY DAYTIME USE.
4. A TYPE III BARRICADE CONSISTS OF THREE (3) HORIZONTAL RAILS SUPPORTED BY FIXED POSTS, A RIGID SKID, A HEAVY DEMOUNTABLE FRAME OR A HEAVY, HINGED "A" FRAME.
5. TYPE III BARRICADES ARE INTENDED FOR USE ON CONSTRUCTION AND MAINTENANCE PROJECTS AS WING BARRICADES AND AT ROAD CLOSURES, WHERE THEY MUST REMAIN IN PLACE FOR EXTENDED PERIODS.
6. THE MARKING FOR BARRICADE RAILS SHALL BE ORANGE AND WHITE (SLOPING DOWNWARD AT AN ANGLE OF 45° IN THE DIRECTION TRAFFIC IS TO PASS).
7. DO NOT PLACE SANDBAGS OR OTHER DEVICES TO PROVIDE MASS ON THE BOTTOM RAIL THAT WILL BLOCK VIEW OR RAIL FACE.
8. FOR ADDITIONAL INFORMATION OR DETAILS, SEE MUTCD, LATEST EDITION.

### BARRICADE CHARACTERISTICS

	I	II	III
WIDTH OF RAIL * #	8" MIN. - 12" MAX.	8" MIN. - 12" MAX.	8" MIN. - 12" MAX.
LENGTH OF RAIL * #	24" MIN.	24" MIN.	48" MIN.
WIDTH OF STRIPE #	6"	6"	6"
HEIGHT	36" MIN.	36" MIN.	60" MIN.
NUMBER OF REFLECTORIZED RAIL FACES	2 (ONE EACH DIRECTION)	4 (TWO EACH DIRECTION)	3 IF FACING TRAFFIC IN ONE DIRECTION 6 IF FACING TRAFFIC IN TWO DIRECTIONS
TYPE OF FRAME	LIGHT	LIGHT "A" FRAME	POST OR SKID

- \* 1. FOR RAILS LESS THAN 36" LONG, 4" WIDE STRIPES MAY BE USED.
- \*\* 2. BARRICADES INTENDED FOR USE ON EXPRESSWAYS, FREEWAYS AND OTHER HIGH SPEED ROADWAYS, SHALL HAVE A MINIMUM OF 270 IN<sup>2</sup> OF REFLECTIVE AREA FACING TRAFFIC.

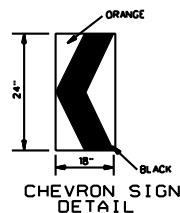

CHEVRON SIGN DETAIL

1. A CHEVRON SIGN CONSISTS OF A BLACK CHEVRON TYPE MARKING ON AN ORANGE BACKGROUND AND SHALL POINT IN THE DIRECTION OF TRAFFIC FLOW.
2. THE CHEVRON SIGN SHALL BE MOUNTED ON FIXED POST OR RIGID SKID.
3. CHEVRON SIGNS MAY BE USED TO SUPPLEMENT OTHER STANDARD DEVICES WHERE ONE OR MORE LANES ARE CLOSED FOR CONSTRUCTION OR MAINTENANCE. THEY SHALL BE PLACED APPROXIMATELY 2'-0" BEHIND THE LANE TRANSITION STRIPE.

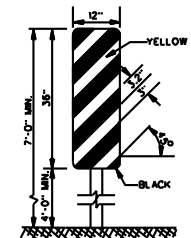

TYPE 3 OBJECT MARKER (OM-3R)

1. TYPE 3 OBJECT MARKERS SHALL BE USED AT ALL EXPOSED BRIDGE ABUTMENTS AND AT OTHER LOCATIONS AS DEEMED NECESSARY BY THE ENGINEER.
2. THE OM-3R IS SHOWN. THE OM-3L IS SIMILAR EXCEPT THE STRIPES SLOPE DOWNWARD FROM THE UPPER LEFT SIDE TO THE LOWER RIGHT SIDE AND SHALL BE PLACED ON THE LEFT SIDE OF THE OBJECT.
3. THE INSIDE EDGE OF THE MARKER SHALL BE IN LINE WITH THE INNER EDGE OF THE OBSTRUCTION.

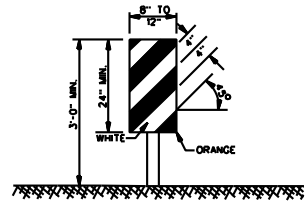

VERTICAL PANEL

1. VERTICAL PANELS CONSIST OF AT LEAST ONE PANEL 8" TO 12" IN WIDTH AND A MINIMUM OF 24" IN HEIGHT.
2. THE DIAGONAL STRIPES SHALL SLOPE DOWNWARD IN THE DIRECTION THAT TRAFFIC IS TO PASS THE PANEL. THE PANELS SHALL BE MOUNTED WITH THE TOP A MINIMUM OF 36" ABOVE THE ROADWAY ON A SINGLE LIGHTMASS POST.
3. VERTICAL PANELS USED ON EXPRESSWAYS, FREEWAYS AND OTHER HIGH-SPEED ROADWAYS SHALL HAVE A MINIMUM OF 270 IN<sup>2</sup> OF RETROREFLECTIVE AREA FACING TRAFFIC.
4. FOR TWO-WAY TRAFFIC OPERATIONS, BACK-TO-BACK PANELS SHALL BE USED.

- GENERAL NOTES:
1. MARKINGS ON ALL DEVICES SHOWN ON THIS SHEET SHALL BE HIGH INTENSITY REFLECTIVE SHEETING.
  2. THE TRAFFIC CONTROL PLAN WILL LIST THE VARIOUS TRAFFIC CONTROL DEVICES REQUIRED FOR EACH PROJECT.

### WING BARRICADES

1. WING BARRICADES ARE TYPE III BARRICADES ERRECTED ON THE SHOULDER ON ONE OR BOTH SIDES OF THE PAVEMENT TO GIVE THE SENSATION OF A NARROWING OR RESTRICTED ROADWAY. WING BARRICADES MAY BE USED AS A MOUNTING FOR THE ADVANCE WARNING SIGNS OR FLASHERS.
2. WING BARRICADES SHOULD BE USED:
  - A. IN ADVANCE OF A CONSTRUCTION PROJECT EVEN WHEN NO PART OF THE ROADWAY IS ACTUALLY CLOSED.
  - B. IN ADVANCE OF ALL BRIDGE OR CULVERT WIDENING OPERATIONS.

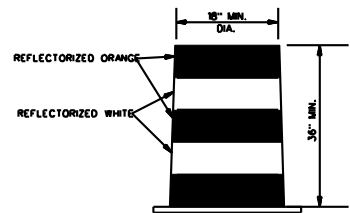

PLASTIC DRUM STRIPING DETAIL

1. PLASTIC DRUMS SHALL BE ON END AND USED AS AN EXPEDIENT METHOD FOR TRAFFIC CHANNELIZATION. THE COLOR AND MARKING OF DRUMS SHALL BE CONSISTENT WITH MARKING STANDARDS FOR BARRICADE. THE PREDOMINANT COLOR ON DRUMS SHALL BE ORANGE WITH FOUR (4) REFLECTORIZED, HORIZONTAL, CIRCUMFERENTIAL STRIPES (2 ORANGE & 2 WHITE) 6" WIDE.
2. DRUMS SHOULD NEVER BE PLACED IN THE ROADWAY WITHOUT WARNING SIGNS.
3. WHERE PRACTICAL PLASTIC DRUMS SHALL BE PLACED NO CLOSER THAN 3'-0" FROM THE EDGE OF TRAVELED LANE.

MISSISSIPPI DEPARTMENT OF TRANSPORTATION	
HIGHWAY SIGN AND BARRICADE DETAIL FOR CONSTRUCTION PROJECTS	
DESIGNER	DATE 8/21/2012
WORKING NUMBER	SHEET NUMBER
SDTCP-10	SDTCP-10
FILENAME: SDTCP-10_06012012.DGN	

- 14 -  
Notice To Bidders  
on d.

MOBILE OPERATIONS ON MULTILANE ROAD ▲

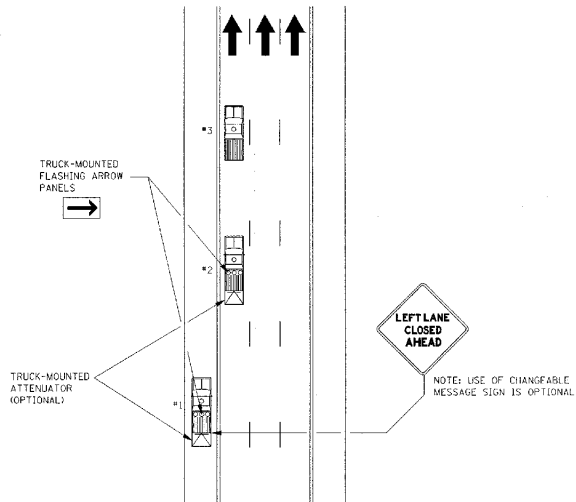

MOBILE OPERATIONS ON MULTILANE ROAD

NOTES:

- VEHICLES USED FOR THESE OPERATIONS SHOULD BE MADE HIGHLY VISIBLE WITH APPROPRIATE EQUIPMENT, SUCH AS FLASHING LIGHTS, ROTATING BEACONS, FLAGS, SIGNS, OR ARROW PANELS.
- PROTECTION VEHICLE #1 SHOULD BE EQUIPPED WITH AN ARROW PANEL. AN APPROPRIATE LANE CLOSURE SIGN SHOULD BE PLACED ON PROTECTION VEHICLE #1 SO AS NOT TO OBSCURE THE ARROW PANEL.
- PROTECTION VEHICLE #2 SHOULD BE EQUIPPED WITH AN ARROW PANEL AND TRUCK-MOUNTED ATTENUATOR (TMA).
- PROTECTION VEHICLE #1 SHOULD TRAVEL AT A VARYING DISTANCE FROM THE WORK OPERATION SO AS TO PROVIDE ADEQUATE SIGHT DISTANCE FOR TRAFFIC APPROACHING FROM THE REAR.
- WHEN ADEQUATE SHOULDER WIDTH IS NOT AVAILABLE, PROTECTION VEHICLE #1 SHOULD BE ELIMINATED.
- ON HIGH-SPEED ROADWAYS, A THIRD PROTECTION VEHICLE SHOULD BE USED (I.E., VEHICLE #1 ON THE SHOULDER IF PRACTICAL, VEHICLE #2 IN THE CLOSED LANE, AND VEHICLE #3 IN THE CLOSED LANE).
- ARROW PANELS SHALL BE AS A MINIMUM TYPE B, 60" X 30" IN ACCORDANCE WITH THE CRITERIA PRESENTED IN THE MUTCD.
- WORK SHOULD NORMALLY BE DONE DURING OFF-PEAK HOURS.
- ALL TRAFFIC CONTROL ITEMS SHOWN ON THIS SHEET WILL NOT BE MEASURED FOR SEPARATE PAYMENT. THIS WORK IS TO BE INCLUDED IN THE PRICE BID FOR MAINTENANCE OF TRAFFIC.

MOBILE OPERATIONS ON TWO-LANE ROAD

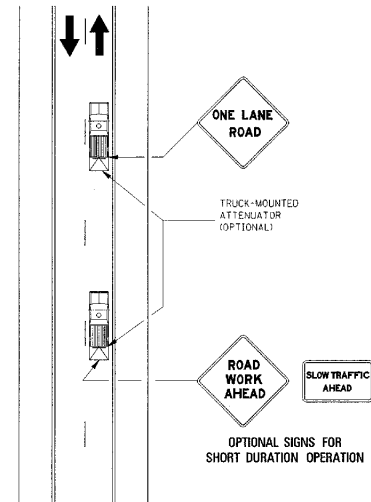

MOBILE OPERATIONS ON TWO-LANE ROAD

NOTES:

- WHERE PRACTICAL AND WHEN NEEDED, THE WORK AND PROTECTION VEHICLES SHOULD PULL OVER PERIODICALLY TO ALLOW TRAFFIC TO PASS. IF THIS CAN NOT BE DONE FREQUENTLY, AS AN ALTERNATIVE, A "DO NOT PASS" SIGN MAY BE PLACED ON THE REAR OF THE VEHICLE BLOCKING THE LANE.
- THE DISTANCE BETWEEN THE WORK AND PROTECTION VEHICLES MAY VARY ACCORDING TO TERRAIN, PAINT DRYING TIME, AND OTHER FACTORS. PROTECTION VEHICLES ARE USED TO WARN TRAFFIC OF THE OPERATION AHEAD. WHENEVER ADEQUATE STOPPING SIGHT DISTANCE EXISTS TO THE REAR, THE PROTECTION VEHICLE SHOULD MAINTAIN THE MINIMUM DISTANCE AND PROCEED AT THE SAME SPEED AS THE WORK VEHICLE. THE PROTECTION VEHICLE SHOULD SLOW DOWN IN ADVANCE OF VERTICAL OR HORIZONTAL CURVES THAT RESTRICT SIGHT DISTANCE.
- ADDITIONAL PROTECTION VEHICLES TO WARN AND REDUCE THE SPEED OF ONCOMING OR OPPOSING TRAFFIC MAY BE USED. POLICE PATROL CARS MAY BE USED FOR THIS PURPOSE.
- A TRUCK-MOUNTED ATTENUATOR (TMA) SHOULD BE USED ON THE PROTECTION VEHICLE AND MAY BE USED ON THE WORK VEHICLE.
- THE WORK VEHICLE SHALL BE EQUIPPED WITH BEACONS, AND THE PROTECTION VEHICLES SHALL BE EQUIPPED WITH TWO HIGH-INTENSITY FLASHING LIGHTS MOUNTED ON THE REAR, ADJACENT TO THE SIGN. PROTECTION AND WORK VEHICLES SHOULD DISPLAY FLASHING OR ROTATING BEACONS BOTH FORWARD AND TO THE REAR.
- VEHICLE-MOUNTED SIGNS SHALL BE MOUNTED WITH THE BOTTOM OF THE SIGN LOCATED AT A MINIMUM HEIGHT OF 48" ABOVE THE PAVEMENT. SIGN LEGENDS SHALL BE COVERED OR TURNED FROM VIEW WHEN WORK IS NOT IN PROGRESS.
- ALL TRAFFIC CONTROL ITEMS SHOWN ON THIS SHEET WILL NOT BE MEASURED FOR SEPARATE PAYMENT. THIS WORK IS TO BE INCLUDED IN THE PRICE BID FOR MAINTENANCE OF TRAFFIC.

STATE	PROJECT NO.
MISS.	

MISSISSIPPI DEPARTMENT OF TRANSPORTATION ROADWAY DESIGN DIVISION STANDARD PLAN	
<b>TRAFFIC CONTROL PLAN                  MOBILE OPERATIONS                  MULTILANE ROADS                  AND                  TWO-LANE ROADS</b>	
DATE REVISION DATE REVISION	WORKING NUMBER TCP-11 SHEET NUMBER 260
ISSUE DATE: OCTOBER 1, 1998	

STATE	PROJECT NO.
MISS.	

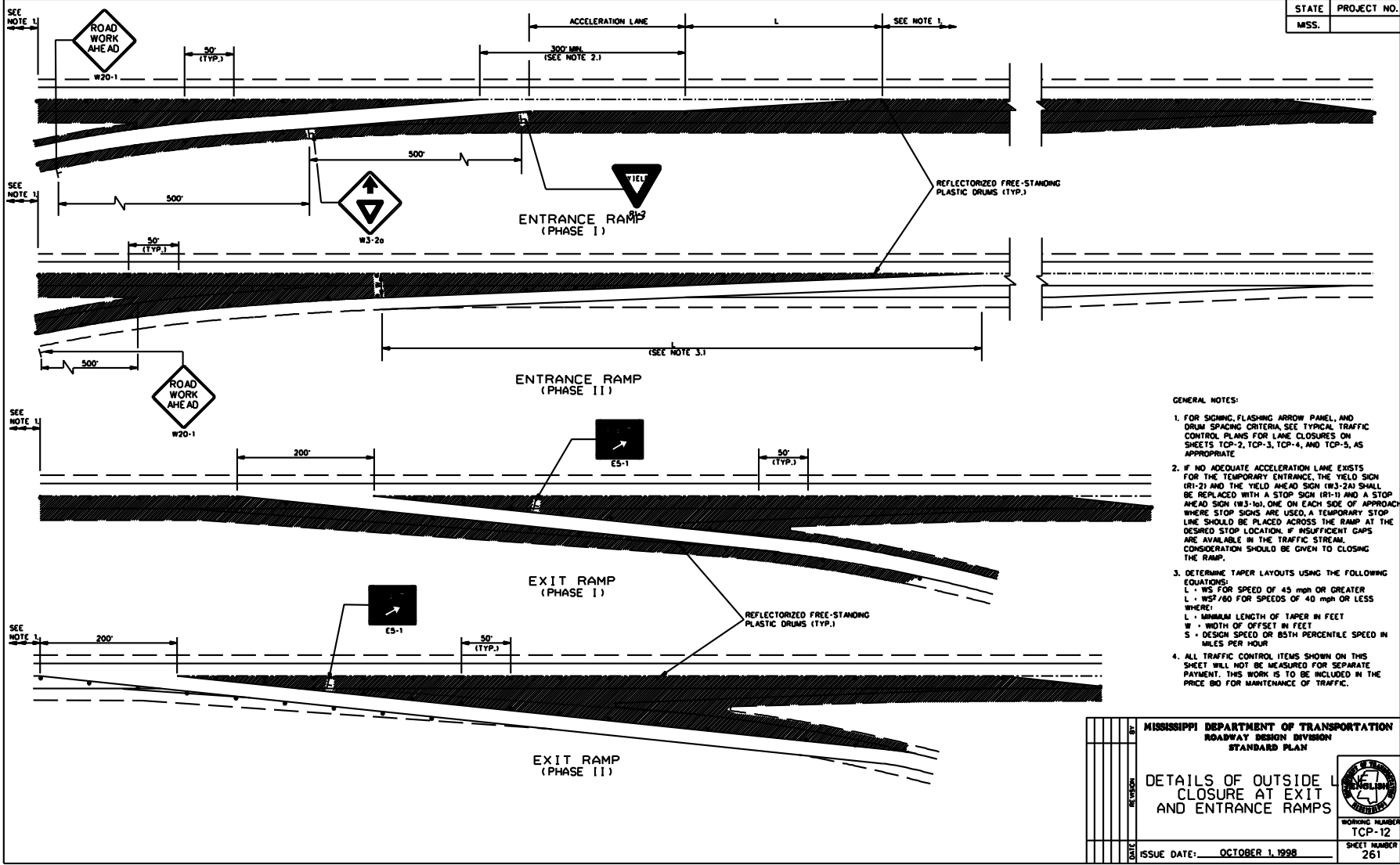

- GENERAL NOTES:
1. FOR SIGNING, FLASHING ARROW PANEL, AND DRUM SPACING CRITERIA, SEE TYPICAL TRAFFIC CONTROL PLANS FOR LANE CLOSURES ON SHEETS TCP-2, TCP-3, TCP-4, AND TCP-5, AS APPROPRIATE.
  2. IF NO ADEQUATE ACCELERATION LANE EXISTS FOR THE TEMPORARY ENTRANCE, THE YIELD SIGN (W3-20) AND THE YIELD AHEAD SIGN (W3-24) SHALL BE REPLACED WITH A STOP SIGN (R1-1) AND A STOP AHEAD SIGN (W3-1a), ONE ON EACH SIDE OF APPROACH. WHERE STOP SIGNS ARE USED, A TEMPORARY STOP LINE SHOULD BE PLACED ACROSS THE RAMP AT THE DESIRED STOP LOCATION. IF INSUFFICIENT GAPS ARE AVAILABLE IN THE TRAFFIC STREAM, CONSIDERATION SHOULD BE GIVEN TO CLOSING THE RAMP.
  3. DETERMINE TAPER LAYOUTS USING THE FOLLOWING EQUATIONS:  
 $L = WS$  FOR SPEED OF 45 mph OR GREATER  
 $L = WS^2/600$  FOR SPEEDS OF 40 mph OR LESS  
 WHERE:  
 $L$  = MINIMUM LENGTH OF TAPER IN FEET  
 $W$  = WIDTH OF OFFSET IN FEET  
 $S$  = DESIGN SPEED OR 85TH PERCENTILE SPEED IN MILES PER HOUR
  4. ALL TRAFFIC CONTROL ITEMS SHOWN ON THIS SHEET WILL NOT BE MEASURED FOR SEPARATE PAYMENT. THIS WORK IS TO BE INCLUDED IN THE PRICE BID FOR MAINTENANCE OF TRAFFIC.

MISSISSIPPI DEPARTMENT OF TRANSPORTATION ROADWAY DESIGN DIVISION STANDARD PLAN	
DETAILS OF OUTSIDE LANE CLOSURE AT EXIT AND ENTRANCE RAMP	
WORKING NUMBER TCP-12	MISSISSIPPI DEPARTMENT OF TRANSPORTATION ROADWAY DESIGN DIVISION
ISSUE DATE: OCTOBER 1, 1998	SHEET NUMBER 261

41

STATE	PROJECT NO.
MISS.	

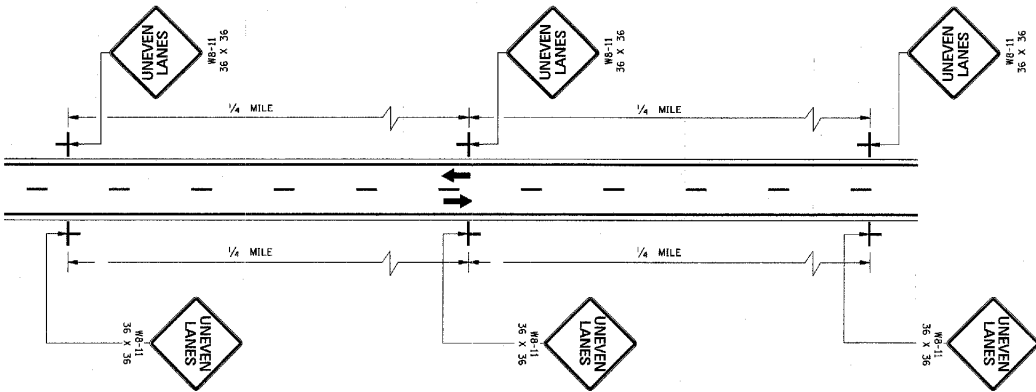

TWO-WAY TRAFFIC

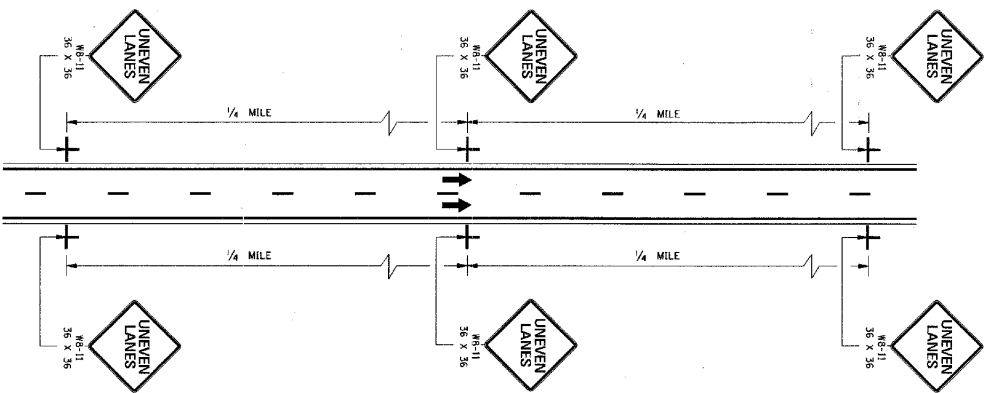

ONE-WAY TRAFFIC

- GENERAL NOTES:
- UNEVEN LANE LINE.
    - IF LESS THAN OR EQUAL TO 1/2", NO SIGNS REQUIRED.
    - IF GREATER THAN 1/2" AND LESS THAN OR EQUAL TO 2/4", PLACE SIGNS AS SHOWN ON THIS SHEET.
    - IF GREATER THAN 2/4", TRAFFIC SHOULD NOT BE ALLOWED TO CROSS UNEVEN LANE LINE.
  - ALL TRAFFIC CONTROL ITEMS SHOWN ON THIS SHEET SHALL BE PAID FOR UNDER MAINTENANCE OF TRAFFIC.
  - THE WB-11 SIGNS SHALL BE SPACED AT 1/4-MILE INTERVALS THROUGHOUT UNEVEN LANE LINE LIMITS.

42

BY		MISSISSIPPI DEPARTMENT OF TRANSPORTATION	
REVISION		ROADWAY DESIGN DIVISION	
DATE		STANDARD PLAN	
		<b>TRAFFIC CONTROL PLANS</b>	
		<b>UNEVEN PAVEMENT</b>	
		<b>DETAILS</b>	
			
		WORKING NUMBER	SHEET NUMBER
		TCP-14	263
ISSUE DATE:		OCTOBER 1, 1998	

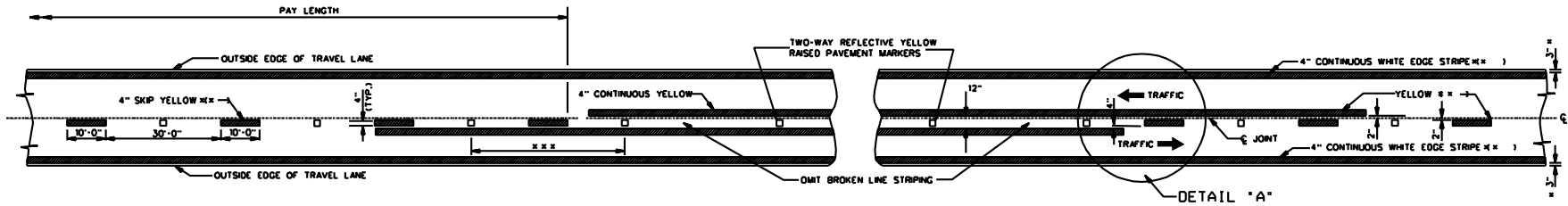

TWO-WAY TRAFFIC  
(ASPHALT OR CONCRETE PAVEMENT)

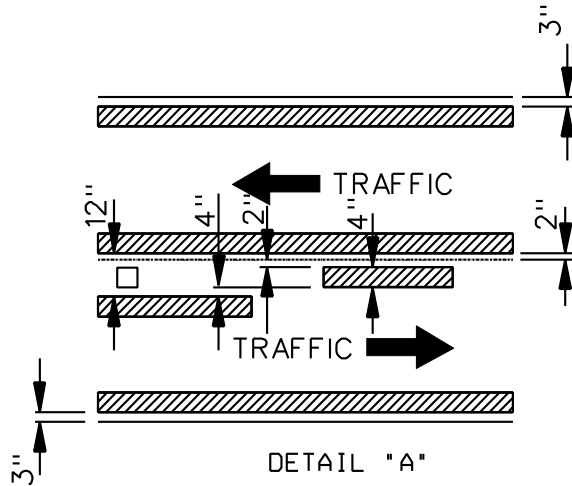

DETAIL "A"



- GENERAL NOTES:
- \*\* 1. 3" UNLESS SHOWN ELSEWHERE ON THE PLANS.
  - \*\* 2. EDGE STRIPE SHALL BE SAME MATERIAL AS LANE-LINE STRIPE (PAINT OR TAPE AS INDICATED IN PAY ITEMS).
  - \*\*\* 3. SPACING OF REFLECTIVE RAISED PAVEMENT MARKERS IS AS FOLLOWS:

	URBAN AREA (11-in)	RURAL AREA (11-in)
TANGENT SECTIONS	40'-0"	80'-0"
HORIZONTAL CURVES	40'-0"	40'-0"
INTERCHANGE LIMITS	40'-0"	140'-0"

- 1 NOTE: ON THE MAIN FACILITY, REFLECTIVE RED-CLEAR RAISED PAVEMENT MARKERS ON A 40'-0" SPACING WILL BE REQUIRED ON LANE-LINE(S) THROUGH ALL INTERCHANGE AREAS BEGINNING 1000' IN ADVANCE (IN DIRECTION OF TRAFFIC) OF THE EXIT RAMP TAPER AND CONTINUING THROUGH THE INTERCHANGE TO THE END OF THE ENTRANCE RAMP TAPER.
4. PAVEMENT MARKERS SHALL BE HIGH PERFORMANCE REFLECTIVE RAISED PAVEMENT MARKERS AS LISTED IN THE MOOT "APPROVED SOURCES OF MATERIALS."
5. REFLECTIVE RAISED PAVEMENT MARKERS TO BE USED IF TEMPORARY MARKINGS ARE TO REMAIN IN PLACE OVER 3 MONTHS

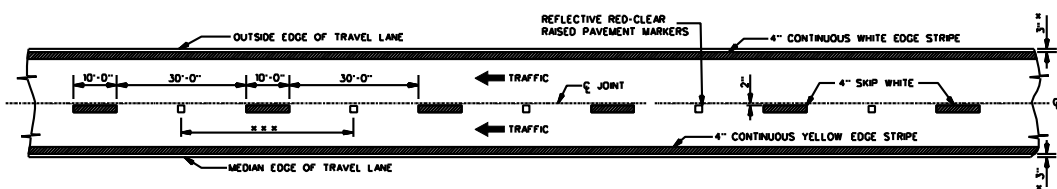

4-LANE WITH ONE-WAY TRAFFIC

MISSISSIPPI DEPARTMENT OF TRANSPORTATION ROADWAY DESIGN DIVISION STANDARD PLAN	
TEMPORARY STRIPING FOR TRAFFIC CONTROL 2-LANE AND 4-LANE DIVIDED HIGHWAYS	
ISSUE DATE: DECEMBER 1, 1999	WORKING NUMBER TCP-15 SHEET NUMBER 264

43

- 18 -

Notice To Bidders: No Proposals Accepted After 4:00 PM on the date shown on the cover sheet.

Cont'd.

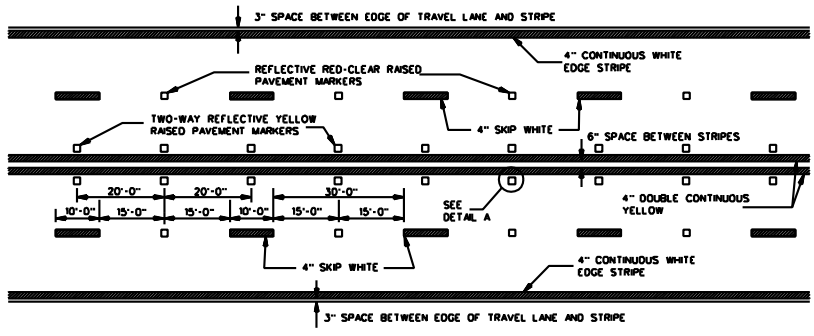

TYPICAL STRIPING AND RAISED PAVEMENT MARKERS FOR 4-LANE SECTION

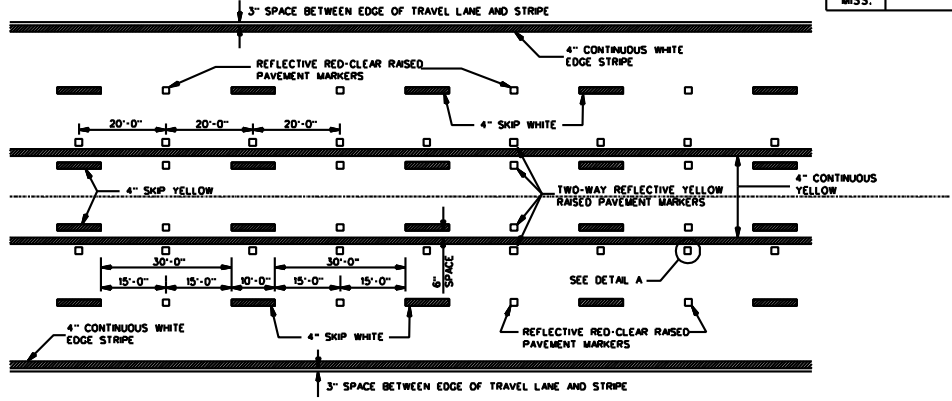

TYPICAL STRIPING AND RAISED PAVEMENT MARKERS FOR 5-LANE SECTION

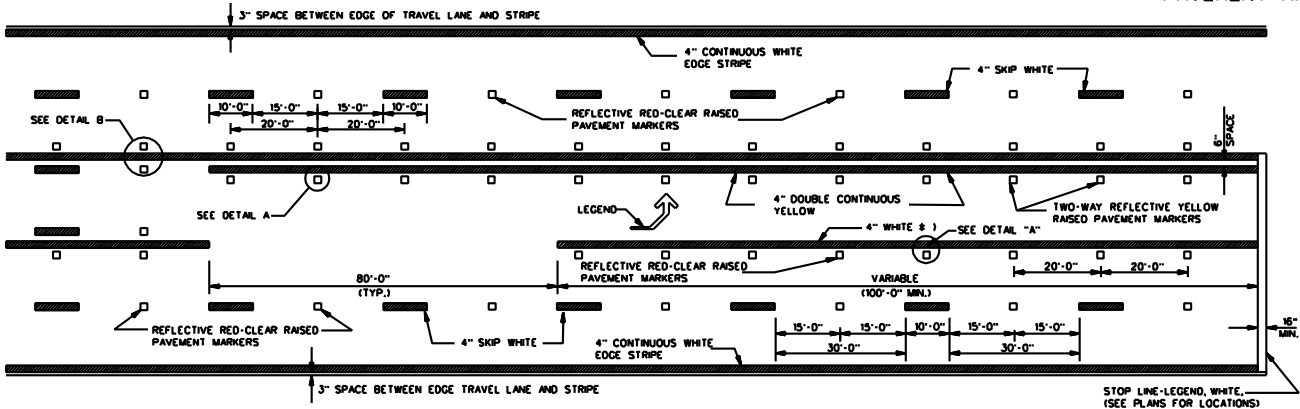

TYPICAL STRIPING AND RAISED PAVEMENT MARKERS AT LEFT TURN LANES

\* NOTE: USE DETAIL STRIPING IF LENGTH ≤ 150' AT THIS LOCATION, OTHERWISE USE CONTINUOUS STRIPING.

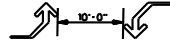

TYPICAL TWO-WAY ARROW INSTALLATION

- NOTES:
1. CONSIDER EACH SEGMENT OF CONTINUOUS TWO-WAY LEFT TURN LANE SEPARATELY.
  2. IF SEGMENT IS LESS THAN 350', PLACE ONE SET OF ARROWS IN CENTER OF SEGMENT.
  3. IF SEGMENT IS GREATER THAN 350', PLACE FIRST SET OF ARROWS 50' TO 100' FROM BEGINNING AND/OR END OF SEGMENT AND SPACE ADDITIONAL SETS OF ARROWS (250' O.C.).

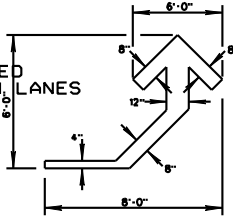

DETAIL OF TEMPORARY TURN ARROW

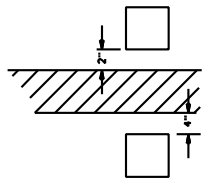

DETAIL B LATERAL PLACEMENT OF PAVEMENT MARKERS

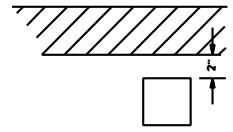

DETAIL A LATERAL PLACEMENT OF PAVEMENT MARKERS

GENERAL NOTE:

1. PAVEMENT MARKERS SHALL BE HIGH PERFORMANCE RAISED PAVEMENT MARKERS AS LISTED IN THE MDT "APPROVED SOURCES OF MATERIALS".
2. REFLECTIVE RAISED PAVEMENT MARKERS TO BE USED IF TEMPORARY MARKINGS ARE TO REMAIN IN PLACE OVER 3 MONTHS.
3. TEMPORARY TURN ARROW TO BE PAID FOR AS TEMPORARY TRAFFIC STRIPE (LEGEND), ESTIMATED AT 10.9 SO. FT. PER ARROW.

BY	MISSISSIPPI DEPARTMENT OF TRANSPORTATION
	ROADWAY DESIGN DIVISION STANDARD PLAN
DATE	TEMPORARY STRIPING FOR TRAFFIC CONTROL 4-LANE AND 5-LANE UNDIVIDED ROADWAYS
	ISSUE DATE: DECEMBER 1, 1999

WORKING NUMBER  
TCP-16  
SHEET NUMBER  
265

Notice to Bidders No. 990014

# MISSISSIPPI DEPARTMENT OF TRANSPORTATION

## SUPPLEMENT TO NOTICE TO BIDDERS NO. 4103

**DATE: 04/09/2013**

The goal is 3 percent for the Disadvantaged Business Enterprise. The low bidder is required to submit Form OCR-481 for all DBEs. Bidders are advised to check the bid tabulation link for this project on the MDOT website at:

<http://sp.gomdot.com/Contract%20Administration/BidSystems/Pages/letting%20calendar.aspx>

Bid tabulations are usually posted by 3:00 pm on Letting Day.

Delete subparagraph (3) under AWARD on page 7, and substitute the following.

- (3) Bidder must submit an OCR-485 listing all firms that submitted quotes for material supplies or items to be subcontracted. Please make and add copies of this form when needed or attach additional sheets containing the information required by the form and add these sheets to the bid proposal. Form OCR-485 must be signed and submitted with the bid proposal. If at least one copy of this form is not signed and included as part of bid proposal, your bid will be deemed irregular.

Delete subparagraph (5) under DBE REPORTS on page 8, and substitute the following.

- (5) OCR-485: Bidder must submit **signed form with bid proposal** of all firms that submitted quotes for material supplies or items to be subcontracted. Please make and add copies of this form when needed or attach additional sheets containing the information required by the form and add these sheets to the bid proposal. If at least one copy of this form is not signed and included as part of bid proposal, your bid will be deemed irregular.

## MISSISSIPPI DEPARTMENT OF TRANSPORTATION

SECTION 904 - NOTICE TO BIDDERS NO. 4103

CODE: (IS)

DATE: 9/12/2012

SUBJECT: DISADVANTAGED BUSINESS ENTERPRISES IN FEDERAL-AID HIGHWAY CONSTRUCTION

This contract is subject to the "[Moving Ahead for Progress in the 21<sup>st</sup> Century Act \(MAP-21\)](#)" and applicable requirements of "Part 26, Title 49, Code of Federal Regulations". Portions of the Act are set forth in this Notice as applicable to compliance by the Contractor and all of the Act, and the MDOT DBE Program, is incorporated by reference herein.

The Department has developed a Disadvantaged Business Enterprise Program that is applicable to this contract and is made a part thereof by reference.

Copies of the program may be obtained from:

Office of Civil Rights  
Mississippi Department of Transportation  
P. O. Box 1850  
Jackson, Mississippi 39215-1850

### POLICY

It is the policy of the Mississippi Department of Transportation to provide a level playing field, to foster equal opportunity in all federally assisted contracts, to improve the flexibility of the DBE Program, to reduce the burdens on small businesses, and to achieve that amount of participation that would be obtained in a non-discriminatory market place. In doing so, it is the policy of MDOT that there will be no discrimination in the award and performance of federally assisted contracts on the basis of race, color, sex, age, religion, national origin, or any handicap.

### ASSURANCES THAT CONTRACTORS MUST TAKE

MDOT will require that each contract which MDOT signs with a sub-recipient or a Contractor, and each subcontract the Prime Contractor signs with a Subcontractor, includes the following assurances:

“The Contractor, subrecipient or Subcontractor shall not discriminate on the basis of race, color, national origin, or sex in the performance of this contract. The Contractor shall carry out applicable requirements of 49 CFR 26 in the award and administration of federally assisted contracts. Failure by the Contractor to carry out these requirements is a material breach of this contract, which may result in the termination of this contract or such other remedy as MDOT deems appropriate.”



**DEFINITIONS**

For purposes of this provision the following definitions will apply:

"Disadvantaged Business" means a small business concern: (a) which is at least 51 percent owned by one or more socially and economically disadvantaged individual(s) or in the case of any publicly owned business, at least 51 percent of the stock of which is owned by one or more socially and economically disadvantaged individual(s); and (b) whose management and daily business operations are controlled by one or more of the socially and economically disadvantaged individual(s) who own it. It is important to note that the business owners themselves must control the operations of the business. Absentee ownership or title ownership by an individual who does not take an active role in controlling the business is not consistent with eligibility as a DBE under CFR 49 Part 26.71.

**CONTRACTOR'S OBLIGATION**

The Contractor and all Subcontractors shall take all necessary and reasonable steps to ensure that DBE firms can compete for and participate in the performance of a portion of the work in this contract and shall not discriminate on the basis of race, color, national origin, religion or sex. Failure on the part of the Contractor to carry out the DBE requirements of this contract constitutes a breach of contract and after proper notification the Department may terminate the contract or take other appropriate action as determined by the Department.

When a contract requires a zero percent (0%) DBE goal, the Contractor still has the responsibility to take all necessary and reasonable steps to ensure that DBE firms can compete for and participate in the performance of the work in the contract. In this case, all work performed by a certified DBE firm is considered to be a "race neutral" measure and the Department will receive DBE credit towards the overall State goals when the DBE firm is paid for their work. If the Prime Contractor is a certified DBE firm, the Department can receive DBE credit only for the work performed by the Prime Contractor's work force or any work subcontracted to another DBE firm. Work performance by a non-DBE Subcontractor is not eligible for DBE credit.

**CONTRACT GOAL**

The goal for participation by DBEs is established for this contract in the attached Supplement. The Contractor shall exercise all necessary and reasonable steps to ensure that participation is equal to or exceeds the contract goal.

The percentage of the contract that is proposed for DBEs shall be so stated on the last bid sheet of the proposal.

The apparent lowest responsive bidder shall submit to the [Office of Civil Rights](#) Form OCR-481, signed by the Prime Contractor and the DBE Subcontractors, no later than the 10th day after opening of the bids.

Form OCR-481 is available on the MDOT website at [GoMDOT.com](http://GoMDOT.com), then Divisions, Civil Rights, Forms, DBE, MDOT Projects, or by calling 601-359-7466.

FORMS ARE AVAILABLE FROM THE OFFICE OF CIVIL RIGHTS

The OCR-481 Form must contain the following information:

The name and address of each certified DBE Contractor / Supplier;

The Reference Number, percent of work and the dollar amount of each item. If a portion of an item is subcontracted, a breakdown of that item including quantities and unit price must be attached, detailing what part of the item the DBE firm is to perform and who will perform the remainder of the item.

If the DBE Commitment shown on the last bid sheet of the proposal, does not equal or exceed the contract goal, the bidder must submit, with the proposal, information to satisfy the Department that adequate good faith efforts have been made to meet the contract goal.

Failure of the lowest bidder to furnish acceptable proof of good faith efforts, submitted with the bid proposal, shall be just cause for rejection of the proposal. Award may then be made to the next lowest responsive bidder or the work may be readvertised.

The following factors are illustrative of matters the Department will consider in judging whether or not the bidder has made adequate good faith effort to satisfy the contract goal.

- (1) Whether the bidder attended the pre-bid meeting that was scheduled by the Department to inform DBEs of subcontracting opportunities;
- (2) Whether the bidder advertised in general circulation, trade association, and minority-focus media concerning the subcontracting opportunities;
- (3) Whether the bidder provided written notice to a reasonable number of specific DBEs that their interest in the contract is being solicited;
- (4) Whether the bidder followed up initial solicitations of interest by contacting DBEs to determine with certainty whether they were interested;
- (5) Whether the bidder selected portions of the work to be performed by DBEs in order to increase the likelihood of meeting the contract goal;
- (6) Whether the bidder provided interested DBEs with adequate information about the plans, specifications and requirements of the contract;
- (7) Whether the bidder negotiated in good faith with interested DBEs and did not reject them as unqualified without sound reasons based on a thorough investigation of their capabilities; and

- (8) Whether the bidder made efforts to assist interested DBEs in obtaining any required bonding or insurance.
- (9) Whether the bidder has written notification to certified DBE Contractors soliciting subcontracting for items of work in the contract.
- (10) Whether the bidder has a statement of why an agreement was not reached.

The bidder's execution of the signature portion of the proposal shall constitute execution of the following assurance:

The bidder hereby gives assurance pursuant to the applicable requirements of "Moving Ahead for Progress in the 21<sup>st</sup> Century Act (MAP-21)" and applicable requirements of "Part 26, Title 49, Code of Federal Regulations" that the bidder has made a good faith effort to meet the contract goal for DBE participation for which this proposal is submitted.

### **DIRECTORY**

A list of "Certified DBE Contractors" which have been certified as such by the Mississippi Department of Transportation and other Unified Certification Partners (UPC) can be found on the Mississippi Department of Transportation website at [www.gomdot.com](http://www.gomdot.com). The DBE firm must be certified at the time the project is let and approved by MDOT to count towards meeting the DBE goal.

### **REPLACEMENT**

If a DBE Subcontractor cannot perform satisfactorily, and this causes the OCR-481 commitment to fall below the contract goal, the Contractor shall take all necessary reasonable steps to replace the DBE with another certified DBE Subcontractor or submit information to satisfy the Mississippi Department of Transportation that adequate good faith efforts have been made to replace the DBE. The replacement DBE must be a DBE who was on the Department's list of "Certified DBE Contractors" when the job was let, and who is still active. All DBE replacements must be approved by the Department.

Under no circumstances shall the Prime or any Subcontractor perform the DBE's work (as shown on the OCR-481) without prior written approval from the Department. See "Sanctions" at the end of this document for penalties for performing DBE's work.

When a Contractor proposes to substitute/replace/terminate a DBE that was originally named on the OCR-481, the Contractor must obtain a release, in writing, from the named DBE explaining why the DBE Subcontractor cannot perform the work. A copy of the original DBE's release must be attached to the Contractor's written request to substitute/replace/terminate along with appropriate Subcontract Forms for the substitute/replacement/terminated Subcontractor, all of which must be submitted to the DBE Coordinator and approved, in advance, by MDOT.

### **GOOD FAITH EFFORTS**

To demonstrate good faith efforts to replace any DBE that is unable to perform successfully, the Contractor must document steps taken to subcontract with another certified DBE Contractor. Such documentation shall include no less than the following:

- (1) Proof of written notification to certified DBE Contractors by certified mail that their interest is solicited in subcontracting the work defaulted by the previous DBE or in subcontracting other items of work in the contract.
- (2) If the Prime Contractor is a certified DBE firm, only the value of the work actually performed by the DBE Prime can be counted towards the project goal, along with any work subcontracted to a certified DBE firm.
- (3) If the Contractor is not a DBE, the work subcontracted to a certified DBE Contractor will be counted toward the goal.
- (4) The Contractor may count toward the goal a portion of the total dollar value of a contract with a joint venture eligible under the standards of this provision equal to the percentage of the DBE partner in the joint venture.
- (5) Expenditures to DBEs that perform a commercially useful function may be counted toward the goal. A business is considered to perform a commercially useful function when it is responsible for the execution of a distinct element of the work and carries out its responsibilities by actually performing, managing, and supervising the work involved.
- (6) The Contractor may count 100% of the expenditures for materials and supplies obtained from certified DBE suppliers and manufacturers that produce goods from raw materials or substantially alters them for resale provided the suppliers and manufacturers assume the actual and contractual responsibility for the provision of the materials and supplies. The Contractor may count sixty percent (60%) of the expenditures to suppliers that are not manufacturers, provided the supplier performs a commercially useful function in the supply process. Within 30 days after receipt of the materials, the Contractor shall furnish to the DBE Coordinator invoices from the certified supplier to verify the DBE goal.
- (7) Any work that a certified DBE firm subcontracts or sub-subcontracts to a non-DBE firm will not count towards the DBE goal.
- (8) Only the dollars actually paid to the DBE firm may be counted towards the DBE goal.

Failure of the Contractor to demonstrate good faith efforts to replace a DBE Subcontractor that cannot perform as intended with another DBE Subcontractor, when required, shall be a breach of contract and may be just cause to be disqualified from further bidding for a period of up to 12 months after notification by certified mail.

### **PRE-BID MEETING**

A pre-bid meeting will be held in Amphitheater 1 & 2 of the Hilton Jackson located at I-55 and County Line Road, Jackson, Mississippi at 2:00 P.M. on the day preceding the date of the bid opening.

This meeting is to inform DBE firms of subcontracting and material supply opportunities. Attendance at this meeting is considered of prime importance in demonstrating good faith effort to meet the contract goal.

### **PARTICIPATION / DBE CREDIT**

Participation shall be counted toward meeting the goal in this contract as follows:

- (1) If the Prime Contractor is a certified DBE firm, only the value of the work actually performed by the DBE Prime can be counted towards the project goal, along with any work subcontracted to a certified DBE firm.
- (2) If the Contractor is not a DBE, the work subcontracted to a certified DBE Contractor will be counted toward the goal.
- (3) The Contractor may count toward the goal a portion of the total dollar value of a contract with a joint venture eligible under the standards of this provision equal to the percentage of the DBE partner in the joint venture.
- (4) Expenditures to DBEs that perform a commercially useful function may be counted toward the goal. A business is considered to perform a commercially useful function when it is responsible for the execution of a distinct element of the work and carries out its responsibilities by actually performing, managing, and supervising the work involved.
- (5) The Contractor may count 100% of the expenditures for materials and supplies obtained from certified DBE suppliers and manufacturers that produce goods from raw materials or substantially alters them for resale provided the suppliers and manufacturers assume the actual and contractual responsibility for the provision of the materials and supplies. The Contractor may count sixty percent (60%) of the expenditures to suppliers that are not manufacturers, provided the supplier performs a commercially useful function in the supply process. Within 30 days after receipt of the materials, the Contractor shall furnish to the DBE Coordinator invoices from the certified supplier to verify the DBE goal.
- (6) Any work that a certified DBE firm subcontracts or sub-subcontracts to a non-DBE firm will not count towards the DBE goal.
- (7) Only the dollars actually paid to the DBE firm may be counted towards the DBE goal.

## **AWARD**

Award of this contract to the low bidder will be contingent upon the following conditions:

- (1) Concurrence from Federal Highway Administration, when applicable.
- (2) Bidder must submit to the [Office of Civil Rights](#) for approval, Form OCR-481 (DBE Commitment) no later than the 10<sup>th</sup> day after opening of the bids, or submit information with the bid proposal to satisfy the Department and that adequate good faith efforts have been made to meet the contract goal. [For answers to questions regarding Form OCR-481, contact the MDOT Office of Civil Rights at \(601\) 359-7466.](#)
- (3) Bidder must submit a list of all firms that submitted quotes for material supplies or items to be subcontracted. This information must be submitted on form OCR-485 in the back of the contract proposal. [Form OCR-485 must be signed and submitted with the bid proposal.](#)

Prior to the start of any work, the bidder must notify the Project Engineer, in writing, of the name of the designated "DBE Liaison Officer" for this project. This notification must be posted on the bulletin board at the project site.

## **DEFAULT**

The contract goal established by MDOT in this proposal must be met to fulfill the terms of the contract. The Contractor may list DBE Subcontractors and items that exceed MDOT's contract goal, but should unforeseen problems arise that would prevent a DBE from completing its total commitment percentage, the Contractor will meet the terms of the contract as long as it meets or exceeds MDOT's Contract Goal. For additional information, refer to "Replacement" section of this Notice.

## **DBE REPORTS**

- (1) OCR-481: Refer to "CONTRACT GOAL" section of this Notice to Bidders for information regarding this form.
- (2) OCR-482: At the conclusion of the project the Contractor will submit to the Project Engineer for verification of quantities and further handling Form OCR-482 whereby the Contractor certifies to the amounts of payments made to each Contractor / Supplier. The Project Engineer shall submit the completed Form OCR-482 to the DBE Coordinator (Office of Civil Rights). Final acceptance of the project is dependent upon Contract Administration Division's receipt of completed Form OCR-482 which they will receive from the Office of Civil Rights.
- (3) OCR-483: The Project Engineer/Inspector will complete Form OCR-483, the Commercially Useful Function (CUF) Performance Report, in accordance with MDOT S.O.P. No. OCR-03-09-01-483. Evaluations reported on this form are used to determine whether or not the DBE firm is performing a CUF. The Prime Contractor should take corrective action when the report contains any negative evaluations. DBE credit may be

disallowed and/or other sanctions imposed if it is determined the DBE firm is not performing a CUF. This form should also be completed and returned to the DBE Coordinator (Office of Civil Rights).

- (4) OCR-484: Each month, the Contractor will submit to the Project Engineer OCR-484 certifying payments to all Subcontractors.
- (5) OCR-485: The bidder must submit **with the bid proposal** a list of all firms that submitted quotes for material supplies or items to be subcontracted.
- (6) OCR-487: Only used by Prime Contractors that are certified DBE firms. This form is used in determining the exact percentage of DBE credit for the specified project. It should be returned to MDOT with the OCR-481 form, or can also be returned with the Permission to Subcontract Forms (CAD-720 or CAD-725).

**SANCTIONS**

The Department has the option to enforce any of the following penalties for failure of the Prime Contractor to fulfill the DBE goal as stated on the OCR-481 form or any violations of the DBE program guidelines:

- (1) Disallow credit towards the DBE goal
- (2) Withhold progress estimate payments
- (3) Deduct from the final estimate an amount equal to the unmet portion of the DBE goal
- (4) Recover an amount equal to the unmet contract goal
- (5) Debar the Contractor involved from bidding on Mississippi Department of Transportation projects.
- (6) Deduct from the Contractor's final estimate all or any combination of the following.

<u>Offense</u>	<u>Percentage of the monetary amount disallowed from (1) above</u>	<u>Lump Sum</u>
# 1	10%	\$ 5,000 or both
# 2	20%	\$ 10,000 or both
# 3	40%	\$ 20,000 & debarment

**MISSISSIPPI DEPARTMENT OF TRANSPORTATION**

**SECTION 904 - NOTICE TO BIDDERS NO. 4189**

**CODE: (SP)**

**DATE: 11/08/2012**

**SUBJECT: Rumble Stripe**

Bidders are hereby advised that when edge lines are placed over rumble strips, the pavement marking stripe must be applied using the atomization/spray method instead of extrusion / ribbon method. To ensure the proper alignment of the rumble stripes, the Contractor will be required to place a layout line to be followed during installation of the edge lines over the rumble strips.



## MISSISSIPPI DEPARTMENT OF TRANSPORTATION

SECTION 904 - NOTICE TO BIDDERS NO. 4214

CODE: (IS)

DATE: 11/29/2012

SUBJECT: Safety Apparel

Bidders are advised that the Code of Federal Regulations CFR 23 Part 634 final rule was adopted November 24, 2006 with an effective date of November 24, 2008. This rule requires that "All workers within the right-of-way of a Federal-Aid Highway who are exposed either to traffic (vehicles using the highway for the purposes of travel) or to construction equipment within the work area shall wear high-visibility safety apparel". High-visibility safety apparel is defined in the CFR as "personnel protective safety clothing that is intended to provide conspicuity during both daytime and nighttime usage, and that meets the Performance Class 2 or 3 requirements of the ANSI/ISEA 107-2004 publication entitled American National Standard for High-Visibility Safety Apparel and Headwear". All workers on Mississippi State Highway right-of-way shall comply with this Federal Regulation. Workers are defined by the CFR as "people on foot whose duties place them within the right-of way of a Federal-Aid Highway, such as highway construction and maintenance forces, survey crews, utility crews, responders to incidents within the highway right-of-way, and law enforcement personnel when directing traffic, investigating crashes, and handling lane closures, obstructed roadways, and disasters within the right-of-way of a Federal-Aid Highway".

More information regarding high visibility safety apparel can be found at the following sites.

<http://www.gpo.gov/fdsys/pkg/CFR-2008-title23-vol1/pdf/CFR-2008-title23-vol1-sec634-1.pdf>

<http://ops.fhwa.dot.gov/wz/resources/policy.htm#hv>

# MISSISSIPPI DEPARTMENT OF TRANSPORTATION

SECTION 904 - NOTICE TO BIDDERS NO. 4308

CODE: (SP)

DATE: 02/07/2013

SUBJECT: Terminal End Sections

Guard rail terminal end sections shall be construction in accordance with the plans, specifications, and the following.

## **Flared.**

Flared terminal end sections shall be FLEAT-350, REGENT, SRT-350, ROSS-350 or approved flared equal and installed in accordance with the manufacturer's recommendation. The Contractor shall provide two copies of the manufacturer's installation details to the Project Engineer. The Project Engineer will keep one copy in the project file and provide one copy to the District Maintenance Engineer. The installation details shall be engineering drawings, a minimum of 11" X 17" in size. Reflective adhesive sheeting with alternating black and yellow stripes (sloping downward at an angle of 45 degrees in the direction traffic is to pass) shall be required on the end of the terminal section. The type of terminal section installed shall be written on the device with a Permanent Marking Stick or some other means of permanent identification.

## **Non-Flared.**

Non-Flared terminal end sections shall be ET-2000, SKT-350, or approved non-flared equal and installed in accordance with the manufacturer's recommendation. The Contractor shall provide two copies of the manufacturer's installation details to the Project Engineer. The Project Engineer will keep one copy in the project file and provide one copy to the District Maintenance Engineer. The installation details shall be engineering drawings, a minimum of 11" X 17" in size. Reflective adhesive sheeting with alternating black and yellow stripes (sloping downward at an angle of 45 degrees in the direction traffic is to pass) shall be required on the end of the terminal section. The type of terminal section installed shall be written on the device with a Permanent Marking Stick or some other means of permanent identification.

Likewise, impact attenuators shall be construction in accordance with the plans, specifications, and the following.

Approved impact attenuator systems shall meet standardized testing defined in Manual for Assessing Safety Hardware (MASH) or NCHRP Report 350. In addition, these devices shall have an acceptance letter from FHWA that documents the device meets the appropriate crash test criteria and can be used on the National Highway System (NHS). The Contractor shall provide two copies of the manufacturer's installation details to the Project Engineer. The Project Engineer shall keep one copy in project file and provide one copy to District Maintenance Engineer. The installation details shall be engineering drawings, a minimum of 11"x17" in size. Reflective adhesive sheeting with alternating black and yellow stripes (sloping downward at an angle of 45 degrees in the direction traffic is to pass) shall be required on the end of the attenuator section. The type of system installed shall be written on the device with a Permanent Marking Stick or some other means of permanent identification.

**MISSISSIPPI DEPARTMENT OF TRANSPORTATION**

**SECTION 904- NOTICE TO BIDDERS NO. 4473**

**CODE: (SP)**

**DATE: 04/08/2013**

**SUBJECT: Alternate Crushed Stone Base Bid Items**

Bidders are advised that the Crushed Stone Base used on this project will be bid as an alternate pay item: ¾" and Down Crushed Stone Base, Size 825B Crushed Stone Base, or Size 610 Crushed Stone Base. Bidders must select one of the alternates at the time of bid. **The Contractor must use the selected crushed stone base throughout the entire project.**

## MISSISSIPPI DEPARTMENT OF TRANSPORTATION

SECTION 904 - NOTICE TO BIDDERS NO. 4488

CODE: (IS)

DATE: 05/01/2013

SUBJECT: DBE Forms, Participation and Payment

Bidders are hereby advised that the participation of a DBE Firm can not be counted towards the Prime Contractor's DBE goal until the amount being counted towards the goal has been paid to the DBE.

Form OCR-482 has been developed to comply with this requirement. Bidders are hereby advised that at the end of the job, the Prime Contractor will submit this form to the Project Engineer before the final estimate is paid and the project is closed out. This form certifies payments to all DBE Subcontractors over the life of the contract.

Form OCR-484 has also been developed to comply with this requirement. Bidders are hereby advised that each month, the Prime Contractors will submit this form to the Project Engineer no later than the last day of each month. This form certifies payments to all Subcontractors and shows all firms even if the Prime Contractor has paid no monies to the firm during that estimate period (negative report). The Project Engineer will attach this form to the monthly estimate before forwarding the estimate to the Contract Administration Division for processing.

Bidders are also advised that Form OCR-485 will be completed by ALL BIDDERS submitting a bid proposal and must be signed and included in the bid proposal package. If at least one copy of this form is not signed and included as part of bid proposal, your bid will be deemed irregular.

DBE Forms, including Forms OCR-482, OCR-484 and OCR-485, can be obtained from the Office of Civil Rights Division, MDOT Administration Building, 401 North West Street, Jackson, MS, or at [www.gomdot.com](http://www.gomdot.com) under *Business, Disadvantaged Enterprise, Applications and Forms for the DBE Program, MDOT Forms*.

**MISSISSIPPI DEPARTMENT OF TRANSPORTATION**

**SECTION 904 - NOTICE TO BIDDERS NO. 4524**

**CODE: (SP)**

**DATE: 05/13/2013**

**SUBJECT: Warm Mix Asphalt**

Bidders are advised that MDOT approved products and processes for the production of Warm Mix Asphalt are available at the following MDOT website.

<http://sp.mdot.ms.gov/Materials/Pages/MPL.aspx>

**MISSISSIPPI DEPARTMENT OF TRANSPORTATION**

**SECTION 904 - NOTICE TO BIDDERS NO. 4526**

**CODE: (SP)**

**DATE: 06/11/2013**

**SUBJECT: Electronic Addendum Process**

Bidders are advised that hard copies of any addenda for this project will no longer be mailed to prospective bidders. All addenda for this project will be posted to the [mdot.ms.gov](http://mdot.ms.gov) webpage under the Proposal Addenda column for the current letting and appropriate call number. Bidders will have to download addenda from the webpage and process the addenda in the same manner as previous lettings. Addenda will be posted by 10:00 a.m. on Friday prior to the letting. It will be the Bidder's responsibility to check and see if any addenda have been posted for this project. Any questions regarding the downloading process of the addenda shall be directed to the Contract Administration Division at 601-359-7700. Any questions regarding the content of the addenda shall be submitted as a question in accordance with the Notice To Bidders entitled "Questions Regarding Bidding".

**MISSISSIPPI DEPARTMENT OF TRANSPORTATION**

**SECTION 904 - NOTICE TO BIDDERS NO. 4565**

**CODE: (SP)**

**DATE: 06/27/2013**

**SUBJECT: Manual on Uniform Traffic Control Devices**

Any reference in the Standard Specifications or contract documents to a particular Section of the Manual on Uniform Traffic Control Devices (MUTCD) it shall mean that Section of the latest version of the Manual on Uniform Traffic Control Devices.

**MISSISSIPPI DEPARTMENT OF TRANSPORTATION**

**SECTION 904 - NOTICE TO BIDDERS NO. 4566**

**CODE: (SP)**

**DATE: 07/02/2013**

**SUBJECT: DUNS Requirement for Federal Funded Projects**

Bidders are advised that the Prime Contractor must maintain current registrations in the Central Contractor Registration ( <http://www.sam.gov> ) at all times during this project. A Dun and Bradstreet Data Universal Numbering System (DUNS) Number ( <http://www.dnb.com> ) is one of the requirements for registration in the Central Contractor Registration.

Bidders are also advised that the following information needs to be completed and included in the bid documents:

DUNS: \_\_\_\_\_

Company Name: \_\_\_\_\_

Company e-mail address: \_\_\_\_\_

By: \_\_\_\_\_



**MISSISSIPPI DEPARTMENT OF TRANSPORTATION**

**SECTION 904 - NOTICE TO BIDDERS NO. 4612**

**CODE: (SP)**

**DATE: 08/13/2013**

**SUBJECT: Adjustments for Bituminous Materials**

Bidders are advised that Subsection 907-402.03.1.2, Tack Coat, in Special Provision 907-402, allows the Contractor several options for OGFC tack coat. Regardless of the tack coat used, the monthly material adjustment, as referenced in Section 109 of the Standard Specifications, will be made using the base and current prices of tack coat Grade PG 76-22.

Bidders are also advised that the specifications allow the use of RC-70, RC-250, RC- 800, RS-1, RS-2, MC-30, MC-250, MS-2h, and CMS-2h in various other construction operations. If the Contractor uses one of these bituminous materials, the monthly material adjustment will be made using the base and current prices of the materials shown below.

<b>Materials Used</b>	<b>Material Adjustment Made Based on Prices For</b>
RC-70, 250, 800	MC-70
RS-1, 2	CRS-2
MC-30, 250	MC-70
MS-2h	SS-1
CMS-2h	SS-1

## MISSISSIPPI DEPARTMENT OF TRANSPORTATION

| SECTION 904 - NOTICE TO BIDDERS NO. 4661

CODE: (IS)

| DATE: 10/16/2013

**SUBJECT: Payroll Requirements**

Bidders are hereby advised that the Contractor and Subcontractor(s) are required to submit payroll information to the Project Engineers on a weekly basis.

On Federal-Aid Projects, CAD-880, CAD-881 and certified payroll submissions are required each week the Contractor or a Subcontractor performs work on the project. This is addressed in Section IV of Form FHWA-1273.

On State-Funded Projects, CAD-880 is required each week the Contractor or a Subcontractor performs work on the project.

| When no work is performed on either Federal-Aid or State-Funded Projects, the Contractor should only submit CAD-880 showing no work activities.

The Contractor shall make all efforts necessary to submit this information to the Project Engineer in a timely manner. The Engineer will have the authority to suspend the work wholly or in part and to withhold payments because of the Contractor's failure to submit the required information. Submission of forms and payrolls shall be current through the first full week of the month for the estimate period in order for the Project Engineer to process an estimate.

Bidders are advised to review the requirements regarding payroll submissions in Section 110 of the Standard Specifications.

**MISSISSIPPI DEPARTMENT OF TRANSPORTATION**

**SECTION 904 - NOTICE TO BIDDERS NO. 4812**

**CODE: (SP)**

**DATE: 01/14/2014**

**SUBJECT: Contract Time**

**PROJECT: NH-0015-02(096) / 106755301 – Jones County**

The calendar date for completion of work to be performed by the Contractor for this project will be determined as follows, which date or extended date as provided in Subsection 907-108.06 shall be the end of contract time. It is anticipated that the Notice of Award will be issued no later than **March 11, 2014** and the effective date of the Notice to Proceed / Beginning of Contract Time will be between **Execution of Contract and July 10, 2014**.

The Contractor shall request a Notice to Proceed / Beginning of Contract Time date between the date of **Execution of Contract and July 10, 2014**.

The calendar date for completion of work will be determined by adding **75 Calendar Days** to the effective date of the Notice to Proceed / Beginning of Contract Time.

Should the Contractor not request a Notice to Proceed by **July 10, 2014**, the date for the Notice to Proceed / Beginning of Contract Time will be **July 10, 2014**.

## MISSISSIPPI DEPARTMENT OF TRANSPORTATION

SECTION 904 - NOTICE TO BIDDERS NO. 4813

DATE: 01/09/2014

SUBJECT: Specialty Items

PROJECT: NH-0015-02(096) / 106755301 - Jones County

Pursuant to the provisions of Section 108, the following work items are hereby designated as "Specialty Items" for this contract. Bidders are reminded that these items must be subcontracted in order to be considered as specialty items.

### CATEGORY: GUARDRAIL, GUIDERAIL

---

Line No	Pay Item	Description
0080	606-B005	Guard Rail, Class A, Type 1, 'W' Beam
0090	606-D015	Guard Rail, Bridge End Section
0100	606-E002	Guard Rail, Terminal End Section, Flared

### CATEGORY: RIPRAP, MAILBOXES

---

Line No	Pay Item	Description
0120	618-B001	Additional Construction Signs

### CATEGORY: MISCELANEOUS/ SPECIALTY WORK ITEMS

---

Line No	Pay Item	Description
0070	423-A001	Rumble Strips, Ground In

### CATEGORY: PAVEMENT STRIPING AND MARKING

---

Line No	Pay Item	Description
0190	627-J001	Two-Way Clear Reflective High Performance Raised Markers
0200	627-K001	Red-Clear Reflective High Performance Raised Markers
0210	627-L001	Two-Way Yellow Reflective High Performance Raised Markers
0290	907-626-A003	6" Thermoplastic Traffic Stripe, Skip White
0300	907-626-C003	6" Thermoplastic Double Drop Edge Stripe, Continuous White
0310	907-626-D003	6" Thermoplastic Traffic Stripe, Skip Yellow
0320	907-626-E004	6" Thermoplastic Traffic Stripe, Continuous Yellow
0330	907-626-F003	6" Thermoplastic Double Drop Edge Stripe, Continuous Yellow
0340	907-626-G004	Thermoplastic Detail Stripe, White
0350	907-626-G005	Thermoplastic Detail Stripe, Yellow
0360	907-626-H004	Thermoplastic Legend, White
0370	907-626-H005	Thermoplastic Legend, White

### CATEGORY: TRAFFIC CONTROL - PERMANENT

---

Line No	Pay Item	Description
0220	630-F001	Delineators, Guard Rail, White

CATEGORY: TRAFFIC CONTROL - PERMANENT

---

Line No	Pay Item	Description
0230	630-F002	Delineators, Guard Rail, Yellow
0240	630-G001	Type 3 Object Markers, OM-3R, Post Mounted
0250	630-G003	Type 3 Object Markers, OM-3L, Post Mounted
0260	635-A001	Vehicle Loop Assemblies

CATEGORY: TRAFFIC CONTROL - TEMPORARY

---

Line No	Pay Item	Description
0130	619-A1002	Temporary Traffic Stripe, Continuous White
0140	619-A2002	Temporary Traffic Stripe, Continuous Yellow
0150	619-A3006	Temporary Traffic Stripe, Skip White
0160	619-A4006	Temporary Traffic Stripe, Skip Yellow
0170	619-A5001	Temporary Traffic Stripe, Detail
0180	619-A6001	Temporary Traffic Stripe, Legend

# MISSISSIPPI DEPARTMENT OF TRANSPORTATION

SECTION 904 - NOTICE TO BIDDERS NO. 4814

CODE: (SP)

DATE: 01/30/2014

SUBJECT: Scope of Work

PROJECT: NH-0015-02(096) / 106755301 -- Jones County

The contract documents do not include an official set of construction plans but may, by reference, include some Standard Drawings when so specified in a Notice to Bidders entitled, "Standard Drawings". All other references to plans in the contract documents and Standard Specifications for Road and Bridge Construction are to be disregarded.

Work on the project shall consist of the following.

**US 84**  
**OVERLAY APPROXIMATELY 3.5 MILES OF US 84 FROM**  
**300 FEET WEST OF SR 28 TO 1200 FEET WEST OF SR 15**  
**6+00 TO 194+06**

(A) Prior to the overlay, centerline alignment shall be determined by the Contractor by measuring the existing roadway at 500-foot intervals in tangent sections, and 100-foot intervals in horizontal curves. The existing shoulders shall be clipped and surplus material shall be spread along the edge of the shoulders, fore slopes, or other adjacent areas as directed by the Project Engineer, and will be an absorbed item.

(B) Cold Mill 1.5" & variable on US 84 at all the transitions including E.O.P., B.O.P., bridge approaches, and all tie-ins. Cold Mill 1.5" for the entire road width from station 146+00 to 194+06. Cold Mill 1.5" for the entire intersection of US 84 & SR 28. All milled areas shall be backfilled with asphalt within 48 hours of milling. **Milled material in the amount of 500 tons shall be stockpiled at the intersection of SR 28 and US 84 as designated by the Engineer and will be property of MDOT.** All other milled material shall become property of the Contractor.

(C) Overlay US 84 with 1.5" of 9.5-mm, HT, asphalt mixture from 300 feet west of SR 28 to 1,200 feet west of SR 15. Prior to the overlay, a leveling course of ¾" & variable of 9.5-mm, HT, Leveling, asphalt shall be required. Existing concrete joints between 16+85 and 148+85 shall be marked prior to leveling in such a manner as to ensure the proper placement of saw joints when the surface course is in place. Smoothness incentive/disincentive will be governed by special provision for MRI (mean roughness index). All incentive/disincentive will be based on theoretical tonnage placed on a 12-foot travel lane. Remove any failed areas on the main facility and repair by backfilling with 19-mm, HT, asphalt as directed by the Project Engineer. Removal areas will be marked by MDOT personnel and include but are not limited to areas included in Table 1. Approximately 230 tons of 19-mm, HT, asphalt will be used for backfill in

all removal sections. The existing west bound deceleration lanes at the cross overs at Flynt Road and Bear Pen Road are to be extended in the length of 200 feet. See typical section for details. Publicly maintained roads or streets shall be surfaced to the existing R.O.W.; privately owned entrances shall be surfaced a distance of 10 feet & variable from edge of pavement. Any site grading at local roads or drives will not be measured for separate payment but will be considered an absorbed item. Cross slopes shall be maintained to achieve a uniform cross slope of 2%. The Contractor will mill a 12-inch rumble strip along the inside of the shoulders and place the traffic stripe on the inside six inches (6") of the rumble strip. If water stands when project is complete, the contractor shall correct at no additional cost to the State.

(D) Raise the existing shoulders to match the new pavement elevation by placing 2.25" & variable depth crushed stone on the shoulders. Placement of the crushed stone on the finished surface course shall not be permitted. The material shall be bladed, rolled and compacted to a finished slope of 4% where practical. Shoulders with existing adequate shoulder material in place shall be bladed to a slope of 4%, the cost of which shall be included in the prices of other items bid.

(E) Temporary striping shall conform to finished stripe specifications for alignment, neatness, reflectivity, and straightness. All permanent pavement markings are to be hot thermoplastic. Edge lines will be placed so as to maintain the original lane width. Glass beads applied to thermoplastic shall conform to Subsection 720.01. On all bridges and concrete sections of highway, old traffic stripe shall be removed and replaced with High Performance Thermoplastic. Special care should be taken for the placement of Thermoplastic Detail Stripe along the edge of pavement at turn-outs on all local roads and along tapers where Detail Stripe is required as per Typical PMD-1.

(F) If pavement section marking tape is encountered on this project, it shall be located prior to overlaying and placed back in same location after paving operations have ceased. The section marking shall be eight inch high performance cold plastic detail stripe and shall be four feet in length. The marking shall be centered across the centerline stripe. The cost of this item shall be absorbed in other bid items.

(G) Raised pavement markers will be placed as per sheet PM-1 of the Standard Drawings. Any removal of existing raised pavement markers or rumble bars shall be considered an absorbed item. Only flexible adhesive shall be allowed for placement of raised pavement markers meeting the requirements of Subsection 720.03.7.7 of the 2004 Mississippi Standard Specifications for Road and Bridge.

(H) The installation of terminal end sections, installed as per manufactures recommendations, shall be National Cooperative Highway Research Program (NCHRP) Report 350 Test Level 3 (TL-3) approved. The flared Terminal End Section or equivalent shall be used at each of the bridge locations on this project. The Contractor shall furnish the Project Engineer two (2) copies of the manufacture's installation instructions prior to beginning guardrail operations. All terminal end sections shall be marked with a Sanford Mean Streak grease pen to identify type installed. Any site grading and all fill material necessary at the guardrail locations will not be measured for separate payment but will be absorbed in other guardrail pay items. Guard rail

pads shall be overlaid prior to placing guardrail and will be paid for under 907-403, 9.5-mm asphalt, HT, mixture. Seeding, fertilizer and vegetative mulch are required on all disturbed areas at the guardrail site and will be considered an absorbed item. Application rate for Bermuda grass seed will be 25 pounds per acre. Application rate for combination fertilizer (13-13-13) will be 1,000 pounds per acre. Application rate for mulch shall be two (2) tons per acre.

The Contractor shall erect and maintain construction signing, and provide all signs and traffic handling devices, and shall provide two portable R16-3 signs per work zone or lane closure in addition to signs required by standard drawings in accordance with Manual Uniform Traffic Control Devices (MUTCD). The cost is to be included in the price bid for pay item No. 618-A, Maintenance of Traffic.

Incidental work such as removing vegetation, shaping and compaction of shoulder, removing excess asphalt material, project clean-up, and other incidental work necessary to complete the project will not be measured for separate payment, but will be included in other bid items, and must be performed during the operating hours for this project.

**TABLE 1**

<b>Removal Locations</b>			
<b>Lane</b>	<b>Station</b>	<b>Length</b>	<b>Width</b>
EB RT	7+00 to 9+00	200	12
EB RT	144+35 to 145+73	138	6
WB LT	144+30 to 144+40	10	6
WB RT	144+17 to 144+39	22	6
	Hillcrest Drive	160	15



NH-0015-02(096) / 106755301

JONES COUNTY

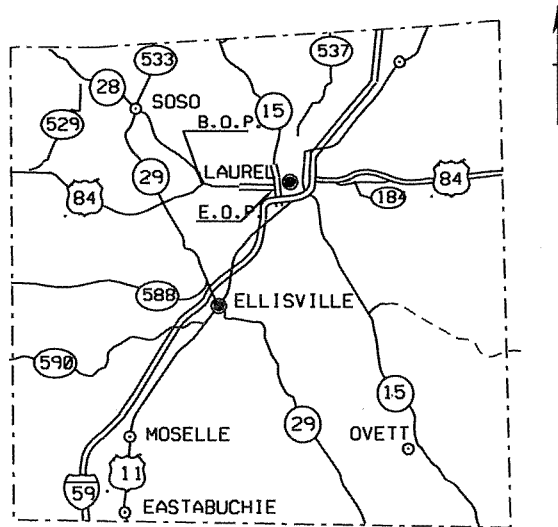

THE ABOVE REFERENCED PROJECT IS FOR OVERLAYING US 84 FROM APPROXIMATELY 300 FEET WEST OF SR 28 3.5 MILES TO APPROXIMATELY 1,200 FEET WEST OF SR 15

72

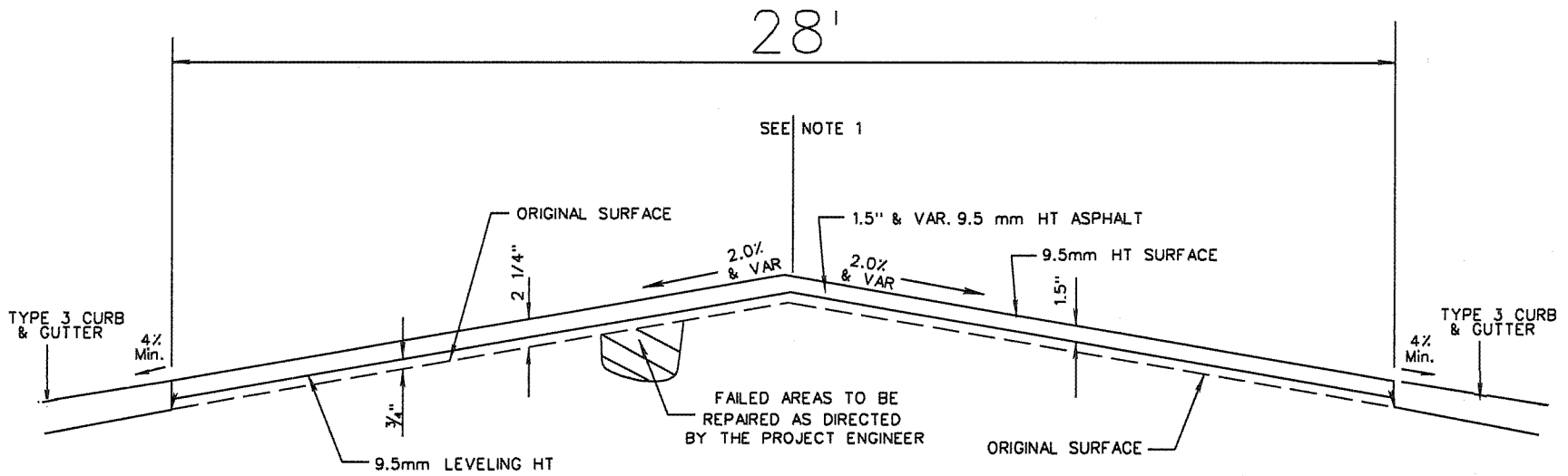

TYPICAL FOR LEFT AND RIGHT LANES  
STATION 6+00 TO 143+95

NOTES:

(1) TRUE CENTERLINE PAVEMENT ALIGNMENT SHALL BE DETERMINED BY THE CONTRACTOR BY MEASURING THE EXISTING ROADWAY AT 500ft. INTERVALS IN TANGENT SECTIONS, AND 100ft. INTERVALS IN HORIZONTAL CURVES.

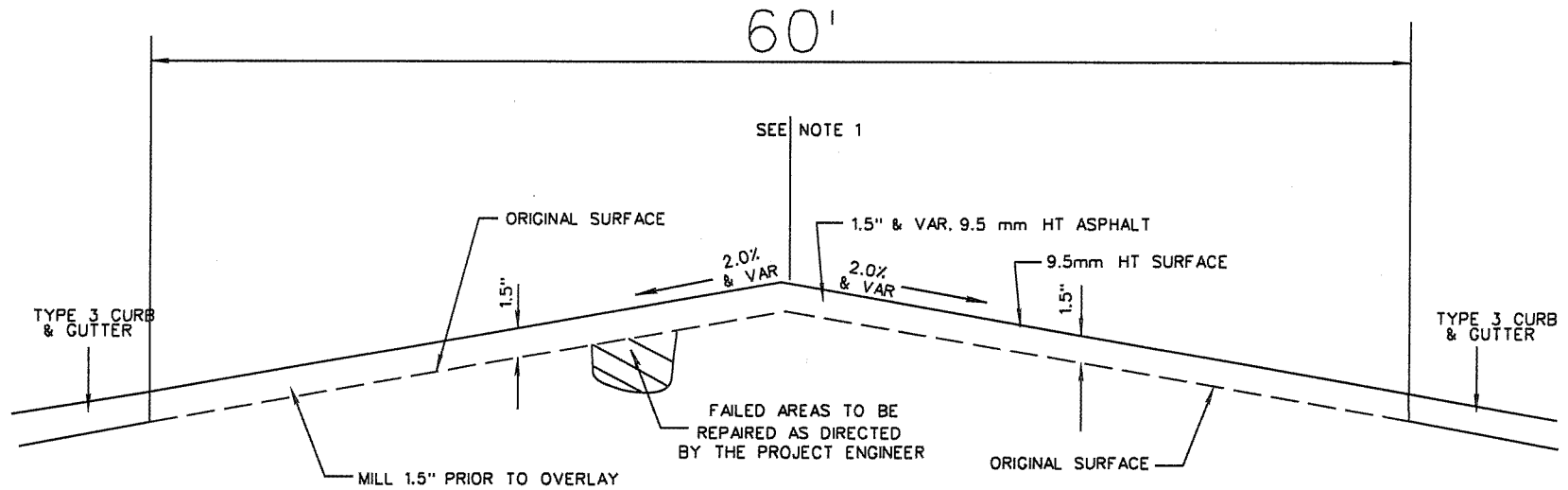

TYPICAL FOR 5 LANE  
STATION 143+95 TO 194+06

NOTES:

(1) TRUE CENTERLINE PAVEMENT ALIGNMENT SHALL BE DETERMINED BY THE CONTRACTOR BY MEASURING THE EXISTING ROADWAY AT 500ft. INTERVALS IN TANGENT SECTIONS, AND 100ft. INTERVALS IN HORIZONTAL CURVES.

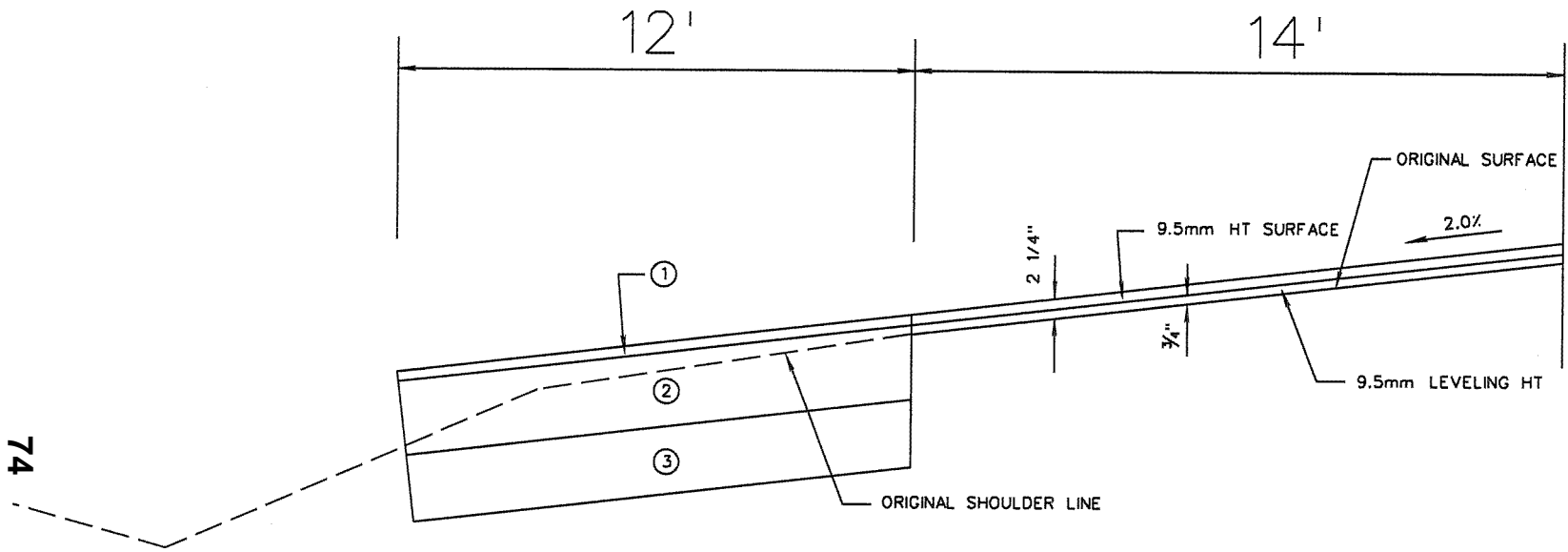

## TYPICAL FOR DECELERATION LANE

NOTES: 200 CY OF EXCESS EXCAVATION SET UP FOR EXISTING SHOULDER REMOVAL

- ① 1.50" 9.5mm HT ASPHALT
- ② 6.00" 19.0mm HT ASPHALT (2 @ 3.00")
- ③ 6.00" CRUSHED STONE W/GEOTEXTILE FABRIC TYPE V (NON WOVEN)

# TYPICAL MILLING DIAGRAM

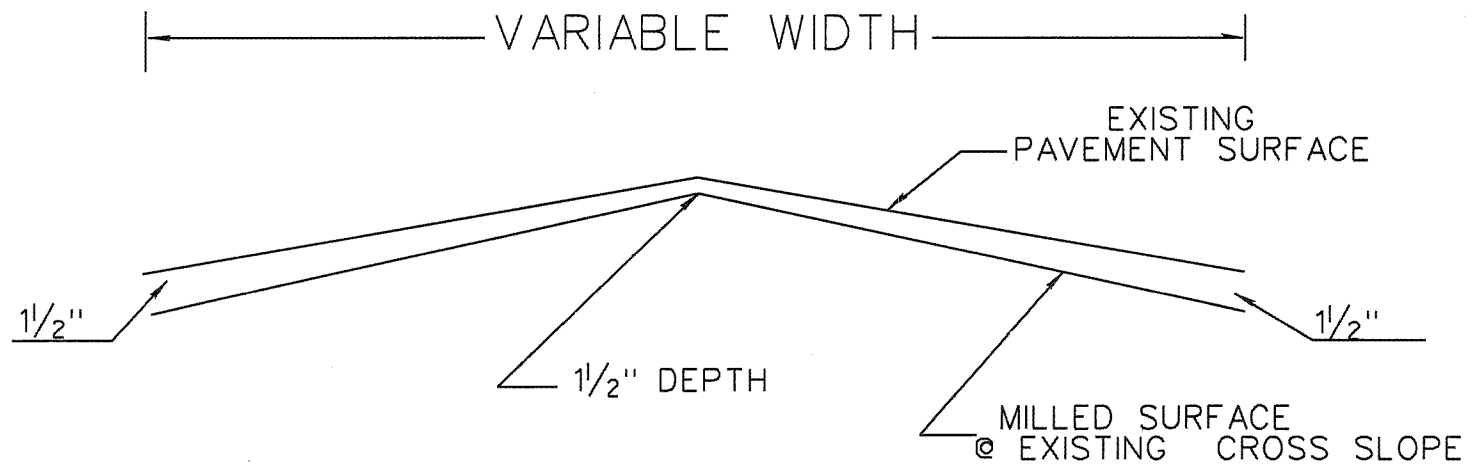

# TYPICAL MILLED TRANSITION AT BRIDGE ABUT. OR PAVEMENT IN PLACE

76

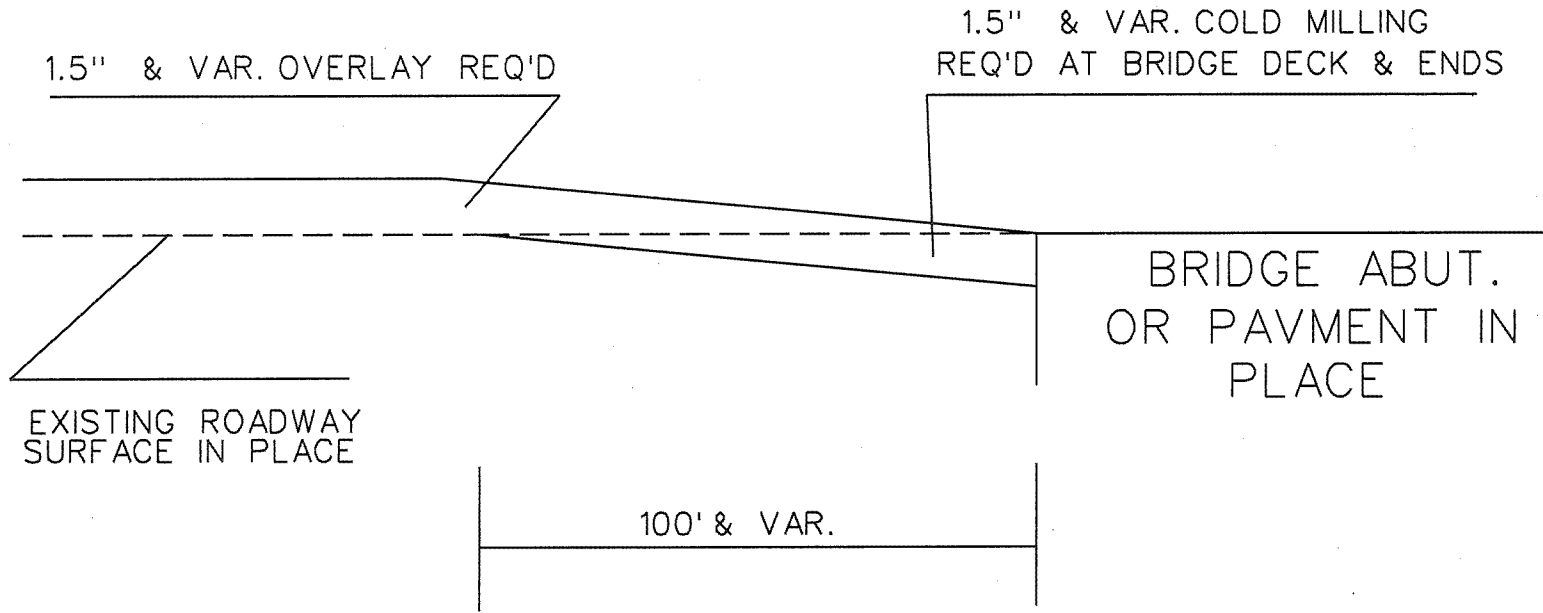

# PRIVATE DRIVEWAY DETAIL

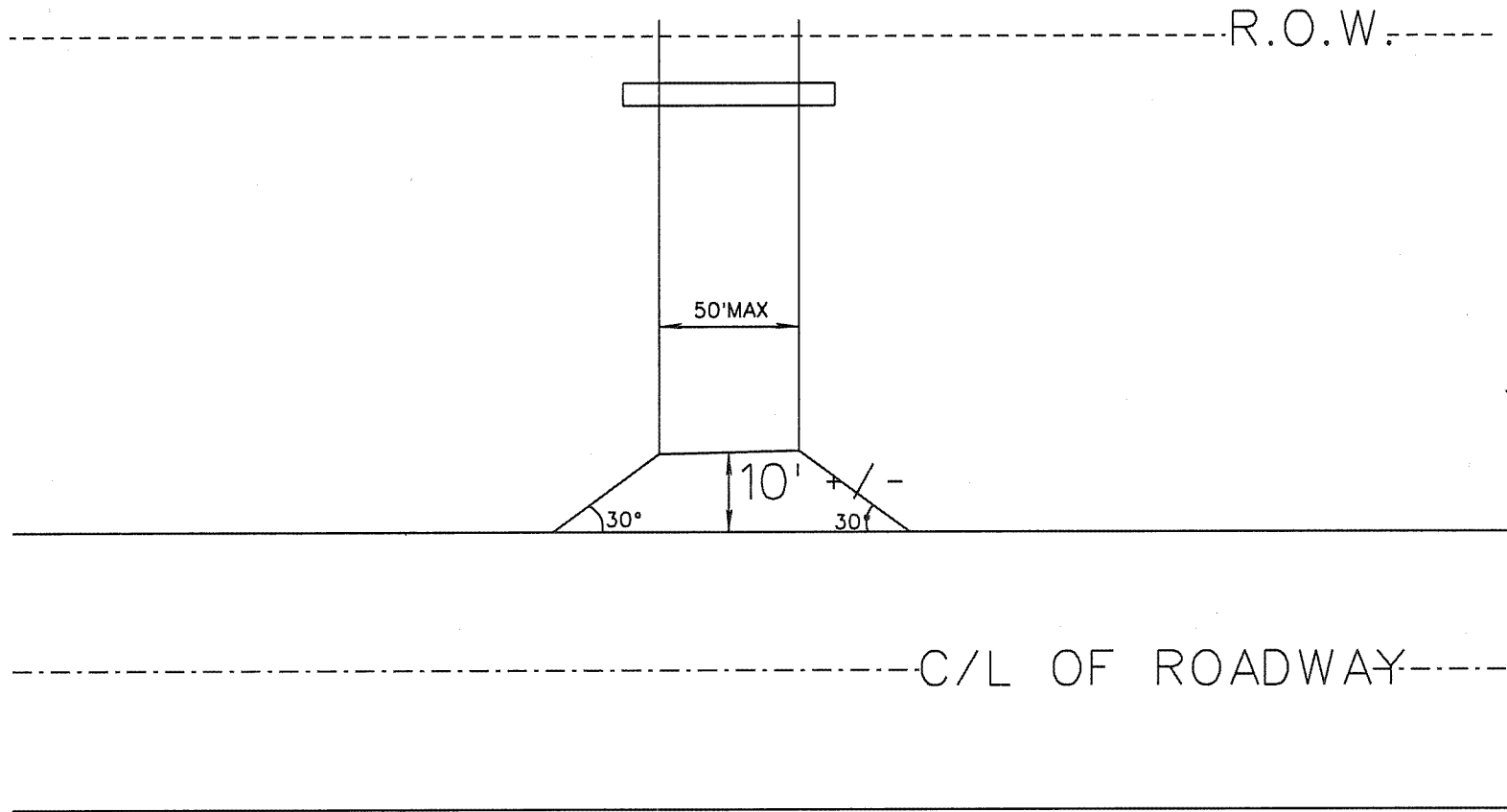

77

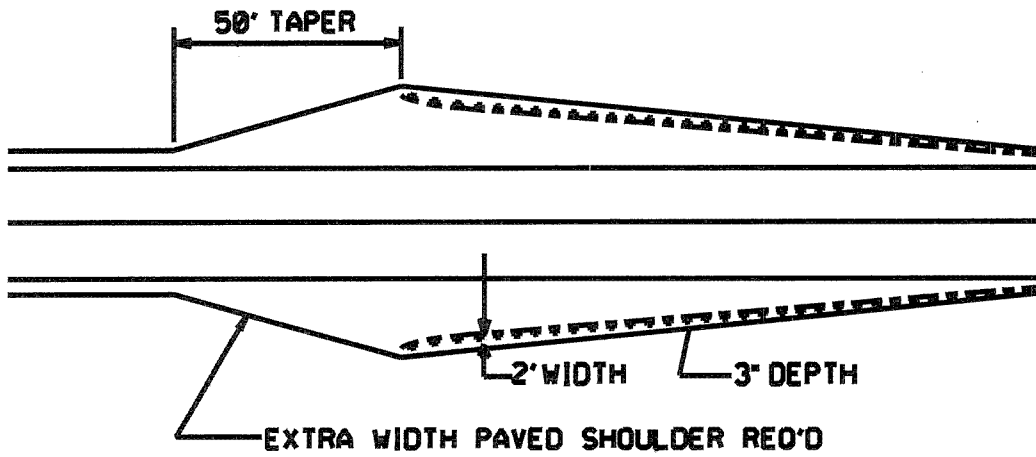

**DETAIL OF INSTALLATION OF EXTRA WIDTH  
PAVED SHOULDERS AT BRIDGES**

1. 3" AND VAR. DEPTH 9.5MM HOT BITUMINOUS PAVEMENT REQ'D

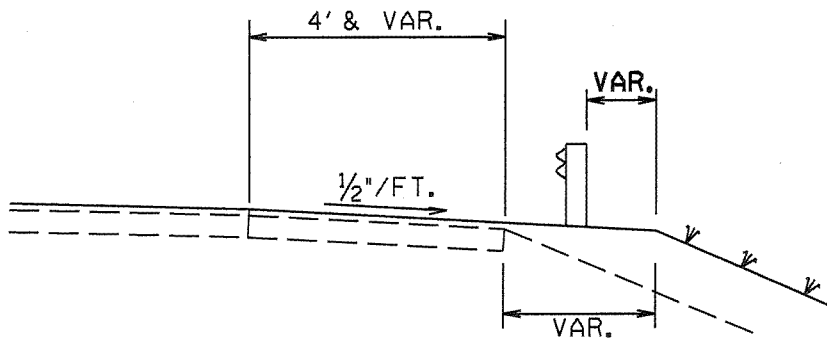

**BOTH SIDES**

**TYPICAL SECTION  
DETAILS OF PAVED SHOULDERS AT  
BRIDGE GUARD RAIL INSTALLATIONS**



STATE	PROJECT NO.
MISS.	

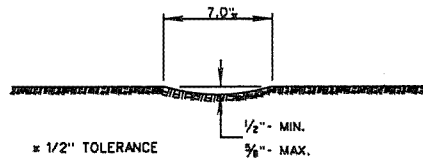

SECTION "A-A"

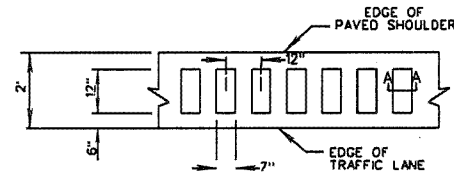

DETAIL "A"

- GENERAL NOTES
1. GROUND-IN RUMBLE STRIPS SHALL BE OMITTED ACROSS PRINCIPAL INTERSECTING ROADWAYS OR OTHER INTERRUPTIONS IN NORMAL SHOULDER WIDTH AS DIRECTED BY THE ENGINEER
  2. GROUND-IN RUMBLE STRIPS SHALL BE APPLIED TO MAINLINE ONLY.

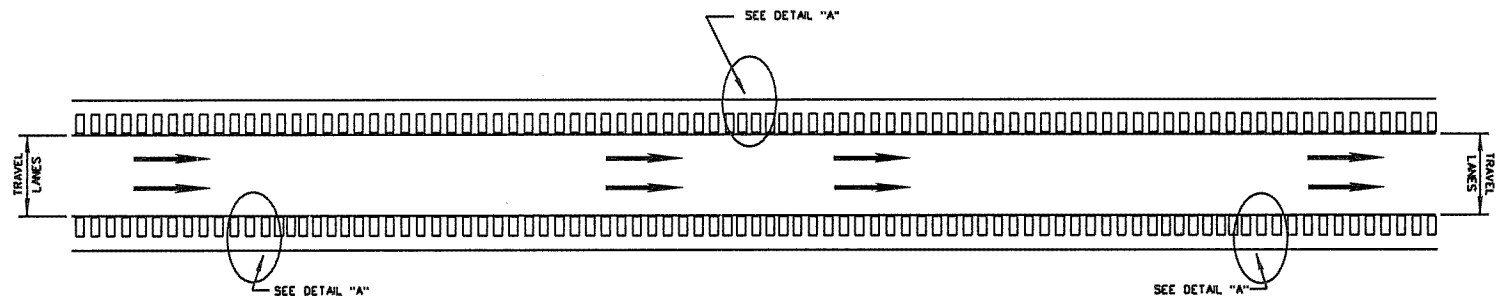

PLAN  
NOT TO SCALE  
DETAIL OF  
RUMBLE STRIPS  
(GROUND-IN)

MISSISSIPPI DEPARTMENT OF TRANSPORTATION	
TYPICAL SECTION	
RUMBLE STRIPS (GROUND-IN)	
FILE NAME:	WORKING NUMBER
DESIGN TEAM:	RS
CHECKED:	SHEET NUMBER
DATE:	

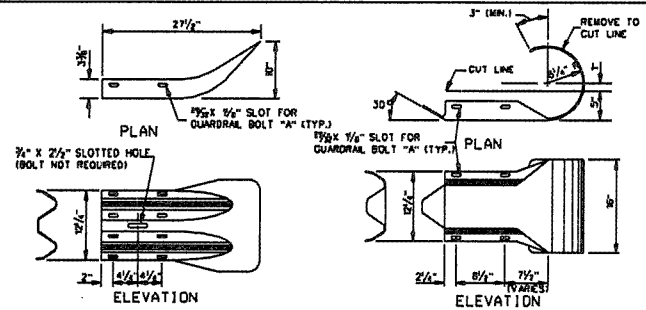

**TYPE "1" "W" BEAM END SECTION**  
 NOTE: THE TYPE "1" END SECTION IS THE STANDARD FLARED "W" BEAM END SECTION AND IS USED WITH THE TYPE "A" AND TYPE "C" BRIDGE END SECTIONS. THE CROSS-SECTIONAL DIMENSIONS OF THIS PART ARE IDENTICAL TO THOSE OF THE STANDARD "W" BEAM GUARDRAIL.

**TYPE "2" "W" BEAM END SECTION**  
 NOTE: THE TYPE "2" END SECTION IS A MODIFICATION OF THE STANDARD ROUNDED "W" BEAM END SECTION AND IS USED EXCLUSIVELY WITH THE TYPE "C" BRIDGE END SECTION. THE CROSS-SECTIONAL DIMENSIONS OF THIS PART ARE IDENTICAL TO THOSE OF THE STANDARD "W" BEAM GUARDRAIL.

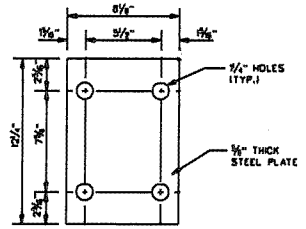

DETAIL OF PLATE "B"

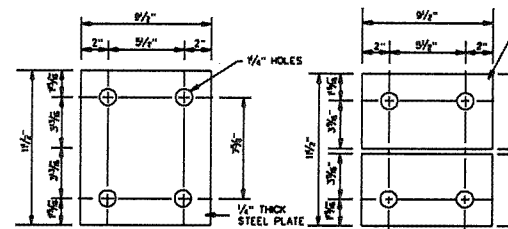

DETAIL OF PLATE "Z" CONCRETE BRIDGE RAIL TYPE "A" & "C"

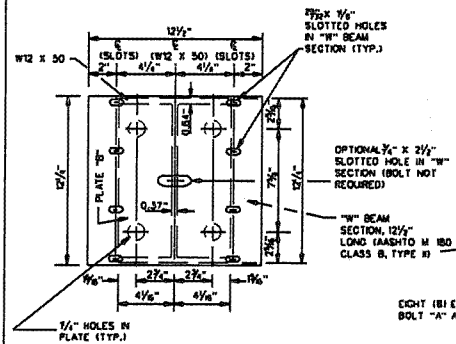

FACE ELEVATION

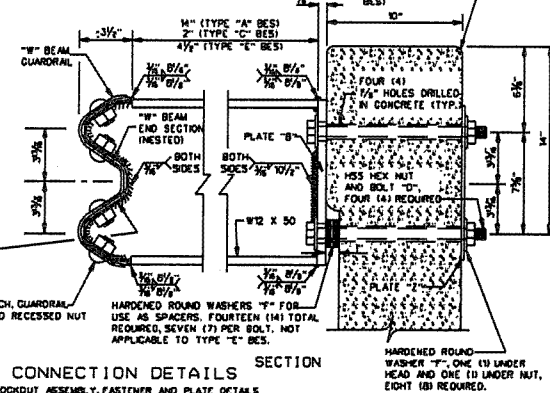

GUARDRAIL CONNECTION DETAILS SECTION

NOTE: UNLESS OTHERWISE SPECIFIED, THE BLOCKOUT ASSEMBLY, FASTENER AND PLATE DETAILS SHOWN ABOVE ARE ALSO APPLICABLE TO THE TYPE "2" BRIDGE END SECTION. SEE GENERAL NOTE 3.

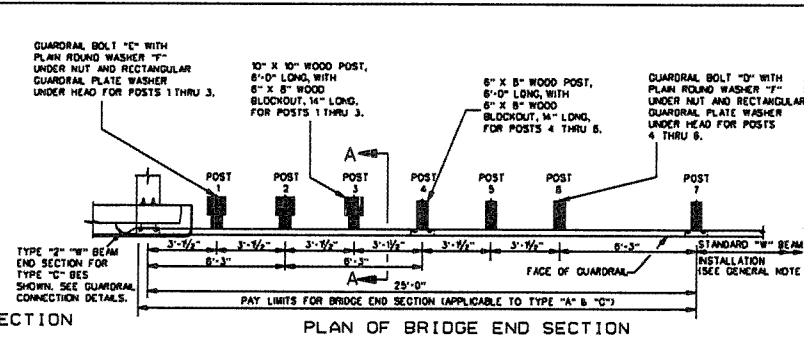

PLAN OF BRIDGE END SECTION

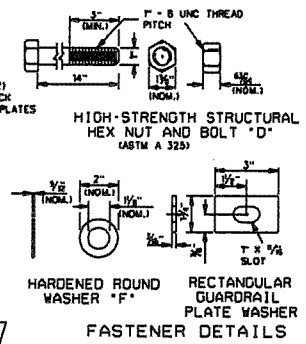

FASTENER DETAILS

- GENERAL NOTES:**
1. ALL NOTES AND DETAILS PERTAINING TO NORMAL "W" BEAM GUARDRAIL INSTALLATION NOT SPECIFICALLY MODIFIED ON THIS SHEET WILL BE FOUND ON EITHER SHEET GR-1 (WOOD POSTS) OR GR-2 (STEEL POSTS).
  2. WOOD POSTS ARE SHOWN ON THIS SHEET. WHEN STEEL POSTS ARE INSTALLED, A SOL BEARING PLATE IS PLACED ON THE STANDARD SIZE STEEL POST FOR POSTS 1 THRU 3 AND A RECTANGULAR GUARDRAIL PLATE WASHER IS PLACED UNDER THE STANDARD POST BOLT HEAD FOR POSTS 4 THRU 6. SEE DETAILS FOR STEEL POST INSTALLATIONS ON SHEET GR-2.
  3. FOR INFORMATION PERTAINING TO THE INSTALLATION OF THE TYPE "2" BRIDGE END SECTION, SEE SHEET GR-2A.
  4. THE HEIGHT OF RAIL AT THE BRIDGE END IS 20 1/2" AND WILL BE TRANSITIONED TO 22" AT POST 7. THIS TRANSITION WILL BE A LINEAR TRANSITION IN THE VERTICAL PLANE.
  5. ALL GUARDRAIL ELEMENTS SHALL BE LAPPED IN THE DIRECTION OF TRAFFIC.
  6. THE APPLICATION OF THIS STANDARD IS FOR ONE-WAY TRAFFIC DIRECTION ONLY.
  7. POINT "B", WHICH IS AT THE CENTERLINE BETWEEN THE ANCHOR BOLTS, WILL BE CENTERED OVER THE CENTERLINE OF THE BRIDGE END WALL EXCEPT IN SKEWED BRIDGE ENDS WHERE THE BOLT NEAREST THE JOINT WILL BE A MINIMUM OF 3" FROM THE JOINT.

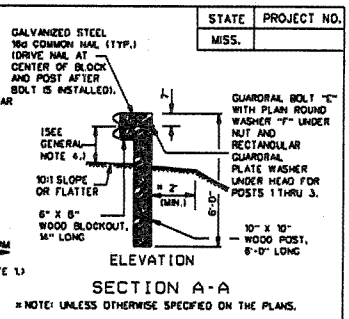

SECTION A-A

NOTE: UNLESS OTHERWISE SPECIFIED ON THE PLANS.

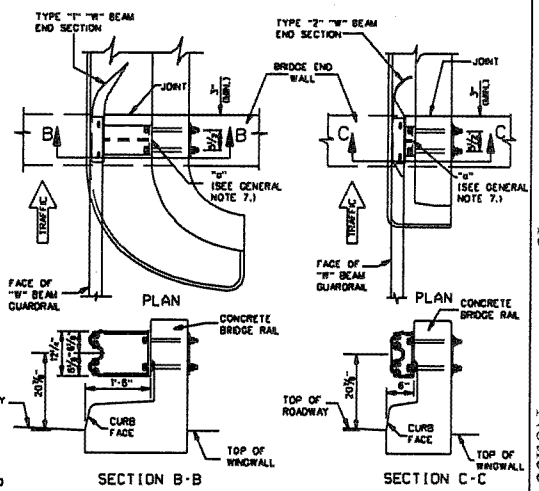

SECTION B-B SECTION C-C

GUARDRAIL CONNECTION AT BRIDGE

MISSISSIPPI DEPARTMENT OF TRANSPORTATION ROADWAY DESIGN DIVISION	
STANDARD PLAN	
<b>GUARDRAIL BRIDGE END SECTION TYPE "A" &amp; "C"</b>	
ISSUE DATE: OCTOBER 1, 1988	SHEET NUMBER 184

STATE	PROJECT NO.
MISS.	

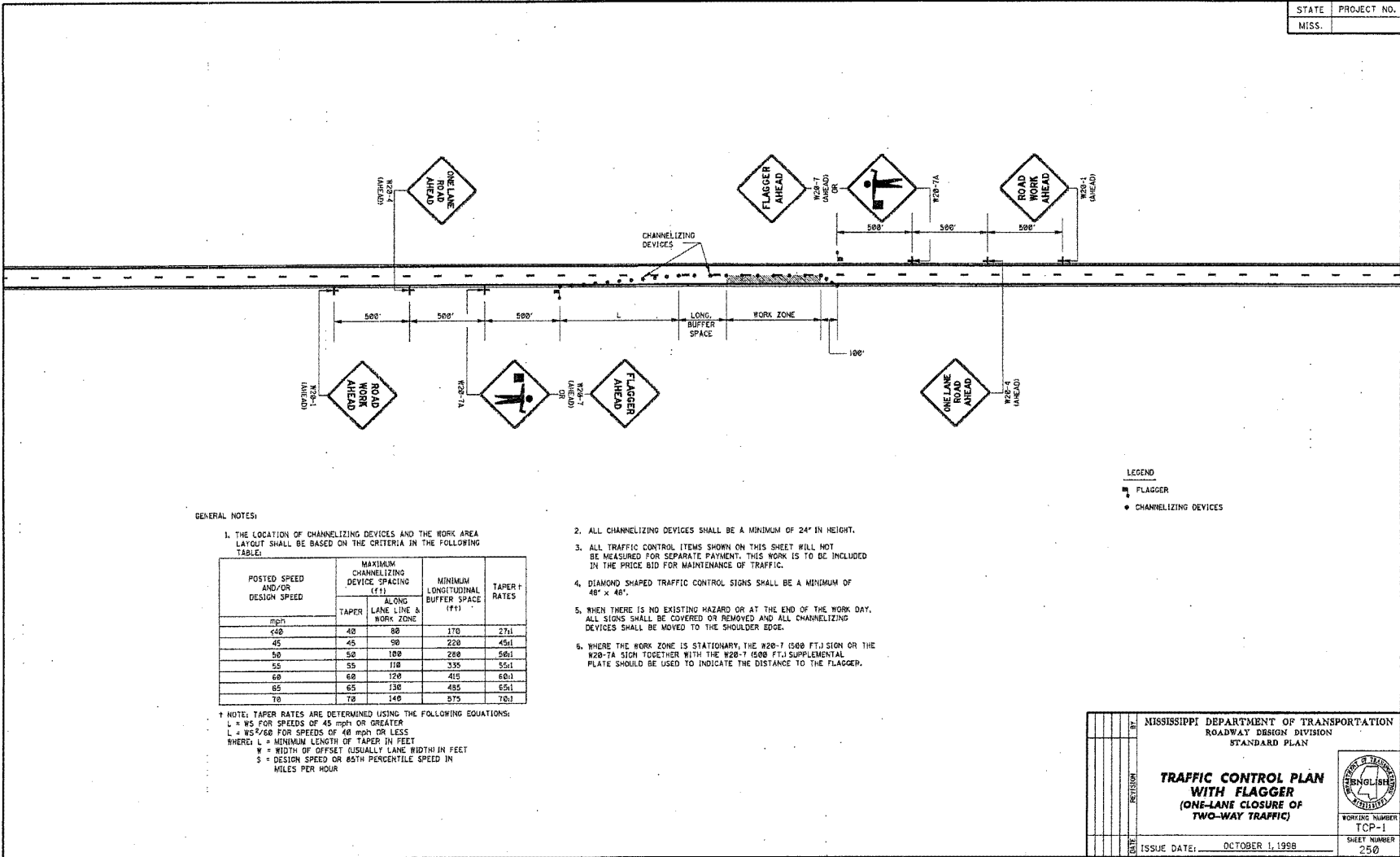

GENERAL NOTES:

1. THE LOCATION OF CHANNELIZING DEVICES AND THE WORK AREA LAYOUT SHALL BE BASED ON THE CRITERIA IN THE FOLLOWING TABLE:

POSTED SPEED AND/OR DESIGN SPEED	MAXIMUM CHANNELIZING DEVICE SPACING (ft)		MINIMUM LONGITUDINAL BUFFER SPACE (ft)	TAPER RATES
	TAPER	ALONG LANE LINE & WORK ZONE		
mph				
<42	40	80	170	27:1
45	45	90	220	45:1
50	50	100	280	50:1
55	55	110	335	55:1
60	60	120	415	60:1
65	65	130	495	65:1
70	70	140	575	70:1

\* NOTE: TAPER RATES ARE DETERMINED USING THE FOLLOWING EQUATIONS:  
 $L = WS$  FOR SPEEDS OF 45 mph OR GREATER  
 $L = WS^2/60$  FOR SPEEDS OF 40 mph OR LESS  
 WHERE: L = MINIMUM LENGTH OF TAPER, IN FEET  
 W = WIDTH OF OFFSET (USUALLY LANE WIDTH) IN FEET  
 S = DESIGN SPEED OR 85TH PERCENTILE SPEED IN MILES PER HOUR

2. ALL CHANNELIZING DEVICES SHALL BE A MINIMUM OF 24" IN HEIGHT.
3. ALL TRAFFIC CONTROL ITEMS SHOWN ON THIS SHEET WILL NOT BE MEASURED FOR SEPARATE PAYMENT. THIS WORK IS TO BE INCLUDED IN THE PRICE BID FOR MAINTENANCE OF TRAFFIC.
4. DIAMOND SHAPED TRAFFIC CONTROL SIGNS SHALL BE A MINIMUM OF 48" x 48".
5. WHEN THERE IS NO EXISTING HAZARD OR AT THE END OF THE WORK DAY, ALL SIGNS SHALL BE COVERED OR REMOVED AND ALL CHANNELIZING DEVICES SHALL BE MOVED TO THE SHOULDER EDGE.
6. WHERE THE WORK ZONE IS STATIONARY, THE W20-7 (500 FT.) SIGN OR THE W20-7A SIGN TOGETHER WITH THE W20-7 (500 FT.) SUPPLEMENTAL PLATE SHOULD BE USED TO INDICATE THE DISTANCE TO THE FLAGGER.

LEGEND  
 ■ FLAGGER  
 ◆ CHANNELIZING DEVICES

DATE	ISSUE DATE: OCTOBER 1, 1998
BY	DESIGNER
BY	CHECKER
BY	APPROVER

MISSISSIPPI DEPARTMENT OF TRANSPORTATION  
 ROADWAY DESIGN DIVISION  
 STANDARD PLAN

**TRAFFIC CONTROL PLAN  
 WITH FLAGGER  
 (ONE-LANE CLOSURE OF  
 TWO-WAY TRAFFIC)**

WORKING NUMBER  
 TCP-1  
 SHEET NUMBER  
 250

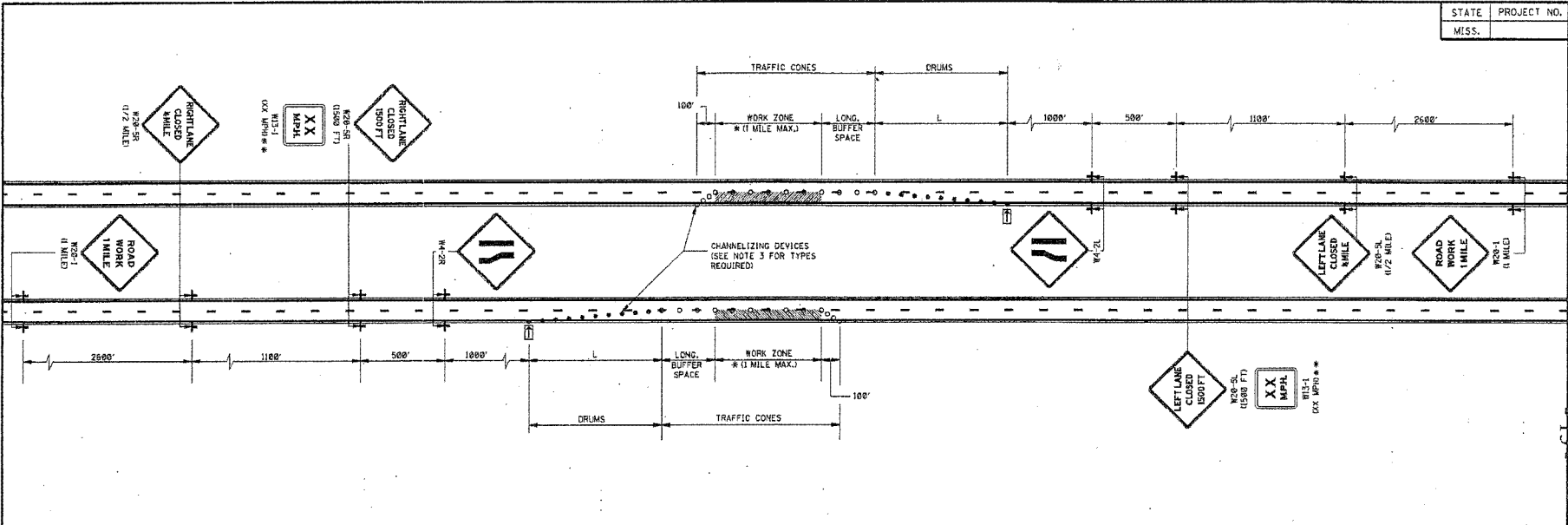

82

GENERAL NOTES:

1. THE LOCATION OF CHANNELIZING DEVICES AND THE WORK AREA LAYOUT SHALL BE BASED ON THE CRITERIA IN THE FOLLOWING TABLE.

POSTED SPEED AND/OR DESIGN SPEED	MAXIMUM CHANNELIZING DEVICE SPACING (ft)		MINIMUM LONGITUDINAL BUFFER SPACE (ft)	TAPER † RATES
	TAPER	ALONG LANE LINE & WORK ZONE		
≤40	40	80	170	27:1
45	45	90	220	45:1
50	50	100	280	56:1
55	55	110	335	69:1
60	60	120	415	69:1
65	65	130	485	65:1
70	70	140	575	76:1

† NOTE: TAPER RATES ARE DETERMINED USING THE FOLLOWING EQUATIONS:  
 $L = WS$  FOR SPEEDS OF 45 mph OR GREATER  
 $L = WS^2/60$  FOR SPEEDS OF 40 mph OR LESS  
 WHERE: L = MINIMUM LENGTH OF TAPER IN FEET  
 W = WIDTH OF OFFSET (USUALLY LANE WIDTH) IN FEET  
 S = DESIGN SPEED OR 85TH PERCENTILE SPEED IN MILES PER HOUR

- FLASHING ARROW PANEL SHALL BE AS LEVEL AS POSSIBLE AS APPROVED BY THE ENGINEER. FLASHING ARROW PANEL SHOULD BE LOCATED AT THE BEGINNING OF THE TAPER OR, IF THE SHOULDER IS TOO NARROW, BEHIND THE CHANNELIZING DEVICES IN THE CLOSED LANE.
- CHANNELIZING DEVICE TYPES FOR:  
 A. APPROACH TAPER- REFLECTORIZED PLASTIC DRUMS  
 B. ALONG LANE LINE AND WORK ZONE- TRAFFIC CONES (28" HEIGHT)  
 C. EXIT TAPER- TRAFFIC CONES (28" HEIGHT)
- WHEN THERE IS NO EXISTING HAZARD, ALL SIGNS SHALL BE COVERED OR REMOVED AND THE DRUMS SHALL BE MOVED TO THE SHOULDER EDGE AT THE END OF THE WORK DAY.
- FOR MOVING OPERATIONS (PAVING) THE CONTRACTOR SHALL HAVE TWO (2) SETS OF ADVANCE WARNING SIGNS, PLASTIC DRUMS, AND ARROW BOARD. WHEN THE CONSTRUCTION ZONE IS MOVED AHEAD, ALL SIGNS, PLASTIC DRUMS AND ARROW BOARD SHALL BE IN PLACE ON THE SECOND ZONE BEFORE REMOVING ANY SIGNS, PLASTIC DRUMS OR ARROW BOARD ON THE FIRST ZONE.
- ALL TRAFFIC CONTROL ITEMS SHOWN ON THIS SHEET WILL NOT BE MEASURED FOR SEPARATE PAYMENT. THIS WORK IS TO BE INCLUDED IN THE PRICE BID FOR MAINTENANCE OF TRAFFIC.
- DIAMOND SHAPED TRAFFIC CONTROL SIGNS SHALL BE A MINIMUM OF 48" X 48".

LEGEND

- \* OR AS SHOWN ELSEWHERE OF THE PLANS.
- \*\* THE LEGEND ON W13-1 (XX MPH) SUPPLEMENTAL PLATE SHALL BE 10 MPH LESS THAN THE POSTED SPEED LIMIT.
- FLASHING ARROW PANEL (TYPE "C")
- REFLECTORIZED FREE-STANDING PLASTIC DRUMS
- TRAFFIC CONES (28" HEIGHT)

MISSISSIPPI DEPARTMENT OF TRANSPORTATION  
 ROADWAY DESIGN DIVISION  
 STANDARD PLAN

**TRAFFIC CONTROL PLAN  
 FOR POSTED SPEED LIMIT  
 LESS THAN 65 MPH  
 (4-LANE, MEDIAN LANE  
 OR OUTSIDE LANE CLOSURE)  
 (WORK DAY ONLY)**

ISSUE DATE: OCTOBER 1, 1998

WORKING NUMBER: TCP-2  
 SHEET NUMBER: 251

Notice To Bidders No. 4814

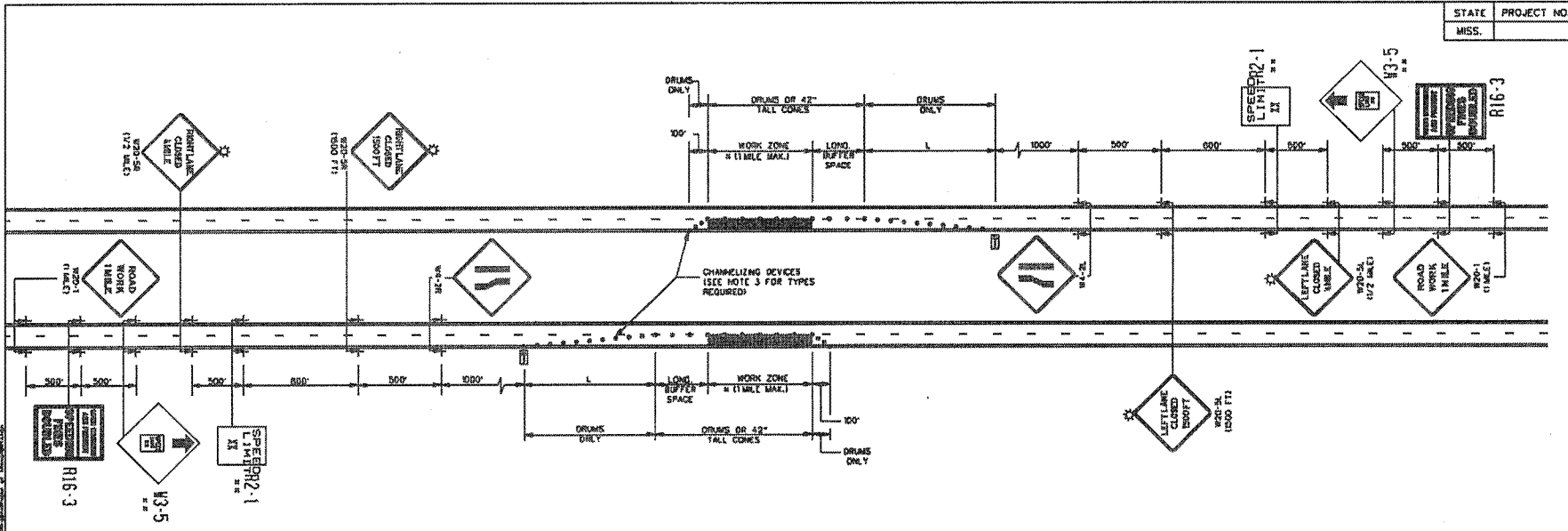

**GENERAL NOTES:**

L THE LOCATION OF CHANNELIZING DEVICES AND THE WORK AREA LAYOUT SHALL BE BASED ON THE CRITERIA IN THE FOLLOWING TABLE:

POSTED SPEED AND/OR DESIGN SPEED	MAXIMUM CHANNELIZING DEVICE SPACING (ft)		MINIMUM LONGITUDINAL BUFFER SPACE (ft)	TAPER RATES
	TAPER	ALONG BUFFER SPACE & WORK ZONE		
20	40	80	170	27:1
25	45	90	220	45:1
30	50	100	280	50:1
35	55	110	330	55:1
40	60	120	415	60:1
45	65	130	485	65:1
50	70	140	575	70:1

NOTE: TAPER RATES ARE DETERMINED USING THE FOLLOWING EQUATIONS:  
 L = WS FOR SPEEDS OF 45 MPH OR GREATER  
 L = WS/2 FOR SPEEDS OF 40 MPH OR LESS  
 WHERE: L = MINIMUM LENGTH OF TAPER IN FEET  
 W = WIDTH OF OFFSET USUALLY LANE WIDTH IN FEET  
 S = DESIGN SPEED OR 80TH PERCENTILE SPEED IN MILES PER HOUR

- FLASHING ARROW PANEL SHALL BE AS LEVEL AS POSSIBLE AS APPROVED BY THE ENGINEER. FLASHING ARROW PANEL SHOULD BE LOCATED AT THE BEGINNING OF THE TAPER OR, IF THE SHOULDER IS TOO NARROW, BEHIND THE CHANNELIZING DEVICES IN THE CLOSED LANE.
- CHANNELIZING DEVICES:
  - ALL CHANNELIZING DEVICES IN TAPERS SHALL BE REFLECTORIZED FREE STANDING PLASTIC DRUMS.
  - CHANNELIZING DEVICES IN TANGENTS MAY BE EITHER REFLECTORIZED FREE STANDING PLASTIC DRUMS OR 42" TALL CONES.
  - FOR NIGHTTIME USE, ALL CHANNELIZING DEVICES SHALL BE RETROREFLECTIVE.
  - RETROREFLECTIVITY SHALL BE IN ACCORDANCE WITH THE LATEST EDITION OF THE MUTCD.
- FOR MOVING OPERATIONS (PAVING) THE CONTRACTOR SHALL HAVE TWO (2) SETS OF ADVANCE WARNING SIGNS, PLASTIC DRUMS, AND ARROW BOARD. WHEN THE CONSTRUCTION ZONE IS MOVED AHEAD, ALL SIGNS, PLASTIC DRUMS AND ARROW BOARD SHALL BE IN PLACE ON THE SECOND ZONE BEFORE REMOVING ANY SIGNS, PLASTIC DRUMS OR ARROW BOARD ON THE FIRST ZONE.
- ALL TRAFFIC CONTROL ITEMS SHOWN ON THIS SHEET WILL NOT BE MEASURED FOR SEPARATE PAYMENT. THIS WORK IS TO BE INCLUDED IN THE PRICE BID FOR MAINTENANCE OF TRAFFIC.
- DIAMOND SHAPED TRAFFIC CONTROL SIGNS SHALL BE A MINIMUM OF 48" X 48".

**LEGEND**

- ☐ DRUM AS SHOWN ELSEWHERE OF THE PLANS.
- ☐ THE LEGEND ON R2-18 R3-3 SPEED LIMIT SIGNS SHALL BE 10 MPH LESS THAN THE ORIGINAL POSTED SPEED LIMIT.
- ☐ FLASHING ARROW PANEL (TYPE "C")
- ☐ REFLECTORIZED FREE-STANDING PLASTIC DRUMS
- ☐ TYPE "B" WARNING LIGHTS

MISSISSIPPI DEPARTMENT OF TRANSPORTATION	
TRAFFIC CONTROL PLAN	
FOR POSTED SPEED LIMIT	
LESS THAN 65 MPH	
(4-LANE, MEDIAN OR	
OUTSIDE LANE CLOSURE)	
(EXTENDED PERIOD)	
WORKING NUMBER	SDTCP-3
SHEET NUMBER	
FILENAME: OVERNIGHTCLOSE/SDTCP-3	
DESIGNER: [ ]	CHECKED: [ ]
DATE: [ ]	

PAVEMENT MARKING			
SYMBOL	DESCRIPTION	TYPE	QUANTITY
(1)	LEFT TURN ARROW AND ONLY (TAPE & ) PAINT		
(2)	RED-CLEAR REFLECTIVE RAISED MARKERS	EACH	
(3)	TWO-WAY YELLOW REFLEC. RAISED MARKER EACH		
(4)	5" TRAFFIC SKIP WHITE (10'-30')	PLASTIC	
(5)	6" CONTINUOUS EDGE WHITE (SOLID)	PLASTIC	
(6)	6" CONTINUOUS TRAFFIC YELLOW (SOLID)	PLASTIC	
(7)	6" CONTINUOUS EDGE YELLOW (SOLID)	PLASTIC	
(8)	6" CONTINUOUS TRAFFIC WHITE	PLASTIC	
(9)	6" DETAIL STRIPE WHITE (SOLID)	PLASTIC	
(10)	6" DETAIL STRIPE YELLOW (SOLID)	PLASTIC	
(11)	6" DETAIL SKIP WHITE (2'-12')	PLASTIC	
(12)	12" DETAIL STRIPE WHITE (SOLID)	PLASTIC	
(13)	24" THERMO. LEGEND (WHITE) STOP BAR		

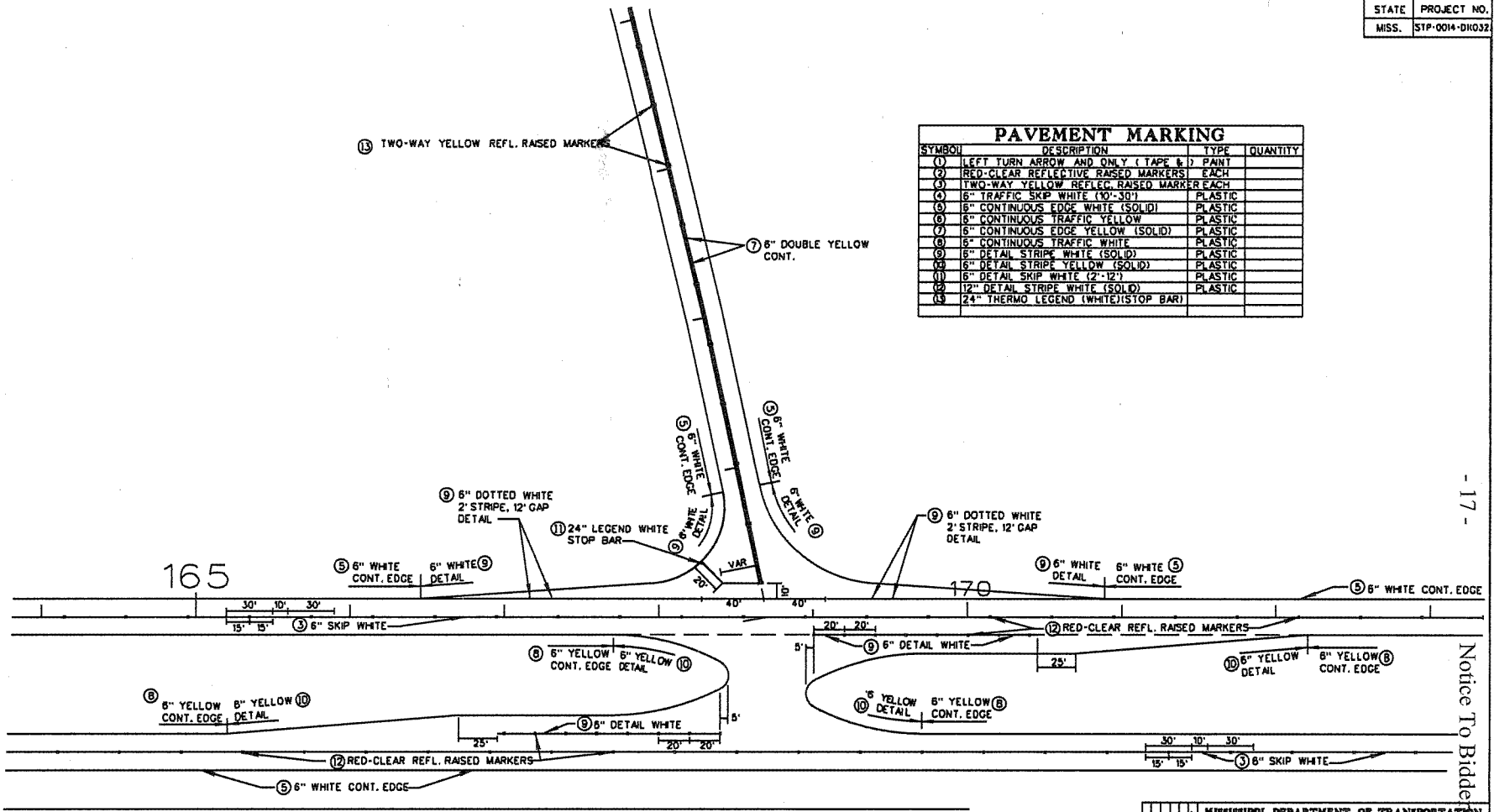

84

- 17 -

Notice To Bidder  
No. 4814  
PMD-1  
5/11/14  
gntd.

MISSISSIPPI DEPARTMENT OF TRANSPORTATION	
DETAIL OF STRIPING	
LOCAL RD. STA. 168+70.68	
PROJECT NO: STP-0014-01(032)	
COUNTY: PIKE	
DATE:	FILENAME:
DESIGN TEAM:	CHECKED: DATE:

# TYPICAL STRIPING FOR SIMPLE INTERSECTION AT LOCAL ROADS

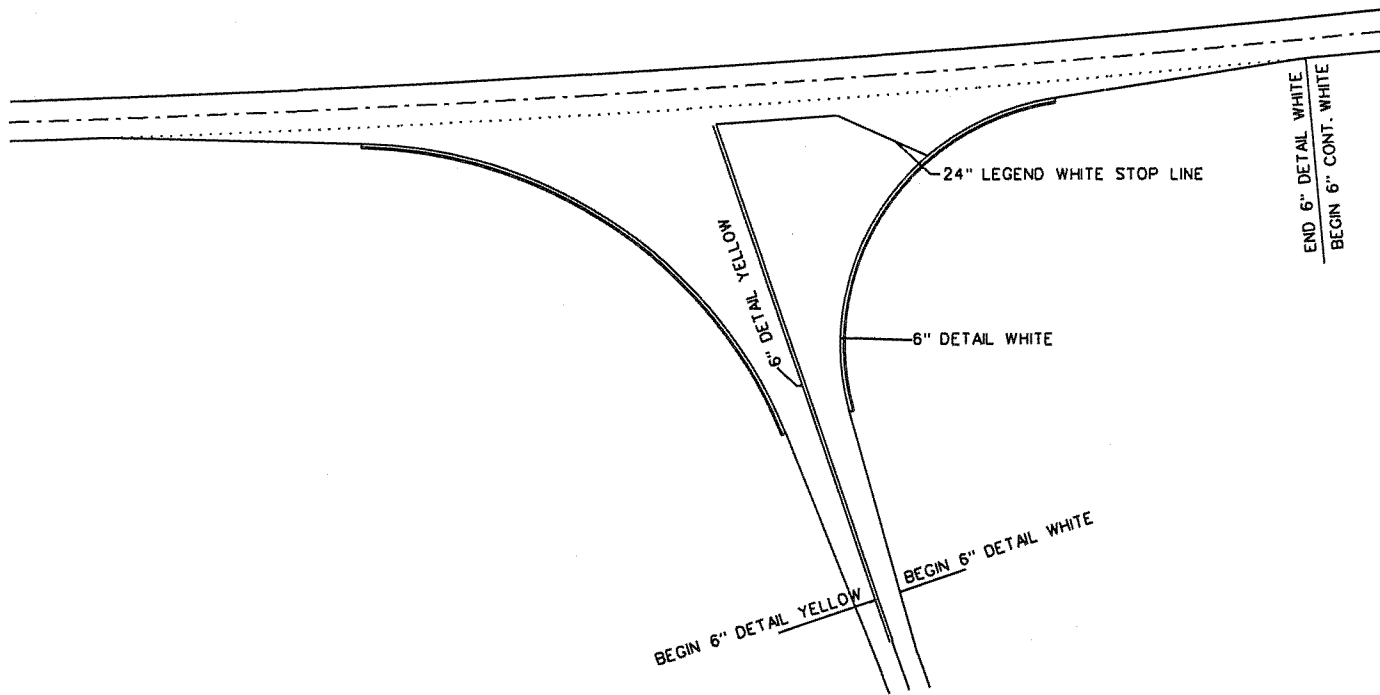

# TYPICAL FOR PAVED TAPER AT LOCAL ROADS

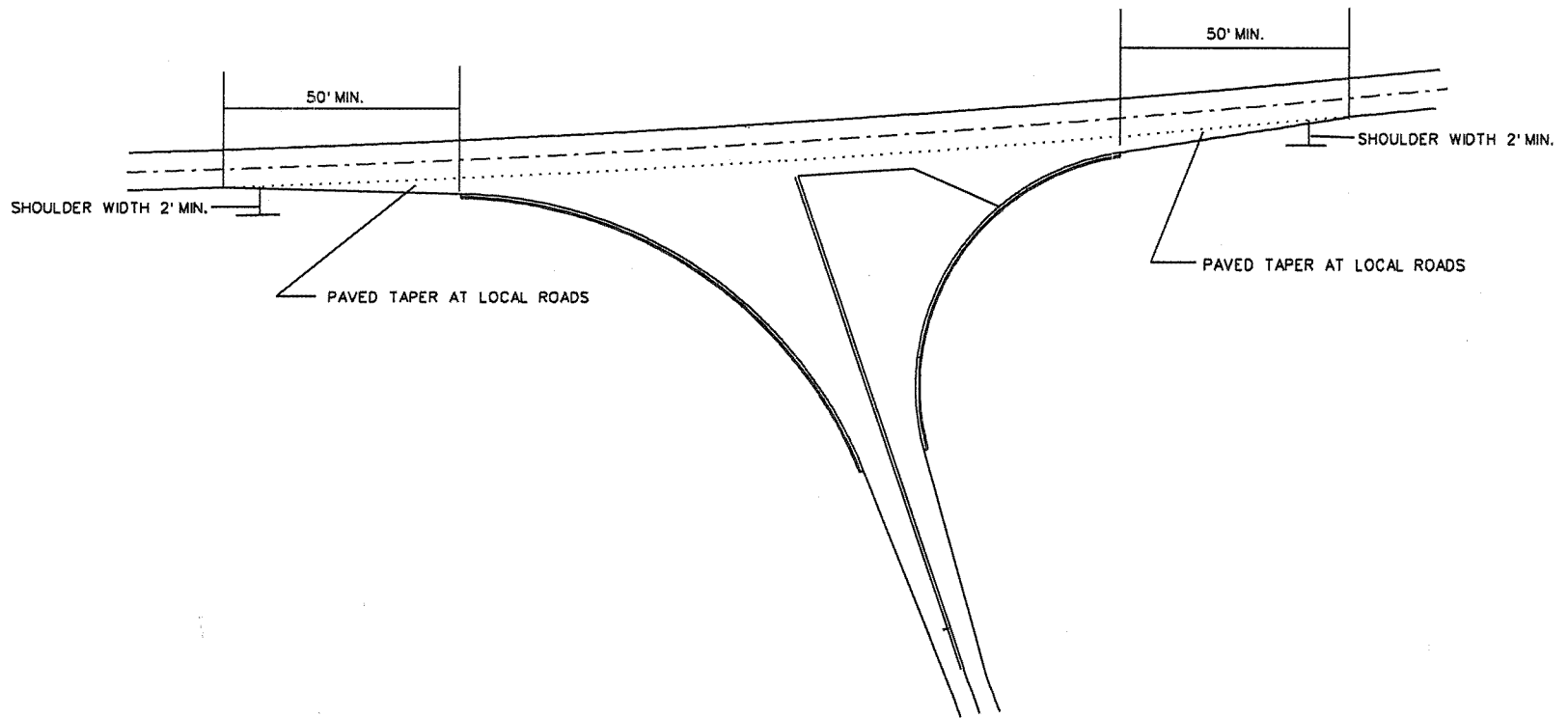

86



STATE	PROJECT NO.
MISS.	

TYPICAL FOR RAISED PAVEMENT MARKERS  
PLACED ON SIDE ROAD RADIUS

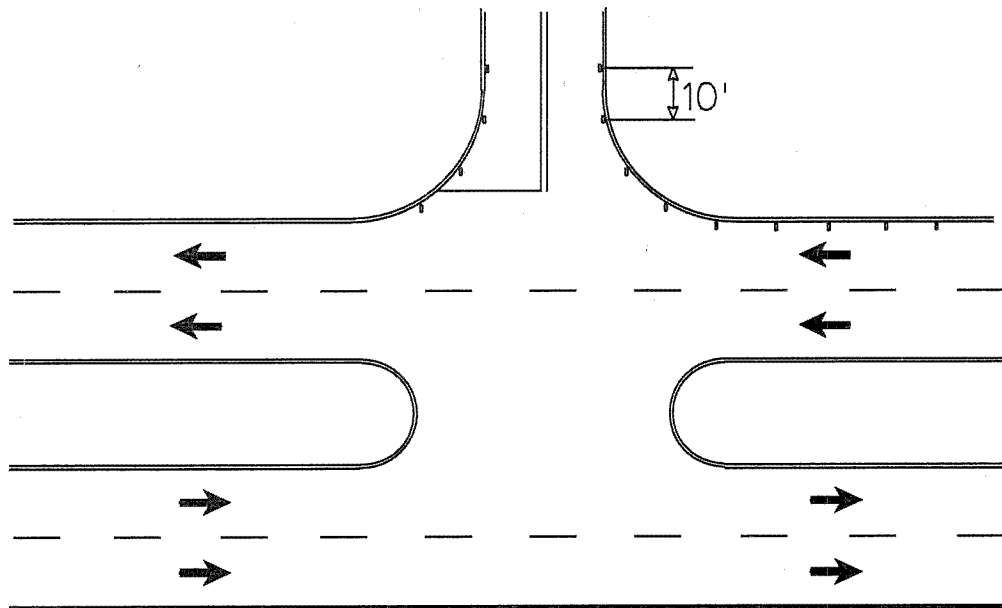

- NOTE 1. MARKERS SHALL BE PLACED EVERY 10 FEET.
- NOTE 2. MARKERS SHALL BE VISIBLE FROM THE TRAVELING MOTORIST ON STATE DESIGNATED HIGHWAYS.
- NOTE 3. MARKERS SHALL BE HIGH PERFORMANCE TWO WAY CLEAR.

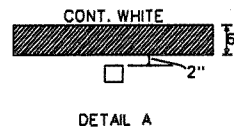

MISSISSIPPI DEPARTMENT OF TRANSPORTATION	
4-LANE RAISED PAVEMENT MARKERS PLACED ON SIDE ROADS	
DATE	BY
FILENAME:	DRAWING NUMBER:
ISSUE YEAR:	CHECKED DATE:

&gt;

General Decision Number: MS140143 01/03/2014 MS143

Superseded General Decision Number: MS20130143

State: Mississippi

Construction Type: Highway

County: Jones County in Mississippi.

HIGHWAY CONSTRUCTION PROJECTS (excluding tunnels, building structures in rest area projects & railroad construction; bascule, suspension & spandrel arch bridges designed for commercial navigation, bridges involving marine construction; and other major bridges).

Modification Number	Publication Date
0	01/03/2014

\* ELEC0480-007 07/01/2013

	Rates	Fringes
ELECTRICIAN.....	\$ 23.35	3%+7.43

\* SUMS2008-104 09/04/2008

	Rates	Fringes
CARPENTER, Includes Form Work....	\$ 11.10	0.60
CEMENT MASON/CONCRETE FINISHER...	\$ 10.67	0.78
IRONWORKER, REINFORCING.....	\$ 10.38	0.00
LABORER: Common or General.....	\$ 8.30	0.00
LABORER: Pipelayer.....	\$ 9.68	0.00
OPERATOR: Backhoe/Excavator.....	\$ 11.13	0.00
OPERATOR: Broom/Sweeper.....	\$ 10.17	0.00
OPERATOR: Bulldozer.....	\$ 11.17	0.00
OPERATOR: Crane.....	\$ 14.57	0.00
OPERATOR: Grader/Blade.....	\$ 11.00	0.00
OPERATOR: Mechanic.....	\$ 12.04	0.00
OPERATOR: Oiler.....	\$ 12.33	0.48
OPERATOR: Roller.....	\$ 9.31	0.00
OPERATOR: Scraper.....	\$ 10.00	0.00

OPERATOR: Tractor.....	\$ 7.25	0.00
OPERATOR: Asphalt Paver and Asphalt Spreader.....	\$ 10.00	0.00
OPERATOR: Loader.....	\$ 10.15	0.00
TRUCK DRIVER.....	\$ 9.71	1.09

---

WELDERS - Receive rate prescribed for craft performing operation to which welding is incidental.

---

Unlisted classifications needed for work not included within the scope of the classifications listed may be added after award only as provided in the labor standards contract clauses (29CFR 5.5 (a) (1) (ii)).

---

The body of each wage determination lists the classification and wage rates that have been found to be prevailing for the cited type(s) of construction in the area covered by the wage determination. The classifications are listed in alphabetical order of "identifiers" that indicate whether the particular rate is union or non-union.

#### Union Identifiers

An identifier enclosed in dotted lines beginning with characters other than "SU" denotes that the union classification and rate have found to be prevailing for that classification. Example: PLUM0198-005 07/01/2011. The first four letters , PLUM, indicate the international union and the four-digit number, 0198, that follows indicates the local union number or district council number where applicable , i.e., Plumbers Local 0198. The next number, 005 in the example, is an internal number used in processing the wage determination. The date, 07/01/2011, following these characters is the effective date of the most current negotiated rate/collective bargaining agreement which would be July 1, 2011 in the above example.

Union prevailing wage rates will be updated to reflect any changes in the collective bargaining agreements governing the rates.

0000/9999: weighted union wage rates will be published annually each January.

#### Non-Union Identifiers

Classifications listed under an "SU" identifier were derived from survey data by computing average rates and are not union rates; however, the data used in computing these rates may include both union and non-union data. Example: SULA2004-007 5/13/2010. SU indicates the rates are not union majority rates, LA indicates the State of Louisiana; 2004 is the year of the survey; and 007 is an internal number used in producing the wage determination. A 1993 or later date, 5/13/2010, indicates the classifications and rates under that identifier were issued as a General Wage Determination on that date.

Survey wage rates will remain in effect and will not change until a new survey is conducted.

-----

WAGE DETERMINATION APPEALS PROCESS

1.) Has there been an initial decision in the matter? This can be:

- \* an existing published wage determination
- \* a survey underlying a wage determination
- \* a Wage and Hour Division letter setting forth a position on a wage determination matter
- \* a conformance (additional classification and rate) ruling

On survey related matters, initial contact, including requests for summaries of surveys, should be with the Wage and Hour Regional Office for the area in which the survey was conducted because those Regional Offices have responsibility for the Davis-Bacon survey program. If the response from this initial contact is not satisfactory, then the process described in 2.) and 3.) should be followed.

With regard to any other matter not yet ripe for the formal process described here, initial contact should be with the Branch of Construction Wage Determinations. Write to:

Branch of Construction Wage Determinations  
Wage and Hour Division  
U.S. Department of Labor  
200 Constitution Avenue, N.W.  
Washington, DC 20210

2.) If the answer to the question in 1.) is yes, then an interested party (those affected by the action) can request review and reconsideration from the Wage and Hour Administrator (See 29 CFR Part 1.8 and 29 CFR Part 7). Write to:

Wage and Hour Administrator  
U.S. Department of Labor  
200 Constitution Avenue, N.W.  
Washington, DC 20210

The request should be accompanied by a full statement of the interested party's position and by any information (wage payment data, project description, area practice material,

etc.) that the requestor considers relevant to the issue.

3.) If the decision of the Administrator is not favorable, an interested party may appeal directly to the Administrative Review Board (formerly the Wage Appeals Board). Write to:

Administrative Review Board  
U.S. Department of Labor  
200 Constitution Avenue, N.W.  
Washington, DC 20210

4.) All decisions by the Administrative Review Board are final.

=====

END OF GENERAL DECISION

## **SUPPLEMENT TO FORM FHWA-1273**

**DATE:** 10/23/2013

**SUBJECT:** Final Certificate and Contract Provisions for Subcontracts

All subcontracts shall be in writing and contain all pertinent provisions and requirements of the prime contract.

Each “Request for Permission to Subcontract” (Mississippi Department of Transportation Form CAD-720) shall include a copy of subcontract [upon request](#) for review by the Mississippi Department of Transportation. The federal contract provisions may be omitted from the subcontract copy submitted for review provided the Contractor certifies that the provisions will be physically incorporated into the agreement furnished to the Subcontractor.

In lieu of submitting a copy of the subcontract for review, the Contractor may certify that the subcontract agreement is in writing and that it contains all the requirements and pertinent provisions of the prime contract.

Each Subcontractor will be required to provide a copy of the subcontract agreement for contract compliance reviews, along with physical evidence (copy of FHWA-1273) that requirements and pertinent provisions have been provided for review and adherence.

**REQUIRED CONTRACT PROVISIONS  
FEDERAL-AID CONSTRUCTION CONTRACTS**

---

- I. General
- II. Nondiscrimination
- III. Nonsegregated Facilities
- IV. Davis-Bacon and Related Act Provisions
- V. Contract Work Hours and Safety Standards Act Provisions
- VI. Subletting or Assigning the Contract
- VII. Safety: Accident Prevention
- VIII. False Statements Concerning Highway Projects
- IX. Implementation of Clean Air Act and Federal Water Pollution Control Act
- X. Compliance with Governmentwide Suspension and Debarment Requirements
- XI. Certification Regarding Use of Contract Funds for Lobbying

#### ATTACHMENTS

A. Employment and Materials Preference for Appalachian Development Highway System or Appalachian Local Access Road Contracts (included in Appalachian contracts only)

#### I. GENERAL

1. Form FHWA-1273 must be physically incorporated in each construction contract funded under Title 23 (excluding emergency contracts solely intended for debris removal). The contractor (or subcontractor) must insert this form in each subcontract and further require its inclusion in all lower tier subcontracts (excluding purchase orders, rental agreements and other agreements for supplies or services).

The applicable requirements of Form FHWA-1273 are incorporated by reference for work done under any purchase order, rental agreement or agreement for other services. The prime contractor shall be responsible for compliance by any subcontractor, lower-tier subcontractor or service provider.

Form FHWA-1273 must be included in all Federal-aid design-build contracts, in all subcontracts and in lower tier subcontracts (excluding subcontracts for design services, purchase orders, rental agreements and other agreements for supplies or services). The design-builder shall be responsible for compliance by any subcontractor, lower-tier subcontractor or service provider.

Contracting agencies may reference Form FHWA-1273 in bid proposal or request for proposal documents, however, the Form FHWA-1273 must be physically incorporated (not referenced) in all contracts, subcontracts and lower-tier subcontracts (excluding purchase orders, rental agreements and other agreements for supplies or services related to a construction contract).

2. Subject to the applicability criteria noted in the following sections, these contract provisions shall apply to all work performed on the contract by the contractor's own organization and with the assistance of workers under the contractor's immediate superintendence and to all work performed on the contract by piecework, station work, or by subcontract.

3. A breach of any of the stipulations contained in these Required Contract Provisions may be sufficient grounds for withholding of progress payments, withholding of final payment, termination of the contract, suspension / debarment or any other action determined to be appropriate by the contracting agency and FHWA.

4. Selection of Labor: During the performance of this contract, the contractor shall not use convict labor for any purpose within the limits of a construction project on a Federal-aid highway unless it is labor performed by convicts who are on parole, supervised release, or probation. The term Federal-aid highway does not include roadways functionally classified as local roads or rural minor collectors.

#### II. NONDISCRIMINATION

The provisions of this section related to 23 CFR Part 230 are applicable to all Federal-aid construction contracts and to all related construction subcontracts of \$10,000 or more. The provisions of 23 CFR Part 230 are not applicable to material supply, engineering, or architectural service contracts.

In addition, the contractor and all subcontractors must comply with the following policies: Executive Order 11246, 41 CFR 60, 29 CFR 1625-1627, Title 23 USC Section 140, the Rehabilitation Act of 1973, as amended (29 USC 794), Title VI of the Civil Rights Act of 1964, as amended, and related regulations including 49 CFR Parts 21, 26 and 27; and 23 CFR Parts 200, 230, and 633.

The contractor and all subcontractors must comply with: the requirements of the Equal Opportunity Clause in 41 CFR 60-1.4(b) and, for all construction contracts exceeding \$10,000, the Standard Federal Equal Employment Opportunity Construction Contract Specifications in 41 CFR 60-4.3.

Note: The U.S. Department of Labor has exclusive authority to determine compliance with Executive Order 11246 and the policies of the Secretary of Labor including 41 CFR 60, and 29 CFR 1625-1627. The contracting agency and the FHWA have the authority and the responsibility to ensure compliance with Title 23 USC Section 140, the Rehabilitation Act of 1973, as amended (29 USC 794), and Title VI of the Civil Rights Act of 1964, as amended, and related regulations including 49 CFR Parts 21, 26 and 27; and 23 CFR Parts 200, 230, and 633.

The following provision is adopted from 23 CFR 230, Appendix A, with appropriate revisions to conform to the U.S. Department of Labor (US DOL) and FHWA requirements.

**1. Equal Employment Opportunity:** Equal employment opportunity (EEO) requirements not to discriminate and to take affirmative action to assure equal opportunity as set forth under laws, executive orders, rules, regulations (28 CFR 35, 29 CFR 1630, 29 CFR 1625-1627, 41 CFR 60 and 49 CFR 27) and orders of the Secretary of Labor as modified by the provisions prescribed herein, and imposed pursuant to 23 U.S.C. 140 shall constitute the EEO and specific affirmative action standards for the contractor's project activities under

this contract. The provisions of the Americans with Disabilities Act of 1990 (42 U.S.C. 12101 et seq.) set forth under 28 CFR 35 and 29 CFR 1630 are incorporated by reference in this contract. In the execution of this contract, the contractor agrees to comply with the following minimum specific requirement activities of EEO:

a. The contractor will work with the contracting agency and the Federal Government to ensure that it has made every good faith effort to provide equal opportunity with respect to all of its terms and conditions of employment and in their review of activities under the contract.

b. The contractor will accept as its operating policy the following statement:

"It is the policy of this Company to assure that applicants are employed, and that employees are treated during employment, without regard to their race, religion, sex, color, national origin, age or disability. Such action shall include: employment, upgrading, demotion, or transfer; recruitment or recruitment advertising; layoff or termination; rates of pay or other forms of compensation; and selection for training, including apprenticeship, pre-apprenticeship, and/or on-the-job training."

**2. EEO Officer:** The contractor will designate and make known to the contracting officers an EEO Officer who will have the responsibility for and must be capable of effectively administering and promoting an active EEO program and who must be assigned adequate authority and responsibility to do so.

**3. Dissemination of Policy:** All members of the contractor's staff who are authorized to hire, supervise, promote, and discharge employees, or who recommend such action, or who are substantially involved in such action, will be made fully cognizant of, and will implement, the contractor's EEO policy and contractual responsibilities to provide EEO in each grade and classification of employment. To ensure that the above agreement will be met, the following actions will be taken as a minimum:

a. Periodic meetings of supervisory and personnel office employees will be conducted before the start of work and then not less often than once every six months, at which time the contractor's EEO policy and its implementation will be reviewed and explained. The meetings will be conducted by the EEO Officer.

b. All new supervisory or personnel office employees will be given a thorough indoctrination by the EEO Officer, covering all major aspects of the contractor's EEO obligations within thirty days following their reporting for duty with the contractor.

c. All personnel who are engaged in direct recruitment for the project will be instructed by the EEO Officer in the contractor's procedures for locating and hiring minorities and women.

d. Notices and posters setting forth the contractor's EEO policy will be placed in areas readily accessible to employees, applicants for employment and potential employees.

e. The contractor's EEO policy and the procedures to implement such policy will be brought to the attention of employees by means of meetings, employee handbooks, or other appropriate means.

**4. Recruitment:** When advertising for employees, the contractor will include in all advertisements for employees the notation: "An Equal Opportunity Employer." All such advertisements will be placed in publications having a large circulation among minorities and women in the area from which the project work force would normally be derived.

a. The contractor will, unless precluded by a valid bargaining agreement, conduct systematic and direct recruitment through public and private employee referral sources likely to yield qualified minorities and women. To meet this requirement, the contractor will identify sources of potential minority group employees, and establish with such identified sources procedures whereby minority and women applicants may be referred to the contractor for employment consideration.

b. In the event the contractor has a valid bargaining agreement providing for exclusive hiring hall referrals, the contractor is expected to observe the provisions of that agreement to the extent that the system meets the contractor's compliance with EEO contract provisions. Where implementation of such an agreement has the effect of discriminating against minorities or women, or obligates the contractor to do the same, such implementation violates Federal nondiscrimination provisions.

c. The contractor will encourage its present employees to refer minorities and women as applicants for employment. Information and procedures with regard to referring such applicants will be discussed with employees.

**5. Personnel Actions:** Wages, working conditions, and employee benefits shall be established and administered, and personnel actions of every type, including hiring, upgrading, promotion, transfer, demotion, layoff, and termination, shall be taken without regard to race, color, religion, sex, national origin, age or disability. The following procedures shall be followed:

a. The contractor will conduct periodic inspections of project sites to insure that working conditions and employee facilities do not indicate discriminatory treatment of project site personnel.

b. The contractor will periodically evaluate the spread of wages paid within each classification to determine any evidence of discriminatory wage practices.

c. The contractor will periodically review selected personnel actions in depth to determine whether there is evidence of discrimination. Where evidence is found, the contractor will promptly take corrective action. If the review indicates that the discrimination may extend beyond the actions reviewed, such corrective action shall include all affected persons.

d. The contractor will promptly investigate all complaints of alleged discrimination made to the contractor in connection with its obligations under this contract, will attempt to resolve such complaints, and will take appropriate corrective action within a reasonable time. If the investigation indicates that the discrimination may affect persons other than the complainant, such corrective action shall include such other persons. Upon completion of each investigation, the contractor will inform every complainant of all of their avenues of appeal.

**6. Training and Promotion:**

a. The contractor will assist in locating, qualifying, and increasing the skills of minorities and women who are



applicants for employment or current employees. Such efforts should be aimed at developing full journey level status employees in the type of trade or job classification involved.

b. Consistent with the contractor's work force requirements and as permissible under Federal and State regulations, the contractor shall make full use of training programs, i.e., apprenticeship, and on-the-job training programs for the geographical area of contract performance. In the event a special provision for training is provided under this contract, this subparagraph will be superseded as indicated in the special provision. The contracting agency may reserve training positions for persons who receive welfare assistance in accordance with 23 U.S.C. 140(a).

c. The contractor will advise employees and applicants for employment of available training programs and entrance requirements for each.

d. The contractor will periodically review the training and promotion potential of employees who are minorities and women and will encourage eligible employees to apply for such training and promotion.

**7. Unions:** If the contractor relies in whole or in part upon unions as a source of employees, the contractor will use good faith efforts to obtain the cooperation of such unions to increase opportunities for minorities and women. Actions by the contractor, either directly or through a contractor's association acting as agent, will include the procedures set forth below:

a. The contractor will use good faith efforts to develop, in cooperation with the unions, joint training programs aimed toward qualifying more minorities and women for membership in the unions and increasing the skills of minorities and women so that they may qualify for higher paying employment.

b. The contractor will use good faith efforts to incorporate an EEO clause into each union agreement to the end that such union will be contractually bound to refer applicants without regard to their race, color, religion, sex, national origin, age or disability.

c. The contractor is to obtain information as to the referral practices and policies of the labor union except that to the extent such information is within the exclusive possession of the labor union and such labor union refuses to furnish such information to the contractor, the contractor shall so certify to the contracting agency and shall set forth what efforts have been made to obtain such information.

d. In the event the union is unable to provide the contractor with a reasonable flow of referrals within the time limit set forth in the collective bargaining agreement, the contractor will, through independent recruitment efforts, fill the employment vacancies without regard to race, color, religion, sex, national origin, age or disability; making full efforts to obtain qualified and/or qualifiable minorities and women. The failure of a union to provide sufficient referrals (even though it is obligated to provide exclusive referrals under the terms of a collective bargaining agreement) does not relieve the contractor from the requirements of this paragraph. In the event the union referral practice prevents the contractor from meeting the obligations pursuant to Executive Order 11246, as amended, and these special provisions, such contractor shall immediately notify the contracting agency.

**8. Reasonable Accommodation for Applicants / Employees with Disabilities:** The contractor must be familiar

with the requirements for and comply with the Americans with Disabilities Act and all rules and regulations established there under. Employers must provide reasonable accommodation in all employment activities unless to do so would cause an undue hardship.

**9. Selection of Subcontractors, Procurement of Materials and Leasing of Equipment:** The contractor shall not discriminate on the grounds of race, color, religion, sex, national origin, age or disability in the selection and retention of subcontractors, including procurement of materials and leases of equipment. The contractor shall take all necessary and reasonable steps to ensure nondiscrimination in the administration of this contract.

a. The contractor shall notify all potential subcontractors and suppliers and lessors of their EEO obligations under this contract.

b. The contractor will use good faith efforts to ensure subcontractor compliance with their EEO obligations.

**10. Assurance Required by 49 CFR 26.13(b):**

a. The requirements of 49 CFR Part 26 and the State DOT's U.S. DOT-approved DBE program are incorporated by reference.

b. The contractor or subcontractor shall not discriminate on the basis of race, color, national origin, or sex in the performance of this contract. The contractor shall carry out applicable requirements of 49 CFR Part 26 in the award and administration of DOT-assisted contracts. Failure by the contractor to carry out these requirements is a material breach of this contract, which may result in the termination of this contract or such other remedy as the contracting agency deems appropriate.

**11. Records and Reports:** The contractor shall keep such records as necessary to document compliance with the EEO requirements. Such records shall be retained for a period of three years following the date of the final payment to the contractor for all contract work and shall be available at reasonable times and places for inspection by authorized representatives of the contracting agency and the FHWA.

a. The records kept by the contractor shall document the following:

(1) The number and work hours of minority and non-minority group members and women employed in each work classification on the project;

(2) The progress and efforts being made in cooperation with unions, when applicable, to increase employment opportunities for minorities and women; and

(3) The progress and efforts being made in locating, hiring, training, qualifying, and upgrading minorities and women;

b. The contractors and subcontractors will submit an annual report to the contracting agency each July for the duration of the project, indicating the number of minority, women, and non-minority group employees currently engaged in each work classification required by the contract work. This information is to be reported on [Form FHWA-1391](#). The staffing data should represent the project work force on board in all or any part of the last payroll period preceding the end of July. If on-the-job training is being required by special provision, the contractor

will be required to collect and report training data. The employment data should reflect the work force on board during all or any part of the last payroll period preceding the end of July.

### III. NONSEGREGATED FACILITIES

This provision is applicable to all Federal-aid construction contracts and to all related construction subcontracts of \$10,000 or more.

The contractor must ensure that facilities provided for employees are provided in such a manner that segregation on the basis of race, color, religion, sex, or national origin cannot result. The contractor may neither require such segregated use by written or oral policies nor tolerate such use by employee custom. The contractor's obligation extends further to ensure that its employees are not assigned to perform their services at any location, under the contractor's control, where the facilities are segregated. The term "facilities" includes waiting rooms, work areas, restaurants and other eating areas, time clocks, restrooms, washrooms, locker rooms, and other storage or dressing areas, parking lots, drinking fountains, recreation or entertainment areas, transportation, and housing provided for employees. The contractor shall provide separate or single-user restrooms and necessary dressing or sleeping areas to assure privacy between sexes.

### IV. DAVIS-BACON AND RELATED ACT PROVISIONS

This section is applicable to all Federal-aid construction projects exceeding \$2,000 and to all related subcontracts and lower-tier subcontracts (regardless of subcontract size). The requirements apply to all projects located within the right-of-way of a roadway that is functionally classified as Federal-aid highway. This excludes roadways functionally classified as local roads or rural minor collectors, which are exempt. Contracting agencies may elect to apply these requirements to other projects.

The following provisions are from the U.S. Department of Labor regulations in 29 CFR 5.5 "Contract provisions and related matters" with minor revisions to conform to the FHWA-1273 format and FHWA program requirements.

#### 1. Minimum wages

a. All laborers and mechanics employed or working upon the site of the work, will be paid unconditionally and not less often than once a week, and without subsequent deduction or rebate on any account (except such payroll deductions as are permitted by regulations issued by the Secretary of Labor under the Copeland Act (29 CFR part 3)), the full amount of wages and bona fide fringe benefits (or cash equivalents thereof) due at time of payment computed at rates not less than those contained in the wage determination of the Secretary of Labor which is attached hereto and made a part hereof, regardless of any contractual relationship which may be alleged to exist between the contractor and such laborers and mechanics.

Contributions made or costs reasonably anticipated for bona fide fringe benefits under section 1(b)(2) of the Davis-Bacon Act on behalf of laborers or mechanics are considered wages

paid to such laborers or mechanics, subject to the provisions of paragraph 1.d. of this section; also, regular contributions made or costs incurred for more than a weekly period (but not less often than quarterly) under plans, funds, or programs which cover the particular weekly period, are deemed to be constructively made or incurred during such weekly period. Such laborers and mechanics shall be paid the appropriate wage rate and fringe benefits on the wage determination for the classification of work actually performed, without regard to skill, except as provided in 29 CFR 5.5(a)(4). Laborers or mechanics performing work in more than one classification may be compensated at the rate specified for each classification for the time actually worked therein: Provided, That the employer's payroll records accurately set forth the time spent in each classification in which work is performed. The wage determination (including any additional classification and wage rates conformed under paragraph 1.b. of this section) and the Davis-Bacon poster (WH-1321) shall be posted at all times by the contractor and its subcontractors at the site of the work in a prominent and accessible place where it can be easily seen by the workers.

b. (1) The contracting officer shall require that any class of laborers or mechanics, including helpers, which is not listed in the wage determination and which is to be employed under the contract shall be classified in conformance with the wage determination. The contracting officer shall approve an additional classification and wage rate and fringe benefits therefore only when the following criteria have been met:

(i) The work to be performed by the classification requested is not performed by a classification in the wage determination; and

(ii) The classification is utilized in the area by the construction industry; and

(iii) The proposed wage rate, including any bona fide fringe benefits, bears a reasonable relationship to the wage rates contained in the wage determination.

(2) If the contractor and the laborers and mechanics to be employed in the classification (if known), or their representatives, and the contracting officer agree on the classification and wage rate (including the amount designated for fringe benefits where appropriate), a report of the action taken shall be sent by the contracting officer to the Administrator of the Wage and Hour Division, Employment Standards Administration, U.S. Department of Labor, Washington, DC 20210. The Administrator, or an authorized representative, will approve, modify, or disapprove every additional classification action within 30 days of receipt and so advise the contracting officer or will notify the contracting officer within the 30-day period that additional time is necessary.

(3) In the event the contractor, the laborers or mechanics to be employed in the classification or their representatives, and the contracting officer do not agree on the proposed classification and wage rate (including the amount designated for fringe benefits, where appropriate), the contracting officer shall refer the questions, including the views of all interested parties and the recommendation of the contracting officer, to the Wage and Hour Administrator for determination. The Wage and Hour Administrator, or an authorized representative, will issue a determination within 30 days of receipt and so advise

the contracting officer or will notify the contracting officer within the 30-day period that additional time is necessary.

(4) The wage rate (including fringe benefits where appropriate) determined pursuant to paragraphs 1.b.(2) or 1.b.(3) of this section, shall be paid to all workers performing work in the classification under this contract from the first day on which work is performed in the classification.

c. Whenever the minimum wage rate prescribed in the contract for a class of laborers or mechanics includes a fringe benefit which is not expressed as an hourly rate, the contractor shall either pay the benefit as stated in the wage determination or shall pay another bona fide fringe benefit or an hourly cash equivalent thereof.

d. If the contractor does not make payments to a trustee or other third person, the contractor may consider as part of the wages of any laborer or mechanic the amount of any costs reasonably anticipated in providing bona fide fringe benefits under a plan or program, Provided, That the Secretary of Labor has found, upon the written request of the contractor, that the applicable standards of the Davis-Bacon Act have been met. The Secretary of Labor may require the contractor to set aside in a separate account assets for the meeting of obligations under the plan or program.

## 2. Withholding

The contracting agency shall upon its own action or upon written request of an authorized representative of the Department of Labor, withhold or cause to be withheld from the contractor under this contract, or any other Federal contract with the same prime contractor, or any other federally-assisted contract subject to Davis-Bacon prevailing wage requirements, which is held by the same prime contractor, so much of the accrued payments or advances as may be considered necessary to pay laborers and mechanics, including apprentices, trainees, and helpers, employed by the contractor or any subcontractor the full amount of wages required by the contract. In the event of failure to pay any laborer or mechanic, including any apprentice, trainee, or helper, employed or working on the site of the work, all or part of the wages required by the contract, the contracting agency may, after written notice to the contractor, take such action as may be necessary to cause the suspension of any further payment, advance, or guarantee of funds until such violations have ceased.

## 3. Payrolls and basic records

a. Payrolls and basic records relating thereto shall be maintained by the contractor during the course of the work and preserved for a period of three years thereafter for all laborers and mechanics working at the site of the work. Such records shall contain the name, address, and social security number of each such worker, his or her correct classification, hourly rates of wages paid (including rates of contributions or costs anticipated for bona fide fringe benefits or cash equivalents thereof of the types described in section 1(b)(2)(B) of the Davis-Bacon Act), daily and weekly number of hours worked, deductions made and actual wages paid. Whenever the Secretary of Labor has found under 29 CFR 5.5(a)(1)(iv) that the wages of any laborer or mechanic include the amount of any costs reasonably anticipated in providing benefits under a plan or program described in section 1(b)(2)(B) of the Davis-

Bacon Act, the contractor shall maintain records which show that the commitment to provide such benefits is enforceable, that the plan or program is financially responsible, and that the plan or program has been communicated in writing to the laborers or mechanics affected, and records which show the costs anticipated or the actual cost incurred in providing such benefits. Contractors employing apprentices or trainees under approved programs shall maintain written evidence of the registration of apprenticeship programs and certification of trainee programs, the registration of the apprentices and trainees, and the ratios and wage rates prescribed in the applicable programs.

b. (1) The contractor shall submit weekly for each week in which any contract work is performed a copy of all payrolls to the contracting agency. The payrolls submitted shall set out accurately and completely all of the information required to be maintained under 29 CFR 5.5(a)(3)(i), except that full social security numbers and home addresses shall not be included on weekly transmittals. Instead the payrolls shall only need to include an individually identifying number for each employee (e.g., the last four digits of the employee's social security number). The required weekly payroll information may be submitted in any form desired. Optional Form WH-347 is available for this purpose from the Wage and Hour Division Web site at <http://www.dol.gov/esa/whd/forms/wh347instr.htm> or its successor site. The prime contractor is responsible for the submission of copies of payrolls by all subcontractors. Contractors and subcontractors shall maintain the full social security number and current address of each covered worker, and shall provide them upon request to the contracting agency for transmission to the State DOT, the FHWA or the Wage and Hour Division of the Department of Labor for purposes of an investigation or audit of compliance with prevailing wage requirements. It is not a violation of this section for a prime contractor to require a subcontractor to provide addresses and social security numbers to the prime contractor for its own records, without weekly submission to the contracting agency..

(2) Each payroll submitted shall be accompanied by a "Statement of Compliance," signed by the contractor or subcontractor or his or her agent who pays or supervises the payment of the persons employed under the contract and shall certify the following:

(i) That the payroll for the payroll period contains the information required to be provided under §5.5 (a)(3)(ii) of Regulations, 29 CFR part 5, the appropriate information is being maintained under §5.5 (a)(3)(i) of Regulations, 29 CFR part 5, and that such information is correct and complete;

(ii) That each laborer or mechanic (including each helper, apprentice, and trainee) employed on the contract during the payroll period has been paid the full weekly wages earned, without rebate, either directly or indirectly, and that no deductions have been made either directly or indirectly from the full wages earned, other than permissible deductions as set forth in Regulations, 29 CFR part 3;

(iii) That each laborer or mechanic has been paid not less than the applicable wage rates and fringe benefits or cash equivalents for the classification of work performed, as specified in the applicable wage determination incorporated into the contract.

(3) The weekly submission of a properly executed certification set forth on the reverse side of Optional Form WH-347 shall satisfy the requirement for submission of the "Statement of Compliance" required by paragraph 3.b.(2) of this section.

(4) The falsification of any of the above certifications may subject the contractor or subcontractor to civil or criminal prosecution under section 1001 of title 18 and section 231 of title 31 of the United States Code.

c. The contractor or subcontractor shall make the records required under paragraph 3.a. of this section available for inspection, copying, or transcription by authorized representatives of the contracting agency, the State DOT, the FHWA, or the Department of Labor, and shall permit such representatives to interview employees during working hours on the job. If the contractor or subcontractor fails to submit the required records or to make them available, the FHWA may, after written notice to the contractor, the contracting agency or the State DOT, take such action as may be necessary to cause the suspension of any further payment, advance, or guarantee of funds. Furthermore, failure to submit the required records upon request or to make such records available may be grounds for debarment action pursuant to 29 CFR 5.12.

#### 4. Apprentices and trainees

##### a. Apprentices (programs of the USDOL).

Apprentices will be permitted to work at less than the predetermined rate for the work they performed when they are employed pursuant to and individually registered in a bona fide apprenticeship program registered with the U.S. Department of Labor, Employment and Training Administration, Office of Apprenticeship Training, Employer and Labor Services, or with a State Apprenticeship Agency recognized by the Office, or if a person is employed in his or her first 90 days of probationary employment as an apprentice in such an apprenticeship program, who is not individually registered in the program, but who has been certified by the Office of Apprenticeship Training, Employer and Labor Services or a State Apprenticeship Agency (where appropriate) to be eligible for probationary employment as an apprentice.

The allowable ratio of apprentices to journeymen on the job site in any craft classification shall not be greater than the ratio permitted to the contractor as to the entire work force under the registered program. Any worker listed on a payroll at an apprentice wage rate, who is not registered or otherwise employed as stated above, shall be paid not less than the applicable wage rate on the wage determination for the classification of work actually performed. In addition, any apprentice performing work on the job site in excess of the ratio permitted under the registered program shall be paid not less than the applicable wage rate on the wage determination for the work actually performed. Where a contractor is performing construction on a project in a locality other than that in which its program is registered, the ratios and wage rates (expressed in percentages of the journeyman's hourly rate) specified in the contractor's or subcontractor's registered program shall be observed.

Every apprentice must be paid at not less than the rate specified in the registered program for the apprentice's level of progress, expressed as a percentage of the journeymen hourly

rate specified in the applicable wage determination. Apprentices shall be paid fringe benefits in accordance with the provisions of the apprenticeship program. If the apprenticeship program does not specify fringe benefits, apprentices must be paid the full amount of fringe benefits listed on the wage determination for the applicable classification. If the Administrator determines that a different practice prevails for the applicable apprentice classification, fringes shall be paid in accordance with that determination.

In the event the Office of Apprenticeship Training, Employer and Labor Services, or a State Apprenticeship Agency recognized by the Office, withdraws approval of an apprenticeship program, the contractor will no longer be permitted to utilize apprentices at less than the applicable predetermined rate for the work performed until an acceptable program is approved.

##### b. Trainees (programs of the USDOL).

Except as provided in 29 CFR 5.16, trainees will not be permitted to work at less than the predetermined rate for the work performed unless they are employed pursuant to and individually registered in a program which has received prior approval, evidenced by formal certification by the U.S. Department of Labor, Employment and Training Administration.

The ratio of trainees to journeymen on the job site shall not be greater than permitted under the plan approved by the Employment and Training Administration.

Every trainee must be paid at not less than the rate specified in the approved program for the trainee's level of progress, expressed as a percentage of the journeyman hourly rate specified in the applicable wage determination. Trainees shall be paid fringe benefits in accordance with the provisions of the trainee program. If the trainee program does not mention fringe benefits, trainees shall be paid the full amount of fringe benefits listed on the wage determination unless the Administrator of the Wage and Hour Division determines that there is an apprenticeship program associated with the corresponding journeyman wage rate on the wage determination which provides for less than full fringe benefits for apprentices. Any employee listed on the payroll at a trainee rate who is not registered and participating in a training plan approved by the Employment and Training Administration shall be paid not less than the applicable wage rate on the wage determination for the classification of work actually performed. In addition, any trainee performing work on the job site in excess of the ratio permitted under the registered program shall be paid not less than the applicable wage rate on the wage determination for the work actually performed.

In the event the Employment and Training Administration withdraws approval of a training program, the contractor will no longer be permitted to utilize trainees at less than the applicable predetermined rate for the work performed until an acceptable program is approved.

c. Equal employment opportunity. The utilization of apprentices, trainees and journeymen under this part shall be in conformity with the equal employment opportunity requirements of Executive Order 11246, as amended, and 29 CFR part 30.

d. Apprentices and Trainees (programs of the U.S. DOT).

Apprentices and trainees working under apprenticeship and skill training programs which have been certified by the Secretary of Transportation as promoting EEO in connection with Federal-aid highway construction programs are not subject to the requirements of paragraph 4 of this Section IV. The straight time hourly wage rates for apprentices and trainees under such programs will be established by the particular programs. The ratio of apprentices and trainees to journeymen shall not be greater than permitted by the terms of the particular program.

**5. Compliance with Copeland Act requirements.** The contractor shall comply with the requirements of 29 CFR part 3, which are incorporated by reference in this contract.

**6. Subcontracts.** The contractor or subcontractor shall insert Form FHWA-1273 in any subcontracts and also require the subcontractors to include Form FHWA-1273 in any lower tier subcontracts. The prime contractor shall be responsible for the compliance by any subcontractor or lower tier subcontractor with all the contract clauses in 29 CFR 5.5.

**7. Contract termination: debarment.** A breach of the contract clauses in 29 CFR 5.5 may be grounds for termination of the contract, and for debarment as a contractor and a subcontractor as provided in 29 CFR 5.12.

**8. Compliance with Davis-Bacon and Related Act requirements.** All rulings and interpretations of the Davis-Bacon and Related Acts contained in 29 CFR parts 1, 3, and 5 are herein incorporated by reference in this contract.

**9. Disputes concerning labor standards.** Disputes arising out of the labor standards provisions of this contract shall not be subject to the general disputes clause of this contract. Such disputes shall be resolved in accordance with the procedures of the Department of Labor set forth in 29 CFR parts 5, 6, and 7. Disputes within the meaning of this clause include disputes between the contractor (or any of its subcontractors) and the contracting agency, the U.S. Department of Labor, or the employees or their representatives.

**10. Certification of eligibility.**

a. By entering into this contract, the contractor certifies that neither it (nor he or she) nor any person or firm who has an interest in the contractor's firm is a person or firm ineligible to be awarded Government contracts by virtue of section 3(a) of the Davis-Bacon Act or 29 CFR 5.12(a)(1).

b. No part of this contract shall be subcontracted to any person or firm ineligible for award of a Government contract by virtue of section 3(a) of the Davis-Bacon Act or 29 CFR 5.12(a)(1).

c. The penalty for making false statements is prescribed in the U.S. Criminal Code, 18 U.S.C. 1001.

**V. CONTRACT WORK HOURS AND SAFETY STANDARDS ACT**

The following clauses apply to any Federal-aid construction contract in an amount in excess of \$100,000 and subject to the overtime provisions of the Contract Work Hours and Safety Standards Act. These clauses shall be inserted in addition to the clauses required by 29 CFR 5.5(a) or 29 CFR 4.6. As used in this paragraph, the terms laborers and mechanics include watchmen and guards.

**1. Overtime requirements.** No contractor or subcontractor contracting for any part of the contract work which may require or involve the employment of laborers or mechanics shall require or permit any such laborer or mechanic in any workweek in which he or she is employed on such work to work in excess of forty hours in such workweek unless such laborer or mechanic receives compensation at a rate not less than one and one-half times the basic rate of pay for all hours worked in excess of forty hours in such workweek.

**2. Violation; liability for unpaid wages; liquidated damages.** In the event of any violation of the clause set forth in paragraph (1.) of this section, the contractor and any subcontractor responsible therefor shall be liable for the unpaid wages. In addition, such contractor and subcontractor shall be liable to the United States (in the case of work done under contract for the District of Columbia or a territory, to such District or to such territory), for liquidated damages. Such liquidated damages shall be computed with respect to each individual laborer or mechanic, including watchmen and guards, employed in violation of the clause set forth in paragraph (1.) of this section, in the sum of \$10 for each calendar day on which such individual was required or permitted to work in excess of the standard workweek of forty hours without payment of the overtime wages required by the clause set forth in paragraph (1.) of this section.

**3. Withholding for unpaid wages and liquidated damages.** The FHWA or the contacting agency shall upon its own action or upon written request of an authorized representative of the Department of Labor withhold or cause to be withheld, from any moneys payable on account of work performed by the contractor or subcontractor under any such contract or any other Federal contract with the same prime contractor, or any other federally-assisted contract subject to the Contract Work Hours and Safety Standards Act, which is held by the same prime contractor, such sums as may be determined to be necessary to satisfy any liabilities of such contractor or subcontractor for unpaid wages and liquidated damages as provided in the clause set forth in paragraph (2.) of this section.

**4. Subcontracts.** The contractor or subcontractor shall insert in any subcontracts the clauses set forth in paragraph (1.) through (4.) of this section and also a clause requiring the subcontractors to include these clauses in any lower tier subcontracts. The prime contractor shall be responsible for compliance by any subcontractor or lower tier subcontractor with the clauses set forth in paragraphs (1.) through (4.) of this section.

## VI. SUBLETTING OR ASSIGNING THE CONTRACT

This provision is applicable to all Federal-aid construction contracts on the National Highway System.

1. The contractor shall perform with its own organization contract work amounting to not less than 30 percent (or a greater percentage if specified elsewhere in the contract) of the total original contract price, excluding any specialty items designated by the contracting agency. Specialty items may be performed by subcontract and the amount of any such specialty items performed may be deducted from the total original contract price before computing the amount of work required to be performed by the contractor's own organization (23 CFR 635.116).

a. The term "perform work with its own organization" refers to workers employed or leased by the prime contractor, and equipment owned or rented by the prime contractor, with or without operators. Such term does not include employees or equipment of a subcontractor or lower tier subcontractor, agents of the prime contractor, or any other assignees. The term may include payments for the costs of hiring leased employees from an employee leasing firm meeting all relevant Federal and State regulatory requirements. Leased employees may only be included in this term if the prime contractor meets all of the following conditions:

(1) the prime contractor maintains control over the supervision of the day-to-day activities of the leased employees;

(2) the prime contractor remains responsible for the quality of the work of the leased employees;

(3) the prime contractor retains all power to accept or exclude individual employees from work on the project; and

(4) the prime contractor remains ultimately responsible for the payment of predetermined minimum wages, the submission of payrolls, statements of compliance and all other Federal regulatory requirements.

b. "Specialty Items" shall be construed to be limited to work that requires highly specialized knowledge, abilities, or equipment not ordinarily available in the type of contracting organizations qualified and expected to bid or propose on the contract as a whole and in general are to be limited to minor components of the overall contract.

2. The contract amount upon which the requirements set forth in paragraph (1) of Section VI is computed includes the cost of material and manufactured products which are to be purchased or produced by the contractor under the contract provisions.

3. The contractor shall furnish (a) a competent superintendent or supervisor who is employed by the firm, has full authority to direct performance of the work in accordance with the contract requirements, and is in charge of all construction operations (regardless of who performs the work) and (b) such other of its own organizational resources (supervision, management, and engineering services) as the contracting officer determines is necessary to assure the performance of the contract.

4. No portion of the contract shall be sublet, assigned or otherwise disposed of except with the written consent of the contracting officer, or authorized representative, and such consent when given shall not be construed to relieve the contractor of any responsibility for the fulfillment of the contract. Written consent will be given only after the

contracting agency has assured that each subcontract is evidenced in writing and that it contains all pertinent provisions and requirements of the prime contract.

5. The 30% self-performance requirement of paragraph (1) is not applicable to design-build contracts; however, contracting agencies may establish their own self-performance requirements.

## VII. SAFETY: ACCIDENT PREVENTION

This provision is applicable to all Federal-aid construction contracts and to all related subcontracts.

1. In the performance of this contract the contractor shall comply with all applicable Federal, State, and local laws governing safety, health, and sanitation (23 CFR 635). The contractor shall provide all safeguards, safety devices and protective equipment and take any other needed actions as it determines, or as the contracting officer may determine, to be reasonably necessary to protect the life and health of employees on the job and the safety of the public and to protect property in connection with the performance of the work covered by the contract.

2. It is a condition of this contract, and shall be made a condition of each subcontract, which the contractor enters into pursuant to this contract, that the contractor and any subcontractor shall not permit any employee, in performance of the contract, to work in surroundings or under conditions which are unsanitary, hazardous or dangerous to his/her health or safety, as determined under construction safety and health standards (29 CFR 1926) promulgated by the Secretary of Labor, in accordance with Section 107 of the Contract Work Hours and Safety Standards Act (40 U.S.C. 3704).

3. Pursuant to 29 CFR 1926.3, it is a condition of this contract that the Secretary of Labor or authorized representative thereof, shall have right of entry to any site of contract performance to inspect or investigate the matter of compliance with the construction safety and health standards and to carry out the duties of the Secretary under Section 107 of the Contract Work Hours and Safety Standards Act (40 U.S.C.3704).

## VIII. FALSE STATEMENTS CONCERNING HIGHWAY PROJECTS

This provision is applicable to all Federal-aid construction contracts and to all related subcontracts.

In order to assure high quality and durable construction in conformity with approved plans and specifications and a high degree of reliability on statements and representations made by engineers, contractors, suppliers, and workers on Federal-aid highway projects, it is essential that all persons concerned with the project perform their functions as carefully, thoroughly, and honestly as possible. Willful falsification, distortion, or misrepresentation with respect to any facts related to the project is a violation of Federal law. To prevent any misunderstanding regarding the seriousness of these and similar acts, Form FHWA-1022 shall be posted on each Federal-aid highway project (23 CFR 635) in one or more places where it is readily available to all persons concerned with the project:

18 U.S.C. 1020 reads as follows:

"Whoever, being an officer, agent, or employee of the United States, or of any State or Territory, or whoever, whether a person, association, firm, or corporation, knowingly makes any false statement, false representation, or false report as to the character, quality, quantity, or cost of the material used or to be used, or the quantity or quality of the work performed or to be performed, or the cost thereof in connection with the submission of plans, maps, specifications, contracts, or costs of construction on any highway or related project submitted for approval to the Secretary of Transportation; or

Whoever knowingly makes any false statement, false representation, false report or false claim with respect to the character, quality, quantity, or cost of any work performed or to be performed, or materials furnished or to be furnished, in connection with the construction of any highway or related project approved by the Secretary of Transportation; or

Whoever knowingly makes any false statement or false representation as to material fact in any statement, certificate, or report submitted pursuant to provisions of the Federal-aid Roads Act approved July 1, 1916, (39 Stat. 355), as amended and supplemented;

Shall be fined under this title or imprisoned not more than 5 years or both."

#### **IX. IMPLEMENTATION OF CLEAN AIR ACT AND FEDERAL WATER POLLUTION CONTROL ACT**

This provision is applicable to all Federal-aid construction contracts and to all related subcontracts.

By submission of this bid/proposal or the execution of this contract, or subcontract, as appropriate, the bidder, proposer, Federal-aid construction contractor, or subcontractor, as appropriate, will be deemed to have stipulated as follows:

1. That any person who is or will be utilized in the performance of this contract is not prohibited from receiving an award due to a violation of Section 508 of the Clean Water Act or Section 306 of the Clean Air Act.

2. That the contractor agrees to include or cause to be included the requirements of paragraph (1) of this Section X in every subcontract, and further agrees to take such action as the contracting agency may direct as a means of enforcing such requirements.

#### **X. CERTIFICATION REGARDING DEBARMENT, SUSPENSION, INELIGIBILITY AND VOLUNTARY EXCLUSION**

This provision is applicable to all Federal-aid construction contracts, design-build contracts, subcontracts, lower-tier subcontracts, purchase orders, lease agreements, consultant contracts or any other covered transaction requiring FHWA approval or that is estimated to cost \$25,000 or more – as defined in 2 CFR Parts 180 and 1200.

##### **1. Instructions for Certification – First Tier Participants:**

a. By signing and submitting this proposal, the prospective first tier participant is providing the certification set out below.

b. The inability of a person to provide the certification set out below will not necessarily result in denial of participation in this

covered transaction. The prospective first tier participant shall submit an explanation of why it cannot provide the certification set out below. The certification or explanation will be considered in connection with the department or agency's determination whether to enter into this transaction. However, failure of the prospective first tier participant to furnish a certification or an explanation shall disqualify such a person from participation in this transaction.

c. The certification in this clause is a material representation of fact upon which reliance was placed when the contracting agency determined to enter into this transaction. If it is later determined that the prospective participant knowingly rendered an erroneous certification, in addition to other remedies available to the Federal Government, the contracting agency may terminate this transaction for cause of default.

d. The prospective first tier participant shall provide immediate written notice to the contracting agency to whom this proposal is submitted if any time the prospective first tier participant learns that its certification was erroneous when submitted or has become erroneous by reason of changed circumstances.

e. The terms "covered transaction," "debarred," "suspended," "ineligible," "participant," "person," "principal," and "voluntarily excluded," as used in this clause, are defined in 2 CFR Parts 180 and 1200. "First Tier Covered Transactions" refers to any covered transaction between a grantee or subgrantee of Federal funds and a participant (such as the prime or general contractor). "Lower Tier Covered Transactions" refers to any covered transaction under a First Tier Covered Transaction (such as subcontracts). "First Tier Participant" refers to the participant who has entered into a covered transaction with a grantee or subgrantee of Federal funds (such as the prime or general contractor). "Lower Tier Participant" refers any participant who has entered into a covered transaction with a First Tier Participant or other Lower Tier Participants (such as subcontractors and suppliers).

f. The prospective first tier participant agrees by submitting this proposal that, should the proposed covered transaction be entered into, it shall not knowingly enter into any lower tier covered transaction with a person who is debarred, suspended, declared ineligible, or voluntarily excluded from participation in this covered transaction, unless authorized by the department or agency entering into this transaction.

g. The prospective first tier participant further agrees by submitting this proposal that it will include the clause titled "Certification Regarding Debarment, Suspension, Ineligibility and Voluntary Exclusion-Lower Tier Covered Transactions," provided by the department or contracting agency, entering into this covered transaction, without modification, in all lower tier covered transactions and in all solicitations for lower tier covered transactions exceeding the \$25,000 threshold.

h. A participant in a covered transaction may rely upon a certification of a prospective participant in a lower tier covered transaction that is not debarred, suspended, ineligible, or voluntarily excluded from the covered transaction, unless it knows that the certification is erroneous. A participant is responsible for ensuring that its principals are not suspended, debarred, or otherwise ineligible to participate in covered transactions. To verify the eligibility of its principals, as well as the eligibility of any lower tier prospective participants, each participant may, but is not required to, check the Excluded Parties List System website (<https://www.epls.gov/>), which is compiled by the General Services Administration.

i. Nothing contained in the foregoing shall be construed to require the establishment of a system of records in order to render in good faith the certification required by this clause. The knowledge and information of the prospective participant is not required to exceed that which is normally possessed by a prudent person in the ordinary course of business dealings.

j. Except for transactions authorized under paragraph (f) of these instructions, if a participant in a covered transaction knowingly enters into a lower tier covered transaction with a person who is suspended, debarred, ineligible, or voluntarily excluded from participation in this transaction, in addition to other remedies available to the Federal Government, the department or agency may terminate this transaction for cause or default.

\* \* \* \* \*

## **2. Certification Regarding Debarment, Suspension, Ineligibility and Voluntary Exclusion – First Tier Participants:**

a. The prospective first tier participant certifies to the best of its knowledge and belief, that it and its principals:

(1) Are not presently debarred, suspended, proposed for debarment, declared ineligible, or voluntarily excluded from participating in covered transactions by any Federal department or agency;

(2) Have not within a three-year period preceding this proposal been convicted of or had a civil judgment rendered against them for commission of fraud or a criminal offense in connection with obtaining, attempting to obtain, or performing a public (Federal, State or local) transaction or contract under a public transaction; violation of Federal or State antitrust statutes or commission of embezzlement, theft, forgery, bribery, falsification or destruction of records, making false statements, or receiving stolen property;

(3) Are not presently indicted for or otherwise criminally or civilly charged by a governmental entity (Federal, State or local) with commission of any of the offenses enumerated in paragraph (a)(2) of this certification; and

(4) Have not within a three-year period preceding this application/proposal had one or more public transactions (Federal, State or local) terminated for cause or default.

b. Where the prospective participant is unable to certify to any of the statements in this certification, such prospective participant shall attach an explanation to this proposal.

### **2. Instructions for Certification - Lower Tier Participants:**

(Applicable to all subcontracts, purchase orders and other lower tier transactions requiring prior FHWA approval or estimated to cost \$25,000 or more - 2 CFR Parts 180 and 1200)

a. By signing and submitting this proposal, the prospective lower tier is providing the certification set out below.

b. The certification in this clause is a material representation of fact upon which reliance was placed when this transaction was entered into. If it is later determined that the prospective lower tier participant knowingly rendered an erroneous certification, in addition to other remedies available to the Federal Government, the department, or agency with which

this transaction originated may pursue available remedies, including suspension and/or debarment.

c. The prospective lower tier participant shall provide immediate written notice to the person to which this proposal is submitted if at any time the prospective lower tier participant learns that its certification was erroneous by reason of changed circumstances.

d. The terms "covered transaction," "debarred," "suspended," "ineligible," "participant," "person," "principal," and "voluntarily excluded," as used in this clause, are defined in 2 CFR Parts 180 and 1200. You may contact the person to which this proposal is submitted for assistance in obtaining a copy of those regulations. "First Tier Covered Transactions" refers to any covered transaction between a grantee or subgrantee of Federal funds and a participant (such as the prime or general contract). "Lower Tier Covered Transactions" refers to any covered transaction under a First Tier Covered Transaction (such as subcontracts). "First Tier Participant" refers to the participant who has entered into a covered transaction with a grantee or subgrantee of Federal funds (such as the prime or general contractor). "Lower Tier Participant" refers any participant who has entered into a covered transaction with a First Tier Participant or other Lower Tier Participants (such as subcontractors and suppliers).

e. The prospective lower tier participant agrees by submitting this proposal that, should the proposed covered transaction be entered into, it shall not knowingly enter into any lower tier covered transaction with a person who is debarred, suspended, declared ineligible, or voluntarily excluded from participation in this covered transaction, unless authorized by the department or agency with which this transaction originated.

f. The prospective lower tier participant further agrees by submitting this proposal that it will include this clause titled "Certification Regarding Debarment, Suspension, Ineligibility and Voluntary Exclusion-Lower Tier Covered Transaction," without modification, in all lower tier covered transactions and in all solicitations for lower tier covered transactions exceeding the \$25,000 threshold.

g. A participant in a covered transaction may rely upon a certification of a prospective participant in a lower tier covered transaction that is not debarred, suspended, ineligible, or voluntarily excluded from the covered transaction, unless it knows that the certification is erroneous. A participant is responsible for ensuring that its principals are not suspended, debarred, or otherwise ineligible to participate in covered transactions. To verify the eligibility of its principals, as well as the eligibility of any lower tier prospective participants, each participant may, but is not required to, check the Excluded Parties List System website (<https://www.epls.gov/>), which is compiled by the General Services Administration.

h. Nothing contained in the foregoing shall be construed to require establishment of a system of records in order to render in good faith the certification required by this clause. The knowledge and information of participant is not required to exceed that which is normally possessed by a prudent person in the ordinary course of business dealings.

i. Except for transactions authorized under paragraph e of these instructions, if a participant in a covered transaction knowingly enters into a lower tier covered transaction with a person who is suspended, debarred, ineligible, or voluntarily excluded from participation in this transaction, in addition to other remedies available to the Federal Government, the



department or agency with which this transaction originated may pursue available remedies, including suspension and/or debarment.

\* \* \* \* \*

**Certification Regarding Debarment, Suspension, Ineligibility and Voluntary Exclusion--Lower Tier Participants:**

1. The prospective lower tier participant certifies, by submission of this proposal, that neither it nor its principals is presently debarred, suspended, proposed for debarment, declared ineligible, or voluntarily excluded from participating in covered transactions by any Federal department or agency.

2. Where the prospective lower tier participant is unable to certify to any of the statements in this certification, such prospective participant shall attach an explanation to this proposal.

\* \* \* \* \*

**XI. CERTIFICATION REGARDING USE OF CONTRACT FUNDS FOR LOBBYING**

This provision is applicable to all Federal-aid construction contracts and to all related subcontracts which exceed \$100,000 (49 CFR 20).

1. The prospective participant certifies, by signing and submitting this bid or proposal, to the best of his or her knowledge and belief, that:

a. No Federal appropriated funds have been paid or will be paid, by or on behalf of the undersigned, to any person for influencing or attempting to influence an officer or employee of any Federal agency, a Member of Congress, an officer or employee of Congress, or an employee of a Member of Congress in connection with the awarding of any Federal contract, the making of any Federal grant, the making of any Federal loan, the entering into of any cooperative agreement, and the extension, continuation, renewal, amendment, or modification of any Federal contract, grant, loan, or cooperative agreement.

b. If any funds other than Federal appropriated funds have been paid or will be paid to any person for influencing or attempting to influence an officer or employee of any Federal agency, a Member of Congress, an officer or employee of Congress, or an employee of a Member of Congress in connection with this Federal contract, grant, loan, or cooperative agreement, the undersigned shall complete and submit Standard Form-LLL, "Disclosure Form to Report Lobbying," in accordance with its instructions.

2. This certification is a material representation of fact upon which reliance was placed when this transaction was made or entered into. Submission of this certification is a prerequisite for making or entering into this transaction imposed by 31 U.S.C. 1352. Any person who fails to file the required certification shall be subject to a civil penalty of not less than \$10,000 and not more than \$100,000 for each such failure.

3. The prospective participant also agrees by submitting its bid or proposal that the participant shall require that the language of this certification be included in all lower tier subcontracts, which exceed \$100,000 and that all such recipients shall certify and disclose accordingly.

**NOTICE OF REQUIREMENTS FOR AFFIRMATIVE  
ACTION TO ENSURE EQUAL EMPLOYMENT  
OPPORTUNITY (EXECUTIVE ORDER 11246)**

1. The Offeror's or Bidder's attention is called to the "Equal Opportunity Clause" and the "Standard Federal Equal Employment Opportunity Construction Contract Specifications" set forth herein.

2. The goal for female participation, expressed in percentage terms for the Contractor's aggregate workforce in each trade on all construction work, is 6.9%.

Until further notice  
Goals for minority participation for each trade (percent)

**SHSA Cities:**

Pascagoula - Moss Point ----- 16.9  
Biloxi - Gulfport ----- 19.2  
Jackson ----- 30.3

**SMSA Counties:**

Desoto ----- 32.3  
Hancock, Harrison, Stone ----- 19.2  
Hinds, Rankin ----- 30.3  
Jackson ----- 16.9

**Non-SMSA Counties:**

George, Greene ----- 26.4

Alcorn, Benton, Bolivar, Calhoun, Carroll, Chickasaw, Clay, Coahoma, Grenada, Itawamba, Lafayette, Lee, Leflore, Marshall, Monroe, Montgomery, Panola, Pontotoc, Prentiss, Quitman, Sunflower, Tallahatchie, Tate, Tippah, Tishomingo, Tunica, Union, Washington, Webster, Yalobusha ----- 26.5

Attala, Choctaw, Claiborne, Clarke, Copiah, Covington, Franklin, Holmes, Humphreys, Issaquena, Jasper, Jefferson, Jefferson Davis, Jones Kemper, Lauderdale, Lawrence, Leake, Lincoln, Lowndes, Madison, Neshoba, Newton, Noxubee, Oktibbeha, Scott, Sharkey, Simpson, Smith, Warren, Wayne, Winston, Yazoo ----- 32.0

Forrest, Lamar, Marion, Pearl River, Perry, Pike, Walthall ----- 27.7

Adams, Amite, Wilkinson ----- 30.4

These goals are applicable to all the Contractor's construction work (whether or not it is Federal or federally assisted) performed in the covered area. If the contractor performs construction work in a geographical area located outside of the covered area, it shall apply the goals established for such geographical area where the work is actually performed. With regard to this second area, the contractor also is subject to the goals for both its federally involved and nonfederally involved construction.

The Contractor's compliance with the Executive Order and the regulations in CFR Part 60-4 shall be based on its implementation of the Equal Opportunity clause, specific affirmative action obligations required by the specifications set forth in 41 CFR 60-4.3(a), and its efforts to meet the goals. The hours of minority and female employment and training must be substantially uniform throughout the length of the contract, and in each trade, and the Contractor shall make a good faith effort to employ minorities and women evenly on each of its projects. The transfer of minority or female employees or trainees from Contractor to Contractor or from project to project for the sole purpose of meeting the Contractor's goals shall be a violation of the contract, the Executive Order and the regulations in 41 CFR Part 60-4.2(d). Compliance with the goals will be measured against the total work hours performed.

3. The Contractor shall provide written notification to the Director of the Office of Federal Contract Compliance Programs within 10 working days of award of any construction subcontract in excess of \$10,000 at any tier for construction work under the contract resulting from this solicitation. The notification shall list the name, address and telephone number of the subcontractor, employer identification number of the subcontractor, estimated dollar amount of the subcontract; estimated starting and completion dates of the subcontract; and the geographical area in which the subcontract is to be performed.

4. As used in this Notice, and in the contract resulting from this solicitation, the "covered area" is to the county and city (if any), stated in the advertisement.

5. The notification required in Paragraph 3 shall be addressed to the following:

Contract Compliance Officer  
Mississippi Department of Transportation  
P.O. Box 1850  
Jackson, Mississippi 39215-1850

(06/28/2012)

## MISSISSIPPI DEPARTMENT OF TRANSPORTATION

SPECIAL PROVISION NO. 907-101-4

CODE: (IS)

DATE: 11/05/2008

SUBJECT: Definitions

Section 101, Definitions and Terms, of the 2004 Edition of the Mississippi Standard Specifications for Road and Bridge Construction is hereby amended as follows:

**907-101.02--Definitions.** Replace the following definitions in Subsection 101.02 on pages 3 through 13.

**Contract** - The written agreement between the Mississippi Transportation Commission and the Contractor setting forth the obligations of the parties thereunder, including but not limited to, the performance of the work, the furnishing of labor and materials, and the basis of payment.

The contract includes the invitation for bids, proposal, contract form and contract bonds, specifications, supplemental specifications, interim specifications, general and detailed plans, special provisions, notices to bidders, notice to proceed, and also any agreements that are required to complete the construction of the work in an acceptable manner, including authorized extensions thereof, all of which constitute one instrument.

**Contract Bonds** - The approved form of security, executed by the Contractor and the Contractor's Surety(ies), guaranteeing complete execution of the contract and all supplemental agreements pertaining thereto and the payment of all legal debts pertaining to the construction of the project. This term includes Performance and Payment Bond(s).

**Surety** - A corporate body, qualified under the laws of Mississippi, which is bound with and for the successful bidder by "contract bond(s)" to guarantee acceptable performance of the contract and payment of all legal taxes and debts pertaining to the construction of the project, including payment of State Sales Tax as prescribed by law, and any overpayment made to the Contractor.

Add the following to the list of definitions in Subsection 101.02 on pages 3 through 13.

**Performance Bond** - The approved form of security, executed by the Contractor and issued by the Contractor's Surety(ies), guaranteeing satisfactory completion of the contract and all supplemental agreements pertaining thereto.

**Payment Bond** - The approved form of security, executed by the Contractor and issued by the Contractor's Surety(ies), guaranteeing the payment of all legal debts pertaining to the construction of the project including, but not limited to, the labor and materials of subcontractors and suppliers to the prime contractor.

## MISSISSIPPI DEPARTMENT OF TRANSPORTATION

**SPECIAL PROVISION NO. 907-102-10**

**CODE: (IS)**

**DATE: 05/01/2013**

**SUBJECT: Bidding Requirements and Conditions**

Section 102, Bidding Requirements and Conditions, of the 2004 Edition of the Mississippi Standard Specifications for Road and Bridge Construction is hereby amended as follows.

**907-102.06--Preparation of Proposal.** Delete the first paragraph of Subsection 102.06 on page 17, and substitute the following.

The bidder's complete original proposal shall be submitted upon the forms (Certification of Performance, Certification Regarding Non-Collusion, etc.) furnished by the Department and shall include Expedite Bid printed bid sheets along with the bid data on the MDOT-supplied USB Flash Drive. Expedite Bid System (EBS) files shall be downloaded from the Department's website <http://mdot.ms.gov>. In case of discrepancy between a unit price and the extension, the unit price will govern and the extension along with the total amount of the proposal will be corrected.

Delete the fifth, sixth, and seventh paragraphs of Subsection 102.06 on page 18, and substitute the following.

Bid sheets generated by the Department's Electronic Bid System (Transport Expedite Bid) along with a completed proposal package (with all forms completed and signed) will constitute the official bid and shall be signed on the last sheet of the Expedite Bid generated bid sheets and delivered to the Department in accordance with the provisions of Subsection 102.09. Bids submitted using any other form, format or means will result in an irregular bid. The bidder's bid data shall be saved on the MDOT-supplied USB Flash Drive and submitted with the bid. Failure to return the USB Flash Drive with bid data will result in an irregular bid. If a Bidder is submitting bids on multiple proposals, the bid data for all proposals can be included on one flash drive and submitted with any of the bid envelopes.

Bidders are cautioned that using other versions of the Expedite Bid may result in improperly printed bid sheets. The correct version of Expedite Bid can be obtained at no cost from the MDOT Contract Administration Division or at the MDOT website, <http://mdot.ms.gov>. The current version of Expedite Bid is also included on the MDOT-supplied USB Flash Drive.

The Expedite Bid generated bid sheets should be stapled together in order beginning with page 1, signed and included in the bid proposal package in the sealed envelope. Only the Expedite Bid generated sheets will be recognized as the official bid. The MDOT-provided USB Flash Drive containing the information printed on the Expedite Bid generated bid sheets should be placed in the padded envelope included with the bid proposal package and enclosed in the sealed envelope. Bid sheets printed from Expedite Bid should be a representation of the data returned on the flash

drive. To have a true representation of the bid sheets, the Bidder must copy the EBS and EBS amendment files used to prepare the bid sheets to the flash drive. Otherwise, the unit prices bid will not be recorded to the flash drive. Bidders are cautioned that failure to follow proper flash drive handling procedures could result in the Department being unable to process the flash drive. Any modification or manipulation of the data contained on the flash drive, other than entering unit bid prices and completing all required Expedite Bid sections, will not be allowed and will cause the Contractor's bid to be considered irregular.

**907-102.08--Proposal Guaranty.** Delete the first and second paragraphs in Subsection 102.08 on page 20 and substitute the following.

No proposal will be considered unless accompanied by certified check, cashier's check or bid bond, made payable to the State of Mississippi, in an amount of not less than five percent (5%) of the total amount of the proposal offered. The guaranty shall be evidence of good faith that, if awarded the contract, the bidder will execute the contract and give performance and payment contract bond(s) as stipulated in Subsection 907-103.05.1, 907-103.05.2, and as required by law.

If a bid bond is offered as guaranty, the bond must be on a form approved by the Executive Director, made by a Surety acceptable to the Executive Director and signed or countersigned by a Mississippi Agent or Qualified Nonresident Agent and the Bidder. Such bid bond shall also conform to the requirements and conditions stipulated in Subsection 907-103.05.2 as applicable.

## MISSISSIPPI DEPARTMENT OF TRANSPORTATION

SPECIAL PROVISION NO. 907-103-8

CODE: (SP)

DATE: 12/15/2009

SUBJECT: Award and Execution of Contract

Section 103, Award and Execution of Contract, of the 2004 Edition of the Mississippi Standard Specifications for Road and Bridge Construction is hereby amended as follows:

**907-103.04--Return of Proposal Guaranty.** Delete the second paragraph of Subsection 103.04 on page 23 and substitute the following:

Certified checks or cashier's checks submitted as proposal guaranties, except those of the two lowest bidders, will be returned within 10 days of contract award. The retained proposal guaranty of the unsuccessful of the two lowest bidders will be returned within ten days following the execution of a contract with the successful low bidder. The retained proposal guaranty of the successful bidder will be returned after satisfactory performance and payment bonds have been furnished and the contract has been executed.

In the event all bids are rejected by the Commission, certified checks or cashier's checks submitted as proposal guaranty by all bidders will be returned within 10 days of rejection.

Delete Subsection 103.05 on page 23 and substitute the following:

**907-103.05--Contract Bonds.**

**907-103.05.1--Requirement of Contract Bonds.** Prior to the execution of the contract, the successful bidder shall execute and deliver to the Executive Director a performance and payment bond(s), in a sum equal to the full amount of the contract as a guaranty for complete and full performance of the contract and the protection of the claimants and the Department for materials and equipment and full payment of wages in accordance with Section 65-1-85 Miss. Code Ann. (1972 as amended). In the event of award of a joint bid, each individual, partnership, firm or corporation shall assume jointly the full obligations under the contract and the contract bond(s).

**907-103.05.2--Form of Bonds.** The form of bond(s) shall be that provided by or acceptable to the Department. These bonds shall be executed by a Mississippi agent or qualified nonresident agent and shall be accompanied by a certification as to authorization of the attorney-in-fact to commit the Surety company. A power of attorney exhibiting the Surety's original seal supporting the Mississippi agent or the qualified nonresident agent's signature shall be furnished with each bond. The Surety company shall be currently authorized and licensed in good standing to conduct business in the State of Mississippi with a minimum rating by A.M. Best of (A-) in the latest printing "Best's Key Rating Guide" to write individual bonds up to ten percent of the policy holders' surplus or listed on the current list of "Companies Holding Certificates of Authority as Acceptable Sureties on Federal Bonds and as Acceptable Reinsuring Companies" as

published by the United States Department of the Treasury, Financial Management Service, Circular 570 (latest revision as published and supplemented on the Financial Management Service Web site and in the Federal Register) within the underwriting limits listed for that Surety. All required signatures on the bond(s) and certifications shall be original signatures, in ink, and not mechanical reproductions or facsimiles. The [Mississippi agent](#) or [qualified nonresident agent](#) shall be in good standing and currently licensed by the Insurance Commissioner of the State of Mississippi to represent the Surety company(ies) executing the bonds.

Surety bonds shall continue to be acceptable to the Commission throughout the life of the Contract and shall not be canceled by the Surety without the consent of the Department. In the event the Surety fails or becomes financially insolvent, the Contractor shall file a new Bond in the amount designated by the Executive Director within thirty (30) days of such failure, insolvency, or bankruptcy. Subsequent to award of Contract, the Commission or the Department may [require additional security for any supplemental agreements executed under the contract or replacement security in the event of the surety\(ies\) loss of the ratings required above](#). Suits concerning bonds shall be filed in the State of Mississippi and adjudicated under its laws without reference to conflict of laws principles.

**907-103.08--Failure to Execute Contract.** In the first sentence of Subsection 103.08 on page 24, change “bond” to “performance and payment bonds”.

**MISSISSIPPI DEPARTMENT OF TRANSPORTATION**

**SPECIAL PROVISION NO. 907-104-5**

**CODE: (IS)**

**DATE: 05/01/2013**

**SUBJECT: Scope of Work**

Section 104, Scope of Work, of the 2004 Edition of the Mississippi Standard Specifications for Road and Bridge Construction is hereby amended as follows:

**907-104.05--Removal and Disposal of All Materials From the Project.** Delete the second sentence of the first full paragraph of Subsection 104.05 on page 30 and substitute the following:

The Contractor shall also furnish the Engineer a certified letter stating that the area of disposal is not in a wetland or in Waters of the U.S.



## MISSISSIPPI DEPARTMENT OF TRANSPORTATION

**SPECIAL PROVISION NO. 907-105-7**

**CODE: (IS)**

**DATE: 05/01/2013**

**SUBJECT: Control of Work**

Section 105, Control of Work, of the 2004 Edition of the Mississippi Standard Specifications for Road and Bridge Construction is modified as follows.

**907-105.05--Cooperation by Contractor.** In the third sentence of the second paragraph of Subsection 105.05 on page 35, change “Notice to Proceed” to “Notice of Award”.

Delete the fourth paragraph of Subsection 105.05 on page 35, and substitute the following.

On projects that include erosion control pay items, the Contractor shall also designate a responsible person whose primary duty shall be to monitor and maintain the effectiveness of the erosion control plan, including NPDES permit requirements. This responsible person must be a Certified Erosion Control Person certified by an organization approved by the Department. Prior to or at the pre-construction conference, the Contractor shall designate in writing the Certified Erosion Control Person to the Project Engineer. The designated Certified Erosion Control Person shall be assigned to only one (1) project. When special conditions exist, such as two (2) adjoining projects or two (2) projects in close proximity, the Contractor may request in writing that the State Construction Engineer approve the use of one (1) Certified Erosion Control Person for both projects. The Contractor may request in writing that the Engineer authorize a substitute Certified Erosion Control Person to act in the absence of the Certified Erosion Control Person. The substitute Certified Erosion Control Person must also be certified by an organization approved by the Department. A copy of the Certified Erosion Control Person's certification must be included in the Contractor's Protection Plan as outlined in Subsection 907-107.22.1. This in no way modifies the requirements regarding the assignment and availability of the superintendent.

**907-105.14--Maintenance During Construction.** Before the first sentence Subsection 105.14 on page 39, add the following.

The Contractor will be responsible for the maintenance of existing roadways within the limits of this project starting on the date of the Notice To Proceed / Beginning of Contract Time. Anytime work is performed in a travel lane, the Contractor shall install portable lane closure signs meeting the requirement of the MDOT Standard Drawing or MUTCD.

## MISSISSIPPI DEPARTMENT OF TRANSPORTATION

| SPECIAL PROVISION NO. 907-107-13

CODE: (IS)

| DATE: 05/01/2013

**SUBJECT: Legal Relations and Responsibility to Public**

Section 107, Legal Relations and Responsibility to Public, of the 2004 Edition of the Mississippi Standard Specifications for Road and Bridge Construction is hereby amended as follows.

**907-107.02--Permits, Licenses and Taxes.** Delete in toto Subsection 107.02 on page 49 and substitute the following.

The Contractor or any Subcontractor shall have the duty to determine any and all permits and licenses required and to procure all permits and licenses, pay all charges, fees and taxes and issue all notices necessary and incidental to the due and lawful prosecution of the work. At any time during the life of this contract, the Department may audit the Contractor's or Subcontractor's compliance with the requirements of this section.

The Contractor or any Subcontractor is advised that the "Mississippi Special Fuel Tax Law", Section 27-55-501, et seq. and the Mississippi Use Tax Law, Section 27-67-1, et seq., and their requirements and penalties, apply to any contract or subcontract for construction, reconstruction, maintenance or repairs, for contracts or subcontracts entered into with the State of Mississippi, any political subdivision of the State of Mississippi, or any Department, Agency, Institute of the State of Mississippi or any political subdivision thereof.

The Contractor or any Subcontractor will be subject to one or more audits by the Department during the life of this contract to make certain that all applicable fuel taxes, as outlined in Section 27-55-501, et seq., and any sales and/or use taxes, as outlined in Section 27-67-1, et seq. are being paid in compliance with the law. The Department will notify the Mississippi State Tax Commission of the names and addresses of any Contractors or Subcontractors.

**907-107.14--Damage Claims and Insurance.**

| **907-107.14.2--Liability Insurance.** Delete Subsection 107.14.2 beginning on page 60 and substitute [the following](#).

**907-107.14.2.1--General.** The Contractor shall carry Contractor's liability, including subcontractors and contractual, with limits not less than: \$500,000 each occurrence; \$1,000,000 aggregate; automobile liability - \$500,000 combined single limit - each accident; Workers' Compensation and Employers' Liability - Statutory & \$100,000 each accident; \$100,000 each employee; \$500,000 policy limit. Each policy shall be signed or countersigned by a Mississippi Agent or Qualified Nonresident Agent of the Insurance Company.

The Contractor shall have certificates furnished to the Department from the insurance companies providing the required coverage. The certificates shall be on the form furnished by the Department and will show the types and limits of coverage.

**907-107.14.2.2--Railroad Protective.** The following provisions are applicable to all work performed under a contract on, over or under the rights-of-way of each railroad shown on the plans.

The Contractor shall assume all liability for any and all damages to work, employees, servants, equipment and materials caused by railroad traffic.

Prior to starting any work on railroad property, the Contractor shall furnish satisfactory evidence to the Department that insurance of the forms and amounts set out herein in paragraphs (a) and (b) has been obtained. Also, the Contractor shall furnish similar evidence to the Railroad Company that insurance has been obtained in accordance with the Standard Provisions for General Liability Policies and the Railroad Protective Liability Form as published in the Code of Federal Regulations, 23 CFR 646, Subpart A. Evidence to the Railroad Company shall be in the form of a Certificate of Insurance for coverages required in paragraph (b), and the original policy of the Railroad Protective Liability Insurance for coverage required in paragraph (a).

All insurance herein specified shall be carried until the contract is satisfactorily complete as evidenced by a release of maintenance from the Department.

The Railroad Company shall be given at least 30 days notice prior to cancellation of the Railroad Protective Liability Insurance policy.

For work within the limits set out in Subsection 107.18 and this subsection, the Contractor shall provide insurance for bodily injury liability, property damage liability and physical damage to property with coverages and limits no less than shown in paragraphs (a) and (b). Bodily injury shall mean bodily injury, sickness, or disease, including death at anytime resulting therefrom. Property damage shall mean damages because of physical injury to or destruction of property, including loss of use of any property due to such injury or destruction. Physical damage shall mean direct and accidental loss of or damage to rolling stock and their contents, mechanical construction equipment or motive power equipment.

(a) **Railroad Protective Liability Insurance** shall be purchased on behalf of the Railroad Company with limits of \$2,000,000 each occurrence; \$6,000,000 aggregate applying separately to each annual period for lines without passenger trains. If the line carries passenger train(s), railroad protective liability insurance shall be purchased on behalf of the Railroad Company with limits of \$5,000,000 each occurrence; \$10,000,000 aggregate applying separately to each annual period.

Coverage shall be limited to damage suffered by the railroad on account of occurrences arising out of the work of the Contractor on or about the railroad right-of-way, independent of the railroad's general supervision or control, except as noted in paragraph 4 below.

Coverage shall include:

- (1) death of or bodily injury to passengers of the railroad and employees of the railroad not covered by State workmen's compensation laws,
- (2) personal property owned by or in the care, custody or control of the railroads,
- (3) the Contractor, or any of the Contractor's agents or employees who suffer bodily injury or death as a result of acts of the railroad or its agents, regardless of the negligence of the railroads, and
- (4) negligence of only the following classes of railroad employees:
  - (i) any supervisory employee of the railroad at the job site
  - (ii) any employee of the railroad while operating, attached to, or engaged on, work trains or other railroad equipment at the job site which are assigned exclusively to the Contractor, or
  - (iii) any employee of the railroad not within (i) or (ii) above who is specifically loaned or assigned to the work of the Contractor for prevention of accidents or protection of property, the cost of whose services is borne specifically by the Contractor or Governmental authority.

(b) **Contractor's Liability - Railroad**, including subcontractors, XCU and railroad contractual with limits of \$1,000,000 each occurrence; \$2,000,000 aggregate. **Automobile** with limits of \$1,000,000 combined single limit any one accident; **Workers' Compensation and Employer's Liability** - statutory and \$100,000 each accident; \$100,000 each employee; \$500,000 policy limit. **Excess/Umbrella Liability** \$5,000,000 each occurrence; \$5,000,000 aggregate. All coverage to be issued in the name of the Contractor shall be so written as to furnish protection to the Contractor respecting the Contractor's operations in performing work covered by the contract. Coverage shall include protection from damages arising out of bodily injury or death and damage or destruction of property which may be suffered by persons other than the Contractor's own employees.

In addition, the Contractor shall provide for and on behalf of each subcontractor by means of a separate and individual liability and property damage policy to cover like liability imposed upon the subcontractor as a result of the subcontractor's operations in the same amounts as contained above; or, in the alternative each subcontractor shall provide same.

**907-107.15--Third Party Beneficiary Clause.** In the first sentence of the first paragraph of Subsection 107.15 on page 61, change "create the public" to "create in the public".

**907-107.17--Contractor's Responsibility for Work.** Delete the fifth sentence of the fifth paragraph of Subsection 107.17 on page 63 and substitute the following.

The eligible permanent items shall be limited to traffic signal systems, changeable message signs, roadway signs and sign supports, lighting items, guard rail items, delineators, impact

attenuators, median barriers, bridge railing or pavement markings. The eligible temporary items shall be limited to changeable message signs, guard rail items, or median barriers.

**907-107.18--Contractor's Responsibility for Utility Property and Services.** After the first sentence of Subsection 107.18 on page 63, add the following:

Prior to any excavation on the project, the Contractor shall contact MS 811 and advise them to mark all known utilities in the area of the excavation.

## MISSISSIPPI DEPARTMENT OF TRANSPORTATION

| SPECIAL PROVISION NO. 907-108-30

CODE: (IS)

| DATE: 05/22/2013

**SUBJECT: Prosecution and Progress**

Section 108, Prosecution and Progress, of the 2004 Edition of the Mississippi Standard Specifications for Road and Bridge Construction is hereby amended as follows.

### **907-108.01--Subletting of Contract.**

**907-108.01.1--General.** At the end of the last paragraph of Subsection 108.01.1 on page 73, add the following.

The Engineer will have the authority to suspend the work wholly or in part and to withhold payments because of the Contractor's failure to make prompt payment within 15 calendar days as required above, or failure to submit the required OCR-484 Form, Certification of Payments to Subcontractors, which is also designed to comply with prompt payment requirements.

**907-108.02--Notice To Proceed.** Delete the second paragraph of Subsection 108.02 on page 75 and substitute the following.

The anticipated date of the Notice to Proceed (NTP) / Beginning of Contract Time (BCT) will be specified in the proposal.

Delete the fourth paragraph of Subsection 108.02 on page 75 and substitute the following.

Upon written request from the Contractor and if circumstances permit, the Notice to Proceed may be issued at an earlier date subject to the conditions stated therein. The Contractor shall not be entitled to any monetary damages or extension of contract time for any delay claim or claim of inefficiency occurring between the early issuance Notice To Proceed date and the Notice to Proceed date stated in the contract.

**907-108.03--Prosecution and Progress.** Delete Subsection 108.03.1 on pages 75 & 76, and substitute the following.

**907-108.03.1--Progress Schedule.** Prior to or at the Pre-Construction Conference, the Contractor shall furnish a progress schedule and be prepared to discuss both its proposed methodologies for fulfilling the scheduling requirements and its sequence of operations. The Engineer will review the schedule and approve the schedule as it relates to compliance with the specifications and logic. The progress schedule must be approved by the Engineer prior to commencing work. The schedule shall be a bar-chart type schedule submitted on 11"x17" paper meeting the below minimum requirements. These activities shall be significantly detailed enough to communicate the Contractor's understanding of the construction sequencing and phasing of the project.

When preparing the progress schedule, the Contractor shall include the following:

- Show a time scale to graphically show the completion of the work within contract time.
- Define and relate activities to the contract pay items.
- Show all activities in the order the work is to be performed including submittals, submittal reviews, fabrication and delivery.
- Show all activities that are controlling factors in the completion of the work.
- Show the time needed to perform each activity and its relationship in time to other activities.

Should the schedule not include the above requirements or becomes unrealistic during construction, the Contractor should immediately submit a revised, more realistic schedule for approval.

**907-108.03.2--Preconstruction Conference.** Delete the first paragraph of Subsection 108.03.2 on page 76 and substitute the following.

Prior to commencement of the work, a preconstruction conference shall be held for the purpose of discussing with the Contractor essential matters pertaining to the prosecution and satisfactory completion of the work. The Contractor will be responsible for scheduling the preconstruction conference. The Contractor will advise the Project Engineer in writing 14 days prior to the requested date that a conference is requested. When the contract requires the Contractor to have a certified erosion control person, the Contractor's certified erosion control person shall be at the preconstruction conference. The Department will arrange for utility representatives and other affected parties to be present.

Delete the third paragraph of Subsection 108.03.2 on page 76.

**907-108.06--Determination and Extension of Contract Time.** Delete Subsections 108.06.1 and 108.06.2 on pages 79 thru 85 and substitute the following.

**907-108.06.1--Blank.**

**907-108.06.2--Based on Calendar Date Completion.**

**907-108.06.2.1--General.** Contract Time will be established on the basis of a Completion Date, as indicated in the contract. The span of time allowed for the completion of the work included in the contract will be indicated in the contract documents and will be known as "Contract Time".

The span of time allowed in the contract as awarded is based on the quantities used for comparison of bids. If satisfactory fulfillment of the contract requires performance of work in greater quantities than those set forth in the proposal, the time allowed for completion shall be increased in Calendar Days in the same ratio that the cost of such added work, exclusive of the cost of work altered by Supplemental Agreement for which a time adjustment is made for such altered work in the Supplemental Agreement, bears to the total value of the original contract unless it can be established that the extra work was of such character that it required more time

than is indicated by the money value.

The Contractor shall provide sufficient materials, equipment and labor to guarantee the completion of the work in the contract in accordance with the plans and specifications within the Contract Time.

**907-108.06.2.2--Contract Time.** The following TABLE OF ANTICIPATED PRODUCTIVE DAYS indicates an average/anticipated number of productive days per month.

**TABLE OF ANTICIPATED PRODUCTIVE DAYS**

Month	Available Productive Days
January	6
February	7
March	11
April	15
May	19
June	20
July	21
August	21
September	20
October	16
November	11
December	5
Calendar Year	172

Allocation of anticipated productive days for a fractional part of the month will be computed as a proportion of the listed anticipated productive days for the applicable month.

Available productive days will start being assessed at the original Notice to Proceed/Beginning of Contract Time date shown in the contract documents, regardless of whether or not the Contractor has been issued an early Notice to Proceed.

Available productive days will be based on soil and weather conditions and other specific conditions cited in the contract. The Engineer will determine on each applicable day the extent to which work in progress could have been productive, regardless of whether the Contractor actually worked.

An available productive day will be assessed as follows:

- (a) any day of the week, Monday through Friday, exclusive of legal holidays recognized by the Department in Subsection 108.04.1, in which the Contractor works or could have worked for more than six (6) consecutive hours on the controlling item(s) of work, as determined by the



Engineer from the Contractor's approved progress schedule. When the Contractor works or could work more than four but less than six consecutive hours, one-half (0.5) of an available work day will be charged for that day. When the Contractor works or could work six or more consecutive hours during the day, one (1.0) available work day will be charged for that day, or

(b) any Saturday, exclusive of legal holidays recognized by the Department in Subsection 108.04.1, in which the Contractor works for more than six (6) consecutive hours on the controlling item(s) of work, as determined by the Engineer from the Contractor's approved progress schedule. When the Contractor works less than four consecutive hours during the day, no time will be charged for that day. When the Contractor works more than four but less than six consecutive hours, one-half (0.5) of an available work day will be charged for that day. When the Contractor works six or more consecutive hours during the day, one (1.0) available work day will be charged for that day.

Should the weather or other conditions be such that four (4) consecutive satisfactory hours are not available prior to noon (for daytime operations) or midnight (for nighttime operations), no time will be assessed for that day regardless of the above conditions. However, if the Contractor elects to work, time will be assessed in accordance with the previous paragraph.

Weather delays will not be considered for Saturdays, Sundays or legal holidays recognized by the Department in Subsection 108.04.1.

Each month the Engineer will complete, and furnish to the Contractor, an "Assessment Report for Available Productive Days" (CSD-765). This report shows the number of available productive days during the estimate period and the cumulative available productive days to date. The Contractor should review the Engineer's report as to the accuracy of the assessment and confer with the Resident or Project Engineer to rectify any differences. Each should make a record of the differences, if any, and conclusions reached. In the event mutual agreement cannot be reached, the Contractor will be allowed a maximum of 15 calendar days following the ending date of the monthly report in question to file a protest Notice of Claim in accordance with the provisions of Subsection 105.17. Otherwise, the Engineer's assessment shall be final unless mathematical errors of assessment are subsequently found to exist, and any claim of the Contractor as to such matter shall be waived.

The Contractor's progress will be determined monthly at the time of each progress estimate and will be based on the percentage of money earned by the Contractor compared to the percentage of elapsed time.

The percentage of money earned will be determined by comparing the total money earned to-date by the Contractor, minus any payment for advancement of materials, to the total dollar amount of the contract. The percentage of time elapsed will be determined by comparing the available productive days assessed to-date on Form CSD-765 to the total available productive days for the contract.

When the "percent complete" lags more than 20 percent behind the "percentage of elapsed time", the Contractor shall immediately submit a written statement and revised progress schedule

indicating any additional equipment, labor, materials, etc. to be assigned to the work to ensure completion within the specified contract time. When the "percent complete" lags more than 40 percent behind the "percentage of elapsed time", the contract may be terminated.

**907-108.06.2.3--Extension of Time.** The Contractor may, prior to the expiration of the Contract Time, make a written request to the Engineer for an extension of time with a valid justification for the request. The Contractor's plea that insufficient time was specified is not a valid reason for extension of time.

No extension of the specified completion date will be granted except as provided herein. An extension of contract time may be granted for unusually severe weather, abnormal delays caused solely by the State or other governmental authorities, or unforeseeable disastrous phenomena of nature of the magnitude of earthquakes, hurricanes, tornadoes, or flooded essential work areas which are deemed to unavoidably prevent prosecuting the work.

Unusually severe weather is defined as when the actual available productive days for the contract time are less than the number of available productive days shown in the Table of Anticipated Productive Days. Any extension of contract time will be based on a calendar days basis, excluding Saturdays, Sundays or legal holidays recognized by the Department in Subsection 108.04.1. Any extension of contract time will be made on or after the specified completion date. No extension of contract time will be made on a monthly basis.

If the **specified completion date** of the project is extended into a season of the year in which completion of certain items of work would be prohibited or delayed because of seasonal or temperature limitations, the Engineer may waive the limitations provided the completion of the work will not result in a reduction in quality. When determined that the completion of the out-of-season items will cause a reduction in the quality of the work, the completion of the project will be further extended so the items may be completed under favorable weather conditions. In either case, the Engineer will notify the Contractor in writing.

Liquidated damages as set forth in Subsection 108.07 under the heading "Daily Charge Per Calendar Day" in the Table titled "Schedule of Deductions for Each Day of Overrun in Contract Time", shall be applicable to each calendar day after the specified completion date, or authorized extension thereof, and until all work under the contract is completed.

**907-108.06.2.4--Cessation of Contract Time.** When the Engineer by written notice schedules a final inspection, time will be suspended until the final inspection is conducted and for an additional 14 calendar days thereafter. If after the end of the 14-day suspension all necessary items of work have not been completed, time charges will resume. If the specified completion date had not been reached at the time the Contractor called for a final inspection, the calendar day difference between the specified completion date and the date the Contractor called for a final inspection will be added after the 14-day period before starting liquidation damages. If a project is on liquidated damages at the time a final inspection is scheduled, liquidated damages will be suspended until the final inspection is conducted and for seven (7) calendar days thereafter. If after the end of the 7-day suspension all necessary items of work have not been completed, liquidated damages will resume. When final inspection has been made by the

Engineer as prescribed in Subsection 105.16 and all items of work have been completed, the daily time charge will cease.

**907-108.07--Failure to Complete the Work on Time.** Delete the Schedule of Deductions table in Subsection 108.07 on page 85, and substitute the following.

**Schedule of Deductions for Each Day of Overrun in Contract Time**

<b>Original Contract Amount</b>		<b>Daily Charge Per Calendar Day</b>
<b>From More Than</b>	<b>To and Including</b>	
\$ 0	100,000	\$ 150
100,000	500,000	360
500,000	1,000,000	540
1,000,000	5,000,000	830
5,000,000	10,000,000	1,200
10,000,000	20,000,000	1,800
20,000,000	-----	3,500

**907-108.10--Termination of Contractor's Responsibility.** In the last sentence of Subsection 108.10 on page 88, change “bond” to “performance and payment bond(s)”.

# MISSISSIPPI DEPARTMENT OF TRANSPORTATION

## SUPPLEMENT TO SPECIAL PROVISION NO. 907-109-6

**DATE:** 12/17/2013

**SUBJECT:** Measurement and Payment

Before the first sentence of Subsection 907-109.04 on page 1, add the following.

Delete the first paragraph under Subsection 109.04 on page 91, and substitute the following.

When extra work results for any reason and is not handled as prescribed elsewhere herein, the Engineer and the Contractor will attempt to agree on equitable prices. When such prices are agreed upon, a Supplemental Agreement will be issued by the Engineer.

When the Supplemental Agreement process is initiated, the Contractor will be required to submit to the Engineer a detailed breakdown for Material, Labor, Equipment, Profit and Overhead. The total allowable markup (which includes Prime Contractor and Subcontractor work, if applicable) for Supplemental Agreement work shall not exceed 20%.

The requirement for detailed cost breakdowns may be waived when a Department's Bid Item History exists for the proposed item(s), and the Contractor's requested price is within 20% of the Department's Bid History cost for that item(s). In any case, the Department reserves the right to request detailed cost breakdowns from the Contractor on any Supplemental Agreement request.

When equitable prices cannot be agreed upon mutually by the Engineer and the Contractor, the Engineer will issue a written order that work will be completed on a force account basis to be compensated in the following manner:

After the last paragraph of Subsection 907-109.07 on page 2, add the following.

Delete the last paragraph of Subsection 109.07 on pages 97 & 98, and substitute the following.

Adjustments herein provided shall not apply to fuels consumed or materials incorporated into the work during any monthly estimate period falling wholly after the expiration of contract time as defined in Subsection 101.02 of the applicable Mississippi Standard Specifications for Road and Bridge Construction, and as determined by checked final quantities..

# MISSISSIPPI DEPARTMENT OF TRANSPORTATION

SPECIAL PROVISION NO. 907-109-6

CODE: (IS)

DATE: 05/01/2013

SUBJECT: Measurement and Payment

Section 109, Measurement and Payment, of the 2004 Edition of the Mississippi Standard Specifications for Road and Bridge Construction is hereby amended as follows.

**907-109.01--Measurement of Quantities.** Delete the third full paragraph of Subsection 109.01 on page 90 and substitute the following.

When requested by the Contractor, material specified to be measured by the cubic yard or ton may be converted to the other measure as appropriate. Factors for this conversion will be determined by the District Materials Engineer and agreed to by the Contractor. The conversion of the materials along with the conversion factor will be incorporated into the contract by supplemental agreement. The supplemental agreement must be executed before such method of measurement is used.

After the second sentence of the fourth full paragraph of Subsection 109.01 on page 90, add the following.

Where loose vehicle measurement (LVM) is used, the capacity will be computed to the nearest one-tenth cubic yard and paid to the whole cubic yard. Measurements greater than or equal to nine-tenths of a cubic yard will be rounded to the next highest number. Measurements less than nine-tenths of a cubic yard will not be rounded to the next highest number. Example: A vehicle measurement of 9.9 cubic yards will be classified as a 10-cubic yard vehicle. A vehicle measurement of 9.8 cubic yards will be classified as a 9-cubic yard vehicle.

**907-109.04--Extra and Force Account Work.** In the last sentence of subparagraph (b) in Subsection 109.04 on page 91, change “bond” to “bond(s)”.

Delete the first sentence of the second paragraph of subparagraph (d) in Subsection 109.04 on page 92 and substitute the following.

In the event an agreement cannot be reached for a particular piece of equipment, the book entitled "Rental Rate Blue Book For Construction Equipment" as published by EquipmentWatch® and is current at the time the force account work is authorized will be used to determine equipment ownership and operating expense rates.

**907-109.06--Partial Payment.**

**907-109.06.1--General.** Delete the fourth and fifth sentences of the third paragraph of Subsection 109.06.1 on page 94, and substitute the following.

In the event mutual agreement cannot be reached, the Contractor will be allowed a maximum of

25 calendar days following the Contractor's receipt of the monthly estimate in question to file in writing, a protest Notice of Claim in accordance with the provisions Subsection 105.17. Otherwise, the Engineer's estimated quantities shall be considered acceptable pending any changes made during the checking of final quantities.

**907-109.07--Changes in Material Costs.** Delete the third full paragraph of Subsection 109.07 on page 96 and substitute the following.

A link to the established base prices for bituminous products and fuels will be included in the contract documents under a Notice to Bidders entitled "Petroleum Products Base Prices."

**MISSISSIPPI DEPARTMENT OF TRANSPORTATION**

| **SPECIAL PROVISION NO. 907-110-2**

**CODE: (SP)**

| **DATE: 04/02/2010**

**SUBJECT: Wage Rates**

Section 110, Required Contract Provisions, of the 2004 Edition of the Mississippi Standard Specifications for Road and Bridge Construction is hereby amended as follows:

**907-110.02--Application.** Delete Subsection 110.02.2 on page 100 and substitute the following.

**907-110.02.2--Wage Rates.** All persons employed or working upon the site of the work will be paid at wage rates not less than those contained in the wage determination decision of the Secretary of Labor in effect 10 days prior to taking bids.

| **Bidders are advised that regardless of the wage rates listed in the Supplement to FHWA 1273 in the contract, minimum federal wage rates must be paid.**

**MISSISSIPPI DEPARTMENT OF TRANSPORTATION**

**SPECIAL PROVISION NO. 907-304-13**

**CODE: (SP)**

**DATE: 06/06/2012**

**SUBJECT: Granular Courses**

Section 907-304, Granular Courses, of the 2004 Edition of the Mississippi Standard Specifications for Road and Bridge Construction is hereby amended as follows.

**907-304.02--Materials.** After the first paragraph of Subsection 304.02.1 on page 183, add the following.

Crushed concrete meeting the requirements of Subsection 907-703.04.3 may be used in lieu of granular courses or crushed stone courses specified in the contract. This applies to base courses, shoulders, or other required construction on a prepared foundation.

**907-304.03--Construction Requirements.**

**907-304.03.5--Shaping, Compacting and Finishing.** Delete the sixth paragraph of Subsection 304.03.5 on page 185.

Delete the first table in Subsection 304.03.5 on page 186 and substitute the following.

Granular Material Class	Lot Average	Individual Test
7,8,9 or 10	97.0	93.0
5 or 6	99.0	95.0
3 or 4	100.0	96.0
1 or 2	102.0	98.0
Crushed Courses*	99.0	95.0

\* When placed on filter fabric on untreated subgrade, the individual tests and the average of the five (5) tests shall equal or exceed the following values.

<u>Lot Average</u>	<u>Individual Test</u>
96.0	92.0

**907-304.05--Basis of Payment.** Add the “907” prefix to the pay items listed on page 187.



# MISSISSIPPI DEPARTMENT OF TRANSPORTATION

## SUPPLEMENT TO SPECIAL PROVISION NO. 907-401-2

**DATE:** 12/17/2013

**SUBJECT:** Hot Mix Asphalt (HMA)

Before the first sentence on page 1, add the following.

**907-401.02.3.1–General.** Delete the second paragraph of Subsection 401.02.3.1 on page 239, and substitute the following.

The total amount of crushed limestone aggregate for mixtures, excluding shoulders, when used in the top lift, shall not exceed 50 percent of the total combined aggregate by weight.

Delete the table in Subsection 401.02.3.1 on page 240 and substitute the following.

Asphalt Mixture	Maximum Percentage of RAP by total weight of mix
4.75 mm	0
9.5 mm	20*
12.5 mm Surface Lift	20*
12.5 mm Underlying Lift	30
19 mm	30
25 mm	30

\* At a minimum, RAP shall be processed and/or screened such that the RAP material size does not exceed the nominal maximum sieve size for the mixture specified.

**907-401.02.4--Substitution of Mixture.** Delete the table in Subsection 401.02.4 on page 242, and substitute the following.

Mixture	Single Lift Laying Thickness Inches	
	Minimum	Maximum
25 mm	3	4
19 mm	2¼	3½
12.5 mm	1½	2½
9.5 mm	1	1½
4.75 mm	½	¾

After Subsection 907-401-02.6.2 on page 2, add the following.

**907-401.02.6.4.1--Roadway Density.** Delete subparagraphs 1., 2., & 3. on page 251 and substitute the following.

1. For all leveling lifts, when full lane width and with a thickness as specified in the table in Subsection 401.02.4, the required lot density shall be 92.0 percent of maximum density.
2. For all single lift overlays, with or without leveling and/or milling, the required lot density shall be 92.0 percent of maximum density.
3. For all multiple lift overlays of two (2) or more lifts excluding leveling lifts, the required lot density of the bottom lift shall be 92.0 percent of maximum density. The required lot density for all subsequent lifts shall be 93.0 percent of maximum density.
4. For all pavements on new construction, the required lot density for all lifts shall be 93.0 percent of maximum density.

Delete Subsections 401.02.6.5 and 401.02.6.6 on pages 253 thru 257 and substitute the following.

**907-401.02.6.5--Blank.**

**907-401.02.6.6--Blank.**

**907-401.02.6.7--Surface Correction.** Delete the paragraph in Subsection 401.02.6.7 on page 257, and substitute the following.

Corrective work to sections exceeding short continuous interval thresholds reported by ProVal, as described in Subsection 907-403.03.2.1, shall consist of diamond grinding in accordance with these specifications or methods approved by the Engineer. All surface areas corrected by grinding shall be sealed with a sealant approved by the Engineer.

**907-401.02.6.8--Acceptance Procedure for Pavement Smoothness Using Mean Roughness Index (MRI).** When compaction is completed, the lift shall have a uniform surface and be in reasonably close conformity with the line, grade and cross section shown on the plans.

The smoothness of the surface lift will be determined by using an Inertial Profiling System (IPS) to measure and record roughness data in each designated location. Roughness data for each longitudinal profile will be reported as a Mean Roughness Index (MRI). MRI is calculated by averaging the International Roughness Index (IRI) values from the two individual wheelpath profiles. The surface shall be tested and corrected to a smoothness index as described herein with the exception of those locations or specific projects that are excluded from smoothness testing with an IPS.

The smoothness of the surface lift will be determined for traffic lanes, auxiliary lanes, climbing lane and two-way turn lanes. Areas excluded from a smoothness test with the IPS are acceleration and deceleration lanes, tapered sections, transition sections for width, shoulders, crossovers, ramps, side street returns, etc. The roadway pavement on bridge replacement projects having 1,000 feet or less of pavement on each side of the structure will be excluded from a smoothness test. Pavement on horizontal curves having a radius of less than 1,000 feet at the centerline and pavement within the super elevation transition of such curves are excluded from smoothness testing. Smoothness testing shall terminate 264 feet from each transverse joint that

separates the pavement from a bridge deck, bridge approach slab or existing pavement not constructed under the contract. This shall apply to any other exceptions including, but not limited to, railroad crossings and manholes. Segments containing a considerable amount of encroachments such as intersections, manholes, curb and gutter sections, etc. may be excluded at the Project Engineer's discretion.

Initial smoothness measurements shall take place no more than 72 hours following placement of surface and must be performed at the posted speed limit or 50 miles per hour ( $\pm 5$  mile per hour), whichever is lower. This speed requirement will be waived for all lightweight profilers. Measurements will be made in both wheel paths of exterior and interior lanes. The wheel paths shall be designated as being located three feet (3') and nine feet (9') from centerline or longitudinal joint, respectively. Beginning and ending latitude and longitude coordinates shall be required on each smoothness surface test. Testing will also be required on sections that have been surface corrected. No smoothness testing shall be performed when there is moisture of any kind on the pavement surface. Any additional testing shall meet the requirements of Subsection 907-403.03.2.

The surface lift will be accepted on a continuous interval basis for pavement smoothness. Continuous reporting is based upon all MRI values for a specified running interval. These values are averaged and presented at the midpoint of the specified running interval. The last 15 feet of a day's lift may not be obtainable until the lift is continued and for this reason may be included in the subsequent section.

Areas of localized roughness exceeding the continuous 25-foot interval threshold described in Subsection 907-403.03.2.1 shall be corrected regardless of the 528-foot interval MRI value of the section. Surface correction by grinding shall be performed in accordance with Subsection 401.02.6.7. The Contractor shall also make other necessary surface corrections to ensure that the final mean roughness index of the section meets the requirements of Subsection 907-403.03.2.

Continuous sections exceeding the accepted long interval MRI value shall be corrected as specified in Subsection 403.03.4. All such corrections shall be performed at no additional costs to the State. Scheduling and traffic control will be the responsibility of the Contractor with approval of the Engineer. All tests and corrections shall be in accordance with AASHTO R 54-10, Accepting Pavement Ride Quality When Measured Using Inertial Profiling Systems.

#### **907-401.02.6.9--High Speed Inertial Profiling System.**

**907-401.02.6.9.1--General.** The IPS, furnished and operated by the Contractor under the supervision of the Engineer or the Engineer's representative, shall be a dual laser high speed or lightweight vehicle meeting the requirements of AASHTO M 328-10, Standard Specification for Inertial Profiler.

**907-401.02.6.9.2--Mechanical Requirements.** The IPS should function independent of vehicle suspension and speed with an operational range of 15-70 mph (for high speed profilers only) and must collect data at a sample interval of no more than three inches (3"). All IPSs, operators, and combinations thereof shall be verified in accordance with AASHTO R 56-10, Standard Practice for Certification of Inertial Profiler Systems and AASHTO R 57-10, Operating Inertial Profiler Systems.

**907-401.02.6.9.3--Computer Requirements.** The computer measurement program must be menu driven, Windows compatible, and able to produce unfiltered profiler runs in any one of the following file formats: University of Michigan's Transportation Research Institute's (UMTRI) Engineering Research Division (\*.erd) file, ProVAL's Pavement Profile (\*.ppf) file, or Ames Engineering's (\*.adf) file format. The computer shall have the ability to display and print data on site for verification and shall have the ability to save and transfer data via Universal Serial Bus (USB) flash drive, which shall be provided by the Contractor.

All profiler runs must be named in the following format for acceptance by the Project Engineer:

- County\_Route\_Direction\_Lane\_BeginStation\_EndStation

In addition to manufacturers software; the latest version of FHWA's ProVAL software shall be installed on the IPS computer. ProVAL software is available for free download at <http://www.roadprofile.com>.

**907-401.03.1.2--Tack Coat.** Delete the three sentences of Subsection 401.03.1.2 on page 259, and substitute the following.

Tack coat shall be applied to previously placed HMA and between lifts, unless otherwise directed by the Engineer. Tack coat shall be applied with a distributor spray bar. A hand wand will only be allowed for applying tack coat on ramp pads, irregular shoulder areas, median crossovers, turnouts, or other irregular areas. Bituminous materials and application rates for tack coat shall be as specified in Table 410-A on page 293. Construction requirements shall be in accordance with Subsection 407.03 of the Standard Specifications.

**907-401.03.1.4--Density.** Delete the first sentence of the first paragraph of Subsection 401.03.1.4 on page 259 and substitute the following.

The lot density for all dense graded pavement lifts, except as provided below for preleveling, wedging [less than fifty percent (50%) of width greater than minimum lift thickness], ramp pads, irregular shoulder areas, median crossovers, turnouts, or other areas where the established rolling pattern cannot be performed, shall not be less than the specified percent (92.0% or 93.0%) of the maximum density based on AASHTO Designation: T 209 for the day's production. For all leveling lifts, when full lane width and with a thickness as specified in the table in Subsection 401.02.4, the required lot density shall be 92.0 percent of maximum density.

**907-401.03.9--Material Transfer Equipment.** Delete the paragraph in Subsection 401.03.9 on page 264 and substitute the following.

Excluding the areas mentioned below, the material transferred from the hauling unit when placing the top lift, or the top two (2) lifts of a multi-lift HMA pavement with density requirements, shall be remixed prior to being placed in the paver hopper or insert by using an approved Materials Transfer Device. Information on approved devices can be obtained from the State Construction Engineer. Areas excluded from this requirement include: leveling courses, temporary work of short duration, detours, bridge replacement projects having less than 1,000 feet of pavement on each side of the structure, acceleration and deceleration lanes less than 1,000 feet in length, tapered sections, transition sections for width, shoulders less than 10 feet in width, crossovers, ramps, side street returns and other areas designated by the Engineer.

After Subsection 401.03.13 on page 266, add the following.

**907-401.03.14--Shoulder Wedge.** The Contractor shall attach a device to the screed of the paver that confines the material at the end gate and extrudes the asphalt material in such a way that results in a compacted wedge shape pavement edge of approximately 30 degrees, but not steeper than 35 degrees. The device shall maintain contact between itself and the road shoulder surface and allow for automatic transition to cross roads, driveways, and obstructions. The device shall be used to constrain the asphalt head reducing the area by 10% to 15% increasing the density of the extruded profile. Conventional single plate strike off shall not be used.

The device shall be TransTech Shoulder Wedge Maker, the Advant-Edge, or a similar approved equal device that produces the same wedge consolidation results. Contact information for these wedge shape compaction devices is the following:

1. TransTech Systems, Inc.  
1594 State Street  
Schenectady, NY 12304  
800-724-6306  
[www.transtechsys.com](http://www.transtechsys.com)
  
2. Advant-Edge Paving Equipment, LLC  
P.O. Box 9163  
Niskayuna, NY 12309-0163  
518-280-6090  
Contact; Gary D. Antonelli  
Cell: 518-368-5699  
email: [garya@nycap.rr.com](mailto:garya@nycap.rr.com)  
Website: [www.advantedgepaving.com](http://www.advantedgepaving.com)

Before using a similar device, the Contractor shall provide proof that the device has been used on previous projects with acceptable results, or construct a test section prior to the beginning of work and demonstrate wedge compaction to the satisfaction of the Engineer. Short sections of handwork will be allowed when necessary for transitions and turnouts, or otherwise authorized by the Engineer.

## MISSISSIPPI DEPARTMENT OF TRANSPORTATION

**SPECIAL PROVISION NO. 907-401-2**

**CODE: (IS)**

**DATE: 11/04/2005**

**SUBJECT: Hot Mix Asphalt (HMA)**

Section 401, Hot Mix Asphalt (HMA) - General, of the 2004 Edition of the Mississippi Standard Specifications for Road and Bridge Construction is hereby amended as follows:

Delete in toto Subsection 401.02.6.2 on pages 248 and 249, and substitute:

**907-401.02.6.2--Assurance Program for Mixture Quality.** The Engineer will conduct a quality assurance program. The quality assurance program will be accomplished as follows:

- 1) Conducting verification tests.
- 2) Validate Contractor test results.
- 3) Periodically observing Contractor quality control sampling and testing.
- 4) Monitoring required quality control charts and test results.
- 5) Sampling and testing materials at any time and at any point in the production or laydown process.

The rounding of all test results will be in accordance with Subsection 700.04.

The Engineer will conduct verification tests on samples taken by the Contractor under the direct supervision of the Engineer at a time specified by the Engineer. The frequency will be equal to or greater than ten percent (10%) of the tests required for Contractor quality control and the data will be provided to the Contractor within two asphalt mixture production days after the sample has been obtained by the Engineer. At least one sample shall be tested from the first two days of production. All testing and data analysis shall be performed by a Certified Asphalt Technician-I (CAT-I) or by an assistant under the direct supervision of the CAT-I. Certification shall be in accordance with the *MDOT HMA Technician Certification Program* chapter in the Materials Division Inspection, Testing, and Certification Manual. The Department shall post a chart giving the names and telephone numbers for the personnel responsible for the assurance program.

The Engineer shall be allowed to inspect Contractor testing equipment and equipment calibration records to confirm both calibration and condition. The Contractor shall calibrate and correlate all testing equipment in accordance with the latest versions of the Department's Test Methods and AASHTO Designation: R 18.

Random differences between the Engineer's verification tests and the current running average of four quality control tests at the time of obtaining the verification sample will be considered acceptable if within the following limits:

Item	Allowable Differences
Sieve - % Passing	
3/8-inch and above	6.0
No. 4	5.0
No. 8	4.0
No. 16, for 4.75 mm mixtures ONLY	3.5
No. 30	3.5
No. 200	2.0
AC Content	0.4
Specimen Bulk SG, Gmb @ $N_{Design}$	0.030
Maximum SG, Gmm	0.020

If four quality control tests have not been tested prior to the time of the first verification test, the verification test results will be compared to the average of the preceding quality control tests. If the verification test is the first material tested on the project or if a significant process adjustment was made just prior to the verification test, the verification test results will be compared to the average of four subsequent quality control test results. For all other cases after a significant process adjustment, the verification test results will be compared to the average of the preceding quality control tests (taken after the adjustment) as in the case of a new project start-up when four quality control tests are not available.

In the event that; 1) the comparison of the Contractor’s running average quality control data and Engineer’s quality assurance verification test results are outside the allowable differences in the above table, or 2) if a bias exists between the results, such that one of the results is predominately higher or lower than the other, and the Engineer’s results fail to meet the JMF control limits, the Engineer will investigate the reason immediately. As soon as the need for an investigation becomes known, the Engineer will increase the quality assurance sampling rate to the same frequency required for Contractor testing. The additional samples obtained by the Engineer may be used as part of the investigation process or for routine quality assurance verification tests. The Engineer's investigation may include testing of the remaining quality control split samples, review and observation of the Contractor's testing procedures and equipment, and a comparison of split sample test results by the Contractor quality control laboratory, Department quality assurance laboratory and the Materials Division laboratory. The procedures outlined in the latest edition of MDOT’s Field Manual for HMA may be used as a guide for the investigation. In the event that the Contractor’s results are determined to be incorrect, the Engineer's results will be used for the quality control data and the appropriate payment for the mixture will be based on the procedures specified in Subsection 401.02.5.8(j).

The Engineer will periodically witness the sampling and testing being performed by the Contractor. The Engineer, both verbally and in writing, will promptly notify the Contractor of any observed deficiencies. When differences exist between the Contractor and the Engineer which cannot be resolved, a decision will be made by the State Materials Engineer, acting as the referee. The Contractor will be promptly notified in writing of the decision. If the deficiencies are not corrected, the Engineer will stop production until corrective action is taken.

## MISSISSIPPI DEPARTMENT OF TRANSPORTATION

**SPECIAL PROVISION NO. 907-401-6**

**CODE: (SP)**

**DATE: 08/21/2012**

**SUBJECT: Warm Mix Asphalt (WMA)**

Section 401, Hot Mix Asphalt (HMA) - General, of the 2004 Edition of the Mississippi Standard Specifications for Road and Bridge Construction as amended by this special provision is applicable to Warm Mix Asphalt Only.

### **907-401.01--Description.**

These specifications include general requirements that are applicable to Warm Mix Asphalt (WMA).

This work consists of the construction of one or more lifts of WMA in accordance with Section 401 for Hot Mix Asphalt, with the exceptions set forth in this special provision. The WMA shall meet the specific requirements for the mixture to be produced and placed in reasonably close conformity with the lines, grades, thicknesses and typical sections shown on the plans or established by the Engineer.

### **907-401.02--Materials.**

**907-401.02.2--WMA Products and Processes.** The Department will maintain a list of qualified WMA products and processes. No product or process shall be used unless it appears on this list.

The Contractor may propose other products or processes for approval by the Product Evaluation Committee. Documentation shall be provided to demonstrate laboratory performance, field performance, and construction experience.

### **907-401.03--Construction Requirements.**

**907-401.03.1.1--Weather Limitations.** The air and pavement temperature at the time of placement shall equal or exceed 40°F, regardless of compacted lift thickness.

**907-401.03.8--Preparation of Mixture.** Warm mix asphalt is defined as a plant produced asphalt mixture that can be produced and constructed at lower temperatures than typical hot mix asphalt. Typical temperature ranges of non-polymer modified, WMA produced by foaming the asphalt binder at the plant are typically 270°F to 295°F at the point of discharge of the plant. Typical temperature ranges of polymer modified, WMA produced by foaming the asphalt binder at the plant are typically 280°F to 305°F at the point of discharge of the plant. WMA produced by addition of a terminal blended additive may allow the producer to reduce the temperatures below 270°F as long as all mixture quality and field density requirements are met. Production temperatures at the plant may need to be increased or decreased due to factors such as material



characteristics, environmental conditions, and haul time to achieve mixture temperatures at the time of compaction in which uniform mat density can be achieved.

**MISSISSIPPI DEPARTMENT OF TRANSPORTATION**

**SUPPLEMENT TO SPECIAL PROVISION NO. 907-403-4**

**DATE:** 12/17/2013

**SUBJECT:** Hot Mix Asphalt (HMA)

Before Subsection 907-403.05.2 on page 1, add the following:

**907-403.03--Construction Requirements.**

**907-403.03.2--Smoothness Tolerances.** Delete the table, footnotes, and first six paragraphs of Subsection 403.03.2 on page 266 & 267, and substitute the following.

	Lower* & Leveling Lifts	Lower* Intermediate Lift	Top Intermediate Lift	Surface Lift
Maximum deviation from grade and cross section at any point .....	1/2"	3/8"	1/4"	1/4"
Maximum deviation from A 10 foot straight edge.....	3/8"	1/4"	1/8"	1/8"

Note: Where more than four (4) lifts of HMA are required, all lifts, excluding the top three (3) lifts, shall meet the requirements of the lower lift.

\* When tested longitudinally from a stringline located equidistant above points 50 feet apart, the distance from the stringline to the surface at any two points located 12 1/2 feet apart shall not vary one from the other more than the maximum deviation allowed above from a 10-foot straight edge.

Delete the last paragraph of Subsection 403.03.2 at the bottom of page 268, the table at the top of page 269, and the first, second and third full paragraphs on page 269, and substitute the following.

Sections(s) or portions thereof representing areas excluded from a smoothness test with the High Speed Inertial Profiling System (IPS) shall also be excluded from consideration for a contract price adjustment for rideability.

Any contract price adjustment for rideability will be applied on a continuous basis to the pay tonnage, determined in accordance with Subsections 907-401.02.6.8 and 403.04, for the section(s) or portions thereof for which an adjustment is warranted.

Contract price adjustments for rideability shall only be applicable to the surface lift and furthermore to only the long continuous section(s) or portions of the long continuous section(s) of the surface lift that require smoothness be determined by using a profiling device.

**907-403.03.2.1--Smoothness Tolerances for Mean Roughness Index (MRI).** Smoothness tolerances shall be applied to asphalt pavements based on the following pavement categories.

**Category A** applies to the following pavement constructions:

- New construction
- Construction with three (3) or more lifts
- Mill and two (2) or more lifts

**Category B** applies to the following pavement constructions:

- Mill and one (1) lift
- Two (2) lift overlays without milling

**Category C** applies to the following pavement constructions:

- Single lift overlay without milling

**NOTE:** Spot Leveling does not count as a lift. Full width / continuous leveling courses will be considered a lift. Leveling lifts that do not have a minimum thickness of 3/4" across the entire lane width will not be considered a lift.

For all projects, the surface lift smoothness data shall be reported by two MRI methods:

1. A continuous 528-foot long interval MRI report
2. A continuous 25-foot short interval MRI report

Areas of the surface lift with localized roughness greater than 160 inches per mile as determined by the continuous short interval report will be identified for correction by the Project Engineer.

**Category A** projects shall have a long interval surface MRI of not more than 60 inches per mile.

**Category B** projects shall have a long interval surface MRI of not more than 70 inches per mile.

**Category C** projects shall have the existing surface profiled at no additional cost to the State. The finished surface lift shall meet the following requirements:

- A 50% improvement in MRI from the existing surface
- or
- 80 inches per mile long interval surface MRI value whichever value is higher.

In the case that 50% of the existing surface MRI is greater than 80 inches per mile, the short continuous threshold shall be increased from 160 inches per mile by the difference between 50% of the existing surface MRI and 80 inches per mile.

When a project has multiple lifts, the lift underlying the surface lift shall have a MRI of no more than 10 inches/mile more than the surface lift threshold for both long and short continuous intervals. Category B projects containing multiple lifts must meet the Category C percent improvement requirement for the underlying lift. Corrective action must be taken on those segments that do not meet this requirement. No unit price adjustment will be applied on any underlying lift.

For Category A and B projects, a unit price increase will be added when the MRI for the final surface lift is less than or equal to fifty inches per mile (50.0 inches / mile) on the long interval report. These Projects will be considered for incentive pay based on the following guidelines for the long interval surface lift MRI.

Mean Roughness Index inches / mile	Contract Price Adjustment percent of Asphalt unit bid price
Less than 35.0	108
35.1 to 40.0	106
40.1 to 45.0	104
45.1 to 50.0	102
50.1 to Required Surface MRI	100

For Category C projects, a unit price increase will be added when the MRI for the final surface lift is less than or equal to fifty inches per mile (50.0 inches / mile) on the long interval report. These Projects will be considered for incentive pay based on the following guidelines for the long interval surface lift MRI.

Mean Roughness Index inches / mile	Contract Price Adjustment percent of HMA unit bid price
Less than or equal to 50.0	103
50.1 to Required Surface MRI	100

No incentive will be allowed if the MRI value from the newly paved surface is greater than the existing surface.

In addition to the above pay incentive factors, a project may be subject to a disincentive when the Long Continuous Interval MRI for the surface exceeds the allowable tolerance. This applies to all project categories and will correlate to the maximum allowed Long Continuous Interval MRI.

Mean Roughness Index inches / mile	Contract Price Adjustment percent of HMA unit bid price
Above 20.0 Over	Remove And Replace
15.1 to 20.0 Over	80
10.1 to 15.0 Over	85
5.1 to 10.0 Over	90
0.1 to 5.0 Over	95
Required Surface MRI	100

Segment(s) or portions thereof representing areas excluded from a smoothness test shall also be excluded from consideration for a contract price adjustment for rideability. Corrective action must be taken on those sections that exceed the 'Remove and Replace' threshold on the Long Continuous Interval as directed by the Project Engineer. Sections that fall into this requirement may also need corrective action on both the preceding and following 264-foot sections as to conform to a complete 528-foot Long Continuous Interval. The minimum remove and replace length will be 528 feet (0.1 mile). Additional smoothness testing shall be required on sections following replacement and will be required to meet *at least* the maximum surface MRI short of 'Remove and Replace'.

The above pay factors will be applied in conjunction with the Long Continuous Histogram Chart from ProVAL's Smoothness Assurance Module. The price adjustments for rideability will be tabulated in MDOT's Pay Incentive spreadsheet on the basis of a theoretical tonnage of 110 lbs/yd<sup>2</sup>\*inch thickness (pounds per square yard \* inch thickness) and 12-foot travel lanes, determined in accordance with Subsections 401.02.6.5 and 403.04, for the segment(s) or portions thereof for which an adjustment is warranted.

Delete Subsection 403.03.5.5 on page 273 and substitute the following.

**907-403.03.5.5--Preliminary Leveling.** All irregularities of the existing pavement, such as ruts, cross-slope deficiencies, etc., shall be corrected by spot leveling, skin patching, feather edging or a wedge lift in advance of placing the first overall lift.

**907-403.04--Method of Measurement.** After the first paragraph of Subsection 403.04 on page 274, add the following.

The pay quantities for each individual job mix formula (JMF) will be calculated using the approved JMF maximum specific gravity (Gmm) and the following formulas.

When the composite mixture has a maximum specific gravity of 2.540 or less,

$$T_p = T_w$$

When the composite mixture has a maximum specific gravity greater than 2.540,

$$T_p = T_w \left( \frac{100 - \left( \frac{G_{mm} \cdot A \cdot B - C}{G_{mm} \cdot A \cdot B} \right) \cdot 100}{100} \right)$$

Where:

- Tp = Total tonnage for payment
- Tw = Total tonnage weighed, used and accepted
- Gmm = Maximum Specific Gravity of the approved composite asphalt mixture
- A = 46.725 lbs/yd<sup>2</sup>/in
- B = 0.93 = 93% density
- C = 110.374 lbs/yd<sup>2</sup>/in = Theoretical density at 2.540 Gmm

**MISSISSIPPI DEPARTMENT OF TRANSPORTATION**

**SPECIAL PROVISION NO. 907-403-4**

**CODE: (IS)**

**DATE: 11/04/2005**

**SUBJECT: Hot Mix Asphalt (HMA)**

Section 403, Hot Bituminous Pavement, of the 2004 Edition of the Mississippi Standard Specifications for Road and Bridge Construction is hereby amended as follows:

**907-403.05.2--Pay Items.** Add the "907" prefix to the pay items listed on page 275 & 276.

MISSISSIPPI DEPARTMENT OF TRANSPORTATION

SPECIAL PROVISION NO. 907-403-12

CODE: (SP)

DATE: 08/21/2012

SUBJECT: Warm Mix Asphalt (WMA)

Section 403, Hot Bituminous Pavement, of the 2004 Edition of the Mississippi Standard Specifications for Road and Bridge Construction as amended by this special provision is applicable to Warm Mix Asphalt Only.

907-403.01--Description. This work consists of constructing one or more lifts of Warm Mix Asphalt (WMA) pavement in accordance with the requirements of Section 403 for Hot Mix Asphalt, with the exceptions set forth in this special provision. The WMA shall meet the requirements of this section and placed in reasonably close conformity with the lines, grade, thicknesses, and typical cross sections shown on the plans or established by the Engineer.

907-403.04--Method of Measurement. Warm mix asphalt will be measured by the ton. The weight of the composite mixture shall be determined in accordance with the provisions of Subsection 401.03.2.1.11.

907-403.05--Basis of Payment. Subject to the adjustments set out in Subsections 401.02.6.3, 401.02.6.4, 401.02.6.5, 401.02.6.6 & 403.03.2, warm mix asphalt, measured as prescribed above, will be paid for at the contract unit price per ton for each lift of pavement specified in the bid schedule and shall be full compensation for completing the work.

907-403.05.2--Pay Items. After the last pay item listed on page 276, add the following:

907-403-M: Warm Mix Asphalt, (1), (2) - per ton
Type Mixture

907-403-N: Warm Mix Asphalt, (1), (3), Leveling - per ton
Type Mixture

907-403-O: Warm Mix Asphalt, (1), (4), Trench Widening - per ton
Type Mixture

907-403-P: Warm Mix Asphalt, HT, (3), Polymer Modified - per ton
Mixture

907-403-Q: Warm Mix Asphalt, HT, (3), Polymer Modified, Leveling - per ton
Mixture



**MISSISSIPPI DEPARTMENT OF TRANSPORTATION**

**SPECIAL PROVISION NO. 907-407-1**

**CODE: (SP)**

**DATE: 02/26/2008**

**SUBJECT: Tack Coat**

Section 407, Tack Coat, of the 2004 Edition of the Mississippi Standard Specifications for Road and Bridge Construction is hereby amended as follows:

**907-407.02.1--Bituminous Material.** Delete the second sentence of the first paragraph of Subsection 407.02.1 on page 281, and substitute the following:

When not specified, the materials shall be as specified in Table 410-A on page 293.

**907-407.03.3--Application of Bituminous Material.** Delete the first paragraph of Subsection 407.03.3 on page 281, and substitute the following.

Tack coat shall be applied with a distributor spray bar. A hand wand will only be allowed for applying tack coat on ramp pads, irregular shoulder areas, median crossovers, turnouts, or other irregular areas. Bituminous materials and application rates for tack coat shall be as specified in Table 410-A on page 293. Tack coat shall not be applied during wet or cold weather, after sunset, or to a wet surface. Emulsions shall be allowed to "break" prior to superimposed construction.

**907-407.05--Basis of Payment.** Delete the pay item at the end of Subsection 407.05 on page 282, and substitute the following:

907-407-A: Asphalt for Tack Coat \* - per gallon

\* Grade may be specified

## MISSISSIPPI DEPARTMENT OF TRANSPORTATION

| SPECIAL PROVISION NO. 907-413-5

CODE: (IS)

| DATE: 05/01/2013

**SUBJECT: Sawing and Sealing Transverse Joints in Asphalt Pavement**

Section 413, Cleaning and Sealing Joints and Cracks, of the 2004 Edition of the Mississippi Standard Specifications for Road and Bridge Construction is hereby amended as follows.

**907-413.02--Materials.** Delete the second and third sentence of the second paragraph of Subsection 413.02 on page 294.

**907-413.03--Construction Requirements.**

**907-413.03.3-- Sawing and Sealing Transverse Joints in Asphalt Pavement.**

**907-413.03.3.1--General.** Delete the first paragraph of Subsection 413.03.3.1 on page 296 and substitute the following.

The Contractor's operation shall be conducted so that sawcutting of transverse joints, cleaning, and sealing is a continuous operation. The entire sawing and sealing operation shall be completed within seven (7) days after the placement of the final wearing course, unless the approved traffic control plan or sequence of operations provide otherwise. Traffic shall not be allowed on sawed unsealed joints in the final wearing course.

When intermediate lifts must be exposed to traffic for over seven (7) days, the Contractor shall be required to make an interim 1/8-inch wide saw cut which is one third (1/3) as deep as the asphalt layer. This interim saw cut does not require sealing. Costs of any interim cut(s) shall be included in the pay item for sawing and sealing transverse joints in asphalt pavement.

The detail for sawing and sealing transverse joints in asphalt pavement shall be as shown below. No sawing and sealing of transverse joints will be required in Open Graded Friction Courses (OGFC). However, the lift under the OGFC will require sawing and sealing.

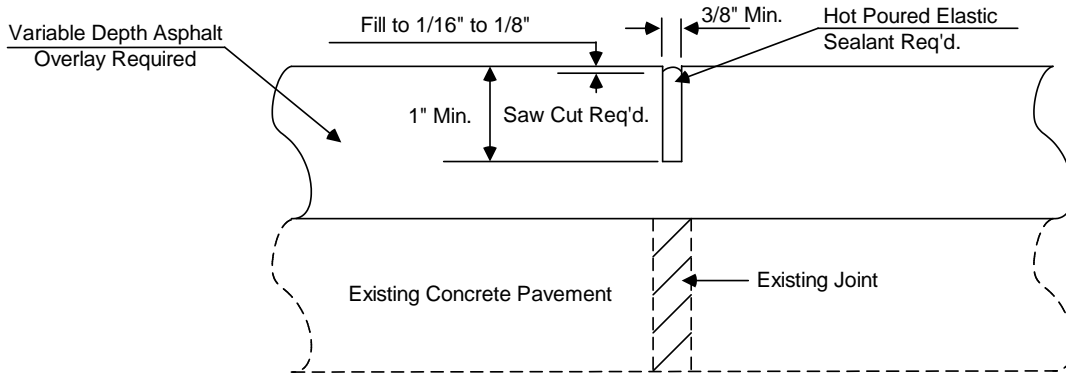

**DETAIL OF SAWING AND SEALING TRANSVERSE JOINTS**

**907-413.03.3.4--Sealing.** Delete the second paragraph of Subsection 413.03.3.4 on page 297.

**907-413.04--Method of Measurement.** Delete the second sentence of the third paragraph of Subsection 413.04 on page 297, and substitute the following.

Sawing and joint sealant material will not be paid for as separate items but will be included in the unit price per linear foot for sawing and sealing transverse joints in asphalt pavement.

**907-413.05--Basis of Payment.** Delete “Bond Breaker Tape and” from the first sentence of the third paragraph of Subsection 413.05 on page 298.

Add the “907” prefix to pay item no. 413-E on page 298.

# MISSISSIPPI DEPARTMENT OF TRANSPORTATION

## SUPPLEMENT TO SPECIAL PROVISION NO. 907-618-1

**DATE:** 01/24/2014

**PROJECT:** NH-0015-02(096) / 106755301 – Jones County

After the first paragraph of Subsection 907-618.01.2 on page 1, add the following.

Additional signs will be required as follows.

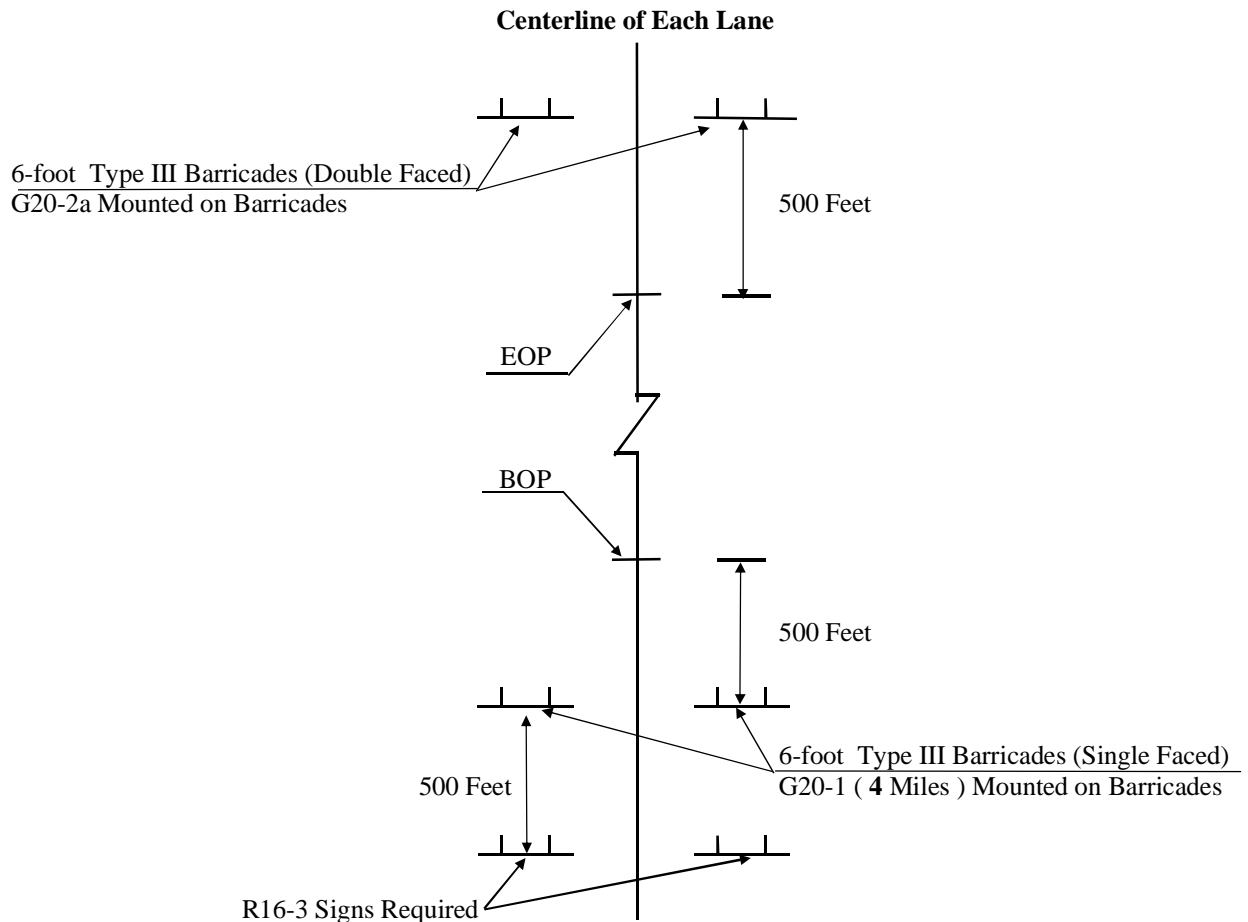

### ADDITIONAL TRAFFIC CONTROL SIGNS REQUIRED:

- 20 - W20-1 "AHEAD" signs required. One (1) sign is required at each local road or street entering the project.
- 4 - R16-3 "SPEEDING FINES DOUBLED" signs required.

R16-3 signs shall be spaced in accordance with sheet titled "Location of R16-3 Signs".

All Construction signing is included in the bid for Pay Item 618-A, Maintenance of Traffic. Fluorescent orange sheeting shall be used on all construction and traffic control signs except for R16-3 which shall be black legend and border on white background.

STATE	PROJECT NO.
MISS.	

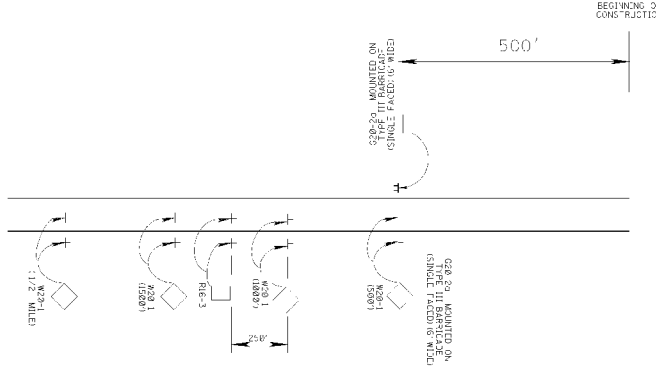

**DIVIDED HIGHWAY  
(PROJECTS LESS THAN 1 MILE LENGTH)**

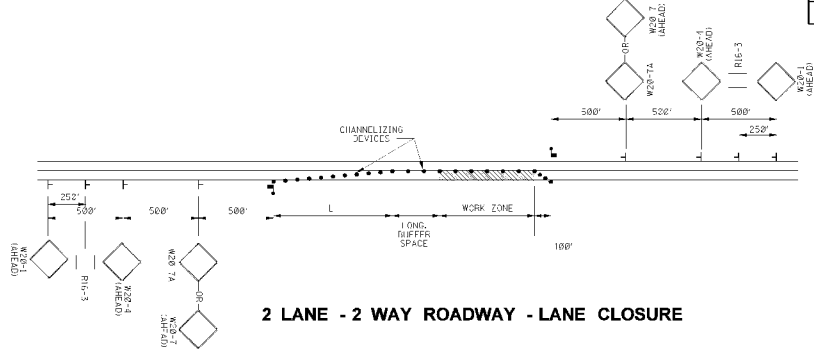

**2 LANE - 2 WAY ROADWAY - LANE CLOSURE**

**NOTES**

R16-3 SIGN TO BE PLACED AS SHOWN OR AS DIRECTED BY THE ENGINEER.  
R16-3 SIGN SHALL BE SPACED AT A MAXIMUM OF 2 MILES THROUGHOUT LENGTH OF PROJECT.

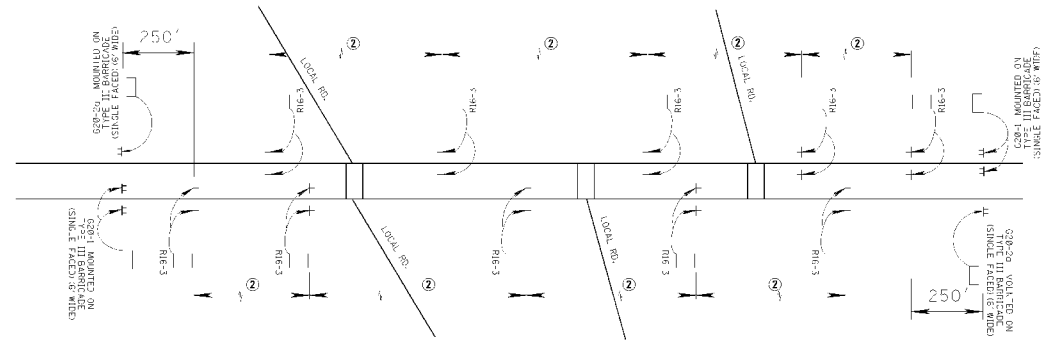

**DIVIDED HIGHWAY SHOWN  
(2 LANE - 2 WAY ROADWAY SIMILAR)  
(PROJECT MORE THAN 1 MILE LENGTH)**

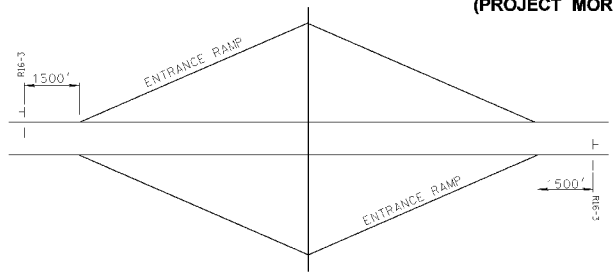

**INTERSTATE DETAIL**

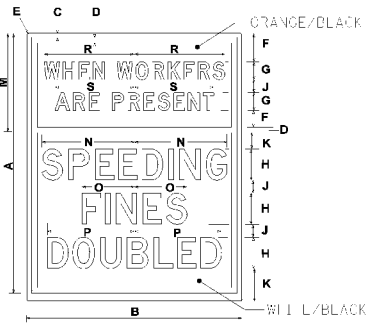

SIGN	DIMENSIONS (INCHES)							
	A	B	C	D	E	F	G	H
STD.	60	48	3/4	1 1/4	3	3 3/4	4 0m	7 1/2
			M	N	O	P	Q	S
STD.	3	6 3/4	2 3/8	2 1/2	1 1/8	1 3/8	2 3/8	1 1/2

48" x 60"  
(UNITS ARE L.S.U.)

SIGN	DIMENSIONS (INCHES)							
	A	B	C	D	E	F	G	H
STD.	48	36	3/4	1 1/4	3	3 3/4	5 0m	6 0
			M	N	O	P	Q	S
STD.	3	4 3/4	1 3/8	1 1/4	7 3/8	1 3/8	1 3/8	1 1/2

36" x 48"  
(ALL OTHER HIGHWAYS)

**R16-3**

MISSISSIPPI DEPARTMENT OF TRANSPORTATION	
<b>LOCATION OF R16-3 SIGNS</b>	
DESIGNER	WORKING NUMBER
CHECKED	SPEED NUMBER
DATE	DATE
PROJECT NAME: SPEED SIGN DETAILED.dwg	
DESIGN TEAM	CHECKED
	DATE: 07-23-04

147

- 2 -

**MISSISSIPPI DEPARTMENT OF TRANSPORTATION**

**SPECIAL PROVISION NO. 907-618-1**

**CODE: (SP)**

**DATE: 04/29/2004**

**SUBJECT: Additional Signing Requirements**

Section 618, Maintenance of Traffic and Traffic Control Plan, of the 2004 Edition of the Mississippi Standard Specifications for Road and Bridge Construction is hereby amended as follows.

**907-618.01.2--Traffic Control Plan.** At the end of Subsection 618.01.2 on page 413, add the following:

For compliance with the traffic control plan, the Contractor will be required to install and maintain construction signs at various location throughout the project. Payment for these signs will be included in the price bid for pay item no. 618-A, Maintenance of Traffic per lump sum.

## MISSISSIPPI DEPARTMENT OF TRANSPORTATION

**SPECIAL PROVISION NO. 907-618-9**

**CODE: (IS)**

**DATE: 11/08/2012**

**SUBJECT: Placement of Temporary Traffic Stripe**

Section 618, Maintenance of Traffic and Traffic Control Plan, of the 2004 Edition of the Mississippi Standard Specifications for Road and Bridge Construction is hereby amended as follows.

**907-618.03.3--Safe Movement of Traffic.** Delete subparagraphs (2) and (3) of Subsection 618.03.3 on page 416, and substitute the following.

- (2) Temporary edge lines on projects requiring shoulders constructed of granular material may be delayed for a period not to exceed three (3) days.

Temporary edge lines placed on the final pavement course of projects requiring paved shoulders with surface treatment may be placed on the adjacent shoulder in as near the permanent location as possible until the surface treatment is placed. When the edge lines are obliterated by the placement of the surface treatment, the edge lines shall be placed in the permanent stripe location. The replacement of edge lines may be delayed for a period not to exceed three (3) days for a two or three-lane roads.

Delete the first sentence of next to last paragraph of Subsection 618.03.3 on page 416 and substitute the following.

Permanent pavement markings are to be applied no sooner than 10 days nor later than 45 days after placement of the final lift of pavement.

MISSISSIPPI DEPARTMENT OF TRANSPORTATION

SPECIAL PROVISION NO. 907-626-25

CODE: (IS)

DATE: 11/13/2012

SUBJECT: Thermoplastic Traffic Markings

Section 626, Thermoplastic Traffic Markings, of the 2004 Edition of the Mississippi Standard Specifications for Road and Bridge Construction is hereby amended as follows.

**907-626.01--Description.** After the last sentence of the first paragraph of Subsection 626.01 on page 443, add the following.

All pavement marking material, excluding edge lines over rumble strips, shall be applied using the extrusion/ribbon method. Edge lines placed over rumble strips shall be applied using the atomization/spray method.

**907-626.03.1.1--Equipment.** After the second paragraph of Subsection 626.03.1.1 on page 444, add the following.

When edge lines are placed over rumble strips, the equipment must be able to apply the marking material using the atomization/spray method instead of extrusion/ribbon method.

**907-626.03.1.2--Construction Details.** Delete the second sentence of the first full paragraph of Subsection 626.03.1.2 on page 445, and substitute the following.

Unless otherwise specified in the plans or contract documents, the thickness shall be 90 mils for edge lines, center lines, lane lines, barrier lines and detail stripe including gore markings, and 120 mils for crosswalks, stop lines, and railroad, word and symbol markings.

After the last sentence of the third full paragraph of Subsection 626.03.1.2 on page 445, add the following.

When double drop thermoplastic stripe is called for in the contract, additional beads by the drop-on method shall be applied as follows.

Class A glass beads at a rate of not less than three pounds of beads per 100 feet of six-inch stripe.  
Class B glass beads at a rate of not less than three pounds of beads per 100 feet of six-inch stripe.

The Class B glass beads shall be applied to the newly placed stripe first, followed by the application of the Class A glass beads.

**907-626.05--Basis of Payment.** Delete the pay items listed on page 446 and substitute the following.



907-626-A: 6" Thermoplastic* Traffic Stripe, Skip White	- per linear foot or mile
907-626-B: 6" Thermoplastic* Traffic Stripe, Continuous White	- per linear foot or mile
907-626-C: 6" Thermoplastic* Edge Stripe, Continuous White	- per linear foot or mile
907-626-D: 6" Thermoplastic* Traffic Stripe, Skip Yellow	- per linear foot or mile
907-626-E: 6" Thermoplastic* Traffic Stripe, Continuous Yellow	- per linear foot or mile
907-626-F: 6" Thermoplastic* Edge Stripe, Continuous Yellow	- per linear foot or mile
907-626-G: Thermoplastic* Detail Stripe, <u>Color</u>	- per linear foot
907-626-H: Thermoplastic* Legend, White	- per linear foot or square foot

\* Indicate Double Drop if applicable

**MISSISSIPPI DEPARTMENT OF TRANSPORTATION**

**SPECIAL PROVISION NO. 907-702-3**

**CODE: (SP)**

**DATE: 05/08/2012**

**SUBJECT: Polyphosphoric Acid (PPA) Modification of Petroleum Asphalt Cement**

Section 702.05, Petroleum Asphalt Cement, of the 2004 Edition of the Mississippi Standard Specifications for Road and Bridge Construction is hereby amended as follows:

**907-702.05--Petroleum Asphalt Cement.** Delete the third paragraph of Subsection 702.05 on page 598, and substitute the following.

The bituminous material used in all types of asphalt mixtures shall conform to AASHTO Designation: M 320, Performance Grade PG 67-22, as modified in the table below, except that Polyphosphoric Acid (PPA) may be used at low dosage rates as a modifier to enhance the physical properties of a base binder to meet the requirements for Performance Grade PG 67-22. In addition, PPA may be used as a catalyst or mixing agent at low dosage rates in the production of Polymer Modified, Performance Grade PG 76-22.

When PPA is used as a modifier, in no case shall the PPA modifier be used to adjust the physical properties of the binder a full binder grade. For example: the base binder (unmodified) is graded as a PG 64-22 and should only be modified by the addition of PPA to a modified binder grade of PG 67-22.

When petroleum asphalt cement is modified by PPA, the following dosage limits shall be applied.

<b>Grade</b>	<b>Dosage Limit</b>
PG 67-22	0.75% by weight of binder
PG 76-22	0.50% by weight of binder

# MISSISSIPPI DEPARTMENT OF TRANSPORTATION

SPECIAL PROVISION NO. 907-703-11

CODE: (IS)

DATE: 05/22/2013

SUBJECT: Aggregates

Section 703, Aggregates, of the 2004 Edition of the Mississippi Standard Specifications for Road and Bridge Construction is hereby amended as follows:

**907-703.03.2.4--Gradation.** Delete the last sentence of the last paragraph of Subsection 703.03.2.4 on page 611.

**907-703.04--Aggregate for Crushed Stone Courses.**

**907-703.04.1--Coarse Aggregate.** Delete the first paragraph of Subsection 703.04.1 on page 611, and substitute the following.

Coarse aggregate, defined as material retained on No. 8 sieve, shall be either crushed limestone, steel slag, granite, concrete, or combination thereof. Crushed concrete is defined as recycled concrete pavement, structural concrete, or other concrete sources that can be crushed to meet the gradation requirements for Size No. 825B as modified below. In no case shall waste from concrete production (wash-out) be used as a crushed stone base.

**907-703.04.2--Fine Aggregate.** Delete the first sentence of the first paragraph of Subsection 703.04.2 on page 612, and substitute the following.

Fine aggregate, defined as material passing the No. 8 sieve, shall be material resulting from the crushing of limestone, steel slag, granite, concrete, or combination thereof.

Delete the third paragraph of Subsection 703.04.2 on page 612.

**907-703.04.3--Gradation.** In the table of Subsection 703.04.3 on page 613, change the requirement for the 1-inch sieve under Size No. 825 B from “75 - 98” to “75 - 100”.

After the table in Subsection 703.04.3 on page 613, add the following.

If crushed concrete is used, the crushed material shall meet the gradation requirements of Size No. 825 B with the exception that the percent passing by weight of the No. 200 sieve shall be 2 – 18.

**907-703.06--Aggregates for Hot Mix Asphalt.**

**907-703.06.1--Coarse Aggregates.** Delete the third paragraph of Subsection 703.06.1 on page 613, and substitute the following.

When tested in accordance with AASHTO Designation: T 19, the dry rodded unit weight of all aggregates except expanded clay and shale shall not be less than 70 pounds per cubic foot.

**907-703.06.1.2--Fine Aggregates.** Delete the last sentence of Subsection 703.06.1.2 on page 614.

**907-703.14--Aggregates for Bituminous Surface Treatments.**

**907-703.14.2--Detail Requirements.**

**907-703.14.2.1--Gradation.** In the table entitled “Gradation Requirements For Cover Aggregate” in Subsection 703.14.2.1 on page 622, delete the requirement for the No. 16 sieve for Size No. 7 under the column “Slag or Expanded Clay”.

**907-703.20.3--Gradation.** Delete the table and notes in Subsection 703.20.3 at the top of page 626, and substitute the following.

**PERCENT PASSING BY WEIGHT**

Square Mesh Sieves	Shell	Coarse			Medium	Fine
		Size I	Size II Note (1)	Size III Note (3)		
3 inch	90-100			100		
2 1/2 inch				90-100		
2 inch		100				
1 1/2 inch		90-100	100	25-60		
1 inch		80-100	97-100			
3/4 inch		55-100	55-100	0-10		
1/2 inch		35-85	35-85	0-5	100	
3/8 inch	12-65	12-65		97-100		
No. 4, Note (2)	0-30	0-30		92-100		
No. 10	0-8	0-8		80-100	100	
No. 40				10-40	80-100	
No. 60				0-20	30-100	
No. 100					15-80	
No. 200	0-5	0-4	0-4	0-5	0-30	
PI Material Passing No. 40				6 or less	0	

Note (1): Size II is intended for use in bases in which portland cement is used.

Note (2): Ground shell shall contain at least 97% passing the No. 4 sieve.

Note (3): Size III is intended for use in stabilized construction entrances.

## MISSISSIPPI DEPARTMENT OF TRANSPORTATION

SPECIAL PROVISION NO. 907-710-1

CODE: (SP)

DATE: 06/24/10

SUBJECT: Fast Dry Solvent Traffic Paint

Section 710, Paint, of the 2004 Edition of the Mississippi Standard Specifications for Road and Bridge Construction is amended as follows:

After Subsection 710.05 on Page 661, add the following:

**907-710.06--Fast Dry Solvent Traffic Paint.** Fast dry solvent traffic paints intended for use under this specification shall include products that are single packaged and ready mixed. Upon curing, these materials shall produce an adherent, reflective pavement marking capable of resisting deformation by traffic. The manufacturer shall have the option of formulating the material according to their own specifications. However, the requirements delineated in this specification, Section 619 and Section 710 shall apply regardless of the formulation used. The material shall be free from all skins, dirt and foreign objects.

**907-710.06.1--Composition.**

**907-710.06.1.1--Percent Pigment.** The percent pigment by weight shall be not less than 51% nor more than 58% when tested in accordance with ASTM D 3723.

**907-710.06.1.2--Viscosity.** The consistency of the paint shall be not less than 75 nor more than 95 Krebs Units (KU) when tested in accordance with ASTM D 562.

**907-710.06.1.3--Weight per Gallon.** The paint shall weigh a minimum 11.8 pounds per gallon and the weight of the production batches shall not vary more than +/- 0.5 pounds per gallon from the weight of the qualification samples when tested in accordance with ASTM D 1475.

**907-710.06.1.4--Total Solids.** The percent of total solids shall not be less than 70% by weight when tested in accordance with ASTM D 2369.

**907-710.06.1.5--Dry Time (No pick-up).** The paint shall dry to a no tracking condition in a maximum of 10 minutes.

**907-710.06.1.6--Volatile Organic Content.** The volatile organic content (VOC) shall contain a maximum of 1.25 pounds of volatile organic matter per gallon of total non-volatile paint material when tested in accordance with ASTM D 3960.

**907-710.06.1.7--Bleeding.** The paint shall have a minimum bleeding ratio of 0.95 when tested in accordance with Federal Specification TT-P-115D.

**907-710.06.1.8--Color.** The initial daytime chromaticity for yellow materials shall fall within the box created by the following coordinates:

**Initial Daytime Chromaticity Coordinates (Corner Points)**

	<b>1</b>	<b>2</b>	<b>3</b>	<b>4</b>
<b>x</b>	<b>0.53</b>	<b>0.51</b>	<b>0.455</b>	<b>0.472</b>
<b>y</b>	<b>0.456</b>	<b>0.485</b>	<b>0.444</b>	<b>0.4</b>

The initial daytime chromaticity of white materials shall fall within the box created by the following coordinates:

**Initial Daytime Chromaticity Coordinates (Corner Points)**

	<b>1</b>	<b>2</b>	<b>3</b>	<b>4</b>
<b>x</b>	<b>0.355</b>	<b>0.305</b>	<b>0.285</b>	<b>0.355</b>
<b>y</b>	<b>0.355</b>	<b>0.305</b>	<b>0.325</b>	<b>0.375</b>

**907-710.06.2--Environmental Requirements.** All yellow materials using lead chromate pigments shall meet the criteria of non-hazardous waste as defined by 40 CFR 261.24 when tested in accordance with EPA Test Method 1311, Toxicity Characteristics Leaching Procedures (TCLP). The striping and marking material , upon preparation and installation, shall not exude fumes which are toxic, or detrimental to persons or property. All material using lead free pigments shall NOT contain either lead or other Resource Conservation and Recovery Act (RCCA) materials in excess of the standard defined by EPA Method 3050 and 6010.

**907-710.06.3--Acceptance Procedures.** Acceptance of all fast dry solvent based traffics paint will be based on the Manufacturer's Certification and Certified Test Results. The Contractor shall furnish the Engineer with three copies of the manufacturer's certification stating that each lot of material in a shipment complies with the requirements of this contract. In addition, the Contractor shall provide Certified Test Reports for all tests required by this specification. The test results shall be representative of the material contained with the shipment.

## MISSISSIPPI DEPARTMENT OF TRANSPORTATION

| SPECIAL PROVISION NO. 907-720-2

CODE: (IS)

| DATE: 05/01/2013

| SUBJECT: Pavement Marking Materials

Section 720, Pavement Marking Materials, of the 2004 Edition of the Mississippi Standard Specifications for Road and Bridge Construction is hereby amended as follows.

| 907-720.01--Glass Beads. After the first sentence of Subsection 720.01 on page 729, add the following.

The glass beads shall contain no more than 200 ppm (mg/kg) total concentration for lead, arsenic, or antimony. The manufacture shall furnish the Engineer with a certified test report indicating that the glass beads meet the above requirement.

907-720.02--Thermoplastic Pavement Markings. Delete the first paragraph of Subsection 720.02 on page 730 and substitute the following.

The thermoplastic material shall be lead free and conform to AASHTO Designation: M 249 except the glass beads shall be moisture resistant coated.

After the first sentence of the second paragraph of Subsection 720.02 on page 730, add the following.

In addition, the certification for the thermoplastic material shall state that the material is lead free.

# S E C T I O N 9 0 5 - P R O P O S A L

Date \_\_\_\_\_

Mississippi Transportation Commission  
Jackson, Mississippi

Sirs: The following proposal is made on behalf of \_\_\_\_\_  
\_\_\_\_\_ of \_\_\_\_\_

for constructing the following designated project(s) within the time(s) hereinafter specified.

The plans are composed of drawings and blue prints on file in the offices of the Mississippi Department of Transportation, Jackson, Mississippi.

The Specifications are the current Standard Specifications of the Mississippi Department of Transportation approved by the Federal Highway Administration, except where superseded or amended by the plans, Special Provisions and Notice(s) to Bidders attached hereto and made a part thereof.

I (We) certify that I (we) possess a copy of said Standard and Supplemental Specifications.

Evidence of my (our) authority to submit the Proposal is hereby furnished. The proposal is made without collusion on the part of any person, firm or corporation. I (We) certify that I (we) have carefully examined the Plans, the Specifications, including the Special Provisions and Notice(s) to Bidders, herein, and have personally examined the site of the work. On the basis of the Specifications, Special Provisions, Notice(s) to Bidders, and Plans, I (we) propose to furnish all necessary machinery, tools, apparatus and other means of construction and do all the work and furnish all the materials in the manner specified. I (We) understand that the quantities mentioned herein are approximate only and are subject to either increase or decrease, and hereby propose to perform any increased or decreased quantities of work at the unit prices bid, in accordance with the above.

Attached hereto is a certified check, cashier's check or Proposal Guaranty Bond in the amount as required in the Advertisement (or, by law).

**INSTRUCTION TO BIDDERS:** Alternate and Optional Items on Bid Schedule.

1. Two or more items entered opposite a single unit quantity WITHOUT DEFINITE DESIGNATION AS "ALTERNATE ITEMS" are considered as "OPTIONAL ITEMS". Bidders may or may not indicate on bids the Optional Item proposed to be furnished or performed WITHOUT PREJUDICE IN REGARD TO IRREGULARITY OF BIDS.
2. Items classified on the bid schedule as "ALTERNATE ITEMS" and/or "ALTERNATE TYPES OF CONSTRUCTION" must be preselected and indicated on bids. However, "Alternate Types of Construction" may include Optional Items to be treated as set out in Paragraph 1, above.
3. Optional items not preselected and indicated on the bid schedule MUST be designated in accordance with Subsection 102.06 prior to or at the time of execution of the contract.
4. Optional and Alternate items designated must be used throughout the project.

I (We) further propose to perform all "force account or extra work" that may be required of me (us) on the basis provided in the Specifications and to give such work my (our) personal attention in order to see that it is economically performed.



**SECTION 905 -- PROPOSAL (CONTINUED)**

I (We) further propose to execute the attached contract agreement (Section 902) as soon as the work is awarded to me (us), and to begin and complete the work within the time limit(s) provided for in the Specifications and Advertisement. I (We) also propose to execute the attached contract bond (Section 903) in an amount not less than one hundred (100) percent of the total of my (our) part, but also to guarantee the excellence of both workmanship and materials until the work is finally accepted.

I (We) enclose a certified check, cashier's check or bid bond for **five percent (5%) of total bid** and hereby agree that in case of my (our) failure to execute the contract and furnish bond within Ten (10) days after notice of award, the amount of this check (bid bond) will be forfeited to the State of Mississippi as liquidated damages arising out of my (our) failure to execute the contract as proposed. It is understood that in case I am (we are) not awarded the work, the check will be returned as provided in the Specifications.

Respectfully Submitted,

DATE \_\_\_\_\_

\_\_\_\_\_  
Contractor

BY \_\_\_\_\_  
Signature

TITLE \_\_\_\_\_

ADDRESS \_\_\_\_\_

CITY, STATE, ZIP \_\_\_\_\_

PHONE \_\_\_\_\_

FAX \_\_\_\_\_

E-MAIL \_\_\_\_\_

(To be filled in if a corporation)

Our corporation is chartered under the Laws of the State of \_\_\_\_\_ and the names, titles and business addresses of the executives are as follows:

\_\_\_\_\_  
President Address

\_\_\_\_\_  
Secretary Address

\_\_\_\_\_  
Treasurer Address

The following is my (our) itemized proposal.

Mill and Overlay approximately 4 miles of US 84 from SR 28 to SR 15, known as Federal Aid Project No. NH-0015-02(096) / 106755301 in Jones County.

Line No.	Item Code	Adj Code	Quantity	Units	Description [Fixed Unit Price]
<b>Roadway Items</b>					
0010	202-B053		1,700	Linear Feet	Removal of Guard Rail Including Post, Blockouts & Hardware
0020	202-B076		2,846	Linear Feet	Removal of Traffic Stripe
0030	202-B078		650	Square Yard	Removal of Pavement, All Types and Depths
0040	203-G004	(E)	200	Cubic Yard	Excess Excavation, LVM, AH
0050	209-A004		534	Square Yard	Geotextile Stabilization, Type V, Non-Woven
0060	406-A001		57,500	Square Yard	Cold Milling of Bituminous Pavement, All Depths
0070	423-A001		10	Mile	Rumble Strips, Ground In
0080	606-B005		1,300	Linear Feet	Guard Rail, Class A, Type 1, 'W' Beam
0090	606-D015		8	Each	Guard Rail, Bridge End Section
0100	606-E002		8	Each	Guard Rail, Terminal End Section, Flared
0110	618-A001		1	Lump Sum	Maintenance of Traffic
0120	618-B001		1	Square Feet	Additional Construction Signs [\$10.00]
0130	619-A1002		11	Mile	Temporary Traffic Stripe, Continuous White
0140	619-A2002		9	Mile	Temporary Traffic Stripe, Continuous Yellow
0150	619-A3006		12	Mile	Temporary Traffic Stripe, Skip White
0160	619-A4006		2	Mile	Temporary Traffic Stripe, Skip Yellow
0170	619-A5001		7,000	Linear Feet	Temporary Traffic Stripe, Detail
0180	619-A6001		1,750	Linear Feet	Temporary Traffic Stripe, Legend
0190	627-J001		234	Each	Two-Way Clear Reflective High Performance Raised Markers
0200	627-K001		1,125	Each	Red-Clear Reflective High Performance Raised Markers
0210	627-L001		749	Each	Two-Way Yellow Reflective High Performance Raised Markers
0220	630-F001		28	Each	Delineators, Guard Rail, White
0230	630-F002		28	Each	Delineators, Guard Rail, Yellow
0240	630-G001		4	Each	Type 3 Object Markers, OM-3R, Post Mounted
0250	630-G003		4	Each	Type 3 Object Markers, OM-3L, Post Mounted
0260	635-A001		2,126	Linear Feet	Vehicle Loop Assemblies
0270	907-407-A001	(A2)	12,700	Gallon	Asphalt for Tack Coat
0280	907-413-E001		9,744	Linear Feet	Sawing and Sealing Transverse Joints in Asphalt Pavement
0290	907-626-A003		7	Mile	6" Thermoplastic Traffic Stripe, Skip White
0300	907-626-C003		6	Mile	6" Thermoplastic Double Drop Edge Stripe, Continuous White
0310	907-626-D003		2	Mile	6" Thermoplastic Traffic Stripe, Skip Yellow
0320	907-626-E004		2	Mile	6" Thermoplastic Traffic Stripe, Continuous Yellow

Line No.	Item Code	Adj Code	Quantity	Units	Description [Fixed Unit Price]
0330	907-626-F003		4	Mile	6" Thermoplastic Double Drop Edge Stripe, Continuous Yellow
0340	907-626-G004		21,000	Linear Feet	Thermoplastic Detail Stripe, White
0350	907-626-G005		15,000	Linear Feet	Thermoplastic Detail Stripe, Yellow
0360	907-626-H004		2,408	Linear Feet	Thermoplastic Legend, White
0370	907-626-H005		882	Square Feet	Thermoplastic Legend, White
0380	907-824-PP008		840	Linear Feet	Bridge Repair, Silicone Sealed Joint, Per Plans
<b>ALTERNATE GROUP AA NUMBER 1</b>					
0390	907-304-F002	(GT )	3,300	Ton	Size 610 Crushed Stone Base
<b>ALTERNATE GROUP AA NUMBER 2</b>					
0400	907-304-F003	(GT )	3,300	Ton	3/4" and Down Crushed Stone Base
<b>ALTERNATE GROUP AA NUMBER 3</b>					
0410	907-304-F004	(GT )	3,300	Ton	Size 825B Crushed Stone Base
<b>ALTERNATE GROUP BB NUMBER 1</b>					
0420	907-403-A005	(BA1 )	14,600	Ton	Hot Mix Asphalt, HT, 9.5-mm mixture
<b>ALTERNATE GROUP BB NUMBER 2</b>					
0430	907-403-M009	(BA1 )	14,600	Ton	Warm Mix Asphalt, HT, 9.5-mm mixture
<b>ALTERNATE GROUP CC NUMBER 1</b>					
0440	907-403-A002	(BA1 )	375	Ton	Hot Mix Asphalt, HT, 19-mm mixture
<b>ALTERNATE GROUP CC NUMBER 2</b>					
0450	907-403-M011	(BA1 )	375	Ton	Warm Mix Asphalt, HT, 19-mm mixture
<b>ALTERNATE GROUP DD NUMBER 1</b>					
0460	907-403-B003	(BA1 )	3,700	Ton	Hot Mix Asphalt, HT, 9.5-mm mixture, Leveling
<b>ALTERNATE GROUP DD NUMBER 2</b>					
0470	907-403-N008	(BA1 )	3,700	Ton	Warm Mix Asphalt, HT, 9.5-mm mixture, Leveling

**CONDITIONS FOR COMBINATION BID**

If a bidder elects to submit a combined bid for two or more of the contracts listed for this month's letting, the bidder must complete and execute these sheets of the proposal in each of the individual proposals to constitute a combination bid. In addition to this requirement, each individual contract shall be completed, executed and submitted in the usual specified manner.

Failure to execute this Combination Bid Proposal in each of the contracts combined will be just cause for each proposal to be received and evaluated as a separate bid.

\*\*\*\*\*

**COMBINATION BID PROPOSAL**

I. This proposal is tendered as one part of a Combination Bid Proposal utilizing option \_\_\_\* of Subsection 102.11 on the following contracts:

\* Option to be shown as either (a), (b), or (c).

<u>Project No.</u>	<u>County</u>	<u>Project No.</u>	<u>County</u>
1. _____	_____	6. _____	_____
2. _____	_____	7. _____	_____
3. _____	_____	8. _____	_____
4. _____	_____	9. _____	_____
5. _____	_____	10. _____	_____

A. If option (a) has been selected, then go to II, and sign Combination Bid Proposal.

B. If option (b) has been selected, then complete the following, go to II, and sign Combination Bid Proposal.

SECTION 905 - COMBINATION BID PROPOSAL (Continued)

Project Number	Pay Item Number	Unit	Unit Price Reduction	Total Item Reduction	Total Contract Reduction
1. _____	_____ _____	_____ _____	_____ _____	_____ _____	
2. _____	_____ _____	_____ _____	_____ _____	_____ _____	
3. _____	_____ _____	_____ _____	_____ _____	_____ _____	
4. _____	_____ _____	_____ _____	_____ _____	_____ _____	
5. _____	_____ _____	_____ _____	_____ _____	_____ _____	
6. _____	_____ _____	_____ _____	_____ _____	_____ _____	
7. _____	_____ _____	_____ _____	_____ _____	_____ _____	
8. _____	_____ _____	_____ _____	_____ _____	_____ _____	

SECTION 905 - COMBINATION BID PROPOSAL (Continued)

Project Number	Pay Item Number	Unit	Unit Price Reduction	Total Item Reduction	Total Contract Reduction
9. _____	_____ _____	_____ _____	_____ _____	_____ _____	
10. _____	_____ _____	_____ _____	_____ _____	_____ _____	

C. If option (c) has been selected, then initial and complete one of the following, go to II. and sign Combination Bid Proposal.

\_\_\_\_\_ I (We) desire to be awarded work not to exceed a total monetary value of \$ \_\_\_\_\_.

\_\_\_\_\_ I (We) desire to be awarded work not to exceed \_\_\_\_\_ number of contracts.

II. It is understood that the Mississippi Transportation Commission not only reserves the right to reject any and all proposals, but also the right to award contracts upon the basis of lowest separate bids or combination bids most advantageous to the State.

It is further understood and agreed that the Combination Bid Proposal is for comparison of bids only and that each contract shall operate in every respect as a separate contract in accordance with its proposal and contract documents.

I (We), the undersigned, agree to complete each contract on or before its specified completion date.

SIGNED \_\_\_\_\_  
\_\_\_\_\_  
\_\_\_\_\_

**Certification with regard to the Performance of Previous  
Contracts or Subcontracts subject to the Equal Opportunity  
Clause and the filing of Required Reports**

The Bidder \_\_\_\_\_, proposed Subcontractor \_\_\_\_\_, hereby certifies that he has \_\_\_\_\_, has not \_\_\_\_\_, participated in a previous contract or subcontract subject to the Equal Opportunity Clause, as required by Executive Orders 10925, 11114, or 11246, and that he has \_\_\_\_\_, has not \_\_\_\_\_, filed with the Joint Reporting Committee, the Director of the Office of Federal Contract Compliance, a Federal Government contracting or administering agency, or the former President's Committee on Equal Employment Opportunity, all reports due under the applicable filing requirements.

\_\_\_\_\_  
(COMPANY)

BY \_\_\_\_\_

\_\_\_\_\_  
(TITLE)

DATE: \_\_\_\_\_

NOTE: The above certification is required by the Equal Employment Opportunity Regulations of the Secretary of Labor (41 CFR 60-1.7 (b) (1)), and must be submitted by bidders and proposed subcontractors only in connection with contracts and subcontracts which are subject to the Equal Opportunity Clause. Contracts and Subcontracts which are exempt from the Equal Opportunity Clause are set forth in 41 CFR 60-1.5. (Generally only contracts or subcontracts of \$10,000 or under are exempt.)

Currently, Standard Form 100 (EEO-1) is the only report required by the Executive Orders or their implementing regulations.

Proposed prime Contractors and Subcontractors who have participated in a previous contract or subcontract subject to the Executive orders and have not filed the required reports should note that 41 CFR 60-1.7 (b) (1) prevents the award of contracts and subcontracts unless such Contractors submit a report covering the delinquent period or such other period specified by the Federal Highway Administration or by the Director, Office of Federal Contract Compliance, U. S. Department of Labor.

**MISSISSIPPI DEPARTMENT OF TRANSPORTATION**

CERTIFICATION  
(Execute in duplicate)

I, \_\_\_\_\_,  
(Name of person signing certification)

individually, and in my capacity as \_\_\_\_\_ of  
(Title)

\_\_\_\_\_ do hereby certify under  
(Name of Firm, Partnership, or Corporation)

penalty of perjury under the laws of the United States and the State of Mississippi that \_\_\_\_\_

\_\_\_\_\_, Bidder  
(Name of Firm, Partnership, or Corporation)

on Project No. **NH-0015-02(096) / 106755301**

in **Jones** County(ies), Mississippi, has not either

directly or indirectly entered into any agreement, participated in any collusion; or otherwise taken any action in restraint of free competitive bidding in connection with this contract; nor have any of its corporate officers or principal owners.

Except as noted hereafter, it is further certified that said legal entity and its corporate officers, principal owners, managers, auditors and others in a position of administering federal funds:

- a) Are not presently debarred, suspended, proposed for debarment, declared ineligible, or voluntarily excluded from covered transactions by any Federal department or agency;
- b) Have not within a three-year period preceding this proposal been convicted of or had a civil judgment rendered against them for commission of fraud or a criminal offense in connection with obtaining, attempting to obtain, or performing a public (Federal, State or local) transaction or contract under a public transaction; violation of Federal or State antitrust statutes or commission of embezzlement, theft, forgery, bribery, falsification or destruction of records, making false statements, or receiving stolen property;
- c) Are not presently indicted for or otherwise criminally or civilly charged by a governmental entity (Federal, State or local) with commission of any of the offenses enumerated in (b) above; and
- d) Have not within a three-year period preceding this application/ proposal had one or more public transactions (Federal, State or local) terminated for cause or default.

Initial here "\_\_\_\_\_" if exceptions are attached and made a part thereof. Any exceptions shall address to whom it applies, initiating agency and dates of such action.



Note: Exceptions will not necessarily result in denial of award but will be considered in determining bidder responsibility. Providing false information may result in criminal prosecution or administrative sanctions.

The bidder further certifies that the certification requirements contained in Section XI of Form FHWA 1273, will be or have been included in all subcontracts, material supply agreements, purchase orders, etc. except those procurement contracts for goods or services that are expected to be less than the Federal procurement small purchase threshold fixed at 10 U.S.C. 2304(g) and 41 U.S.C. 253(g) (currently \$25,000) which are excluded from the certification requirements.

The bidder further certifies, to the best of his or her knowledge and belief, that:

- 1) No Federal appropriated funds have been paid or will be paid to any person for influencing or attempting to influence an officer or employee of any Federal agency, a Member of Congress, an officer or employee of Congress, or an employee of a Member of Congress in connection with the awarding of any Federal contract, the making of any Federal grant, the making of any Federal loan, the entering into of any cooperative agreement, and the extension, continuation, renewal, amendment, or modification of any Federal contract, grant, loan, or cooperative agreement.
- 2) If any funds other than Federal appropriated funds have been paid or will be paid to any person for influencing or attempting to influence an officer or employee of any Federal agency, a Member of Congress, an officer or employee of Congress, or an employee of a Member of Congress in connection with this contract, Standard Form-LLL, "Disclosure Form to Report Lobbying," in accordance with its instructions will be completed and submitted.

The certification contained in (1) and (2) above is a material representation of fact upon which reliance is placed and a prerequisite imposed by Section 1352, Title 31, U.S. Code prior to entering into this contract. Failure to comply shall be subject to a civil penalty of not less than \$10,000 and not more than \$100,000. The bidder shall include the language of the certification in all subcontracts exceeding \$100,000 and all subcontractors shall certify and disclose accordingly.

All of the foregoing and attachments (when indicated) is true and correct.

Executed on \_\_\_\_\_

\_\_\_\_\_  
Signature

# MISSISSIPPI DEPARTMENT OF TRANSPORTATION

## CERTIFICATION (Execute in duplicate)

I, \_\_\_\_\_,  
(Name of person signing certification)

individually, and in my capacity as \_\_\_\_\_ of  
(Title)

\_\_\_\_\_ do hereby certify under  
(Name of Firm, Partnership, or Corporation)

penalty of perjury under the laws of the United States and the State of Mississippi that \_\_\_\_\_

\_\_\_\_\_, Bidder  
(Name of Firm, Partnership, or Corporation)

on Project No. **NH-0015-02(096) / 106755301**

in **Jones** County(ies), Mississippi, has not either

directly or indirectly entered into any agreement, participated in any collusion; or otherwise taken any action in restraint of free competitive bidding in connection with this contract; nor have any of its corporate officers or principal owners.

Except as noted hereafter, it is further certified that said legal entity and its corporate officers, principal owners, managers, auditors and others in a position of administering federal funds:

- e) Are not presently debarred, suspended, proposed for debarment, declared ineligible, or voluntarily excluded from covered transactions by any Federal department or agency;
- f) Have not within a three-year period preceding this proposal been convicted of or had a civil judgment rendered against them for commission of fraud or a criminal offense in connection with obtaining, attempting to obtain, or performing a public (Federal, State or local) transaction or contract under a public transaction; violation of Federal or State antitrust statutes or commission of embezzlement, theft, forgery, bribery, falsification or destruction of records, making false statements, or receiving stolen property;
- g) Are not presently indicted for or otherwise criminally or civilly charged by a governmental entity (Federal, State or local) with commission of any of the offenses enumerated in (b) above; and
- h) Have not within a three-year period preceding this application/ proposal had one or more public transactions (Federal, State or local) terminated for cause or default.

Initial here "\_\_\_\_\_" if exceptions are attached and made a part thereof. Any exceptions shall address to whom it applies, initiating agency and dates of such action.

Note: Exceptions will not necessarily result in denial of award but will be considered in determining bidder responsibility. Providing false information may result in criminal prosecution or administrative sanctions.

The bidder further certifies that the certification requirements contained in Section XI of Form FHWA 1273, will be or have been included in all subcontracts, material supply agreements, purchase orders, etc. except those procurement contracts for goods or services that are expected to be less than the Federal procurement small purchase threshold fixed at 10 U.S.C. 2304(g) and 41 U.S.C. 253(g) (currently \$25,000) which are excluded from the certification requirements.

The bidder further certifies, to the best of his or her knowledge and belief, that:

- 3) No Federal appropriated funds have been paid or will be paid to any person for influencing or attempting to influence an officer or employee of any Federal agency, a Member of Congress, an officer or employee of Congress, or an employee of a Member of Congress in connection with the awarding of any Federal contract, the making of any Federal grant, the making of any Federal loan, the entering into of any cooperative agreement, and the extension, continuation, renewal, amendment, or modification of any Federal contract, grant, loan, or cooperative agreement.
- 4) If any funds other than Federal appropriated funds have been paid or will be paid to any person for influencing or attempting to influence an officer or employee of any Federal agency, a Member of Congress, an officer or employee of Congress, or an employee of a Member of Congress in connection with this contract, Standard Form-LLL, "Disclosure Form to Report Lobbying," in accordance with its instructions will be completed and submitted.

The certification contained in (1) and (2) above is a material representation of fact upon which reliance is placed and a prerequisite imposed by Section 1352, Title 31, U.S. Code prior to entering into this contract. Failure to comply shall be subject to a civil penalty of not less than \$10,000 and not more than \$100,000. The bidder shall include the language of the certification in all subcontracts exceeding \$100,000 and all subcontractors shall certify and disclose accordingly.

All of the foregoing and attachments (when indicated) is true and correct.

Executed on \_\_\_\_\_

\_\_\_\_\_  
Signature

**S E C T I O N   9 0 2**

CONTRACT FOR   NH-0015-02(096) / 106755301

LOCATED IN THE COUNTY(IES) OF   Jones

STATE OF MISSISSIPPI,  
COUNTY OF HINDS

This contract entered into by and between the Mississippi Transportation Commission on one hand, and the undersigned contractor, on the other witnesseth;

That, in consideration of the payment by the Mississippi Transportation Commission of the prices set out in the proposal hereto attached, to the undersigned contractor, such payment to be made in the manner and at the time of times specified in the specifications and the special provisions, if any, the undersigned contractor hereby agrees to accept the prices stated in the proposal in full compensation for the furnishing of all materials and equipment and the executing of all the work contemplated in this contract.

It is understood and agreed that the advertising according to law, the Advertisement, the instructions to bidders, the proposal for the contract, the specifications, the revisions of the specifications, the special provisions, and also the plans for the work herein contemplated, said plans showing more particularly the details of the work to be done, shall be held to be, and are hereby made a part of this contract by specific reference thereto and with like effect as if each and all of said instruments had been set out fully herein in words and figures.

It is further agreed that for the same consideration the undersigned contractor shall be responsible for all loss or damage arising out of the nature of the work aforesaid; or from the action of the elements and unforeseen obstructions or difficulties which may be encountered in the prosecution of the same and for all risks of every description connected with the work, exceptions being those specifically set out in the contract; and for faithfully completing the whole work in good and workmanlike manner according to the approved Plans, Specifications, Special Provisions, Notice(s) to Bidders and requirements of the Mississippi Department of Transportation.

It is further agreed that the work shall be done under the direct supervision and to the complete satisfaction of the Executive Director of the Mississippi Department of Transportation, or his authorized representatives, and when Federal Funds are involved subject to inspection at all times and approval by the Federal Highway Administration, or its agents as the case may be, or the agents of any other Agency whose funds are involved in accordance with those Acts of the Legislature of the State of Mississippi approved by the Governor and such rules and regulations issued pursuant thereto by the Mississippi Transportation Commission and the authorized Federal Agencies.

The Contractor agrees that all labor as outlined in the Special Provisions may be secured from list furnished by

It is agreed and understood that each and every provision of law and clause required by law to be inserted in this contract shall be deemed to be inserted herein and this contract shall be read and enforced as though it were included herein, and, if through mere mistake or otherwise any such provision is not inserted, then upon the application of either party hereto, the contract shall forthwith be physically amended to make such insertion.

The Contractor agrees that he has read each and every clause of this Contract, and fully understands the meaning of same and that he will comply with all the terms, covenants and agreements therein set forth.

Witness our signatures this the \_\_\_\_\_ day of \_\_\_\_\_, \_\_\_\_\_.

\_\_\_\_\_  
Contractor (s)

By \_\_\_\_\_

MISSISSIPPI TRANSPORTATION COMMISSION

Title \_\_\_\_\_

By \_\_\_\_\_

Signed and sealed in the presence of:  
(names and addresses of witnesses)

Executive Director

\_\_\_\_\_

Secretary to the Commission

Award authorized by the Mississippi Transportation Commission in session on the \_\_\_\_ day of \_\_\_\_\_, \_\_\_\_\_, Minute Book No. \_\_\_\_\_, Page No. \_\_\_\_\_.

**S E C T I O N 9 0 3**  
**PERFORMANCE AND PAYMENT BOND**

CONTRACT BOND FOR: NH-0015-02(096) / 106755301

LOCATED IN THE COUNTY(IES) OF: Jones

STATE OF MISSISSIPPI,

COUNTY OF HINDS

Know all men by these presents: that we, \_\_\_\_\_  
( Contractor )

\_\_\_\_\_ Principal, a \_\_\_\_\_

residing at \_\_\_\_\_ in the State of \_\_\_\_\_

and \_\_\_\_\_  
( Surety )

residing at \_\_\_\_\_ in the State of \_\_\_\_\_,

authorized to do business in the State of Mississippi, under the laws thereof, as surety, are held and firmly bound unto the State of Mississippi in the sum of \_\_\_\_\_

\_\_\_\_\_ Dollars, lawful money of the United States of America, to be paid to it for which payment well and truly to be made, we bind ourselves, our heirs, administrators, successors, or assigns jointly and severally by these presents.

Signed and sealed this the \_\_\_\_\_ day of \_\_\_\_\_ A.D. \_\_\_\_\_.

The conditions of this bond are such, that whereas the said \_\_\_\_\_

principal, has (have) entered into a contract with the Mississippi Transportation Commission, bearing the date of \_\_\_\_\_ day of \_\_\_\_\_ A.D. \_\_\_\_\_ hereto annexed, for the construction of certain projects(s) in the State of Mississippi as mentioned in said contract in accordance with the Contract Documents therefor, on file in the offices of the Mississippi Department of Transportation, Jackson, Mississippi.

Now therefore, if the above bounden \_\_\_\_\_

\_\_\_\_\_ in all things shall stand to and abide by and well and truly observe, do keep and perform all and singular the terms, covenants, conditions, guarantees and agreements in said contract, contained on his (their) part to be observed, done, kept and performed and each of them, at the time and in the manner and form and furnish all of the material and equipment specified in said contract in strict accordance with the terms of said contract which said plans, specifications and special provisions are included in and form a part of said contract and shall maintain the said work contemplated until its final completion and acceptance as specified in Subsection 109.11 of the approved specifications, and save harmless said Mississippi Transportation Commission from any loss or damage arising out of or occasioned by the negligence, wrongful or criminal act, overcharge, fraud, or any other loss or damage whatsoever, on the part of said principal (s), his (their) agents, servants, or employees in the performance of said work or in any manner connected therewith, and shall be liable and responsible in a civil action instituted by the State at the instance of the Mississippi Transportation Commission or any officer of the State authorized in such cases, for double any amount in money or property, the State may lose or be overcharged or otherwise defrauded of, by reason of wrongful or criminal act, if any, of the Contractor(s), his (their) agents or employees, and shall promptly pay the said

agents, servants and employees and all persons furnishing labor, material, equipment or supplies therefor, including premiums incurred, for Surety Bonds, Liability Insurance, and Workmen's Compensation Insurance; with the additional obligation that such Contractor shall promptly make payment of all taxes, licenses, assessments, contributions, damages, any liquidated damages which may arise prior to any termination of said principal's contract, any liquidated damages which may arise after termination of the said principal's contract due to default on the part of said principal, penalties and interest thereon, when and as the same may be due this state, or any county, municipality, board, department, commission or political subdivision: in the course of the performance of said work and in accordance with Sections 31-5-51 et seq. Mississippi Code of 1972, and other State statutes applicable thereto, and shall carry out to the letter and to the satisfaction of the Executive Director of the Mississippi Department of Transportation, all, each and every one of the stipulations, obligations, conditions, covenants and agreements and terms of said contract in accordance with the terms thereof and all of the expense and cost and attorney's fee that may be incurred in the enforcement of the performance of said contract, or in the enforcement of the conditions and obligations of this bond, then this obligation shall be null and void, otherwise to be and remain in full force and virtue.

Witness our signatures and seals this the \_\_\_\_\_ day of \_\_\_\_\_ A.D. \_\_\_\_\_.

\_\_\_\_\_ (Contractors) Principal \_\_\_\_\_ Surety

By \_\_\_\_\_ By \_\_\_\_\_  
(Signature) Attorney in Fact

Address \_\_\_\_\_

Title \_\_\_\_\_ (Contractor's Seal) \_\_\_\_\_ (Printed) MS Agent

\_\_\_\_\_  
(Signature) MS Agent

Address \_\_\_\_\_

\_\_\_\_\_  
(Surety Seal)

\_\_\_\_\_  
Mississippi Insurance ID Number



# BID BOND

KNOW ALL MEN BY THESE PRESENTS, that we \_\_\_\_\_  
Contractor

\_\_\_\_\_  
Address

\_\_\_\_\_  
City, State ZIP

as Principal, hereinafter called the Principal, and \_\_\_\_\_  
Surety

a corporation duly organized under the laws of the state of \_\_\_\_\_

as Surety, hereinafter called the Surety, are held and firmly bound unto State of Mississippi, Jackson, Mississippi

As Obligee, hereinafter called Obligee, in the sum of **Five Per Cent (5%) of Amount Bid**  
Dollars (\$ \_\_\_\_\_)

for the payment of which sum will and truly to be made, the said Principal and said Surety, bind ourselves, our heirs, executors, administrators, successors and assigns, jointly and severally, firmly by these presents.

WHEREAS, the Principal has submitted a bid for **Mill and Overlay approximately 4 miles of US 84 from SR 28 to SR 15, known as Federal Aid Project No. NH-0015-02(096) / 106755301 in Jones County.**

NOW THEREFORE, the condition of this obligation is such that if the aforesaid Principal shall be awarded the contract, the said Principal will, within the time required, enter into a formal contract and give a good and sufficient bond to secure the performance of the terms and conditions of the contract, then this obligation to be void; otherwise the Principal and Surety will pay unto the Obligee the difference in money between the amount of the bid of the said Principal and the amount for which the Obligee legally contracts with another party to perform the work if the latter amount be in excess of the former, but in no event shall liability hereunder exceed the penal sum hereof.

Signed and sealed this \_\_\_\_\_ day of \_\_\_\_\_, 20\_\_\_\_

\_\_\_\_\_  
(Principal) (Seal)

\_\_\_\_\_  
(Witness)

By: \_\_\_\_\_  
(Name) (Title)

\_\_\_\_\_  
(Surety) (Seal)

\_\_\_\_\_  
(Witness)

By: \_\_\_\_\_  
(Attorney-in-Fact)

\_\_\_\_\_  
MS Agent

\_\_\_\_\_  
Mississippi Insurance ID Number

MISSISSIPPI DEPARTMENT OF TRANSPORTATION  
OFFICE OF CIVIL RIGHTS  
JACKSON, MISSISSIPPI

LIST OF FIRMS SUBMITTING QUOTES

I/we received quotes from the following firms on Project No: **NH-0015-02(096) / 106755301**  
County: **Jones** Letting Date: **February 25, 2014**

Disadvantaged Business Enterprise (DBE) Regulations as stated in 49 CFR 26.11 require the Mississippi Department of Transportation (MDOT) to create and maintain a comprehensive list of all firms quoting/bidding subcontracts on prime contracts and quoting/bidding subcontracts on federally-funded transportation projects. For every firm, we require the following information:

Firm Name: \_\_\_\_\_  
Contact Name/Title: \_\_\_\_\_  
Firm Mailing Address \_\_\_\_\_  
Phone Number: \_\_\_\_\_  
\_\_\_\_\_ DBE Firm \_\_\_\_\_ Non-DBE Firm

Firm Name: \_\_\_\_\_  
Contact Name/Title: \_\_\_\_\_  
Firm Mailing Address \_\_\_\_\_  
Phone Number: \_\_\_\_\_  
\_\_\_\_\_ DBE Firm \_\_\_\_\_ Non-DBE Firm

Firm Name: \_\_\_\_\_  
Contact Name/Title: \_\_\_\_\_  
Firm Mailing Address \_\_\_\_\_  
Phone Number: \_\_\_\_\_  
\_\_\_\_\_ DBE Firm \_\_\_\_\_ Non-DBE Firm

Firm Name: \_\_\_\_\_  
Contact Name/Title: \_\_\_\_\_  
Firm Mailing Address \_\_\_\_\_  
Phone Number: \_\_\_\_\_  
\_\_\_\_\_ DBE Firm \_\_\_\_\_ Non-DBE Firm

Firm Name: \_\_\_\_\_  
Contact Name/Title: \_\_\_\_\_  
Firm Mailing Address \_\_\_\_\_  
Phone Number: \_\_\_\_\_  
\_\_\_\_\_ DBE Firm \_\_\_\_\_ Non-DBE Firm

\_\_\_\_\_  
**SUBMITTED BY (Signature)**

\_\_\_\_\_  
**FIRM NAME**

Submit this form to **Contract Administration as a part of your bid package**. If at least one copy of this form is not **signed** and included as part of the bid packet, your bid will be deemed irregular. Question regarding this form shall be directed to [www.gomdot.com](http://www.gomdot.com) under the current letting webpage. Please make and add copies of this form when needed or attach additional sheets containing the information required by this form and add these sheets to the bid package.