



SM No. CMP6026550151

PROPOSAL AND CONTRACT DOCUMENTS

FOR THE CONSTRUCTION OF

22

Overlay approximately 6 miles of SR 26 from White Sands Bridge East, known as State Project No. MP-6026-55(015) / 305799301 in Pearl River County.

Project Completion: Flexible

(STATE DELEGATED)

NOTICE

**BIDDERS MUST PURCHASE A BID PROPOSAL FROM
MDOT CONTRACT ADMINISTRATION DIVISION TO BID
THIS PROJECT.**

Electronic addendum updates will be posted on www.gomdot.com

SECTION 900

OF THE CURRENT

2004 STANDARD SPECIFICATIONS

FOR ROAD AND BRIDGE CONSTRUCTION

JACKSON, MISSISSIPPI

**MISSISSIPPI DEPARTMENT OF TRANSPORTATION
TABLE OF CONTENTS**

PROJECT: MP-6026-55(015) / 305799301 - Pearl River

Section 901 - Advertisement

Section 904 - Notice to Bidders

#1	Governing Specifications
#3	Final Cleanup
#1405	Errata & Modifications to 2004 Standard Specifications
#1928	Federal Bridge Formula
#3131	Temporary Traffic Paint
#3893	Petroleum Products Base Price
#4214	Safety Apparel
#4526	Electronic Addendum Process
#4565	Manual on Uniform Traffic Control Devices (MUTCD)
#5044	Questions Regarding Bidding
#5053	Contractor Correspondence
#5080	Standard Drawings
#5405	Traffic Control Devices
#5412	Weight Limits
#5824	Adjustments for Bituminous Materials
#5866	Payroll Requirements
#6321	Contract Time
#6322	Scope of work

Section 907 - Special Provisions

907-101-4	Definitions
907-102-12	Bidding Requirements and Conditions
907-103-11	Award and Execution
907-104-5	Scope of Work
907-104-6	Partnering Process
907-105-8	Control of Work
907-107-13	Legal Relations and Responsibility to Public, w/Supplement
907-108-38	Prosecution and Progress
907-109-8	Measurement and Payment
907-304-13	Granular Courses
907-401-7	Asphalt Pavements, w/ Supplement
907-403-14	Asphalt Pavements
907-406-4	Cold Milling
907-407-2	Tack Coat
907-411-5	Ultra-Thin Asphalt Pavement (UTAP)
907-618-9	Placement of Temporary Traffic Stripe
907-618-13	Temporary Construction Signs
907-618-14	Additional Signing Requirements, w/ Supplement
907-626-25	Thermoplastic Traffic Markings
907-702-5	Specifications for Bituminous Materials
907-703-12	Aggregates, w/ Supplement

PROJECT: MP-6026-55(015) / 305799301 - Pearl River

907-710-1 Fast Dry Solvent Traffic Paint
907-720-2 Pavement Marking Materials
907-823-9 Preformed Joint Seal, w/ Attachments

Section 905 - Proposal, Proposal Bid Items, Combination Bid Proposal
State Board of Contractors Requirement
State Certification Regarding Non-Collusion, Debarment and Suspensions
Section 902 - Contract Form
Section 903 - Contract Bond Forms

Progress Schedule

(REVISIONS TO THE ABOVE WILL BE INDICATED ON THE SECOND SHEET
OF SECTION 905 AS ADDENDA)

04/28/2016 06:23 AM

MISSISSIPPI DEPARTMENT OF TRANSPORTATION

SECTION 901 - ADVERTISEMENT

Electronic bids will be received by the Mississippi Transportation Commission at 10:00 o'clock A.M., Tuesday, May 24, 2016, from the Bid Express Service and shortly thereafter publicly read on the Sixth Floor for:

Overlay approximately 6 miles of SR 26 from White Sands Bridge East, known as State Project No. MP-6026-55(015) / 305799301 in Pearl River County.

The attention of bidders is directed to the predetermined minimum wage rate set by the U. S. Department of Labor under the Fair Labor Standards Act.

The Mississippi Department of Transportation hereby notifies all bidders that it will affirmatively insure that in any contract entered into pursuant to this advertisement, disadvantaged business enterprises will be afforded full opportunity to submit bids in response to this invitation and will not be discriminated against on the grounds of race, color, sex, age, disability, religion or national origin in consideration for an award.

The specifications are on file in the offices of the Mississippi Department of Transportation.

Bid proposals must be purchased online at <https://shopmdot.ms.gov>. Specimen proposals may be viewed and downloaded online at no cost at <http://mdot.ms.gov> or purchased online. Proposals are available at a cost of Ten Dollars (\$10.00) per proposal plus a small convenience fee. Cash or checks will not be accepted as payment.

Bid bond, signed or countersigned by a Mississippi Agent or Qualified Nonresident Agent, with Power of Attorney attached, a Cashier's check or Certified Check for five (5%) percent of bid, payable to STATE OF MISSISSIPPI, must accompany each proposal.

The attention of bidders is directed to the provisions of Subsection 102.07 pertaining to irregular proposals and rejection of bids.

MELINDA L. MCGRATH
EXECUTIVE DIRECTOR

MISSISSIPPI DEPARTMENT OF TRANSPORTATION

SECTION 904 - NOTICE TO BIDDERS NO. 1

CODE: (IS)

DATE: 05/03/2004

SUBJECT: Governing Specifications

The current (2004) Edition of the Standard Specifications for Road and Bridge Construction adopted by the Mississippi Transportation Commission is made a part hereof fully and completely as if it were attached hereto, except where superseded by special provisions, or amended by revisions of the Specifications contained herein. Copies of the specification book may be purchased from the MDOT Construction Division.

A reference in any contract document to controlling requirements in another portion of the contract documents shall be understood to apply equally to any revision or amendment thereof included in the contract.

In the event the plans or proposal contain references to the 1990 Edition of the Standard Specifications for Road and Bridge Construction, it is to be understood that such references shall mean the comparable provisions of the 2004 Edition of the Standard Specifications.

MISSISSIPPI DEPARTMENT OF TRANSPORTATION

SECTION 904 - NOTICE TO BIDDERS NO. 3

CODE: (SP)

DATE: 05/03/2004

SUBJECT: Final Clean-Up

Immediately prior to final inspection for release of maintenance, the Contractor shall pick up, load, transport and properly dispose of all litter from the entire highway right-of-way that is within the termini of the project.

Litter shall include, but not be limited to, solid wastes such as glass, paper products, tires, wood products, metal, synthetic materials and other miscellaneous debris.

Litter removal is considered incidental to other items of work and will not be measured for separate payment.

MISSISSIPPI DEPARTMENT OF TRANSPORTATION

SECTION 904 - NOTICE TO BIDDERS NO. 1405

CODE: (IS)

DATE: 03/15/2007

SUBJECT: ERRATA AND MODIFICATIONS TO THE 2004 STANDARD SPECIFICATIONS

<u>Page</u>	<u>Subsection</u>	<u>Change</u>
101	201.01	In the second sentence of the first paragraph, change “salvable” to “salvageable”.
107	202.04	In the fourth sentence of the fourth paragraph, change “yard” to “feet”.
107	202.05	In the list of units measurements for 202-B, add “square foot”.
132	211.03.4	In the second sentence of the second paragraph, change “planted” to “plated”.
192	306.02.4	In the first line of the first paragraph, delete the word “be”.
200	307.03.7	In the fourth sentence of the second paragraph, change “lime-fly ash” to “treated”.
236	401.01	Change the header from “Section 403” to “Section 401”.
242	401.02.3.2	In the first sentence of the third full paragraph, add “1/8” in the blank before the inch mark.
250	401.02.6.3	In the second sentence of the first paragraph on page 250, change “rutting over ” to “rutting over 1/8” ”.
253	401.02.6.4.2	In the paragraph preceding the table, change “91.0” to “89.0”.
259	401.03.1.4	In the first paragraph, change “92.0 percent” to “the specified percentage (92.0 or 93.0)”.
269	403.03.2	In the table at the top of page 269, change the PI requirement from “=” to “≤”.

- 278 404.04 In the second sentence, change the subsection from “401.04” to “403.04”.
- 283 409.02.2 Change “PG 64-22” to “PG 67-22”.
- 294 413.02 In the first sentence of the second paragraph, change “707.02.1.3” to “Subsection 707.02.1.3”.
- 340 511.04 In the second sentence of the second paragraph, change “412” to “512”.
- 349 601.03.3 In the first sentence, change “804.03.2” to “804.03.5”.
- 355 603.02 Change the subsection reference for Joint mortar from “707.03” to “714.11”.
- 369 604.04 In the first sentence, change “601.04” to “Subsection 601.04”.
- 427 619.04 Delete the second paragraph.
- 442 625.04 In the third paragraph, change “626.04” to “Subsection 626.04”.
- 444 626.03.1.2 Delete the third sentence of the first paragraph.
- 464 631.02 Change the subsection reference for Water from “714.01.0” to “714.01.1”.
- 570 682.03 Change the subsection number from “682-03” to “682.03”.
- 575 683.10.4 Change the subsection number from “683.10.4” to “683.04”.
- 575 683.10.5 Change the subsection number from “683.10.5” to “683.05”.
- 596 701.02 In the table under the column titled “Cementations material required”, change “Class F, FA” to “Class F FA,”.
- 603 702.11 In the first sentence, change “702.12” to “Subsection 702.12”.
- 612 703.04.2 In the fifth paragraph, delete “Subsection 703.11 and”.
- 616 703.07.2 In the Percentage By Weight Passing Square Mesh Sieves table, change the No. 10 requirement for Class 7 material from “30 - 10” to “30 - 100”.

- 618 703.13.1 In the first sentence of the first paragraph, change “703.09” to “703.06”.
- 618 703.13.2 In the first sentence, change “703.09” to “703.06”.
- 671 712.06.2.2 In the first sentence, change “712.05.1” to “Subsection 712.05.1”.
- 689 714.11.2 In the first sentence, change “412” to “512”.
- 709 715.09.5 In the first sentence of the first paragraph, change “guage” to “gauge”.
- 717 717.02.3.4 In the top line of the tension table, change “1 1/2” to “1 1/8” and change “1 1/8” to “1 1/2”.
- 741 720.05.2.2 In the last sentence of this subsection, change “720.05.2.1” to “Subsection 720.05.2.1”.
- 827 803.03.2.3.7.5.2 In the first sentence of the second paragraph, change “803.03.5.4” to “803.03.2.3.4”.
- 833 803.03.2.6 In the first sentence, change “803.03.7” to “803.03.2.5”.
- 854 804.02.11 In the last sentence of the first paragraph, change “automatically” to “automatic”.
- 859 804.02.13.1.3 In the last sentence, change Subsection “804.02.12.1” to “804.02.12”.
- 879 804.03.19.3.2 In the first sentence of the third paragraph, change “listed on of Approved” to “listed on the Approved”.
- 879 804.03.19.3.2 In the last sentence of the last paragraph, change “804.03.19.3.1” to “Subsection 804.03.19.3.1”.
- 962 814.02.3 In the first sentence, change “710.03” to “Subsection 710.03”.
- 976 820.03.2.1 In the first sentence, change “803.02.6” to “803.03.1.7”.
- 976 820.03.2.2 In the first sentence, change “803.03.9.6” to “803.03.1.9.2”.
- 985 Index Change the subsection reference for Petroleum Asphalt Cement from “702.5” to “702.05”.

985	Index	Change the subsection reference for the Definition of Asphaltic Cement or Petroleum Asphalt from “700.2” to “700.02”.
985	Index	Change the subsection reference for Automatic Batchers from “501.03.2.4” to “804.02.10.4”.
986	Index	Delete “501.03.2” as a subsection reference for Batching Plant & Equipment.
988	Index	Change the subsection reference for the Central Mixed Concrete from “501.03.3.2” to “804.02.11”.
988	Index	Change the subsection reference for the Concrete Batching Plant & Equipment from “501.03.2” to “804.02.11”.
999	Index	Delete “501.03.3.3” as a subsection reference for Truck Mixers.
1001	Index	Change the subsection reference for Edge Drain Pipes from “605.3.5” to “605.03.5”.
1002	Index	Change the subsection reference for Metal Posts from “713.05.2” to “712.05.2”.
1007	Index	Change the subsection reference for Coarse Aggregate of Cement Concrete Table from “703.3” to “703.03”.
1007	Index	Change the subsection reference for Composite Gradation for Mechanically Stabilized Courses Table from “703.8” to “703.08”.
1009	Index	Delete “501.03.3.3” as a subsection reference for Truck Mixers and Truck Agitators.
1010	Index	Delete reference to “Working Day, Definition of”.

MISSISSIPPI DEPARTMENT OF TRANSPORTATION

| SECTION 904 - NOTICE TO BIDDERS NO. 1928

CODE: (IS)

| DATE: 04/14/2008

SUBJECT: Federal Bridge Formula

Bidders are hereby advised that Federal Highway Administration Publication No. FHWA-MC-94-007, **BRIDGE FORMULA WEIGHTS**, dated January 1994, is made a part of this contract when applicable.

Prior to the preconstruction conference, the Contractor shall advise the Engineer, in writing, what materials, if any, will be delivered to the jobsite via Interstate route(s).

Copies of the **BRIDGE FORMULA WEIGHTS** publication may be obtained by contacting:

Federal Highway Administration
400 7th Street, SW
Washington, DC 20590
(202) 366-2212

or

| http://ops.fhwa.dot.gov/freight/sw/brdgcalc/calc_page.htm

MISSISSIPPI DEPARTMENT OF TRANSPORTATION

SECTION 904 - NOTICE TO BIDDERS NO. 3131

CODE: (SP)

DATE: 06/24/2010

SUBJECT: Temporary Traffic Paint

Bidders are hereby advised that the temporary traffic paint for this project can be waterborne paint as specified in the 2004 Mississippi Standard Specifications For Road and Bridge Construction or fast dry solvent traffic paint meeting the requirements set out in 907-710-1 (Fast Dry Solvent Traffic Paint).

Payment for all temporary traffic paint shall be paid under the appropriate 619 pay items.

When using fast dry solvent traffic stripe, no paint can be sprayed or placed on the ground during set-up or clean-up.

MISSISSIPPI DEPARTMENT OF TRANSPORTATION

SECTION 904 - NOTICE TO BIDDERS NO. 3893

CODE: (SP)

DATE: 04/10/2012

SUBJECT: Petroleum Products Base Prices

Bidders are advised that monthly petroleum products base prices will be available at the web site listed below. Current monthly prices will be posted to this web site on or before the 15th of each month. Bidders are advised to use the petroleum base prices on this web site when preparing their bids. The current monthly petroleum products base prices will be acknowledged by the Bidder and become part of the contract during the execution process.

Monthly Petroleum Products Base Prices can be viewed at:

<http://sp.gomdot.com/Contract%20Administration/BidSystems/Pages/letting%20calendar.aspx>

MISSISSIPPI DEPARTMENT OF TRANSPORTATION

SECTION 904 - NOTICE TO BIDDERS NO. 4214

CODE: (IS)

DATE: 11/29/2012

SUBJECT: Safety Apparel

Bidders are advised that the Code of Federal Regulations CFR 23 Part 634 final rule was adopted November 24, 2006 with an effective date of November 24, 2008. This rule requires that "All workers within the right-of-way of a Federal-Aid Highway who are exposed either to traffic (vehicles using the highway for the purposes of travel) or to construction equipment within the work area shall wear high-visibility safety apparel". High-visibility safety apparel is defined in the CFR as "personnel protective safety clothing that is intended to provide conspicuity during both daytime and nighttime usage, and that meets the Performance Class 2 or 3 requirements of the ANSI/ISEA 107-2004 publication entitled American National Standard for High-Visibility Safety Apparel and Headwear". All workers on Mississippi State Highway right-of-way shall comply with this Federal Regulation. Workers are defined by the CFR as "people on foot whose duties place them within the right-of way of a Federal-Aid Highway, such as highway construction and maintenance forces, survey crews, utility crews, responders to incidents within the highway right-of-way, and law enforcement personnel when directing traffic, investigating crashes, and handling lane closures, obstructed roadways, and disasters within the right-of-way of a Federal-Aid Highway".

More information regarding high visibility safety apparel can be found at the following sites.

<http://www.gpo.gov/fdsys/pkg/CFR-2008-title23-vol1/pdf/CFR-2008-title23-vol1-sec634-1.pdf>

<http://ops.fhwa.dot.gov/wz/resources/policy.htm#hv>

MISSISSIPPI DEPARTMENT OF TRANSPORTATION

SECTION 904 - NOTICE TO BIDDERS NO. 4526

CODE: (SP)

DATE: 06/11/2013

SUBJECT: Electronic Addendum Process

Bidders are advised that hard copies of any addenda for this project will no longer be mailed to prospective bidders. All addenda for this project will be posted to the mdot.ms.gov webpage under the Proposal Addenda column for the current letting and appropriate call number. Bidders will have to download addenda from the webpage and process the addenda in the same manner as previous lettings. Addenda will be posted by 10:00 a.m. on Friday prior to the letting. It will be the Bidder's responsibility to check and see if any addenda have been posted for this project. Any questions regarding the downloading process of the addenda shall be directed to the Contract Administration Division at 601-359-7700. Any questions regarding the content of the addenda shall be submitted as a question in accordance with the Notice To Bidders entitled "Questions Regarding Bidding".

MISSISSIPPI DEPARTMENT OF TRANSPORTATION

SECTION 904 - NOTICE TO BIDDERS NO. 4565

CODE: (SP)

DATE: 06/27/2013

SUBJECT: Manual on Uniform Traffic Control Devices

Any reference in the Standard Specifications or contract documents to a particular Section of the Manual on Uniform Traffic Control Devices (MUTCD) it shall mean that Section of the latest version of the Manual on Uniform Traffic Control Devices.

MISSISSIPPI DEPARTMENT OF TRANSPORTATION

SECTION 904 - NOTICE TO BIDDERS NO. 5044

CODE: (SP)

DATE: 05/13/2014

SUBJECT: Questions Regarding Bidding

Bidders are advised that all questions that arise regarding the contract documents (proposal) or plans on this project shall be directed to the www.gomdot.com current letting webpage. Click on the call number for this project to open an email form to submit your question. Questions must be submitted by 8:00 a.m. on **the day** prior to the letting. Answers to questions will be posted by 6:00 p.m. on **the day** prior to the letting. Answers can be viewed by clicking on Q&A link under the Proposal Addenda column.

It shall be the Bidders responsibility to familiarize themselves with the questions and answers that have been submitted on this project. Bidders are advised that by signing the contract documents for this project, they agree that the on-line Questions and Answers submitted on this project shall be added to and made part of the official contract.

MISSISSIPPI DEPARTMENT OF TRANSPORTATION

SECTION 904 - NOTICE TO BIDDERS NO. 5053

CODE: (SP)

DATE: 06/03/2014

SUBJECT: Contractor Correspondence

Bidders are advised that all correspondence concerning this project, other than correspondence related to the execution of the contract and sub-contracting, shall be sent to the Project Engineer. The Project Engineer will then forward any necessary correspondence to the appropriate Division. This includes general correspondence, submittals, shop drawings, requests for advancement of materials, etc.

MISSISSIPPI DEPARTMENT OF TRANSPORTATION

SECTION 904 – NOTICE TO BIDDERS NO. 5080

CODE: (SP)

DATE: 06/10/2014

SUBJECT: Standard Drawings

Standard Drawings attached hereto shall govern appropriate items of required work.

Larger copies of Standard Drawings may be purchased from:

MDOT Plans Print Shop
MDOT Shop Complex, Building C, Room 114
2567 North West Street
P.O. Box 1850
Jackson, MS 39215-1850
Telephone: (601) 359-7460
or FAX: (601) 359-7461
or e-mail: plans@mdot.state.ms.us

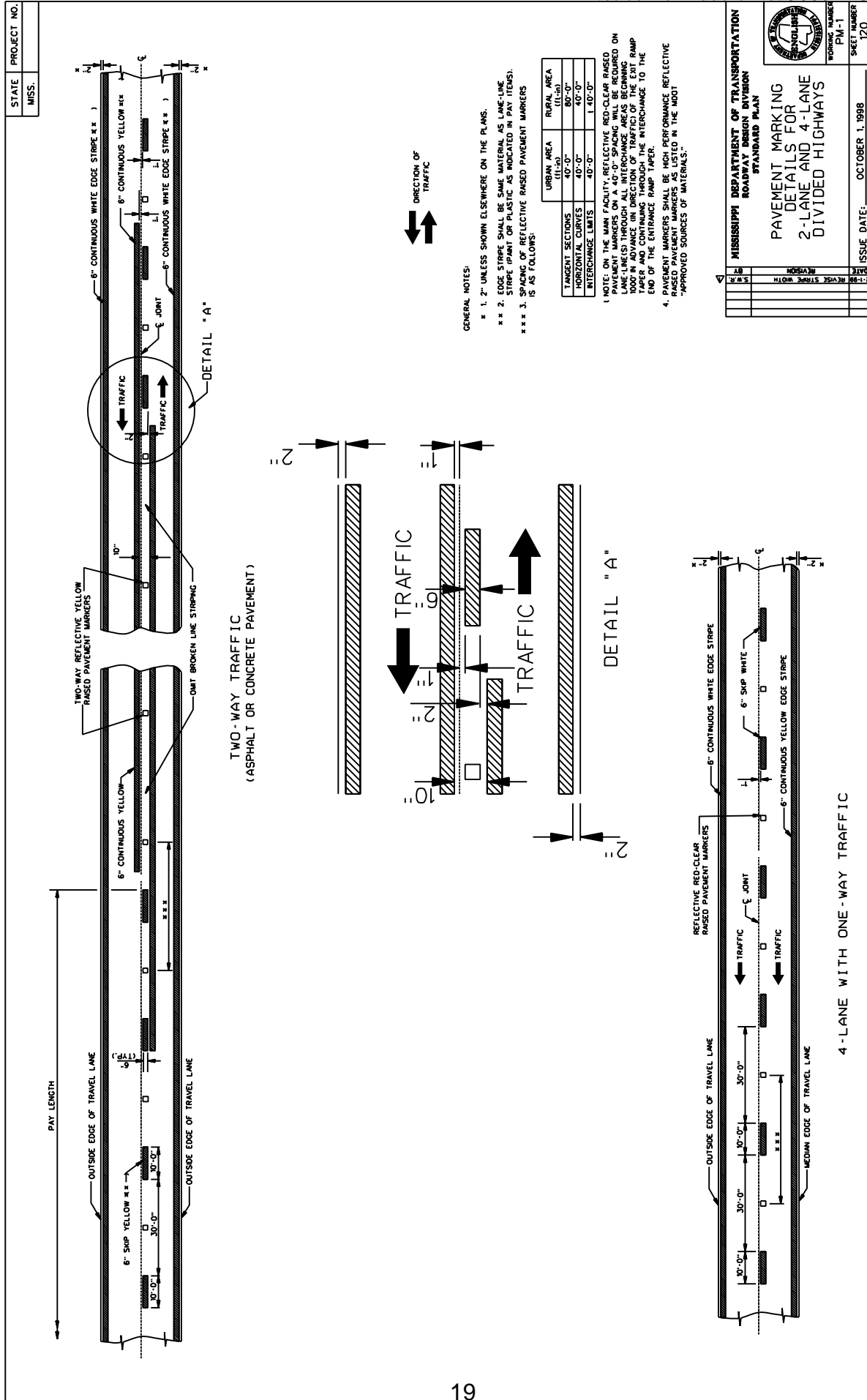

STATE	PROJECT NO.
MISS.	

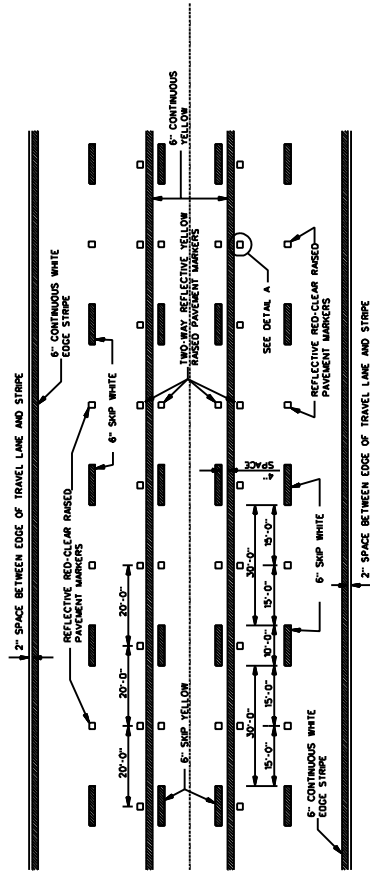

TYPICAL STRIPING AND RAISED PAVEMENT MARKERS FOR 5-LANE SECTION

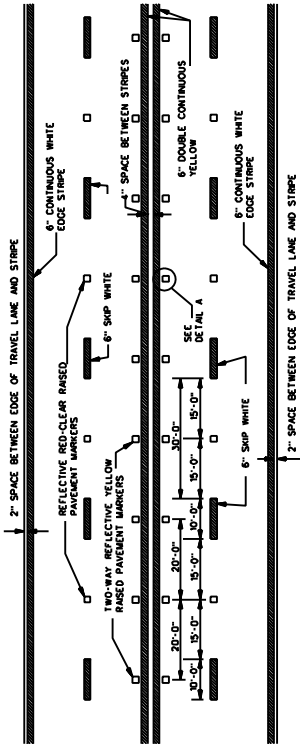

TYPICAL STRIPING AND RAISED PAVEMENT MARKERS FOR 4-LANE SECTION

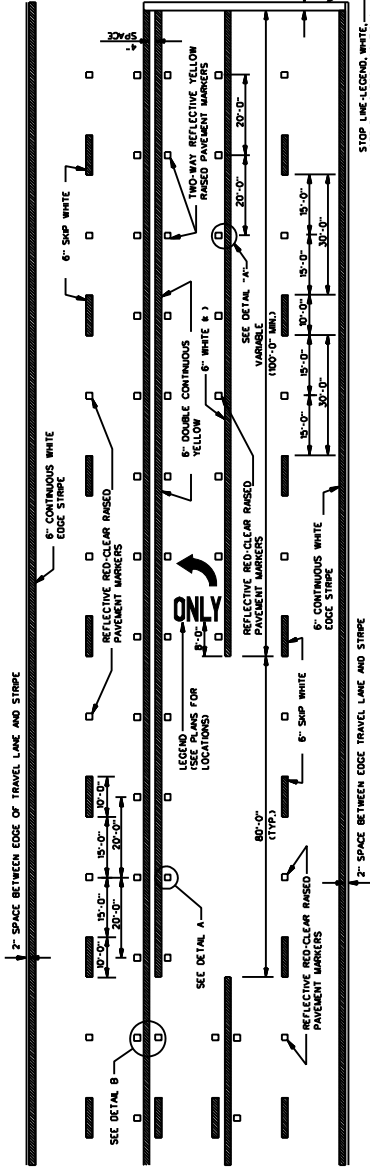

TYPICAL STRIPING AND RAISED PAVEMENT MARKERS AT LEFT TURN LANES

*NOTE: USE DETAIL STRIPING # LENGTH 5' SPD AT THIS LOCATION, OTHERWISE USE CONTINUOUS STRIPING.

TYPICAL TWO-WAY ARROW INSTALLATION

- 1. CONSIDER EACH SEGMENT OF CONTINUOUS TWO-WAY LEFT TURN LANE SEPARATELY.
- 2. IF SEGMENT IS LESS THAN 350', PLACE ONE SET OF ARROWS IN CENTER OF SEGMENT.
- 3. IF SEGMENT IS GREATER THAN 350', PLACE FIRST SET OF ARROWS 50' TO 100' FROM BEGINNING AND/OR END OF SEGMENT AND SPACE ADDITIONAL SETS OF ARROWS 1250' O.C.

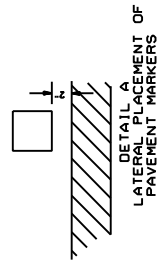

DETAIL A
LATERAL PLACEMENT OF PAVEMENT MARKERS

GENERAL NOTE:
1. PAVEMENT MARKERS SHALL BE HIGH PERFORMANCE RAISED PAVEMENT MARKERS AS LISTED IN THE MOST APPROVED SOURCE OF MATERIALS.

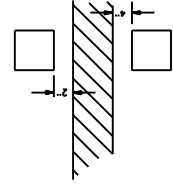

DETAIL B
LATERAL PLACEMENT OF PAVEMENT MARKERS

MISSISSIPPI DEPARTMENT OF TRANSPORTATION	
PAVEMENT MARKING	
DETAILS FOR	
4-LANE AND 5-LANE	
UNDIVIDED ROADWAYS	
DATE	2/20/10
DESIGNER	SDPM
FILE NAME	SDPM-2.DGN
DESIGN TITLE	CRETE
PROJECT NO.	
SHEET NUMBER	
DATE	04/13/10

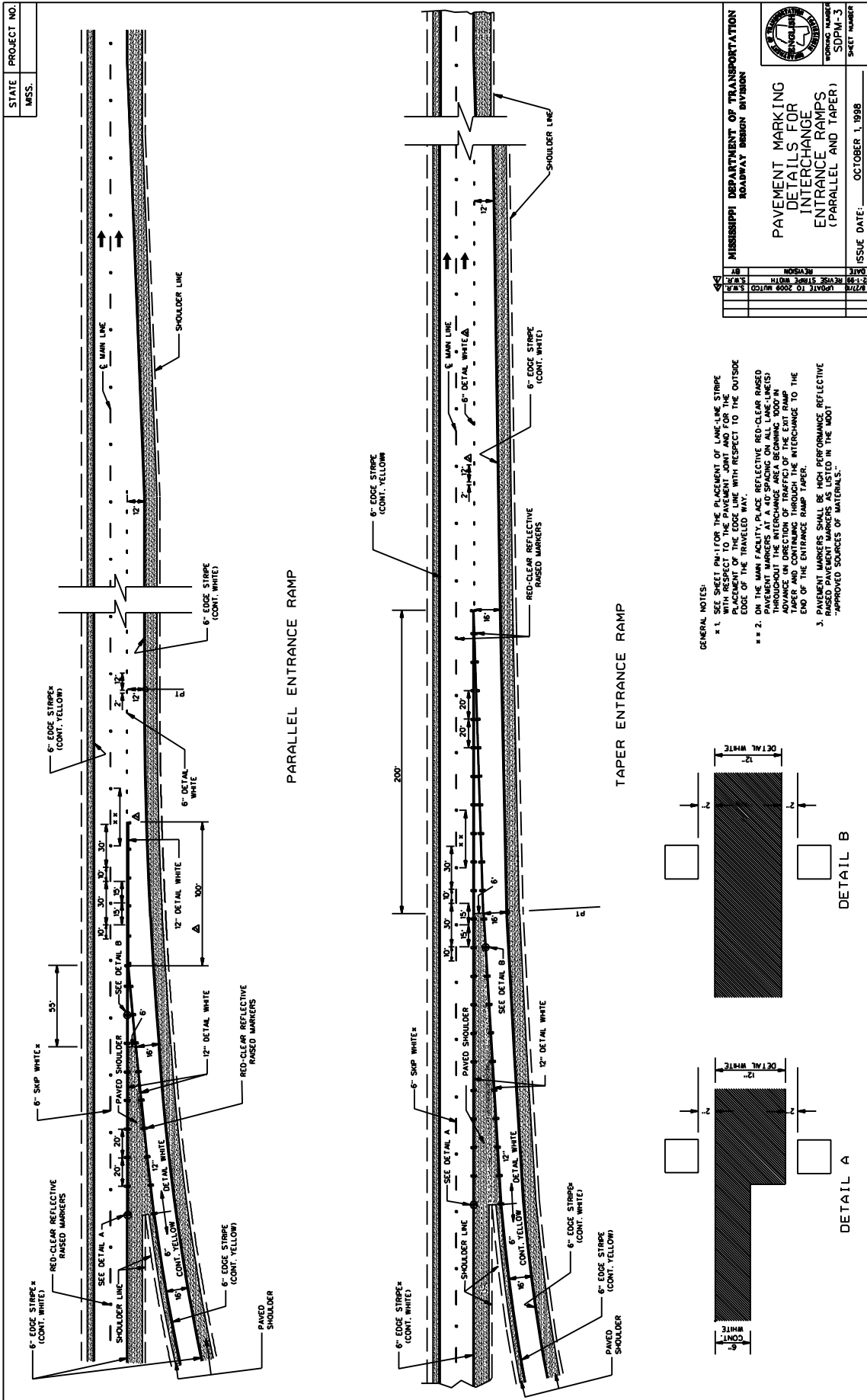

STATE PROJECT NO.
MISS.

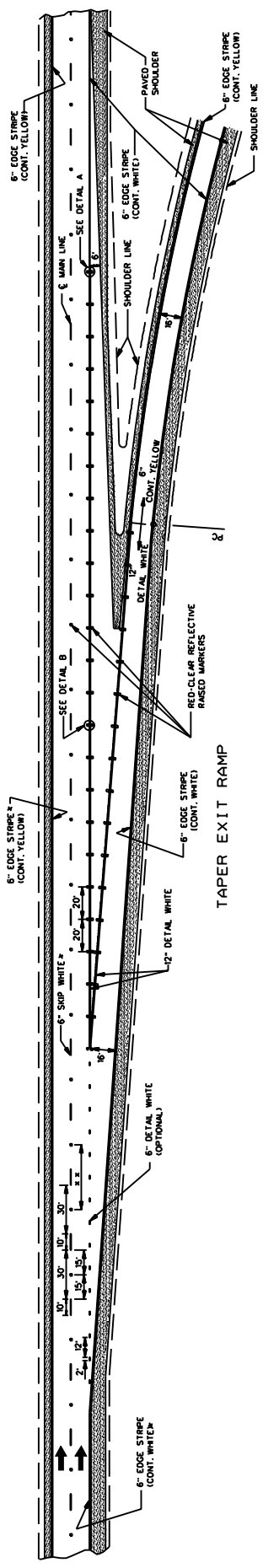

TAPER EXIT RAMP

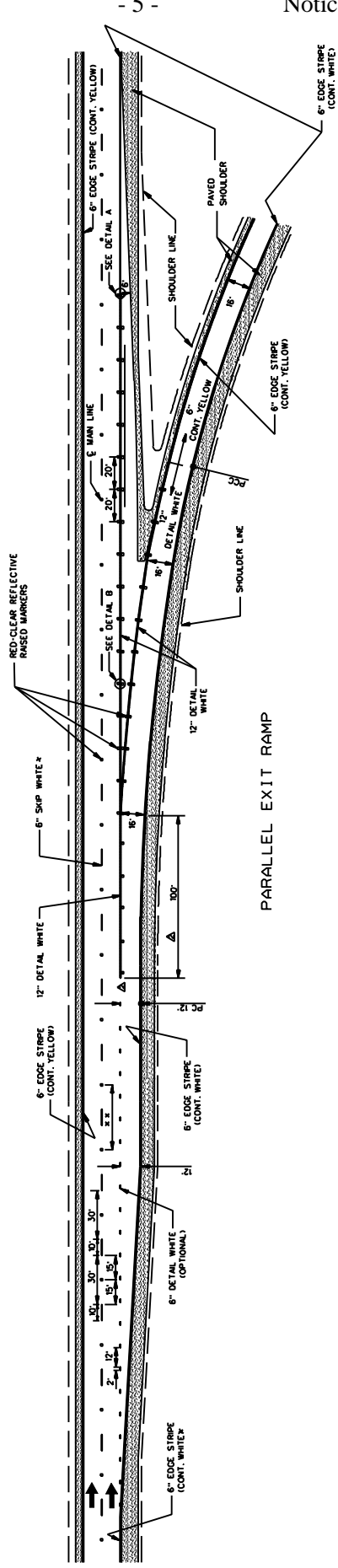

PARALLEL EXIT RAMP

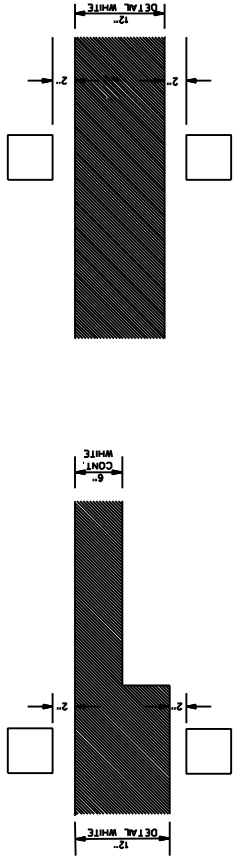

- GENERAL NOTES:
- SEE SHEET PM-1 FOR THE PLACEMENT OF LINE-LINE STRIPE WITH RESPECT TO THE PAVEMENT JOINT AND FOR THE PLACEMENT OF THE EDGE LINE WITH RESPECT TO THE OUTSIDE EDGE OF THE TRAVELED WAY.
 - PAVEMENT MARKERS SHALL BE HIGH PERFORMANCE REFLECTIVE RASSED MARKERS. PAVEMENT MARKERS SHALL BE PLACED THROUGHOUT THE INTERCHANGE AREA BEGINNING 1000' IN ADVANCE IN DIRECTION OF TRAFFIC OF THE EXIT RAMP TAPER AND CONTINUING THROUGH THE INTERCHANGE TO THE END OF THE ENTRANCE RAMP TAPER.
 - PAVEMENT MARKERS SHALL BE HIGH PERFORMANCE REFLECTIVE RASSED MARKERS. APPROVED SOURCES OF MATERIALS:

8/27/99	REVISION	STRIP WIDTH
8/27/99	UPDATE TO 2008 M/C/D	
8/27/99	REVISION	STRIP WIDTH
8/27/99	REVISION	STRIP WIDTH

MISSISSIPPI DEPARTMENT OF TRANSPORTATION
ROADWAY DESIGN DIVISION

PAVEMENT MARKING
DETAILS FOR
INTERCHANGE
EXIT RAMP
(PARALLEL AND TAPER)

ISSUE DATE: OCTOBER 1, 1998

WORKING NUMBER: SDPM-41

SHEET NUMBER: 41

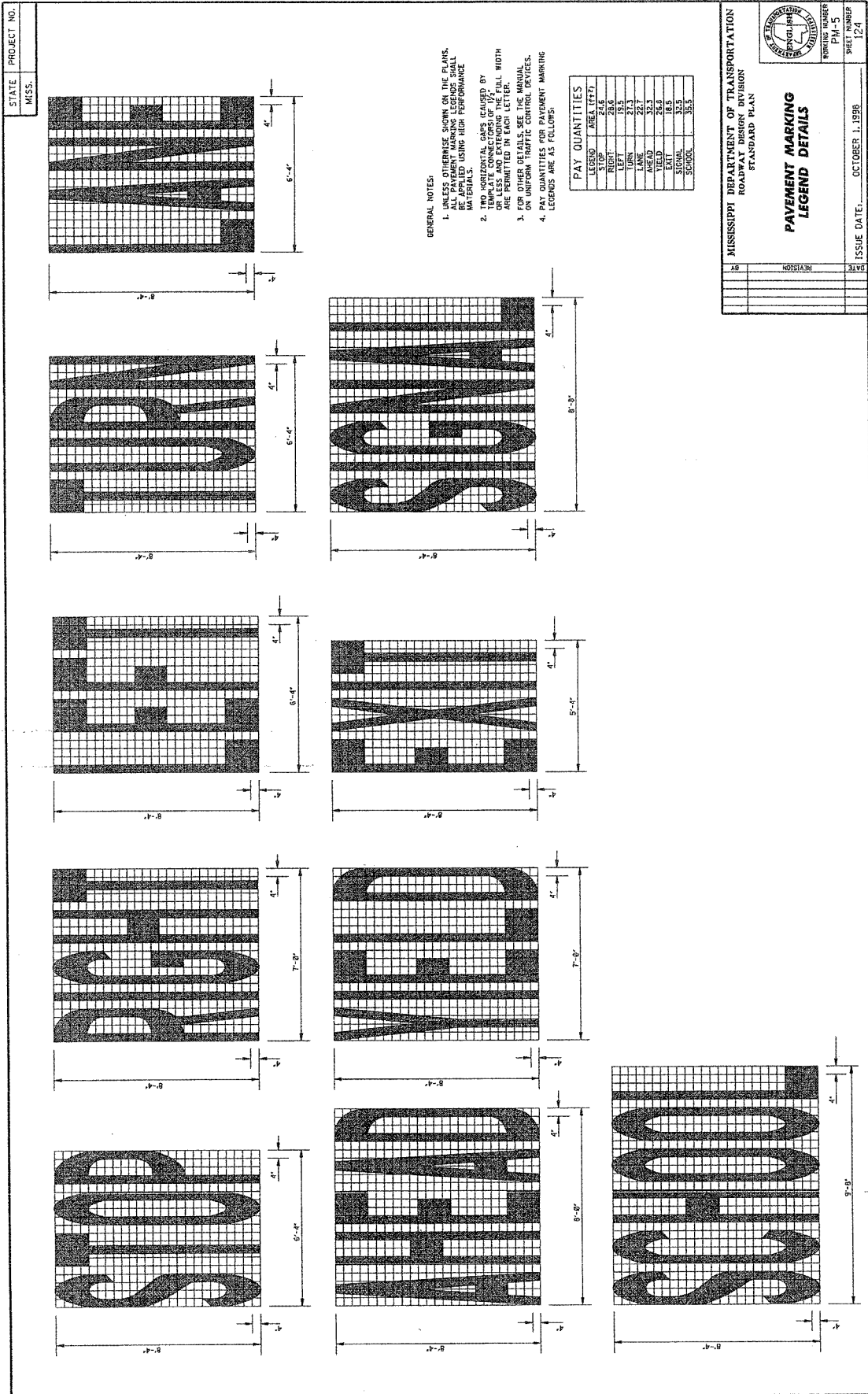

STATE MISS.	PROJECT NO.	
----------------	----------------------	--

THRU ARROW

TURN ARROW

1-WAY ARROW

COMBINATION ARROW

GENERAL NOTES:

1. UNLESS OTHERWISE SHOWN ON THE PLANS, ALL PAVEMENT MARKING LEGENDS SHALL BE APPLIED USING HIGH PERFORMANCE MATERIALS.
2. TWO HORIZONTAL GAPS CAUSED BY TEMPLATE CONNECTORS OF 1/2" OR LESS AND EXTENDING THE FULL WIDTH ARE PERMITTED IN EACH LETTER.
3. FOR OTHER DETAILS, SEE THE MANUAL OR UNIFORM PAVEMENT MARKING LEGENDS.
4. PAY QUANTITIES FOR PAVEMENT MARKING LEGENDS ARE AS FOLLOWS:

PAY QUANTITIES	
LEGEND/SYMBOL	AREA (ft ²)
ONLY	22.0
TURN ARROW	16.4
THRU ARROW	27.5
COMBINATION ARROW	24.3

MISSISSIPPI DEPARTMENT OF TRANSPORTATION
ROADWAY DESIGN DIVISION
STANDARD PLAN

**PAVEMENT MARKING
LEGEND DETAILS**

DATE	REVISION	BY	ISSUE DATE:	OCTOBER 1, 1998	SHEET NUMBER	125
------	----------	----	-------------	-----------------	--------------	-----

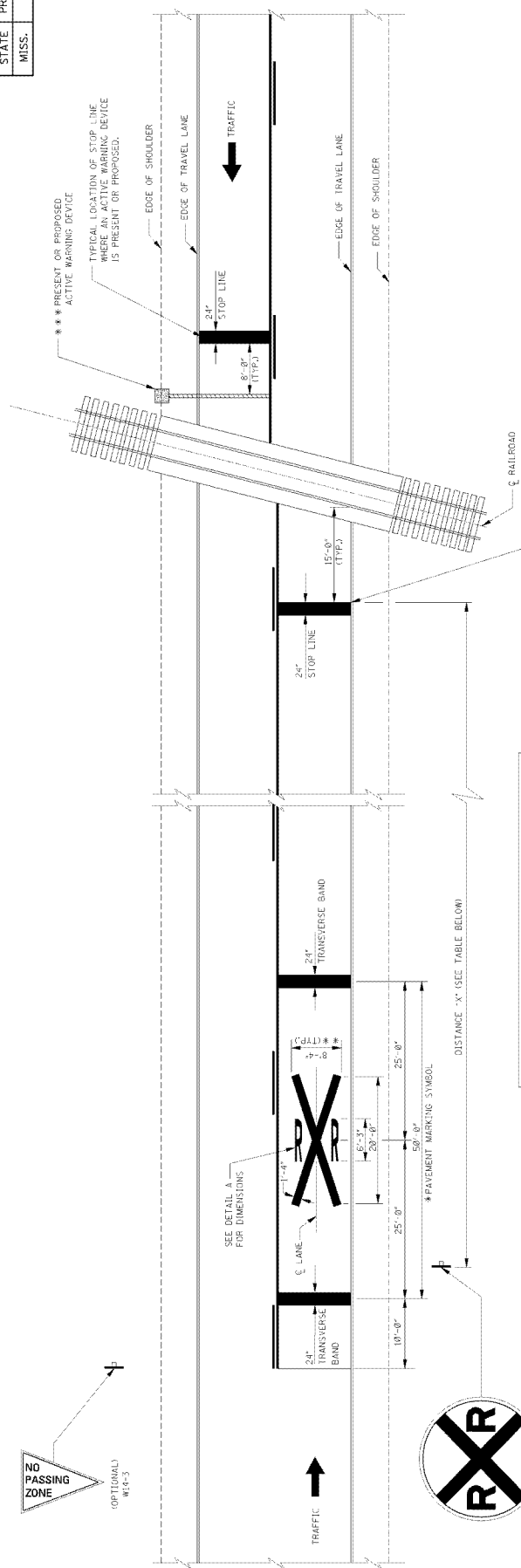

ADVANCE WARNING SIGN PLACEMENT DISTANCE

POSTED SPEED (mph)	DISTANCE "X" (FT)	
	RURAL	URBAN
20	175	100
25	250	100
30	325	100
35	400	150
40	475	225
45	550	300
50	625	375
55	700	450
60	775	550

NOTES:
 ① DISTANCE "X" MAY BE ADJUSTED IF PROHIBITIVE PHYSICAL CONDITIONS EXIST AT THE DESIGNATED DISTANCE.
 ② THESE DISTANCES MAY BE ADJUSTED TO A MINIMUM OF 100' IN RESTRICTED AREAS OR BUSINESS DISTRICTS WHERE LOW SPEEDS ARE PREVALENT.

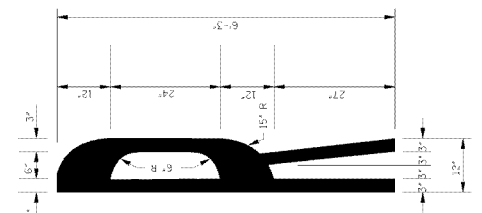

DETAIL A
STANDARD "R" PAVEMENT MARKING
FOR R X R SYMBOL

GENERAL NOTES:
 * 1. A PORTION OF THE PAVEMENT MARKING SYMBOL SHOULD BE DIRECTLY OPPOSITE THE ADVANCE WARNING SIGN (WD-1).
 ** 2. WIDTH OF R X R SYMBOL MAY VARY ACCORDING TO LANE WIDTH. HOWEVER, ON MULTI-LANE ROADS, THE TRANSVERSE BANDS AND STOP LINE SHOULD EXTEND ACROSS ALL APPROACH LANES, AND INDIVIDUAL R X R SYMBOLS SHOULD BE USED IN EACH APPROACH LANE.
 Δ 3. R X R SYMBOL (63.0 ± 0.2), TRANSVERSE BANDS AND STOP LINE SHALL BE PAID FOR AS LEGEND, WHITE (PLASTIC, MATERIAL OPTIONAL FOR OTHER AGENCIES).
 *** 4. REFER TO THE 'MANUAL ON UNIFORM TRAFFIC CONTROL DEVICES' FOR LOCATION OF PROPOSED WARNING DEVICES AT RAILROAD-HIGHWAY GRADE CROSSINGS.

MISSISSIPPI DEPARTMENT OF TRANSPORTATION
ROADWAY DESIGN DIVISION
STANDARD PLAN

TYPICAL PLACEMENT OF WARNING SIGNS AND PAVEMENT MARKINGS AT RAILROAD HIGHWAY GRADE CROSSINGS

WORKSHEET NO. 12
SHEET NO. 12

ISSUE DATE: OCTOBER 11, 1998

REVISIONS:

NO.	DATE	DESCRIPTION
1		ISSUE

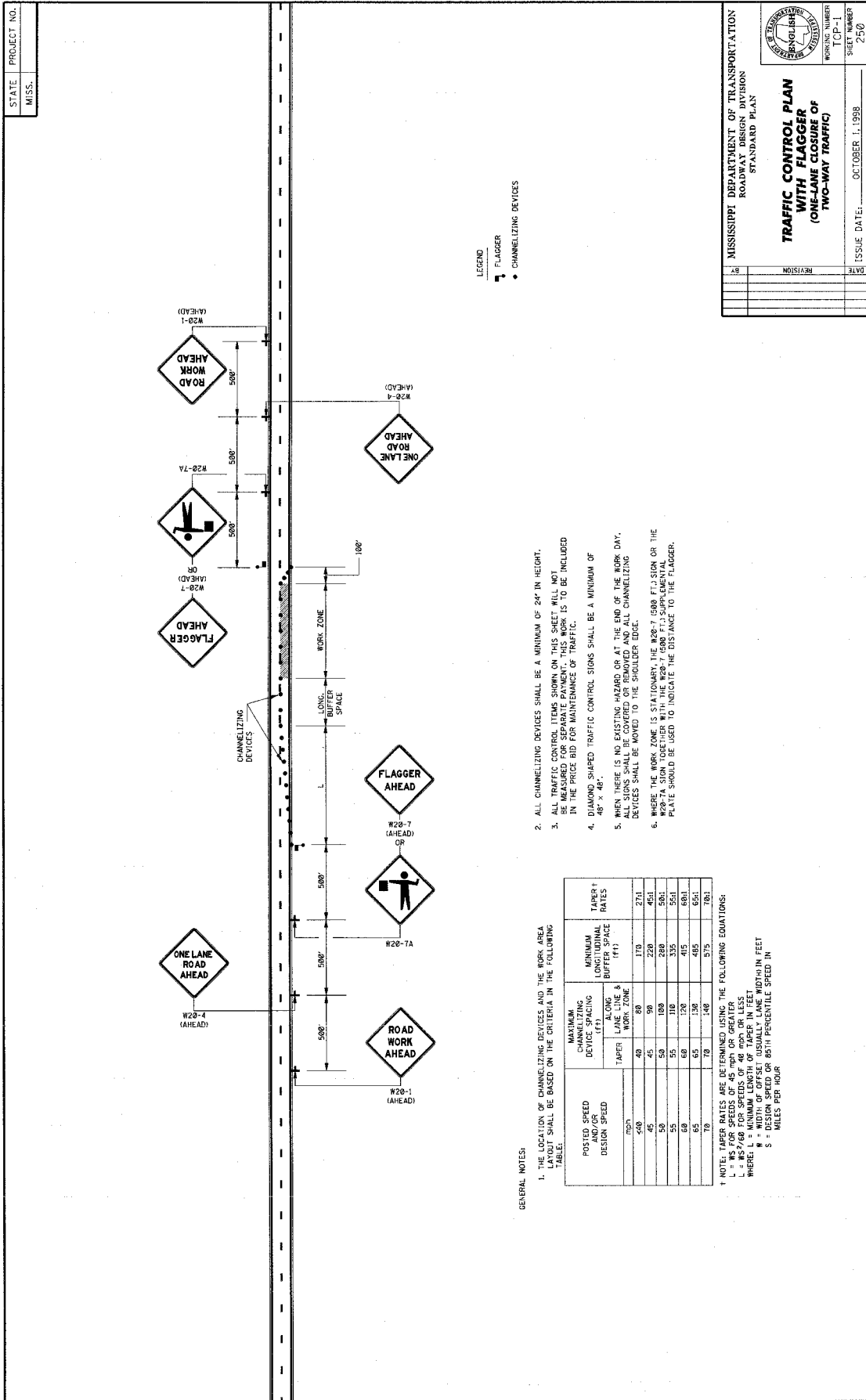

STATE PROJECT NO.
MISS.

MISSISSIPPI DEPARTMENT OF TRANSPORTATION
ROADWAY DESIGN DIVISION
STANDARD PLAN

**TRAFFIC CONTROL PLAN
WITH FLAGGER
(ONE-LANE CLOSURE OF
TWO-WAY TRAFFIC)**

WORKING NUMBER: TCP-1
SHEET NUMBER: 250
ISSUE DATE: OCTOBER 1, 1998

DATE	REVISION

LEGEND
 FLAGGER
 CHANNELIZING DEVICES

- ALL CHANNELIZING DEVICES SHALL BE A MINIMUM OF 24" IN HEIGHT.
- ALL TRAFFIC CONTROL ITEMS SHOWN ON THIS SHEET WILL NOT BE MEASURED FOR SEPARATE PAYMENT. THIS WORK IS TO BE INCLUDED IN THE PRICE BID FOR MAINTENANCE OF TRAFFIC.
- DIAMOND SHAPED TRAFFIC CONTROL SIGNS SHALL BE A MINIMUM OF 48" X 48".
- WHEN THERE IS NO CASTING HAZARD OR AT THE END OF THE WORK DAY, ALL SIGNS SHALL BE COVERED OR REMOVED AND ALL CHANNELIZING DEVICES SHALL BE MOVED TO THE SHOULDER EDGE.
- WHERE THE WORK ZONE IS STATIONARY, THE W20-7 (500 FT.) SIGN OR THE W20-7A SIGN TOGETHER WITH THE W20-7 (500 FT.) SUPPLEMENTAL PLATE SHOULD BE USED TO INDICATE THE DISTANCE TO THE FLAGGER.

GENERAL NOTES:
 1. THE LOCATION OF CHANNELIZING DEVICES AND THE WORK AREA LAYOUT SHALL BE BASED ON THE CRITERIA IN THE FOLLOWING TABLE:

POSTED SPEED AND/OR DESIGN SPEED	CHANNELIZING DEVICES SPACING		MINIMUM LONGITUDINAL BUFFER SPACE (FT.)	TAPER † RATES
	MAXIMUM ALONG WORK ZONE	MINIMUM ALONG WORK ZONE		
200	40	80	170	271
40	45	90	220	451
50	50	100	280	501
55	55	110	335	551
60	60	120	415	601
65	65	130	485	651
70	70	140	575	701

† NOTE: TAPER RATES ARE DETERMINED USING THE FOLLOWING EQUATIONS:
 L = WS FOR SPEEDS OF 45 MPH OR GREATER
 L = WS FOR SPEEDS OF 30 MPH OR GREATER
 WHERE: L = MINIMUM LENGTH OF TAPER IN FEET
 W = WIDTH OF OFFSET USUALLY LANE WIDTH IN FEET
 S = DESIGN SPEED OR 85TH PERCENTILE SPEED IN MILES PER HOUR

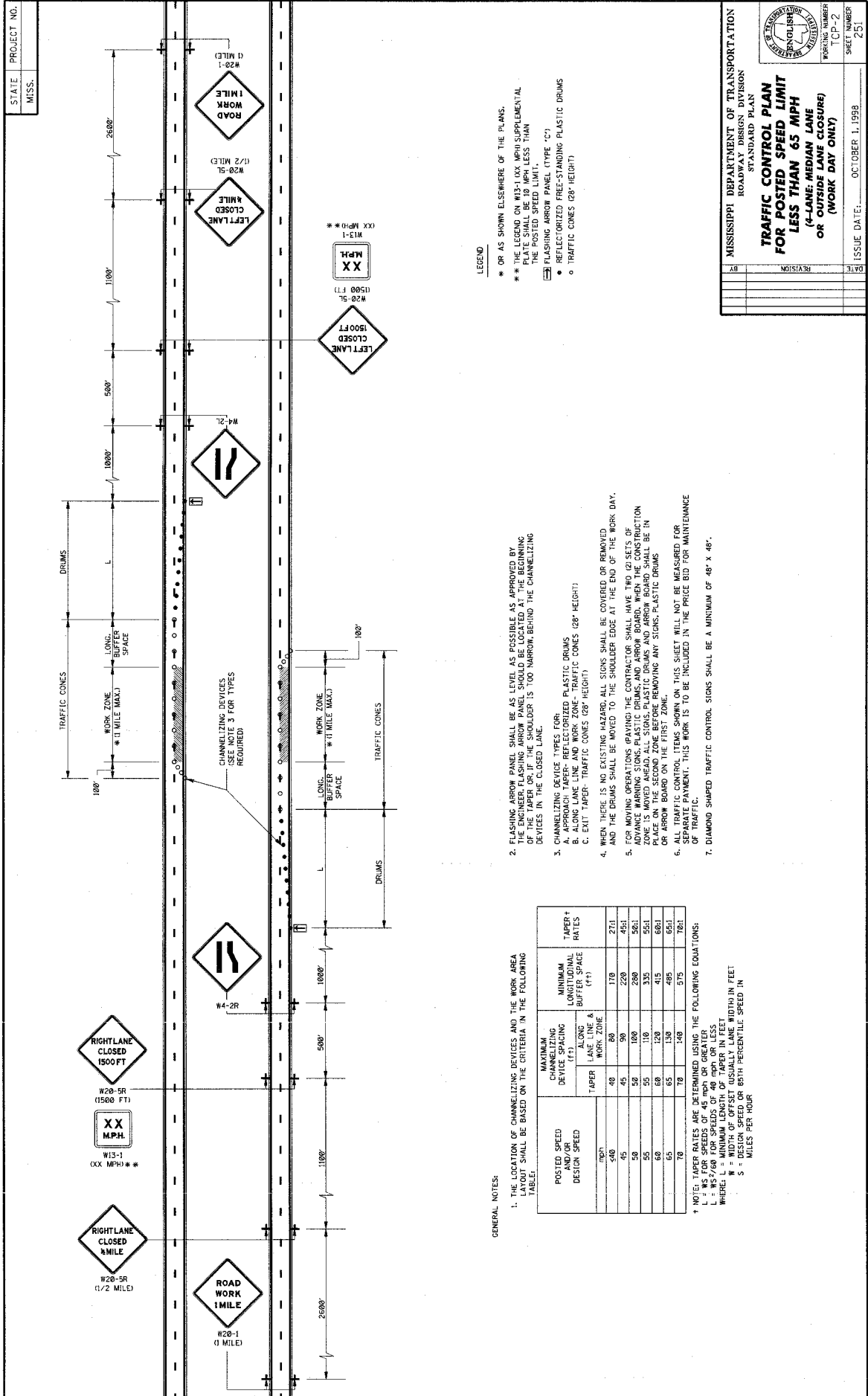

STATE PROJECT NO.
MISS.

MISSISSIPPI DEPARTMENT OF TRANSPORTATION
ROADWAY DESIGN DIVISION
STANDARD PLAN
**TRAFFIC CONTROL PLAN
FOR POSTED SPEED LIMIT
LESS THAN 65 MPH
(4-LANE; MEDIUM LANE
OR OUTSIDE LANE CLOSURE)
(WORK DAY ONLY)**

WORKING NUMBER
TCP-2
SHEET NUMBER
251
ISSUE DATE: OCTOBER 1, 1999

- LEGEND
- * OR AS SHOWN ELSEWHERE OF THE PLANS.
 - ** THE LEGEND ON W13-1XX MPH SUPPLEMENTAL PLATE SHALL BE 10 MPH LESS THAN THE POSTED SPEED LIMIT.
 - ◻ FLASHING ARROW PANEL (TYPE "C")
 - REFLECTORIZED FREE-STANDING PLASTIC DRUMS
 - TRAFFIC CONES (28" HEIGHT)

2. FLASHING ARROW PANEL SHALL BE AS LEVEL AS POSSIBLE AS APPROVED BY THE ENGINEER. FLASHING ARROW PANELS SHOULD BE LOCATED AT THE BEGINNING OF THE WORK ZONE. THE SIGN SHOULD BE LOCATED 100' NARROW BEHIND THE CHANNELIZING DEVICES IN THE CLOSED LANE.
3. CHANNELIZING DEVICE TYPES FOR:
 - A. ALONG LANE LINE AND WORK ZONE - TRAFFIC CONES (28" HEIGHT)
 - B. EXIT TAPER - TRAFFIC CONES (28" HEIGHT)
4. WHEN THERE IS NO EXISTING HAZARD, ALL SIGNS SHALL BE COVERED OR REMOVED, AND THE DRUMS SHALL BE MOVED TO THE SHOULDER EDGE AT THE END OF THE WORK DAY.
5. FOR MOVING OPERATIONS INVOLVED THE CONTRACTOR SHALL HAVE TWO SETS OF CHANNELIZING DEVICES. THE FIRST SET SHALL BE MOVED TO THE SHOULDER OF THE WORK ZONE IS MOVED AHEAD. ALL SIGNS, PLASTIC DRUMS AND ARROW BOARD SHALL BE IN PLACE ON THE SECOND ZONE BEFORE REMOVING ANY SIGNS, PLASTIC DRUMS OR ARROW BOARD ON THE FIRST ZONE.
6. ALL TRAFFIC CONTROL ITEMS SHOWN ON THIS SHEET WILL NOT BE MEASURED FOR DIAMOND SHARED TRAFFIC CONTROL. THIS WORK IS TO BE INCLUDED IN THE PRICE BID FOR MAINTENANCE OF TRAFFIC.
7. DIAMOND SHARED TRAFFIC CONTROL SIGNS SHALL BE A MINIMUM OF 48" X 48".

GENERAL NOTES:

1. THE LOCATION OF CHANNELIZING DEVICES AND THE WORK AREA LAYOUT SHALL BE BASED ON THE CRITERIA IN THE FOLLOWING TABLE:

POSTED SPEED (MPH) AND/OR DESIGN SPEED	MAXIMUM CHANNELIZING DEVICE SPACING (FT)		MINIMUM LONGITUDINAL BUFFER SPACE (FT)†	TAPER RATES
	LANE LINE & WORK ZONE	EXIT TAPER		
40	40	80	170	27:1
45	45	90	220	45:1
50	50	100	280	36:1
55	55	110	335	55:1
60	60	120	415	68:1
65	65	130	495	65:1
70	70	140	575	78:1

† NOTE: TAPER RATES ARE DETERMINED USING THE FOLLOWING EQUATIONS:
 L = WS FOR SPEEDS OF 45 MPH OR GREATER
 L = WS^{2/60} FOR SPEEDS OF 40 MPH OR LESS
 WHERE: W = WIDTH OF OFFSET USUALLY LANE WIDTH IN FEET
 S = DESIGN SPEED OR 85TH PERCENTILE SPEED IN MILES PER HOUR

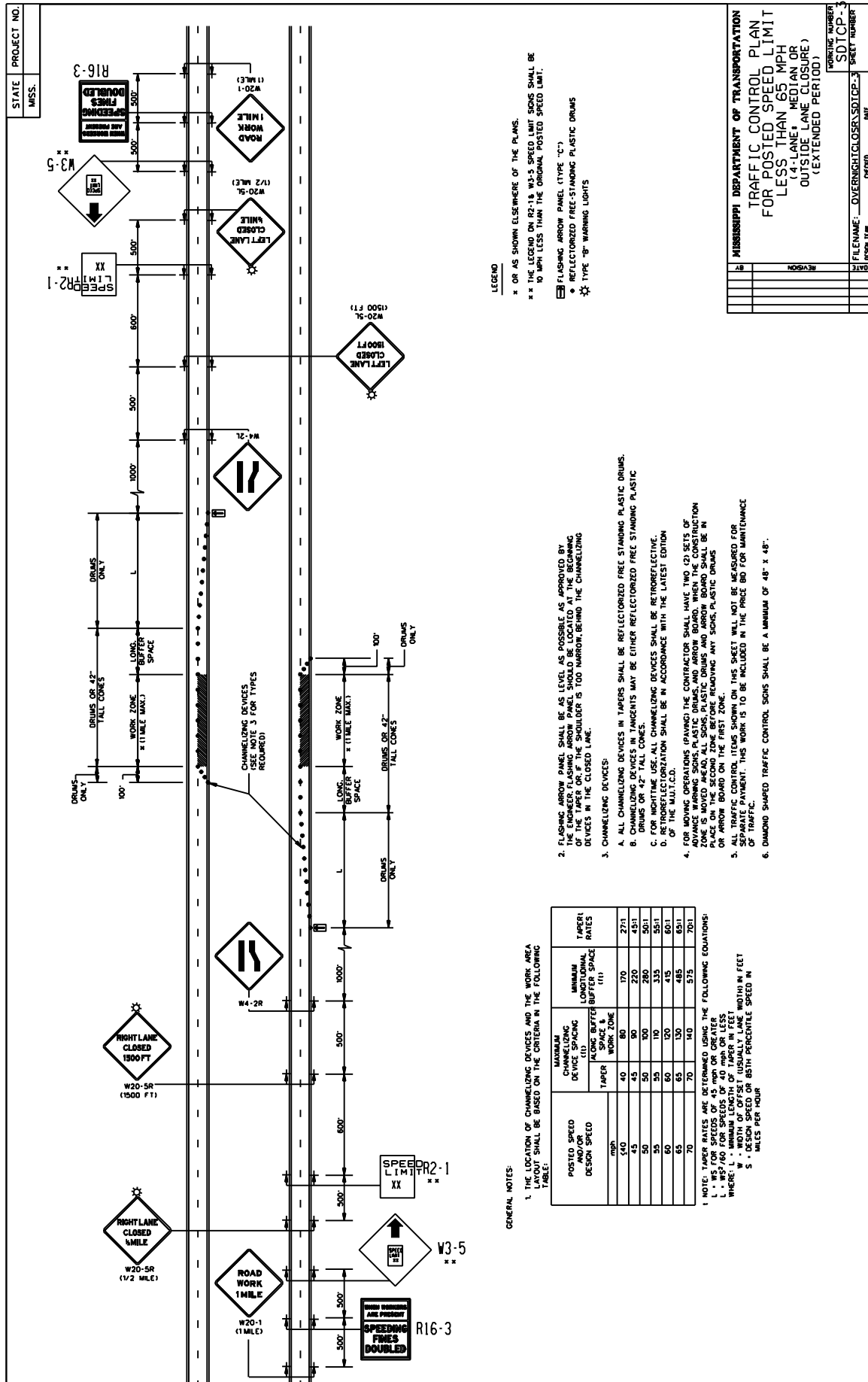

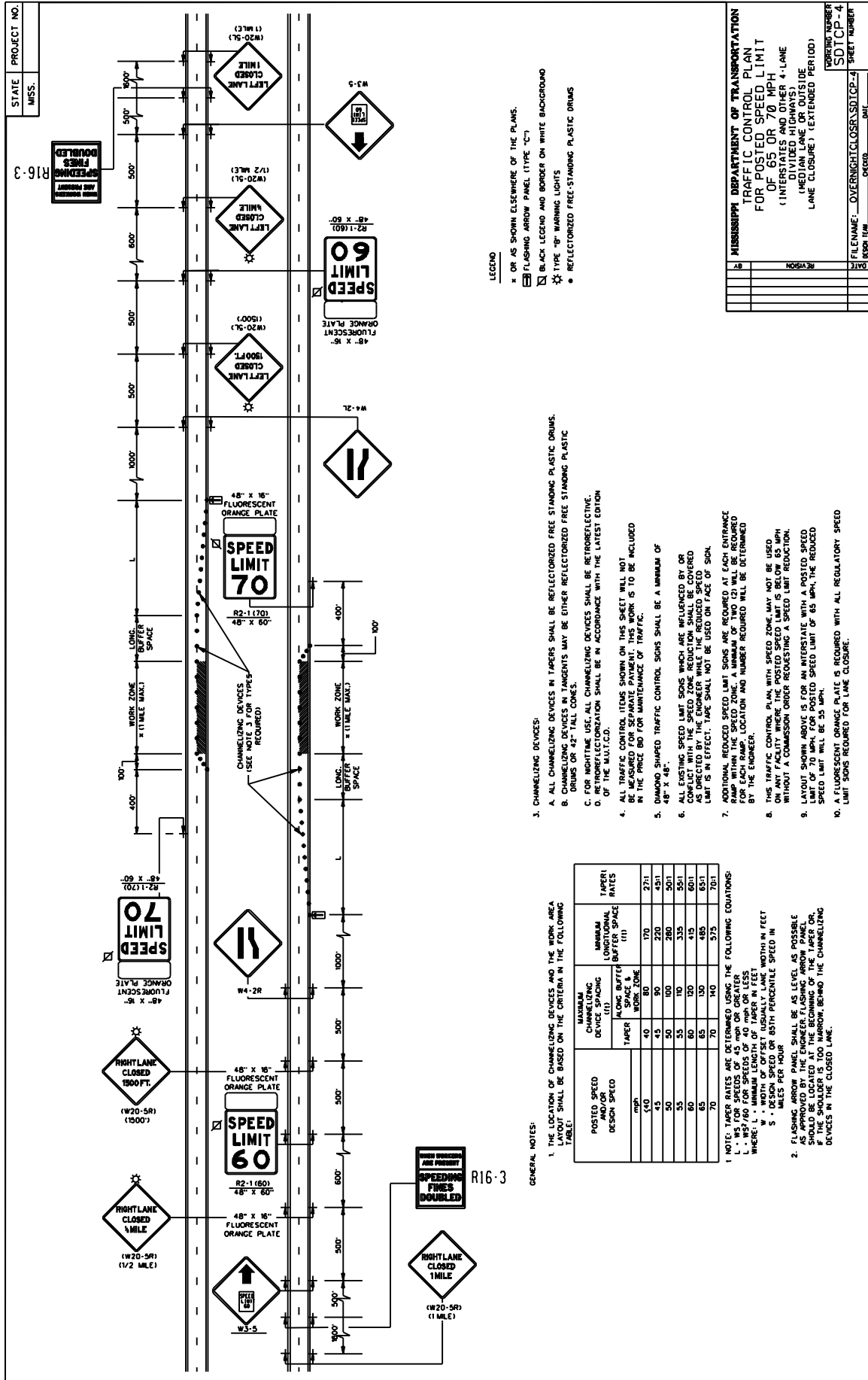

STATE PROJECT NO.
MISS. R16-3

SPEEDING FINES DOUBLED
SEE SIGNAGE FOR DETAILS

- LEGEND**
- * OR AS SHOWN ELSEWHERE OF THE PLANS.
 - FLASHING ARROW PANEL (TYPE "C")
 - BLACK LEGEND AND BORDER ON WHITE BACKGROUND
 - ☆ TYPE "80" WARNING LIGHTS
 - REFLECTORIZED FREE-STANDING PLASTIC DRUMS

- 3. CHANNELING DEVICES:**
- A. ALL CHANNELING DEVICES IN TAPERS SHALL BE REFLECTORIZED FREE STANDING PLASTIC DRUMS.
 - B. CHANNELING DEVICES IN TARGETS MAY BE EITHER REFLECTORIZED FREE STANDING PLASTIC DRUMS OR 42" TALL CONES.
 - C. FOR NIGHTTIME USE, ALL CHANNELING DEVICES SHALL BE RETROREFLECTIVE.
 - D. RETROREFLECTORIZATION SHALL BE IN ACCORDANCE WITH THE LATEST EDITION OF THE MUTCD.
- 4. ALL TRAFFIC CONTROL ITEMS SHOWN ON THIS SHEET WILL NOT BE REFLECTORIZED UNLESS SPECIFICALLY NOTED TO BE INCLUDED IN THE PRICE BID FOR MAINTENANCE OF TRAFFIC.**
- 5. DAMAGED SHIPPED TRAFFIC CONTROL SIGNS SHALL BE A MINIMUM OF 48" x 48".**
- 6. ALL EXISTING SPEED LIMIT SIGNS WHICH ARE UNLIT BY OR WHICH ARE NOT IN ACCORDANCE WITH THE MUTCD SHALL BE COVERED AS DIRECTED BY THE ENGINEER WHILE THE REDUCED SPEED LIMIT IS IN EFFECT. TAPE SHALL NOT BE USED ON FACE OF SIGN.**
- 7. ADDITIONAL REDUCED SPEED LIMIT SIGNS ARE REQUIRED AT EACH ENTRANCE RAMP WITHIN THE SPEED ZONE. A MINIMUM OF TWO (2) WILL BE REQUIRED FOR EACH RAMP. LOCATION AND NUMBER REQUIRED WILL BE DETERMINED BY THE ENGINEER.**
- 8. THIS TRAFFIC CONTROL PLAN, WITH SPEED ZONE, MAY NOT BE USED ON ANY FACILITY WHERE THE POSTED SPEED LIMIT IS BELOW 65 MPH WITHOUT A COMMISSION ORDER REQUESTING A SPEED LIMIT REDUCTION.**
- 9. LAYOUT SHOWN ABOVE IS FOR AN INTERSTATE WITH A POSTED SPEED LIMIT OF 70 MPH. IF THE INTERSTATE SPEED LIMIT IS 65 MPH, THE REDUCED SPEED LIMIT WILL BE 55 MPH.**
- 10. A FLUORESCENT ORANGE PLATE IS REQUIRED WITH ALL REGULATORY SPEED LIMIT SIGNS REQUIRED FOR LANE CLOSURE.**

1. THE LOCATION OF CHANNELING DEVICES AND THE WORK AREA TABLE SHALL BE BASED ON THE CRITERIA IN THE FOLLOWING TABLE:

POSTED SPEED AND/OR DESIGN SPEED (mph)	MAXIMUM CHANNELING DEVICE SPACING		MINIMUM TAPER RATES
	LONG BUFFER SPACE & WORK ZONE	SHORT BUFFER SPACE & WORK ZONE	
40	40	80	170
45	45	90	220
50	50	100	280
55	55	110	350
60	60	120	420
65	65	130	485
70	70	140	575

1. NOTE: TAPER RATES ARE DETERMINED USING THE FOLLOWING EQUATIONS:

- L - WS FOR SPEEDS OF 45 mph OR GREATER
- L - WS/60 FOR SPEEDS OF 40 mph OR LESS
- WHERE L = MINIMUM LENGTH OF TAPER IN FEET
- W = WIDTH OF TAPER IN FEET
- S = DESIGN SPEED OR 85TH PERCENTILE SPEED IN MILES PER HOUR

2. FLASHING ARROW PANEL SHALL BE AS LEVEL AS POSSIBLE AS APPROVED BY THE ENGINEER. FLASHING ARROW PANELS SHALL BE PLACED AT THE END OF THE SHOULDER OR IF THE SHOULDER IS TOO NARROW, BEHIND THE CHANNELING DEVICES IN THE CLOSED LANE.

MISSISSIPPI DEPARTMENT OF TRANSPORTATION
TRAFFIC CONTROL PLAN
FOR POSTED SPEED LIMIT
OF 65 OR 70 MPH
(INTERSTATES AND OTHER 4-LANE DIVIDED HIGHWAYS, MEDIAN LANE OR OUTSIDE LANE CLOSURE) (TEXTURED PERIOD)

DATE: _____
DRAWN BY: _____
CHECKED BY: _____
DESIGN TEAM: _____
FILE NAME: OVERNIGHTCLOSASD1CP-4
SHEET NUMBER: SDTCP-4

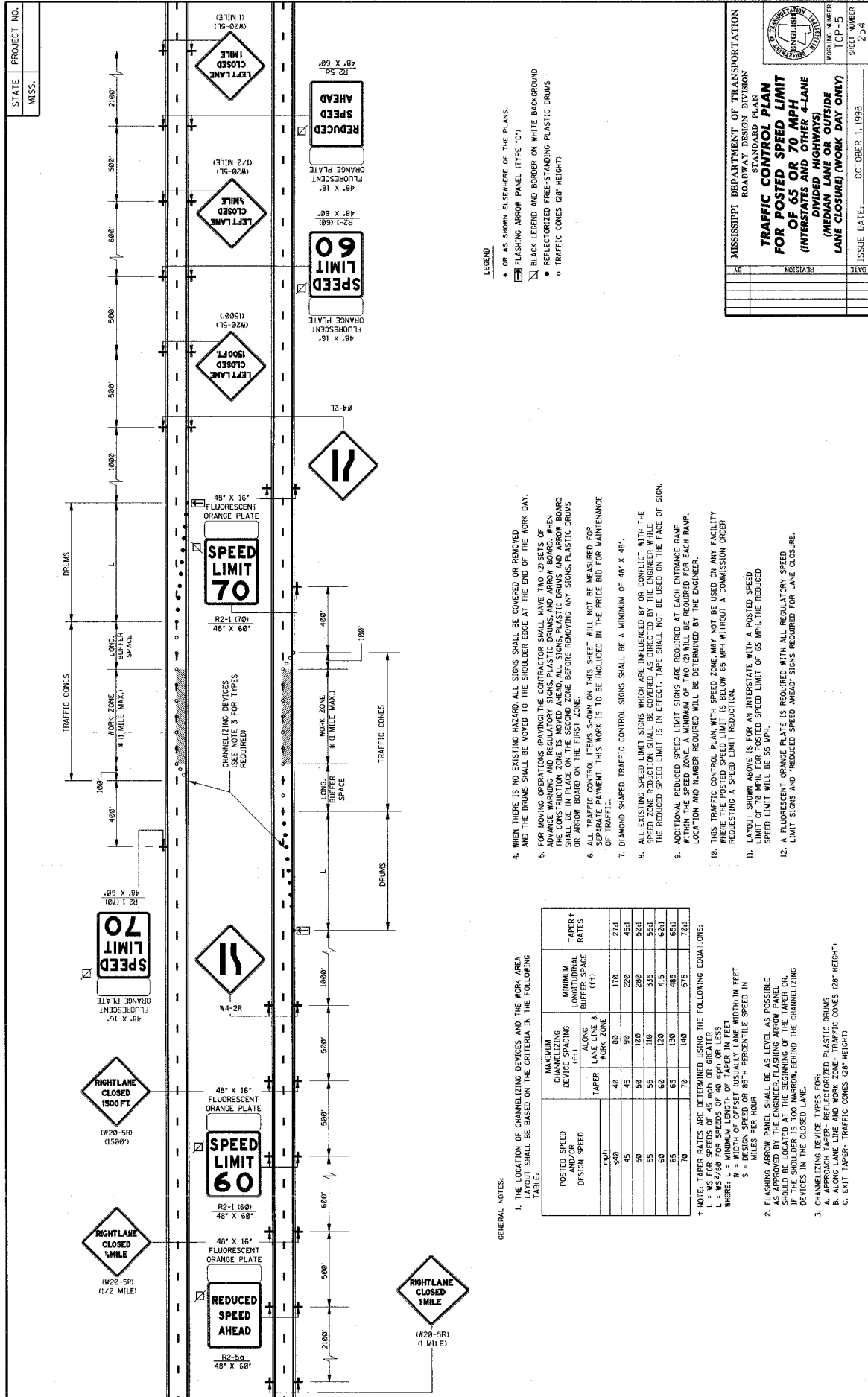

STATE PROJECT NO.
MISS.

MISSISSIPPI DEPARTMENT OF TRANSPORTATION
ROADWAY DESIGN DIVISION
STANDARD PLAN
**TRAFFIC CONTROL PLAN
FOR POSTED SPEED LIMIT
OF 65 OR 70 MPH
(INTERSTATES AND OTHER 4-LANE
DIVIDED HIGHWAYS)
(MEDIAN LANE OR OUTSIDE
LANE CLOSURE) (WORK DAY ONLY)**

WORKING NUMBER: TPC-5
SHEET NUMBER: 254
ISSUE DATE: OCTOBER 1, 1998

LEGEND

- * OR AS SHOWN ELSEWHERE OF THE PLANS.
- FLASHING ARROW PANEL (TYPE "C")
- BLACK LEGEND AND BORDER ON WHITE BACKGROUND
- REFLECTORIZED FREE-STANDING PLASTIC DRUMS
- TRAFFIC CONES (28" HEIGHT)

4. WHEN THERE IS NO EXISTING HAZARD, ALL SIGNS SHALL BE COVERED OR REMOVED, AND THE DRUMS SHALL BE MOVED TO THE SHOULDER EDGE AT THE END OF THE WORK DAY.
5. FOR MOVING OPERATIONS (PAVING) THE CONTRACTOR SHALL HAVE TWO (2) SETS OF THE CONSTRUCTION ZONE IS MOVED AHEAD ALL SIGNS, PLASTIC DRUMS, AND ARROW BOARD OR ARROW BOARD ON THE SECOND ZONE BEFORE REMOVING ANY SIGNS, PLASTIC DRUMS OR ARROW BOARD ON THE FIRST ZONE.
6. ALL TRAFFIC CONTROL ITEMS SHOWN ON THIS SHEET WILL NOT BE MEASURED FOR PAYMENT. THIS WORK IS TO BE INCLUDED IN THE PRICE BID FOR MAINTENANCE OF TRAFFIC.
7. DIAMOND SHAPED TRAFFIC CONTROL SIGNS SHALL BE A MINIMUM OF 48" X 48".
8. ALL EXISTING SPEED LIMIT SIGNS WHICH ARE INFLUENCED BY OR CONFLICT WITH THE SPEED ZONE REDUCTION SHALL BE COVERED AS DIRECTED BY THE ENGINEER WHILE THE REDUCED SPEED LIMIT IS IN EFFECT. TAPE SHALL NOT BE USED ON THE FACE OF SIGN.
9. ADDITIONAL REDUCED SPEED LIMIT SIGNS ARE REQUIRED AT EACH ENTRANCE RAMP WITHIN THE SPEED ZONE. A MINIMUM OF TWO (2) WILL BE REQUIRED FOR EACH RAMP. LOCATION AND NUMBER REQUIRED WILL BE DETERMINED BY THE ENGINEER.
10. THIS TRAFFIC CONTROL PLAN WITH SPEED ZONE, MAY NOT BE USED ON ANY FACILITY WHERE THE POSTED SPEED LIMIT IS BELOW 65 MPH WITHOUT A COMMISSION ORDER REQUESTING A SPEED LIMIT REDUCTION.
11. LAYOUT SHOWN ABOVE IS FOR AN INTERSTATE WITH A POSTED SPEED LIMIT OF 70 MPH. FOR POSTED SPEED LIMIT OF 65 MPH, THE REDUCED SPEED LIMIT WILL BE 55 MPH.
12. A FLUORESCENT ORANGE PLATE IS REQUIRED WITH ALL REGULATORY SPEED LIMIT SIGNS AND "REDUCED SPEED AHEAD" SIGNS REQUIRED FOR LANE CLOSURE.

GENERAL NOTES:
1. THE LOCATION OF CHANNELIZING DEVICES AND THE WORK AREA WIDTH SHALL BE BASED ON THE CRITERIA IN THE FOLLOWING TABLE:

POSTED SPEED AND/OR DESIGN SPEED (mph)	CHANNELIZING DEVICE SPACING (FT)		MINIMUM BUFFER SPACE (FT)	TAPER RATES
	LANE LINE & BUFFER SPACE	WORK ZONE		
50	40	80	170	27:1
45	45	90	220	45:1
50	50	100	280	50:1
55	55	110	335	55:1
60	60	120	415	60:1
65	65	130	485	65:1
70	70	140	575	70:1

† NOTE: TAPER RATES ARE DETERMINED USING THE FOLLOWING EQUATIONS:

- L = W S FOR SPEEDS OF 45 MPH OR GREATER
- L = W S / 60 FOR SPEEDS OF 50 MPH OR GREATER
- W = MINIMUM LENGTH OF TAPER IN FEET
- S = DESIGN SPEED OR 85TH PERCENTILE SPEED IN MILES PER HOUR

2. FLASHING ARROW PANEL SHALL BE AS LEVEL AS POSSIBLE AND SHALL BE LOCATED AT THE BEGINNING OF THE TAPER OR, IF THE SHOULDER IS TOO NARROW, BEHIND THE CHANNELIZING DEVICES IN THE CLOSED LANE.

3. CHANNELIZING DEVICE TYPES (TOP):
A. APPROACH TAPER - REFLECTORIZED PLASTIC DRUMS (28" HEIGHT)
B. TAPER - REFLECTORIZED PLASTIC CONES (28" HEIGHT)
C. EXIT TAPER - TRAFFIC CONES (28" HEIGHT)

STATE PROJECT NO.

MISS.

DATE: _____

ISSUE DATE: 10-04-2011

WING BARRICADES

- WING BARRICADES ARE TYPE III BARRICADES ERECTED ON THE SHOULDER ON ONE OR BOTH SIDES OF THE PAVEMENT TO GIVE THE SENSATION OF A NARROWING OR RESTRICTED ROADWAY. WING BARRICADES MAY BE USED AS A MOUNTING FOR THE ADVANCE WARNING SIGNS OR FLASHERS.
- WING BARRICADES SHOULD BE USED:
 - IN ADVANCE OF A CONSTRUCTION PROJECT EVEN WHEN NO PROJECTS AS WING BARRICADES AND AT ROAD CLOSURES, WHERE THEY MUST REMAIN IN PLACE FOR EXTENDED PERIODS.
 - IN ADVANCE OF ALL BRIDGE OR CONVEYOR REBIDDING OPERATIONS.

STANDARD BARRICADES

- A TYPE I BARRICADE CONSISTS OF ONE (1) HORIZONTAL RAIL SUPPORTED BY A DEMOUNTABLE FRAME OR A LIGHT "A" FRAME. A TYPE I BARRICADE NORMALLY WOULD BE USED ON CONVENTIONAL ROADS OR URBAN STREETS AND ARTERIALS.
- A TYPE II BARRICADE CONSISTS OF TWO (2) HORIZONTAL RAILS ON A LIGHT "A" FRAME. TYPE II BARRICADES ARE INTENDED FOR USE ON EXPRESSWAYS AND FREEWAYS AND OTHER HIGH-SPEED ROADWAYS.
- TYPE I AND TYPE II BARRICADES ARE INTENDED FOR USE WHERE THE HAZARD IS RELATIVELY SMALL AS, FOR EXAMPLE, ON CITY STREETS, OR FOR THE MORE OR LESS CONTINUOUS DELIMITING OF A RESTRICTED ROADWAY, OR FOR TEMPORARY ODTIME USE.
- A TYPE III BARRICADE CONSISTS OF THREE (3) HORIZONTAL RAILS SUPPORTED BY FIXED POSTS, A RIGID SKID, A HEAVY DEMOUNTABLE FRAME OR A HEAVY, RINGED "A" FRAME.
- TYPE III BARRICADES ARE INTENDED FOR USE ON CONSTRUCTION AND MAINTENANCE PROJECTS AS WING BARRICADES AND AT ROAD CLOSURES, WHERE THEY MUST REMAIN IN PLACE FOR EXTENDED PERIODS.
- THE MARKING FOR BARRICADE RAILS SHALL BE ORANGE AND WHITE (SLOPING DOWNWARD AT AN ANGLE OF 45° IN THE DIRECTION TRAFFIC IS TO PASS).
- DO NOT PLACE SANDBAGS OR OTHER DEVICES TO PROVIDE MASS ON THE BOTTOM RAIL THAT WILL BLOCK VIEW OR RAIL FACE.
- FOR ADDITIONAL INFORMATION OR DETAILS, SEE METHOD, LATEST EDITION.
- BARRICADES ARE CLASSIFIED BY FHWA AS CATEGORY II WORK ZONE DEVICES WHICH REQUIRE CRASHWORTHINESS ACCEPTANCE LETTERS. TO DATE, 2-IN. THICK TIMBER RAILS HAVE NOT BEEN SUCCESSFULLY CRASH TESTED. A LIST OF CRASHWORTHY BARRICADES AND OTHER CATEGORY II DEVICES CAN BE FOUND ON FHWA'S WEBSITE: http://safety.fhwa.dot.gov/roadway_dept/policy_guide/road_haz/ohw/ohw/cmr2.cfm

BARRICADE CLOSING A ROAD

BARRICADE CHARACTERISTICS			
	I	II	III
WIDTH OF RAIL **	8" MIN. - 12" MAX.	8" MIN. - 12" MAX.	8" MIN. - 12" MAX.
LENGTH OF RAIL **	24" MIN.	24" MIN.	48" MIN.
WIDTH OF STRIPE #	6"	36" MIN.	6"
HEIGHT	36" MIN.	36" MIN.	60" MIN.
NUMBER OF REFLECTORIZED RAIL FACES	2 (ONE EACH DIRECTION)	4 (TWO EACH DIRECTION)	3 (IF FACING TRAFFIC IN ONE DIRECTION) 6 (IF FACING TRAFFIC IN TWO DIRECTIONS)
TYPE OF FRAME	LIGHT	LIGHT "A" FRAME	POST OR SKID

* 1. FOR RAILS LESS THAN 36" LONG, 4" WIDE STRIPES MAY BE USED.
 ** 2. BARRICADES INTENDED FOR USE ON EXPRESSWAYS, FREEWAYS AND OTHER HIGH SPEED ROADWAYS SHALL HAVE A MINIMUM OF 270° OF REFLECTIVE AREA FACING TRAFFIC.

PLASTIC DRUM STRIPING DETAIL

- PLASTIC DRUMS SHALL BE ON END AND USED AS AN EXPEDIENT METHOD FOR TEMPORARY ROAD CLOSURES. DRUMS SHALL BE MOUNTED WITH MARKING STANDARDS FOR BARRICADE. THE PREDOMINANT COLOR ON DRUMS SHALL BE ORANGE WITH FOUR (4) REFLECTORIZED, HORIZONTAL, CIRCUMFERENTIAL STRIPES (2 ORANGE & 2 WHITE) 6" WIDE.
- DRUMS SHOULD NEVER BE PLACED IN THE ROADWAY WITHOUT WARNING SIGNS.
- WHERE PRACTICAL PLASTIC DRUMS SHALL BE PLACED NO CLOSER THAN 3'-0" FROM THE EDGE OF TRAVELED LANE.

VERTICAL PANEL

- VERTICAL PANELS CONSIST OF AT LEAST ONE PANEL 8" TO 12" IN WIDTH AND A MINIMUM OF 24" IN HEIGHT.
- THE DIAGONAL STRIPES SHALL SLOPE DOWNWARD FROM THE TOP LEFT TO THE BOTTOM RIGHT. THE PANELS SHALL BE MOUNTED WITH THE TOP A MINIMUM OF 36" ABOVE THE ROADWAY ON A SINGLE LIGHTMASS POST.
- VERTICAL PANELS USED ON EXPRESSWAYS, FREEWAYS AND OTHER HIGH-SPEED ROADWAYS SHALL BE A MINIMUM OF 36" ABOVE THE ROADWAY ON A SINGLE FACING TRAFFIC.
- FOR TWO-WAY TRAFFIC OPERATIONS, BACK-TO-BACK PANELS SHALL BE USED.

GENERAL NOTES:
 1. MARKINGS ON ALL DEVICES SHOWN ON THIS SHEET SHALL BE HIGH INTENSITY REFLECTIVE SHEETING.
 2. THE TRAFFIC CONTROL PLAN WILL LIST THE VARIOUS TRAFFIC CONTROL DEVICES REQUIRED FOR EACH PROJECT.

TYPE 3 OBJECT MARKER (OW-3R)

- TYPE 3 OBJECT MARKERS SHALL BE USED AT ALL EXPOSED BRIDGE ABUTMENTS AND AT OTHER LOCATIONS AS DEEMED NECESSARY BY THE ENGINEER.
- THE OW-3R IS SHOWN. THE OW-3R IS SIMILAR EXCEPT THE STRIPES SLOPE DOWNWARD FROM THE UPPER LEFT SIDE TO THE LOWER RIGHT SIDE AND SHALL BE PLACED ON THE LEFT SIDE OF THE OBJECT.
- THE INSIDE EDGE OF THE MARKER SHALL BE IN LINE WITH THE INNER EDGE OF THE OBSTRUCTION.

CHEVRON SIGN DETAIL

- A CHEVRON SIGN CONSISTS OF A BLACK CHEVRON TYPE MARKING ON AN ORANGE BACKGROUND AND SHALL POINT IN THE DIRECTION OF TRAFFIC FLOW.
- THE CHEVRON SIGN SHALL BE MOUNTED ON FIXED POST OR RIGID SKID.
- CHEVRON SIGNS MAY BE USED TO SUPPLEMENT OTHER STANDARD DEVICES WHERE ONE OR MORE LANES ARE CLOSED FOR CONSTRUCTION OR MAINTENANCE. THEY SHALL BE PLACED APPROXIMATELY 2'-0" BEHIND THE LANE TRANSITION STRIPE.

PLASTIC DRUM STRIPING DETAIL

- PLASTIC DRUMS SHALL BE ON END AND USED AS AN EXPEDIENT METHOD FOR TEMPORARY ROAD CLOSURES. DRUMS SHALL BE MOUNTED WITH MARKING STANDARDS FOR BARRICADE. THE PREDOMINANT COLOR ON DRUMS SHALL BE ORANGE WITH FOUR (4) REFLECTORIZED, HORIZONTAL, CIRCUMFERENTIAL STRIPES (2 ORANGE & 2 WHITE) 6" WIDE.
- DRUMS SHOULD NEVER BE PLACED IN THE ROADWAY WITHOUT WARNING SIGNS.
- WHERE PRACTICAL PLASTIC DRUMS SHALL BE PLACED NO CLOSER THAN 3'-0" FROM THE EDGE OF TRAVELED LANE.

VERTICAL PANEL

- VERTICAL PANELS CONSIST OF AT LEAST ONE PANEL 8" TO 12" IN WIDTH AND A MINIMUM OF 24" IN HEIGHT.
- THE DIAGONAL STRIPES SHALL SLOPE DOWNWARD FROM THE TOP LEFT TO THE BOTTOM RIGHT. THE PANELS SHALL BE MOUNTED WITH THE TOP A MINIMUM OF 36" ABOVE THE ROADWAY ON A SINGLE LIGHTMASS POST.
- VERTICAL PANELS USED ON EXPRESSWAYS, FREEWAYS AND OTHER HIGH-SPEED ROADWAYS SHALL BE A MINIMUM OF 36" ABOVE THE ROADWAY ON A SINGLE FACING TRAFFIC.
- FOR TWO-WAY TRAFFIC OPERATIONS, BACK-TO-BACK PANELS SHALL BE USED.

GENERAL NOTES:
 1. MARKINGS ON ALL DEVICES SHOWN ON THIS SHEET SHALL BE HIGH INTENSITY REFLECTIVE SHEETING.
 2. THE TRAFFIC CONTROL PLAN WILL LIST THE VARIOUS TRAFFIC CONTROL DEVICES REQUIRED FOR EACH PROJECT.

STATE PROJECT NO.

MISS.

DATE: _____

ISSUE DATE: 10-04-2011

MISSISSIPPI DEPARTMENT OF TRANSPORTATION

HIGHWAY SIGN AND BARRICADE DETAILS FOR CONSTRUCTION PROJECTS

WORKING NUMBER: SDTCP-10

SHEET NUMBER: _____

STATE PROJECT NO.
MISS. _____

MOBILE OPERATIONS ON TWO-LANE ROAD

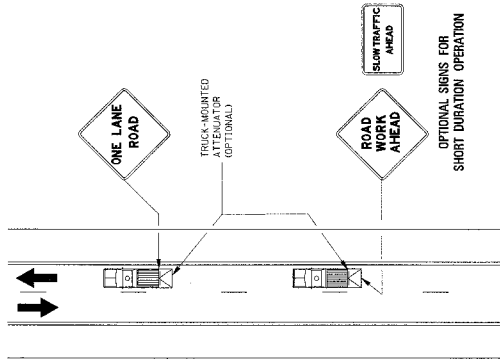

MOBILE OPERATIONS ON TWO-LANE ROAD

- NOTES:
1. BE PRACTICAL AND WHEN NEAR THE WORK AND PROTECTION VEHICLES SHOULD PULL OVER PERIODICALLY TO ALLOW TRAFFIC TO PASS. IF THIS CAN NOT BE DONE FREQUENTLY, AS AN ALTERNATIVE, A "DO NOT PASS" SIGN MAY BE PLACED ON THE REAR OF THE VEHICLE BLOCKING THE LANE.
 2. THE DISTANCE BETWEEN THE WORK AND PROTECTION VEHICLES MAY VARY ACCORDING TO TERRAIN, PAINT DRYING TIME, AND OTHER FACTORS. PROTECTION VEHICLES ARE USED TO WARN TRAFFIC OF THE OPERATION AHEAD. WHENEVER ADEQUATE WARNING IS PROVIDED, PROTECTION VEHICLES SHOULD MAINTAIN THE MINIMUM DISTANCE AND PROCEED AT THE SAME SPEED AS THE WORK VEHICLE. THE PROTECTION VEHICLE SHOULD SLOW DOWN IN ADVANCE OF VERTICAL OR HORIZONTAL CURVES THAT RESTRICT SIGHT DISTANCE.
 3. ADDITIONAL PROTECTION VEHICLES TO WARN AND REDUCE THE SPEED OF ONCOMING OR OPPOSING TRAFFIC MAY BE USED. POLICE PATROL CARS MAY BE USED FOR THIS PURPOSE.
 4. A TRUCK-MOUNTED ATTENUATOR (TMA) SHOULD BE USED ON THE PROTECTION VEHICLE AND MAY BE USED ON THE WORK VEHICLE.
 5. THE WORK VEHICLE SHALL BE EQUIPPED WITH BEACONS AND THE PROTECTION VEHICLES SHALL BE EQUIPPED WITH THE MINIMUM TYPE FLASHING LIGHTS. PROTECTION AND WORK LIGHTS MOUNTED ON THE REAR, ADJACENT TO THE SIGN, PROTECTION AND WORK VEHICLES SHOULD DISPLAY FLASHING OR ROTATING BEACONS BOTH FORWARD AND TO THE REAR.
 6. VEHICLE-MOUNTED SIGNS SHALL BE MOUNTED WITH THE BOTTOM OF THE SIGN LOCATED AT A MINIMUM HEIGHT OF 49" ABOVE THE PAVEMENT. SIGN LEGS SHALL BE COVERED OR TURNED FROM VIEW WHEN WORK IS NOT IN PROGRESS.
 7. ALL TRAFFIC CONTROL ITEMS SHOWN ON THIS SHEET WILL NOT BE MEASURED FOR SEPARATE PAYMENT. THIS WORK IS TO BE INCLUDED IN THE PRICE BID FOR MAINTENANCE OF TRAFFIC.

MOBILE OPERATIONS ON MULTILANE ROAD

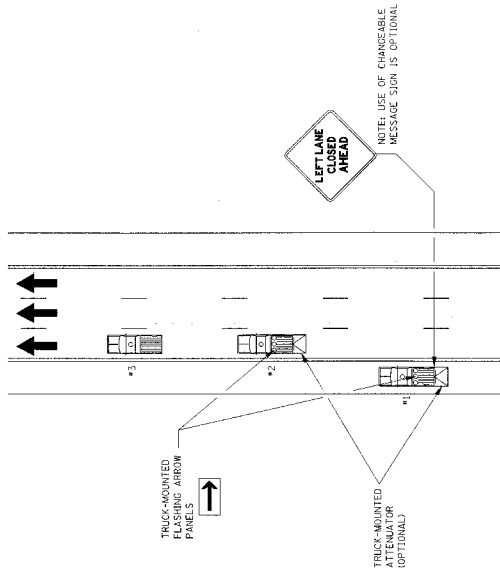

MOBILE OPERATIONS ON MULTILANE ROAD

- NOTES:
1. VEHICLES USED FOR THESE OPERATIONS SHOULD BE MADE HIGHLY VISIBLE BY EQUIPPING THEM WITH BEACONS, FLASHING LIGHTS, ROTATING BEACONS, FLAG, SIGNS, OR ARROW PANELS.
 2. PROTECTION VEHICLE #1 SHOULD BE EQUIPPED WITH AN ARROW PANEL. WHEN TRAFFIC IS IN THE CLOSED LANE, THIS SIGN SHOULD BE PLACED ON PROTECTION VEHICLE #1 SO AS NOT TO OBSCURE THE ARROW PANEL.
 3. PROTECTION VEHICLE #2 SHOULD BE EQUIPPED WITH AN ARROW PANEL AND TRUCK-MOUNTED ATTENUATOR (TMA).
 4. PROTECTION VEHICLE #1 SHOULD TRAVEL AT A VARYING DISTANCE FROM THE WORK OPERATION SO AS TO PROVIDE ADEQUATE SIGHT DISTANCE FOR TRAFFIC APPROACHING FROM THE REAR.
 5. WHEN ADEQUATE SHOULDER WIDTH IS NOT AVAILABLE, PROTECTION VEHICLE #1 SHOULD BE ELIMINATED.
 6. ON HIGH-SPEED ROADWAYS, A THIRD PROTECTION VEHICLE SHOULD BE USED (I.E., VEHICLE #1 ON THE SHOULDER (IF PRACTICAL), VEHICLE #2 IN THE CLOSED LANE, AND VEHICLE #3 IN THE CLOSED LANE).
 7. ARROW PANELS SHALL BE AS A MINIMUM TYPE B, 60" X 30" IN ACCORDANCE WITH THE CRITERIA PRESENTED IN THE MUTCD.
 8. WORK SHOULD NORMALLY BE DONE DURING OFF-PEAK HOURS.
 9. ALL TRAFFIC CONTROL ITEMS SHOWN ON THIS SHEET WILL NOT BE MEASURED FOR SEPARATE PAYMENT. THIS WORK IS TO BE INCLUDED IN THE PRICE BID FOR MAINTENANCE OF TRAFFIC.

MISSISSIPPI DEPARTMENT OF TRANSPORTATION ROADWAY DESIGN DIVISION STANDARD PLAN	
TRAFFIC CONTROL PLAN MOBILE OPERATIONS MULTILANE ROADS TWO-LANE ROADS	
NO. 213	REVISED
NO. 212	NO. 211
NO. 211	NO. 210
NO. 210	NO. 209
NO. 209	NO. 208
NO. 208	NO. 207
NO. 207	NO. 206
NO. 206	NO. 205
NO. 205	NO. 204
NO. 204	NO. 203
NO. 203	NO. 202
NO. 202	NO. 201
NO. 201	NO. 200
NO. 200	NO. 199
NO. 199	NO. 198
NO. 198	NO. 197
NO. 197	NO. 196
NO. 196	NO. 195
NO. 195	NO. 194
NO. 194	NO. 193
NO. 193	NO. 192
NO. 192	NO. 191
NO. 191	NO. 190
NO. 190	NO. 189
NO. 189	NO. 188
NO. 188	NO. 187
NO. 187	NO. 186
NO. 186	NO. 185
NO. 185	NO. 184
NO. 184	NO. 183
NO. 183	NO. 182
NO. 182	NO. 181
NO. 181	NO. 180
NO. 180	NO. 179
NO. 179	NO. 178
NO. 178	NO. 177
NO. 177	NO. 176
NO. 176	NO. 175
NO. 175	NO. 174
NO. 174	NO. 173
NO. 173	NO. 172
NO. 172	NO. 171
NO. 171	NO. 170
NO. 170	NO. 169
NO. 169	NO. 168
NO. 168	NO. 167
NO. 167	NO. 166
NO. 166	NO. 165
NO. 165	NO. 164
NO. 164	NO. 163
NO. 163	NO. 162
NO. 162	NO. 161
NO. 161	NO. 160
NO. 160	NO. 159
NO. 159	NO. 158
NO. 158	NO. 157
NO. 157	NO. 156
NO. 156	NO. 155
NO. 155	NO. 154
NO. 154	NO. 153
NO. 153	NO. 152
NO. 152	NO. 151
NO. 151	NO. 150
NO. 150	NO. 149
NO. 149	NO. 148
NO. 148	NO. 147
NO. 147	NO. 146
NO. 146	NO. 145
NO. 145	NO. 144
NO. 144	NO. 143
NO. 143	NO. 142
NO. 142	NO. 141
NO. 141	NO. 140
NO. 140	NO. 139
NO. 139	NO. 138
NO. 138	NO. 137
NO. 137	NO. 136
NO. 136	NO. 135
NO. 135	NO. 134
NO. 134	NO. 133
NO. 133	NO. 132
NO. 132	NO. 131
NO. 131	NO. 130
NO. 130	NO. 129
NO. 129	NO. 128
NO. 128	NO. 127
NO. 127	NO. 126
NO. 126	NO. 125
NO. 125	NO. 124
NO. 124	NO. 123
NO. 123	NO. 122
NO. 122	NO. 121
NO. 121	NO. 120
NO. 120	NO. 119
NO. 119	NO. 118
NO. 118	NO. 117
NO. 117	NO. 116
NO. 116	NO. 115
NO. 115	NO. 114
NO. 114	NO. 113
NO. 113	NO. 112
NO. 112	NO. 111
NO. 111	NO. 110
NO. 110	NO. 109
NO. 109	NO. 108
NO. 108	NO. 107
NO. 107	NO. 106
NO. 106	NO. 105
NO. 105	NO. 104
NO. 104	NO. 103
NO. 103	NO. 102
NO. 102	NO. 101
NO. 101	NO. 100
NO. 100	NO. 99
NO. 99	NO. 98
NO. 98	NO. 97
NO. 97	NO. 96
NO. 96	NO. 95
NO. 95	NO. 94
NO. 94	NO. 93
NO. 93	NO. 92
NO. 92	NO. 91
NO. 91	NO. 90
NO. 90	NO. 89
NO. 89	NO. 88
NO. 88	NO. 87
NO. 87	NO. 86
NO. 86	NO. 85
NO. 85	NO. 84
NO. 84	NO. 83
NO. 83	NO. 82
NO. 82	NO. 81
NO. 81	NO. 80
NO. 80	NO. 79
NO. 79	NO. 78
NO. 78	NO. 77
NO. 77	NO. 76
NO. 76	NO. 75
NO. 75	NO. 74
NO. 74	NO. 73
NO. 73	NO. 72
NO. 72	NO. 71
NO. 71	NO. 70
NO. 70	NO. 69
NO. 69	NO. 68
NO. 68	NO. 67
NO. 67	NO. 66
NO. 66	NO. 65
NO. 65	NO. 64
NO. 64	NO. 63
NO. 63	NO. 62
NO. 62	NO. 61
NO. 61	NO. 60
NO. 60	NO. 59
NO. 59	NO. 58
NO. 58	NO. 57
NO. 57	NO. 56
NO. 56	NO. 55
NO. 55	NO. 54
NO. 54	NO. 53
NO. 53	NO. 52
NO. 52	NO. 51
NO. 51	NO. 50
NO. 50	NO. 49
NO. 49	NO. 48
NO. 48	NO. 47
NO. 47	NO. 46
NO. 46	NO. 45
NO. 45	NO. 44
NO. 44	NO. 43
NO. 43	NO. 42
NO. 42	NO. 41
NO. 41	NO. 40
NO. 40	NO. 39
NO. 39	NO. 38
NO. 38	NO. 37
NO. 37	NO. 36
NO. 36	NO. 35
NO. 35	NO. 34
NO. 34	NO. 33
NO. 33	NO. 32
NO. 32	NO. 31
NO. 31	NO. 30
NO. 30	NO. 29
NO. 29	NO. 28
NO. 28	NO. 27
NO. 27	NO. 26
NO. 26	NO. 25
NO. 25	NO. 24
NO. 24	NO. 23
NO. 23	NO. 22
NO. 22	NO. 21
NO. 21	NO. 20
NO. 20	NO. 19
NO. 19	NO. 18
NO. 18	NO. 17
NO. 17	NO. 16
NO. 16	NO. 15
NO. 15	NO. 14
NO. 14	NO. 13
NO. 13	NO. 12
NO. 12	NO. 11
NO. 11	NO. 10
NO. 10	NO. 9
NO. 9	NO. 8
NO. 8	NO. 7
NO. 7	NO. 6
NO. 6	NO. 5
NO. 5	NO. 4
NO. 4	NO. 3
NO. 3	NO. 2
NO. 2	NO. 1
NO. 1	NO. 0

ISSUE DATE: OCTOBER 1, 1998
DRAWN BY: _____
CHECKED BY: _____
DATE: _____
SCALE: _____
SHEET NO. 260

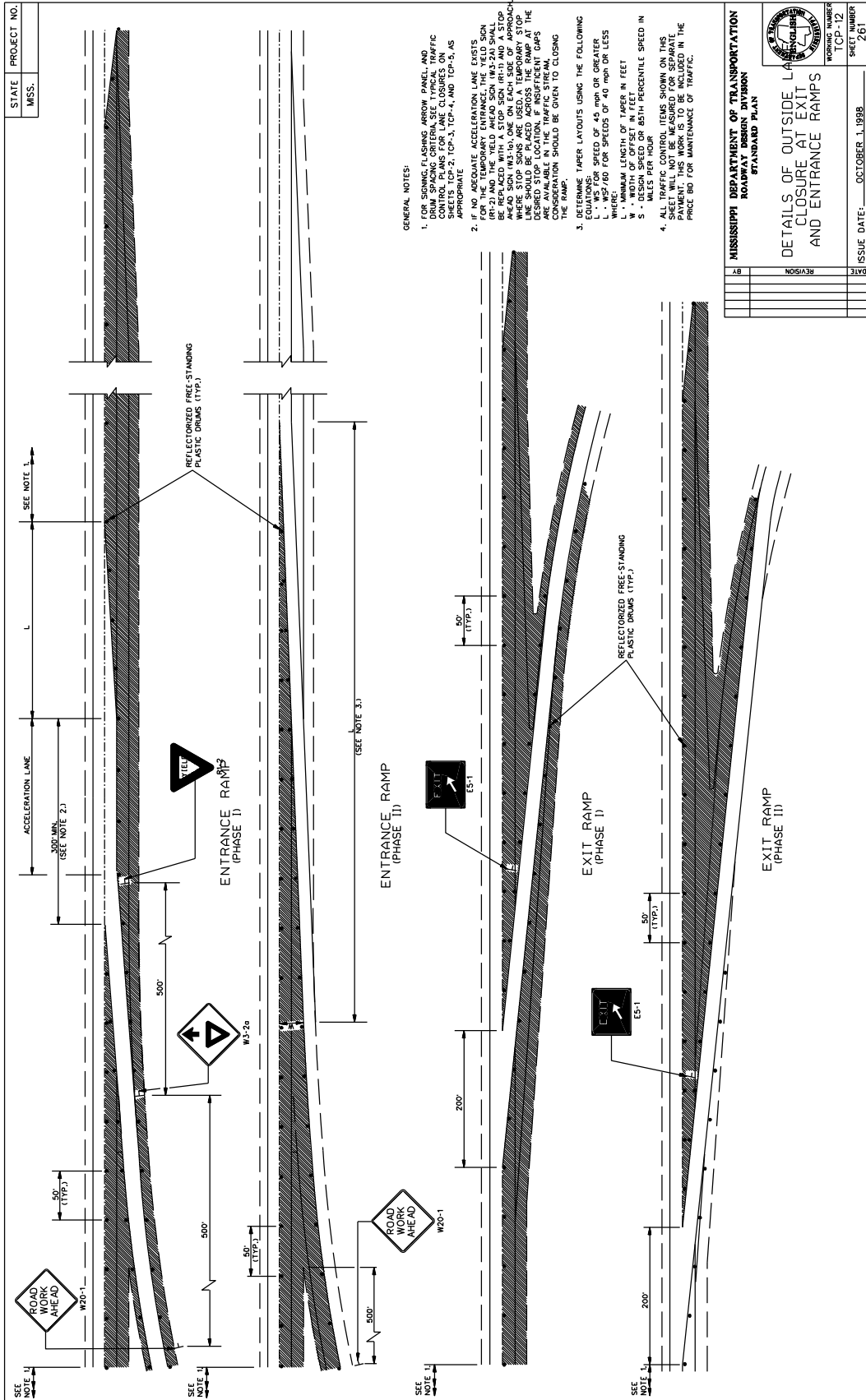

STATE MISS. PROJECT NO.

- GENERAL NOTES:
1. UNEVEN LANE LINE SIGNS SHALL BE EQUAL TO 1/2" NO. SIGNS REQUIRED.
 2. IF GREATER THAN 1/2" AND LESS THAN OR EQUAL TO 2 1/4", PLACE SIGNS AS SHOWN ON THIS SHEET.
 3. IF GREATER THAN 2 1/4", TRAFFIC SHOULD NOT BE ALLOWED TO CROSS UNEVEN LANE LINE.
 4. ALL TRAFFIC CONTROL ITEMS SHOWN ON THIS SHEET SHALL BE PAID FOR UNDER MAINTENANCE OF TRAFFIC.
 5. THE W8-11 SIGNS SHALL BE SPACED AT 1/4-MILE INTERVALS THROUGHOUT UNEVEN LANE LINE LIMITS.

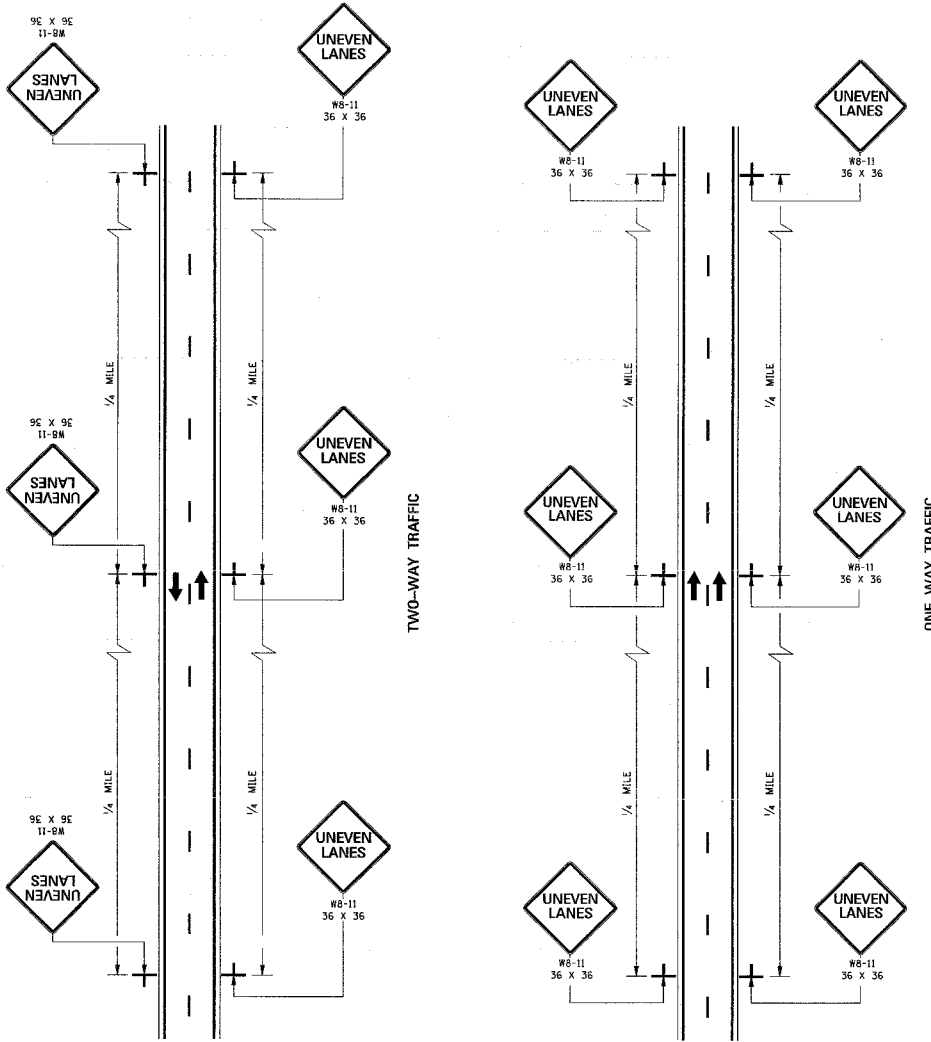

MISSISSIPPI DEPARTMENT OF TRANSPORTATION
 ROADWAY DESIGN DIVISION
 STANDARD PLAN

**TRAFFIC CONTROL PLANS
 UNEVEN PAVEMENT
 DETAILS**

WORKING NUMBER: CP-14
 SHEET NUMBER: 263

ISSUE DATE: OCTOBER 1, 1998

DATE	REVISION

STATE PROJECT NO.
MISS.

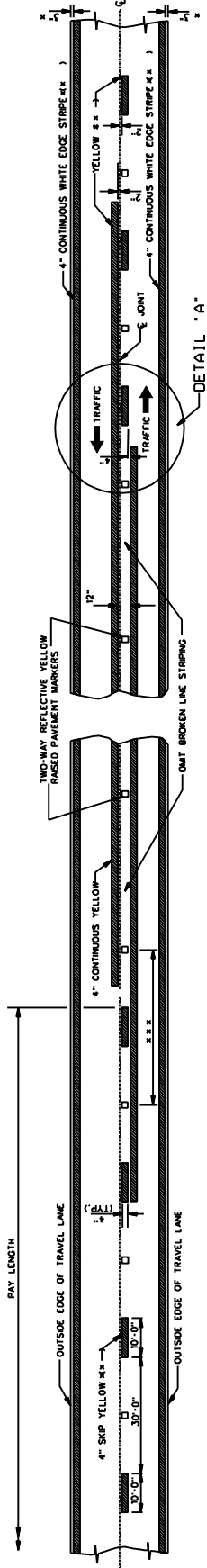

TWO-WAY TRAFFIC
(ASPHALT OR CONCRETE PAVEMENT)

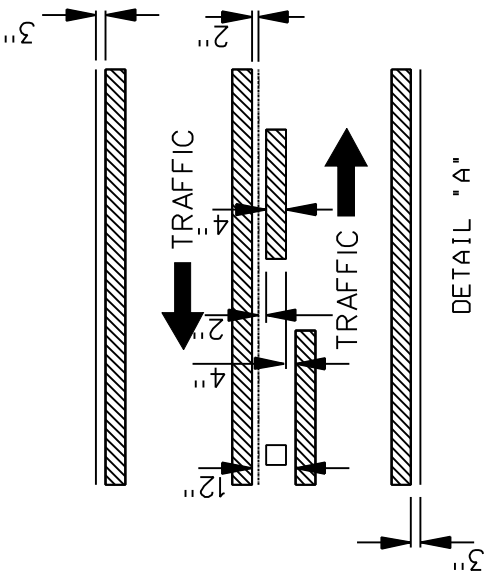

DETAIL "A"

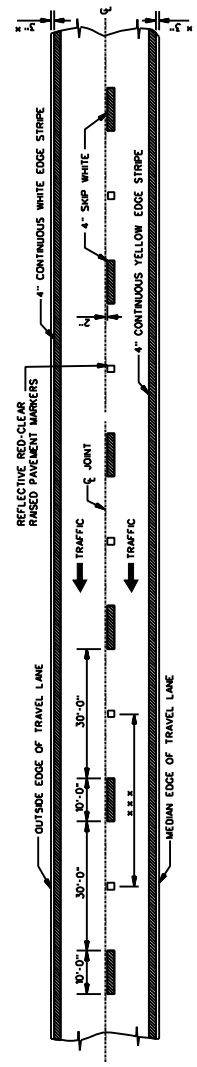

4-LANE WITH ONE-WAY TRAFFIC



GENERAL NOTES:

- x 1. 3" UNLESS SHOWN ELSEWHERE ON THE PLANS.
- ** 2. EDGE STRIPES SHALL BE SAME MATERIAL AS LANE LINE STRIPES (PAINT OR TAPE AS INDICATED IN PAY ITEMS).
- *** 3. SPACING OF REFLECTIVE RAISED PAVEMENT MARKERS

TANGENT SECTIONS	URBAN AREA (U-1)	RURAL AREA (U-2)
HORIZONTAL CURVES	40'-0"	80'-0"
INTERCHANGE LIMITS	40'-0"	140'-0"

- 1. NOTE: ON THE MAIN FACILITY, REFLECTIVE RED-CLEAR RAISED PAVEMENT MARKERS ON A 40'-0" SPACING WILL BE REQUIRED ON LANE LINES THROUGH ALL INTERCHANGE AREAS BEGINNING 100' IN ADVANCE IN DIRECTION OF TRAFFIC OF THE EXIT RAMP AND ENDING 100' IN ADVANCE OF THE INTERCHANGE TO THE END OF THE ENTRANCE RAMP TAPE.
- 4. PAVEMENT MARKERS SHALL BE HIGH PERFORMANCE REFLECTIVE RAISED PAVEMENT MARKERS AS LISTED IN THE MOOT "APPROVED SOURCES OF MATERIALS."
- 5. REFLECTIVE RAISED PAVEMENT MARKERS TO BE USED IF TEMPORARY MARKINGS ARE TO REMAIN IN PLACE OVER 3 MONTHS.

MISSISSIPPI DEPARTMENT OF TRANSPORTATION
ROADWAY DESIGN DIVISION
STANDARD PLAN

TEMPORARY STRIPING FOR
TRAFFIC CONTROL
2-LANE AND 4-LANE
DIVIDED HIGHWAYS

WORKING NUMBER
TCP-15

SHEET NUMBER
264

ISSUE DATE: DECEMBER 1, 1989



STATE PROJECT NO.		MSS.	
MISSISSIPPI DEPARTMENT OF TRANSPORTATION ROADWAY DESIGN DIVISION STANDARD PLAN		TEMPORARY STRIPING FOR TRAFFIC CONTROL 4-LANE AND 5-LANE UNDIVIDED ROADWAYS	
DRAWING NUMBER TCP-16		SHEET NUMBER 265	
ISSUE DATE: DECEMBER 1, 1999			

STATE PROJECT NO.	
MSS.	

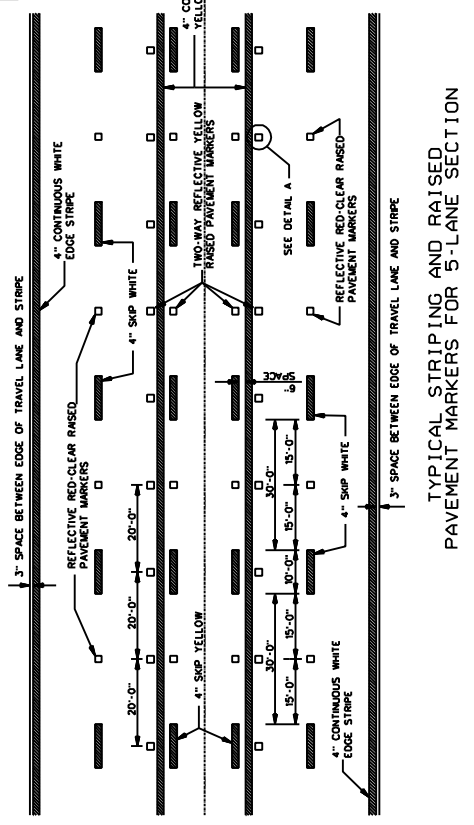

TYPICAL STRIPING AND RAISED PAVEMENT MARKERS FOR 5-LANE SECTION

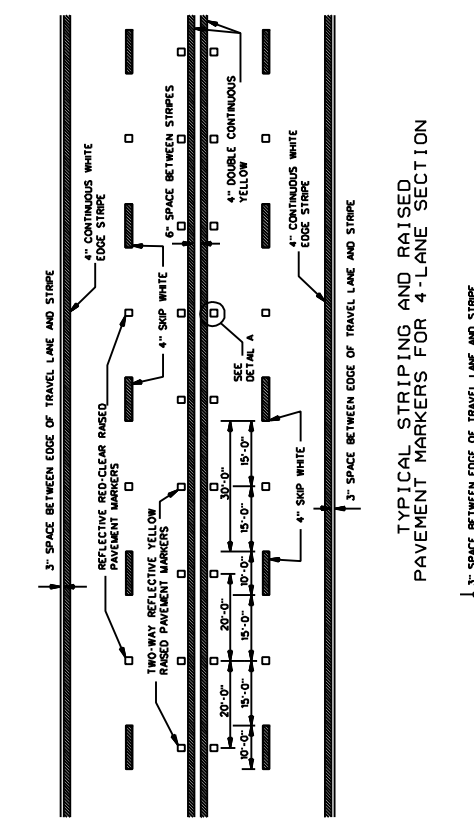

TYPICAL STRIPING AND RAISED PAVEMENT MARKERS FOR 4-LANE SECTION

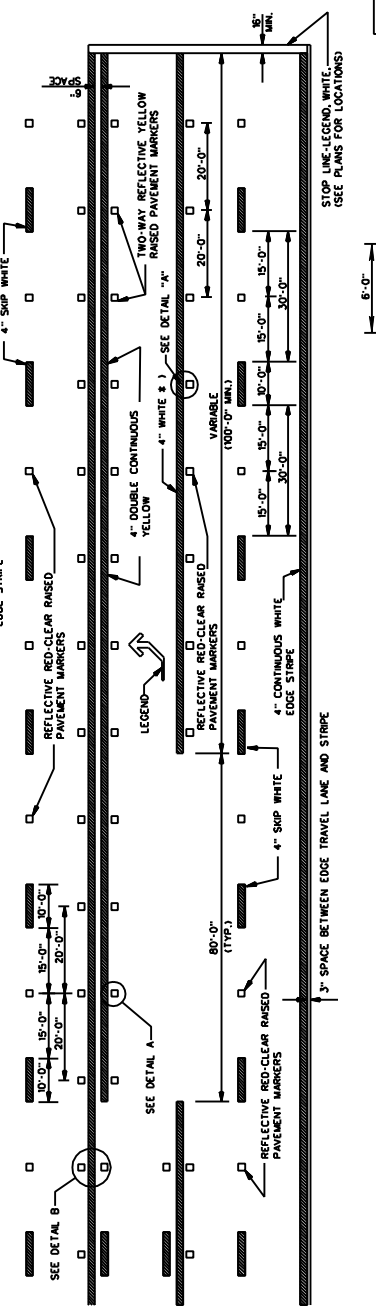

TYPICAL STRIPING AND RAISED PAVEMENT MARKERS AT LEFT TURN LANE

STOP LINE-LEGEND, WHITE (SEE PLANS FOR LOCATIONS)

GENERAL NOTE:
 1. PAVEMENT MARKERS SHALL BE HIGH PERFORMANCE RASD PAVEMENT MARKERS AS LISTED IN THE MOST APPROVED SOURCES OF MATERIALS.
 2. REFLECTIVE RASD PAVEMENT MARKERS TO BE USED IF TEMPORARY MARKERS ARE TO REMAIN IN PLACE OVER 3 MONTHS.
 3. TEMPORARY TURN ARROW TO BE PAID FOR AS TEMPORARY TRAFFIC MARKERS. STRIPE LEGEND, ESTIMATED AT 10.9 SQ. FT. PER ARROW

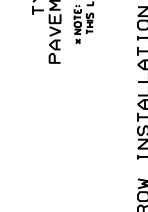
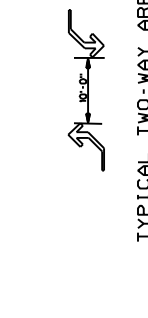

DETAIL A
LATERAL PLACEMENT OF PAVEMENT MARKERS

DETAIL B
LATERAL PLACEMENT OF PAVEMENT MARKERS

DETAIL OF TEMPORARY TURN ARROW

TYPICAL TWO-WAY ARROW INSTALLATION

NOTES:
 1. CONSIDER EACH SEGMENT OF CONTINUOUS TWO-WAY LEFT TURN LANE SEPARATELY.
 2. IF SEGMENT IS LESS THAN 350', PLACE ONE SET OF ARROWS IN CENTER OF SEGMENT.
 3. IF SEGMENT IS GREATER THAN 350', PLACE FIRST SET OF ARROWS 50' TO 100' FROM BEGINNING AND/OR END OF SEGMENT AND SPACE ADDITIONAL SETS OF ARROWS (250' O.C.).

* NOTE: USE DETAIL STRIPING IF LENGTH $\leq 150'$ AT THIS LOCATION, OTHERWISE USE CONTINUOUS STRIPING.

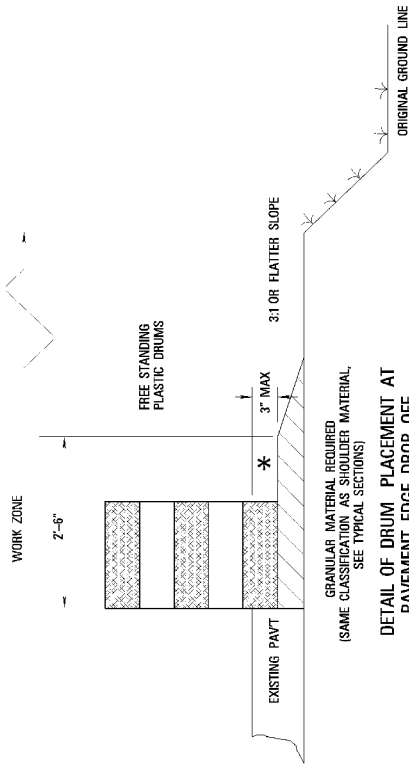

GRANULAR MATERIAL REQUIRED
(SAME CLASSIFICATION AS SHOULDER MATERIAL,
SEE TYPICAL SECTIONS)

**DETAIL OF DRUM PLACEMENT AT
PAVEMENT EDGE DROP-OFF**

NOTES

- * A. PAVEMENT EDGE DROP-OFF
 1. IF LESS THAN TWO AND ONE QUARTER (2.25) INCHES-NO PROTECTION REQUIRED. PLACE A SHOULDER WORK SIGN (W21-5) 500 FEET IN ADVANCE OF WORK ZONE SHOULDER AND A LOW SHOULDER SIGN (W8-9) AT THE BEGINNING AND THROUGHOUT THE WORK ZONE @ (750 ± 0.0).
 2. TWO AND ONE QUARTER TO THREE INCHES-PLACE DRUMS, VERTICAL PANELS OR BARRICADES EVERY 100 FEET ON TANGENT SECTIONS FOR SPEEDS OF 50 MILES PER HOUR OR GREATER. CONES MAY BE USED IN PLACE OF DRUMS, PANELS, AND BARRICADES DURING DAYLIGHT HOURS. FOR TANGENT SECTIONS WITH SPEEDS LESS THAN 50 MILES PER HOUR AND FOR CURVES, DEVICES SHOULD BE PLACED EVERY 50 FEET. SPACING FOR TAPERS SHOULD BE IN ACCORDANCE WITH THE M.U.T.C.D. (1/3 L, WHERE L IS THE TAPER LENGTH IN FEET)
 3. GREATER THAN THREE (3) INCHES-POSITIVE SEPARATION OR WEDGE WITH 3:1 OR FLATTER SLOPE NEEDED. IF THERE IS EIGHT (8) FEET OR MORE DISTANCE BETWEEN THE EDGE OF TRAVEL LANE AND DROP-OFF, THEN DRUMS/PANELS OR BARRICADES MAY BE USED.
 4. FOR TEMPORARY CONDITIONS DROP OFFS GREATER THAN THREE (3) INCHES MAY BE PROTECTED WITH DRUMS, VERTICAL PANELS OR BARRICADES. IF CONCRETE BARRIERS ARE USED, SPECIAL REFLECTIVE DEVICES OR STEADY BURN LIGHTS SHOULD BE USED FOR OVERNIGHT INSTALLATIONS.
 5. FOR SHORT DISTANCES DURING DAYLIGHT HOURS WHILE WORK IS BEING DONE IN THE DROP-OFF AREA.
- B. DRUM SPACING
 - 1. TANGENTS = $2 \times S$
 - 2. CURVES = $L \times W$
 - WHERE $L = \frac{S^2}{W}$
 - L = TAPER LENGTH IN FEET
 - S = SPEED IN MPH (POSTED OR 85 PERCENTILE)
 - W = WIDTH OF OFFSET IN FEET
- C. ALL TRAFFIC CONTROL ITEMS SHOWN ON THIS SHEET SHALL BE PAID FOR UNDER MAINTENANCE OF TRAFFIC.

TABLE VI-1 GUIDELINES FOR LENGTH OF LONGITUDINAL BUFFER SPACE

SPEED (MPH)	LENGTH (FEET)
20	25
25	35
30	45
35	55
40	65
45	75
50	85
55	95
60	105
65	115
70	125
75	135
80	145
85	155

* POSTED SPEED OFF-PEAK 85 PERCENTILE SPEED
PRIOR TO WORK STARTING OR THE ANTICIPATED
GROUNDING SPEED IN MPH.

PLASTIC DRUMS
(SEE NOTE FOR SPACING)

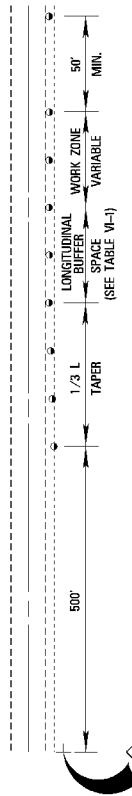

TYPICAL SHOULDER CLOSURE

- (1) TO BE USED WITH EIGHT (8) FOOT OR GREATER WIDTH IMPROVED SHOULDER.
- (2) TO BE USED WHEN CONSTRUCTION VEHICLES (EQUIPMENT) ENCLOSED ON OR WITHIN TWO (2) FEET OF THE SHOULDER BREAK.

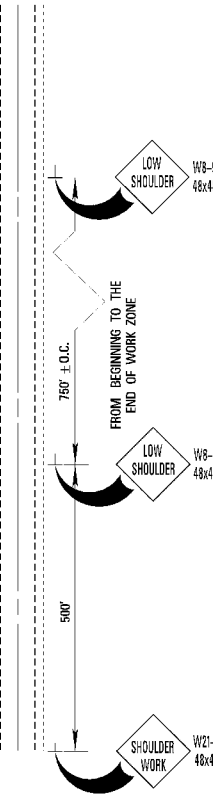

TYPICAL SHOULDER WORK #1

(SEE NOTE A-1 THIS SHEET)

PLASTIC DRUMS
(SEE NOTE FOR SPACING)

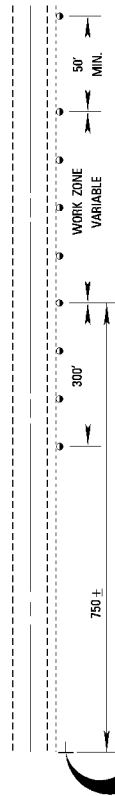

TYPICAL SHOULDER WORK #2

NOTE: WORK OUTSIDE THE (2) FOOT LIMIT AND WITHIN TEN (10) FEET OF THE SHOULDER BREAK MAY BE PROTECTED BY PLACING DRUMS ALONG THE SHOULDER EDGE, 300 FEET PRIOR TO AND 50 FEET BEYOND THE WORK AREA. DR SEE NOTE A-3 THIS SHEET.

MISSISSIPPI DEPARTMENT OF TRANSPORTATION

**TRAFFIC CONTROL DETAILS
DRUM PLACEMENT
AND
SHOULDER CLOSURE**

PROJECT NO.:
COUNTY:
DATE: 02.28.23

TCP SHEET NO. 25

MISSISSIPPI DEPARTMENT OF TRANSPORTATION

SECTION 904 - NOTICE TO BIDDERS NO. 5405

CODE: (SP)

DATE: 02/11/2015

SUBJECT: Traffic Control Devices

Bidders are advised of the following two changes regarding traffic control devices.

Flashing Arrow Panels

In Subsection 619.02.5 of the Standard Specifications, it states that flashing arrow panels shall meet the requirements of Section 6F.53 of the MUTCD. The new MUTCD has changed this reference to Section 6F.61. Flashing arrow panels on this project must meet the requirements of Section 6F.61 of the latest MUTCD.

Type III Barricade Rails

The use of 2-inch nominal thickness timber for rails on Type III barricades has not been approved by NCHRP as a crashworthy device. Therefore, the use of 2-inch nominal thickness timbers will not be allowed for rails on Type III Barricades. Timber rails for Type III Barricades shall be as follows.

- For barricades up to four feet (4') wide, the maximum thickness of timber rails shall be one inch (1") and the material shall be pine timber or 3/4-inch ACX plywood.
- For barricades more than four feet (4') wide, timber rails shall be constructed of 3/4-inch ACX plywood.

A list of crashworthy Type III Barricades can be found at the below FHWA website.

http://safety.fhwa.dot.gov/roadway_dept/policy_guide/road_hardware/wzd/

MISSISSIPPI DEPARTMENT OF TRANSPORTATION

SECTION 904 - NOTICE TO BIDDERS NO. 5412

CODE: (SP)

DATE: 02/18/2015

SUBJECT: Weight Limits

Bidders are hereby advised that all trucks hauling materials to and from this project shall comply with the legal weight limits as established by law. MDOT will not compensate the Contractor for any portion of a load delivered to the project in excess of the legal limit for that truck.

Vehicles relying on harvest permits are limited to hauling only those materials set forth in Section 27-19-81(4) of the Mississippi Code, as amended.

MISSISSIPPI DEPARTMENT OF TRANSPORTATION

SECTION 904 - NOTICE TO BIDDERS NO. 5824

CODE: (SP)

DATE: 09/10/2015

SUBJECT: Adjustments for Bituminous Materials

Bidders are advised that Subsection 907-402.03.1.2, Tack Coat, in Special Provision 907-402, allows the Contractor several options for OGFC tack coat. Regardless of the tack coat used, the monthly material adjustment, as referenced in Section 109 of the Standard Specifications, will be made using the base and current prices of tack coat Grade PG 76-22.

Bidders are also advised that the specifications allow the use of RC-70, RC-250, RC-800, RS-1, RS-2, MC-30, MC-250, MS-2h, CMS-2h, LD-7, CQS-1h, ETAC-H, and NTSS-1HM in various other construction operations. If the Contractor uses one of these bituminous materials, the monthly material adjustment will be made using the base and current prices of the materials shown below.

Materials Used	Material Adjustment Made Based on Prices For
RC-70, 250, 800	MC-70
RS-1, 2	CRS-2
MC-30, 250	MC-70
MS-2h, CMS-2h	SS-1
LD-7, CQS-1h, ETAC-H, NTSS-1HM	CSS-1

MISSISSIPPI DEPARTMENT OF TRANSPORTATION

SECTION 904 - NOTICE TO BIDDERS NO. 5866

CODE: (SP)

DATE: 10/28/2015

SUBJECT: Payroll Requirements

Bidders are hereby advised that the Contractor and Subcontractor(s) are required to submit payroll information to the Project Engineers on a weekly basis.

On Federal-Aid Projects, CAD-880, CAD-881 and certified payroll submissions are required each week the Contractor or a Subcontractor performs work on the project. This is addressed in Section IV of Form FHWA-1273.

On State-Funded Projects, CAD-880 is required each week the Contractor or a Subcontractor performs work on the project.

When no work is performed on either Federal-Aid or State-Funded Projects, the Contractor should only submit CAD-880 showing no work activities.

The Contractor shall make all efforts necessary to submit this information to the Project Engineer **weekly**. The Engineer will have the authority to suspend the work wholly or in part and to withhold payments because of the Contractor's failure to submit the required information. Submission of forms and payrolls shall be current through the first full week of the month for the estimate period in order for the Project Engineer to process an estimate.

Bidders are advised to review the requirements regarding payroll submissions in Section 110 of the Standard Specifications.

MISSISSIPPI DEPARTMENT OF TRANSPORTATION

SECTION 904 - NOTICE TO BIDDERS NO. 6321

CODE: (SP)

DATE: 04/18/2016

SUBJECT: Contract Time

PROJECT: MP-6026-55(015) / 305779301 – Pearl River County

The completion of work to be performed by the Contractor for this project will not be a specified date but shall be when all allowable working days are assessed, or any extension thereto as provided in Subsection 907-108.06. It is anticipated that the Notice of Award will be issued no later than **June 14, 2016** and the effective date of the Notice to Proceed / Beginning of Contract Time will be between **July 14, 2016 and September 8, 2016**.

Should the Contractor not request a Notice to Proceed by **September 8, 2016**, the date for the Notice to Proceed / Beginning of Contract Time will be **September 8, 2016**.

23 Working Days have been allowed for the completion of work on this project.

The progress schedule for this project shows the Notice to Proceed / Beginning of Contract time starting at the latest possible date. If the Contractor request a Notice to Proceed earlier than this date, the Contractor shall submit a revised progress schedule showing the work beginning at the new Notice to Proceed / Beginning of Contract Time date.

MISSISSIPPI DEPARTMENT OF TRANSPORTATION

SECTION 904 - NOTICE TO BIDDERS NO. 6322

CODE: (SP)

DATE: 04/07/2016

SUBJECT: Scope Of Work

PROJECT: MP-6026-55(015) / 305799301 -- Pearl River County

The contract documents do not include an official set of construction plans but may, by reference, include some Standard Drawings when so specified in a Notice to Bidders entitled, "Standard Drawings". All other references to plans in the contract documents and Standard Specifications for Road and Bridge Construction are to be disregarded.

Work on the project shall consist of the following:

STATE ROUTE 26
OVERLAY STATE ROUTE 26
FROM WHITE SANDS BRIDGE EAST FOR 5.3 MILES

(A) Prior to the overlay, centerline alignment shall be determined by the contractor by measuring the existing roadway at 500-foot intervals in tangent sections, and 100-foot intervals in horizontal curves.

(B) Cold mill a 100-foot transition at the BOP and EOP, local roads to ROW as directed by the Project Engineer, and any other areas designated by the Project Engineer to ensure smooth transition of new overlay with existing grade. (See Typical Drawings).

(C) Prior to placement of the asphalt, all raised pavement markers throughout the project shall be removed (cost absorbed). Overlay SR 26 with 3/4" and variable 9.5-mm, MT, leveling asphalt, as directed by the Project Engineer. Overlay State Route 26 and all side roads to state ROW with 3/4" of Ultra-thin Asphalt. Publicly maintained roads or streets shall be surfaced to the existing R.O.W.; privately owned entrances shall be surfaced a distance of 10 feet and variable from edge of pavement to match existing conditions. Any site grading at local roads or drives will not be measured for separate payment but will be considered an absorbed item. Cross slopes shall be increased where practical with contract quantities in an effort to achieve a uniform cross slope of 2%.

It is estimated that 3,200 tons of ultra-thin asphalt will be used for Mainline and 200 tons of ultra-thin asphalt will be used for local roads and driveways.

(D) The Mean Roughness Index (MRI) shall be used to determine the pavement smoothness.

(E) Temporary and permanent striping shall be placed where existing stripes are located, and shall conform to finished stripe specifications for alignment, neatness, reflectivity, and

straightness. When the centerline or turn lane stripe is removed during milling operations, temporary stripe shall be placed prior to opening the roadway to traffic. All permanent pavement markings on asphalt are to be hot thermoplastic. Edge lines will be placed so as to maintain the original lane width. Glass beads applied to thermoplastic shall conform to Subsection 720.01.

(F) Raised pavement markers will be placed at 80-foot intervals in tangents and 40-foot intervals in curves along the centerline of roadway.

(G) Raise the existing shoulders to match the new pavement with Size 825B Crushed Stone Base. Placement of the shoulder material(s) on the finished surface course shall not be permitted. The material(s) shall be bladed, rolled, and compacted to a finished slope of 4% where practical.

(H) Pay Item 907-823, Preformed Joint Seal, shall be used on all bridge locations.

(I) It shall be the responsibility of the Contractor to protect existing structures such as pipes, inlets, aprons, bridges, etc. from damage which might occur during construction. The Contractor shall replace or repair, as directed by the engineer, any structures damaged during the life of the contract. No payment will be made for the replacement or repair of damaged items.

(J) Incidental work such as removing vegetation, shaping and compaction of shoulder, removing excess asphalt material, project clean-up, and other incidental work necessary to complete the project will not be measured for separate payment, but will be included in other bid items.

(K) If pavement section marking tape is encountered on this project, it shall be located prior to overlaying and placed back in same location after paving operations have ceased. The section marking shall be 8-inch high performance cold plastic detail stripe and shall be four feet (4') in length. The marking shall be centered across the centerline stripe. The cost of this item shall be absorbed in other bid items.

(L) All Construction signing as well as Plastic Traffic Drums and Barricades are included in the bid for Pay Item 907-618-A, Maintenance of Traffic. Fluorescent orange sheeting shall be used on all construction and traffic control signs except for R4-1 and R4-2 signs which shall be black legend and border on white background. The Contractor shall erect and maintain construction signing, and provide all signs and traffic handling devices in accordance with Manual Uniform Traffic Control Devices (MUTCD).

TYPICAL MILLED TRANSITION AT BRIDGE ABUT. OR PAVEMENT IN PLACE

4" & VAR. COLD MILLING
REQ'D ON BRIDGE DECKS
OVERLAYED WITH ASPHALT, AND ENDS.

1" & VAR. OVERLAY REQ'D

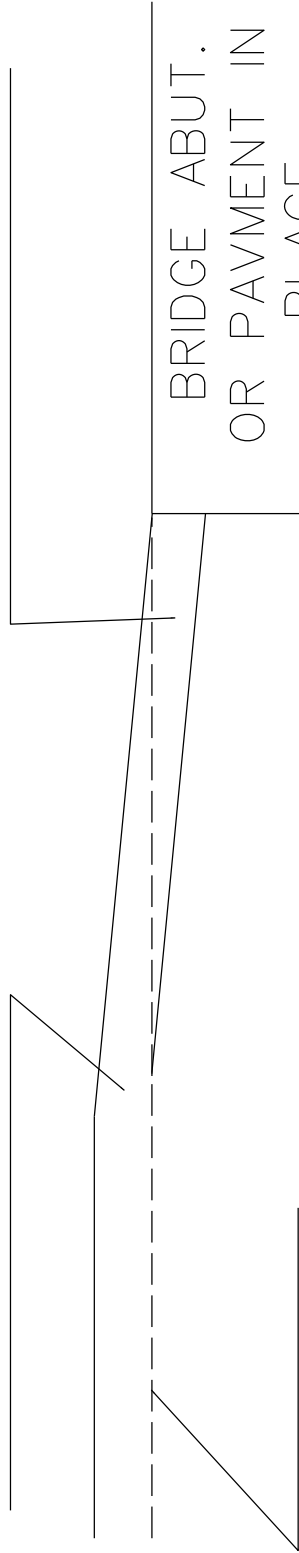

EXISTING ROADWAY
SURFACE IN PLACE

200ft & VAR

OR AS DIRECTED BY
THE PROJECT ENGINEER

BRIDGE ABUT.
OR PAVEMENT IN
PLACE

TYPICAL FOR PAVED TAPER AT LOCAL ROADS

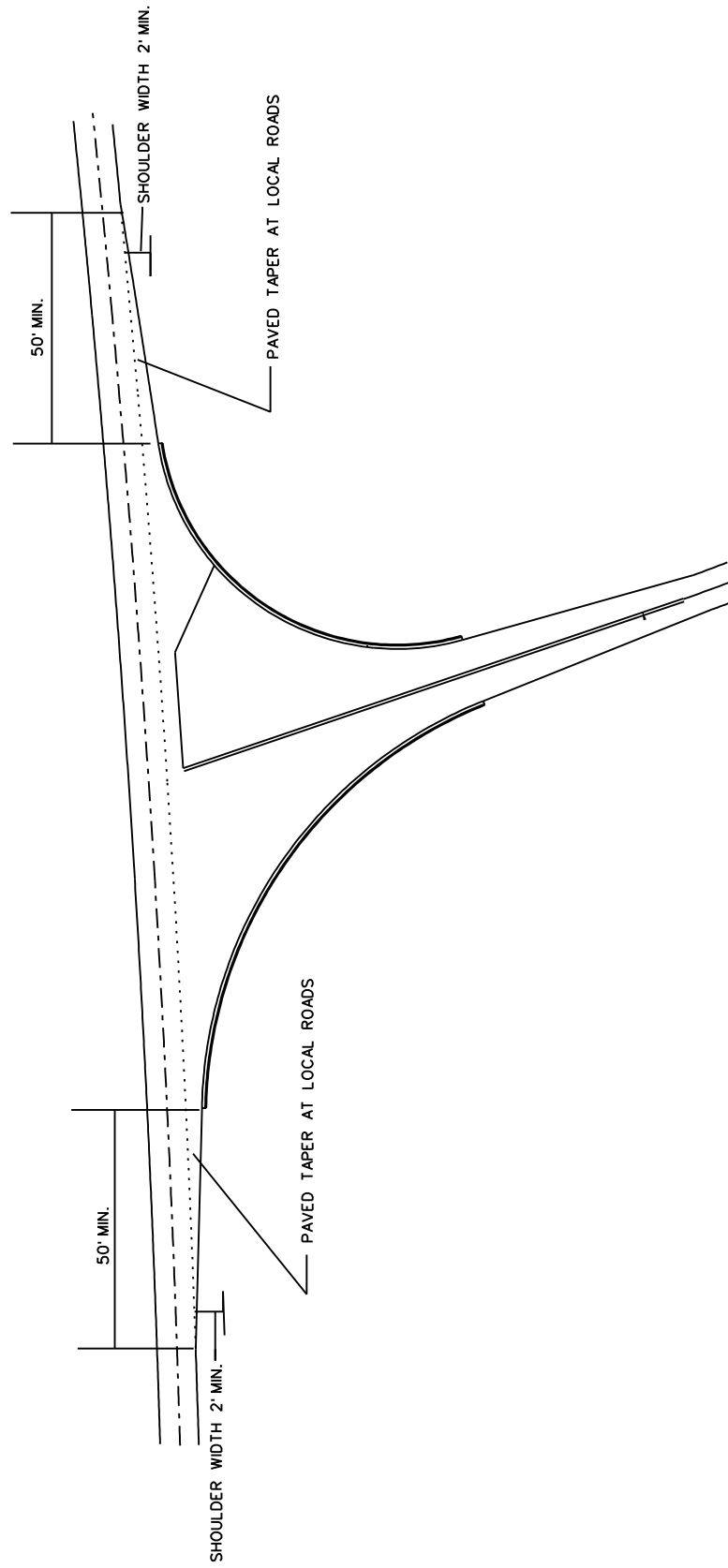

PRIVATE DRIVEWAY DETAIL

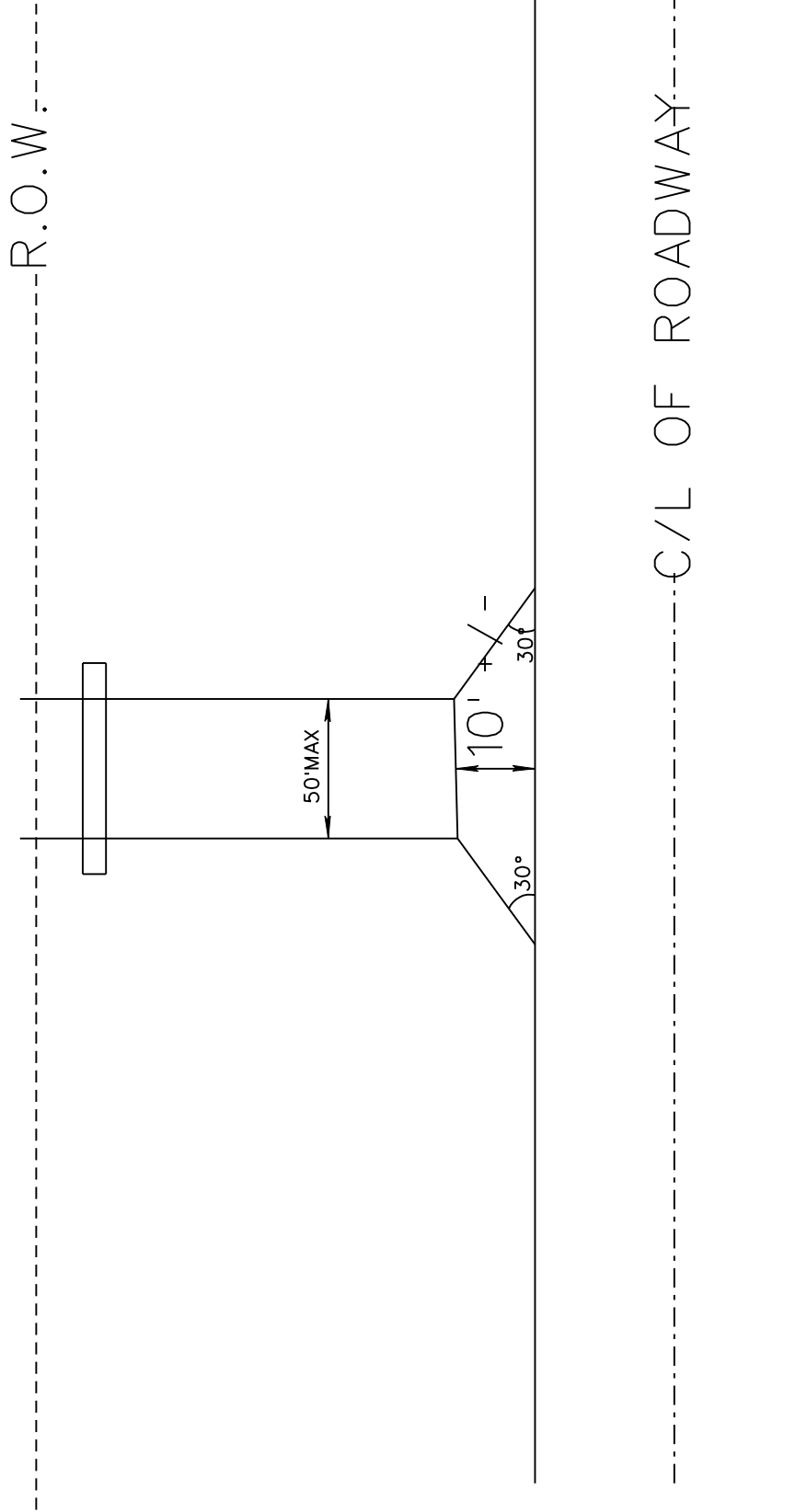

TYPICAL STRIPING FOR SIMPLE INTERSECTION AT LOCAL ROADS

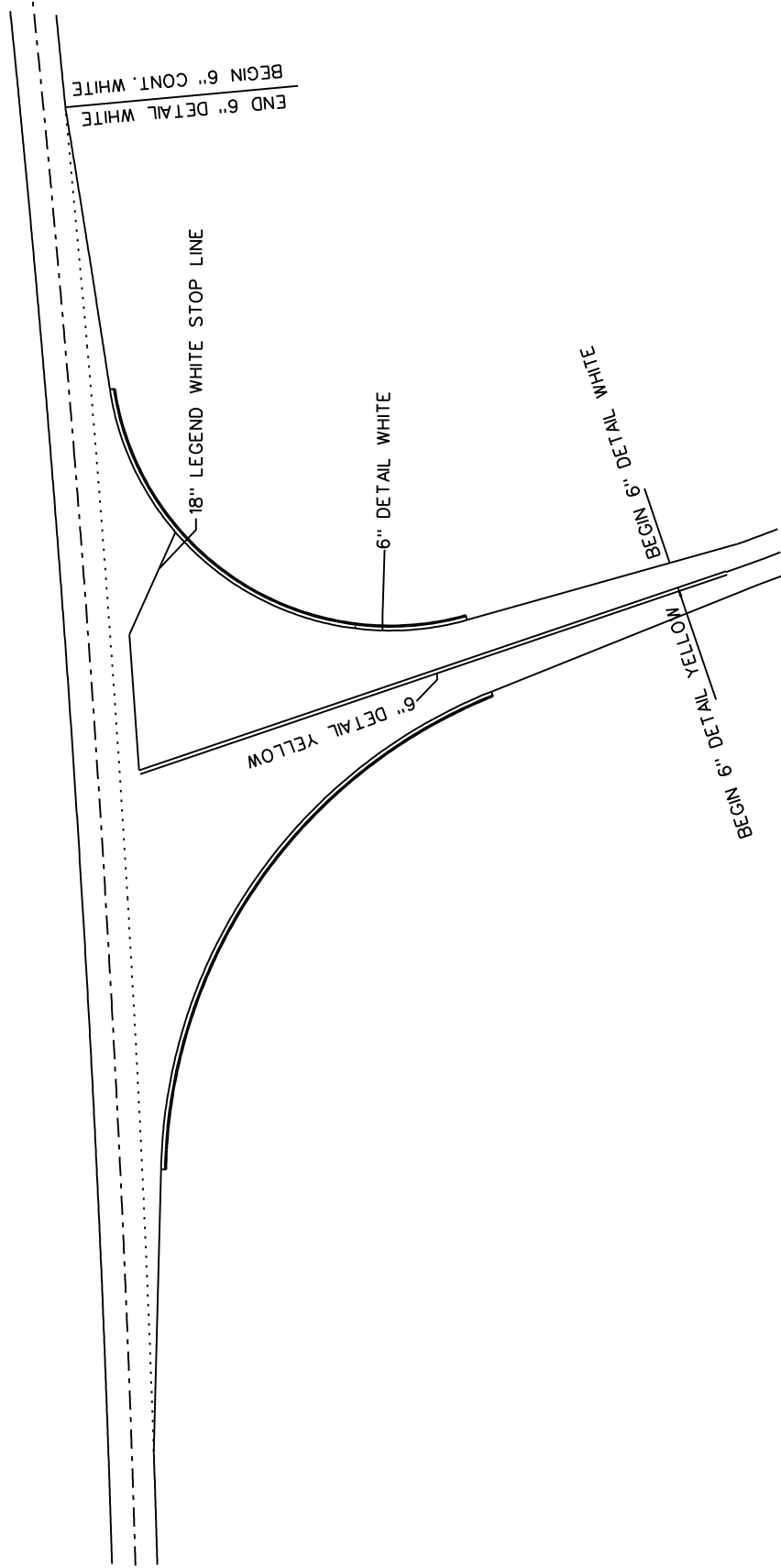

STATE	PROJECT NO.
MISS.	

TYPICAL FOR RAISED PAVEMENT MARKERS
PLACED ON SIDE ROAD RADIUS

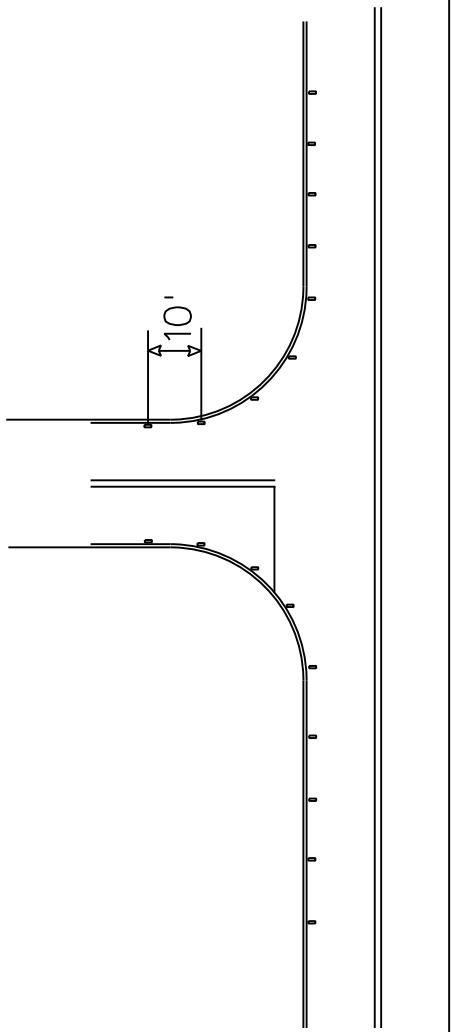

NOTE 1. MARKERS SHALL BE PLACED EVERY 10 FEET.

NOTE 2. MARKERS SHALL BE VISIBLE FROM THE TRAVELING MOTORIST ON STATE DESIGNATED HIGHWAYS.

NOTE 3. MARKERS SHALL BE HIGH PERFORMANCE TWO WAY CLEAR.

NOTE 4. 5 MARKERS SHALL BE PLACED ALONG MAINLINE EDGE STRIPE.

NOTE 5. MARKERS FOR COUNTY RD. SHALL BEGIN AT RADIUS AND CONTINUE DOWN EDGE STRIPE A DISTANCE OF 40 FEET.

MISSISSIPPI DEPARTMENT OF TRANSPORTATION	
2-LANE	
RAISED PAVEMENT MARKERS	
PLACED ON SIDE ROADS	
DATE	FILE NAME
06/04/14	06/04/14
DWG NUMBER	SHEET NUMBER

MISSISSIPPI DEPARTMENT OF TRANSPORTATION

SPECIAL PROVISION NO. 907-101-4

CODE: (IS)

DATE: 11/05/2008

SUBJECT: Definitions

Section 101, Definitions and Terms, of the 2004 Edition of the Mississippi Standard Specifications for Road and Bridge Construction is hereby amended as follows:

907-101.02--Definitions. Replace the following definitions in Subsection 101.02 on pages 3 through 13.

Contract - The written agreement between the Mississippi Transportation Commission and the Contractor setting forth the obligations of the parties thereunder, including but not limited to, the performance of the work, the furnishing of labor and materials, and the basis of payment.

The contract includes the invitation for bids, proposal, contract form and contract bonds, specifications, supplemental specifications, interim specifications, general and detailed plans, special provisions, notices to bidders, notice to proceed, and also any agreements that are required to complete the construction of the work in an acceptable manner, including authorized extensions thereof, all of which constitute one instrument.

Contract Bonds - The approved form of security, executed by the Contractor and the Contractor's Surety(ies), guaranteeing complete execution of the contract and all supplemental agreements pertaining thereto and the payment of all legal debts pertaining to the construction of the project. This term includes Performance and Payment Bond(s).

Surety - A corporate body, qualified under the laws of Mississippi, which is bound with and for the successful bidder by "contract bond(s)" to guarantee acceptable performance of the contract and payment of all legal taxes and debts pertaining to the construction of the project, including payment of State Sales Tax as prescribed by law, and any overpayment made to the Contractor.

Add the following to the list of definitions in Subsection 101.02 on pages 3 through 13.

Performance Bond - The approved form of security, executed by the Contractor and issued by the Contractor's Surety(ies), guaranteeing satisfactory completion of the contract and all supplemental agreements pertaining thereto.

Payment Bond - The approved form of security, executed by the Contractor and issued by the Contractor's Surety(ies), guaranteeing the payment of all legal debts pertaining to the construction of the project including, but not limited to, the labor and materials of subcontractors and suppliers to the prime contractor.

MISSISSIPPI DEPARTMENT OF TRANSPORTATION

SPECIAL PROVISION NO. 907-102-12

CODE: (SP)

DATE: 11/18/2015

SUBJECT: Bidding Requirements and Conditions

Section 102, Bidding Requirements and Conditions, of the 2004 Edition of the Mississippi Standard Specifications for Road and Bridge Construction is hereby amended as follows.

907-102.06--Preparation of Proposal. Delete Subsection 102.06 on pages 17 thru 19 and substitute the following.

907-102.06--Preparation of Proposal. MDOT will receive bids for construction projects online using the Bid Express Service (BIDX).

The Bidder's complete proposal (Certification of Performance, Certification Regarding Non-Collusion, etc.) will be submitted to MDOT electronically via the Bid Express Service no later than the day and at the time bids are to be received. Bidders will be responsible for joining Bid Express and getting all necessary clearances and a digital ID in sufficient time for Bid Express to submit their bid.

Bid Express files shall be downloaded from <http://www.bidx.com>. Bidders are to select Mississippi Department of Transportation under the U.S. AGENCY drop down menu and select the desired project. After completing all necessary data, the Bidders shall submit their bid to Bid Express in sufficient time for the bid to be properly sent to MDOT.

Bids submitted via the Bid Express Service will constitute the official bid and shall be digitally signed and delivered to the Department by the Bid Express Service.

It is the responsibility of every bidder to check for any addendum or modification to the contract document(s) for which they intend to submit a response. It shall be the bidder's responsibility to be sure they are in receipt of all addenda, pre-bid conference information, and/or questions and answers provided at, or subsequent to, the pre-bid conference, if any are issued.

The Mississippi Transportation Commission has no responsibility for defects, irregularities or other problems caused by the use of electronic media. Operation of this electronic media is done at the sole risk of the user.

When the bid schedule contains a fixed contract unit price (FCP) for an item, this price shall be the contract unit price for the item and no alteration shall be made by the bidder.

When an item in the proposal contains a choice to be made by the bidder, the bidder shall indicate the choice in accordance with the INSTRUCTION TO BIDDERS in Section 905 - Proposal; reference is made to Alternate Designs, Alternate Items, and Optional Items as defined in

Subsection 101.02.

Where the bid schedule lists alternate designs or alternate items, the one alternate bid shall be designated by bidding only that alternate, and thereafter no further choice will be permitted.

When the bid schedule lists optional items, the Contractor's selection may, but is not required to, be made at the time of bidding. For optional items not pre-selected, the Contractor's selection shall be made prior to or at the time of execution of the contract.

Each proposal issued will contain a Certification regarding debarment, suspension, and other responsibility matters to be completed by the bidder. The Certification must be sworn to and shall be under penalty of perjury and bidders are cautioned to read and understand its contents in entirety before digitally signing the bid.

The Contractor shall provide immediate written notice to the Contract Administration Engineer Division at any time, prior to or after award, that it is known a certification was erroneous when executed or has become erroneous by reason of changed circumstances.

The bidder's proposal must be digitally signed by the individual, by one or more members of the partnership, by one or more members or officers of each firm representing a joint venture, or by one or more officers of a corporation; or by an agent of the Contractor legally qualified to bind the Contractor and acceptable to the State. If the proposal is made by an individual, the individual's name and address must be shown; by a partnership, the name and address of each partnership member must be shown; as a joint venture, the name and address of each member or officer of the firms represented by the joint venture must be shown; by a corporation, the name of the corporation and the business address of its corporate officials must be shown.

The address stated on the proposal shall be the bidder's permanent address until changed by written notice to the Executive Director. All notices provided for in the contract shall be considered as delivered to the Contractor when mailed or delivered to such address.

907-102.08--Proposal Guaranty. Delete the first and second paragraphs in Subsection 102.08 on page 20 and substitute the following.

No proposal will be considered unless accompanied by certified check, cashier's check or bid bond, made payable to the State of Mississippi, in an amount of not less than five percent (5%) of the total amount of the proposal offered. The guaranty shall be evidence of good faith that, if awarded the contract, the bidder will execute the contract and give performance and payment contract bond(s) as stipulated in Subsection 907-103.05.1, 907-103.05.2, and as required by law.

If a bid bond is offered as guaranty, the bond must be made by a Surety acceptable to the Executive Director and signed or countersigned by a Mississippi Agent or Qualified Nonresident Agent and the Bidder. Such bid bond shall also conform to the requirements and conditions stipulated in Subsection 907-103.05.2 as applicable.

907-102.09--Delivery of Proposals. Delete the paragraph under Subsection 102.09 on page 20,

and substitute the following.

Unless otherwise specified, each proposal shall be submitted online using the Bid Express service. Proposal Forms are non-transferable and no name or names of interested parties may be shown other than those to whom the proposal was issued. All proposals shall be submitted to Bid Express prior to the time and place specified in the Notice to Contractors and on the Bid Express website.

907-102.10--Withdrawal or Revision of Proposals. Delete the paragraph under Subsection 102.10 on page 20, and substitute the following.

A bidder may withdraw or revise a proposal after it has been submitted to Bid Express any time prior to the time set for opening proposals.

MISSISSIPPI DEPARTMENT OF TRANSPORTATION

| SPECIAL PROVISION NO. 907-103-11

CODE: (SP)

| DATE: 07/22/2015

SUBJECT: Award and Execution of Contract

Section 103, Award and Execution of Contract, of the 2004 Edition of the Mississippi Standard Specifications for Road and Bridge Construction is hereby amended as follows:

907-103.04--Return of Proposal Guaranty. Delete the second paragraph of Subsection 103.04 on page 23 and substitute the following:

Certified checks or cashier's checks submitted as proposal guaranties, except those of the two lowest bidders, will be returned within 10 days of contract award. The retained proposal guaranty of the unsuccessful of the two lowest bidders will be returned within ten days following the execution of a contract with the successful low bidder. The retained proposal guaranty of the successful bidder will be returned after satisfactory performance and payment bonds have been furnished and the contract has been executed.

In the event all bids are rejected by the Commission, certified checks or cashier's checks submitted as proposal guaranty by all bidders will be returned within 10 days of rejection.

Delete Subsection 103.05 on page 23 and substitute the following:

907-103.05--Contract Bonds.

907-103.05.1--Requirement of Contract Bonds. Prior to the execution of the contract, the successful bidder shall execute and deliver to the Executive Director a performance and payment bond(s), in a sum equal to the full amount of the contract as a guaranty for complete and full performance of the contract and the protection of the claimants and the Department for materials and equipment and full payment of wages in accordance with Section 65-1-85 Miss. Code Ann. (1972 as amended). In the event of award of a joint bid, each individual, partnership, firm or corporation shall assume jointly the full obligations under the contract and the contract bond(s).

907-103.05.2--Form of Bonds. The form of bond(s) shall be that provided by or acceptable to the Department. These bonds shall be executed by a Mississippi agent or qualified nonresident agent and shall be accompanied by a certification as to authorization of the attorney-in-fact to commit the Surety company. A power of attorney exhibiting the Surety's original seal supporting the Mississippi agent or the qualified nonresident agent's signature shall be furnished with each bond. The Surety company shall be currently authorized and licensed in good standing to conduct business in the State of Mississippi with a minimum rating by A.M. Best of (A-) in the latest printing "Best's Key Rating Guide" to write individual bonds up to ten percent of the policy holders' surplus or listed on the current list of "Companies Holding Certificates of Authority as Acceptable Sureties on Federal Bonds and as Acceptable Reinsuring Companies" as

published by the United States Department of the Treasury, Financial Management Service, Circular 570 (latest revision as published and supplemented on the Financial Management Service Web site and in the Federal Register) within the underwriting limits listed for that Surety. The Mississippi agent or qualified nonresident agent shall be in good standing and currently licensed by the Insurance Commissioner of the State of Mississippi to represent the Surety company(ies) executing the bonds.

Surety bonds shall continue to be acceptable to the Commission throughout the life of the Contract and shall not be canceled by the Surety without the consent of the Department. In the event the Surety fails or becomes financially insolvent, the Contractor shall file a new Bond in the amount designated by the Executive Director within thirty (30) days of such failure, insolvency, or bankruptcy. Subsequent to award of Contract, the Commission or the Department may require additional security for any supplemental agreements executed under the contract or replacement security in the event of the surety(ies) loss of the ratings required above. Suits concerning bonds shall be filed in the State of Mississippi and adjudicated under its laws without reference to conflict of laws principles.

907-103.08--Failure to Execute Contract. In the first sentence of Subsection 103.08 on page 24, change “bond” to “performance and payment bonds”.

MISSISSIPPI DEPARTMENT OF TRANSPORTATION

SPECIAL PROVISION NO. 907-104-5

CODE: (IS)

DATE: 05/01/2013

SUBJECT: Scope of Work

Section 104, Scope of Work, of the 2004 Edition of the Mississippi Standard Specifications for Road and Bridge Construction is hereby amended as follows:

907-104.05--Removal and Disposal of All Materials From the Project. Delete the second sentence of the first full paragraph of Subsection 104.05 on page 30 and substitute the following:

The Contractor shall also furnish the Engineer a certified letter stating that the area of disposal is not in a wetland or in Waters of the U.S.

MISSISSIPPI DEPARTMENT OF TRANSPORTATION

| SPECIAL PROVISION NO. 907-104-6

CODE: (SP)

| DATE: 11/20/2014

SUBJECT: Partnering Process

Section 104, Scope of Work, of the 2004 Edition of the Mississippi Standard Specifications for Road and Bridge Construction is hereby amended as follows:

907-104.01--Intent of Contract. At the end of Subsection 104.01 on Page 24, add the following:

907-104.01.1--Partnering Process.

COVENANT OF GOOD FAITH AND FAIR DEALING:

This contract imposes an obligation of good faith and fair dealing in its performance and enforcement.

The Contractor and the Department, with a positive commitment to honesty and integrity, agree to the following mutual duties:

- A. Each will function within the laws and statutes applicable to their duties and responsibilities.
- B. Each will assist in the other's performance.
- C. Each will avoid hindering the other's performance.
- D. Each will proceed to fulfill its obligations diligently.
- E. Each will cooperate in the common endeavor of the contract.

| The Mississippi Department of Transportation intends to encourage the foundation of a cohesive partnership with the contractor and its principal subcontractors and supplier. This partnership will be structured to draw on the strengths of each organization to identify and achieve reciprocal goals. The objectives are effective and efficient contract performance and completion within budget, on schedule, and in accordance with plans and specifications.

| FORMAL PARTNERING:

| This partnership will be bilateral in make-up, and participation will be **required by both MDOT and the Contractor**. Any cost associated with effectuating this partnering will be agreed to by both parties and will be shared equally.

To implement this partnering initiative prior to starting of work in accordance with the requirements of Subsection 108.02 Notice to Proceed and prior to the preconstruction conference, the contractor's management personnel and MDOT's District Engineer, will initiate a partnering development seminar/team building workshop. The Contractor working with the assistance of the District and the State Construction Engineer will make arrangements to determine attendees for the workshop, agenda of the workshop, duration, and location. Persons required to be in attendance will be the MDOT key project personnel, the contractor's on-site project manager and key project supervision personnel of both the prime and principal subcontractors and suppliers. The project design engineers, FHWA and key local government personnel will be also be invited to attend as necessary. The contractors and MDOT will also be required to have Regional/District and Corporate/State level managers on the project team.

Follow-up workshops may be held periodically throughout the duration of the contract as agreed by the contractor and Mississippi Department of Transportation.

The establishment of a partnership charter on a project will not change the legal relationship of the parties to the contract nor relieve either party from any of the terms of the contract.

INFORMAL PARTNERING:

If the Contractor and MDOT does not choose to have a Formal Partnering process or the contract does not require a Mandatory Formal Partnering process, an informal partnering meeting shall be conducted on at least a monthly basis. It will be mandatory that the Project Engineer and Project Superintendent attend the meeting. It is recommended that MDOT Inspectors, foremen, and other project managers attend the meeting.

The Project Engineer will be responsible for taking minute of the meeting. As soon as practical after the meeting, the Engineer will send a copy of the minutes of the meeting to the Contractor, District Construction Engineer, and State Construction Engineer. The Contractor will have 30 days to dispute the contents of the minutes or they will become an official record of the project.

MISSISSIPPI DEPARTMENT OF TRANSPORTATION

SPECIAL PROVISION NO. 907-105-8

CODE: (SP)

DATE: 11/20/2014

SUBJECT: Control of Work

Section 105, Control of Work, of the 2004 Edition of the Mississippi Standard Specifications for Road and Bridge Construction is modified as follows.

907-105.04--Coordination of Plans, Specifications, Interim Specifications, Special Provisions and Notice to Bidders. Delete the second full paragraph of Subsection 105.04 on page 35, and substitute the following.

In case of a conflict between plan quantities, advertisement quantities, and/or bid sheet quantities, the bid sheet quantities shall prevail.

907-105.05--Cooperation by Contractor. Delete Subsection 105.05 on page 35 and substitute the following.

907-105.05--Cooperation by Contractor. The Contractor shall give the work the attention necessary to expedite its progress, and shall cooperate with the Engineer, inspectors and other Contractors in every possible way.

907-105.05.1--Project Superintendent. The Contractor shall have a competent and experienced full time resident superintendent who is capable of reading and understanding the plans and specifications for the particular work being performed. The superintendent shall be on the project site at any time work is being performed by the Prime Contractor or any Subcontractors. The superintendent shall advise the Project Engineer of an intended absence from the work and designate a person to be in charge of the work during such absence. The superintendent shall receive instructions from the Engineer or authorized representative. Upon issuance of the Notice to Award, the Contractor or duly appointed agent authorized to bind the Contractor shall file with the Executive Director the name and address of the superintendent who will supervise the work with copies to the Construction Engineer, Contract Administration Engineer, District Engineer and Project Engineer. The Executive Director shall be immediately notified in writing with copies to those stated when a change is made in the Contractor's superintendent or superintendent's address. The superintendent shall have full authority to execute orders or directives of the Engineer without delay and to promptly supply materials, equipment, labor and incidentals as may be required. Such superintendence shall be furnished irrespective of the amount of work sublet.

907-105.05.2--Certified Erosion Control Person. On projects that require an erosion control plan, the Contractor shall also designate a responsible person whose primary duty shall be to monitor and maintain the effectiveness of the erosion control plan, including NPDES permit

requirements. This responsible person must be a Certified Erosion Control Person certified by an organization approved by the Department. Prior to or at the pre-construction conference, the Contractor shall designate in writing the Certified Erosion Control Person to the Project Engineer. The designated Certified Erosion Control Person shall be assigned to only one (1) project. When special conditions exist, such as two (2) adjoining projects or two (2) projects in close proximity, the Contractor may request in writing that the State Construction Engineer approve the use of one (1) Certified Erosion Control Person for both projects. The Contractor may request in writing that the Engineer authorize a substitute Certified Erosion Control Person to act in the absence of the Certified Erosion Control Person. The substitute Certified Erosion Control Person must also be certified by an organization approved by the Department. A copy of the Certified Erosion Control Person's certification must be included in the Contractor's Protection Plan as outlined in Subsection 907-107.22.1. This in no way modifies the requirements regarding the assignment and availability of the superintendent.

907-105.14--Maintenance During Construction. Before the first sentence Subsection 105.14 on page 39, add the following.

The Contractor will be responsible for the maintenance of existing roadways within the limits of this project starting on the date of the Notice To Proceed / Beginning of Contract Time. Anytime work is performed in a travel lane, the Contractor shall install portable lane closure signs meeting the requirement of the MDOT Standard Drawing or MUTCD.

907-105.16--Acceptance. Delete Subsection 105.16 on pages 40 and 41, and substitute the following.

907-105.16--Acceptance.

907-105.16.1--Partial Acceptance of a Unit. When the Contractor has completed a unit of the work such as an interchange, a structure, a portion of the road or pavement or one project of a multi-project contract, the Contractor may request the Engineer to make a final inspection of that unit; or the Executive Director may order a final inspection of the unit if it is in the public's interest. If the Engineer finds upon inspection that the unit has been completed in compliance with the contract and it is a complete facility which can be made available to the public or made available for the prosecution of work under another contract, the Executive Director may conditionally accept the unit and conditionally relieve the Contractor of certain contractual responsibilities as defined in the release.

In the event items of work covered by such release are found to be defective or deficient as evidenced by unsatisfactory test reports of materials incorporated in the work or other engineering determination, the release shall terminate upon written notification to the Contractor. The Contractor shall make all corrections, restorations, constructions or reconstructions deemed necessary and shall resume all contractual responsibilities until all corrective measures have been made in accordance with the terms of the contract.

Partial acceptance does not constitute final acceptance of the work, or any part thereof, nor in any way void or alter any of the terms of the contract.

Relief from "certain contractual responsibilities" as indicated herein may, or may not, include:

- (a) Further maintenance of the defined limits of the partially accepted work.
- (b) Further public liability for the defined limits of the partially accepted work.
- (c) Further liability for liquidated damages as applicable to the value of the partially accepted work when the quantities for the partially accepted work are separate quantities listed on the Summary of Quantities sheet of the plans, and the separate quantities and the total amounts thereof are listed on the Engineer's Estimate. Otherwise, no reduction in liquidated damages will be made because of such partial acceptance.

Unless specifically provided in the contract, the liability for liquidated damages shall not be reduced to less than that applicable under the contract for an amount of such work equal to at least fifty percent (50%) of the total amount of work under the contract.

907-105.16.2--Partial Maintenance Release of a Project. Upon written notice from the Contractor of presumptive completion of all the work and upon due notice from the Resident or Project Engineer, the Engineer will make an inspection.

If the inspection discloses any work as being unsatisfactory or incomplete, the Engineer will discuss in detail with the Contractor all discrepancies in the work. Upon correction of the work, another inspection will be made which shall constitute the final inspection provided the work has been satisfactorily completed.

However, if during the final inspection the Engineer determines that all work has been satisfactorily completed save that of growth and coverage of plant establishment on all or part of the work, the Engineer may recommend partial release of all work except items related to growth and coverage. Upon such recommendation, the Contractor will be given a partial release of maintenance and shall be released from further contractual liabilities for the completed work. The Contractor will retain responsibility for plant establishment and all maintenance and repairs appurtenant thereto until satisfactory growth and coverage is achieved.

907-105.16.3--Final Maintenance Release of a Project. Upon written notice from the Contractor of presumptive completion of all the work and upon due notice from the Resident or Project Engineer, the Engineer will make an inspection. If all work provided by the contract has been completed to the Engineer's satisfaction, the inspection will constitute the final inspection, and the Engineer will conditionally release the Contractor of maintenance.

As provided in the contract, in the event items of work are found to be deficient or defective as evidenced by unsatisfactory test reports of material incorporated into the work, the Contractor shall assume full responsibility for corrective measures, and shall reassume maintenance and public liability until such corrective measures are completed to the satisfaction of the Engineer.

907-105.16.4.--Final Acceptance of a Project. Upon evidence that the Contractor has fulfilled all obligations under the contract, the Executive Director will make final acceptance and notify the Contractor in writing. Final acceptance of the project will not be given until all obligations imposed under the contract, including but not limited to the final reporting of payrolls, final reporting of DBE payments, acceptable certifications and test reports of materials used, etc., have been fulfilled.

MISSISSIPPI DEPARTMENT OF TRANSPORTATION

SUPPLEMENT TO SPECIAL PROVISION NO. 907-107-13

DATE: 11/17/2015

SUBJECT: Permits, Licenses and Taxes

After the second paragraph of Subsection 907-107.02 on page 1, add the following.

Prior to commencing work on any Project, the Contractor shall obtain a Material Purchase Certificate number (MPC#) from the Mississippi Department of Revenue, pursuant to Miss. Code Ann. § 27-65-21, and Miss. Admin. Code 35.IV.10.01. Upon receipt of the MPC#, the Contractor must immediately provide the MPC# to the Contract Administration Division of the Department. Failure to obtain and submit a MPC# prior to commencing work shall result in the withholding of payment to the Contractor until such time that a MPC# is obtained and submitted to the Department.

Delete the last sentence of the last paragraph of Subsection 907-107.02 on page 1, and substitute the following.

The Department will notify the Mississippi Department of Revenue of the names and addresses of any Contractors or Subcontractors.

MISSISSIPPI DEPARTMENT OF TRANSPORTATION

| SPECIAL PROVISION NO. 907-107-13

CODE: (IS)

| DATE: 05/01/2013

SUBJECT: Legal Relations and Responsibility to Public

Section 107, Legal Relations and Responsibility to Public, of the 2004 Edition of the Mississippi Standard Specifications for Road and Bridge Construction is hereby amended as follows.

907-107.02--Permits, Licenses and Taxes. Delete in toto Subsection 107.02 on page 49 and substitute the following.

The Contractor or any Subcontractor shall have the duty to determine any and all permits and licenses required and to procure all permits and licenses, pay all charges, fees and taxes and issue all notices necessary and incidental to the due and lawful prosecution of the work. At any time during the life of this contract, the Department may audit the Contractor's or Subcontractor's compliance with the requirements of this section.

The Contractor or any Subcontractor is advised that the "Mississippi Special Fuel Tax Law", Section 27-55-501, et seq. and the Mississippi Use Tax Law, Section 27-67-1, et seq., and their requirements and penalties, apply to any contract or subcontract for construction, reconstruction, maintenance or repairs, for contracts or subcontracts entered into with the State of Mississippi, any political subdivision of the State of Mississippi, or any Department, Agency, Institute of the State of Mississippi or any political subdivision thereof.

The Contractor or any Subcontractor will be subject to one or more audits by the Department during the life of this contract to make certain that all applicable fuel taxes, as outlined in Section 27-55-501, et seq., and any sales and/or use taxes, as outlined in Section 27-67-1, et seq. are being paid in compliance with the law. The Department will notify the Mississippi State Tax Commission of the names and addresses of any Contractors or Subcontractors.

907-107.14--Damage Claims and Insurance.

| **907-107.14.2--Liability Insurance.** Delete Subsection 107.14.2 beginning on page 60 and substitute [the following](#).

907-107.14.2.1--General. The Contractor shall carry Contractor's liability, including subcontractors and contractual, with limits not less than: \$500,000 each occurrence; \$1,000,000 aggregate; automobile liability - \$500,000 combined single limit - each accident; Workers' Compensation and Employers' Liability - Statutory & \$100,000 each accident; \$100,000 each employee; \$500,000 policy limit. Each policy shall be signed or countersigned by a Mississippi Agent or Qualified Nonresident Agent of the Insurance Company.

The Contractor shall have certificates furnished to the Department from the insurance companies providing the required coverage. The certificates shall be on the form furnished by the Department and will show the types and limits of coverage.

907-107.14.2.2--Railroad Protective. The following provisions are applicable to all work performed under a contract on, over or under the rights-of-way of each railroad shown on the plans.

The Contractor shall assume all liability for any and all damages to work, employees, servants, equipment and materials caused by railroad traffic.

Prior to starting any work on railroad property, the Contractor shall furnish satisfactory evidence to the Department that insurance of the forms and amounts set out herein in paragraphs (a) and (b) has been obtained. Also, the Contractor shall furnish similar evidence to the Railroad Company that insurance has been obtained in accordance with the Standard Provisions for General Liability Policies and the Railroad Protective Liability Form as published in the Code of Federal Regulations, 23 CFR 646, Subpart A. Evidence to the Railroad Company shall be in the form of a Certificate of Insurance for coverages required in paragraph (b), and the original policy of the Railroad Protective Liability Insurance for coverage required in paragraph (a).

All insurance herein specified shall be carried until the contract is satisfactorily complete as evidenced by a release of maintenance from the Department.

The Railroad Company shall be given at least 30 days notice prior to cancellation of the Railroad Protective Liability Insurance policy.

For work within the limits set out in Subsection 107.18 and this subsection, the Contractor shall provide insurance for bodily injury liability, property damage liability and physical damage to property with coverages and limits no less than shown in paragraphs (a) and (b). Bodily injury shall mean bodily injury, sickness, or disease, including death at anytime resulting therefrom. Property damage shall mean damages because of physical injury to or destruction of property, including loss of use of any property due to such injury or destruction. Physical damage shall mean direct and accidental loss of or damage to rolling stock and their contents, mechanical construction equipment or motive power equipment.

(a) **Railroad Protective Liability Insurance** shall be purchased on behalf of the Railroad Company with limits of \$2,000,000 each occurrence; \$6,000,000 aggregate applying separately to each annual period for lines without passenger trains. If the line carries passenger train(s), railroad protective liability insurance shall be purchased on behalf of the Railroad Company with limits of \$5,000,000 each occurrence; \$10,000,000 aggregate applying separately to each annual period.

Coverage shall be limited to damage suffered by the railroad on account of occurrences arising out of the work of the Contractor on or about the railroad right-of-way, independent of the railroad's general supervision or control, except as noted in paragraph 4 below.

Coverage shall include:

- (1) death of or bodily injury to passengers of the railroad and employees of the railroad not covered by State workmen's compensation laws,
- (2) personal property owned by or in the care, custody or control of the railroads,
- (3) the Contractor, or any of the Contractor's agents or employees who suffer bodily injury or death as a result of acts of the railroad or its agents, regardless of the negligence of the railroads, and
- (4) negligence of only the following classes of railroad employees:
 - (i) any supervisory employee of the railroad at the job site
 - (ii) any employee of the railroad while operating, attached to, or engaged on, work trains or other railroad equipment at the job site which are assigned exclusively to the Contractor, or
 - (iii) any employee of the railroad not within (i) or (ii) above who is specifically loaned or assigned to the work of the Contractor for prevention of accidents or protection of property, the cost of whose services is borne specifically by the Contractor or Governmental authority.

(b) **Contractor's Liability - Railroad**, including subcontractors, XCU and railroad contractual with limits of \$1,000,000 each occurrence; \$2,000,000 aggregate. **Automobile** with limits of \$1,000,000 combined single limit any one accident; **Workers' Compensation and Employer's Liability** - statutory and \$100,000 each accident; \$100,000 each employee; \$500,000 policy limit. **Excess/Umbrella Liability** \$5,000,000 each occurrence; \$5,000,000 aggregate. All coverage to be issued in the name of the Contractor shall be so written as to furnish protection to the Contractor respecting the Contractor's operations in performing work covered by the contract. Coverage shall include protection from damages arising out of bodily injury or death and damage or destruction of property which may be suffered by persons other than the Contractor's own employees.

In addition, the Contractor shall provide for and on behalf of each subcontractor by means of a separate and individual liability and property damage policy to cover like liability imposed upon the subcontractor as a result of the subcontractor's operations in the same amounts as contained above; or, in the alternative each subcontractor shall provide same.

907-107.15--Third Party Beneficiary Clause. In the first sentence of the first paragraph of Subsection 107.15 on page 61, change "create the public" to "create in the public".

907-107.17--Contractor's Responsibility for Work. Delete the fifth sentence of the fifth paragraph of Subsection 107.17 on page 63 and substitute the following.

The eligible permanent items shall be limited to traffic signal systems, changeable message signs, roadway signs and sign supports, lighting items, guard rail items, delineators, impact

attenuators, median barriers, bridge railing or pavement markings. The eligible temporary items shall be limited to changeable message signs, guard rail items, or median barriers.

907-107.18--Contractor's Responsibility for Utility Property and Services. After the first sentence of Subsection 107.18 on page 63, add the following:

Prior to any excavation on the project, the Contractor shall contact MS 811 and advise them to mark all known utilities in the area of the excavation.

MISSISSIPPI DEPARTMENT OF TRANSPORTATION

SPECIAL PROVISION NO. 907-108-38

CODE: (SP)

DATE: 04/18/2016

SUBJECT: Prosecution and Progress

Section 108, Prosecution and Progress, of the 2004 Edition of the Mississippi Standard Specifications for Road and Bridge Construction is hereby amended as follows.

907-108.01--Subletting of Contract.

907-108.01.1--General. At the end of the last paragraph of Subsection 108.01.1 on page 73, add the following.

The Engineer will have the authority to suspend the work wholly or in part and to withhold payments because of the Contractor's failure to make prompt payment within 15 calendar days as required above, or failure to submit the required OCR-484 Form, Certification of Payments to Subcontractors, which is also designed to comply with prompt payment requirements.

907-108.02--Notice To Proceed. Delete the second paragraph of Subsection 108.02 on page 75 and substitute the following.

The anticipated date of the Notice to Proceed (NTP) / Beginning of Contract Time (BCT) will be specified in the proposal.

Delete the fourth paragraph of Subsection 108.02 on page 75 and substitute the following.

Upon written request from the Contractor and if circumstances permit, the Notice to Proceed may be issued at an earlier date subject to the conditions stated therein. The Contractor shall not be entitled to any monetary damages or extension of contract time for any delay claim or claim of inefficiency occurring between the early issuance Notice To Proceed date and the Notice to Proceed date stated in the contract.

907-108.03--Prosecution and Progress. Delete Subsection 108.03.1 on pages 75 & 76, and substitute the following.

907-108.03.1--Progress Schedule. On working day projects, the Department will furnish the Contractor a progress schedule developed for the determination of contract time which may be used as the contract progress schedule, or the Contractor's own proposed progress schedule may be submitted for approval. If the Contractor elects to furnish a progress schedule for approval by the Engineer, it should be furnished promptly after award of the contract.

On completion date projects which include A + B projects, the Contractor shall furnish a progress schedule and be prepared to discuss both its proposed methodologies for fulfilling the scheduling requirements and its sequence of operations.

On projects using A + C bidding, the Contractor shall furnish a progress schedule and be prepared to discuss both its proposed methodologies for fulfilling the scheduling requirements and its sequence of operations.

The Engineer will review Contractor prepared progress schedules and approve schedules as it relates to compliance with the specifications and logic. The progress schedule must be approved by the Engineer prior to commencing work. The progress schedule shall be a computer generated bar-chart type schedule meeting the below minimum requirements. These activities shall be significantly detailed enough to communicate the Contractor's understanding of the construction sequencing and phasing of the project.

When preparing the progress schedule, the Contractor shall include the following:

- Show a time scale to graphically show the completion of the work within contract time.
- Define and relate activities to the contract pay items.
- Show all activities in the order the work is to be performed including submittals, submittal reviews, fabrication and delivery.
- Show all activities that are controlling factors in the completion of the work.
- Show the time needed to perform each activity and its relationship in time to other activities.

This progress schedule shall provide a bar for each major phase of construction such as, but not limited to, clearing and grubbing, grading, drainage structures, bridges, base, shoulders, paving, etc. with an estimated start working day and completion working day for each bar, all within the specified contract time.

A revised progress schedule may be required within ten days of the occurrence of any one of the following conditions:

- when a major change occurs in the work
- when a time extension is granted
- when the progress schedule becomes unrealistic

The Engineer's approval of the aforementioned Progress Schedules does not waive any contract requirements.

In the event the Contractor has not submitted an approvable progress schedule by the beginning of contract time, the progress schedule prepared by the Department shall be the approved progress schedule and used to assess contract time.

An approved progress schedule shall be in effect until the date on which a revised schedule is approved. The approved progress schedule will be the basis for contract time assessment.

When a Critical Path Method (CPM) schedule is required in the proposal, this schedule will be used in lieu of the bar graph progress schedule in evaluating work progress. In such case, the same time frame noted in this subsection for the original submittal along with the update requirements will apply.

907-108.03.2--Preconstruction Conference. Delete the first paragraph of Subsection 108.03.2 on page 76 and substitute the following.

Prior to commencement of the work, a preconstruction conference shall be held for the purpose of discussing with the Contractor essential matters pertaining to the prosecution and satisfactory completion of the work. The Contractor will be responsible for scheduling the preconstruction conference. The Contractor will advise the Project Engineer in writing 14 days prior to the requested date that a conference is requested. When the contract requires the Contractor to have a certified erosion control person, the Contractor's certified erosion control person shall be at the preconstruction conference. The Department will arrange for utility representatives and other affected parties to be present.

Delete the third paragraph of Subsection 108.03.2 on page 76.

907-108.06--Determination and Extension of Contract Time. Delete Subsections 108.06.1 and 108.06.2 on pages 79 thru 85 and substitute the following.

907-108.06.1--Based on Working Day Completion.

907-108.06.1.1--General. Contract Time will be established on the basis of an allowable number of Working Days, as indicated in the contract. A working day is defined as a day the Contractor worked or could have worked in accordance with the conditions set forth in Subsection 907-108.06.1.2, Subparagraphs (a) and (b), except during the months of December, January, and February.

During the months of December, January, and February, time will be assessed in the miscellaneous phase regardless of whether or not the Contractor actually works. The value for the time on any particular day will be determined by dividing the number of anticipated working day shown in the following table by the number of days in the particular month. This number will be expressed to three decimal places (0.000)

The span of time allowed for the completion of the work included in the contract will be indicated in the contract documents and will be known as "Contract Time".

907-108.06.1.2--Contract Time. The following TABLE OF ANTICIPATED WORKING DAYS indicates an average/anticipated number of working days per month.

TABLE OF ANTICIPATED WORKING DAYS

Month	Working Days
January	6
February	7
March	11
April	15
May	19
June	20
July	21
August	21
September	20
October	16
November	11
December	5
Calendar Year	172

NOTE: The above Table is for informational purposes only. The actual working day total as assessed by the Project Engineer on Form CSD-765 shall govern.

On projects other than A + C projects, available working days will start being assessed at the original Notice to Proceed/Beginning of Contract Time date shown in the contract documents, regardless of whether or not the Contractor has been issued an early Notice to Proceed. On A + C projects, available working days will start being assessed at the original Notice to Proceed/Beginning of Contract Time date shown in the contract documents, or the earlier Notice to Proceed/Beginning of Contract Time date if an early Notice to Proceed is allowed.

Available working days will be based on soil and weather conditions and other specific conditions cited in the contract. The Engineer will determine on each applicable day the extent to which work in progress could have been productive, regardless of whether the Contractor actually worked.

An available working day will be assessed as follows:

(a) any day of the week, Monday through Friday, exclusive of legal holidays recognized by the Department in Subsection 108.04.1, in which the Contractor works or could have worked for more than six (6) consecutive hours on the controlling item(s) of work, as determined by the Engineer from the approved progress schedule. When the Contractor works or could work more than four but less than six consecutive hours, one-half (0.5) of an available work day will be charged for that day. When the Contractor works or could work six or more consecutive hours during the day, one (1.0) available work day will be charged for that day, and

(b) any Saturday, exclusive of legal holidays recognized by the Department in Subsection 108.04.1, in which the Contractor works for more than six (6) consecutive hours on the controlling item(s) of work, as determined by the Engineer from the approved progress schedule.

When the Contractor works less than four consecutive hours during the day, no time will be charged for that day. When the Contractor works more than four but less than six consecutive hours, one-half (0.5) of an available work day will be charged for that day. When the Contractor works six or more consecutive hours during the day, one (1.0) available work day will be charged for that day.

Should the weather or other conditions be such that four (4) consecutive satisfactory hours are not available prior to noon (for daytime operations) or midnight (for nighttime operations), no time will be assessed for that day regardless of the above conditions. However, if the Contractor elects to work, time will be assessed in accordance with the previous paragraph.

Time will not be charged during any required waiting period for placement of permanent pavement markings as set forth in Subsection 618.03 provided all other work is complete except growth and coverage of vegetative items as provided in Subsection 210.01.

Each month the Engineer will complete, and furnish to the Contractor, an "Assessment Report of Working Days" (CSD-765). This report shows the number of working days assessed during the estimate period and the cumulative working days assessed to date. The Contractor should review the Engineer's report as to the accuracy of the assessment and confer with the Resident or Project Engineer to rectify any differences. Each should make a record of the differences, if any, and conclusions reached. In the event mutual agreement cannot be reached, the Contractor will be allowed a maximum of 15 calendar days following the ending date of the monthly report in question to file a protest Notice of Claim in accordance with the provisions of Subsection 105.17. Otherwise, the Engineer's assessment shall be final unless mathematical errors of assessment are subsequently found to exist, and any claim of the Contractor as to such matter shall be waived.

The Contractor's progress will be determined monthly at the time of each progress estimate and will be based on the percentage of money earned by the Contractor compared to the percentage of elapsed time.

The percentage of money earned will be determined by comparing the total money earned to-date by the Contractor, minus any payment for advancement of materials, to the total dollar amount of the contract. The percentage of time elapsed will be determined by comparing the working days assessed to-date on Form CSD-765 to the total allowable working days for the contract.

When the "percent complete" lags more than 20 percent behind the "percentage of elapsed time", the Contractor shall immediately submit a written statement and revised progress schedule indicating any additional equipment, labor, materials, etc. to be assigned to the work to ensure completion within the specified contract time. When the "percent complete" lags more than 40 percent behind the "percentage of elapsed time", the contract may be terminated.

907-108.06.1.3--Extension of Time. The Contractor may, prior to the expiration of the Contract Time, make a written request to the Engineer for an extension of time with a valid justification for the request. The Contractor's plea that insufficient time was specified is not a valid reason for extension of time.

An extension of contract time may be granted for unforeseen utility delays, abnormal delays caused solely by the State or other governmental authorities, or unforeseeable disastrous phenomena of nature of the magnitude of earthquakes, hurricanes, named tropical storms, tornadoes, or flooded essential work areas which are deemed to unavoidably prevent prosecuting the work.

The span of time allowed in the contract as awarded is based on the quantities used for comparison of bids. If satisfactory fulfillment of the contract requires performance of work in greater quantities than those set forth in the proposal, the time allowed for completion shall be increased in Working Days in the same ratio that the cost of such added work, exclusive of the cost of work altered by Supplemental Agreement for which a time adjustment is made for such altered work in the Supplemental Agreement, bears to the total value of the original contract unless it can be established that the extra work was of such character that it required more time than is indicated by the money value.

Any extension of contract time will be on a working day basis.

The Contractor shall provide sufficient materials, equipment and labor to guarantee the completion of the work in the contract in accordance with the plans and specifications within the Contract Time.

If the contract time of the project is extended into a season of the year in which completion of certain items of work would be prohibited or delayed because of seasonal or temperature limitations, the Engineer may waive the limitations provided the completion of the work will not result in a reduction in quality. When determined that the completion of the out-of-season items will cause a reduction in the quality of the work, the completion of the project will be further extended so the items may be completed under favorable weather conditions. In either case, the Engineer will notify the Contractor in writing.

Liquidated damages as set forth in Subsection 907-108.07 under the heading "Daily Charge Per Calendar Day" in the Table titled "Schedule of Deductions for Each Day of Overrun in Contract Time", shall be applicable to each calendar day after the specified completion date, or authorized extension thereof, and until all work under the contract is completed.

907-108.06.1.4--Cessation of Contract Time. When the Engineer by written notice schedules a final inspection, time will be suspended until the final inspection is conducted and for an additional 14 calendar days thereafter. If after the end of the 14-day suspension all necessary items of work have not been completed, time charges will resume. If the specified completion date had not been reached at the time the Contractor called for a final inspection, the calendar day difference between the specified completion date and the date the Contractor called for a final inspection will be added after the 14-day period before starting liquidation damages. If a project is on liquidated damages at the time a final inspection is scheduled, liquidated damages will be suspended until the final inspection is conducted and for seven (7) calendar days thereafter. If after the end of the 7-day suspension all necessary items of work have not been completed, liquidated damages will resume. When final inspection has been made by the Engineer as prescribed in Subsection 105.16 and all items of work have been completed, the daily time charge will cease.

907-108.06.2--Based on Specified Completion Date.

907-108.06.2.1--General. Contract Time will be established on the basis of a Specified Completion Date indicated in the Contract, or as determined by the Contractor in accordance with the contract documents. The span of time allowed for the completion of the work included in the contract will be known as "Contract Time".

For contracts in which a Specified Completion Date is indicated in the Contract, the span of Contract Time shall be between the date of the Beginning of Contract Time and the Specified Completion Date indicated in the Contract.

For contracts in which a Completion Date is determined by the Contractor (A + B Contracts), the span of Contract Time shall be between the date of the Beginning of Contract Time and the date representing the number of Calendar Days determined by the Contractor to complete the work.

The Contractor shall provide sufficient materials, equipment and labor to guarantee the completion of the work in the contract in accordance with the plans and specifications within the Contract Time.

At any given date, the ratio of the accumulated monetary value of that part of the work actually accomplished to the total contract bid amount adjusted to reflect approved increases or decreases shall determine the "percent complete" of the work.

The Contractor's progress will be determined monthly at the time of each progress estimate and will be based on the percentage of money earned by the Contractor compared to the percentage of elapsed time.

The percentage of money earned will be determined by comparing the total money earned to-date by the Contractor, minus any payment for advancement of materials, to the total dollar amount of the contract. The percentage elapsed time shall be calculated as a direct ratio of the expired Calendar Days to the total Calendar Days provided for in the contract.

When the "percent complete" lags more than 20 percent behind the "percentage of elapsed time", the Contractor shall immediately submit a written statement and revised progress schedule indicating any additional equipment, labor, materials, etc. to be assigned to the work to ensure completion within the specified contract time. When the "percent complete" lags more than 40 percent behind the "percentage of elapsed time", the contract may be terminated.

907-108.06.2.2--Extension of Time. The Contractor may, prior to the expiration of the Contract Time, make a written request to the Engineer for an extension of time with a valid justification for the request. The Contractor's plea that insufficient time was specified is not a valid reason for extension of time.

On all completion date contracts, an extension of contract time may be granted for unforeseen utility delays, abnormal delays caused solely by the State or other governmental authorities, or unforeseeable disastrous phenomena of nature of the magnitude of earthquakes, hurricanes, named

tropical storms, tornadoes, or flooded essential work areas which are deemed to unavoidably prevent prosecuting the work.

The span of time allowed in the contract as awarded is based on the quantities used for comparison of bids. If satisfactory fulfillment of the contract requires performance of work in greater quantities than those set forth in the proposal, the time allowed for completion shall be increased in Calendar Days in the same ratio that the cost of such added work, exclusive of the cost of work altered by Supplemental Agreement for which a time adjustment is made for such altered work in the Supplemental Agreement, bears to the total value of the original contract unless it can be established that the extra work was of such character that it required more time than is indicated by the money value.

Any extension of contract time will be based on a calendar day basis, excluding Saturdays, Sundays or legal holidays recognized by the Department in Subsection 108.04.1.

If the contract time of the project is extended into a season of the year in which completion of certain items of work would be prohibited or delayed because of seasonal or temperature limitations, the Engineer may waive the limitations provided the completion of the work will not result in a reduction in quality. When determined that the completion of the out-of-season items will cause a reduction in the quality of the work, the completion of the project will be further extended so the items may be completed under favorable weather conditions. In either case, the Engineer will notify the Contractor in writing.

Liquidated damages as set forth in Subsection 907-108.07 under the heading "Daily Charge Per Calendar Day" in the Table titled "Schedule of Deductions for Each Day of Overrun in Contract Time", shall be applicable to each calendar day after the specified completion date, or authorized extension thereof, and until all work under the contract is completed.

907-108.06.2.3--Cessation of Contract Time. When the Engineer by written notice schedules a final inspection, time will be suspended until the final inspection is conducted and for an additional 14 calendar days thereafter. If after the end of the 14-day suspension all necessary items of work have not been completed, time charges will resume. If the specified completion date had not been reached at the time the Contractor called for a final inspection, the calendar day difference between the specified completion date and the date the Contractor called for a final inspection will be added after the 14-day period before starting liquidation damages. If a project is on liquidated damages at the time a final inspection is scheduled, liquidated damages will be suspended until the final inspection is conducted and for seven (7) calendar days thereafter. If after the end of the 7-day suspension all necessary items of work have not been completed, liquidated damages will resume. When final inspection has been made by the Engineer as prescribed in Subsection 105.16 and all items of work have been completed, the daily time charge will cease.

907-108.07--Failure to Complete the Work on Time. Delete the Schedule of Deductions table in Subsection 108.07 on page 85, and substitute the following.

Schedule of Deductions for Each Day of Overrun in Contract Time

Original Contract Amount		Daily Charge Per Calendar Day
From More Than	To and Including	
\$ 0	100,000	\$ 150
100,000	500,000	360
500,000	1,000,000	540
1,000,000	5,000,000	830
5,000,000	10,000,000	1,200
10,000,000	20,000,000	1,800
20,000,000	-----	3,500

907-108.10--Termination of Contractor's Responsibility. In the last sentence of Subsection 108.10 on page 88, change “bond” to “performance and payment bond(s)”.

MISSISSIPPI DEPARTMENT OF TRANSPORTATION

| SPECIAL PROVISION NO. 907-109-8

CODE: (SP)

| DATE: 09/10/2015

SUBJECT: Measurement and Payment

Section 109, Measurement and Payment, of the 2004 Edition of the Mississippi Standard Specifications for Road and Bridge Construction is hereby amended as follows.

907-109.01--Measurement of Quantities. Delete the third full paragraph of Subsection 109.01 on page 90 and substitute the following.

When requested by the Contractor, material specified to be measured by the cubic yard or ton may be converted to the other measure as appropriate. Factors for this conversion will be determined by the District Materials Engineer and agreed to by the Contractor. The conversion of the materials along with the conversion factor will be incorporated into the contract by supplemental agreement. The supplemental agreement must be executed before such method of measurement is used.

After the second sentence of the fourth full paragraph of Subsection 109.01 on page 90, add the following.

Where loose vehicle measurement (LVM) is used, the capacity will be computed to the nearest one-tenth cubic yard and paid to the whole cubic yard. Measurements greater than or equal to nine-tenths of a cubic yard will be rounded to the next highest number. Measurements less than nine-tenths of a cubic yard will not be rounded to the next highest number. Example: A vehicle measurement of 9.9 cubic yards will be classified as a 10-cubic yard vehicle. A vehicle measurement of 9.8 cubic yards will be classified as a 9-cubic yard vehicle.

907-109.04--Extra and Force Account Work. Delete the first paragraph under Subsection 109.04 on page 91, and substitute the following.

When extra work results for any reason and is not handled as prescribed elsewhere herein, the Engineer and the Contractor will attempt to agree on equitable prices. When such prices are agreed upon, a Supplemental Agreement will be issued by the Engineer.

When the Supplemental Agreement process is initiated, the Contractor will be required to submit to the Engineer a detailed breakdown for Material, Labor, Equipment, Profit and Overhead. The total allowable markup (which includes Prime Contractor and Subcontractor work, if applicable) for Supplemental Agreement work shall not exceed 20%, **which also includes tax and bond.**

The requirement for detailed cost breakdowns may be waived when a Department's Bid Item History exists for the proposed item(s), and the Contractor's requested price, including mark-up, is within 20% of the Department's Bid History cost for that item(s). In any case, the Department reserves the right to request detailed cost breakdowns from the Contractor on any Supplemental Agreement request.

When equitable prices cannot be agreed upon mutually by the Engineer and the Contractor, the Engineer will issue a written order that work will be completed on a force account basis to be compensated in the following manner:

In the last sentence of subparagraph (b) in Subsection 109.04 on page 91, change "bond" to "bond(s)".

Delete the first and second paragraphs of subparagraph (d) in Subsection 109.04 on page 92 and substitute the following.

Equipment. For any machinery or special equipment, other than small tools, authorized by the Engineer, the Contractor will use the rates shown in the book entitled "Rental Rate Blue Book For Construction Equipment" as published by EquipmentWatch® and is current at the time the force account work is authorized, unless otherwise allowed by the Engineer. This book shall be used to determine equipment ownership and operating expense rates. These rates do not include allowances for operating labor, mobilization or demobilization costs, overhead or profit, and do not represent rental charges for those in the business of renting equipment. Operating labor and overhead cost will be allowed. Subject to advance approval of the Engineer, actual transportation cost for a distance of not more than 200 miles will be reimbursed for equipment not already on the project. The cost of transportation after completion of the force account work will be reimbursed except it cannot exceed the allowance for moving the equipment to the work.

907-109.06--Partial Payment.

907-109.06.1--General. Delete the fourth and fifth sentences of the third paragraph of Subsection 109.06.1 on page 94, and substitute the following.

In the event mutual agreement cannot be reached, the Contractor will be allowed a maximum of 25 calendar days following the Contractor's receipt of the monthly estimate in question to file in writing, a protest Notice of Claim in accordance with the provisions Subsection 105.17. Otherwise, the Engineer's estimated quantities shall be considered acceptable pending any changes made during the checking of final quantities.

907-109.06.2--Advancement on Materials. Delete Subsection 109.06.2 on pages 94 & 95, and substitute the following.

907-109.06.2--Advancement on Materials. Partial payments may include advance payment for certain nonperishable or durable materials such as base aggregates, reinforcing steel, bridge piling, structural steel, prefabricated bridge components, traffic signal equipment, electrical equipment, fencing materials, and sign materials with approval of the Engineer. Advance payment may be requested for structural steel members provided fabrication has been completed and the members have been declared satisfactory for storage by a Department representative. The Contractor must make a written request to the Project Engineer for advanced payment and furnish written consent of the Surety. To qualify for advance payment, materials must be stored or stockpiled on or near the project or at other locations approved by the Engineer; or in the case of precast concrete members, treated timber, guard posts and other approved preprocessed durable and bulky materials, the materials may be stored at the commercial producer's yard provided it is located in Mississippi; or in the case of prestressed concrete members that may

require being produced at an out-of-state location, the prestress members shall be produced and may be stored at the commercial manufacturer's yard provided it is a PCI certified plant on the Department's List of Approved Prestress & Precast Plants and it is located within the continental United States; or in the case of structural steel members that may require fabrication at an out-of-state location, the fabricated members may be stored at the location of the commercial fabricator's yard provided it is located within the continental United States.

Advancements will not be allowed until the Project Engineer has received copies of material invoices and certified test reports or acceptable certificates of conformance, and in the case of materials stored at the commercial producer's/fabricator's yard, the material shall be positively identified for the specific project and a Certificate of Storage issued by the Department or a designated representative of the Department. Requests for advancements on fabricated structural steel members and prestress concrete members stored out-of-state will be denied when the Department does not have available a designated representative to issue a Certificate of Storage.

The Contractor shall make suitable arrangements to the satisfaction of the Engineer for storage and protection at approved sites or, in the case of materials stored at the commercial producer's yard located in Mississippi or, in the case of fabricated structural steel members stored at the commercial fabricator's yard or prestress concrete members stored at a commercial manufacturer's yard located within the continental United States, the Contractor shall make arrangements with the producer/fabricator for suitable storage and protection. If advanced payment is allowed and the materials are damaged, lost, destroyed or for any reason become unacceptable, the previous payments will be deducted from subsequent estimates until the materials are replaced or restored to an acceptable condition. In all cases, the Contractor shall save harmless the Commission in the event of loss or damage, regardless of cause.

An invoice or an accumulation of invoices for each eligible material must total \$10,000 or more before consideration will be given for making advanced payment. When allowed, advance payment will be based on verified actual material cost plus transportation charges to the point of storage. Sales tax, local haul and handling costs shall not be included as material cost.

Advanced payment shall not exceed 100% of the invoice price or 75% of the total contract bid price for the pay item, whichever is less.

Advanced payment for a component of a pay item shall not exceed 95% of the invoice price or 75% of the total contract bid price for the pay item of which the material is a part, whichever is less.

Advanced payment will be made only on materials that will be incorporated permanently in the project.

No advanced payment will be made on minor material items, hardware, etc.

No advanced payment will be made for materials when it is anticipated that those materials will be incorporated into the project within 60 calendar days.

Advanced payment will be paid for those materials which are not readily available, and which can be easily identified and secured for a specific project and for which lengthy stockpiling periods would not be detrimental.

Where a storage area is used for more than one project, material for each project shall be segregated from material for other projects, identified, and secured. Adequate access for auditing shall be provided. All units shall be stored in a manner so that they are clearly visible for counting and/or inspection of the individual units.

Unless specifically provided for in the contract, advance payment will not be made on materials, except for fabricated structural steel members or prestress concrete members, stored or stockpiled outside of the State of Mississippi.

Materials for which an advanced payment has been allowed must be paid for by the Contractor within 60 days of the estimate on which the advanced payment was first allowed and proof of said payment must be verified by the supplier. If proof of payment is not furnished within the allowable 60 days, the advanced payment will be deducted on subsequent current estimates until such time proof of payment is furnished.

As the materials are incorporated into the work, proportionate reductions for advance payments shall be made from monthly estimates covering the work performed. Calculation of percentage of completion, or rate of progress, shall be based on completed work and no consideration will be given to stockpiled materials.

907-109.07--Changes in Material Costs. Delete the third full paragraph of Subsection 109.07 on page 96 and substitute the following.

A link to the established base prices for bituminous products and fuels will be included in the contract documents under a Notice to Bidders entitled "Petroleum Products Base Prices."

Delete the last paragraph of Subsection 109.07 on pages 97 & 98, and substitute the following.

Adjustments herein provided shall not apply to fuels consumed or materials incorporated into the work during any monthly estimate period falling wholly after the expiration of contract time as defined in Subsection 101.02 of the applicable Mississippi Standard Specifications for Road and Bridge Construction, and as determined by checked final quantities.

MISSISSIPPI DEPARTMENT OF TRANSPORTATION

SPECIAL PROVISION NO. 907-304-13

CODE: (SP)

DATE: 06/06/2012

SUBJECT: Granular Courses

Section 907-304, Granular Courses, of the 2004 Edition of the Mississippi Standard Specifications for Road and Bridge Construction is hereby amended as follows.

907-304.02--Materials. After the first paragraph of Subsection 304.02.1 on page 183, add the following.

Crushed concrete meeting the requirements of Subsection 907-703.04.3 may be used in lieu of granular courses or crushed stone courses specified in the contract. This applies to base courses, shoulders, or other required construction on a prepared foundation.

907-304.03--Construction Requirements.

907-304.03.5--Shaping, Compacting and Finishing. Delete the sixth paragraph of Subsection 304.03.5 on page 185.

Delete the first table in Subsection 304.03.5 on page 186 and substitute the following.

Granular Material Class	Lot Average	Individual Test
7,8,9 or 10	97.0	93.0
5 or 6	99.0	95.0
3 or 4	100.0	96.0
1 or 2	102.0	98.0
Crushed Courses*	99.0	95.0

* When placed on filter fabric on untreated subgrade, the individual tests and the average of the five (5) tests shall equal or exceed the following values.

<u>Lot Average</u>	<u>Individual Test</u>
96.0	92.0

907-304.05--Basis of Payment. Add the “907” prefix to the pay items listed on page 187.

MISSISSIPPI DEPARTMENT OF TRANSPORTATION

SUPPLEMENT TO SPECIAL PROVISION NO. 907-401-7

DATE: 03/22/2016

SUBJECT: Asphalt Pavements

Delete subparagraph 4 of Subsection 907-401.02.6.4.1 on page 16, and substitute the following.

4. For all pavements on new construction except shoulders that are untreated, the required lot density for all lifts shall be 93.0 percent of maximum density. For all pavements on shoulders that are untreated, the required lot density for all lifts shall be 92.0 percent of maximum density.

MISSISSIPPI DEPARTMENT OF TRANSPORTATION

SPECIAL PROVISION NO. 907-401-7

CODE: (SP)

DATE: 12/02/2014

SUBJECT: Asphalt Pavements

Section 401, Hot Mix Asphalt (HMA) - General, of the 2004 Edition of the Mississippi Standard Specifications for Road and Bridge Construction is hereby deleted and replaced as follows.

SECTION 907-401 - ASPHALT PAVEMENT -- GENERAL

907-401.01--Description. These specifications include general requirements that are applicable to all types of asphalt whether producing Hot Mix Asphalt (HMA) mixtures or Warm Mix Asphalt (WMA) mixtures. These specifications also include the specific requirements for each particular mixture when deviations from the general requirements are necessary.

This work consists of the construction of one or more lifts of asphalt pavement in accordance with these specifications and the specific requirements for the mixture to be produced and in reasonably close conformity with the lines, grades, thicknesses and typical sections shown on the plans or established by the Engineer.

907-401.01.1--Definitions.

Maximum Sieve Size - Maximum sieve size is the smallest sieve size at which 100 percent of the aggregate passes.

Nominal Maximum Sieve Size - The nominal maximum sieve size is one sieve size larger than the first sieve to retain more than 10 percent of the aggregate.

Maximum Density Line - The maximum density line is a straight line plot on the FHWA 0.45 power gradation chart which extends from the zero origin point of the chart through the plotted point of the combined aggregate gradation curve on the nominal maximum sieve size.

Mechanically Fractured Face - An angular, rough, or broken surface of an aggregate particle created by crushing as determined by ASTM Designation: D 5821.

907-401.02--Materials.

907-401.02.1--Component Materials.

907-401.02.1.1--General. Component materials will be conditionally accepted at the plant subject to later rejection if incorporated in a mixture or in work which fails to meet contract requirements.

907-401.02.1.2--Aggregates. The source of aggregates shall meet the applicable requirements of Section 703.

907-401.02.1.2.1--Coarse Aggregate Blend. Mechanically fractured faces by weight of the combined mineral aggregate coarser than the No. 4 sieve:

<u>Mixture</u>	<u>Percent Fractured Faces, minimum</u>
25-mm	70, one-face
19-mm *	80, one-face
12.5-mm	90, two-face
9.5-mm	90, two-face
4.75-mm	90, two-face

* When used on routes requiring polymer modified asphalt, the top intermediate lift (19-mm mixture), including travel lane and adjacent lane, shall have at least 90 percent two fractured faces minimum. When placed on an existing Portland Cement Concrete surface, all intermediate lifts (19-mm mixture) shall have at least 90 percent fractured two faces minimum.

The maximum percentage by weight of flat and elongated particles, for all mixes other than 4.75-mm, maximum to minimum dimension greater than 5, shall not exceed 10% for all mixtures. This shall be determined in accordance with ASTM Designation: D 4791, Section 8.4, on the combined mineral aggregate retained on the 3/8" sieve.

907-401.02.1.2.2--Fine Aggregate Blend. Of all the material passing the No. 8 sieve and retained on the No. 200 sieve, not more than 60 percent shall pass the No. 30 sieve.

Uncrushed natural sand shall pass the 3/8" sieve and may be used, excluding the content in RAP, in the percentages of the total mineral aggregate by weight set out in the following table:

Mixture	Maximum Percentage of Natural Sand by Total Weight of Mineral Aggregate		
	HT	MT	ST
25-mm	10	10	20
19-mm	10	10	20
12.5-mm	10	10	20
9.5-mm	10	10	10
4.75-mm	25	30	35

907-401.02.1.2.3--Combined Aggregate Blend.

Design Master Range

Mixture:	25-mm	19-mm	12.5-mm	9.5-mm	4.75-mm
Nominal Maximum Sieve Size:	1 inch	3/4 inch	1/2 inch	3/8 inch	1/4 inch
Sieve Size	Percent Passing				
1½ inch	100				
1 inch	90-100	100			
¾ inch	89 max.	90-100	100		
½ inch	-	89 max.	90-100	100	100
3/8 inch	-	-	89 max.	90-100	95-100
No. 4	-	-	-	89 max.	90-100
No. 8	16-50	18-55	20-60	22-70	-
No. 16	-	-	-	-	30-60
No. 200	4.0-9.0	4.0-9.0	4.0-9.0	4.0-9.0	6.0-12.0

For MT and HT mixtures, the combined aggregate gradation of the job mix formula, when plotted on FHWA 0.45 power chart paper, shall fall entirely below the Maximum Density Line on all sieve sizes smaller than the No. 4 sieve. However, MT and HT mixtures having a minimum fine aggregate angularity index of 44.0, per ASTM Designation: C1252, Method A, may be designed above the maximum density line.

The 9.5-mm mixtures shall have a minimum fine aggregate angularity of 44.0 for HT and MT mixtures and 40.0 for ST mixtures when tested on combined aggregate in accordance with ASTM Designation: C1252 Method A. The 4.75-mm mixtures shall have a minimum fine aggregate angularity of 45.0 for all design levels when tested on combined aggregate in accordance with ASTM Designation: C 1252, Method A.

The minus No. 40 fraction of the combined aggregate shall be non-plastic when tested according to AASHTO Designation: T 90. The clay content for the combined aggregate for underlying layers shall not exceed 1.0 percent, and for the top layer shall not exceed 0.5 percent by weight of the total mineral aggregate when tested according to AASHTO Designation: T 88.

907-401.02.1.3--Bituminous Materials. Bituminous materials shall meet the applicable requirements of Section 702 for the grade specified.

Tack coat shall be the same neat grade asphalt cement used in the mixture being placed or those materials specified for tack coat in Table 410-A on the last page of Section 410. Emulsified asphalt shall not be diluted without approval of the Engineer.

907-401.02.1.4--Blank.

907-401.02.1.5--Hydrated Lime. Hydrated lime shall meet the requirements of Subsection

714.03.2 for lime used in soil stabilization.

907-401.02.1.6--Asphalt Admixtures. Additives for liquid asphalt, when required or permitted, shall meet the requirements of Subsection 702.08.

907-401.02.1.7--Polymers. Polymers for use in polymer modified asphalt pavements shall meet the requirements of Subsection 702.08.3.

907-401.02.2--WMA Products and Processes. The Department will maintain a list of qualified WMA products and processes. No product or process shall be used unless it appears on this list.

The Contractor may propose other products or processes for approval by the Product Evaluation Committee. Documentation shall be provided to demonstrate laboratory performance, field performance, and construction experience.

907-401.02.3--Composition of Mixtures.

907-401.02.3.1--General. Unless otherwise specified or permitted, the asphalt shall consist of a uniform mixture of asphalt, aggregate, hydrated lime and, when required or necessary to obtain desired properties, antistripping agent and/or other materials.

The total amount of crushed limestone aggregate for mixtures, excluding shoulders, when used in the top lift, shall not exceed 50 percent of the total combined aggregate by weight.

Hydrated lime shall be used in all asphalt at the rate of one percent (1%) by weight of the total dry aggregate including aggregate in RAP, if used. The aggregate, prior to the addition of the hydrated lime, shall contain sufficient surface moisture. If necessary, the Contractor shall add moisture to the aggregate according to the procedures set out in Subsection 907-401.03.2.1.2.

The Contractor shall obtain a shipping ticket for each shipment of hydrated lime. The Contractor shall provide the District Materials Engineer with a copy of each shipping ticket from the supplier, including the date, time and weight of hydrated lime shipped and used in hot mix asphalt production. An amount equal to twenty-five percent (25%) of the total value of asphalt items performed during the initial estimate period in which the Contractor fails to submit the hydrated lime shipping tickets to the District Materials Engineer will be withheld from the Contractor's earned work. Non-conformance with this specification for successive estimate period(s) will result in the total value (100%) of asphalt items performed during this period(s) being withheld from the Contractor's earned work. Monies withheld for this non-conformance will be released for payment on the next monthly estimate following the date the submittal of hydrated lime shipping tickets to the District Materials Engineer is brought back into compliance with this specification.

Mixtures will require the addition of an antistripping agent when the Tensile Strength Ratio (MT-63) and/or the Boiling Water Test (MT-59) fail to meet the following criteria.

Tensile Strength Ratio (TSR - MT-63)

- Wet Strength / Dry Strength 85 percent minimum
 - Interior Face Coating 95 percent minimum
- Boiling Water Test (MT-59)
- Particle Coating 95 percent minimum

Reclaimed asphalt pavement (RAP) materials may be used in the production of asphalt in the percentages of the total mix by weight set out in the following table:

Asphalt Mixture	Maximum Percentage of RAP by total weight of mix
4.75-mm	0
9.5-mm	20 *
12.5-mm Surface Lift	20 *
12.5-mm Underlying Lift	30
19-mm	30
25-mm	30

* At a minimum, RAP shall be processed and/or screened such that the RAP material size does not exceed the nominal maximum sieve size for the mixture specified.

During asphalt production, the RAP shall pass through a maximum 2-inch square sieve located in the asphalt plant after the RAP cold feed bin and prior to the RAP weighing system.

Crushed reclaimed concrete pavement may be used as an aggregate component of all asphalt pavements. When crushed reclaimed concrete pavement is used as an aggregate component, controls shall be implemented to prevent segregation. Crushed reclaimed concrete pavement aggregate shall be separated into coarse and fine aggregate stockpiles using the 3/8-inch or 1/2-inch sieve as a break-point unless otherwise approved by the Engineer in writing.

907-401.02.3.1.1--Mixture Properties.

<u>ALL MIXTURES</u>	<u>Percent of Maximum Specific Gravity (Gmm)</u>
N _{Design}	96.0
N _{Initial}	Less than 90.0
N _{Maximum}	Less than 98.0
 <u>VMA CRITERIA</u>	 <u>Minimum percent</u>
25-mm mixture	12.0
19-mm mixture	13.0
12.5-mm mixture	14.0
9.5-mm mixture	15.0
4.75-mm mixture	16.0

Mixtures with VMA more than two percent higher than the minimum may be susceptible to

flushing and rutting; therefore, unless satisfactory experience with high VMA mixtures is available, mixtures with VMA greater than two percent above the minimum should be avoided.

The specified VFA range for 4.75-mm nominal maximum size mixtures for design traffic levels >3 million ESAL's (HT Mixtures) shall be 75 to 78 percent, for design traffic levels of 1.0 to 3 million ESAL's (MT mixtures) 65 to 78 percent, and for design traffic levels of <1.0 million ESAL's (ST mixtures) 65 to 78 percent.

DUST/BINDER RATIO for 4.75-mm mixtures

Percent Passing No.200 / Effective Binder Percent 0.9 to 2.0

DUST/BINDER RATIO for 9.5-mm, 12.5-mm, 19-mm & 25-mm mixtures

Percent Passing No.200 / Effective Binder Percent 0.8 to 1.6

907-401.02.3.2--Job Mix Formula. The job mix formula shall be established in accordance with Mississippi Test Method: MT-78, where N represents the number of revolutions of the gyratory compactor.

Compaction Requirements:	N _{Initial}	N _{Design}	N _{Maximum}
High Type (HT) Mixtures			
19-mm, 12.5-mm, 9.5-mm & 4.75-mm	7	85	130
Medium Type (MT) Mixtures			
19-mm, 12.5-mm, 9.5-mm & 4.75-mm	7	65	100
All Standard Type (ST) Mixtures;			
25-mm HT & MT Mixtures	6	50	75

At least 10 working days prior to the proposed use of each mixture, the Contractor shall submit in writing to the Engineer a proposed job-mix formula or request the transfer of a verified job-mix formula as set forth in the latest edition of MDOT's Field Manual for HMA and SOP TMD-11-78-00-000. The proposed job-mix formula shall indicate whether the mixture will be produced as HMA or WMA. The process or product used to produce WMA should also be noted on the proposed documentation for the job-mix formula. The job-mix formula shall be signed by a Certified Mixture Design Technician (CMDT).

The Department will perform the tests necessary for review of a proposed job-mix formula for each required mixture free of charge one time only. A charge will be made for additional job-mix formulas submitted by the Contractor for review.

Review of the proposed job-mix formula will be based on percent maximum specific gravity at N_{Initial}, N_{Design}, and N_{Maximum}, VMA @ N_{Design}, resistance to stripping, and other criteria specified for the mixture.

The mixture shall conform thereto within the range of tolerances specified for the particular

mixture. No change in properties or proportion of any component of the job-mix formula shall be made without permission of the Engineer. The job-mix formula for each mixture shall be in effect until revised in writing by the Engineer.

A job-mix formula may be transferred to other contracts in accordance with conditions set forth in the Department's Field Manual for HMA.

The Contractor shall not place any asphalt prior to receiving "tentative" approval and a MDOT design number from the Central Laboratory.

When a change in source of materials, unsatisfactory mixture production results (such as segregation, bleeding, shoving, rutting over 1/8", raveling & cracking) or changed conditions make it necessary, a new job-mix formula will be required. The conditions set out herein for the original job-mix formula are applicable to the new job-mix formula.

In the event the Contractor wishes to change from an approved HMA job-mix formula to WMA or an approved WMA job-mix formula to HMA, the Contractor shall submit the proposed change in writing to the Engineer at least 10 working days prior to the proposed change. If no changes (other than the plant production temperature) are to be made to the job-mix formula, a new MDOT design number will be assigned by the MDOT Central Laboratory.

907-401.02.4--Substitution of Mixture. The substitution of a one (1) size finer mixture for an underlying lift shall require written permission of the State Construction Engineer, except no substitution of a 4.75-mm mixture will be allowed. A 9.5-mm mixture may be substituted for the 12.5-mm mixture designated on the plans as the top lift or pre-leveling. The 19-mm mixture may be substituted for the 25-mm mixture in trench widening work. Any substitution of mixtures shall be of the same type. No other substitutions will be allowed. The quantity of substituted mixture shall be measured and paid for at the contract unit price for the mixture designated on the plans. The substitution of any mixture will be contingent on meeting the required total structure thickness and maintaining the minimum and/or maximum laying thickness for the particular substituted mixture as set out in the following table.

Mixture	Single Lift Laying Thickness Inches	
	Minimum	Maximum
25-mm	3	4
19-mm	2¼	3½
12.5-mm	1½	2½
9.5-mm	1	1½
4.75-mm	½	¾

907-401.02.5--Contractor's Quality Management Program.

907-401.02.5.1--General. The Contractor shall have full responsibility for quality management

and maintain a quality control system that will furnish reasonable assurance that the mixtures and all component materials incorporated in the work conform to contract requirements. The Contractor shall have responsibility for the initial determination and all subsequent adjustments in proportioning materials used to produce the specified mixture. Adjustments to plant operation and spreading and compaction procedures shall be made immediately when results indicate that they are necessary. Mixture produced by the Contractor without the required testing or personnel on the project shall be subject to removal and replacement by the Contractor at no additional cost to the State.

907-401.02.5.2--Personnel Requirements. The Contractor shall provide at least one Certified Asphalt Technician-I (CAT-I) full-time during asphalt production at each plant site used to furnish material to the project. Sampling shall be conducted by a certified technician or by plant personnel under the direct observation of a certified technician. All testing, data analysis and data posting will be performed by the CAT-I or by an assistant under the direct supervision of the CAT-I. The Contractor shall have a Certified Asphalt Technician-II (CAT-II) available to make any necessary process adjustments. Technician certification shall be in accordance with MDOT SOP TMD-22-10-00-000, MDOT HMA Technician Certification Program. An organizational chart, including names, telephone numbers and current certification, of all those responsible for the quality control program shall be posted in the Contractor's laboratory while the asphaltic paving work is in progress.

907-401.02.5.3--Testing Requirements. As a minimum, the Contractor's quality management program shall include the following:

- (a) Bituminous Material. Provide Engineer with samples in a sealed one quart metal container at the frequency given in MDOT SOP TMD-20-04-00-000.
- (b) Mechanically Fractured Face. Determine mechanically fractured face content of aggregates retained on the No. 4 sieve, at a minimum of one test per day of production.
- (c) Mixture Gradation. Conduct extraction tests for gradation determination on the mixture. Sample according to the frequency in paragraph (i) and test according to Mississippi Test Method MT-31.
- (d) Total Voids and VMA. Determine total voids and voids in mineral aggregate (VMA), at N_{Design} , from the results of bulk specific gravity tests on laboratory compacted specimens. Sample according to the sampling frequency in paragraph (i) and test according to the latest edition of MDOT's Field Manual for HMA.
- (e) Asphalt Content. Sample according to the sampling frequency in paragraph (i). Determine the asphalt content using one of the following procedures.
 - (1) Nuclear gauge per Mississippi Test Method MT-6.
 - (2) Incinerator oven per AASHTO Designation: T 308, Method A.
- (f) Stripping Tests. Conduct a minimum of one stripping test at the beginning of each job-

mix production and thereafter, at least once per each two weeks of production according to Mississippi Test Method: MT-63 and one stripping test per day of production according to Mississippi Test Method: MT-59. Should either the TSR (MT-63) or the boiling water (MT-59) stripping tests fail, a new antistrip additive or rate shall be established or other changes made immediately that will result in a mixture which conforms to the specifications; otherwise, production shall be suspended until corrections are made.

- (g) Density Tests. For 25-mm, 19.5-mm, 12.5-mm & 9.5-mm mixtures, conduct density tests as necessary to control and maintain required compaction according to Mississippi Test Method: MT-16, Method C (nuclear gauge), or AASHTO Designation: T 166. Note - The nuclear gauge may be correlated, at the Contractor's option, with the average of a minimum of five pavement sample densities. For 4.75-mm mixtures, conduct density tests as necessary to control and maintain required compaction according to AASHTO Designation: T 166.
- (h) Quality Control Charts. Plot the individual test data, the average of the last four tests and the control limits for the following items as a minimum:

- Mixture Gradation (Percent Passing) Sieves:
 - 1/2-inch, 3/8-inch, No. 8, No. 16, No. 30 and No. 200.
 - Asphalt Content, Percent
 - Maximum Specific Gravity, G_{mm}
 - Total Voids @ N_{Design} , Percent
 - VMA @ N_{Design} , Percent

NOTE: For 4.75-mm mixtures, Quality Control Charts for mixture gradation are not required on the No. 8 and No. 30 sieves. For 4.75-mm mixtures, as a minimum, Quality Control Charts for mixture gradation shall be kept on the 3/8-inch, No. 16 and No. 200 sieves. For all mixtures other than 4.75-mm, Quality Control Charts for mixture gradation are not required on the No. 16 sieve.

Keep charts up-to-date and posted in a readily observable location. Charts may be kept on a computer, however, the charts shall be printed out a minimum of once each production day and displayed in the laboratory. Note any process changes or adjustments on the Air Voids chart.

- (i) Sampling Frequency. Conduct those tests as required above at the following frequency for each mixture produced based on the estimated plant tonnage at the beginning of the day.

<u>Total Estimated Production, tons</u>	<u>Number of Tests</u>
50-800	1
801-1700	2
1701-2700	3
2701+	4

NOTE: Material placed in a storage silo from a previous day's production shall be randomly sampled and tested when removed for placement on the roadway. Such sample(s) shall be independent of the day's production sampling frequency and shall be used in calculating the four (4) sample running average.

- (j) Sample Requirements. Obtain the asphalt mixture samples from trucks at the plant. Obtain aggregate samples from cold feed bins or aggregate stockpile. Save a split portion of all mixture samples at the laboratory site in a dry and protected location for 14 calendar days. At the completion of the project, the remaining samples may be disposed of with the approval of the Engineer.

The above testing frequencies are for the estimated plant production for the day. If production is discontinued or interrupted, the tests will be conducted at the previously established sample tonnage points for the materials that are actually produced. If the production exceeds the estimated tonnage, sampling and testing will continue at the testing increments previously established for the day. A testing increment is defined as the estimated daily tonnage divided by the required number of tests from the table in Subsection 907-401.02.5.3 paragraph (i).

In addition to the above program, the following tests shall be conducted on the first day of production and once for every eight production samples thereafter, with a minimum of one test per production week.

Aggregate Stockpile Gradations per AASHTO Designations: T-11 and T-27.

Reclaimed Asphalt Pavement (RAP) Gradation per Mississippi Test Method MT-31.

Fine Aggregate Angularity for all 4.75-mm and 9.5-mm mixtures and all MT and HT mixtures designed above the maximum density line per ASTM Designation: C 1252, Method A.

Testing of the aggregate and RAP stockpiles during production will be waived provided the Contractor provides the Engineer with gradation test results for the materials in the stockpile determined during the building of the stockpiles. The test results provided shall represent a minimum frequency of one per one thousand tons of material in the stockpile. If the Contractor continues to add materials to the stockpile during asphalt production, the requirements for gradation testing during production are not waived.

907-401.02.5.4--Documentation. The Contractor shall document all observations, records of inspection, adjustments to the mixture, and test results on a daily basis. All tests conducted by the Contractor in accordance with Subsection 907-401.02.5.3(h) shall be included in the running average calculations. If single tests are performed as a check on individual asphalt properties, between regular samples, without performing all tests required in Subsection 907-401.02.5.3(h), the results of those individual tests shall not be included in the running average calculations for that particular property. The Contractor shall record the results of observations and records of inspection as they occur in a permanent field record. The Contractor shall record all process

adjustments and job mix formula (JMF) changes on the air void charts. The Contractor shall provide copies of all test data sheets and the daily summary reports on the appropriate Mississippi DOT forms to the Engineer on a daily basis. The Contractor shall provide a written description of any process change, including blend proportions, to the Engineer as they occur. Information provided to the Engineer must be received in the Engineer's office by no later than 9:00 AM the day after the asphalt is produced. Fourteen days after the completion of the placement of the asphalt, the Contractor shall provide the Engineer with the original testing records and control charts in a neat and orderly manner.

907-401.02.5.5--Control Limits. The following control limits for the job mix formula (JMF) and warning limits are based on a running average of the last four data points.

<u>Item</u>	<u>JMF Limits</u>	<u>Warning Limits</u>
Sieve - % Passing		
1/2-inch	± 5.5	± 4.0
3/8-inch	± 5.5	± 4.0
No. 8	± 5.0	± 4.0
No. 16, for 4.75-mm mixtures ONLY	± 4.0	± 3.0
No. 30	± 4.0	± 3.0
No. 200	± 1.5	± 1.0
Asphalt Content, %	-0.3 to +0.5	-0.2 to + 0.4
Total Voids @ N _{Design} , %	± 1.3	± 1.0
VMA @ N _{Design} , %	- 1.5	- 1.0

907-401.02.5.6--Warning Bands. Warning bands are defined as the area between the JMF limits and the warning limits.

907-401.02.5.7--Job Mix Formula Adjustments. A request for a JMF adjustment signed by a CAT-II may be made to the Engineer by the Contractor. Submit sufficient testing data with the request to justify the change. The requested change will be reviewed by the State Materials Engineer for the Department. If current production values meet the mixture design requirements, a revised JMF will be issued. Adjustments to the JMF shall conform to the latest edition of MDOT's Field Manual for HMA. Adjustments to the JMF to conform to actual production shall not exceed the tolerances specified for the JMF limits. Regardless of such tolerances, any adjusted JMF gradation shall be within the design master range for the mixture specified. The JMF asphalt content may only be reduced if the production VMA meets or exceeds the minimum design VMA requirements for the mixture being produced.

907-401.02.5.8--Actions and Adjustments. Based on the process control test results for any property in question, the following actions shall be taken or adjustments made when appropriate:

- (a) When the running average trends toward the warning limits, the Contractor shall consider taking corrective action. The corrective action, if any, shall be documented. All tests shall be part of the contract files and shall be included in the running average

- calculations.
- (b) The Contractor shall notify the Engineer whenever the running average exceeds the warning limits.
 - (c) If two consecutive running averages exceed the warning limit, the Contractor shall stop production and make adjustments. Production shall only be restarted after notifying the Engineer of the adjustments made.
 - (d) If the adjustment made under (c) improves the process such that the running average after four additional tests is within the warning limits, the Contractor may continue production with no reduction in payment.
 - (e) If the adjustment made under (c) does not improve the process and the running average after four additional tests stays in the warning band, the mixture will be considered unsatisfactory. Reduced payment for unsatisfactory mixtures will be applied starting from the stop point to the point when the running average is back within the warning limits in accordance with Subsection 907-401.02.6.3.
 - (f) Failure to stop production and make adjustments when required shall subject all mixture produced from the stop point to the point when the running average is back within the warning limits to be considered unsatisfactory. Reduced payment for unsatisfactory mixtures will be applied in accordance with Subsection 907-401.02.6.3.
 - (g) If the running average exceeds the JMF limits, the Contractor shall stop production and make adjustments. Production shall only be restarted after notifying the Engineer of the adjustments made.
 - (h) All materials for which the running average exceeds the JMF limits will be considered unacceptable and shall be removed and replaced by the Contractor at no additional cost to the State. The Engineer will determine the quantity of material to be replaced based on a review of the individual testing data which make up the running average in question and an inspection of the completed pavement. If the Engineer decides to leave the mixture in place because of special circumstances, the quantity of mixture, as defined above, will be paid for in accordance with Subsection 907-401.02.6.3.
 - (i) Single test results shall be compared to 1.7 times the warning and JMF limits. If the test results verified by QA testing (within allowable differences in Subsection 907-401.02.6.2) exceed these limits, the pay factor provided in Subsection 907-401.02.6.3 will apply for the quantity of material represented by the test(s). Single test limits will be used for the acceptance of projects when insufficient tonnage is produced to require four (4) Contractor's tests.
 - (j) The above corrective action will also apply for a mixture when the Contractor's testing data has been proven incorrect. The Contractor's data will be considered incorrect when;
1) the Contractor's tests and the Engineer's tests do not agree within the allowable differences given in Subsection 907-401.02.6.2 and the difference can not be resolved, or
2) the Engineer's tests indicates that production is outside the JMF limits and the results have been verified by the Materials Division. The Engineer's data will be used in place of the Contractor's data to determine the appropriate pay factor.

907-401.02.6--Standards of Acceptance.

907-401.02.6.1--General. Acceptance for mixture quality (VMA and total voids @ N_{Design} , gradation, and asphalt content) will be based on random samples tested in accordance with the

latest edition of MDOT's Field Manual for HMA. Pavement densities and smoothness will be accepted by lots as set out in Subsections 907-401.02.6.4 and 907-401.02.6.5.

907-401.02.6.2--Assurance Program for Mixture Quality. The Engineer will conduct a quality assurance program. The quality assurance program will be accomplished as follows:

- 1) Conducting verification tests.
- 2) Validate Contractor test results.
- 3) Periodically observing Contractor quality control sampling and testing.
- 4) Monitoring required quality control charts and test results.
- 5) Sampling and testing materials at any time and at any point in the production or laydown process.

The rounding of all test results will be in accordance with Subsection 700.04.

The Engineer will conduct verification tests on samples taken by the Contractor under the direct supervision of the Engineer at a time specified by the Engineer. The frequency will be equal to or greater than ten percent (10%) of the tests required for Contractor quality control and the data will be provided to the Contractor within two asphalt mixture production days after the sample has been obtained by the Engineer. At least one sample shall be tested from the first two days of production. All testing and data analysis shall be performed by a Certified Asphalt Technician-I (CAT-I) or by an assistant under the direct supervision of the CAT-I. Certification shall be in accordance with the *MDOT HMA Technician Certification Program* chapter in the Materials Division Inspection, Testing, and Certification Manual. The Department shall post a chart giving the names and telephone numbers for the personnel responsible for the assurance program.

The Engineer shall be allowed to inspect Contractor testing equipment and equipment calibration records to confirm both calibration and condition. The Contractor shall calibrate and correlate all testing equipment in accordance with the latest versions of the Department's Test Methods and AASHTO Designation: R 18.

Random differences between the Engineer's verification tests and the current running average of four quality control tests at the time of obtaining the verification sample will be considered acceptable if within the following limits:

Item	Allowable Differences
Sieve - % Passing	
3/8-inch and above	6.0
No. 4	5.0
No. 8	4.0
No. 16, for 4.75-mm mixtures ONLY	3.5
No. 30	3.5
No. 200	2.0
AC Content	0.4
Specimen Bulk SG, Gmb @ N _{Design}	0.030
Maximum SG, Gmm	0.020

If four quality control tests have not been tested prior to the time of the first verification test, the verification test results will be compared to the average of the preceding quality control tests. If the verification test is the first material tested on the project or if a significant process adjustment was made just prior to the verification test, the verification test results will be compared to the average of four subsequent quality control test results. For all other cases after a significant process adjustment, the verification test results will be compared to the average of the preceding quality control tests (taken after the adjustment) as in the case of a new project start-up when four quality control tests are not available.

In the event that; 1) the comparison of the Contractor's running average quality control data and Engineer's quality assurance verification test results are outside the allowable differences in the above table, or 2) if a bias exists between the results, such that one of the results is predominately higher or lower than the other, and the Engineer's results fail to meet the JMF control limits, the Engineer will investigate the reason immediately. As soon as the need for an investigation becomes known, the Engineer will increase the quality assurance sampling rate to the same frequency required for Contractor testing. The additional samples obtained by the Engineer may be used as part of the investigation process or for routine quality assurance verification tests. The Engineer's investigation may include testing of the remaining quality control split samples, review and observation of the Contractor's testing procedures and equipment, and a comparison of split sample test results by the Contractor quality control laboratory, Department quality assurance laboratory and the Materials Division laboratory. The procedures outlined in the latest edition of MDOT's Field Manual for HMA may be used as a guide for the investigation. In the event that the Contractor's results are determined to be incorrect, the Engineer's results will be used for the quality control data and the appropriate payment for the mixture will be based on the procedures specified in Subsection 907-401.02.5.8(j).

The Engineer will periodically witness the sampling and testing being performed by the Contractor. The Engineer, both verbally and in writing, will promptly notify the Contractor of any observed deficiencies. When differences exist between the Contractor and the Engineer which cannot be resolved, a decision will be made by the State Materials Engineer, acting as the referee. The Contractor will be promptly notified in writing of the decision. If the deficiencies are not corrected,

the Engineer will stop production until corrective action is taken.

907-401.02.6.3--Acceptance Procedure for Mixture Quality. All obviously defective material or mixture will be subject to rejection by the Engineer. Such defective material or mixture shall not be incorporated into the finished work. If the defective material has already been placed in the work, the material shall be removed and replaced at no additional cost to the State.

The Engineer will base final acceptance of the asphalt mixture production on the results of the Contractor's testing for total voids and VMA @ N_{Design} , gradation, and asphalt content as verified by the Engineer in the manner hereinbefore described and the uniformity and condition of the completed pavement. Areas of pavement that exhibit non-uniformity or failures, materials or construction related, such as but not limited to segregation, bleeding, shoving, rutting over $\frac{1}{8}$ ", raveling, slippage, or cracking will not be accepted. Such areas will be removed and replaced at no additional cost to the State.

Bituminous mixture placed prior to correction for deficiencies in VMA and total voids @ N_{Design} , gradation, or asphalt content, as required in Subsection 907-401.02.5.8 and determined by the Engineer satisfactory to remain in place will be paid for in accordance with the following pay factors times the contract unit price per ton.

Pay Factor for Mixture Quality *

Item	Produced in Warning Bands	Produced Outside JMF Limits, Allowed to Remain in Place
Gradation	0.90	0.75
Asphalt Content	0.85	0.75
Total Voids @ N_{Design}	0.70	0.50
VMA @ N_{Design}	0.90	0.75

* The minimum single payment will apply.

907-401.02.6.4--Acceptance Procedure for Density. Each completed lift will be accepted with respect to compaction on a lot to lot basis from density tests performed by the Department. For normal production days, divide the production into approximately equal lots as shown in the following table. When cores are being used for the compaction evaluation, randomly obtain one core from each lot. When the nuclear density gauge is being used for compaction evaluation, obtain two random readings from each lot and average the results. See Chapter 7 of the latest edition of MDOT's Field Manual for HMA for more details. Additional tests may be required by the Engineer to determine acceptance of work appearing deficient. The Contractor shall furnish and maintain traffic control for all compaction evaluations, including coring, required in satisfying specified density requirements.

Lot Determination

<u>Daily Production - Tons</u>	<u>Number of Lots</u>
0 - 300	1
301 - 600	2
601 - 1000	3
1001 - 1500	4
1501 - 2100	5
2101 - 2800	6
2801+	7

907-401.02.6.4.1--Roadway Density. The density requirement for each completed lift on a lot to lot basis from density tests performed by the Department shall be as follows:

1. For all leveling lifts, when full lane width and with a thickness as specified in the table in Subsection 907-401.02.4, the required lot density shall be 92.0 percent of maximum density.
2. For all single lift overlays, with or without leveling and/or milling, the required lot density shall be 92.0 percent of maximum density.
3. For all multiple lift overlays of two (2) or more lifts excluding leveling lifts, the required lot density of the bottom lift shall be 92.0 percent of maximum density. The required lot density for all subsequent lifts shall be 93.0 percent of maximum density.
4. For all pavements on new construction, the required lot density for all lifts shall be 93.0 percent of maximum density.

When it is determined that the density for a lot is below the required density (93.0 percent or 92.0 percent) but not lower than 91.0 or 90.0 percent of maximum density, respectively, the Contractor will have the right to remove and replace the lot(s) not meeting the specified density requirements in lieu of accepting reduced payment for the lot(s).

When it is determined that the density for a lot is above 96.0 percent, the Engineer shall notify the Contractor who will make plant adjustments to resolve the problem.

When it is determined that the density for a lot is below 91.0 or 90.0 percent, respectively, the lot(s), or portions thereof shall be removed and replaced in accordance with Chapter 7 of the latest edition of MDOT's Field Manual for HMA at no additional cost to the State. A corrected lot will be retested for approval. No resampling will be performed when pavement samples are used for determining density.

At any time the average daily compaction (the total of the percent compaction for the lots produced in one day divided by the total number of lots for the day) does not meet the required percent compaction or more for two consecutive days, the Contractor shall notify the Engineer of proposed changes to the compactive effort. If the average daily compaction does not meet the

required percent compaction or more for a third consecutive day, the Contractor shall stop production until compaction procedures are established to meet the specified density requirements.

Each lot of work found not to meet the density requirement of 92.0% or 93% of maximum density, respectively, may remain in place with a reduction in payment as set out in the following tables:

PAYMENT SCHEDULE FOR COMPACTION OF 92.0 PERCENT OF MAXIMUM DENSITY

<u>Pay Factor</u>	<u>Lot Density **</u> <u>% of Maximum Density</u>
1.00	92.0 and above
0.90	91.0 - 91.9
0.70	90.0 - 90.9

** Any lot or portion thereof with a density of less than 90.0 percent of maximum density shall be removed and replaced at no additional cost to the State.

PAYMENT SCHEDULE FOR COMPACTION OF 93.0 PERCENT OF MAXIMUM DENSITY

<u>Pay Factor</u>	<u>Lot Density ***</u> <u>% of Maximum Density</u>
1.00	93.0 and above
0.90	92.0 - 92.9
0.70	91.0 - 91.9

*** Any lot or portion thereof with a density of less than 91.0 percent of maximum density shall be removed and replaced at no additional cost to the State.

The compaction pay factors and mixture quality pay factor, as described in Subsection 907-401.02.6.3, will each apply separately. However, the combined pay factor shall not be less than 0.50 for any mixture allowed to remain in place.

907-401.02.6.4.2--Trench Widening Density. The density for trench widening on a lot to lot basis shall be determined from density tests performed by the Department using pavement samples (cores).

When it is determined that the density for a trench widening lot is below 89.0 percent but not lower than 88.0 percent of maximum density, the Contractor will have the right to remove and replace the lot(s) not meeting the specified density requirements in lieu of accepting reduced payment for the lot(s).

When it is determined that the density for a trench widening lot is above 95.0 percent, the Engineer shall notify the Contractor who will make plant adjustments to resolve the problem.

When it is determined that the density for a trench widening lot is below 88.0 percent, the lot(s), or portions thereof shall be removed and replaced in accordance with Chapter 7 of the latest edition of MDOT's Field Manual for HMA at no additional cost to the State. A corrected lot will be retested for approval. No resampling will be performed when pavement samples are used for determining density.

At any time the daily compaction (the total of the percent compaction for the lots produced in one day divided by the total number of lots for the day) does not meet 89.0 percent compaction or more for two consecutive days, the Contractor shall notify the Engineer of proposed changes to the compactive effort. If the average daily compaction does not meet 89.0 percent compaction or more for a third consecutive day, the Contractor shall stop production until compaction procedures are established to meet the specified density requirement.

Each lot of trench widening work found not to meet the density requirement of 91.0 percent of maximum density may remain in place with a reduction in payment as set out in the following table:

**PAYMENT SCHEDULE FOR COMPACTION
TRENCH WIDENING WORK**

<u>Pay Factor</u>	<u>Lot Density *** % of Maximum Density</u>
1.00	89.0 and above
0.50	88.0 - 88.9

*** Any lot or portion thereof with a density of less than 88.0 percent of maximum density shall be removed and replaced at no additional cost to the State.

The compaction pay factors and mixture quality pay factor, as described in Subsection 907-401.02.6.3, will each apply separately. However, the combined pay factor shall not be less than 0.50 for any mixture allowed to remain in place.

907-401.02.6.5--Blank.

907-401.02.6.6--Blank.

907-401.02.6.7--Surface Correction. Corrective work to sections exceeding short continuous interval thresholds reported by ProVal, as described in Subsection 907-403.03.2.1, shall consist of diamond grinding in accordance with these specifications or methods approved by the Engineer. All surface areas corrected by grinding shall be sealed with a sealant approved by the Engineer.

907-401.02.6.7.1--Diamond Grinding. Grinding of asphalt surfaces shall consist of diamond

grinding the existing asphalt pavement surface to remove surface distortions to achieve the specified surface smoothness requirements.

907-401.02.6.7.2--Equipment. The grinding equipment shall be a power driven, self-propelled machine that is specifically designed to smooth and texture pavement surfaces with diamond blades. The effective wheel base of the machine shall not be less than 12.0 feet. It shall have a set of pivoting tandem bogey wheels at the front of the machine and the rear wheels shall be arranged to travel in the track of the fresh cut pavement. The center of the grinding head shall be no further than 3.0 feet forward from the center of the back wheels.

The equipment shall be of a size that will cut or plane at least two feet (2') wide. It shall also be of a shape and dimension that does not encroach on traffic movement outside of the work area. The equipment shall be capable of grinding the surface without causing spalls at joints, or other locations.

907-401.02.6.7.3--Construction. The construction operation shall be scheduled and proceed in a manner that produces a uniform finish surface. Grinding will be accomplished in a manner to provide positive lateral drainage by maintaining a constant cross-slope between grinding extremities in each lane.

The operation shall result in pavement that conforms to the typical cross-section and the requirements specified in Subsection 907-401.02.6.7.4. It is the intent of this specification that the surface smoothness characteristics be within the limits specified.

The Contractor shall establish positive means for removal of grinding residue. Solid residue shall be removed from pavement surfaces before it is blown by traffic action or wind. Residue shall not be permitted to flow across lanes used by public traffic or into gutters or drainage facilities, but may be allowed to flow into adjacent ditches.

907-401.02.6.7.4--Finished Pavement Surface. The grinding process shall produce a pavement surface that is smooth and uniform in appearance with a longitudinal line type texture. The line type texture shall contain parallel longitudinal corrugations that present a narrow ridge corduroy type appearance. The peaks of the ridges shall not be more than 1/16 inch higher than the bottoms of the grooves.

The finished pavement surface will be measured for riding quality. The grinding shall produce a riding surface which does not exceed either the specified profile index or the specified bump and dip limit.

907-401.02.6.8--Acceptance Procedure for Pavement Smoothness Using Mean Roughness Index (MRI). When compaction is completed, the lift shall have a uniform surface and be in reasonably close conformity with the line, grade and cross section shown on the plans.

The smoothness of the surface lift will be determined by using an Inertial Profiling System (IPS) to measure and record roughness data in each designated location. Roughness data for each longitudinal profile will be reported as a Mean Roughness Index (MRI). MRI is calculated by

averaging the International Roughness Index (IRI) values from the two individual wheelpath profiles. The surface shall be tested and corrected to a smoothness index as described herein with the exception of those locations or specific projects that are excluded from smoothness testing with an IPS.

The smoothness of the surface lift will be determined for traffic lanes, auxiliary lanes, climbing lane and two-way turn lanes. Areas excluded from a smoothness test with the IPS are acceleration and deceleration lanes, tapered sections, transition sections for width, shoulders, crossovers, ramps, side street returns, etc. The roadway pavement on bridge replacement projects having 1,000 feet or less of pavement on each side of the structure will be excluded from a smoothness test. Pavement on horizontal curves having a radius of less than 1,000 feet at the centerline and pavement within the super elevation transition of such curves are excluded from smoothness testing. Smoothness testing shall terminate 264 feet from each transverse joint that separates the pavement from a bridge deck, bridge approach slab or existing pavement not constructed under the contract. This shall apply to any other exceptions including, but not limited to, railroad crossings and manholes. Segments containing a considerable amount of encroachments such as intersections, manholes, curb and gutter sections, etc. may be excluded at the Project Engineer's discretion.

Initial smoothness measurements shall take place no more than 72 hours following placement of surface and must be performed at the posted speed limit or 50 miles per hour (± 5 mile per hour), whichever is lower. This speed requirement will be waived for all lightweight profilers. Measurements will be made in both wheel paths of exterior and interior lanes. The wheel paths shall be designated as being located three feet (3') and nine feet (9') from centerline or longitudinal joint, respectively. Beginning and ending latitude and longitude coordinates shall be required on each smoothness surface test. Testing will also be required on sections that have been surface corrected. No smoothness testing shall be performed when there is moisture of any kind on the pavement surface. Any additional testing shall meet the requirements of Subsection 907-403.03.2.

The surface lift will be accepted on a continuous interval basis for pavement smoothness. Continuous reporting is based upon all MRI values for a specified running interval. These values are averaged and presented at the midpoint of the specified running interval. The last 15 feet of a day's lift may not be obtainable until the lift is continued and for this reason may be included in the subsequent section.

Areas of localized roughness exceeding the continuous 25-foot interval threshold described in Subsection 907-403.03.2.1 shall be corrected regardless of the 528-foot interval MRI value of the section. Surface correction by grinding shall be performed in accordance with Subsection 907-401.02.6.7. The Contractor shall also make other necessary surface corrections to ensure that the final mean roughness index of the section meets the requirements of Subsection 907-403.03.2.

Continuous sections exceeding the accepted long interval MRI value shall be corrected as specified in Subsection 403.03.4. All such corrections shall be performed at no additional costs to the State. Scheduling and traffic control will be the responsibility of the Contractor with

approval of the Engineer. All tests and corrections shall be in accordance with AASHTO R 54-10, Accepting Pavement Ride Quality When Measured Using Inertial Profiling Systems.

907-401.02.6.9--High Speed Inertial Profiling System.

907-401.02.6.9.1--General. The IPS, furnished and operated by the Contractor under the supervision of the Engineer or the Engineer's representative, shall be a dual laser high speed or lightweight vehicle meeting the requirements of AASHTO M 328-10, Standard Specification for Inertial Profiler.

907-401.02.6.9.2--Mechanical Requirements. The IPS should function independent of vehicle suspension and speed with an operational range of 15-70 mph (for high speed profilers only) and must collect data at a sample interval of no more than three inches (3"). All IPSs, operators, and combinations thereof shall be verified in accordance with AASHTO R 56-10, Standard Practice for Certification of Inertial Profiler Systems and AASHTO R 57-10, Operating Inertial Profiler Systems.

907-401.02.6.9.3--Computer Requirements. The computer measurement program must be menu driven, Windows compatible, and able to produce unfiltered profiler runs in any one of the following file formats: University of Michigan's Transportation Research Institute's (UMTRI) Engineering Research Division (*.erd) file, ProVAL's Pavement Profile (*.ppf) file, or Ames Engineering's (*.adf) file format. The computer shall have the ability to display and print data on site for verification and shall have the ability to save and transfer data via Universal Serial Bus (USB) flash drive, which shall be provided by the Contractor.

All profiler runs must be named in the following format for acceptance by the Project Engineer:

- County_Route_Direction_Lane_BeginStation_EndStation

In addition to manufacturers software; the latest version of FHWA's ProVAL software shall be installed on the IPS computer. ProVAL software is available for free download at <http://www.roadprofile.com>.

907-401.02.7--Nuclear Gauges.

907-401.02.7.1--Nuclear Moisture-Density Gauge. The nuclear gauge unit used to monitor density shall contain a full data processor which holds all calibration constants necessary to compute and directly display wet density, moisture, and dry density in pounds per cubic foot. The data processor shall compute and display the percent moisture and percent density based on dry weight.

907-401.02.7.2--Nuclear Asphalt Content Gauge. The Contractor shall furnish and calibrate, unless designated otherwise in the contract, a Troxler Nuclear Asphalt Content Gauge Model 3241 or updated model, or a Campbell Nuclear Asphalt Content Gauge Model AC-2 or an approved equal.

907-401.03--Construction Requirements. Mississippi DOT has adopted the "Hot-Mix Asphalt

Paving Handbook” as the guideline for acceptable asphalt construction practices.

907-401.03.1--Specific Requirements.

907-401.03.1.1--Weather Limitations - General. The mixture shall not be placed when weather conditions prevent the proper handling and finishing or the surface on which it is to be placed is wet or frozen.

When paving operations are discontinued because of rain, the mixture in transit shall be protected until the rain ceases. The surface on which the mixture is to be placed shall be swept to remove as much moisture as possible and the mixture may then be placed subject to removal and replacement at no additional cost to the State if contract requirements are not met.

907-401.03.1.1.1--Weather Limitations For HMA. At the time of placement, the air and pavement surface temperature limitations shall be equal to or exceed that specified in the following table.

TEMPERATURE LIMITATIONS

Compacted Thickness	Temperature
Less than 1½ inches	55°F
1½ inches to 2 inches	50°F
2¼ inches to 3 inches	45°F
Greater than 3 inches	40°F

907-401.03.1.1.2--Weather Limitations For WMA. The air and pavement temperature at the time of placement shall equal or exceed 40°F, regardless of compacted lift thickness.

907-401.03.1.2--Tack Coat. Tack coat shall be applied to previously placed asphalt and between lifts, unless otherwise directed by the Engineer. Tack coat shall be applied with a distributor spray bar. A hand wand will only be allowed for applying tack coat on ramp pads, irregular shoulder areas, median crossovers, turnouts, or other irregular areas. Bituminous materials and application rates for tack coat shall be as specified in Table 410-A on page 293. Construction requirements shall be in accordance with Subsection 407.03 of the Standard Specifications.

907-401.03.1.3--Blank.

907-401.03.1.4--Density. The lot density for all dense graded pavement lifts, except as provided below for preleveling, wedging [less than fifty percent (50%) of width greater than minimum lift thickness], ramp pads, irregular shoulder areas, median crossovers, turnouts, or other areas where the established rolling pattern cannot be performed, shall not be less than the specified percent (92.0% or 93.0%) of the maximum density based on AASHTO Designation: T 209 for the day’s production. For all leveling lifts, when full lane width and with a thickness as specified in the table in Subsection 907-401.02.4, the required lot density shall be 92.0 percent of maximum

density. If a job-mix formula adjustment is made during the day which affects the maximum specific gravity, calculate a new average maximum density for the lot(s) placed after the change.

Pavement core samples obtained for determining density which has a thickness less than two times the maximum size aggregate permitted by the job-mix formula will not be used as a representative sample.

Preleveling, wedging (less than fifty percent of width greater than minimum lift thickness), ramp pads, irregular shoulder areas, median crossovers, turnouts, and other areas where an established rolling pattern cannot be obtained shall be compacted to refusal densification.

907-401.03.2--Bituminous Mixing Plants.

907-401.03.2.1--Plant Requirements.

907-401.03.2.1.1--Cold Aggregate Storage. The cold storage for hydrated lime shall be a separate bulk storage bin with a vane feeder or other approved feeder system which can readily be calibrated. The system shall provide a means for easy sampling of the hydrated lime additive and verifying the quantity of lime dispensed. The feeder system shall require a totalizer.

The hydrated lime additive equipment shall be interlocked and synchronized with the cold feed controls to operate concurrently with the cold feed operation which will automatically adjust the hydrated lime feed to variations in the cold aggregate feed. A positive signal system shall be installed which will automatically shut the plant down when malfunctions cause an improper supply of hydrated lime or water.

The plant shall not operate unless the entire hydrated lime system is functioning properly.

907-401.03.2.1.2--Cold Aggregate Feed. The hydrated lime shall be dispensed dry or as a slurry directly onto the composite aggregate between the cold feed and the dryer. The slurry shall consist of 1 part hydrated lime to 3 parts water.

When hydrated lime is introduced dry, a spray bar or other approved system capable of spraying all aggregate with water shall be installed in order to maintain all aggregate at the moisture condition set out in Subsection 907-401.02.3.1 prior to addition of the hydrated lime. An alternate system for spraying the coarse aggregate stockpiles may be allowed when approved by the Engineer. The approved equipment and methods shall consistently maintain the aggregate in a uniform, surface wet condition. The moisture content of the aggregate-hydrated lime mixture, following spraying and mixing, shall be introduced into the automatic moisture controls of the plant.

The aggregate-hydrated lime mixture shall be uniformly blended by some mechanical means such as a motorized "on the belt" mixer or pug mill located between the cold feed and the dryer. Other mixing devices may be used subject to approval by the Engineer.

A maximum of forty five (45) percent of the total aggregate blend may be fed through any single

cold feed bin. If the JMF calls for more than forty five (45) percent of a specific aggregate, that aggregate must be fed through two (2) or more separate cold feed bins.

907-401.03.2.1.3--Dryer. The efficiency of drying aggregates shall be such that the moisture content of the top asphalt mixture shall not exceed 0.50 percent by weight of the total mixture, and the moisture content of all the underlying mixtures shall not exceed 0.75 percent by weight of the total mixture being produced.

907-401.03.2.1.4--Blank.

907-401.03.2.1.5--Control of Bituminous Material and Antistripping Agent. Specified bituminous materials from different manufacturers or from different refineries of a single manufacturer shall not be mixed in the plant's asphalt cement supply system storage tank and used in the work without prior written approval of the Engineer. Approval is contingent upon the Engineer's receipt of three copies of the manufacturer's certified test report(s) from the Contractor showing that the bituminous material blend conforms to the specifications.

A satisfactory method of weighing or metering shall be provided to ensure the specified quantity of bituminous material. Provisions shall be provided for checking the quantity or rate of flow. Weighing or metering devices shall be accurate within plus or minus one-half percent.

The antistripping agent shall be injected into the bituminous material immediately prior to the mixing operation with an approved in-line injector system capable of being calibrated so as to ensure the prescribed dosage.

An in-line spigot for sampling of asphalt shall be located between the asphalt storage tank and the antistripping agent in-line injector.

907-401.03.2.1.6--Thermometric Equipment. An armored thermometer of adequate range and calibrated in 5°F increments shall be fixed at a suitable location in the bituminous line near the charging valve of the mixer unit.

The plant shall be equipped with an approved dial-scale, mercury-actuated thermometer, pyrometer or other approved thermometric instrument placed at the discharge chute of the dryer to measure the temperature of the material.

When the temperature control is unsatisfactory, the Engineer may require an approved temperature-recording apparatus for better regulation of the temperature.

907-401.03.2.1.7--Screens. A scalping screen shall be used.

907-401.03.2.1.8--Dust Collector. The plant shall be equipped with a dust collector constructed to waste or return collected material. When collected material is returned, it shall be returned through a controlling device which will provide a uniform flow of material into the aggregate mixture.

907-401.03.2.1.9--Safety Requirements. A platform or other suitable device shall be provided so the Engineer will have access to the truck bodies for sampling and mixture temperature data.

907-401.03.2.1.10--Blank.

907-401.03.2.1.11--Truck Scales. The specifications, tolerances and regulations for commercial weighing and measuring devices as recommended by the National Bureau of Standards [National Institute of Standards and Technology (NIST) Handbook 44] shall govern truck scales used in the State of Mississippi, except weighing devices with a capacity of ten thousand (10,000) pounds or more used to weigh road construction materials (i.e. sand, gravel, asphalt, fill dirt, topsoil and concrete) shall have a tolerance of one-half of one percent (1/2 of 1%) in lieu of the requirements of Handbook 44 and shall be regulated by the Mississippi Department of Transportation.

Scales shall be checked and certified by a scale company certified in heavy truck weights by the Mississippi Department of Agriculture and Commerce. In the case of scales used for measurement of materials on Department of Transportation projects, certification shall be performed in the presence of an authorized representative of the Department or a copy of the certification may be furnished for scales that have been checked and certified within the last six months for use on other Department of Transportation projects and are still in the position where previously tested. Scales that have not been checked and certified under NIST Handbook 44 guidelines, except for the herein modified tolerances allowed, shall be so checked and certified prior to use for measurement of materials on Department of Transportation projects. Tests shall be continued on six month intervals with the test conducted in the presence of an authorized representative of the Department.

Truck scales shall be accurate to one-half of one percent of the applied load, shall be sensitive to 20 pounds, and shall have a graduation of not more than 20 pounds.

The Contractor may use an electronic weighing system approved by the Engineer in lieu of truck scales. The system shall be equipped with an automatic print out system which will print a ticket for each load with the following information:

MDOT, Contractor's name, project number, county, ticket number, load number, pay item number, item description of the material delivered, date, time of day, haul vehicle number, gross weight, tare weight, net weight and total daily net weight.

When approved by the Engineer and materials are measured directly from a storage bin equipped with load cells, exceptions may be made to the gross and tare weight requirements.

The ticket shall also have a place for recording the temperature of asphalt mixtures, if applicable, and the signatures of MDOT's plant and roadway inspectors. The load numbers for each project shall begin with load number one (1) for the first load of the day and shall be numbered consecutively without a break until the last load of the day. The Contractor shall provide MDOT with an original and one copy of each ticket. When the ticket information provided by the Contractor proves to be unsatisfactory, MDOT will use imprinter(s) and imprinter tickets to

record load information. All recorded weights shall be in pounds and shall be accurate to within one-half of one percent of the true weight, and the system shall be sensitive to 20 pounds. The Engineer will require random loads to be checked on certified platform scales at no cost to the Department.

When an electronic weighing system utilizes the plant scales of a batch plant, the system may be used only in conjunction with a fully automatic batching and control system.

907-401.03.2.2--Additional Requirements for Batching Plants.

907-401.03.2.2.1--Plant Scales. The plant batch scale weight shall not exceed the platform scale weight by more than one percent (1.0%).

907-401.03.2.3--Additional Requirements for Drum Mixing Plants.

907-401.03.2.3.1--Plant Controls. The plant shall be operated with all the automatic controls as designed and provided by the plant manufacturer. If the automatic controls malfunction, brief periods of manual operations to complete the day's work or to protect the work already placed may be conducted with the approval of the Engineer. During manual operation, the Contractor must continue to produce a uniform mixture meeting all contract requirements.

907-401.03.2.3.2--Aggregate Handling and Proportioning. A screening unit shall be placed between the bins and the mixer to remove oversized aggregate, roots, clayballs, etc.

907-401.03.2.4--Surge or Storage Bins. Surge and/or storage systems may be used at the option of the Contractor provided each system is approved by the Department prior to use. Surge bins shall be emptied at the end of each day's operation. Storage silos may be used to store mixtures as follows:

- 19-mm & 25-mm mixtures 24 hours
- 9.5-mm & 12.5-mm mixtures 36 hours

The storage silos must be well sealed, completely heated and very well insulated. The mixture when removed from the storage silo shall be tested to ensure that it meets all the same specifications and requirements as the mixture delivered directly to the paving site. See Subsection 907-401.02.5.3, subparagraph (i) for sampling and testing requirements.

907-401.03.3--Hauling Equipment. The inside surfaces of each vehicle bed shall be coated with a light application of water and thin oil, soap solution, lime water solution or other approved material to prevent the mixture from sticking. Diesel fuel or gasoline shall not be used to lubricate vehicle beds. Truck beds shall be raised to drain excessive lubricants before placing mixture in the bed. An excess of lubricant will not be permitted.

907-401.03.4--Bituminous Pavers. The screed or strikeoff assembly shall be capable of vibrating and heating the full width of the mixture being placed and shall lay the lift with an automatic control device to the specified slope and grade without tearing, pulling or gouging the

mixture surface.

907-401.03.5--Rollers. All rollers shall be self-propelled units capable of maintaining a smooth and uniform forward and reverse speed as required for proper compaction. They shall be equipped with adjustable scrapers, water tanks, mats and a device for wetting the wheels or tires to prevent the mixture from sticking. Adhesion of the mixture to the rollers will not be permitted. The use of diesel fuel or gasoline for cleaning roller wheels or tires or to aid in preventing the mixture from sticking to the wheels or tires is prohibited.

All rollers shall be in good mechanical condition, free from leaking fuels and lubricants, loose link motion, faulty steering mechanism, worn king bolts and bearings. They shall be operational at slow speeds to avoid displacement of the mixture and capable of reversing direction smoothly and without backlash.

907-401.03.6--Preparation of Grade. The foundation upon which asphalt pavement is to be placed shall be prepared in accordance with the applicable Section of the Standard Specification.

Unless otherwise directed, tack coat shall be applied to the underlying surface on which the mixture is to be placed. Emulsions, if used, must be allowed to "break" prior to placement of the bituminous mixture.

Bituminous mixture shall not be placed against the edge of pavements, curbs, gutters, manholes and other structures until sprayed with a thin uniform tack coating. The tack coat shall be protected until the mixture has been placed.

Existing asphalt pavements that require preliminary leveling or patching in advance of placing the bituminous mixture shall be sprayed with a tack coat material and then brought as nearly as practicable to uniform grade and cross section. The material shall be placed by hand or machine in one or more compacted layers approximately two (2) inches or less in compacted thickness.

907-401.03.7--Blank.

907-401.03.8--Preparation of Mixture.

907-401.03.8.1--Preparation of Mixture For HMA. The temperature of the mixture, when discharged from the mixer, shall not exceed 340°F.

907-401.03.8.2--Preparation of Mixture For WMA. Warm mix asphalt is defined as a plant produced asphalt mixture that can be produced and constructed at lower temperatures than typical hot mix asphalt. Typical temperature ranges of non-polymer modified, WMA produced by foaming the asphalt binder at the plant are typically 270°F to 295°F at the point of discharge of the plant. Typical temperature ranges of polymer modified, WMA produced by foaming the asphalt binder at the plant are typically 280°F to 305°F at the point of discharge of the plant. WMA produced by addition of a terminal blended additive may allow the producer to reduce the temperatures below 270°F as long as all mixture quality and field density requirements are met. Production temperatures at the plant may need to be increased or decreased due to factors such as

material characteristics, environmental conditions, and haul time to achieve mixture temperatures at the time of compaction in which uniform mat density can be achieved.

907-401.03.9--Material Transfer Equipment. Excluding the areas mentioned below, the material transferred from the hauling unit when placing the top lift, or the top two (2) lifts of a multi-lift asphalt pavement with density requirements, shall be remixed prior to being placed in the paver hopper or insert by using an approved Materials Transfer Device. Information on approved devices can be obtained from the State Construction Engineer. Areas excluded from this requirement include: leveling courses, temporary work of short duration, detours, bridge replacement projects having less than 1,000 feet of pavement on each side of the structure, acceleration and deceleration lanes less than 1,000 feet in length, tapered sections, transition sections for width, shoulders less than 10 feet in width, crossovers, ramps, side street returns and other areas designated by the Engineer.

907-401.03.10--Spreading and Finishing. Grade control for asphalt pavements shall be established by stringline at least 500 feet ahead of spreading, unless placement is adjacent to curb and gutter, concrete pavement, or other allowed grade control.

The mixture shall be spread to the depth and width that will provide the specified compacted thickness, line, grade and cross section. Placing of the mixture shall be as continuous as possible. On areas where mechanical spreading and finishing is impracticable, the mixture may be spread, raked and luted by hand tools.

Immediately after screeding and prior to compaction, the surface shall be checked by the Contractor and irregularities adjusted. When the edge is feathered as in a wedge lift, it may be sealed by rolling. Irregularities in alignment and grade along the edges shall be corrected before the edges are rolled.

Hauling, spreading and finishing equipment shall be furnished that is capable of and operated in such a manner that the rolling operation will satisfactorily correct any surface blemishes.

The longitudinal joint in the subsequent lift shall offset that in the underlying lift by approximately six (6) inches. However, the joint in the top lift shall be at the centerline or lane line.

907-401.03.11--Compaction. After the mixture has been spread and surface irregularities corrected, it shall be thoroughly and uniformly compacted to the required line, grade, cross section and density.

907-401.03.12--Joints. Joints between previously placed pavement and pavement being placed shall be so formed as to insure thorough and continuous bond.

Transverse construction joints shall be formed by cutting the previously placed mixture to expose the full depth of the lift.

The contact surface of transverse joints and longitudinal joints, except hot joints, shall be sprayed

with a thin uniform tack coating before additional mixture is placed against the previously placed material.

Longitudinal joints shall be formed by overlapping the screed on the previously placed material for a width of at least one (1) inch and depositing the quantity of mixture to form a smooth, tight joint.

Joint Sealant. When a pay item for 907-403-S, Joint Sealant, is included in the contract, the contact surface of transverse joints and longitudinal joints in the surface lift, except hot joints, shall be sealed by spraying a thin, uniform coat of Pavon™, Crafcot™ Pavement Joint Adhesive No. 34524, Dura-Fill Cold Joint Adhesive, or approved equal, prior to placement of additional asphalt against the previously placed material. Manufacturer's recommendations shall be followed if the material needs to be re-heated, and when placing the thin, uniform coat.

Prior to application of the sealant, the face of the joint shall be thoroughly dry and free from dust or any other material that would prevent proper sealing. All joints shall be swept or blown free of loose material, dirt, vegetation, and other debris by means of compressed air or a power sweeper.

Truck and vehicle traffic shall not drive across a sealed joint until it has dried sufficient to prevent damage from tracking.

The Contractor shall furnish the Engineer three copies of the manufacturer's certification stating that the material used meets the requirement of the specifications.

907-401.03.13--Pavement Samples. The Contractor shall cut samples from each lift of asphalt at the time and locations designated by the Engineer. The samples shall be taken for the full depth of each lift and shall be of a size approved by the Engineer but not to exceed 120 square inches. Tools used for cutting or coring of samples shall be of the revolving blade type such as saw or core drill. Cores shall be taken using a 4.0 to 6.0-inch inside diameter coring bit. The sample hole shall be filled, compacted and finished by the Contractor to conform with the surrounding area. No additional compensation will be allowed for furnishing samples and repairing the areas with new pavement.

907-401.03.14--Shoulder Wedge. The Contractor shall attach a device to the screed of the paver that confines the material at the end gate and extrudes the asphalt material in such a way that results in a compacted wedge shape pavement edge of approximately 30 degrees, but not steeper than 35 degrees. The device shall maintain contact between itself and the road shoulder surface and allow for automatic transition to cross roads, driveways, and obstructions. The device shall be used to constrain the asphalt head reducing the area by 10% to 15% increasing the density of the extruded profile. Conventional single plate strike off shall not be used.

The device shall be TransTech Shoulder Wedge Maker, the Advant-Edge, or a similar approved equal device that produces the same wedge consolidation results. Contact information for these wedge shape compaction devices is the following.

1. TransTech Systems, Inc.
1594 State Street
Schenectady, NY 12304
800-724-6306
www.transtechsys.com

2. Advant-Edge Paving Equipment, LLC
P.O. Box 9163
Niskayuna, NY 12309-0163
518-280-6090
Contact; Gary D. Antonelli
Cell: 518-368-5699
email: garya@nycap.rr.com
Website: www.advantedgepaving.com

Before using a similar device, the Contractor shall provide proof that the device has been used on previous projects with acceptable results, or construct a test section prior to the beginning of work and demonstrate wedge compaction to the satisfaction of the Engineer. Short sections of handwork will be allowed when necessary for transitions and turnouts, or otherwise authorized by the Engineer.

MISSISSIPPI DEPARTMENT OF TRANSPORTATION

SPECIAL PROVISION NO. 907-403-14

CODE: (SP)

DATE: 12/02/2014

SUBJECT: Asphalt Pavements

Section 403, Asphalt Pavements, of the 2004 Edition of the Mississippi Standard Specifications for Road and Bridge Construction is deleted and replaced as follows.

SECTION 907-403 - ASPHALT PAVEMENTS

907-403.01--Description. This work consists of constructing one or more lifts of asphalt pavement meeting the requirements of Section 907-401 on a prepared surface in accordance with the requirements of this section and in reasonably close conformity with the lines, grades, thicknesses, and typical cross sections shown on the plans or established by the Engineer. This work shall also include applicable in-grade preparation of the underlying course in accordance with Section 321.

The Contractor must select one of the asphalt mixture processes (HMA or WMA) to be used on this project.

907-403.02--Material Requirements. Materials and their use shall conform to the applicable requirements of Subsection 907-401.02.

907-403.03--Construction Requirements.

907-403.03.1--General. Construction requirements shall be as specified in Subsection 907-401.03, except as otherwise indicated in this section or applicable special provisions.

907-403.03.2--Smoothness Tolerances. Except as noted herein, the finished smoothness of each lift shall conform to the designated grade and cross section within the following tolerances from grade stakes or other grade reference points set at 25-foot intervals:

	Lower* & Leveling Lifts	Lower* Intermediate Lift	Top Intermediate Lift	Surface Lift
Maximum deviation from grade and cross section at any point	1/2"	3/8"	1/4"	1/4"
Maximum deviation from A 10 foot straight edge.....	3/8"	1/4"	1/8"	1/8"

Note: Where more than four (4) lifts of asphalt are required, all lifts, excluding the top three (3) lifts, shall meet the requirements of the lower lift.

- * When tested longitudinally from a stringline located equidistant above points 50 feet apart, the distance from the stringline to the surface at any two points located 12½ feet apart shall not vary one from the other more than the maximum deviation allowed above from a 10-foot straight edge.

Grade stakes or other grade reference points set at 25-foot intervals and maximum deviation from grade and cross section will not be required provided an approved profile averaging device is furnished and properly used for the four conditions set forth herein; however, all other surface requirements are applicable.

- (a) Overlays with one overall lift.
- (b) Overlays with two or more overall lifts -- for each lift above the first overall lift provided each underlying overall lift is within the allowable tolerances.
- (c) Surface lift of new construction provided the underlying lift is within the allowable tolerances.
- (d) Full-depth asphalt construction for lifts above the lower lift provided the lower lift is within the specified tolerances for the lower intermediate lift.

In the placement of full depth asphalt pavement, where the chemically treated base is constructed, graded and/or trimmed, full lane width, to a surface tolerance of $\pm 3/8$ inches from design grade, stringline grade controls may be eliminated for the placement of the asphalt drainage course and all asphalt lifts. In addition, where the base course is crushed stone or crushed concrete and is constructed to a surface tolerance of $\pm 3/8$ inches from design grade using a stringline controlled spreader, stringline grade controls may be eliminated for the placement of the asphalt drainage course and all asphalt lifts.

All other tolerances as specified in Section 321 are applicable, except for bases, when tested longitudinally, the maximum deviation when measured at the 12½-foot midpoint shall be $\pm 3/8$ inches.

Acceptance and payment of asphalt will be determined on a lot to lot basis by cores taken from the completed pavement as outlined in Subsection 907-403.03.3.

Approved contacting type profile averaging devices are those devices capable of working in conjunction with a taut string or wire set to grade, or ski-type device with extreme contact points with the surface at least 30 feet apart. Approved non-contacting type profile averaging devices are laser type ski devices with at least four referencing mobile stations at a minimum length of 24 feet, or an approved equal.

When approved by the Engineer, a short ski or shoe may be substituted for a long ski on the

second paving operation working in tandem.

During the finishing and compacting of pavement lifts, it shall be the responsibility of the Contractor to check the surface and joints for progress toward conformance to surface requirements set forth herein. Variations from surface requirements exceeding the allowable tolerances shall be corrected at the Contractor's expense.

When a portland cement concrete pavement is to be placed on an asphalt lift, the finished top of the asphalt lift shall meet the requirements of Sections 321 and 501.

Sections(s) or portions thereof representing areas excluded from a smoothness test with the High Speed Inertial Profiling System (IPS) shall also be excluded from consideration for a contract price adjustment for rideability.

Any contract price adjustment for rideability will be applied on a continuous basis to the pay tonnage, determined in accordance with Subsections 907-401.02.6.8 and 907-403.04, for the section(s) or portions thereof for which an adjustment is warranted.

Contract price adjustments for rideability shall only be applicable to the surface lift and furthermore to only the long continuous section(s) or portions of the long continuous section(s) of the surface lift that require smoothness be determined by using a profiling device.

907-403.03.2.1--Smoothness Tolerances for Mean Roughness Index (MRI). Smoothness tolerances shall be applied to asphalt pavements based on the following pavement categories.

Category A applies to the following pavement constructions:

- New construction
- Construction with three (3) or more lifts
- Mill and two (2) or more lifts

Category B applies to the following pavement constructions:

- Mill and one (1) lift
- Two (2) lift overlays without milling

Category C applies to the following pavement constructions:

- Single lift overlay without milling
- All 57,650-pound routes regardless of the pavement construction

Additional projects may qualify for Category C construction at the department's discretion. Spot Leveling does not count as a lift. Full width / continuous leveling courses that have a minimum thickness of ¾" across the entire lane width will be considered a lift.

Category A projects shall have a long continuous interval (528-foot) surface MRI of not more than 60 inches per mile.

Category B projects shall have a long continuous interval (528-foot) surface MRI of not more than 70 inches per mile.

Category C projects shall have the existing surface profiled at no additional cost to the State. These projects shall be measured by a long fixed interval (528-foot) surface MRI and meet the higher value of the following requirements:

- A 50% improvement in MRI from the existing surface
- OR
- 80 inches per mile

In the case that 50% of the existing surface MRI is greater than 80 inches per mile, the short continuous threshold shall be increased from 160 inches per mile by the difference between 50% of the existing surface MRI and 80 inches per mile.

For all projects, areas of the surface lift with localized roughness greater than 160 inches per mile as determined by the continuous short interval (25') report will be identified for correction by the Project Engineer.

When a project has multiple lifts, the lift underlying the surface lift shall have a MRI of no more than 10 inches/mile more than the surface lift threshold for both long and short continuous intervals. Category B projects containing multiple lifts must meet the Category C percent improvement requirement for the underlying lift. Corrective action must be taken on those segments that do not meet this requirement. No unit price adjustment will be applied on any underlying lift.

For Category A and B projects, a unit price increase will be added when the MRI for the final surface lift, prior to any required localized roughness (short interval) corrective action, is less than or equal to fifty inches per mile (50.0 inches / mile) on the long interval report. These Projects will be considered for incentive pay based on the following guidelines for the long interval surface lift MRI.

Mean Roughness Index inches / mile	Contract Price Adjustment Percent of Asphalt Unit Bid Price
Less than 35.0	108
35.1 to 40.0	106
40.1 to 45.0	104
45.1 to 50.0	102
50.1 to Required Surface MRI	100

In addition to the above pay incentive factors, a project may be subject to a disincentive when the Long Continuous Interval MRI for the surface exceeds the allowable tolerance.

Mean Roughness Index (inches / mile)	Contract Price Adjustment Percent of Asphalt Unit Bid Price
Above 20.0 Over	REMOVE AND REPLACE
15.1 to 20.0 Over	80
10.1 to 15.0 Over	85
5.1 to 10.0 Over	90
0.1 to 5.0 Over	95
Required Surface MRI	100

For Category C projects, segments may be subject to a disincentive when the Fixed Interval MRI for the surface does not meet the minimum requirements.

Percent Improvement MRI (inches/mile)	Contract Price Adjustment Percent of Asphalt Unit Bid Price
Below 30 Percent	REMOVE AND REPLACE
30.1 to 35.0 Percent	80
35.1 to 40.0 Percent	85
40.1 to 45.0 Percent	90
45.1 to 50.0 Percent	95
Above 50%	100

Segment(s) or portions thereof representing areas excluded from a smoothness test shall also be excluded from consideration for a contract price adjustment for rideability. Where a segment less than 528 feet occurs at the end of a section, it will be combined with the preceding 528-foot segment for calculation of MRI. Corrective action must be taken on those sections that exceed the 'Remove and Replace' threshold as directed by the Project Engineer. The minimum remove and replace length will be 528 feet (0.1 mile). Additional smoothness testing shall be required on sections following replacement and will be required to meet *at least* the maximum surface MRI short of 'Remove and Replace' tolerance.

The above pay factors will be applied in conjunction with the Long Continuous Histogram Chart from ProVAL's Smoothness Assurance Module. The price adjustments for rideability will be tabulated in MDOT's Pay Incentive spreadsheet on the basis of a theoretical tonnage of 110 lbs/yd² * inch thickness (pounds per square yard * inch thickness) determined in accordance with Subsections 907-401.02.6.5 and 907-403.04, for the segment(s) or portions thereof for which an adjustment is warranted.

907-403.03.3--Thickness Requirements. Asphalt overlay lifts shall be constructed as nearly in accordance with the thickness shown on the plans as the underlying pavement and foundation will permit. Periodic and cumulative yield tests will be made to determine practicable conformity to the thickness of each lift. The Engineer may order modifications in placement thicknesses to prevent unwarranted variations in plan quantities.

When the paver is operating off an established grade line, no thickness determination will be

required for the various lifts of pavement. It is understood that the tolerances from design grade will control the thickness requirements.

When grade stakes are eliminated by Notice to Bidders or as outlined in Subsection 907-403.03.2(d) and where resulting in the placement of two (2) or more lifts, acceptance and payment will be determined on a lot to lot basis by cores taken from the completed pavement. Lots will be coincidental with acceptance lots for the surface lift as provided in Subsection 907-401.02.6.4, except that only lots resulting from the placement of mainline surface lift will be used for thickness assessment. One core will be obtained at random from each lot. Irregular areas will not be cored.

When the average thickness of all the cores from the lots representing a day's production, excluding any discarded by the Engineer for justifiable reason, is within three-eighths of an inch (3/8") of the total pavement thickness shown on the plans, excluding lift(s) placed using an established grade line, corrective action will not be required and a price adjustment will not be made for non-conformity to specified thickness.

When the average thickness of all the cores from the lots representing a day's production is deficient in thickness by more than three eighths of an inch (3/8") of the total pavement thickness shown on the plans, excluding lift(s) placed using an established grade line, the deficiency shall be corrected by overlaying the entire length of the day's production. The thickness of the overlay shall be equal to the thickness deficiency but no less than the minimum single lift laying thickness for the specified mixture.

When the thickness of all the cores from the lots representing a day's production is more than three eighths of an inch (3/8") thicker than the total thickness shown on the plans, excluding lift(s) placed using an established grade line, a price adjustment will be made in accordance with Subsection 907-403.05.1.

The cores shall be cut and removed by the Contractor in the presence of the Engineer's representative and turned over to the Engineer's representative for further handling. The Contractor shall fill each core hole with surface lift mixture and compact to the satisfaction of the Engineer within 24 hours after coring.

907-403.03.4--Lift Corrections. Pavement exceeding the allowable surface tolerances shall be corrected at the Contractor's expense by the following methods:

Lower, Leveling and Lower Intermediate Lifts:

- (a) Removal or addition of mixture by skin patching, feather edging, wedge lift construction or full depth patching where appropriate and can be completed in a satisfactory manner.
- (b) Superimposing an additional layer which shall be an approved grade raise for the full roadway width and length of the area to be corrected.

Top Intermediate Lift:

- (a) Removal and the addition of sufficient mixture to provide the specified thickness. Corrections by this method shall be square or rectangular in shape and shall completely cover the area to be corrected.
- (b) Superimposing an additional layer of minimum lift thickness for mixture being used which shall be an approved grade raise for full roadway width of the area to be corrected. Transverse joints shall be perpendicular to the centerline of the pavement.

Surface Lift:

- (a) Removal and the addition of sufficient mixture to provide new material of at least minimum single lift laying thickness for full lane width of the area to be corrected. Transverse joints shall be perpendicular to the centerline of the lane.
- (b) Superimposing an additional layer (minimum lift thickness for mixture being used) which shall be an approved grade raise for full roadway width of the area to be corrected. Transverse joints shall be perpendicular to the centerline of the pavement.

All mixtures used in the correction of unacceptable pavement shall be approved by the Engineer prior to use.

907-403.03.5--Overlays or Widening and Overlays. In addition to the requirements of Subsections 907-403.03.1 through 907-403.03.4, the following requirements will be applicable when an existing pavement is to be overlaid or widened and overlaid.

907-403.03.5.1--Blank.

907-403.03.5.2--Sequence of Operations. In order to expedite the safe movement of traffic and to protect each phase of the work as it is performed, a firm sequence of operations is essential. Unless otherwise provided in the traffic control plan and/or the contract, the following appropriate items of work shall be begun and continually prosecuted in the order listed:

- (a) In sections designated by the Engineer, trim the shoulders along the pavement edges to provide drainage from the pavement.
- (b) Perform pre-rolling to locate areas of pavement with excessive movement per Section 511.
- (c) Perform selective undercutting and patching as directed per Subsection 907-403.03.5.4.
- (d) Perform pressure grouting as specified in Section 512.
- (e) Clean and seal joints per Section 413.
- (f) Complete preparation on one side of roadway to be widened and place widening

materials.

- (g) Reconstruct shoulders to elevation necessary to assure traffic safety.
- (h) Open the widened section to traffic.
- (i) Complete above work for other side of roadway.
- (j) Perform preliminary leveling as directed.
- (k) Apply interlayer as specified.
- (l) Place the first overall leveling lift.
- (m) After the first overall leveling lift, reconstruct shoulders as necessary to eliminate vertical differentials which may be hazardous to traffic.
- (n) Place first intermediate lift.
- (o) Construct shoulders to the contiguous elevation of the first intermediate lift.
- (p) Place remaining intermediate lift, if required.
- (q) Place surface lift.
- (r) Complete construction of shoulders.
- (s) Apply permanent traffic marking.
- (t) Final cleanup.

The above operations shall be performed in such a manner that traffic will be maintained on a paved surface at all times. Two-lane, two-way highways should not be restricted to a single lane in excess of a 3,000-foot section.

907-403.03.5.3--Widening of Pavement. The foundation for widening shall be formed by trenching or excavating to the required depth and constructing a smooth, firm and compacted foundation. It shall have sufficient density and stability to withstand the placement and compaction of subsequent lifts. Soft, yielding and other unsuitable material which the Engineer determines will not compact readily shall be removed and backfilled with granular material or asphalt as directed.

Except as provided herein, excavation for widening, undercutting or other required excavation shall be spread along the edge of the shoulders, foreslopes or other adjacent areas as directed and will be an absorbed item. When the quantity is in excess of what may be used satisfactorily on adjacent areas, the Engineer may direct that the material be loaded, hauled and spread uniformly

on other designated areas. In this case, compensation for handling surplus material will be in accordance with the appropriate pay items as provided in the contract or as extra work.

If the plans require widening of the shoulders or embankment with Contractor furnished material, all suitable material obtained from widening excavation may be used and will be measured and paid for as Contractor furnished materials. No measurement for payment of haul will be made.

Removal and disposal of old stakes, forms and other debris encountered in excavating shall be in accordance with Section 201 and shall be considered as incidental to and included in the unit prices bid for other items. No separate measurement will be made therefor. Pavement edges and surfaces shall be cleaned prior to final shaping and compaction of adjacent trenching or undercut areas.

Granular material for widening shall be placed on a previously prepared, smooth, firm and unyielding foundation in accordance with the typical section. Density of the granular material shall be as specified.

Asphalt for widening, including trench widening, shall meet the applicable requirements of Section 907-401, Section 907-403, and shall be placed in one or more layers as shown on the plans or directed. The surface of the mixture shall be finished as a continuation of the adjacent pavement slope.

Trench rollers or other compaction equipment shall be used to compact the foundation, granular material and bituminous mixtures for widening when standard width rolling equipment cannot be used.

907-403.03.5.4--Patching. Existing pavement which has failed or unsatisfactorily stabilized shall be removed as directed. Removal of pavement will be measured and paid for under the appropriate pay items as provided in the contract.

Backfill shall consist of asphalt or a combination of compacted layers of aggregate material and asphalt. Unless otherwise specified, the Engineer will make this determination based on depth and field conditions.

Asphalt used for backfilling will be measured and paid for at the contract unit price for the mixture designated on the plans as the lowest lift. Aggregate will be measured and paid for under the appropriate pay item as provided in the contract or as extra work.

907-403.03.5.5--Preliminary Leveling. All irregularities of the existing pavement, such as ruts, cross-slope deficiencies, etc., shall be corrected by spot leveling, skin patching, feather edging or a wedge lift in advance of placing the first overall lift.

907-403.03.5.6--Placement of Lifts. The leveling lift shall be placed in a layer, or layers, not exceeding approximately two and one-half inches compacted thickness.

When single lane construction is required, placement of a lift on the adjacent lane may be performed by an approved profile averaging device provided the lane previously placed is within the allowable tolerances for all surface requirements. When any of the tolerances are exceeded, the Contractor shall reestablish the control stringline for laying the adjacent lane should the Contractor elect to perform this work prior to correcting the deficiencies of the lane previously placed. In no case shall a "matching shoe" be used to control the grade of an adjacent lane.

In instances where there are only minor deviations from the allowable tolerances in the first overall lift, the Engineer may permit the Contractor to place the next higher lift by graded stringline in lieu of making the corrections.

Single lane placement of leveling, intermediate and surface lifts shall be limited to the distance covered in one and one-half days in advance of that placed in the adjacent lane.

907-403.03.5.7--Protection of Pavement. The pavement shall be protected and properly maintained until it has been compacted and cooled sufficiently for use by traffic.

907-403.04--Method of Measurement. Asphalt pavement, of the type specified, will be measured by the ton. The weight of the composite mixture shall be determined in accordance with the provisions of Subsection 907-401.03.2.1.11.

The pay quantities for each individual job mix formula (JMF) will be calculated using the approved JMF maximum specific gravity (Gmm) and the following formulas.

When the composite mixture has a maximum specific gravity of 2.540 or less,

$$T_p = T_w$$

When the composite mixture has a maximum specific gravity greater than 2.540,

$$T_p = T_w((100-(((Gmm*A*B)-C)/(Gmm*A*B))*100))/100$$

Where:

- Tp = Total tonnage for payment
- Tw = Total tonnage weighed, used and accepted
- Gmm = Maximum Specific Gravity of the approved composite asphalt mixture
- A = 46.725 lbs/yd²/in
- B = 0.93 = 93% density
- C = 110.374 lbs/yd²/in = Theoretical density at 2.540 Gmm

Unless shown as a separate pay item, the furnishing and application of the tack coat will not be measured for payment. When payment is provided, tack coat will be measured as set out in Section 407.

Joint sealant will be measured by the linear foot for each joint sealed.

The quantity of bituminous mixture required to correct the work, when made at the expense of the Contractor, will not be measured for payment.

Any trenching required for widening will not be measured for payment, such cost thereof shall be included in other items of work.

Undercut required by the Engineer will be measured for payment under the appropriate excavation item as provided in the contract or as extra work. Pavement removal and any required trenching will not be included in the measurement for undercut.

Class "B" structural concrete base substituted for asphalt under portland cement concrete bridge end pavement, as per Subsection 502.03.1, will be paid for as asphalt calculated as follows:

Square yards of portland cement concrete bridge end pavement x concrete base thickness in inches x 0.055 = tons of asphalt.

907-403.05--Basis of Payment. Subject to the adjustments set out in Subsections 907-401.02.6.3, 907-401.02.6.4, 907-401.02.6.5 & 907-403.03.2, asphalt pavement, measured as prescribed above, will be paid for at the contract unit price per ton for each lift of pavement specified in the bid schedule and shall be full compensation for completing the work.

Joint sealant will be paid for at the contract unit price per linear foot for each joint which shall be full compensation for furnishing the joint sealant material, cleaning the joint, applying the sealant, and for all equipment, tools, labor, and incidentals necessary to complete the work.

907-403.05.1--Price Adjustment for Thickness Requirement. When grade stakes are eliminated as provided in Subsection 907-403.03.3 and the average thickness of all cores from lots representing a day's production is more than three eights of an inch (3/8") thicker than the total specified thickness of the pavement, excluding lift(s) placed using an established grade line, a lump sum reduction in payment for the surface lift of lots representing a day's production will be made as follows:

$$\text{Individual Day's L.S. Reduction} = \frac{\text{Monetary Value of the Day's Surface Lift Production} \times (D - 3/8)}{ST}$$

Where:

D = The day's average deviation from total pavement thickness shown on the plans, excluding lift(s) placed using an established grade line.

ST = Specified thickness for surface lift.

The total L.S. reduction for the project is the summation of the individual day's reductions in payment.

907-403.05.2--Pay Items.

Payment will be made under:

907-403-A: <u>(1)</u> , <u>(4)</u> , Asphalt Pavement	- per ton
907-403-B: <u>(2)</u> , <u>(4)</u> , Asphalt Pavement, Leveling	- per ton
907-403-C: <u>(3)</u> , <u>(4)</u> , Asphalt Pavement, Trench Widening	- per ton
907-403-D: <u>(2)</u> , HT, Asphalt Pavement, Polymer Modified	- per ton
907-403-E: <u>(2)</u> , HT, Asphalt Pavement, Polymer Modified, Leveling	- per ton
907-403-S: Joint Sealant	- per linear foot or mile

- (1) 4.75-mm mixture, 9.5-mm mixture, 12.5-mm mixture, 19-mm mixture, or 25-mm mixture
- (2) 4.75-mm mixture, 9.5-mm mixture, 12.5-mm mixture, or 19-mm mixture
- (3) 19-mm mixture or 25-mm mixture
- (4) ST, MT or HT

MISSISSIPPI DEPARTMENT OF TRANSPORTATION

SPECIAL PROVISION NO. 907-406-4

CODE: (SP)

DATE: 10/13/2015

SUBJECT: Cold Milling

Section 406, Cold Milling, of the 2004 Edition of the Mississippi Standard Specifications for Road and Bridge Construction is hereby amended as follows.

907-406.01--Description. After the first paragraph of Subsection 406.01 on page 279, add the following.

This work also consists of the removal of portions of existing pavement using a cold fine milling process to a nominal depth using grade control as specified on the Plans or as directed by the Engineer. It shall also include the loading, hauling, and disposal of the milled materials by the Contractor in accordance with the plans and specifications. The planed surface shall provide a textured surface suitable for repairs, paving, or as a temporary riding surface, whichever is specified.

907-406.03--Construction Requirements.

907-406.03.1--Equipment. Delete the third sentence of the first paragraph of Subsection 406.03.1 on page 279, and substitute the following.

The equipment shall accurately and automatically establishing profile grades along each edge of the machine by referencing from the existing pavement with means of an approved profile averaging device with extreme contact points with surface at least 30 feet apart, or from an independent grade line and shall have an automatic system for controlling cross slope.

After the second paragraph of Subsection 406.03.1 on page 279, add the following.

When fine milling is required, the milling machine shall, in addition to the above, be designed specifically for grinding surfaces to close tolerances and shall be operated at a rate recommended by the manufacturer so as to avoid tearing and gouging of the pavement surface. The fine milling machine shall be equipped with a fine milling drum of the size and shape necessary to produce an ultrafine texture to the milled surface and meet the requirements of this specification. The bit or teeth spacing on the drum shall have a maximum spacing of six millimeter (6 mm). The equipment shall have a positive means for limiting any dust resulting from the operation from escaping into the air.

After Subsection 406.03.2 on page 280, add the following.

907-406.03.3--Fine Milling. Unless otherwise noted or advised by the Engineer, the fine milling operation shall be conducted using an automatic grade control device, as referenced in Subsection

406.03.1, to establish accurate grade control and cross slope. The milled surface shall be textured, substantially free from waves or irregularities.

Prior to beginning a fine milling operation, the Engineer may require the Contractor to construct a 500-foot test section. The texture and consistency of profile and cross slope of this test section will be evaluated by the Engineer to verify the above straight-edge requirement can be met.

If the tolerance is exceeded in the test section, the Contractor shall cease work and take corrective actions to improve the process. Once corrective actions are taken, the Contractor will construct another test section. This designated section shall be fine milled to conform to the same requirements as those required in the initial test section. The Contractor shall not be allowed to start continuous fine milling until an acceptable test section is obtained.

Fine milling shall produce a uniform finished surface and maintain a constant cross slope between extremities in each lane.

The surface tolerance of the fine milling shall be checked to assure a uniform pavement texture that is true to line, grade, and cross section.

Fine milled pavement surfaces are subject to visual and straightedge inspections by the Engineer at any time during the milling operation. The final fine milled surface shall be a uniform finish on the grade and slope shown to be required on the plans. The finished surface shall also not vary more than ¼" from a 10-foot straightedge placed anywhere on the surface of the milled area.

The cross slope shall be checked to assure uniformity and that no depressions or slope misalignments exist when the slope is tested with a straightedge placed perpendicular to the center line.

Dust, residue, and loose milled material shall be removed from the fine milled surface. Traffic shall not be allowed on the milled surface nor any asphalt placed on the milled surface until removal is complete.

907-406.04--Method of Measurement. Delete the paragraph in Subsection 406.04 on page 280, and substitute the following.

Cold milling of pavement and shoulders, all depths, will be measured by the square yard, cubic yard (LVM), or ton as indicated in the contract. Loading, hauling, and disposal will not be measured for separate payment.

Fine milling of the specified pavement will be measured by the square yard, cubic yard (LVM), or ton as indicated in the contract. Loading, hauling, and disposal will not be measured for separate payment.

Fine milling to repair failed areas in Open Graded Friction Courses will not be measured for payment unless authorized by the Engineer.

907-406.05--Basis of Payment. Delete the first and second paragraphs of Subsection 406.05 on page 280, and substitute the following.

Cold milling of pavement and shoulders, all depths, measured as prescribed above, will be paid for at the contract unit price per square yard, cubic yard (LVM) or ton, as indicated, which price shall be full compensation for completing the work.

Fine milling, measured as prescribed above, will be paid for at the contract unit price per square yard, cubic yard (LVM) or ton, as indicated, which price shall be full compensation for completing the work.

When not shown as a separate pay item in the contract, the price for each item of milling shall include the cost of continuous maintenance of traffic and protective services as required by the Department's Traffic Control Plan, including all required individual traffic control devices.

Delete the pay items listed on page 280 and substitute the following.

- 907-406-A: Cold Milling of Bituminous Pavement, All Depths - per square yard, cubic yard or ton
- 907-406-B: Cold Milling of Concrete Pavement, All Depths - per square yard, cubic yard or ton
- 907-406-C: Cold Milling of Shoulders, All Types, All Depths - per square yard, cubic yard or ton
- 907-406-D: Fine Milling of Bituminous Pavement, All Depths - per square yard, cubic yard or ton
- 907-406-E: Fine Milling of Concrete Pavement, All Depths - per square yard, cubic yard or ton
- 907-406-F: Fine Milling of Shoulders, All Depths - per square yard, cubic yard or ton

MISSISSIPPI DEPARTMENT OF TRANSPORTATION

SPECIAL PROVISION NO. 907-407-2

CODE: (SP)

DATE: 07/22/2014

SUBJECT: Tack Coat

Section 407, Tack Coat, of the 2004 Edition of the Mississippi Standard Specifications for Road and Bridge Construction is hereby amended as follows:

907-407.02.1--Bituminous Material. Delete the second sentence of the first paragraph of Subsection 407.02.1 on page 281, and substitute the following:

When not specified, the materials shall be as specified in Table 410-A on page 293.

907-407.03.3--Application of Bituminous Material. Delete the first paragraph of Subsection 407.03.3 on page 281, and substitute the following.

Tack coat shall be applied with a distributor spray bar. A hand wand will only be allowed for applying tack coat on ramp pads, irregular shoulder areas, median crossovers, turnouts, or other irregular areas. Bituminous materials and application rates for tack coat shall be as specified in Table 410-A on page 293. Tack coat shall not be applied during wet or cold weather, or to a wet surface. Emulsions shall be allowed to "break" prior to superimposed construction.

907-407.05--Basis of Payment. Delete the pay item at the end of Subsection 407.05 on page 282, and substitute the following:

907-407-A: Asphalt for Tack Coat * - per gallon

* Grade may be specified

MISSISSIPPI DEPARTMENT OF TRANSPORTATION

| SPECIAL PROVISION NO. 907-411-5

CODE: (SP)

| DATE: 01/21/2015

SUBJECT: Ultra-Thin Asphalt Pavement (UTAP)

Section 907-411, Ultra-Thin Asphalt Pavement, is hereby added to and made part of the 2004 Edition of the Mississippi Standard Specifications for Road and Bridge Construction as follows:

SECTION 907-411 - ULTRA-THIN ASPHALT PAVEMENT

907-411.01--Description. These specifications include general requirements that are applicable to Ultra-Thin Hot Mix Asphalt (UHMA) and Ultra-Thin Warm Mix Asphalt (UWMA).

This work consists of the construction of one lift of UTAP in accordance with these specifications and the specific requirements for the mixture to be produced and placed in reasonable close conformity with the lines, grades, thicknesses and typical sections shown on the plans or established by the Engineer.

The asphalt mixture (UHMA or UWMA) used on this project will **not** be bid as an alternate pay item. **The Contractor must select one of the asphalt mixtures, UHMA or UWMA, to be used throughout the entire project.**

907-411.01.1--Definitions.

Maximum Sieve Size - Maximum sieve size is the smallest sieve size at which 100 percent of the aggregate passes.

Nominal Maximum Sieve Size - The nominal maximum sieve size is one sieve size larger than the first sieve to retain more than 10 percent of the aggregate.

Maximum Density Line - The maximum density line is a straight line plot on the FHWA 0.45 power gradation chart which extends from the zero origin point of the chart through the plotted point of the combined aggregate gradation curve on the nominal maximum sieve size.

Mechanically Fractured Face - An angular, rough, or broken surface of an aggregate particle created by crushing as determined by ASTM Designation: D 5821.

907-411.02--Materials.

907-411.02.1--Component Materials.

907-411.02.1.1--Aggregates. The source of aggregates shall meet the applicable requirements of Section 703.

The total amount of crushed limestone shall not exceed fifty percent (50%) of the total aggregate by weight.

907-411.02.1.1.1--Coarse Aggregate Blend. Mechanically fractured faces by weight of the combined mineral aggregate coarser than the No. 4 sieve shall be 90 percent, two faces.

907-411.02.1.1.2--Fine Aggregate Blend. Uncrushed natural sand shall pass the 3/8" sieve and can be used, excluding the content in RAP, as no greater than 30 percent of the total mineral aggregate by weight.

907-411.02.1.1.3--Combined Aggregate Blend. The gradation requirements for Ultra-thin asphalt pavements are provided in the following table:

Sieve Size	Percent Passing
1/2 inch	100
3/8 inch	95-100
No. 4	75 min
No. 8	22-70
No.16	--
No. 200	4-12

The ultra-thin mixtures shall have a minimum fine aggregate angularity of 40.0 when tested on combined aggregate in accordance with ASTM Designation: C1252 Method A.

The minus No. 40 fraction of the combined aggregate shall be non-plastic when tested according to AASHTO T 90. The clay content shall not exceed 0.5 percent by weight of the total mineral aggregate when tested according to AASHTO T 88.

907-411.02.1.2--Reclaimed Asphalt Pavement. Reclaimed asphalt pavement may be used in ultra-thin asphalt pavement and shall be no greater than 25 percent of the total mix weight.

Reclaimed asphalt pavement shall be separated into coarse and fine aggregate stockpiles using a 1/2" sieve as the break point.

907-411.02.1.3--Bituminous Materials. Bituminous materials shall meet the applicable requirements of Section 702 for the grade specified.

907-411.02.1.4--Hydrated Lime. Hydrated lime shall meet the requirements of Subsection 714.03.2 for lime used in soil stabilization.

907-411.02.1.5--Mineral Filler. Mineral filler shall meet the requirements of Subsection 703.16.

907-411.02.2--Composition of Mixtures.

907-411.02.2.1--General. Unless otherwise specified or permitted, the UTAP shall consist of a uniform mixture of asphalt, aggregate, mineral filler, hydrated lime and, when required or necessary to obtain desired properties, antistripping agent and/or other materials.

Hydrated lime shall be used in all UTAP at the rate of one percent (1%) by weight of the total dry aggregate. The aggregate, prior to the addition of the hydrated lime, shall contain sufficient surface moisture.

The Contractor shall obtain a shipping ticket for each shipment of hydrated lime. The Contractor shall provide the District Materials Engineer with a copy of each shipping ticket from the supplier, including the date, time and weight of hydrated lime shipped.

Mixtures will require the addition of an antistripping agent when the Tensile Strength Ratio (MT-63) and/or the Boiling Water Test (MT-59) fail to meet the following criteria.

Tensile Strength Ratio (TSR - MT-63)

Wet Strength / Dry Strength	85 percent minimum
Interior Face Coating	95 percent minimum

Boiling Water Test (MT-59)

Particle Coating	95 percent minimum
------------------	--------------------

907-411.02.2.2--Mixture Properties. Ultra-thin asphalt pavement shall be designed at N_{design} of 50 revolutions of the gyratory compactor.

Mixtures shall be designed such that the percent of maximum specific gravity (G_{mm}) shall be between 94.0 and 96.0.

There will not be voids in mineral aggregate (VMA) requirement for ultra-thin hot mix asphalt. However, the specified volume of effective binder (the difference between total air voids and VMA) shall be a minimum of 12 percent.

Dust/Binder Ratio (Percent Passing No. 200 / Effective Binder Content) for ultra-thin asphalt pavement shall be between 1.0 and 2.0.

907-411.02.2.3--Job Mix Formula. At least 10 working days prior to the proposed use of each mixture, the Contractor shall submit in writing to the Engineer a proposed job-mix formula or request the transfer of a verified job-mix formula as set forth in the latest edition of MDOT's Field Manual for HMA. The job-mix formula shall be signed by a Certified Mixture Design Technician (CMDT).

The Department will perform the tests necessary for review of a proposed job-mix formula for each required mixture free of charge one time only. A charge will be made for additional job-mix formulas submitted by the Contractor for review.

The mixture shall conform thereto within the range of tolerances specified for the particular mixture. No change in properties or proportion of any component of the job-mix formula shall be made without permission of the Engineer. The job-mix formula for each mixture shall be in effect until revised in writing by the Engineer.

A job-mix formula may be transferred to other contracts in accordance with conditions set forth in the Department's Field Manual for HMA.

The Contractor shall not place any UTAP prior to receiving "tentative" approval and a MDOT design number from the Central Laboratory.

When a change in source of materials, unsatisfactory mixture production results such as segregation, bleeding, shoving, rutting over 1/8 inch, raveling & cracking, or changed conditions make it necessary, a new job-mix formula will be required. The conditions set out herein for the original job-mix formula are applicable to the new job-mix formula.

907-411.02.2.4--Single Lift Laying Thickness. The minimum lift thickness for ultra-thin asphalt pavement shall be 1/2 inch and the maximum lift thickness shall not exceed one inch (1").

907-411.02.2.5--UWMA Products and Processes. The Department will maintain a list of qualified UWMA products and processes. No product or process shall be used unless it appears on this list.

The Contractor may propose other products or processes for approval by the Product Evaluation Committee. Documentation shall be provided to demonstrate laboratory performance, field performance, and construction experience.

907-411.02.3--Contractor's Quality Management Program.

907-411.02.3.1--General. The Contractor shall have full responsibility for quality management and maintain a quality control system that will furnish reasonable assurance that the mixtures and all component materials incorporated in the work conform to contract requirements. The Contractor shall have responsibility for the initial determination and all subsequent adjustments in proportioning materials used to produce the specified mixture. Adjustments to plant operation and spreading and compaction procedures shall be made immediately when results indicate that they are necessary. Mixture produced by the Contractor without the required testing or personnel on the project shall be subject to removal and replacement by the Contractor at no additional cost to the State.

907-411.02.3.2--Personnel Requirements. The Contractor shall provide at least one Certified Asphalt Technician-I (CAT-I) full-time during UTAP production at each plant site used to furnish material to the project. Sampling shall be conducted by a certified technician or by plant personnel under the direct observation of a certified technician. All testing, data analysis and data posting will be performed by the CAT-I or by an assistant under the direct supervision of the CAT-I. The Contractor shall have a Certified Asphalt Technician-II (CAT-II) available to make any necessary

process adjustments. An organizational chart, including names, telephone numbers and current certification, of all those responsible for the quality control program shall be posted in the contractor's laboratory while the UTAP paving work is in progress

907-411.02.3.3--Testing Requirements. As a minimum, the Contractor's quality management program shall include the following:

- (a) Bituminous Material. Provide Engineer with samples in a sealed one-quart metal container at the frequency given in MDOT SOP TMD-20-04-00-000.
- (b) Mechanically Fractured Face. Determine mechanically fractured face content of aggregates retained on the No. 4 sieve, at a minimum of one test per day of production.
- (c) Mixture Gradation. Conduct extraction tests for gradation determination on the mixture. Sample according to the frequency in paragraph (i) and test according to Mississippi Test Method MT-31.
- (d) Total Voids and V_{be} . Determine total voids and volume of effective binder (V_{be}), at N_{Design} , from the results of bulk specific gravity tests on laboratory compacted specimens. Sample according to the sampling frequency in paragraph (h) and test according to the latest edition of MDOT's Field Manual for HMA.
- (e) Asphalt Content. Sample according to the sampling frequency in paragraph (i), and determine the asphalt content using one of the following procedures.
 - (1) Nuclear gauge. (Mississippi Test Method MT-6)
 - (2) Incinerator oven. (AASHTO T 308, Method A)
- (f) Stripping Tests. Conduct a minimum of one stripping test at the beginning of each job-mix production and thereafter, at least once per each two weeks of production according to Mississippi Test Method: MT-63 and one stripping test per day of production according to Mississippi Test Method: MT-59. Should either the TSR (MT-63) or the boiling water (MT-59) stripping tests fail, a new antistrip additive or rate shall be established or other changes made immediately that will result in a mixture which conforms to the specifications; otherwise, production shall be suspended until corrections are made.
- (g) Quality Control Charts. Plot the individual test data, the average of the last four tests and the control limits for the following items as a minimum:

- Mixture Gradation (Percent Passing) Sieves:
 - 1/2-in, 3/8-in, No. 4, No. 8, No. 30, and No. 200.
- Asphalt Content, Percent
- Maximum Specific Gravity
- Total Voids @ N_{Design} , Percent
- V_{be} @ N_{Design} , Percent

Keep charts up-to-date and posted in a readily observable location. Charts may be kept on a computer; however, the charts shall be printed out a minimum of once each production day and displayed in the laboratory. Note any process changes or adjustments on the Air Voids chart.

- (h) Sampling Frequency. Conduct those tests as required above at the following frequency for each mixture produced based on the estimated plant tonnage at the beginning of the day.

<u>Total Estimated Production, tons</u>	<u>Number of Tests</u>
0-500	1
501-1000	2
1001-1500	3
1501-2000	4
2001+	5

- (j) Sample Requirements. Obtain the asphalt mixture samples from trucks at the plant. Obtain aggregate samples from cold feed bins or aggregate stockpile. Save a split portion of all mixture samples at the laboratory site in a dry and protected location for 14 calendar days. At the completion of the project, the remaining samples may be disposed of with the approval of the Engineer.

The above testing frequencies are for the estimated plant production for the day. If production is discontinued or interrupted, the tests will be conducted at the previously established sample tonnage points for the materials that are actually produced. If the production exceeds the estimated tonnage, sampling and testing will continue at the testing increments previously established for the day. A testing increment is defined as the estimated daily tonnage divided by the required number of tests from the table in Subsection 907-411.02.3.3 paragraph (h).

In addition to the above program, aggregate stockpile gradation tests (AASHTO T-11 and T-27) shall be conducted every other production day. Fine aggregate angularity tests (ASTM C 1252, Method A) shall be conducted on the first day of production and once for every eight production samples thereafter, with a minimum of one test per production week.

907-411.02.3.4--Documentation. The Contractor shall document all observations, records of inspection, adjustments to the mixture, and test results on a daily basis. All tests conducted by the Contractor in accordance with Subsection 907-411.02.3.3 (g) shall be included in the running average calculations. If single tests are performed as a check on individual UTAP properties, between regular samples, without performing all tests required in Subsection 907-411.02.3.3 (g), the results of those individual tests shall not be included in the running average calculations for that particular property. The Contractor shall record the results of observations and records of inspection as they occur in a permanent field record. The Contractor shall record all process adjustments and job mix formula (JMF) changes on the air void charts. The Contractor shall provide copies of all test data sheets and the daily summary reports on the appropriate Mississippi DOT forms to the Engineer on a daily basis. The Contractor shall provide a written

description of any process change, including blend proportions, to the Engineer as they occur. Information provided to the Engineer must be received in the Engineer's office by no later than 9:00 AM the day after the UTAP is produced. Fourteen days after the completion of the placement of the UTAP, the Contractor shall provide the Engineer with the original testing records and control charts in a neat and orderly manner

907-411.02.3.5--Control Limits. The following control limits for the job mix formula (JMF) and warning limits are based on a running average of the last four data points.

<u>Sieve - % Passing</u>	<u>JMF Limits</u>	<u>Warning Limits</u>
1/2-in	± 5.5	± 4.0
3/8-in	± 5.5	± 4.0
No. 4	± 4.0	± 3.0
No. 8	± 4.0	± 3.0
No. 30	± 4.0	± 3.0
No. 200	± 2.0	± 1.5
Asphalt Content, %	-0.3 to +0.5	-0.2 to +0.4
Design Total Voids @N _{Design} , %	± 1.3	± 1.0
V _{be} @ N _{Design} , %	- 1.5	- 1.0

907-411.02.3.6--Warning Bands. Warning bands are defined as the area between the JMF limits and the warning limits.

907-411.02.3.7--Job Mix Formula Adjustments. A request for a JMF adjustment signed by a CAT-II may be made to the Engineer by the Contractor. Submit sufficient testing data with the request to justify the change. The requested change will be reviewed by the State Materials Engineer for the Department. If current production values meet the mixture design requirements, a revised JMF will be issued. Adjustments to the JMF shall conform to the latest edition of MDOT's Field Manual for HMA. Adjustments to the JMF to conform to actual production shall not exceed the tolerances specified for the JMF limits. Regardless of such tolerances, any adjusted JMF gradation shall be within the range given in Subsection 907-411.02.1.1.3 for the mixture specified. **The JMF asphalt content may only be reduced if the production V_{be} meets or exceeds the minimum design V_{be} requirements for the mixture being produced.**

907-411.02.3.8--Actions and Adjustments. Actions and adjustments shall be in accordance with Subsection 401.02.5.8.

907-411.02.4--Standards of Acceptance.

907-411.02.4.1--General. Acceptance for mixture quality (V_{be} and total voids @ N_{Design}, gradation, and asphalt content) will be based on random samples tested in accordance with the latest edition of MDOT's Field Manual for HMA. Smoothness will be accepted by lots as set out in Subsection 907-411.02.4.3.

907-411.02.4.2--Assurance Program for Mixture Quality. The Engineer will conduct a quality assurance program in accordance with Subsection 401.02.6.2.

907-411.02.4.3--Acceptance Procedure for Mixture Quality. All obviously defective material or mixture will be subject to rejection by the Engineer. Such defective material or mixture shall not be incorporated into the finished work. If the defective material has already been placed in the work, the material shall be removed and replaced at no additional cost to the State.

The Engineer will base final acceptance of the asphalt mixture production on the results of the Contractor's testing for total voids and V_{be} @ N_{Design} , gradation, and asphalt content as verified by the Engineer in the manner hereinbefore described and the uniformity and condition of the completed pavement. Areas of pavement that exhibit nonuniformity or failures (materials or construction related) such as but not limited to segregation, bleeding, shoving, rutting over 1/8 inch, raveling, slippage, or cracking will not be accepted. Such areas will be removed and replaced at no additional cost to the State.

Bituminous mixture placed prior to correction for deficiencies in V_{be} and total voids @ N_{Design} , gradation, or asphalt content, as required in Subsection 907-411.02.3.8 and determined by the Engineer satisfactory to remain in place will be paid for in accordance with the following pay factors times the contract unit price per ton.

Pay Factor for Mixture Quality *

Item	Produced in Warning Bands	Produced Outside JMF Limits (Allowed to Remain in Place)
Gradation	0.90	0.75
Asphalt Content	0.85	0.75
Total Voids @ N_{Design}	0.70	0.50
V_{be} @ N_{Design}	0.90	0.75

* The minimum single payment will apply.

907-411.02.4.4--Acceptance Procedure for Density. The density requirement for UTAP shall be roll to refusal. Refusal is defined as the number of roller passes to maximize the in-place unit weight of the mixture. On the first day of production and every three production days thereafter, a 500-foot test strip shall be evaluated to determine the required number of roller passes. Three random sites within the test strip shall be selected and monitored with the nuclear density gauge to determine refusal.

907-411.02.4.5--Acceptance Procedure for Pavement Smoothness. Prior to placement of UTAP, the Contractor shall determine the existing surface Mean Roughness Index at no additional cost to the State. The finished UTAP lift shall have a mean roughness index no greater than that of the existing surface.

907-411.02.5--High Speed Inertial Profiling System. The high speed inertial profiling system shall meet the applicable requirements of Subsection 907-401.02.6.9.

907-411.02.6--Surface Correction. In the event surface correction is needed it shall be accomplished by removal and replacement in accordance with Subsection 403.03.4. All such corrections shall be at no additional cost to the State.

The finished pavement surface will be measured for riding quality.

907-411.02.7--Nuclear Gauges. Nuclear gauges shall meet the requirements of Subsection 401.02.7.

907-411.03--Construction Requirements. Mississippi DOT has adopted the “Hot-Mix Asphalt Paving Handbook” as the guideline for acceptable UTAP construction practices.

907-411.03.1--Weather Limitations. The mixture shall not be placed when weather conditions prevent the proper handling and finishing or the surface on which it is to be placed is wet or frozen. At the time of placement, the air and pavement surface temperature limitations shall be equal to or exceed 55°F for UHMA and 40°F for UWMA, regardless of the compacted lift thickness.

When paving operations are discontinued because of rain, the mixture in transit shall be protected until the rain ceases. The surface on which the mixture is to be placed shall be swept to remove as much moisture as possible and the mixture may then be placed subject to removal and replacement at no additional cost to the State if contract requirements are not met.

907-411.03.2--Tack Coat. Tack coat shall meet the requirements of Subsection 401.03.1.2.

907-411.03.3--Bituminous Mixing Plants. Bituminous mixing plants shall meet the applicable requirements of Subsection 410.03.2.

907-411.03.4--Hauling Equipment. Hauling equipment shall meet the requirements of Subsection 401.03.3.

907-411.03.5--Bituminous Pavers. Bituminous pavers shall meet the requirements of Subsection 401.03.4.

907-411.03.6--Rollers. All rollers shall meet the requirements of Subsection 401.03.5.

907-411.03.7--Preparation of Grade. The foundation upon which UTAP pavement is to be placed shall be prepared in accordance with Subsection 401.03.6.

907-411.03.8--Preparation of Mixture. The temperature of the mixture, when discharged from the mixer, shall not exceed 340°F for UHMA and 280°F for UWMA.

907-411.03.9--Spreading and Finishing. Spreading and finishing of UTAP shall be in accordance with Subsection 401.03.10.

907-411.03.10--Joints. Joints shall be constructed in accordance with Subsection 401.03.12.

907-411.04--Method of Measurement. Ultra-thin asphalt pavement will be measured by the ton.

Bituminous Tack Coat for the ultra-thin asphalt pavement shall be measured by the gallon as in accordance with the provisions of Subsections 109.01 and 410.04.

907-411-05--Basis of Payment. Ultra-thin asphalt pavement, measured as prescribed above, will be paid for at the contract unit price per ton, which price shall be full compensation for completing the work.

Bituminous Tack Coat, measured as prescribed above, will be paid for at the contract unit price per gallon, which price shall be full compensation for completing the work.

Payment will be made under the following items:

- 907-411-A: Ultra-Thin Asphalt Pavement -per ton
- 907-411-B: Bituminous Tack Coat - per gallon

MISSISSIPPI DEPARTMENT OF TRANSPORTATION

SPECIAL PROVISION NO. 907-618-9

CODE: (IS)

DATE: 11/08/2012

SUBJECT: Placement of Temporary Traffic Stripe

Section 618, Maintenance of Traffic and Traffic Control Plan, of the 2004 Edition of the Mississippi Standard Specifications for Road and Bridge Construction is hereby amended as follows.

907-618.03.3--Safe Movement of Traffic. Delete subparagraphs (2) and (3) of Subsection 618.03.3 on page 416, and substitute the following.

- (2) Temporary edge lines on projects requiring shoulders constructed of granular material may be delayed for a period not to exceed three (3) days.

Temporary edge lines placed on the final pavement course of projects requiring paved shoulders with surface treatment may be placed on the adjacent shoulder in as near the permanent location as possible until the surface treatment is placed. When the edge lines are obliterated by the placement of the surface treatment, the edge lines shall be placed in the permanent stripe location. The replacement of edge lines may be delayed for a period not to exceed three (3) days for a two or three-lane roads.

Delete the first sentence of next to last paragraph of Subsection 618.03.3 on page 416 and substitute the following.

Permanent pavement markings are to be applied no sooner than 10 days nor later than 45 days after placement of the final lift of pavement.

MISSISSIPPI DEPARTMENT OF TRANSPORTATION

SPECIAL PROVISION NO. 907-618-13

CODE: (SP)

DATE: 06/03/2014

SUBJECT: Temporary Construction Signs

Section 618, Maintenance of Traffic and Traffic Control Plan, of the 2004 Edition of the Mississippi Standard Specifications for Road and Bridge Construction is hereby amended as follows.

907-618.03--Construction Requirements.

907-618.03.2--Barricades, Signs, and Flaggers. Delete the second paragraph of Subsection 618.03.2 on page 414, and substitute the following.

Flaggers shall be stationed at such points as may be deemed necessary.

Temporary construction signs shall be removed as their use becomes inapplicable. However, placing temporary signs and their supports flat on the ground outside the shoulder break line will be allowed.

907-618.05--Basis of Payment. Delete the first two pay items listed on page 418, and substitute the following.

907-618-A: Maintenance of Traffic - lump sum

907-618-B: Additional Construction Signs - per square foot

MISSISSIPPI DEPARTMENT OF TRANSPORTATION

SUPPLEMENT TO SPECIAL PROVISION NO. 907-618-14

DATE: 04/07/2016

PROJECT: MP-6026-55(015) / 305799301 -- Pearl River County

After the first paragraph of Subsection 907-618.01.2 on page 1, add the following.

Additional signs will be required as follows.

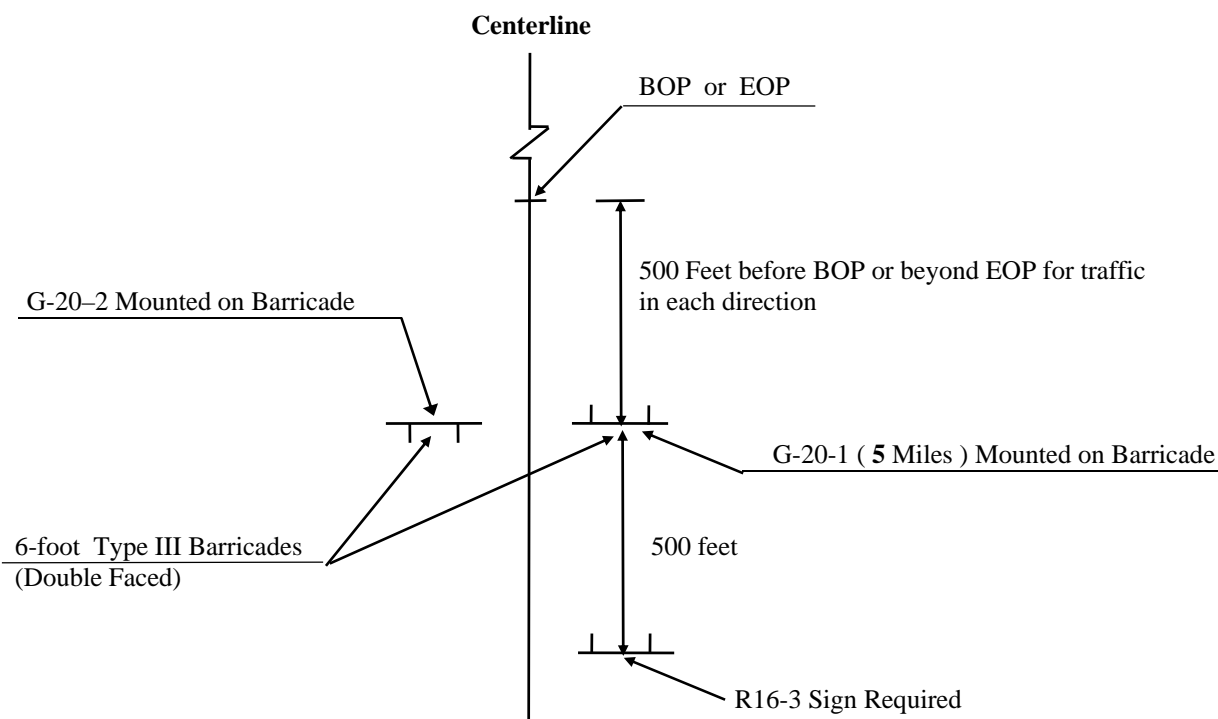

ADDITIONAL TRAFFIC CONTROL SIGNS REQUIRED:

- 11 - W20-1 "AHEAD" signs required. One (1) W20-1 "AHEAD" sign is required at each local road or street entering the project.
- 19 - R4-1 "DO NOT PASS" signs required.
- 24 - R4-2 "PASS WITH CARE" signs required.
- 16 - W14-3 "NO PASSING ZONE" signs required.
- 2 - R16-3 "SPEEDING FINES DOUBLED" signs required.

R4-1 "DO NOT PASS", R4-2 "PASS WITH CARE", and W14-3 "NO PASSING ZONE" signs are required in accordance with Subsection 618.03.3, this drawing, and as specified in the Manual on Uniform Traffic Control Devices. If no passing zones are 1,000 feet or more, additional "DO NOT PASS" signs shall be installed.

R16-3 signs shall be spaced in accordance with sheet titled "Location of R16-3 Signs".

All Construction signing is included in the bid for Pay Item 907-618-A, Maintenance of Traffic. Fluorescent orange sheeting shall be used on all construction and traffic control signs except for R16-3, R4-1 and R4-2 signs which shall be black legend and border on white background.

Two portable R16-3 signs are required per work zone or lane closure in addition to the signs required by MUTCD.

STATE PROJECT NO.
MISS.

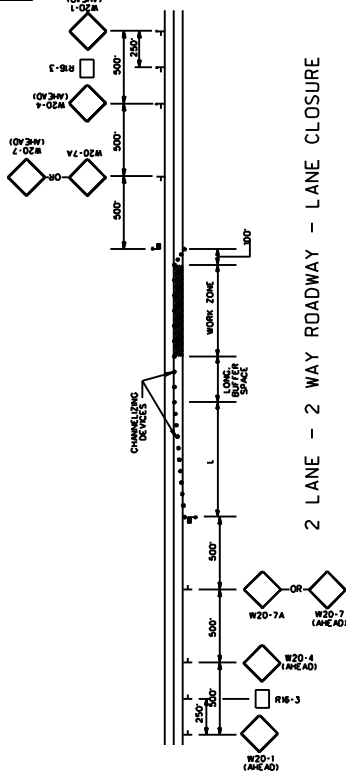

2 LANE - 2 WAY ROADWAY - LANE CLOSURE

DIVIDED HIGHWAY
(PROJECTS LESS THAN 1 MILE LENGTH)

- NOTES
- 1. R16-3 SIGN TO BE PLACED AS SHOWN OR AS DIRECTED BY THE ENGINEER.
 - 2. R16-3 SIGN SHALL BE SPACED AT A MAXIMUM OF 2 MILES THROUGHOUT LENGTH OF PROJECT.

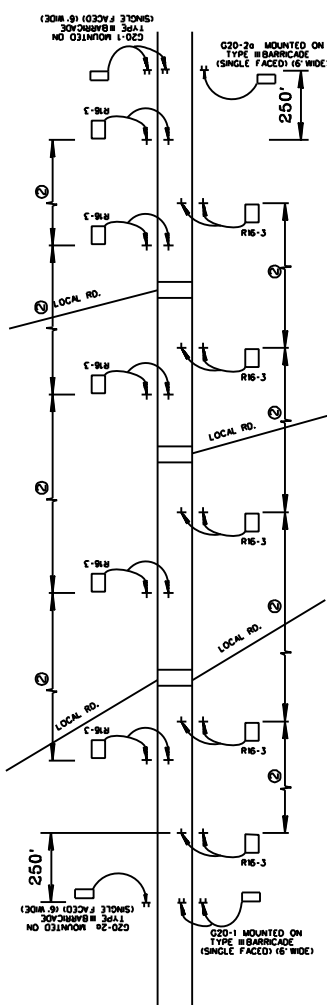

DIVIDED HIGHWAY SHOWN
(2 LANE - 2 WAY ROADWAY SIMILAR)
(PROJECT MORE THAN 1 MILE LENGTH)

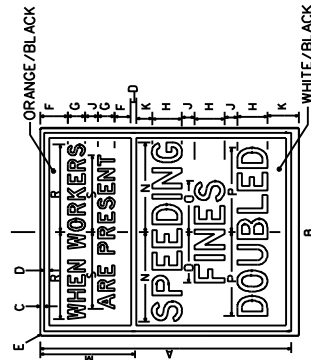
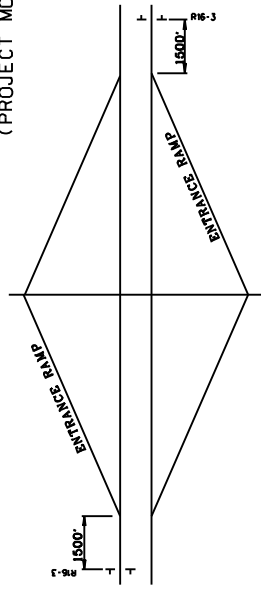

SIZE	DIMENSIONS (INCHES)												
S10	A	B	C	D	E	F	G	H	I	J	K	L	M
S10	60	48	3/4	1/4	3/4	1 1/2	1 1/2	1 1/2	1 1/2	1 1/2	1 1/2	1 1/2	1 1/2
S10	3	4 1/2	1 1/2	1 1/2	1 1/2	1 1/2	1 1/2	1 1/2	1 1/2	1 1/2	1 1/2	1 1/2	1 1/2
S10	48	36	3/4	1/4	3/4	1 1/2	1 1/2	1 1/2	1 1/2	1 1/2	1 1/2	1 1/2	1 1/2

48" x 60" (INTERSTATE USE)
36" x 48" (ALL OTHER HIGHWAYS)

MISSISSIPPI DEPARTMENT OF TRANSPORTATION

LOCATION OF R16-3 SIGNS

REVISION	WORKING NUMBER
FILE NAME: SPEED_SIGN_DETAIL.DWG	SHEET NUMBER
DATE: 02/08/09	CHECKED

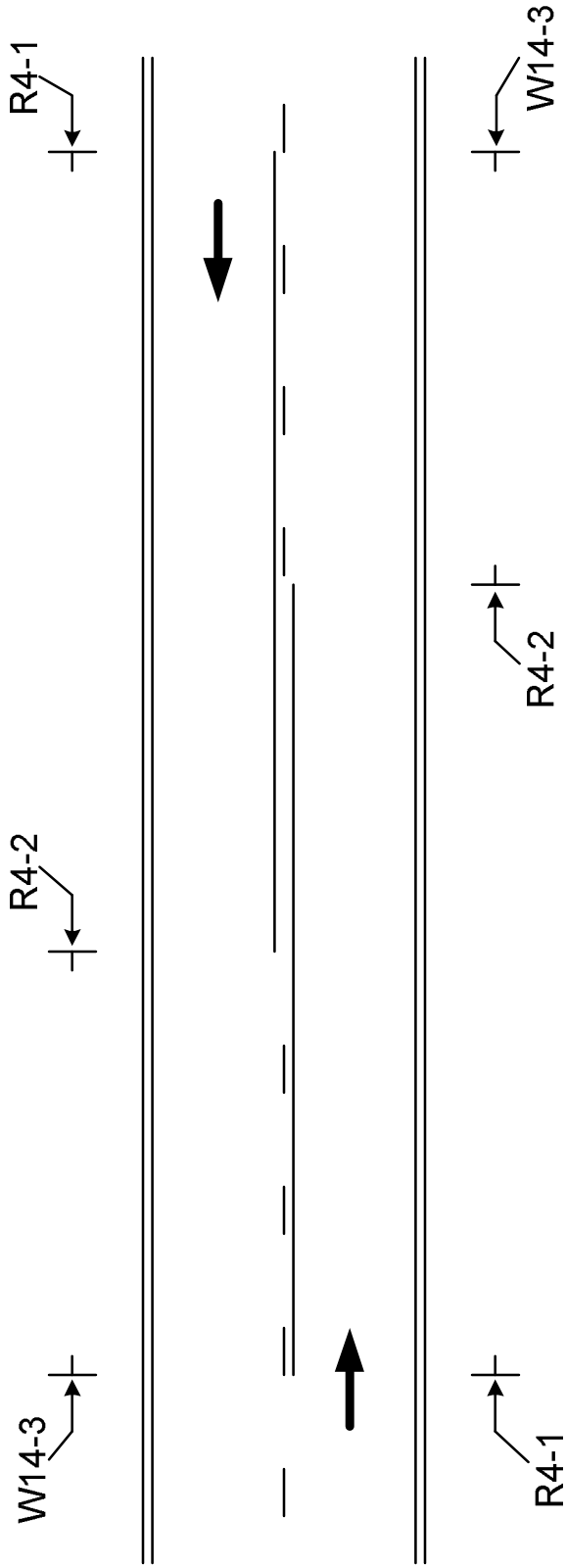

The W14-3, No Passing Zone sign, shall be placed on the left side of the road at the beginning of each no passing zone.

The R4-1, Do Not Pass signs, shall be placed on the right side of the road at the beginning of the no passing zone. Additional R4-1 signs shall be placed right and left in increments of 750 to 1000 feet throughout the length of the no passing zone.

The R4-2, Pass With Care sign, shall be placed on the right side of the road at the end of the no passing zone.

The R4-1, R4-2 and W14-3 signs are to be used when standard pavement markings are not in place. The signs may also be used to emphasize pavement markings.

MISSISSIPPI DEPARTMENT OF TRANSPORTATION

| SPECIAL PROVISION NO. 907-618-14

CODE: (SP)

| DATE: 06/17/2014

SUBJECT: Additional Signing Requirements

Section 618, Maintenance of Traffic and Traffic Control Plan, of the 2004 Edition of the Mississippi Standard Specifications for Road and Bridge Construction is hereby amended as follows.

907-618.01.2--Traffic Control Plan. At the end of Subsection 618.01.2 on page 413, add the following:

For compliance with the traffic control plan, the Contractor will be required to install and maintain construction signs at various locations throughout the project. Payment for these signs will be included in the price bid for pay item no. 907-618-A, Maintenance of Traffic per lump sum.

MISSISSIPPI DEPARTMENT OF TRANSPORTATION

SPECIAL PROVISION NO. 907-626-25

CODE: (IS)

DATE: 11/13/2012

SUBJECT: Thermoplastic Traffic Markings

Section 626, Thermoplastic Traffic Markings, of the 2004 Edition of the Mississippi Standard Specifications for Road and Bridge Construction is hereby amended as follows.

907-626.01--Description. After the last sentence of the first paragraph of Subsection 626.01 on page 443, add the following.

All pavement marking material, excluding edge lines over rumble strips, shall be applied using the extrusion/ribbon method. Edge lines placed over rumble strips shall be applied using the atomization/spray method.

907-626.03.1.1--Equipment. After the second paragraph of Subsection 626.03.1.1 on page 444, add the following.

When edge lines are placed over rumble strips, the equipment must be able to apply the marking material using the atomization/spray method instead of extrusion/ribbon method.

907-626.03.1.2--Construction Details. Delete the second sentence of the first full paragraph of Subsection 626.03.1.2 on page 445, and substitute the following.

Unless otherwise specified in the plans or contract documents, the thickness shall be 90 mils for edge lines, center lines, lane lines, barrier lines and detail stripe including gore markings, and 120 mils for crosswalks, stop lines, and railroad, word and symbol markings.

After the last sentence of the third full paragraph of Subsection 626.03.1.2 on page 445, add the following.

When double drop thermoplastic stripe is called for in the contract, additional beads by the drop-on method shall be applied as follows.

Class A glass beads at a rate of not less than three pounds of beads per 100 feet of six-inch stripe.
Class B glass beads at a rate of not less than three pounds of beads per 100 feet of six-inch stripe.

The Class B glass beads shall be applied to the newly placed stripe first, followed by the application of the Class A glass beads.

907-626.05--Basis of Payment. Delete the pay items listed on page 446 and substitute the following.

907-626-A: 6" Thermoplastic* Traffic Stripe, Skip White	- per linear foot or mile
907-626-B: 6" Thermoplastic* Traffic Stripe, Continuous White	- per linear foot or mile
907-626-C: 6" Thermoplastic* Edge Stripe, Continuous White	- per linear foot or mile
907-626-D: 6" Thermoplastic* Traffic Stripe, Skip Yellow	- per linear foot or mile
907-626-E: 6" Thermoplastic* Traffic Stripe, Continuous Yellow	- per linear foot or mile
907-626-F: 6" Thermoplastic* Edge Stripe, Continuous Yellow	- per linear foot or mile
907-626-G: Thermoplastic* Detail Stripe, <u>Color</u>	- per linear foot
907-626-H: Thermoplastic* Legend, White	- per linear foot or square foot

* Indicate Double Drop if applicable

MISSISSIPPI DEPARTMENT OF TRANSPORTATION

| SPECIAL PROVISION NO. 907-702-5

CODE: (SP)

| DATE: 08/12/2014

| SUBJECT: Specifications for Bituminous Materials

Section 702, Bituminous Materials, of the 2004 Edition of the Mississippi Standard Specifications for Road and Bridge Construction is hereby amended as follows.

907-702.05--Petroleum Asphalt Cement. Delete the third paragraph of Subsection 702.05 on page 598, and substitute the following.

The bituminous material used in all types of asphalt mixtures shall conform to AASHTO Designation: M 320, Performance Grade PG 67-22, as modified in the table below, except that Polyphosphoric Acid (PPA) may be used at low dosage rates as a modifier to enhance the physical properties of a base binder to meet the requirements for Performance Grade PG 67-22. In addition, PPA may be used as a catalyst or mixing agent at low dosage rates in the production of Polymer Modified, Performance Grade PG 76-22.

When PPA is used as a modifier, in no case shall the PPA modifier be used to adjust the physical properties of the binder a full binder grade. For example: the base binder (unmodified) is graded as a PG 64-22 and should only be modified by the addition of PPA to a modified binder grade of PG 67-22.

When petroleum asphalt cement is modified by PPA, the following dosage limits shall be applied.

<u>Grade</u>	<u>Dosage Limit</u>
PG 67-22	0.75% by weight of binder
PG 76-22	0.50% by weight of binder

| **907-702.07--Emulsified Asphalt.**

907-702.07.2--Anionic and Cationic. After the last paragraph of Subsection 702.07.2 on page 600, add the following.

LockDown (LD-7) and CQS-1h shall conform to the requirements of Table V.

907-702.07.3--Polymer Modified Cationic Emulsified Asphalt (CRS-2P). Delete the paragraph in Subsection 702.07.3 on page 600, and substitute the following.

Polymer Modified Cationic Emulsified Asphalt shall conform to the requirements of AASHTO Designation: M 316, with the following exception:

In Table 1, the Ductility, 25 °C, 5 cm/min, shall be a minimum of 100 cm.

907-702.12--Tables. After the last Table of Subsection 702.12 on page 606, add the following.

**TABLE V
SPECIFICATION FOR FOG SEAL**

Test Requirements	LD-7		CQS-1h		Test Method
	Min.	Max.	Min.	Max.	
Viscosity, Saybolt Furol, @ 25°C, Sec.	15	100	20	150	AASHTO T 72
Storage Stability Test, 24 hr, %	-	1	-	1	AASHTO T 59
Settlement, 5 day, %	-	5	-	-	AASHTO T 59
Particle Charge	-	-	Positive		AASHTO T 59
Oil Distillate, %	-	1	-	-	AASHTO T 59
Sieve Test, % *	-	0.3	-	0.1	AASHTO T 59
Residue by Distillation, %	40	-	60	-	AASHTO T 59
Test on Residue from Distillation					
Penetration @ 25°C	-	20	-	-	AASHTO T 49
Penetration @ 25°C, 100g, 5s	-	-	60	110	AASHTO T 49
Softening Point, °C	65	-	-	-	ASTM 36
Solubility in trichloroethylene, %	97.5	-	97.5	-	AASHTO T 44
Ductility @ 25°C, cm	-	-	40	-	AASHTO T 51
Original DSR @ 82° (G*/Sinδ, 10 rad/sec)	1	-	-	-	AASHTO T 111

* The Sieve result is tested for reporting purpose only, and it may be waived if no application problems are present in the field.

MISSISSIPPI DEPARTMENT OF TRANSPORTATION

SUPPLEMENT TO SPECIAL PROVISION NO. 907-703-12

DATE: 01/29/2015

SUBJECT: Aggregates

In the title of Subsection 907-703.06 on page 2, delete “Hot Mix”.

MISSISSIPPI DEPARTMENT OF TRANSPORTATION

SPECIAL PROVISION NO. 907-703-12

CODE: (IS)

DATE: 10/28/2014

SUBJECT: Aggregates

Section 703, Aggregates, of the 2004 Edition of the Mississippi Standard Specifications for Road and Bridge Construction is hereby amended as follows:

907-703.03.2.4--Gradation. Delete the table in Subsection 703.03.2.4 on page 611 and substitute the following.

**Table of Sizes and Gradation of Coarse Aggregate
for Portland Cement Concrete**

Square Mesh Sieves	Percent Passing by Weight						
	Size No. 467	Size No. 57	Size No. 67	Size No. 7	Size No. 78	Size No. 8	Size No. 89
2 inch	100						
1½ inch	95-100	100					
1 inch		80-100	100				
¾ inch	35-70		80-100	100	100	100	
½ inch		25-60		90-100	90-100	95 100	100
⅜ inch	10-30		20-55	40-70	40-75	75-100	85 100
No. 4	0-5	0-10	0-10	0-15	5-25	5-30	20-40
No. 8		0-5	0-5	0-5	0-10	0-10	0-10
No. 16					0-5	0-5	0-5

Delete the last sentence of the last paragraph of Subsection 703.03.2.4 on page 611.

907-703.04--Aggregate for Crushed Stone Courses.

907-703.04.1--Coarse Aggregate. Delete the first paragraph of Subsection 703.04.1 on page 611, and substitute the following.

Coarse aggregate, defined as material retained on No. 8 sieve, shall be either crushed limestone, steel slag, granite, concrete, or combination thereof. Crushed concrete is defined as recycled concrete pavement, structural concrete, or other concrete sources that can be crushed to meet the gradation requirements for Size No. 825B as modified below. In no case shall waste from concrete production (wash-out) be used as a crushed stone base.

907-703.04.2--Fine Aggregate. Delete the first sentence of the first paragraph of Subsection 703.04.2 on page 612, and substitute the following.

Fine aggregate, defined as material passing the No. 8 sieve, shall be material resulting from the crushing of limestone, steel slag, granite, concrete, or combination thereof.

Delete the third paragraph of Subsection 703.04.2 on page 612.

907-703.04.3--Gradation. In the table of Subsection 703.04.3 on page 613, change the requirement for the 1-inch sieve under Size No. 825 B from “75 - 98” to “75 - 100”.

After the table in Subsection 703.04.3 on page 613, add the following.

If crushed concrete is used, the crushed material shall meet the gradation requirements of Size No. 825 B with the exception that the percent passing by weight of the No. 200 sieve shall be 2 – 18.

907-703.06--Aggregates for Hot Mix Asphalt.

907-703.06.1--Coarse Aggregates. Delete the third paragraph of Subsection 703.06.1 on page 613, and substitute the following.

When tested in accordance with AASHTO Designation: T 19, the dry rodded unit weight of all aggregates except expanded clay and shale shall not be less than 70 pounds per cubic foot.

907-703.06.1.2--Fine Aggregates. Delete the last sentence of Subsection 703.06.1.2 on page 614.

907-703.14--Aggregates for Bituminous Surface Treatments.

907-703.14.2--Detail Requirements.

907-703.14.2.1--Gradation. In the table entitled “Gradation Requirements For Cover Aggregate” in Subsection 703.14.2.1 on page 622, delete the requirement for the No. 16 sieve for Size No. 7 under the column “Slag or Expanded Clay”.

Delete Subsection 703.19 on page 624, and substitute the following.

907-703.19--Lightweight Aggregate for Concrete.

907-703.19.1--Lightweight Aggregate for Structural Concrete. Lightweight aggregate for structural concrete shall meet the requirements of AASHTO Designation: M 195.

907-703.19.2--Lightweight Aggregate for Internal Curing of Concrete. Lightweight aggregate for internal curing of concrete shall meet the requirements of ASTM Designation: C 1761. The lightweight aggregate shall meet the gradation requirements listed in Table 1 for either “9.5 mm to 2.36 mm (3/8 in. to No. 8)” Coarse aggregate, “9.5 mm to 0 (3/8 in. to 0)” Combined fine and coarse aggregate, or “4.75 mm to 0 (No. 4 to 0)” Fine aggregate. The fineness modulus of the lightweight aggregate shall not be less than 2.70.

907-703.20--Aggregate for Stabilizer.

907-703.20.3--Gradation. Delete the table and notes in Subsection 703.20.3 at the top of page 626, and substitute the following.

PERCENT PASSING BY WEIGHT

Square Mesh Sieves	Shell	Coarse			Medium	Fine
		Size I	Size II Note (1)	Size III Note (3)		
3 inch	90-100			100		
2 1/2 inch				90-100		
2 inch		100				
1 1/2 inch		90-100	100	25-60		
1 inch		80-100	97-100			
3/4 inch		55-100	55-100	0-10		
1/2 inch		35-85	35-85	0-5	100	
3/8 inch		12-65	12-65		97-100	
No. 4, Note (2)		0-30	0-30		92-100	
No. 10		0-8	0-8		80-100	100
No. 40				10-40	80-100	
No. 60				0-20	30-100	
No. 100					15-80	
No. 200	0-5	0-4	0-4	0-5	0-30	
PI Material Passing No. 40				6 or less	0	

Note (1): Size II is intended for use in bases in which portland cement is used.

Note (2): Ground shell shall contain at least 97% passing the No. 4 sieve.

Note (3): Size III is intended for use in stabilized construction entrances.

MISSISSIPPI DEPARTMENT OF TRANSPORTATION

SPECIAL PROVISION NO. 907-710-1

CODE: (SP)

DATE: 06/24/10

SUBJECT: Fast Dry Solvent Traffic Paint

Section 710, Paint, of the 2004 Edition of the Mississippi Standard Specifications for Road and Bridge Construction is amended as follows:

After Subsection 710.05 on Page 661, add the following:

907-710.06--Fast Dry Solvent Traffic Paint. Fast dry solvent traffic paints intended for use under this specification shall include products that are single packaged and ready mixed. Upon curing, these materials shall produce an adherent, reflective pavement marking capable of resisting deformation by traffic. The manufacturer shall have the option of formulating the material according to their own specifications. However, the requirements delineated in this specification, Section 619 and Section 710 shall apply regardless of the formulation used. The material shall be free from all skins, dirt and foreign objects.

907-710.06.1--Composition.

907-710.06.1.1--Percent Pigment. The percent pigment by weight shall be not less than 51% nor more than 58% when tested in accordance with ASTM D 3723.

907-710.06.1.2--Viscosity. The consistency of the paint shall be not less than 75 nor more than 95 Krebs Units (KU) when tested in accordance with ASTM D 562.

907-710.06.1.3--Weight per Gallon. The paint shall weigh a minimum 11.8 pounds per gallon and the weight of the production batches shall not vary more than +/- 0.5 pounds per gallon from the weight of the qualification samples when tested in accordance with ASTM D 1475.

907-710.06.1.4--Total Solids. The percent of total solids shall not be less than 70% by weight when tested in accordance with ASTM D 2369.

907-710.06.1.5--Dry Time (No pick-up). The paint shall dry to a no tracking condition in a maximum of 10 minutes.

907-710.06.1.6--Volatile Organic Content. The volatile organic content (VOC) shall contain a maximum of 1.25 pounds of volatile organic matter per gallon of total non-volatile paint material when tested in accordance with ASTM D 3960.

907-710.06.1.7--Bleeding. The paint shall have a minimum bleeding ratio of 0.95 when tested in accordance with Federal Specification TT-P-115D.

907-710.06.1.8--Color. The initial daytime chromaticity for yellow materials shall fall within the box created by the following coordinates:

Initial Daytime Chromaticity Coordinates (Corner Points)

	1	2	3	4
x	0.53	0.51	0.455	0.472
y	0.456	0.485	0.444	0.4

The initial daytime chromaticity of white materials shall fall within the box created by the following coordinates:

Initial Daytime Chromaticity Coordinates (Corner Points)

	1	2	3	4
x	0.355	0.305	0.285	0.355
y	0.355	0.305	0.325	0.375

907-710.06.2--Environmental Requirements. All yellow materials using lead chromate pigments shall meet the criteria of non-hazardous waste as defined by 40 CFR 261.24 when tested in accordance with EPA Test Method 1311, Toxicity Characteristics Leaching Procedures (TCLP). The striping and marking material , upon preparation and installation, shall not exude fumes which are toxic, or detrimental to persons or property. All material using lead free pigments shall NOT contain either lead or other Resource Conservation and Recovery Act (RCCA) materials in excess of the standard defined by EPA Method 3050 and 6010.

907-710.06.3--Acceptance Procedures. Acceptance of all fast dry solvent based traffics paint will be based on the Manufacturer's Certification and Certified Test Results. The Contractor shall furnish the Engineer with three copies of the manufacturer's certification stating that each lot of material in a shipment complies with the requirements of this contract. In addition, the Contractor shall provide Certified Test Reports for all tests required by this specification. The test results shall be representative of the material contained with the shipment.

MISSISSIPPI DEPARTMENT OF TRANSPORTATION

SPECIAL PROVISION NO. 907-720-2

CODE: (IS)

DATE: 05/01/2013

SUBJECT: Pavement Marking Materials

Section 720, Pavement Marking Materials, of the 2004 Edition of the Mississippi Standard Specifications for Road and Bridge Construction is hereby amended as follows.

907-720.01--Glass Beads. After the first sentence of Subsection 720.01 on page 729, add the following.

The glass beads shall contain no more than 200 ppm (mg/kg) total concentration for lead, arsenic, or antimony. The manufacture shall furnish the Engineer with a certified test report indicating that the glass beads meet the above requirement.

907-720.02--Thermoplastic Pavement Markings. Delete the first paragraph of Subsection 720.02 on page 730 and substitute the following.

The thermoplastic material shall be lead free and conform to AASHTO Designation: M 249 except the glass beads shall be moisture resistant coated.

After the first sentence of the second paragraph of Subsection 720.02 on page 730, add the following.

In addition, the certification for the thermoplastic material shall state that the material is lead free.

MISSISSIPPI DEPARTMENT OF TRANSPORTATION

SPECIAL PROVISIONS NO. 907-823-9

CODE: (SP)

DATE: 04/05/2016

SUBJECT: **Preformed Joint Seal**

Section 907-823, Preformed Joint Seal, is hereby added to and becomes a part of the 2004 Edition of the Mississippi Standard Specifications for Road and Bridge Construction as follows.

SECTION 907-823--PREFORMED JOINT SEAL

907-823.01--Description. This work consists of furnishing and installing preformed joint seals in accordance with these specifications and the details shown in the Plans or drawings provided.

907-823.02--Materials. The Contractor shall furnish a manufacturer's certification stating that the material used meets the requirements of this specification.

The preformed joint seal shall be one of the following, or an approved equal. The size of the seal, Type I or Type II, shall be determined based on the size of the joint opening, as detailed in the Plans or drawings provided. It is the Contractor's responsibility to ensure that the size selected is appropriate for the width of the joint. Type I shall be used for joint openings less than two inches (2"). Type II shall be used for joint openings greater than two inches (2"), with the maximum joint opening being two and one-half inches (2½"). In cases where the joint opening is greater than two and one-half inches (2½"), another type of expansion material shall be required as directed by the Director of Structures, State Bridge Engineer.

1. Silicoflex Joint Sealing System
Manufactured by R.J. Watson, Inc. in Alden, NY
www.rjwatson.com
2. Wabo@SPS Joint System
Manufactured by Watson Bowman Acme Corporation in Amherst, NY
www.wbacorp.com
3. Silspec SSS Silicone Strip Seal
Manufactured by SSI Commercial & Highway Construction Materials in Tulsa, OK
www.ssicm.com

907-823.03--Construction Methods. Preformed joint seals shall be installed in accordance with the manufacturer's recommendations. The material shall seal the deck surface, gutters, and curbs to prevent moisture or other contaminants from leaking through the joints. The joint seal shall be installed in such a manner that the top surface of the material is within the minimum and maximum depths below the roadway or bridge surface recommended by the manufacturer.

Saw cutting for the joint repair shall be accomplished by sawing at the locations and depth shown

on the joint repair detail sheets in the plans or in the contract documents. Saw cuts shall be as near vertical as possible at the saw line of the repair area. The saw cut depth shall be equivalent to the installation depth required by the manufacturer's specifications, and the type specified shall be the same as the type specified for preformed joint seal.

907-823.04--Method of Measurement. Preformed joint seal of the type specified will be measured in linear feet along the length of the centerline joint.

Saw cuts of the type specified will be measured by the linear foot along the length of the bridge deck on each side of the centerline joint.

907-823.05--Basis of Payment. Preformed joint seal, measured as prescribed above, will be paid for at the contract unit price per linear foot, which shall be full compensation for furnishing all labor, equipment, tools, materials, and incidentals necessary to complete the work.

Saw cuts, measured as prescribed above, will be paid for at the contract unit price per linear foot, which shall be full compensation for furnishing all labor, equipment, tools, materials, and incidentals necessary to complete the work.

Payment will be made under:

907-823-A: Preformed Joint Seal, Type ____ - per linear foot

907-823-B: Saw Cut, Type _____ - per linear foot

STATE	PROJECT NO.
MISS.	

NOTES ON ASSOCIATED ITEMS OF WORK:

202-BE98 REMOVAL OF EXISTING JOINT MATERIAL
 Description: Shall include the removal of material associated with armor, slitting rails, and neoprene expansion joints. As designated, it shall be removed from the joint. This item of work shall be included under the item of work unless otherwise directed by the Engineer.
 Basis of Payment: Removal of armor and slitting rails shall be paid for in linear feet at the contract unit price along the length of the bridge deck on each side of the centerline. Removal of neoprene expansion joints shall be paid for as the length along the centerline of the joint.

808-A001 JOINT PREPARATION

Description: Shall include the work necessary to repair joints in preparation for the placement of new expansion material. This shall also be included under this item of work. Removal of existing silicone seals, compression, and AC sealed joint material shall be included under this item of work. All other provisions shall be in accordance with the applicable provisions of Section 808 of the Specifications and any other sections specified therein.
 Basis of Payment: The accepted quantities will be paid for in linear feet at the contract unit price along the length of the bridge deck on each side of the centerline joint.

907-BE3-B001 SAW CUT, TYPE I & 907-BE3-B002 SAW CUT, TYPE II

Description: The saw cut depth shall be equivalent to the installation depth required by the manufacturer's specifications. The saw cut type shall be the same as the preformed joint seal selected.
 Basis of Payment: The accepted quantities will be paid for in linear feet at the contract unit price along the length of the bridge deck on each side of the centerline joint.
907-BE3-A001 PREFORMED JOINT SEAL, TYPE I
907-BE3-A002 PREFORMED JOINT SEAL, TYPE II
 Basis of Payment: The accepted quantities will be paid for in linear feet at the contract unit price along the length of the centerline joint.

EPoxy MORTAR AND POLYMER CONCRETE NOTES:

Either Epoxy Mortar or Polymer Concrete May Be Used. Guidelines for Selection of Materials Can Be Found in Section 808 of the Specifications.
GENERAL NOTES:
 1. Specifications Mississippi Standard Specifications For Road And Bridge Construction 2004.
 2. No Change Or Plans Will Be Permitted Except By Written Approval Of The Engineer. All Changes To Design Or Construction Procedure May Be Authorized By The Bridge Engineer Provided Such Changes Will Not Be Caused For Contract Price Adjustment. Proposed Will Be For The Engineer's Approval. All Changes To Design Or Construction Procedure Will Be Paid For Directly And Shall Therefore Be Considered An Assembled Item of Work.

MISSISSIPPI DEPARTMENT OF TRANSPORTATION		WORKING NUMBER
JOINT REPAIR		SHEET NUMBER
ARMORED EXPANSION JOINTS		COUNTY
PROJECT		
DATE	APPROVED	DESIGNED
		BY
		BY
		BY
		BY
		BY
		BY

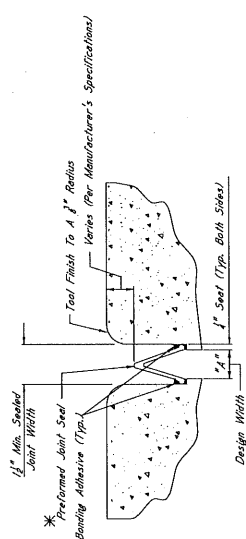
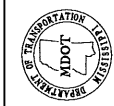

TYPICAL SECTION AT SAWCUT & SEALED JOINT

Showing Sealed Joint After Sawcut And Repair With Epoxy Mortar

*** NOTES:**

- The preformed joint seal shall be one of the following, installed according to the manufacturer's specifications:
 - Silicate Joint Sealing System Manufactured By R.J. Watson, Inc. in Adams, NY www.rjwatson.com
 - Wells SPS Joint System Manufactured By Wells Bowman Acme Corporation in Adams, NY
 - Silicate SPS Epoxy Seal Manufactured By SSI Commercial & Highway Construction Materials www.ssi.com
- For Estimating Purposes, The R.J. Watson Silicate Joint Sealing System Was Selected. However, Should Another Supplier Be Chosen, It Is The Contractor's Responsibility To Verify That The Manufacturer's Installation Depth, And Width, Adhesive Setting Times, And Any Other Dimensions Between The Specifications of the Manufacturer To Ensure That The Contractor Is Properly Scheduled In Installation Of The Joint Material.
- Joints Shall Be Sealed At Their Design Width, Dimension "A", Which Is Defined As Seal Required On Both Sides Of The Joint. Preformed Joint Seal Type I Shall Be Used For Joints With Width Less Than Equal To Design Width. Seal Type II Shall Be Used For Joints In Cases Where Design Width Are Greater Than "A". Another Type Of Expansion Material Shall Be Used Where The Manufacturer's Responsibility To Ensure That The Seal Selected Is Appropriate For The Width Of The Joint.

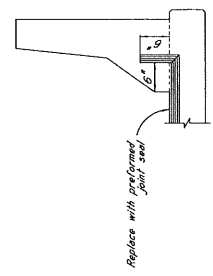

ELEVATION AT END OF SPAN

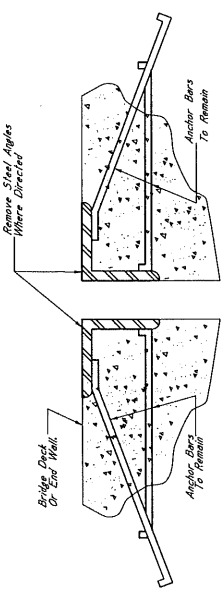

TYPICAL SECTION AT EXISTING JOINT

Showing Existing Expansion Device To Be Removed And Replaced With Preformed Joint Seal

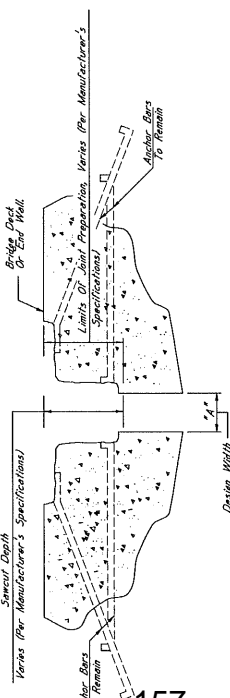

TYPICAL SECTION AT JOINT AFTER REMOVAL OF EXISTING MATERIAL

Showing Limits Of Joint Preparation For Application Of New Joint Seal Material

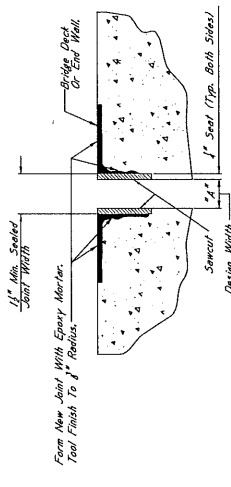

TYPICAL SECTION AT SAWCUT & JOINT REPAIR

Showing Area Where Repairs Are Made After Sawcut With Epoxy Mortar Or Approved Equivalent

STATE	PROJECT NO.
MISS.	

NOTES ON ASSOCIATED ITEMS OF WORK:

202-8238 REMOVAL OF EXISTING JOINT MATERIAL

Description: Shall include the removal of material associated with existing expansion joints, including the removal of existing sealant, washers, and concrete. All material to be removed shall be included under this item unless otherwise directed by the Engineer.

Basis Of Payment: Removal of armor and sliding plate joint material will be paid for in linear feet. At the contract unit price of \$100.00 per linear foot, including the cost of labor, materials, and equipment. Material will only be paid for as the length along the centerline of the joint.

808-4001 JOINT PREPARATION

Description: Shall include the work necessary to rough, joint, in preparation for the placement of new expansion material. As directed in the detail drawings provided, epoxy mortar shall be included under this item of work. Removal of material will not be paid for directly and shall be considered as awarded under this item of work. All other requirements shall be in accordance with the applicable provisions of Section 808 of the specifications and any other sections specified therein.

Basis Of Payment: The accepted quantities will be paid for in linear feet at the contract unit price along the length of the bridge deck on each side of the cantilever joint.

907-823-8001 SAW CUT, TYPE I & 907-823-8002 SAW CUT, TYPE II

Description: The saw cut depth shall be equivalent to the installation depth of the sealant. The saw cut shall be the same as the dimensioned joint seal specified.

Basis Of Payment: The accepted quantities will be paid for in linear feet at the contract unit price along the length of the bridge deck on each side of the cantilever joint.

907-823-4001 PREFORMED JOINT SEAL, TYPE I

907-823-4002 PREFORMED JOINT SEAL, TYPE II

Basis Of Payment: The accepted quantities will be paid for in linear feet at the contract unit price along the length of the cantilever joint.

EPoxy MORTAR AND POLYMER CONCRETE NOTES:

Either Epoxy Mortar or Polymer Concrete may be used. Guidelines for selection of materials can be found in Section 808 of the specifications.

GENERAL NOTES:

1. Specifications: Mississippi Standard Specifications For Road And Bridge Construction, 2004.
2. Approval of the Director of Structures, State Bridge Engineers. Minor changes to detail of design or construction procedure will be authorized by the Bridge Engineers provided such changes do not affect the structural integrity of the work. The proposal will not be paid for directly and shall therefore be considered an assumed item of work.

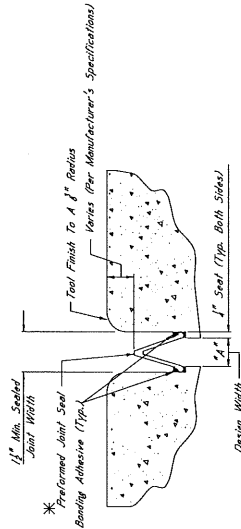

TYPICAL SECTION AT SAWCUT & SEALED JOINT
Showing Sealed Joint After Sawcut And Repair With Epoxy Mortar

***NOTES:**

1. The preformed joint seal shall be one of the following, included according to the manufacturer's specifications:
 - A. Silastic Joint Sealing System, Manufactured By, M. J. Walden, Inc. in Akron, NY
 - B. Wicks 825 Joint Sealant, Manufactured By, Wicks-Bowman Acme Corporation, in Amherst, NY
 - C. Silastic 555 Silicone Strip Seal, Manufactured By, M. J. Walden, Inc. in Akron, NY

2. For epoxy mortar, prepare the joint in accordance with the manufacturer's specifications. It is the contractor's responsibility to ensure that the manufacturer's recommendations are followed. Any other variances between the specifications provided by the manufacturer and the manufacturer's representative shall be presented at the time joint sealing begins.

3. Joints shall be sealed at their design width, dimension "A", which is defined as the actual width of the joint opening. This width does not account for the sealant thickness. The sealant thickness shall be as specified in the manufacturer's specifications. The design width shall be greater than or equal to "A" with the maximum design width shall be as specified in the manufacturer's specifications. It is the contractor's responsibility to ensure that the size selected is appropriate for the width of the joint.

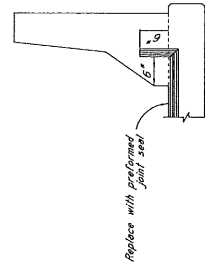

ELEVATION AT END OF SPAN
Replace with preformed joint seal

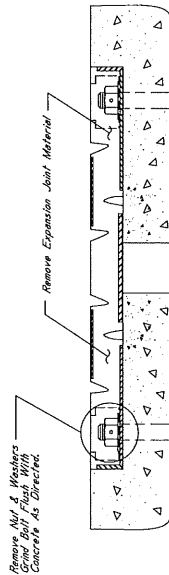

TYPICAL SECTION AT EXISTING JOINT
Showing Existing Expansion Device To Be Removed And Replaced With Preformed Joint Seal

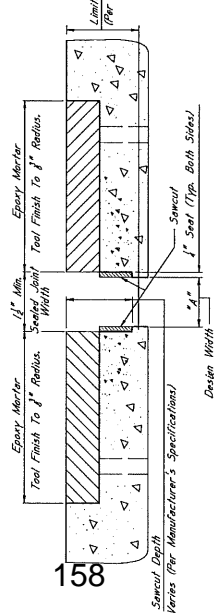

TYPICAL SECTION AT JOINT AFTER REMOVAL OF EXISTING SEAL
Showing Limits Of Joint Preparation For Application Of New Joint Seal Materials

MISSISSIPPI DEPARTMENT OF TRANSPORTATION
JOINT REPAIR
NEOPRENE EXPANSION JOINTS
PROJECT
WORKING NUMBER
COUNTY
SHEET NUMBER



STATE	PROJECT NO.
MSS.	

NOTES ON ASSOCIATED ITEMS OF WORK:
808-4001 JOINT PREPARATION

Description: Shall include the Work Necessary To Repair Joints In Preparation For The Placement Of New Expansion Material, As Designated In The Detail Drawings Provided. Epoxy Mortar Shall Also Be Included Under This Item Of Work. Removal Of Existing Expansion Material From The Joint Shall Be Considered As Assured Under This Item Of Work. All Other Requirements Shall Be As Specified In Section 808 OF THE SPECIFICATIONS AND ANY OTHER SECTIONS SPECIFIED THEREIN.

Basis Of Payment: The Accepted Quantities Will Be Paid For In Linear Feet At The Contract Unit Price Along The Length Of The Bridge Deck On Each Side Of The Centerline Joint.

907-823-8001 SAW CUT, TYPE I & 907-823-8002 SAW CUT, TYPE II

Description: The Saw Cut Depth Shall Be Equivalent To The Installation Depth Required By The Manufacturer's Specifications. The Saw Cut Type Shall Be The Same As The Preformed Joint Seal Selected.

Basis Of Payment: The Accepted Quantities Will Be Paid For In Linear Feet At The Contract Unit Price Along The Length Of The Bridge Deck On Each Side Of The Centerline Joint. It Is The Contractor's Responsibility To Verify The Installation Depth Is Selected Based On The Manufacturer's Recommendations.

907-823-4001 PREFORMED JOINT SEAL, TYPE I
907-823-4002 PREFORMED JOINT SEAL, TYPE II

Basis Of Payment: The Accepted Quantities Will Be Paid For In Linear Feet At The Contract Unit Price Along The Length Of The Centerline Joint.

EPOXY MORTAR AND POLYMER CONCRETE NOTES:
 Either Epoxy Mortar Or Polymer Concrete May Be Used. Guidelines For Selection Of Materials Can Be Found In Section 808 OF THE SPECIFICATIONS.

GENERAL NOTES:

1. Specifications: Mississippi Standard Specifications For Road And Bridge Construction 2004.
2. No Change Of Plans Will Be Permitted Except By Written Approval From The State Bridge Engineer. Any Construction Method Changes To Detail Of Design Or Construction Procedures May Be Authorized By The Bridge Engineer Provided Such Changes Will Not Affect The Performance Of The Joint. The Contractor Will Be Responsible For Obtaining All Necessary Approvals. Work Not To Be Paid For Directly And Shall Therefore Be Considered An Assured Item of Work.
- 3.

MISSISSIPPI DEPARTMENT OF TRANSPORTATION	
JOINT REPAIR	
SILICONE SEALED EXPANSION JOINTS	
PROJECT	
WORKING NUMBER	SHEET NUMBER
COUNTY	
CHECKED: _____ DESIGNED: _____ DRAWN: _____ DATE: _____ BY: _____ STATE BRIDGE ENGINEER - JAMES W. HARRIS, P.E. STATE BRIDGE ENGINEER - JAMES W. HARRIS, P.E.	

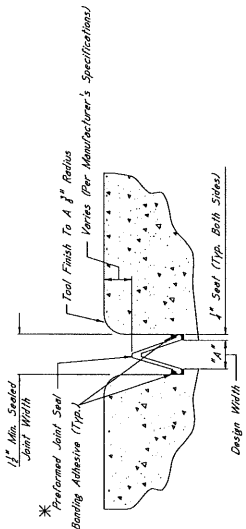

TYPICAL SECTION AT SAWCUT & SEALED JOINT
 Showing Sealed Joint After Sawcut And Repair With Epoxy Mortar

- *NOTES:**
1. The Preformed Joint Seal Shall Be One Of The Following Labeled Accordingly To The Manufacturer's Specifications:
 A. Silicatec Joint Sealing System Manufactured By H.J. Watson, Inc. In Alton, NY
 B. Wipac Joint Seal System Manufactured By Wipac, Inc. In Alton, NY
 C. Silicac SSS Silicone Strip Seal Manufactured By SSI Commercial & Highway Construction Materials www.ssi.com
 2. The Contractor Shall Be Responsible For Obtaining All Necessary Approvals From The State Bridge Engineer. Any Construction Method Changes To Detail Of Design Or Construction Procedures May Be Authorized By The Bridge Engineer Provided Such Changes Will Not Affect The Performance Of The Joint. The Contractor Will Be Responsible For Obtaining All Necessary Approvals. Work Not To Be Paid For Directly And Shall Therefore Be Considered An Assured Item of Work.
 3. Joints Shall Be Sealed At Their Design Width, Dimension "A", Which Is Defined As The Actual Width Of The Joint Opening. This Width Does Not Account For The Saw Cut Depth. The Seal Width Shall Be As Specified In The Manufacturer's Specifications. The Seal Width Shall Be As Specified In The Manufacturer's Specifications. The Seal Width Shall Be As Specified In The Manufacturer's Specifications. The Seal Width Shall Be As Specified In The Manufacturer's Specifications.

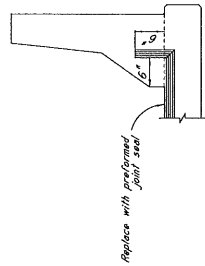

ELEVATION AT END OF SPAN
 Replace with preformed joint seal

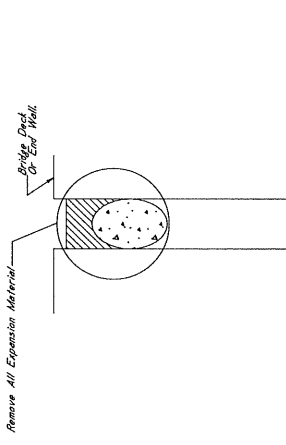

TYPICAL SECTION AT EXISTING JOINT
 Showing Existing Expansion Materials To Be Removed And Replaced With Preformed Joint Seal

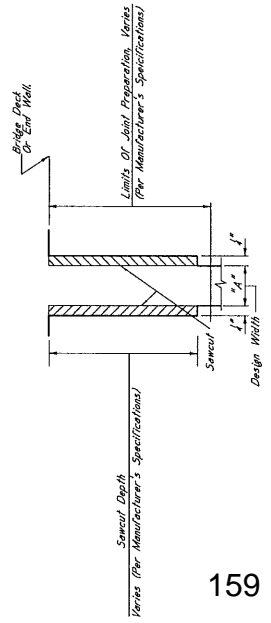

TYPICAL SECTION AT JOINT AFTER REMOVAL OF EXISTING SEAL
 Showing Limits Of Joint Preparation, Epoxy Mortar Application Of New Joint Seal Materials

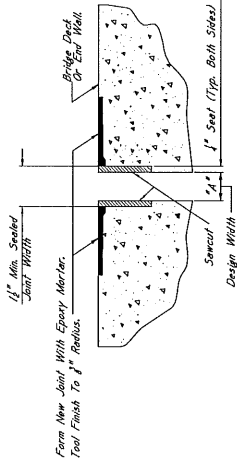

TYPICAL SECTION AT SAWCUT & JOINT REPAIR
 Showing Area Where Repairs Are Made After Sawcut With Epoxy Mortar Or Approved Equivalent

STATE	PROJECT NO.
MISS.	

NOTES ON ASSOCIATED ITEMS OF WORK

808-1001 JOINT PREPARATION

Description:

Shall include the work necessary to repair joints in preparation for the placement of new expansion material, as designed in the detail drawings. Epoxy Mortar shall be used for all repairs. The use of any other materials will not be paid for. Directly and AC Sealed Joint Materials shall be used for all repairs. All other materials shall be used at the discretion of the contractor. The contractor shall be responsible for ensuring that the repair depth is specified in the specifications and any other sections specified therein.

Basis of Payment:

The Accepted Quantities Will Be Paid For In Linear Feet At The Contract Unit Price Along The Length Of The Bridge Deck On Each Side Of The Centerline Joint.

907-823-8001 SAW CUT, TYPE I & 907-823-8002 SAW CUT, TYPE II

The Saw Cut Depth Shall Be Equivalent To The Installation Depth Required By The Manufacturer's Specifications. The Saw Cut Type Shall Be The Same As The Prefabricated Joint Seal Selected.

Basis of Payment:

The Accepted Quantities Will Be Paid For In Linear Feet At The Contract Unit Price Along The Length Of The Bridge Deck On Each Side Of The Centerline Joint. The Contractor's Responsibility To Ensure That The Repair Depth Is Specified Based On The Manufacturer's Recommendations.

907-823-1001 PREFORMED JOINT SEAL, TYPE I

The Accepted Quantities Will Be Paid For In Linear Feet At The Contract Unit Price Along The Length Of The Centerline Joint.

907-823-1002 PREFORMED JOINT SEAL, TYPE II

The Accepted Quantities Will Be Paid For In Linear Feet At The Contract Unit Price Along The Length Of The Centerline Joint.

EROPY MORTAR AND POLYMER CONCRETE NOTES:

The Contractor Shall Be Responsible For Obtaining All Necessary Permits For The Use Of Epoxy Mortar And Polymer Concrete. The Contractor Shall Be Responsible For Obtaining All Necessary Permits For The Use Of Epoxy Mortar And Polymer Concrete.

GENERAL NOTES:

1. See Specifications, Mississippi Standard Specifications For Road And Bridge Construction, 2004.
2. No Change Of Plans Will Be Permitted Except By Written Approval Of The Director Of Structures, State Bridge Engineer.
3. The Contractor Shall Be Responsible For Obtaining All Necessary Permits For The Use Of Epoxy Mortar And Polymer Concrete. The Contractor Shall Be Responsible For Obtaining All Necessary Permits For The Use Of Epoxy Mortar And Polymer Concrete. The Contractor Shall Be Responsible For Obtaining All Necessary Permits For The Use Of Epoxy Mortar And Polymer Concrete. The Contractor Shall Be Responsible For Obtaining All Necessary Permits For The Use Of Epoxy Mortar And Polymer Concrete.

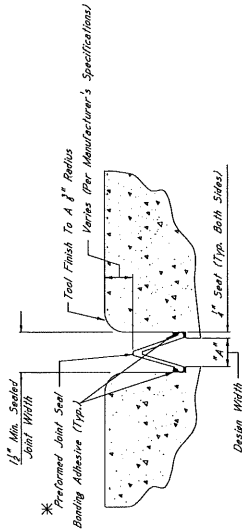

TYPICAL SECTION AT SAWCUT & SEALED JOINT

Showing Sawcut Joint After Sawcut And Repair With Epoxy Mortar

***NOTES:**

1. The Prefabricated Joint Seal Shall Be One Of The Following, Installed According To The Manufacturer's Specifications:
 - A. Silcoflex Joint Sealing System
www.silcoflex.com
 - B. Wika SPS Joint System
Manufactured By Wika-Bonman Acme Corporation In Amherst, NY
www.wikaepc.com
 - C. Silplex SSS Silicone Strip Seal
Manufactured By SSI Commercial & Highway Construction Materials
2. For Each Manufacturer, The Bidder Shall Specify Joint Seal Type, Surface Preparation, and the Manufacturer's Recommendations. It Is The Contractor's Responsibility To Ensure That The Manufacturer's Recommendations Are Followed. The Contractor Shall Be Responsible For Obtaining All Necessary Permits For The Use Of Epoxy Mortar And Polymer Concrete. The Contractor Shall Be Responsible For Obtaining All Necessary Permits For The Use Of Epoxy Mortar And Polymer Concrete. The Contractor Shall Be Responsible For Obtaining All Necessary Permits For The Use Of Epoxy Mortar And Polymer Concrete.
3. Joints Shall Be Sealed At Their Design Widths, Dimension "A", Which Is Defined As The Actual Width Of The Joint, Opening, Groove, or Channel. The Contractor Shall Be Responsible For Obtaining All Necessary Permits For The Use Of Epoxy Mortar And Polymer Concrete. The Contractor Shall Be Responsible For Obtaining All Necessary Permits For The Use Of Epoxy Mortar And Polymer Concrete. The Contractor Shall Be Responsible For Obtaining All Necessary Permits For The Use Of Epoxy Mortar And Polymer Concrete.

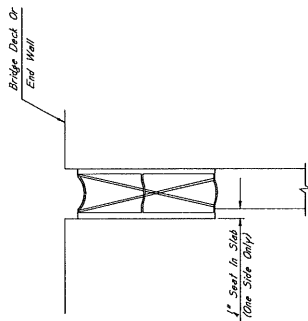

TYPICAL SECTION AT EXISTING JOINT

Showing Existing Expansion Device To Be Removed And Replaced With Prefabricated Joint Seal

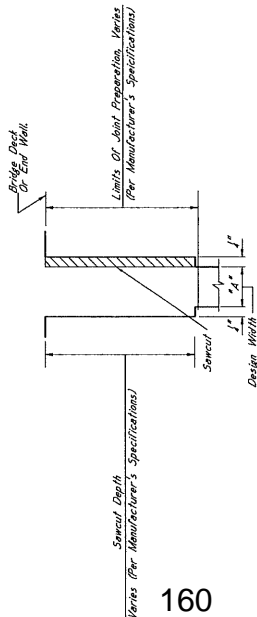

TYPICAL SECTION AT JOINT AFTER REMOVAL OF EXISTING SEAL

Showing Limits Of Joint Preparation For Application Of New Joint Seal Materials

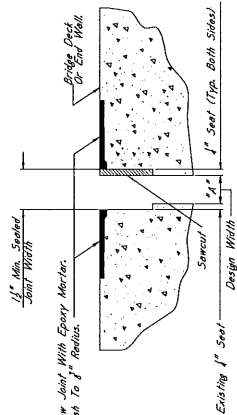

TYPICAL SECTION AT SAWCUT & JOINT REPAIR

Showing Area Where Repairs Are Made After Sawcut With Epoxy Mortar Or Approved Equivalent

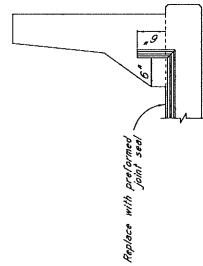

ELEVATION AT END OF SPAN



MISSISSIPPI DEPARTMENT OF TRANSPORTATION	
JOINT REPAIR	
COMPRESSION EXPANSION JOINTS	
PROJECT	
COUNTY	WORKING NUMBER
CHARTER	SHEET NUMBER
DATE	
BY	
FOR DIRECTOR OF STRUCTURES, MISSISSIPPI DEPARTMENT OF TRANSPORTATION	

STATE	PROJECT NO.
MISS.	

NOTES ON ASSOCIATED ITEMS OF WORK:

202-8238 REMOVAL OF EXISTING JOINT MATERIAL

Description: Shall include the removal of material associated with existing joints. The joint preparation shall be completed in accordance with the joint preparation specifications. The joint preparation shall be completed in accordance with the joint preparation specifications. The joint preparation shall be completed in accordance with the joint preparation specifications.

Basis Of Payment: Removal of armor and sliding plate joint material will be paid for in linear feet. At the contract unit price along the length of the bridge deck on each side of the material will only be paid for as the length along the centerline of the joint.

808-4001 JOINT PREPARATION

Description: Shall include the work necessary to repair joints in concrete. The joint preparation shall be completed in accordance with the joint preparation specifications. The joint preparation shall be completed in accordance with the joint preparation specifications. The joint preparation shall be completed in accordance with the joint preparation specifications.

Basis Of Payment: The accepted quantities will be paid for in linear feet. At the contract unit price along the length of the bridge deck on each side of the centerline joint.

907-823-8001 SAW CUT, TYPE I & 907-823-8002 SAW CUT, TYPE II

Description: The saw cut depth shall be equivalent to the installation depth required by the manufacturer's specifications. The saw cut type shall be the same as the preformed joint seal selected. The accepted quantities will be paid for in linear feet. At the contract unit price along the length of the bridge deck on each side of the centerline joint.

907-823-4001 PREFORMED JOINT SEAL, TYPE I

Basis Of Payment: The accepted quantities will be paid for in linear feet. At the contract unit price along the length of the centerline joint.

907-823-4002 PREFORMED JOINT SEAL, TYPE II

Basis Of Payment: The accepted quantities will be paid for in linear feet. At the contract unit price along the length of the centerline joint.

EPoxy MORTAR AND POLYMER CONCRETE NOTES:

- 1. Specifications: Mississippi Standard Specifications For Road Construction, Section 202-8238.
- 2. No Change Of Plans Will Be Permitted Except By Written Approval Of The Director Of Structures, State Bridge Engineer. Major Changes To Details Of Bridge Or Construction Processes Will Not Be Cause For Contract Price Adjustment.
- 3. Work For Which No Pay Item Is Provided In The Proposal Will Be Paid For At The Contract Unit Price Therefor Be Considered An Associated Item Of Work.

GENERAL NOTES:

- 1. Specifications: Mississippi Standard Specifications For Road Construction, Section 202-8238.
- 2. No Change Of Plans Will Be Permitted Except By Written Approval Of The Director Of Structures, State Bridge Engineer. Major Changes To Details Of Bridge Or Construction Processes Will Not Be Cause For Contract Price Adjustment.
- 3. Work For Which No Pay Item Is Provided In The Proposal Will Be Paid For At The Contract Unit Price Therefor Be Considered An Associated Item Of Work.

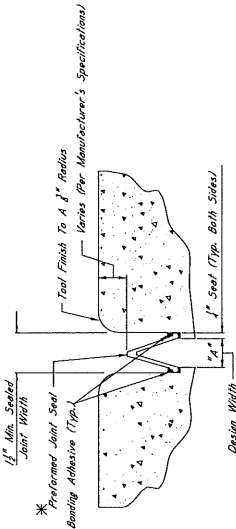

TYPICAL SECTION AT SAWCUT & SEALED JOINT
Showing Sealed Joint After Sawcut And Repair With Epoxy Mortar

* NOTES:
1. The Preformed Joint Seal Shall Be One Of The Following, Included According To The Manufacturer's Specifications:

- A. Silcoflex Joint Sealing System Manufactured By R.J. Watson, Inc. In Aloha, NY www.rjwatson.com
- B. Mds 575 Joint Sealing System Manufactured By Mds Polymer Systems In Amherst, NY www.mdsps.com
- C. Silcoflex SSS Silicone Strip Seal Manufactured By SSS Commercial & Highway Construction Materials www.sss.com

For Estimating Purposes, The R.J. Watson Silcoflex Joint Sealing System Manufacturer's Recommendations Are Followed For Joint Preparation, Installation Details And Weights. Adhesive Sealing Time, And A Manufacturer Representative Shall Be Present At The Time Joint Sealing Begins To Ensure That The Contractor Is Properly Schooled In Installation Of The Joint Material.

2. For Estimating Purposes, The R.J. Watson Silcoflex Joint Sealing System Manufacturer's Recommendations Are Followed For Joint Preparation, Installation Details And Weights. Adhesive Sealing Time, And A Manufacturer Representative Shall Be Present At The Time Joint Sealing Begins To Ensure That The Contractor Is Properly Schooled In Installation Of The Joint Material.

3. Joint Seal Width Of The Joint Design Width Does Not Exceed 1/2" Which Is Defined As Seal Applied On Both Sides Of The Joint. Preformed Joint Seal, Type I, Shall Be For Design Widths Greater Than Or Equal To 2" With The Maximum Design Width Being 2". In Cases Where Design Widths Are Greater Than 2", The Joint Seal Shall Be Selected In Accordance With The Manufacturer's Recommendations To Ensure That The Seal Selected Is Appropriate For The Width Of The Joint.

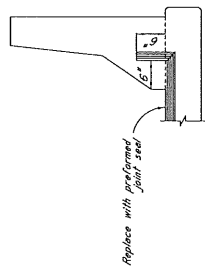

ELEVATION AT END OF SEAL

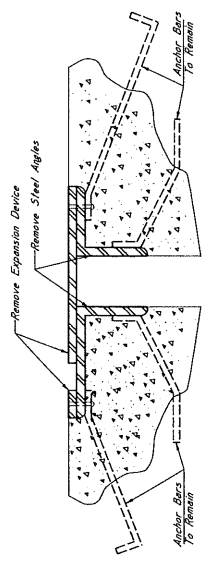

TYPICAL SECTION AT EXISTING JOINT
Showing Existing Expansion Device To Be Removed And Replaced With Preformed Joint Seal

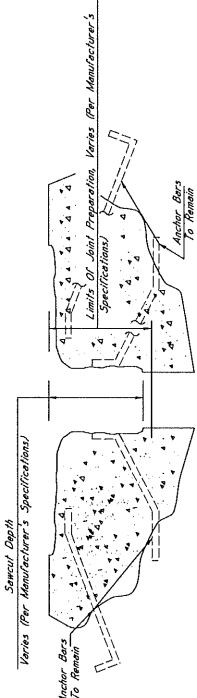

TYPICAL SECTION AT JOINT AFTER REMOVAL OF EXISTING SEAL
Showing Limits Of Joint Preparation, Application Of New Joint Seal Material

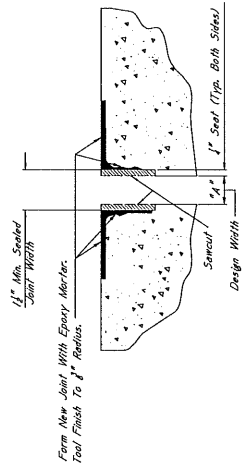

TYPICAL SECTION AT SAWCUT & JOINT REPAIR
Showing Repair With Epoxy Mortar Or Approved Equivalent

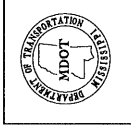

MISSISSIPPI DEPARTMENT OF TRANSPORTATION	
JOINT REPAIR	
SLIDING PLATE EXPANSION JOINTS	
PROJECT	
DATE	WORKING NUMBER
DESIGNED BY	COUNTY
CHECKED BY	
DATE	SHEET NUMBER

STATE	PROJECT NO.
MESS.	

NOTES ON ASSOCIATED ITEMS OF WORK:

808-1001 JOINT PREPARATION

Description:

Shall include the work necessary to repair joints in concrete bridge decks. The repair shall be made as designed in the Detail Drawings. Epoxy Mortar shall also be included under this item of work. Removal of old concrete shall be done in accordance with the specifications and shall be considered as associated under this item of work. All other requirements shall be in accordance with the applicable provisions of the specifications and any other sections specified therein.

Basis of Payment:

The Accepted Quantities Will Be Paid For In Linear Feet At Each Side Of The Cantineline Joint.

807-823-8001 SAW CUT, TYPE I

Description:

The Saw Cut Depth Shall Be Established To The Installation Depth Of The Sealant. The Sealant Type Shall Be The Same As The Preformed Joint Seal Specified.

Basis of Payment:

The Accepted Quantities Will Be Paid For In Linear Feet At Each Side Of The Cantineline Joint. It Is The Contractor's Responsibility To Ensure That The Proper Depth Is Selected Based On The Manufacturer's Recommendations.

807-823-1001 PREFORMED JOINT SEAL, TYPE I

Description:

The Accepted Quantities Will Be Paid For In Linear Feet At Each Side Of The Cantineline Joint.

807-823-1002 PREFORMED JOINT SEAL, TYPE II

Description:

The Accepted Quantities Will Be Paid For In Linear Feet At Each Side Of The Cantineline Joint.

EPXY MORTAR AND POLYMER CONCRETE NOTES:

1. Specifications, Mississippi Standard Specifications For Road Construction, shall apply to the use of Epoxy Mortar and Polymer Concrete.
2. No Change Of Place Will Be Permitted Except By Written Approval Of The Director Of Structures, State Bridge Engineer. Minor Changes To Detail Or Design Or Construction Procedure Will Be Permitted Only When Approved In Advance. Such Changes Will Not Be Cause For Contract Price Adjustment.
3. Work For Which No Pay Item Is Provided In The Proposal Will Not Be Paid For Directly And Shall Therefore Be Considered An Associated Item Of Work.

REVISIONS			
DATE			
DESIGNED BY		CHECKED BY	
DRAWN BY		IN CHARGE	
DATE		DATE	

MISSISSIPPI DEPARTMENT OF TRANSPORTATION
 COUNTY PROJECT
 AC SEALED EXPANSION JOINTS
 WORKING NUMBER
 SHEET NUMBER



Remove All Expansion Material From Old Joint.

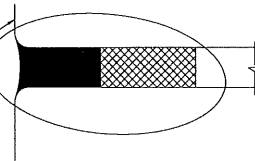

TYPICAL SECTION AT EXISTING JOINT

Showing Existing Expansion Material To Be Removed And Replaced With Preformed Joint Seal

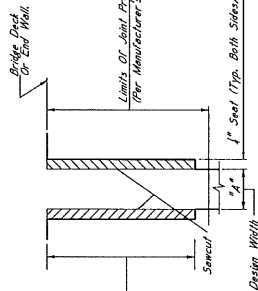

TYPICAL SECTION AT JOINT AFTER REMOVAL OF EXISTING SEAL

Showing Limits of Joint Preparation For Application Of New Joint Seal Material

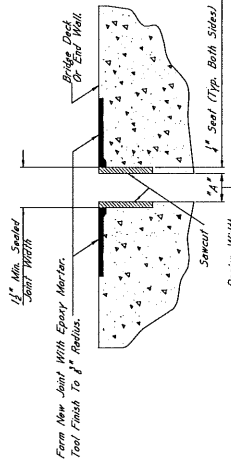

TYPICAL SECTION AT SAWCUT & JOINT REPAIR

Showing Preparation For Application Of Epoxy Mortar, Polymer Concrete, Epoxy Mortar, Or Approved Equivalent

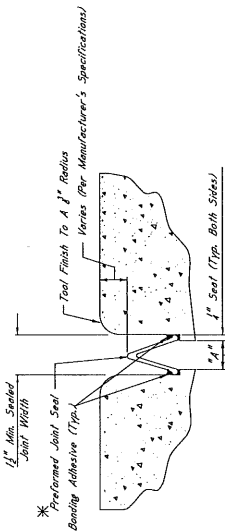

TYPICAL SECTION AT SAWCUT & SEALED JOINT

Showing Sealed Joint After Sawcut And Repair With Epoxy Mortar

*** NOTES:**

1. The Preformed Joint Seal Shall Be One Of The Following, Installed According To The Manufacturer's Specifications:
 - A. Siluxflex Joint Sealing System Manufactured By R.L. Watson, Inc. in Atlanta, NY www.rlwatson.com
 - B. Mega SP2 Joint System Manufactured By SSI Commercial & Highway Construction Materials www.ssi.com
 - C. Silux SSS Silux System Manufactured By R.J. Watson Siluxflex Joint Sealing System, Memphis, TN www.rlwatson.com
2. For Existing Repairs, The R.J. Watson Siluxflex Joint Sealing System Must Be Used. For New Repairs, The Choice Of Sealant Material Shall Be Based On The Manufacturer's Recommendations. For Joint Preparation, Installation Depth, And Widths, Adhesive Setting Time, And Cure Time, The Contractor Shall Refer To The Manufacturer's Recommendations. A Manufacturer Representative Shall Be Present At The Time Joint Sealing Begins To Ensure That The Contractor Is Properly Schooled In Installation Methods.
3. Joints Shall Be Sealed At Their Design Width, Dimension "A", Which Is Defined As Seal Applied On Both Sides Of The Joint. Preformed Joint Seal, Type B, Shall Be Used On Joints Where The Joint Width Is Greater Than 1/2". The Sealant Shall Be Applied On Both Sides Of The Joint. Sealant Shall Be Applied On Both Sides Of The Joint. Sealant Shall Be Applied On Both Sides Of The Joint. Sealant Shall Be Applied On Both Sides Of The Joint. Sealant Shall Be Applied On Both Sides Of The Joint.

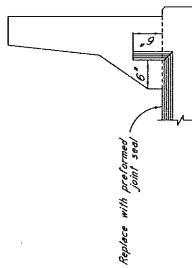

ELEVATION AT END OF SPAN

STATE	PROJECT NO.
MISS.	

NOTES ON ASSOCIATED ITEMS OF WORK:

907-823-9007 BRIDGE REPAIR, ENDWALL REPAIR

Description: Shall include the Work Necessary to Remove and Replace the Damaged Endwall As Designated in the Detail Drawings Provided. Existing Reinforcing Steel Shall Be Removed Along the Entire Width of the Bridge Deck. Existing Reinforcing Steel Shall Be Replaced Along the Entire Width of the Bridge Deck.

Basis of Payment: The Accepted Quantities Will Be Paid For In Linear Feet At The Contract Unit Price Along the Width of the Bridge Deck.

Damage Caused To Other Elements Of The Structure Or Roadway While Completing This Item Of Work Shall Be Repaired By The Contractor At No Cost To The Department.

Prior To Placing New Concrete, All Concrete Surfaces That Will Be In Contact With New Concrete, Or Filled With An Approved Epoxy Resin Grout, Shall Be Sand New Concrete To O.C.

New Concrete Shall Be High Early-Strength Concrete, As Follows:

The concrete mix-ture design shall be furnished by the Contractor for approval by the Materials Division. Mixture design parameters are as follows:

- Required Strength: 2500 psi prior to releasing to traffic
- Total Air Content: 3-6 %
- Maximum Slump: 6 inches

Non-chloride based accelerator may be used if the ambient temperature is 50°F or less, but shall not be used if the ambient temperature is greater than 50°F. Synthetic structural fibers shall be used. The Contractor shall select a manufacturer from MDOT's Approved Products List, and the manufacturer's recommendations shall be followed for the dosage rate.

Curing is to be continuous until 2500 psi is attained. Traffic is to be diverted from the repair area until this value is reached. The Contractor may use the following for the curing of concrete: 1. Covering the concrete with a plastic sheeting. 2. Spraying the concrete with a curing compound. However, final acceptance of the in-place concrete shall be determined using eight concrete test cylinders, which shall be cured in a cabinet next to the repair area. The two remaining cylinders shall be used to determine the 28-day compressive strength of the concrete.

The Removal of Existing Expansion Material May Require Any Number Of The Pay Items Listed Below. Once The Expansion Device Is Identified, Refer To The Corresponding Joint Repair Detail Sheet For Additional Details On The Associated Items Of Work.

- 202-8239 REMOVAL OF EXISTING JOINT MATERIAL
- 907-823-9001 EPOXY PREPARATION
- 907-823-9002 SAW CUT, TYPE I
- 907-823-9001 PREFORMED JOINT SEAL, TYPE I
- 907-823-9002 PREFORMED JOINT SEAL, TYPE II

GENERAL NOTES:

- Specifications: Mississippi Standard Specifications For Road And Bridge Construction, 2004.
- Approval: Of The Director Of Structures, State Bridge Engineer. Minor Changes To Detail Of Design Or Construction Procedure Will Not Be Cause For Contract Price Adjustment. Work For Which No Pay Item Is Provided In The Proposal Will Be Considered An Associated Item of Work.

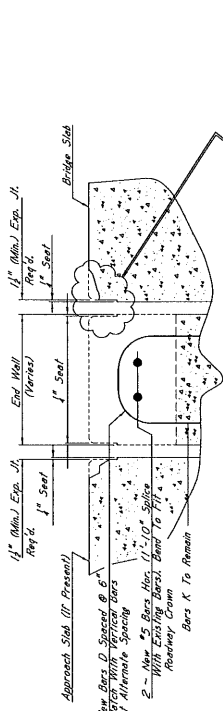

DETAIL 'D'

Showing Repair Details Of End Wall Reinforcing Steel, And Expansion Joint Formation.

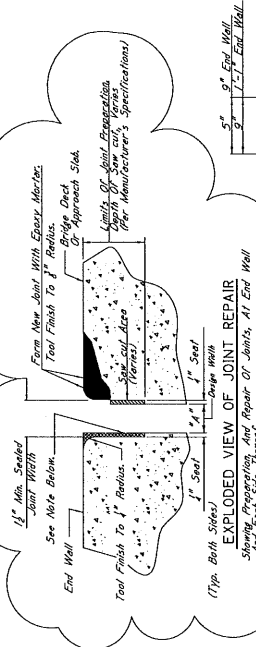

EXPLODED VIEW OF JOINT REPAIR

Showing Vertical Faces Of End Wall To Include 1\"/>

NOTE: Form Vertical Faces Of End Wall To Include 1\"/>

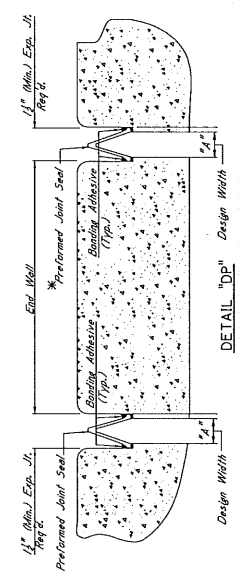

ELEVATION (SECTION A-A)

Showing Details Of Removal Of Damaged End Wall.

***NOTES:**

- Manufacturer's Specification: As Specified Joint Sealing System. www.construction.com
- Web Site: www.construction.com
- Manufacturer's Specification: As Specified Joint Sealing System. www.construction.com
- Web Site: www.construction.com
- Manufacturer's Specification: As Specified Joint Sealing System. www.construction.com
- Web Site: www.construction.com



MISSISSIPPI DEPARTMENT OF TRANSPORTATION	
END WALL REPAIR	
PROJECT	
COUNTY	
WORKING NUMBER	SHEET NUMBER
DATE	ISSUE DATE
DESIGNER	DRAWN
CHECKED	IN CHARGE
BY	DATE

PROJECT NO.
STATE
M.S.S.

NOTES ON ASSOCIATED ITEMS OF WORK:

802-8238 REMOVAL OF EXISTING JOINT MATERIAL
 Description: Shall include the removal of material associated with armor, sliding plates, and neoprene expansion joints, as designated in the detail drawings provided. This item of work shall be performed in accordance with the item of work unless otherwise directed by the Engineer.

Basis Of Payment: Removal of armor and sliding plates, joint material, and neoprene expansion joints shall be paid for in lump sum along the length of the bridge deck on each side of the centerline joint, while removal of neoprene joint material shall be paid for as the length along the centerline of the joint.

808-4001 JOINT PREPARATION

Description: Shall include the work necessary to repair joints in preparation for the placement of new expansion material. This shall include the removal of epoxy mortar, epoxy mortar, and the installation of new epoxy mortar. Existing materials will not be paid for directly and shall be considered as included in the applicable provisions of Section 808 of the Specifications and any other sections specified therein.

Basis Of Payment: The accepted quantities will be paid for in lump sum along the length of the bridge deck on each side of the centerline joint.

907-823-9001 SAW CUT, TYPE I & 907-823-9002 SAW CUT, TYPE II

Description: The saw cut depth shall be equivalent to the installation depth required by the manufacturer's specifications. The saw cut type shall be the same as the preformed joint seal selected.

Basis Of Payment: The accepted quantities will be paid for in lump sum along the length of the bridge deck on each side of the centerline joint.

907-823-4001 PREFORMED JOINT SEAL, TYPE I

Description: The accepted quantities will be paid for in lump sum along the length of the centerline joint.

907-823-4002 PREFORMED JOINT SEAL, TYPE II

Description: The accepted quantities will be paid for in lump sum along the length of the centerline joint.

EPoxy MORTAR AND POLYMER CONCRETE NOTES:
 Either Epoxy Mortar Or Polymer Concrete May Be Used. Guidelines For Selection Of Materials Can Be Found In Section 808 of the Specifications.

GENERAL NOTES:

1. See the Mississippi Standard Specifications For Road And Bridge Construction 2004.
2. No Change Of Plans Will Be Permitted Except By Written Approval Of The Director Of Structures, State Bridge Engineer.
3. Any Change In Material Or Method Of Construction May Be Authorized By The Bridge Engineer Provided Such Changes Will Not Be Cause For Contract Price Adjustment. Work For Which Payment Is Provided In The Proposal Will Not Be Paid Unless It Is Specifically Identified As Contained An Assumed Item Of Work.

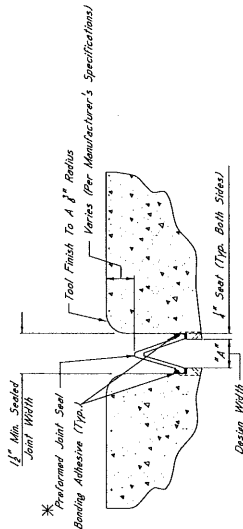

TYPICAL SECTION AT SAWCUT & SEALED JOINT
 Showing Sealed Joint After Sawcut And Repair With Epoxy Mortar.

*** NOTES:**

1. The Preformed Joint Seal Shall Be One Of The Following, Installed According To The Manufacturer's Specifications:
 A. Silicatex Joint Sealing System Manufactured By R.J. Walton, Inc. In Alden, NY
 www.rjwalton.com
 B. Holo 255 Joint Sealing System Manufactured By SSI Commercial & Highway Construction Materials
 www.ssi.com

C. For Estimating Purposes, The R.J. Walton Silicatex Joint Sealing System Was The Responsibility To Ensure That The Manufacturer's Recommendations Are Followed For Joint Preparation, Installation Depth, And Widths, Abrasive Slitting Times, And

Application. Manufacturer Representative Shall Be Present At The Time Joint Sealing Begins To Ensure That The Contractor Is Properly Scheduled In Installation Of The Joint

Seal. The Seal Shall Be Sealed At Their Design Width, Dimension "A" Which Is Defined As The Actual Width Of The Joint Opening. This Width Does Not Account For The Seal Applied On Both Sides Of The Joint. The Preformed Joint Seal Type B Shall Be Used For Design Widths Greater Than Or Equal To 2" With The Maximum Design Width Being 2" In Cases Where Design Widths Are Greater Than 2" Another Strip Seal, State Bridge Engineer, If It Is The Contractor's Responsibility To Ensure That The Seal Selected Is Appropriate For The Width Of The Joint.

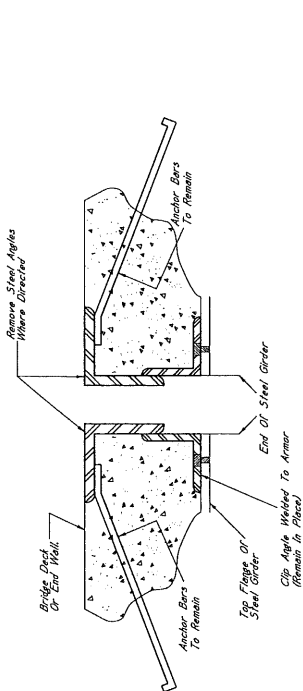

TYPICAL SECTION AT EXISTING JOINT
 Showing Existing With Preformed Joint Seal

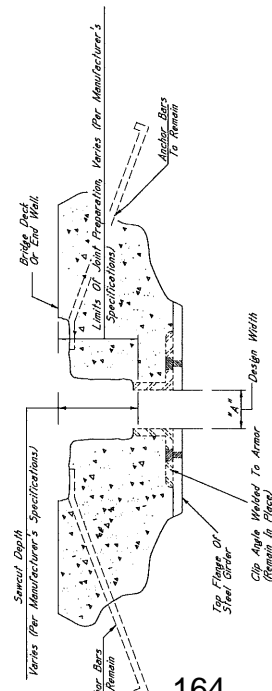

TYPICAL SECTION AT JOINT AFTER REMOVAL OF EXISTING MATERIAL
 Showing Limits Of Joint Preparation For Application Of New Joint Seal Materials

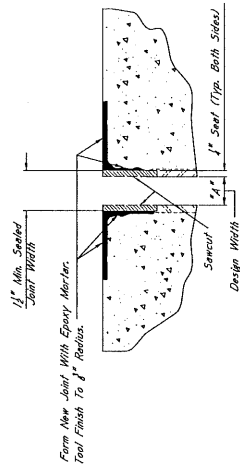

TYPICAL SECTION AT SAWCUT & JOINT REPAIR
 Showing Area Where Repairs Are Made After Sawcut With Epoxy Mortar Or Approved Equivalent



MISSISSIPPI DEPARTMENT OF TRANSPORTATION
 JOINT REPAIR
 ARMORED EXPANSION JOINTS
 STEEL GIRDER SPANS
 PROJECT

COUNTY	WORKING NUMBER
SHEET NUMBER	SHEET NUMBER

STATE	PROJECT NO.
MISS.	

NOTES ON ASSOCIATED ITEMS OF WORK:

202-8238 REMOVAL OF EXISTING JOINT MATERIAL
 Description: Shall include the Removal of Material Associated With Armor, Sliding Plates, and Negative Expansion Joints, as Detailed in the Detail Drawings. Provided, That the Contractor Shall Remove All Material From the Joint Unless Otherwise Directed by the Engineer.
 Basis of Payment: Removal of Armor and Sliding Plate Joint Material Will Be Paid For Along The Length of The Bridge Deck On Each Side of The Centerline Joint, While Removal of Negative Joint Material Will Only Be Paid For As The Length Along The Centerline of The Joint.

808-4001 JOINT PREPARATION
 Description: Shall include the Work Necessary to Repair Joints in Preparation For the Placement of New Expansion Material, As Detailed in the Detail Drawings. Provided, Epoxy Mortar or Existing Silicone Sealant Compression and AC Sealed Joint Materials Will Not Be Paid For Directly and Shall Be Considered as Part of the Work Under Item 808-4002. The Contractor Shall Be in Accordance With the Applicable Provisions of Section 808 of The Specifications and Any Other Sections Accepted Therein.
 Basis of Payment: The Accepted Quantities Will Be Paid For in Linear Feet At The Contract Unit Price Along The Length of The Bridge Deck On Each Side of The Centerline Joint.

907-823-9001 SAW CUT, TYPE I & 907-823-9002 SAW CUT, TYPE II
 Description: The Saw Cut Depth Shall Be Equivalent To The Indicated Depth Required By The Manufacturer's Specifications. The Saw Cut Type Shall Be The Same As The Prefabricated Joint Seal Selected.
 Basis of Payment: The Accepted Quantities Will Be Paid For in Linear Feet At The Contract Unit Price Along The Length of The Bridge Deck On Each Side of The Centerline Joint.

907-823-4001 PREFORMED JOINT SEAL, TYPE I
907-823-4002 PREFORMED JOINT SEAL, TYPE II
 Basis of Payment: The Accepted Quantities Will Be Paid For in Linear Feet At The Contract Unit Price Along The Length of The Centerline Joint.

EPOXY MORTAR AND POLYMER CONCRETE NOTES:
 Either Epoxy Mortar or Polymer Concrete May Be Used. Guidelines For Selection of Materials Can Be Found in Section 808 of The Specifications.

GENERAL NOTES:

- Specifications, Mississippi Standard Specifications For Road and Bridge Construction, shall apply unless otherwise stated.
- Approval of Plans Will Be Permitted Except By Written Approval of The Director of Structures, State Bridge Engineer. Any Changes to Detail of Design or Construction Procedure Will Be Made Only Through the Standard Change Order Process. No Work Will Be Done For Contract Price Adjustment Until the Work For Which No Pay Item is Provided in the Proposal Will Not Be Paid For. The Contractor Shall Be Responsible for the Accuracy of the Plans and Shall Therefore Be Considered as Assured of Them.

MISSISSIPPI DEPARTMENT OF TRANSPORTATION	
JOINT REPAIR	
SLIDING PLATE EXPANSION JOINTS	
STEEL GIRDER SPANS	
PROJECT	COUNTY
WORKING NUMBER	SHEET NUMBER
DATE	
DRAWN BY	CHECKED BY
DESIGNED BY	IN CHARGE
BY DIRECTOR OF STRUCTURES, STATE BRIDGE ENGINEER, 165 ALBANY, MISS.	BY DIRECTOR OF STRUCTURES, STATE BRIDGE ENGINEER, 165 ALBANY, MISS.

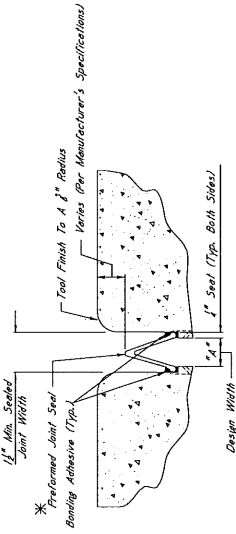

TYPICAL SECTION AT SAWCUT & SEALED JOINT
 Showing Sealed Joint After Sawcut and Repair With Epoxy Mortar.

***NOTES:**

- The Prefabricated Joint Seal Shall Be One of The Following, Installed According to The Manufacturer's Specifications:
 - Elcor, Inc. Joint Expansion System, Manufactured By R.J. Wicks, Inc. in Alton, NY, www.elcor.com
 - Weld SPS Joint System, Manufactured By Wilson Bowman Acme Corporation in Amherst, NY, www.wilsonb.com
 - Sealastic, Manufactured By Sealastic, Inc. in Alton, NY, www.sealastic.com
 - For Estimating Purposes, The R.J. Wicks System Shall Be Used. However, Should Another Supplier Be Chosen, It Is The Contractor's Responsibility to Verify That the Supplier's System Meets the Requirements of the Specifications. For Joint Preparation, Installation Details and Methods, Adhesive, Sealing Times, and Any Other Variables Between the Specifications Provided by The Manufacturer, To Ensure That the Contractor is Properly Substituted in Installation of The Joint Material.
- Joints Shall Be Sealed At Their Design Widths. Dimension "A", Which is Defined As Seal Required on Both Sides of The Joint, Prefabricated Joint Seal Type I Shall Be Used For Design Widths Less Than 2". Prefabricated Joint Seal Type II Shall Be Used For Design Widths Greater Than 2". In Cases Where Design Widths Are Greater Than 2", Another Type of Expansion Material Shall Be Required As Directed By The Director of Structures. Selection of Material is the Responsibility of the Contractor to Ensure that the Seal Selected is Appropriate For the Width of The Joint.

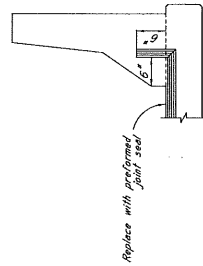

ELEVATION AT END OF SPAN
 Replace with prefabricated joint seal.

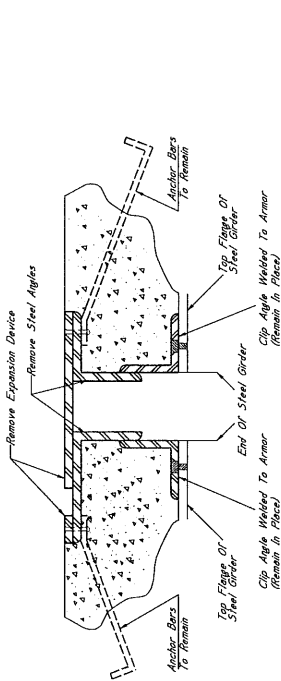

TYPICAL SECTION AT EXISTING JOINT
 Showing Existing Expansion Device to Be Removed and Replaced With Prefabricated Joint Seal.

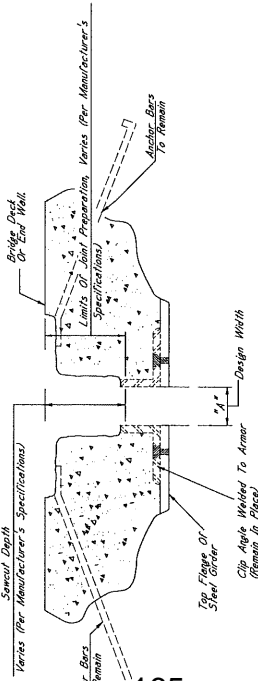

TYPICAL SECTION AT JOINT AFTER REMOVAL OF EXISTING MATERIAL
 Showing Limits of Joint Preparation For Application of New Joint Seal Material.

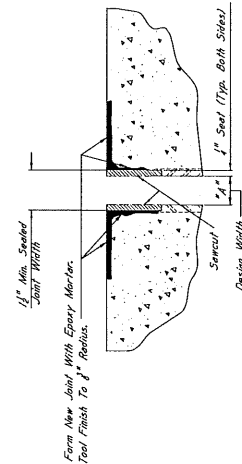

TYPICAL SECTION AT SAWCUT & JOINT REPAIR
 Showing Area Where Repairs Are Made After Sawcut With Epoxy Mortar or Approved Equivalent.

SECTION 905 - PROPOSAL

Date _____

Mississippi Transportation Commission
Jackson, Mississippi

Sirs: The following proposal is made on behalf of _____
_____ of _____

for constructing the following designated project(s) within the time(s) hereinafter specified.

The plans are composed of drawings and blue prints on file in the offices of the Mississippi Department of Transportation, Jackson, Mississippi.

The Specifications are the current Standard Specifications of the Mississippi Department of Transportation approved by the Federal Highway Administration, except where superseded or amended by the plans, Special Provisions and Notice(s) to Bidders attached hereto and made a part thereof.

I (We) certify that I (we) possess a copy of said Standard and any Supplemental Specifications.

Evidence of my (our) authority to submit the Proposal is hereby furnished. The proposal is made without collusion on the part of any person, firm or corporation. I (We) certify that I (we) have carefully examined the Plans, the Specifications, including the Special Provisions and Notice(s) to Bidders, herein, and have personally examined the site of the work. On the basis of the Specifications, Special Provisions, Notice(s) to Bidders, and Plans, I (we) propose to furnish all necessary machinery, tools, apparatus and other means of construction and do all the work and furnish all the materials in the manner specified. I (We) understand that the quantities mentioned herein are approximate only and are subject to either increase or decrease, and hereby propose to perform any increased or decreased quantities of work at the unit prices bid, in accordance with the above.

I (We) acknowledge that this proposal will be found irregular and/or non-responsive unless a certified check, cashier's check, or Proposal Guaranty Bond in the amount as required in the Advertisement (or, by law) is submitted electronically with the proposal or is delivered to the Contract Administration Engineer prior to the bid opening time specified in the advertisement.

INSTRUCTION TO BIDDERS: Alternate and Optional Items on Bid Schedule.

1. Two or more items entered opposite a single unit quantity WITHOUT DEFINITE DESIGNATION AS "ALTERNATE ITEMS" are considered as "OPTIONAL ITEMS". Bidders may or may not indicate on bids the Optional Item proposed to be furnished or performed WITHOUT PREJUDICE IN REGARD TO IRREGULARITY OF BIDS.
2. Items classified on the bid schedule as "ALTERNATE ITEMS" and/or "ALTERNATE TYPES OF CONSTRUCTION" must be preselected and indicated on bids. However, "Alternate Types of Construction" may include Optional Items to be treated as set out in Paragraph 1, above.
3. Optional items not preselected and indicated on the bid schedule MUST be designated in accordance with Subsection 102.06 prior to or at the time of execution of the contract.
4. Optional and Alternate items designated must be used throughout the project.

I (We) further propose to perform all "force account or extra work" that may be required of me (us) on the basis provided in the Specifications and to give such work my (our) personal attention in order to see that it is economically performed.

I (We) further propose to execute the attached contract agreement (Section 902) as soon as the work is awarded to me (us), and to begin and complete the work within the time limit(s) provided for in the Specifications and Advertisement. I (We) also propose to execute the attached contract bond (Section 903) in an amount not less than one hundred (100) percent of the total of my (our) part, but also to guarantee the excellence of both workmanship and materials until the work is finally accepted.

I (We) shall submit electronically with our proposal or deliver prior to the bid opening time a certified check, cashier's check or bid bond for **five percent (5%) of total bid** and hereby agree that in case of my (our) failure to execute the contract and furnish bond within Ten (10) days after notice of award, the amount of this check (bid bond) will be forfeited to the State of Mississippi as liquidated damages arising out of my (our) failure to execute the contract as proposed. It is understood that in case I am (we are) not awarded the work, the check will be returned as provided in the Specifications.

SECTION 905 -- PROPOSAL (CONTINUED)

I (We) hereby certify by digital signature and electronic submission via Bid Express of the Section 905 proposal below, that all certifications, disclosures and affidavits incorporated herein are deemed to be duly executed in the aggregate, fully enforceable and binding upon delivery of the bid proposal. I (We) further acknowledge that this certification shall not extend to the bid bond or alternate security which must be separately executed for the benefit of the Commission. This signature does not cure deficiencies in any required certifications, disclosures and/or affidavits. I (We) also acknowledge the right of the Commission to require full and final execution on any certification, disclosure or affidavit contained in the proposal at the Commission's election upon award. Failure to so execute at the Commission's request within the time allowed in the Standard Specifications for execution of all contract documents will result in forfeiture of the bid bond or alternate security.

Respectfully Submitted,

DATE _____

Contractor

BY _____
Signature

TITLE _____

ADDRESS _____

CITY, STATE, ZIP _____

PHONE _____

FAX _____

E-MAIL _____

(To be filled in if a corporation)

Our corporation is chartered under the Laws of the State of _____ and the names, titles and business addresses of the executives are as follows:

President Address

Secretary Address

Treasurer Address

The following is my (our) itemized proposal.

Overlay approximately 6 miles of SR 26 from White Sands Bridge East, known as State Project No. MP-6026-55(015) / 305799301 in Pearl River County.

Line no.	Item Code	Adj Code	Quantity	Units	Description[Fixed Unit Price]
Roadway Items					
0010	619-A1002		22	Mile	Temporary Traffic Stripe, Continuous White
0020	619-A2002		10	Mile	Temporary Traffic Stripe, Continuous Yellow
0030	619-A4006		9	Mile	Temporary Traffic Stripe, Skip Yellow
0040	619-A6001		625	Linear Feet	Temporary Traffic Stripe, Legend
0050	620-A001		1	Lump Sum	Mobilization
0060	627-J001		180	Each	Two-Way Clear Reflective High Performance Raised Markers
0070	627-L001		370	Each	Two-Way Yellow Reflective High Performance Raised Markers
0080	907-304-F004	(GT)	4,500	Ton	Size 825B Crushed Stone Base
0090	907-403-B016	(BA1)	3,200	Ton	9.5-mm, MT, Asphalt Pavement, Leveling
0100	907-406-A001		625	Square Yard	Cold Milling of Bituminous Pavement, All Depths
0110	907-407-A001	(A2)	5,400	Gallon	Asphalt for Tack Coat
0120	907-411-A003	(BA1)	3,400	Ton	Ultra Thin Asphalt Pavement
0130	907-411-B001	(A2)	5,600	Gallon	Bituminous Tack Coat
0140	907-618-A001		1	Lump Sum	Maintenance of Traffic
0150	907-618-B001		1	Square Feet	Additional Construction Signs (\$10.00)
0160	907-626-C003		11	Mile	6" Thermoplastic Double Drop Edge Stripe, Continuous White
0170	907-626-D003		5	Mile	6" Thermoplastic Traffic Stripe, Skip Yellow
0180	907-626-E004		5	Mile	6" Thermoplastic Traffic Stripe, Continuous Yellow
0190	907-626-G004		1,300	Linear Feet	Thermoplastic Detail Stripe, White
0200	907-626-H004		625	Linear Feet	Thermoplastic Legend, White
0210	907-823-A001		240	Linear Feet	Preformed Joint Seal, Type I

SECTION 905 - COMBINATION BID PROPOSAL (Continued)

CONDITIONS FOR COMBINATION BID

If a bidder elects to submit a combined bid for two or more of the contracts listed for this month's letting, the bidder must complete and execute these sheets of the proposal in each of the individual proposals to constitute a combination bid. In addition to this requirement, each individual contract shall be completed, executed and submitted in the usual specified manner.

Failure to execute this Combination Bid Proposal in each of the contracts combined will be just cause for each proposal to be received and evaluated as a separate bid.

It is understood that the Mississippi Transportation Commission not only reserves the right to reject any and all proposals, but also the right to award contracts upon the basis of lowest separate bids or combination bids most advantageous to the State.

It is further understood and agreed that the Combination Bid Proposal is for comparison of bids only and that each contract shall operate in every respect as a separate contract in accordance with its proposal and contract documents.

I (We) agree to complete each contract on or before its specified completion date.

COMBINATION BID PROPOSAL

This proposal is tendered as one part of a Combination Bid Proposal utilizing option ___* of Subsection 102.11 on the following contracts:

* Option to be shown as either (a), (b), or (c).

	<u>Project No.</u>	<u>County</u>	<u>Project No.</u>	<u>County</u>
1.	_____	_____	6.	_____
2.	_____	_____	7.	_____
3.	_____	_____	8.	_____
4.	_____	_____	9.	_____
5.	_____	_____	10.	_____

(a) If Combination A has been selected, your Combination Bid is complete.

(b) If Combination B has been selected, then complete the following page.

SECTION 905 - COMBINATION BID PROPOSAL (Continued)

Project Number	Pay Item Number	Unit	Unit Price Reduction	Total Item Reduction	Total Contract Reduction
1.					
2.					
3.					
4.					
5.					
6.					
7.					
8.					

For Informational Purposes Only

SECTION 905 - COMBINATION BID PROPOSAL (Continued)

Project Number	Pay Item Number	Unit	Unit Price Reduction	Total Item Reduction	Total Contract Reduction
9.					
10.					

(c) If Combination C has been selected, then initial and complete ONE of the following.

_____ I (We) desire to be awarded work not to exceed a total monetary value of \$ _____.

_____ I (We) desire to be awarded work not to exceed _____ number of contracts.



TO: EXECUTIVE DIRECTOR, MISSISSIPPI DEPARTMENT OF TRANSPORTATION
JACKSON, MISSISSIPPI

CERTIFICATE

If awarded this contract, I (we) contemplate that portions of the contract will be sublet. I (we) certify that those subcontracts which are equal to or in excess of fifty thousand dollars (\$50,000.00) will be in accordance with regulations promulgated and adopted by the Mississippi State Board of Contractors on September 8, 2011.

I (we) agree that this notification of intent DOES NOT constitute APPROVAL of the subcontracts.

_____	_____
(Individual or Firm)	(Address)
_____	_____
(Individual or Firm)	(Address)
_____	_____
(Individual or Firm)	(Address)
_____	_____
(Individual or Firm)	(Address)

NOTE: Failure to complete the above DOES NOT preclude subsequent subcontracts. Subsequent subcontracts, if any, equal to or in excess of fifty thousand dollars (\$50,000.00) will be in accordance with regulations promulgated and adopted by the Mississippi State Board of Contractors on September 8, 2011.

Contractor _____

MISSISSIPPI DEPARTMENT OF TRANSPORTATION
CERTIFICATION

I, _____,
(Name of person signing bid)

individually, and in my capacity as _____ of
(Title of person signing bid)

(Name of Firm, partnership, or Corporation)

do hereby certify under penalty of perjury under the laws of the United States and the State of Mississippi

that _____, Bidder
(Name of Firm, Partnership, or Corporation)

on Project No. **MP-6026-55(015) / 305799301**

in **Pearl River** County(ies), Mississippi, has not either directly or indirectly entered into any agreement, participated in any collusion; or otherwise taken any action in restraint of free competitive bidding in connection with this contract; nor have any of its corporate officers or principal owners.

Except as noted hereafter, it is further certified that said legal entity and its corporate officers, principal owners, managers, auditors and others in a position of administering federal funds are not currently under suspension, debarment, voluntary exclusion or determination of ineligibility; nor have a debarment pending; nor been suspended, debarred, voluntarily excluded or determined ineligible within the past three years by the Mississippi Transportation Commission, the State of Mississippi, any other State or a federal agency; nor been indicted, convicted or had a civil judgment rendered by a court of competent jurisdiction in any matter involving fraud or official misconduct within the past three years.

Do exceptions exist and are made a part thereof? Yes / No

Any exceptions shall address to whom it applies, initiating agency and dates of such action.

Note: Exceptions will not necessarily result in denial of award but will be considered in determining bidder responsibility. Providing false information may result in criminal prosecution or administrative sanctions.

All of the foregoing is true and correct.

(1/2016 S)

SECTION 902

CONTRACT FOR MP-6026-55(015) / 305799301

LOCATED IN THE COUNTY(IES) OF Pearl River

STATE OF MISSISSIPPI,
COUNTY OF HINDS

This contract entered into by and between the Mississippi Transportation Commission on one hand, and the undersigned contractor, on the other witnesseth;

That, in consideration of the payment by the Mississippi Transportation Commission of the prices set out in the proposal hereto attached, to the undersigned contractor, such payment to be made in the manner and at the time of times specified in the specifications and the special provisions, if any, the undersigned contractor hereby agrees to accept the prices stated in the proposal in full compensation for the furnishing of all materials and equipment and the executing of all the work contemplated in this contract.

It is understood and agreed that the advertising according to law, the Advertisement, the instructions to bidders, the proposal for the contract, the specifications, the revisions of the specifications, the special provisions, and also the plans for the work herein contemplated, said plans showing more particularly the details of the work to be done, shall be held to be, and are hereby made a part of this contract by specific reference thereto and with like effect as if each and all of said instruments had been set out fully herein in words and figures.

It is further agreed that for the same consideration the undersigned contractor shall be responsible for all loss or damage arising out of the nature of the work aforesaid; or from the action of the elements and unforeseen obstructions or difficulties which may be encountered in the prosecution of the same and for all risks of every description connected with the work, exceptions being those specifically set out in the contract; and for faithfully completing the whole work in good and workmanlike manner according to the approved Plans, Specifications, Special Provisions, Notice(s) to Bidders and requirements of the Mississippi Department of Transportation.

It is further agreed that the work shall be done under the direct supervision and to the complete satisfaction of the Executive Director of the Mississippi Department of Transportation, or his authorized representatives, and when Federal Funds are involved subject to inspection at all times and approval by the Federal Highway Administration, or its agents as the case may be, or the agents of any other Agency whose funds are involved in accordance with those Acts of the Legislature of the State of Mississippi approved by the Governor and such rules and regulations issued pursuant thereto by the Mississippi Transportation Commission and the authorized Federal Agencies.

The Contractor agrees that all labor as outlined in the Special Provisions may be secured from list furnished by

It is agreed and understood that each and every provision of law and clause required by law to be inserted in this contract shall be deemed to be inserted herein and this contract shall be read and enforced as though it were included herein, and, if through mere mistake or otherwise any such provision is not inserted, then upon the application of either party hereto, the contract shall forthwith be physically amended to make such insertion.

The Contractor agrees that he has read each and every clause of this Contract, and fully understands the meaning of same and that he will comply with all the terms, covenants and agreements therein set forth.

Witness our signatures this the ___ day of _____, _____.

Contractor(s)

By _____

MISSISSIPPI TRANSPORTATION COMMISSION

Title _____

By _____

Signed and sealed in the presence of:
(names and addresses of witnesses)

Executive Director

Secretary to the Commission

Award authorized by the Mississippi Transportation Commission in session on the ___ day of _____, _____, Minute Book No. _____, Page No. _____.

SECTION 903
PERFORMANCE AND PAYMENT BOND

CONTRACT BOND FOR: MP-6026-55(015) / 305799301

LOCATED IN THE COUNTY(IES) OF: Pearl River

STATE OF MISSISSIPPI,
COUNTY OF HINDS

Know all men by these presents: that we, _____

(Contractor)

Principal, a _____

residing at _____ in the State of _____

and _____

(Surety)
residing at _____ in the State of _____,

authorized to do business in the State of Mississippi, under the laws thereof, as surety, effective as of the contract date shown below, are held and firmly bound unto the State of Mississippi in the sum of _____

_____ Dollars, lawful money of the United States of America, to be paid to it for which payment well and truly to be made, we bind ourselves, our heirs, administrators, successors, or assigns jointly and severally by these presents.

The conditions of this bond are such, that whereas the said _____

_____ principal, has (have) entered into a contract with the Mississippi Transportation Commission, bearing the date of _____ day of _____ A.D. _____ hereto annexed, for the construction of certain projects(s) in the State of Mississippi as mentioned in said contract in accordance with the Contract Documents therefor, on file in the offices of the Mississippi Department of Transportation, Jackson, Mississippi.

Now therefore, if the above bounden _____ in all things shall stand to and abide by and well and truly observe, do keep and perform all and singular the terms, covenants, conditions, guarantees and agreements in said contract, contained on his (their) part to be observed, done, kept and performed and each of them, at the time and in the manner and form and furnish all of the material and equipment specified in said contract in strict accordance with the terms of said contract which said plans, specifications and special provisions are included in and form a part of said contract and shall maintain the said work contemplated until its final completion and acceptance as specified in Subsection 109.11 of the approved specifications, and save harmless said Mississippi Transportation Commission from any loss or damage arising out of or occasioned by the negligence, wrongful or criminal act, overcharge, fraud, or any other loss or damage whatsoever, on the part of said principal (s), his (their) agents, servants, or employees in the performance of said work or in any manner connected therewith, and shall be liable and responsible in a civil action instituted by the State at the instance of the Mississippi Transportation Commission or any officer of the State authorized in such cases, for double any amount in money or property, the State may lose or be overcharged or otherwise defrauded of, by reason of wrongful or criminal act, if any, of the Contractor(s), his (their) agents or employees, and shall promptly pay the said agents, servants and employees and all persons furnishing labor, material, equipment or supplies therefor, including premiums incurred, for Surety Bonds, Liability Insurance, and Workmen's Compensation Insurance; with the additional obligation that such Contractor shall promptly make payment of all taxes, licenses, assessments, contributions, damages,

any liquidated damages which may arise prior to any termination of said principal's contract, any liquidated damages which may arise after termination of the said principal's contract due to default on the part of said principal, penalties and interest thereon, when and as the same may be due this state, or any county, municipality, board, department, commission or political subdivision: in the course of the performance of said work and in accordance with Sections 31-5-51 et seq. Mississippi Code of 1972, and other State statutes applicable thereto, and shall carry out to the letter and to the satisfaction of the Executive Director of the Mississippi Department of Transportation, all, each and every one of the stipulations, obligations, conditions, covenants and agreements and terms of said contract in accordance with the terms thereof and all of the expense and cost and attorney's fee that may be incurred in the enforcement of the performance of said contract, or in the enforcement of the conditions and obligations of this bond, then this obligation shall be null and void, otherwise to be and remain in full force and virtue.

_____	_____
(Contractors) Principal	Surety
By _____	By _____
	(Signature) Attorney in Fact
	Address _____

Title _____	_____
(Contractor's Seal)	(Printed) MS Agent

	(Signature) MS Agent
	Address _____

	(Surety Seal)

	Mississippi Insurance ID Number



BID BOND

KNOW ALL MEN BY THESE PRESENTS, that we _____
Contractor

Address

City, State ZIP

As principal, hereinafter called the Principal, and _____
Surety

a corporation duly organized under the laws of the state of _____

as Surety, hereinafter called the Surety, are held and firmly bound unto State of Mississippi, Jackson, Mississippi

As Obligee, hereinafter called Obligee, in the sum of **Five Per Cent (5%) of Amount Bid**

Dollars(\$ _____)

for the payment of which sum will and truly to be made, the said Principal and said Surety, bind ourselves, our heirs, executors, administrators, successors and assigns, jointly and severally, firmly by these presents.

WHEREAS, the Principal has submitted a bid for **Overlay approximately 6 miles of SR 26 from White Sands Bridge East, known as State Project No. MP-6026-55(015) / 305799301 in Pearl River County.**

NOW THEREFORE, the condition of this obligation is such that if the aforesaid Principal shall be awarded the contract, the said Principal will, within the time required, enter into a formal contract and give a good and sufficient bond to secure the performance of the terms and conditions of the contract, then this obligation to be void; otherwise the Principal and Surety will pay unto the Obligee the difference in money between the amount of the bid of the said Principal and the amount for which the Obligee legally contracts with another party to perform the work if the latter amount be in excess of the former, but in no event shall liability hereunder exceed the penal sum hereof.

Signed and sealed this _____ day of _____, 20__

(Witness)

(Principal) (Seal)

By: _____
(Name) (Title)

(Surety) (Seal)

(Witness)

By: _____
(Attorney-in-Fact)

(MS Agent)

Mississippi Insurance ID Number

