

MDOT Use Only

Checked _____

Loaded _____

Keyed _____

04 -



SM No. CBR0059011191

PROPOSAL AND CONTRACT DOCUMENTS

FOR THE CONSTRUCTION OF

04

Bridge Painting on I-59 Bridge Nos. 10993, 10994, 11962 & 11963, known as Federal Aid Project Nos. BR-0059-01(119) / 107567301 & BR-0059-02(109) / 107568301 in Forrest & Jones Counties.

Project Completion: 06/11/2018

(STATE DELEGATED)

NOTICE

**BIDDERS MUST PURCHASE A BID PROPOSAL FROM
MDOT CONTRACT ADMINISTRATION DIVISION TO BID
THIS PROJECT.**

Electronic addendum updates will be posted on www.gomdot.com

SECTION 900

OF THE CURRENT 2017 STANDARD SPECIFICATIONS FOR ROAD AND BRIDGE CONSTRUCTION JACKSON, MISSISSIPPI

**MISSISSIPPI DEPARTMENT OF TRANSPORTATION
TABLE OF CONTENTS**

**PROJECT: BR-0059-01(119) / 107567301 - Forrest
BR-0059-02(109)/107568301 - Jones**

Section 901 - Advertisement

Section 904 - Notice to Bidders

- #1 Governing Specification
- #2 Status of ROW, w/ Attachments
- #7 Disadvantaged Business Enterprise In Federal-Aid Highway Construction, w/
Supplement
- #8 Errata and Modifications to the 2017 Standard Specifications
- #9 Federal Bridge Formula
- #10 DUNS Requirement for Federal Funded Projects
- #12 MASH Compliant Devices
- #115 Standard Drawings
- #249 Contract Time
- #250 Scope of Work
- #296 Reduced Speed Limit Signs

906 Required Federal Contract Provisions -- FHWA 1273, w/Supplements

Section 907 - Special Provisions

- 907-103-2 Award and Execution of Contract
- 907-823-1 Preformed Joint Seal
- 907-845-1 Coating Existing Structural Steel

Section 905 - Proposal, Proposal Bid Items, Combination Bid Proposal

Certification of Performance - Prior Federal-Aid Contracts

Certification Regarding Non-Collusion, Debarment and Suspension

SAM.GOV Registration and DUNS Number

Section 902 - Contract Form

Section 903 - Contract Bond Forms

Form -- OCR-485

(REVISIONS TO THE ABOVE WILL BE INDICATED ON THE SECOND SHEET
OF SECTION 905 AS ADDENDA)

07/26/2017 01:09 PM

MISSISSIPPI DEPARTMENT OF TRANSPORTATION

SECTION 901 - ADVERTISEMENT

Electronic bids will be received by the Mississippi Transportation Commission at 10:00 o'clock A.M., Tuesday, August 22, 2017, from the Bid Express Service and shortly thereafter publicly read on the Sixth Floor For:

Bridge Painting on I-59 Bridge Nos. 10993, 10994, 11962 & 11963, known as Federal Aid Project Nos. BR-0059-01(119) / 107567301 & BR-0059-02(109) / 107568301 in Forrest & Jones Counties.

The attention of bidders is directed to the Contract Provisions governing selection and employment of labor. Minimum wage rates have been predetermined by the Secretary of Labor and are subject to Public Law 87-581, Work Hours Act of 1962, as set forth in the Contract Provisions.

The Mississippi Department of Transportation hereby notifies all bidders that it will affirmatively insure that in any contract entered into pursuant to this advertisement, disadvantaged business enterprises will be afforded full opportunity to submit bids in response to this invitation and will not be discriminated against on the grounds of race, color, sex, age, disability, religion or national origin in consideration for an award.

The award of this contract will be contingent upon the Contractor satisfying the DBE requirements.

The specifications are on file in the offices of the Mississippi Department of Transportation.

Bid proposals must be purchased online at <https://shopmdot.ms.gov>. Specimen proposals may be viewed and downloaded online at no cost at <http://mdot.ms.gov> or purchased online. Proposals are available at a cost of Ten Dollars (\$10.00) per proposal plus a small convenience fee. Cash or checks will not be accepted as payment.

Bid bond, signed or countersigned by a Mississippi Agent or Qualified Nonresident Agent, with Power of Attorney attached, a Cashier's check or Certified Check for five (5%) percent of bid, payable to STATE OF MISSISSIPPI, must accompany each proposal.

The attention of bidders is directed to the provisions of Subsection 102.07 pertaining to irregular proposals and rejection of bids.

MELINDA L. MCGRATH
EXECUTIVE DIRECTOR

MISSISSIPPI DEPARTMENT OF TRANSPORTATION

SECTION 904 - NOTICE TO BIDDERS NO. 1

CODE: (IS)

DATE: 03/01/2017

SUBJECT: Governing Specifications

The current (2017) Edition of the Standard Specifications for Road and Bridge Construction adopted by the Mississippi Transportation Commission is made a part hereof fully and completely as if it were attached hereto, except where superseded by special provisions, or amended by revisions of the Specifications contained within this proposal. Copies of the specification book may be purchased from the MDOT Construction Division, or online at shopmdot/default.aspx?StoreIndex=1.

A reference in any contract document to controlling requirements in another portion of the contract documents shall be understood to apply equally to any revision or amendment thereof included in the contract.

In the event the plans or proposal contain references to the 2004 Edition of the Standard Specifications for Road and Bridge Construction, it is to be understood that such references shall mean the comparable provisions of the 2017 Edition of the Standard Specifications.

MISSISSIPPI DEPARTMENT OF TRANSPORTATION

SECTION 904 - NOTICE TO BIDDERS NO. 2

CODE: (IS)

DATE: 03/01/2017

SUBJECT: Status of Right-of-Way

Although it is desirable to have acquired all rights-of-way and completed all railroad agreements, utility adjustments and work to be performed by others prior to receiving bids, sometimes it is not considered to be in the public interest to wait until each and every such clearance has been obtained. The bidder is hereby advised of possible unacquired rights-of-way, relocations, railroad agreements and utilities adjustments which have not been completed.

The status of right-of-way acquisition, utility adjustments, encroachments, potentially contaminated sites, railroad facilities, improvements, and asbestos contamination are set forth in the following attachments.

In the event right of entry is not available to ALL parcels of right-of-way and/or all work that is to be accomplished by others on the date set forth in the contract for the Notice to Proceed is not complete, the Department will issue a restricted Notice to Proceed.

STATUS OF RIGHT-OF-WAY

BR-0059-01(119)

107567-301000

Forrest County

All rights of way and legal rights of entry have been acquired **except:**

None.

ASBESTOS CONTAMINATION STATUS OF BUILDINGS
TO BE REMOVED BY THE CONTRACTOR

BR-0059-01(119)

107567 - 301000

Forrest County

April 18, 2017

Reference is made to notices to bidders entitled "Asbestos National Emission Standards for Hazardous Air Pollutants (NESHAP)" and "Removal of Obstructions".

The following pertinent information is furnished concerning asbestos containing materials (ACMs), if any, found in buildings to be removed by the Contractor.

There is no Right of Way required for this project. There are no buildings to be removed by the contractor.

STATUS OF POTENTIALLY CONTAMINATED SITES

BR-0059-01(119)

107567-301000

Forrest County

April 18, 2017

THERE IS NO RIGHT OF WAY REQUIRED FOR THIS PROJECT. NO INITIAL SITE ASSESSMENT WILL BE PERFORMED. IF CONTAMINATION ON EXISTING RIGHT OF WAY IS DISCOVERED, IT WILL BE HANDLED BY THE DEPARTMENT.

MISSISSIPPI DEPARTMENT OF TRANSPORTATION
Inter-Departmental Memorandum

TO: Ann Russell
Right of Way Division

DATE: April 14, 2017

FROM: Keith Steele
District Preconstruction Engineer

SUBJECT OR PROJECT NO: BR-0059-01(119)
107567/301000

INFORMATION COPY TO:
File
Trudi Loflin (84-01)

COUNTY: Forrest

ENCROACHMENT CERTIFICATION

This is to certify that the above referenced project has been inspected and there are no encroachments

**STATUS OF UTILITIES
PROJECT NO. BR-0059-01(119) – 107567/301000
FORREST COUNTY**

All work associated with this project is to be done within existing rights-of-way. No conflict with contractor's operations is anticipated.

Forty-eight hours prior commencing any excavation operations the contractor is advised to call MS One-Call at 1 800-227-6477.

ROW STATUS REPORT OF AFFECTED RAILROAD FACILITIES

PROJECT EXTERNAL NUMBER: BR-0059-01(119)

PROJECT FMS NUMBER: 107567/301000

TERMINI: I-59 Bridge Painting (10993 and 10994)

COUNTY: Forrest

DATE: April 14, 2017

There are no railroad facilities affected by the above referenced project.

Improvements to be included in Notice to Bidders to be removed by the Construction Contractor
FMS Construction Project No: 107567-301000
External ROW No: BR-0059-01(119)

Parcel No:
Station No:
Property Owner:
Description/Pictures:

NA

STATUS OF RIGHT-OF-WAY

BR-0059-02(109)

107568-301000

Jones County

All rights of way and legal rights of entry have been acquired **except:**

None.

ASBESTOS CONTAMINATION STATUS OF BUILDINGS
TO BE REMOVED BY THE CONTRACTOR

BR-0059-02(109)

107568 - 301000

Jones County

April 18, 2017

Reference is made to notices to bidders entitled "Asbestos National Emission Standards for Hazardous Air Pollutants (NESHAP)" and "Removal of Obstructions".

The following pertinent information is furnished concerning asbestos containing materials (ACMs), if any, found in buildings to be removed by the Contractor.

There is no Right of Way required for this project. There are no buildings to be removed by the contractor.

STATUS OF POTENTIALLY CONTAMINATED SITES

BR-0059-02(109)

107568-301000

Jones County

April 18, 2017

THERE IS NO RIGHT OF WAY REQUIRED FOR THIS PROJECT. NO INITIAL SITE ASSESSMENT WILL BE PERFORMED. IF CONTAMINATION ON EXISTING RIGHT OF WAY IS DISCOVERED; IT WILL BE HANDLED BY THE DEPARTMENT.

MISSISSIPPI DEPARTMENT OF TRANSPORTATION
Inter-Departmental Memorandum

TO: Ann Russell
Right of Way Division

DATE: April 14, 2017

FROM: Keith Steele
District Preconstruction Engineer

SUBJECT OR PROJECT NO: BR-0059-02(109)
107568/301000

INFORMATION COPY TO:
File
Trudi Loflin (84-01)

COUNTY: Jones

ENCROACHMENT CERTIFICATION

This is to certify that the above referenced project has been inspected and there are no encroachments

STATUS OF UTILITIES
PROJECT NO. BR-0059-02(109) – 107568/301000
JONES COUNTY

All work associated with this project is to be done within existing rights-of-way. No conflict with contractor's operations is anticipated.

Forty-eight hours prior commencing any excavation operations the contractor is advised to call MS One-Call at 1 800-227-6477.

ROW STATUS REPORT OF AFFECTED RAILROAD FACILITIES

PROJECT EXTERNAL NUMBER: BR-0059-02(109)

PROJECT FMS NUMBER: 107568/301000

TERMINI: I-59 Bridge Painting (11962 and 11963)

COUNTY: Jones

DATE: April 14, 2017

There are no railroad facilities affected by the above referenced project.

Improvements to be included in Notice to Bidders to be removed by the Construction Contractor
FMS Construction Project No: 107568-301000
External ROW No: BR-0059-02(109)

Parcel No:
Station No:
Property Owner:
Description/Pictures:

NA

MISSISSIPPI DEPARTMENT OF TRANSPORTATION

SUPPLEMENT TO NOTICE TO BIDDERS NO. 7

DATE: 01/17/2017

The goal is 0 percent for the Disadvantaged Business Enterprise. The low bidder is required to submit Form OCR-481 for all DBEs. Bidders are advised to check the bid tabulation link for this project on the MDOT website at:

<http://sp.gomdot.com/Contract%20Administration/BidSystems/Pages/letting%20calendar.aspx>

Bid tabulations are usually posted by 3:00 pm on Letting Day.

MISSISSIPPI DEPARTMENT OF TRANSPORTATION

SECTION 904 - NOTICE TO BIDDERS NO. 7

CODE: (IS)

DATE: 03/01/2017

SUBJECT: Disadvantaged Business Enterprises In Federal-Aid Highway Construction

This contract is subject to the "Moving Ahead for Progress in the 21st Century Act (MAP-21)" and applicable requirements of "Part 26, Title 49, Code of Federal Regulations". Portions of the Act are set forth in this Notice as applicable to compliance by the Contractor and all of the Act, and the MDOT DBE Program, is incorporated by reference herein.

The Department has developed a Disadvantaged Business Enterprise Program that is applicable to this contract and is made a part thereof by reference.

Copies of the program may be obtained from:

Office of Civil Rights
Mississippi Department of Transportation
P. O. Box 1850
Jackson, Mississippi 39215-1850

POLICY

It is the policy of the Mississippi Department of Transportation to provide a level playing field, to foster equal opportunity in all federally assisted contracts, to improve the flexibility of the DBE Program, to reduce the burdens on small businesses, and to achieve that amount of participation that would be obtained in a non-discriminatory market place. In doing so, it is the policy of MDOT that there will be no discrimination in the award and performance of federally assisted contracts on the basis of race, color, sex, age, religion, national origin, or any handicap.

ASSURANCES THAT CONTRACTORS MUST TAKE

MDOT will require that each contract which MDOT signs with a sub-recipient or a Contractor, and each subcontract the Prime Contractor signs with a Subcontractor, includes the following assurances:

“The Contractor, sub-recipient or Subcontractor shall not discriminate on the basis of race, color, national origin, or sex in the performance of this contract. The Contractor shall carry out applicable requirements of 49 CFR 26 in the award and administration of federally assisted contracts. Failure by the Contractor to carry out these requirements is a material breach of this contract, which may result in the termination of this contract or such other remedy as MDOT deems appropriate.”

DEFINITIONS

For purposes of this provision the following definitions will apply:

"Disadvantaged Business" means a small business concern: (a) which is at least 51 percent owned by one or more socially and economically disadvantaged individual(s) or in the case of any publicly owned business, at least 51 percent of the stock of which is owned by one or more socially and economically disadvantaged individual(s); and (b) whose management and daily business operations are controlled by one or more of the socially and economically disadvantaged individual(s) who own it. It is important to note that the business owners themselves must control the operations of the business. Absentee ownership or title ownership by an individual who does not take an active role in controlling the business is not consistent with eligibility as a DBE under CFR 49 Part 26.71.

CONTRACTOR'S OBLIGATION

The Contractor and all Subcontractors shall take all necessary and reasonable steps to ensure that DBE firms can compete for and participate in the performance of a portion of the work in this contract and shall not discriminate on the basis of race, color, national origin, religion or sex. Failure on the part of the Contractor to carry out the DBE requirements of this contract constitutes a breach of contract and after proper notification the Department may terminate the contract or take other appropriate action as determined by the Department.

When a contract requires a zero percent (0%) DBE goal, the Contractor still has the responsibility to take all necessary and reasonable steps to ensure that DBE firms can compete for and participate in the performance of the work in the contract. In this case, all work performed by a certified DBE firm is considered to be a "race neutral" measure and the Department will receive DBE credit towards the overall State goals when the DBE firm is paid for their work. If the Prime Contractor is a certified DBE firm, the Department can receive DBE credit only for the work performed by the Prime Contractor's work force or any work subcontracted to another DBE firm. Work performance by a non-DBE Subcontractor is not eligible for DBE credit.

CONTRACT GOAL

The goal for participation by DBEs is established for this contract in the attached Supplement. The Contractor shall exercise all necessary and reasonable steps to ensure that participation is equal to or exceeds the contract goal.

If the percentage of the contract that is proposed for DBEs is 1% or greater, the Contractor shall agree to meet or exceed the contract goal on the last bid sheet of the proposal.

The apparent lowest responsive bidder shall submit to the Office of Civil Rights Form OCR-481, signed by the Prime Contractor and the DBE Subcontractors, no later than the 3rd business day after opening of the bids.

Form OCR-481 is available on the MDOT website at GoMDOT.com, then Divisions, Civil Rights, Forms, DBE, MDOT Projects, or by calling 601-359-7466.

The OCR-481 Form must contain the following information:

The name and address of each certified DBE Contractor / Supplier;

The Reference Number, percent of work and the dollar amount of each item. If a portion of an item is subcontracted, a breakdown of that item including quantities and unit price must be attached, detailing what part of the item the DBE firm is to perform and who will perform the remainder of the item.

If the DBE Commitment shown on the last bid sheet of the proposal, does not equal or exceed the contract goal, the bidder must submit, to MDOT Contract Administration Division prior to bid opening, information to satisfy the Department that adequate good faith efforts have been made to meet the contract goal.

Failure of the lowest bidder to furnish acceptable proof of good faith efforts, submitted to MDOT Contract Administration Division prior to bid opening, shall be just cause for rejection of the proposal. Award may then be made to the next lowest responsive bidder or the work may be re-advertised.

The following factors are illustrative of matters the Department will consider in judging whether or not the bidder has made adequate good faith effort to satisfy the contract goal.

- (1) Whether the bidder attended the pre-bid meeting that was scheduled by the Department to inform DBEs of subcontracting opportunities;
- (2) Whether the bidder advertised in general circulation, trade association, and minority-focus media concerning the subcontracting opportunities;
- (3) Whether the bidder provided written notice to a reasonable number of specific DBEs that their interest in the contract is being solicited;
- (4) Whether the bidder followed up initial solicitations of interest by contacting DBEs to determine with certainty whether they were interested;
- (5) Whether the bidder selected portions of the work to be performed by DBEs in order to increase the likelihood of meeting the contract goal;
- (6) Whether the bidder provided interested DBEs with adequate information about the plans, specifications and requirements of the contract;
- (7) Whether the bidder negotiated in good faith with interested DBEs and did not reject them as unqualified without sound reasons based on a thorough investigation of their capabilities; and
- (8) Whether the bidder made efforts to assist interested DBEs in obtaining any required bonding or insurance.
- (9) Whether the bidder has written notification to certified DBE Contractors soliciting subcontracting for items of work in the contract.
- (10) Whether the bidder has a statement of why an agreement was not reached.

The bidder’s execution of the signature portion of the proposal shall constitute execution of the following assurance:

The bidder hereby gives assurance pursuant to the applicable requirements of "Moving Ahead for Progress in the 21st Century Act (MAP-21)" and applicable requirements of "Part 26, Title 49, Code of Federal Regulations" that the bidder has made a good faith effort to meet the contract goal for DBE participation for which this proposal is submitted.

DIRECTORY

A list of “Certified DBE Contractors” which have been certified as such by the Mississippi Department of Transportation and other Unified Certification Partners (UPC) can be found on the Mississippi Department of Transportation website at www.gomdot.com. The list is in the top left corner of the current Letting Calendar under Contracts & Letting. The DBE firm must be certified at the time the project is let and approved by MDOT to count towards meeting the DBE goal.

REPLACEMENT

If a DBE Subcontractor cannot perform satisfactorily, and this causes the OCR-481 commitment to fall below the contract goal, the Contractor shall take all necessary reasonable steps to replace the DBE with another certified DBE Subcontractor or submit information to satisfy the Mississippi Department of Transportation that adequate good faith efforts have been made to replace the DBE. The replacement DBE must be a DBE who was on the Department's list of "Certified DBE Contractors" when the job was let, and who is still active. All DBE replacements must be approved by the Department.

Under no circumstances shall the Prime or any Subcontractor perform the DBE's work (as shown on the OCR-481) without prior written approval from the Department. See "Sanctions" at the end of this document for penalties for performing DBE's work.

When a Contractor proposes to substitute/replace/terminate a DBE that was originally named on the OCR-481, the Contractor must obtain a release, in writing, from the named DBE explaining why the DBE Subcontractor cannot perform the work. A copy of the original DBE's release must be attached to the Contractor's written request to substitute/replace/terminate along with appropriate Subcontract Forms for the substitute/replacement/terminated Subcontractor, all of which must be submitted to the DBE Coordinator and approved, in advance, by MDOT.

GOOD FAITH EFFORTS

To demonstrate good faith efforts to replace any DBE that is unable to perform successfully, the Contractor must document steps taken to subcontract with another certified DBE Contractor. Such documentation shall include no less than the following:

- (1) Proof of written notification to certified DBE Contractors by certified mail that their interest is solicited in subcontracting the work defaulted by the previous DBE or in subcontracting other items of work in the contract.

- (2) If the Prime Contractor is a certified DBE firm, only the value of the work actually performed by the DBE Prime can be counted towards the project goal, along with any work subcontracted to a certified DBE firm.
- (3) If the Contractor is not a DBE, the work subcontracted to a certified DBE Contractor will be counted toward the goal.
- (4) The Contractor may count toward the goal a portion of the total dollar value of a contract with a joint venture eligible under the standards of this provision equal to the percentage of the DBE partner in the joint venture.
- (5) Expenditures to DBEs that perform a commercially useful function may be counted toward the goal. A business is considered to perform a commercially useful function when it is responsible for the execution of a distinct element of the work and carries out its responsibilities by actually performing, managing, and supervising the work involved.
- (6) The Contractor may count 100% of the expenditures for materials and supplies obtained from certified DBE suppliers and manufacturers that produce goods from raw materials or substantially alters them for resale provided the suppliers and manufacturers assume the actual and contractual responsibility for the provision of the materials and supplies. The Contractor may count sixty percent (60%) of the expenditures to suppliers that are not manufacturers, provided the supplier performs a commercially useful function in the supply process. Within 30 days after receipt of the materials, the Contractor shall furnish to the DBE Coordinator invoices from the certified supplier to verify the DBE goal.
- (7) Any work that a certified DBE firm subcontracts or sub-subcontracts to a non-DBE firm will not count towards the DBE goal.
- (8) Only the dollars actually paid to the DBE firm may be counted towards the DBE goal.

Failure of the Contractor to demonstrate good faith efforts to replace a DBE Subcontractor that cannot perform as intended with another DBE Subcontractor, when required, shall be a breach of contract and may be just cause to be disqualified from further bidding for a period of up to 12 months after notification by certified mail.

PRE-BID MEETING

A pre-bid meeting will be held in Amphitheater 1 & 2 of the Hilton Jackson located at I-55 and County Line Road, Jackson, Mississippi at 2:00 P.M. on the day preceding the date of the bid opening.

This meeting is to inform DBE firms of subcontracting and material supply opportunities. Attendance at this meeting is considered of prime importance in demonstrating good faith effort to meet the contract goal.

PARTICIPATION / DBE CREDIT

Participation shall be counted toward meeting the goal in this contract as follows:

- (1) If the Prime Contractor is a certified DBE firm, only the value of the work actually performed by the DBE Prime can be counted towards the project goal, along with any work subcontracted to a certified DBE firm.
- (2) If the Contractor is not a DBE, the work subcontracted to a certified DBE Contractor will be counted toward the goal.
- (3) The Contractor may count toward the goal a portion of the total dollar value of a contract with a joint venture eligible under the standards of this provision equal to the percentage of the DBE partner in the joint venture.
- (4) Expenditures to DBEs that perform a commercially useful function may be counted toward the goal. A business is considered to perform a commercially useful function when it is responsible for the execution of a distinct element of the work and carries out its responsibilities by actually performing, managing, and supervising the work involved.
- (5) The Contractor may count 100% of the expenditures for materials and supplies obtained from certified DBE suppliers and manufacturers that produce goods from raw materials or substantially alters them for resale provided the suppliers and manufacturers assume the actual and contractual responsibility for the provision of the materials and supplies. The Contractor may count sixty percent (60%) of the expenditures to suppliers that are not manufacturers, provided the supplier performs a commercially useful function in the supply process. Within 30 days after receipt of the materials, the Contractor shall furnish to the DBE Coordinator invoices from the certified supplier to verify the DBE goal.
- (6) Any work that a certified DBE firm subcontracts or sub-subcontracts to a non-DBE firm will not count towards the DBE goal.
- (7) Only the dollars actually paid to the DBE firm may be counted towards the DBE goal. The participation of a DBE Firm cannot be counted towards the Prime Contractor's DBE goal until the amount being counted towards the goal has been paid to the DBE.

AWARD

Award of this contract to the low bidder will be contingent upon the following conditions:

- (1) Concurrence from Federal Highway Administration, when applicable.
- (2) Bidder must submit to the Office of Civil Rights for approval, Form OCR-481 (DBE Commitment) no later than the 3rd business day after opening of the bids to satisfy the Department and that adequate good faith efforts have been made to meet the contract goal. For answers to questions regarding Form OCR-481, contact the MDOT Office of Civil Rights at (601) 359-7466.
- (3) Bidder must include OCR-485 information with their bid proposal listing all firms that submitted quotes for material supplies or items to be subcontracted. OCR-485 information

must be included with the bid proposal. If the OCR-485 information is not included as part of bid proposal, your bid will be deemed irregular.

Prior to the start of any work, the bidder must notify the Project Engineer, in writing, of the name of the designated "DBE Liaison Officer" for this project. This notification must be posted on the bulletin board at the project site.

DEFAULT

If the contract goal established by MDOT in this proposal is 1% or greater, it must be met to fulfill the terms of the contract. The Contractor may list DBE Subcontractors and items that exceed MDOT's contract goal, but should unforeseen problems arise that would prevent a DBE from completing its total commitment percentage, the Contractor will meet the terms of the contract as long as it meets or exceeds MDOT's Contract Goal. For additional information, refer to "Replacement" section of this Notice.

DBE REPORTS

- (1) OCR-481: Refer to "CONTRACT GOAL" section of this Notice to Bidders for information regarding this form.
- (2) OCR-482: OCR-482: At the conclusion of the project, before the final estimate is paid and the project is closed out, the Prime Contractor will submit to the Project Engineer for verification of quantities and further handling Form OCR-482 whereby the Contractor certifies to the amounts of payments made to all Contractors / Suppliers over the life of the contract. The Project Engineer shall submit the completed Form OCR-482 to the DBE Coordinator (Office of Civil Rights). Final acceptance of the project is dependent upon Contract Administration Division's receipt of completed Form OCR-482 which they will receive from the Office of Civil Rights.
- (3) OCR-483: The Project Engineer/Inspector will complete Form OCR-483, the Commercially Useful Function (CUF) Performance Report, in accordance with MDOT S.O.P. No. OCR-03-09-01-483. Evaluations reported on this form are used to determine whether or not the DBE firm is performing a CUF. The Prime Contractor should take corrective action when the report contains any negative evaluations. DBE credit may be disallowed and/or other sanctions imposed if it is determined the DBE firm is not performing a CUF. This form should also be completed and returned to the DBE Coordinator (Office of Civil Rights).
- (4) OCR-484: Each month, the Prime Contractor will submit to the Project Engineer OCR-484 that certifies payments to all Subcontractors and shows all firms even if the Prime Contractor has paid no monies to the firm during that estimate period (negative report). The Project Engineer will attach the form to the monthly estimate before forwarding to the Contract Administration Division for further processing. Failure of the Contractor to submit the OCR-484 will result in the estimate not being processed and paid.

- (5) OCR-485: ALL BIDDERS must submit signed form with bid proposal of all firms that submitted quotes for material supplies or items to be subcontracted. If the OCR-485 information is not included as part of bid proposal, the bid will be deemed irregular.
- (6) OCR-487: Only used by Prime Contractors that are certified DBE firms. This form is used in determining the exact percentage of DBE credit for the specified project. It should be returned to MDOT with the OCR-481 form, or can also be returned with the Permission to Subcontract Forms (CAD-720, CAD-725 and CAD-521).

DBE Forms, can be obtained from the Office of Civil Rights Division, MDOT Administration Building, 401 North West Street, Jackson, MS, or at www.gomdot.com under Divisions, Civil Rights, and Forms.

SANCTIONS

The Department has the option to enforce any of the following penalties for failure of the Prime Contractor to fulfill the DBE goal as stated on the OCR-481 form or any violations of the DBE program guidelines:

- (1) Disallow credit towards the DBE goal
- (2) Withhold progress estimate payments
- (3) Deduct from the final estimate or recover an amount equal to the unmet portion of the DBE goal which may include additional monetary penalties as outlined below based on the number of offenses and the severity of the violation as determined by MDOT.

1 st Offense	10% of unmet portion of goal	or	\$5,000 lump sum payment	or	Both
2 nd Offense	20% of unmet portion of goal	or	\$10,000 lump sum payment	or	Both
3 rd Offense	40% of unmet portion of goal	or	\$20,000 lump sum payment	or	\$20,000 lump sum payment and debarment

- (4) Debar the Contractor involved from bidding on MDOT federally funded projects.

MISSISSIPPI DEPARTMENT OF TRANSPORTATION

SECTION 904 - NOTICE TO BIDDERS NO. 8

CODE: (SP)

DATE: 07/19/2017

SUBJECT: Errata and Modifications to the 2017 Standard Specifications

<u>Page</u>	<u>Subsection</u>	<u>Change</u>
16	102.06	In the seventh full paragraph, change “Engineer” to “Director.”
33	105.05.1	In the sixth sentence, change “Contract Administration Engineer” to “Contract Administration Director.”
34	105.05.2.1	In subparagraph 2, change “SWPPP, ECP” to “SWPPP and the ECP”
35	105.05.2.2	In subparagraphs 2, add “ and” to the end of the sentence. In subparagraph 3, remove “, and” and add “.”.
90	109.04.2	In the last paragraph of subparagraph (a), place a period “.” at the end of the sentence.
93	109.04.2	In the last paragraph of subparagraph (g), place a period “.” at the end of the sentence. Also, in the first paragraph of subparagraph (h), place a period “.” at the end of the sentence.
98	109.11	In the third sentence, change “Engineer” to “Director.”
219	308.04	In the last sentence of the last paragraph, change “Contractor’s decision” to “Engineer’s decision.”
300	405.02.5.9	In the first sentence of the second paragraph, change “Hot Mix Asphalt” to “Asphalt Mixtures.”
502	630.01.1	In the first paragraph, change “ <u>AASHTO</u> ” to “ <u>AASHTO’s LRFD</u> ”.
532	642.02.6.6.2	Change the subsection number from “642.02.6.6.2” to “632.02.6.6.2”
532	642.02.6.6.2	Change “Section 661” to “Section 907-661.”
532	632.02.6.6.4	Change “Subsection 663.02.2” to “Subsection 907-663.02.2.”
554	634.05	In the description for 634-A, change “ ___ ’ Pole” to “ ___ ’ Shaft.”

- | | | |
|-----|---------------|---------------------------------------------------------------------------------------------------|
| 688 | 630.03.2 | Change the subsection number from “630.03.2” to “680.03.2.” |
| 725 | 702.08.3 | In the second sentence of the first paragraph, change “hot-mix” to “asphalt.” |
| 954 | 804.02.13.1.6 | In the definition for “M” in the % Reduction formulas, change “paragraph 7.3” to “paragraph 5.3.” |

MISSISSIPPI DEPARTMENT OF TRANSPORTATION

SECTION 904 - NOTICE TO BIDDERS NO. 9

CODE: (IS)

DATE: 03/01/2017

SUBJECT: Federal Bridge Formula

Bidders are hereby advised that the latest revision of Federal Highway Administration Publication No. FHWA-HOP-06-105, **BRIDGE FORMULA WEIGHTS**, dated August 2006, is made a part of this contract when applicable.

Prior to the preconstruction conference, the Contractor shall advise the Engineer, in writing, what materials, if any, will be delivered to the jobsite via Interstate route(s).

Copies of the **BRIDGE FORMULA WEIGHTS** publication may be obtained by contacting:

Federal Highway Administration
400 7th Street, SW
Washington, DC 20590
(202) 366-2212

or

http://www.ops.fhwa.dot.gov/Freight/publications/brdg_frm_wgths/bridge_formula_all_rev.pdf

An on line **BRIDGE FORMULA WEIGHTS CALCULATOR** is available at

http://ops.fhwa.dot.gov/freight/sw/brdgcalc/calc_page.htm

MISSISSIPPI DEPARTMENT OF TRANSPORTATION

SECTION 904 - NOTICE TO BIDDERS NO. 10

CODE: (IS)

DATE: 03/01/2017

SUBJECT: DUNS Requirement for Federal Funded Projects

Bidders are advised that the Prime Contractor must maintain current registrations in the System for Award Management (<http://www.sam.gov>) at all times during this project. A Dun and Bradstreet Data Universal Numbering System (DUNS) Number (<http://www.dnb.com>) is one of the requirements for registration in the System for Award Management.

Bidders are also advised that prior to the award of this contract, they MUST be registered in the System for Award Management.

MISSISSIPPI DEPARTMENT OF TRANSPORTATION

SECTION 904 - NOTICE TO BIDDERS NO. 12

CODE: (IS)

DATE: 03/01/2017

SUBJECT: MASH Compliant Devices

Bidders are hereby advised that the Standard Specifications may require certain traffic control and permanent safety hardware devices to meet the requirements of the Manual for Assessing Safety Hardware (MASH). However, devices meeting the requirements of NCHRP Report 350 will be allowed until the mandatory effective date for MASH compliance. The following table shows the effective dates for MASH compliant devices.

Device	Effective Date for MASH Compliance
W-beam barriers, cast-in-place concrete barriers	December 31, 2017
W-beam terminals	June 30, 2018
Cable barriers, cable barrier terminals, crash cushions	December 31, 2018
Bridge rails, transitions, all other longitudinal barriers including portable barriers installed permanently, all other terminals, sign supports, all other breakaway hardware	December 31, 2019

Temporary work zone devices, including portable barriers manufactured after December 31, 2019, must have been successfully tested to the 2016 Edition of MASH. Such devices manufactured on or before this date and successfully tested to NCHRP Report 350 or the 2009 Edition of MASH may continue to be used throughout their normal service lives.

MISSISSIPPI DEPARTMENT OF TRANSPORTATION

SECTION 904 – NOTICE TO BIDDERS NO. 115

CODE: (SP)

DATE: 04/19/2017

SUBJECT: Standard Drawings

Standard Drawings attached hereto shall govern appropriate items of required work.

Larger copies of Standard Drawings may be purchased from:

MDOT Plans Print Shop
MDOT Shop Complex, Building C, Room 114
2567 North West Street
P.O. Box 1850
Jackson, MS 39215-1850
Telephone: (601) 359-7460
or FAX: (601) 359-7461
or e-mail: plans@mdot.state.ms.us

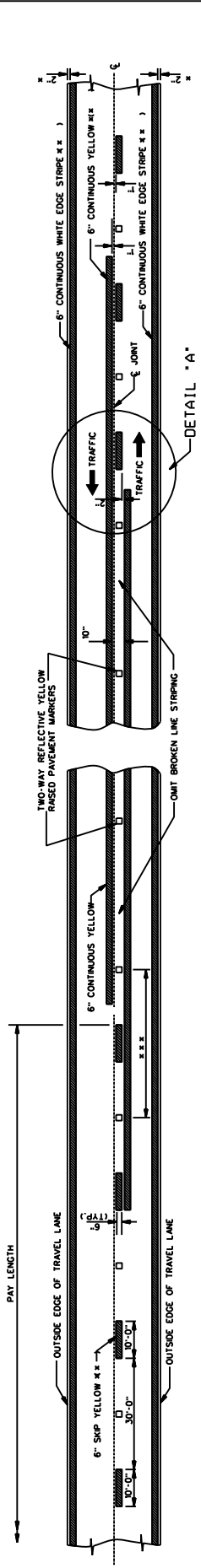

TWO-WAY TRAFFIC
(ASPHALT OR CONCRETE PAVEMENT)

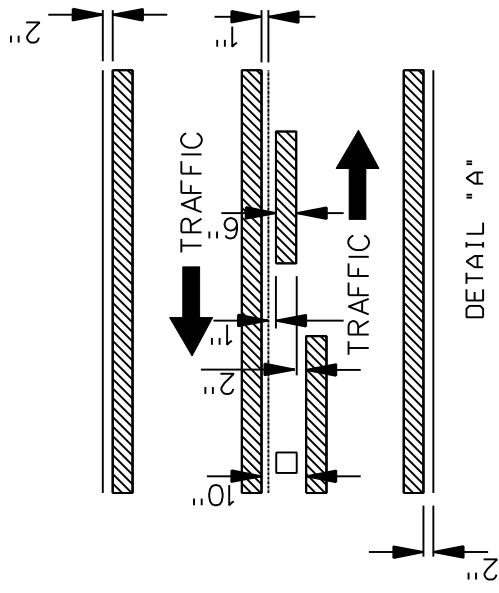

DETAIL "A"

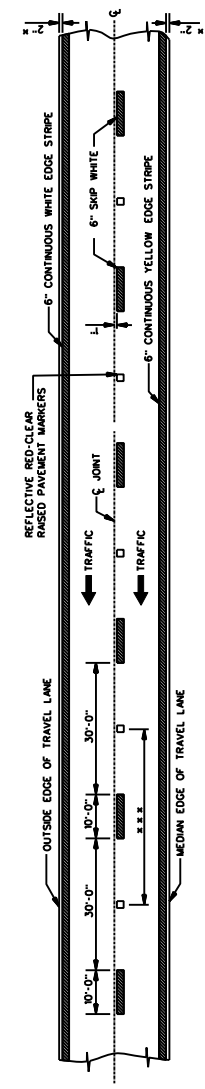

4-LANE WITH ONE-WAY TRAFFIC



GENERAL NOTES:

- * 1. 2" UNLESS SHOWN ELSEWHERE ON THE PLANS.
- ** 2. EDGE STRIPE SHALL BE SAME MATERIAL AS LANE-LINE STRIPE (PAINT OR PLASTIC AS INDICATED IN PAY ITEMS).
- *** 3. SPACING OF REFLECTIVE RAISED PAVEMENT MARKERS IS AS FOLLOWS:

TANGENT SECTIONS	URBAN AREA (U/Lin)	RURAL AREA (U/Lin)
HORIZONTAL CURVES	40'-0"	80'-0"
INTERCHANGE LIMITS	40'-0"	40'-0"
	40'-0"	140'-0"

- 1. NOTES: ON THE MAIN FACILITY, REFLECTIVE RED-CLEAR BASED PAVEMENT MARKERS ON A 40'-0" SPACING WILL BE REQUIRED ON LANE-LINES THROUGH ALL INTERCHANGE AREAS BEGINNING 1000' IN ADVANCE (IN DIRECTION OF TRAFFIC) OF THE EXIT RAMP AND ENDING 1000' FROM THE INTERCHANGE TO THE END OF THE ENTRANCE RAMP TAPER.
- 4. PAVEMENT MARKERS SHALL BE HIGH PERFORMANCE REFLECTIVE RAISED PAVEMENT MARKERS AS LISTED IN THE MOOT "APPROVED SOURCES OF MATERIALS."

Notice To Bidders

MISSISSIPPI DEPARTMENT OF TRANSPORTATION
ROADWAY DESIGN DIVISION
STANDARD PLAN

PAVEMENT MARKING
DETAILS FOR
2-LANE AND 4-LANE
DIVIDED HIGHWAYS

WORK NUMBER: PM-1
SHEET NUMBER: 100

ISSUE DATE: OCTOBER 1, 1998

STATE	PROJECT NO.
MISS.	

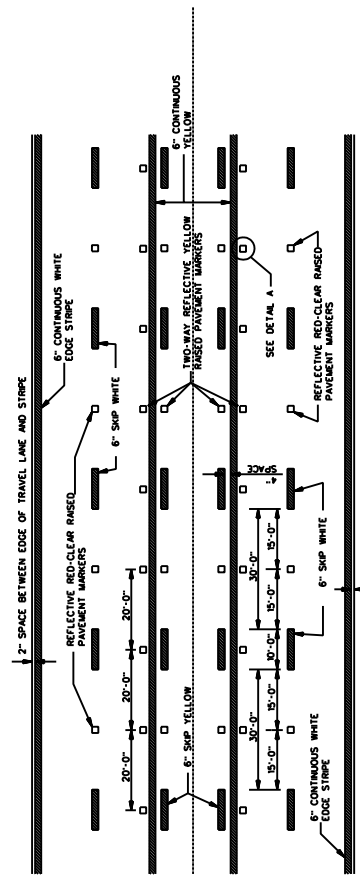

TYPICAL STRIPING AND RAISED PAVEMENT MARKERS FOR 5-LANE SECTION

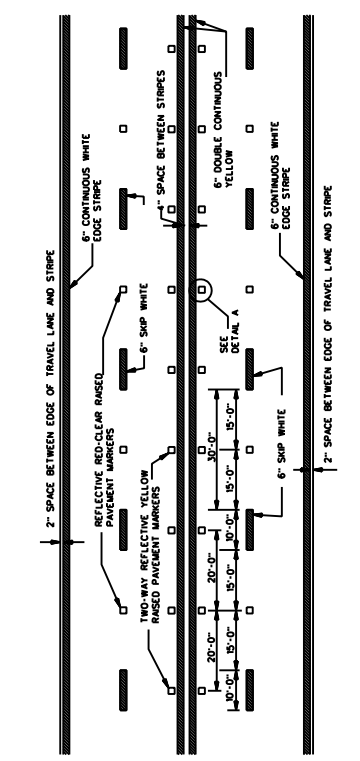

TYPICAL STRIPING AND RAISED PAVEMENT MARKERS FOR 4-LANE SECTION

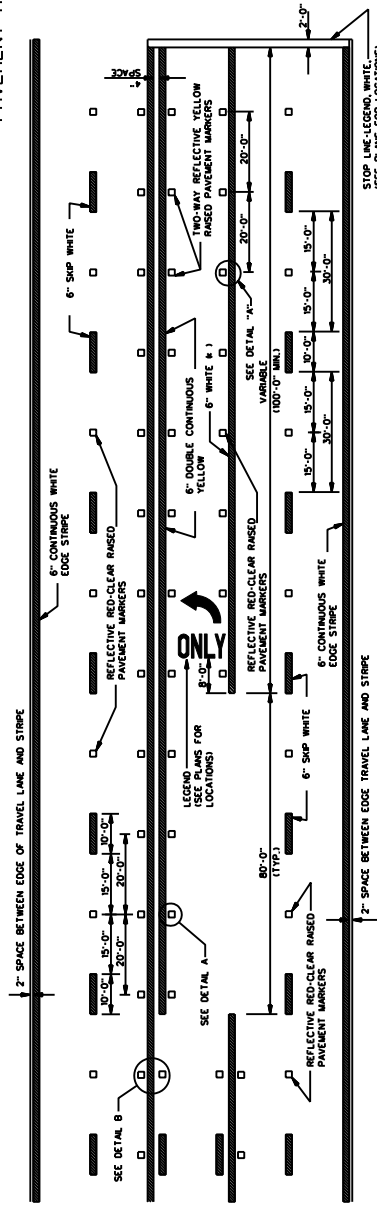

TYPICAL STRIPING AND RAISED PAVEMENT MARKERS AT LEFT TURN LANES

*NOTE: USE DETAIL STRIPING IF LENGTH \leq 150' AT THIS LOCATION, OTHERWISE USE CONTINUOUS STRIPING.

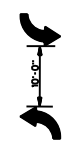

TYPICAL TWO-WAY ARROW INSTALLATION

NOTES: 1. CONSIDER EACH SEGMENT OF CONTINUOUS TWO-WAY LEFT TURN LANE SEPARATELY.
 2. IF SEGMENT IS LESS THAN 300', PLACE ONE SET OF ARROWS IN CENTER OF SEGMENT.
 3. IF SEGMENT IS GREATER THAN 300', PLACE FIRST SET OF ARROWS 50' TO 100' FROM BEGINNING AND/OR END OF SEGMENT AND SPACE ADDITIONAL SETS OF ARROWS 1250' O.C.

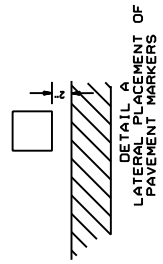

DETAIL A
LATERAL PLACEMENT OF PAVEMENT MARKERS

GENERAL NOTE:
 1. PAVEMENT MARKERS SHALL BE HIGH PERFORMANCE RAISED PAVEMENT MARKERS AS LISTED IN THE MOOT-APPROVED SOURCE OF MATERIALS.

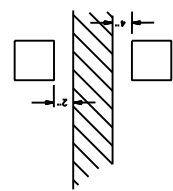

DETAIL B
LATERAL PLACEMENT OF PAVEMENT MARKERS

MISSISSIPPI DEPARTMENT OF TRANSPORTATION	
PAVEMENT MARKING	
DETAILS FOR	
4-LANE AND 5-LANE	
UNDIVIDED ROADWAYS	
DATE	03/20/12
FILENAME	SDPM-2.DGN
DESIGNER	CH2M
CHECKER	
DATE	
PROJECT NO.	
SHEET NUMBER	

STATE	PROJECT NO.
MISS.	

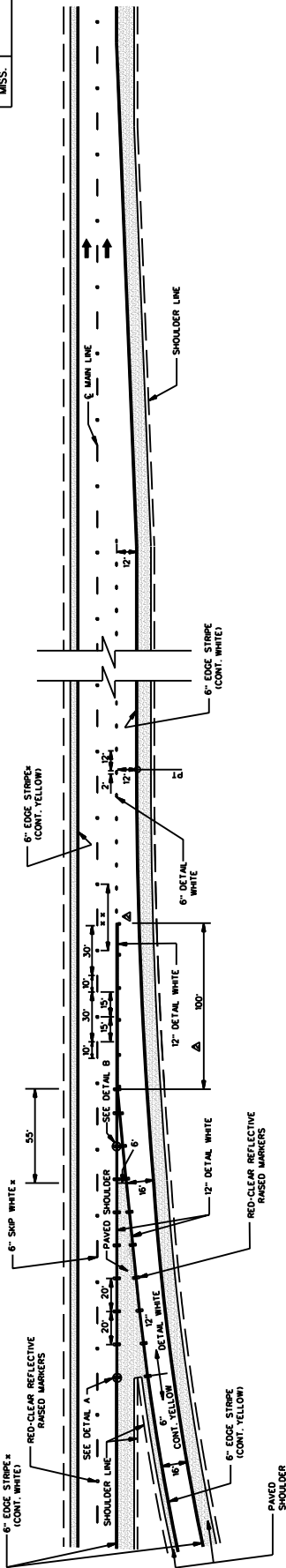

PARALLEL ENTRANCE RAMP

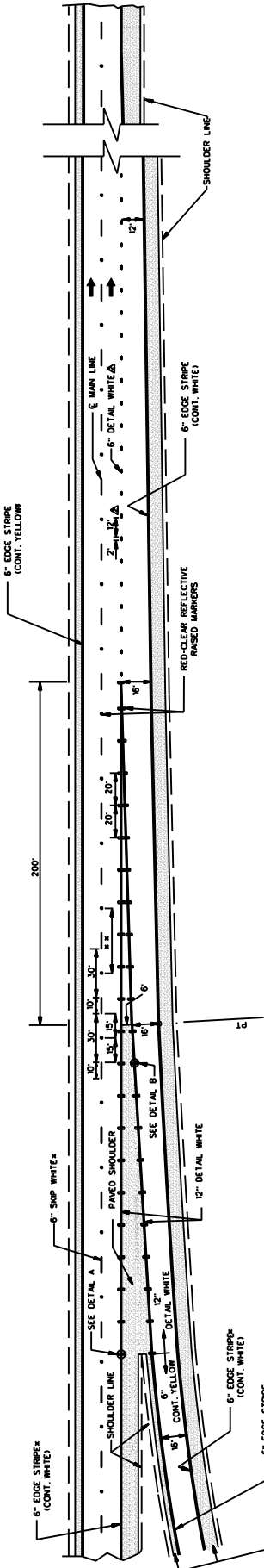

TAPER ENTRANCE RAMP

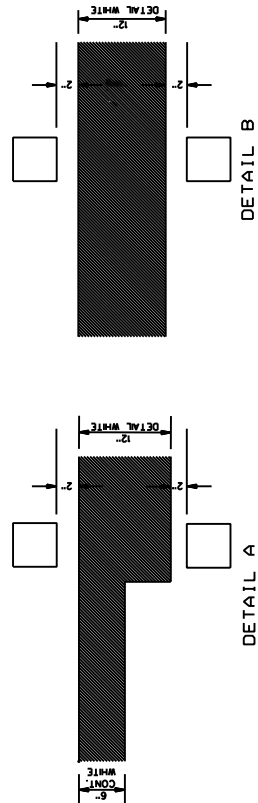

- GENERAL NOTES:
- * 1. SEE SHEET PM-1 FOR THE PLACEMENT OF LANE-LINE STRIPES AND RED-CLEAR REFLECTIVE RAISED MARKERS. THE PLACEMENT OF THE EDGE LINE WITH RESPECT TO THE OUTSIDE EDGE OF THE TRAVELED WAY.
 - * 2. ON THE MAIN FACILITY, PLACE REFLECTIVE RED-CLEAR RAISED PAVEMENT MARKERS AT A 40' SPACING ON ALL LANE-LINES THROUGHOUT THE INTERCHANGE AREA BEGINNING 300' IN THE MAIN FACILITY FROM THE INTERCHANGE TAPER AND CONTINUING THROUGH THE INTERCHANGE TO THE END OF THE ENTRANCE RAMP TAPER.
 - 3. PAVEMENT MARKERS SHALL BE HIGH PERFORMANCE REFLECTIVE RAISED PAVEMENT MARKERS AS LISTED IN THE MOOT "APPROVED SOURCES OF MATERIALS."

MISSISSIPPI DEPARTMENT OF TRANSPORTATION ROADWAY DESIGN DIVISION			WORKING NUMBER SDPM-3 SHEET NUMBER
PAVEMENT MARKING DETAILS FOR INTERCHANGE RAMP (PARALLEL AND TAPER)			
DATE	BY	CHKD	APP'D
10/1/98	SM	SM	SM
10/1/98	SM	SM	SM
10/1/98	SM	SM	SM
10/1/98	SM	SM	SM
10/1/98	SM	SM	SM
10/1/98	SM	SM	SM

STATE	PROJECT NO.
MISS.	

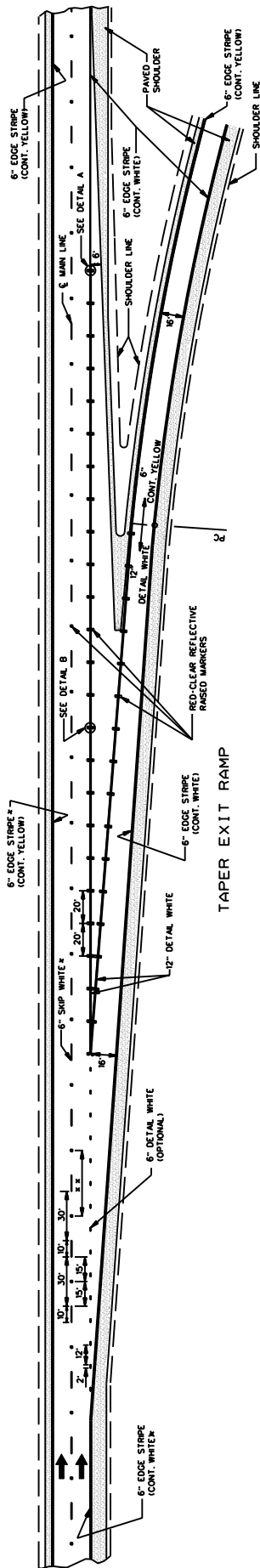

TAPER EXIT RAMP

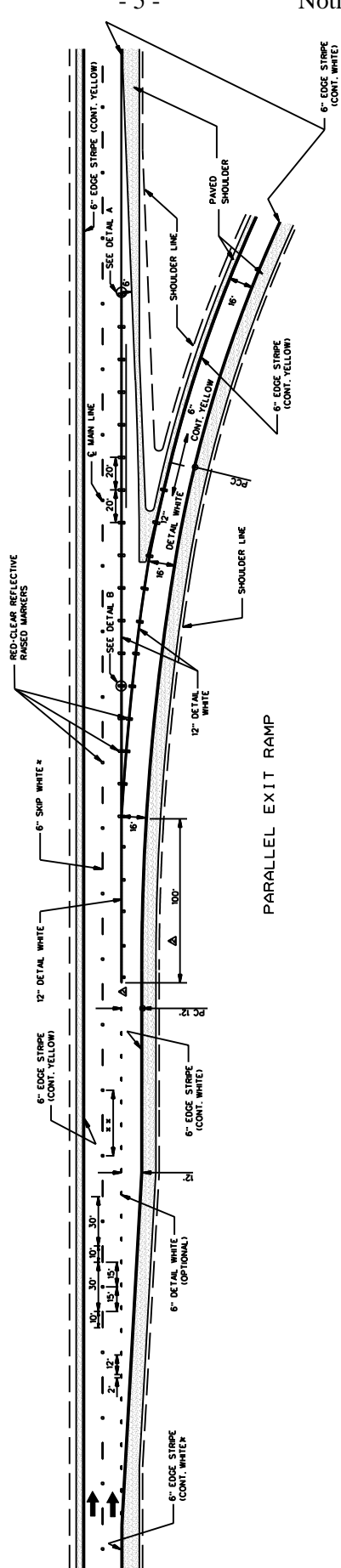

PARALLEL EXIT RAMP

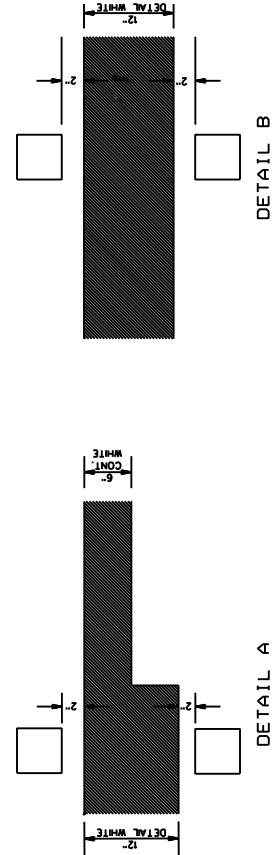

- GENERAL NOTES:
- SEE SHEET PM-1 FOR THE PLACEMENT OF LINE-LINE STRIPE WITH RESPECT TO THE PAVEMENT JOINT AND FOR THE PLACEMENT OF THE EDGE LINE WITH RESPECT TO THE OUTSIDE EDGE OF THE TRAVELED WAY.
 - ON THE MAINLINE, PLACE REFLECTIVE RED-CLEAR BASED PAVEMENT MARKING (RCPM) IN THE INTERCHANGE AREA THROUGHOUT THE INTERCHANGE AREA BEGINNING 1000' IN ADVANCE IN DIRECTION OF TRAFFIC OF THE EXIT RAMP TAPER AND CONTINUING THROUGH THE INTERCHANGE TO THE END OF THE ENTRANCE RAMP TAPER.
 - PAVEMENT MARKERS SHALL BE HIGH PERFORMANCE REFLECTIVE MARKERS AS SPECIFIED IN THE MDDI.
- *APPROVED SOURCES OF MATERIALS:

MISSISSIPPI DEPARTMENT OF TRANSPORTATION
ROADWAY DESIGN DIVISION

PAVEMENT MARKING
DETAILS FOR
INTERCHANGE
EXIT RAMP
(PARALLEL AND TAPER)

ISSUE DATE: OCTOBER 1, 1998

WORKING NUMBER: SDPM-41
SHEET NUMBER: 37

DATE	BY	REVISION
8/21/98	REVISION	REVISION
8/27/98	UPDATE TO 2008 M/ICD	UPDATE TO 2008 M/ICD

STATE PROJECT NO.
MISS.

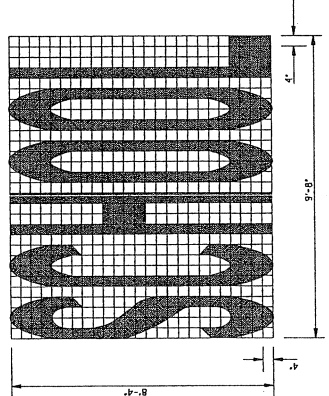
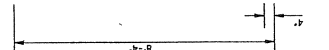
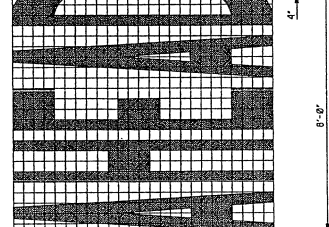
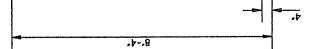
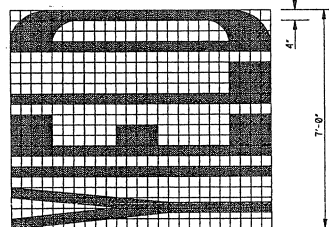
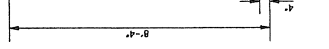
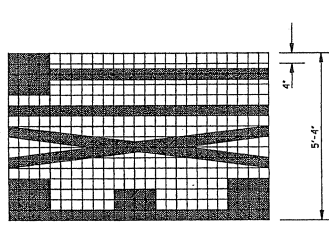
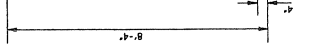
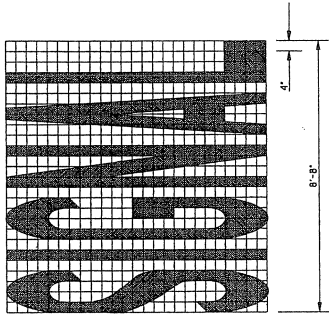
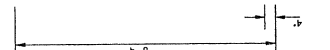
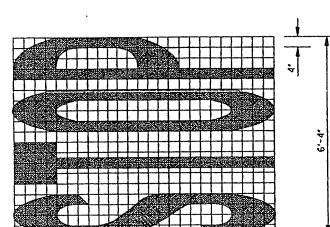
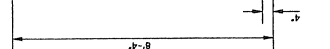
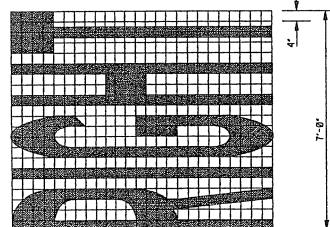
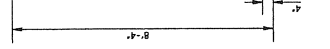
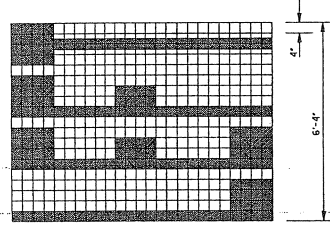
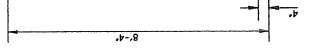
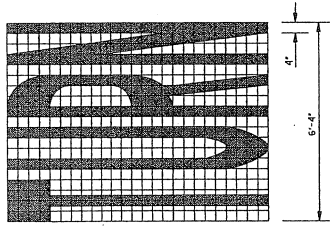
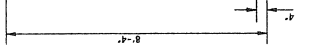
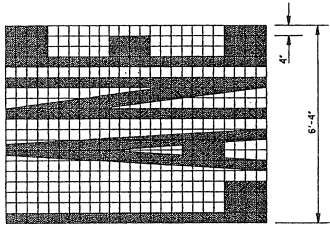

- GENERAL NOTES:
1. UNLESS OTHERWISE SHOWN ON THE PLANS, ALL PAVEMENT MARKING LEGENDS SHALL BE APPLIED USING HIGH PERFORMANCE POLYURETHANE PAINT.
 2. TWO HORIZONTAL GAPS (CAUSED BY TEMPLATE CONNECTORS) OF 1/4" OR LESS AND EXTENDING 1/2" FROM EITHER SIDE OF THE LETTER SHALL BE PERMITTED.
 3. FOR OTHER DETAILS SEE THE MANUAL ON UNIFORM TRAFFIC CONTROL DEVICES.
 4. PAY QUANTITIES FOR PAVEMENT MARKING LEGENDS ARE AS FOLLOWS:

LEGEND	AREA (FT ²)
STOP	24.6
RIGHT	15.8
LEFT	15.8
TURN	23.3
LANE	22.7
AHEAD	32.3
STOP AHEAD	18.5
SIGNAL	32.5
SCHOOL	35.5

MISSISSIPPI DEPARTMENT OF TRANSPORTATION
ROADWAY DESIGN DIVISION
STANDARD PLAN



**PAVEMENT MARKING
LEGEND DETAILS**

REVISION NUMBER
PW-33
SHEET NUMBER
124

DATE: OCTOBER 1, 1998

REVISION	
BY	DATE

STATE PROJECT NO.					
MISS.					

THRU ARROW

TURN ARROW

COMBINATION ARROW

1-WAY ARROW

GENERAL NOTES:

- UNLESS OTHERWISE SHOWN ON THE PLANS, ALL PAVEMENT MARKING SHALL BE APPLIED USING HIGH PERFORMANCE MATERIALS.
- TWO HORIZONTAL GAPS CAUSED BY TEMPLATE CONNECTORS OF 1/2" OR LESS AND EXTENDING THE FULL WIDTH ARE PERMITTED IN EACH LETTER.
- FOR OTHER DETAILS, SEE THE MANUAL ON UNIFORM PAVEMENT MARKINGS.
- PAY QUANTITIES FOR PAVEMENT MARKING LEGENDS ARE AS FOLLOWS:

PAY QUANTITIES	
LEGEND/SYMBOL	AREA (ft ²)
ONLY	22.0
TURN ARROW	18.4
THRU ARROW	21.2
COMBINATION ARROW	27.5
1-WAY ARROW	24.3

MISSISSIPPI DEPARTMENT OF TRANSPORTATION
ROADWAY DESIGN DIVISION
STANDARD PLAN

**PAVEMENT MARKING
LEGEND DETAILS**

DATE	ISSUE DATE: OCTOBER 1, 1998
REVISION	
BY	

WORKING NUMBER: PM-6
SHEET NUMBER: 125

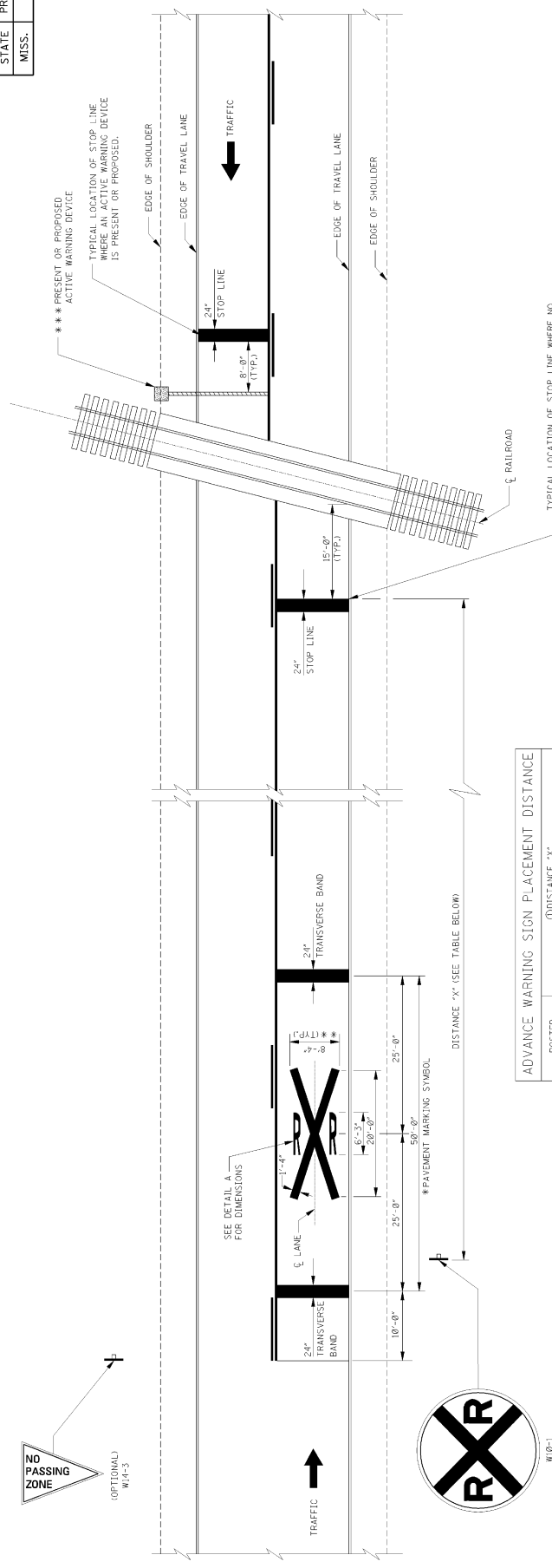

ADVANCE WARNING SIGN PLACEMENT DISTANCE

POSTED SPEED (mph)	DISTANCE "X" (FT)	
	RURAL	URBAN
20	175	100
25	250	100
30	325	100
35	400	150
40	475	225
45	550	300
50	625	375
55	700	450
60	775	525

NOTES:
 (1) DISTANCE "X" MAY BE ADJUSTED, IF PROHIBITIVE PHYSICAL CONDITIONS EXIST AT THE DESIGNATED DISTANCE.
 (2) THESE DISTANCES MAY BE ADJUSTED TO A MINIMUM OF 100 IN. FOR BUSINESS OR BUSINESS DISTRICTS WHERE LOW SPEEDS ARE PREVALENT.

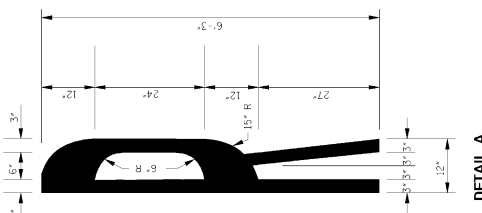

DETAIL A
STANDARD "R" PAVEMENT MARKING
FOR R X R SYMBOL

GENERAL NOTES:
 * 1. A PORTION OF THE PAVEMENT MARKING SYMBOL SHOULD BE DIRECTLY OPPOSITE THE ADVANCE WARNING SIGN (W10-1).
 * 2. WIDTH OF R X R SYMBOL MAY VARY ACCORDING TO LANE WIDTH. HOWEVER, ON MULTI-LANE ROADS, THE TRANSVERSE BANDS AND STOP LINE SHOULD EXTEND ACROSS ALL APPROACH LANES, AND INDIVIDUAL R X R SYMBOLS SHOULD BE USED IN EACH APPROACH LANE.
 * 3. R X R SYMBOL (63.0 #42), TRANSVERSE BANDS AND STOP LINE SHALL BE PAID FOR AS LEGEND, WHITE (PLASTIC), MATERIAL OPTIONAL FOR OTHER AGENCIES.
 * 4. REFER TO THE "MANUAL ON UNIFORM TRAFFIC CONTROL DEVICES" FOR LOCATION OF PROPOSED WARNING DEVICES AT RAILROAD-HIGHWAY GRADE CROSSINGS.

MISSISSIPPI DEPARTMENT OF TRANSPORTATION
ROADWAY DESIGN DIVISION
STANDARD PLAN

TYPICAL PLACEMENT OF WARNING SIGNS AND PAVEMENT MARKINGS AT RAILROAD HIGHWAY GRADE CROSSINGS

DATE	ISSUE	NO.
10-10-1998	1	15

WORKSHEET NO. 15
SHEET NUMBER 12 OF 18
ISSUE DATE: OCTOBER 11, 1998

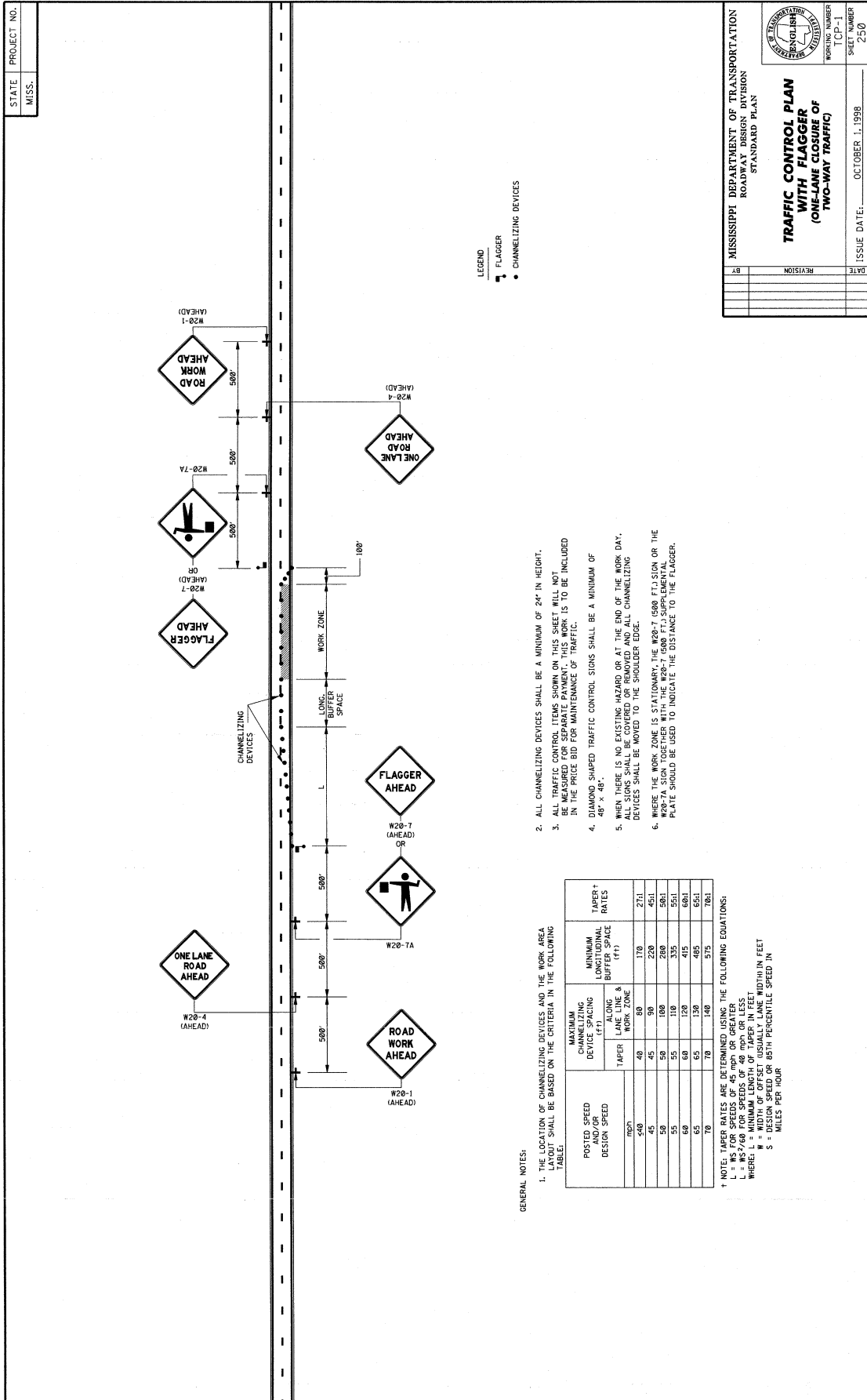

LEGEND
 FLAGGER
 CHANNELIZING DEVICES

2. ALL CHANNELIZING DEVICES SHALL BE A MINIMUM OF 24" IN HEIGHT.
3. ALL TRAFFIC CONTROL ITEMS SHOWN ON THIS SHEET WILL NOT BE MEASURED FOR SEPARATE PAYMENT. THIS WORK IS TO BE INCLUDED IN THE PRICE BID FOR MAINTENANCE OF TRAFFIC.
4. DIAMOND SHAPED TRAFFIC CONTROL SIGNS SHALL BE A MINIMUM OF 48" X 48".
5. WHEN THERE IS NO EXISTING HAZARD OR AT THE END OF THE WORK DAY, DEVICES SHALL BE COVERED OR REMOVED AND ALL CHANNELIZING DEVICES SHALL BE MOVED TO THE SHOULDER EDGE.
6. WHERE THE WORK ZONE IS STATIONARY THE W20-7 (600 FT.) SIGN OR THE W20-7A SIGN TOGETHER WITH THE W20-7 (600 FT.) SUPPLEMENTAL PLATE SHOULD BE USED TO INDICATE THE DISTANCE TO THE FLAGGER.

GENERAL NOTES:
 1. THE LOCATION OF CHANNELIZING DEVICES AND THE WORK AREA LAYOUT SHALL BE BASED ON THE CRITERIA IN THE FOLLOWING TABLE:

POSTED SPEED AND/OR DESIGN SPEED (MPH)	MAXIMUM CHANNELIZING DEVICES ALONG WORK ZONE (FT.)		MINIMUM LONGITUDINAL BUFFER SPACE (FT.)	TAPER + BUFFER SPACE RATES
	ALONG WORK ZONE	ALONG BUFFER SPACE		
40	40	80	170	271
45	45	90	220	451
50	50	100	280	501
55	55	110	335	551
60	60	120	415	661
65	65	130	485	651
70	70	140	575	761

† NOTE: TAPER RATES ARE DETERMINED USING THE FOLLOWING EQUATIONS:
 L = WS FOR SPEEDS OF 45 MPH OR GREATER
 L = WS FOR SPEEDS OF 40 MPH OR GREATER
 WHERE: L = MINIMUM LENGTH OF TAPER IN FEET
 W = WIDTH OF OFFSET (USUALLY LANE WIDTH) IN FEET
 S = DESIGN SPEED OR 85TH PERCENTILE SPEED IN MILES PER HOUR

MISSISSIPPI DEPARTMENT OF TRANSPORTATION
 ROADWAY DESIGN DIVISION
 STANDARD PLAN

**TRAFFIC CONTROL PLAN
 WITH FLAGGER
 (ONE-LANE CLOSURE OF
 TWO-WAY TRAFFIC)**

WORKING NUMBER: TCP-1
 SHEET NUMBER: 250
 ISSUE DATE: OCTOBER 1, 1998

DATE	REVISION

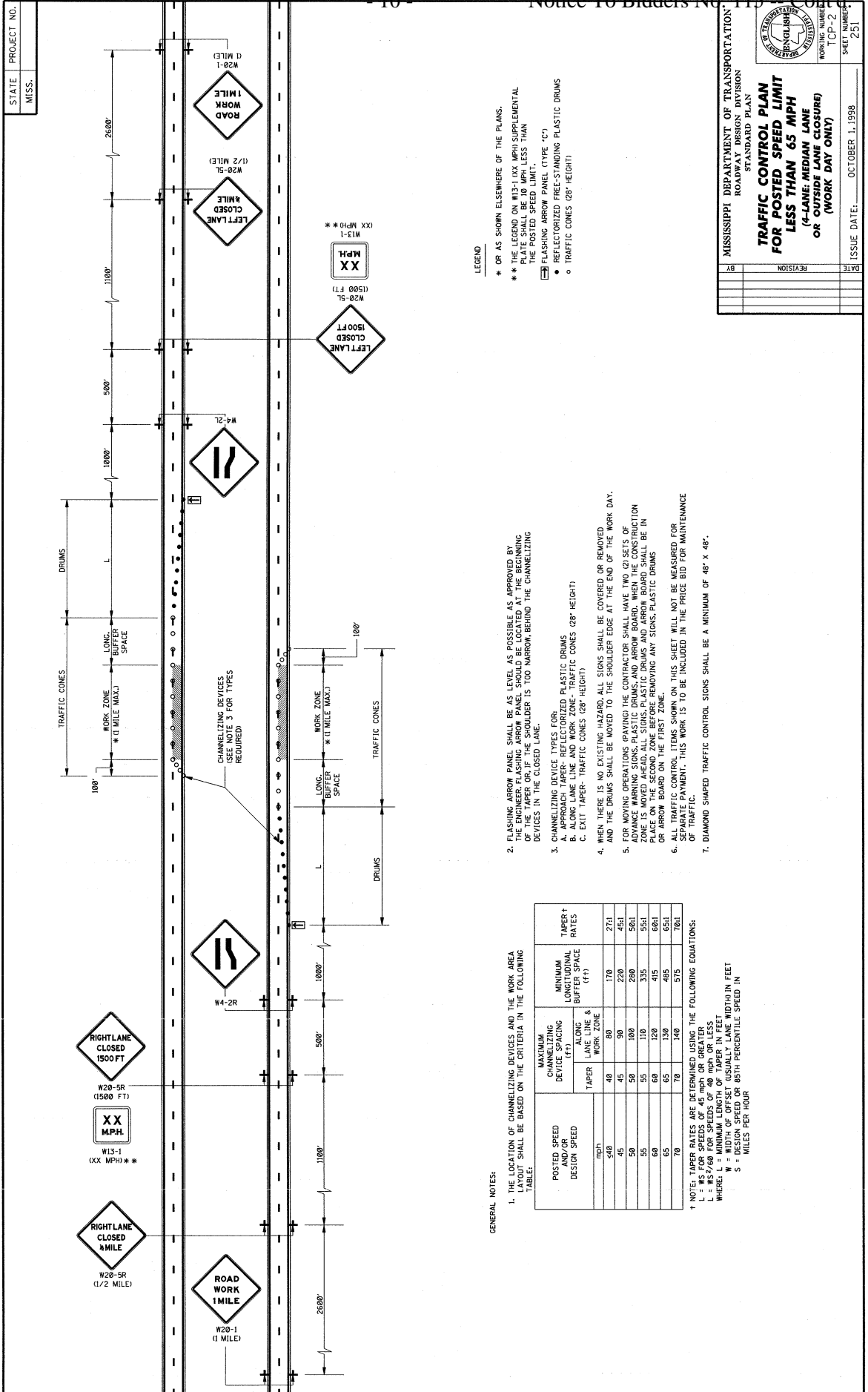

- LEGEND**
- * OR AS SHOWN ELSEWHERE OF THE PLANS.
 - ** THE LEGEND ON W13-1 (XX MPH) SUPPLEMENTAL PLATE SHALL BE 10 MPH LESS THAN THE POSTED SPEED LIMIT.
 - REFLECTORIZED PRE-STANDING PLASTIC DRUMS
 - TRAFFIC CONES (28" HEIGHT)

2. FLASHING ARROW PANEL SHALL BE AS LEVEL AS POSSIBLE AS APPROVED BY THE ENGINEER. FLASHING ARROW PANEL SHOULD BE LOCATED AT THE BEGINNING OF THE TAPER OR IF THE SHOULDER IS TOO NARROW, BEHIND THE CHANNELIZING DEVICES IN THE CLOSED LANE.
3. CHANNELIZING DEVICE TYPES FOR:
 - A. APPROACH TAPER- REFLECTORIZED PLASTIC DRUMS
 - B. ALONG LANE LINE AND WORK ZONE- TRAFFIC CONES (28" HEIGHT)
 - C. EXIT TAPER- TRAFFIC CONES (28" HEIGHT)
4. WHEN THERE IS NO EXISTING HAZARD, ALL SIGNS SHALL BE COVERED OR REMOVED AND THE DRUMS SHALL BE MOVED TO THE SHOULDER EDGE AT THE END OF THE WORK DAY.
5. FOR MOVING OPERATIONS (PAVING) THE CONTRACTOR SHALL HAVE TWO (2) SETS OF ADVANCE WARNING SIGNS, PLASTIC DRUMS, AND ARROW BOARD. WHEN THE CONSTRUCTION ZONE IS MOVED AHEAD, ALL SIGNS, PLASTIC DRUMS AND ARROW BOARD SHALL BE IN PLACE BEFORE REMOVING ANY SIGNS, PLASTIC DRUMS OR ARROW BOARD ON THE PREVIOUS ZONE.
6. ALL TRAFFIC CONTROL ITEMS SHOWN ON THIS SHEET WILL NOT BE MEASURED FOR SEPARATE PAYMENT. THIS WORK IS TO BE INCLUDED IN THE PRICE BID FOR MAINTENANCE OF TRAFFIC.
7. DIAMOND SHAPED TRAFFIC CONTROL SIGNS SHALL BE A MINIMUM OF 48" X 48".

GENERAL NOTES:

1. THE LOCATION OF CHANNELIZING DEVICES AND THE WORK AREA SHALL BE BASED ON THE CRITERIA IN THE FOLLOWING TABLE:

POSTED SPEED AND/OR DESIGN SPEED	MAXIMUM CHANNELIZING DEVICE SPACING (FT)		MINIMUM LONGITUDINAL BUFFER SPACE (ft)	TAPER + TAPER RATES
	ALONG LANE LINE	WORK ZONE		
40	40	80	170	27:1
45	45	90	220	45:1
50	50	100	280	50:1
55	55	110	335	55:1
60	60	120	415	60:1
65	65	130	485	65:1
70	70	140	575	70:1

† NOTE: TAPER RATES ARE DETERMINED USING THE FOLLOWING EQUATIONS:
 $L = W^2$ FOR SPEEDS OF 45 MPH OR GREATER
 $L = WS$ FOR SPEEDS OF 45 MPH OR GREATER
 WHERE L = MINIMUM LENGTH OF TAPER IN FEET
 W = WIDTH OF OFFSET USUALLY LANE WIDTH IN FEET
 S = DESIGN SPEED OR 85TH PERCENTILE SPEED IN MILES PER HOUR

STATE PROJECT NO. MISS.

MISSISSIPPI DEPARTMENT OF TRANSPORTATION
 ROADWAY DESIGN DIVISION
 STANDARD PLAN

**TRAFFIC CONTROL PLAN
 FOR POSTED SPEED LIMIT
 LESS THAN 65 MPH
 (4-LANE MEDIAN LANE
 OR CLOSURE MEASURE)
 (WORK DAY ONLY)**

WORKING NUMBER: TCP-2
 SHEET NUMBER: 251
 ISSUE DATE: OCTOBER 1, 1998

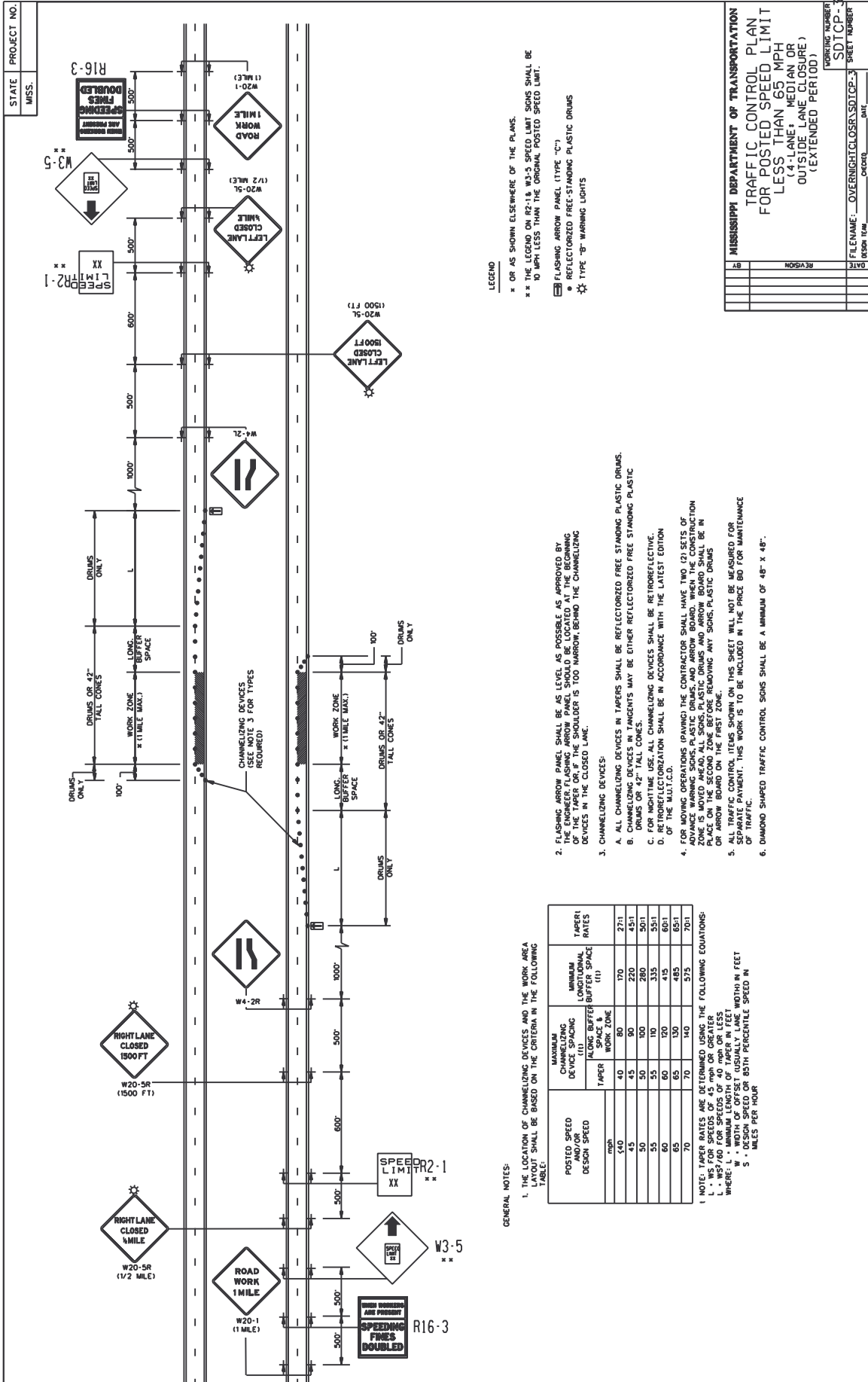

- LEGEND**
- * OR AS SHOWN ELSEWHERE OF THE PLANS.
 - ** THE LEGEND ON R2-18 W3-5 SPEED LIMIT SIGNS SHALL BE 10 MPH LESS THAN THE ORIGINAL POSTED SPEED LIMIT.
 - ◻ FLASHING ARROW PANEL (TYPE "C")
 - ◊ REFLECTORIZED FREE-STANDING PLASTIC DRUMS
 - ⊙ TYPE "B" WARNING LIGHTS

- GENERAL NOTES:**
- THE LOCATION OF CHANNELIZING DEVICES AND THE WORK AREA LAYOUT SHALL BE BASED ON THE CRITERIA IN THE FOLLOWING TABLE:

POSTED SPEED AND/OR DESIGN SPEED	MAXIMUM CHANNELIZING DEVICES SPACING ALONG BUFFER SPACE	MINIMUM LONGITUDINAL BUFFER SPACE	TAPER RATES
40	80	170	7:1
45	90	220	4:1
50	100	280	3:1
55	110	335	2.5:1
60	120	415	2:1
65	130	485	1.5:1
70	140	575	1:1

NOTE: TAPER RATES ARE DETERMINED USING THE FOLLOWING EQUATIONS:
 L = WS FOR SPEEDS OF 45 MPH OR GREATER
 L = WS/40 FOR SPEEDS OF 40 MPH OR LESS
 WHERE:
 W = WIDTH OF OFFSET (USUALLY LANE WIDTH) IN FEET
 S = DESIGN SPEED OR 85TH PERCENTILE SPEED IN MILES PER HOUR

MISSISSIPPI DEPARTMENT OF TRANSPORTATION
 TRAFFIC CONTROL PLAN
 FOR POSTED SPEED LIMIT
 LESS THAN 65 MPH
 (4 LANE MEDIAN OR
 DUAL LANE CLOSURE)
 (EXTENDED PERIOD)

PROJECT NUMBER: SDT CP-3
 SHEET NUMBER: 3

DATE	REVISION

DESIGNER: OVERNIGHT CONSTRUCTION
 CHECKED:
 DATE:
 FILENAME: OVERNIGHTCONSDT CP-3

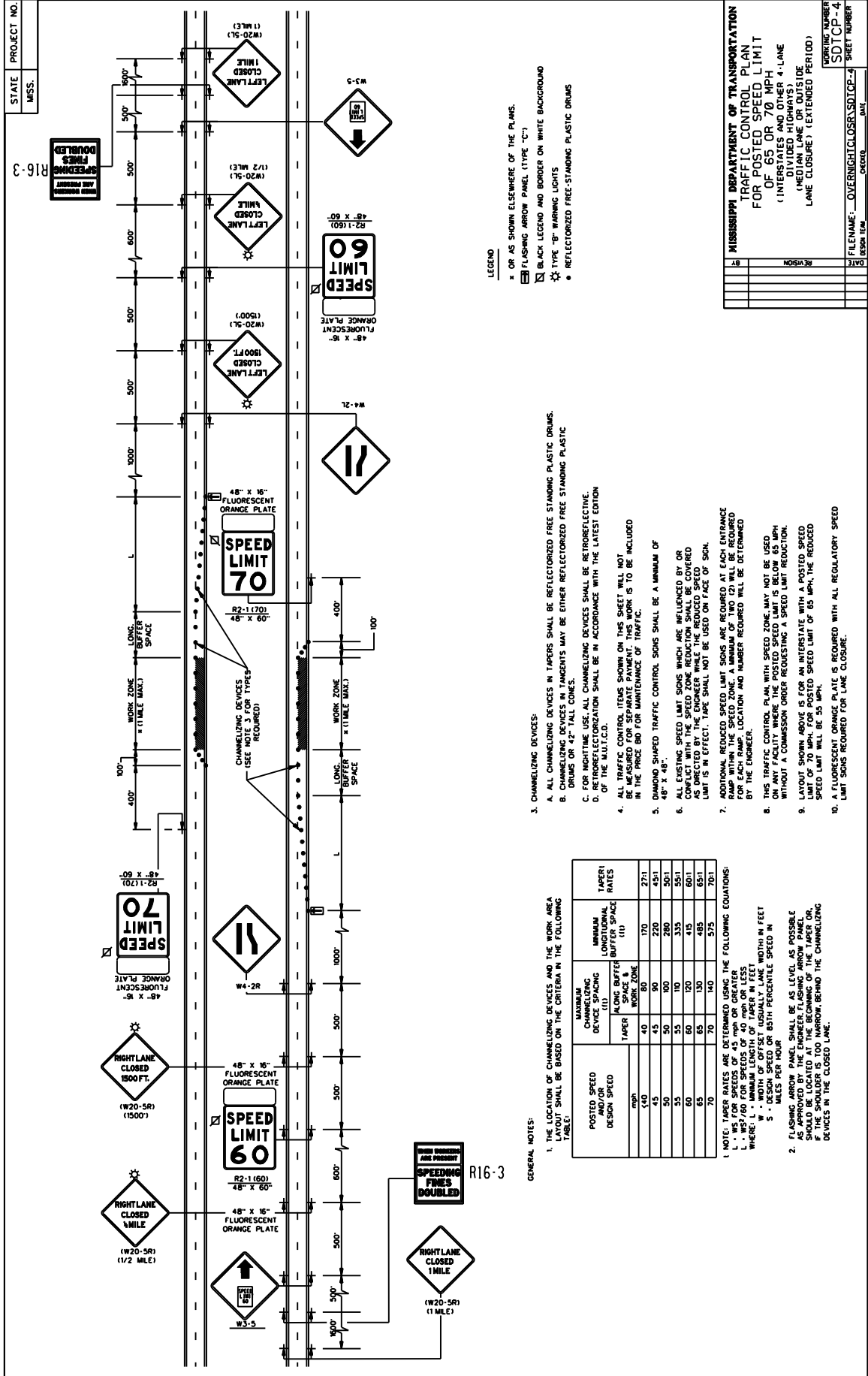

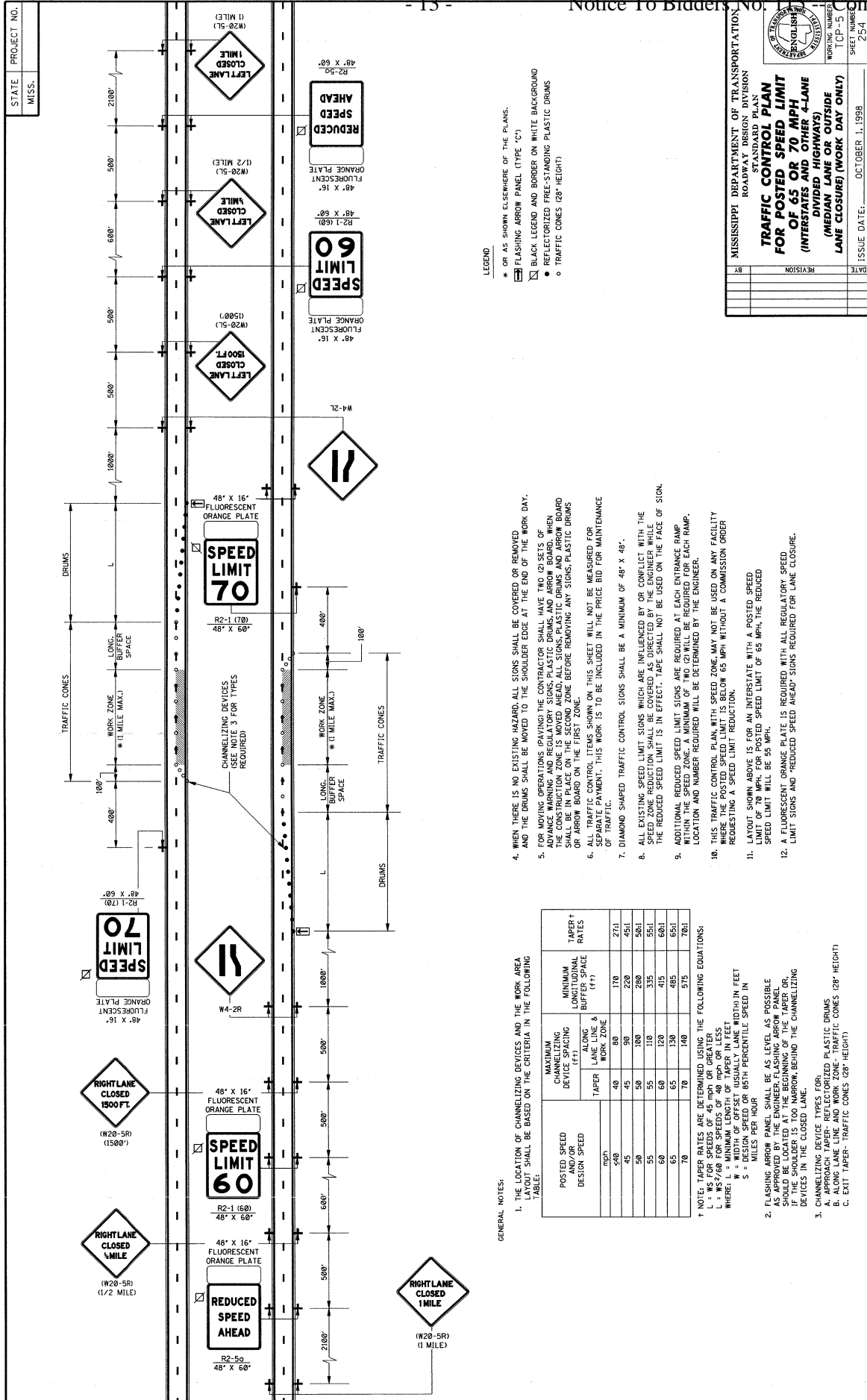

GENERAL NOTES:

1. THE LOCATION OF CHANNELIZING DEVICES AND THE WORK AREA LAYOUT SHALL BE BASED ON THE CRITERIA IN THE FOLLOWING TABLE:
2. FLASHING ARROW PANEL SHALL BE AS LEVEL AS POSSIBLE. THE SIGN SHALL BE LOCATED AT THE BEGINNING OF THE TAPER OR, IF THE SHOULDER IS TOO NARROW, BEHIND THE CHANNELIZING DEVICES IN THE CLOSED LANE.
3. CHANNELIZING DEVICE TYPES FOR:
 - A. APPROACH TAPER- REFLECTORIZED PLASTIC DRUMS
 - B. EXIT TAPER- REFLECTORIZED PLASTIC CONES (28" HEIGHT)
 - C. EXIT TAPER- TRAFFIC CONES (28" HEIGHT)
4. WHEN THERE IS NO EXISTING HAZARD, ALL SIGNS SHALL BE COVERED OR REMOVED AND THE DRUMS SHALL BE MOVED TO THE SHOULDER EDGE AT THE END OF THE WORK DAY.
5. FOR MOVING OPERATIONS PAYING THE CONTRACTOR SHALL HAVE TWO (2) SETS OF CHANNELIZING DEVICES TO BE MOVED AHEAD OF THE WORK ZONE. THE CONSTRUCTION ZONE IS MOVED AHEAD ALL SIGNS, PLASTIC DRUMS AND ARROW BOARD OR ARROW BOARD ON THE FIRST ZONE.
6. ALL TRAFFIC CONTROL ITEMS SHOWN ON THIS SHEET WILL NOT BE MEASURED FOR SEPARATE PAYMENT. THIS WORK IS TO BE INCLUDED IN THE PRICE BID FOR MAINTENANCE OF TRAFFIC.
7. DIAMOND SHAPED TRAFFIC CONTROL SIGNS SHALL BE A MINIMUM OF 48" X 48".
8. ALL EXISTING SPEED LIMIT SIGNS WHICH ARE INFLUENCED BY OR CONFLICT WITH THE SPEED ZONE REDUCTION SHALL BE COVERED AS DIRECTED BY THE ENGINEER WHILE THE REDUCED SPEED LIMIT IS IN EFFECT. TAPE SHALL NOT BE USED ON THE FACE OF SIGN.
9. ADDITIONAL REDUCED SPEED LIMIT SIGNS ARE REQUIRED AT EACH ENTRANCE RAMP WITHIN THE SPEED ZONE. A MINIMUM OF TWO (2) WILL BE REQUIRED FOR EACH RAMP. LOCATION AND NUMBER REQUIRED WILL BE DETERMINED BY THE ENGINEER.
10. THIS TRAFFIC CONTROL PLAN WITH SPEED ZONE MAY NOT BE USED ON ANY FACILITY WHERE THE POSTED SPEED LIMIT IS BELOW 65 MPH WITHOUT A COMMISSION ORDER REQUESTING A SPEED LIMIT REDUCTION.
11. LAYOUT SHOWN ABOVE IS FOR AN INTERSTATE WITH A POSTED SPEED LIMIT OF 70 MPH. FOR POSTED SPEED LIMIT OF 65 MPH, THE REDUCED SPEED LIMIT WILL BE 55 MPH.
12. A FLUORESCENT ORANGE PLATE IS REQUIRED WITH ALL REGULATORY SPEED LIMIT SIGNS AND "REDUCED SPEED AHEAD" SIGNS REQUIRED FOR LANE CLOSURE.

POSTED SPEED DESIGN SPEED	CHANNELIZING DEVICE SPACING (FT)		MINIMUM LONGITUDINAL BUFFER SPACE (FT)	TAPER + RATES
	LANE LINE WORK ZONE	LANE LINE & WORK ZONE		
50	40	80	170	27:1
55	45	90	220	45:1
60	50	100	280	50:1
65	55	110	335	55:1
70	60	120	415	60:1
75	65	130	485	65:1
80	70	140	575	70:1

† NOTE: TAPER RATES ARE DETERMINED USING THE FOLLOWING EQUATIONS:
 L = WS FOR SPEEDS OF 45 mph OR GREATER
 L = WS/60 FOR SPEEDS OF 40 mph OR LESS
 WHERE:
 W = WIDTH OF OFFSET (USUALLY LANE WIDTH) IN FEET
 S = DESIGN SPEED OR 85TH PERCENTILE SPEED IN MILES PER HOUR

LEGEND

- ◻ OR AS SHOWN ELSEWHERE OF THE PLANS.
- ◻ FLASHING ARROW PANEL (TYPE "C")
- ◻ BLACK LEGEND AND BORDER ON WHITE BACKGROUND
- ◻ REFLECTORIZED FREE-STANDING PLASTIC DRUMS
- TRAFFIC CONES (28" HEIGHT)

MISSISSIPPI DEPARTMENT OF TRANSPORTATION
 STANDARD PLAN
**TRAFFIC CONTROL PLAN
 FOR POSTED SPEED LIMIT
 OF 65 OR 70 MPH
 (INTERSTATES AND OTHER 4-LANE
 DIVIDED HIGHWAYS)
 (MEDIAN LANE OR OUTSIDE
 LANE CLOSURE) (WORK DAY ONLY)**

WORKING NUMBER: TCP-5
 SHEET NUMBER: 254
 ISSUE DATE: OCTOBER 1, 1988

MISSISSIPPI DEPARTMENT OF TRANSPORTATION
HIGHWAY SIGN AND BARRICADE DETAIL FOR CONSTRUCTS

WORKING NUMBER: SDTCP-10
SHEET NUMBER: 10
DATE: 06/21/2012
FILE NAME: SDTCP-10_06012012.DGN
PERSON: [blank]

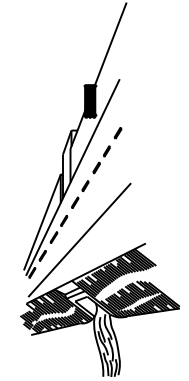

WING BARRICADES

- WING BARRICADES ARE TYPE BARRICADES ERECTED ON THE SHOULDER ON ONE OR BOTH SIDES OF THE PAVEMENT TO GIVE THE SENSATION OF A NARROWING OR RESTRICTED ROADWAY. WING BARRICADES MAY BE USED AS A MOUNTING FOR THE ADVANCE WARNING SIGNS OR FLASHERS.
- WING BARRICADES SHOULD BE USED:
 - IN ADVANCE OF A CONSTRUCTION PROJECT EVEN WHEN NO PART OF THE ROADWAY IS ACTUALLY CLOSED.
 - IN ADVANCE OF ALL BRIDGE OR CULVERT MOVING OPERATIONS.

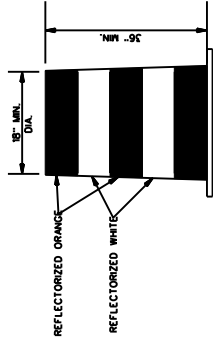
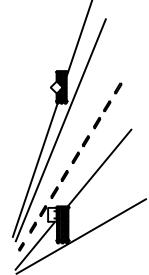

PLASTIC DRUM STRIPING DETAIL

- PLASTIC DRUMS SHALL BE ON END AND USED AS AN EXPEDIENT METHOD FOR TRAFFIC CHANNELIZATION. THE COLOR AND MARKING METHOD FOR WITH LAMING STANDARDS FOR BARRICADES. THE PREDOMINANT COLOR ON DRUMS SHALL BE ORANGE. THE PREDOMINANT COLOR ON DRUMS SHALL BE WHITE. STRIPES (2 ORANGE & 2 WHITE) 6" WIDE.
- DRUMS SHOULD NEVER BE PLACED IN THE ROADWAY WITHOUT WARNING SIGNS.
- WHERE PRACTICAL PLASTIC DRUMS SHALL BE PLACED NO CLOSER THAN 3'-0" FROM THE EDGE OF TRAVELED LANE.

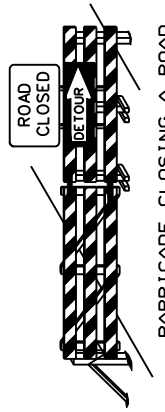

BARRICADE CLOSING A ROAD

BARRICADE CHARACTERISTICS

	I	II	III
WIDTH OF RAIL **	8" MIN. - 12" MAX.	8" MIN. - 12" MAX.	8" MIN. - 12" MAX.
LENGTH OF RAIL **	24" MIN.	24" MIN.	48" MIN.
WIDTH OF STRIPE *	6"	6"	6"
HEIGHT	35" MIN.	35" MIN.	60" MIN.
NUMBER OF REFLECTORIZED RAIL FACES	2 (ONE EACH DIRECTION)	4 (TWO EACH DIRECTION)	3 IF FACING TRAFFIC IN ONE DIRECTION 6 IF FACING TRAFFIC IN TWO DIRECTIONS
TYPE OF FRAME	LIGHT	LIGHT "X" FRAME	POST OR SHD

* 1. FOR RAILS LESS THAN 36" LONG, 4" WIDE STRIPES MAY BE USED.

** 2. BARRICADES INTENDED FOR USE ON EXPRESSWAYS, FREEWAYS AND OTHER HIGH SPEED ROADWAYS SHALL HAVE A MINIMUM OF 270 IN OF REFLECTIVE AREA FACING TRAFFIC.

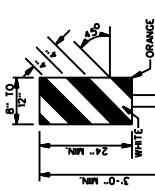

VERTICAL PANEL

- VERTICAL PANELS CONSIST OF AT LEAST ONE PANEL 8" TO 12" IN WIDTH AND A MINIMUM OF 24" IN HEIGHT.
- THE DIAGONAL STRIPES SHALL SLOPE DOWNWARD IN THE DIRECTION THAT TRAFFIC IS TO PASS THE PANEL. THE MINIMUM OF 36" ABOVE THE ROADWAY ON A SINGLE LIGHTMASS POST.
- VERTICAL PANELS USED ON EXPRESSWAYS, FREEWAYS AND OTHER HIGH-SPEED ROADWAYS SHALL HAVE A MINIMUM OF 270 IN² OF RETROREFLECTIVE AREA FACING TRAFFIC.
- FOR TWO-WAY TRAFFIC OPERATIONS, BACK-TO-BACK PANELS SHALL BE USED.

GENERAL NOTES:

- MARKINGS ON ALL DEVICES SHOWN ON THIS SHEET SHALL BE HIGH INTENSITY REFLECTIVE SHEETING.
- THE TRAFFIC CONTROL PLAN WILL LIST THE VARIOUS TRAFFIC CONTROL DEVICES REQUIRED FOR EACH PROJECT.

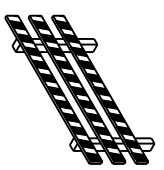

TYPE I



TYPE II



TYPE III

STANDARD BARRICADES

- A TYPE I BARRICADE CONSISTS OF ONE (1) HORIZONTAL RAIL SUPPORTED BY A DEMOUNTABLE FRAME. BARRICADES NORMALLY WOULD BE USED ON CONVENTIONAL ROADS OR URBAN STREETS AND ARTERIALS.
- A TYPE II BARRICADE CONSISTS OF TWO (2) HORIZONTAL RAILS ON A LIGHT "X" FRAME. TYPE II BARRICADES ARE INTENDED FOR USE WHERE THE HAZARD IS LESS SEVERE THAN THAT OF TYPE I BARRICADES. THESE BARRICADES ARE USED FOR TEMPORARY DAYTIME USE, CONTINUOUS DELIMITING OF A RESTRICTED ROADWAY, OR FOR TEMPORARY DAYTIME USE.
- A TYPE III BARRICADE CONSISTS OF THREE (3) HORIZONTAL RAILS SUPPORTED BY FIXED POSTS, A ROAD SHD, A HEAVY DEMOUNTABLE FRAME OR A HEAVY WINGED "X" FRAME.
- TYPE I BARRICADES ARE INTENDED FOR USE ON CONSTRUCTION AND MAINTENANCE PROJECTS AS BARRICADES AND AT ROAD CLOSURES, WHERE THEY MUST REMAIN IN PLACE FOR EXTENDED PERIODS.
- THE MARKING FOR BARRICADE RAILS SHALL BE ORANGE AND WHITE (SLOPING DOWNWARD AT AN ANGLE OF 45° IN THE DIRECTION TRAFFIC IS TO PASS).
- DO NOT PLACE SANDBAGS OR OTHER DEVICES TO PROVIDE MASS ON THE BOTTOM RAIL THAT WILL BLOCK VIEW OR RAIL FACE.
- FOR ADDITIONAL INFORMATION OR DETAILS, SEE MUTCD, LATEST EDITION.

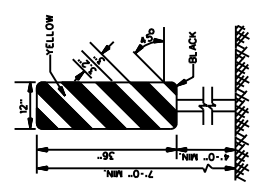

TYPE 3 OBJECT MARKER (OM-3R)

- TYPE 3 OBJECT MARKERS SHALL BE USED AT ALL EXPOSED BRIDGE ABUTMENTS AND AT OTHER LOCATIONS AS DEEMED NECESSARY BY THE ENGINEER.
- THE OM-3R IS SHOWN. THE OM-3R IS SIMILAR EXCEPT THE STRIPES SLOPE DOWNWARD FROM THE UPPER LEFT SIDE TO THE LOWER RIGHT SIDE AND SHALL BE PLACED ON THE LEFT SIDE OF THE OBJECT.
- THE INSIDE EDGE OF THE MARKER SHALL BE IN LINE WITH THE INNER EDGE OF THE OBSTRUCTION.

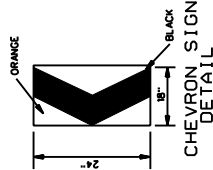

CHEVRON SIGN DETAIL

- A CHEVRON SIGN CONSISTS OF A BLACK CHEVRON TYPE MARKING ON AN ORANGE BACKGROUND AND SHALL POINT IN THE DIRECTION OF TRAFFIC FLOW.
- THE CHEVRON SIGN SHALL BE MOUNTED ON FIXED POST OR ROAD SHD.
- CHEVRON SIGNS MAY BE USED TO SUPPLEMENT OTHER STANDARD DEVICES WHERE ONE OR MORE LANES ARE CLOSED FOR CONSTRUCTION OR MAINTENANCE. THEY SHALL BE PLACED APPROXIMATELY 2'-0" BEHIND THE LANE TRANSITION STRIPE.

STATE PROJECT NO.
MISS.

MOBILE OPERATIONS ON TWO-LANE ROAD

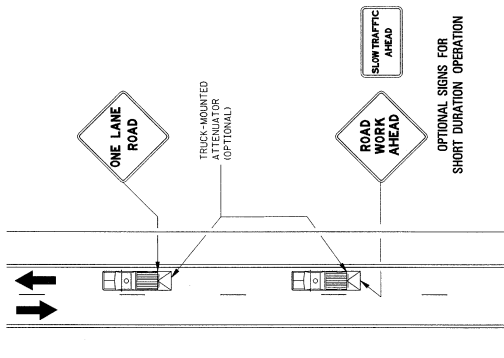

MOBILE OPERATIONS ON TWO-LANE ROAD

- NOTES:**
1. WHERE PRACTICAL AND WHEN NEEDED, THE WORK AND PROTECTION VEHICLES SHOULD BE EQUIPPED WITH LIGHTS WHICH ARE HIGHLY VISIBLE. FLASHING LIGHTS, ROTATING BEACONS, FLAOS, SIGNS, OR ARROW PANELS SHOULD BE USED FREQUENTLY, AS AN ALTERNATIVE A "DO NOT PASS" SIGN MAY BE PLACED ON THE REAR OF THE VEHICLE BLOCKING THE LANE.
 2. THE DISTANCE BETWEEN THE WORK AND PROTECTION VEHICLES MAY VARY ACCORDING TO TERRAIN, PAINT DRYING TIME, AND OTHER FACTORS. PROTECTION VEHICLES ARE USED TO WARN TRAFFIC OF THE OPERATION AHEAD, WHENEVER ADEQUATE STOPPING SIGHT DISTANCE EXISTS TO THE WORK. PROTECTION VEHICLES SHOULD BE PLACED ON THE SHOULDERS OF HIGHWAY AS NEAR AS PRACTICABLE AS POSSIBLE TO THE WORK. THE PROTECTION VEHICLE SHOULD SLOW DOWN IN ADVANCE OF VERTICAL OR HORIZONTAL CURVES THAT RESTRICT SIGHT DISTANCE.
 3. ADDITIONAL PROTECTION VEHICLES TO WARN AND REDUCE THE SPEED OF ONCOMING WORK OPERATION SO AS TO PROVIDE ADEQUATE SIGHT DISTANCE FOR TRAFFIC APPROACHING FROM THE REAR.
 4. A TRUCK-MOUNTED ATTENUATOR (TMA) SHOULD BE USED ON THE PROTECTION VEHICLE AND MAY BE USED ON THE WORK VEHICLE.
 5. THE WORK VEHICLE SHALL BE EQUIPPED WITH BEACONS, AND THE PROTECTION VEHICLE SHALL BE EQUIPPED WITH BEACONS AND LIGHTS. THE SIGN PROTECTION AND WORK VEHICLES SHOULD DISPLAY FLASHING OR ROTATING BEACONS BOTH FORWARD AND TO THE REAR.
 6. VEHICLE CONTROL SIGNS SHALL BE MOUNTED WITH THE BOTTOM OF THE SIGN LOCATED AT A MINIMUM HEIGHT OF 48" ABOVE THE PAVEMENT. SIGN LEGENDS SHALL BE COVERED OR TURNED FROM VIEW WHEN WORK IS NOT IN PROGRESS.
 7. ALL TRAFFIC CONTROL ITEMS SHOWN ON THIS SHEET WILL NOT BE MEASURED FOR SEPARATE PAYMENT. THIS WORK IS TO BE INCLUDED IN THE PRICE BID FOR MAINTENANCE OF TRAFFIC.

S.M.	DATE	REVISION

ISSUE DATE: OCTOBER 1, 1998
SHEET NUMBER: 260



MISSISSIPPI DEPARTMENT OF TRANSPORTATION
ROADWAY DESIGN DIVISION
STANDARD PLAN
TRAFFIC CONTROL PLAN
MOBILE OPERATIONS
MULTILANE ROADS
AND
TWO-LANE ROADS

MOBILE OPERATIONS ON MULTILANE ROAD

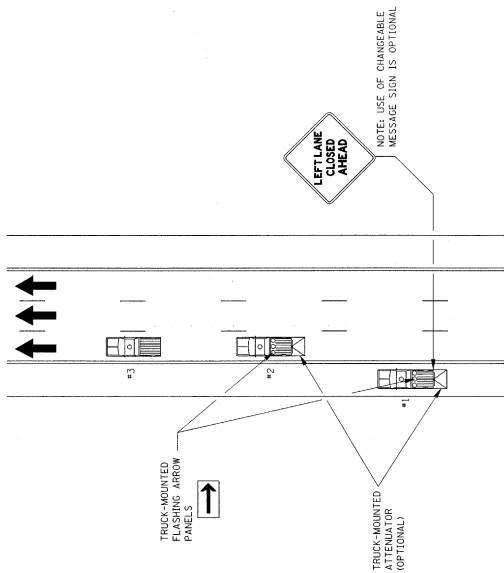

MOBILE OPERATIONS ON MULTILANE ROAD

- NOTES:**
1. VEHICLES USED FOR THESE OPERATIONS SHOULD BE MADE HIGHLY VISIBLE WITH APPROPRIATE EQUIPMENT SUCH AS FLASHING LIGHTS, ROTATING BEACONS, FLAOS, SIGNS, OR ARROW PANELS.
 2. PROTECTION VEHICLE #1 SHOULD BE EQUIPPED WITH AN ARROW PANEL. AN APPROPRIATE LANE CLOSURE SIGN SHOULD BE PLACED ON PROTECTION VEHICLE #1 SO AS NOT TO OBLSCURE THE ARROW PANEL.
 3. PROTECTION VEHICLE #2 SHOULD BE EQUIPPED WITH AN ARROW PANEL AND TRUCK-MOUNTED ATTENUATOR (TMA).
 4. PROTECTION VEHICLE #3 SHOULD TRAVEL AT A VARYING DISTANCE FROM THE WORK OPERATION SO AS TO PROVIDE ADEQUATE SIGHT DISTANCE FOR TRAFFIC APPROACHING FROM THE REAR.
 5. WHEN ADEQUATE SHOULDER WIDTH IS NOT AVAILABLE, PROTECTION VEHICLE #1 SHOULD BE ELIMINATED.
 6. ON HIGH-SPEED ROADWAYS, A THIRD PROTECTION VEHICLE SHOULD BE USED (I.E., VEHICLE #1 ON THE SHOULDER (IF PRACTICAL), VEHICLE #2 IN THE CLOSED LANE, AND VEHICLE #3 IN THE CLOSED LANE).
 7. ARROW PANELS SHALL BE AS A MINIMUM TYPE 60" X 30" IN ACCORDANCE WITH THE CRITERIA PRESENTED IN THE MUTCD.
 8. WORK SHOULD NORMALLY BE DONE DURING OFF-PEAK HOURS.
 9. ALL TRAFFIC CONTROL ITEMS SHOWN ON THIS SHEET WILL NOT BE MEASURED FOR SEPARATE PAYMENT. THIS WORK IS TO BE INCLUDED IN THE PRICE BID FOR MAINTENANCE OF TRAFFIC.

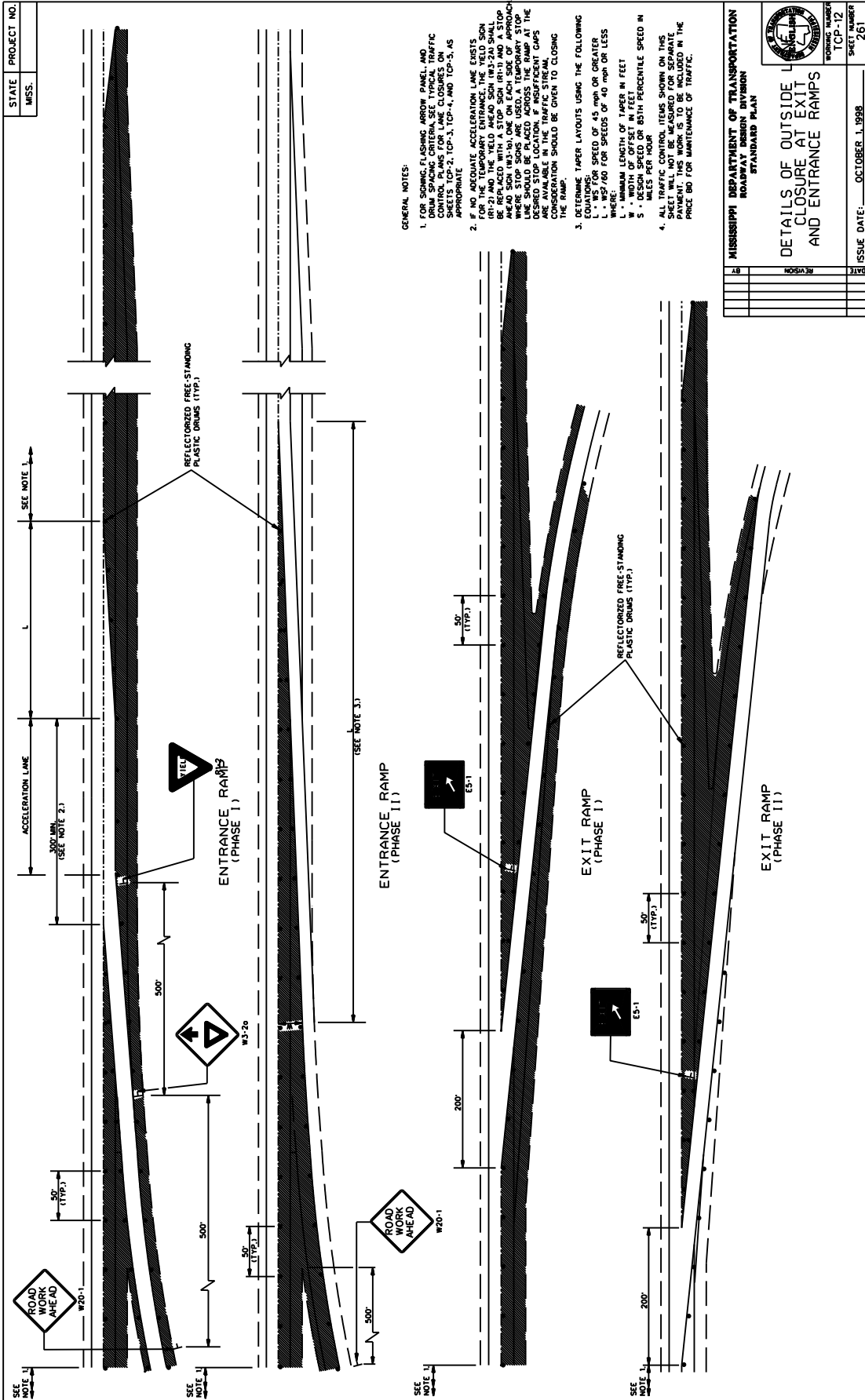

GENERAL NOTES:

- FOR SIGNING, FLASHING ARROW PANEL AND TRAFFIC CONTROL PLANS FOR LANE CLOSURES ON SHEETS TCP-2, TCP-3, TCP-4, AND TCP-5, AS APPROPRIATE.
- IF NO ADEQUATE ACCELERATION LANE EXISTS AT THE ENTRANCE TO A RAMP, THE RAMP SHOULD BE REPLACED WITH A STOP SIGN (R11) AND A STOP AHEAD SIGN (W3-26) ON EACH SIDE OF APPROACH. THE STOP SIGN SHOULD BE PLACED AT THE DESIRED STOP LOCATION, IF INSUFFICIENT GAPS EXIST. THE STOP SIGN SHOULD BE PLACED AT THE DESIRED STOP LOCATION, IF INSUFFICIENT GAPS EXIST. THE STOP SIGN SHOULD BE PLACED AT THE DESIRED STOP LOCATION, IF INSUFFICIENT GAPS EXIST.
- DETERMINE TAPER LAYOUTS USING THE FOLLOWING EQUATIONS:
 - $L = 1.47 S V$ FOR SPEEDS OF 40 MPH OR GREATER
 - $L = W S^2 / 100$ FOR SPEEDS OF 40 MPH OR LESS
 WHERE:
 - L = MINIMUM LENGTH OF TAPER IN FEET
 - S = DESIGN SPEED OR 85TH PERCENTILE SPEED IN MILES PER HOUR
 - W = TRAFFIC CONTROL ITEMS SHOWN ON THIS SHEET
- ALL TRAFFIC CONTROL ITEMS SHOWN ON THIS SHEET ARE TO BE USED FOR MAINTENANCE OF TRAFFIC. THE WORK SHOULD BE USED IN THE PRICE BID FOR MAINTENANCE OF TRAFFIC.

MISSISSIPPI DEPARTMENT OF TRANSPORTATION	
ROADWAY MAINTENANCE DIVISION	
STANDARD PLAN	
	
WORKING NUMBER	TCP-12
SHEET NUMBER	261
ISSUE DATE:	OCTOBER 1, 1998

DETAILS OF OUTSIDE LANE CLOSURE AT EXIT AND ENTRANCE RAMP

STATE	PROJECT NO.
MISS.	

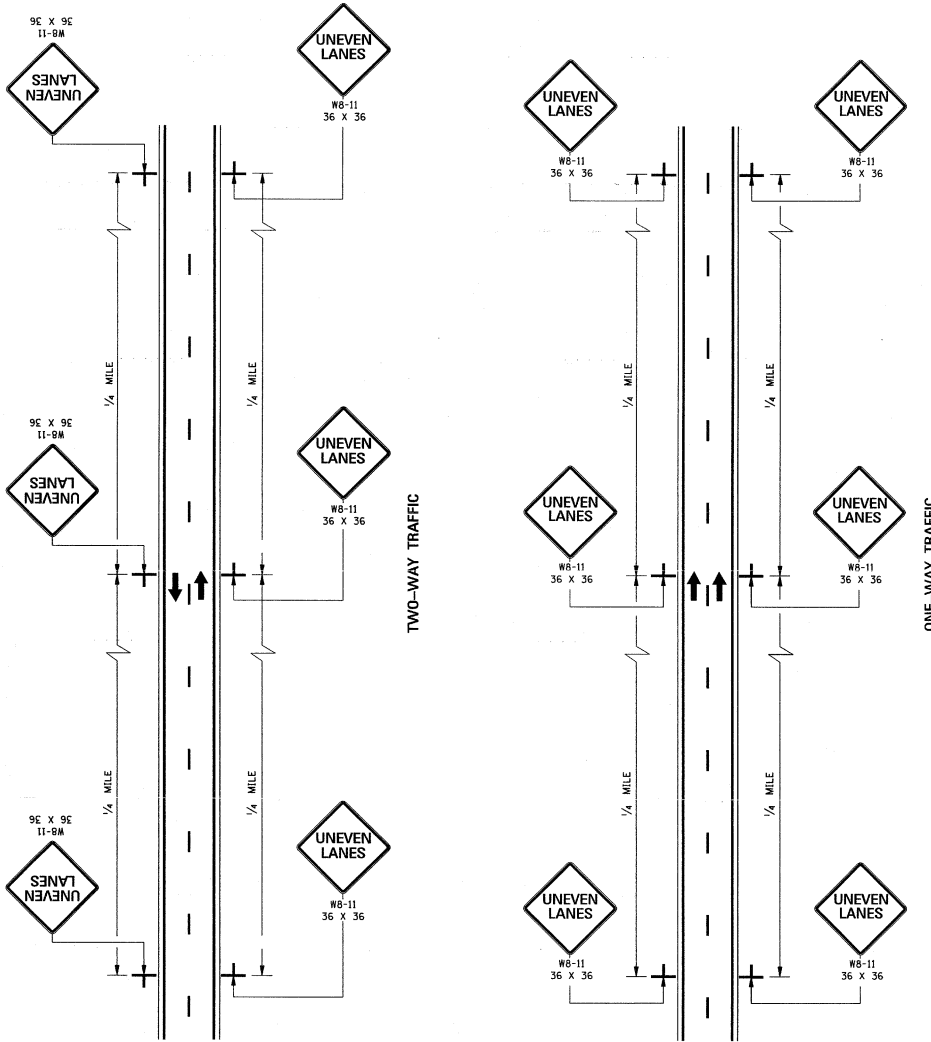

GENERAL NOTES:

1. UNEVEN LANE LINE SPACING SHALL BE EQUAL TO 1/2" NO SIGNS REQUIRED.
2. IF SPACING IS GREATER THAN 1/2" AND LESS THAN OR EQUAL TO 2/4" PLACE SIGNS AS SHOWN ON THIS SHEET.
3. IF SPACING IS GREATER THAN 2/4" TRAFFIC SHOULD NOT BE ALLOWED TO CROSS UNEVEN LANE LINE.
4. ALL TRAFFIC CONTROL ITEMS SHOWN ON THIS SHEET SHALL BE PAID FOR UNDER MAINTENANCE OF TRAFFIC.
5. THE W8-11 SIGNS SHALL BE SPACED AT 1/4-MILE INTERVALS THROUGHOUT UNEVEN LANE LINE LIMITS.

MISSISSIPPI DEPARTMENT OF TRANSPORTATION	
ROADWAY DESIGN DIVISION	
STANDARD PLAN	
TRAFFIC CONTROL PLANS	
UNEVEN PAVEMENT	
DETAILS	
WORKING NUMBER	CP-14
SHEET NUMBER	263
DATE	OCTOBER 1, 1998
BY	
REVISION	

STATE	PROJECT NO.
MISS.	

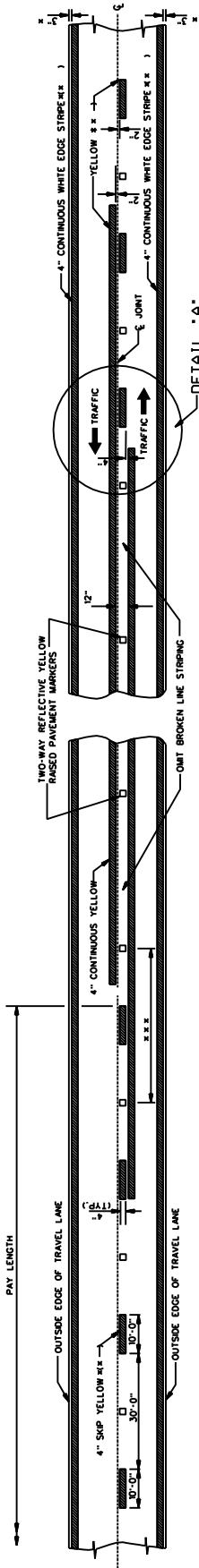

TWO-WAY TRAFFIC
(ASPHALT OR CONCRETE PAVEMENT)

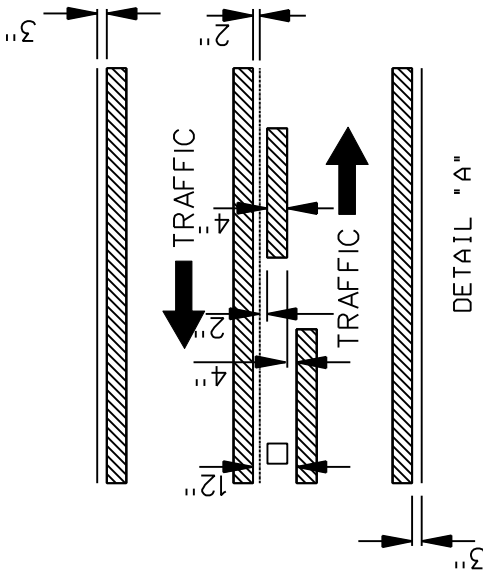

DETAIL "A"

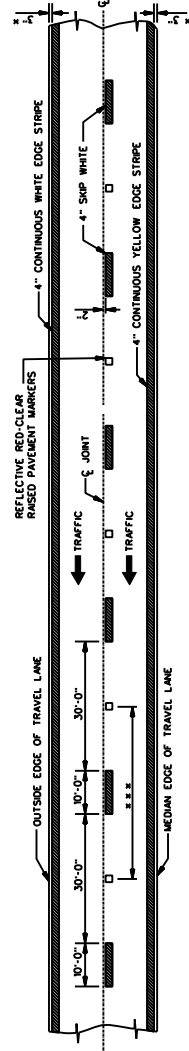

4-LANE WITH ONE-WAY TRAFFIC



GENERAL NOTES:

- * 1. 3" UNLESS SHOWN ELSEWHERE ON THE PLANS.
- ** 2. EDGE STRIPE SHALL BE SAME MATERIAL AS LANE-LINE STRIPE (PAINT OR TAPE AS INDICATED IN PAY ITEMS).
- *** 3. SPACING OF REFLECTIVE RAISED PAVEMENT MARKERS IS AS FOLLOWS:

TARGET SECTIONS	URBAN AREA (U-L-0)	RURAL AREA (U-L-0)
LANE LINES	40'-0"	80'-0"
INTERCHANGE LIMITS	40'-0"	140'-0"

- 1. NOTE: ON THE MAIN FACILITY, REFLECTIVE RED-CLEAR RAISED PAVEMENT MARKERS SHALL BE PLACED ON THE LANE-LINES THROUGH ALL INTERCHANGE AREAS BEGINNING 1000' IN ADVANCE IN DIRECTION OF TRAFFIC OF THE EXIT RAMP TAPER AND CONTINUING THROUGH THE INTERCHANGE TO THE END OF THE ENTRANCE RAMP TAPER.
- 4. PAVEMENT MARKERS SHALL BE HIGH PERFORMANCE REFLECTIVE MATERIALS AS APPROVED BY THE STATE IN THE MOOT "APPROVED SOURCES OF MATERIALS."
- 5. REFLECTIVE RAISED PAVEMENT MARKERS TO BE USED IF TEMPORARY MARKERS ARE TO REMAIN IN PLACE OVER 3 MONTHS

MISSISSIPPI DEPARTMENT OF TRANSPORTATION ROADWAY DESIGN DIVISION STANDARD PLAN	
TEMPORARY STRIPING FOR TRAFFIC CONTROL 2-LANE AND 4-LANE DIVIDED HIGHWAYS	
WORKING NUMBER	TCP-15
SHEET NUMBER	264
ISSUE DATE:	DECEMBER 1, 1999

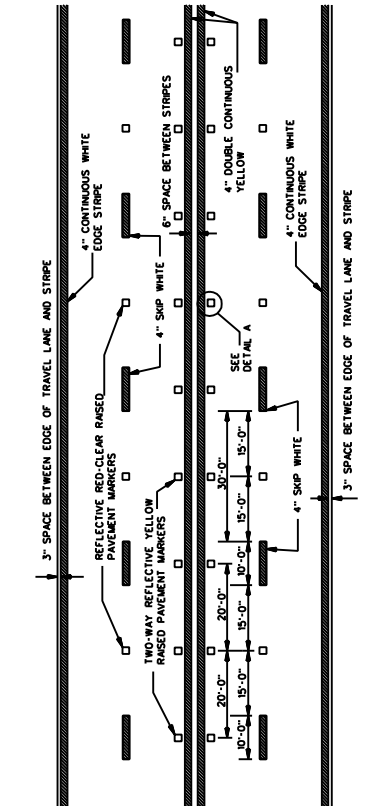

TYPICAL STRIPING AND RAISED PAVEMENT MARKERS FOR 4-LANE SECTION

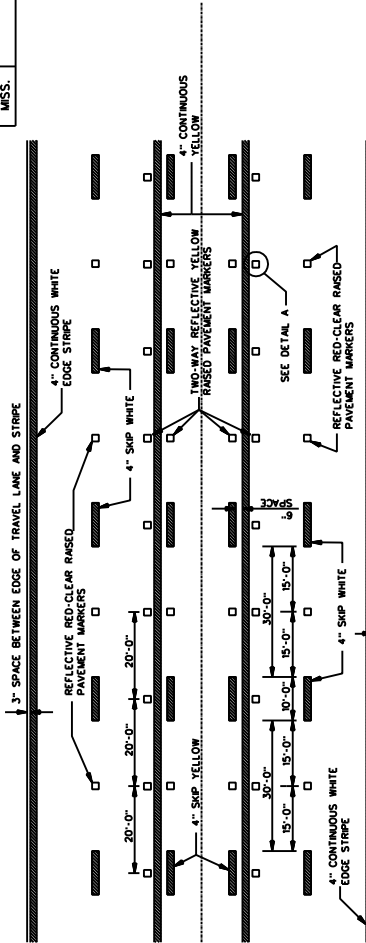

TYPICAL STRIPING AND RAISED PAVEMENT MARKERS FOR 5-LANE SECTION

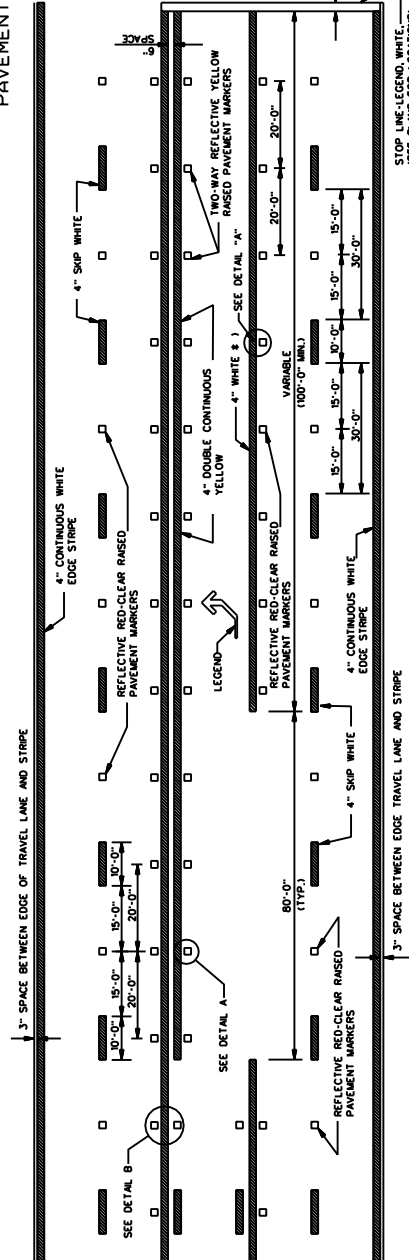

TYPICAL STRIPING AND RAISED PAVEMENT MARKERS AT LEFT TURN LANES

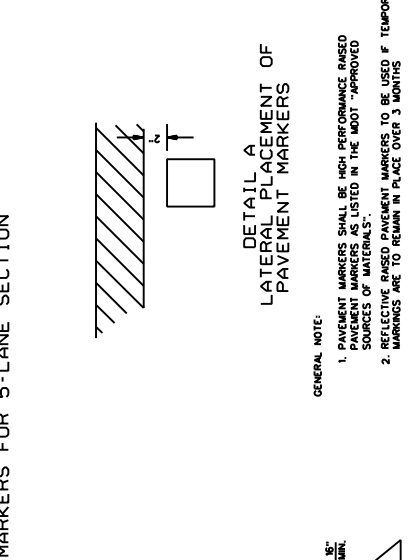

TYPICAL TWO-WAY ARROW INSTALLATION

- NOTES:
1. CONSIDER EACH SEGMENT OF CONTINUOUS TWO-WAY LEFT TURN LANE SEPARATELY.
 2. IF SEGMENT IS LESS THAN 350', PLACE ONE SET OF ARROWS IN CENTER OF SEGMENT.
 3. IF SEGMENT IS GREATER THAN 350', PLACE FIRST SET OF ARROWS 50 TO 100' FROM BEGINNING AND/OR END OF SEGMENT AND SPACE ADDITIONAL SETS OF ARROWS (250 O.C.).

DETAIL A
LATERAL PLACEMENT OF
PAVEMENT MARKERS

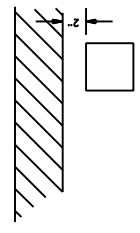

- GENERAL NOTE:
1. PAVEMENT MARKERS SHALL BE HIGH PERFORMANCE RAISED PAVEMENT MARKERS AS LISTED IN THE MOST APPROVED SOURCE OF MATERIALS.
 2. REFLECTIVE RAISED PAVEMENT MARKERS TO BE USED IF TEMPORARY MARKERS ARE TO REMAIN IN PLACE OVER 3 MONTHS.
 3. TEMPORARY TURN ARROW TO BE PAID FOR AS TEMPORARY TRAFFIC CONTROL MARKERS, ESTIMATED AT 10.9 SQ. FT. PER ARROW.

MISSISSIPPI DEPARTMENT OF TRANSPORTATION
ROADWAY DESIGN DIVISION
STANDARD PLAN

TEMPORARY STRIPING FOR
TRAFFIC CONTROL
4-LANE AND 5-LANE
UNDIVIDED ROADWAYS

NO.	REVISION	DATE
1	ISSUE	DECEMBER 1, 1999

WORKING NUMBER: TCP-16
SHEET NUMBER: 265

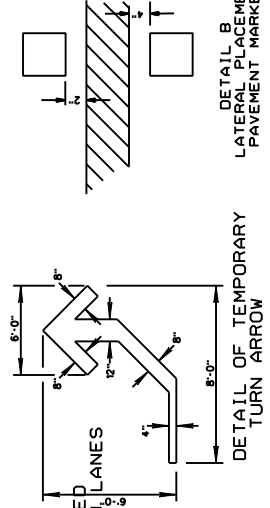

DETAIL B
LATERAL PLACEMENT OF
PAVEMENT MARKERS

- * NOTE: USE DETAIL STRIPING IF LENGTH < 150' AT THIS LOCATION, OTHERWISE USE CONTINUOUS STRIPING.

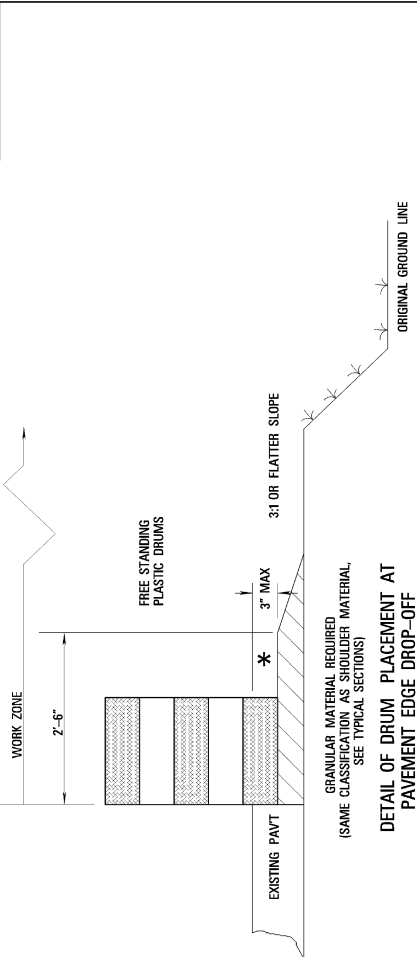

DETAIL OF DRUM PLACEMENT AT PAVEMENT EDGE DROP-OFF

GRANULAR MATERIAL REQUIRED (SAME CLASSIFICATION AS SHOULDER MATERIAL, SEE TYPICAL SECTIONS)

NOTES

- * A. PAVEMENT EDGE DROP-OFF
 1. IF LESS THAN TWO AND ONE QUARTER (2.25) INCHES-NO PROTECTION REQUIRED. PLACE A SHOULDER WORK SIGN (W21-5) 500 FEET IN ADVANCE OF WORK ZONE SHOULDER AND A LOW SHOULDER SIGN (W8-3) AT THE BEGINNING AND THROUGHOUT THE WORK ZONE @ (750 ± O.C.).
 2. TWO AND ONE QUARTER TO THREE INCHES-PLACE DRUMS, VERTICAL PANELS OR BARRICADES EVERY 100 FEET ON TANGENT SECTIONS FOR SPEEDS OF 50 MILES PER HOUR OR GREATER. COMES MAY BE USED IN PLACE OF DRUMS, PANELS AND BARRICADES DURING DAYLIGHT HOURS. FOR TANGENT SECTIONS WITH SPEEDS LESS THAN 50 MILES PER HOUR AND FOR CURVES, DEVICES SHOULD BE PLACED EVERY 50 FEET. SPACING FOR TAPERS SHOULD BE IN ACCORDANCE WITH THE M.U.T.C.D. (1/3 L, WHERE L IS THE TAPER LENGTH IN FEET)
 3. GREATER THAN THREE (3) INCHES-POSITIVE SEPARATION OR WEDGE WITH 3:1 OR FLATTER SLOPE NEEDED. IF THERE IS EIGHT (8) FEET OR MORE DISTANCE BETWEEN THE EDGE OF TRAVEL LANE AND DROP-OFF, THEN DRUMS/PANELS OR BARRICADES MAY BE USED. IF CONCRETE BARRIERS ARE USED, SPECIAL REFLECTIVE DEVICES OR STEADY BURN LIGHTS SHOULD BE USED FOR OVERNIGHT INSTALLATIONS.
 4. FOR TEMPORARY CONDITIONS, DROP-OFFS GREATER THAN THREE (3) INCHES MAY BE PROTECTED WITH DRUMS, VERTICAL PANELS OR BARRICADES FOR SHORT DISTANCES DURING DAYLIGHT HOURS WHILE WORK IS BEING DONE IN THE DROP-OFF AREA.
 5. LESSER TREATMENTS THAN THOSE DESCRIBED ABOVE MAY BE CONSIDERED FOR LOW-VOLUME LOCAL STREETS.

- B. DRUM SPACING
 1. TANGENTS = $2 \times S$
 2. CURVES = $L \times W$
 - WHERE $L = \frac{S^2}{W}$
 - L = TAPER LENGTH IN FEET
 - S = SPEED IN MPH (POSTED OR 85 PERCENTILE)
 - W = WIDTH OF OFFSET IN FEET

C. ALL TRAFFIC CONTROL ITEMS SHOWN ON THIS SHEET SHALL BE PAID FOR UNDER MAINTENANCE OF TRAFFIC.

TABLE V1-1 GUIDELINES FOR LENGTH OF LONGITUDINAL BUFFER SPACE

SPEED (MPH)	MINIMUM LENGTH (FEET)	MAXIMUM LENGTH (FEET)
20	35	45
25	45	60
30	60	75
35	75	90
40	90	105
45	105	120
50	120	135
55	135	150
60	150	165
65	165	180
70	180	195
75	195	210
80	210	225
85	225	240

* POSTED SPEED OFF PEAK 85 PERCENTILE SPEED PRIOR TO WORK STARTING OR THE ANTICIPATED STOPPING SPEED IN MPH

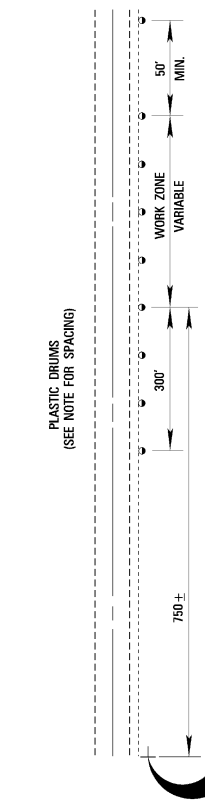
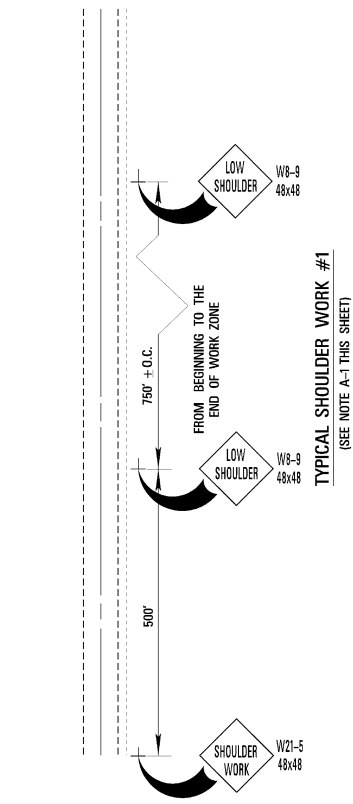
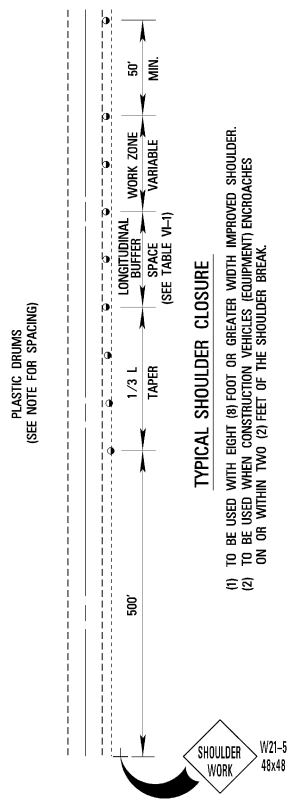

TYPICAL SHOULDER WORK #2

NOTE: WORK OUTSIDE THE (2) FOOT LIMIT AND WITHIN TEN (10) FEET OF THE SHOULDER BREAK MAY BE PROTECTED BY PLACING DRUMS ALONG THE SHOULDER EDGE, 300 FEET PRIOR TO AND 50 FEET BEYOND THE WORK AREA. OR SEE NOTE A-3 THIS SHEET.

MISSISSIPPI DEPARTMENT OF TRANSPORTATION

TRAFFIC CONTROL DETAILS
DRUM PLACEMENT
AND
SHOULDER CLOSURE

PROJECT NO.: _____
COUNTY: _____

FILE NAME: _____
PERSON: _____
DATE: 12-28-20

WORKING TITLE: TCP-115
SHEET NUMBER: _____

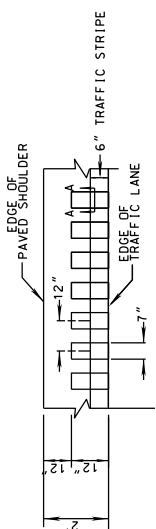

DETAIL "A"

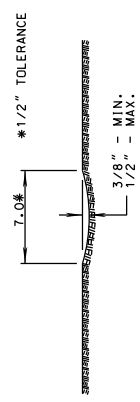

SECTION "A-A"

- GENERAL NOTES
1. GROUND-IN RUMBLE STRIPES SHALL BE APPLIED ON LEFT AND RIGHT SHOULDERS OF ALL PAVED SHOULDERS ON THIS PROJECT
 2. GROUND-IN RUMBLE STRIPES SHALL BE OMITTED ACROSS PRINCIPAL INTERSECTING ROADWAYS OR OTHER INTERRUPTIONS IN NORMAL SHOULDER WIDTH AS DIRECTED BY THE ENGINEER
 3. COST TO BE PAID FOR USING APPROPRIATE PAY ITEMS
 4. GROUND-IN RUMBLE STRIPES SHALL BE APPLIED TO MAINLINE ONLY.
 5. DO NOT USE WHERE TRAVEL LANE IS LESS THAN 11' WIDE.

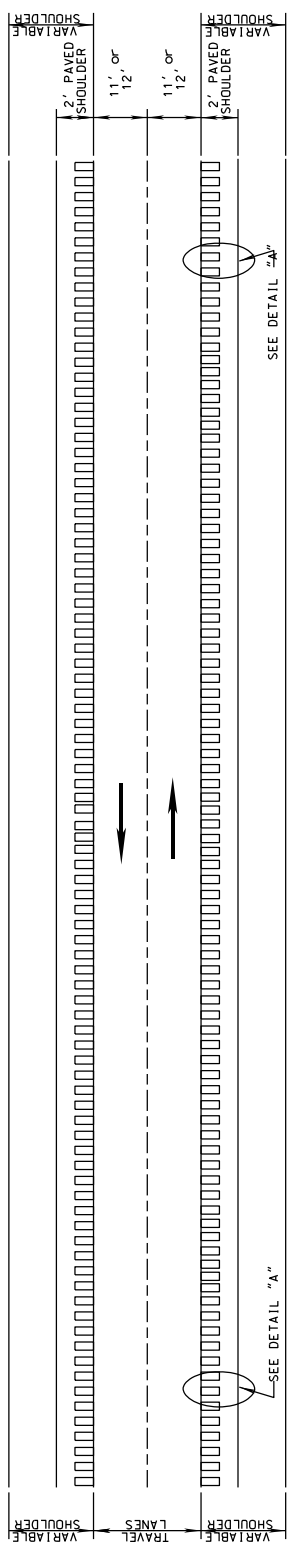

PLAN
NOT TO SCALE

MISSISSIPPI DEPARTMENT OF TRANSPORTATION	
RUMBLE STRIPES	
2-LANE HIGHWAYS	
(ASPH. LANES,	
2-FT ASPH. SHLD)	
PROJECT NO:	
COUNTY:	
ISSUING NUMBER	RS-1
SHEET NUMBER	
DATE	05/02/14
BY	
REVISION	
DATE	
FILE NAME	
DESIGN TEAM	SERVICES CHECKED

MISSISSIPPI DEPARTMENT OF TRANSPORTATION	
RUMBLE STRIPES	
4-LANE HIGHWAYS	
(ASPH. LANES, 2-FT ASPH. SHLD)	
WORKING NUMBER	RS 2
SHEET NUMBER	54
PROJECT NO:	
COUNTY:	
FILE NAME:	
PERSON:	
CHECKED:	
DATE:	05/07/14

- GENERAL NOTES
1. ALL RUMBLE STRIPES SHALL BE GROUND-IN. RUMBLE STRIPES SHALL BE OMITTED ACROSS PRINCIPAL INTERSECTING ROADWAYS OR OTHER INTERRUPTIONS IN NORMAL SHOULDER WIDTH AS DIRECTED BY THE ENGINEER
 2. GROUND-IN RUMBLE STRIPES SHALL BE APPLIED TO MAINLINE ONLY.

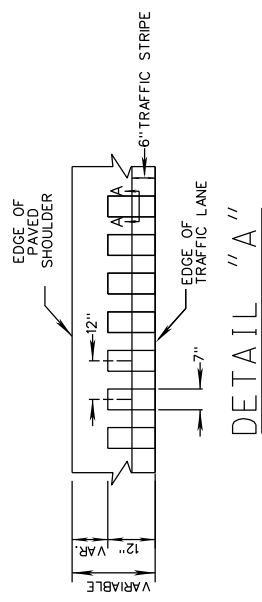

SECTION "A-A"

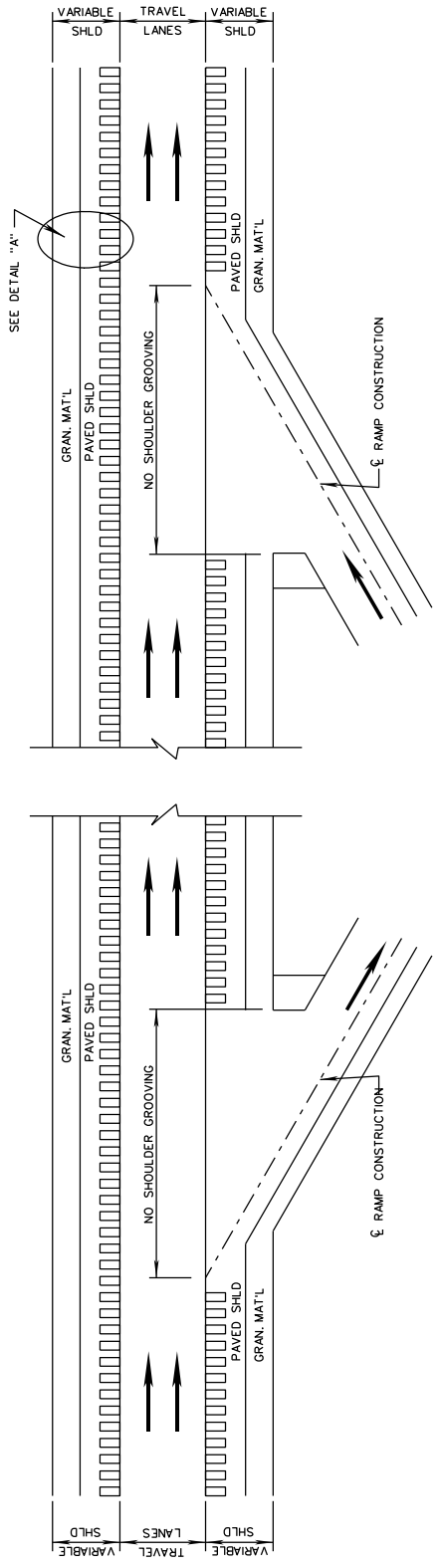

NOT TO SCALE
DETAILS OF
RUMBLE STRIPS

STATE	PROJECT NO.
MISS.	

- GENERAL NOTES
1. ALL RUMBLE STRIPES SHALL BE GROUND-IN RUMBLE STRIPES SHALL BE OMITTED ACROSS PRINCIPAL INTERSECTING ROADWAYS OR OTHER INTERRUPTIONS IN NORMAL SHOULDER WIDTH AS DIRECTED BY THE ENGINEER
 2. GROUND-IN RUMBLE STRIPES SHALL BE APPLIED TO MAINLINE ONLY.

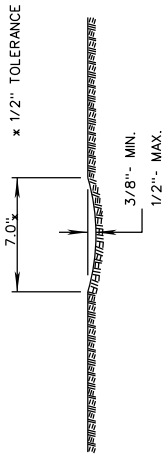
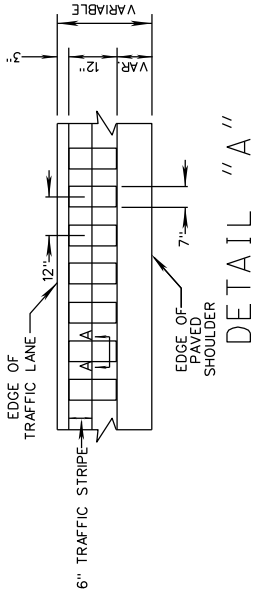

SECTION "A-A"

DETAIL "A"

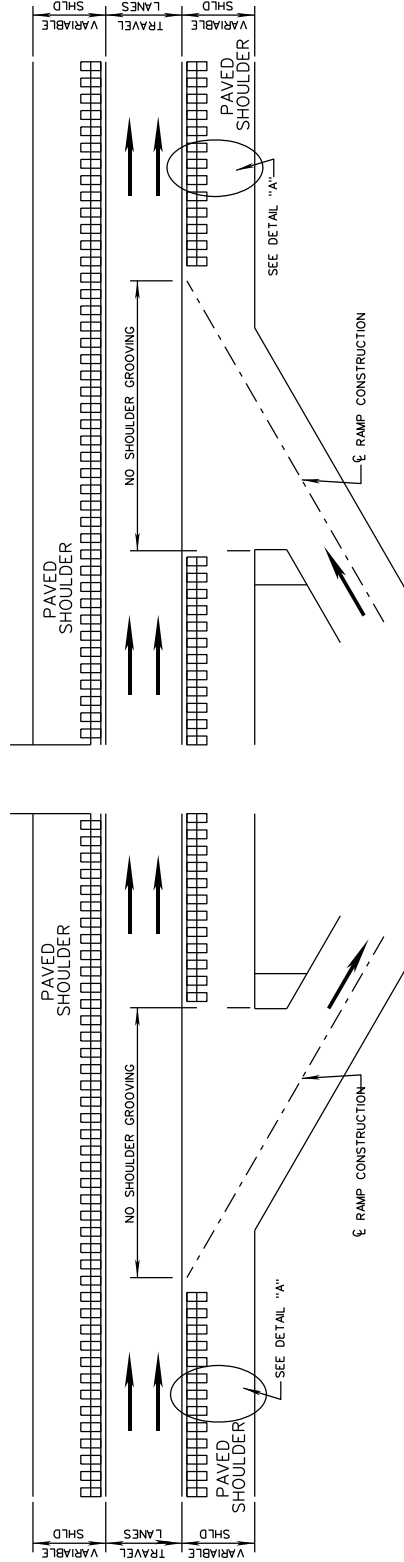

PLAN
NOT TO SCALE
DETAILS OF
RUMBLE STRIPS
(GROUND-IN)

MISSISSIPPI DEPARTMENT OF TRANSPORTATION	
RUMBLE STRIPES	
4-LANE WITH FULL-WIDTH	
PAVED SHOULDERS	
(CONC. LANES, ASPH. SHLD)	
WORKING NUMBER	PROJECT NO:
RS-3	COUNTY:
SHEET NUMBER	FILE NAME:
	DESIGN TEAM
	CHECKED:
	DATE 05/07/14

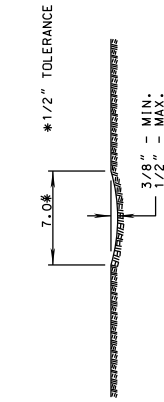
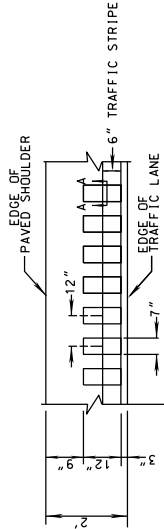

DETAIL "A"

SECTION "A-A"

- GENERAL NOTES
1. GROUND-IN RUMBLE STRIPES SHALL BE APPLIED ON LEFT AND RIGHT SHOULDERS OF ALL PAVED SHOULDERS ON THIS PROJECT
 2. GROUND-IN RUMBLE STRIPES SHALL BE OMITTED ACROSS PRINCIPAL INTERSECTING ROADWAY OR OTHER INTERRUPTIONS IN TRAFFIC LANE WIDTH AS DIRECTED BY THE ENGINEER
 3. COST TO BE PAID FOR USING APPROPRIATE PAY ITEMS
 4. GROUND-IN RUMBLE STRIPES SHALL BE APPLIED TO MAINLINE ONLY.
 5. DO NOT USE WHERE TRAVEL LANE IS LESS THAN 11' WIDE.

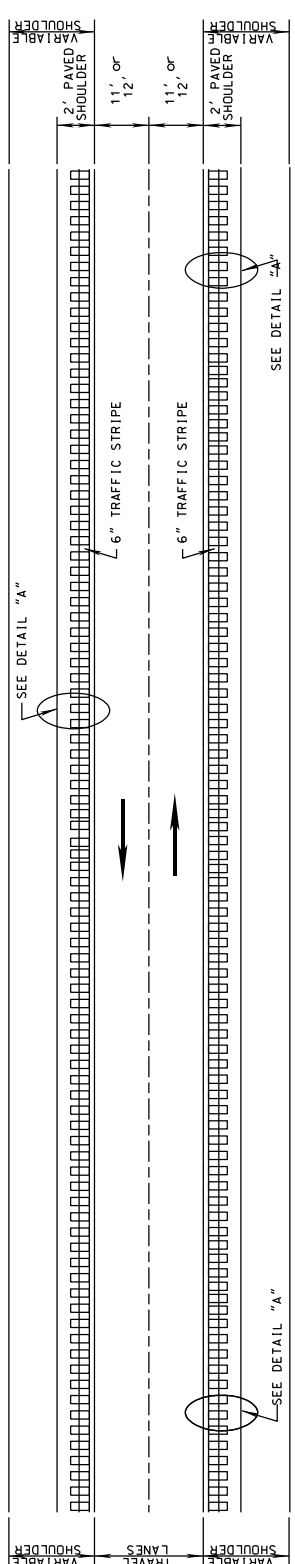

PLAN
NOT TO SCALE

MISSISSIPPI DEPARTMENT OF TRANSPORTATION	
RUMBLE STRIPES	
2-LANE HIGHWAY	
(CONCRETE LANES,	
2-FT. ASPH. SHLD.)	
PROJECT NO:	
COUNTY:	
DATE:	DRAWING NUMBER:
DATE:	PROJECT NUMBER:
DATE:	SHEET NUMBER:
DATE:	SHEET NUMBER:

GENERAL NOTES

1. GROUND-IN RUMBLE STRIPS SHALL BE APPLIED ON LEFT AND RIGHT SHOULDERS OF ALL PAVED SHOULDERS ON THIS PROJECT
2. GROUND-IN RUMBLE STRIPS SHALL BE OMITTED ACROSS PRINCIPAL INTERSECTIONS, ROADWAYS OR OTHER INTERRUPTIONS IN NORMAL SHOULDER WIDTH AS DIRECTED BY THE ENGINEER
3. COST TO BE PAID FOR IN PAY ITEM 907-423-A RUMBLE STRIPS (GROUND-IN).
4. GROUND-IN RUMBLE STRIPS SHALL BE APPLIED TO MAINLINE ONLY.



SECTION E-E

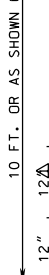

SECTION B-B

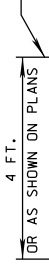

SECTION C-C

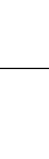

SECTION D-D

SECTION E-E

PLAN

Notice To Bidders

MISSISSIPPI DEPARTMENT OF TRANSPORTATION

RUMBLE STRIP DETAIL FOR O.G.F.C. OR CONC ROADWAY WITH ASPH SHLD

PROJECT NO. : COUNTY :

DATE	REVISION	BY	SS

WORKING NUMBER: R05 SHEET NUMBER: 115

FILENAME: RumbleStripOGFC.dgn DATE: 05/02/14 CHECKED: DESIGN TEAM

STATE	PROJECT NO.
MSS.	

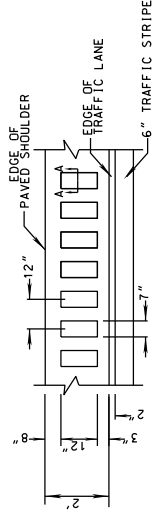
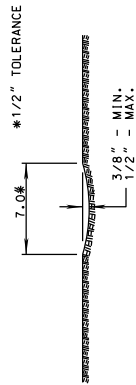

GENERAL NOTES
 1. GROUND-IN RUMBLE STRIPS SHALL BE APPLIED ON LEFT AND RIGHT SHOULDERS OF ALL PAVED SHOULDERS ON THIS PROJECT

2. GROUND-IN RUMBLE STRIPS SHALL BE OMITTED ACROSS PRINCIPAL INTERSECTING ROADWAYS OR OTHER INTERRUPTIONS IN NORMAL SHOULDER WIDTH AS DIRECTED BY THE ENGINEER

3. COST TO BE PAID FOR USING APPROPRIATE PAY ITEMS

4. GROUND-IN RUMBLE STRIPS SHALL BE APPLIED TO MAINLINE ONLY.

5. DO NOT USE WHERE TRAVEL LANE IS LESS THAN 11' WIDE.

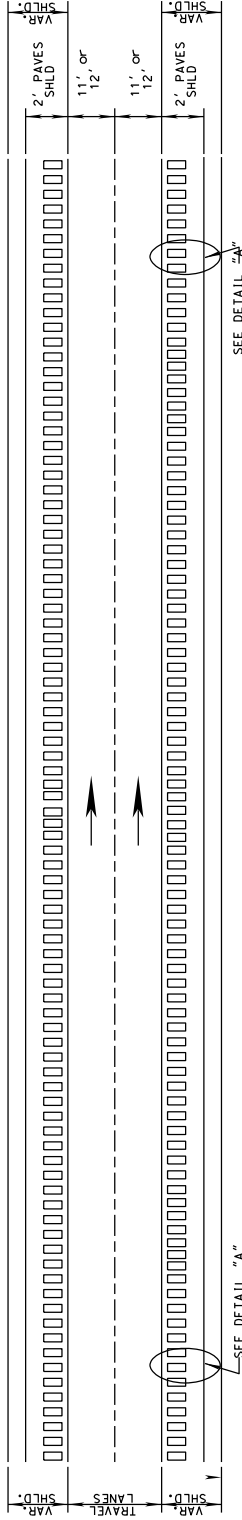

MISSISSIPPI DEPARTMENT OF TRANSPORTATION	
RUMBLE STRIPS FOR 4-LANE DIVIDED ROADWAYS WITH 2-FOOT PAVED SHOULDERS CONCRETE LANES, ASPH. SHOULDER	
PROJECT NO. :	
COUNTY :	
WORKING NUMBER RS-6	SHEET NUMBER
FILE NAME: \\FS-C\Cummins\LDIS.DWG	DATE: 05/20/14
DESIGN: T.M. S. LEWIS	DIRECTOR

PLAN
 NOT TO SCALE

MISSISSIPPI DEPARTMENT OF TRANSPORTATION

SECTION 904 - NOTICE TO BIDDERS NO. 249

CODE: (SP)

DATE: 6/28/2017

SUBJECT: Contract Time

**PROJECT: BR-0059-01(119) / 107567301 – Forrest County &
BR-0059-02(109) / 107568301 – Jones County**

The calendar date for completion of work to be performed by the Contractor for this project shall be **June 11, 2018** which date or extended date as provided in Subsection 108.06 shall be the end of contract time. It is anticipated that the Notice of Award will be issued no later than **September 12, 2017** and the effective date of the Notice to Proceed / Beginning of Contract Time will be **October 12, 2017**.

Should the Contractor request a Notice to Proceed earlier than **October 12, 2017** and it is agreeable with the Department for an early Notice to Proceed, the requested date will become the new Notice to Proceed date.

MISSISSIPPI DEPARTMENT OF TRANSPORTATION

SECTION 904 -NOTICE TO BIDDERS NO. 250

CODE: (SP)

DATE: 07/05/2017

SUBJECT: Scope of Work

PROJECT: BR-0059-01(119) / 107567301 & BR-0059-02(109) / 107568301 -- Forrest and Jones Counties

The contract documents do not include an official set of construction plans but may, by reference, include some Standard Drawings when so specified in a Notice to Bidders entitled, "Standard Drawings". All other references to plans in the contract documents and Standard Specifications for Road and Bridge Construction are to be disregarded.

Work on the projects shall consist of cleaning caps, removing all of the existing paint, cleaning the exposed structural steel, and painting all of the existing structural steel on the following bridges:

I-59 over the Bouie River, 0.8 miles north of US 49
Bridge# 67.7A & B
Bridge ID # 10993 & 10994
Approximate Area- 40,320 square feet

I-59 over the Leaf River, 4.8 miles north of Forrest County line
Bridge# 77.4A & B
Bridge ID # 11962 & 11963
Approximate Area- 40,220 square feet

Note: All of the structural steel girders and bridge components on these bridges shall be abrasive blasted, as referenced in 907-845.03.7.6, and repainted.

The above square footages are for information purposes only and are approximate and will not be measured for payment. Actual square footages may be more or less than given above and shall not be a basis for additional compensation. Payment shall be made by the lump sum regardless of over-run or under-run of the above approximate square footages.

A containment system shall be required at bridge work sites. The Contractor shall design, install and maintain a containment system in accordance with Special Provision 907-845 to assure that the traveling public, including waterway traffic, will not be exposed to construction debris and materials during the cleaning and painting process. The Contractor will be required to properly dispose of all debris at an approved landfill.

Joint Repair & Sealing:

Joint repair and sealing will only be required on the I-59 over the Leaf River in Jones County. The joint repair shall include removal of all existing joint material, joint preparation, saw cutting,

installation of the preformed joint seal and other necessary work per the included standard drawings or as directed by the Engineer. All concrete approach slab joints shall be sealed. If the bridge has an asphalt approach, the joint between the asphalt and concrete shall not be disturbed. Removal of all material associated with armor, sliding plate, or neoprene expansion joints shall be paid under Pay Item No. 202-B, Removal of Existing Joint Material. Removal of material from all other joint types will not be paid directly and shall be considered an absorbed item of work.

After the existing joint material has been removed, the joints shall then be saw cut as per the Joint Repair Standard Drawings. Saw cuts will be paid for under Pay Item No. 907-823- B, Saw Cut, Type 1. The joints are then to be repaired, if necessary, with epoxy mortar or an approved equivalent. This work will be paid for under Pay Item No. 808-A, Joint Preparation.

The joint shall then be sealed by one of the three approved Manufacturers listed in Special Provision 907-823 and installed according to the Manufacturer's specifications.

Existing joint armor shall remain in place at bents 7, 8, 11, & 12. The armor at bents 7 & 12 should be prepped for the seal under Pay Item No. 808-A001, Joint Preparation. The joints shall then be sealed by one of the three approved Manufacturers listed in Special Provision 907-823 and installed according to the Manufacturer's specifications.

Cap Cleaning:

Cap cleaning should be performed by removing all large debris by hand. All other debris (dirt and rust) shall be removed by pressure washing the bent caps from the bridge deck to the satisfaction of the Project Engineer. The pressure washer shall be able to maintain 3,500 PSI of pressure. This work will be paid for under Pay Item No. 907-824-PP, Bridge Repair, Cap Cleaning.

Incidental work such as project clean up, debris disposal, and other incidental work necessary to complete the project will not be measured for separate payment and will be considered absorbed items.

The Contractor shall erect and maintain construction signing and provide all signs and traffic handling devices necessary to safely maintain traffic around or through the work areas in accordance with the Traffic Control Plan. Payment shall be included in the price bid for Pay Item No. 618-A, Maintenance of Traffic. Special signing is required for the waterway and is addressed in the Notice to Bidders entitled "Special Sign Requirement".

MISSISSIPPI DEPARTMENT OF TRANSPORTATION

SECTION 904 - NOTICE TO BIDDERS NO. 296

CODE: (SP)

DATE: 07/25/2017

SUBJECT: Reduced Speed Limit Signs

Bidders are advised that when the plans or contract documents require the speed limit on a project to be reduced, the Contractor shall begin work within 48 hours of installing the reduced speed limit signs. Should the Contractor not start work or have no plans to start work within 48 hours of installing the signs, the reduced speed limit signs shall be covered and existing speed limit signs uncovered.

General Decision Number: MS170235 04/14/2017 MS235

Superseded General Decision Number: MS20160235

State: Mississippi

Construction Type: Highway

County: Forrest County in Mississippi.

HIGHWAY CONSTRUCTION PROJECTS

Note: Under Executive Order (EO) 13658, an hourly minimum wage of \$10.20 for calendar year 2017 applies to all contracts subject to the Davis-Bacon Act for which the contract is awarded (and any solicitation was issued) on or after January 1, 2015. If this contract is covered by the EO, the contractor must pay all workers in any classification listed on this wage determination at least \$10.20 (or the applicable wage rate listed on this wage determination, if it is higher) for all hours spent performing on the contract in calendar year 2017. The EO minimum wage rate will be adjusted annually. Additional information on contractor requirements and worker protections under the EO is available at www.dol.gov/whd/govcontracts.

Modification Number	Publication Date
0	01/06/2017
1	04/14/2017

* ELEC0903-006 12/01/2016

	Rates	Fringes
ELECTRICIAN.....	\$ 26.10	12.5%+4.00

SUMS2010-054 08/04/2014

	Rates	Fringes
CARPENTER (Form Work Only).....	\$ 12.00	0.00
CEMENT MASON/CONCRETE FINISHER...	\$ 11.54	1.63
HIGHWAY/PARKING LOT STRIPING:		
Truck Driver (Line Striping Truck).....	\$ 14.55	0.00
INSTALLER - SIGN.....	\$ 12.19	0.00
INSTALLER: Guardrail.....	\$ 12.39	0.00
IRONWORKER, REINFORCING.....	\$ 16.44	0.00
LABORER: Common or General, Including Asphalt Raking, Shoveling, Spreading.....	\$ 10.34	0.00
LABORER: Flagger.....	\$ 11.42	0.00

LABORER: Grade Checker.....	\$ 14.82	0.00
LABORER: Luteman.....	\$ 12.88	0.00
LABORER: Mason Tender - Cement/Concrete.....	\$ 10.57	0.00
LABORER: Pipelayer.....	\$ 14.50	0.00
LABORER: Laborer-Cones/ Barricades/Barrels - Setter/Mover/Sweeper.....	\$ 12.17	0.00
OPERATOR: Asphalt Spreader.....	\$ 14.71	0.00
OPERATOR: Backhoe/Excavator/Trackhoe.....	\$ 14.20	0.00
OPERATOR: Bobcat/Skid Steer/Skid Loader.....	\$ 11.86	0.00
OPERATOR: Broom/Sweeper.....	\$ 10.94	0.00
OPERATOR: Bulldozer.....	\$ 13.99	0.00
OPERATOR: Concrete Saw.....	\$ 13.93	0.00
OPERATOR: Crane.....	\$ 14.80	0.00
OPERATOR: Distributor.....	\$ 11.46	0.00
OPERATOR: Grader/Blade.....	\$ 16.09	0.00
OPERATOR: Loader.....	\$ 13.99	0.00
OPERATOR: Mechanic.....	\$ 13.00	0.00
OPERATOR: Milling Machine.....	\$ 16.96	0.00
OPERATOR: Oiler.....	\$ 12.22	0.00
OPERATOR: Paver (Asphalt, Aggregate, and Concrete).....	\$ 11.56	0.00
OPERATOR: Roller (All Types)....	\$ 12.17	0.00
OPERATOR: Scraper.....	\$ 14.00	0.00
OPERATOR: Tractor.....	\$ 12.00	0.00
SURVEYOR (Staking, Marking and Brush Clearing).....	\$ 11.56	0.00
TRUCK DRIVER: Flatbed Truck.....	\$ 14.72	0.00
TRUCK DRIVER: Lowboy Truck.....	\$ 14.18	0.00
TRUCK DRIVER: Mechanic.....	\$ 12.31	0.00

TRUCK DRIVER: Water Truck.....	\$ 17.08	0.00
TRUCK DRIVER: Dump Truck (All Types).....	\$ 11.58	0.00
TRUCK DRIVER: Semi/Trailer Truck.....	\$ 14.36	0.00

WELDERS - Receive rate prescribed for craft performing operation to which welding is incidental.

Note: Executive Order (EO) 13706, Establishing Paid Sick Leave for Federal Contractors applies to all contracts subject to the Davis-Bacon Act for which the contract is awarded (and any solicitation was issued) on or after January 1, 2017. If this contract is covered by the EO, the contractor must provide employees with 1 hour of paid sick leave for every 30 hours they work, up to 56 hours of paid sick leave each year. Employees must be permitted to use paid sick leave for their own illness, injury or other health-related needs, including preventive care; to assist a family member (or person who is like family to the employee) who is ill, injured, or has other health-related needs, including preventive care; or for reasons resulting from, or to assist a family member (or person who is like family to the employee) who is a victim of, domestic violence, sexual assault, or stalking. Additional information on contractor requirements and worker protections under the EO is available at www.dol.gov/whd/govcontracts.

Unlisted classifications needed for work not included within the scope of the classifications listed may be added after award only as provided in the labor standards contract clauses (29CFR 5.5 (a) (1) (ii)).

The body of each wage determination lists the classification and wage rates that have been found to be prevailing for the cited type(s) of construction in the area covered by the wage determination. The classifications are listed in alphabetical order of "identifiers" that indicate whether the particular rate is a union rate (current union negotiated rate for local), a survey rate (weighted average rate) or a union average rate (weighted union average rate).

Union Rate Identifiers

A four letter classification abbreviation identifier enclosed in dotted lines beginning with characters other than "SU" or "UAVG" denotes that the union classification and rate were prevailing for that classification in the survey. Example: PLUM0198-005 07/01/2014. PLUM is an abbreviation identifier of the union which prevailed in the survey for this classification, which in this example would be Plumbers. 0198 indicates the local union number or district council number

where applicable, i.e., Plumbers Local 0198. The next number, 005 in the example, is an internal number used in processing the wage determination. 07/01/2014 is the effective date of the most current negotiated rate, which in this example is July 1, 2014.

Union prevailing wage rates are updated to reflect all rate changes in the collective bargaining agreement (CBA) governing this classification and rate.

Survey Rate Identifiers

Classifications listed under the "SU" identifier indicate that no one rate prevailed for this classification in the survey and the published rate is derived by computing a weighted average rate based on all the rates reported in the survey for that classification. As this weighted average rate includes all rates reported in the survey, it may include both union and non-union rates. Example: SULA2012-007 5/13/2014. SU indicates the rates are survey rates based on a weighted average calculation of rates and are not majority rates. LA indicates the State of Louisiana. 2012 is the year of survey on which these classifications and rates are based. The next number, 007 in the example, is an internal number used in producing the wage determination. 5/13/2014 indicates the survey completion date for the classifications and rates under that identifier.

Survey wage rates are not updated and remain in effect until a new survey is conducted.

Union Average Rate Identifiers

Classification(s) listed under the UAVG identifier indicate that no single majority rate prevailed for those classifications; however, 100% of the data reported for the classifications was union data. EXAMPLE: UAVG-OH-0010 08/29/2014. UAVG indicates that the rate is a weighted union average rate. OH indicates the state. The next number, 0010 in the example, is an internal number used in producing the wage determination. 08/29/2014 indicates the survey completion date for the classifications and rates under that identifier.

A UAVG rate will be updated once a year, usually in January of each year, to reflect a weighted average of the current negotiated/CBA rate of the union locals from which the rate is based.

WAGE DETERMINATION APPEALS PROCESS

1.) Has there been an initial decision in the matter? This can be:

- * an existing published wage determination
- * a survey underlying a wage determination
- * a Wage and Hour Division letter setting forth a position on a wage determination matter

* a conformance (additional classification and rate) ruling

On survey related matters, initial contact, including requests for summaries of surveys, should be with the Wage and Hour Regional Office for the area in which the survey was conducted because those Regional Offices have responsibility for the Davis-Bacon survey program. If the response from this initial contact is not satisfactory, then the process described in 2.) and 3.) should be followed.

With regard to any other matter not yet ripe for the formal process described here, initial contact should be with the Branch of Construction Wage Determinations. Write to:

Branch of Construction Wage Determinations
Wage and Hour Division
U.S. Department of Labor
200 Constitution Avenue, N.W.
Washington, DC 20210

2.) If the answer to the question in 1.) is yes, then an interested party (those affected by the action) can request review and reconsideration from the Wage and Hour Administrator (See 29 CFR Part 1.8 and 29 CFR Part 7). Write to:

Wage and Hour Administrator
U.S. Department of Labor
200 Constitution Avenue, N.W.
Washington, DC 20210

The request should be accompanied by a full statement of the interested party's position and by any information (wage payment data, project description, area practice material, etc.) that the requestor considers relevant to the issue.

3.) If the decision of the Administrator is not favorable, an interested party may appeal directly to the Administrative Review Board (formerly the Wage Appeals Board). Write to:

Administrative Review Board
U.S. Department of Labor
200 Constitution Avenue, N.W.
Washington, DC 20210

4.) All decisions by the Administrative Review Board are final.

=====

END OF GENERAL DECISION

General Decision Number: MS170198 02/24/2017 MS198

Superseded General Decision Number: MS20160198

State: Mississippi

Construction Type: Highway

County: Jones County in Mississippi.

HIGHWAY CONSTRUCTION PROJECTS

Note: Under Executive Order (EO) 13658, an hourly minimum wage of \$10.20 for calendar year 2017 applies to all contracts subject to the Davis-Bacon Act for which the contract is awarded (and any solicitation was issued) on or after January 1, 2015. If this contract is covered by the EO, the contractor must pay all workers in any classification listed on this wage determination at least \$10.20 (or the applicable wage rate listed on this wage determination, if it is higher) for all hours spent performing on the contract in calendar year 2017. The EO minimum wage rate will be adjusted annually. Additional information on contractor requirements and worker protections under the EO is available at www.dol.gov/whd/govcontracts.

Modification Number	Publication Date
0	01/06/2017
1	02/24/2017

* ELEC0917-006 01/01/2017

	Rates	Fringes
ELECTRICIAN.....	\$ 24.80	9.18

SUMS2010-017 08/04/2014

	Rates	Fringes
CARPENTER (Form Work Only).....	\$ 12.66	0.60
CARPENTER, Excludes Form Work....	\$ 14.21	0.00
CEMENT MASON/CONCRETE FINISHER...	\$ 12.47	0.78
HIGHWAY/PARKING LOT STRIPING: Truck Driver (Line Striping Truck).....	\$ 12.26	0.00
INSTALLER - GUARDRAIL.....	\$ 11.68	0.00
INSTALLER - SIGN.....	\$ 12.01	0.00
IRONWORKER, REINFORCING.....	\$ 15.28	0.00
LABORER: Common or General, Including Asphalt Raking, Shoveling, Spreading.....	\$ 10.12	0.00

LABORER: Flagger.....	\$ 10.00	0.00
LABORER: Grade Checker.....	\$ 12.41	0.00
LABORER: Mason Tender - Cement/Concrete.....	\$ 11.10	0.00
LABORER: Pipelayer.....	\$ 12.27	0.00
LABORER: Laborer-Cones/ Barricades/Barrels - Setter/Mover/Sweeper.....	\$ 12.02	0.00
OPERATOR: Asphalt Spreader.....	\$ 15.33	0.00
OPERATOR: Backhoe/Excavator/Trackhoe.....	\$ 14.29	0.00
OPERATOR: Broom/Sweeper.....	\$ 10.75	0.00
OPERATOR: Bulldozer.....	\$ 13.16	0.00
OPERATOR: Concrete Saw.....	\$ 14.32	0.00
OPERATOR: Crane.....	\$ 18.35	0.00
OPERATOR: Distributor.....	\$ 12.00	0.00
OPERATOR: Drill.....	\$ 19.22	0.00
OPERATOR: Grader/Blade.....	\$ 16.89	0.00
OPERATOR: Loader.....	\$ 14.31	0.00
OPERATOR: Mechanic.....	\$ 15.41	0.00
OPERATOR: Milling Machine.....	\$ 16.59	0.00
OPERATOR: Mixer.....	\$ 12.42	0.00
OPERATOR: Oiler.....	\$ 13.05	0.00
OPERATOR: Paver (Asphalt, Aggregate, and Concrete).....	\$ 11.69	0.00
OPERATOR: Piledriver.....	\$ 15.13	0.00
OPERATOR: Roller (All Types)....	\$ 12.24	0.00
OPERATOR: Scraper.....	\$ 12.63	0.00
OPERATOR: Tractor.....	\$ 11.02	0.00
OPERATOR: Trencher.....	\$ 13.75	0.00
SURVEYOR (Staking, Marking and Brush Clearing).....	\$ 12.34	0.00
TRUCK DRIVER: Flatbed Truck.....	\$ 13.29	0.00

TRUCK DRIVER: Lowboy Truck.....	\$ 12.59	0.00
TRUCK DRIVER: Mechanic.....	\$ 12.30	0.00
TRUCK DRIVER: Off the Road Truck.....	\$ 12.31	0.00
TRUCK DRIVER: Water Truck.....	\$ 9.63	0.00
TRUCK DRIVER: Dump (All Axles)...	\$ 11.00	0.00
TRUCK DRIVER: Semi/Trailer Truck.....	\$ 12.50	0.00

WELDERS - Receive rate prescribed for craft performing operation to which welding is incidental.

=====
Note: Executive Order (EO) 13706, Establishing Paid Sick Leave for Federal Contractors applies to all contracts subject to the Davis-Bacon Act for which the contract is awarded (and any solicitation was issued) on or after January 1, 2017. If this contract is covered by the EO, the contractor must provide employees with 1 hour of paid sick leave for every 30 hours they work, up to 56 hours of paid sick leave each year. Employees must be permitted to use paid sick leave for their own illness, injury or other health-related needs, including preventive care; to assist a family member (or person who is like family to the employee) who is ill, injured, or has other health-related needs, including preventive care; or for reasons resulting from, or to assist a family member (or person who is like family to the employee) who is a victim of, domestic violence, sexual assault, or stalking. Additional information on contractor requirements and worker protections under the EO is available at www.dol.gov/whd/govcontracts.

Unlisted classifications needed for work not included within the scope of the classifications listed may be added after award only as provided in the labor standards contract clauses (29CFR 5.5 (a) (1) (ii)).

The body of each wage determination lists the classification and wage rates that have been found to be prevailing for the cited type(s) of construction in the area covered by the wage determination. The classifications are listed in alphabetical order of "identifiers" that indicate whether the particular rate is a union rate (current union negotiated rate for local), a survey rate (weighted average rate) or a union average rate (weighted union average rate).

Union Rate Identifiers

A four letter classification abbreviation identifier enclosed

in dotted lines beginning with characters other than "SU" or "UAVG" denotes that the union classification and rate were prevailing for that classification in the survey. Example: PLUM0198-005 07/01/2014. PLUM is an abbreviation identifier of the union which prevailed in the survey for this classification, which in this example would be Plumbers. 0198 indicates the local union number or district council number where applicable, i.e., Plumbers Local 0198. The next number, 005 in the example, is an internal number used in processing the wage determination. 07/01/2014 is the effective date of the most current negotiated rate, which in this example is July 1, 2014.

Union prevailing wage rates are updated to reflect all rate changes in the collective bargaining agreement (CBA) governing this classification and rate.

Survey Rate Identifiers

Classifications listed under the "SU" identifier indicate that no one rate prevailed for this classification in the survey and the published rate is derived by computing a weighted average rate based on all the rates reported in the survey for that classification. As this weighted average rate includes all rates reported in the survey, it may include both union and non-union rates. Example: SULA2012-007 5/13/2014. SU indicates the rates are survey rates based on a weighted average calculation of rates and are not majority rates. LA indicates the State of Louisiana. 2012 is the year of survey on which these classifications and rates are based. The next number, 007 in the example, is an internal number used in producing the wage determination. 5/13/2014 indicates the survey completion date for the classifications and rates under that identifier.

Survey wage rates are not updated and remain in effect until a new survey is conducted.

Union Average Rate Identifiers

Classification(s) listed under the UAVG identifier indicate that no single majority rate prevailed for those classifications; however, 100% of the data reported for the classifications was union data. EXAMPLE: UAVG-OH-0010 08/29/2014. UAVG indicates that the rate is a weighted union average rate. OH indicates the state. The next number, 0010 in the example, is an internal number used in producing the wage determination. 08/29/2014 indicates the survey completion date for the classifications and rates under that identifier.

A UAVG rate will be updated once a year, usually in January of each year, to reflect a weighted average of the current negotiated/CBA rate of the union locals from which the rate is based.

WAGE DETERMINATION APPEALS PROCESS

1.) Has there been an initial decision in the matter? This can be:

- * an existing published wage determination
- * a survey underlying a wage determination
- * a Wage and Hour Division letter setting forth a position on a wage determination matter
- * a conformance (additional classification and rate) ruling

On survey related matters, initial contact, including requests for summaries of surveys, should be with the Wage and Hour Regional Office for the area in which the survey was conducted because those Regional Offices have responsibility for the Davis-Bacon survey program. If the response from this initial contact is not satisfactory, then the process described in 2.) and 3.) should be followed.

With regard to any other matter not yet ripe for the formal process described here, initial contact should be with the Branch of Construction Wage Determinations. Write to:

Branch of Construction Wage Determinations
Wage and Hour Division
U.S. Department of Labor
200 Constitution Avenue, N.W.
Washington, DC 20210

2.) If the answer to the question in 1.) is yes, then an interested party (those affected by the action) can request review and reconsideration from the Wage and Hour Administrator (See 29 CFR Part 1.8 and 29 CFR Part 7). Write to:

Wage and Hour Administrator
U.S. Department of Labor
200 Constitution Avenue, N.W.
Washington, DC 20210

The request should be accompanied by a full statement of the interested party's position and by any information (wage payment data, project description, area practice material, etc.) that the requestor considers relevant to the issue.

3.) If the decision of the Administrator is not favorable, an interested party may appeal directly to the Administrative Review Board (formerly the Wage Appeals Board). Write to:

Administrative Review Board
U.S. Department of Labor
200 Constitution Avenue, N.W.
Washington, DC 20210

4.) All decisions by the Administrative Review Board are final.

=====

END OF GENERAL DECISION

SUPPLEMENT TO FORM FHWA-1273

DATE: 01/06/2016

SUBJECT: Final Certificate and Contract Provisions for Subcontracts

All subcontracts shall be in writing and contain all pertinent provisions and requirements of the prime contract.

Each "Request for Permission to Subcontract" (Mississippi Department of Transportation Form CAD-720) shall include a copy of subcontract upon request for review by the Mississippi Department of Transportation. The federal contract provisions may be omitted from the subcontract copy submitted for review provided the Contractor certifies that the provisions will be physically incorporated into the agreement furnished to the Subcontractor.

In lieu of submitting a copy of the subcontract for review, the Contractor may certify that the subcontract agreement is in writing and that it contains all the requirements and pertinent provisions of the prime contract.

Each Subcontractor will be required to provide a copy of the subcontract agreement for contract compliance reviews, along with physical evidence (copy of FHWA-1273) that requirements and pertinent provisions have been provided for review and adherence.

The Contractor is hereby advised of the requirements set forth in the following Attachment (Title 46 - Shipping) as it pertains to the implementation of Cargo Preference Act (CPA) requirements in the Federal-aid Highway Program.

By signing this contract, the Contractor agrees to conform to the requirements of the CPA.

Attachment

Title 46- Shipping

Volume: 8

Date: 2014-10-01

Original Date: 2014-10-01

Title: Section 381.7 - Federal Grant, Guaranty, Loan and Advance at Funds Agreements.

Context: Title 46- Shipping. CHAPTER II- MARITIME ADMINISTRATION, DEPARTMENT OF TRANSPORTATION. SUBCHAPTER J - MISCELLANEOUS. PART 381 - CARGO PREFERENCE-U.S.-FLAG VESSELS.

§ 381.7 Federal Grant, Guaranty, Loan and Advance of Funds Agreements.

In order to insure a fair and reasonable participation by privately owned United States-flag commercial vessels in transporting cargoes which are subject to the Cargo Preference Act of 1954 and which are generated by U.S. Government Grant, Guaranty, Loan and/or Advance of Funds Programs, the head of each affected department or agency shall require appropriate clauses to be inserted in those Grant, Guaranty, Loan and/or Advance of Funds Agreements and all third party contracts executed between the borrower/grantee and other parties, where the possibility exists for ocean transportation of items procured, contracted for or otherwise obtained by or on behalf of the grantee, borrower, or any of their contractors or subcontractors. The clauses required by this part shall provide that at least 50 percent of the freight revenue and tonnage of cargo generated by the U.S. Government Grant, Guaranty, Loan or Advance of Funds be transported on privately owned United States-flag commercial vessels. These clauses shall also require that all parties provide to the Maritime Administration the necessary shipment information as set forth in § 381.3. A copy of the appropriate clauses required by this part shall be submitted by each affected agency or department to the Secretary, Maritime Administration, for approval no later than 30 days after the effective date of this part. The following are suggested acceptable clauses with respect to the use of United States-flag vessels to be incorporated in the Grant, Guaranty, Loan and/or Advance of Funds Agreements as well as contracts and subcontracts resulting therefrom:

(a) *Agreement Clauses.* "Use of United States-flag vessels:

"(1) Pursuant to Pub. L 664 (43 U.S.C. 1241(b)) at least 50 percent of any equipment, materials or commodities procured, contracted for or otherwise obtained with funds granted, guaranteed, loaned, or advanced by the U.S. Government under this agreement, and which may be transported by ocean vessel, shall be transported on privately owned United States-flag commercial vessels, if available.

"(2) Within 20 days following the date of loading for shipments originating within the United States or within 30 working days following the date of loading for shipments originating outside the United States, a legible copy of a rated, 'on-board' commercial ocean bill-of-lading in English for each shipment of cargo described in paragraph (a)(1) of this section shall be furnished to both the Contracting Officer (through the prime contractor in the case of subcontractor bills-of-lading) and to the Division of National Cargo, Office of Market Development, Maritime Administration, Washington, DC 20590."

(b) *Contractor and Subcontractor Clauses.* "Use of United States-flag vessels: The contractor agrees --

"(1) To utilize privately owned United States-flag commercial vessels to ship at least 50 percent of the gross tonnage (computed separately for dry bulk carriers, dry cargo liners, and tankers) involved, whenever shipping any equipment, material, or commodities pursuant to this contract, to the extent such vessels are available at fair and reasonable rates for United States-flag commercial vessels.

"(2) To furnish within 20 days following the date of loading for shipments originating within the United

States or within 30 working days following the date of loading for shipments originating outside the United States, a legible copy of a rated, 'on-board' commercial ocean bill-of-lading in English for each shipment of cargo described in paragraph (b) (1) of this section to both the Contracting Officer (through the prime contractor in the case of subcontractor bills-of-lading) and to the Division of National Cargo, Office of Market Development, Maritime Administration, Washington, DC 20590.

"(3) To insert the substance of the provisions of this clause in all subcontracts issued pursuant to this contract."

(Reorganization Plans No.21 of 1950(64 Stat. 1273) and No. 7 of 1961 (75 Stat. 840) as amended by Pub. L 91.469 (84 Stat 1036) and Department of Commerce Organization Order 10-8 (38 FR 19707, July 23, 1973)) (42 FR 57126, Nov. 1, 1977]

**REQUIRED CONTRACT PROVISIONS
FEDERAL-AID CONSTRUCTION CONTRACTS**

- I. General
- II. Nondiscrimination
- III. Nonsegregated Facilities
- IV. Davis-Bacon and Related Act Provisions
- V. Contract Work Hours and Safety Standards Act Provisions
- VI. Subletting or Assigning the Contract
- VII. Safety: Accident Prevention
- VIII. False Statements Concerning Highway Projects
- IX. Implementation of Clean Air Act and Federal Water Pollution Control Act
- X. Compliance with Governmentwide Suspension and Debarment Requirements
- XI. Certification Regarding Use of Contract Funds for Lobbying

ATTACHMENTS

A. Employment and Materials Preference for Appalachian Development Highway System or Appalachian Local Access Road Contracts (included in Appalachian contracts only)

I. GENERAL

1. Form FHWA-1273 must be physically incorporated in each construction contract funded under Title 23 (excluding emergency contracts solely intended for debris removal). The contractor (or subcontractor) must insert this form in each subcontract and further require its inclusion in all lower tier subcontracts (excluding purchase orders, rental agreements and other agreements for supplies or services).

The applicable requirements of Form FHWA-1273 are incorporated by reference for work done under any purchase order, rental agreement or agreement for other services. The prime contractor shall be responsible for compliance by any subcontractor, lower-tier subcontractor or service provider.

Form FHWA-1273 must be included in all Federal-aid design-build contracts, in all subcontracts and in lower tier subcontracts (excluding subcontracts for design services, purchase orders, rental agreements and other agreements for supplies or services). The design-builder shall be responsible for compliance by any subcontractor, lower-tier subcontractor or service provider.

Contracting agencies may reference Form FHWA-1273 in bid proposal or request for proposal documents, however, the Form FHWA-1273 must be physically incorporated (not referenced) in all contracts, subcontracts and lower-tier subcontracts (excluding purchase orders, rental agreements and other agreements for supplies or services related to a construction contract).

2. Subject to the applicability criteria noted in the following sections, these contract provisions shall apply to all work performed on the contract by the contractor's own organization and with the assistance of workers under the contractor's immediate superintendence and to all work performed on the contract by piecework, station work, or by subcontract.

3. A breach of any of the stipulations contained in these Required Contract Provisions may be sufficient grounds for withholding of progress payments, withholding of final payment, termination of the contract, suspension / debarment or any other action determined to be appropriate by the contracting agency and FHWA.

4. Selection of Labor: During the performance of this contract, the contractor shall not use convict labor for any purpose within the limits of a construction project on a Federal-aid highway unless it is labor performed by convicts who are on parole, supervised release, or probation. The term Federal-aid highway does not include roadways functionally classified as local roads or rural minor collectors.

II. NONDISCRIMINATION

The provisions of this section related to 23 CFR Part 230 are applicable to all Federal-aid construction contracts and to all related construction subcontracts of \$10,000 or more. The provisions of 23 CFR Part 230 are not applicable to material supply, engineering, or architectural service contracts.

In addition, the contractor and all subcontractors must comply with the following policies: Executive Order 11246, 41 CFR 60, 29 CFR 1625-1627, Title 23 USC Section 140, the Rehabilitation Act of 1973, as amended (29 USC 794), Title VI of the Civil Rights Act of 1964, as amended, and related regulations including 49 CFR Parts 21, 26 and 27; and 23 CFR Parts 200, 230, and 633.

The contractor and all subcontractors must comply with: the requirements of the Equal Opportunity Clause in 41 CFR 60-1.4(b) and, for all construction contracts exceeding \$10,000, the Standard Federal Equal Employment Opportunity Construction Contract Specifications in 41 CFR 60-4.3.

Note: The U.S. Department of Labor has exclusive authority to determine compliance with Executive Order 11246 and the policies of the Secretary of Labor including 41 CFR 60, and 29 CFR 1625-1627. The contracting agency and the FHWA have the authority and the responsibility to ensure compliance with Title 23 USC Section 140, the Rehabilitation Act of 1973, as amended (29 USC 794), and Title VI of the Civil Rights Act of 1964, as amended, and related regulations including 49 CFR Parts 21, 26 and 27; and 23 CFR Parts 200, 230, and 633.

The following provision is adopted from 23 CFR 230, Appendix A, with appropriate revisions to conform to the U.S. Department of Labor (US DOL) and FHWA requirements.

1. Equal Employment Opportunity: Equal employment opportunity (EEO) requirements not to discriminate and to take affirmative action to assure equal opportunity as set forth under laws, executive orders, rules, regulations (28 CFR 35, 29 CFR 1630, 29 CFR 1625-1627, 41 CFR 60 and 49 CFR 27) and orders of the Secretary of Labor as modified by the provisions prescribed herein, and imposed pursuant to 23 U.S.C. 140 shall constitute the EEO and specific affirmative action standards for the contractor's project activities under

this contract. The provisions of the Americans with Disabilities Act of 1990 (42 U.S.C. 12101 et seq.) set forth under 28 CFR 35 and 29 CFR 1630 are incorporated by reference in this contract. In the execution of this contract, the contractor agrees to comply with the following minimum specific requirement activities of EEO:

a. The contractor will work with the contracting agency and the Federal Government to ensure that it has made every good faith effort to provide equal opportunity with respect to all of its terms and conditions of employment and in their review of activities under the contract.

b. The contractor will accept as its operating policy the following statement:

"It is the policy of this Company to assure that applicants are employed, and that employees are treated during employment, without regard to their race, religion, sex, color, national origin, age or disability. Such action shall include: employment, upgrading, demotion, or transfer; recruitment or recruitment advertising; layoff or termination; rates of pay or other forms of compensation; and selection for training, including apprenticeship, pre-apprenticeship, and/or on-the-job training."

2. EEO Officer: The contractor will designate and make known to the contracting officers an EEO Officer who will have the responsibility for and must be capable of effectively administering and promoting an active EEO program and who must be assigned adequate authority and responsibility to do so.

3. Dissemination of Policy: All members of the contractor's staff who are authorized to hire, supervise, promote, and discharge employees, or who recommend such action, or who are substantially involved in such action, will be made fully cognizant of, and will implement, the contractor's EEO policy and contractual responsibilities to provide EEO in each grade and classification of employment. To ensure that the above agreement will be met, the following actions will be taken as a minimum:

a. Periodic meetings of supervisory and personnel office employees will be conducted before the start of work and then not less often than once every six months, at which time the contractor's EEO policy and its implementation will be reviewed and explained. The meetings will be conducted by the EEO Officer.

b. All new supervisory or personnel office employees will be given a thorough indoctrination by the EEO Officer, covering all major aspects of the contractor's EEO obligations within thirty days following their reporting for duty with the contractor.

c. All personnel who are engaged in direct recruitment for the project will be instructed by the EEO Officer in the contractor's procedures for locating and hiring minorities and women.

d. Notices and posters setting forth the contractor's EEO policy will be placed in areas readily accessible to employees, applicants for employment and potential employees.

e. The contractor's EEO policy and the procedures to implement such policy will be brought to the attention of employees by means of meetings, employee handbooks, or other appropriate means.

4. Recruitment: When advertising for employees, the contractor will include in all advertisements for employees the notation: "An Equal Opportunity Employer." All such advertisements will be placed in publications having a large circulation among minorities and women in the area from which the project work force would normally be derived.

a. The contractor will, unless precluded by a valid bargaining agreement, conduct systematic and direct recruitment through public and private employee referral sources likely to yield qualified minorities and women. To meet this requirement, the contractor will identify sources of potential minority group employees, and establish with such identified sources procedures whereby minority and women applicants may be referred to the contractor for employment consideration.

b. In the event the contractor has a valid bargaining agreement providing for exclusive hiring hall referrals, the contractor is expected to observe the provisions of that agreement to the extent that the system meets the contractor's compliance with EEO contract provisions. Where implementation of such an agreement has the effect of discriminating against minorities or women, or obligates the contractor to do the same, such implementation violates Federal nondiscrimination provisions.

c. The contractor will encourage its present employees to refer minorities and women as applicants for employment. Information and procedures with regard to referring such applicants will be discussed with employees.

5. Personnel Actions: Wages, working conditions, and employee benefits shall be established and administered, and personnel actions of every type, including hiring, upgrading, promotion, transfer, demotion, layoff, and termination, shall be taken without regard to race, color, religion, sex, national origin, age or disability. The following procedures shall be followed:

a. The contractor will conduct periodic inspections of project sites to insure that working conditions and employee facilities do not indicate discriminatory treatment of project site personnel.

b. The contractor will periodically evaluate the spread of wages paid within each classification to determine any evidence of discriminatory wage practices.

c. The contractor will periodically review selected personnel actions in depth to determine whether there is evidence of discrimination. Where evidence is found, the contractor will promptly take corrective action. If the review indicates that the discrimination may extend beyond the actions reviewed, such corrective action shall include all affected persons.

d. The contractor will promptly investigate all complaints of alleged discrimination made to the contractor in connection with its obligations under this contract, will attempt to resolve such complaints, and will take appropriate corrective action within a reasonable time. If the investigation indicates that the discrimination may affect persons other than the complainant, such corrective action shall include such other persons. Upon completion of each investigation, the contractor will inform every complainant of all of their avenues of appeal.

6. Training and Promotion:

a. The contractor will assist in locating, qualifying, and increasing the skills of minorities and women who are

applicants for employment or current employees. Such efforts should be aimed at developing full journey level status employees in the type of trade or job classification involved.

b. Consistent with the contractor's work force requirements and as permissible under Federal and State regulations, the contractor shall make full use of training programs, i.e., apprenticeship, and on-the-job training programs for the geographical area of contract performance. In the event a special provision for training is provided under this contract, this subparagraph will be superseded as indicated in the special provision. The contracting agency may reserve training positions for persons who receive welfare assistance in accordance with 23 U.S.C. 140(a).

c. The contractor will advise employees and applicants for employment of available training programs and entrance requirements for each.

d. The contractor will periodically review the training and promotion potential of employees who are minorities and women and will encourage eligible employees to apply for such training and promotion.

7. Unions: If the contractor relies in whole or in part upon unions as a source of employees, the contractor will use good faith efforts to obtain the cooperation of such unions to increase opportunities for minorities and women. Actions by the contractor, either directly or through a contractor's association acting as agent, will include the procedures set forth below:

a. The contractor will use good faith efforts to develop, in cooperation with the unions, joint training programs aimed toward qualifying more minorities and women for membership in the unions and increasing the skills of minorities and women so that they may qualify for higher paying employment.

b. The contractor will use good faith efforts to incorporate an EEO clause into each union agreement to the end that such union will be contractually bound to refer applicants without regard to their race, color, religion, sex, national origin, age or disability.

c. The contractor is to obtain information as to the referral practices and policies of the labor union except that to the extent such information is within the exclusive possession of the labor union and such labor union refuses to furnish such information to the contractor, the contractor shall so certify to the contracting agency and shall set forth what efforts have been made to obtain such information.

d. In the event the union is unable to provide the contractor with a reasonable flow of referrals within the time limit set forth in the collective bargaining agreement, the contractor will, through independent recruitment efforts, fill the employment vacancies without regard to race, color, religion, sex, national origin, age or disability; making full efforts to obtain qualified and/or qualifiable minorities and women. The failure of a union to provide sufficient referrals (even though it is obligated to provide exclusive referrals under the terms of a collective bargaining agreement) does not relieve the contractor from the requirements of this paragraph. In the event the union referral practice prevents the contractor from meeting the obligations pursuant to Executive Order 11246, as amended, and these special provisions, such contractor shall immediately notify the contracting agency.

8. Reasonable Accommodation for Applicants / Employees with Disabilities: The contractor must be familiar

with the requirements for and comply with the Americans with Disabilities Act and all rules and regulations established there under. Employers must provide reasonable accommodation in all employment activities unless to do so would cause an undue hardship.

9. Selection of Subcontractors, Procurement of Materials and Leasing of Equipment: The contractor shall not discriminate on the grounds of race, color, religion, sex, national origin, age or disability in the selection and retention of subcontractors, including procurement of materials and leases of equipment. The contractor shall take all necessary and reasonable steps to ensure nondiscrimination in the administration of this contract.

a. The contractor shall notify all potential subcontractors and suppliers and lessors of their EEO obligations under this contract.

b. The contractor will use good faith efforts to ensure subcontractor compliance with their EEO obligations.

10. Assurance Required by 49 CFR 26.13(b):

a. The requirements of 49 CFR Part 26 and the State DOT's U.S. DOT-approved DBE program are incorporated by reference.

b. The contractor or subcontractor shall not discriminate on the basis of race, color, national origin, or sex in the performance of this contract. The contractor shall carry out applicable requirements of 49 CFR Part 26 in the award and administration of DOT-assisted contracts. Failure by the contractor to carry out these requirements is a material breach of this contract, which may result in the termination of this contract or such other remedy as the contracting agency deems appropriate.

11. Records and Reports: The contractor shall keep such records as necessary to document compliance with the EEO requirements. Such records shall be retained for a period of three years following the date of the final payment to the contractor for all contract work and shall be available at reasonable times and places for inspection by authorized representatives of the contracting agency and the FHWA.

a. The records kept by the contractor shall document the following:

(1) The number and work hours of minority and non-minority group members and women employed in each work classification on the project;

(2) The progress and efforts being made in cooperation with unions, when applicable, to increase employment opportunities for minorities and women; and

(3) The progress and efforts being made in locating, hiring, training, qualifying, and upgrading minorities and women;

b. The contractors and subcontractors will submit an annual report to the contracting agency each July for the duration of the project, indicating the number of minority, women, and non-minority group employees currently engaged in each work classification required by the contract work. This information is to be reported on [Form FHWA-1391](#). The staffing data should represent the project work force on board in all or any part of the last payroll period preceding the end of July. If on-the-job training is being required by special provision, the contractor

will be required to collect and report training data. The employment data should reflect the work force on board during all or any part of the last payroll period preceding the end of July.

III. NONSEGREGATED FACILITIES

This provision is applicable to all Federal-aid construction contracts and to all related construction subcontracts of \$10,000 or more.

The contractor must ensure that facilities provided for employees are provided in such a manner that segregation on the basis of race, color, religion, sex, or national origin cannot result. The contractor may neither require such segregated use by written or oral policies nor tolerate such use by employee custom. The contractor's obligation extends further to ensure that its employees are not assigned to perform their services at any location, under the contractor's control, where the facilities are segregated. The term "facilities" includes waiting rooms, work areas, restaurants and other eating areas, time clocks, restrooms, washrooms, locker rooms, and other storage or dressing areas, parking lots, drinking fountains, recreation or entertainment areas, transportation, and housing provided for employees. The contractor shall provide separate or single-user restrooms and necessary dressing or sleeping areas to assure privacy between sexes.

IV. DAVIS-BACON AND RELATED ACT PROVISIONS

This section is applicable to all Federal-aid construction projects exceeding \$2,000 and to all related subcontracts and lower-tier subcontracts (regardless of subcontract size). The requirements apply to all projects located within the right-of-way of a roadway that is functionally classified as Federal-aid highway. This excludes roadways functionally classified as local roads or rural minor collectors, which are exempt. Contracting agencies may elect to apply these requirements to other projects.

The following provisions are from the U.S. Department of Labor regulations in 29 CFR 5.5 "Contract provisions and related matters" with minor revisions to conform to the FHWA-1273 format and FHWA program requirements.

1. Minimum wages

a. All laborers and mechanics employed or working upon the site of the work, will be paid unconditionally and not less often than once a week, and without subsequent deduction or rebate on any account (except such payroll deductions as are permitted by regulations issued by the Secretary of Labor under the Copeland Act (29 CFR part 3)), the full amount of wages and bona fide fringe benefits (or cash equivalents thereof) due at time of payment computed at rates not less than those contained in the wage determination of the Secretary of Labor which is attached hereto and made a part hereof, regardless of any contractual relationship which may be alleged to exist between the contractor and such laborers and mechanics.

Contributions made or costs reasonably anticipated for bona fide fringe benefits under section 1(b)(2) of the Davis-Bacon Act on behalf of laborers or mechanics are considered wages

paid to such laborers or mechanics, subject to the provisions of paragraph 1.d. of this section; also, regular contributions made or costs incurred for more than a weekly period (but not less often than quarterly) under plans, funds, or programs which cover the particular weekly period, are deemed to be constructively made or incurred during such weekly period. Such laborers and mechanics shall be paid the appropriate wage rate and fringe benefits on the wage determination for the classification of work actually performed, without regard to skill, except as provided in 29 CFR 5.5(a)(4). Laborers or mechanics performing work in more than one classification may be compensated at the rate specified for each classification for the time actually worked therein: Provided, That the employer's payroll records accurately set forth the time spent in each classification in which work is performed. The wage determination (including any additional classification and wage rates conformed under paragraph 1.b. of this section) and the Davis-Bacon poster (WH-1321) shall be posted at all times by the contractor and its subcontractors at the site of the work in a prominent and accessible place where it can be easily seen by the workers.

b. (1) The contracting officer shall require that any class of laborers or mechanics, including helpers, which is not listed in the wage determination and which is to be employed under the contract shall be classified in conformance with the wage determination. The contracting officer shall approve an additional classification and wage rate and fringe benefits therefore only when the following criteria have been met:

(i) The work to be performed by the classification requested is not performed by a classification in the wage determination; and

(ii) The classification is utilized in the area by the construction industry; and

(iii) The proposed wage rate, including any bona fide fringe benefits, bears a reasonable relationship to the wage rates contained in the wage determination.

(2) If the contractor and the laborers and mechanics to be employed in the classification (if known), or their representatives, and the contracting officer agree on the classification and wage rate (including the amount designated for fringe benefits where appropriate), a report of the action taken shall be sent by the contracting officer to the Administrator of the Wage and Hour Division, Employment Standards Administration, U.S. Department of Labor, Washington, DC 20210. The Administrator, or an authorized representative, will approve, modify, or disapprove every additional classification action within 30 days of receipt and so advise the contracting officer or will notify the contracting officer within the 30-day period that additional time is necessary.

(3) In the event the contractor, the laborers or mechanics to be employed in the classification or their representatives, and the contracting officer do not agree on the proposed classification and wage rate (including the amount designated for fringe benefits, where appropriate), the contracting officer shall refer the questions, including the views of all interested parties and the recommendation of the contracting officer, to the Wage and Hour Administrator for determination. The Wage and Hour Administrator, or an authorized representative, will issue a determination within 30 days of receipt and so advise

the contracting officer or will notify the contracting officer within the 30-day period that additional time is necessary.

(4) The wage rate (including fringe benefits where appropriate) determined pursuant to paragraphs 1.b.(2) or 1.b.(3) of this section, shall be paid to all workers performing work in the classification under this contract from the first day on which work is performed in the classification.

c. Whenever the minimum wage rate prescribed in the contract for a class of laborers or mechanics includes a fringe benefit which is not expressed as an hourly rate, the contractor shall either pay the benefit as stated in the wage determination or shall pay another bona fide fringe benefit or an hourly cash equivalent thereof.

d. If the contractor does not make payments to a trustee or other third person, the contractor may consider as part of the wages of any laborer or mechanic the amount of any costs reasonably anticipated in providing bona fide fringe benefits under a plan or program, Provided, That the Secretary of Labor has found, upon the written request of the contractor, that the applicable standards of the Davis-Bacon Act have been met. The Secretary of Labor may require the contractor to set aside in a separate account assets for the meeting of obligations under the plan or program.

2. Withholding

The contracting agency shall upon its own action or upon written request of an authorized representative of the Department of Labor, withhold or cause to be withheld from the contractor under this contract, or any other Federal contract with the same prime contractor, or any other federally-assisted contract subject to Davis-Bacon prevailing wage requirements, which is held by the same prime contractor, so much of the accrued payments or advances as may be considered necessary to pay laborers and mechanics, including apprentices, trainees, and helpers, employed by the contractor or any subcontractor the full amount of wages required by the contract. In the event of failure to pay any laborer or mechanic, including any apprentice, trainee, or helper, employed or working on the site of the work, all or part of the wages required by the contract, the contracting agency may, after written notice to the contractor, take such action as may be necessary to cause the suspension of any further payment, advance, or guarantee of funds until such violations have ceased.

3. Payrolls and basic records

a. Payrolls and basic records relating thereto shall be maintained by the contractor during the course of the work and preserved for a period of three years thereafter for all laborers and mechanics working at the site of the work. Such records shall contain the name, address, and social security number of each such worker, his or her correct classification, hourly rates of wages paid (including rates of contributions or costs anticipated for bona fide fringe benefits or cash equivalents thereof of the types described in section 1(b)(2)(B) of the Davis-Bacon Act), daily and weekly number of hours worked, deductions made and actual wages paid. Whenever the Secretary of Labor has found under 29 CFR 5.5(a)(1)(iv) that the wages of any laborer or mechanic include the amount of any costs reasonably anticipated in providing benefits under a plan or program described in section 1(b)(2)(B) of the Davis-

Bacon Act, the contractor shall maintain records which show that the commitment to provide such benefits is enforceable, that the plan or program is financially responsible, and that the plan or program has been communicated in writing to the laborers or mechanics affected, and records which show the costs anticipated or the actual cost incurred in providing such benefits. Contractors employing apprentices or trainees under approved programs shall maintain written evidence of the registration of apprenticeship programs and certification of trainee programs, the registration of the apprentices and trainees, and the ratios and wage rates prescribed in the applicable programs.

b. (1) The contractor shall submit weekly for each week in which any contract work is performed a copy of all payrolls to the contracting agency. The payrolls submitted shall set out accurately and completely all of the information required to be maintained under 29 CFR 5.5(a)(3)(i), except that full social security numbers and home addresses shall not be included on weekly transmittals. Instead the payrolls shall only need to include an individually identifying number for each employee (e.g., the last four digits of the employee's social security number). The required weekly payroll information may be submitted in any form desired. Optional Form WH-347 is available for this purpose from the Wage and Hour Division Web site at <http://www.dol.gov/esa/whd/forms/wh347instr.htm> or its successor site. The prime contractor is responsible for the submission of copies of payrolls by all subcontractors. Contractors and subcontractors shall maintain the full social security number and current address of each covered worker, and shall provide them upon request to the contracting agency for transmission to the State DOT, the FHWA or the Wage and Hour Division of the Department of Labor for purposes of an investigation or audit of compliance with prevailing wage requirements. It is not a violation of this section for a prime contractor to require a subcontractor to provide addresses and social security numbers to the prime contractor for its own records, without weekly submission to the contracting agency..

(2) Each payroll submitted shall be accompanied by a "Statement of Compliance," signed by the contractor or subcontractor or his or her agent who pays or supervises the payment of the persons employed under the contract and shall certify the following:

(i) That the payroll for the payroll period contains the information required to be provided under §5.5 (a)(3)(ii) of Regulations, 29 CFR part 5, the appropriate information is being maintained under §5.5 (a)(3)(i) of Regulations, 29 CFR part 5, and that such information is correct and complete;

(ii) That each laborer or mechanic (including each helper, apprentice, and trainee) employed on the contract during the payroll period has been paid the full weekly wages earned, without rebate, either directly or indirectly, and that no deductions have been made either directly or indirectly from the full wages earned, other than permissible deductions as set forth in Regulations, 29 CFR part 3;

(iii) That each laborer or mechanic has been paid not less than the applicable wage rates and fringe benefits or cash equivalents for the classification of work performed, as specified in the applicable wage determination incorporated into the contract.

(3) The weekly submission of a properly executed certification set forth on the reverse side of Optional Form WH-347 shall satisfy the requirement for submission of the "Statement of Compliance" required by paragraph 3.b.(2) of this section.

(4) The falsification of any of the above certifications may subject the contractor or subcontractor to civil or criminal prosecution under section 1001 of title 18 and section 231 of title 31 of the United States Code.

c. The contractor or subcontractor shall make the records required under paragraph 3.a. of this section available for inspection, copying, or transcription by authorized representatives of the contracting agency, the State DOT, the FHWA, or the Department of Labor, and shall permit such representatives to interview employees during working hours on the job. If the contractor or subcontractor fails to submit the required records or to make them available, the FHWA may, after written notice to the contractor, the contracting agency or the State DOT, take such action as may be necessary to cause the suspension of any further payment, advance, or guarantee of funds. Furthermore, failure to submit the required records upon request or to make such records available may be grounds for debarment action pursuant to 29 CFR 5.12.

4. Apprentices and trainees

a. Apprentices (programs of the USDOL).

Apprentices will be permitted to work at less than the predetermined rate for the work they performed when they are employed pursuant to and individually registered in a bona fide apprenticeship program registered with the U.S. Department of Labor, Employment and Training Administration, Office of Apprenticeship Training, Employer and Labor Services, or with a State Apprenticeship Agency recognized by the Office, or if a person is employed in his or her first 90 days of probationary employment as an apprentice in such an apprenticeship program, who is not individually registered in the program, but who has been certified by the Office of Apprenticeship Training, Employer and Labor Services or a State Apprenticeship Agency (where appropriate) to be eligible for probationary employment as an apprentice.

The allowable ratio of apprentices to journeymen on the job site in any craft classification shall not be greater than the ratio permitted to the contractor as to the entire work force under the registered program. Any worker listed on a payroll at an apprentice wage rate, who is not registered or otherwise employed as stated above, shall be paid not less than the applicable wage rate on the wage determination for the classification of work actually performed. In addition, any apprentice performing work on the job site in excess of the ratio permitted under the registered program shall be paid not less than the applicable wage rate on the wage determination for the work actually performed. Where a contractor is performing construction on a project in a locality other than that in which its program is registered, the ratios and wage rates (expressed in percentages of the journeyman's hourly rate) specified in the contractor's or subcontractor's registered program shall be observed.

Every apprentice must be paid at not less than the rate specified in the registered program for the apprentice's level of progress, expressed as a percentage of the journeymen hourly

rate specified in the applicable wage determination. Apprentices shall be paid fringe benefits in accordance with the provisions of the apprenticeship program. If the apprenticeship program does not specify fringe benefits, apprentices must be paid the full amount of fringe benefits listed on the wage determination for the applicable classification. If the Administrator determines that a different practice prevails for the applicable apprentice classification, fringes shall be paid in accordance with that determination.

In the event the Office of Apprenticeship Training, Employer and Labor Services, or a State Apprenticeship Agency recognized by the Office, withdraws approval of an apprenticeship program, the contractor will no longer be permitted to utilize apprentices at less than the applicable predetermined rate for the work performed until an acceptable program is approved.

b. Trainees (programs of the USDOL).

Except as provided in 29 CFR 5.16, trainees will not be permitted to work at less than the predetermined rate for the work performed unless they are employed pursuant to and individually registered in a program which has received prior approval, evidenced by formal certification by the U.S. Department of Labor, Employment and Training Administration.

The ratio of trainees to journeymen on the job site shall not be greater than permitted under the plan approved by the Employment and Training Administration.

Every trainee must be paid at not less than the rate specified in the approved program for the trainee's level of progress, expressed as a percentage of the journeyman hourly rate specified in the applicable wage determination. Trainees shall be paid fringe benefits in accordance with the provisions of the trainee program. If the trainee program does not mention fringe benefits, trainees shall be paid the full amount of fringe benefits listed on the wage determination unless the Administrator of the Wage and Hour Division determines that there is an apprenticeship program associated with the corresponding journeyman wage rate on the wage determination which provides for less than full fringe benefits for apprentices. Any employee listed on the payroll at a trainee rate who is not registered and participating in a training plan approved by the Employment and Training Administration shall be paid not less than the applicable wage rate on the wage determination for the classification of work actually performed. In addition, any trainee performing work on the job site in excess of the ratio permitted under the registered program shall be paid not less than the applicable wage rate on the wage determination for the work actually performed.

In the event the Employment and Training Administration withdraws approval of a training program, the contractor will no longer be permitted to utilize trainees at less than the applicable predetermined rate for the work performed until an acceptable program is approved.

c. Equal employment opportunity. The utilization of apprentices, trainees and journeymen under this part shall be in conformity with the equal employment opportunity requirements of Executive Order 11246, as amended, and 29 CFR part 30.

d. Apprentices and Trainees (programs of the U.S. DOT).

Apprentices and trainees working under apprenticeship and skill training programs which have been certified by the Secretary of Transportation as promoting EEO in connection with Federal-aid highway construction programs are not subject to the requirements of paragraph 4 of this Section IV. The straight time hourly wage rates for apprentices and trainees under such programs will be established by the particular programs. The ratio of apprentices and trainees to journeymen shall not be greater than permitted by the terms of the particular program.

5. Compliance with Copeland Act requirements. The contractor shall comply with the requirements of 29 CFR part 3, which are incorporated by reference in this contract.

6. Subcontracts. The contractor or subcontractor shall insert Form FHWA-1273 in any subcontracts and also require the subcontractors to include Form FHWA-1273 in any lower tier subcontracts. The prime contractor shall be responsible for the compliance by any subcontractor or lower tier subcontractor with all the contract clauses in 29 CFR 5.5.

7. Contract termination: debarment. A breach of the contract clauses in 29 CFR 5.5 may be grounds for termination of the contract, and for debarment as a contractor and a subcontractor as provided in 29 CFR 5.12.

8. Compliance with Davis-Bacon and Related Act requirements. All rulings and interpretations of the Davis-Bacon and Related Acts contained in 29 CFR parts 1, 3, and 5 are herein incorporated by reference in this contract.

9. Disputes concerning labor standards. Disputes arising out of the labor standards provisions of this contract shall not be subject to the general disputes clause of this contract. Such disputes shall be resolved in accordance with the procedures of the Department of Labor set forth in 29 CFR parts 5, 6, and 7. Disputes within the meaning of this clause include disputes between the contractor (or any of its subcontractors) and the contracting agency, the U.S. Department of Labor, or the employees or their representatives.

10. Certification of eligibility.

a. By entering into this contract, the contractor certifies that neither it (nor he or she) nor any person or firm who has an interest in the contractor's firm is a person or firm ineligible to be awarded Government contracts by virtue of section 3(a) of the Davis-Bacon Act or 29 CFR 5.12(a)(1).

b. No part of this contract shall be subcontracted to any person or firm ineligible for award of a Government contract by virtue of section 3(a) of the Davis-Bacon Act or 29 CFR 5.12(a)(1).

c. The penalty for making false statements is prescribed in the U.S. Criminal Code, 18 U.S.C. 1001.

V. CONTRACT WORK HOURS AND SAFETY STANDARDS ACT

The following clauses apply to any Federal-aid construction contract in an amount in excess of \$100,000 and subject to the overtime provisions of the Contract Work Hours and Safety Standards Act. These clauses shall be inserted in addition to the clauses required by 29 CFR 5.5(a) or 29 CFR 4.6. As used in this paragraph, the terms laborers and mechanics include watchmen and guards.

1. Overtime requirements. No contractor or subcontractor contracting for any part of the contract work which may require or involve the employment of laborers or mechanics shall require or permit any such laborer or mechanic in any workweek in which he or she is employed on such work to work in excess of forty hours in such workweek unless such laborer or mechanic receives compensation at a rate not less than one and one-half times the basic rate of pay for all hours worked in excess of forty hours in such workweek.

2. Violation; liability for unpaid wages; liquidated damages. In the event of any violation of the clause set forth in paragraph (1.) of this section, the contractor and any subcontractor responsible therefor shall be liable for the unpaid wages. In addition, such contractor and subcontractor shall be liable to the United States (in the case of work done under contract for the District of Columbia or a territory, to such District or to such territory), for liquidated damages. Such liquidated damages shall be computed with respect to each individual laborer or mechanic, including watchmen and guards, employed in violation of the clause set forth in paragraph (1.) of this section, in the sum of \$10 for each calendar day on which such individual was required or permitted to work in excess of the standard workweek of forty hours without payment of the overtime wages required by the clause set forth in paragraph (1.) of this section.

3. Withholding for unpaid wages and liquidated damages. The FHWA or the contacting agency shall upon its own action or upon written request of an authorized representative of the Department of Labor withhold or cause to be withheld, from any moneys payable on account of work performed by the contractor or subcontractor under any such contract or any other Federal contract with the same prime contractor, or any other federally-assisted contract subject to the Contract Work Hours and Safety Standards Act, which is held by the same prime contractor, such sums as may be determined to be necessary to satisfy any liabilities of such contractor or subcontractor for unpaid wages and liquidated damages as provided in the clause set forth in paragraph (2.) of this section.

4. Subcontracts. The contractor or subcontractor shall insert in any subcontracts the clauses set forth in paragraph (1.) through (4.) of this section and also a clause requiring the subcontractors to include these clauses in any lower tier subcontracts. The prime contractor shall be responsible for compliance by any subcontractor or lower tier subcontractor with the clauses set forth in paragraphs (1.) through (4.) of this section.

VI. SUBLETTING OR ASSIGNING THE CONTRACT

This provision is applicable to all Federal-aid construction contracts on the National Highway System.

1. The contractor shall perform with its own organization contract work amounting to not less than 30 percent (or a greater percentage if specified elsewhere in the contract) of the total original contract price, excluding any specialty items designated by the contracting agency. Specialty items may be performed by subcontract and the amount of any such specialty items performed may be deducted from the total original contract price before computing the amount of work required to be performed by the contractor's own organization (23 CFR 635.116).

a. The term "perform work with its own organization" refers to workers employed or leased by the prime contractor, and equipment owned or rented by the prime contractor, with or without operators. Such term does not include employees or equipment of a subcontractor or lower tier subcontractor, agents of the prime contractor, or any other assignees. The term may include payments for the costs of hiring leased employees from an employee leasing firm meeting all relevant Federal and State regulatory requirements. Leased employees may only be included in this term if the prime contractor meets all of the following conditions:

(1) the prime contractor maintains control over the supervision of the day-to-day activities of the leased employees;

(2) the prime contractor remains responsible for the quality of the work of the leased employees;

(3) the prime contractor retains all power to accept or exclude individual employees from work on the project; and

(4) the prime contractor remains ultimately responsible for the payment of predetermined minimum wages, the submission of payrolls, statements of compliance and all other Federal regulatory requirements.

b. "Specialty Items" shall be construed to be limited to work that requires highly specialized knowledge, abilities, or equipment not ordinarily available in the type of contracting organizations qualified and expected to bid or propose on the contract as a whole and in general are to be limited to minor components of the overall contract.

2. The contract amount upon which the requirements set forth in paragraph (1) of Section VI is computed includes the cost of material and manufactured products which are to be purchased or produced by the contractor under the contract provisions.

3. The contractor shall furnish (a) a competent superintendent or supervisor who is employed by the firm, has full authority to direct performance of the work in accordance with the contract requirements, and is in charge of all construction operations (regardless of who performs the work) and (b) such other of its own organizational resources (supervision, management, and engineering services) as the contracting officer determines is necessary to assure the performance of the contract.

4. No portion of the contract shall be sublet, assigned or otherwise disposed of except with the written consent of the contracting officer, or authorized representative, and such consent when given shall not be construed to relieve the contractor of any responsibility for the fulfillment of the contract. Written consent will be given only after the

contracting agency has assured that each subcontract is evidenced in writing and that it contains all pertinent provisions and requirements of the prime contract.

5. The 30% self-performance requirement of paragraph (1) is not applicable to design-build contracts; however, contracting agencies may establish their own self-performance requirements.

VII. SAFETY: ACCIDENT PREVENTION

This provision is applicable to all Federal-aid construction contracts and to all related subcontracts.

1. In the performance of this contract the contractor shall comply with all applicable Federal, State, and local laws governing safety, health, and sanitation (23 CFR 635). The contractor shall provide all safeguards, safety devices and protective equipment and take any other needed actions as it determines, or as the contracting officer may determine, to be reasonably necessary to protect the life and health of employees on the job and the safety of the public and to protect property in connection with the performance of the work covered by the contract.

2. It is a condition of this contract, and shall be made a condition of each subcontract, which the contractor enters into pursuant to this contract, that the contractor and any subcontractor shall not permit any employee, in performance of the contract, to work in surroundings or under conditions which are unsanitary, hazardous or dangerous to his/her health or safety, as determined under construction safety and health standards (29 CFR 1926) promulgated by the Secretary of Labor, in accordance with Section 107 of the Contract Work Hours and Safety Standards Act (40 U.S.C. 3704).

3. Pursuant to 29 CFR 1926.3, it is a condition of this contract that the Secretary of Labor or authorized representative thereof, shall have right of entry to any site of contract performance to inspect or investigate the matter of compliance with the construction safety and health standards and to carry out the duties of the Secretary under Section 107 of the Contract Work Hours and Safety Standards Act (40 U.S.C.3704).

VIII. FALSE STATEMENTS CONCERNING HIGHWAY PROJECTS

This provision is applicable to all Federal-aid construction contracts and to all related subcontracts.

In order to assure high quality and durable construction in conformity with approved plans and specifications and a high degree of reliability on statements and representations made by engineers, contractors, suppliers, and workers on Federal-aid highway projects, it is essential that all persons concerned with the project perform their functions as carefully, thoroughly, and honestly as possible. Willful falsification, distortion, or misrepresentation with respect to any facts related to the project is a violation of Federal law. To prevent any misunderstanding regarding the seriousness of these and similar acts, Form FHWA-1022 shall be posted on each Federal-aid highway project (23 CFR 635) in one or more places where it is readily available to all persons concerned with the project:

18 U.S.C. 1020 reads as follows:

"Whoever, being an officer, agent, or employee of the United States, or of any State or Territory, or whoever, whether a person, association, firm, or corporation, knowingly makes any false statement, false representation, or false report as to the character, quality, quantity, or cost of the material used or to be used, or the quantity or quality of the work performed or to be performed, or the cost thereof in connection with the submission of plans, maps, specifications, contracts, or costs of construction on any highway or related project submitted for approval to the Secretary of Transportation; or

Whoever knowingly makes any false statement, false representation, false report or false claim with respect to the character, quality, quantity, or cost of any work performed or to be performed, or materials furnished or to be furnished, in connection with the construction of any highway or related project approved by the Secretary of Transportation; or

Whoever knowingly makes any false statement or false representation as to material fact in any statement, certificate, or report submitted pursuant to provisions of the Federal-aid Roads Act approved July 1, 1916, (39 Stat. 355), as amended and supplemented;

Shall be fined under this title or imprisoned not more than 5 years or both."

IX. IMPLEMENTATION OF CLEAN AIR ACT AND FEDERAL WATER POLLUTION CONTROL ACT

This provision is applicable to all Federal-aid construction contracts and to all related subcontracts.

By submission of this bid/proposal or the execution of this contract, or subcontract, as appropriate, the bidder, proposer, Federal-aid construction contractor, or subcontractor, as appropriate, will be deemed to have stipulated as follows:

1. That any person who is or will be utilized in the performance of this contract is not prohibited from receiving an award due to a violation of Section 508 of the Clean Water Act or Section 306 of the Clean Air Act.

2. That the contractor agrees to include or cause to be included the requirements of paragraph (1) of this Section X in every subcontract, and further agrees to take such action as the contracting agency may direct as a means of enforcing such requirements.

X. CERTIFICATION REGARDING DEBARMENT, SUSPENSION, INELIGIBILITY AND VOLUNTARY EXCLUSION

This provision is applicable to all Federal-aid construction contracts, design-build contracts, subcontracts, lower-tier subcontracts, purchase orders, lease agreements, consultant contracts or any other covered transaction requiring FHWA approval or that is estimated to cost \$25,000 or more – as defined in 2 CFR Parts 180 and 1200.

1. Instructions for Certification – First Tier Participants:

a. By signing and submitting this proposal, the prospective first tier participant is providing the certification set out below.

b. The inability of a person to provide the certification set out below will not necessarily result in denial of participation in this

covered transaction. The prospective first tier participant shall submit an explanation of why it cannot provide the certification set out below. The certification or explanation will be considered in connection with the department or agency's determination whether to enter into this transaction. However, failure of the prospective first tier participant to furnish a certification or an explanation shall disqualify such a person from participation in this transaction.

c. The certification in this clause is a material representation of fact upon which reliance was placed when the contracting agency determined to enter into this transaction. If it is later determined that the prospective participant knowingly rendered an erroneous certification, in addition to other remedies available to the Federal Government, the contracting agency may terminate this transaction for cause of default.

d. The prospective first tier participant shall provide immediate written notice to the contracting agency to whom this proposal is submitted if any time the prospective first tier participant learns that its certification was erroneous when submitted or has become erroneous by reason of changed circumstances.

e. The terms "covered transaction," "debarred," "suspended," "ineligible," "participant," "person," "principal," and "voluntarily excluded," as used in this clause, are defined in 2 CFR Parts 180 and 1200. "First Tier Covered Transactions" refers to any covered transaction between a grantee or subgrantee of Federal funds and a participant (such as the prime or general contractor). "Lower Tier Covered Transactions" refers to any covered transaction under a First Tier Covered Transaction (such as subcontracts). "First Tier Participant" refers to the participant who has entered into a covered transaction with a grantee or subgrantee of Federal funds (such as the prime or general contractor). "Lower Tier Participant" refers any participant who has entered into a covered transaction with a First Tier Participant or other Lower Tier Participants (such as subcontractors and suppliers).

f. The prospective first tier participant agrees by submitting this proposal that, should the proposed covered transaction be entered into, it shall not knowingly enter into any lower tier covered transaction with a person who is debarred, suspended, declared ineligible, or voluntarily excluded from participation in this covered transaction, unless authorized by the department or agency entering into this transaction.

g. The prospective first tier participant further agrees by submitting this proposal that it will include the clause titled "Certification Regarding Debarment, Suspension, Ineligibility and Voluntary Exclusion-Lower Tier Covered Transactions," provided by the department or contracting agency, entering into this covered transaction, without modification, in all lower tier covered transactions and in all solicitations for lower tier covered transactions exceeding the \$25,000 threshold.

h. A participant in a covered transaction may rely upon a certification of a prospective participant in a lower tier covered transaction that is not debarred, suspended, ineligible, or voluntarily excluded from the covered transaction, unless it knows that the certification is erroneous. A participant is responsible for ensuring that its principals are not suspended, debarred, or otherwise ineligible to participate in covered transactions. To verify the eligibility of its principals, as well as the eligibility of any lower tier prospective participants, each participant may, but is not required to, check the Excluded Parties List System website (<https://www.epls.gov/>), which is compiled by the General Services Administration.

i. Nothing contained in the foregoing shall be construed to require the establishment of a system of records in order to render in good faith the certification required by this clause. The knowledge and information of the prospective participant is not required to exceed that which is normally possessed by a prudent person in the ordinary course of business dealings.

j. Except for transactions authorized under paragraph (f) of these instructions, if a participant in a covered transaction knowingly enters into a lower tier covered transaction with a person who is suspended, debarred, ineligible, or voluntarily excluded from participation in this transaction, in addition to other remedies available to the Federal Government, the department or agency may terminate this transaction for cause or default.

* * * * *

2. Certification Regarding Debarment, Suspension, Ineligibility and Voluntary Exclusion – First Tier Participants:

a. The prospective first tier participant certifies to the best of its knowledge and belief, that it and its principals:

(1) Are not presently debarred, suspended, proposed for debarment, declared ineligible, or voluntarily excluded from participating in covered transactions by any Federal department or agency;

(2) Have not within a three-year period preceding this proposal been convicted of or had a civil judgment rendered against them for commission of fraud or a criminal offense in connection with obtaining, attempting to obtain, or performing a public (Federal, State or local) transaction or contract under a public transaction; violation of Federal or State antitrust statutes or commission of embezzlement, theft, forgery, bribery, falsification or destruction of records, making false statements, or receiving stolen property;

(3) Are not presently indicted for or otherwise criminally or civilly charged by a governmental entity (Federal, State or local) with commission of any of the offenses enumerated in paragraph (a)(2) of this certification; and

(4) Have not within a three-year period preceding this application/proposal had one or more public transactions (Federal, State or local) terminated for cause or default.

b. Where the prospective participant is unable to certify to any of the statements in this certification, such prospective participant shall attach an explanation to this proposal.

2. Instructions for Certification - Lower Tier Participants:

(Applicable to all subcontracts, purchase orders and other lower tier transactions requiring prior FHWA approval or estimated to cost \$25,000 or more - 2 CFR Parts 180 and 1200)

a. By signing and submitting this proposal, the prospective lower tier is providing the certification set out below.

b. The certification in this clause is a material representation of fact upon which reliance was placed when this transaction was entered into. If it is later determined that the prospective lower tier participant knowingly rendered an erroneous certification, in addition to other remedies available to the Federal Government, the department, or agency with which

this transaction originated may pursue available remedies, including suspension and/or debarment.

c. The prospective lower tier participant shall provide immediate written notice to the person to which this proposal is submitted if at any time the prospective lower tier participant learns that its certification was erroneous by reason of changed circumstances.

d. The terms "covered transaction," "debarred," "suspended," "ineligible," "participant," "person," "principal," and "voluntarily excluded," as used in this clause, are defined in 2 CFR Parts 180 and 1200. You may contact the person to which this proposal is submitted for assistance in obtaining a copy of those regulations. "First Tier Covered Transactions" refers to any covered transaction between a grantee or subgrantee of Federal funds and a participant (such as the prime or general contract). "Lower Tier Covered Transactions" refers to any covered transaction under a First Tier Covered Transaction (such as subcontracts). "First Tier Participant" refers to the participant who has entered into a covered transaction with a grantee or subgrantee of Federal funds (such as the prime or general contractor). "Lower Tier Participant" refers any participant who has entered into a covered transaction with a First Tier Participant or other Lower Tier Participants (such as subcontractors and suppliers).

e. The prospective lower tier participant agrees by submitting this proposal that, should the proposed covered transaction be entered into, it shall not knowingly enter into any lower tier covered transaction with a person who is debarred, suspended, declared ineligible, or voluntarily excluded from participation in this covered transaction, unless authorized by the department or agency with which this transaction originated.

f. The prospective lower tier participant further agrees by submitting this proposal that it will include this clause titled "Certification Regarding Debarment, Suspension, Ineligibility and Voluntary Exclusion-Lower Tier Covered Transaction," without modification, in all lower tier covered transactions and in all solicitations for lower tier covered transactions exceeding the \$25,000 threshold.

g. A participant in a covered transaction may rely upon a certification of a prospective participant in a lower tier covered transaction that is not debarred, suspended, ineligible, or voluntarily excluded from the covered transaction, unless it knows that the certification is erroneous. A participant is responsible for ensuring that its principals are not suspended, debarred, or otherwise ineligible to participate in covered transactions. To verify the eligibility of its principals, as well as the eligibility of any lower tier prospective participants, each participant may, but is not required to, check the Excluded Parties List System website (<https://www.epls.gov/>), which is compiled by the General Services Administration.

h. Nothing contained in the foregoing shall be construed to require establishment of a system of records in order to render in good faith the certification required by this clause. The knowledge and information of participant is not required to exceed that which is normally possessed by a prudent person in the ordinary course of business dealings.

i. Except for transactions authorized under paragraph e of these instructions, if a participant in a covered transaction knowingly enters into a lower tier covered transaction with a person who is suspended, debarred, ineligible, or voluntarily excluded from participation in this transaction, in addition to other remedies available to the Federal Government, the

department or agency with which this transaction originated may pursue available remedies, including suspension and/or debarment.

* * * * *

Certification Regarding Debarment, Suspension, Ineligibility and Voluntary Exclusion--Lower Tier Participants:

1. The prospective lower tier participant certifies, by submission of this proposal, that neither it nor its principals is presently debarred, suspended, proposed for debarment, declared ineligible, or voluntarily excluded from participating in covered transactions by any Federal department or agency.

2. Where the prospective lower tier participant is unable to certify to any of the statements in this certification, such prospective participant shall attach an explanation to this proposal.

* * * * *

XI. CERTIFICATION REGARDING USE OF CONTRACT FUNDS FOR LOBBYING

This provision is applicable to all Federal-aid construction contracts and to all related subcontracts which exceed \$100,000 (49 CFR 20).

1. The prospective participant certifies, by signing and submitting this bid or proposal, to the best of his or her knowledge and belief, that:

a. No Federal appropriated funds have been paid or will be paid, by or on behalf of the undersigned, to any person for influencing or attempting to influence an officer or employee of any Federal agency, a Member of Congress, an officer or employee of Congress, or an employee of a Member of Congress in connection with the awarding of any Federal contract, the making of any Federal grant, the making of any Federal loan, the entering into of any cooperative agreement, and the extension, continuation, renewal, amendment, or modification of any Federal contract, grant, loan, or cooperative agreement.

b. If any funds other than Federal appropriated funds have been paid or will be paid to any person for influencing or attempting to influence an officer or employee of any Federal agency, a Member of Congress, an officer or employee of Congress, or an employee of a Member of Congress in connection with this Federal contract, grant, loan, or cooperative agreement, the undersigned shall complete and submit Standard Form-LLL, "Disclosure Form to Report Lobbying," in accordance with its instructions.

2. This certification is a material representation of fact upon which reliance was placed when this transaction was made or entered into. Submission of this certification is a prerequisite for making or entering into this transaction imposed by 31 U.S.C. 1352. Any person who fails to file the required certification shall be subject to a civil penalty of not less than \$10,000 and not more than \$100,000 for each such failure.

3. The prospective participant also agrees by submitting its bid or proposal that the participant shall require that the language of this certification be included in all lower tier subcontracts, which exceed \$100,000 and that all such recipients shall certify and disclose accordingly.

**NOTICE OF REQUIREMENTS FOR AFFIRMATIVE
ACTION TO ENSURE EQUAL EMPLOYMENT
OPPORTUNITY (EXECUTIVE ORDER 11246)**

1. The Offeror's or Bidder's attention is called to the "Equal Opportunity Clause" and the "Standard Federal Equal Employment Opportunity Construction Contract Specifications" set forth herein.

2. The goal for female participation, expressed in percentage terms for the Contractor's aggregate workforce in each trade on all construction work, is 6.9%.

Until further notice Goals for minority participation for each trade (percent)

SHSA Cities:
 Pascagoula - Moss Point ----- 16.9
 Biloxi - Gulfport ----- 19.2
 Jackson ----- 30.3

SMSA Counties:
 Desoto ----- 32.3
 Hancock, Harrison, Stone ----- 19.2
 Hinds, Rankin ----- 30.3
 Jackson ----- 16.9

Non-SMSA Counties:
 George, Greene ----- 26.4

Alcorn, Benton, Bolivar, Calhoun, Carroll, Chickasaw, Clay, Coahoma, Grenada, Itawamba, Lafayette, Lee, Leflore, Marshall, Monroe, Montgomery, Panola, Pontotoc, Prentiss, Quitman, Sunflower, Tallahatchie, Tate, Tippah, Tishomingo, Tunica, Union, Washington, Webster, Yalobusha ----- 26.5

Attala, Choctaw, Claiborne, Clarke, Copiah, Covington, Franklin, Holmes, Humphreys, Issaquena, Jasper, Jefferson, Jefferson Davis, Jones Kemper, Lauderdale, Lawrence, Leake, Lincoln, Lowndes, Madison, Neshoba, Newton, Noxubee, Oktibbeha, Scott, Sharkey, Simpson, Smith, Warren, Wayne, Winston, Yazoo ----- 32.0

Forrest, Lamar, Marion, Pearl River, Perry, Pike, Walthall ----- 27.7

Adams, Amite, Wilkinson ----- 30.4

These goals are applicable to all the Contractor's construction work (whether or not it is Federal or federally assisted) performed in the covered area. If the contractor performs construction work in a geographical area located outside of the covered area, it shall apply the goals established for such geographical area where the work is actually performed. With regard to this second area, the contractor also is subject to the goals for both its federally involved and nonfederally involved construction.

The Contractor's compliance with the Executive Order and the regulations in CFR Part 60-4 shall be based on its implementation of the Equal Opportunity clause, specific affirmative action obligations required by the specifications set forth in 41 CFR 60-4.3(a), and its efforts to meet the goals. The hours of minority and female employment and training must be substantially uniform throughout the length of the contract, and in each trade, and the Contractor shall make a good faith effort to employ minorities and women evenly on each of its projects. The transfer of minority or female employees or trainees from Contractor to Contractor or from project to project for the sole purpose of meeting the Contractor's goals shall be a violation of the contract, the Executive Order and the regulations in 41 CFR Part 60-4.2(d). Compliance with the goals will be measured against the total work hours performed.

3. The Contractor shall provide written notification to the Director of the Office of Federal Contract Compliance Programs within 10 working days of award of any construction subcontract in excess of \$10,000 at any tier for construction work under the contract resulting from this solicitation. The notification shall list the name, address and telephone number of the subcontractor, employer identification number of the subcontractor, estimated dollar amount of the subcontract; estimated starting and completion dates of the subcontract; and the geographical area in which the subcontract is to be performed.

4. As used in this Notice, and in the contract resulting from this solicitation, the "covered area" is to the county and city (if any), stated in the advertisement.

5. The notification required in Paragraph 3 shall be addressed to the following:

Contract Compliance Officer
 Mississippi Department of Transportation
 P.O. Box 1850
 Jackson, Mississippi 39215-1850

(06/28/2012)

MISSISSIPPI DEPARTMENT OF TRANSPORTATION

SPECIAL PROVISION NO. 907-103-2

CODE: (SP)

DATE: 06/22/2017

SUBJECT: Award and Execution of Contract

Section 103, Award and Execution of Contract, of the 2017 Edition of the Mississippi Standard Specifications for Road and Bridge Construction is hereby amended as follows.

907-103.01--Consideration of Proposal. Delete the second and third paragraphs of Subsection 103.01 on page 19, and substitute the following.

907-103.01.1--For Projects Constructed Without Federal Funds. Resident Contractors actually domiciled in Mississippi are to be granted preference over nonresidents in awarding of Contracts financed 100% with State funds.

In consideration of proposals that are equal to or in excess of \$50,000 and financed 100% with State funds, a nonresident bidder domiciled in a state having laws granting preference to local Contractors will be considered for such contracts on the same basis as the nonresident bidder's state awards contracts to Mississippi Contractors bidding under similar circumstances. When a nonresident Contractor submits a bid equal to or in excess of \$50,000 on a contract financed 100% with State funds, a copy of the current laws from the state of domicile and an explanation thereof pertaining to treatment of nonresident Contractors shall be attached. If no preferential treatment is provided for Contractors in the state of domicile and contracts are awarded to the lowest responsible bidder, a statement to this effect shall be attached. Should the attachment not accompany the bid when submitted, the Contractor shall have 10 days following the opening of the bids to furnish the required information to the Contract Administration Director for attachment to the bid. Failure to provide the attachment within 10 days will result in the nonresident Contractor's bid being rejected and not considered for award. As used herein, the term "resident Contractor" includes a nonresident person, firm or corporation that has been qualified to do business in this State and has maintained a permanent full-time office in the State of Mississippi for two years prior to the submission of the bid, and the subsidiaries and affiliates of such a person, firm or corporation.

MISSISSIPPI DEPARTMENT OF TRANSPORTATION

SPECIAL PROVISIONS NO. 907-823-1

CODE: (SP)

DATE: 01/17/2017

SUBJECT: **Preformed Joint Seal**

Section 907-823, Preformed Joint Seal, is hereby added to and made a part of the 2017 Edition of the Mississippi Standard Specifications for Road and Bridge Construction as follows.

SECTION 907-823--PREFORMED JOINT SEAL

907-823.01--Description. This work consists of furnishing and installing preformed joint seals in accordance with these specifications and the details shown in the Plans or drawings provided.

907-823.02--Materials. The Contractor shall furnish a manufacturer's certification stating that the material used meets the requirements of this specification.

The preformed joint seal shall be one of the following, or an approved equal. The size of the seal, Type I or Type II, shall be determined based on the size of the joint opening, as detailed in the Plans or drawings provided. It is the Contractor's responsibility to ensure that the size selected is appropriate for the width of the joint. Type I shall be used for joint openings less than two inches (2"). Type II shall be used for joint openings greater than two inches (2"), with the maximum joint opening being two and one-half inches (2½"). In cases where the joint opening is greater than two and one-half inches (2½"), another type of expansion material shall be required as directed by the Director of Structures, State Bridge Engineer.

1. Silicoflex Joint Sealing System
Manufactured by R.J. Watson, Inc. in Alden, NY
www.rjwatson.com
2. Wabo®SPS Joint System
Manufactured by Watson Bowman Acme Corporation in Amherst, NY
www.wbacorp.com
3. Silspec SSS Silicone Strip Seal
Manufactured by SSI Commercial & Highway Construction Materials in Tulsa, OK
www.ssicm.com

907-823.03--Construction Methods. Preformed joint seals shall be installed in accordance with the manufacturer's recommendations. The material shall seal the deck surface, gutters, and curbs to prevent moisture or other contaminants from leaking through the joints. The joint seal shall be installed in such a manner that the top surface of the material is within the minimum and maximum depths below the roadway or bridge surface recommended by the manufacturer.

Saw cutting for the joint repair shall be accomplished by sawing at the locations and depth shown

on the joint repair detail sheets in the plans or in the contract documents. Saw cuts shall be as near vertical as possible at the saw line of the repair area. The saw cut depth shall be equivalent to the installation depth required by the manufacturer's specifications, and the type specified shall be the same as the type specified for preformed joint seal.

907-823.04--Method of Measurement. Preformed joint seal of the type specified will be measured in linear feet along the length of the centerline joint.

Saw cuts of the type specified will be measured by the linear foot along the length of the bridge deck on each side of the centerline joint.

907-823.05--Basis of Payment. Preformed joint seal, measured as prescribed above, will be paid for at the contract unit price per linear foot, which shall be full compensation for furnishing all labor, equipment, tools, materials, and incidentals necessary to complete the work.

Saw cuts, measured as prescribed above, will be paid for at the contract unit price per linear foot, which shall be full compensation for furnishing all labor, equipment, tools, materials, and incidentals necessary to complete the work.

Payment will be made under:

907-823-A: Preformed Joint Seal, Type ____ - per linear foot

907-823-B: Saw Cut, Type _____ - per linear foot

STATE	PROJECT NO.
MISS.	

NOTES ON ASSOCIATED ITEMS OF WORK.

202-BE88 REMOVAL OF EXISTING JOINT MATERIAL

Descriptions: Shall include the Removal of Material Associated With Arms, Siding, Top, and Negative Expansion Joints, As Well As the Removal of Existing Sealant From the Joint Unless Otherwise Directed by the Engineer.

Basis of Payment: Removal of Armor and Siding (Pne. Joint Material) Will Be Paid For in the Same Manner as the Contract Joint Preparation. The Contract Joint Preparation Will Be Paid For in the Same Manner as the Contract Joint Preparation. The Contract Joint Preparation Will Be Paid For in the Same Manner as the Contract Joint Preparation.

808-A001 JOINT PREPARATION

Descriptions: Shall include the Work Necessary to Repair Joints, As Directed in the Detail Drawings Provided. Epoxy Mortar Joint Also Be Included Under This Item of Work. Existing Joint Materials Will Not Be Paid For Directly and Shall Be Considered as Work Included Under the Applicable Provisions of Section 808 of The Specifications and Any Other Sections Specified Herein.

Basis of Payment: The Accepted Quantities Will Be Paid For in Lower Foot At On Each Side of The Contract Joint.

907-823-9001 SAW CUT, TYPE I, & 907-823-9002 SAW CUT, TYPE II

Descriptions: The Saw Cut Depth Shall Be Established By The Installation Depth Required by The Manufacturer's Specifications. The Saw Cut Type Shall Be The Same As The Preferred Joint Seal Selected.

Basis of Payment: The Accepted Quantities Will Be Paid For in Lower Foot At On Each Side of The Contract Joint.

907-823-9001 PREFORMED JOINT SEAL, TYPE I

Basis of Payment: The Accepted Quantities Will Be Paid For in Lower Foot At On Each Side of The Contract Joint.

907-823-9002 PREFORMED JOINT SEAL, TYPE II

Basis of Payment: The Accepted Quantities Will Be Paid For in Lower Foot At On Each Side of The Contract Joint.

EPOXY MORTAR AND POLYMER CONCRETE NOTES:

- 1. General Notes:
 - a. All Change of Items Will Be Permitted Except By Written Approval of the Engineer.
 - b. Minor Changes to Detail of Design or Construction Procedure Will Be Authorized by the Design Engineer. Proposed Such Changes Will Be Subject to the Approval of the Engineer. The Proposal Will Be Returned to the Contractor for Approval. The Contractor Shall Be Responsible for the Cost of Such Changes.

MISSISSIPPI DEPARTMENT OF TRANSPORTATION	
JOINT REPAIR	
ARMORED EXPANSION JOINTS	
PROJECT	COUNTY
WORKING NUMBER	SHEET NUMBER

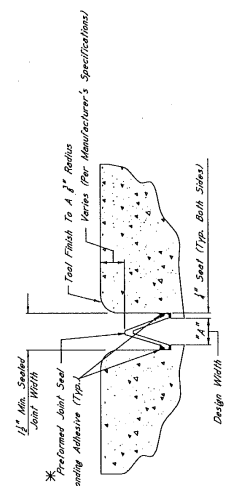

TYPICAL SECTION AT SAWCUT & SEALED JOINT
Showing Repair With Epoxy Mortar

- * NOTES:
- The Preferred Joint Seal Shall Be One of The Following, Included According to The Manufacturer's Specifications:
 - A. Silicate Joint Sealing System
www.cemson.com
 - B. Welo 575 Joint System
Manufactured by Welo Bauwesen AG, Wetzlar, Germany
 - C. Silcrete 555 Silcrete Strip Seal
Manufactured by 357 Commercial & Highway Construction Materials
www.siam.com
 - For Existing Proposals To Install Joint Seal, The Contractor Shall Be Responsible for the Cost of the Sealant. The Contractor Shall Be Responsible for the Cost of the Sealant. The Contractor Shall Be Responsible for the Cost of the Sealant.
 - Joints Shall Be Sealed At Their Design Width. Minimum Sealant Depth Shall Be 1/2" (12.5mm) For All Joints. The Contractor Shall Be Responsible for the Cost of the Sealant. The Contractor Shall Be Responsible for the Cost of the Sealant.

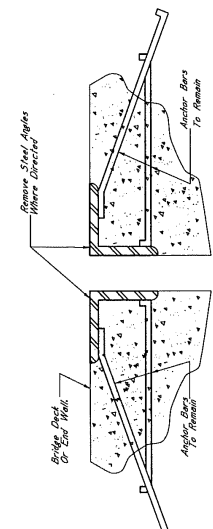

TYPICAL SECTION AT EXISTING JOINT
Showing Existing Conditions, To Be Removed and Replaced With Preferred Joint Seal

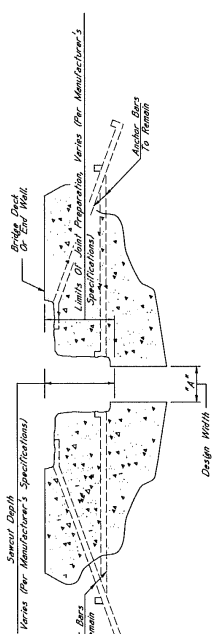

TYPICAL SECTION AT JOINT AFTER REMOVAL OF EXISTING MATERIAL
Showing Limits of Joint Preparation and Application of New Joint

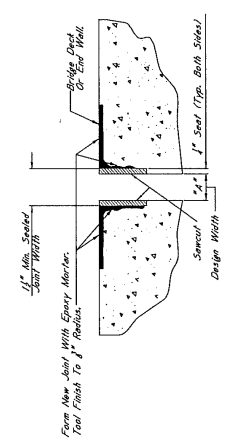

TYPICAL SECTION AT SAWCUT & JOINT REPAIR
Showing Area Where Repairs Are Made After Sawcut With Epoxy Mortar Or Approved Equivalent



STATE	PROJECT NO.
MSS.	

NOTES ON ASSOCIATED ITEMS OF WORK:

802-8999 REMOVAL OF EXISTING JOINT MATERIAL
 Description: Shall include the Removal of Material Associated With Armor, Sliding Plates, and Neoprene Expansion Joints. Joint Types Shall Not Be Included Under This Item of Work Unless Otherwise Directed By The Engineer.

Basis of Payment: Removal of Armor and Sliding Plate Joint Material Will Be Paid For in Linear Feet At The Contract Unit Price For Removal of Material From the Length of the Centerline Joint, With Removal of Neoprene Joint Material, Concrete, or the Plate, For As The Length Along the Centerline of the Joint.

808-4001 JOINT PREPARATION

Description: Shall include the Work Necessary to Repair Joints in Concrete or Masonry. The Work Shall Be Done in Accordance With the Specifications. The Contractor Shall Be Responsible for the Removal of Existing Material and the Installation of New Material. The Contractor Shall Be Responsible for the Removal of Existing Material and the Installation of New Material. The Contractor Shall Be Responsible for the Removal of Existing Material and the Installation of New Material.

Basis of Payment: The Accepted Quantities Will Be Paid For in Linear Feet At The Contract Unit Price Along the Length of the Bridge Deck on Each Side of the Centerline Joint.

907-823-8001 SAW CUT, TYPE I & 907-823-8002 SAW CUT, TYPE II

Description: The Saw Cut Depth Shall Be Equivalent to The Installation Depth Required By The Manufacturer's Specifications. The Saw Cut Type Shall Be the Same As the Preformed Joint Seal Selected.

Basis of Payment: The Accepted Quantities Will Be Paid For in Linear Feet At The Contract Unit Price Along the Length of the Bridge Deck on Each Side of the Centerline Joint.

907-823-4001 PREFORMED JOINT SEAL, TYPE I

Description: The Accepted Quantities Will Be Paid For in Linear Feet At The Contract Unit Price Along the Length of the Centerline Joint.

907-823-4002 PREFORMED JOINT SEAL, TYPE II

Description: The Accepted Quantities Will Be Paid For in Linear Feet At The Contract Unit Price Along the Length of the Centerline Joint.

EPOXY MORTAR AND POLYMER CONCRETE NOTES:

1. Epoxy Mortar and Polymer Concrete Shall Be Applied in Accordance With the Manufacturer's Specifications. The Contractor Shall Be Responsible for the Selection of Materials. The Contractor Shall Be Responsible for the Selection of Materials.

GENERAL NOTES:

1. Specifications: Mississippi Standard Specifications For Road Construction, Section 100.01, 100.02, 100.03, 100.04, 100.05, 100.06, 100.07, 100.08, 100.09, 100.10, 100.11, 100.12, 100.13, 100.14, 100.15, 100.16, 100.17, 100.18, 100.19, 100.20, 100.21, 100.22, 100.23, 100.24, 100.25, 100.26, 100.27, 100.28, 100.29, 100.30, 100.31, 100.32, 100.33, 100.34, 100.35, 100.36, 100.37, 100.38, 100.39, 100.40, 100.41, 100.42, 100.43, 100.44, 100.45, 100.46, 100.47, 100.48, 100.49, 100.50, 100.51, 100.52, 100.53, 100.54, 100.55, 100.56, 100.57, 100.58, 100.59, 100.60, 100.61, 100.62, 100.63, 100.64, 100.65, 100.66, 100.67, 100.68, 100.69, 100.70, 100.71, 100.72, 100.73, 100.74, 100.75, 100.76, 100.77, 100.78, 100.79, 100.80, 100.81, 100.82, 100.83, 100.84, 100.85, 100.86, 100.87, 100.88, 100.89, 100.90, 100.91, 100.92, 100.93, 100.94, 100.95, 100.96, 100.97, 100.98, 100.99, 101.00.



TYPICAL SECTION AT SAWCUT & SEALED JOINT
 Showing Limits of Joint Preparation, Limits of Seal Materials

* NOTES:
 1. The Preformed Joint Seal Shall Be One Of The Following, Installed According To The Manufacturer's Specifications:
 A. Sealant
 B. Sealant
 C. Sealant

2. For Epoxy Mortar, The P. J. Wilson Slitter Joint Sealing System Was Specified. However, Should Another Supplier Be Chosen, It Be The Contractor's Responsibility to Provide the Manufacturer's Specifications. The Contractor Shall Be Responsible for the Selection of Materials. The Contractor Shall Be Responsible for the Selection of Materials.

3. Joints Shall Be Sealed At Their Origin Within a Maximum of 10 Feet From the Joint. The Sealant Shall Be Applied to the Joint Within 10 Feet From the Joint. The Sealant Shall Be Applied to the Joint Within 10 Feet From the Joint.

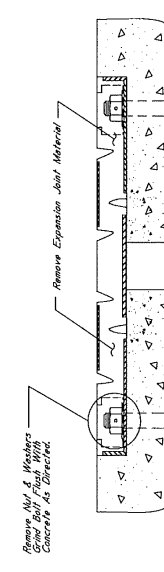

TYPICAL SECTION AT EXISTING JOINT
 Showing Existing Expansion Device To Be Removed And Replaced With Preformed Joint Seal

* NOTES:
 1. The Preformed Joint Seal Shall Be One Of The Following, Installed According To The Manufacturer's Specifications:
 A. Sealant
 B. Sealant
 C. Sealant

2. For Epoxy Mortar, The P. J. Wilson Slitter Joint Sealing System Was Specified. However, Should Another Supplier Be Chosen, It Be The Contractor's Responsibility to Provide the Manufacturer's Specifications. The Contractor Shall Be Responsible for the Selection of Materials. The Contractor Shall Be Responsible for the Selection of Materials.

3. Joints Shall Be Sealed At Their Origin Within a Maximum of 10 Feet From the Joint. The Sealant Shall Be Applied to the Joint Within 10 Feet From the Joint. The Sealant Shall Be Applied to the Joint Within 10 Feet From the Joint.

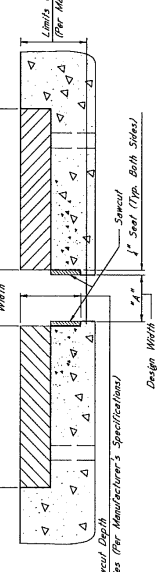

TYPICAL SECTION AT JOINT AFTER REMOVAL OF EXISTING SEAL
 Showing Limits of Joint Preparation, Limits of Seal Materials

* NOTES:
 1. The Preformed Joint Seal Shall Be One Of The Following, Installed According To The Manufacturer's Specifications:
 A. Sealant
 B. Sealant
 C. Sealant

2. For Epoxy Mortar, The P. J. Wilson Slitter Joint Sealing System Was Specified. However, Should Another Supplier Be Chosen, It Be The Contractor's Responsibility to Provide the Manufacturer's Specifications. The Contractor Shall Be Responsible for the Selection of Materials. The Contractor Shall Be Responsible for the Selection of Materials.

3. Joints Shall Be Sealed At Their Origin Within a Maximum of 10 Feet From the Joint. The Sealant Shall Be Applied to the Joint Within 10 Feet From the Joint. The Sealant Shall Be Applied to the Joint Within 10 Feet From the Joint.

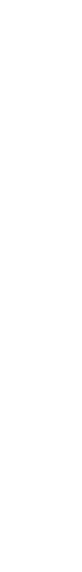

ELEVATION AT END OF SPAN

* NOTES:
 1. The Preformed Joint Seal Shall Be One Of The Following, Installed According To The Manufacturer's Specifications:
 A. Sealant
 B. Sealant
 C. Sealant

2. For Epoxy Mortar, The P. J. Wilson Slitter Joint Sealing System Was Specified. However, Should Another Supplier Be Chosen, It Be The Contractor's Responsibility to Provide the Manufacturer's Specifications. The Contractor Shall Be Responsible for the Selection of Materials. The Contractor Shall Be Responsible for the Selection of Materials.

3. Joints Shall Be Sealed At Their Origin Within a Maximum of 10 Feet From the Joint. The Sealant Shall Be Applied to the Joint Within 10 Feet From the Joint. The Sealant Shall Be Applied to the Joint Within 10 Feet From the Joint.



MISSISSIPPI DEPARTMENT OF TRANSPORTATION	
JOINT REPAIR	
NEOPRENE EXPANSION JOINTS	
PROJECT	
WORKING NUMBER	SHEET NUMBER
COUNTY	
CHECKED	DATE
DESIGNED	BY
DRAWN	BY
APP. DIRECTOR OF TRANSPORTATION	STATE ENGINEER

STATE MISS.	PROJECT NO.				
----------------	-------------	--	--	--	--

NOTES ON ASSOCIATED ITEMS OF WORK:

907-823-001 JOINT PREPARATION

Description: Shall include the field measurement of repair joints to be prepared in the field. Damages, existing epoxy mortar and other materials shall be removed to the extent specified in the contract documents. All existing silicone sealant shall be removed. All materials shall be prepared for direct application and shall be considered as new. The repair shall be in accordance with the applicable provisions of Section 808 of the Specifications and any other sections specified herein.

Basis of Payment: The accepted quantities, measured along the length of the bridge deck on each side of the centerline joint.

907-823-002 SAW CUT, TYPE II

Description: The saw cut depth shall be equivalent to the installation depth required by the manufacturer's specifications. The saw cut type shall be the same as the prepared joint seal selected.

Basis of Payment: The accepted quantities will be paid for in linear feet at the contract unit price along the length of the centerline joint.

907-823-001 PREPARED JOINT SEAL, TYPE II

907-823-002 PREPARED JOINT SEAL, TYPE II

Basis of Payment: The accepted quantities will be paid for in linear feet at the contract unit price along the length of the centerline joint.

EPOXY MORTAR AND POLYMER CONCRETE JOINTS:

Either epoxy mortar or polymer concrete may be used. Guidelines for selection of materials can be found in Section 808 of the Specifications.

GENERAL NOTES:

- Specifications, Mississippi Standard Specifications For Road And Bridges, 2007 Edition, shall apply unless otherwise indicated.
- No change of Plans will be permitted except by written approval of the District Engineer, State Bridge Engineer, or the District Director of Bridge Operations. Any change authorized by the District Engineer, State Bridge Engineer, or the District Director of Bridge Operations shall be in writing and shall be provided to the contractor in the form of a change order. Work for which no provision is made in the contract documents shall not be paid for directly and shall therefore be considered an associated item of work.

MISSISSIPPI DEPARTMENT OF TRANSPORTATION

JOINT REPAIR

SILICONE SEALED EXPANSION JOINTS

PROJECT

COUNTY

WORKING NUMBER

SHEET NUMBER

DATE

DRAWN BY

CHECKED BY

APPROVED BY

DESIGNED BY

SUPERVISOR

ENGINEER

DISTRICT ENGINEER

STATE BRIDGE ENGINEER

DISTRICT DIRECTOR OF BRIDGE OPERATIONS

TYPICAL SECTION AT SAWCUT & SEALED JOINT

Showing Sealed Joint After Sawcut And Repair With Epoxy Mortar

***NOTES:**

- The Prepared Joint Seal Shall Be One Of The Following, Installed According To The Manufacturer's Specifications:
 A. *Sealant Strip*
 Manufactured By: *P. C. Whitbeck, Inc. in Akron, NY*
 www.pcwitbeck.com
 B. *Weld-On Seal System*
 Manufactured By: *SSI Commercial & Highway Construction Materials*
 www.ssi.com
 C. *Silicone SSS Silicone Strip Seal*
 Manufactured By: *SSI Commercial & Highway Construction Materials*
 www.ssi.com
 For Existing Repairs, The P. C. Whitbeck Sealant Strip System Was Selected. However, Should Another System Be Chosen, It Is The Contractor's Responsibility To Provide A Manufacturer's Specification, Installation Details, And Material Properties, Including Density, And Viscosity, Subject To The Approval Of The District Engineer. The Contractor Shall Be Responsible For Providing A Manufacturer's Representative Shall Be Present At The Time Sealant Strip Is Installed. The Contractor Is Properly Scheduled In Installation Of The Joint Sealant Strip.
 2. The Actual Width Of The Joint, Opening, The Width Does Not Account For The 1/2 Inch Sawcut Depth. The Sealant Strip Shall Be Applied To The Full Width Of The Joint. The Sealant Strip Shall Be Applied To The Full Width Of The Joint. The Sealant Strip Shall Be Applied To The Full Width Of The Joint.
 3. The Sealant Strip Shall Be Applied To The Full Width Of The Joint. The Sealant Strip Shall Be Applied To The Full Width Of The Joint. The Sealant Strip Shall Be Applied To The Full Width Of The Joint.

TYPICAL SECTION AT SAWCUT & JOINT REPAIR

Showing Area Where Repairs Are Made After Sawcut With Epoxy Mortar Or Approved Equivalent

TYPICAL SECTION AT EXISTING JOINT

Showing Existing Epoxy Mortar To Be Removed And Replaced With Prepared Joint Seal

TYPICAL SECTION AT JOINT AFTER REMOVAL OF EXISTING SEAL

Showing Limits Of Joint Preparation For Application Of New Seal

TYPICAL SECTION AT SAWCUT & SEALED JOINT

Showing Sealed Joint After Sawcut And Repair With Epoxy Mortar

ELEVATION AT END OF SEAL

STATE	PROJECT NO.	MISS.	
-------	-------------	-------	--

NOTES ON ASSOCIATED ITEMS OF WORK:
 808-4001 - JOINT PREPARATION

Description: Block includes the Work Necessary To Repair, Patch, Or Prepare For The Placement Of New Expansion Material, Concrete Or Steel Reinforcement, Or Other Repair Material, On Existing Concrete, Masonry, Or Steel, Or Other Material. It Includes The Removal Of Existing Material, And The Preparation Of A Sound Surface For The Placement Of New Material. All Other Requirements Shall Be As Specified In The Contract Documents, Or In The Specifications, Or In The Manufacturer's Recommendations.

Basis Of Payment: The Accepted Quantities Will Be Paid For In Lower Feet At The Actual Cost Of The Contractor.

807-823-8002 - SAW CUT, TYPE I & 807-823-8002 - SAW CUT, TYPE II

Description: The Saw Cut Depth Shall Be Equivalent To The Installation Depth Required By The Manufacturer's Specifications. The Saw Cut Type Shall Be As Specified In The Contract Documents, Or In The Specifications, Or In The Manufacturer's Recommendations.

Basis Of Payment: The Contract Unit Price Along The Length Of The Bridge Deck On Each Side Of The Concrete Joint. It Is The Contractor's Responsibility To Determine The Depth Of The Saw Cut Based On The Manufacturer's Recommendations.

807-823-4001 - PREFORMED JOINT SEAL, TYPE I
 807-823-4002 - PREFORMED JOINT SEAL, TYPE II

Basis Of Payment: The Accepted Quantities Will Be Paid For In Lower Feet At The Actual Cost Of The Contractor.

EPOXY MORTAR AND POLYMER CONCRETE NOTES:
 For Selection Of Materials See The Notes In Section 808 of the Specifications.

GENERAL NOTES:
 1. Specifications: Mississippi Standard Specifications For Road And Bridge Construction, Section 808.
 2. Approval Of The Director Of Structures, State Bridge Engineer, May Be Withheld By The Bridge Engineer Provided Such Changes Will Not Affect The Contract Price Adjustment, Provided As Stated In The Contract Documents.
 3. Material And Method Of Construction Shall Be As Specified In The Contract Documents, Or In The Specifications, Or In The Manufacturer's Recommendations.

TYPICAL SECTION AT EXISTING JOINT
 Showing Existing Existing With Performed Joint Seal

Remove All Expansion Material From Bridge Deck Or End Wall

1/2" Min. Sealant Joint Width

Preformed Joint Seal

Bonding Adhesive (Type 1)

Form To A 1" Radius

Form (Per Manufacturer's Specifications)

Design Depth

1" Seal (Type, Both Sides)

TYPICAL SECTION AT SAWCUT & JOINT REPAIR
 Showing Area Where Repairs Are Made After Saws Cut With Epoxy Mortar Or Approved Equivalent

1/2" Min. Sealant Joint Width

Form New Joint With Epoxy Mortar

Form Finish To A Radius

Design Depth

Bridge Deck Or End Wall

1" Seal (Type, Both Sides)

TYPICAL SECTION AT SAWCUT & SEALED JOINT
 Showing Saws Cut After Saws Cut And Repair With Epoxy Mortar

1/2" Min. Sealant Joint Width

Form Finish To A 1" Radius

Form (Per Manufacturer's Specifications)

Design Depth

1" Seal (Type, Both Sides)

***NOTES:**
 1. The Manufacturer's Recommendations Shall Be One Of The Following, Labeled Accordingly To The Manufacturer's Recommendations:
 A. Silicate Joint Sealing Systems Manufactured By R. J. White, Inc. In Albany, NY
 B. Wicks 505 Joint Sealing Systems Manufactured By Wicks-Burman Acme Corporation In Amherst, NY
 C. Silcock 555 Silicone Seal Systems Manufactured By 353 Commercial & Highway Construction Materials In Amherst, NY
 2. Epoxy Mortar Products: The R. J. White Silicate Joint Sealing System Which Is A Two Part System Shall Be Used Unless Otherwise Specified In The Contract Documents. For Joint Preparations, Installation Depth, And Width, Always Follow The Manufacturer's Recommendations. A Manufacturer's Representative Shall Be Present At The Time Joint Sealing Begins To Ensure That The Contractor Is Properly Trained In Installation Of The Joint Sealant.
 3. Joints Shall Be Sealed At Their Design Widths, Which Shall Be Determined By The Actual Width Of The Existing Joint. The Width Of The Joint Sealant Shall Be As Specified In The Contract Documents. The Sealant Shall Be Applied To The Joint Using The Proper Widths And Thicknesses. The Sealant Shall Be Applied To The Joint Using The Proper Widths And Thicknesses. The Sealant Shall Be Applied To The Joint Using The Proper Widths And Thicknesses.

TYPICAL SECTION AT JOINT AFTER REMOVAL OF EXISTING SEAL
 Showing Limits Of Joint Preparation For Application Of New Seal

Bridge Deck Or End Wall

Limits Of Joint Preparation, Form (Per Manufacturer's Specifications)

Sawcut

Design Depth

1" Seal (Type, Both Sides)

TYPICAL SECTION AT END OF SPAN
 Showing Limits Of Joint Preparation For Application Of New Seal

1/2" Min. Sealant Joint Width

Form New Joint With Epoxy Mortar

Form Finish To A Radius

Design Depth

Bridge Deck Or End Wall

1" Seal (Type, Both Sides)

TYPICAL SECTION AT SAWCUT & JOINT REPAIR
 Showing Area Where Repairs Are Made After Saws Cut With Epoxy Mortar Or Approved Equivalent

1/2" Min. Sealant Joint Width

Form New Joint With Epoxy Mortar

Form Finish To A Radius

Design Depth

Bridge Deck Or End Wall

1" Seal (Type, Both Sides)

MISSISSIPPI DEPARTMENT OF TRANSPORTATION

JOINT REPAIR

AC SEALED EXPANSION JOINTS

PROJECT

COUNTY

WORKING NUMBER

SHEET NUMBER

14

CONTRACT

DATE

DESIGNED BY

CHECKED BY

APPROVED BY

FOR SERVICE OF CONTRACTOR, STATE BRIDGE NUMBER - 2018-10-14

STATE	PROJECT NO.
MISS.	

NOTES ON ASSOCIATED ITEMS OF WORK

907-823-4007 BRIDGE REPAIR, ENDWALL REPAIR

Description: Shall include the Work Necessary to Remove and Replace the Damaged Ends, As Designed in The Detail Drawings Provided. Existing Reinforcing Bars, Endwall Shall Be Removed Along The Entire Width Of The Bridge Deck. Concrete On Approach Slabs Will Be Replaced For A Length Foot At The Ends of Pavement. The Associated Quantities Will Be Replaced For A Length Foot At The Ends of Pavement. This Item of Work Shall Be Reported By The Contractor At No Cost To The Department.

Other Elements Of This Structure Or Structure Which, Completion Of This Item of Work Shall Be Reported By The Contractor At No Cost To The Department:

Concrete On Approach Slabs Will Be Replaced For A Length Foot At The Ends of Pavement. This Item of Work Shall Be Reported By The Contractor At No Cost To The Department.

New Concrete Shall Be High Early Strength Concrete, As Follows:
 The concrete mixture design shall be furnished by the Contractor for approval by the Materials Division. Mixture design parameters are as follows:
 Required Strength: 2500 psi prior to releasing to traffic
 Total Air Content: 3-4 %
 Maximum Slump: 6 inches

Non-chloride based accelerator may be used if the ambient temperature is 50°F or less, but shall not be used if the ambient temperature is greater than 50°F. Synthetic structural fibers shall be used. The Contractor shall select a manufacturer from AASHTO approved products list, and the manufacturer's recommendations shall be followed for the design mix.

Core is to be continuous with 200 psi to be attained. Traffic is to be maintained on the structure. The Contractor shall estimate the concrete compressive strength for the purpose of releasing the repair area to traffic. Right concrete test cylinders, which shall be cured in a container next to the concrete placement. Two cylinders are to be tested at 0, 1, 6, and 28 hour compressive strength of the concrete.

The Removal of Existing Expansion Material May Require Any Member Of The Item Listed Below. Once The Expansion Device Is Identified, Refer To The Corresponding Joint Repair Detail Sheet For Additional Details On The Associated Items of Work.

- 202-8289 REMOVAL OF EXISTING JOINT MATERIAL
- 507-823-8001 SAW CUT, TYPE I
- 507-823-8002 SAW CUT, TYPE II
- 507-823-4002 PREFORMED JOINT SEAL, TYPE II

GENERAL NOTES:

1. Specifications shall be in accordance with the Standard Specifications for Road and Bridge Construction, 2004 Edition, as amended.
2. No Change of Plans Will Be Permitted Except By Written Approval of the Engineer. All Changes to Details of Design or Construction Procedures Shall Be Approved By The Bridge Engineer. Proposed Such Changes Shall Be Approved By The Engineer. All Changes to Details of Design or Construction Procedures Shall Be Approved By The Engineer. All Changes to Details of Design or Construction Procedures Shall Be Approved By The Engineer.
3. Material and Workmanship Shall Be As Specified In The Proposal And Shall Therein Be Considered An Associated Item of Work.

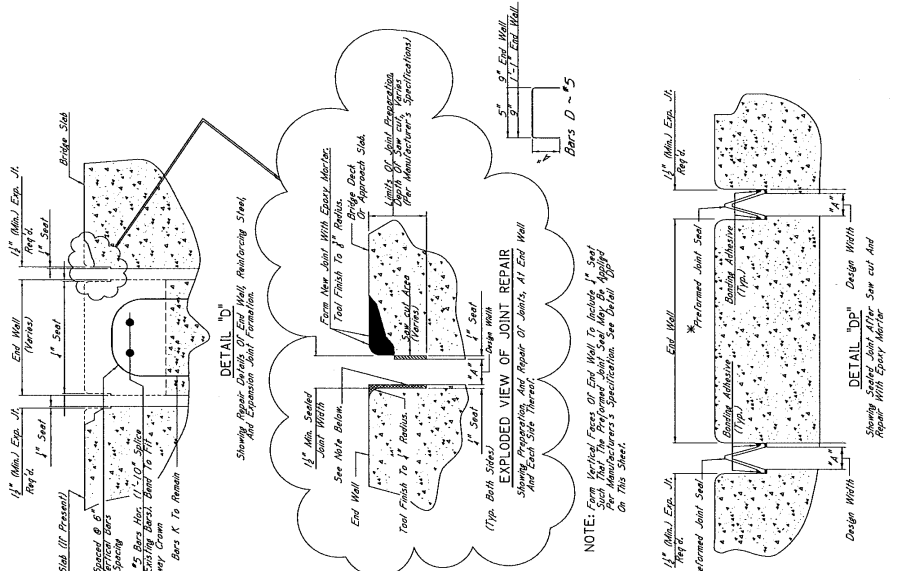

MISSISSIPPI DEPARTMENT OF TRANSPORTATION	
END WALL REPAIR	
PROJECT	
DATE	WORKING NUMBER
DESIGNED BY	CHECKED BY
DRAWN BY	DATE
SCALE	COUNTY
SHEET NUMBER	SHEET NUMBER



- *NOTES:**
1. The Proposed Joint Seal Shall Be One Of The Following, Installed According To The Manufacturer's Instructions:
 - A. SikaSeal Joint Sealing System, www.sika.com
 - B. SikaSeal Joint Sealing System, www.sika.com
 - C. SikaSeal Joint Sealing System, www.sika.com
 - D. SikaSeal Joint Sealing System, www.sika.com
 - E. SikaSeal Joint Sealing System, www.sika.com
 2. For Expanding Devices, The At Least Suitable, Self Sealing System May Be Used. The Contractor Shall Provide The Manufacturer's Recommendations For The Expansion Device. The Contractor Shall Provide The Manufacturer's Recommendations For The Expansion Device. The Contractor Shall Provide The Manufacturer's Recommendations For The Expansion Device.
 3. Joint Seal On Slab At The Ends of Pavement, Expansion Joints, Which Is Located On The Slab, Shall Be Installed On Both Sides of The Slab. The Contractor Shall Provide The Manufacturer's Recommendations For The Expansion Device. The Contractor Shall Provide The Manufacturer's Recommendations For The Expansion Device. The Contractor Shall Provide The Manufacturer's Recommendations For The Expansion Device.

STATE	PROJECT NO.
MIS.	

NOTES ON ASSOCIATED ITEMS OF WORK
202-8239 REMOVAL OF EXISTING JOINT MATERIAL

Description: Shall include the removal of material associated with damaged joints in the original drawings provided. Other joint types shall be installed under the direction of the Engineer. Work shall be done under the direction of the Engineer.

Basis of Payment: Removal of armor and stiling plate material will be paid for on a unit price basis for the length of the joint. The length of the bridge deck on each side of the centerline joint, while removal of the armor and stiling plate material is in progress, shall be paid for as the length along the centerline of the joint.

608-1001 JOINT PREPARATION

Description: Shall include the work necessary to repair joints in concrete. The contractor shall provide the epoxy mortar. The epoxy mortar shall be installed in the joint as shown on the drawings. The epoxy mortar shall be installed in the joint as shown on the drawings. The epoxy mortar shall be installed in the joint as shown on the drawings. The epoxy mortar shall be installed in the joint as shown on the drawings.

Basis of Payment: The accepted quantities will be paid for a linear foot of joint on each side of the centerline joint.

907-823-9001 SAW CUT, TYPE 1 & 907-823-9002 SAW CUT, TYPE II

Description: The saw cut depth shall be equivalent to the installation depth as shown on the drawings. The saw cut shall be made in the concrete. The saw cut shall be made in the concrete. The saw cut shall be made in the concrete. The saw cut shall be made in the concrete.

Basis of Payment: The accepted quantities will be paid for a linear foot of joint on each side of the centerline joint.

907-823-1001 PREFORMED JOINT SEAL, TYPE I

Description: The accepted quantities will be paid for a linear foot of joint on each side of the centerline joint.

907-823-1002 PREFORMED JOINT SEAL, TYPE II

Description: The accepted quantities will be paid for a linear foot of joint on each side of the centerline joint.

EPOXY MORTAR AND POLYMER CONCRETE NOTES:

1. Epoxy mortar and polymer concrete shall conform to the specifications for road and bridge construction 2004.
2. No change of joint will be permitted except by written approval of the Engineer. Any change to the joint shall be approved by the Engineer. Any change to the joint shall be approved by the Engineer.
3. Work for which no pay item is provided in the proposal will not be paid for directly and shall therefore be considered an assumed item of work.

GENERAL NOTES:

1. See Mississippi Standard Specifications for Road and Bridge Construction 2004.
2. No change of joint will be permitted except by written approval of the Engineer. Any change to the joint shall be approved by the Engineer. Any change to the joint shall be approved by the Engineer.
3. Work for which no pay item is provided in the proposal will not be paid for directly and shall therefore be considered an assumed item of work.

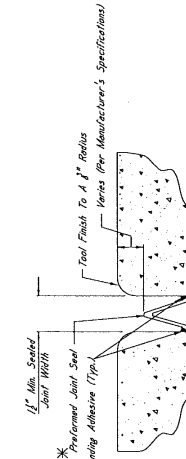

TYPICAL SECTION AT SAWCUT & SEALED JOINT
 Showing Sealant Joint After Sawcut And Repair With Epoxy Mortar

***NOTES:**

1. The Preformed Joint Seal Shall be One of The Following, Installed According To The Manufacturer's Specifications:
 A. Silicifier Joint Sealing System Manufactured By R.Z. Wehrich, Inc. In Akron, NY
 B. Silicifier Joint Sealing System Manufactured By R.Z. Wehrich, Inc. In Akron, NY
 C. Silicifier Joint Sealing System Manufactured By R.Z. Wehrich, Inc. In Akron, NY

2. For Epoxy Mortar, The RZ Wehrich Silicifier Joint Sealing System Was Used. The Epoxy Mortar Shall Be Applied In The Joint As Shown On The Drawings. The Epoxy Mortar Shall Be Applied In The Joint As Shown On The Drawings. The Epoxy Mortar Shall Be Applied In The Joint As Shown On The Drawings. The Epoxy Mortar Shall Be Applied In The Joint As Shown On The Drawings.

3. Joints Shall Be Sealed At Their Design Widths. Dimension A, Which Is Defined As Sealant Depth On Both Sides Of The Joint, Shall Be Equal To The Design Width. For Design Widths Greater Than Or Equal To 2 Inches, The Sealant Depth Shall Be Equal To The Design Width. For Design Widths Less Than 2 Inches, The Sealant Depth Shall Be Equal To The Design Width. For Design Widths Less Than 2 Inches, The Sealant Depth Shall Be Equal To The Design Width.

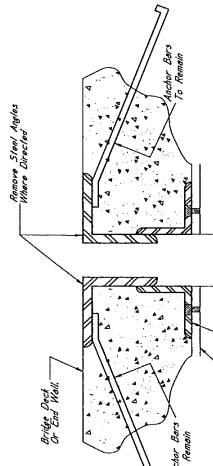

TYPICAL SECTION AT EXISTING JOINT
 Showing Existing Expansion Device To Be Removed And Replaced With Preformed Joint Seal

***NOTES:**

1. The Preformed Joint Seal Shall be One of The Following, Installed According To The Manufacturer's Specifications:
 A. Silicifier Joint Sealing System Manufactured By R.Z. Wehrich, Inc. In Akron, NY
 B. Silicifier Joint Sealing System Manufactured By R.Z. Wehrich, Inc. In Akron, NY
 C. Silicifier Joint Sealing System Manufactured By R.Z. Wehrich, Inc. In Akron, NY

2. For Epoxy Mortar, The RZ Wehrich Silicifier Joint Sealing System Was Used. The Epoxy Mortar Shall Be Applied In The Joint As Shown On The Drawings. The Epoxy Mortar Shall Be Applied In The Joint As Shown On The Drawings. The Epoxy Mortar Shall Be Applied In The Joint As Shown On The Drawings. The Epoxy Mortar Shall Be Applied In The Joint As Shown On The Drawings.

3. Joints Shall Be Sealed At Their Design Widths. Dimension A, Which Is Defined As Sealant Depth On Both Sides Of The Joint, Shall Be Equal To The Design Width. For Design Widths Greater Than Or Equal To 2 Inches, The Sealant Depth Shall Be Equal To The Design Width. For Design Widths Less Than 2 Inches, The Sealant Depth Shall Be Equal To The Design Width.

TYPICAL SECTION AT JOINT AFTER REMOVAL OF EXISTING MATERIAL

Showing Limits of Joint Preparation For Application of New Joint Seal Materials

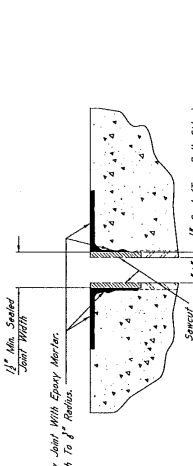

TYPICAL SECTION AT SAWCUT & JOINT REPAIR
 Showing Area Where Epoxy Mortar Is Applied After Sawcut With Epoxy Mortar Or Approved Equipment

1. Epoxy mortar and polymer concrete shall conform to the specifications for road and bridge construction 2004.
2. No change of joint will be permitted except by written approval of the Engineer. Any change to the joint shall be approved by the Engineer. Any change to the joint shall be approved by the Engineer.
3. Work for which no pay item is provided in the proposal will not be paid for directly and shall therefore be considered an assumed item of work.



MISSISSIPPI DEPARTMENT OF TRANSPORTATION	
JOINT REPAIR JOINTS	
ARMORED EXPANSION JOINTS	
STEEL GIRDER SPANS	
PROJECT	
COUNTY	WORKING NUMBER
SHEET NUMBER	SHEET NUMBER

STATE	PROJECT NO.
MISS.	

NOTES ON ASSOCIATED ITEMS OF WORK:

202-8238 REMOVAL OF EXISTING JOINT MATERIAL

Description: Shall include the Removal of Material Associated With Armor, Sliding Plates, and Expansion Joints, As Well As the Removal of Existing Joint Material. All Work Unless Otherwise Directed By The Engineer.

Items of Payment: Removal of Armor and Sliding Plate Joint Material Will Be Paid For In Line Item 202-8238 At The Contract Unit Price of The Contract Joint, While Removal of Expansion Joint Material Will Be Paid For As The Length Along The Centerline of The Joint.

202-8239 JOINT PREPARATION

Description: Shall include The Work Necessary To Repair Joints, In Accordance With The Detail Drawings Provided. Epoxy Mortar Shall Also Be Installed Under This Item of Work. Removal of Existing Joint Material Shall Be Done In Accordance With Section 808 OF THE SPECIFICATIONS AND ANY OTHER SPECIFICATIONS THEREIN.

Items of Payment: The Accepted Quantities Will Be Paid For In Line Item 202-8239 On Each Side of The Contrition Joint.

202-8239-001 SAW CUT, TYPE I & 907-823-002B SAW CUT, TYPE II

Description: The Saw Cut Depth Shall Be Established To The Indicated Depth Required By The Manufacturer's Specifications. The Saw Cut Type Shall Be The Same As The Prefabricated Joint Seal Selected.

Items of Payment: The Accepted Quantities Will Be Paid For In Line Item 202-8239-001 PREFORMED JOINT SEAL, TYPE I

202-8239-002 PREFORMED JOINT SEAL, TYPE II

Items of Payment: The Accepted Quantities Will Be Paid For In Line Item 202-8239-002 On Each Side of The Contrition Joint.

202-8239-003 EPOXY MORTAR AND POLYMER CONCRETE NOTES:

The Contractor Shall Be Responsible For Obtaining The Necessary Permits For Substitution Of Materials Can Be Found In Section 808 OF THE SPECIFICATIONS.

GENERAL NOTES:

- Steel Reinforcement Shall Be Installed In Accordance With The Mississippi Standard Specifications For Road And Bridge Construction, Section 808.02. No Change of Plans Will Be Permitted Except By Written Approval of The Engineer.
- Minor Changes To Detail Of Design Or Construction Procedure May Be Authorized By The Bridge Engineer Provided Such Changes Do Not Affect The Safety, Strength, or Durability of The Work For Which No Pay Item Is Provided in The Proposal. Will Not Be Paid For Unless Specifically And Shall Therefore Be Considered As Accurate Item of Work.

TYPICAL SECTION AT SAWCUT & SEALED JOINT

***NOTES:**

- The Prefabricated Joint Seal Shall Be One Of The Following, Installed According To The Manufacturer's Specifications:
 - Silicate Joint Sealing System Manufactured By R.L. Weston, Inc. in Allen, NY www.rlw.com
 - Weld SPS Joint System Manufactured By Weston-Burman Acme Corporation in Amherst, NY www.weston-burman.com
 - Silicate Joint Sealing System Manufactured By 353 Commercial & Highway Construction Materials www.353.com
- For Estimating Purposes The 20' Minimum Slab Depth, 2' Minimum Slab Width, and 1' Minimum Slab Thickness Shall Be Assumed. The Manufacturer's Recommendations Are Followed, Unless Otherwise Indicated. The Contractor Shall Be Responsible For Obtaining The Necessary Permits For Substitution Of Materials. To Ensure That The Contractor Is Properly Substituted In Installation Of The Joint Material.
- Joints Shall Be Sealed At Their Design Widths, Dimensions, and Locations. The Seal Shall Be Applied On Both Sides Of The Joint. The Seal Shall Be Applied On The Top Surface Of The Slab, With The Maximum Design Width For Depth Widths Greater Than or Equal To 2'. With The Maximum Design Width Of Expansion Material Being As Required As Governed By The Section Of Structures. The Contractor Shall Be Responsible For The Responsibility To Ensure That The Size Selected is Appropriate For The Width of The Joint.

TYPICAL SECTION AT JOINT AFTER REMOVAL OF EXISTING MATERIAL

TYPICAL SECTION AT JOINT AFTER REMOVAL OF EXISTING MATERIAL

Showing Limits Of Joint Preparation, Application Of New Joint Seal Material.

TYPICAL SECTION AT EXISTING JOINT

TYPICAL SECTION AT EXISTING JOINT

Showing Existing Expansion Device To Be Removed and Replaced With Prefabricated Joint Seal

TYPICAL SECTION AT SAWCUT & JOINT REPAIR

TYPICAL SECTION AT SAWCUT & JOINT REPAIR

Showing Area Where Repairs Are Made After Sawcut With Epoxy Mortar Or Approved Equivalent

TYPICAL SECTION AT JOINT AFTER REMOVAL OF EXISTING MATERIAL

TYPICAL SECTION AT JOINT AFTER REMOVAL OF EXISTING MATERIAL

Showing Limits Of Joint Preparation, Application Of New Joint Seal Material.

TYPICAL SECTION AT SAWCUT & JOINT REPAIR

TYPICAL SECTION AT SAWCUT & JOINT REPAIR

Showing Area Where Repairs Are Made After Sawcut With Epoxy Mortar Or Approved Equivalent

MISSISSIPPI DEPARTMENT OF TRANSPORTATION

JOINT REPAIR

SLIDING PLATE EXPANSION JOINTS

STEEL GIRDER SPANS

PROJECT

COUNTY

WORKING NUMBER

SHEET NUMBER

SE TRANSPORTATION

MISSISSIPPI

DEPARTMENT OF TRANSPORTATION

STATE OF MISSISSIPPI

CONTRACT NO.

SECTION NO.

DATE

BY

CHECKED BY

APPROVED BY

MISSISSIPPI DEPARTMENT OF TRANSPORTATION

SPECIAL PROVISION NO. 907-845-1

CODE: (SP)

DATE: 03/01/2017

SUBJECT: Coating Existing Structural Steel

Section 907-845, Coating Existing Structural Steel, is hereby added to and made a part of the 2017 Edition of the Mississippi Standard Specifications for Road and Bridge Construction as follows.

SECTION 907-845 – COATING EXISTING STRUCTURAL STEEL

907-845.01--Description. This work consists of furnishing all labor, material, and equipment required for coating existing structural steel in accordance with the requirements of this Section, by removing and replacing the existing coating where shown in the plans or described herein.

907-845.02--Materials.

907-845.02.1--Coating Systems. One of the following organic zinc/epoxy/urethane three-coat systems, or an approved equal, shall be used for removal and replacement of paint.

	1st	2nd	3rd
Carboline	Carbozinc 859 dft = 3-5 mils	Carbogaurd 888 dft = 3-5 mils	Carbothane 133LH dft = 3-5 mils
Ameron	Amercoat 68HS dft = 3-5 mils	Amercoat 399 dft = 4-8 mils	Amercoat 450H dft = 3-5 mils
Sherwin Williams	Zinc Clad III HS dft = 3-5 mils	Macropoxy 646 dft = 5-10 mils	Acrolon 218HS dft = 3-6 mils

907-845.02.2--Thinners, Solvents and Cleaners. Only thinners, solvents and cleaners listed on the coating manufacturer's product data sheet shall be used.

907-845.02.3--Caulking. Only Caulks that are paintable, compatible with the coating system, and recommended by the coating manufacturer as part of the coating system shall be used.

907-845.02.4--Soluble Salts Test Kit. Soluble salts test kit shall be in accordance with SSPC-Guide 15 utilizing a Class A retrieval method. The test sleeve or cell shall create a sealed, encapsulated environment during ion extraction and be suitable for testing all structural steel surfaces.

907-845.02.5--Abrasives. Properly sized abrasives shall be used to achieve the required cleanliness and surface profile. Abrasives shall meet the requirements of SSPC-AB 1, Mineral and Slag Abrasives, SSPC-AB 2, Cleanliness of Recycled Ferrous Metallic Abrasives, or SSPC-AB 3, Ferrous Metallic Abrasive and shall not introduce any contamination that interferes with the

coating application and performance. The Contractor shall provide a certification to the Engineer that the abrasives used meet the requirements of this specification and do not contain any chlorides and other salts.

For recycled abrasives, the Contractor shall verify compliance with the conductivity and cleanliness requirements of SSPC-AB 2 after each recycling or more frequently if required by the Engineer. A sample shall be selected from each recycling machine in use and water-soluble contaminant and oil content tests conducted as outlined in SSPC-AB 2 at least one time each week or more frequently if directed by the Engineer. The non-abrasive residue and lead content tests shall be conducted as directed by the Engineer. If test results do not meet requirements, the Engineer shall be notified immediately, the abrasive shall be removed and replaced, the recycling equipment shall be cleaned, and tests conducted each day to confirm the equipment is functioning properly. Testing shall return to the weekly testing interval as directed by the Engineer.

907-845.02.6--Rust Preventative Compound. The rust preventative compound shall be a Class 3 compound meeting the requirements of Military Specification MIL-C-11796C, Corrosion Preventative Compound, Petrolatum, Hot Applied.

907-845.02.7--Storage. Materials shall be stored in conformance with the manufacturer's recommendations.

907-845.03--Construction Requirements.

907-845.03.1--Compressed Air. The compressed air system shall be capable of delivering clean, dry, continuous nozzle pressure to achieve the required surface cleanliness and profile or spray pattern. The system must comply with the instructions and recommendations of the manufacturer of the abrasive blasting system or coating application system.

907-845.03.2--Abrasive Blasting System. The blasting system shall be designed to produce the specified cleanliness and profile.

907-845.03.3--Coating Application System. The coating application equipment shall be approved by and in accordance with the Coating Manufacturer's technical data requirements.

907-845.03.4--Quality Control. The Contractor shall provide a current Corporate Quality Control Plan approved by SSPC under the SSPC QP1 and SSPC QP2 certifications as appropriate and a site specific Coating Quality Control Plan to the Engineer at least 14 calendar days prior to beginning coatings work. The Contractor shall not begin coatings work until the site specific Coating Quality Control Plan has been approved by the Engineer.

The Contractor shall submit a specific traffic control plan for each phase of the work that conforms to the project plans and specifications. The Contractor shall not begin work until the traffic control plan is approved by the Department.

907-845.03.5--Inspection. All inspection equipment shall be maintained in accordance with the manufacturer's instructions, calibrated, and in good working condition. All activities shall be

observed and approved by a quality control coatings inspector meeting the requirements of this specification. Daily inspection reports shall be maintained at the job site for review by the Engineer. All daily inspection reports shall be proved to the Engineer upon completion of the project, or more frequently as requested by the Engineer.

907-845.03.6--Qualifications.

907-845.03.6.1--Field Contractor. The Field Contractor shall provide documentation to the Engineer at least 14 days prior to beginning work that the field contractor performing any work in accordance with this specification is certified by SSPC to the requirements of SSPC-QP1 and/or SSPC-QP2 as appropriate.

907-845.03.6.2--Quality Control Inspectors in the Shop and Field. The Contractor shall provide documentation to the Engineer that all personnel performing quality control inspections are certified at a minimum as a National Association of Corrosion Engineers (NACE) Coating Inspector Level I or a SSPC Level 1 Bridge Coating Inspector, and that they report directly to a Quality Control Supervisor who is certified either as a NACE Coating Inspector Level 3 or a SSPC Level 2 Bridge Coating Inspector.

907-845.03.6.3--Certifications. Certifications shall be maintained for the duration of the Contract. If the certifications expire, no work shall be performed until certifications are reissued. The Engineer shall be notified of any change in certification status.

907-845.03.7--Surface Preparation.

907-845.03.7.1--General. The portions of the existing coating designated to be removed and replaced shall be cleaned, washed, tested, and soluble salts removed. This shall be accomplished by abrasive blasting or hand and power tool cleaning to remove all existing coating and corrosion in the intended locations. The edges of all existing coating shall be feathered back to remain a minimum of three inches (3") around the area of existing coating to provide a smooth transition. The edges of the existing coating shall be intact and verified by probing with a dull putty knife in accordance with SSPC SP 2. The existing coating in the feathered area shall be roughened to ensure proper adhesion of the new coating. The Engineer shall be notified immediately when any structural steel appears to be defective.

The portions of the existing coating to remain shall be cleaned, washed, tested, and soluble salts removed. All surfaces to be coated shall be clean, dry, and free from oil, grease, dirt, dust, soluble salts, corrosion, peeling, caulking, weld spatter, mill scale and any other surface contaminants. The surface preparations and coating operations shall be performed so that freshly applied coatings will not be contaminated by dust or foreign matter. The Contractor shall protect all equipment and adjacent surfaces not to be coated from surface preparation operations. In the event that any rusting or contamination occurs after the completion of the surface preparation, the surfaces shall be prepared again to the initial requirements. Surface preparation work shall be performed only when the temperature of the steel surface is at least 5°F above the dew point temperature.

907-845.03.7.2--Mechanical Removal of Surface Defects. All corners resulting from sawing,

burning, or shearing shall be broke. In areas where burning has been used, the flame hardened surface of the steel shall be removed to the extent necessary to achieve the required surface profile after abrasive blast cleaning. All weld slag and weld spatter shall be removed. In addition, all pack rust shall be removed prior to solvent cleaning. All of this work shall be conducted in accordance with AASHTO/NSBA Steel Bridge Collaboration S 8.1.

907-845.03.7.3--Cleaning. All steel surfaces shall be cleaned in accordance with the requirements of SSPC-SP 1.

907-845.03.7.4--Washing. All steel surfaces shall be washed during removal of soluble salts in accordance with the requirements of SSPC-SP WJ-4.

907-845.03.7.5--Soluble Salts Detection and Removal. The chloride, sulfate and nitrate concentrations shall be determined on all steel surfaces using soluble salts test kits meeting the requirements of subsection 907-845.02.4. The concentration levels shall be measured using the method described in SSPC-TU 4. The tests shall be performed after washing and after each applied coat of the coating system. Five random locations shall be tested in the first 1,000 square feet and one random location for each subsequent 1,000 square feet. The non-visible surface contaminant concentrations on blast-cleaned surfaces shall not exceed 7 $\mu\text{g}/\text{cm}^2$ for chloride ions, 10 $\mu\text{g}/\text{cm}^2$ for ferrous ions, 17 $\mu\text{g}/\text{cm}^2$ for sulfate ions, and 10 $\mu\text{g}/\text{cm}^2$ for nitrate ions. When any concentration exceeds these levels, the entire surface area shall be rewashed and retested. If additional washing does not reduce the concentration to the acceptable level, a surface treatment or water additive may be used. Surface treatment or water additive shall be approved by the coating system supplier and the Engineer.

907-845.03.7.6--Abrasive Blast Cleaning. Steel shall be prepared by abrasive blast cleaning to "Near-White" metal condition as defined in SSPC-SP 10. SSPC VIS 1 shall be used as an aid in establishing cleanliness. After abrasive blast cleaning, the surface profile shall meet the requirements of the coating manufacturer's product data sheet. The surface profile shall be determined by using replica tape in accordance with ASTM D 4417, Method C.

All abrasive blast cleaning shall be performed within a containment system to ensure confinement of all particulates. The containment system shall be designed to comply with all applicable Federal, State, and Local regulations. The abrasive blast cleaning shall not produce holes, cause distortion, remove metal, or cause thinning of the substrate.

907-845.03.7.7--Hand and Power Tool Cleaning. Steel shall be prepared by power and hand tool cleaning as defined in SSPC-SP 11, SSPC-SP 3, and SSPC-SP 2 for touch up and repair when approved by the Engineer. SSPC-VIS 3 shall be used as an aid in establishing cleanliness.

907-845.03.8--Application.

907-845.03.8.1--General. All of the paint on the exposed steel surfaces shall be removed and re-coated, unless otherwise noted or otherwise directed by the Engineer. A coating of rust preventative compound shall be applied to all machine finished or similar surfaces not to be coated as directed by the Engineer. Prior to the application of any coating, the substrate shall be inspected

for contamination and defects, and the surface prepared before application of the next coat. Each coat including a stripe coat shall be applied in a color that contrasts with the substrate or preceding coat.

907-845.03.8.2--Weather and Temperature Limitations. Spray coating shall not be performed when the measured wind speed in the immediate coating area is above 15 miles per hour. Coatings shall not be applied when contamination from rainfall is imminent or when the ambient air temperature, relative humidity, dew point temperature, or temperature of the steel is outside limits of the coating manufacturer's product data sheet.

907-845.03.8.3--Sealing Using Caulk. The perimeter of all faying surfaces, cracks and crevices, joints open less than 1/2 inch, and skip-welded joints shall be completely sealed using caulk. The caulk shall be applied to the joint following the caulk manufacturer's recommendations. The caulk bead shall have a smooth and uniform finish and be cured according to the caulk manufacturer's recommendation prior to the application of the coating system.

907-845.03.8.4--Protection of Adjacent Surfaces. All surfaces and working mechanisms not intended to be coated during the application of coatings shall be protected. Surfaces that have been contaminated with coatings shall be cleaned until all traces of the coating have been removed. Material from cleaning and coating operations shall not be dispersed outside the work site.

907-845.03.8.5--Mixing and Thinning. All coatings shall be mixed in accordance with the manufacturer's product data sheet. Only complete kits shall be mixed. Thinners and solvents shall be in accordance with the requirements of the coating manufacturer's product data sheet. The amount of thinner added shall not exceed any State and Federal regulations regarding Volatile Organic Compounds (VOC). All mixing operations shall be performed over an impervious surface with provisions to prevent runoff to grade of any spilled material.

907-845.03.8.6--Application Methods. The Contractor shall use coating application equipment and apply coatings per the coating manufacturer's product data sheet. Application with brushes may be permitted for minor touchup of spray applications, stripe coats, or when otherwise approved by the Engineer. Spray equipment shall be adjusted to produce an even, wet coat with minimum overspray. Coatings shall be applied in even, parallel passes, overlapping fifty percent (50%). Coatings shall be agitated during application as required by the coating manufacturer's product data sheet.

907-845.03.8.7--Stripe Coating. Stripe coats shall be applied to achieve complete coverage and proper thickness on welds, corners, crevices, sharp edges, bolts, nuts, rivets, and rough or pitted surfaces.

907-845.03.8.8--Thickness of Coats. Coatings shall be applied to the thickness as identified in the manufacturer's product data sheet. After application of each coat, the surfaces shall be thoroughly inspected and the dry film thickness (DFT) measured in accordance with SSPC-PA 2. When the DFT is deficient or excessive, corrections shall be made in accordance with the coating manufacturer's recommendations and retest the area.

907-845.03.8.9--Coating Drying, and Curing. Coatings shall be applied within the time specified by the coating manufacturer's product data sheet for drying and recoating. Before handling, cure shall be tested in accordance with the manufacturer's recommended method. When the manufacturer's technical data sheet does not state a specified cure test, the requirements of ASTM D 5402 for organic zinc primers shall be met. The Contractor shall obtain the acceptance criteria from the coating manufacturer and report the results to the Engineer.

907-845.03.8.10--Coating Finish. Each coat shall be applied free of runs, sags, blisters, bubbles, and mud cracking; variations in color, gloss, or texture, holidays, excessive film buildup, foreign contaminants, orange peeling, and overspray.

907-845.03.9--Touchup and Repair. All welds, rivets, bolts, and all damaged or defective coating and rusted areas shall be cleaned and coated. Upon approval by the Engineer, aluminum mastic may be used in accordance with the manufacturer's recommendations. Aluminum mastic shall contain aluminum pigment and minimum 80% volume solids.

907-845.03.10--Protection of the Environment, Public, and Workers.

907-845.03.10.1--General. Plans and programs shall be established to protect the environment, public, contractor employees, and other workers from exposure to toxic heavy metals as well as releases and emissions of hazardous materials and nuisance dusts. All coating application and removal operations shall be conducted in compliance with EPA, OSHA, and other applicable Federal, State and local regulations. A contingency plan shall be provided for the remediation of water and land in the event of contamination by solid or liquid paint and contaminated water.

907-845.03.10.2--Environmental Protection. Plans and programs for the protection of the environment and public based on the applicable EPA requirements, the requirements of this Specification, and the Contract Documents shall be prepared and submitted to the Engineer. The plans and programs shall also include the protection of the air, soil/ground, and water.

907-845.03.10.2.1--Pollution Control. The Contractor shall submit a written pollution control and monitoring plan at the preconstruction meeting or as directed by the Engineer which clearly describes the means for complying with all Local, State and Federal regulations including pollution control provisions specified herein. The written plan shall be in accordance with SSPC Project Design: Industrial Lead Paint Removal Handbook, Volume II, Phase 6, Environmental Monitoring, and specifically include, but not be limited to, providing a scaled map of the work site layout showing the proposed number and location of soil sampling, Total Suspended Particulate (TSP) monitoring sites, waste storage areas, staging areas, temporary waste storage areas, and ambient air and personnel sampling frequency.

The Contractor shall comply with all applicable Federal, State, and Local rules and regulations. In the event a violation of any environmental regulation or a failure to properly execute any pollution control provisions occurs, the Contractor shall immediately cease all operations. Operations shall only resume after written proposed corrective procedures have been submitted to and approved by the Engineer and implemented.

907-845.03.10.2.2--Permits. The Contractor shall submit all required permits from all applicable regulatory agencies to the Engineer prior to the commencement of any work. The Contractor shall seek permit determination from these regulatory agencies to avoid any potential permit non-compliance issues during work activities. The Contractor shall be responsible for all liability resulting from non-compliance with pertinent rules and regulations including permit requirements.

907-845.03.10.2.3--Ambient Air Quality Compliance and Protection of the Air.

907-845.03.10.2.3.1--Visible Emissions. The visible emissions shall be accessed using EPA Method 22, Timing of Emissions as defined by 40 CFR 60, Appendix A, Standards of Performance for New Stationary Sources. During abrasive blasting, the Contractor shall not allow visible emissions from a containment to exceed a random cumulative duration of more than one percent (1%) of the workday (SSPC Guide 6, Level 1 Emissions). During pressurized water cleaning for removal of soluble salts, The Contractor shall not allow visible emissions from a containment to exceed a random cumulative duration of more than ten percent (10%) of the workday (SSPC Guide 6, Level 3 Emissions).

907-865.03.10.2.3.2--Total Suspended Particulate (TSP) Matter. Emissions from the containment area shall be controlled to prevent exceeding the TSP Lead of 1.5 µg/m³ over a 90-day period, or the daily and adjusted daily allowances of SSPC-TU 7. TSP Lead monitoring shall be conducted in accordance with 40 CFR 50, Appendix B, Reference Method for Determination of TSP Matter in the Atmosphere (high volume sampler required), and 40 CFR 50, Appendix G, Reference Method for Determination of TSP Matter Collected from Ambient Air. The TSP Lead monitoring equipment shall be positioned in general accordance with 40 CFR 58, Ambient Air Quality Surveillance.

When lead is present in the coating, TSP Lead background monitoring shall be performed for a period of three (3) days prior to the beginning of abrasive blast cleaning operations. The results from background monitoring and the first week of monitoring during abrasive blast cleaning shall be submitted to the Engineer for review within five (5) calendar days after the first week of work. Monitoring shall continue unless otherwise directed by the Engineer.

907-865.03.10.2.3.3--Regulated Area. A regulated area around the work site shall be established to prohibit unauthorized persons from areas where exposure to hazardous airborne metals may exceed the following action levels:

<u>Airborne Metals</u>	<u>Action Level</u>
Lead	30 µg/m ³
Cadmium	2.5 µg/m ³
Arsenic	5 µg/m ³
Hexavalent Chromium (Cr6+)	2.5 µg/m ³

Monitoring shall be conducted in accordance with the National Institute for Occupational Safety and Health (NIOSH) procedures upon initiation of dust producing operations and the test results shall be submitted to the Engineer within 72 hours of sampling. Sample results shall be reported as 8-hour Time Weighted Averages (TWA). The regulated area shall be re-established and additional

sampling shall be performed when the results exceed the action levels or when directed by the Engineer. All pertinent data shall be documented in a field logbook. Air-sampling pumps shall be positioned around the project perimeter where the public or personnel can approach the work area. Sampler inlets shall be placed at breathing height. The regulated area shall be clearly marked by the use of warning signs, rope, barrier tape, or temporary construction fencing.

907-845.03.10.2.4--Soil/Ground Quality. The ground beneath and in proximity to the structure shall be inspected in the presence of the Engineer for visible paint chips to establish an initial job site cleanliness standard. When heavy metals are in the existing coatings, soil samples shall be tested prior to the beginning of operations and after project completion for heavy metals. The number and specific locations where the initial samples are taken shall be documented as outlined in the SSPC Project Design-Industrial Lead Paint Removal Handbook, Volume 2 to ensure the post samples are collected from the same locations. All samples shall be submitted to the Engineer for review. If the project activities increase the heavy metal content in soil to more than 20% above the pre-job geometric mean or 100% at any one location, the site shall be returned to the pre-job levels. Additional soil testing shall be conducted as necessary to determine the extent of contamination.

In addition, a pre- and post-soil sampling plan shall be submitted for storage areas identifying the sample location, depth, analyses list, lab certification, and turnaround time. Once approved by the Engineer, sampling results shall be submitted along with a scaled drawing indicating designated sample locations.

907-845.03.10.2.5--Water Quality. The Contractor shall not release, discharge or otherwise cause hazardous materials, debris, waste, or paint chips to enter the water. The Contractor shall also protect against releases due to rain and methods of surface preparation from reaching rivers, streams, lakes, storm drains, or other bodies of water.

907-845.03.10.3--Containment System. The Contractor shall submit a written containment system design plan in accordance with this subsection and the contract documents at the pre-construction conference or as directed by the Engineer which clearly describes the proposed containment system applicable to the intended removal method and in accordance with the requirements outlined herein and SSPC Guide 6, Guide for Containing Debris Generated During Paint Removal Activities. The plan shall include, but is not limited to, removal method; methods for collecting debris; and containment enclosure components. Fire retardant materials shall be used. Containment drawings, calculations, and assumptions, including ventilation criteria if applicable, shall be provided signed and sealed by the Contractor's Engineer of Record experienced with containment systems. A complete structural impact analysis prepared by a Specialty Engineer shall be provided to verify the existing structure can withstand the dead, live and wind loads imposed upon the structure due to the containment system. The lighting inside the containment shall be in accordance with SSPC Guide 12, Guide for Illumination of Industrial Painting Projects. Lighting shall have a minimum intensity of 10 ft-cd for general, 20 ft-cd for work, and 50 ft-cd for inspection. All drawings and calculations shall be submitted and accepted before any work begins. A clear description of the ventilation system components and information shall be provided including the fan curve and design point on the proposed dust collector. The Design shall provide ventilation according to the notes provided in SSPC Guide 6: 100 feet per

minute for cross draft and 50-60 feet per minute for downdraft.

The immediate area of the structure shall be isolated to ensure compliance with current and permit requirements for air, water, soil, and pollution prevention. The containment system shall be protected from vehicular and pedestrian traffic. Paint, paint chips, or other debris shall not fall outside of the containment area under any circumstances. Any damage created by fastening, bracing, or handling the scaffolding and staging shall be repaired. If a suspended platform is constructed, rigid or flexible materials shall be used as needed to create an air and dust impenetrable enclosure. The platform and its components shall be designed and constructed to support at least four (4) times its maximum intended load without failure, with wire cables capable of supporting at least six (6) times their maximum intended load without failure. The Contractor shall strictly comply with all applicable OSHA regulations regarding scaffolding. The category and class of containment shall be as required in the Contract Documents.

907-845.03.10.4--Protection of Adjacent Areas. All areas adjacent to abrasive blast cleaning, including machinery and deck grating, shall be protected. Before the commencement of any cleaning and coating operations, a control plan shall be provided for the protection of adjacent surfaces from damage by nearby blasting and coating to the Engineer for review. Any damage to adjacent areas shall be repaired. The repair procedure shall be submitted to the Engineer for acceptance prior to any remediation.

907-845.03.10.5--Worker Protection. The Contractor shall be responsible for complying with all current OSHA regulations regarding worker protection as it relates to the duties required by this Specification. Appropriate safety procedures shall be implemented for all hazards on the job site whether specifically identified herein or not.

907-845.03.11--Waste Handling and Management.

907-845.03.11.1--General. A waste management program plan shall be prepared which addresses the applicable requirements from EPA regulations for hazardous waste management and the Contract Documents. Include provisions for the handling and disposal of non-hazardous waste. The Contractor shall dispose of all waste in accordance with all federal, state, and local laws and regulations.

907-845.03.11.2--Collection and Handling of Waste. All paint removal debris, both solid and liquid, shall be properly classified, packaged and stored in accordance with SSPC Guide 7, Guide for the Disposal of Lead-Contaminated Surface Preparation Debris, the Federal Water Pollution Control Act with amendments, and all other current government regulations and guidelines. The Contractor shall comply with the Resource Conservation and Recovery Act to include, at a minimum, CFR 40 260 through CFR 40 268. Prior to identification and storage, the Contractor shall separate solid and liquid waste, and separate individual waste streams.

907-845.03.11.3--Testing and Analysis. Laboratory analyses for all waste stream and environmental samples shall be conducted by an EPA certified, independent laboratory with an approved Quality Assurance Plan. Laboratory analyses for worker monitoring and regulated area samples shall be conducted by an American Industrial Hygiene Association (AIHA) metals

accredited laboratory. A copy of all sampling and test reports shall be provided no later than 72 hours after collection of samples.

907-845.03.11.4--Waste Identification. Samples shall be collected in accordance with EPA SW 846, Test Methods for Evaluating Solid Waste - Physical/Chemical Methods. A random and representative sampling technique shall be used. A minimum of four representative samples shall be collected of each waste stream. These waste streams shall include, but are not limited to, water, paint chips, dust, and paint chips mixed with disposable abrasives and debris. The Contractor shall complete the initial sampling of each waste stream immediately upon filling the first drum, but shall not allow waste to accumulate for longer than seven (7) days before sampling.

After the representative samples are collected, they shall be sent immediately to the EPA certified laboratory for analysis. Unless otherwise directed by the Engineer, required by State regulations, or required by the waste recycling or disposal facility, once each waste stream is sampled, tested, and classified, additional sampling and analysis will not be required for subsequent shipments unless the waste stream changes. Samples shall be submitted to an approved laboratory to be tested for arsenic, barium, cadmium, hexavalent chromium, lead, mercury, selenium, and silver in accordance with EPA Method 3050 and Method 6010 (content) and EPA Method 1311, Toxicity Characteristics Leaching Procedures (TCLP). Each sample shall be clearly marked with sample number, date and time of sampling, name of collector, and location of collection.

Chain of custody forms shall be maintained for each sample. Each sample shall be entered on a sample analysis request form. The sample numbers, type of waste, amount of each sample, distribution of samples, signature and all other information shall be entered into field logbook.

907-845.03.11.5--Waste Storage. Waste from the control devices, equipment, and all work surfaces shall be collected on a daily basis. Hazardous and non-hazardous waste shall be kept separate. Blasting debris shall not be mixed with any other type of waste. Waste shall be placed in approved storage drums.

All hazardous waste within a regulated area shall be located. The maximum weight for each drum, when filled, shall be 821 lbs. All drums shall be properly sealed and labeled. Waste storage drums shall be transported to a secured, marked, temporary storage area. The temporary storage area shall be located on well-drained ground not susceptible to flooding or storm water run-off. Drums shall be placed on pallets and covered with fiber reinforced, impermeable tarpaulins. Drums shall be stored no more than two drums wide and two drums high. Drums shall be arranged so that labels are easily readable. Waste shall not be stored in the temporary storage area longer than 90 days.

907-845.03.11.6--Waste Disposal. All hazardous and non-hazardous waste shall be transported, treated and disposed of. The Engineer shall be notified a minimum of three (3) weeks prior to the date of shipment of any waste to an off-site facility. The Engineer shall be provided with documentation that the receiving disposal facilities are properly licensed. Manifests shall be provided for all hazardous and non-hazardous waste shipments. Any waste disposal subcontractors shall be identified and provide the Engineer with a copy of their licensing to perform waste disposal and transport operations.

907-845.03.11.7--Permits. The Contractor shall be responsible for all liability resulting from non-compliance with pertinent rules and regulations including permit requirements.

907-845.04--Method of Measurement. Coating Existing Structural Steel will be measured as a lump sum quantity.

907-845.05--Basis of Payment. Coating Existing Structural Steel, measured as prescribed above, will be paid for at the contract lump sum price which shall be full compensation for all materials, labor, tools, equipment, containment systems, testing, removal and disposal of the existing coating, and all incidentals necessary for completing the work as described herein.

Payment will be made under:

907-845-A: Coating Existing Structural Steel

- lump sum

SECTION 905 - PROPOSAL

Date _____

Mississippi Transportation Commission
Jackson, Mississippi

Sirs: The following proposal is made on behalf of _____
_____ of _____

for constructing the following designated project(s) within the time(s) hereinafter specified.

The plans are composed of drawings and blue prints on file in the offices of the Mississippi Department of Transportation, Jackson, Mississippi.

The Specifications are the current Standard Specifications of the Mississippi Department of Transportation approved by the Federal Highway Administration, except where superseded or amended by the plans, Special Provisions and Notice(s) to Bidders attached hereto and made a part thereof.

I (We) certify that I (we) possess a copy of said Standard and any Supplemental Specifications.

Evidence of my (our) authority to submit the Proposal is hereby furnished. The proposal is made without collusion on the part of any person, firm or corporation. I (We) certify that I (we) have carefully examined the Plans, the Specifications, including the Special Provisions and Notice(s) to Bidders, herein, and have personally examined the site of the work. On the basis of the Specifications, Special Provisions, Notice(s) to Bidders, and Plans, I (we) propose to furnish all necessary machinery, tools, apparatus and other means of construction and do all the work and furnish all the materials in the manner specified. I (We) understand that the quantities mentioned herein are approximate only and are subject to either increase or decrease, and hereby propose to perform any increased or decreased quantities of work at the unit prices bid, in accordance with the above.

I (We) acknowledge that this proposal will be found irregular and/or non-responsive unless a certified check, cashier's check, or Proposal Guaranty Bond in the amount as required in the Advertisement (or, by law) is submitted electronically with the proposal or is delivered to the Contract Administration Engineer prior to the bid opening time specified in the advertisement.

INSTRUCTION TO BIDDERS: Alternate and Optional Items on Bid Schedule.

1. Two or more items entered opposite a single unit quantity WITHOUT DEFINITE DESIGNATION AS "ALTERNATE ITEMS" are considered as "OPTIONAL ITEMS". Bidders may or may not indicate on bids the Optional Item proposed to be furnished or performed WITHOUT PREJUDICE IN REGARD TO IRREGULARITY OF BIDS.
2. Items classified on the bid schedule as "ALTERNATE ITEMS" and/or "ALTERNATE TYPES OF CONSTRUCTION" must be preselected and indicated on bids. However, "Alternate Types of Construction" may include Optional Items to be treated as set out in Paragraph 1, above.
3. Optional items not preselected and indicated on the bid schedule MUST be designated in accordance with Subsection 102.06 prior to or at the time of execution of the contract.
4. Optional and Alternate items designated must be used throughout the project.

I (We) further propose to perform all "force account or extra work" that may be required of me (us) on the basis provided in the Specifications and to give such work my (our) personal attention in order to see that it is economically performed.

I (We) further propose to execute the attached contract agreement (Section 902) as soon as the work is awarded to me (us), and to begin and complete the work within the time limit(s) provided for in the Specifications and Advertisement. I (We) also propose to execute the attached contract bond (Section 903) in an amount not less than one hundred (100) percent of the total of my (our) part, but also to guarantee the excellence of both workmanship and materials until the work is finally accepted.

I (We) shall submit electronically with our proposal or deliver prior to the bid opening time a certified check, cashier's check or bid bond for **five percent (5%) of total bid** and hereby agree that in case of my (our) failure to execute the contract and furnish bond within Ten (10) days after notice of award, the amount of this check (bid bond) will be forfeited to the State of Mississippi as liquidated damages arising out of my (our) failure to execute the contract as proposed. It is understood that in case I am (we are) not awarded the work, the check will be returned as provided in the Specifications.

SECTION 905 -- PROPOSAL (CONTINUED)

I (We) hereby certify by digital signature and electronic submission via Bid Express of the Section 905 proposal below, that all certifications, disclosures and affidavits incorporated herein are deemed to be duly executed in the aggregate, fully enforceable and binding upon delivery of the bid proposal. I (We) further acknowledge that this certification shall not extend to the bid bond or alternate security which must be separately executed for the benefit of the Commission. This signature does not cure deficiencies in any required certifications, disclosures and/or affidavits. I (We) also acknowledge the right of the Commission to require full and final execution on any certification, disclosure or affidavit contained in the proposal at the Commission's election upon award. Failure to so execute at the Commission's request within the time allowed in the Standard Specifications for execution of all contract documents will result in forfeiture of the bid bond or alternate security.

Respectfully Submitted,

DATE _____

Contractor

BY _____
Signature

TITLE _____

ADDRESS _____

CITY, STATE, ZIP _____

PHONE _____

FAX _____

E-MAIL _____

(To be filled in if a corporation)

Our corporation is chartered under the Laws of the State of _____ and the names, titles and business addresses of the executives are as follows:

President Address

Secretary Address

Treasurer Address

The following is my (our) itemized proposal.

Bridge Painting on I-59 Bridge Nos. 10993, 10994, 11962 & 11963, known as Federal Aid Project Nos. BR-0059-01(119) / 107567301 & BR-0059-02(109) / 107568301 in Forrest & Jones Counties.

Line no.	Item Code	Adj Code	Quantity	Units	Description[Fixed Unit Price]
Roadway Items					
0010	618-A001		1	Lump Sum	Maintenance of Traffic
0020	620-A001		1	Lump Sum	Mobilization
Bridge Items					
0030	202-B169		660	Linear Feet	Removal of Joint Material
0040	808-A001	(S)	1,320	Linear Feet	Joint Preparation
0050	907-823-A001		660	Linear Feet	Preformed Joint Seal, Type I
0060	907-823-B001		1,320	Linear Feet	Saw Cut, Type I
0070	907-824-PP006		70	Each	Bridge Repair, Cap Cleaning
0080	907-845-A001	(S)	1	Lump Sum	Coating Existing Structural Steel

SECTION 905 - COMBINATION BID PROPOSAL (Continued)

CONDITIONS FOR COMBINATION BID

If a bidder elects to submit a combined bid for two or more of the contracts listed for this month's letting, the bidder must complete and execute these sheets of the proposal in each of the individual proposals to constitute a combination bid. In addition to this requirement, each individual contract shall be completed, executed and submitted in the usual specified manner.

Failure to execute this Combination Bid Proposal in each of the contracts combined will be just cause for each proposal to be received and evaluated as a separate bid.

It is understood that the Mississippi Transportation Commission not only reserves the right to reject any and all proposals, but also the right to award contracts upon the basis of lowest separate bids or combination bids most advantageous to the State.

It is further understood and agreed that the Combination Bid Proposal is for comparison of bids only and that each contract shall operate in every respect as a separate contract in accordance with its proposal and contract documents.

I (We) agree to complete each contract on or before its specified completion date.

COMBINATION BID PROPOSAL

This proposal is tendered as one part of a Combination Bid Proposal utilizing option ___* of Subsection 102.11 on the following contracts:

* Option to be shown as either (a), (b), or (c).

	<u>Project No.</u>	<u>County</u>	<u>Project No.</u>	<u>County</u>
1.	_____	_____	6.	_____
2.	_____	_____	7.	_____
3.	_____	_____	8.	_____
4.	_____	_____	9.	_____
5.	_____	_____	10.	_____

(a) If Combination A has been selected, your Combination Bid is complete.

(b) If Combination B has been selected, then complete the following page.

SECTION 905 - COMBINATION BID PROPOSAL (Continued)

Project Number	Pay Item Number	Unit	Unit Price Reduction	Total Item Reduction	Total Contract Reduction
1.					
2.					
3.					
4.					
5.					
6.					
7.					
8.					

For Informational Purposes Only

SECTION 905 - COMBINATION BID PROPOSAL (Continued)

Project Number	Pay Item Number	Unit	Unit Price Reduction	Total Item Reduction	Total Contract Reduction
9.					
10.					

(c) If Combination C has been selected, then initial and complete ONE of the following.

_____ I (We) desire to be awarded work not to exceed a total monetary value of \$ _____.

_____ I (We) desire to be awarded work not to exceed _____ number of contracts.



**Certification with regard to the Performance of Previous
Contracts or Subcontracts subject to the Equal Opportunity
Clause and the filing of Required Reports**

The Bidder hereby certifies that he has _____, has not _____, participated in a previous contract or subcontract subject to the Equal Opportunity Clause, as required by Executive Orders 10925, 11114, or 11246, and that he has _____, has not _____, filed with the Joint Reporting Committee, the Director of the Office of Federal Contract Compliance, a Federal Government contracting or administering agency, or the former President's Committee on Equal Employment Opportunity, all reports due under the applicable filing requirements.

(COMPANY)

DATE: _____

NOTE: The above certification is required by the Equal Employment Opportunity Regulations of the Secretary of Labor (41 CFR 60-1.7 (b) (1)), and must be submitted by bidders and proposed subcontractors only in connection with contracts and subcontracts which are subject to the Equal Opportunity Clause. Contracts and Subcontracts which are exempt from the Equal Opportunity Clause are set forth in 41 CFR 60-1.5. (Generally only contracts or subcontracts of \$10,000 or under are exempt.)

Currently, Standard Form 100 (EEO-1) is the only report required by the Executive Orders or their implementing regulations.

Proposed prime Contractors and Subcontractors who have participated in a previous contract or subcontract subject to the Executive orders and have not filed the required reports should note that 41 CFR 60-1.7 (b) (1) prevents the award of contracts and subcontracts unless such Contractors submit a report covering the delinquent period or such other period specified by the Federal Highway Administration or by the Director, Office of Federal Contract Compliance, U. S. Department of Labor.

MISSISSIPPI DEPARTMENT OF TRANSPORTATION
CERTIFICATION

I, _____,
(Name of person signing bid)

individually, and in my capacity as _____ of
(Title of person signing bid)

_____ do hereby certify under
(Name of Firm, partnership, or Corporation)

penalty of perjury under the laws of the United States and the State of Mississippi that _____

_____, Bidder
(Name of Firm, Partnership, or Corporation)

on Project No. **BR-0059-01(119) / 107567301000 & BR-0059-02(109)/ 107568301000**

in **Forrest & Jones** County(ies), Mississippi, has not either

directly or indirectly entered into any agreement, participated in any collusion; or otherwise taken any action in restraint of free competitive bidding in connection with this contract; nor have any of its corporate officers or principal owners.

Except as noted hereafter, it is further certified that said legal entity and its corporate officers, principal owners, managers, auditors and others in a position of administering federal funds:

- a) Are not presently debarred, suspended, proposed for debarment, declared ineligible, or voluntarily excluded from covered transactions by any Federal department or agency;
- b) Have not within a three-year period preceding this proposal been convicted of or had a civil judgment rendered against them for commission of fraud or a criminal offense in connection with obtaining, attempting to obtain, or performing a public (Federal, State or local) transaction or contract under a public transaction; violation of Federal or State antitrust statutes or commission of embezzlement, theft, forgery, bribery, falsification or destruction of records, making false statements, or receiving stolen property;
- c) Are not presently indicted for or otherwise criminally or civilly charged by a governmental entity (Federal, State or local) with commission of any of the offenses enumerated in (b) above; and
- d) Have not within a three-year period preceding this application/ proposal had one or more public transactions (Federal, State or local) terminated for cause or default.

Do exceptions exist and are made a part thereof? Yes / No

Any exceptions shall address to whom it applies, initiating agency and dates of such action.

Note: Exceptions will not necessarily result in denial of award but will be considered in determining bidder responsibility. Providing false information may result in criminal prosecution or administrative sanctions.

The bidder further certifies that the certification requirements contained in Section XI of Form FHWA 1273, will be or have been included in all subcontracts, material supply agreements, purchase orders, etc. except those procurement contracts for goods or services that are expected to be less than the Federal procurement small purchase threshold fixed at 10 U.S.C. 2304(g) and 41 U.S.C. 253(g) (currently \$25,000) which are excluded from the certification requirements.

The bidder further certifies, to the best of his or her knowledge and belief, that:

1) No Federal appropriated funds have been paid or will be paid to any person for influencing or attempting to influence an officer or employee of any Federal agency, a Member of Congress, an officer or employee of Congress, or an employee of a Member of Congress in connection with the awarding of any Federal contract, the making of any Federal grant, the making of any Federal loan, the entering into of any cooperative agreement, and the extension, continuation, renewal, amendment, or modification of any Federal contract, grant, loan, or cooperative agreement.

2) If any funds other than Federal appropriated funds have been paid or will be paid to any person for influencing or attempting to influence an officer or employee of any Federal agency, a Member of Congress, an officer or employee of Congress, or an employee of a Member of Congress in connection with this contract, Standard Form-LLL, Disclosure Form to Report Lobbying, in accordance with its instructions will be completed and submitted.

The certification contained in (1) and (2) above is a material representation of fact upon which reliance is placed and a prerequisite imposed by Section 1352, Title 31, U.S. Code prior to entering into this contract. Failure to comply shall be subject to a civil penalty of not less than \$10,000 and not more than \$100,000. The bidder shall include the language of the certification in all subcontracts exceeding \$100,000 and all subcontractors shall certify and disclose accordingly.

All of the foregoing is true and correct.

Executed on _____

Signature

MISSISSIPPI DEPARTMENT OF TRANSPORTATION

SAM.GOV Registration and DUNS Number

Bidders are advised that the Prime Contractor must maintain current registration in the **System for Award Management** (<http://www.sam.gov>) at all times during the project. A Dun and Bradstreet Data Universal Numbering System (DUNS) Number (<http://www.dnb.com>) is one of the requirements for registration in the System for Award Management.

Bidders are advised that prior to the award of this contract, they **MUST** be registered in the System for Award Management.

I (We) acknowledge that this contract cannot be awarded if I (We) are not registered in the System for Award Management prior to the award of this contract. _____ (Yes / No)

I (We) have a DUNS Number . _____ (Yes / No)

DUNS Number: _____

Company Name: _____

Company e-mail address: _____

(6/2015F)

For Informational Purposes Only

SECTION 902

CONTRACT FOR BR-0059-01(119) / 107567301000 & BR-0059-02(109)/ 107568301000

LOCATED IN THE COUNTY(IES) OF Forrest & Jones

STATE OF MISSISSIPPI,
COUNTY OF HINDS

This contract entered into by and between the Mississippi Transportation Commission on one hand, and the undersigned contractor, on the other witnesseth;

That, in consideration of the payment by the Mississippi Transportation Commission of the prices set out in the proposal hereto attached, to the undersigned contractor, such payment to be made in the manner and at the time of times specified in the specifications and the special provisions, if any, the undersigned contractor hereby agrees to accept the prices stated in the proposal in full compensation for the furnishing of all materials and equipment and the executing of all the work contemplated in this contract.

It is understood and agreed that the advertising according to law, the Advertisement, the instructions to bidders, the proposal for the contract, the specifications, the revisions of the specifications, the special provisions, and also the plans for the work herein contemplated, said plans showing more particularly the details of the work to be done, shall be held to be, and are hereby made a part of this contract by specific reference thereto and with like effect as if each and all of said instruments had been set out fully herein in words and figures.

It is further agreed that for the same consideration the undersigned contractor shall be responsible for all loss or damage arising out of the nature of the work aforesaid; or from the action of the elements and unforeseen obstructions or difficulties which may be encountered in the prosecution of the same and for all risks of every description connected with the work, exceptions being those specifically set out in the contract; and for faithfully completing the whole work in good and workmanlike manner according to the approved Plans, Specifications, Special Provisions, Notice(s) to Bidders and requirements of the Mississippi Department of Transportation.

It is further agreed that the work shall be done under the direct supervision and to the complete satisfaction of the Executive Director of the Mississippi Department of Transportation, or his authorized representatives, and when Federal Funds are involved subject to inspection at all times and approval by the Federal Highway Administration, or its agents as the case may be, or the agents of any other Agency whose funds are involved in accordance with those Acts of the Legislature of the State of Mississippi approved by the Governor and such rules and regulations issued pursuant thereto by the Mississippi Transportation Commission and the authorized Federal Agencies.

The Contractor agrees that all labor as outlined in the Special Provisions may be secured from list furnished by

It is agreed and understood that each and every provision of law and clause required by law to be inserted in this contract shall be deemed to be inserted herein and this contract shall be read and enforced as though it were included herein, and, if through mere mistake or otherwise any such provision is not inserted, then upon the application of either party hereto, the contract shall forthwith be physically amended to make such insertion.

The Contractor agrees that he has read each and every clause of this Contract, and fully understands the meaning of same and that he will comply with all the terms, covenants and agreements therein set forth.

Witness our signatures this the ___ day of _____, _____.

Contractor(s)

By _____

MISSISSIPPI TRANSPORTATION COMMISSION

Title _____

By _____

Signed and sealed in the presence of:
(names and addresses of witnesses)

Executive Director

Secretary to the Commission

Award authorized by the Mississippi Transportation Commission in session on the ___ day of _____, _____, Minute Book No. _____, Page No. _____.

SECTION 903
PERFORMANCE AND PAYMENT BOND

CONTRACT BOND FOR: BR-0059-01(119) / 107567301000 & BR-0059-02(109)/ 107568301000

LOCATED IN THE COUNTY(IES) OF: Forrest & Jones

STATE OF MISSISSIPPI,
COUNTY OF HINDS

Know all men by these presents: that we, _____

(Contractor)

Principal, a _____

residing at _____ in the State of _____

and _____

(Surety)
residing at _____ in the State of _____,

authorized to do business in the State of Mississippi, under the laws thereof, as surety, effective as of the contract date

shown below, are held and firmly bound unto the State of Mississippi in the sum of _____

(\$ _____) Dollars, lawful money of the United States of America, to be paid to it for which

payment well and truly to be made, we bind ourselves, our heirs, administrators, successors, or assigns jointly and

severally by these presents.

The conditions of this bond are such, that whereas the said _____

principal, has (have) entered into a contract with the Mississippi Transportation Commission, bearing the date of

_____ day of _____ A.D. _____ hereto annexed, for the construction of certain projects(s) in

the State of Mississippi as mentioned in said contract in accordance with the Contract Documents therefor, on file in the

offices of the Mississippi Department of Transportation, Jackson, Mississippi.

Now therefore, if the above bounden _____

in all things shall stand to and abide by and well and truly observe, do keep and perform all and singular the terms, covenants, conditions, guarantees and agreements in said contract, contained on his (their) part to be observed, done, kept and performed and each of them, at the time and in the manner and form and furnish all of the material and equipment specified in said contract in strict accordance with the terms of said contract which said plans, specifications and special provisions are included in and form a part of said contract and shall maintain the said work contemplated until its final completion and acceptance as specified in Subsection 109.11 of the approved specifications, and save harmless said Mississippi Transportation Commission from any loss or damage arising out of or occasioned by the negligence, wrongful or criminal act, overcharge, fraud, or any other loss or damage whatsoever, on the part of said principal (s), his (their) agents, servants, or employees in the performance of said work or in any manner connected therewith, and shall be liable and responsible in a civil action instituted by the State at the instance of the Mississippi Transportation Commission or any officer of the State authorized in such cases, for double any amount in money or property, the State may lose or be overcharged or otherwise defrauded of, by reason of wrongful or criminal act, if any, of the Contractor(s), his (their) agents or employees, and shall promptly pay the said agents, servants and employees and all persons furnishing labor, material, equipment or supplies therefor, including premiums incurred, for Surety Bonds, Liability Insurance, and Workmen's Compensation Insurance; with the additional obligation that such Contractor shall promptly make payment of all taxes, licenses, assessments, contributions, damages,

any liquidated damages which may arise prior to any termination of said principal's contract, any liquidated damages which may arise after termination of the said principal's contract due to default on the part of said principal, penalties and interest thereon, when and as the same may be due this state, or any county, municipality, board, department, commission or political subdivision: in the course of the performance of said work and in accordance with Sections 31-5-51 et seq. Mississippi Code of 1972, and other State statutes applicable thereto, and shall carry out to the letter and to the satisfaction of the Executive Director of the Mississippi Department of Transportation, all, each and every one of the stipulations, obligations, conditions, covenants and agreements and terms of said contract in accordance with the terms thereof and all of the expense and cost and attorney's fee that may be incurred in the enforcement of the performance of said contract, or in the enforcement of the conditions and obligations of this bond, then this obligation shall be null and void, otherwise to be and remain in full force and virtue.

_____	_____
(Contractors) Principal	Surety
By _____	By _____
	(Signature) Attorney in Fact
	Address _____

Title _____	_____
(Contractor's Seal)	(Printed) MS Agent

	(Signature) MS Agent
	Address _____

	(Surety Seal)

	Mississippi Insurance ID Number



BID BOND

KNOW ALL MEN BY THESE PRESENTS, that we _____
Contractor

Address

City, State ZIP

As principal, hereinafter called the Principal, and _____
Surety

a corporation duly organized under the laws of the state of _____

as Surety, hereinafter called the Surety, are held and firmly bound unto State of Mississippi, Jackson, Mississippi

As Obligee, hereinafter called Obligee, in the sum of **Five Per Cent (5%) of Amount Bid**

Dollars(\$ _____)

for the payment of which sum will and truly to be made, the said Principal and said Surety, bind ourselves, our heirs, executors, administrators, successors and assigns, jointly and severally, firmly by these presents.

WHEREAS, the Principal has submitted a bid for **Bridge Painting on I-59 Bridge Nos. 10993, 10994, 11962 & 11963, known as Federal Aid Project Nos. BR-0059-01(119) / 107567301 & BR-0059-02(109) / 107568301 in Forrest & Jones Counties.**

NOW THEREFORE, the condition of this obligation is such that if the aforesaid Principal shall be awarded the contract, the said Principal will, within the time required, enter into a formal contract and give a good and sufficient bond to secure the performance of the terms and conditions of the contract, then this obligation to be void; otherwise the Principal and Surety will pay unto the Obligee the difference in money between the amount of the bid of the said Principal and the amount for which the Obligee legally contracts with another party to perform the work if the latter amount be in excess of the former, but in no event shall liability hereunder exceed the penal sum hereof.

Signed and sealed this _____ day of _____, 20__

(Witness)

(Principal) (Seal)
By: _____
(Name) (Title)

(Witness)

(Surety) (Seal)
By: _____
(Attorney-in-Fact)

(MS Agent)

Mississippi Insurance ID Number

**MISSISSIPPI DEPARTMENT OF TRANSPORTATION
OFFICE OF CIVIL RIGHTS
JACKSON, MISSISSIPPI**

LIST OF FIRMS SUBMITTING QUOTES

I/we received quotes from the following firms on:

Letting Date: **August 22, 2017**

Project No: **BR-0059-01(119) / 107567301000 & BR-0059-02(109)/ 107568301000**

County: **Forrest & Jones**

Disadvantaged Business Enterprise (DBE) Regulations as stated in 49 CFR 26.11 require the Mississippi Department of Transportation (MDOT) to create and maintain a comprehensive list of all firms quoting/bidding subcontracts on prime contracts and quoting/bidding subcontracts on federally-funded transportation projects. For every firm, we require the following information:

Firm Name: _____
Contact Name/Title: _____
Firm Mailing Address: _____
Phone Number: _____
_____ DBE Firm _____ Non-DBE Firm

Firm Name: _____
Contact Name/Title: _____
Firm Mailing Address: _____
Phone Number: _____
_____ DBE Firm _____ Non-DBE Firm

Firm Name: _____
Contact Name/Title: _____
Firm Mailing Address: _____
Phone Number: _____
_____ DBE Firm _____ Non-DBE Firm

Firm Name: _____
Contact Name/Title: _____
Firm Mailing Address: _____
Phone Number: _____
_____ DBE Firm _____ Non-DBE Firm

Firm Name: _____
Contact Name/Title: _____
Firm Mailing Address: _____
Phone Number: _____
_____ DBE Firm _____ Non-DBE Firm