

MDOT Use Only

Checked \_\_\_\_\_

Loaded \_\_\_\_\_

Keyed \_\_\_\_\_

03 -



SM No. CSTP0003011981

# PROPOSAL AND CONTRACT DOCUMENTS

## FOR THE CONSTRUCTION OF

03

Overlay of US 90 from Russell Ave. to Debuys Road, known as Federal Aid Project  
No. STP-0003-01(198) / 107748301 in Harrison County.

Project Completion: 104 Working Days

**(STATE DELEGATED)**

### NOTICE

**BIDDERS MUST COMPLETE AN ONLINE REQUEST  
FOR PERMISSION TO BID THIS PROJECT.**

Electronic addendum updates will be posted on [www.gomdot.com](http://www.gomdot.com)

**SECTION 900**  
**OF THE CURRENT**  
**2017 STANDARD SPECIFICATIONS**  
**FOR ROAD AND BRIDGE CONSTRUCTION**  
**JACKSON, MISSISSIPPI**

**MISSISSIPPI DEPARTMENT OF TRANSPORTATION  
TABLE OF CONTENTS**

**PROJECT: STP-0003-01(198)/107748301 - Harrison**

Section 901 - Advertisement

Section 904 - Notice to Bidders

|      |   |
|------|---|
| #1   | Governing Specification   |
| #2   | Status of ROW, w/ Attachments   |
| #3   | Final Cleanup   |
| #7   | Disadvantaged Business Enterprise In Federal-Aid Highway Construction, w/<br>Supplement |
| #8   | Errata and Modifications to the 2017 Standard Specifications                            |
| #9   | Federal Bridge Formula  |
| #10  | DUNS Requirement for Federal Funded Projects  |
| #12  | MASH Compliant Devices  |
| #13  | Safety Edge   |
| #113 | Tack Coat   |
| #296 | Reduced Speed Limit Signs   |
| #401 | Standard Drawings   |
| #445 | Mississippi Agent and Qualified Nonresident Agent                                       |
| #446 | Traffic on Milled Surface in Urban Areas  |
| #742 | Contract Time   |
| #743 | Specialty Items   |
| #744 | Scope of Work   |
| 906  | Required Federal Contract Provisions -- FHWA 1273, w/Supplements                        |

Section 907 - Special Provisions

|           |   |
|-----------|---|
| 907-102-2 | Bidding Requirements and Conditions           |
| 907-103-2 | Award and Execution of Contract               |
| 907-603-3 | Video Pipe Inspection                         |
| 907-618-4 | Additional Signing Requirements, w/Supplement |
| 907-687-2 | Traffic Recorder Classification System        |
| 907-899-1 | Railway-Highway Provisions                    |

Section 905 - Proposal, Proposal Bid Items, Combination Bid Proposal

Certification of Performance - Prior Federal-Aid Contracts

Certification Regarding Non-Collusion, Debarment and Suspension

SAM.GOV Registration and DUNS Number

Section 902 - Contract Form

Section 903 - Contract Bond Forms

Form -- OCR-485

Progress Schedule

(REVISIONS TO THE ABOVE WILL BE INDICATED ON THE SECOND SHEET  
OF SECTION 905 AS ADDENDA)

03/29/2018 06:49 AM

# MISSISSIPPI DEPARTMENT OF TRANSPORTATION

## SECTION 901 - ADVERTISEMENT

Electronic bids will be received by the Mississippi Transportation Commission at 10:00 o'clock A.M., Tuesday, April 24, 2018, from the Bid Express Service and shortly thereafter publicly read on the Sixth Floor For:

Overlay of US 90 from Russell Ave. to Debuys Road, known as Federal Aid Project No. STP-0003-01(198) / 107748301 in Harrison County.

The attention of bidders is directed to the Contract Provisions governing selection and employment of labor. Minimum wage rates have been predetermined by the Secretary of Labor and are subject to Public Law 87-581, Work Hours Act of 1962, as set forth in the Contract Provisions.

The Mississippi Department of Transportation hereby notifies all bidders that it will affirmatively insure that in any contract entered into pursuant to this advertisement, disadvantaged business enterprises will be afforded full opportunity to submit bids in response to this invitation and will not be discriminated against on the grounds of race, color, sex, age, disability, religion or national origin in consideration for an award.

**The award of this contract will be contingent upon the Contractor satisfying the DBE requirements.**

The specifications are on file in the offices of the Mississippi Department of Transportation.

Contractors may request permission to bid online at <http://shopmdot.ms.gov> at no cost. Upon approval, Contractors shall be eligible to submit a bid using Bid Express at <http://bidx.com>. Specimen proposals may be viewed and downloaded online at no cost at <http://mdot.ms.gov> or purchased online at <http://shopmdot.ms.gov> at a cost of Ten Dollars (\$10.00) per proposal plus a small convenience fee. Cash or checks will not be accepted as payment.

Bid bond, signed or countersigned by a Mississippi Agent or Qualified Nonresident Agent, with Power of Attorney attached, a Cashier's check or Certified Check for five (5%) percent of bid, payable to STATE OF MISSISSIPPI, must accompany each proposal.

The attention of bidders is directed to the provisions of Subsection 102.07 pertaining to irregular proposals and rejection of bids.

MELINDA L. MCGRATH  
EXECUTIVE DIRECTOR

# MISSISSIPPI DEPARTMENT OF TRANSPORTATION

**SECTION 904 - NOTICE TO BIDDERS NO. 1**

**CODE: (IS)**

**DATE: 03/01/2017**

**SUBJECT: Governing Specifications**

The current (2017) Edition of the Standard Specifications for Road and Bridge Construction adopted by the Mississippi Transportation Commission is made a part hereof fully and completely as if it were attached hereto, except where superseded by special provisions, or amended by revisions of the Specifications contained within this proposal. Copies of the specification book may be purchased from the MDOT Construction Division, or online at [shopmdot/default.aspx?StoreIndex=1](http://shopmdot/default.aspx?StoreIndex=1).

A reference in any contract document to controlling requirements in another portion of the contract documents shall be understood to apply equally to any revision or amendment thereof included in the contract.

In the event the plans or proposal contain references to the 2004 Edition of the Standard Specifications for Road and Bridge Construction, it is to be understood that such references shall mean the comparable provisions of the 2017 Edition of the Standard Specifications.

## MISSISSIPPI DEPARTMENT OF TRANSPORTATION

**SECTION 904 - NOTICE TO BIDDERS NO. 2**

**CODE: (IS)**

**DATE: 03/01/2017**

**SUBJECT: Status of Right-of-Way**

Although it is desirable to have acquired all rights-of-way and completed all railroad agreements, utility adjustments and work to be performed by others prior to receiving bids, sometimes it is not considered to be in the public interest to wait until each and every such clearance has been obtained. The bidder is hereby advised of possible unacquired rights-of-way, relocations, railroad agreements and utilities adjustments which have not been completed.

The status of right-of-way acquisition, utility adjustments, encroachments, potentially contaminated sites, railroad facilities, improvements, and asbestos contamination are set forth in the following attachments.

In the event right of entry is not available to ALL parcels of right-of-way and/or all work that is to be accomplished by others on the date set forth in the contract for the Notice to Proceed is not complete, the Department will issue a restricted Notice to Proceed.

**STATUS OF RIGHT-OF-WAY**

STP-0003-01(198)

107748-301000

Harrison County

All rights of way and legal rights of entry have been acquired **except:**

**None.**

ASBESTOS CONTAMINATION STATUS OF BUILDINGS  
TO BE REMOVED BY THE CONTRACTOR  
STP-0003-01(198)  
107748-301000  
Harrison County  
January 18, 2018

Reference is made to notices to bidders entitled "Asbestos National Emission Standards for Hazardous Air Pollutants (NESHAP)" and "Removal of Obstructions".

The following pertinent information is furnished concerning asbestos containing materials (ACMs), if any, found in buildings to be removed by the Contractor.

There is no Right of Way required for this project. There are no buildings to be removed by the contractor.

STATUS OF POTENTIALLY CONTAMINATED SITES

STP-0003-01(198)

107748-301000

Harrison County

January 18, 2018

THERE IS NO RIGHT OF WAY REQUIRED FOR THIS PROJECT. NO INITIAL SITE ASSESSMENT WILL BE PERFORMED. IF CONTAMINATION ON EXISTING RIGHT OF WAY IS DISCOVERED, IT WILL BE HANDLED BY THE DEPARTMENT.



# MISSISSIPPI DEPARTMENT OF TRANSPORTATION

## *Inter-Departmental Memorandum*

TO: Ann Russell  
Right of Way Division

DATE: February 12, 2018

FROM: Cape Jones  
District Maintenance Engineer

SUBJECT OR PROJECT NO: STP-0003-01(198)  
107748/301000

INFORMATION COPY TO:  
File  
Trudi Loflin (84-01)

COUNTY: Harrison

### District Status Report

1. **STATUS OF RIGHT OF WAY:** All work to be done within existing ROW.
2. **RIGHT OF WAY CLEARANCE:** There are no encroachments.
3. **STATUS OF AFFECTED RAILROAD OPERATING FACILITIES:** No Right of Way is required from the railroad. See Notice to Bidders.
4. **STATUS OF REQUIRED UTILITY RELOCATIONS:** No utility conflicts
5. **STATUS OF CONSTRUCTION AGREEMENT:** None required.

Improvements to be included in Notice to Bidders to be removed by the Construction Contractor  
FMS Construction Project No: 107748-301000  
External ROW No: STP-0003-01(198)

Parcel No:  
Station No:  
Property Owner:  
Description/Pictures:

**NA**

**MISSISSIPPI DEPARTMENT OF TRANSPORTATION**

**SECTION 904 - NOTICE TO BIDDERS NO. 3**

**CODE: (SP)**

**DATE: 01/17/2017**

**SUBJECT: Final Clean-Up**

Immediately prior to final inspection for release of maintenance, the Contractor shall pick up, load, transport and properly dispose of all litter from the entire highway right-of-way that is within the termini of the project.

Litter shall include, but not be limited to, solid wastes such a glass, paper products, tires, wood products, metal, synthetic materials and other miscellaneous debris.

Litter removal is considered incidental to other items of work and will not be measured for separate payment.

## MISSISSIPPI DEPARTMENT OF TRANSPORTATION

### SUPPLEMENT TO NOTICE TO BIDDERS NO. 7

**DATE:** 01/17/2017

The goal is 1 percent for the Disadvantaged Business Enterprise. The low bidder is required to submit Form OCR-481 for all DBEs. Bidders are advised to check the bid tabulation link for this project on the MDOT website at:

<http://sp.gomdot.com/Contract%20Administration/BidSystems/Pages/letting%20calendar.aspx>

Bid tabulations are usually posted by 3:00 pm on Letting Day.

# MISSISSIPPI DEPARTMENT OF TRANSPORTATION

**SECTION 904 - NOTICE TO BIDDERS NO. 7**

**CODE: (IS)**

**DATE: 03/01/2017**

**SUBJECT: Disadvantaged Business Enterprises In Federal-Aid Highway Construction**

This contract is subject to the "Moving Ahead for Progress in the 21<sup>st</sup> Century Act (MAP-21)" and applicable requirements of "Part 26, Title 49, Code of Federal Regulations". Portions of the Act are set forth in this Notice as applicable to compliance by the Contractor and all of the Act, and the MDOT DBE Program, is incorporated by reference herein.

The Department has developed a Disadvantaged Business Enterprise Program that is applicable to this contract and is made a part thereof by reference.

Copies of the program may be obtained from:

Office of Civil Rights  
Mississippi Department of Transportation  
P. O. Box 1850  
Jackson, Mississippi 39215-1850

## **POLICY**

It is the policy of the Mississippi Department of Transportation to provide a level playing field, to foster equal opportunity in all federally assisted contracts, to improve the flexibility of the DBE Program, to reduce the burdens on small businesses, and to achieve that amount of participation that would be obtained in a non-discriminatory market place. In doing so, it is the policy of MDOT that there will be no discrimination in the award and performance of federally assisted contracts on the basis of race, color, sex, age, religion, national origin, or any handicap.

## **ASSURANCES THAT CONTRACTORS MUST TAKE**

MDOT will require that each contract which MDOT signs with a sub-recipient or a Contractor, and each subcontract the Prime Contractor signs with a Subcontractor, includes the following assurances:

“The Contractor, sub-recipient or Subcontractor shall not discriminate on the basis of race, color, national origin, or sex in the performance of this contract. The Contractor shall carry out applicable requirements of 49 CFR 26 in the award and administration of federally assisted contracts. Failure by the Contractor to carry out these requirements is a material breach of this contract, which may result in the termination of this contract or such other remedy as MDOT deems appropriate.”

## **DEFINITIONS**

For purposes of this provision the following definitions will apply:

"Disadvantaged Business" means a small business concern: (a) which is at least 51 percent owned by one or more socially and economically disadvantaged individual(s) or in the case of any publicly owned business, at least 51 percent of the stock of which is owned by one or more socially and economically disadvantaged individual(s); and (b) whose management and daily business operations are controlled by one or more of the socially and economically disadvantaged individual(s) who own it. It is important to note that the business owners themselves must control the operations of the business. Absentee ownership or title ownership by an individual who does not take an active role in controlling the business is not consistent with eligibility as a DBE under CFR 49 Part 26.71.

### **CONTRACTOR'S OBLIGATION**

The Contractor and all Subcontractors shall take all necessary and reasonable steps to ensure that DBE firms can compete for and participate in the performance of a portion of the work in this contract and shall not discriminate on the basis of race, color, national origin, religion or sex. Failure on the part of the Contractor to carry out the DBE requirements of this contract constitutes a breach of contract and after proper notification the Department may terminate the contract or take other appropriate action as determined by the Department.

When a contract requires a zero percent (0%) DBE goal, the Contractor still has the responsibility to take all necessary and reasonable steps to ensure that DBE firms can compete for and participate in the performance of the work in the contract. In this case, all work performed by a certified DBE firm is considered to be a "race neutral" measure and the Department will receive DBE credit towards the overall State goals when the DBE firm is paid for their work. If the Prime Contractor is a certified DBE firm, the Department can receive DBE credit only for the work performed by the Prime Contractor's work force or any work subcontracted to another DBE firm. Work performance by a non-DBE Subcontractor is not eligible for DBE credit.

### **CONTRACT GOAL**

The goal for participation by DBEs is established for this contract in the attached Supplement. The Contractor shall exercise all necessary and reasonable steps to ensure that participation is equal to or exceeds the contract goal.

If the percentage of the contract that is proposed for DBEs is 1% or greater, the Contractor shall agree to meet or exceed the contract goal on the last bid sheet of the proposal.

The apparent lowest responsive bidder shall submit to the Office of Civil Rights Form OCR-481, signed by the Prime Contractor and the DBE Subcontractors, no later than the 3<sup>rd</sup> business day after opening of the bids.

Form OCR-481 is available on the MDOT website at GoMDOT.com, then Divisions, Civil Rights, Forms, DBE, MDOT Projects, or by calling 601-359-7466.

The OCR-481 Form must contain the following information:

The name and address of each certified DBE Contractor / Supplier;

The Reference Number, percent of work and the dollar amount of each item. If a portion of an item is subcontracted, a breakdown of that item including quantities and unit price must be attached, detailing what part of the item the DBE firm is to perform and who will perform the remainder of the item.

If the DBE Commitment shown on the last bid sheet of the proposal, does not equal or exceed the contract goal, the bidder must submit, to MDOT Contract Administration Division prior to bid opening, information to satisfy the Department that adequate good faith efforts have been made to meet the contract goal.

Failure of the lowest bidder to furnish acceptable proof of good faith efforts, submitted to MDOT Contract Administration Division prior to bid opening, shall be just cause for rejection of the proposal. Award may then be made to the next lowest responsive bidder or the work may be re-advertised.

The following factors are illustrative of matters the Department will consider in judging whether or not the bidder has made adequate good faith effort to satisfy the contract goal.

- (1) Whether the bidder attended the pre-bid meeting that was scheduled by the Department to inform DBEs of subcontracting opportunities;
- (2) Whether the bidder advertised in general circulation, trade association, and minority-focus media concerning the subcontracting opportunities;
- (3) Whether the bidder provided written notice to a reasonable number of specific DBEs that their interest in the contract is being solicited;
- (4) Whether the bidder followed up initial solicitations of interest by contacting DBEs to determine with certainty whether they were interested;
- (5) Whether the bidder selected portions of the work to be performed by DBEs in order to increase the likelihood of meeting the contract goal;
- (6) Whether the bidder provided interested DBEs with adequate information about the plans, specifications and requirements of the contract;
- (7) Whether the bidder negotiated in good faith with interested DBEs and did not reject them as unqualified without sound reasons based on a thorough investigation of their capabilities; and
- (8) Whether the bidder made efforts to assist interested DBEs in obtaining any required bonding or insurance.
- (9) Whether the bidder has written notification to certified DBE Contractors soliciting subcontracting for items of work in the contract.
- (10) Whether the bidder has a statement of why an agreement was not reached.

The bidder’s execution of the signature portion of the proposal shall constitute execution of the following assurance:

The bidder hereby gives assurance pursuant to the applicable requirements of "Moving Ahead for Progress in the 21<sup>st</sup> Century Act (MAP-21)" and applicable requirements of "Part 26, Title 49, Code of Federal Regulations" that the bidder has made a good faith effort to meet the contract goal for DBE participation for which this proposal is submitted.

### **DIRECTORY**

A list of “Certified DBE Contractors” which have been certified as such by the Mississippi Department of Transportation and other Unified Certification Partners (UPC) can be found on the Mississippi Department of Transportation website at [www.gomdot.com](http://www.gomdot.com). The list is in the top left corner of the current Letting Calendar under Contracts & Letting. The DBE firm must be certified at the time the project is let and approved by MDOT to count towards meeting the DBE goal.

### **REPLACEMENT**

If a DBE Subcontractor cannot perform satisfactorily, and this causes the OCR-481 commitment to fall below the contract goal, the Contractor shall take all necessary reasonable steps to replace the DBE with another certified DBE Subcontractor or submit information to satisfy the Mississippi Department of Transportation that adequate good faith efforts have been made to replace the DBE. The replacement DBE must be a DBE who was on the Department's list of "Certified DBE Contractors" when the job was let, and who is still active. All DBE replacements must be approved by the Department.

Under no circumstances shall the Prime or any Subcontractor perform the DBE's work (as shown on the OCR-481) without prior written approval from the Department. See "Sanctions" at the end of this document for penalties for performing DBE's work.

When a Contractor proposes to substitute/replace/terminate a DBE that was originally named on the OCR-481, the Contractor must obtain a release, in writing, from the named DBE explaining why the DBE Subcontractor cannot perform the work. A copy of the original DBE's release must be attached to the Contractor's written request to substitute/replace/terminate along with appropriate Subcontract Forms for the substitute/replacement/terminated Subcontractor, all of which must be submitted to the DBE Coordinator and approved, in advance, by MDOT.

### **GOOD FAITH EFFORTS**

To demonstrate good faith efforts to replace any DBE that is unable to perform successfully, the Contractor must document steps taken to subcontract with another certified DBE Contractor. Such documentation shall include no less than the following:

- (1) Proof of written notification to certified DBE Contractors by certified mail that their interest is solicited in subcontracting the work defaulted by the previous DBE or in subcontracting other items of work in the contract.



- (2) If the Prime Contractor is a certified DBE firm, only the value of the work actually performed by the DBE Prime can be counted towards the project goal, along with any work subcontracted to a certified DBE firm.
- (3) If the Contractor is not a DBE, the work subcontracted to a certified DBE Contractor will be counted toward the goal.
- (4) The Contractor may count toward the goal a portion of the total dollar value of a contract with a joint venture eligible under the standards of this provision equal to the percentage of the DBE partner in the joint venture.
- (5) Expenditures to DBEs that perform a commercially useful function may be counted toward the goal. A business is considered to perform a commercially useful function when it is responsible for the execution of a distinct element of the work and carries out its responsibilities by actually performing, managing, and supervising the work involved.
- (6) The Contractor may count 100% of the expenditures for materials and supplies obtained from certified DBE suppliers and manufacturers that produce goods from raw materials or substantially alters them for resale provided the suppliers and manufacturers assume the actual and contractual responsibility for the provision of the materials and supplies. The Contractor may count sixty percent (60%) of the expenditures to suppliers that are not manufacturers, provided the supplier performs a commercially useful function in the supply process. Within 30 days after receipt of the materials, the Contractor shall furnish to the DBE Coordinator invoices from the certified supplier to verify the DBE goal.
- (7) Any work that a certified DBE firm subcontracts or sub-subcontracts to a non-DBE firm will not count towards the DBE goal.
- (8) Only the dollars actually paid to the DBE firm may be counted towards the DBE goal.

Failure of the Contractor to demonstrate good faith efforts to replace a DBE Subcontractor that cannot perform as intended with another DBE Subcontractor, when required, shall be a breach of contract and may be just cause to be disqualified from further bidding for a period of up to 12 months after notification by certified mail.

### **PRE-BID MEETING**

A pre-bid meeting will be held in Amphitheater 1 & 2 of the Hilton Jackson located at I-55 and County Line Road, Jackson, Mississippi at 2:00 P.M. on the day preceding the date of the bid opening.

This meeting is to inform DBE firms of subcontracting and material supply opportunities. Attendance at this meeting is considered of prime importance in demonstrating good faith effort to meet the contract goal.

### **PARTICIPATION / DBE CREDIT**

Participation shall be counted toward meeting the goal in this contract as follows:

- (1) If the Prime Contractor is a certified DBE firm, only the value of the work actually performed by the DBE Prime can be counted towards the project goal, along with any work subcontracted to a certified DBE firm.
- (2) If the Contractor is not a DBE, the work subcontracted to a certified DBE Contractor will be counted toward the goal.
- (3) The Contractor may count toward the goal a portion of the total dollar value of a contract with a joint venture eligible under the standards of this provision equal to the percentage of the DBE partner in the joint venture.
- (4) Expenditures to DBEs that perform a commercially useful function may be counted toward the goal. A business is considered to perform a commercially useful function when it is responsible for the execution of a distinct element of the work and carries out its responsibilities by actually performing, managing, and supervising the work involved.
- (5) The Contractor may count 100% of the expenditures for materials and supplies obtained from certified DBE suppliers and manufacturers that produce goods from raw materials or substantially alters them for resale provided the suppliers and manufacturers assume the actual and contractual responsibility for the provision of the materials and supplies. The Contractor may count sixty percent (60%) of the expenditures to suppliers that are not manufacturers, provided the supplier performs a commercially useful function in the supply process. Within 30 days after receipt of the materials, the Contractor shall furnish to the DBE Coordinator invoices from the certified supplier to verify the DBE goal.
- (6) Any work that a certified DBE firm subcontracts or sub-subcontracts to a non-DBE firm will not count towards the DBE goal.
- (7) Only the dollars actually paid to the DBE firm may be counted towards the DBE goal. The participation of a DBE Firm cannot be counted towards the Prime Contractor's DBE goal until the amount being counted towards the goal has been paid to the DBE.

**AWARD**

Award of this contract to the low bidder will be contingent upon the following conditions:

- (1) Concurrence from Federal Highway Administration, when applicable.
- (2) Bidder must submit to the Office of Civil Rights for approval, Form OCR-481 (DBE Commitment) no later than the 3<sup>rd</sup> business day after opening of the bids to satisfy the Department and that adequate good faith efforts have been made to meet the contract goal. For answers to questions regarding Form OCR-481, contact the MDOT Office of Civil Rights at (601) 359-7466.
- (3) Bidder must include OCR-485 information with their bid proposal listing all firms that submitted quotes for material supplies or items to be subcontracted. OCR-485 information

must be included with the bid proposal. If the OCR-485 information is not included as part of bid proposal, your bid will be deemed irregular.

Prior to the start of any work, the bidder must notify the Project Engineer, in writing, of the name of the designated "DBE Liaison Officer" for this project. This notification must be posted on the bulletin board at the project site.

### **DEFAULT**

If the contract goal established by MDOT in this proposal is 1% or greater, it must be met to fulfill the terms of the contract. The Contractor may list DBE Subcontractors and items that exceed MDOT's contract goal, but should unforeseen problems arise that would prevent a DBE from completing its total commitment percentage, the Contractor will meet the terms of the contract as long as it meets or exceeds MDOT's Contract Goal. For additional information, refer to "Replacement" section of this Notice.

### **DBE REPORTS**

- (1) OCR-481: Refer to "CONTRACT GOAL" section of this Notice to Bidders for information regarding this form.
- (2) OCR-482: OCR-482: At the conclusion of the project, before the final estimate is paid and the project is closed out, the Prime Contractor will submit to the Project Engineer for verification of quantities and further handling Form OCR-482 whereby the Contractor certifies to the amounts of payments made to all Contractors / Suppliers over the life of the contract. The Project Engineer shall submit the completed Form OCR-482 to the DBE Coordinator (Office of Civil Rights). Final acceptance of the project is dependent upon Contract Administration Division's receipt of completed Form OCR-482 which they will receive from the Office of Civil Rights.
- (3) OCR-483: The Project Engineer/Inspector will complete Form OCR-483, the Commercially Useful Function (CUF) Performance Report, in accordance with MDOT S.O.P. No. OCR-03-09-01-483. Evaluations reported on this form are used to determine whether or not the DBE firm is performing a CUF. The Prime Contractor should take corrective action when the report contains any negative evaluations. DBE credit may be disallowed and/or other sanctions imposed if it is determined the DBE firm is not performing a CUF. This form should also be completed and returned to the DBE Coordinator (Office of Civil Rights).
- (4) OCR-484: Each month, the Prime Contractor will submit to the Project Engineer OCR-484 that certifies payments to all Subcontractors and shows all firms even if the Prime Contractor has paid no monies to the firm during that estimate period (negative report). The Project Engineer will attach the form to the monthly estimate before forwarding to the Contract Administration Division for further processing. Failure of the Contractor to submit the OCR-484 will result in the estimate not being processed and paid.

- (5) OCR-485: ALL BIDDERS must submit signed form with bid proposal of all firms that submitted quotes for material supplies or items to be subcontracted. If the OCR-485 information is not included as part of bid proposal, the bid will be deemed irregular.
- (6) OCR-487: Only used by Prime Contractors that are certified DBE firms. This form is used in determining the exact percentage of DBE credit for the specified project. It should be returned to MDOT with the OCR-481 form, or can also be returned with the Permission to Subcontract Forms (CAD-720, CAD-725 and CAD-521).

DBE Forms, can be obtained from the Office of Civil Rights Division, MDOT Administration Building, 401 North West Street, Jackson, MS, or at [www.gomdot.com](http://www.gomdot.com) under Divisions, Civil Rights, and Forms.

**SANCTIONS**

The Department has the option to enforce any of the following penalties for failure of the Prime Contractor to fulfill the DBE goal as stated on the OCR-481 form or any violations of the DBE program guidelines:

- (1) Disallow credit towards the DBE goal
- (2) Withhold progress estimate payments
- (3) Deduct from the final estimate or recover an amount equal to the unmet portion of the DBE goal which may include additional monetary penalties as outlined below based on the number of offenses and the severity of the violation as determined by MDOT.

|                         |                              |    |                           |    |   |
|-------------------------|------------------------------|----|---------------------------|----|---|
| 1 <sup>st</sup> Offense | 10% of unmet portion of goal | or | \$5,000 lump sum payment  | or | Both                                    |
| 2 <sup>nd</sup> Offense | 20% of unmet portion of goal | or | \$10,000 lump sum payment | or | Both                                    |
| 3 <sup>rd</sup> Offense | 40% of unmet portion of goal | or | \$20,000 lump sum payment | or | \$20,000 lump sum payment and debarment |

- (4) Debar the Contractor involved from bidding on MDOT federally funded projects.

# MISSISSIPPI DEPARTMENT OF TRANSPORTATION

SECTION 904 - NOTICE TO BIDDERS NO. 8

CODE: (SP)

DATE: 07/19/2017

SUBJECT: Errata and Modifications to the 2017 Standard Specifications

| <u>Page</u> | <u>Subsection</u> | <u>Change</u>  |
|-------------|-------------------|--|
| 16          | 102.06            | In the seventh full paragraph, change “Engineer” to “Director.”  |
| 33          | 105.05.1          | In the sixth sentence, change “Contract Administration Engineer” to “Contract Administration Director.”  |
| 34          | 105.05.2.1        | In subparagraph 2, change “SWPPP, ECP” to “SWPPP and the ECP”  |
| 35          | 105.05.2.2        | In subparagraphs 2, add “ and” to the end of the sentence. In subparagraph 3, remove “, and” and add “.”.  |
| 90          | 109.04.2          | In the last paragraph of subparagraph (a), place a period “.” at the end of the sentence.  |
| 93          | 109.04.2          | In the last paragraph of subparagraph (g), place a period “.” at the end of the sentence. Also, in the first paragraph of subparagraph (h), place a period “.” at the end of the sentence. |
| 98          | 109.11            | In the third sentence, change “Engineer” to “Director.”  |
| 219         | 308.04            | In the last sentence of the last paragraph, change “Contractor’s decision” to “Engineer’s decision.”   |
| 300         | 405.02.5.9        | In the first sentence of the second paragraph, change “Hot Mix Asphalt” to “Asphalt Mixtures.”   |
| 502         | 630.01.1          | In the first paragraph, change “ <u>AASHTO</u> ” to “ <u>AASHTO’s LRFD</u> ”.  |
| 532         | 642.02.6.6.2      | Change the subsection number from “642.02.6.6.2” to “632.02.6.6.2”   |
| 532         | 642.02.6.6.2      | Change “Section 661” to “Section 907-661.”   |
| 532         | 632.02.6.6.4      | Change “Subsection 663.02.2” to “Subsection 907-663.02.2.”   |
| 554         | 634.05            | In the description for 634-A, change “___’ Pole” to “___’ Shaft.”  |

- |     |               |   |
|-----|---------------|---|
| 688 | 630.03.2      | Change the subsection number from “630.03.2” to “680.03.2.”                                       |
| 725 | 702.08.3      | In the second sentence of the first paragraph, change “hot-mix” to “asphalt.”                     |
| 954 | 804.02.13.1.6 | In the definition for “M” in the % Reduction formulas, change “paragraph 7.3” to “paragraph 5.3.” |

**MISSISSIPPI DEPARTMENT OF TRANSPORTATION**

**SECTION 904 - NOTICE TO BIDDERS NO. 9**

**CODE: (IS)**

**DATE: 03/01/2017**

**SUBJECT: Federal Bridge Formula**

Bidders are hereby advised that the latest revision of Federal Highway Administration Publication No. FHWA-HOP-06-105, **BRIDGE FORMULA WEIGHTS**, dated August 2006, is made a part of this contract when applicable.

Prior to the preconstruction conference, the Contractor shall advise the Engineer, in writing, what materials, if any, will be delivered to the jobsite via Interstate route(s).

Copies of the **BRIDGE FORMULA WEIGHTS** publication may be obtained by contacting:

Federal Highway Administration  
400 7<sup>th</sup> Street, SW  
Washington, DC 20590  
(202) 366-2212

or

[http://www.ops.fhwa.dot.gov/Freight/publications/brdg\\_frm\\_wgths/bridge\\_formula\\_all\\_rev.pdf](http://www.ops.fhwa.dot.gov/Freight/publications/brdg_frm_wgths/bridge_formula_all_rev.pdf)

An on line **BRIDGE FORMULA WEIGHTS CALCULATOR** is available at

[http://ops.fhwa.dot.gov/freight/sw/brdgcalc/calc\\_page.htm](http://ops.fhwa.dot.gov/freight/sw/brdgcalc/calc_page.htm)

## MISSISSIPPI DEPARTMENT OF TRANSPORTATION

SECTION 904 - NOTICE TO BIDDERS NO. 10

CODE: (IS)

DATE: 03/01/2017

**SUBJECT: DUNS Requirement for Federal Funded Projects**

Bidders are advised that the Prime Contractor must maintain current registrations in the System for Award Management ( <http://www.sam.gov> ) at all times during this project. A Dun and Bradstreet Data Universal Numbering System (DUNS) Number ( <http://www.dnb.com> ) is one of the requirements for registration in the System for Award Management.

Bidders are also advised that prior to the award of this contract, they MUST be registered in the System for Award Management.



**MISSISSIPPI DEPARTMENT OF TRANSPORTATION**

**SECTION 904 - NOTICE TO BIDDERS NO. 12**

**CODE: (IS)**

**DATE: 03/01/2017**

**SUBJECT: MASH Compliant Devices**

Bidders are hereby advised that the Standard Specifications may require certain traffic control and permanent safety hardware devices to meet the requirements of the Manual for Assessing Safety Hardware (MASH). However, devices meeting the requirements of NCHRP Report 350 will be allowed until the mandatory effective date for MASH compliance. The following table shows the effective dates for MASH compliant devices.

| <b>Device</b>  | <b>Effective Date for MASH Compliance</b> |
|--|---|
| W-beam barriers, cast-in-place concrete barriers   | December 31, 2017                         |
| W-beam terminals   | June 30, 2018                             |
| Cable barriers, cable barrier terminals, crash cushions  | December 31, 2018                         |
| Bridge rails, transitions, all other longitudinal barriers including portable barriers installed permanently, all other terminals, sign supports, all other breakaway hardware | December 31, 2019                         |

Temporary work zone devices, including portable barriers manufactured after December 31, 2019, must have been successfully tested to the 2016 Edition of MASH. Such devices manufactured on or before this date and successfully tested to NCHRP Report 350 or the 2009 Edition of MASH may continue to be used throughout their normal service lives.

**MISSISSIPPI DEPARTMENT OF TRANSPORTATION**

**SECTION 904 - NOTICE TO BIDDERS NO. 13**

**CODE: (IS)**

**DATE: 03/01/2017**

**SUBJECT: Safety Edge**

Bidders are hereby advised that the Shoulder Wedge (Safety Edge) specified in Section 401, Asphalt Pavements, shall only apply to the top two (2) lifts of asphalt. Open Graded Friction Courses (OGFC) are not to be considered a lift as it pertains to safety edge. Attached is a drawing showing the safety edge. Note that the shoulder dimensions in the bottom two drawings will be less than three feet (3').

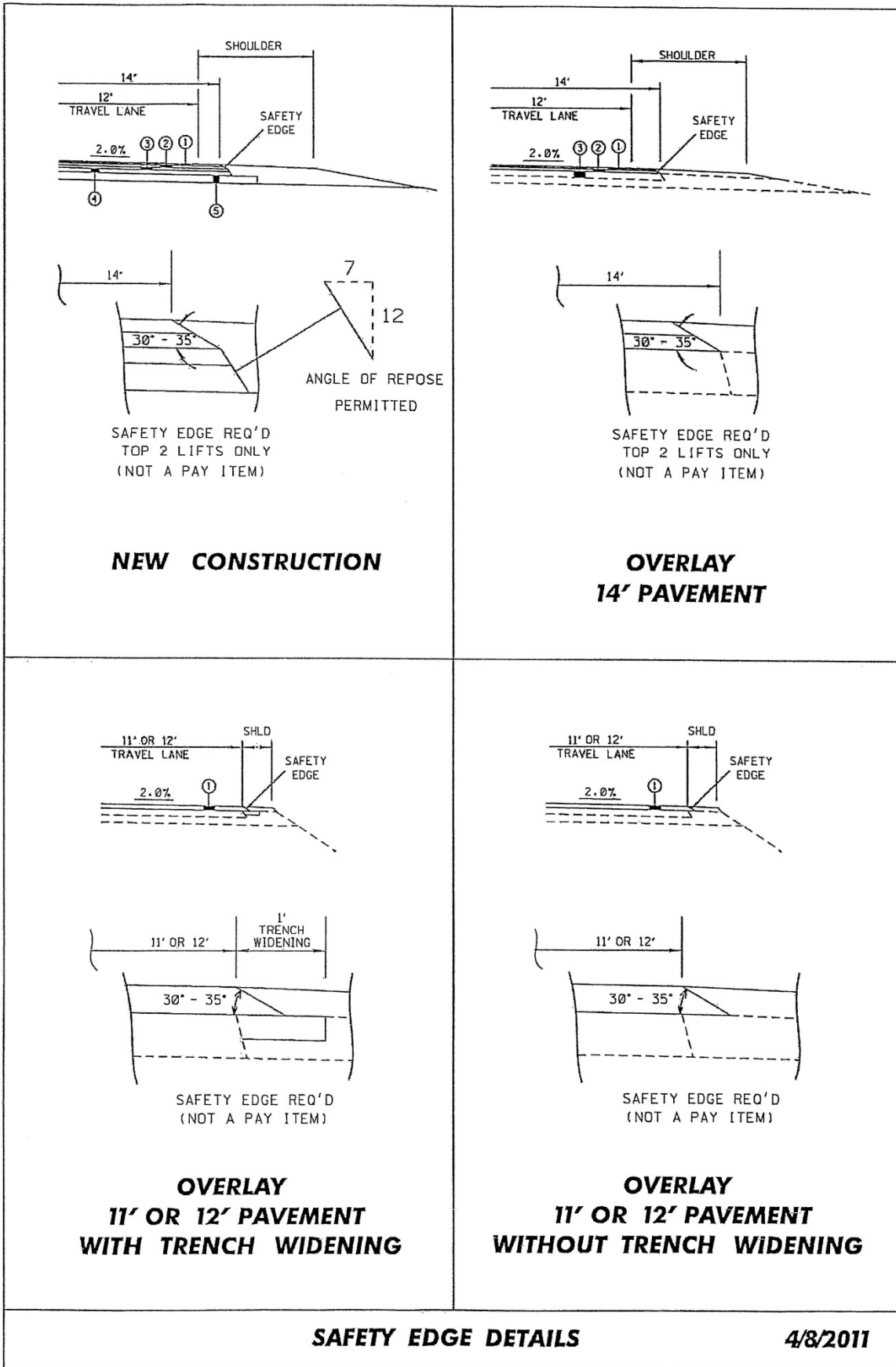

## MISSISSIPPI DEPARTMENT OF TRANSPORTATION

**SECTION 904 - NOTICE TO BIDDERS NO. 113**

**CODE: (SP)**

**DATE: 04/18/2017**

**SUBJECT: Tack Coat**

Bidders are advised that in addition to the products listed on the Department's APL as referenced in Subsection 401.03.1.2 on page 256, the Contractor may use one of the following as a tack coat.

- CSS-1
- CSS-1h
- SS-1
- SS-1h

**MISSISSIPPI DEPARTMENT OF TRANSPORTATION**

**SECTION 904 - NOTICE TO BIDDERS NO. 296**

**CODE: (SP)**

**DATE: 07/25/2017**

**SUBJECT: Reduced Speed Limit Signs**

Bidders are advised that when the plans or contract documents require the speed limit on a project to be reduced, the Contractor shall begin work within 48 hours of installing the reduced speed limit signs. Should the Contractor not start work or have no plans to start work within 48 hours of installing the signs, the reduced speed limit signs shall be covered and existing speed limit signs uncovered.

**MISSISSIPPI DEPARTMENT OF TRANSPORTATION**

**SECTION 904 – NOTICE TO BIDDERS NO. 401**

**CODE: (SP)**

**DATE: 09/12/2017**

**SUBJECT: Standard Drawings**

Standard Drawings attached hereto shall govern appropriate items of required work.

Larger copies of Standard Drawings may be purchased from:

MDOT Plans Print Shop  
MDOT Shop Complex, Building C, Room 114  
2567 North West Street  
P.O. Box 1850  
Jackson, MS 39215-1850  
Telephone: (601) 359-7460  
or FAX: (601) 359-7461  
or e-mail: [plans@mdot.state.ms.us](mailto:plans@mdot.state.ms.us)

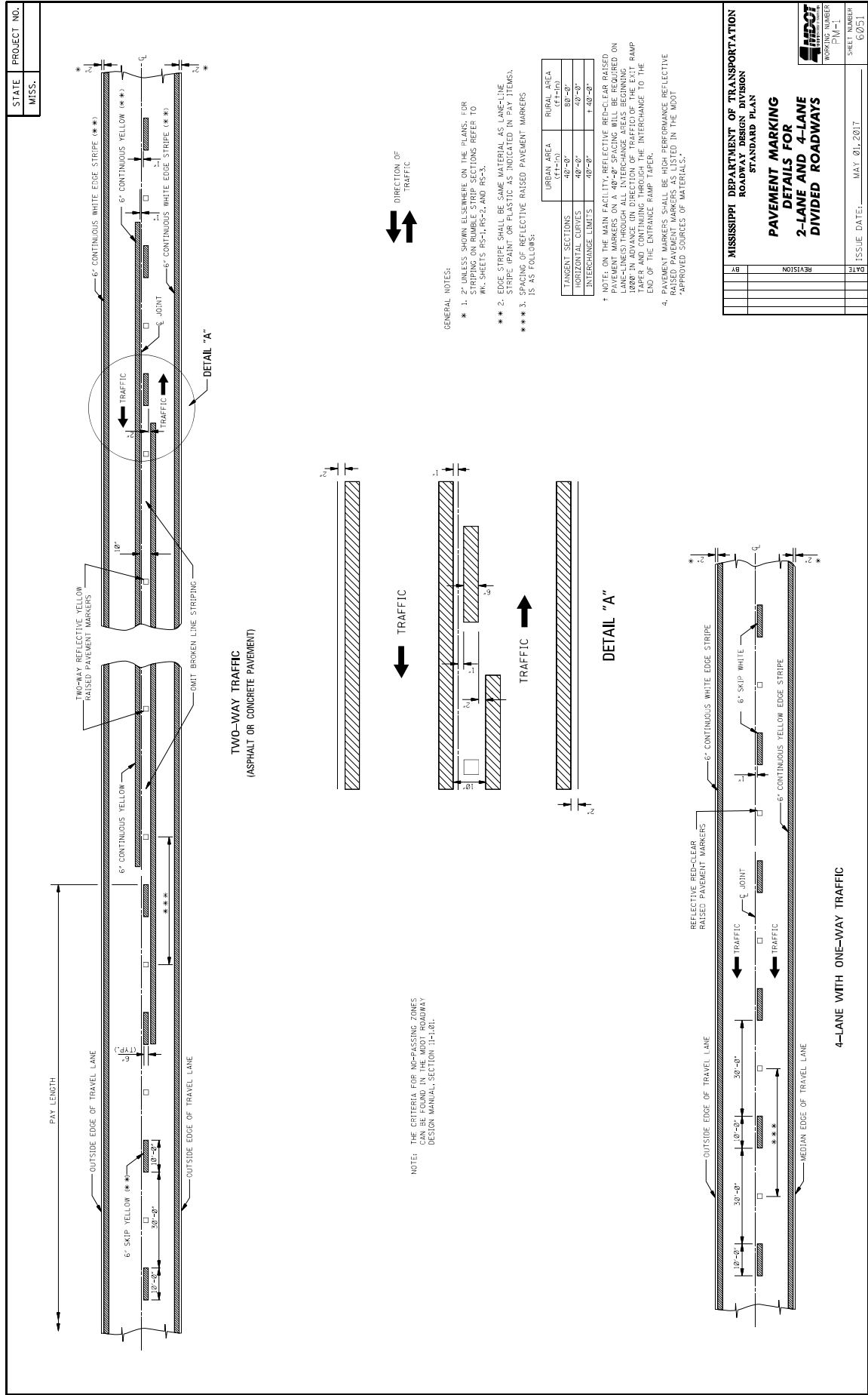

|   |                          |
|---|--------------------------|
| <b>MISSISSIPPI DEPARTMENT OF TRANSPORTATION</b><br>ROADWAY DESIGN DIVISION<br>STANDARD PLAN |                          |
| <b>PAVEMENT MARKING<br/>DETAILS FOR<br/>2-LANE AND 4-LANE<br/>DIVIDED ROADWAYS</b>          |                          |
| DATE  | ISSUE DATE: MAY 01, 2017 |
| REVISION  |                          |
|   |                          |
|   |                          |
|   |                          |



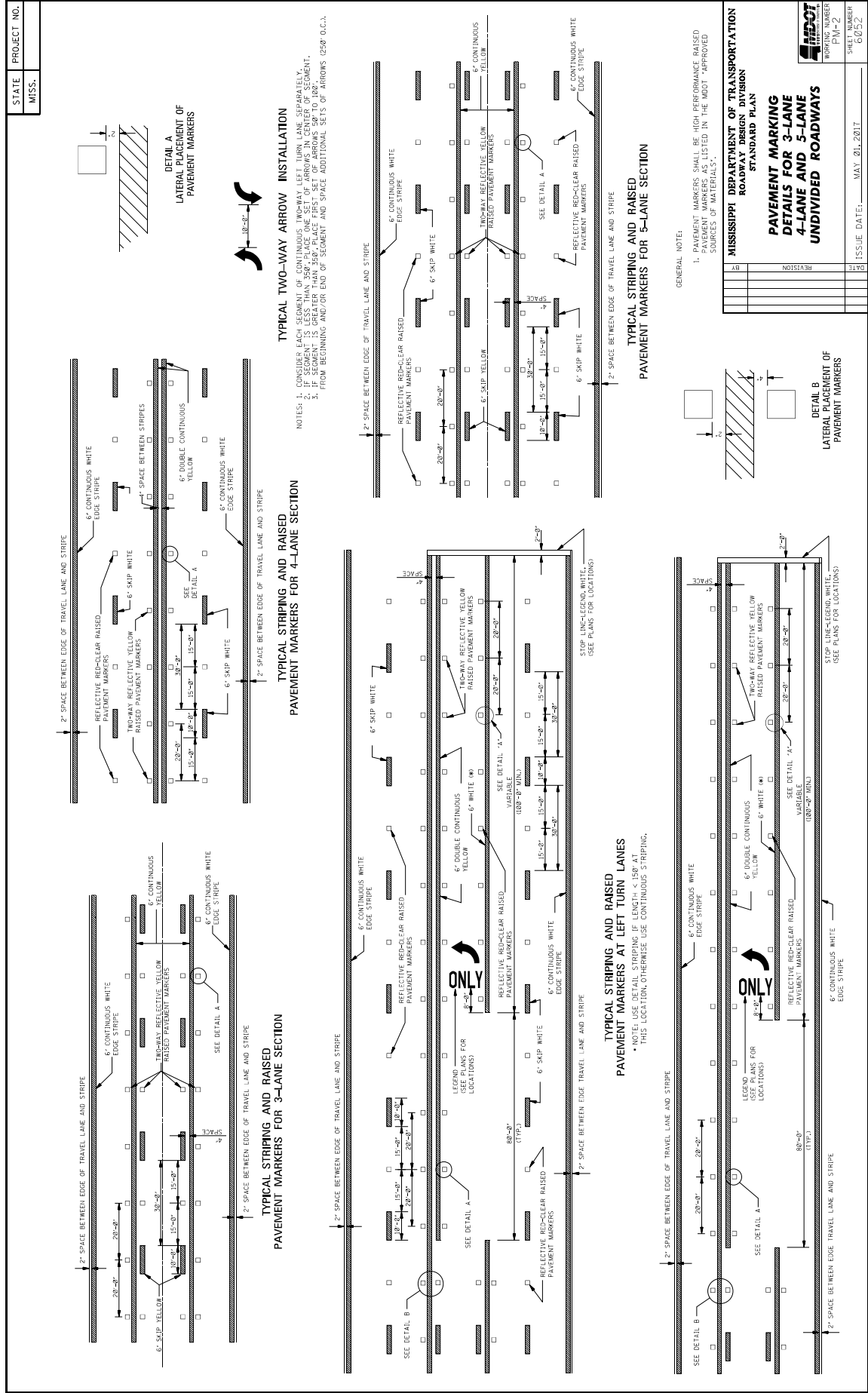



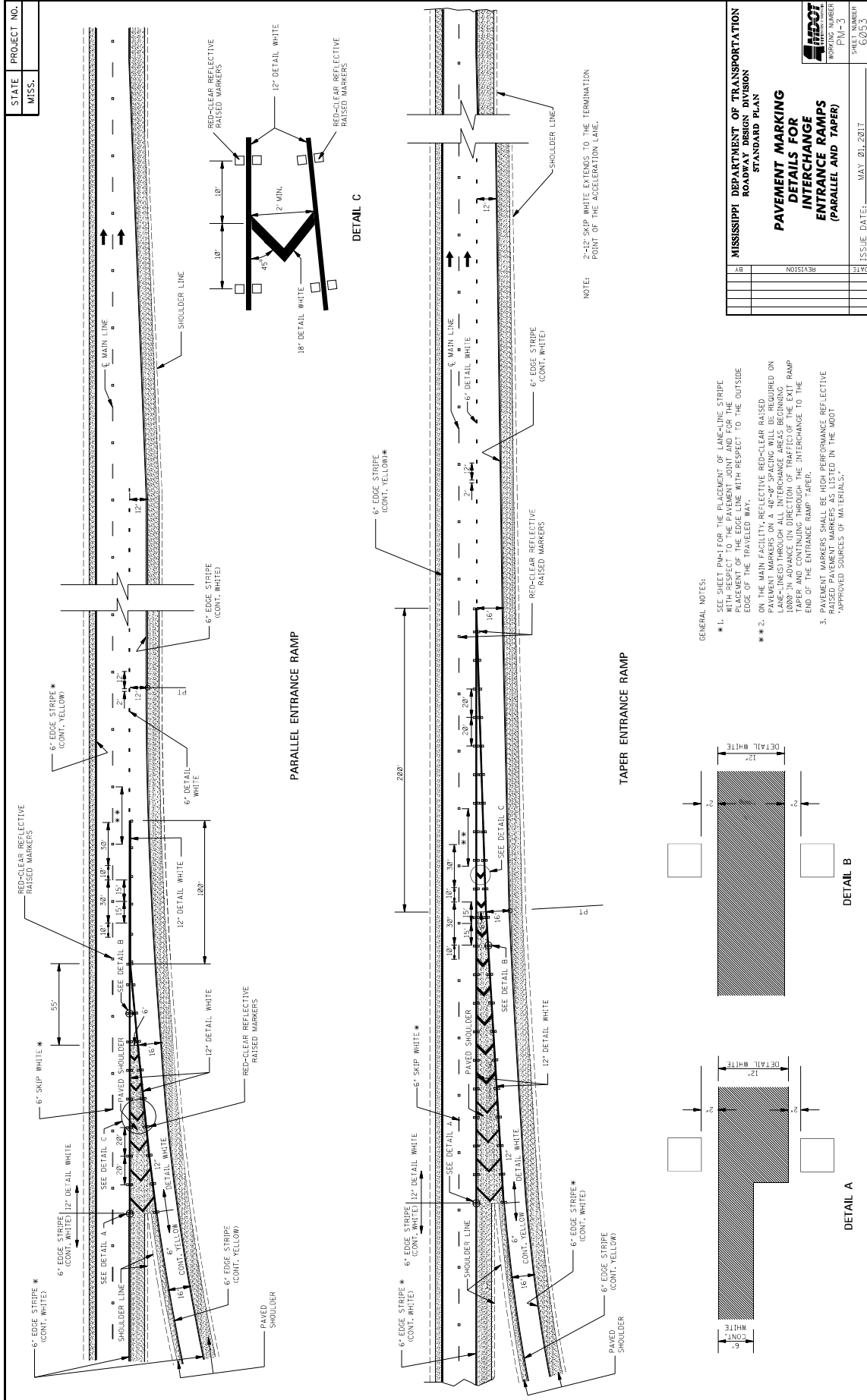

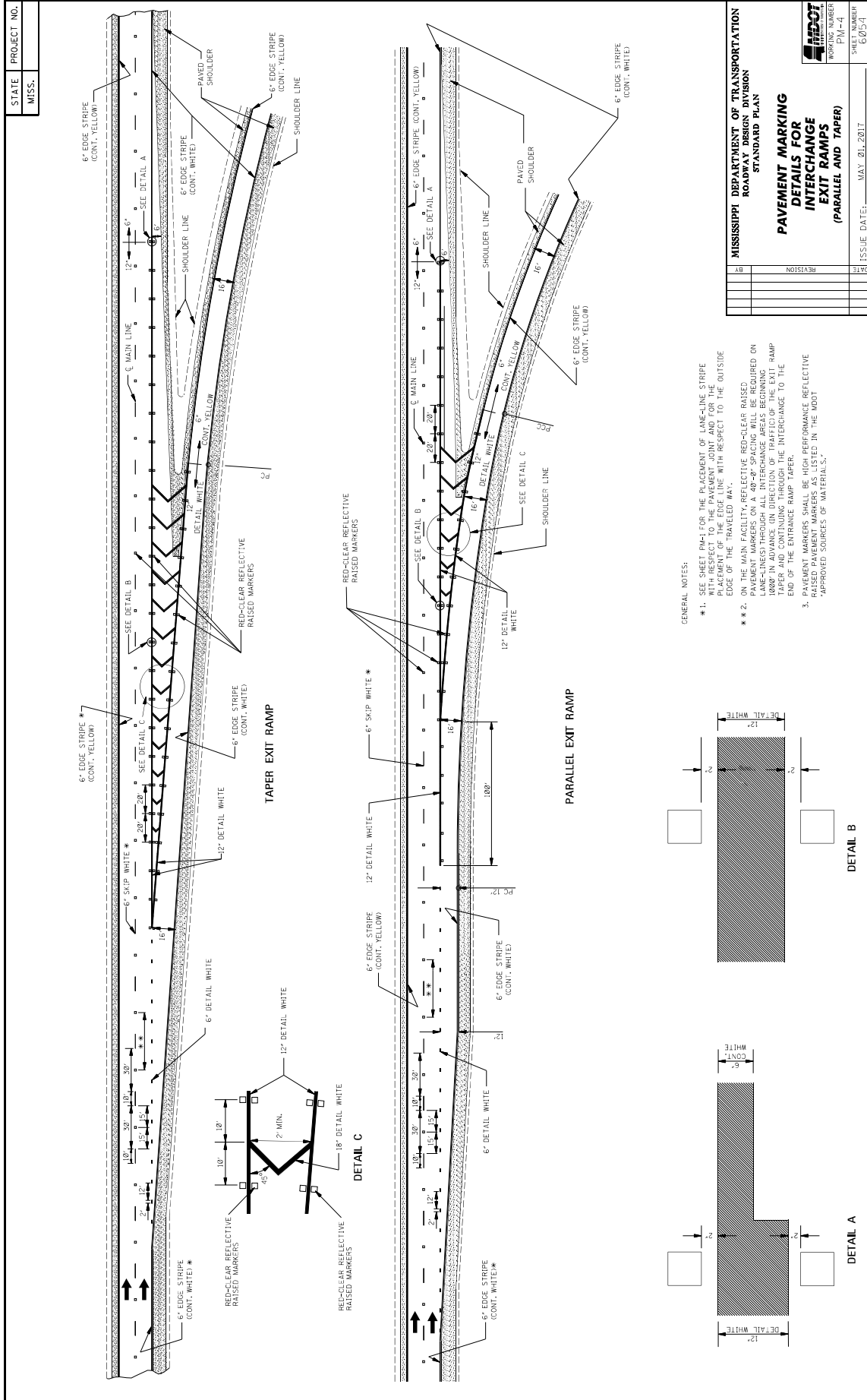

GENERAL NOTES:

- \*\* 1. SEE SHEET PMA-1 FOR THE PLACEMENT OF LANE-LINE STRIPE WITH RESPECT TO THE PAVEMENT JOINT AND FOR THE PLACEMENT OF PAVED SHOULDER WITH RESPECT TO THE OUTSIDE EDGE OF MAIN CARRIAGEWAY.
- \*\* 2. EDGE OF MAIN CARRIAGEWAY REFLECTIVE BEAD-BEAD RAISED PAVEMENT MARKERS ON A 48"-60" SPACING WILL BE REQUIRED ON LANE-LINES THROUGH ALL INTERCHANGE AREAS BEGINNING 1000' IN ADVANCE (IN DIRECTION OF TRAFFIC) OF THE EXIT RAMP TAPER AND CONTINUING THROUGH THE INTERCHANGE TO THE END OF THE ENTRANCE RAMP TAPER.
- 3. RAISED PAVEMENT MARKERS BE HIGH PERFORMANCE REFLECTIVE "APPROVED SOURCES OF MATERIALS."

|  |                          |
|--|--------------------------|
| MISSISSIPPI DEPARTMENT OF TRANSPORTATION<br>ROADWAY DESIGN DIVISION<br>STANDARD PLAN           |                          |
| <b>PAVEMENT MARKING<br/>DETAILS FOR<br/>INTERCHANGE<br/>EXIT RAMP<br/>(PARALLEL AND TAPER)</b> |                          |
| WORKING NUMBER<br>PM-4   | SHEET NUMBER<br>602/5-1  |
| DATE   | ISSUE DATE: MAY 01, 2017 |
| BY   | REVISION                 |
|  |                          |
|  |                          |
|  |                          |

|                |             |  |  |  |  |  |  |  |  |  |  |
|----------------|-------------|--|--|--|--|--|--|--|--|--|--|
| STATE<br>MISS. | PROJECT NO. |  |  |  |  |  |  |  |  |  |  |
|----------------|-------------|--|--|--|--|--|--|--|--|--|--|

**GENERAL NOTES:**

- TWO HORIZONTAL GAPS (CAUSED BY TEMPLATE CONNECTIONS) OF 1/2" LESS THAN THE STANDING LETTER HEIGHT SHALL BE PROVIDED AT THE TOP AND BOTTOM OF ALL LETTERS.
- FOR OTHER DETAILS, SEE THE MANUAL ON UNIFORM TRAFFIC CONTROL DEVICES.
- PAY QUANTITIES FOR PAVEMENT MARKING LEGENDS ARE AS FOLLOWS:

| LEGEND  | AREA (FT <sup>2</sup> ) |
|---------|-------------------------|
| STOP    | 24.6                    |
| RIGHT   | 28.6                    |
| LEFT    | 19.5                    |
| TRAFFIC | 24.2                    |
| YIELD   | 32.3                    |
| AHEAD   | 26.8                    |
| EXIT    | 18.5                    |
| SIGNAL  | 32.5                    |
| SCHOOL  | 35.5                    |

**MISSISSIPPI DEPARTMENT OF TRANSPORTATION  
ROADWAY DESIGN DIVISION  
STANDARD PLAN**

WORKING NUMBER  
PM-5  
SHEET NUMBER  
60355

|      |          |    |  |  |  |  |  |  |  |  |                          |
|------|----------|----|--|--|--|--|--|--|--|--|--------------------------|
|      |          |    |  |  |  |  |  |  |  |  |                          |
| DATE | REVISION | BY |  |  |  |  |  |  |  |  | ISSUE DATE: MAY 01, 2017 |

|                |             |  |
|----------------|-------------|--|
| STATE<br>MISS. | PROJECT NO. |  |
|----------------|-------------|--|

**ONLY**

**TURN** ARROW

**THRU** ARROW

YIELD LINE  
TRAFFIC

**LANE-REDUCTION** ARROW

**1-WAY** ARROW

**COMBINATION** ARROW

**GENERAL NOTES:**

- TWO HORIZONTAL GAPS (CAUSED BY TEMPLATE CONNECTORS OF 1/16" OR LESS AND EXTENDING THE FULL WIDTH) ARE PERMITTED IN EACH LETTER.
- FOR OTHER DETAILS, SEE THE MANUAL ON UNIFORM TRAFFIC CONTROL DEVICES.
- DIMENSIONS OF THE YIELD LINE MAY VARY WITH APPROVAL OF THE ENGINEER. SEE MUTCD, LATEST EDITION, FOR ALLOWABLE DIMENSIONS.
- PAY QUANTITIES FOR PAVEMENT MARKING LEGENDS ARE AS FOLLOWS:

| PAY QUANTITIES       |                         |
|----------------------|-------------------------|
| LEGEND/SYMBOL        | AREA (FT <sup>2</sup> ) |
| ONLY                 | 22.0                    |
| TURN ARROW           | 16.4                    |
| THRU ARROW           | 12.3                    |
| COMB. ARROW          | 27.5                    |
| 1-WAY ARROW          | 24.3                    |
| LANE REDUCTION ARROW | 40.0                    |

| DATE | REVISION | BY |
|------|----------|----|
|      |          |    |
|      |          |    |
|      |          |    |

**MISSISSIPPI DEPARTMENT OF TRANSPORTATION  
ROADWAY DESIGN DIVISION  
STANDARD PLAN**

**PAVEMENT MARKING  
LEGEND DETAILS**

  

|                        |                          |
|------------------------|--------------------------|
| SHEET NUMBER<br>PM-6   | ISSUE DATE: MAY 01, 2017 |
| WORKING NUMBER<br>6056 |                          |

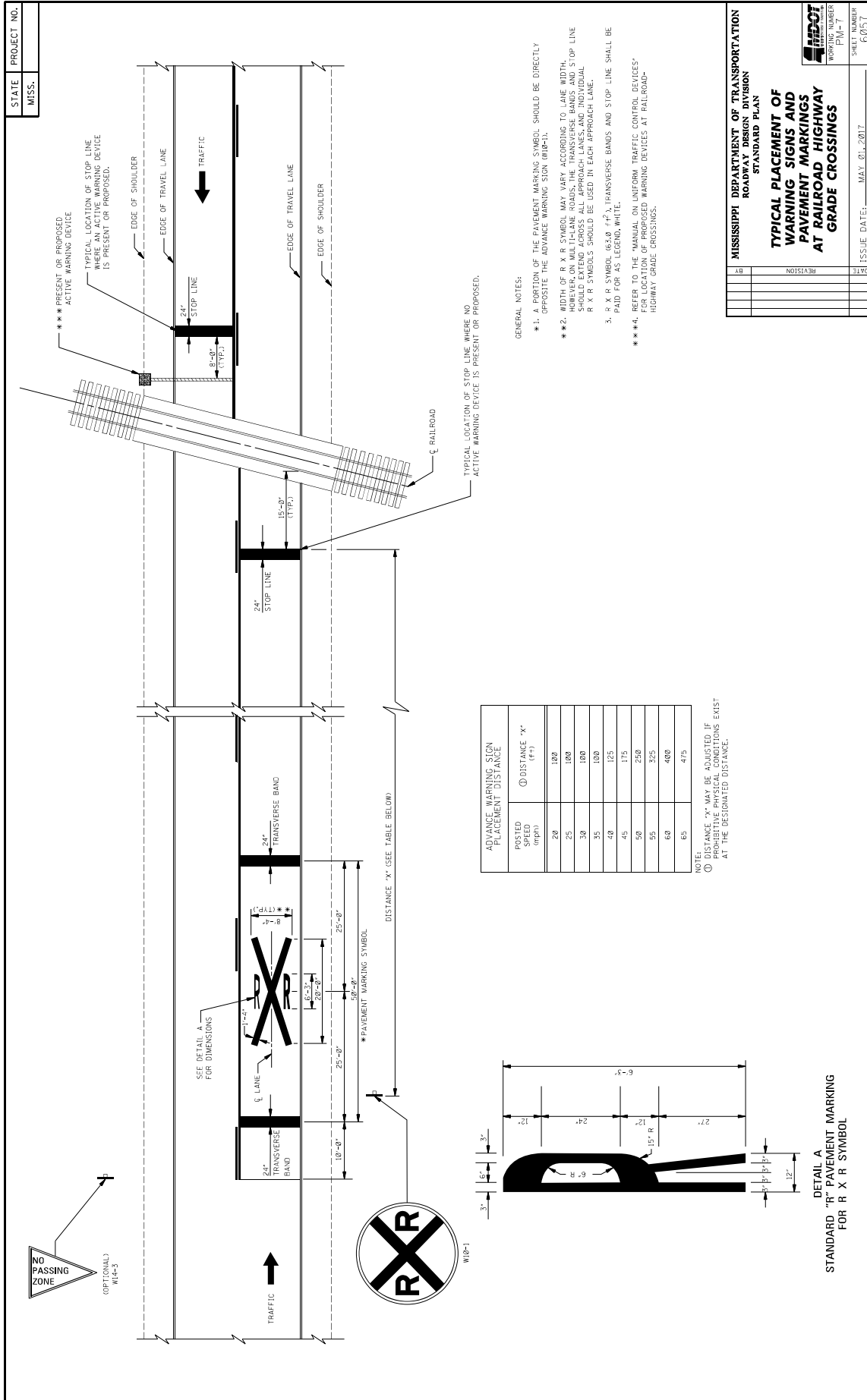

| POSTED SPEED (mph) | ADVANCE WARNING SIGN PLACEMENT DISTANCE (ft) |
|--------------------|--|
| 20                 | 100  |
| 25                 | 100  |
| 30                 | 100  |
| 35                 | 100  |
| 40                 | 125  |
| 45                 | 175  |
| 50                 | 250  |
| 55                 | 325  |
| 60                 | 400  |
| 65                 | 475  |

NOTE: DISTANCE "X" MAY BE SHORTER IF PROTECTIVE PHYSICAL CONDITIONS EXIST AT THE DESIGNATED DISTANCE.

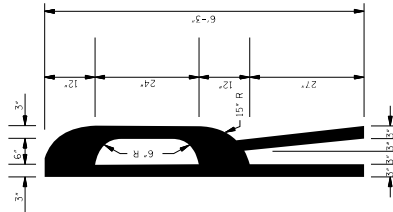

DETAIL A  
STANDARD "R" PAVEMENT MARKING  
FOR R X R SYMBOL

- GENERAL NOTES:
- \*\* 1. A PORTION OF THE PAVEMENT MARKING SYMBOL SHOULD BE DIRECTLY OPPOSITE THE ADVANCE WARNING SIGN (W14-3).
  - \*\* 2. WIDTH OF R X R SYMBOL MAY VARY ACCORDING TO LANE WIDTH. SYMBOL SHOULD EXTEND ACROSS ALL APPROACH LANES AND INDIVIDUAL R X R SYMBOLS SHOULD BE USED IN EACH APPROACH LANE.
  - 3. R X R SYMBOL (63.8 #1) TRANSVERSE BANDS AND STOP LINE SHALL BE PAID FOR AS LEGEND WHITE.
  - \*\* \* 4. REFER TO THE MANUAL ON UNIFORM TRAFFIC CONTROL DEVICES FOR LOCATION OF PROPOSED WARNING DEVICES AT RAILROAD-HIGHWAY GRADE CROSSINGS.

STATE PROJECT NO.  
MISS.

MISSISSIPPI DEPARTMENT OF TRANSPORTATION  
ROADWAY DESIGN DIVISION  
STANDARD PLAN

**TYPICAL PLACEMENT OF WARNING SIGNS AND PAVEMENT MARKINGS AT RAILROAD-HIGHWAY GRADE CROSSINGS**

WORKING NUMBER: P10-1  
SHEET NUMBER: 6031

ISSUE DATE: MAY 01, 2017

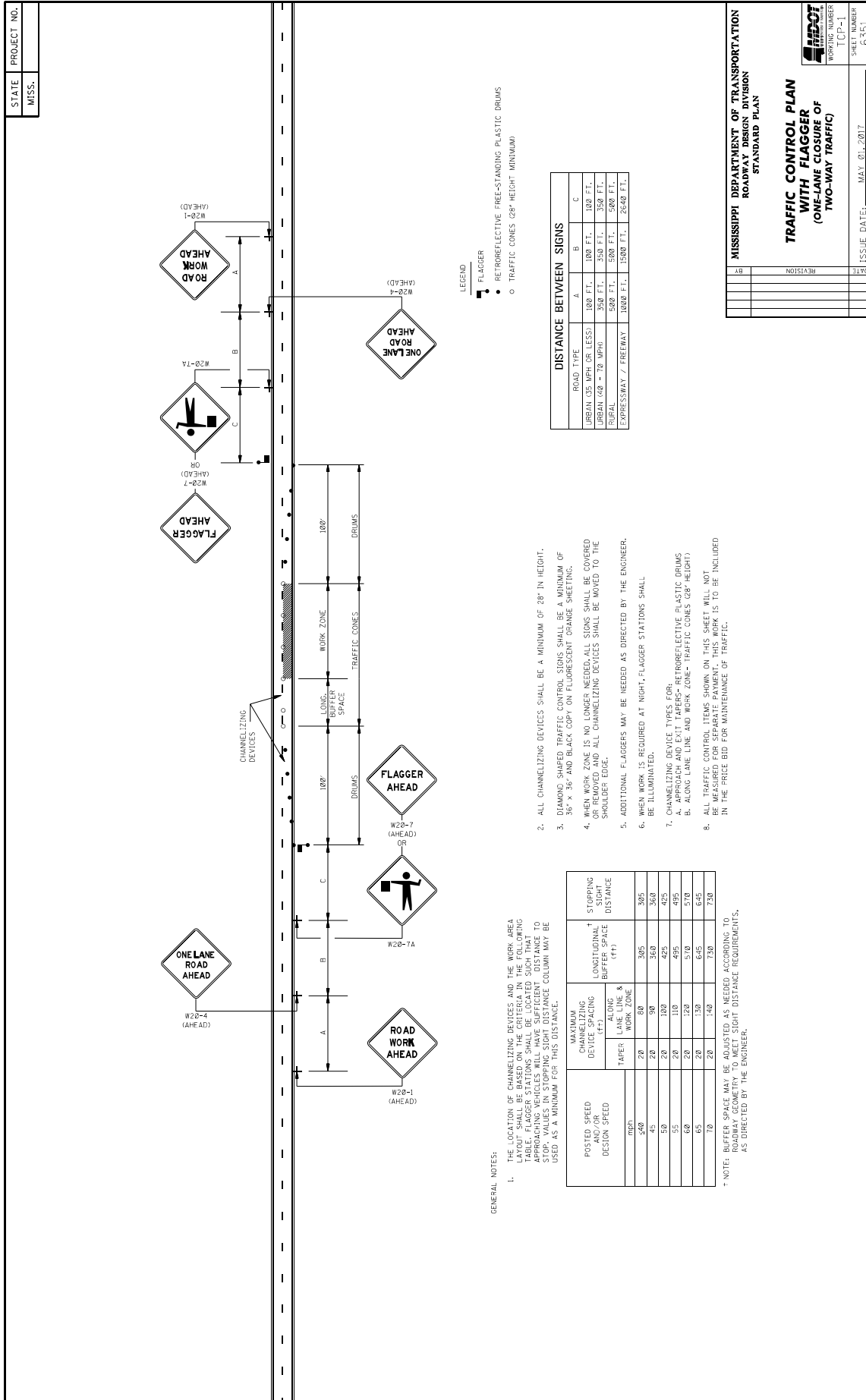

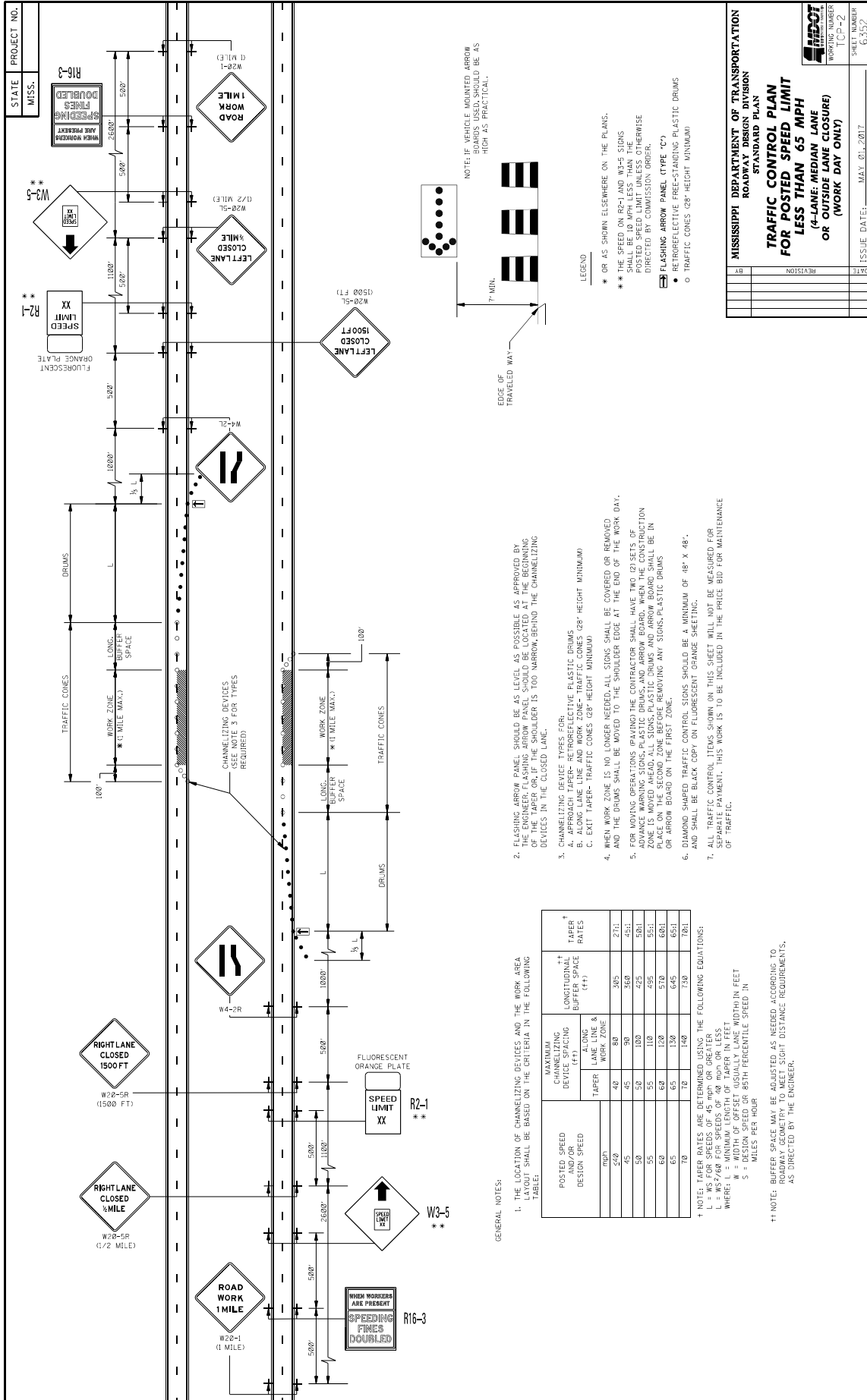

|                                     |          |
|-------------------------------------|----------|
| STATE PROJECT NO.<br>MISS.<br>R16-3 |          |
| SHEET NUMBER<br>TCP-2               |          |
| ISSUE DATE: MAY 01, 2017            |          |
| DATE                                | REVISION |
|                                     |          |
|                                     |          |
|                                     |          |
|                                     |          |
|                                     |          |

MISSISSIPPI DEPARTMENT OF TRANSPORTATION  
ROADWAY DESIGN DIVISION  
STANDARD PLAN  
**TRAFFIC CONTROL PLAN  
FOR POSTED SPEED LIMIT  
LESS THAN 65 MPH  
(4-LANE; MEDIAN LANE  
OR OUTSIDE LANE CLOSURE)  
OR (WORK DAY ONLY)**

†† NOTE: BUFFER SPACE MAY BE ADJUSTED AS NEEDED ACCORDING TO ROADWAY GEOMETRY TO MEET SIGHT DISTANCE REQUIREMENTS, AS DIRECTED BY THE ENGINEER.

1. THE LOCATION OF CHANNELIZING DEVICES AND THE WORK AREA LAYOUT SHALL BE BASED ON THE CRITERIA IN THE FOLLOWING TABLE:
2. FLASHING ARROW PANEL SHOULD BE AS LEVEL AS POSSIBLE AS APPROVED BY THE ENGINEER. PANELS SHOULD BE PLACED AT THE END OF THE TAPER OR IF THE SHOULDER IS TOO NARROW, BEHIND THE CHANNELIZING DEVICES IN THE CLOSED LANE.
3. CHANNELIZING DEVICES TYPES FOR:
  - A. APPROACH TAPER- RETROREFLECTIVE PLASTIC DRUMS
  - B. ALONG LANE LINE AND WORK ZONE- TRAFFIC CONES (28" HEIGHT MINIMUM)
  - C. EXIT TAPER- TRAFFIC CONES (28" HEIGHT MINIMUM)
4. WHEN WORK ZONE IS NO LONGER NEEDED, ALL SIGNS SHALL BE COVERED OR REMOVED.
5. FOR MOVING OPERATIONS (PAVING) THE CONTRACTOR SHALL HAVE TWO (2) SETS OF ADVANCE WARNING SIGNS, PLASTIC DRUMS, AND ARROW BOARD. WHEN THE CONSTRUCTION ZONE IS MOVED AHEAD, ALL SIGNS, PLASTIC DRUMS AND ARROW BOARD SHALL BE IN PLACE ON THE SECOND ZONE BEFORE REMOVING ANY SIGNS, PLASTIC DRUMS OR ARROW BOARD ON THE FIRST ZONE.
6. DIAMOND SHAPED TRAFFIC CONTROL SIGNS SHOULD BE A MINIMUM OF 48" X 48" AND SHALL BE BLACK COPY ON FLOURESCENT ORANGE SHEETING.
7. ALL TRAFFIC CONTROL ITEMS SHOWN ON THIS SHEET WILL NOT BE MEASURED FOR PAYMENT. THIS WORK IS TO BE INCLUDED IN THE PRICE BID FOR MAINTENANCE OF TRAFFIC.

| POSTED SPEED AND/OR DESIGN SPEED | MAXIMUM CHANNELIZING DEVICE SPACING (FT) |       | LONGITUDINAL BUFFER SPACE (FT) | TAPER RATES |
|----------------------------------|--|-------|--------------------------------|-------------|
|                                  | LANE LINE & WORK ZONE                    | FLANK |                                |             |
| 45                               | 40                                       | 80    | 305                            | 27:1        |
| 50                               | 45                                       | 90    | 360                            | 45:1        |
| 55                               | 50                                       | 100   | 425                            | 50:1        |
| 60                               | 55                                       | 110   | 495                            | 55:1        |
| 65                               | 60                                       | 120   | 570                            | 60:1        |
| 70                               | 65                                       | 130   | 645                            | 65:1        |
| 75                               | 70                                       | 140   | 730                            | 70:1        |

†† NOTE: TAPER RATES ARE DETERMINED USING THE FOLLOWING EQUATIONS:  
 L = WS FOR SPEEDS OF 45 MPH OR GREATER  
 L = 1.47WS FOR SPEEDS OF 30 MPH TO 44 MPH  
 WHERE: L = MINIMUM LENGTH OF TAPER IN FEET  
 W = WIDTH OF OFFSET (USUALLY LANE WIDTH IN FEET)  
 S = DESIGN SPEED OR 85TH PERCENTILE SPEED IN MILES PER HOUR

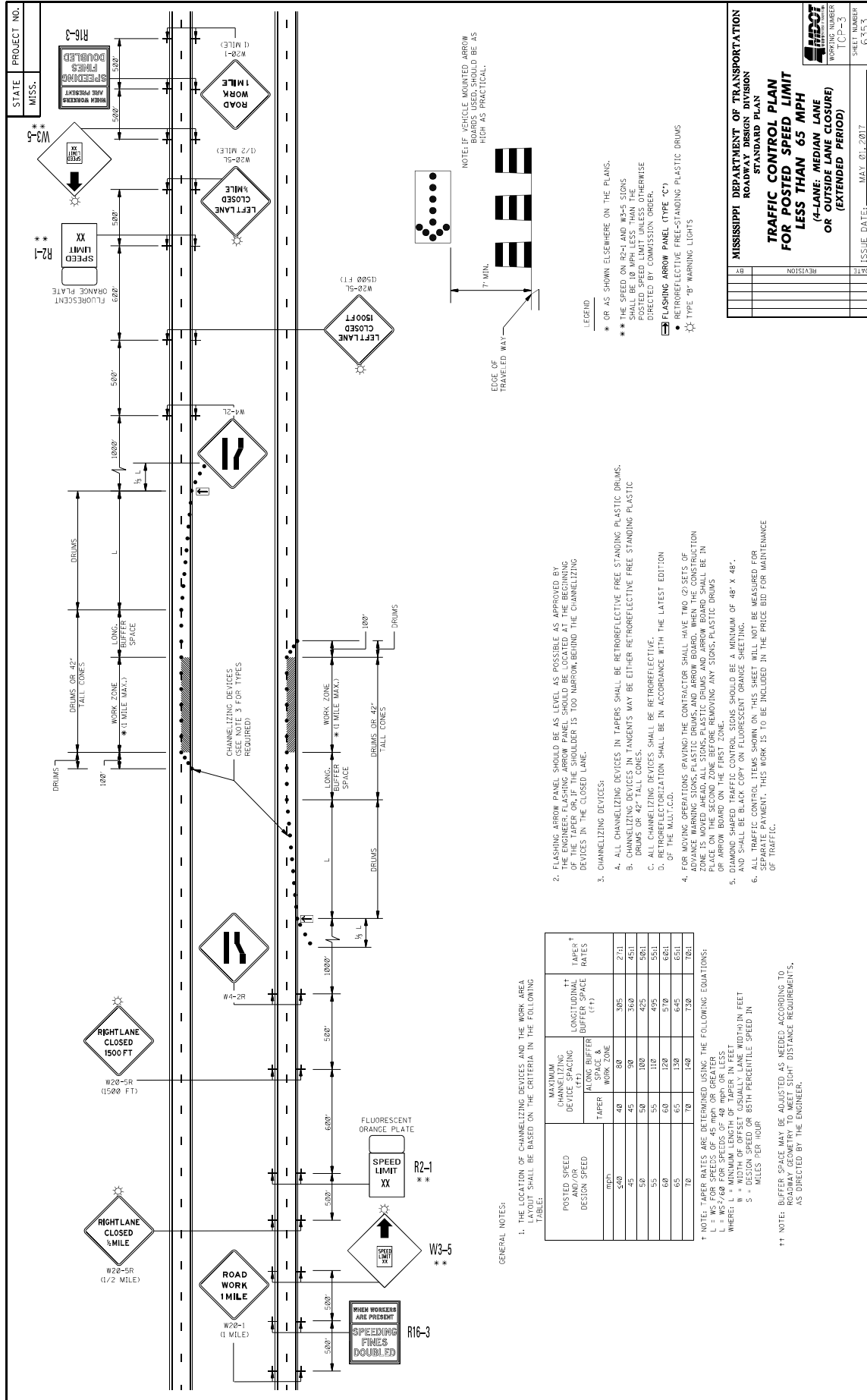

GENERAL NOTES:

1. THE LOCATION OF CHANNELIZING DEVICES AND THE WORK AREA LAYOUT SHALL BE BASED ON THE CRITERIA IN THE FOLLOWING TABLE:

| POSTED SPEED DESIGN SPEED (MPH) | MAXIMUM CHANNELIZING DEVICES SPACING (FEET) |           | TAPER LENGTH (FEET) | LONGITUDINAL BUFFER SPACE (FEET) | TRANSVERSE BUFFER SPACE (FEET) | TAPER RATES (%) |
|---------------------------------|---|-----------|---------------------|----------------------------------|--------------------------------|-----------------|
|                                 | ALONG BUFFER                                | WORK ZONE |                     |                                  |                                |                 |
| 40                              | 40  | 80        | 305                 | 305                              | 27.5                           | 7.5             |
| 45                              | 45  | 90        | 360                 | 360                              | 45.1                           | 7.5             |
| 50                              | 50  | 100       | 425                 | 425                              | 50.1                           | 7.5             |
| 55                              | 55  | 110       | 495                 | 495                              | 55.1                           | 7.5             |
| 60                              | 60  | 120       | 570                 | 570                              | 60.1                           | 7.5             |
| 65                              | 65  | 130       | 645                 | 645                              | 65.1                           | 7.5             |
| 70                              | 70  | 140       | 730                 | 730                              | 70.1                           | 7.5             |

† TAPER RATES ARE DETERMINED USING THE FOLLOWING EQUATIONS:

L = 45 FOR SPEEDS OF 45 MPH OR GREATER  
 L = 45/60 FOR SPEEDS OF 40 MPH OR LESS  
 WHERE: N = WIDTH OF OFFSET, USUALLY LANE WIDTH IN FEET  
 S = DESIGN SPEED OR 85TH PERCENTILE SPEED IN MILES PER HOUR

†† NOTE: BUFFER SPACE MAY BE ADJUSTED AS NEEDED, ACCORDING TO ROADWAY GEOMETRY TO MEET SIGHT DISTANCE REQUIREMENTS, AS DIRECTED BY THE ENGINEER.

2. FLASHING ARROW PANEL SHOULD BE AS LEVEL AS POSSIBLE AS APPROVED BY THE ENGINEER. FLASHING ARROW PANEL SHOULD BE LOCATED AT THE BEGINNING OF THE WORK ZONE. THE BUFFER SHOULD BE 100' AHEAD OF THE CHANNELIZING DEVICES IN THE CLOSED LANE.

3. CHANNELIZING DEVICES:

- A. ALL CHANNELIZING DEVICES IN TAPERS SHALL BE RETROREFLECTIVE FREE STANDING PLASTIC DRUMS.
- B. CHANNELIZING DEVICES IN TANGENTS MAY BE EITHER RETROREFLECTIVE FREE STANDING PLASTIC DRUMS OR 42" TALL CONES.

C. ALL CHANNELIZING DEVICES SHALL BE RETROREFLECTIVE.

D. RETROREFLECTORIZATION SHALL BE IN ACCORDANCE WITH THE LATEST EDITION OF THE MUTCD.

4. FOR TAPERING (WORK) TANGENTS THE CONTRACTOR SHALL HAVE TWO (2) FEET OF WORKING SPACE. CHANNELIZING DEVICES SHALL BE LOCATED AT THE BEGINNING OF THE WORK ZONE. CHANNELIZING DEVICES SHALL BE LOCATED AT THE BEGINNING OF THE WORK ZONE. CHANNELIZING DEVICES SHALL BE LOCATED AT THE BEGINNING OF THE WORK ZONE. CHANNELIZING DEVICES SHALL BE LOCATED AT THE BEGINNING OF THE WORK ZONE.

5. ALL CHANNELIZING DEVICES SHALL BE 48" X 48".

6. ALL TRAFFIC CONTROL ITEMS SHOWN ON THIS SHEET WILL NOT BE MEASURED FOR SEPARATE PAYMENT. THIS WORK IS TO BE INCLUDED IN THE PRICE BID FOR MAINTENANCE OF TRAFFIC.

OR AS SHOWN ELSEWHERE ON THE PLANS.  
 \* THE SPEED ON R2-1 AND R2-2 SIGNS SHALL BE 10 MPH LESS THAN THE POSTED SPEED LIMIT UNLESS OTHERWISE DIRECTED BY COMMISSION ORDER.

FLASHING ARROW PANEL (TYPE 'C')

RETROREFLECTIVE FREE-STANDING PLASTIC DRUMS

TYPE 'B' WARNING LIGHTS

LEGEND

OR AS SHOWN ELSEWHERE ON THE PLANS.

THE SPEED ON R2-1 AND R2-2 SIGNS SHALL BE 10 MPH LESS THAN THE POSTED SPEED LIMIT UNLESS OTHERWISE DIRECTED BY COMMISSION ORDER.

FLASHING ARROW PANEL (TYPE 'C')

RETROREFLECTIVE FREE-STANDING PLASTIC DRUMS

TYPE 'B' WARNING LIGHTS

MISSISSIPPI DEPARTMENT OF TRANSPORTATION  
 ROADWAY DESIGN DIVISION  
 STANDARD PLAN  
**TRAFFIC CONTROL PLAN  
 FOR POSTED SPEED LIMIT  
 LESS THAN 65 MPH  
 (4-LANE, MEDIAN LANE  
 OR OUTSIDE LANE CLOSURE)  
 (EXTENDED PERIOD)**

WORKING NUMBER: TCP-3  
 SHEET NUMBER: 6353

ISSUE DATE: MAY 01, 2017



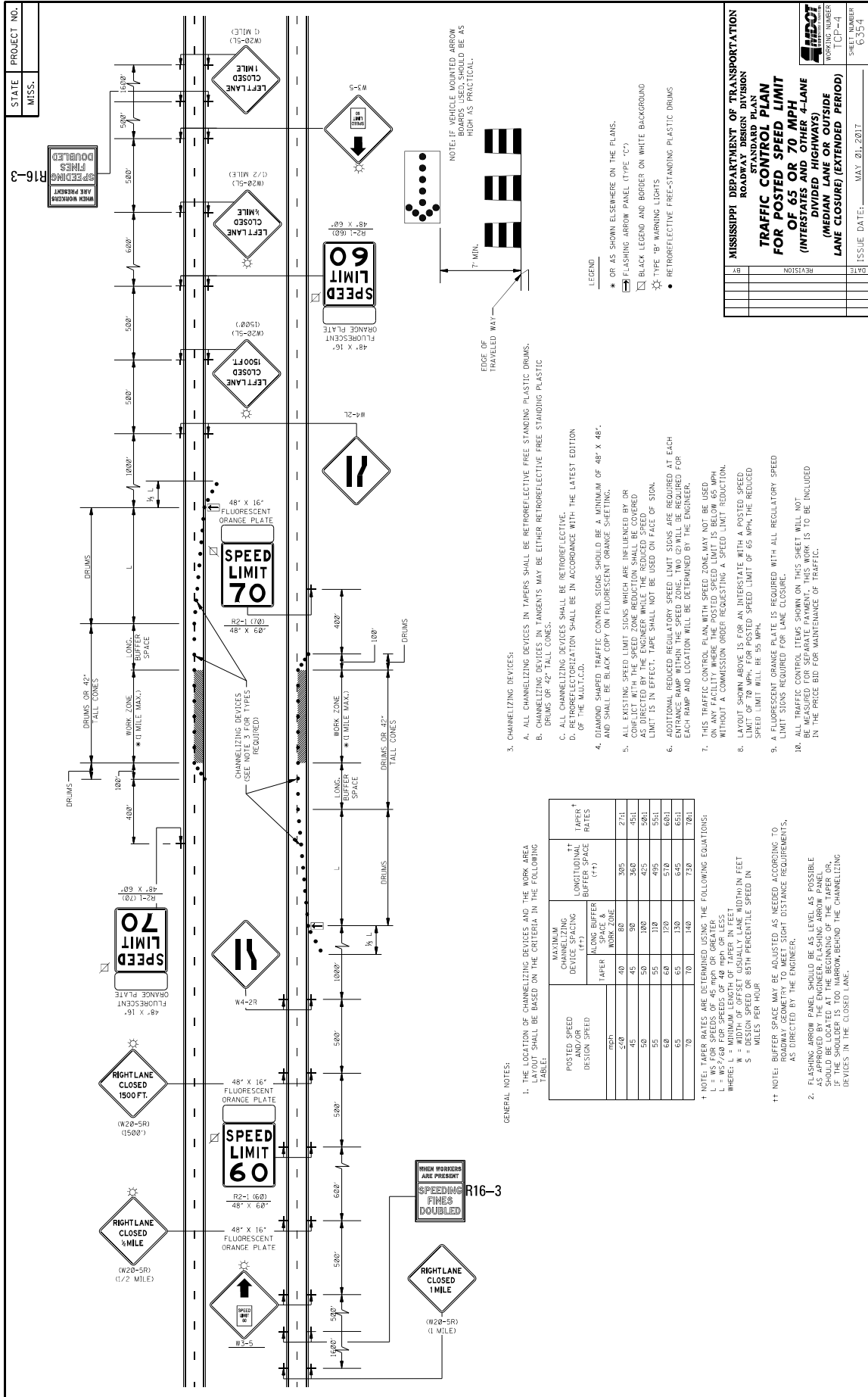

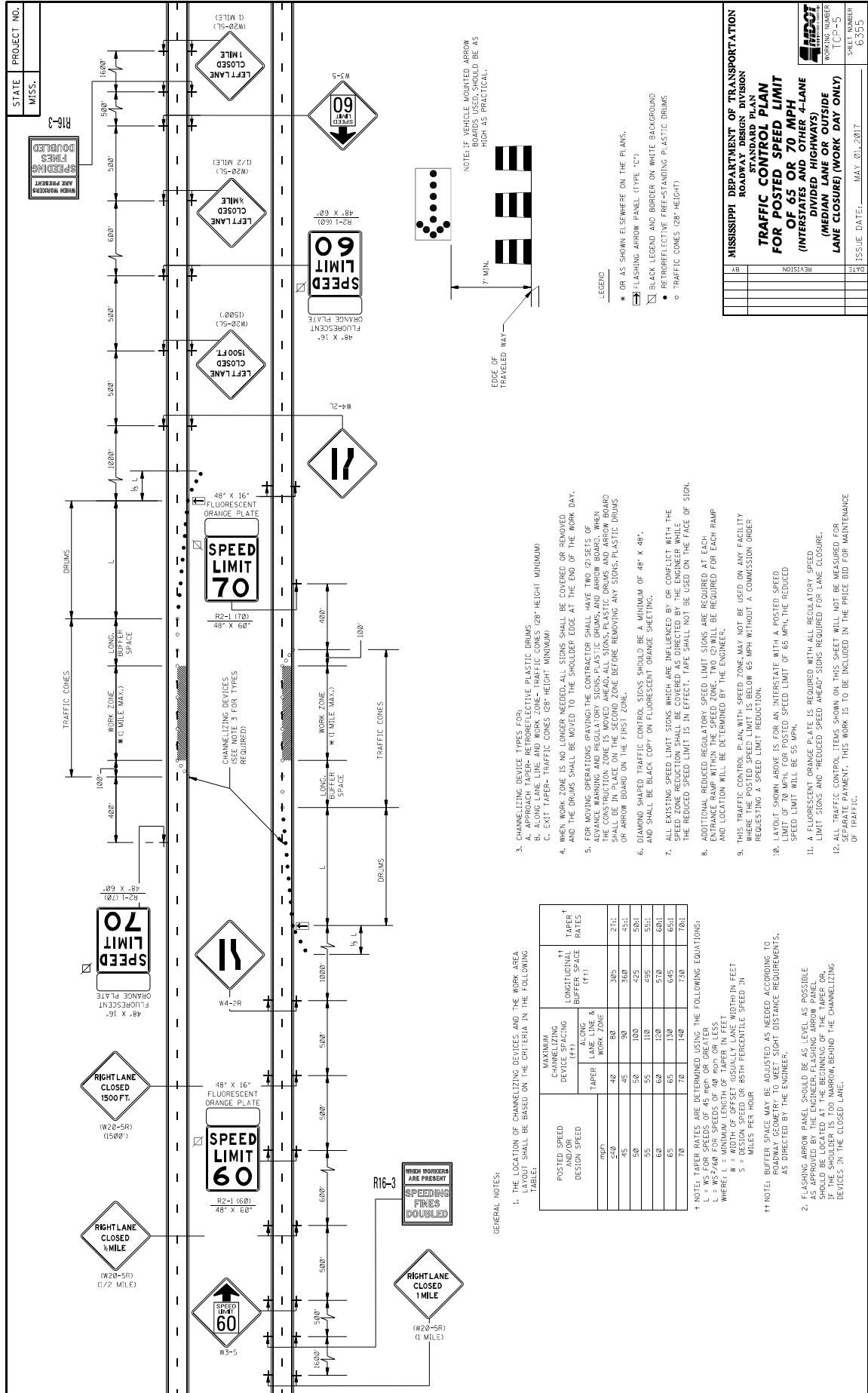

STATE PROJECT NO.  
MISS.

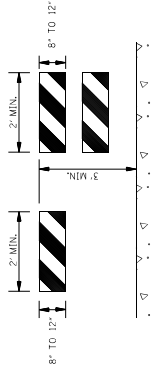

TYPE I  
TYPE II

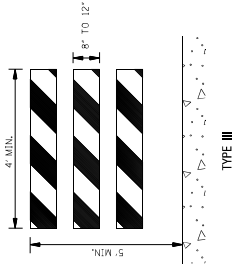

TYPE III

**STANDARD BARRICADES**

1. THE MARKING FOR BARRICADE RAILS SHALL BE ORANGE AND WHITE (SLOPING DOWNWARD AT AN ANGLE OF 45° IN THE DIRECTION OF TRAFFIC IS TO PASS).
2. RAIL STRIPE SHALL BE 6 INCHES, EXCEPT THAT 4-INCH WIDE STRIPES MAY BE USED IF RAIL LENGTHS ARE LESS THAN 36 INCHES.
3. DO NOT PLACE SANDBAGS OR OTHER DEVICES TO PROVIDE MASS ON THE BOTTOM RAIL THAT WILL BLOCK VIEW OR RAIL FACE.
4. FOR ADDITIONAL INFORMATION OR DETAILS, SEE MUTCD, LATEST EDITION.
5. BARRICADES ARE CLASSIFIED BY FHWA AS CATEGORY II WORK ZONE DEVICES WHICH REQUIRE SUCCESSFUL CRASH TESTING. A LIST OF CRASHWORTHY BARRICADES AND OTHER CATEGORY II DEVICES CAN BE FOUND ON FHWA'S WEBSITE: [http://safety.fhwa.dot.gov/roadway\\_dept/policy\\_guidance/road\\_hardware/cat2.cfm](http://safety.fhwa.dot.gov/roadway_dept/policy_guidance/road_hardware/cat2.cfm)

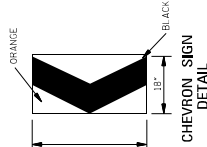

CHEVRON SIGN  
DETAIL

1. A CHEVRON SIGN CONSISTS OF A BLACK CHEVRON TYPE MARKING ON AN ORANGE BACKGROUND AND SHALL POINT IN THE DIRECTION OF TRAFFIC FLOW.
2. THE CHEVRON SIGN SHALL BE MOUNTED ON CRASHWORTHY SUPPORT.
3. CHEVRON SIGNS MAY BE USED TO SUPPLEMENT OTHER STANDARD DEVICES WHERE ONE OR MORE LANES ARE CLOSED FOR CONSTRUCTION OR MAINTENANCE. THEY SHOULD BE PLACED APPROXIMATELY 2'-0" BEHIND THE LANE TRANSITION STRIPE.

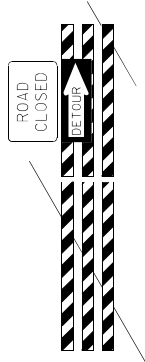

BARRICADE CLOSING A ROAD

**BARRICADE CHARACTERISTICS**

|   | I                      | II                     | III   |
|---|------------------------|------------------------|---|
| WIDTH OF RAIL **                        | 8" MIN. - 12" MAX.     | 8" MIN. - 12" MAX.     | 8" MIN. - 12" MAX.  |
| LENGTH OF RAIL **                       | 24" MIN.               | 24" MIN.               | 48" MIN.  |
| WIDTH OF STRIPE **                      | 6"                     | 6"                     | 6"  |
| HEIGHT                                  | 36" MIN.               | 36" MIN.               | 60" MIN.  |
| NUMBER OF RETROREFLECTORIZED RAIL FACES | 2 (ONE EACH DIRECTION) | 4 (TWO EACH DIRECTION) | 3 IF FACING TRAFFIC IN ONE DIRECTION<br>6 IF FACING TRAFFIC IN TWO DIRECTIONS |

- \* 1. FOR RAILS LESS THAN 36" LONG, 4" WIDE STRIPES MAY BE USED.
- \*\* 2. BARRICADES INTENDED FOR USE ON EXPRESSWAYS, FREEWAYS AND OTHER HIGH SPEED ROADWAYS, SHALL HAVE A MINIMUM OF 270 IN<sup>2</sup> OF REFLECTIVE AREA FACING TRAFFIC.

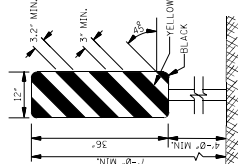

TYPE 3 OBJECT MARKER  
(OM-3R)

1. TYPE 3 OBJECT MARKERS SHALL BE USED AT ALL EXPOSED BRIDGE ABUTMENTS AND AT OTHER LOCATIONS AS DEEMED NECESSARY BY THE ENGINEER.
2. THE OM-3R IS SIMILAR EXCEPT THE STRIPES SLOPE DOWNWARD FROM THE UPPER LEFT SIDE TO THE LOWER RIGHT SIDE AND SHALL BE PLACED ON THE LEFT SIDE OF THE OBJECT.
3. THE INSIDE EDGE OF THE MARKER SHALL BE IN LINE WITH THE INNER EDGE OF THE OBSTRUCTION.

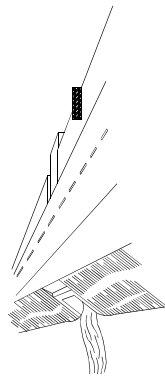

**WING BARRICADES**

1. WING BARRICADES ARE TYPE III BARRICADES ERECTED ON THE SHOULDER OF A ROADWAY TO RESTRICT TRAFFIC FROM ENTERING OR EXITING A WORK ZONE OR RESTRICTED ROADWAY. WING BARRICADES MAY BE USED AS A MOUNTING FOR THE ADVANCE WARNING SIGNS OR FLASHERS.
2. WING BARRICADES SHOULD BE USED:
  - A. IN ADVANCE OF A CONSTRUCTION PROJECT EVEN WHEN NO PART OF THE ROADWAY IS ACTUALLY CLOSED.
  - B. IN ADVANCE OF ALL BRIDGE OR CULVERT WIDENING OPERATIONS.

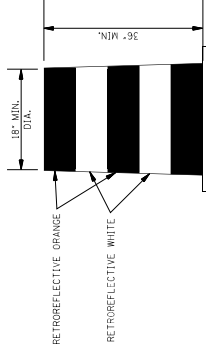

**PLASTIC DRUM STRIPING DETAIL**

1. PLASTIC DRUMS SHALL BE ON END AND USED AS AN EXPEDITED METHOD FOR TRAFFIC CHANNELIZATION. THE COLOR AND MARKING OF DRUMS SHALL BE CONSISTENT WITH MUTCD. STRIPES SHALL BE RETROREFLECTIVE. COLOR OF DRUMS SHALL BE WHITE. STRIPES SHALL BE RETROREFLECTIVE. HORIZONTAL, CIRCUMFERENTIAL STRIPES 12 ORANGE & 2 WHITE/6" WIDE.
2. DRUMS SHOULD NEVER BE PLACED IN THE ROADWAY WITHOUT WARNING SIGNS.
3. WHERE PRACTICAL PLASTIC DRUMS SHOULD BE PLACED NO CLOSER THAN 3'-0" FROM THE EDGE OF TRAVELED LANE.

MISSISSIPPI DEPARTMENT OF TRANSPORTATION  
ROADWAY DESIGN DIVISION  
STANDARD PLAN

**HIGHWAY SIGN AND BARRICADE DETAILS FOR CONSTRUCTION PROJECTS**

| NO. | REVISION | DATE |
|-----|----------|------|
|     |          |      |
|     |          |      |
|     |          |      |
|     |          |      |
|     |          |      |

ISSUE DATE: MAY 01, 2017

WORKING NUMBER: TCEP-6  
SHEET NUMBER: 6350B

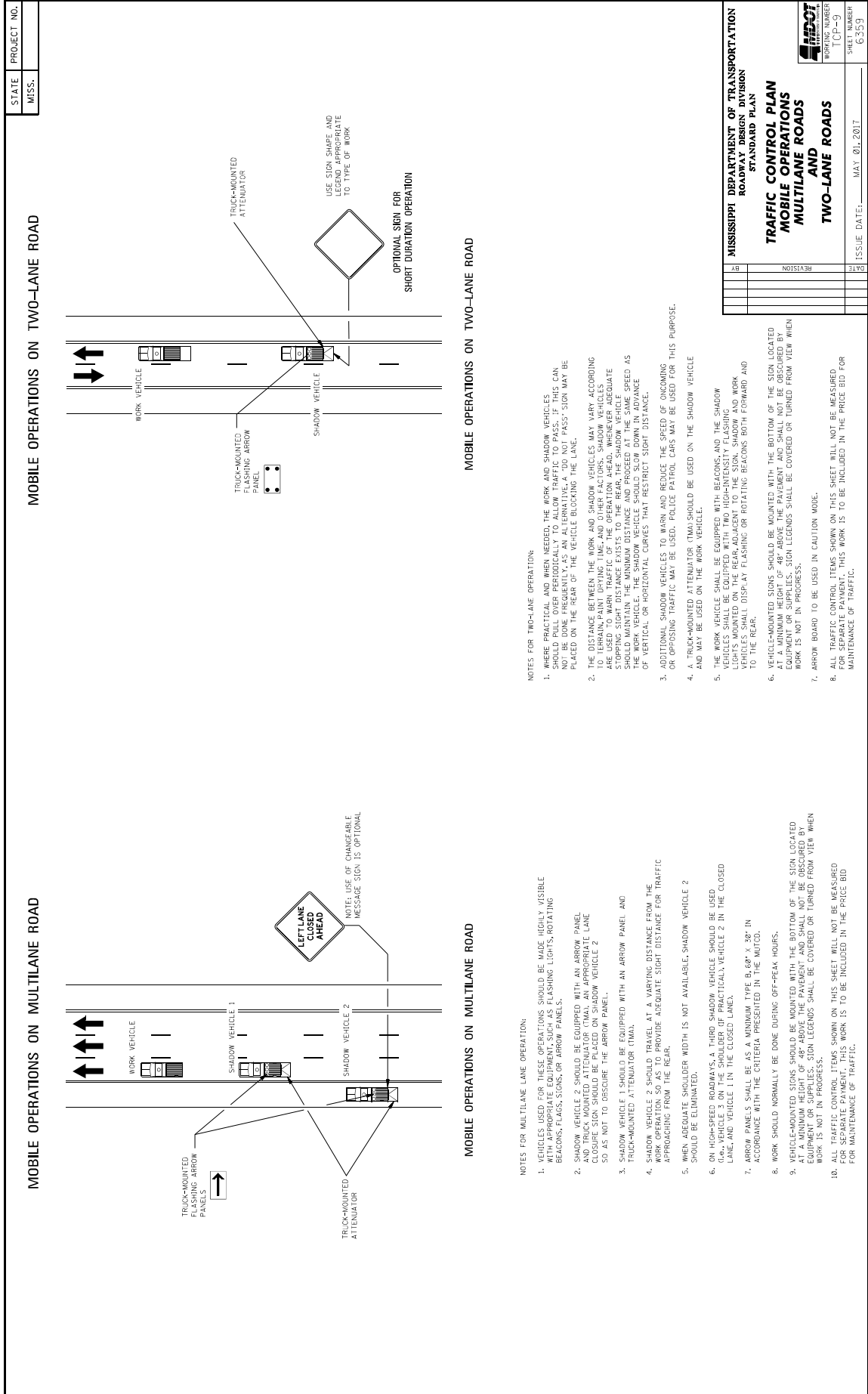

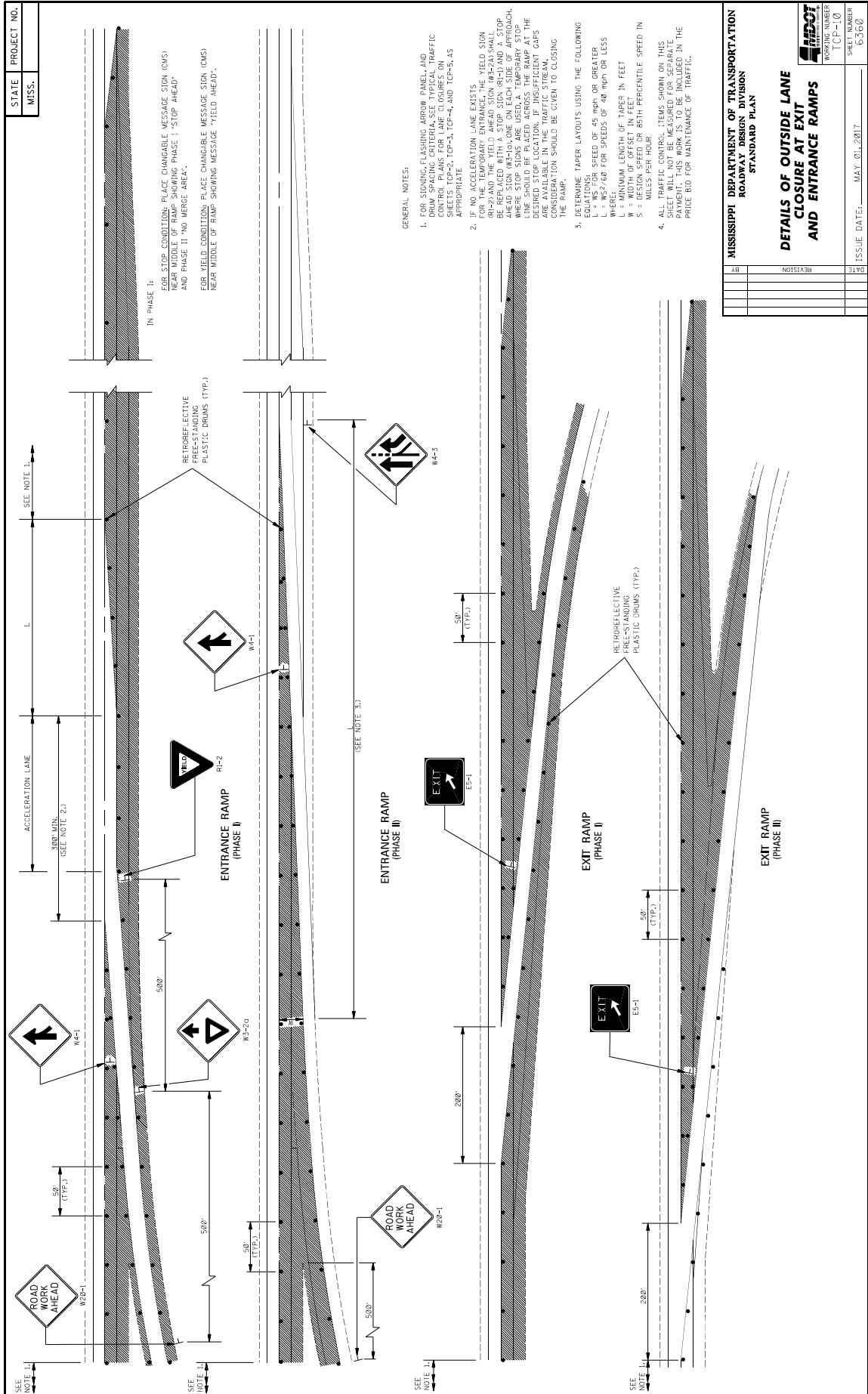

GENERAL NOTES:

- FOR SIGNING FLASHING ARROW PANEL AND DRUM SPACING CRITERIA SEE TYPICAL TRAFFIC CONTROL PLANS FOR LANE CLOSURES ON APPROXIMATELY 20' TOP-3, TOP-4, AND TOP-5, AS APPROPRIATE.
- IF NO ACCELERATION LANE EXISTS FOR THE TEMPORARY LANE ENTRIES (RH-2) AND THE YIELD AHEAD SIGN (W3-2A) SHALL BE REPLACED WITH A STOP SIGN (R1-1) AND A STOP LINE SHOULD BE PLACED ACROSS THE RAMP AT THE DESIRED STOP LOCATION IF INSUFFICIENT GAPS CONSIDERATION SHOULD BE GIVEN TO CLOSING THE RAMP.
- DETERMINE TAPER LAYOUTS USING THE FOLLOWING EQUATIONS: SPEEDS OF 45 MPH OR GREATER  
 $L = WS^2/60$  FOR SPEEDS OF 40 MPH OR LESS  
WHERE:  
L = MINIMUM LENGTH OF TAPER IN FEET  
S = DESIGN SPEED OR 80TH PERCENTILE SPEED IN MILES PER HOUR
- ALL TRAFFIC CONTROL ITEMS SHOWN ON THIS SHEET WILL NOT BE MEASURED FOR SEPARATE BIDDING. ALL TRAFFIC CONTROL ITEMS SHOWN IN THE PRICE BID FOR MAINTENANCE OF TRAFFIC.

|                |             |
|----------------|-------------|
| STATE<br>MISS. | PROJECT NO. |
|----------------|-------------|

|  |                          |
|--|--------------------------|
| MISSISSIPPI DEPARTMENT OF TRANSPORTATION                         |                          |
| ROADWAY DESIGN DIVISION  |                          |
| STANDARD PLAN  |                          |
| <b>DETAILS OF OUTSIDE LANE CLOSURE AT EXIT AND ENTRANCE RAMP</b> |                          |
| MISSISSIPPI DEPARTMENT OF TRANSPORTATION                         |                          |
| DATE   | ISSUE DATE: MAY 01, 2017 |
| REVISION   | SHEET NUMBER             |
|  | 63060                    |
| WORKING NUMBER   | ICP-110                  |
| ICP-110  |                          |

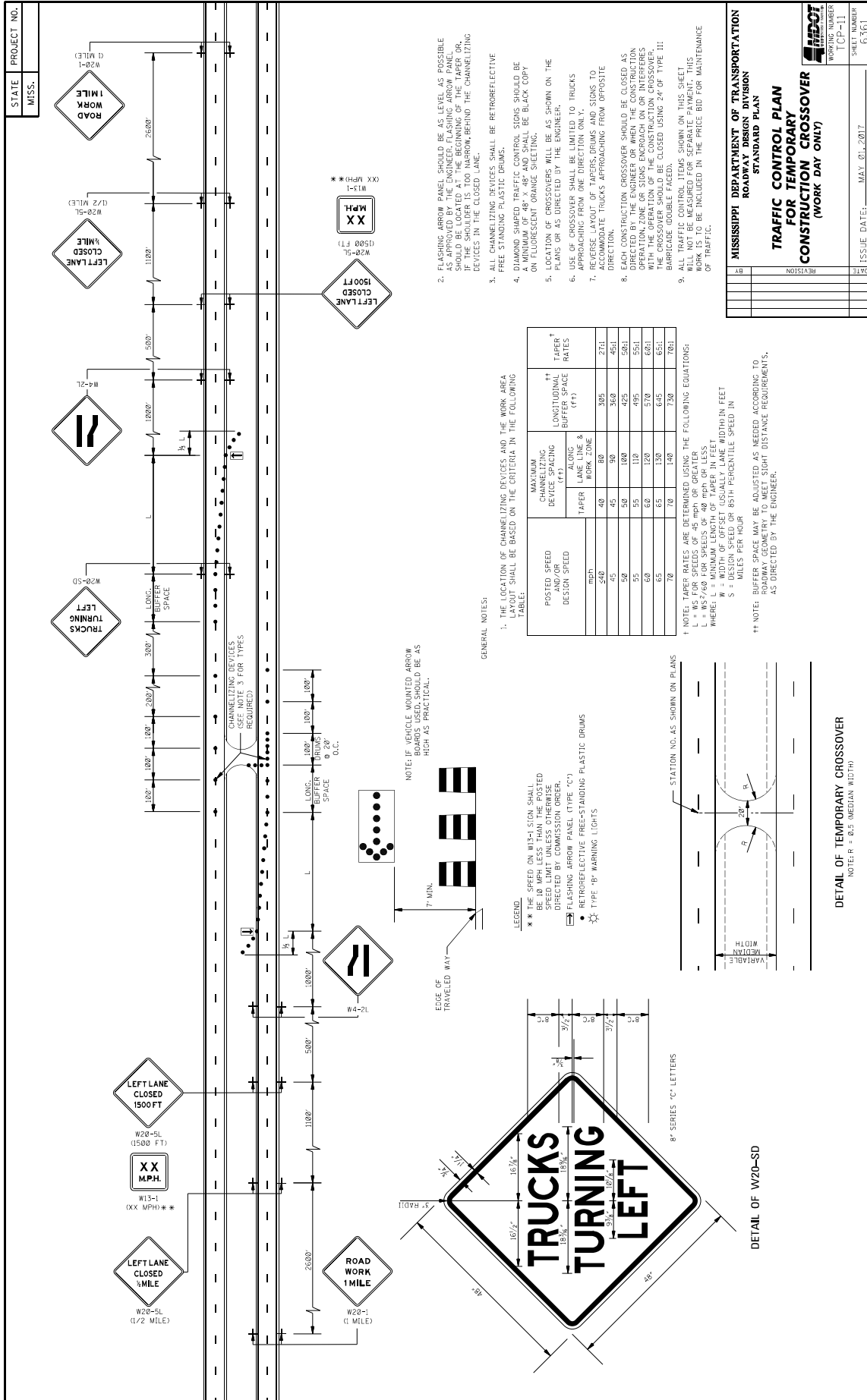

|       |             |
|-------|-------------|
| STATE | PROJECT NO. |
| MISS. |             |

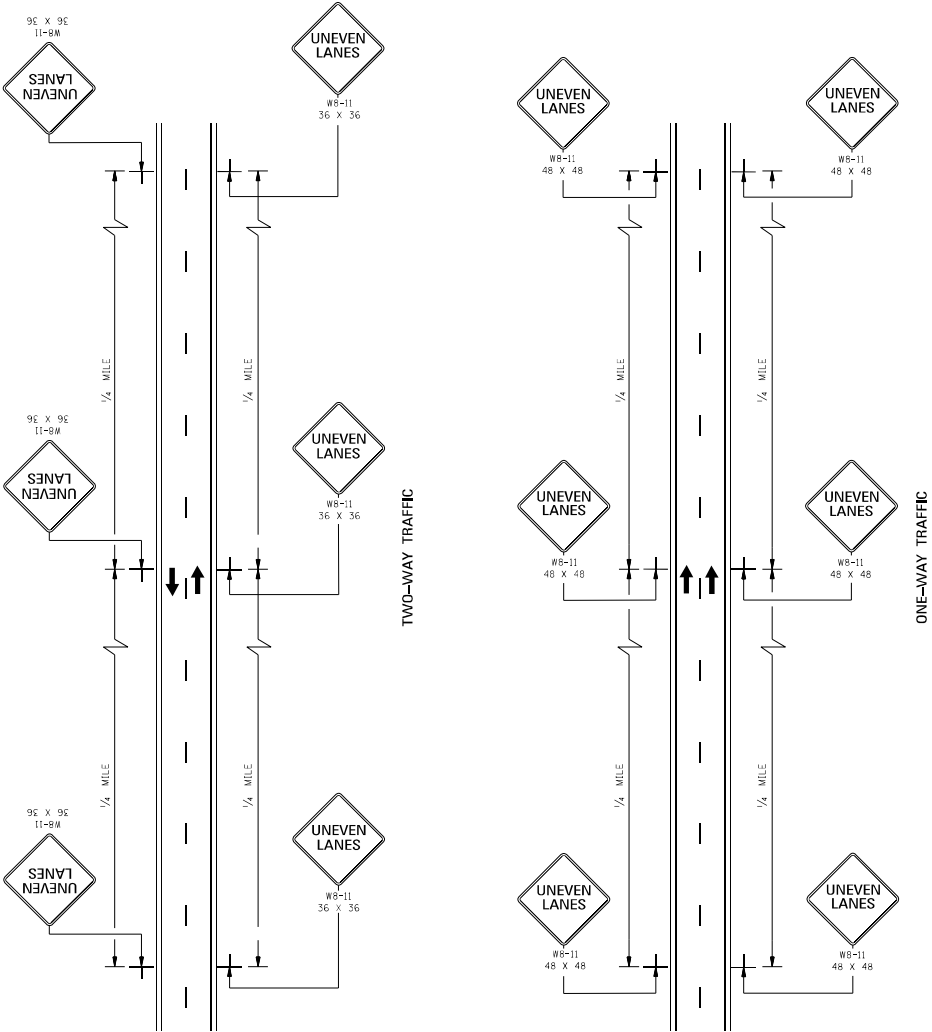

GENERAL NOTES:

- UNEVEN LANE LINE.
  - IF LESS THAN OR EQUAL TO 1/4 MILE, NO SIGNS REQUIRED.
  - IF MORE THAN 1/4 MILE AND LESS THAN 1/2 MILE, PLACE SIGNS AS SHOWN ON THIS SHEET.
  - IF MORE THAN 1/2 MILE, PLACE SIGNS AS SHOWN ON THIS SHEET.
  - IF GREATER THAN 1/4 MILE, TRAFFIC SHOULD NOT BE ALLOWED TO CROSS UNEVEN LANE LINE.
- THE WB-11 SIGNS SHOULD BE SPACED AT 1/4-MILE INTERVALS THROUGHOUT UNEVEN LANE LINE LIMITS.
- ALL TRAFFIC CONTROL ITEMS SHOWN ON THIS SHEET SHALL BE PAID FOR UNDER MAINTENANCE OF TRAFFIC.

|  |              |
|--|--------------|
| MISSISSIPPI DEPARTMENT OF TRANSPORTATION<br>ROADWAY DESIGN DIVISION<br>STANDARD PLAN |              |
| <b>TRAFFIC CONTROL PLANS<br/>UNEVEN PAVEMENT<br/>DETAILS</b>                         |              |
| WORKING NUMBER   | SHEET NUMBER |
| ICP-12   | 6362         |
| DATE   | ISSUE DATE   |
|  | MAY 01, 2017 |
| REVISION   |              |
| BY   |              |

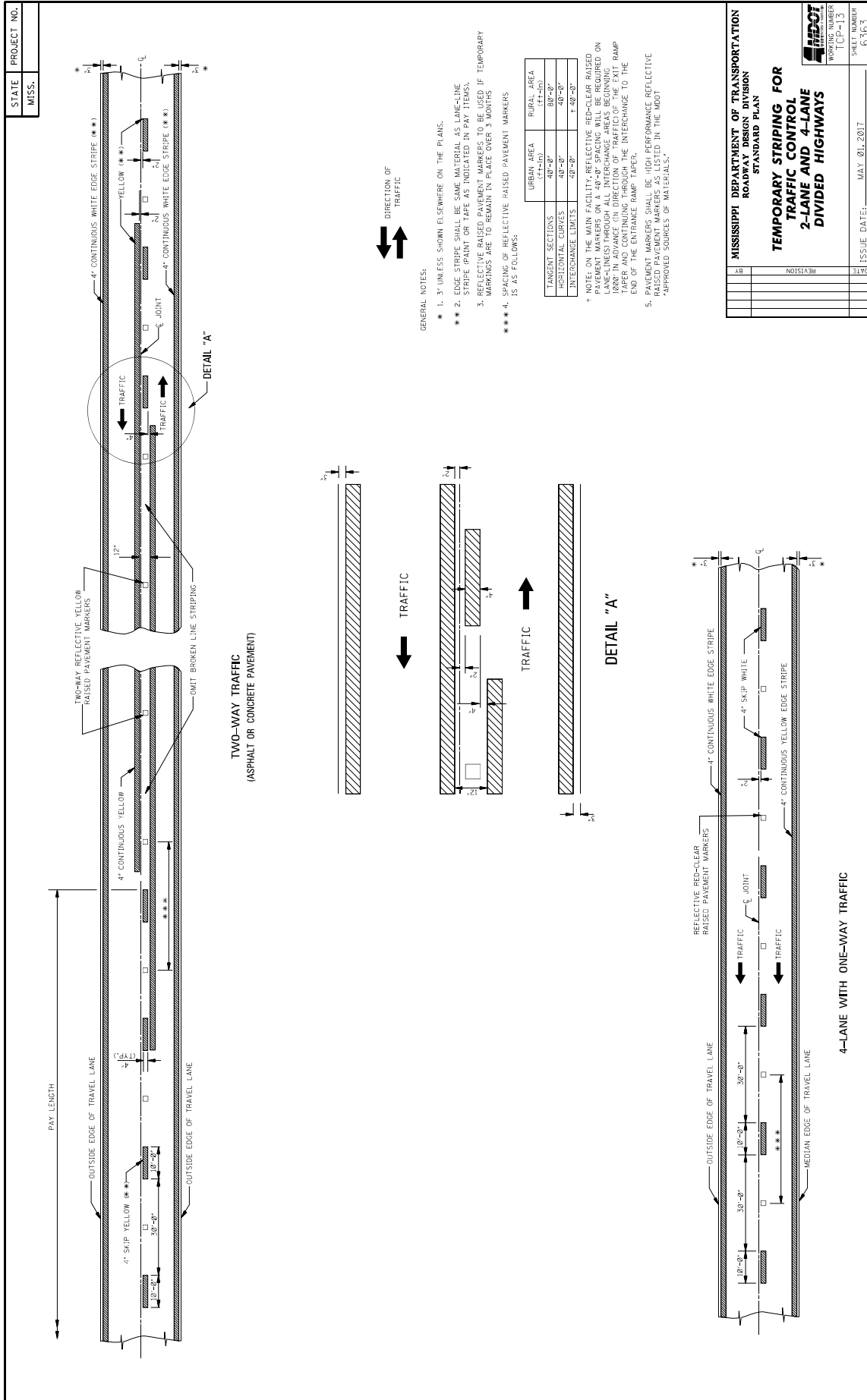



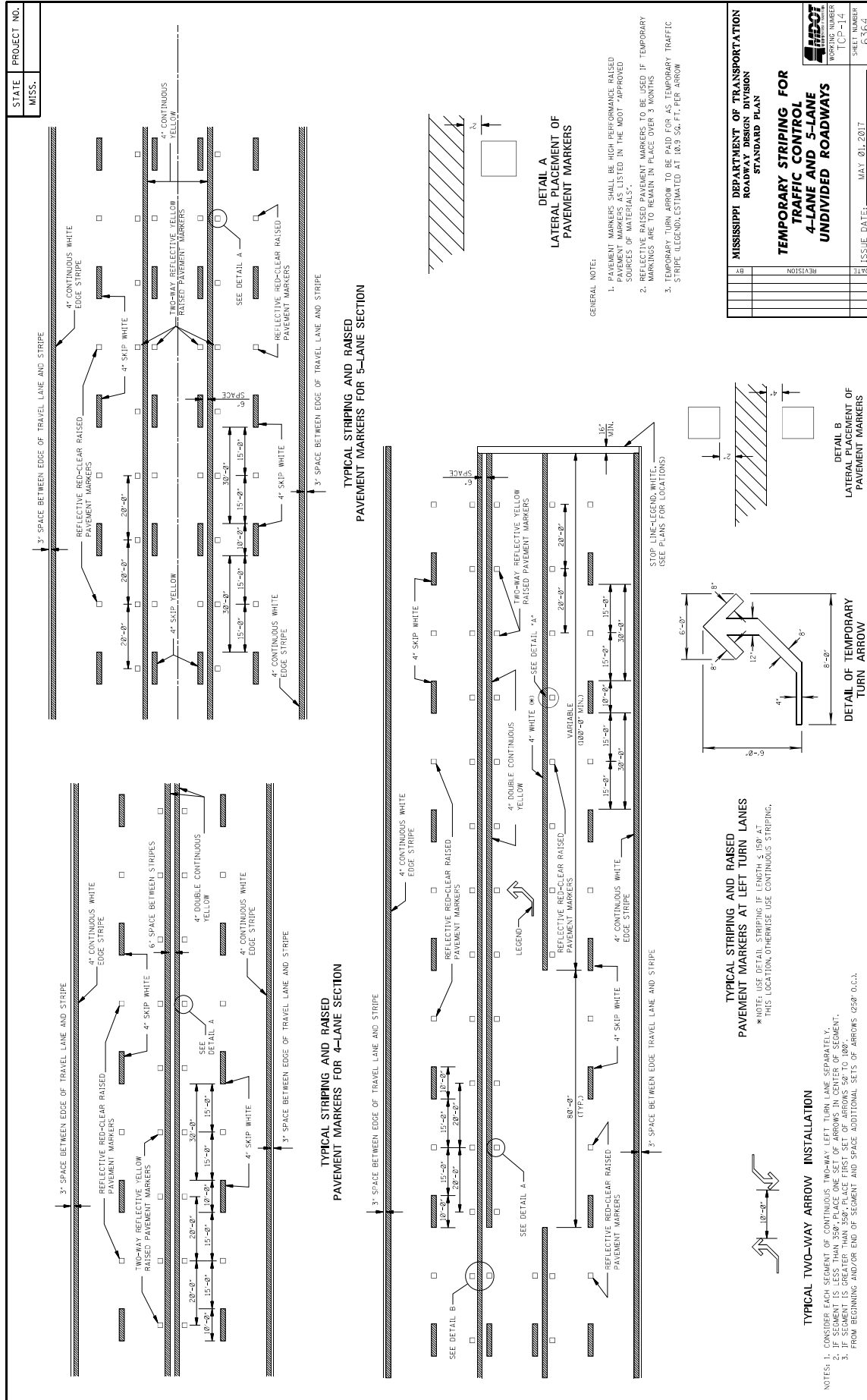

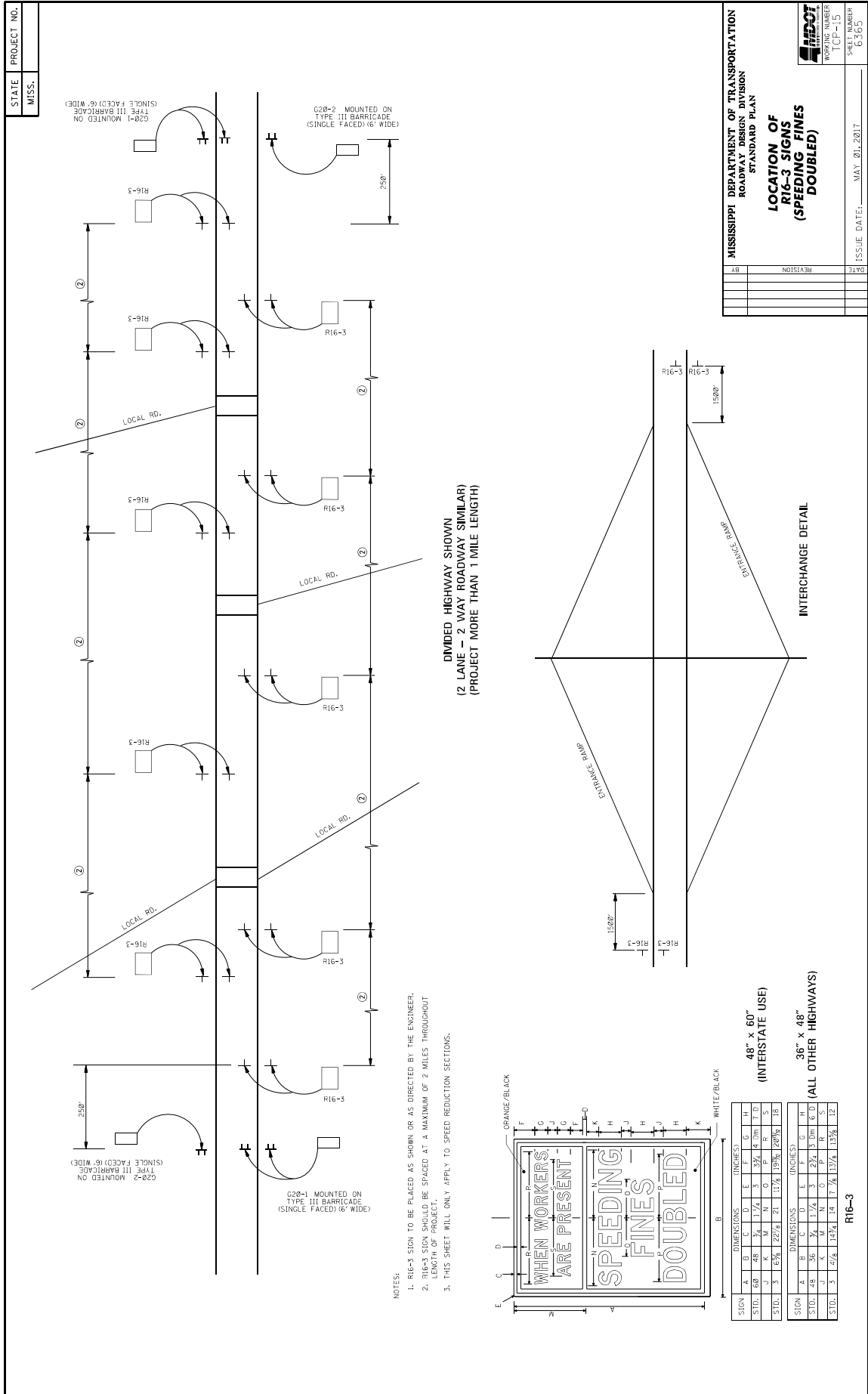

|       |             |
|-------|-------------|
| STATE | PROJECT NO. |
| MISS. |             |

|  |              |
|--|--------------|
| MISSISSIPPI DEPARTMENT OF TRANSPORTATION<br>ROADWAY DESIGN DIVISION<br>STANDARD PLAN |              |
| <b>LOCATION OF<br/>R16-3 SIGNS<br/>(SPEEDING FINES<br/>DOUBLED)</b>                  |              |
| WORKING NUMBER   | ICP-15       |
| SHEET NUMBER   | 6366         |
| ISSUE DATE:  | MAY 20, 2017 |

- NOTES:
1. R16-3 SIGN TO BE PLACED AS SHOWN OR AS DIRECTED BY THE ENGINEER.
  2. R16-3 SIGN SHOULD BE SPACED AT A MAXIMUM OF 2 MILES THROUGHOUT LENGTH OF PROJECT.
  3. THIS SHEET WILL ONLY APPLY TO SPEED REDUCTION SECTIONS.

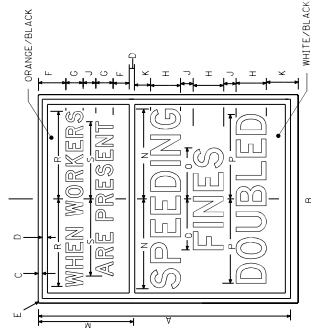

|      |     |                     |        |       |       |       |     |       |       |       |       |       |       |       |
|------|-----|---------------------|--------|-------|-------|-------|-----|-------|-------|-------|-------|-------|-------|-------|
| SIGN |     | DIMENSIONS (INCHES) |        |       |       |       |     |       |       |       |       |       |       |       |
| A    | B   | C                   | D      | E     | F     | G     | H   | I     | J     | K     | L     | M     | N     | O     |
| STD. | 6-0 | 48                  | 36     | 1-1/4 | 5-1/4 | 4     | 1/2 | 1-1/4 | 1-1/4 | 1-1/4 | 1-1/4 | 1-1/4 | 1-1/4 | 1-1/4 |
| SIGN |     | DIMENSIONS (INCHES) |        |       |       |       |     |       |       |       |       |       |       |       |
| A    | B   | C                   | D      | E     | F     | G     | H   | I     | J     | K     | L     | M     | N     | O     |
| STD. | 3   | 47-1/4              | 35-1/4 | 1-1/4 | 4-3/4 | 3-1/2 | 1/2 | 1-1/4 | 1-1/4 | 1-1/4 | 1-1/4 | 1-1/4 | 1-1/4 | 1-1/4 |

**48" x 60"**  
(INTERSTATE USE)

**36" x 48"**  
(ALL OTHER HIGHWAYS)

**R16-3**

|                |             |  |
|----------------|-------------|--|
| STATE<br>MISS. | PROJECT NO. |  |
|----------------|-------------|--|

**TYPICAL SHOULDER CLOSURE**

(1) TO BE USED WITH EIGHT (8) FOOT OR GREATER WIDTH IMPROVED SHOULDER.  
(2) TO BE USED WHEN CONSTRUCTION VEHICLES (EQUIPMENT) ENCRUSHES ON OR WITHIN TWO (2) FEET OF THE SHOULDER BREAK.

**TYPICAL SHOULDER WORK #1**  
(SEE NOTE A-I THIS SHEET)

**TYPICAL SHOULDER WORK #2**

NOTE:  
WORK OUTSIDE TWO (2) FOOT AND WITHIN TEN (10) FEET OF THE SHOULDER BREAK MAY BE PROTECTED BY PLACING DRUMS ALONG THE SHOULDER EDGE 300 FEET PRIOR TO AND 50 FEET BEYOND THE WORK AREA, OR SEE NOTE A-3 THIS SHEET.

**DETAIL OF DRUM PLACEMENT AT PAVEMENT EDGE DROP-OFF**

GRANULAR MATERIAL REQUIRED (SAME CLASSIFICATION AS SHOULDER MATERIAL, SEE TYPICAL SECTIONS)

**NOTES:**

\* A. PAVEMENT EDGE DROP-OFF

1. IF LESS THAN TWO AND ONE QUARTER (2.25) INCHES-NO PROTECTION REQUIRED. PLACE A SHOULDER SIGN (W21-5) 500 FEET IN ADVANCE OF WORK ZONE SHOULDER AND A LOW SHOULDER SIGN (W8-9) AT THE BEGINNING AND THROUGHOUT THE WORK ZONE B (1508'+O.C.).
2. TWO AND ONE QUARTER TO THREE INCHES-PLACE DRUMS, VERTICAL PANELS OR BARRICADES EVERY 100 FEET ON TANGENT SECTIONS FOR SPEEDS OF 50 MILES PER HOUR OR GREATER. CONES MAY BE USED IN PLACE OF DRUMS, PANELS, AND BARRICADES DURING DAYLIGHT HOURS. FOR TANGENT SECTIONS WITH SPEEDS LESS THAN 50 MILES PER HOUR AND FOR CURVES, DEVICES SHOULD BE PLACED EVERY 50 FEET. SPACING FOR TAPERS SHOULD BE IN ACCORDANCE WITH THE MULTIPLIER  $L/3L$ , WHERE L IS THE TAPER LENGTH IN FEET.
3. GREATER THAN THREE (3) INCHES-POSITIVE SEPARATION OR WEDGE WITH 4:1 OR FLATTER SLOPE NEEDED. IF THERE IS EIGHT (8) FEET OR MORE DISTANCE BETWEEN THE EDGE OF TRAVEL LANE AND DROP-OFF, THEN DRUMS, PANELS OR BARRICADES MAY BE USED.
4. FOR TEMPORARY CONDITIONS, DROP-OFFS GREATER THAN THREE (3) INCHES MAY BE PROTECTED WITH DRUMS, VERTICAL PANELS OR BARRICADES FOR SHORT DISTANCES DURING DAYLIGHT HOURS WHILE WORK IS BEING DONE IN THE DROP-OFF AREA.
5. LESSER TREATMENTS THAN THOSE DESCRIBED ABOVE MAY BE CONSIDERED FOR LOW-VOLUME LOCAL STREETS.

**B. DRUM SPACING**

1. TANGENTS =  $2 \times S$
2. WHERE  $S =$  SPEED IN MPH (POSTED OR 85 PERCENTILE)
3. WHERE  $L =$  TAPER LENGTH IN FEET
4. WHERE  $W =$  WIDTH OF OFFSET IN FEET

**C. ALL TRAFFIC CONTROL ITEMS SHOWN ON THIS SHEET SHALL BE PAID FOR UNDER MAINTENANCE OF TRAFFIC.**

TABLE V-1 GUIDELINES FOR LENGTH OF LONGITUDINAL BUFFER SPACE

| X  | X * SPEED (MPH) | LENGTH (FEET) |
|----|-----------------|---------------|
| 25 | 25              | 625           |
| 30 | 30              | 900           |
| 35 | 35              | 1225          |
| 40 | 40              | 1600          |
| 45 | 45              | 2025          |
| 50 | 50              | 2500          |
| 55 | 55              | 3025          |
| 60 | 60              | 3600          |
| 65 | 65              | 4225          |

\* \* \* POSTED SPEED, OFF-PEAK 85 PERCENTILE SPEED PRIOR TO WORK STARTING, OR THE ANTICIPATED OPERATING SPEED IN MPH.

**MISSISSIPPI DEPARTMENT OF TRANSPORTATION**  
ROADWAY DESIGN DIVISION  
STANDARD PLAN

**TRAFFIC CONTROL DETAILS**  
**DRUM PLACEMENT**  
**SHOULDER CLOSURE**

|      |          |
|------|----------|
| DATE | REVISION |
|      |          |
|      |          |
|      |          |
|      |          |
|      |          |

ISSUE DATE: MAY 01, 2017  
SHEET NUMBER: T-CP-16  
PROJECT NUMBER: G5366

|       |             |
|-------|-------------|
| STATE | PROJECT NO. |
| MISS. |             |

- GENERAL NOTES
- GROUND-IN RUMBLE STRIPES SHALL BE APPLIED ON LEFT AND RIGHT SHOULDERS OF ALL PAVED SHOULDERS ON THIS PROJECT.
  - GROUND-IN RUMBLE STRIPES SHALL BE APPLIED TO ALL PAVED SHOULDERS ON ROADWAYS OR OTHER INTERUPTIONS IN NORMAL SHOULDER WIDTH AS DIRECTED BY THE ENGINEER.
  - COST TO BE PAID FOR USING APPROPRIATE PAY ITEMS.
  - GROUND-IN RUMBLE STRIPES SHALL BE APPLIED TO:
    - MAINLINE
    - INTERSECTING ROADWAY IF OVERLAD OR RECONSTRUCTED BEYOND NORMAL MAINLINE R.O.W.
    - ANY ROADWAY WITH EXISTING RUMBLE STRIPES PRIOR TO CONSTRUCTION.
  - DO NOT USE WHERE TRAVEL LANE IS LESS THAN 11' WIDE.

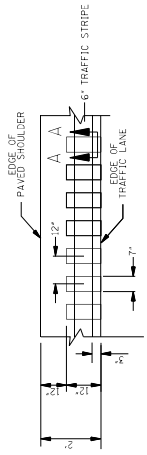

DETAIL "A"

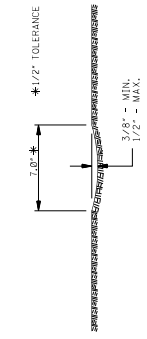

SECTION "A-A"

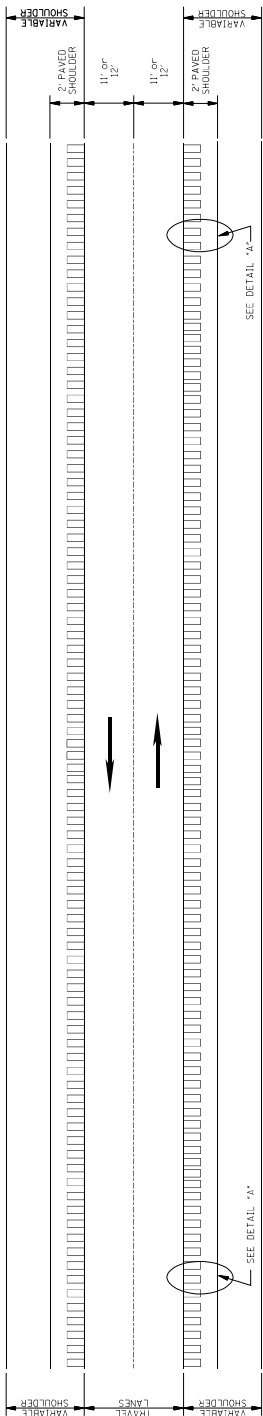

PLAN  
NOT TO SCALE

|   |                          |
|---|--------------------------|
| MISSISSIPPI DEPARTMENT OF TRANSPORTATION<br>ROADWAY DESIGN DIVISION<br>STANDARD PLAN      |                          |
| <b>RUMBLE STRIPES<br/>2-LANE HIGHWAYS<br/>(ASPHALT LANES,<br/>2-FT ASPHALT SHOULDERS)</b> |                          |
| BY  | REVISION                 |
| DATE  | ISSUE DATE: MAY 21, 2017 |
| SHEET NUMBER<br>RS-1<br>6064  |                          |

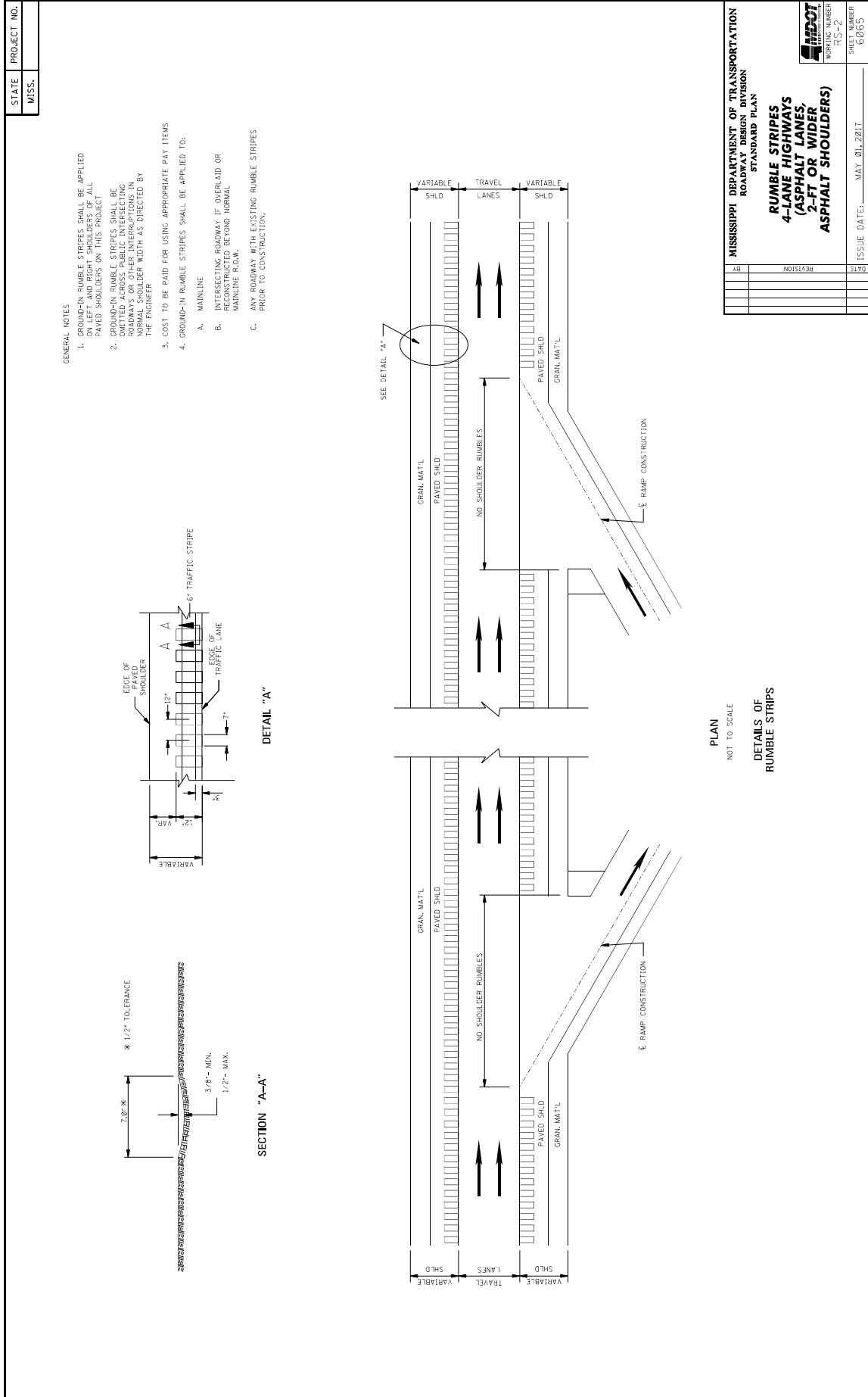

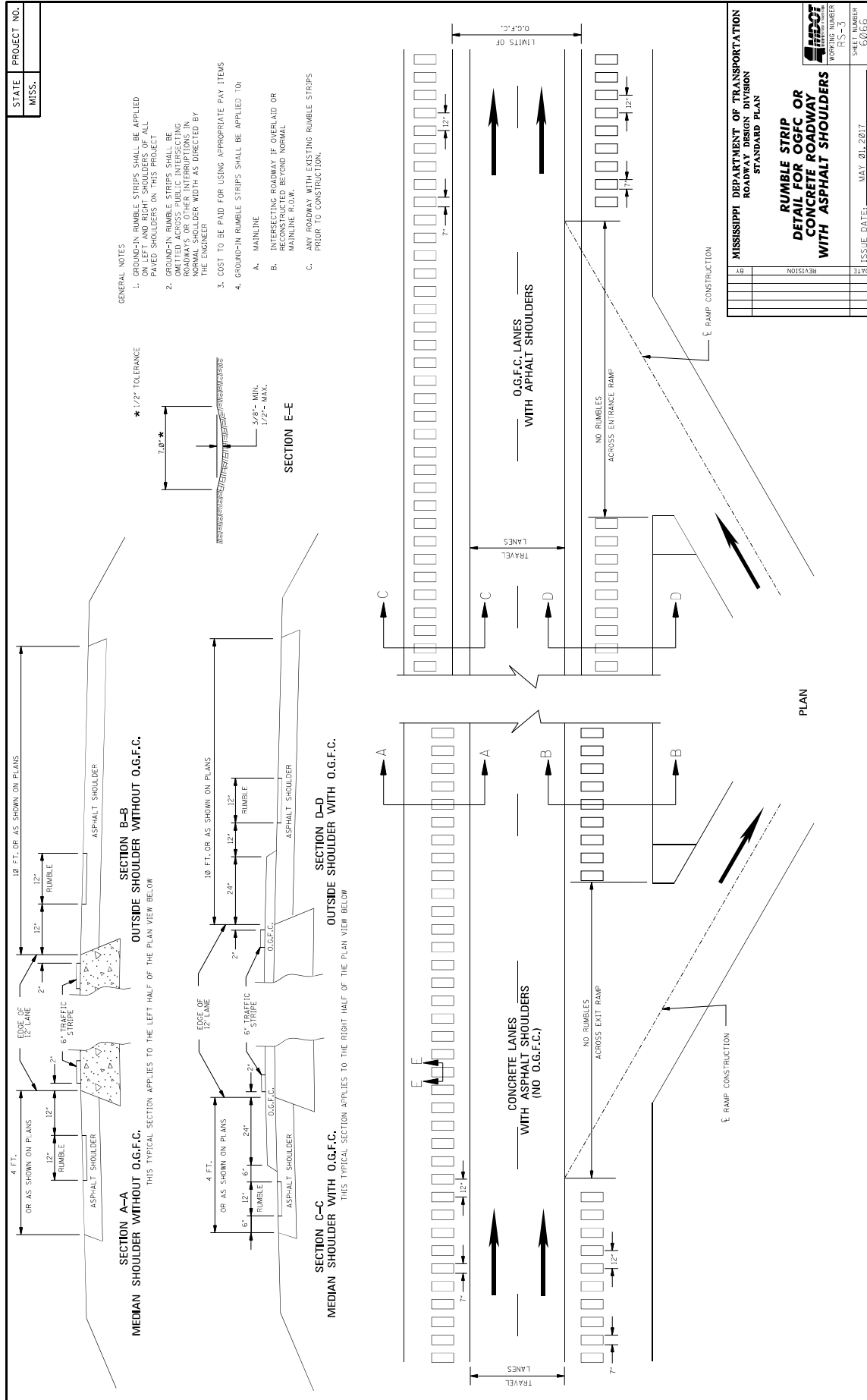

**MISSISSIPPI DEPARTMENT OF TRANSPORTATION**

**SECTION 904 - NOTICE TO BIDDERS NO. 445**

**CODE: (SP)**

**DATE: 10/10/2017**

**SUBJECT: Mississippi Agent or Qualified Nonresident Agent**

Bidders are hereby advised of the requirements of Subsections 102.08, 103.05.2, and 107.14.2.1 of the *2017 Standard Specifications for Road and Bridge Construction* as it refers to bonding agents. Proposal guaranties, bonds, and liability insurance policies must be signed by a **Mississippi Agent or Qualified Nonresident Agent.**

**MISSISSIPPI DEPARTMENT OF TRANSPORTATION**

**SECTION 904 - NOTICE TO BIDDERS NO. 446**

**CODE: (SP)**

**DATE: 10/18/2017**

**SUBJECT: Traffic on Milled Surface in Urban Areas**

Bidders are hereby advised that when the main lanes of a roadway are fine milled, traffic will be allowed to run on a milled surfaces for up to five (5) calendar days. The Contractor will be assessed a penalty of **\$5,000 per calendar day** afterwards until the milled surfaces are covered with the next lift of asphalt. It shall be the Contractor's responsibility to ensure that the milling operations do not commence until such time as forecasted weather conditions are suitable enough to allow the placement of the asphalt pavement after the milling operations.



**MISSISSIPPI DEPARTMENT OF TRANSPORTATION**

**SECTION 904 - NOTICE TO BIDDERS NO. 742**

**CODE: (SP)**

**DATE: 03/12/2018**

**SUBJECT: Contract Time**

**PROJECT: STP-0003-01(198) / 107748301 – Harrison County**

The completion of work to be performed by the Contractor for this project will not be a specified date but shall be when all allowable working days are assessed, or any extension thereto as provided in Subsection 108.06. It is anticipated that the Notice of Award will be issued no later than **May 8, 2018** and the date for Notice to Proceed / Beginning of Contract Time will be **June 7, 2018**

Should the Contractor request a Notice to Proceed earlier than **June 7, 2018** and it is agreeable with the Department for an early Notice to Proceed, the requested date will become the new Notice to Proceed date.

**104** Working Days have been allowed for the completion of work on this project.

## MISSISSIPPI DEPARTMENT OF TRANSPORTATION

SECTION 904 - NOTICE TO BIDDERS NO. 743

DATE: March 8, 2018

SUBJECT: Specialty Items

PROJECT: STP-0003-01(198)/107748301 - HARRISON

Pursuant to the provisions of Section 108, the following work items are hereby designated as "Specialty Items" for this contract. Bidders are reminded that these items must be subcontracted in order to be considered as specialty items.

### CATEGORY: CURBING, SIDEWALKS, GUTTERS

---

| Line No | Pay Item | Description           |
|---------|----------|-----------------------|
| 0210    | 609-B002 | Concrete Curb, Header |

### CATEGORY: PAVEMENT STRIPING AND MARKING

---

| Line No | Pay Item | Description  |
|---------|----------|--|
| 0360    | 626-A004 | 6" Thermoplastic Traffic Stripe, Skip White                    |
| 0370    | 626-B002 | 6" Thermoplastic Double Drop Traffic Stripe, Continuous White  |
| 0380    | 626-E001 | 6" Thermoplastic Double Drop Traffic Stripe, Continuous Yellow |
| 0390    | 626-G001 | Thermoplastic Detail Stripe, Blue-ADA                          |
| 0400    | 626-G002 | Thermoplastic Detail Stripe, White                             |
| 0410    | 626-G003 | Thermoplastic Detail Stripe, Yellow                            |
| 0420    | 626-H003 | Thermoplastic Legend, Blue-ADA                                 |
| 0430    | 626-H004 | Thermoplastic Legend, White                                    |
| 0440    | 626-H005 | Thermoplastic Legend, White                                    |
| 0450    | 627-K001 | Red-Clear Reflective High Performance Raised Markers           |
| 0460    | 627-L001 | Two-Way Yellow Reflective High Performance Raised Markers      |

### CATEGORY: TRAFFIC CONTROL - TEMPORARY

---

| Line No | Pay Item  | Description                                 |
|---------|-----------|---|
| 0300    | 619-A1001 | Temporary Traffic Stripe, Continuous White  |
| 0310    | 619-A2001 | Temporary Traffic Stripe, Continuous Yellow |
| 0320    | 619-A3001 | Temporary Traffic Stripe, Skip White        |
| 0330    | 619-A5001 | Temporary Traffic Stripe, Detail            |
| 0340    | 619-A6002 | Temporary Traffic Stripe, Legend            |

**MISSISSIPPI DEPARTMENT OF TRANSPORTATION**

**SECTION 904 - NOTICE TO BIDDERS NO. 744**

**CODE: (SP)**

**DATE: 02/21/2018**

**SUBJECT: Scope of Work**

**PROJECT: STP-0003-01(198) / 107748301 -- Harrison County**

The contract documents do not include an official set of construction plans but may, by reference, include some Standard Drawings when so specified in a Notice to Bidders entitled, "Standard Drawings". All other references to plans in the contract documents and Standard Specifications for Road and Bridge Construction are to be disregarded.

Work on the project shall consist of the following:

**US 90**  
**OVERLAY 10 MILES OF US 90, FROM THE 200 FEET EAST OF**  
**RUSSELL AVENUE TO DEBUYS ROAD**

(A) Prior to the overlay, the Contractor shall inspect all drainage inlets. All sand and debris shall be cleaned from each inlet if required. Upon inspection, inlets may be identified as requiring repair including removal and replacement of inlet tops, adjusting inlets or repair of pipe connections to inlet box. The repairs will be accomplished using existing pay items. It is estimated that eight (8) inlets will require cleaning. It is estimated that five (5) inlets will require repair. The repair may include removal and replacement of concrete box lids and five feet (5') of curb on each side of the lid. This will be paid each (EA). Existing inlet grates and frame shall be reused. Other inlets may be identified during the execution of this project.

| <b>Obstructed Inlet Box</b> |             |             |
|-----------------------------|-------------|-------------|
| <b>STA #</b>                | <b>Lane</b> | <b>Side</b> |
| 529+78                      | R           | R           |
| 744+00                      | R           | L&R         |
| 838+55                      | R           | R           |
| 859+30                      | R           | L&R         |
| 744+00                      | R           | L&R         |

| <b>Inlet Box Lids</b> |             |             |             |
|-----------------------|-------------|-------------|-------------|
| <b>STA #</b>          | <b>Lane</b> | <b>Side</b> | <b>Each</b> |
| 466+90                | R           | R           | 1           |
| 802+30                | R           | R           | 1           |
| 914+00                | R           | R           | 1           |
| 854+19                | L           | L           | 1           |
| 688+60                | L           | R           | 1           |
| Total                 |             |             | 5           |

(B) Cross drains identified by the Project Engineer shall be cleaned of any obstructions and inspected by video. The video inspection shall be in the presence of the Project Engineer or their representative. A video recording for each line inspected shall be furnished to the Department. Any deficiencies in the drainage system shall be identified and repaired as directed by the Project Engineer. Repairs may require but not limited to excavation, backfill with Size 825B

crushed stone, and/or encasement with flowable fill. Flowable fill may also be required in voids identified throughout the project as directed by the Project Engineer.

The following locations have been identified for pipe cleaning and inspection. Additional locations will be identified during the execution of this project.

| <b>Pipe Cleaning Locations</b> |             |             |            |
|--------------------------------|-------------|-------------|------------|
| <b>STA #</b>                   | <b>Lane</b> | <b>Side</b> | <b>LF</b>  |
| 567+80                         | R           | R&L         | 24         |
| 580+40                         | R           | R&L         | 24         |
| 581+25                         | R           | R&L         | 24         |
| 682+86                         | R           | R&L         | 24         |
| 689+70                         | R           | R&L         | 24         |
| 742+20                         | R           | R&L         | 24         |
| 751+90                         | R           | R&L         | 24         |
| 807+40                         | R           | R&L         | 24         |
| 846+40                         | R           | R&L         | 24         |
| <b>Total</b>                   |             |             | <b>216</b> |

(C) Concrete curb and 10-inch concrete median island have been identified for replacement. Additional locations may be identified during the execution of this project. Curb replacement locations are as follows:

| <b>Header Curb Repair</b> |             |             |                    |
|---------------------------|-------------|-------------|--------------------|
| <b>STA #</b>              | <b>Lane</b> | <b>Side</b> | <b>Length (Ft)</b> |
| 470+68                    | R           | R           | 3                  |
| 503+35                    | R           | L           | 6                  |
| 539+98                    | R           | R           | 4                  |
| 800+00                    | R           | L           | 6                  |
| 821+50                    | R           | R           | 4                  |
| 499+60                    | R           | R           | 4                  |
| 454+80                    | R           | R           | 4                  |
| 869+00                    | R           | R           | 8                  |
| 878+65                    | R           | R           | 8                  |
| 883+20                    | R           | R           | 8                  |
| 854+19                    | L           | R           | 10                 |
| 466+10                    | L           | L           | 5                  |
| 602+65                    | L           | R           | 10                 |
| 821+50                    | R           | R           | 4                  |
| <b>Total</b>              |             |             | <b>84</b>          |

The 10” median island is identified as follows:

| <b>10" Median Island Pavement</b> |             |             |                |
|-----------------------------------|-------------|-------------|----------------|
| <b>STA #</b>                      | <b>Lane</b> | <b>Side</b> | <b>Sq. Yd.</b> |
| 802+30 (P. Bay)                   | R           | R           | 1              |
| <b>Total</b>                      |             |             | <b>1</b>       |

(D) Nine (9) areas have been identified for base repair. Repair of these areas will be dependent on the underlying material. It is anticipated that these areas will require backfill with Size 825B crushed stone and 12.5-mm, ST, asphalt pavement. Additional locations may be identified during the execution of this project. The locations are as follows:

| <b>Removal of Pavement, All Types and Depths</b> |             |             |                       |                  |
|--|-------------|-------------|-----------------------|------------------|
| <b>STA #</b>                                     | <b>Lane</b> | <b>Side</b> | <b>Length x Width</b> | <b>Area (SY)</b> |
| 567+80   | R           | R&L         | 24' x 10'             | 26.7             |
| 580+40   | R           | R&L         | 24' x 10'             | 26.7             |
| 581+25   | R           | R&L         | 24' x 10'             | 26.7             |
| 682+86   | R           | R&L         | 24' x 10'             | 26.7             |
| 689+70   | R           | R&L         | 24' x 10'             | 26.7             |
| 742+20   | R           | R&L         | 24' x 10'             | 26.7             |
| 751+90   | R           | R&L         | 24' x 10'             | 26.7             |
| 807+40   | R           | R&L         | 24' x 10'             | 26.7             |
| 846+40   | R           | R&L         | 24' x 10'             | 26.7             |
| <b>Total</b>                                     |             |             |                       | <b>240.0</b>     |

(E) Any saw cuts required for any removal areas is to be absorbed in other bid items.

(F) Prior to the overlay, the Contractor shall be responsible for locating all utility access points within in the roadway. The Contractor shall verify the size and type of the access points and then procure necessary riser rings to adjust each access point to ensure the utility access is flush with the new finished asphalt surface. Surface asphalt shall not be placed until the riser rings are on-site for installation. No patching will be permitted around the riser rings.

The size, type, and number of the riser rings must be verified by the Contractor. For estimating purposes, the Department estimates the following:

| <b>Utility Adjustments</b> |                 |                 |
|----------------------------|-----------------|-----------------|
| <b>Type</b>                | <b>Quantity</b> | <b>Pay Item</b> |
| SS-3 Grate                 | 254             | 613-C001        |
| Manholes                   | 86              | 613-D005        |
| Water                      | 65              | 613-D009        |

(G) Repairs will be required to the concrete median wall. Seven (7) areas have been identified for repairs. These repairs may include one or more of the following: chipping out of broken concrete to expose existing rebar, dowel and epoxy into existing wall, add reinforcement, forming and placing Class B Concrete.

In addition to the wall repair, the Contractor will be required to grout cracks in the wall. The Department will identify significant cracks to be grouted. It is anticipated that there will be approximately 11 cracks identified.

(H) Prior to the overlay, centerline alignment shall be determined by the Contractor by measuring the existing roadway at 500-foot intervals in tangent sections, and 100-foot intervals in horizontal curves.

(I) Fine milling will be required at the BOP, the EOP, and tie in with local roads (See Typical Drawings). Transverse bumps in excess of 3/4" shall be milled prior to placement of leveling asphalt.

(J) Overlay US 90 from the BOP to the EOP with a 3/4" leveling lift. A 9.5-mm, MT, Leveling lift shall be required on the mainline of US 90. Overlay the turn lanes, crossovers, and parking areas with 3/4" of 9.5-mm, ST, Leveling asphalt.

Overlay the mainline of US 90 from the BOP to the EOP with 1 1/4" of 9.5-mm, MT, asphalt. Overlay the crossovers, turn lane, side roads, and parking areas with 1 1/4" of 9.5-mm, ST, asphalt.

Publicly maintained roads or streets shall be surfaced to the existing R.O.W. Any site grading at local roads or drives will not be measured for separate payment but will be considered an absorbed item.

(K) The Mean Roughness Index (MRI) shall be used to determine the pavement smoothness.

(L) Sawing and sealing of transverse joints will be required in the surface asphalt. The Contractor will be responsible to locate/mark these joints prior to construction.

(M) Temporary and permanent striping shall be placed where existing stripes are located, and shall conform to finished stripe specifications for alignment, neatness, reflectivity, and straightness. When the centerline or turn lane stripe is removed during milling operations, temporary stripe shall be placed prior to opening the roadway to traffic. All permanent pavement markings on asphalt are to be hot thermoplastic. Edge lines will be placed so as to maintain the original lane width.

(N) Raised pavement markers will be placed at 40-foot intervals along skip white pavement markings. Gore areas shall be delineated with two-way yellow high performance raised pavement markers. Any removals of existing raised pavement markers shall be considered an absorbed item.

(O) The following concrete sidewalk and 4-inch median island pavement areas have been identified for removal and replacement:

| <b>Sidewalk Repair</b> |             |             |                       |                  |
|------------------------|-------------|-------------|-----------------------|------------------|
| <b>STA #</b>           | <b>Lane</b> | <b>Side</b> | <b>Length x Width</b> | <b>Area (SY)</b> |
| 517+80                 | R           | R           | 5 x 5                 | 2.78             |
| 557+30                 | R           | R           | 5 x 5                 | 2.78             |
| 562+21                 | R           | R           | 5 x 5                 | 2.78             |
| 575+30                 | R           | R           | 5 x 10                | 5.56             |
| 581+15                 | R           | R           | 5 x 15                | 8.33             |
| 586+50                 | R           | R           | 5 x 20                | 11.11            |
| 592+17                 | R           | R           | 5 x 35                | 19.44            |
| 594+50                 | R           | R           | 5 x 30                | 16.67            |
| 599+80                 | R           | R           | 5 x 10                | 5.56             |
| 601+75                 | R           | R           | 5 x 35                | 19.44            |
| 613+25                 | R           | R           | 5 x 15                | 8.33             |
| 767+20                 | R           | R           | 5 x 5                 | 2.78             |
| 787+30                 | R           | R           | 5 x 10                | 5.56             |
| 789+90                 | R           | R           | 5 x 15                | 8.33             |
| 796+80                 | R           | R           | 5 x 5                 | 2.78             |
| 796+80                 | R           | R           | 5 x 10                | 5.56             |
| 611+90                 | R           | R           | 5 x 10                | 5.56             |
| 857+50                 | R           | R           | 5 x 5                 | 2.78             |
| 861+70                 | R           | R           | 5 x 25                | 13.89            |
| 878+80                 | R           | R           | 5 x 60                | 33.33            |
| 917+18                 | R           | R           | 5 x 5                 | 2.78             |
| 924+40                 | R           | R           | 5 x 20                | 11.11            |
| 864+20                 | L           | L           | 5 x 10                | 5.56             |
| 886+00                 | L           | L           | 5 x 12                | 6.67             |
| 864+40                 | R           | R           | 5 x 5                 | 2.78             |
|                        |             |             | <b>Total</b>          | <b>212</b>       |

| <b>4" Median Island Pavement</b> |             |             |                |
|----------------------------------|-------------|-------------|----------------|
| <b>STA #</b>                     | <b>Lane</b> | <b>Side</b> | <b>Sq. Yd.</b> |
| 466+90                           | R           | R           | 15.00          |
| 470+68                           | R           | R           | 11.11          |
| 472+91                           | R           | R           | 20.00          |
| 475+53                           | R           | R           | 16.00          |
| 557+30                           | R           | R           | 87.67          |
| 821+50                           | R           | R           | 3.33           |
| 827+70                           | R           | R           | 10.00          |
| 838+55                           | R           | R           | 5.00           |

|              |            |
|--------------|------------|
| <b>Total</b> | <b>168</b> |
|--------------|------------|

The indicated areas shall be removed and replaced with concrete sidewalk, without reinforcement 4” thick or 4-inch median island pavement. Additional areas may be identified during the execution of this project.

(P) Areas underneath the concrete sidewalk and/or concrete median island pavement have been undermined. The Contractor shall transport State Furnished Borrow material and backfill under these areas. The State Furnished Borrow material will be located in a storage location in Gulfport, MS on Highway 90 near 30<sup>th</sup> Avenue.

| <b>State Furnished Borrow (LVM)</b> |             |             |                   |
|-------------------------------------|-------------|-------------|-------------------|
| <b>STA #</b>                        | <b>Lane</b> | <b>Side</b> | <b>Cubic Yard</b> |
| 505+02 to 517+80                    | R           | R           | 62.48             |
| 536+60 to 537+60                    | R           | R           | 4.89              |
| 575+30 to 576+50                    | R           | R           | 5.85              |
| 599+00 to 602+80                    | R           | R           | 18.59             |
| 792+90 to 796+50                    | R           | R           | 17.59             |
| <b>Total</b>                        |             |             | <b>109</b>        |

(Q) All work shall be performed Sunday through Thursday only, from 7:00 P.M. to 6:00 A.M. Changes or variances from these restrictions shall be submitted to the Project Engineer for review and written approval. A lane rental fee of \$1,500.00 per full or partial 5-minute period shall be assessed for closures or obstructions that extend beyond the times mentioned above. No exposed signs shall be viewable to the traveling public prior to or after the above-mentioned times. No part of a closure, including drums or cones, shall be in the roadway prior to or after the above-mentioned times. Work requiring a shoulder or lane closure shall begin within one (1) hour of the completion of the closure setup. Lane closures will be allowed only at times when work requiring a lane closure is underway. Failure to begin working within this 1-hour period will result in the Contractor being assessed a lane rental fee of \$1,500.00 for each full or partial 5-minute period until work has begun.

(R) Whenever the Contractor's operations are being conducted at night, the Contractor shall provide artificial lighting as may be necessary to provide for safe and proper construction and inspection of the work in accordance with Section 680 of the Standard Specifications. Night work shall not begin until a lighting plan submitted by the Contractor meeting the requirements of the specification has been approved. Portable Construction Lighting will not be measured for separate payment, but will be included in other bid items.

(S) It shall be the responsibility of the Contractor to protect existing structures such as pipes, inlets, aprons, bridges, etc. from damage which might occur during construction. The Contractor shall replace or repair, as directed by the Engineer, any structures damaged during the life of the contract. No payment will be made for the replacement or repair of damaged items.



(T) The Contractor shall erect and maintain construction signing, and provide all signs and traffic handling devices in accordance with Manual Uniform Traffic Control Devices (MUTCD). The cost is to be included in the price bid for pay item 618-A001, Maintenance of Traffic.

(U) Incidental work such as removing vegetation, shaping and compaction of shoulder, removing excess asphalt material, project clean-up, and other incidental work necessary to complete the project will not be measured for separate payment, but will be included in other bid items.

(V) All Construction signing as well as plastic traffic drums and barricades are included in the bid for Pay Item 618-A, Maintenance of Traffic. Fluorescent orange sheeting shall be used on all construction and traffic control signs except for R4-1 and R4-2 signs which shall be black legend and border on white background. The Contractor shall erect and maintain construction signing, and provide all signs and traffic handling devices in accordance with Manual Uniform Traffic Control Devices (MUTCD).

(W) If pavement section marking tape is encountered on this project, it shall be located prior to overlaying and placed back in same location after paving operations have ceased. The section marking shall be 8-inch high performance cold plastic detail stripe and shall be four feet (4') in length. The marking shall be centered across the centerline stripe. The cost of this item shall be absorbed in other bid items.

(X) The Contractor shall be responsible to provide Railroad Insurance meet all requirements for crossing the railroad track. Any costs associated with crossing the railroad tracks including but not limited to insurance, permits, and flaggers are to be included under Pay Item 907-899-A001. Prior to bid and starting any work, the Contractor shall contact CSX Railroad at the following address for insurance and construction requirements.

Insurance Department  
CSX Transportation, Inc.  
500 Water Street, C-907  
Jacksonville, FL 32202

or

insurancedocuments@csx.com

# TYPICAL MILLED TRANSITION AT BRIDGE ABUT. OR PAVEMENT IN PLACE

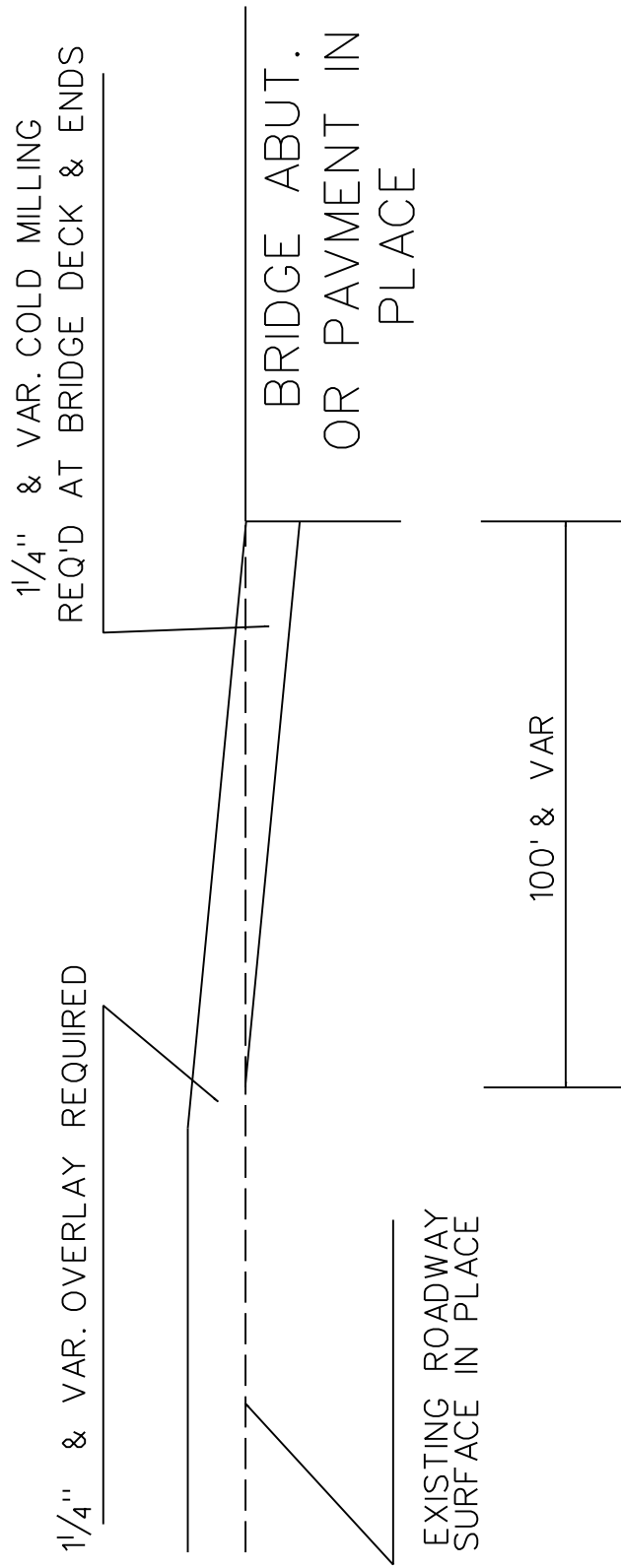

PRIVATE DRIVEWAY DETAIL

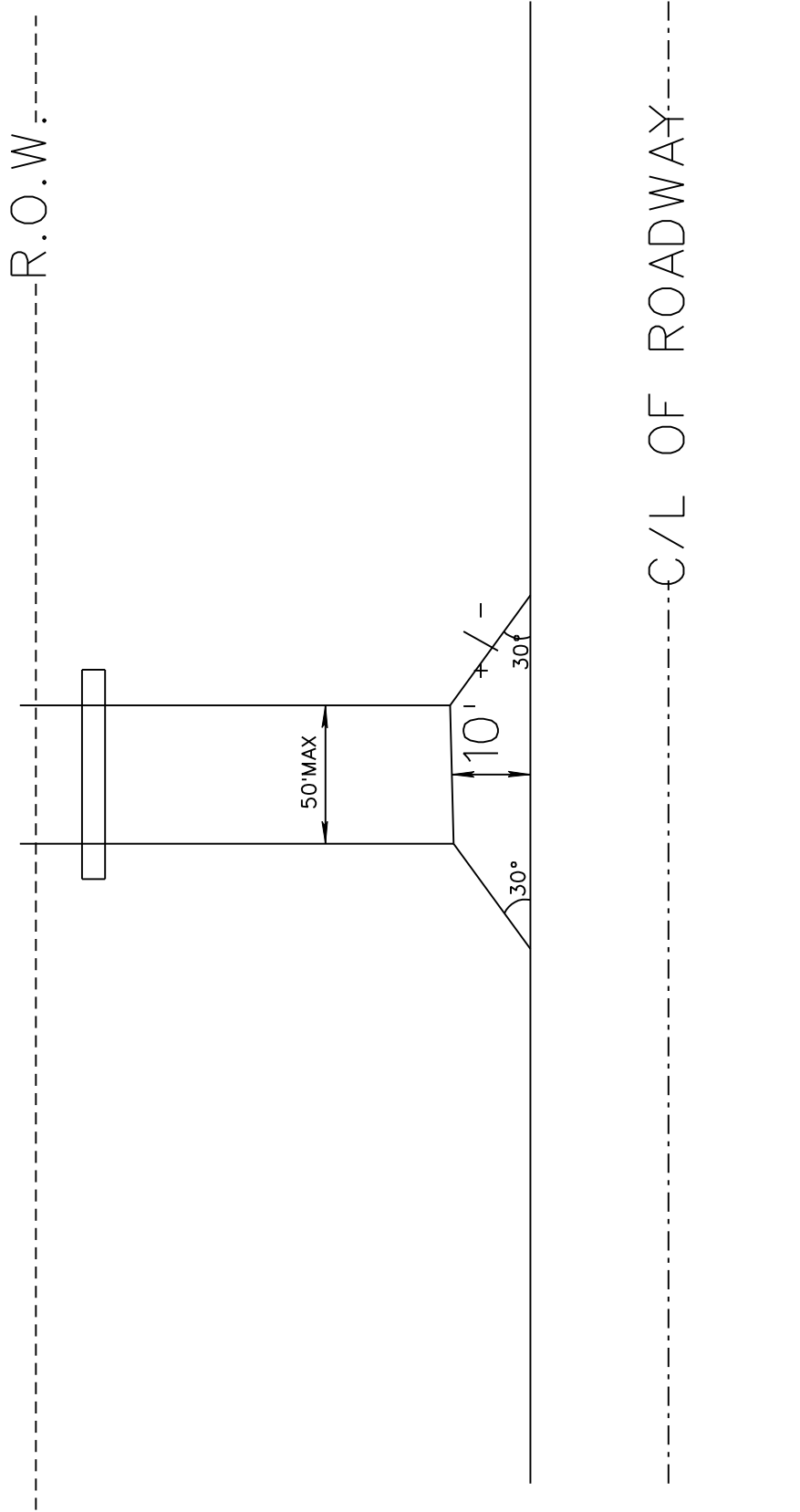

# TYPICAL FOR PAVED TAPER AT LOCAL ROADS

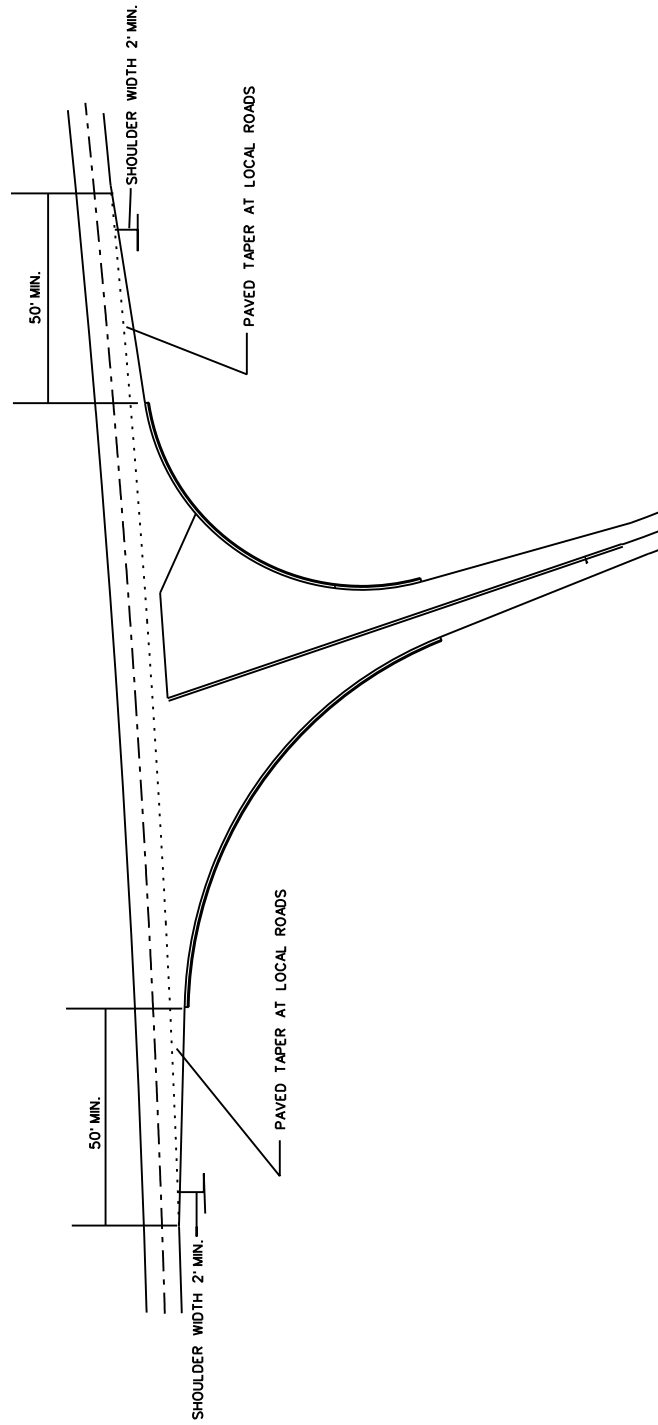

# TYPICAL STRIPING AT RAILROAD CROSSING

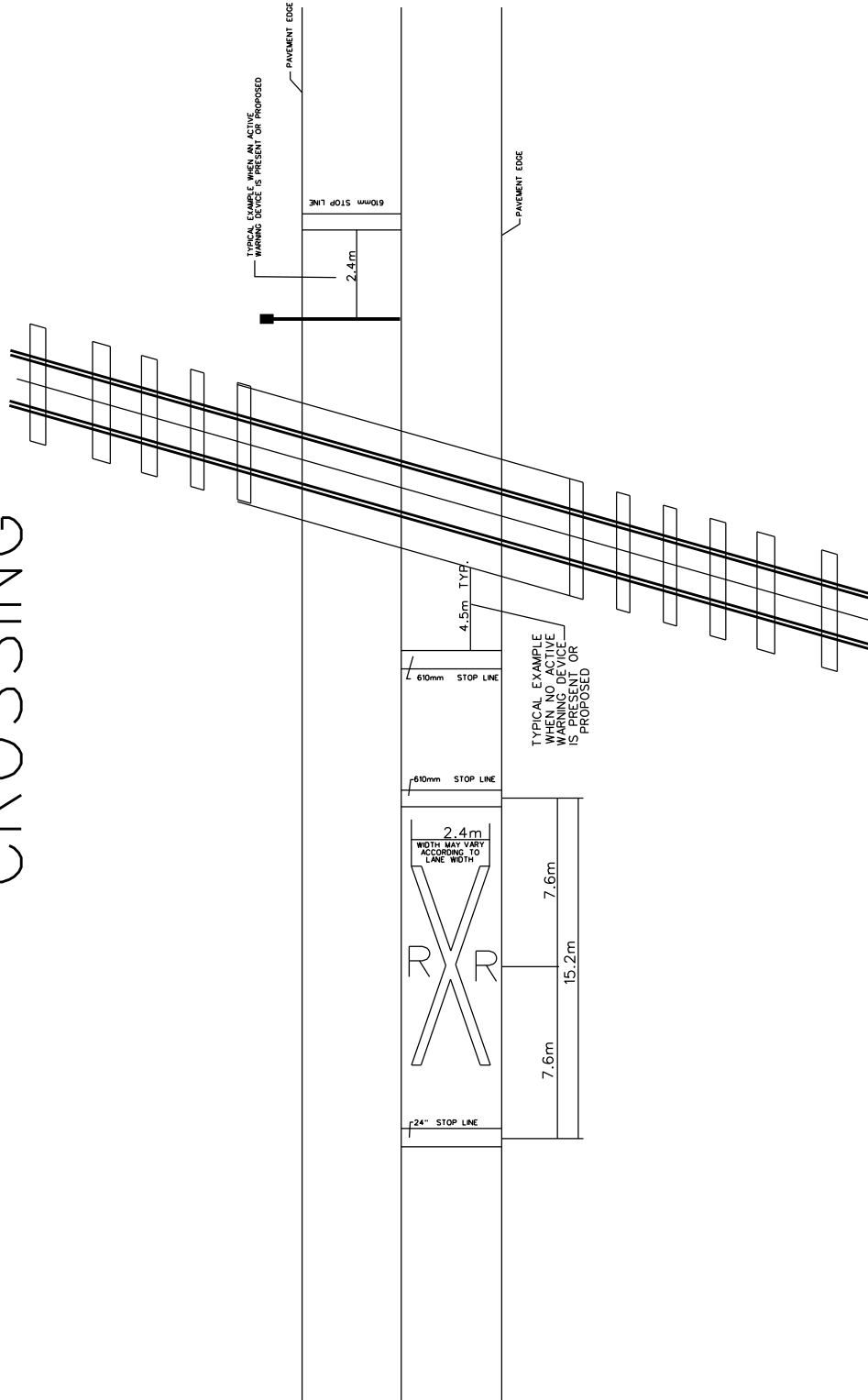

# TYPICAL STRIPING FOR SIMPLE INTERSECTION AT LOCAL ROADS

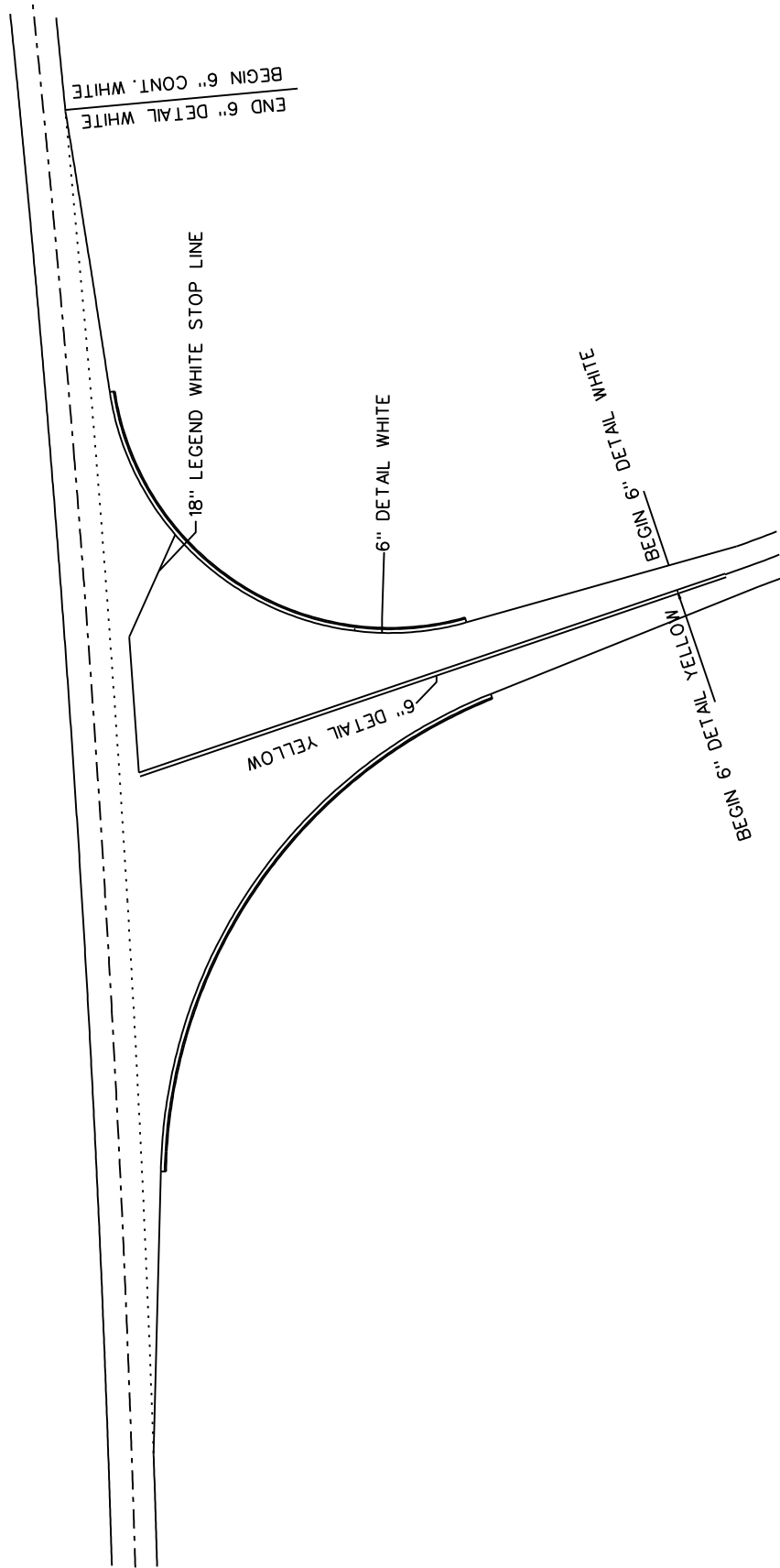

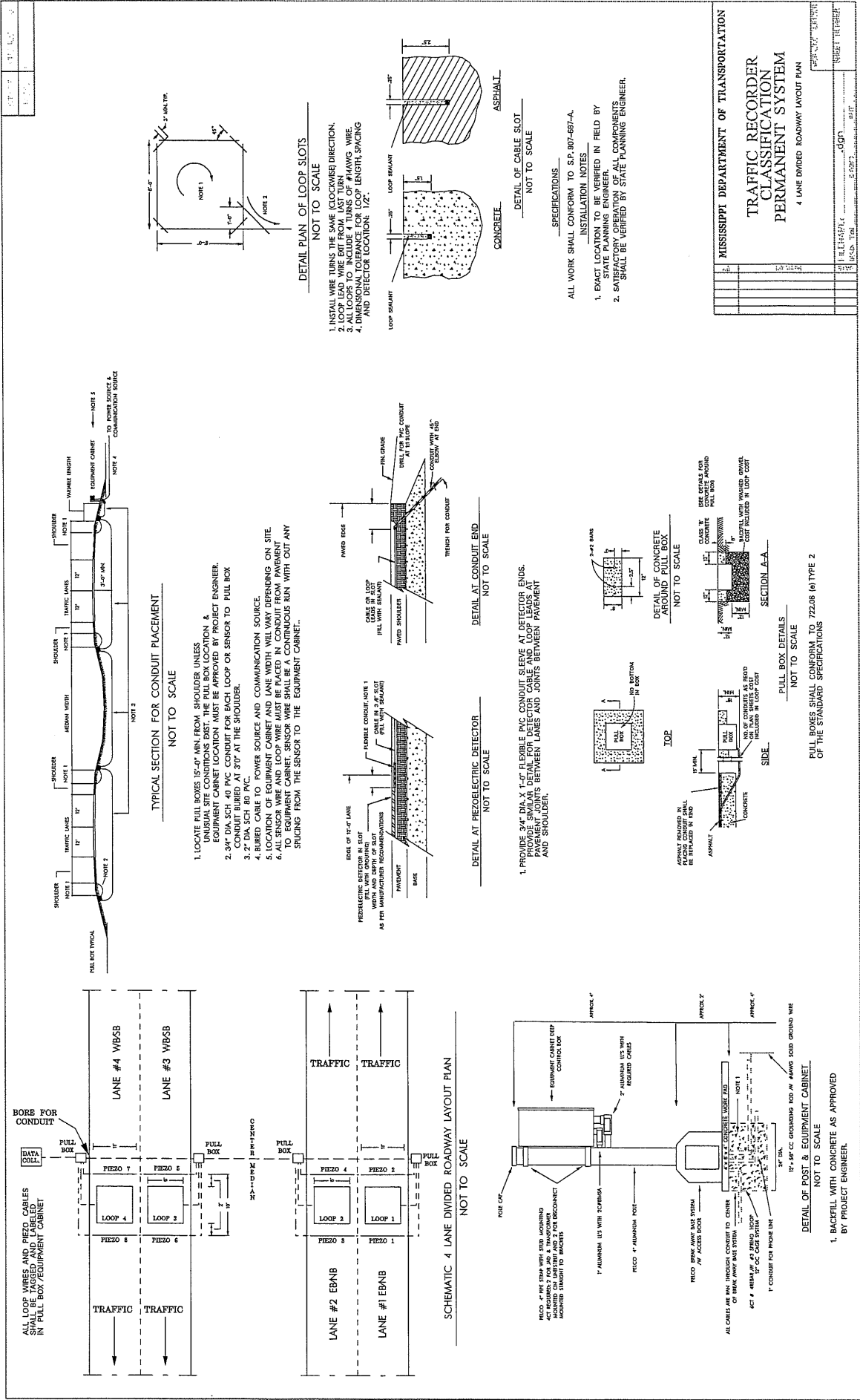

ALL LOOP WIRES AND PIEZO CABLES SHALL BE TAGGED AND LABELED IN PULL BOX/EQUIPMENT CABINET

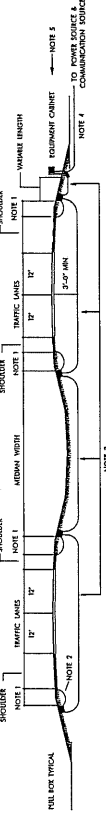
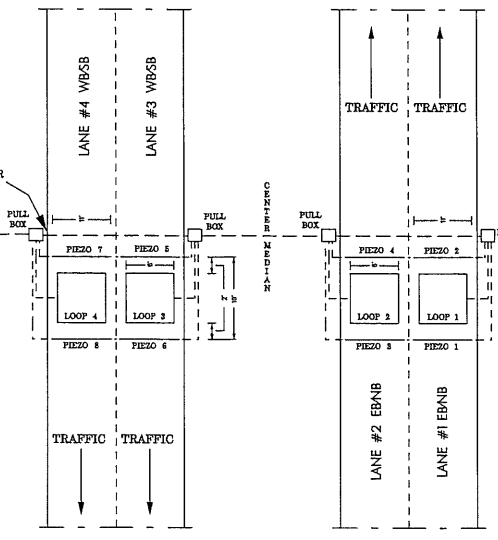

1. LOCATE PULL BOXES 15'-0" MIN. FROM SHOULDER UNLESS INDIVIDUAL SITE CONDITIONS REQUIRE OTHERWISE. PULL BOX LOCATION MUST BE APPROVED BY PROJECT ENGINEER.

2. 3/4" DIA. SCH. 40 PVC CONDUIT FOR EACH LOOP OR SENSOR TO PULL BOX.

3. 2" DIA. SCH. 80 PVC.

4. BURIED CABLE TO POWER SOURCE AND COMMUNICATION SOURCE.

5. LOCATION OF EQUIPMENT CABINET AND LANE WIDTH WILL VARY DEPENDING ON SITE.

6. ALL SENSOR WIRE AND LOOP WIRE MUST BE PLACED IN CONDUIT FROM PAVEMENT TO EQUIPMENT CABINET. CONDUITS RUN WITH OUT ANY SPACING FROM THE SENSOR TO THE EQUIPMENT CABINET.

**DETAIL PLAN OF LOOP SLOTS**  
NOT TO SCALE

1. INSTALL WIRE TURNS THE SAME (CLOCKWISE) DIRECTION.

2. LOOP LEAD WIRE BIT FROM LAST TURN.

3. ALL LOOPS TO INCLUDE TURNS OF LENGTH, SPACING AND DETECTOR LOCATION: 1/2".

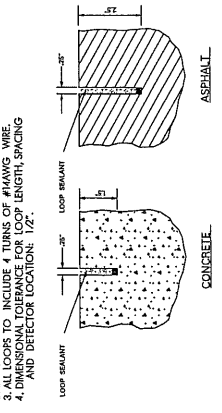

ALL WORK SHALL CONFORM TO S.P. 807-897-A.

INSTALLATION NOTES:

1. EXACT LOCATION TO BE VERIFIED IN FIELD BY STATE PLANNING ENGINEER.

2. SATISFACTORY OPERATION OF ALL COMPONENTS SHALL BE VERIFIED BY STATE PLANNING ENGINEER.

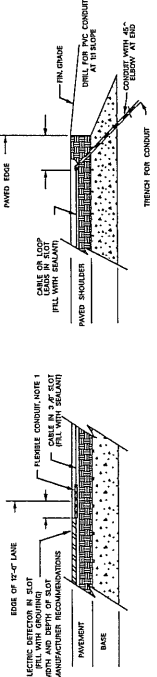

MISSISSIPPI DEPARTMENT OF TRANSPORTATION

TRAFFIC RECORDER CLASSIFICATION PERMANENT SYSTEM

4 LANE DIVIDED ROADWAY LAYOUT PLAN

|              |           |
|--------------|-----------|
| DATE         | 11/17/93  |
| BY           | W. B. ... |
| CHECKED      | ...       |
| DESIGNED     | ...       |
| IN CHARGE    | ...       |
| PROJECT NO.  | ...       |
| SCALE        | ...       |
| SHEET NO.    | ...       |
| TOTAL SHEETS | ...       |

General Decision Number: MS180237 01/05/2018 MS237

Superseded General Decision Number: MS20170237

State: Mississippi

Construction Type: Highway

County: Harrison County in Mississippi.

HIGHWAY CONSTRUCTION PROJECTS

Note: Under Executive Order (EO) 13658, an hourly minimum wage of \$10.35 for calendar year 2018 applies to all contracts subject to the Davis-Bacon Act for which the contract is awarded (and any solicitation was issued) on or after January 1, 2015. If this contract is covered by the EO, the contractor must pay all workers in any classification listed on this wage determination at least \$10.35 per hour (or the applicable wage rate listed on this wage determination, if it is higher) for all hours spent performing on the contract in calendar year 2018. The EO minimum wage rate will be adjusted annually. Please note that this EO applies to the above-mentioned types of contracts entered into by the federal government that are subject to the Davis-Bacon Act itself, but it does not apply to contracts subject only to the Davis-Bacon Related Acts, including those set forth at 29 CFR 5.1(a)(2)-(60). Additional information on contractor requirements and worker protections under the EO is available at [www.dol.gov/whd/govcontracts](http://www.dol.gov/whd/govcontracts).

|                     |                  |
|---------------------|------------------|
| Modification Number | Publication Date |
| 0                   | 01/05/2018       |

SUMS2010-056 08/04/2014

|   | Rates    | Fringes |
|---|----------|---------|
| CARPENTER (Form Work Only).....   | \$ 14.43 | 0.00    |
| CEMENT MASON/CONCRETE FINISHER....  | \$ 15.25 | 0.00    |
| ELECTRICIAN.....  | \$ 25.57 | 6.79    |
| HIGHWAY/PARKING LOT STRIPING:   |          |         |
| Truck Driver (Line Striping<br>Truck).....                                      | \$ 14.75 | 0.00    |
| INSTALLER - SIGN.....   | \$ 13.41 | 0.00    |
| INSTALLER: Guardrail.....   | \$ 11.78 | 0.00    |
| IRONWORKER, REINFORCING.....  | \$ 17.33 | 0.00    |
| LABORER: Asphalt, Includes<br>Raker, Shoveler, Spreader and<br>Distributor..... | \$ 12.27 | 0.00    |



|  |          |      |
|--|----------|------|
| LABORER: Common or General.....  | \$ 11.00 | 0.00 |
| LABORER: Flagger.....  | \$ 11.16 | 0.00 |
| LABORER: Grade Checker.....  | \$ 15.63 | 0.00 |
| LABORER: Landscape.....  | \$ 12.00 | 0.00 |
| LABORER: Luteman.....  | \$ 12.88 | 0.00 |
| LABORER: Mason Tender -<br>Cement/Concrete.....                              | \$ 13.14 | 0.00 |
| LABORER: Pipelayer.....  | \$ 15.00 | 0.00 |
| LABORER: Laborer-Cones/<br>Barricades/Barrels -<br>Setter/Mover/Sweeper..... | \$ 13.19 | 0.00 |
| OPERATOR: Asphalt Spreader.....  | \$ 14.83 | 0.00 |
| OPERATOR:<br>Backhoe/Excavator/Trackhoe.....                                 | \$ 15.62 | 0.00 |
| OPERATOR: Bobcat/Skid<br>Steer/Skid Loader.....                              | \$ 11.86 | 0.00 |
| OPERATOR: Broom/Sweeper.....   | \$ 14.25 | 0.00 |
| OPERATOR: Bulldozer.....   | \$ 15.47 | 0.00 |
| OPERATOR: Concrete Saw.....  | \$ 14.96 | 3.27 |
| OPERATOR: Crane.....   | \$ 15.89 | 0.00 |
| OPERATOR: Distributor.....   | \$ 13.87 | 0.00 |
| OPERATOR: Grader/Blade.....  | \$ 16.44 | 0.00 |
| OPERATOR: Loader.....  | \$ 14.38 | 0.00 |
| OPERATOR: Mechanic.....  | \$ 19.33 | 0.00 |
| OPERATOR: Milling Machine.....   | \$ 15.44 | 0.00 |
| OPERATOR: Oiler.....   | \$ 12.22 | 0.00 |
| OPERATOR: Paver (Asphalt,<br>Aggregate, and Concrete).....                   | \$ 15.81 | 0.00 |
| OPERATOR: Roller (All Types)....   | \$ 14.23 | 0.00 |
| OPERATOR: Scraper.....   | \$ 14.00 | 0.00 |
| OPERATOR: Tractor.....   | \$ 12.29 | 0.00 |
| TRUCK DRIVER: Flatbed Truck.....   | \$ 14.72 | 0.00 |
| TRUCK DRIVER: Lowboy Truck.....  | \$ 11.00 | 0.00 |

|  |          |      |
|--|----------|------|
| TRUCK DRIVER: Mechanic.....                  | \$ 12.31 | 0.00 |
| TRUCK DRIVER: Water Truck.....               | \$ 17.08 | 0.00 |
| TRUCK DRIVER: Dump Truck (All<br>Types)..... | \$ 14.32 | 0.00 |
| TRUCK DRIVER: Semi/Trailer<br>Truck.....     | \$ 14.36 | 0.00 |

---

WELDERS - Receive rate prescribed for craft performing operation to which welding is incidental.

=====

Note: Executive Order (EO) 13706, Establishing Paid Sick Leave for Federal Contractors applies to all contracts subject to the Davis-Bacon Act for which the contract is awarded (and any solicitation was issued) on or after January 1, 2017. If this contract is covered by the EO, the contractor must provide employees with 1 hour of paid sick leave for every 30 hours they work, up to 56 hours of paid sick leave each year. Employees must be permitted to use paid sick leave for their own illness, injury or other health-related needs, including preventive care; to assist a family member (or person who is like family to the employee) who is ill, injured, or has other health-related needs, including preventive care; or for reasons resulting from, or to assist a family member (or person who is like family to the employee) who is a victim of, domestic violence, sexual assault, or stalking. Additional information on contractor requirements and worker protections under the EO is available at [www.dol.gov/whd/govcontracts](http://www.dol.gov/whd/govcontracts).

Unlisted classifications needed for work not included within the scope of the classifications listed may be added after award only as provided in the labor standards contract clauses (29CFR 5.5 (a) (1) (ii)).

-----

The body of each wage determination lists the classification and wage rates that have been found to be prevailing for the cited type(s) of construction in the area covered by the wage determination. The classifications are listed in alphabetical order of "identifiers" that indicate whether the particular rate is a union rate (current union negotiated rate for local), a survey rate (weighted average rate) or a union average rate (weighted union average rate).

Union Rate Identifiers

A four letter classification abbreviation identifier enclosed in dotted lines beginning with characters other than "SU" or "UAVG" denotes that the union classification and rate were prevailing for that classification in the survey. Example: PLUM0198-005 07/01/2014. PLUM is an abbreviation identifier of the union which prevailed in the survey for this

classification, which in this example would be Plumbers. 0198 indicates the local union number or district council number where applicable, i.e., Plumbers Local 0198. The next number, 005 in the example, is an internal number used in processing the wage determination. 07/01/2014 is the effective date of the most current negotiated rate, which in this example is July 1, 2014.

Union prevailing wage rates are updated to reflect all rate changes in the collective bargaining agreement (CBA) governing this classification and rate.

#### Survey Rate Identifiers

Classifications listed under the "SU" identifier indicate that no one rate prevailed for this classification in the survey and the published rate is derived by computing a weighted average rate based on all the rates reported in the survey for that classification. As this weighted average rate includes all rates reported in the survey, it may include both union and non-union rates. Example: SULA2012-007 5/13/2014. SU indicates the rates are survey rates based on a weighted average calculation of rates and are not majority rates. LA indicates the State of Louisiana. 2012 is the year of survey on which these classifications and rates are based. The next number, 007 in the example, is an internal number used in producing the wage determination. 5/13/2014 indicates the survey completion date for the classifications and rates under that identifier.

Survey wage rates are not updated and remain in effect until a new survey is conducted.

#### Union Average Rate Identifiers

Classification(s) listed under the UAVG identifier indicate that no single majority rate prevailed for those classifications; however, 100% of the data reported for the classifications was union data. EXAMPLE: UAVG-OH-0010 08/29/2014. UAVG indicates that the rate is a weighted union average rate. OH indicates the state. The next number, 0010 in the example, is an internal number used in producing the wage determination. 08/29/2014 indicates the survey completion date for the classifications and rates under that identifier.

A UAVG rate will be updated once a year, usually in January of each year, to reflect a weighted average of the current negotiated/CBA rate of the union locals from which the rate is based.

---

#### WAGE DETERMINATION APPEALS PROCESS

1.) Has there been an initial decision in the matter? This can be:

- \* an existing published wage determination
- \* a survey underlying a wage determination

- \* a Wage and Hour Division letter setting forth a position on a wage determination matter
- \* a conformance (additional classification and rate) ruling

On survey related matters, initial contact, including requests for summaries of surveys, should be with the Wage and Hour Regional Office for the area in which the survey was conducted because those Regional Offices have responsibility for the Davis-Bacon survey program. If the response from this initial contact is not satisfactory, then the process described in 2.) and 3.) should be followed.

With regard to any other matter not yet ripe for the formal process described here, initial contact should be with the Branch of Construction Wage Determinations. Write to:

Branch of Construction Wage Determinations  
 Wage and Hour Division  
 U.S. Department of Labor  
 200 Constitution Avenue, N.W.  
 Washington, DC 20210

2.) If the answer to the question in 1.) is yes, then an interested party (those affected by the action) can request review and reconsideration from the Wage and Hour Administrator (See 29 CFR Part 1.8 and 29 CFR Part 7). Write to:

Wage and Hour Administrator  
 U.S. Department of Labor  
 200 Constitution Avenue, N.W.  
 Washington, DC 20210

The request should be accompanied by a full statement of the interested party's position and by any information (wage payment data, project description, area practice material, etc.) that the requestor considers relevant to the issue.

3.) If the decision of the Administrator is not favorable, an interested party may appeal directly to the Administrative Review Board (formerly the Wage Appeals Board). Write to:

Administrative Review Board  
 U.S. Department of Labor  
 200 Constitution Avenue, N.W.  
 Washington, DC 20210

4.) All decisions by the Administrative Review Board are final.

=====

END OF GENERAL DECISION

**SUPPLEMENT TO FORM FHWA-1273**

**DATE:** 01/06/2016

**SUBJECT:** Final Certificate and Contract Provisions for Subcontracts

All subcontracts shall be in writing and contain all pertinent provisions and requirements of the prime contract.

Each "Request for Permission to Subcontract" (Mississippi Department of Transportation Form CAD-720) shall include a copy of subcontract upon request for review by the Mississippi Department of Transportation. The federal contract provisions may be omitted from the subcontract copy submitted for review provided the Contractor certifies that the provisions will be physically incorporated into the agreement furnished to the Subcontractor.

In lieu of submitting a copy of the subcontract for review, the Contractor may certify that the subcontract agreement is in writing and that it contains all the requirements and pertinent provisions of the prime contract.

Each Subcontractor will be required to provide a copy of the subcontract agreement for contract compliance reviews, along with physical evidence (copy of FHWA-1273) that requirements and pertinent provisions have been provided for review and adherence.

The Contractor is hereby advised of the requirements set forth in the following Attachment (Title 46 - Shipping) as it pertains to the implementation of Cargo Preference Act (CPA) requirements in the Federal-aid Highway Program.

By signing this contract, the Contractor agrees to conform to the requirements of the CPA.

## Attachment

### Title 46- Shipping

Volume: 8

Date: 2014-10-01

Original Date: 2014-10-01

Title: Section 381.7 - Federal Grant, Guaranty, Loan and Advance at Funds Agreements.

Context: Title 46- Shipping. CHAPTER II- MARITIME ADMINISTRATION, DEPARTMENT OF TRANSPORTATION. SUBCHAPTER J - MISCELLANEOUS. PART 381 - CARGO PREFERENCE-U.S.- FLAG VESSELS.

#### **§ 381.7 Federal Grant, Guaranty, Loan and Advance of Funds Agreements.**

In order to insure a fair and reasonable participation by privately owned United States-flag commercial vessels in transporting cargoes which are subject to the Cargo Preference Act of 1954 and which are generated by U.S. Government Grant, Guaranty, Loan and/or Advance of Funds Programs, the head of each affected department or agency shall require appropriate clauses to be inserted in those Grant, Guaranty, Loan and/or Advance of Funds Agreements and all third party contracts executed between the borrower/grantee and other parties, where the possibility exists for ocean transportation of items procured, contracted for or otherwise obtained by or on behalf of the grantee, borrower, or any of their contractors or subcontractors. The clauses required by this part shall provide that at least 50 percent of the freight revenue and tonnage of cargo generated by the U.S. Government Grant, Guaranty, Loan or Advance of Funds be transported on privately owned United States-flag commercial vessels. These clauses shall also require that all parties provide to the Maritime Administration the necessary shipment information as set forth in § 381.3. A copy of the appropriate clauses required by this part shall be submitted by each affected agency or department to the Secretary, Maritime Administration, for approval no later than 30 days after the effective date of this part. The following are suggested acceptable clauses with respect to the use of United States-flag vessels to be incorporated in the Grant, Guaranty, Loan and/or Advance of Funds Agreements as well as contracts and subcontracts resulting therefrom:

(a) *Agreement Clauses.* "Use of United States-flag vessels:

"(1) Pursuant to Pub. L 664 (43 U.S.C. 1241(b)) at least 50 percent of any equipment, materials or commodities procured, contracted for or otherwise obtained with funds granted, guaranteed, loaned, or advanced by the U.S. Government under this agreement, and which may be transported by ocean vessel, shall be transported on privately owned United States-flag commercial vessels, if available.

"(2) Within 20 days following the date of loading for shipments originating within the United States or within 30 working days following the date of loading for shipments originating outside the United States, a legible copy of a rated, 'on-board' commercial ocean bill-of-lading in English for each shipment of cargo described in paragraph (a)(1) of this section shall be furnished to both the Contracting Officer (through the prime contractor in the case of subcontractor bills-of-lading) and to the Division of National Cargo, Office of Market Development, Maritime Administration, Washington, DC 20590."

(b) *Contractor and Subcontractor Clauses.* "Use of United States-flag vessels: The contractor agrees --

"(1) To utilize privately owned United States-flag commercial vessels to ship at least 50 percent of the gross tonnage (computed separately for dry bulk carriers, dry cargo liners, and tankers) involved, whenever shipping any equipment, material, or commodities pursuant to this contract, to the extent such vessels are available at fair and reasonable rates for United States-flag commercial vessels.

"(2) To furnish within 20 days following the date of loading for shipments originating within the United

States or within 30 working days following the date of loading for shipments originating outside the United States, a legible copy of a rated, 'on-board' commercial ocean bill-of-lading in English for each shipment of cargo described in paragraph (b) (1) of this section to both the Contracting Officer (through the prime contractor in the case of subcontractor bills-of-lading) and to the Division of National Cargo, Office of Market Development, Maritime Administration, Washington, DC 20590.

"(3) To insert the substance of the provisions of this clause in all subcontracts issued pursuant to this contract."

(Reorganization Plans No.21 of 1950(64 Stat. 1273) and No. 7 of 1961 (75 Stat. 840) as amended by Pub. L 91.469 (84 Stat 1036) and Department of Commerce Organization Order 10-8 (38 FR 19707, July 23, 1973)) (42 FR 57126, Nov. 1, 1977]

**REQUIRED CONTRACT PROVISIONS  
FEDERAL-AID CONSTRUCTION CONTRACTS**

---

- I. General
- II. Nondiscrimination
- III. Nonsegregated Facilities
- IV. Davis-Bacon and Related Act Provisions
- V. Contract Work Hours and Safety Standards Act Provisions
- VI. Subletting or Assigning the Contract
- VII. Safety: Accident Prevention
- VIII. False Statements Concerning Highway Projects
- IX. Implementation of Clean Air Act and Federal Water Pollution Control Act
- X. Compliance with Governmentwide Suspension and Debarment Requirements
- XI. Certification Regarding Use of Contract Funds for Lobbying

3. A breach of any of the stipulations contained in these Required Contract Provisions may be sufficient grounds for withholding of progress payments, withholding of final payment, termination of the contract, suspension / debarment or any other action determined to be appropriate by the contracting agency and FHWA.

4. Selection of Labor: During the performance of this contract, the contractor shall not use convict labor for any purpose within the limits of a construction project on a Federal-aid highway unless it is labor performed by convicts who are on parole, supervised release, or probation. The term Federal-aid highway does not include roadways functionally classified as local roads or rural minor collectors.

#### ATTACHMENTS

A. Employment and Materials Preference for Appalachian Development Highway System or Appalachian Local Access Road Contracts (included in Appalachian contracts only)

#### I. GENERAL

1. Form FHWA-1273 must be physically incorporated in each construction contract funded under Title 23 (excluding emergency contracts solely intended for debris removal). The contractor (or subcontractor) must insert this form in each subcontract and further require its inclusion in all lower tier subcontracts (excluding purchase orders, rental agreements and other agreements for supplies or services).

The applicable requirements of Form FHWA-1273 are incorporated by reference for work done under any purchase order, rental agreement or agreement for other services. The prime contractor shall be responsible for compliance by any subcontractor, lower-tier subcontractor or service provider.

Form FHWA-1273 must be included in all Federal-aid design-build contracts, in all subcontracts and in lower tier subcontracts (excluding subcontracts for design services, purchase orders, rental agreements and other agreements for supplies or services). The design-builder shall be responsible for compliance by any subcontractor, lower-tier subcontractor or service provider.

Contracting agencies may reference Form FHWA-1273 in bid proposal or request for proposal documents, however, the Form FHWA-1273 must be physically incorporated (not referenced) in all contracts, subcontracts and lower-tier subcontracts (excluding purchase orders, rental agreements and other agreements for supplies or services related to a construction contract).

2. Subject to the applicability criteria noted in the following sections, these contract provisions shall apply to all work performed on the contract by the contractor's own organization and with the assistance of workers under the contractor's immediate superintendence and to all work performed on the contract by piecework, station work, or by subcontract.

#### II. NONDISCRIMINATION

The provisions of this section related to 23 CFR Part 230 are applicable to all Federal-aid construction contracts and to all related construction subcontracts of \$10,000 or more. The provisions of 23 CFR Part 230 are not applicable to material supply, engineering, or architectural service contracts.

In addition, the contractor and all subcontractors must comply with the following policies: Executive Order 11246, 41 CFR 60, 29 CFR 1625-1627, Title 23 USC Section 140, the Rehabilitation Act of 1973, as amended (29 USC 794), Title VI of the Civil Rights Act of 1964, as amended, and related regulations including 49 CFR Parts 21, 26 and 27; and 23 CFR Parts 200, 230, and 633.

The contractor and all subcontractors must comply with: the requirements of the Equal Opportunity Clause in 41 CFR 60-1.4(b) and, for all construction contracts exceeding \$10,000, the Standard Federal Equal Employment Opportunity Construction Contract Specifications in 41 CFR 60-4.3.

Note: The U.S. Department of Labor has exclusive authority to determine compliance with Executive Order 11246 and the policies of the Secretary of Labor including 41 CFR 60, and 29 CFR 1625-1627. The contracting agency and the FHWA have the authority and the responsibility to ensure compliance with Title 23 USC Section 140, the Rehabilitation Act of 1973, as amended (29 USC 794), and Title VI of the Civil Rights Act of 1964, as amended, and related regulations including 49 CFR Parts 21, 26 and 27; and 23 CFR Parts 200, 230, and 633.

The following provision is adopted from 23 CFR 230, Appendix A, with appropriate revisions to conform to the U.S. Department of Labor (US DOL) and FHWA requirements.

**1. Equal Employment Opportunity:** Equal employment opportunity (EEO) requirements not to discriminate and to take affirmative action to assure equal opportunity as set forth under laws, executive orders, rules, regulations (28 CFR 35, 29 CFR 1630, 29 CFR 1625-1627, 41 CFR 60 and 49 CFR 27) and orders of the Secretary of Labor as modified by the provisions prescribed herein, and imposed pursuant to 23 U.S.C. 140 shall constitute the EEO and specific affirmative action standards for the contractor's project activities under



this contract. The provisions of the Americans with Disabilities Act of 1990 (42 U.S.C. 12101 et seq.) set forth under 28 CFR 35 and 29 CFR 1630 are incorporated by reference in this contract. In the execution of this contract, the contractor agrees to comply with the following minimum specific requirement activities of EEO:

a. The contractor will work with the contracting agency and the Federal Government to ensure that it has made every good faith effort to provide equal opportunity with respect to all of its terms and conditions of employment and in their review of activities under the contract.

b. The contractor will accept as its operating policy the following statement:

"It is the policy of this Company to assure that applicants are employed, and that employees are treated during employment, without regard to their race, religion, sex, color, national origin, age or disability. Such action shall include: employment, upgrading, demotion, or transfer; recruitment or recruitment advertising; layoff or termination; rates of pay or other forms of compensation; and selection for training, including apprenticeship, pre-apprenticeship, and/or on-the-job training."

**2. EEO Officer:** The contractor will designate and make known to the contracting officers an EEO Officer who will have the responsibility for and must be capable of effectively administering and promoting an active EEO program and who must be assigned adequate authority and responsibility to do so.

**3. Dissemination of Policy:** All members of the contractor's staff who are authorized to hire, supervise, promote, and discharge employees, or who recommend such action, or who are substantially involved in such action, will be made fully cognizant of, and will implement, the contractor's EEO policy and contractual responsibilities to provide EEO in each grade and classification of employment. To ensure that the above agreement will be met, the following actions will be taken as a minimum:

a. Periodic meetings of supervisory and personnel office employees will be conducted before the start of work and then not less often than once every six months, at which time the contractor's EEO policy and its implementation will be reviewed and explained. The meetings will be conducted by the EEO Officer.

b. All new supervisory or personnel office employees will be given a thorough indoctrination by the EEO Officer, covering all major aspects of the contractor's EEO obligations within thirty days following their reporting for duty with the contractor.

c. All personnel who are engaged in direct recruitment for the project will be instructed by the EEO Officer in the contractor's procedures for locating and hiring minorities and women.

d. Notices and posters setting forth the contractor's EEO policy will be placed in areas readily accessible to employees, applicants for employment and potential employees.

e. The contractor's EEO policy and the procedures to implement such policy will be brought to the attention of employees by means of meetings, employee handbooks, or other appropriate means.

**4. Recruitment:** When advertising for employees, the contractor will include in all advertisements for employees the notation: "An Equal Opportunity Employer." All such advertisements will be placed in publications having a large circulation among minorities and women in the area from which the project work force would normally be derived.

a. The contractor will, unless precluded by a valid bargaining agreement, conduct systematic and direct recruitment through public and private employee referral sources likely to yield qualified minorities and women. To meet this requirement, the contractor will identify sources of potential minority group employees, and establish with such identified sources procedures whereby minority and women applicants may be referred to the contractor for employment consideration.

b. In the event the contractor has a valid bargaining agreement providing for exclusive hiring hall referrals, the contractor is expected to observe the provisions of that agreement to the extent that the system meets the contractor's compliance with EEO contract provisions. Where implementation of such an agreement has the effect of discriminating against minorities or women, or obligates the contractor to do the same, such implementation violates Federal nondiscrimination provisions.

c. The contractor will encourage its present employees to refer minorities and women as applicants for employment. Information and procedures with regard to referring such applicants will be discussed with employees.

**5. Personnel Actions:** Wages, working conditions, and employee benefits shall be established and administered, and personnel actions of every type, including hiring, upgrading, promotion, transfer, demotion, layoff, and termination, shall be taken without regard to race, color, religion, sex, national origin, age or disability. The following procedures shall be followed:

a. The contractor will conduct periodic inspections of project sites to insure that working conditions and employee facilities do not indicate discriminatory treatment of project site personnel.

b. The contractor will periodically evaluate the spread of wages paid within each classification to determine any evidence of discriminatory wage practices.

c. The contractor will periodically review selected personnel actions in depth to determine whether there is evidence of discrimination. Where evidence is found, the contractor will promptly take corrective action. If the review indicates that the discrimination may extend beyond the actions reviewed, such corrective action shall include all affected persons.

d. The contractor will promptly investigate all complaints of alleged discrimination made to the contractor in connection with its obligations under this contract, will attempt to resolve such complaints, and will take appropriate corrective action within a reasonable time. If the investigation indicates that the discrimination may affect persons other than the complainant, such corrective action shall include such other persons. Upon completion of each investigation, the contractor will inform every complainant of all of their avenues of appeal.

**6. Training and Promotion:**

a. The contractor will assist in locating, qualifying, and increasing the skills of minorities and women who are

applicants for employment or current employees. Such efforts should be aimed at developing full journey level status employees in the type of trade or job classification involved.

b. Consistent with the contractor's work force requirements and as permissible under Federal and State regulations, the contractor shall make full use of training programs, i.e., apprenticeship, and on-the-job training programs for the geographical area of contract performance. In the event a special provision for training is provided under this contract, this subparagraph will be superseded as indicated in the special provision. The contracting agency may reserve training positions for persons who receive welfare assistance in accordance with 23 U.S.C. 140(a).

c. The contractor will advise employees and applicants for employment of available training programs and entrance requirements for each.

d. The contractor will periodically review the training and promotion potential of employees who are minorities and women and will encourage eligible employees to apply for such training and promotion.

**7. Unions:** If the contractor relies in whole or in part upon unions as a source of employees, the contractor will use good faith efforts to obtain the cooperation of such unions to increase opportunities for minorities and women. Actions by the contractor, either directly or through a contractor's association acting as agent, will include the procedures set forth below:

a. The contractor will use good faith efforts to develop, in cooperation with the unions, joint training programs aimed toward qualifying more minorities and women for membership in the unions and increasing the skills of minorities and women so that they may qualify for higher paying employment.

b. The contractor will use good faith efforts to incorporate an EEO clause into each union agreement to the end that such union will be contractually bound to refer applicants without regard to their race, color, religion, sex, national origin, age or disability.

c. The contractor is to obtain information as to the referral practices and policies of the labor union except that to the extent such information is within the exclusive possession of the labor union and such labor union refuses to furnish such information to the contractor, the contractor shall so certify to the contracting agency and shall set forth what efforts have been made to obtain such information.

d. In the event the union is unable to provide the contractor with a reasonable flow of referrals within the time limit set forth in the collective bargaining agreement, the contractor will, through independent recruitment efforts, fill the employment vacancies without regard to race, color, religion, sex, national origin, age or disability; making full efforts to obtain qualified and/or qualifiable minorities and women. The failure of a union to provide sufficient referrals (even though it is obligated to provide exclusive referrals under the terms of a collective bargaining agreement) does not relieve the contractor from the requirements of this paragraph. In the event the union referral practice prevents the contractor from meeting the obligations pursuant to Executive Order 11246, as amended, and these special provisions, such contractor shall immediately notify the contracting agency.

**8. Reasonable Accommodation for Applicants / Employees with Disabilities:** The contractor must be familiar

with the requirements for and comply with the Americans with Disabilities Act and all rules and regulations established there under. Employers must provide reasonable accommodation in all employment activities unless to do so would cause an undue hardship.

**9. Selection of Subcontractors, Procurement of Materials and Leasing of Equipment:** The contractor shall not discriminate on the grounds of race, color, religion, sex, national origin, age or disability in the selection and retention of subcontractors, including procurement of materials and leases of equipment. The contractor shall take all necessary and reasonable steps to ensure nondiscrimination in the administration of this contract.

a. The contractor shall notify all potential subcontractors and suppliers and lessors of their EEO obligations under this contract.

b. The contractor will use good faith efforts to ensure subcontractor compliance with their EEO obligations.

**10. Assurance Required by 49 CFR 26.13(b):**

a. The requirements of 49 CFR Part 26 and the State DOT's U.S. DOT-approved DBE program are incorporated by reference.

b. The contractor or subcontractor shall not discriminate on the basis of race, color, national origin, or sex in the performance of this contract. The contractor shall carry out applicable requirements of 49 CFR Part 26 in the award and administration of DOT-assisted contracts. Failure by the contractor to carry out these requirements is a material breach of this contract, which may result in the termination of this contract or such other remedy as the contracting agency deems appropriate.

**11. Records and Reports:** The contractor shall keep such records as necessary to document compliance with the EEO requirements. Such records shall be retained for a period of three years following the date of the final payment to the contractor for all contract work and shall be available at reasonable times and places for inspection by authorized representatives of the contracting agency and the FHWA.

a. The records kept by the contractor shall document the following:

(1) The number and work hours of minority and non-minority group members and women employed in each work classification on the project;

(2) The progress and efforts being made in cooperation with unions, when applicable, to increase employment opportunities for minorities and women; and

(3) The progress and efforts being made in locating, hiring, training, qualifying, and upgrading minorities and women;

b. The contractors and subcontractors will submit an annual report to the contracting agency each July for the duration of the project, indicating the number of minority, women, and non-minority group employees currently engaged in each work classification required by the contract work. This information is to be reported on [Form FHWA-1391](#). The staffing data should represent the project work force on board in all or any part of the last payroll period preceding the end of July. If on-the-job training is being required by special provision, the contractor

will be required to collect and report training data. The employment data should reflect the work force on board during all or any part of the last payroll period preceding the end of July.

### III. NONSEGREGATED FACILITIES

This provision is applicable to all Federal-aid construction contracts and to all related construction subcontracts of \$10,000 or more.

The contractor must ensure that facilities provided for employees are provided in such a manner that segregation on the basis of race, color, religion, sex, or national origin cannot result. The contractor may neither require such segregated use by written or oral policies nor tolerate such use by employee custom. The contractor's obligation extends further to ensure that its employees are not assigned to perform their services at any location, under the contractor's control, where the facilities are segregated. The term "facilities" includes waiting rooms, work areas, restaurants and other eating areas, time clocks, restrooms, washrooms, locker rooms, and other storage or dressing areas, parking lots, drinking fountains, recreation or entertainment areas, transportation, and housing provided for employees. The contractor shall provide separate or single-user restrooms and necessary dressing or sleeping areas to assure privacy between sexes.

### IV. DAVIS-BACON AND RELATED ACT PROVISIONS

This section is applicable to all Federal-aid construction projects exceeding \$2,000 and to all related subcontracts and lower-tier subcontracts (regardless of subcontract size). The requirements apply to all projects located within the right-of-way of a roadway that is functionally classified as Federal-aid highway. This excludes roadways functionally classified as local roads or rural minor collectors, which are exempt. Contracting agencies may elect to apply these requirements to other projects.

The following provisions are from the U.S. Department of Labor regulations in 29 CFR 5.5 "Contract provisions and related matters" with minor revisions to conform to the FHWA-1273 format and FHWA program requirements.

#### 1. Minimum wages

a. All laborers and mechanics employed or working upon the site of the work, will be paid unconditionally and not less often than once a week, and without subsequent deduction or rebate on any account (except such payroll deductions as are permitted by regulations issued by the Secretary of Labor under the Copeland Act (29 CFR part 3)), the full amount of wages and bona fide fringe benefits (or cash equivalents thereof) due at time of payment computed at rates not less than those contained in the wage determination of the Secretary of Labor which is attached hereto and made a part hereof, regardless of any contractual relationship which may be alleged to exist between the contractor and such laborers and mechanics.

Contributions made or costs reasonably anticipated for bona fide fringe benefits under section 1(b)(2) of the Davis-Bacon Act on behalf of laborers or mechanics are considered wages

paid to such laborers or mechanics, subject to the provisions of paragraph 1.d. of this section; also, regular contributions made or costs incurred for more than a weekly period (but not less often than quarterly) under plans, funds, or programs which cover the particular weekly period, are deemed to be constructively made or incurred during such weekly period. Such laborers and mechanics shall be paid the appropriate wage rate and fringe benefits on the wage determination for the classification of work actually performed, without regard to skill, except as provided in 29 CFR 5.5(a)(4). Laborers or mechanics performing work in more than one classification may be compensated at the rate specified for each classification for the time actually worked therein: Provided, That the employer's payroll records accurately set forth the time spent in each classification in which work is performed. The wage determination (including any additional classification and wage rates conformed under paragraph 1.b. of this section) and the Davis-Bacon poster (WH-1321) shall be posted at all times by the contractor and its subcontractors at the site of the work in a prominent and accessible place where it can be easily seen by the workers.

b. (1) The contracting officer shall require that any class of laborers or mechanics, including helpers, which is not listed in the wage determination and which is to be employed under the contract shall be classified in conformance with the wage determination. The contracting officer shall approve an additional classification and wage rate and fringe benefits therefore only when the following criteria have been met:

(i) The work to be performed by the classification requested is not performed by a classification in the wage determination; and

(ii) The classification is utilized in the area by the construction industry; and

(iii) The proposed wage rate, including any bona fide fringe benefits, bears a reasonable relationship to the wage rates contained in the wage determination.

(2) If the contractor and the laborers and mechanics to be employed in the classification (if known), or their representatives, and the contracting officer agree on the classification and wage rate (including the amount designated for fringe benefits where appropriate), a report of the action taken shall be sent by the contracting officer to the Administrator of the Wage and Hour Division, Employment Standards Administration, U.S. Department of Labor, Washington, DC 20210. The Administrator, or an authorized representative, will approve, modify, or disapprove every additional classification action within 30 days of receipt and so advise the contracting officer or will notify the contracting officer within the 30-day period that additional time is necessary.

(3) In the event the contractor, the laborers or mechanics to be employed in the classification or their representatives, and the contracting officer do not agree on the proposed classification and wage rate (including the amount designated for fringe benefits, where appropriate), the contracting officer shall refer the questions, including the views of all interested parties and the recommendation of the contracting officer, to the Wage and Hour Administrator for determination. The Wage and Hour Administrator, or an authorized representative, will issue a determination within 30 days of receipt and so advise

the contracting officer or will notify the contracting officer within the 30-day period that additional time is necessary.

(4) The wage rate (including fringe benefits where appropriate) determined pursuant to paragraphs 1.b.(2) or 1.b.(3) of this section, shall be paid to all workers performing work in the classification under this contract from the first day on which work is performed in the classification.

c. Whenever the minimum wage rate prescribed in the contract for a class of laborers or mechanics includes a fringe benefit which is not expressed as an hourly rate, the contractor shall either pay the benefit as stated in the wage determination or shall pay another bona fide fringe benefit or an hourly cash equivalent thereof.

d. If the contractor does not make payments to a trustee or other third person, the contractor may consider as part of the wages of any laborer or mechanic the amount of any costs reasonably anticipated in providing bona fide fringe benefits under a plan or program, Provided, That the Secretary of Labor has found, upon the written request of the contractor, that the applicable standards of the Davis-Bacon Act have been met. The Secretary of Labor may require the contractor to set aside in a separate account assets for the meeting of obligations under the plan or program.

## 2. Withholding

The contracting agency shall upon its own action or upon written request of an authorized representative of the Department of Labor, withhold or cause to be withheld from the contractor under this contract, or any other Federal contract with the same prime contractor, or any other federally-assisted contract subject to Davis-Bacon prevailing wage requirements, which is held by the same prime contractor, so much of the accrued payments or advances as may be considered necessary to pay laborers and mechanics, including apprentices, trainees, and helpers, employed by the contractor or any subcontractor the full amount of wages required by the contract. In the event of failure to pay any laborer or mechanic, including any apprentice, trainee, or helper, employed or working on the site of the work, all or part of the wages required by the contract, the contracting agency may, after written notice to the contractor, take such action as may be necessary to cause the suspension of any further payment, advance, or guarantee of funds until such violations have ceased.

## 3. Payrolls and basic records

a. Payrolls and basic records relating thereto shall be maintained by the contractor during the course of the work and preserved for a period of three years thereafter for all laborers and mechanics working at the site of the work. Such records shall contain the name, address, and social security number of each such worker, his or her correct classification, hourly rates of wages paid (including rates of contributions or costs anticipated for bona fide fringe benefits or cash equivalents thereof of the types described in section 1(b)(2)(B) of the Davis-Bacon Act), daily and weekly number of hours worked, deductions made and actual wages paid. Whenever the Secretary of Labor has found under 29 CFR 5.5(a)(1)(iv) that the wages of any laborer or mechanic include the amount of any costs reasonably anticipated in providing benefits under a plan or program described in section 1(b)(2)(B) of the Davis-

Bacon Act, the contractor shall maintain records which show that the commitment to provide such benefits is enforceable, that the plan or program is financially responsible, and that the plan or program has been communicated in writing to the laborers or mechanics affected, and records which show the costs anticipated or the actual cost incurred in providing such benefits. Contractors employing apprentices or trainees under approved programs shall maintain written evidence of the registration of apprenticeship programs and certification of trainee programs, the registration of the apprentices and trainees, and the ratios and wage rates prescribed in the applicable programs.

b. (1) The contractor shall submit weekly for each week in which any contract work is performed a copy of all payrolls to the contracting agency. The payrolls submitted shall set out accurately and completely all of the information required to be maintained under 29 CFR 5.5(a)(3)(i), except that full social security numbers and home addresses shall not be included on weekly transmittals. Instead the payrolls shall only need to include an individually identifying number for each employee (e.g., the last four digits of the employee's social security number). The required weekly payroll information may be submitted in any form desired. Optional Form WH-347 is available for this purpose from the Wage and Hour Division Web site at <http://www.dol.gov/esa/whd/forms/wh347instr.htm> or its successor site. The prime contractor is responsible for the submission of copies of payrolls by all subcontractors. Contractors and subcontractors shall maintain the full social security number and current address of each covered worker, and shall provide them upon request to the contracting agency for transmission to the State DOT, the FHWA or the Wage and Hour Division of the Department of Labor for purposes of an investigation or audit of compliance with prevailing wage requirements. It is not a violation of this section for a prime contractor to require a subcontractor to provide addresses and social security numbers to the prime contractor for its own records, without weekly submission to the contracting agency..

(2) Each payroll submitted shall be accompanied by a "Statement of Compliance," signed by the contractor or subcontractor or his or her agent who pays or supervises the payment of the persons employed under the contract and shall certify the following:

(i) That the payroll for the payroll period contains the information required to be provided under §5.5 (a)(3)(ii) of Regulations, 29 CFR part 5, the appropriate information is being maintained under §5.5 (a)(3)(i) of Regulations, 29 CFR part 5, and that such information is correct and complete;

(ii) That each laborer or mechanic (including each helper, apprentice, and trainee) employed on the contract during the payroll period has been paid the full weekly wages earned, without rebate, either directly or indirectly, and that no deductions have been made either directly or indirectly from the full wages earned, other than permissible deductions as set forth in Regulations, 29 CFR part 3;

(iii) That each laborer or mechanic has been paid not less than the applicable wage rates and fringe benefits or cash equivalents for the classification of work performed, as specified in the applicable wage determination incorporated into the contract.

(3) The weekly submission of a properly executed certification set forth on the reverse side of Optional Form WH-347 shall satisfy the requirement for submission of the "Statement of Compliance" required by paragraph 3.b.(2) of this section.

(4) The falsification of any of the above certifications may subject the contractor or subcontractor to civil or criminal prosecution under section 1001 of title 18 and section 231 of title 31 of the United States Code.

c. The contractor or subcontractor shall make the records required under paragraph 3.a. of this section available for inspection, copying, or transcription by authorized representatives of the contracting agency, the State DOT, the FHWA, or the Department of Labor, and shall permit such representatives to interview employees during working hours on the job. If the contractor or subcontractor fails to submit the required records or to make them available, the FHWA may, after written notice to the contractor, the contracting agency or the State DOT, take such action as may be necessary to cause the suspension of any further payment, advance, or guarantee of funds. Furthermore, failure to submit the required records upon request or to make such records available may be grounds for debarment action pursuant to 29 CFR 5.12.

#### 4. Apprentices and trainees

##### a. Apprentices (programs of the USDOL).

Apprentices will be permitted to work at less than the predetermined rate for the work they performed when they are employed pursuant to and individually registered in a bona fide apprenticeship program registered with the U.S. Department of Labor, Employment and Training Administration, Office of Apprenticeship Training, Employer and Labor Services, or with a State Apprenticeship Agency recognized by the Office, or if a person is employed in his or her first 90 days of probationary employment as an apprentice in such an apprenticeship program, who is not individually registered in the program, but who has been certified by the Office of Apprenticeship Training, Employer and Labor Services or a State Apprenticeship Agency (where appropriate) to be eligible for probationary employment as an apprentice.

The allowable ratio of apprentices to journeymen on the job site in any craft classification shall not be greater than the ratio permitted to the contractor as to the entire work force under the registered program. Any worker listed on a payroll at an apprentice wage rate, who is not registered or otherwise employed as stated above, shall be paid not less than the applicable wage rate on the wage determination for the classification of work actually performed. In addition, any apprentice performing work on the job site in excess of the ratio permitted under the registered program shall be paid not less than the applicable wage rate on the wage determination for the work actually performed. Where a contractor is performing construction on a project in a locality other than that in which its program is registered, the ratios and wage rates (expressed in percentages of the journeyman's hourly rate) specified in the contractor's or subcontractor's registered program shall be observed.

Every apprentice must be paid at not less than the rate specified in the registered program for the apprentice's level of progress, expressed as a percentage of the journeymen hourly

rate specified in the applicable wage determination. Apprentices shall be paid fringe benefits in accordance with the provisions of the apprenticeship program. If the apprenticeship program does not specify fringe benefits, apprentices must be paid the full amount of fringe benefits listed on the wage determination for the applicable classification. If the Administrator determines that a different practice prevails for the applicable apprentice classification, fringes shall be paid in accordance with that determination.

In the event the Office of Apprenticeship Training, Employer and Labor Services, or a State Apprenticeship Agency recognized by the Office, withdraws approval of an apprenticeship program, the contractor will no longer be permitted to utilize apprentices at less than the applicable predetermined rate for the work performed until an acceptable program is approved.

##### b. Trainees (programs of the USDOL).

Except as provided in 29 CFR 5.16, trainees will not be permitted to work at less than the predetermined rate for the work performed unless they are employed pursuant to and individually registered in a program which has received prior approval, evidenced by formal certification by the U.S. Department of Labor, Employment and Training Administration.

The ratio of trainees to journeymen on the job site shall not be greater than permitted under the plan approved by the Employment and Training Administration.

Every trainee must be paid at not less than the rate specified in the approved program for the trainee's level of progress, expressed as a percentage of the journeyman hourly rate specified in the applicable wage determination. Trainees shall be paid fringe benefits in accordance with the provisions of the trainee program. If the trainee program does not mention fringe benefits, trainees shall be paid the full amount of fringe benefits listed on the wage determination unless the Administrator of the Wage and Hour Division determines that there is an apprenticeship program associated with the corresponding journeyman wage rate on the wage determination which provides for less than full fringe benefits for apprentices. Any employee listed on the payroll at a trainee rate who is not registered and participating in a training plan approved by the Employment and Training Administration shall be paid not less than the applicable wage rate on the wage determination for the classification of work actually performed. In addition, any trainee performing work on the job site in excess of the ratio permitted under the registered program shall be paid not less than the applicable wage rate on the wage determination for the work actually performed.

In the event the Employment and Training Administration withdraws approval of a training program, the contractor will no longer be permitted to utilize trainees at less than the applicable predetermined rate for the work performed until an acceptable program is approved.

c. Equal employment opportunity. The utilization of apprentices, trainees and journeymen under this part shall be in conformity with the equal employment opportunity requirements of Executive Order 11246, as amended, and 29 CFR part 30.

d. Apprentices and Trainees (programs of the U.S. DOT).

Apprentices and trainees working under apprenticeship and skill training programs which have been certified by the Secretary of Transportation as promoting EEO in connection with Federal-aid highway construction programs are not subject to the requirements of paragraph 4 of this Section IV. The straight time hourly wage rates for apprentices and trainees under such programs will be established by the particular programs. The ratio of apprentices and trainees to journeymen shall not be greater than permitted by the terms of the particular program.

**5. Compliance with Copeland Act requirements.** The contractor shall comply with the requirements of 29 CFR part 3, which are incorporated by reference in this contract.

**6. Subcontracts.** The contractor or subcontractor shall insert Form FHWA-1273 in any subcontracts and also require the subcontractors to include Form FHWA-1273 in any lower tier subcontracts. The prime contractor shall be responsible for the compliance by any subcontractor or lower tier subcontractor with all the contract clauses in 29 CFR 5.5.

**7. Contract termination: debarment.** A breach of the contract clauses in 29 CFR 5.5 may be grounds for termination of the contract, and for debarment as a contractor and a subcontractor as provided in 29 CFR 5.12.

**8. Compliance with Davis-Bacon and Related Act requirements.** All rulings and interpretations of the Davis-Bacon and Related Acts contained in 29 CFR parts 1, 3, and 5 are herein incorporated by reference in this contract.

**9. Disputes concerning labor standards.** Disputes arising out of the labor standards provisions of this contract shall not be subject to the general disputes clause of this contract. Such disputes shall be resolved in accordance with the procedures of the Department of Labor set forth in 29 CFR parts 5, 6, and 7. Disputes within the meaning of this clause include disputes between the contractor (or any of its subcontractors) and the contracting agency, the U.S. Department of Labor, or the employees or their representatives.

**10. Certification of eligibility.**

a. By entering into this contract, the contractor certifies that neither it (nor he or she) nor any person or firm who has an interest in the contractor's firm is a person or firm ineligible to be awarded Government contracts by virtue of section 3(a) of the Davis-Bacon Act or 29 CFR 5.12(a)(1).

b. No part of this contract shall be subcontracted to any person or firm ineligible for award of a Government contract by virtue of section 3(a) of the Davis-Bacon Act or 29 CFR 5.12(a)(1).

c. The penalty for making false statements is prescribed in the U.S. Criminal Code, 18 U.S.C. 1001.

**V. CONTRACT WORK HOURS AND SAFETY STANDARDS ACT**

The following clauses apply to any Federal-aid construction contract in an amount in excess of \$100,000 and subject to the overtime provisions of the Contract Work Hours and Safety Standards Act. These clauses shall be inserted in addition to the clauses required by 29 CFR 5.5(a) or 29 CFR 4.6. As used in this paragraph, the terms laborers and mechanics include watchmen and guards.

**1. Overtime requirements.** No contractor or subcontractor contracting for any part of the contract work which may require or involve the employment of laborers or mechanics shall require or permit any such laborer or mechanic in any workweek in which he or she is employed on such work to work in excess of forty hours in such workweek unless such laborer or mechanic receives compensation at a rate not less than one and one-half times the basic rate of pay for all hours worked in excess of forty hours in such workweek.

**2. Violation; liability for unpaid wages; liquidated damages.** In the event of any violation of the clause set forth in paragraph (1.) of this section, the contractor and any subcontractor responsible therefor shall be liable for the unpaid wages. In addition, such contractor and subcontractor shall be liable to the United States (in the case of work done under contract for the District of Columbia or a territory, to such District or to such territory), for liquidated damages. Such liquidated damages shall be computed with respect to each individual laborer or mechanic, including watchmen and guards, employed in violation of the clause set forth in paragraph (1.) of this section, in the sum of \$10 for each calendar day on which such individual was required or permitted to work in excess of the standard workweek of forty hours without payment of the overtime wages required by the clause set forth in paragraph (1.) of this section.

**3. Withholding for unpaid wages and liquidated damages.** The FHWA or the contacting agency shall upon its own action or upon written request of an authorized representative of the Department of Labor withhold or cause to be withheld, from any moneys payable on account of work performed by the contractor or subcontractor under any such contract or any other Federal contract with the same prime contractor, or any other federally-assisted contract subject to the Contract Work Hours and Safety Standards Act, which is held by the same prime contractor, such sums as may be determined to be necessary to satisfy any liabilities of such contractor or subcontractor for unpaid wages and liquidated damages as provided in the clause set forth in paragraph (2.) of this section.

**4. Subcontracts.** The contractor or subcontractor shall insert in any subcontracts the clauses set forth in paragraph (1.) through (4.) of this section and also a clause requiring the subcontractors to include these clauses in any lower tier subcontracts. The prime contractor shall be responsible for compliance by any subcontractor or lower tier subcontractor with the clauses set forth in paragraphs (1.) through (4.) of this section.

## VI. SUBLETTING OR ASSIGNING THE CONTRACT

This provision is applicable to all Federal-aid construction contracts on the National Highway System.

1. The contractor shall perform with its own organization contract work amounting to not less than 30 percent (or a greater percentage if specified elsewhere in the contract) of the total original contract price, excluding any specialty items designated by the contracting agency. Specialty items may be performed by subcontract and the amount of any such specialty items performed may be deducted from the total original contract price before computing the amount of work required to be performed by the contractor's own organization (23 CFR 635.116).

a. The term "perform work with its own organization" refers to workers employed or leased by the prime contractor, and equipment owned or rented by the prime contractor, with or without operators. Such term does not include employees or equipment of a subcontractor or lower tier subcontractor, agents of the prime contractor, or any other assignees. The term may include payments for the costs of hiring leased employees from an employee leasing firm meeting all relevant Federal and State regulatory requirements. Leased employees may only be included in this term if the prime contractor meets all of the following conditions:

(1) the prime contractor maintains control over the supervision of the day-to-day activities of the leased employees;

(2) the prime contractor remains responsible for the quality of the work of the leased employees;

(3) the prime contractor retains all power to accept or exclude individual employees from work on the project; and

(4) the prime contractor remains ultimately responsible for the payment of predetermined minimum wages, the submission of payrolls, statements of compliance and all other Federal regulatory requirements.

b. "Specialty Items" shall be construed to be limited to work that requires highly specialized knowledge, abilities, or equipment not ordinarily available in the type of contracting organizations qualified and expected to bid or propose on the contract as a whole and in general are to be limited to minor components of the overall contract.

2. The contract amount upon which the requirements set forth in paragraph (1) of Section VI is computed includes the cost of material and manufactured products which are to be purchased or produced by the contractor under the contract provisions.

3. The contractor shall furnish (a) a competent superintendent or supervisor who is employed by the firm, has full authority to direct performance of the work in accordance with the contract requirements, and is in charge of all construction operations (regardless of who performs the work) and (b) such other of its own organizational resources (supervision, management, and engineering services) as the contracting officer determines is necessary to assure the performance of the contract.

4. No portion of the contract shall be sublet, assigned or otherwise disposed of except with the written consent of the contracting officer, or authorized representative, and such consent when given shall not be construed to relieve the contractor of any responsibility for the fulfillment of the contract. Written consent will be given only after the

contracting agency has assured that each subcontract is evidenced in writing and that it contains all pertinent provisions and requirements of the prime contract.

5. The 30% self-performance requirement of paragraph (1) is not applicable to design-build contracts; however, contracting agencies may establish their own self-performance requirements.

## VII. SAFETY: ACCIDENT PREVENTION

This provision is applicable to all Federal-aid construction contracts and to all related subcontracts.

1. In the performance of this contract the contractor shall comply with all applicable Federal, State, and local laws governing safety, health, and sanitation (23 CFR 635). The contractor shall provide all safeguards, safety devices and protective equipment and take any other needed actions as it determines, or as the contracting officer may determine, to be reasonably necessary to protect the life and health of employees on the job and the safety of the public and to protect property in connection with the performance of the work covered by the contract.

2. It is a condition of this contract, and shall be made a condition of each subcontract, which the contractor enters into pursuant to this contract, that the contractor and any subcontractor shall not permit any employee, in performance of the contract, to work in surroundings or under conditions which are unsanitary, hazardous or dangerous to his/her health or safety, as determined under construction safety and health standards (29 CFR 1926) promulgated by the Secretary of Labor, in accordance with Section 107 of the Contract Work Hours and Safety Standards Act (40 U.S.C. 3704).

3. Pursuant to 29 CFR 1926.3, it is a condition of this contract that the Secretary of Labor or authorized representative thereof, shall have right of entry to any site of contract performance to inspect or investigate the matter of compliance with the construction safety and health standards and to carry out the duties of the Secretary under Section 107 of the Contract Work Hours and Safety Standards Act (40 U.S.C.3704).

## VIII. FALSE STATEMENTS CONCERNING HIGHWAY PROJECTS

This provision is applicable to all Federal-aid construction contracts and to all related subcontracts.

In order to assure high quality and durable construction in conformity with approved plans and specifications and a high degree of reliability on statements and representations made by engineers, contractors, suppliers, and workers on Federal-aid highway projects, it is essential that all persons concerned with the project perform their functions as carefully, thoroughly, and honestly as possible. Willful falsification, distortion, or misrepresentation with respect to any facts related to the project is a violation of Federal law. To prevent any misunderstanding regarding the seriousness of these and similar acts, Form FHWA-1022 shall be posted on each Federal-aid highway project (23 CFR 635) in one or more places where it is readily available to all persons concerned with the project:

18 U.S.C. 1020 reads as follows:

"Whoever, being an officer, agent, or employee of the United States, or of any State or Territory, or whoever, whether a person, association, firm, or corporation, knowingly makes any false statement, false representation, or false report as to the character, quality, quantity, or cost of the material used or to be used, or the quantity or quality of the work performed or to be performed, or the cost thereof in connection with the submission of plans, maps, specifications, contracts, or costs of construction on any highway or related project submitted for approval to the Secretary of Transportation; or

Whoever knowingly makes any false statement, false representation, false report or false claim with respect to the character, quality, quantity, or cost of any work performed or to be performed, or materials furnished or to be furnished, in connection with the construction of any highway or related project approved by the Secretary of Transportation; or

Whoever knowingly makes any false statement or false representation as to material fact in any statement, certificate, or report submitted pursuant to provisions of the Federal-aid Roads Act approved July 1, 1916, (39 Stat. 355), as amended and supplemented;

Shall be fined under this title or imprisoned not more than 5 years or both."

#### **IX. IMPLEMENTATION OF CLEAN AIR ACT AND FEDERAL WATER POLLUTION CONTROL ACT**

This provision is applicable to all Federal-aid construction contracts and to all related subcontracts.

By submission of this bid/proposal or the execution of this contract, or subcontract, as appropriate, the bidder, proposer, Federal-aid construction contractor, or subcontractor, as appropriate, will be deemed to have stipulated as follows:

1. That any person who is or will be utilized in the performance of this contract is not prohibited from receiving an award due to a violation of Section 508 of the Clean Water Act or Section 306 of the Clean Air Act.

2. That the contractor agrees to include or cause to be included the requirements of paragraph (1) of this Section X in every subcontract, and further agrees to take such action as the contracting agency may direct as a means of enforcing such requirements.

#### **X. CERTIFICATION REGARDING DEBARMENT, SUSPENSION, INELIGIBILITY AND VOLUNTARY EXCLUSION**

This provision is applicable to all Federal-aid construction contracts, design-build contracts, subcontracts, lower-tier subcontracts, purchase orders, lease agreements, consultant contracts or any other covered transaction requiring FHWA approval or that is estimated to cost \$25,000 or more – as defined in 2 CFR Parts 180 and 1200.

##### **1. Instructions for Certification – First Tier Participants:**

a. By signing and submitting this proposal, the prospective first tier participant is providing the certification set out below.

b. The inability of a person to provide the certification set out below will not necessarily result in denial of participation in this

covered transaction. The prospective first tier participant shall submit an explanation of why it cannot provide the certification set out below. The certification or explanation will be considered in connection with the department or agency's determination whether to enter into this transaction. However, failure of the prospective first tier participant to furnish a certification or an explanation shall disqualify such a person from participation in this transaction.

c. The certification in this clause is a material representation of fact upon which reliance was placed when the contracting agency determined to enter into this transaction. If it is later determined that the prospective participant knowingly rendered an erroneous certification, in addition to other remedies available to the Federal Government, the contracting agency may terminate this transaction for cause of default.

d. The prospective first tier participant shall provide immediate written notice to the contracting agency to whom this proposal is submitted if any time the prospective first tier participant learns that its certification was erroneous when submitted or has become erroneous by reason of changed circumstances.

e. The terms "covered transaction," "debarred," "suspended," "ineligible," "participant," "person," "principal," and "voluntarily excluded," as used in this clause, are defined in 2 CFR Parts 180 and 1200. "First Tier Covered Transactions" refers to any covered transaction between a grantee or subgrantee of Federal funds and a participant (such as the prime or general contractor). "Lower Tier Covered Transactions" refers to any covered transaction under a First Tier Covered Transaction (such as subcontracts). "First Tier Participant" refers to the participant who has entered into a covered transaction with a grantee or subgrantee of Federal funds (such as the prime or general contractor). "Lower Tier Participant" refers any participant who has entered into a covered transaction with a First Tier Participant or other Lower Tier Participants (such as subcontractors and suppliers).

f. The prospective first tier participant agrees by submitting this proposal that, should the proposed covered transaction be entered into, it shall not knowingly enter into any lower tier covered transaction with a person who is debarred, suspended, declared ineligible, or voluntarily excluded from participation in this covered transaction, unless authorized by the department or agency entering into this transaction.

g. The prospective first tier participant further agrees by submitting this proposal that it will include the clause titled "Certification Regarding Debarment, Suspension, Ineligibility and Voluntary Exclusion-Lower Tier Covered Transactions," provided by the department or contracting agency, entering into this covered transaction, without modification, in all lower tier covered transactions and in all solicitations for lower tier covered transactions exceeding the \$25,000 threshold.

h. A participant in a covered transaction may rely upon a certification of a prospective participant in a lower tier covered transaction that is not debarred, suspended, ineligible, or voluntarily excluded from the covered transaction, unless it knows that the certification is erroneous. A participant is responsible for ensuring that its principals are not suspended, debarred, or otherwise ineligible to participate in covered transactions. To verify the eligibility of its principals, as well as the eligibility of any lower tier prospective participants, each participant may, but is not required to, check the Excluded Parties List System website (<https://www.epls.gov/>), which is compiled by the General Services Administration.



i. Nothing contained in the foregoing shall be construed to require the establishment of a system of records in order to render in good faith the certification required by this clause. The knowledge and information of the prospective participant is not required to exceed that which is normally possessed by a prudent person in the ordinary course of business dealings.

j. Except for transactions authorized under paragraph (f) of these instructions, if a participant in a covered transaction knowingly enters into a lower tier covered transaction with a person who is suspended, debarred, ineligible, or voluntarily excluded from participation in this transaction, in addition to other remedies available to the Federal Government, the department or agency may terminate this transaction for cause or default.

\* \* \* \* \*

## **2. Certification Regarding Debarment, Suspension, Ineligibility and Voluntary Exclusion – First Tier Participants:**

a. The prospective first tier participant certifies to the best of its knowledge and belief, that it and its principals:

(1) Are not presently debarred, suspended, proposed for debarment, declared ineligible, or voluntarily excluded from participating in covered transactions by any Federal department or agency;

(2) Have not within a three-year period preceding this proposal been convicted of or had a civil judgment rendered against them for commission of fraud or a criminal offense in connection with obtaining, attempting to obtain, or performing a public (Federal, State or local) transaction or contract under a public transaction; violation of Federal or State antitrust statutes or commission of embezzlement, theft, forgery, bribery, falsification or destruction of records, making false statements, or receiving stolen property;

(3) Are not presently indicted for or otherwise criminally or civilly charged by a governmental entity (Federal, State or local) with commission of any of the offenses enumerated in paragraph (a)(2) of this certification; and

(4) Have not within a three-year period preceding this application/proposal had one or more public transactions (Federal, State or local) terminated for cause or default.

b. Where the prospective participant is unable to certify to any of the statements in this certification, such prospective participant shall attach an explanation to this proposal.

### **2. Instructions for Certification - Lower Tier Participants:**

(Applicable to all subcontracts, purchase orders and other lower tier transactions requiring prior FHWA approval or estimated to cost \$25,000 or more - 2 CFR Parts 180 and 1200)

a. By signing and submitting this proposal, the prospective lower tier is providing the certification set out below.

b. The certification in this clause is a material representation of fact upon which reliance was placed when this transaction was entered into. If it is later determined that the prospective lower tier participant knowingly rendered an erroneous certification, in addition to other remedies available to the Federal Government, the department, or agency with which

this transaction originated may pursue available remedies, including suspension and/or debarment.

c. The prospective lower tier participant shall provide immediate written notice to the person to which this proposal is submitted if at any time the prospective lower tier participant learns that its certification was erroneous by reason of changed circumstances.

d. The terms "covered transaction," "debarred," "suspended," "ineligible," "participant," "person," "principal," and "voluntarily excluded," as used in this clause, are defined in 2 CFR Parts 180 and 1200. You may contact the person to which this proposal is submitted for assistance in obtaining a copy of those regulations. "First Tier Covered Transactions" refers to any covered transaction between a grantee or subgrantee of Federal funds and a participant (such as the prime or general contract). "Lower Tier Covered Transactions" refers to any covered transaction under a First Tier Covered Transaction (such as subcontracts). "First Tier Participant" refers to the participant who has entered into a covered transaction with a grantee or subgrantee of Federal funds (such as the prime or general contractor). "Lower Tier Participant" refers any participant who has entered into a covered transaction with a First Tier Participant or other Lower Tier Participants (such as subcontractors and suppliers).

e. The prospective lower tier participant agrees by submitting this proposal that, should the proposed covered transaction be entered into, it shall not knowingly enter into any lower tier covered transaction with a person who is debarred, suspended, declared ineligible, or voluntarily excluded from participation in this covered transaction, unless authorized by the department or agency with which this transaction originated.

f. The prospective lower tier participant further agrees by submitting this proposal that it will include this clause titled "Certification Regarding Debarment, Suspension, Ineligibility and Voluntary Exclusion-Lower Tier Covered Transaction," without modification, in all lower tier covered transactions and in all solicitations for lower tier covered transactions exceeding the \$25,000 threshold.

g. A participant in a covered transaction may rely upon a certification of a prospective participant in a lower tier covered transaction that is not debarred, suspended, ineligible, or voluntarily excluded from the covered transaction, unless it knows that the certification is erroneous. A participant is responsible for ensuring that its principals are not suspended, debarred, or otherwise ineligible to participate in covered transactions. To verify the eligibility of its principals, as well as the eligibility of any lower tier prospective participants, each participant may, but is not required to, check the Excluded Parties List System website (<https://www.epls.gov/>), which is compiled by the General Services Administration.

h. Nothing contained in the foregoing shall be construed to require establishment of a system of records in order to render in good faith the certification required by this clause. The knowledge and information of participant is not required to exceed that which is normally possessed by a prudent person in the ordinary course of business dealings.

i. Except for transactions authorized under paragraph e of these instructions, if a participant in a covered transaction knowingly enters into a lower tier covered transaction with a person who is suspended, debarred, ineligible, or voluntarily excluded from participation in this transaction, in addition to other remedies available to the Federal Government, the

department or agency with which this transaction originated may pursue available remedies, including suspension and/or debarment.

\* \* \* \* \*

**Certification Regarding Debarment, Suspension, Ineligibility and Voluntary Exclusion--Lower Tier Participants:**

1. The prospective lower tier participant certifies, by submission of this proposal, that neither it nor its principals is presently debarred, suspended, proposed for debarment, declared ineligible, or voluntarily excluded from participating in covered transactions by any Federal department or agency.

2. Where the prospective lower tier participant is unable to certify to any of the statements in this certification, such prospective participant shall attach an explanation to this proposal.

\* \* \* \* \*

**XI. CERTIFICATION REGARDING USE OF CONTRACT FUNDS FOR LOBBYING**

This provision is applicable to all Federal-aid construction contracts and to all related subcontracts which exceed \$100,000 (49 CFR 20).

1. The prospective participant certifies, by signing and submitting this bid or proposal, to the best of his or her knowledge and belief, that:

a. No Federal appropriated funds have been paid or will be paid, by or on behalf of the undersigned, to any person for influencing or attempting to influence an officer or employee of any Federal agency, a Member of Congress, an officer or employee of Congress, or an employee of a Member of Congress in connection with the awarding of any Federal contract, the making of any Federal grant, the making of any Federal loan, the entering into of any cooperative agreement, and the extension, continuation, renewal, amendment, or modification of any Federal contract, grant, loan, or cooperative agreement.

b. If any funds other than Federal appropriated funds have been paid or will be paid to any person for influencing or attempting to influence an officer or employee of any Federal agency, a Member of Congress, an officer or employee of Congress, or an employee of a Member of Congress in connection with this Federal contract, grant, loan, or cooperative agreement, the undersigned shall complete and submit Standard Form-LLL, "Disclosure Form to Report Lobbying," in accordance with its instructions.

2. This certification is a material representation of fact upon which reliance was placed when this transaction was made or entered into. Submission of this certification is a prerequisite for making or entering into this transaction imposed by 31 U.S.C. 1352. Any person who fails to file the required certification shall be subject to a civil penalty of not less than \$10,000 and not more than \$100,000 for each such failure.

3. The prospective participant also agrees by submitting its bid or proposal that the participant shall require that the language of this certification be included in all lower tier subcontracts, which exceed \$100,000 and that all such recipients shall certify and disclose accordingly.

**NOTICE OF REQUIREMENTS FOR AFFIRMATIVE  
ACTION TO ENSURE EQUAL EMPLOYMENT  
OPPORTUNITY (EXECUTIVE ORDER 11246)**

1. The Offeror's or Bidder's attention is called to the "Equal Opportunity Clause" and the "Standard Federal Equal Employment Opportunity Construction Contract Specifications" set forth herein.

2. The goal for female participation, expressed in percentage terms for the Contractor's aggregate workforce in each trade on all construction work, is 6.9%.

Until further notice Goals for minority participation for each trade (percent)

SHSA Cities:  
 Pascagoula - Moss Point ----- 16.9  
 Biloxi - Gulfport ----- 19.2  
 Jackson ----- 30.3

SMSA Counties:  
 Desoto ----- 32.3  
 Hancock, Harrison, Stone ----- 19.2  
 Hinds, Rankin ----- 30.3  
 Jackson ----- 16.9

Non-SMSA Counties:  
 George, Greene ----- 26.4

Alcorn, Benton, Bolivar, Calhoun, Carroll, Chickasaw, Clay, Coahoma, Grenada, Itawamba, Lafayette, Lee, Leflore, Marshall, Monroe, Montgomery, Panola, Pontotoc, Prentiss, Quitman, Sunflower, Tallahatchie, Tate, Tippah, Tishomingo, Tunica, Union, Washington, Webster, Yalobusha ----- 26.5

Attala, Choctaw, Claiborne, Clarke, Copiah, Covington, Franklin, Holmes, Humphreys, Issaquena, Jasper, Jefferson, Jefferson Davis, Jones Kemper, Lauderdale, Lawrence, Leake, Lincoln, Lowndes, Madison, Neshoba, Newton, Noxubee, Oktibbeha, Scott, Sharkey, Simpson, Smith, Warren, Wayne, Winston, Yazoo ----- 32.0

Forrest, Lamar, Marion, Pearl River, Perry, Pike, Walthall ----- 27.7

Adams, Amite, Wilkinson ----- 30.4

These goals are applicable to all the Contractor's construction work (whether or not it is Federal or federally assisted) performed in the covered area. If the contractor performs construction work in a geographical area located outside of the covered area, it shall apply the goals established for such geographical area where the work is actually performed. With regard to this second area, the contractor also is subject to the goals for both its federally involved and nonfederally involved construction.

The Contractor's compliance with the Executive Order and the regulations in CFR Part 60-4 shall be based on its implementation of the Equal Opportunity clause, specific affirmative action obligations required by the specifications set forth in 41 CFR 60-4.3(a), and its efforts to meet the goals. The hours of minority and female employment and training must be substantially uniform throughout the length of the contract, and in each trade, and the Contractor shall make a good faith effort to employ minorities and women evenly on each of its projects. The transfer of minority or female employees or trainees from Contractor to Contractor or from project to project for the sole purpose of meeting the Contractor's goals shall be a violation of the contract, the Executive Order and the regulations in 41 CFR Part 60-4.2(d). Compliance with the goals will be measured against the total work hours performed.

3. The Contractor shall provide written notification to the Director of the Office of Federal Contract Compliance Programs within 10 working days of award of any construction subcontract in excess of \$10,000 at any tier for construction work under the contract resulting from this solicitation. The notification shall list the name, address and telephone number of the subcontractor, employer identification number of the subcontractor, estimated dollar amount of the subcontract; estimated starting and completion dates of the subcontract; and the geographical area in which the subcontract is to be performed.

4. As used in this Notice, and in the contract resulting from this solicitation, the "covered area" is to the county and city (if any), stated in the advertisement.

5. The notification required in Paragraph 3 shall be addressed to the following:

Contract Compliance Officer  
 Mississippi Department of Transportation  
 P.O. Box 1850  
 Jackson, Mississippi 39215-1850

(06/28/2012)

## MISSISSIPPI DEPARTMENT OF TRANSPORTATION

SPECIAL PROVISION NO. 907-102-2

CODE: (IS)

DATE: 11/22/2017

SUBJECT: **Bidding Requirements and Conditions**

Section 102, Bidding Requirements and Conditions, of the 2017 Edition of the Mississippi Standard Specifications for Road and Bridge Construction is hereby amended as follows.

**907-102.01--Prequalification of Bidders.** Delete the last sentence of the third paragraph of Subsection 102.01 on page 13, and substitute the following.

The Bidder's Certificate of Responsibility number must be on file with the Department's Contract Administration Division prior to request for permission to bid.

**907-102.02--Contents of Proposal Forms.** Delete the fourth paragraph in Subsection 102.02 on page 13, and substitute the following.

Prospective bidders must complete an online request for permission to be eligible to bid a project. Upon approval, the bidder will be authorized to submit a bid electronically using Bid Express at <http://bidx.com>.

## MISSISSIPPI DEPARTMENT OF TRANSPORTATION

SPECIAL PROVISION NO. 907-103-2

CODE: (SP)

DATE: 06/22/2017

SUBJECT: Award and Execution of Contract

Section 103, Award and Execution of Contract, of the 2017 Edition of the Mississippi Standard Specifications for Road and Bridge Construction is hereby amended as follows.

**907-103.01--Consideration of Proposal.** Delete the second and third paragraphs of Subsection 103.01 on page 19, and substitute the following.

**907-103.01.1--For Projects Constructed Without Federal Funds.** Resident Contractors actually domiciled in Mississippi are to be granted preference over nonresidents in awarding of Contracts financed 100% with State funds.

In consideration of proposals that are equal to or in excess of \$50,000 and financed 100% with State funds, a nonresident bidder domiciled in a state having laws granting preference to local Contractors will be considered for such contracts on the same basis as the nonresident bidder's state awards contracts to Mississippi Contractors bidding under similar circumstances. When a nonresident Contractor submits a bid equal to or in excess of \$50,000 on a contract financed 100% with State funds, a copy of the current laws from the state of domicile and an explanation thereof pertaining to treatment of nonresident Contractors shall be attached. If no preferential treatment is provided for Contractors in the state of domicile and contracts are awarded to the lowest responsible bidder, a statement to this effect shall be attached. Should the attachment not accompany the bid when submitted, the Contractor shall have 10 days following the opening of the bids to furnish the required information to the Contract Administration Director for attachment to the bid. Failure to provide the attachment within 10 days will result in the nonresident Contractor's bid being rejected and not considered for award. As used herein, the term "resident Contractor" includes a nonresident person, firm or corporation that has been qualified to do business in this State and has maintained a permanent full-time office in the State of Mississippi for two years prior to the submission of the bid, and the subsidiaries and affiliates of such a person, firm or corporation.

## MISSISSIPPI DEPARTMENT OF TRANSPORTATION

SPECIAL PROVISION NO. 907-603-3

CODE: (SP)

DATE: 01/23/2018

SUBJECT: Video Pipe Inspection

Section 603, Culverts and Storm Drains, of the 2017 Edition of the Mississippi Standard Specifications for Road and Bridge Construction is hereby modified as follows.

**907-603.01--Description.** After the last paragraph of Subsection 603.01 on page 383, add the following.

This work also includes the video inspection of drainage systems.

After Subsection 603.03.9.3 on page 390, add the following.

**907-603.03.10--Video Pipe Inspection.** All drainage pipe involved in the work shall be video inspected to determine the condition of the pipe system before and after the work is performed, unless otherwise advised. The drainage system shall be video inspected by the Contractor in the presence of the Engineer or the Engineer's representative. A video recording for each line inspected shall be furnished to the Engineer. The line location (station number) and distance traversed by the camera shall be recorded on a standard compact disc (CD).

Video equipment used for inspecting the drainage system shall be capable of the following minimum requirements:

- (1) Providing color video inspection of the pipeline. The color camera must have a minimum 400-line horizontal resolution.
- (2) Video inspecting up to 300 linear feet of drainage pipe, by pushing, pull cabling, jetting or tractoring the camera through the line and recording the condition on video tape.
- (3) Equipped with a video monitor capable of allowing live viewing of the video inspection.
- (4) Displaying and recording on the video tape, the date, line identification, footage and type of pipe deficiency.
- (5) Recording the distance traversed by the camera to within 0.5 feet, allowing for overlapping of distances if a reversal is required to permit full-length inspection.

Any foreign materials that restricts the movement of the inspection equipment or impairs the quality of the video within the drainage system shall be flushed from the system. Flushing of the

drainage system will be by water jetting or other methods approved by the Engineer. Costs associated with flushing the system will not be made under separate payment. The system shall be re-inspected after flushing in the same manner as the initial inspection as described above. Re-inspection of the system shall be at no additional cost to the State.

**907-603.04--Method of Measurement.** After the last paragraph of Subsection 603.04 on page 390, add the following.

Video pipe inspection will be measured by the linear foot of drainage pipe inspected. The length to be paid will be the slope length of the pipe for each inspection.

**907-603.05--Basis of Payment.** After the second paragraph of Subsection 603.05 on page 390, add the following.

Video pipe inspection, measured as prescribed above, will be paid for at the contract unit price per linear foot of drainage pipe inspected, which price shall be full compensation for furnishing all labor, equipment, CDs, tools and incidentals necessary to complete the work.

After the last pay item listed on page 393, add the following.

**VIDEO PIPE INSPECTION**

907-603-V: Video Pipe Inspection, All Sizes - per linear foot

# MISSISSIPPI DEPARTMENT OF TRANSPORTATION

## SUPPLEMENT TO SPECIAL PROVISION NO. 907-618-4

DATE: 02/20/2018

PROJECT: STP-0003-01(198) / 107748301 -- Harrison County

After the first paragraph of Subsection 907-618.01.2 on page 1, add the following.

Additional traffic control devices will be required as follows.

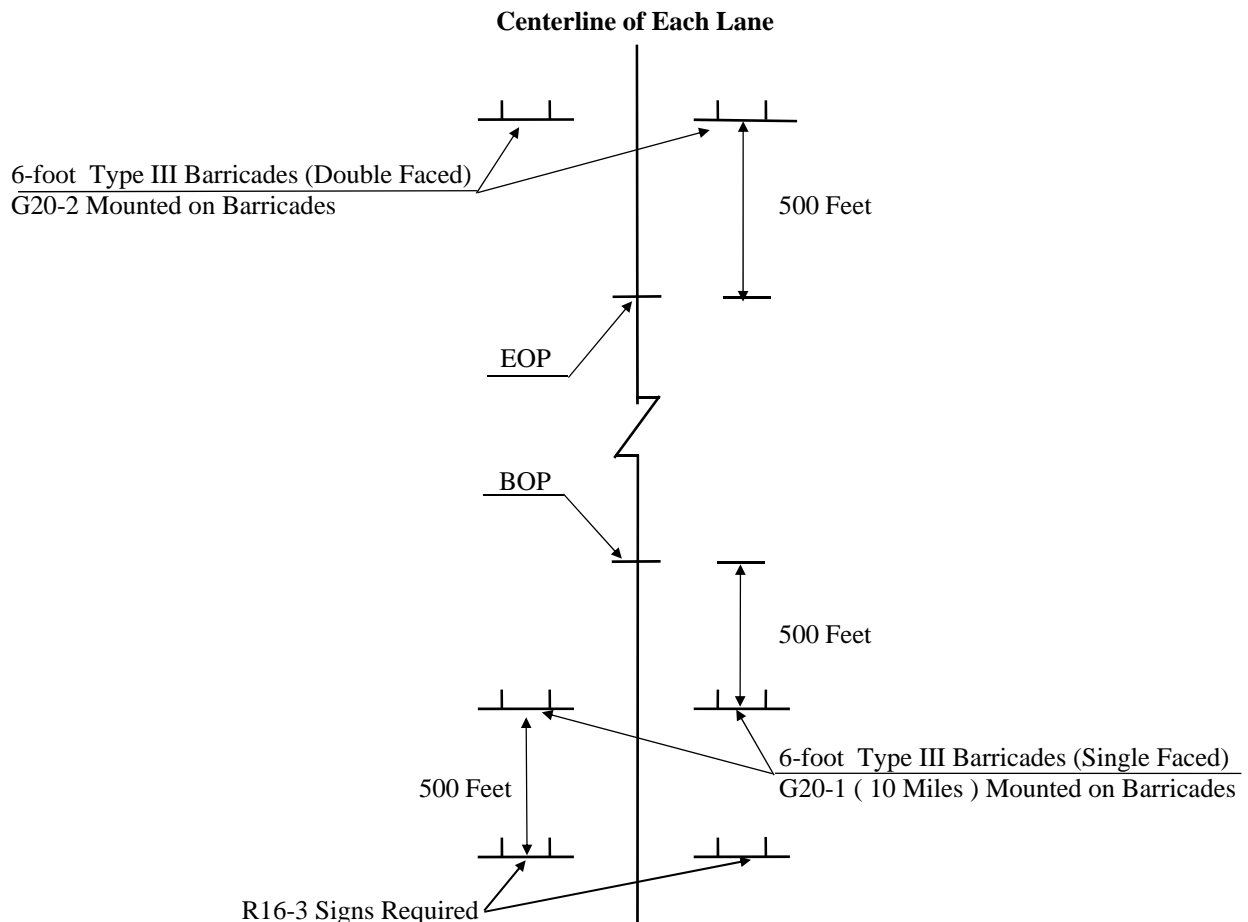

### ADDITIONAL TRAFFIC CONTROL SIGNS REQUIRED:

- 80 - W20-1 "AHEAD" signs required. One (1) sign is required at each local road or street entering the project.
- 2 - R16-3 "SPEEDING FINES DOUBLED" signs required.

R16-3 signs shall be spaced in accordance with sheet titled "Location of R16-3 Signs".

All construction signs and barricades shown on this page shall be included in the bid price for Pay Item 618-A, Maintenance of Traffic. Fluorescent orange sheeting shall be used on all construction and traffic control signs except for R16-3 which shall be black legend and border on white background.





**MISSISSIPPI DEPARTMENT OF TRANSPORTATION**

**SPECIAL PROVISION NO. 907-618-4**

**CODE: (SP)**

**DATE: 02/01/2018**

**SUBJECT: Additional Signing Requirements**

Section 618, Maintenance of Traffic and Traffic Control Plan, of the 2017 Edition of the Mississippi Standard Specifications for Road and Bridge Construction is hereby amended as follows.

**907-618.01.2--Traffic Control Plan.** At the end of Subsection 618.01.2 on page 441, add the following:

For compliance with the traffic control plan, the Contractor will be required to install and maintain **traffic control devices** at various locations throughout the project. Payment for these **devices** will be included in the price bid for pay item no. 618-A, Maintenance of Traffic per lump sum.

# MISSISSIPPI DEPARTMENT OF TRANSPORTATION

**SPECIAL PROVISION NO. 907-687-2**

**CODE: (SP)**

**DATE: 01/24/2018**

**SUBJECT: Traffic Recorder Classification System**

Section 907-687, Traffic Recorder Classification System, is hereby added to and made a part of the 2017 Edition of the Mississippi Standard Specifications for Road and Bridge Construction as follows.

## **SECTION 907-687 - TRAFFIC RECORDER CLASSIFICATION SYSTEM**

**907-687.01--Description.** This work consists of furnishing Traffic Recorder Classification Systems of the types specified which includes assembling, constructing, erecting, and installing a new complete system in conformity with these specifications to insure properly operating units in accordance with the designs and at the locations shown on the plans, or as directed. This axle detector system should classify vehicles in all lanes of traffic. Submittals shall be sent directly to the Planning Analysis Section of the Planning Division with a copy of the cover letter sent to the Project Engineer. The submittals will be returned within a seven (7) business day period from when they are received.

The Contractor shall include all hardware and software necessary to operate the field station unattended, which includes a battery backup and modem. The station is to operate continuously without human intervention.

The system may be a Traffic Recorder Classification Permanent System (907-687-A) or a Traffic Recorder Classification Short Term Permanent System (907-687-B). The type of system shall be defined in the plans or contract documents.

The Traffic Recorder Classification Permanent System shall require an AC power source and communication source via a data communication phone line as referenced in the plans.

The Traffic Recorder Classification Short Term Permanent System shall not require an AC power source and communication source via a data communication phone line.

Both systems shall utilize two (2) Class 1 Brass Linguini (BL) Piezo strips as utilized by Mikros RAKTEL 8010 System or latest system as approved by MDOT and one (1) loop per lane in all lanes as recommended by the manufacturer.

The person(s) performing the installation of the Mikros RAKTEL Piezo Classification System must be certified by Mikros or an authorized Mikros representative in the installation procedures of the Mikros RAKTEL Piezo Classification System and must be on the job site at each installation when the Mikros RAKTEL Systems are being installed. Certification can be acquired from Mikros or an authorized Mikros representative as long as a certified Mikros representative is on site to assist during the installation. Details regarding Mikros certification

can be acquired through direct communication with Mikros or an authorized Mikros representative. Any delays in the construction due to the certification process will not be grounds for an extension of the completion date.

A multiplexer shall be required for sites utilizing two (2) Mikros RAKTEL Systems in order for both systems to have access to one phone line.

The Contractor shall provide three (3) copies of all manuals on Installation, Operating, Schematics, and Maintenance for the entire System.

The BL Piezo sensors, equipment cabinet, inductive loops, cables, leads and electronic hardware and software will be furnished, installed, tested, calibrated and made operational by the Contractor. The Contractor shall provide all services required for construction, tests, the satisfactory performance period(s), and miscellaneous usage on this project until the site inspection of the project. Deposits, customer charges, connection cost, etc., associated with the System up to and including the date of the site inspection (Subsection 907-687.03.18.1--Site Inspection) of the System shall be the responsibility of the Contractor. At least five (5) business days prior to starting work, the Contractor shall provide notice to the MDOT Planning Division and the MDOT Project Office so that a representative of the Planning Division can be on site while the work is being performed.

**907-687.02--Materials.** The materials used in the traffic recorder classification system shall conform to the requirements of these specifications as set out herein. Prior to the scheduled start of work, the Contractor shall provide the Engineer with submittals on the following items and shall obtain the Engineer's approval before starting affected work. The Contractor shall use new materials and equipment. Any existing traffic counting equipment at the site is the sole property of the MDOT and shall not be removed by the Contractor.

**907-687.02.1--Sensors.** Vehicle axle detectors shall utilize piezoelectric cable in a sensor assembly and be of a type that has been shown to be successful for vehicle classification in both asphaltic and concrete pavements. BL Piezo sensor length shall be eleven (11) feet minimum. Sensors as delivered from manufacturer shall include a shielded transmission cable of sufficient length for a continuous run to the equipment cabinet without splicing.

**907-687.02.1.1--Automatic Traffic Recorder Station.** Piezoelectric Cable/Sensors shall be as those utilized by Mikros RAKTEL 8010 System or latest system as approved by MDOT. Sensitivity dispersion shall be Class 1,  $\pm 5\%$ .

**907-687.02.2--Shielded Transmission Cable.** Coaxial cable type RG58 C/U shall conform to IMSA 50-2 for polyethylene insulated, polyethylene jacketed cable, AWG #14. Cable shall meet the requirements of Section 640 for the Standard Specifications.

**907-687.02.3--Conduit and Pull Boxes.** Conduit and pull boxes shall meet the requirements of Section 637 of the Standard Specifications.

**907-687.02.3.1--Under Roadways.** Conduits under the roadway shall be Schedule 80 PVC or coated rigid galvanized steel.

**907-687.02.3.2--Other Conduit.** Other conduit shall be Schedule 40 PVC direct buried conduit unless noted otherwise.

**907-687.02.3.3--Pull Boxes.** Pull boxes shall be size Type 2 and the cover does not require words inscribed on the top.

**907-687.02.4--Loop Wire.** Loop wire, IMSA 51-3, AWG #14 stranded copper, shall meet the requirements of Subsection 722.03 of the Standard Specifications.

**907-687.02.5--Loop Sealant.** Loop sealant shall be "Traffic Loop Sealant" as manufactured by 3M Corporation, or approved equal.

**907-687.02.6--Sensor Cement.** The sensor assembly shall be cemented into the pavement with an epoxy resin of a type recommended by the sensor manufacturer.

**907-687.02.7--Equipment Cabinet.** The installation and setup of the equipment cabinet and all its applications must comply with all requirements of the plans. The Contractor will install the equipment cabinet along the highway right of way at a location approved by the Engineer. The equipment cabinet shall utilize a locking door. The housing shall be positioned so that the data collector will be approximately four (4) feet above the ground and mounted on a pole as depicted in the plans. Lightning protection shall be provided for each installation. A 5/8-inch by 12-foot ground rod shall be used with AWG #6 copper conductors. Class B concrete shall be used for equipment cabinet footings and 4' x 6' x 4" concrete work pad.

**907-687.03--Construction Requirements.** The general layout of the work shall conform to the details shown on the typical installation plans and shall be verified at each location with the Project Engineer. No hazards, such as open holes on site during construction, shall be left overnight.

All traffic control shall meet the requirements as defined in the most updated Manual on Uniform Traffic Control Devices.

**907-687.03.1--Manufacturer's Recommendations.** Sensors must be installed in accordance with the approved procedures and specifications provided by the sensor manufacturer. All sensors and connecting cables, shall be positioned and installed to assure compatibility with the inductive loops to provide electrical signals for vehicle classification.

**907-687.03.2--Conflicts.** Conflicts between any piece of equipment, which if installed as shown in relation to any previously installed equipment that may impair the proper operation of that equipment, shall be resolved by the Contractor as approved by the Engineer.

**907-687.03.3--Conduit Runs.** The number of conductors, conduits and fittings necessary to produce an operative system as specified herein shall be provided by the Contractor. All joints, connections, etc. shall be completely water and moisture tight. Shielded transmission cable and wire leads shall be installed in conduit from paved shoulders to pull boxes.

**907-687.03.4--Slots in Pavement.** All slots required in pavement and paved shoulders shall be saw cut with diamond blade power saw. Edges shall be straight, smooth and true. Depth shall be uniform.

**907-687.03.4.1--Loop Slots.** Slots for loop wire shall be ¼-inch minimum width. Slot depth shall be 2½ inches in asphalt and 1½ inches in concrete. Diagonal slots shall be cut at corners by overlapping cuts so that the entire slot intended for wire has full depth. There shall be no jagged edges or protrusions which may damage wire. When the top lift of asphalt is an Open Graded Friction Course, the loops shall be cut in the top immediate lift beneath the open graded friction course.

**907-687.03.4.2--Cable Slots.** Slots for cable shall be 3/8-inch width ( $\pm 1/16$ "") and 2¼-inch depth. To ensure that the slots are full depth, all turns and overlay cuts shall not exceed 45 degrees. There shall be no jagged edges or protrusions which may damage cable. Cable leads from each sensor shall be run in individual saw cut slots at a minimum spacing of 12 inches.

**907-687.03.4.3--Sensors Slots.** Slots for sensors shall be of the width and depth specified by the sensor manufacturer. Cavity of sensor slots may be made with chisel between saw cut sides, but the bottom shall be smooth and level without protrusions. At the base of the side of the sensor slot, a ½-inch diameter hole shall be drilled at a 45 degree angle every 10 inches. In overlays of four inches (4") or less, the slot shall extend to the top of the course below the overlay. Before placing sensor, the slot shall be cleaned with compressed air.

**907-687.03.5--Loop Assemblies.** Inductive loop assemblies shall meet the requirements of Section 635 of the Standard Specifications.

**907-687.03.6--Inspection.** Pavement slots shall be inspected at time of sensor and cable installation. Surfaces shall be clean and dry, free of all dust, grit, moisture and other contaminants that might affect sealant or cement bond.

**907-687.03.6.1--Sensor Check.** Prior to final installation, sensor assembly shall be placed in position in slot and inspected for compliance with manufacturer's requirements as to clearance, surface alignment, etc. Sensor output shall be checked using an oscilloscope or other test equipment recommended by the sensor manufacturer.

**907-687.03.6.2--Cable Inspection.** The cable shall not have any cuts, nicks, abrasions or breaks in the insulation at the time of filling slot with sealant. Any sensor having defects in the shielded transmission cable shall be replaced.

**907-687.03.6.3--Loop Inspection.** The loop wire shall not have any cuts, nicks, abrasions or breaks in the insulation before or after installation in the slot. Loop inductance shall be 124 microhenries.

**907-687.03.7--Sensor Installation.** Approved epoxy cement shall completely fill the cavity spaces and surround all four sides of the sensor assembly. All excess epoxy cement shall be removed from pavement surface and sensor to conduit to prevent damage during installation. Sensor installation shall be protected from traffic until epoxy cement is sufficiently cured.

**907-687.03.8--Sleeves.** Flexible sleeve or other protection shall be provided for shielded cable at sensor ends to prevent damage. The Contractor shall take care to insure that the sleeve is not filled with epoxy cement. In addition, the Contractor shall provide flexible sleeve, approximately 12 inches long, at pavement construction joints including joints between lanes and between pavement and paved shoulder.

**907-687.03.9--Cable and Wire Installation.** The cable or lead wires shall be placed in the bottom of the slot so that there are no kinks, curls, straining or stretching of the insulation. The two loop lead wires shall be twisted two to five turns per foot before placement in the slot. The loop wire must be protected from water at all times. In the event that the loop wire is going to be spliced, the wire must be sealed with a 3M 82-A Series Power Cable Splice Kit, or approved equal. Loop wires may not lay in the pull boxes exposed to water and moisture during the construction and installation of the traffic recorder classification system. There shall be no splicing the sensor cables. The sensor cables must be a continuous run from the sensor to the equipment cabinet. Special care shall be taken in seating the cable and wire so that the insulation will not be broken or abraded. No sharp tools such as screwdriver or metal object shall be used for this operation.

**907-687.03.9.1--Conditions.** The Contractor shall install the sealant in strict adherence to the manufacturer's recommendation and these specifications. No sealant shall be installed during inclement weather or under any condition, which might introduce moisture into the pavement slots.

**907-687.03.9.2--Sealant.** The viscosity of the sealant shall be such that it can be readily placed in the slot, completely surround the wires, displace all air and fill the slot so that the sealant is flush with the roadway surface. The finished installation shall be waterproof and present a neat workmanlike appearance. Minimum required clearance shall be maintained to cable and wire.

**907-687.03.9.3--Protection.** The sealant shall be sufficiently hardened before opening to traffic.

**907-687.03.10--Cleaning.** All excess encapsulate and sealant shall be removed from pavement surface, inductive loop, and sensor after installation. A hand grinder shall be used, if necessary, to smooth out rough or high areas that might affect sensor operation.

**907-687.03.11--Tags.** Each shielded transmission cable and pair of lead wires shall be uniquely identified by an insulated, waterproof tag in every pull box.

**907-687.03.12--Trenching and Backfilling.** All trenching shall be done by mechanical means and all sides shall be straight and vertical. Width of trenches shall not exceed eight (8) inches on either side of placed conduits. All backfill shall be made with a friable material, which has been approved by the Engineer. Material shall be placed in compacted lifts as approved by the Engineer. The site, including shoulders and grassing, shall be returned to its original condition.

**907-687.03.13--Jacking or Boring.** Approved jacking or boring methods shall be used where a conduit must be placed under an existing roadway. Jacking/boring pits shall be kept a minimum of five (5) feet from the edge of shoulder, and care shall be taken not to disturb existing

pavement. Excessive use of water or other methods, which could undermine pavements, shall not be permitted. The jacking/boring site must be returned to its undisturbed state upon completion of the operation. Only experienced labor shall be used for jacking/boring work. Conduit shall be not less than 36 inches below pavement surface.

**907-687.03.14--Pull Boxes.** The location of the pull boxes must be approved by the Project Engineer. Pull boxes shall be set on 12-inch minimum thickness washed gravel. Holes for drainage shall be provided in bottom of pull box. Conduit entering pull box shall be located so as to leave the major portion of the box clear.

**907-687.03.15--Conduit.** Conduit shall be laid to a depth of not less than 36 inches below the finished grade, except at conduit ends. All conduits shall be run at least 10 feet outside shoulder unless otherwise approved. One size of conduit shall be used for each run; no reducing couplings will be permitted.

**907-687.03.16--Conductor Installation.** Before placing shielded cable or wire leads in conduit, the conduit shall be cleaned with compressed air and rigid metal conduit shall be cleaned with a mandrel. Only approved lubricants which will not injure conductor insulation while pulling cables shall be used.

Loop splices shall be made in pull boxes only, soldered, and sealed in an approved power cable splice kit. An insulation equal in rating and thickness to the conductor insulation shall be provided.

**907-687.03.17--Plant Establishment.** Any areas of vegetation disturbed during the installation of the classification system, pull boxes, equipment cabinets, etc. shall be graded and grassed / solid sodded to the satisfaction of the Engineer to return the area to its condition prior to construction. It also may be necessary to install temporary erosion control devices during the installation process. Unless pay items for these items of work are included in the bid items, the cost of this work will be included in other items bid.

**907-687.03.18--System Acceptance.** The Contractor shall be required to demonstrate to the Engineer the satisfactory operation of each device installed on this project.

**907-687.03.19--Material Warranty.** The following warranty stipulations are in addition to those covered by Subsection 106.01 of the Standard Specifications.

**907-687.03.19.1--Site Inspection.** After meeting the consecutive polling requirement, a site inspection may be made upon completion of an individual site but must be made before the final inspection of the project.

The Contractor, with MDOT's representatives present to verify that the site is working properly, shall test all Traffic Recorder Classification Systems.

Sensors, loops and related components at all sites shall be operational at the final inspection of the project.



**907-687.03.19.1.1--Consecutive Polling.** All Traffic Recorder Classification Permanent Systems shall have polled without any problems for at least 10 consecutive days and data for each day must pass quality control and quality assurance checks prior to the site inspection.

**907-687.03.19.1.2--Data Collection.** The Contractor shall provide 48 hours of data (IMG files) to the Planning Division for all Traffic Recorder Classification Short Term Permanent Systems

**907-687.03.19.2--Guarantee.** At each location, the Contractor shall warrant and guarantee all sensors, loops and related components for a period of 12 months, beginning at the date of release from maintenance, or partial release from maintenance, of the project.

**907-687.03.19.3--Responsibility.** It is the intent of the preceding paragraph to provide for equipment that performs as intended by the manufacturer. It is the further intent to obtain from the Contractor a level of workmanship that will assure the Department of an operation system devoid of Contractor laxities. Failure to perform as indicated shall require the Contractor to replace in kind or repair, at the Contractor's option, the equipment or workmanship in question. All material and labor cost resulting from the replacement or repair of equipment or correction of poor workmanship shall be at no additional costs to the Department.

**907-687.03.19.4--Repairs.** The Department shall report any failures and outages to the Contractor. The Contractor will be required to make the necessary repairs within 10 business days of the report. The Contractor shall not be responsible for outages occurring during the 12-month warranty period due to vandalism, traffic accidents, or any problems not related to materials or workmanship. The Contractor will be required to make the necessary repairs for such outages and a reasonable cost for such repair(s) will be borne by the Department.

**907-687.03.19.5--Manufacturer's Guarantees.** All manufacturer's standard warranties or guarantees for all electrical and mechanical equipment which are provided as customary trade practice shall be made out to the Department and shall begin simultaneously with the commencement of the 12-month warranty period.

**907-687.03.19.6--Guarantee of Repairs.** This warrantee and guarantee on the fixed or replaced items shall be identical in scope to the warrantee and guarantee in Subsections 907-687.03.18.1 through 907-687.03.18.5.

**907-687.04--Method of Measurement.** Traffic Recorder Classification System of the type specified, complete in place and accepted, will be measured per each location.

**907-687.05--Basis of Payment.** Traffic Recorder Classification system, measured as prescribed above, will be paid for at the contract unit price per each, which price shall be full compensation for furnishing, installing, testing and guaranteeing all equipment, and for all materials, labor, equipment, operation, and other incidentals necessary to complete the work.

Payment will be made under:

907-687-A: Traffic Recorder Classification Permanent System, \* - per each

907-687-B: Traffic Recorder Classification Short Term Permanent System, \* - per each

\* Site No. or Location may be specified

## MISSISSIPPI DEPARTMENT OF TRANSPORTATION

SPECIAL PROVISION NO. 907-899-1

CODE: (SP)

DATE: 01/17/2017

SUBJECT: Railway-Highway Provisions

Section 907-899, Railway-Highway Provisions, is hereby added to and made part of the 2017 Edition of the Mississippi Standard Specifications for Road and Bridge Construction as follows:

### SECTION 907-899--RAILWAY-HIGHWAY PROVISIONS

**907-899.01--Description.** This special provision addresses the Contractor's involvement with railroad flagging, Contractor Safety Orientation, Contractor Background Investigation, Contractor Roadway Worker on Track Safety Program and Safety Action Plan, and any other requirements set forth by the Railroad and any attached Exhibits.

Prior to bidding, the Contractor shall read and comply with the requirements of the Railroad and any attached Exhibits. The Contractor shall contact the Railroad concerning insurance coverage requirements, Railroad flagging costs, Contractor Safety Orientation, Contractor Background Investigation, Contractor Roadway Worker on Track Safety Program and Safety Action Plan, and any other requirements set forth by the Railroad and any attached Exhibits. In case the railroad requires coverage over and above that required by the Standard Specifications, the railroad requirements shall be met.

If in the opinion of the RAILROAD, the presence of an authorized representative of the RAILROAD is required to supervise the same, the RAILROAD shall render bills to the Contractor for all expenses incurred by it for such supervision. This includes all labor costs for flagmen or cable locate supplied by the RAILROAD to protect RAILROAD operation, and for the full cost of furnishing, installation and later removal of any temporary supports for said tracks, as the RAILROAD's Chief Engineer's Office may deem necessary.

**It will be the Contractor's responsibility to pay all bills associated with the Railroad requirements and any attached Exhibits.**

A cable locate of RAILROAD owned facilities may be required to identify and protect Signal & Communication cables that have been installed to provide power, signal control, wayside communications. These cables are vital to a safe and reliable railway operation. The cable locate will be performed by a qualified RAILROAD employee.

Outside Contractors are prohibited from driving on, along, or across any track that does not have a RAILROAD installed crossing. They may utilize an existing public crossing. The practice of allowing rubber tired equipment to operate over track with no crossing has been banned.

The Contractor shall complete and process any required forms addressed by the Railroad or any attached Exhibits. The Contractor shall not commence or carry on any form of work on, under, above or within the designated distance from the Railroad track prior to getting approval from the Railroad.

**907-899.02--Blank.**

**907-899.03--Construction Requirements.** The Contractor shall read and comply with the requirements of the Railroad and any attached Exhibits.

**907-899.04--Method of Measurement.** Railway-highway provisions will be measured as a unit lump sum quantity. Measurement for payment will be in accordance with the following schedule:

- a) On the first estimate, twenty five percent (25%) of the amount bid for Railway Highway Provision will be paid.
- b) When twenty five percent (25%) of the original contract amount is earned from all direct pay items, fifty percent (50%) of the amount bid for Railway Highway Provision will be paid.
- c) When fifty percent (50%) of the original contract amount is earned from all direct pay items, one hundred percent (100%) of the amount bid for Railway Highway Provision will be paid.

**907-899.05--Basis of Payment.** Railway-highway provisions, measured as prescribed above, will be paid for at the contract lump sum price, which price shall be payment in full for all insurance coverage requirements, railroad flagging costs, Contractor safety orientation, Contractor background investigation, Contractor safety programs and plans, and any other requirements set forth by the Railroad and any attached Exhibits, and other incidentals necessary to complete the requirements of this work.

Payment will be made under:

907-899-A: Railway-Highway Provisions

- lump sum

# SECTION 905 - PROPOSAL

Date \_\_\_\_\_

Mississippi Transportation Commission  
Jackson, Mississippi

Sirs: The following proposal is made on behalf of \_\_\_\_\_  
\_\_\_\_\_ of \_\_\_\_\_

for constructing the following designated project(s) within the time(s) hereinafter specified.

The plans are composed of drawings and blue prints on file in the offices of the Mississippi Department of Transportation, Jackson, Mississippi.

The Specifications are the current Standard Specifications of the Mississippi Department of Transportation approved by the Federal Highway Administration, except where superseded or amended by the plans, Special Provisions and Notice(s) to Bidders attached hereto and made a part thereof.

I (We) certify that I (we) possess a copy of said Standard and any Supplemental Specifications.

Evidence of my (our) authority to submit the Proposal is hereby furnished. The proposal is made without collusion on the part of any person, firm or corporation. I (We) certify that I (we) have carefully examined the Plans, the Specifications, including the Special Provisions and Notice(s) to Bidders, herein, and have personally examined the site of the work. On the basis of the Specifications, Special Provisions, Notice(s) to Bidders, and Plans, I (we) propose to furnish all necessary machinery, tools, apparatus and other means of construction and do all the work and furnish all the materials in the manner specified. I (We) understand that the quantities mentioned herein are approximate only and are subject to either increase or decrease, and hereby propose to perform any increased or decreased quantities of work at the unit prices bid, in accordance with the above.

I (We) acknowledge that this proposal will be found irregular and/or non-responsive unless a certified check, cashier's check, or Proposal Guaranty Bond in the amount as required in the Advertisement (or, by law) is submitted electronically with the proposal or is delivered to the Contract Administration Engineer prior to the bid opening time specified in the advertisement.

**INSTRUCTION TO BIDDERS: Alternate and Optional Items on Bid Schedule.**

1. Two or more items entered opposite a single unit quantity WITHOUT DEFINITE DESIGNATION AS "ALTERNATE ITEMS" are considered as "OPTIONAL ITEMS". Bidders may or may not indicate on bids the Optional Item proposed to be furnished or performed WITHOUT PREJUDICE IN REGARD TO IRREGULARITY OF BIDS.
2. Items classified on the bid schedule as "ALTERNATE ITEMS" and/or "ALTERNATE TYPES OF CONSTRUCTION" must be preselected and indicated on bids. However, "Alternate Types of Construction" may include Optional Items to be treated as set out in Paragraph 1, above.
3. Optional items not preselected and indicated on the bid schedule MUST be designated in accordance with Subsection 102.06 prior to or at the time of execution of the contract.
4. Optional and Alternate items designated must be used throughout the project.

I (We) further propose to perform all "force account or extra work" that may be required of me (us) on the basis provided in the Specifications and to give such work my (our) personal attention in order to see that it is economically performed.

I (We) further propose to execute the attached contract agreement (Section 902) as soon as the work is awarded to me (us), and to begin and complete the work within the time limit(s) provided for in the Specifications and Advertisement. I (We) also propose to execute the attached contract bond (Section 903) in an amount not less than one hundred (100) percent of the total of my (our) part, but also to guarantee the excellence of both workmanship and materials until the work is finally accepted.

I (We) shall submit electronically with our proposal or deliver prior to the bid opening time a certified check, cashier's check or bid bond for **five percent (5%) of total bid** and hereby agree that in case of my (our) failure to execute the contract and furnish bond within Ten (10) days after notice of award, the amount of this check (bid bond) will be forfeited to the State of Mississippi as liquidated damages arising out of my (our) failure to execute the contract as proposed. It is understood that in case I am (we are) not awarded the work, the check will be returned as provided in the Specifications.

**SECTION 905 -- PROPOSAL (CONTINUED)**

I (We) hereby certify by digital signature and electronic submission via Bid Express of the Section 905 proposal below, that all certifications, disclosures and affidavits incorporated herein are deemed to be duly executed in the aggregate, fully enforceable and binding upon delivery of the bid proposal. I (We) further acknowledge that this certification shall not extend to the bid bond or alternate security which must be separately executed for the benefit of the Commission. This signature does not cure deficiencies in any required certifications, disclosures and/or affidavits. I (We) also acknowledge the right of the Commission to require full and final execution on any certification, disclosure or affidavit contained in the proposal at the Commission's election upon award. Failure to so execute at the Commission's request within the time allowed in the Standard Specifications for execution of all contract documents will result in forfeiture of the bid bond or alternate security.

Respectfully Submitted,

DATE \_\_\_\_\_

\_\_\_\_\_  
Contractor

BY \_\_\_\_\_  
Signature

TITLE \_\_\_\_\_

ADDRESS \_\_\_\_\_

CITY, STATE, ZIP \_\_\_\_\_

PHONE \_\_\_\_\_

FAX \_\_\_\_\_

E-MAIL \_\_\_\_\_

(To be filled in if a corporation)

Our corporation is chartered under the Laws of the State of \_\_\_\_\_ and the names, titles and business addresses of the executives are as follows:

\_\_\_\_\_  
President Address

\_\_\_\_\_  
Secretary Address

\_\_\_\_\_  
Treasurer Address

The following is my (our) itemized proposal.

Overlay of US 90 from Russell Ave. to Debuys Road, known as Federal Aid Project No. STP-0003-01(198) / 107748301 in Harrison County.

| Line no.             | Item Code | Adj Code | Quantity | Units       | Description[Fixed Unit Price]   |
|----------------------|-----------|----------|----------|-------------|---|
| <b>Roadway Items</b> |           |          |          |             |   |
| 0010                 | 202-B051  |          | 100      | Linear Feet | Removal of Concrete Curb  |
| 0020                 | 202-B059  |          | 170      | Square Yard | Removal of Concrete Median & Island Pavement, All Depths                  |
| 0030                 | 202-B080  |          | 215      | Square Yard | Removal of Concrete Sidewalk  |
| 0040                 | 202-B099  |          | 8        | Each        | Removal of Debris and Sand From Inlet and Junction Box, All types & Sizes |
| 0050                 | 202-B114  |          | 250      | Linear Feet | Removal of Debris and Sand From Pipe, All Sizes                           |
| 0060                 | 202-B163  |          | 5        | Each        | Removal of Inlet Tops   |
| 0070                 | 202-B188  |          | 240      | Square Yard | Removal of Pavement, All Types and Depths                                 |
| 0080                 | 203-E001  | (E)      | 150      | Cubic Yard  | Borrow Excavation, AH, LVM, State Furnished                               |
| 0090                 | 304-F003  | (GT)     | 450      | Ton         | Size 825B Crushed Stone Base  |
| 0100                 | 403-A003  | (BA1)    | 250      | Ton         | 12.5-mm, ST, Asphalt Pavement   |
| 0110                 | 403-A014  | (BA1)    | 22,000   | Ton         | 9.5-mm, MT, Asphalt Pavement  |
| 0120                 | 403-A015  | (BA1)    | 8,100    | Ton         | 9.5-mm, ST, Asphalt Pavement  |
| 0130                 | 403-B011  | (BA1)    | 13,000   | Ton         | 9.5-mm, MT, Asphalt Pavement, Leveling                                    |
| 0140                 | 403-B012  | (BA1)    | 4,500    | Ton         | 9.5-mm, ST, Asphalt Pavement, Leveling                                    |
| 0150                 | 406-D001  |          | 3,200    | Square Yard | Fine Milling of Bituminous Pavement, All Depths                           |
| 0160                 | 407-A001  | (A2)     | 55,500   | Gallon      | Asphalt for Tack Coat   |
| 0170                 | 413-E001  |          | 82,000   | Linear Feet | Sawing and Sealing Transverse Joints in Asphalt Pavement                  |
| 0180                 | 601-B001  | (S)      | 5        | Cubic Yard  | Class "B" Structural Concrete, Minor Structures                           |
| 0190                 | 602-A001  | (S)      | 222      | Pounds      | Reinforcing Steel   |
| 0200                 | 608-A001  | (S)      | 220      | Square Yard | Concrete Sidewalk, Without Reinforcement                                  |
| 0210                 | 609-B002  | (S)      | 84       | Linear Feet | Concrete Curb, Header   |
| 0220                 | 612-A001  |          | 150      | Cubic Yard  | Flowable Fill, Excavatable  |
| 0230                 | 613-C001  |          | 254      | Each        | Adjustment of Grating   |
| 0240                 | 613-D005  |          | 86       | Each        | Adjustment of Manhole   |
| 0250                 | 613-D009  |          | 65       | Each        | Adjustment of Utility Appurtenance  |
| 0260                 | 616-A001  | (S)      | 1        | Square Yard | Concrete Median and/or Island Pavement, 10-inch                           |
| 0270                 | 616-A004  | (S)      | 170      | Square Yard | Concrete Median and/or Island Pavement, 4-inch                            |
| 0280                 | 618-A001  |          | 1        | Lump Sum    | Maintenance of Traffic  |
| 0290                 | 618-B001  |          | 1        | Square Feet | Additional Construction Signs (\$10.00)                                   |
| 0300                 | 619-A1001 |          | 29       | Mile        | Temporary Traffic Stripe, Continuous White                                |
| 0310                 | 619-A2001 |          | 26       | Mile        | Temporary Traffic Stripe, Continuous Yellow                               |
| 0320                 | 619-A3001 |          | 42       | Mile        | Temporary Traffic Stripe, Skip White                                      |
| 0330                 | 619-A5001 |          | 52,000   | Linear Feet | Temporary Traffic Stripe, Detail  |
| 0340                 | 619-A6002 |          | 3,000    | Linear Feet | Temporary Traffic Stripe, Legend  |

| Line no. | Item Code    | Adj Code | Quantity | Units       | Description[Fixed Unit Price]                                  |
|----------|--------------|----------|----------|-------------|--|
| 0350     | 620-A001     |          | 1        | Lump Sum    | Mobilization   |
| 0360     | 626-A004     |          | 21       | Mile        | 6" Thermoplastic Traffic Stripe, Skip White                    |
| 0370     | 626-B002     |          | 15       | Mile        | 6" Thermoplastic Double Drop Traffic Stripe, Continuous White  |
| 0380     | 626-E001     |          | 13       | Mile        | 6" Thermoplastic Double Drop Traffic Stripe, Continuous Yellow |
| 0390     | 626-G001     |          | 1,350    | Linear Feet | Thermoplastic Detail Stripe, Blue-ADA                          |
| 0400     | 626-G002     |          | 93,000   | Linear Feet | Thermoplastic Detail Stripe, White                             |
| 0410     | 626-G003     |          | 40,000   | Linear Feet | Thermoplastic Detail Stripe, Yellow                            |
| 0420     | 626-H003     |          | 416      | Square Feet | Thermoplastic Legend, Blue-ADA                                 |
| 0430     | 626-H004     |          | 6,065    | Square Feet | Thermoplastic Legend, White                                    |
| 0440     | 626-H005     |          | 30,000   | Linear Feet | Thermoplastic Legend, White                                    |
| 0450     | 627-K001     |          | 4,500    | Each        | Red-Clear Reflective High Performance Raised Markers           |
| 0460     | 627-L001     |          | 355      | Each        | Two-Way Yellow Reflective High Performance Raised Markers      |
| 0470     | 907-603-V001 |          | 600      | Linear Feet | Video Pipe Inspection, All Sizes                               |
| 0480     | 907-687-A001 |          | 1        | Each        | Traffic Recorder Classification Permanent System               |
| 0490     | 907-899-A001 |          | 1        | Lump Sum    | Railway-Highway Provisions                                     |



SECTION 905 - COMBINATION BID PROPOSAL (Continued)

**CONDITIONS FOR COMBINATION BID**

If a bidder elects to submit a combined bid for two or more of the contracts listed for this month's letting, the bidder must complete and execute these sheets of the proposal in each of the individual proposals to constitute a combination bid. In addition to this requirement, each individual contract shall be completed, executed and submitted in the usual specified manner.

Failure to execute this Combination Bid Proposal in each of the contracts combined will be just cause for each proposal to be received and evaluated as a separate bid.

It is understood that the Mississippi Transportation Commission not only reserves the right to reject any and all proposals, but also the right to award contracts upon the basis of lowest separate bids or combination bids most advantageous to the State.

It is further understood and agreed that the Combination Bid Proposal is for comparison of bids only and that each contract shall operate in every respect as a separate contract in accordance with its proposal and contract documents.

I (We) agree to complete each contract on or before its specified completion date.

\*\*\*\*\*

**COMBINATION BID PROPOSAL**

This proposal is tendered as one part of a Combination Bid Proposal utilizing option \_\_\_\* of Subsection 102.11 on the following contracts:

\* Option to be shown as either (a), (b), or (c).

|    | <u>Project No.</u> | <u>County</u> | <u>Project No.</u> | <u>County</u> |
|----|--------------------|---------------|--------------------|---------------|
| 1. | _____              | _____         | 6.                 | _____         |
| 2. | _____              | _____         | 7.                 | _____         |
| 3. | _____              | _____         | 8.                 | _____         |
| 4. | _____              | _____         | 9.                 | _____         |
| 5. | _____              | _____         | 10.                | _____         |

(a) If Combination A has been selected, your Combination Bid is complete.

(b) If Combination B has been selected, then complete the following page.

SECTION 905 - COMBINATION BID PROPOSAL (Continued)

| Project Number | Pay Item Number | Unit | Unit Price Reduction | Total Item Reduction | Total Contract Reduction |
|----------------|-----------------|------|----------------------|----------------------|--------------------------|
| 1.             |                 |      |                      |                      |                          |
| 2.             |                 |      |                      |                      |                          |
| 3.             |                 |      |                      |                      |                          |
| 4.             |                 |      |                      |                      |                          |
| 5.             |                 |      |                      |                      |                          |
| 6.             |                 |      |                      |                      |                          |
| 7.             |                 |      |                      |                      |                          |
| 8.             |                 |      |                      |                      |                          |

For Informational Purposes Only

SECTION 905 - COMBINATION BID PROPOSAL (Continued)

| Project Number | Pay Item Number | Unit | Unit Price Reduction | Total Item Reduction | Total Contract Reduction |
|----------------|-----------------|------|----------------------|----------------------|--------------------------|
| 9.             |                 |      |                      |                      |                          |
|                |                 |      |                      |                      |                          |
|                |                 |      |                      |                      |                          |
| 10.            |                 |      |                      |                      |                          |
|                |                 |      |                      |                      |                          |
|                |                 |      |                      |                      |                          |

(c) If Combination C has been selected, then initial and complete ONE of the following.

\_\_\_\_\_ I (We) desire to be awarded work not to exceed a total monetary value of \$ \_\_\_\_\_.

\_\_\_\_\_ I (We) desire to be awarded work not to exceed \_\_\_\_\_ number of contracts.



**Certification with regard to the Performance of Previous  
Contracts or Subcontracts subject to the Equal Opportunity  
Clause and the filing of Required Reports**

The Bidder hereby certifies that he has \_\_\_\_\_, has not \_\_\_\_\_, participated in a previous contract or subcontract subject to the Equal Opportunity Clause, as required by Executive Orders 10925, 11114, or 11246, and that he has \_\_\_\_\_, has not \_\_\_\_\_, filed with the Joint Reporting Committee, the Director of the Office of Federal Contract Compliance, a Federal Government contracting or administering agency, or the former President's Committee on Equal Employment Opportunity, all reports due under the applicable filing requirements.

\_\_\_\_\_  
(COMPANY)

DATE: \_\_\_\_\_

NOTE: The above certification is required by the Equal Employment Opportunity Regulations of the Secretary of Labor (41 CFR 60-1.7 (b) (1)), and must be submitted by bidders and proposed subcontractors only in connection with contracts and subcontracts which are subject to the Equal Opportunity Clause. Contracts and Subcontracts which are exempt from the Equal Opportunity Clause are set forth in 41 CFR 60-1.5. (Generally only contracts or subcontracts of \$10,000 or under are exempt.)

Currently, Standard Form 100 (EEO-1) is the only report required by the Executive Orders or their implementing regulations.

Proposed prime Contractors and Subcontractors who have participated in a previous contract or subcontract subject to the Executive orders and have not filed the required reports should note that 41 CFR 60-1.7 (b) (1) prevents the award of contracts and subcontracts unless such Contractors submit a report covering the delinquent period or such other period specified by the Federal Highway Administration or by the Director, Office of Federal Contract Compliance, U. S. Department of Labor.

**MISSISSIPPI DEPARTMENT OF TRANSPORTATION**  
**CERTIFICATION**

I, \_\_\_\_\_,  
(Name of person signing bid)

individually, and in my capacity as \_\_\_\_\_ of  
(Title of person signing bid)

\_\_\_\_\_ do hereby certify under  
(Name of Firm, partnership, or Corporation)

penalty of perjury under the laws of the United States and the State of Mississippi that \_\_\_\_\_

\_\_\_\_\_, Bidder  
(Name of Firm, Partnership, or Corporation)

on Project No. **STP-0003-01(198)/ 107748301000**

in **Harrison** County(ies), Mississippi, has not either

directly or indirectly entered into any agreement, participated in any collusion; or otherwise taken any action in restraint of free competitive bidding in connection with this contract; nor have any of its corporate officers or principal owners.

Except as noted hereafter, it is further certified that said legal entity and its corporate officers, principal owners, managers, auditors and others in a position of administering federal funds:

- a) Are not presently debarred, suspended, proposed for debarment, declared ineligible, or voluntarily excluded from covered transactions by any Federal department or agency;
- b) Have not within a three-year period preceding this proposal been convicted of or had a civil judgment rendered against them for commission of fraud or a criminal offense in connection with obtaining, attempting to obtain, or performing a public (Federal, State or local) transaction or contract under a public transaction; violation of Federal or State antitrust statutes or commission of embezzlement, theft, forgery, bribery, falsification or destruction of records, making false statements, or receiving stolen property;
- c) Are not presently indicted for or otherwise criminally or civilly charged by a governmental entity (Federal, State or local) with commission of any of the offenses enumerated in (b) above; and
- d) Have not within a three-year period preceding this application/ proposal had one or more public transactions (Federal, State or local) terminated for cause or default.

Do exceptions exist and are made a part thereof? Yes / No

Any exceptions shall address to whom it applies, initiating agency and dates of such action.

Note: Exceptions will not necessarily result in denial of award but will be considered in determining bidder responsibility. Providing false information may result in criminal prosecution or administrative sanctions.

The bidder further certifies that the certification requirements contained in Section XI of Form FHWA 1273, will be or have been included in all subcontracts, material supply agreements, purchase orders, etc. except those procurement contracts for goods or services that are expected to be less than the Federal procurement small purchase threshold fixed at 10 U.S.C. 2304(g) and 41 U.S.C. 253(g) (currently \$25,000) which are excluded from the certification requirements.

The bidder further certifies, to the best of his or her knowledge and belief, that:

1) No Federal appropriated funds have been paid or will be paid to any person for influencing or attempting to influence an officer or employee of any Federal agency, a Member of Congress, an officer or employee of Congress, or an employee of a Member of Congress in connection with the awarding of any Federal contract, the making of any Federal grant, the making of any Federal loan, the entering into of any cooperative agreement, and the extension, continuation, renewal, amendment, or modification of any Federal contract, grant, loan, or cooperative agreement.

2) If any funds other than Federal appropriated funds have been paid or will be paid to any person for influencing or attempting to influence an officer or employee of any Federal agency, a Member of Congress, an officer or employee of Congress, or an employee of a Member of Congress in connection with this contract, Standard Form-LLL, Disclosure Form to Report Lobbying, in accordance with its instructions will be completed and submitted.

The certification contained in (1) and (2) above is a material representation of fact upon which reliance is placed and a prerequisite imposed by Section 1352, Title 31, U.S. Code prior to entering into this contract. Failure to comply shall be subject to a civil penalty of not less than \$10,000 and not more than \$100,000. The bidder shall include the language of the certification in all subcontracts exceeding \$100,000 and all subcontractors shall certify and disclose accordingly.

All of the foregoing is true and correct.

Executed on \_\_\_\_\_

\_\_\_\_\_  
Signature

**MISSISSIPPI DEPARTMENT OF TRANSPORTATION**

SAM.GOV Registration and DUNS Number

Bidders are advised that the Prime Contractor must maintain current registration in the **System for Award Management** (<http://www.sam.gov>) at all times during the project. A Dun and Bradstreet Data Universal Numbering System (DUNS) Number (<http://www.dnb.com>) is one of the requirements for registration in the System for Award Management.

Bidders are advised that prior to the award of this contract, they **MUST** be registered in the System for Award Management.

I (We) acknowledge that this contract cannot be awarded if I (We) are not registered in the System for Award Management prior to the award of this contract. \_\_\_\_\_ (Yes / No)

I (We) have a DUNS Number . \_\_\_\_\_ (Yes / No)

DUNS Number: \_\_\_\_\_

Company Name: \_\_\_\_\_

Company e-mail address: \_\_\_\_\_

(6/2015F)

For Informational Purposes Only

SECTION 902

CONTRACT FOR STP-0003-01(198)/ 107748301000

LOCATED IN THE COUNTY(IES) OF Harrison

STATE OF MISSISSIPPI,  
COUNTY OF HINDS

This contract entered into by and between the Mississippi Transportation Commission on one hand, and the undersigned contractor, on the other witnesseth;

That, in consideration of the payment by the Mississippi Transportation Commission of the prices set out in the proposal hereto attached, to the undersigned contractor, such payment to be made in the manner and at the time of times specified in the specifications and the special provisions, if any, the undersigned contractor hereby agrees to accept the prices stated in the proposal in full compensation for the furnishing of all materials and equipment and the executing of all the work contemplated in this contract.

It is understood and agreed that the advertising according to law, the Advertisement, the instructions to bidders, the proposal for the contract, the specifications, the revisions of the specifications, the special provisions, and also the plans for the work herein contemplated, said plans showing more particularly the details of the work to be done, shall be held to be, and are hereby made a part of this contract by specific reference thereto and with like effect as if each and all of said instruments had been set out fully herein in words and figures.

It is further agreed that for the same consideration the undersigned contractor shall be responsible for all loss or damage arising out of the nature of the work aforesaid; or from the action of the elements and unforeseen obstructions or difficulties which may be encountered in the prosecution of the same and for all risks of every description connected with the work, exceptions being those specifically set out in the contract; and for faithfully completing the whole work in good and workmanlike manner according to the approved Plans, Specifications, Special Provisions, Notice(s) to Bidders and requirements of the Mississippi Department of Transportation.

It is further agreed that the work shall be done under the direct supervision and to the complete satisfaction of the Executive Director of the Mississippi Department of Transportation, or his authorized representatives, and when Federal Funds are involved subject to inspection at all times and approval by the Federal Highway Administration, or its agents as the case may be, or the agents of any other Agency whose funds are involved in accordance with those Acts of the Legislature of the State of Mississippi approved by the Governor and such rules and regulations issued pursuant thereto by the Mississippi Transportation Commission and the authorized Federal Agencies.

The Contractor agrees that all labor as outlined in the Special Provisions may be secured from list furnished by

It is agreed and understood that each and every provision of law and clause required by law to be inserted in this contract shall be deemed to be inserted herein and this contract shall be read and enforced as though it were included herein, and, if through mere mistake or otherwise any such provision is not inserted, then upon the application of either party hereto, the contract shall forthwith be physically amended to make such insertion.

The Contractor agrees that he has read each and every clause of this Contract, and fully understands the meaning of same and that he will comply with all the terms, covenants and agreements therein set forth.

Witness our signatures this the \_\_\_ day of \_\_\_\_\_, \_\_\_\_\_.

\_\_\_\_\_  
Contractor(s)

By \_\_\_\_\_

MISSISSIPPI TRANSPORTATION COMMISSION

Title \_\_\_\_\_

By \_\_\_\_\_

Signed and sealed in the presence of:  
(names and addresses of witnesses)

Executive Director

\_\_\_\_\_

\_\_\_\_\_

Secretary to the Commission

Award authorized by the Mississippi Transportation Commission in session on the \_\_\_ day of \_\_\_\_\_, \_\_\_\_\_, Minute Book No. \_\_\_\_\_, Page No. \_\_\_\_\_.

Revised 8/06/2003



**SECTION 903**  
**PERFORMANCE AND PAYMENT BOND**

CONTRACT BOND FOR: STP-0003-01(198)/ 107748301000

LOCATED IN THE COUNTY(IES) OF: Harrison

STATE OF MISSISSIPPI,  
COUNTY OF HINDS

Know all men by these presents: that we, \_\_\_\_\_  
\_\_\_\_\_  
Principal, a \_\_\_\_\_ (Contractor)

residing at \_\_\_\_\_ in the State of \_\_\_\_\_

and \_\_\_\_\_  
\_\_\_\_\_  
(Surety)

residing at \_\_\_\_\_ in the State of \_\_\_\_\_,

authorized to do business in the State of Mississippi, under the laws thereof, as surety, effective as of the contract date

shown below, are held and firmly bound unto the State of Mississippi in the sum of \_\_\_\_\_

\_\_\_\_\_ Dollars, lawful money of the United States of America, to be paid to it for which payment well and truly to be made, we bind ourselves, our heirs, administrators, successors, or assigns jointly and severally by these presents.

The conditions of this bond are such, that whereas the said \_\_\_\_\_

\_\_\_\_\_ principal, has (have) entered into a contract with the Mississippi Transportation Commission, bearing the date of \_\_\_\_\_ day of \_\_\_\_\_ A.D. \_\_\_\_\_ hereto annexed, for the construction of certain projects(s) in the State of Mississippi as mentioned in said contract in accordance with the Contract Documents therefor, on file in the offices of the Mississippi Department of Transportation, Jackson, Mississippi.

Now therefore, if the above bounden \_\_\_\_\_ in all things shall stand to and abide by and well and truly observe, do keep and perform all and singular the terms, covenants, conditions, guarantees and agreements in said contract, contained on his (their) part to be observed, done, kept and performed and each of them, at the time and in the manner and form and furnish all of the material and equipment specified in said contract in strict accordance with the terms of said contract which said plans, specifications and special provisions are included in and form a part of said contract and shall maintain the said work contemplated until its final completion and acceptance as specified in Subsection 109.11 of the approved specifications, and save harmless said Mississippi Transportation Commission from any loss or damage arising out of or occasioned by the negligence, wrongful or criminal act, overcharge, fraud, or any other loss or damage whatsoever, on the part of said principal (s), his (their) agents, servants, or employees in the performance of said work or in any manner connected therewith, and shall be liable and responsible in a civil action instituted by the State at the instance of the Mississippi Transportation Commission or any officer of the State authorized in such cases, for double any amount in money or property, the State may lose or be overcharged or otherwise defrauded of, by reason of wrongful or criminal act, if any, of the Contractor(s), his (their) agents or employees, and shall promptly pay the said agents, servants and employees and all persons furnishing labor, material, equipment or supplies therefor, including premiums incurred, for Surety Bonds, Liability Insurance, and Workmen's Compensation Insurance; with the additional obligation that such Contractor shall promptly make payment of all taxes, licenses, assessments, contributions, damages,

any liquidated damages which may arise prior to any termination of said principal's contract, any liquidated damages which may arise after termination of the said principal's contract due to default on the part of said principal, penalties and interest thereon, when and as the same may be due this state, or any county, municipality, board, department, commission or political subdivision: in the course of the performance of said work and in accordance with Sections 31-5-51 et seq. Mississippi Code of 1972, and other State statutes applicable thereto, and shall carry out to the letter and to the satisfaction of the Executive Director of the Mississippi Department of Transportation, all, each and every one of the stipulations, obligations, conditions, covenants and agreements and terms of said contract in accordance with the terms thereof and all of the expense and cost and attorney's fee that may be incurred in the enforcement of the performance of said contract, or in the enforcement of the conditions and obligations of this bond, then this obligation shall be null and void, otherwise to be and remain in full force and virtue.

|                         |                                 |
|-------------------------|---------------------------------|
| _____                   | _____                           |
| (Contractors) Principal | Surety                          |
| By _____                | By _____                        |
|                         | (Signature) Attorney in Fact    |
|                         | Address _____                   |
|                         | _____                           |
| Title _____             | _____                           |
| (Contractor's Seal)     | (Printed) MS Agent              |
|                         | _____                           |
|                         | (Signature) MS Agent            |
|                         | Address _____                   |
|                         | _____                           |
|                         | _____                           |
|                         | (Surety Seal)                   |
|                         | _____                           |
|                         | Mississippi Insurance ID Number |



# BID BOND

KNOW ALL MEN BY THESE PRESENTS, that we \_\_\_\_\_  
Contractor

\_\_\_\_\_  
Address

\_\_\_\_\_  
City, State ZIP

As principal, hereinafter called the Principal, and \_\_\_\_\_  
Surety

a corporation duly organized under the laws of the state of \_\_\_\_\_

as Surety, hereinafter called the Surety, are held and firmly bound unto **State of Mississippi, Jackson, Mississippi**

As Obligee, hereinafter called Obligee, in the sum of **Five Per Cent (5%) of Amount Bid**

Dollars(\$ \_\_\_\_\_ )

for the payment of which sum will and truly to be made, the said Principal and said Surety, bind ourselves, our heirs, executors, administrators, successors and assigns, jointly and severally, firmly by these presents.

WHEREAS, the Principal has submitted a bid for **Overlay of US 90 from Russell Ave. to Debuys Road, known as Federal Aid Project No. STP-0003-01(198) / 107748301 in Harrison County.**

NOW THEREFORE, the condition of this obligation is such that if the aforesaid Principal shall be awarded the contract, the said Principal will, within the time required, enter into a formal contract and give a good and sufficient bond to secure the performance of the terms and conditions of the contract, then this obligation to be void; otherwise the Principal and Surety will pay unto the Obligee the difference in money between the amount of the bid of the said Principal and the amount for which the Obligee legally contracts with another party to perform the work if the latter amount be in excess of the former, but in no event shall liability hereunder exceed the penal sum hereof.

Signed and sealed this \_\_\_\_\_ day of \_\_\_\_\_, 20\_\_

\_\_\_\_\_  
(Witness)

\_\_\_\_\_  
(Principal) (Seal)

By: \_\_\_\_\_  
(Name) (Title)

\_\_\_\_\_  
(Surety) (Seal)

\_\_\_\_\_  
(Witness)

By: \_\_\_\_\_  
(Attorney-in-Fact)

\_\_\_\_\_  
(MS Agent)

\_\_\_\_\_  
Mississippi Insurance ID Number

MISSISSIPPI DEPARTMENT OF TRANSPORTATION  
OFFICE OF CIVIL RIGHTS  
JACKSON, MISSISSIPPI

LIST OF FIRMS SUBMITTING QUOTES

I/we received quotes from the following firms on:

Letting Date: **April 24, 2018**

Project No: STP-0003-01(198)/ 107748301000

County: Harrison

Disadvantaged Business Enterprise (DBE) Regulations as stated in 49 CFR 26.11 require the Mississippi Department of Transportation (MDOT) to create and maintain a comprehensive list of all firms quoting/bidding subcontracts on prime contracts and quoting/bidding subcontracts on federally-funded transportation projects. For every firm, we require the following information:

Firm Name: \_\_\_\_\_  
Contact Name/Title: \_\_\_\_\_  
Firm Mailing Address: \_\_\_\_\_  
Phone Number: \_\_\_\_\_  
\_\_\_\_\_ DBE Firm \_\_\_\_\_ Non-DBE Firm

Firm Name: \_\_\_\_\_  
Contact Name/Title: \_\_\_\_\_  
Firm Mailing Address: \_\_\_\_\_  
Phone Number: \_\_\_\_\_  
\_\_\_\_\_ DBE Firm \_\_\_\_\_ Non-DBE Firm

Firm Name: \_\_\_\_\_  
Contact Name/Title: \_\_\_\_\_  
Firm Mailing Address: \_\_\_\_\_  
Phone Number: \_\_\_\_\_  
\_\_\_\_\_ DBE Firm \_\_\_\_\_ Non-DBE Firm

Firm Name: \_\_\_\_\_  
Contact Name/Title: \_\_\_\_\_  
Firm Mailing Address: \_\_\_\_\_  
Phone Number: \_\_\_\_\_  
\_\_\_\_\_ DBE Firm \_\_\_\_\_ Non-DBE Firm

Firm Name: \_\_\_\_\_  
Contact Name/Title: \_\_\_\_\_  
Firm Mailing Address: \_\_\_\_\_  
Phone Number: \_\_\_\_\_  
\_\_\_\_\_ DBE Firm \_\_\_\_\_ Non-DBE Firm

