

MDOT Use Only

Checked \_\_\_\_\_

Loaded \_\_\_\_\_

Keyed \_\_\_\_\_

04 -



SM No. CSTP0015021231

# PROPOSAL AND CONTRACT DOCUMENTS

## FOR THE CONSTRUCTION OF

04

Overlay approximately 10 miles of US 84 (East Bound Lanes Only) from SR 588 to the Jones County Line, known as Federal Aid Project No. STP-0015-02(123) / 107798301 in Covington County.

Project Completion: 52 Working Days

**(STATE DELEGATED)**

### NOTICE

**BIDDERS MUST COMPLETE AN ONLINE REQUEST  
FOR PERMISSION TO BID THIS PROJECT.**

Electronic addendum updates will be posted on [www.gomdot.com](http://www.gomdot.com)

## **SECTION 900**

### **OF THE CURRENT**

### **2017 STANDARD SPECIFICATIONS**

### **FOR ROAD AND BRIDGE CONSTRUCTION**

**JACKSON, MISSISSIPPI**

**MISSISSIPPI DEPARTMENT OF TRANSPORTATION  
TABLE OF CONTENTS**

**PROJECT: STP-0015-02(123)/107798301 - Covington**

Section 901 - Advertisement

Section 904 - Notice to Bidders

#1	Governing Specification
#2	Status of ROW, w/ Attachments
#3	Final Cleanup
#7	Disadvantaged Business Enterprise In Federal-Aid Highway Construction, w/ Supplement
#9	Federal Bridge Formula
#10	DUNS Requirement for Federal Funded Projects
#12	MASH Compliant Devices
#13	Safety Edge
#113	Tack Coat
#296	Reduced Speed Limit Signs
#401	Standard Drawings
#445	Mississippi Agent and Qualified Nonresident Agent
#516	Errata and Modifications to the 2017 Standard Specifications
#796	Contract Time
#797	Specialty Items
#798	Cooperation Between Contractors
#799	Scope of Work
906	Required Federal Contract Provisions -- FHWA 1273, w/Supplements

Section 907 - Special Provisions

907-102-2	Bidding Requirements and Conditions
907-103-2	Award and Execution of Contract
907-618-4	Additional Signing Requirements, w/Supplement
907-624-1	Inverted Profile Thermoplastic Traffic Stripe

Section 905 - Proposal, Proposal Bid Items, Combination Bid Proposal

Certification of Performance - Prior Federal-Aid Contracts

Certification Regarding Non-Collusion, Debarment and Suspension

SAM.GOV Registration and DUNS Number

Section 902 - Contract Form

Section 903 - Contract Bond Forms

Form -- OCR-485

Progress Schedule

(REVISIONS TO THE ABOVE WILL BE INDICATED ON THE SECOND SHEET  
OF SECTION 905 AS ADDENDA)

04/25/2018 09:25 AM

# MISSISSIPPI DEPARTMENT OF TRANSPORTATION

## SECTION 901 - ADVERTISEMENT

Electronic bids will be received by the Mississippi Transportation Commission at 10:00 o'clock A.M., Tuesday, May 22, 2018, from the Bid Express Service and shortly thereafter publicly read on the Sixth Floor For:

Overlay approximately 10 miles of US 84 (East Bound Lanes Only) from SR 588 to the Jones County Line, known as Federal Aid Project No. STP-0015-02(123) / 107798301 in Covington County.

The attention of bidders is directed to the Contract Provisions governing selection and employment of labor. Minimum wage rates have been predetermined by the Secretary of Labor and are subject to Public Law 87-581, Work Hours Act of 1962, as set forth in the Contract Provisions.

The Mississippi Department of Transportation hereby notifies all bidders that it will affirmatively insure that in any contract entered into pursuant to this advertisement, disadvantaged business enterprises will be afforded full opportunity to submit bids in response to this invitation and will not be discriminated against on the grounds of race, color, sex, age, disability, religion or national origin in consideration for an award.

**The award of this contract will be contingent upon the Contractor satisfying the DBE requirements.**

The specifications are on file in the offices of the Mississippi Department of Transportation.

Contractors may request permission to bid online at <http://shopmdot.ms.gov> at no cost. Upon approval, Contractors shall be eligible to submit a bid using Bid Express at <http://bidx.com>. Specimen proposals may be viewed and downloaded online at no cost at <http://mdot.ms.gov> or purchased online at <http://shopmdot.ms.gov> at a cost of Ten Dollars (\$10.00) per proposal plus a small convenience fee. Cash or checks will not be accepted as payment.

Bid bond, signed or countersigned by a Mississippi Agent or Qualified Nonresident Agent, with Power of Attorney attached, a Cashier's check or Certified Check for five (5%) percent of bid, payable to STATE OF MISSISSIPPI, must accompany each proposal.

The attention of bidders is directed to the provisions of Subsection 102.07 pertaining to irregular proposals and rejection of bids.

MELINDA L. MCGRATH  
EXECUTIVE DIRECTOR

# MISSISSIPPI DEPARTMENT OF TRANSPORTATION

**SECTION 904 - NOTICE TO BIDDERS NO. 1**

**CODE: (IS)**

**DATE: 03/01/2017**

**SUBJECT: Governing Specifications**

The current (2017) Edition of the Standard Specifications for Road and Bridge Construction adopted by the Mississippi Transportation Commission is made a part hereof fully and completely as if it were attached hereto, except where superseded by special provisions, or amended by revisions of the Specifications contained within this proposal. Copies of the specification book may be purchased from the MDOT Construction Division, or online at [shopmdot/default.aspx?StoreIndex=1](http://shopmdot/default.aspx?StoreIndex=1).

A reference in any contract document to controlling requirements in another portion of the contract documents shall be understood to apply equally to any revision or amendment thereof included in the contract.

In the event the plans or proposal contain references to the 2004 Edition of the Standard Specifications for Road and Bridge Construction, it is to be understood that such references shall mean the comparable provisions of the 2017 Edition of the Standard Specifications.

## MISSISSIPPI DEPARTMENT OF TRANSPORTATION

**SECTION 904 - NOTICE TO BIDDERS NO. 2**

**CODE: (IS)**

**DATE: 03/01/2017**

**SUBJECT: Status of Right-of-Way**

Although it is desirable to have acquired all rights-of-way and completed all railroad agreements, utility adjustments and work to be performed by others prior to receiving bids, sometimes it is not considered to be in the public interest to wait until each and every such clearance has been obtained. The bidder is hereby advised of possible unacquired rights-of-way, relocations, railroad agreements and utilities adjustments which have not been completed.

The status of right-of-way acquisition, utility adjustments, encroachments, potentially contaminated sites, railroad facilities, improvements, and asbestos contamination are set forth in the following attachments.

In the event right of entry is not available to ALL parcels of right-of-way and/or all work that is to be accomplished by others on the date set forth in the contract for the Notice to Proceed is not complete, the Department will issue a restricted Notice to Proceed.

**STATUS OF RIGHT-OF-WAY**

STP-0015-02(123)

107798-301000

Covington County

All rights of way and legal rights of entry have been acquired **except:**

**None.**

ASBESTOS CONTAMINATION STATUS OF BUILDINGS  
TO BE REMOVED BY THE CONTRACTOR  
STP-0015-02(123)  
107798-301000  
Covington County  
March 21, 2018

Reference is made to notices to bidders entitled "Asbestos National Emission Standards for Hazardous Air Pollutants (NESHAP)" and "Removal of Obstructions".

The following pertinent information is furnished concerning asbestos containing materials (ACMs), if any, found in buildings to be removed by the Contractor.

There is no Right of Way required for this project. There are no buildings to be removed by the contractor.

STATUS OF POTENTIALLY CONTAMINATED SITES

STP-0015-02(123)

107798-301000

Covington County

March 21, 2018

THERE IS NO RIGHT OF WAY REQUIRED FOR THIS PROJECT. NO INITIAL SITE ASSESSMENT WILL BE PERFORMED. IF CONTAMINATION ON EXISTING RIGHT OF WAY IS DISCOVERED, IT WILL BE HANDLED BY THE DEPARTMENT.



# MISSISSIPPI DEPARTMENT OF TRANSPORTATION

## *Inter-Departmental Memorandum*

TO: Ms. Trudi Loflin  
Right-of-Way Division (84-01)

DATE: 3/12/2018

FROM: Gregory L. Wilkinson *GLW*  
District Seven Preconstruction (17-01)

SUBJECT OR PROJECT NO: STP-0015-02(123)/107798301000  
US 84

INFORMATION COPY TO:  
Preconstruction File  
Central File  
District Seven (Mr. White & Mr. Morris)  
District Seven (Ms. Brock)  
Construction Division (Ms. Lamey)

COUNTY: Covington

1. **STATUS OF RIGHT OF WAY:** All work will be done within the existing ROW.
2. **RIGHT OF WAY CLEARANCE:** There are no encroachments.
3. **STATUS OF AFFECTED RAILROAD OPERATING FACILITIES:** None affected.
4. **STATUS OF REQUIRED UTILITY RELOCATIONS:** No utility conflicts.
5. **STATUS OF CONSTRUCTION AGREEMENT:** None required.

If any other information is required, please advise.

Improvements to be included in Notice to Bidders to be removed by the Construction Contractor  
FMS Construction Project No: 107798-301000  
External ROW No: STP-0015-02(123)

Parcel No:  
Station No:  
Property Owner:  
Description/Pictures:

**NA**

**MISSISSIPPI DEPARTMENT OF TRANSPORTATION**

**SECTION 904 - NOTICE TO BIDDERS NO. 3**

**CODE: (SP)**

**DATE: 01/17/2017**

**SUBJECT: Final Clean-Up**

Immediately prior to final inspection for release of maintenance, the Contractor shall pick up, load, transport and properly dispose of all litter from the entire highway right-of-way that is within the termini of the project.

Litter shall include, but not be limited to, solid wastes such a glass, paper products, tires, wood products, metal, synthetic materials and other miscellaneous debris.

Litter removal is considered incidental to other items of work and will not be measured for separate payment.

## MISSISSIPPI DEPARTMENT OF TRANSPORTATION

### SUPPLEMENT TO NOTICE TO BIDDERS NO. 7

**DATE:**       **01/17/2017**

The goal is 1 percent for the Disadvantaged Business Enterprise. The low bidder is required to submit Form OCR-481 for all DBEs. Bidders are advised to check the bid tabulation link for this project on the MDOT website at:

<http://sp.gomdot.com/Contract%20Administration/BidSystems/Pages/letting%20calendar.aspx>

Bid tabulations are usually posted by 3:00 pm on Letting Day.

# MISSISSIPPI DEPARTMENT OF TRANSPORTATION

**SECTION 904 - NOTICE TO BIDDERS NO. 7**

**CODE: (IS)**

**DATE: 03/01/2017**

**SUBJECT: Disadvantaged Business Enterprises In Federal-Aid Highway Construction**

This contract is subject to the "Moving Ahead for Progress in the 21<sup>st</sup> Century Act (MAP-21)" and applicable requirements of "Part 26, Title 49, Code of Federal Regulations". Portions of the Act are set forth in this Notice as applicable to compliance by the Contractor and all of the Act, and the MDOT DBE Program, is incorporated by reference herein.

The Department has developed a Disadvantaged Business Enterprise Program that is applicable to this contract and is made a part thereof by reference.

Copies of the program may be obtained from:

Office of Civil Rights  
Mississippi Department of Transportation  
P. O. Box 1850  
Jackson, Mississippi 39215-1850

## **POLICY**

It is the policy of the Mississippi Department of Transportation to provide a level playing field, to foster equal opportunity in all federally assisted contracts, to improve the flexibility of the DBE Program, to reduce the burdens on small businesses, and to achieve that amount of participation that would be obtained in a non-discriminatory market place. In doing so, it is the policy of MDOT that there will be no discrimination in the award and performance of federally assisted contracts on the basis of race, color, sex, age, religion, national origin, or any handicap.

## **ASSURANCES THAT CONTRACTORS MUST TAKE**

MDOT will require that each contract which MDOT signs with a sub-recipient or a Contractor, and each subcontract the Prime Contractor signs with a Subcontractor, includes the following assurances:

“The Contractor, sub-recipient or Subcontractor shall not discriminate on the basis of race, color, national origin, or sex in the performance of this contract. The Contractor shall carry out applicable requirements of 49 CFR 26 in the award and administration of federally assisted contracts. Failure by the Contractor to carry out these requirements is a material breach of this contract, which may result in the termination of this contract or such other remedy as MDOT deems appropriate.”

## **DEFINITIONS**

For purposes of this provision the following definitions will apply:

"Disadvantaged Business" means a small business concern: (a) which is at least 51 percent owned by one or more socially and economically disadvantaged individual(s) or in the case of any publicly owned business, at least 51 percent of the stock of which is owned by one or more socially and economically disadvantaged individual(s); and (b) whose management and daily business operations are controlled by one or more of the socially and economically disadvantaged individual(s) who own it. It is important to note that the business owners themselves must control the operations of the business. Absentee ownership or title ownership by an individual who does not take an active role in controlling the business is not consistent with eligibility as a DBE under CFR 49 Part 26.71.

**CONTRACTOR'S OBLIGATION**

The Contractor and all Subcontractors shall take all necessary and reasonable steps to ensure that DBE firms can compete for and participate in the performance of a portion of the work in this contract and shall not discriminate on the basis of race, color, national origin, religion or sex. Failure on the part of the Contractor to carry out the DBE requirements of this contract constitutes a breach of contract and after proper notification the Department may terminate the contract or take other appropriate action as determined by the Department.

When a contract requires a zero percent (0%) DBE goal, the Contractor still has the responsibility to take all necessary and reasonable steps to ensure that DBE firms can compete for and participate in the performance of the work in the contract. In this case, all work performed by a certified DBE firm is considered to be a "race neutral" measure and the Department will receive DBE credit towards the overall State goals when the DBE firm is paid for their work. If the Prime Contractor is a certified DBE firm, the Department can receive DBE credit only for the work performed by the Prime Contractor's work force or any work subcontracted to another DBE firm. Work performance by a non-DBE Subcontractor is not eligible for DBE credit.

**CONTRACT GOAL**

The goal for participation by DBEs is established for this contract in the attached Supplement. The Contractor shall exercise all necessary and reasonable steps to ensure that participation is equal to or exceeds the contract goal.

If the percentage of the contract that is proposed for DBEs is 1% or greater, the Contractor shall agree to meet or exceed the contract goal on the last bid sheet of the proposal.

The apparent lowest responsive bidder shall submit to the Office of Civil Rights Form OCR-481, signed by the Prime Contractor and the DBE Subcontractors, no later than the 3<sup>rd</sup> business day after opening of the bids.

Form OCR-481 is available on the MDOT website at GoMDOT.com, then Divisions, Civil Rights, Forms, DBE, MDOT Projects, or by calling 601-359-7466.

The OCR-481 Form must contain the following information:

The name and address of each certified DBE Contractor / Supplier;

The Reference Number, percent of work and the dollar amount of each item. If a portion of an item is subcontracted, a breakdown of that item including quantities and unit price must be attached, detailing what part of the item the DBE firm is to perform and who will perform the remainder of the item.

If the DBE Commitment shown on the last bid sheet of the proposal, does not equal or exceed the contract goal, the bidder must submit, to MDOT Contract Administration Division prior to bid opening, information to satisfy the Department that adequate good faith efforts have been made to meet the contract goal.

Failure of the lowest bidder to furnish acceptable proof of good faith efforts, submitted to MDOT Contract Administration Division prior to bid opening, shall be just cause for rejection of the proposal. Award may then be made to the next lowest responsive bidder or the work may be re-advertised.

The following factors are illustrative of matters the Department will consider in judging whether or not the bidder has made adequate good faith effort to satisfy the contract goal.

- (1) Whether the bidder attended the pre-bid meeting that was scheduled by the Department to inform DBEs of subcontracting opportunities;
- (2) Whether the bidder advertised in general circulation, trade association, and minority-focus media concerning the subcontracting opportunities;
- (3) Whether the bidder provided written notice to a reasonable number of specific DBEs that their interest in the contract is being solicited;
- (4) Whether the bidder followed up initial solicitations of interest by contacting DBEs to determine with certainty whether they were interested;
- (5) Whether the bidder selected portions of the work to be performed by DBEs in order to increase the likelihood of meeting the contract goal;
- (6) Whether the bidder provided interested DBEs with adequate information about the plans, specifications and requirements of the contract;
- (7) Whether the bidder negotiated in good faith with interested DBEs and did not reject them as unqualified without sound reasons based on a thorough investigation of their capabilities; and
- (8) Whether the bidder made efforts to assist interested DBEs in obtaining any required bonding or insurance.
- (9) Whether the bidder has written notification to certified DBE Contractors soliciting subcontracting for items of work in the contract.
- (10) Whether the bidder has a statement of why an agreement was not reached.

The bidder’s execution of the signature portion of the proposal shall constitute execution of the following assurance:

The bidder hereby gives assurance pursuant to the applicable requirements of "Moving Ahead for Progress in the 21<sup>st</sup> Century Act (MAP-21)" and applicable requirements of "Part 26, Title 49, Code of Federal Regulations" that the bidder has made a good faith effort to meet the contract goal for DBE participation for which this proposal is submitted.

### **DIRECTORY**

A list of “Certified DBE Contractors” which have been certified as such by the Mississippi Department of Transportation and other Unified Certification Partners (UPC) can be found on the Mississippi Department of Transportation website at [www.gomdot.com](http://www.gomdot.com). The list is in the top left corner of the current Letting Calendar under Contracts & Letting. The DBE firm must be certified at the time the project is let and approved by MDOT to count towards meeting the DBE goal.

### **REPLACEMENT**

If a DBE Subcontractor cannot perform satisfactorily, and this causes the OCR-481 commitment to fall below the contract goal, the Contractor shall take all necessary reasonable steps to replace the DBE with another certified DBE Subcontractor or submit information to satisfy the Mississippi Department of Transportation that adequate good faith efforts have been made to replace the DBE. The replacement DBE must be a DBE who was on the Department's list of "Certified DBE Contractors" when the job was let, and who is still active. All DBE replacements must be approved by the Department.

Under no circumstances shall the Prime or any Subcontractor perform the DBE's work (as shown on the OCR-481) without prior written approval from the Department. See "Sanctions" at the end of this document for penalties for performing DBE's work.

When a Contractor proposes to substitute/replace/terminate a DBE that was originally named on the OCR-481, the Contractor must obtain a release, in writing, from the named DBE explaining why the DBE Subcontractor cannot perform the work. A copy of the original DBE's release must be attached to the Contractor's written request to substitute/replace/terminate along with appropriate Subcontract Forms for the substitute/replacement/terminated Subcontractor, all of which must be submitted to the DBE Coordinator and approved, in advance, by MDOT.

### **GOOD FAITH EFFORTS**

To demonstrate good faith efforts to replace any DBE that is unable to perform successfully, the Contractor must document steps taken to subcontract with another certified DBE Contractor. Such documentation shall include no less than the following:

- (1) Proof of written notification to certified DBE Contractors by certified mail that their interest is solicited in subcontracting the work defaulted by the previous DBE or in subcontracting other items of work in the contract.



- (2) If the Prime Contractor is a certified DBE firm, only the value of the work actually performed by the DBE Prime can be counted towards the project goal, along with any work subcontracted to a certified DBE firm.
- (3) If the Contractor is not a DBE, the work subcontracted to a certified DBE Contractor will be counted toward the goal.
- (4) The Contractor may count toward the goal a portion of the total dollar value of a contract with a joint venture eligible under the standards of this provision equal to the percentage of the DBE partner in the joint venture.
- (5) Expenditures to DBEs that perform a commercially useful function may be counted toward the goal. A business is considered to perform a commercially useful function when it is responsible for the execution of a distinct element of the work and carries out its responsibilities by actually performing, managing, and supervising the work involved.
- (6) The Contractor may count 100% of the expenditures for materials and supplies obtained from certified DBE suppliers and manufacturers that produce goods from raw materials or substantially alters them for resale provided the suppliers and manufacturers assume the actual and contractual responsibility for the provision of the materials and supplies. The Contractor may count sixty percent (60%) of the expenditures to suppliers that are not manufacturers, provided the supplier performs a commercially useful function in the supply process. Within 30 days after receipt of the materials, the Contractor shall furnish to the DBE Coordinator invoices from the certified supplier to verify the DBE goal.
- (7) Any work that a certified DBE firm subcontracts or sub-subcontracts to a non-DBE firm will not count towards the DBE goal.
- (8) Only the dollars actually paid to the DBE firm may be counted towards the DBE goal.

Failure of the Contractor to demonstrate good faith efforts to replace a DBE Subcontractor that cannot perform as intended with another DBE Subcontractor, when required, shall be a breach of contract and may be just cause to be disqualified from further bidding for a period of up to 12 months after notification by certified mail.

### **PRE-BID MEETING**

A pre-bid meeting will be held in Amphitheater 1 & 2 of the Hilton Jackson located at I-55 and County Line Road, Jackson, Mississippi at 2:00 P.M. on the day preceding the date of the bid opening.

This meeting is to inform DBE firms of subcontracting and material supply opportunities. Attendance at this meeting is considered of prime importance in demonstrating good faith effort to meet the contract goal.

### **PARTICIPATION / DBE CREDIT**

Participation shall be counted toward meeting the goal in this contract as follows:

- (1) If the Prime Contractor is a certified DBE firm, only the value of the work actually performed by the DBE Prime can be counted towards the project goal, along with any work subcontracted to a certified DBE firm.
- (2) If the Contractor is not a DBE, the work subcontracted to a certified DBE Contractor will be counted toward the goal.
- (3) The Contractor may count toward the goal a portion of the total dollar value of a contract with a joint venture eligible under the standards of this provision equal to the percentage of the DBE partner in the joint venture.
- (4) Expenditures to DBEs that perform a commercially useful function may be counted toward the goal. A business is considered to perform a commercially useful function when it is responsible for the execution of a distinct element of the work and carries out its responsibilities by actually performing, managing, and supervising the work involved.
- (5) The Contractor may count 100% of the expenditures for materials and supplies obtained from certified DBE suppliers and manufacturers that produce goods from raw materials or substantially alters them for resale provided the suppliers and manufacturers assume the actual and contractual responsibility for the provision of the materials and supplies. The Contractor may count sixty percent (60%) of the expenditures to suppliers that are not manufacturers, provided the supplier performs a commercially useful function in the supply process. Within 30 days after receipt of the materials, the Contractor shall furnish to the DBE Coordinator invoices from the certified supplier to verify the DBE goal.
- (6) Any work that a certified DBE firm subcontracts or sub-subcontracts to a non-DBE firm will not count towards the DBE goal.
- (7) Only the dollars actually paid to the DBE firm may be counted towards the DBE goal. The participation of a DBE Firm cannot be counted towards the Prime Contractor's DBE goal until the amount being counted towards the goal has been paid to the DBE.

## **AWARD**

Award of this contract to the low bidder will be contingent upon the following conditions:

- (1) Concurrence from Federal Highway Administration, when applicable.
- (2) Bidder must submit to the Office of Civil Rights for approval, Form OCR-481 (DBE Commitment) no later than the 3<sup>rd</sup> business day after opening of the bids to satisfy the Department and that adequate good faith efforts have been made to meet the contract goal. For answers to questions regarding Form OCR-481, contact the MDOT Office of Civil Rights at (601) 359-7466.
- (3) Bidder must include OCR-485 information with their bid proposal listing all firms that submitted quotes for material supplies or items to be subcontracted. OCR-485 information

must be included with the bid proposal. If the OCR-485 information is not included as part of bid proposal, your bid will be deemed irregular.

Prior to the start of any work, the bidder must notify the Project Engineer, in writing, of the name of the designated "DBE Liaison Officer" for this project. This notification must be posted on the bulletin board at the project site.

### **DEFAULT**

If the contract goal established by MDOT in this proposal is 1% or greater, it must be met to fulfill the terms of the contract. The Contractor may list DBE Subcontractors and items that exceed MDOT's contract goal, but should unforeseen problems arise that would prevent a DBE from completing its total commitment percentage, the Contractor will meet the terms of the contract as long as it meets or exceeds MDOT's Contract Goal. For additional information, refer to "Replacement" section of this Notice.

### **DBE REPORTS**

- (1) OCR-481: Refer to "CONTRACT GOAL" section of this Notice to Bidders for information regarding this form.
- (2) OCR-482: OCR-482: At the conclusion of the project, before the final estimate is paid and the project is closed out, the Prime Contractor will submit to the Project Engineer for verification of quantities and further handling Form OCR-482 whereby the Contractor certifies to the amounts of payments made to all Contractors / Suppliers over the life of the contract. The Project Engineer shall submit the completed Form OCR-482 to the DBE Coordinator (Office of Civil Rights). Final acceptance of the project is dependent upon Contract Administration Division's receipt of completed Form OCR-482 which they will receive from the Office of Civil Rights.
- (3) OCR-483: The Project Engineer/Inspector will complete Form OCR-483, the Commercially Useful Function (CUF) Performance Report, in accordance with MDOT S.O.P. No. OCR-03-09-01-483. Evaluations reported on this form are used to determine whether or not the DBE firm is performing a CUF. The Prime Contractor should take corrective action when the report contains any negative evaluations. DBE credit may be disallowed and/or other sanctions imposed if it is determined the DBE firm is not performing a CUF. This form should also be completed and returned to the DBE Coordinator (Office of Civil Rights).
- (4) OCR-484: Each month, the Prime Contractor will submit to the Project Engineer OCR-484 that certifies payments to all Subcontractors and shows all firms even if the Prime Contractor has paid no monies to the firm during that estimate period (negative report). The Project Engineer will attach the form to the monthly estimate before forwarding to the Contract Administration Division for further processing. Failure of the Contractor to submit the OCR-484 will result in the estimate not being processed and paid.

- (5) OCR-485: ALL BIDDERS must submit signed form with bid proposal of all firms that submitted quotes for material supplies or items to be subcontracted. If the OCR-485 information is not included as part of bid proposal, the bid will be deemed irregular.
- (6) OCR-487: Only used by Prime Contractors that are certified DBE firms. This form is used in determining the exact percentage of DBE credit for the specified project. It should be returned to MDOT with the OCR-481 form, or can also be returned with the Permission to Subcontract Forms (CAD-720, CAD-725 and CAD-521).

DBE Forms, can be obtained from the Office of Civil Rights Division, MDOT Administration Building, 401 North West Street, Jackson, MS, or at [www.gomdot.com](http://www.gomdot.com) under Divisions, Civil Rights, and Forms.

**SANCTIONS**

The Department has the option to enforce any of the following penalties for failure of the Prime Contractor to fulfill the DBE goal as stated on the OCR-481 form or any violations of the DBE program guidelines:

- (1) Disallow credit towards the DBE goal
- (2) Withhold progress estimate payments
- (3) Deduct from the final estimate or recover an amount equal to the unmet portion of the DBE goal which may include additional monetary penalties as outlined below based on the number of offenses and the severity of the violation as determined by MDOT.

1 <sup>st</sup> Offense	10% of unmet portion of goal	or	\$5,000 lump sum payment	or	Both
2 <sup>nd</sup> Offense	20% of unmet portion of goal	or	\$10,000 lump sum payment	or	Both
3 <sup>rd</sup> Offense	40% of unmet portion of goal	or	\$20,000 lump sum payment	or	\$20,000 lump sum payment and debarment

- (4) Debar the Contractor involved from bidding on MDOT federally funded projects.

**MISSISSIPPI DEPARTMENT OF TRANSPORTATION**

**SECTION 904 - NOTICE TO BIDDERS NO. 9**

**CODE: (IS)**

**DATE: 03/01/2017**

**SUBJECT: Federal Bridge Formula**

Bidders are hereby advised that the latest revision of Federal Highway Administration Publication No. FHWA-HOP-06-105, **BRIDGE FORMULA WEIGHTS**, dated August 2006, is made a part of this contract when applicable.

Prior to the preconstruction conference, the Contractor shall advise the Engineer, in writing, what materials, if any, will be delivered to the jobsite via Interstate route(s).

Copies of the **BRIDGE FORMULA WEIGHTS** publication may be obtained by contacting:

Federal Highway Administration  
400 7<sup>th</sup> Street, SW  
Washington, DC 20590  
(202) 366-2212

or

[http://www.ops.fhwa.dot.gov/Freight/publications/brdg\\_frm\\_wgths/bridge\\_formula\\_all\\_rev.pdf](http://www.ops.fhwa.dot.gov/Freight/publications/brdg_frm_wgths/bridge_formula_all_rev.pdf)

An on line **BRIDGE FORMULA WEIGHTS CALCULATOR** is available at

[http://ops.fhwa.dot.gov/freight/sw/brdgcalc/calc\\_page.htm](http://ops.fhwa.dot.gov/freight/sw/brdgcalc/calc_page.htm)

**MISSISSIPPI DEPARTMENT OF TRANSPORTATION**

**SECTION 904 - NOTICE TO BIDDERS NO. 10**

**CODE: (IS)**

**DATE: 03/01/2017**

**SUBJECT: DUNS Requirement for Federal Funded Projects**

Bidders are advised that the Prime Contractor must maintain current registrations in the System for Award Management ( <http://www.sam.gov> ) at all times during this project. A Dun and Bradstreet Data Universal Numbering System (DUNS) Number ( <http://www.dnb.com> ) is one of the requirements for registration in the System for Award Management.

Bidders are also advised that prior to the award of this contract, they MUST be registered in the System for Award Management.

# MISSISSIPPI DEPARTMENT OF TRANSPORTATION

**SECTION 904 - NOTICE TO BIDDERS NO. 12**

**CODE: (IS)**

**DATE: 03/01/2017**

**SUBJECT: MASH Compliant Devices**

Bidders are hereby advised that the Standard Specifications may require certain traffic control and permanent safety hardware devices to meet the requirements of the Manual for Assessing Safety Hardware (MASH). However, devices meeting the requirements of NCHRP Report 350 will be allowed until the mandatory effective date for MASH compliance. The following table shows the effective dates for MASH compliant devices.

<b>Device</b>	<b>Effective Date for MASH Compliance</b>
W-beam barriers, cast-in-place concrete barriers	December 31, 2017
W-beam terminals	June 30, 2018
Cable barriers, cable barrier terminals, crash cushions	December 31, 2018
Bridge rails, transitions, all other longitudinal barriers including portable barriers installed permanently, all other terminals, sign supports, all other breakaway hardware	December 31, 2019

Temporary work zone devices, including portable barriers manufactured after December 31, 2019, must have been successfully tested to the 2016 Edition of MASH. Such devices manufactured on or before this date and successfully tested to NCHRP Report 350 or the 2009 Edition of MASH may continue to be used throughout their normal service lives.

**MISSISSIPPI DEPARTMENT OF TRANSPORTATION**

**SECTION 904 - NOTICE TO BIDDERS NO. 13**

**CODE: (IS)**

**DATE: 03/01/2017**

**SUBJECT: Safety Edge**

Bidders are hereby advised that the Shoulder Wedge (Safety Edge) specified in Section 401, Asphalt Pavements, shall only apply to the top two (2) lifts of asphalt. Open Graded Friction Courses (OGFC) are not to be considered a lift as it pertains to safety edge. Attached is a drawing showing the safety edge. Note that the shoulder dimensions in the bottom two drawings will be less than three feet (3').





## MISSISSIPPI DEPARTMENT OF TRANSPORTATION

**SECTION 904 - NOTICE TO BIDDERS NO. 113**

**CODE: (SP)**

**DATE: 04/18/2017**

**SUBJECT: Tack Coat**

Bidders are advised that in addition to the products listed on the Department's APL as referenced in Subsection 401.03.1.2 on page 256, the Contractor may use one of the following as a tack coat.

- CSS-1
- CSS-1h
- SS-1
- SS-1h

**MISSISSIPPI DEPARTMENT OF TRANSPORTATION**

**SECTION 904 - NOTICE TO BIDDERS NO. 296**

**CODE: (SP)**

**DATE: 07/25/2017**

**SUBJECT: Reduced Speed Limit Signs**

Bidders are advised that when the plans or contract documents require the speed limit on a project to be reduced, the Contractor shall begin work within 48 hours of installing the reduced speed limit signs. Should the Contractor not start work or have no plans to start work within 48 hours of installing the signs, the reduced speed limit signs shall be covered and existing speed limit signs uncovered.

**MISSISSIPPI DEPARTMENT OF TRANSPORTATION**

**SECTION 904 – NOTICE TO BIDDERS NO. 401**

**CODE: (SP)**

**DATE: 09/12/2017**

**SUBJECT: Standard Drawings**

Standard Drawings attached hereto shall govern appropriate items of required work.

Larger copies of Standard Drawings may be purchased from:

MDOT Plans Print Shop  
MDOT Shop Complex, Building C, Room 114  
2567 North West Street  
P.O. Box 1850  
Jackson, MS 39215-1850  
Telephone: (601) 359-7460  
or FAX: (601) 359-7461  
or e-mail: [plans@mdot.state.ms.us](mailto:plans@mdot.state.ms.us)



STATE MISS.	PROJECT NO.	
----------------	-------------	--

**DETAIL A**  
LATERAL PLACEMENT OF PAVEMENT MARKERS

**DETAIL B**  
LATERAL PLACEMENT OF PAVEMENT MARKERS

**TYPICAL TWO-WAY ARROW INSTALLATION**

**TYPICAL STRIPING AND RAISED PAVEMENT MARKERS FOR 3-LANE SECTION**

NOTES: 1. CONSIDER EACH SEGMENT OF CONTINUOUS TWO-WAY LEFT TURN LANE SEPARATELY. 2. IF SEGMENT IS GREATER THAN 300' PLACE FIRST SET OF ARROWS 50' TO 100' FROM BEGINNING AND/OR END OF SEGMENT AND SPACE ADDITIONAL SETS OF ARROWS (250' O.C.).

**TYPICAL STRIPING AND RAISED PAVEMENT MARKERS FOR 4-LANE SECTION**

**TYPICAL STRIPING AND RAISED PAVEMENT MARKERS AT LEFT TURN LANES**

\* NOTE: USE DETAIL STRIPING IF LENGTH < 150' AT THIS LOCATION, OTHERWISE USE CONTINUOUS STRIPING.

**TYPICAL STRIPING AND RAISED PAVEMENT MARKERS FOR 3-LANE SECTION**

**TYPICAL STRIPING AND RAISED PAVEMENT MARKERS FOR 4-LANE SECTION**

**TYPICAL STRIPING AND RAISED PAVEMENT MARKERS FOR 3-LANE SECTION**

**TYPICAL STRIPING AND RAISED PAVEMENT MARKERS FOR 4-LANE SECTION**

<b>MISSISSIPPI DEPARTMENT OF TRANSPORTATION</b>	
<b>ROADWAY DESIGN DIVISION</b>	
<b>STANDARD PLAN</b>	
<b>PAVEMENT MARKING</b>	
<b>DETAILS FOR 3-LANE</b>	
<b>4-LANE AND 3-LANE</b>	
<b>UNDIVIDED ROADWAYS</b>	
DATE	ISSUE DATE: MAY 21, 2017
REVISION	SHEET NUMBER
	PJM-2
	SHEET NUMBER
	60352

GENERAL NOTE:  
1. PAVEMENT MARKERS SHALL BE HIGH PERFORMANCE RAISED PAVEMENT MARKERS AS LISTED IN THE MOST APPROVED SOURCE OF MATERIALS.

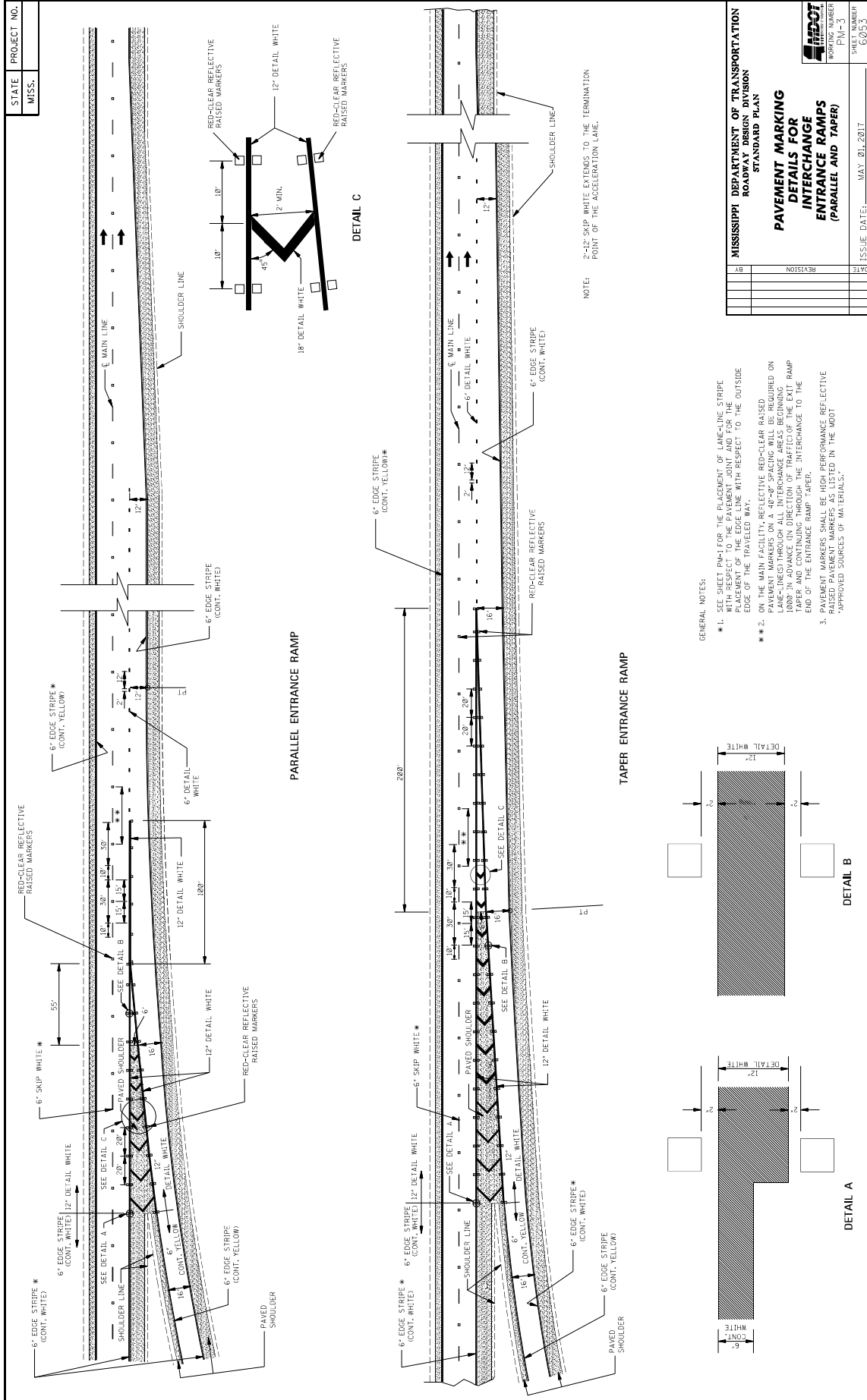

STATE	PROJECT NO.
MISS.	

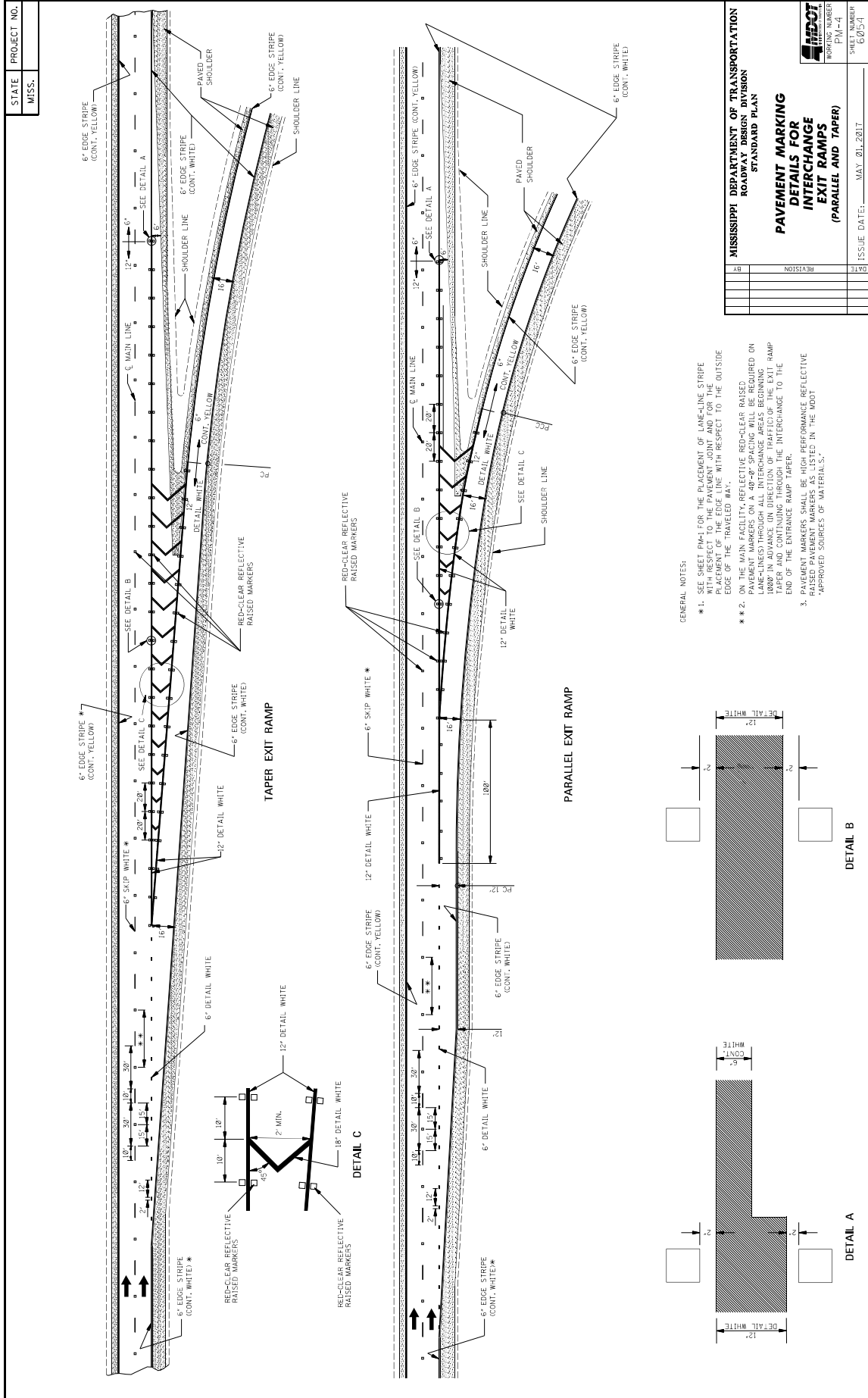

MISSISSIPPI DEPARTMENT OF TRANSPORTATION ROADWAY DESIGN DIVISION STANDARD PLAN	
<b>PAVEMENT MARKING DETAILS FOR INTERCHANGE EXIT RAMPS (PARALLEL AND TAPER)</b>	
WORKING NUMBER	PM-4
SHEET NUMBER	602/3-1
DATE	ISSUE DATE: MAY 01, 2017
BY	REVISION

- GENERAL NOTES:
- \*\* 1. SEE SHEET PM-1 FOR THE PLACEMENT OF LANE-LINE STRIPE WITH RESPECT TO THE PAVEMENT JOINT AND FOR THE PLACEMENT OF THE EDGE STRIPE WITH RESPECT TO THE EDGE OF THE PAVED SHOULDER.
  - \*\* 2. EDGE OF MAIN EXISTING REFLECTIVE ROADWAYS (AS PAVED) PAVEMENT MARKERS ON A 40'-50' SPACING WILL BE REQUIRED ON LANE-LINES THROUGH ALL INTERCHANGE AREAS BEGINNING 1000' IN ADVANCE (IN DIRECTION OF TRAFFIC) OF THE EXIT RAMP TAPER AND CONTINUING THROUGH THE INTERCHANGE TO THE END OF THE ENTRANCE RAMP TAPER.
  - 3. RAISED PAVEMENT MARKERS BE HIGH PERFORMANCE REFLECTIVE 'APPROVED SOURCES OF MATERIALS.'

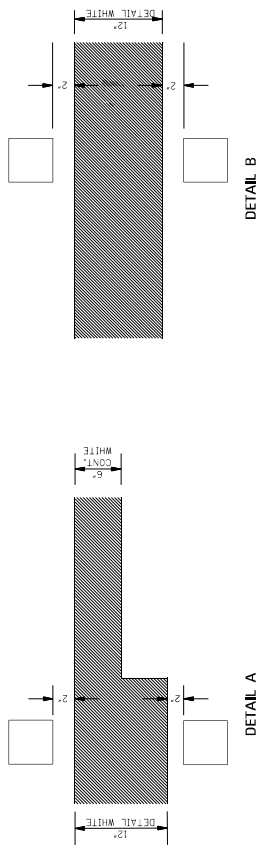



STATE MISS.	PROJECT NO.										
----------------	-------------	--	--	--	--	--	--	--	--	--	--

**GENERAL NOTES:**

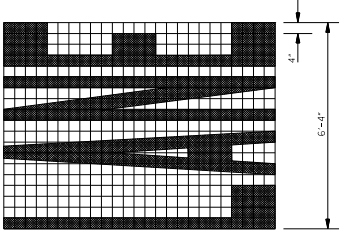
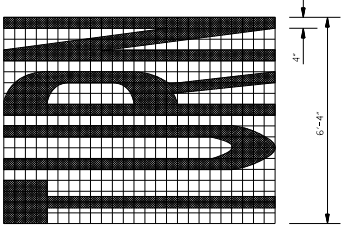
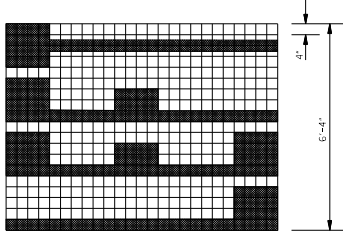
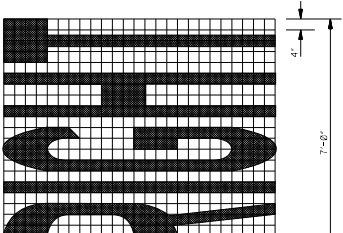
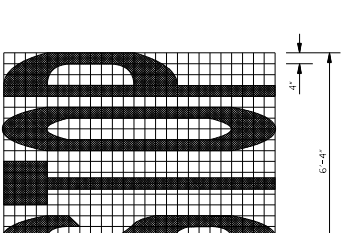
- TWO HORIZONTAL GAPS (CAUSED BY TEMPLATE CONNECTIONS) OF 1/2" LESS THAN THE STRETCHING LETTERS SHALL BE SHOWN IN THE STRETCHING LETTERS.
- FOR OTHER DETAILS, SEE THE MANUAL ON UNIFORM TRAFFIC CONTROL DEVICES.
- PAY QUANTITIES FOR PAVEMENT MARKING LEGENDS ARE AS FOLLOWS:

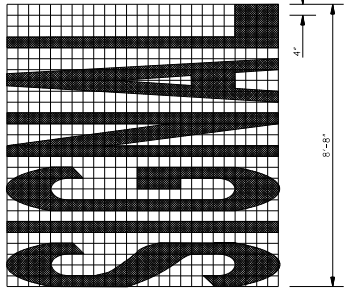
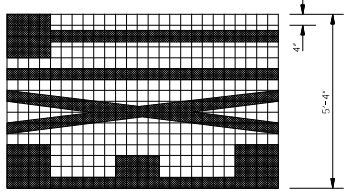
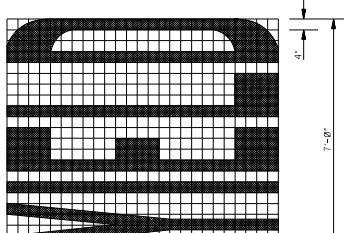
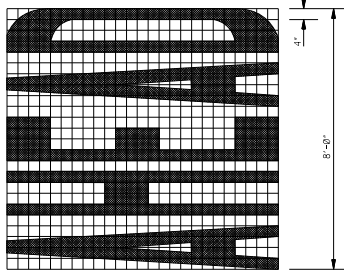
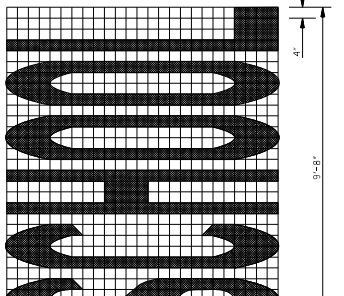
LEGEND	AREA (FT <sup>2</sup> )
STOP	24.6
RIGHT	28.6
LEFT	19.5
TRAFFIC	22.2
AHEAD	32.3
YIELD	26.8
EXIT	18.5
SIGNAL	32.5
SCHOOL	35.5

**MISSISSIPPI DEPARTMENT OF TRANSPORTATION  
ROADWAY DESIGN DIVISION  
STANDARD PLAN**

**PAVEMENT MARKING  
LEGEND DETAILS**

DATE	REVISION
BY	BY

ISSUE DATE: MAY 01, 2017  
SHEET NUMBER: PM-5  
PROJECT NUMBER: 60355

STATE MISS.	PROJECT NO.	
----------------	-------------	--

**THRU ARROW**

**TURN ARROW**

**LANE-REDUCTION ARROW**

**COMBINATION ARROW**

**ONLY**

**YIELD LINE**

**1-WAY ARROW**

**GENERAL NOTES:**

- TWO HORIZONTAL GAPS (CAUSED BY TEMPLATE CONNECTORS OF 1/16" OR LESS AND EXTENDING THE FULL WIDTH) ARE PERMITTED IN EACH LETTER.
- FOR OTHER DETAILS, SEE THE MANUAL ON UNIFORM TRAFFIC CONTROL DEVICES.
- DIMENSIONS OF THE YIELD LINE MAY VARY WITH APPROVAL OF THE ENGINEER. SEE MUTCD, LATEST EDITION, FOR ALLOWABLE DIMENSIONS.
- PAY QUANTITIES FOR PAVEMENT MARKING LEGENDS ARE AS FOLLOWS:

PAY QUANTITIES	
LEGEND/SYMBOL	AREA (FT <sup>2</sup> )
ONLY	22.0
TURN ARROW	16.4
THRU ARROW	12.3
COMB. ARROW	27.5
1-WAY ARROW	24.3
LANE REDUCTION ARROW	40.0

**MISSISSIPPI DEPARTMENT OF TRANSPORTATION**  
ROADWAY DESIGN DIVISION  
STANDARD PLAN

**PAVEMENT MARKING  
LEGEND DETAILS**

  

DATE	BY	REVISION	DATE	BY	REVISION	DATE	BY	REVISION

ISSUE DATE: MAY 01, 2017

MPDOT  
MISSISSIPPI DEPARTMENT OF TRANSPORTATION  
WORKING NUMBER  
PM-6  
SHEET NUMBER  
60/56



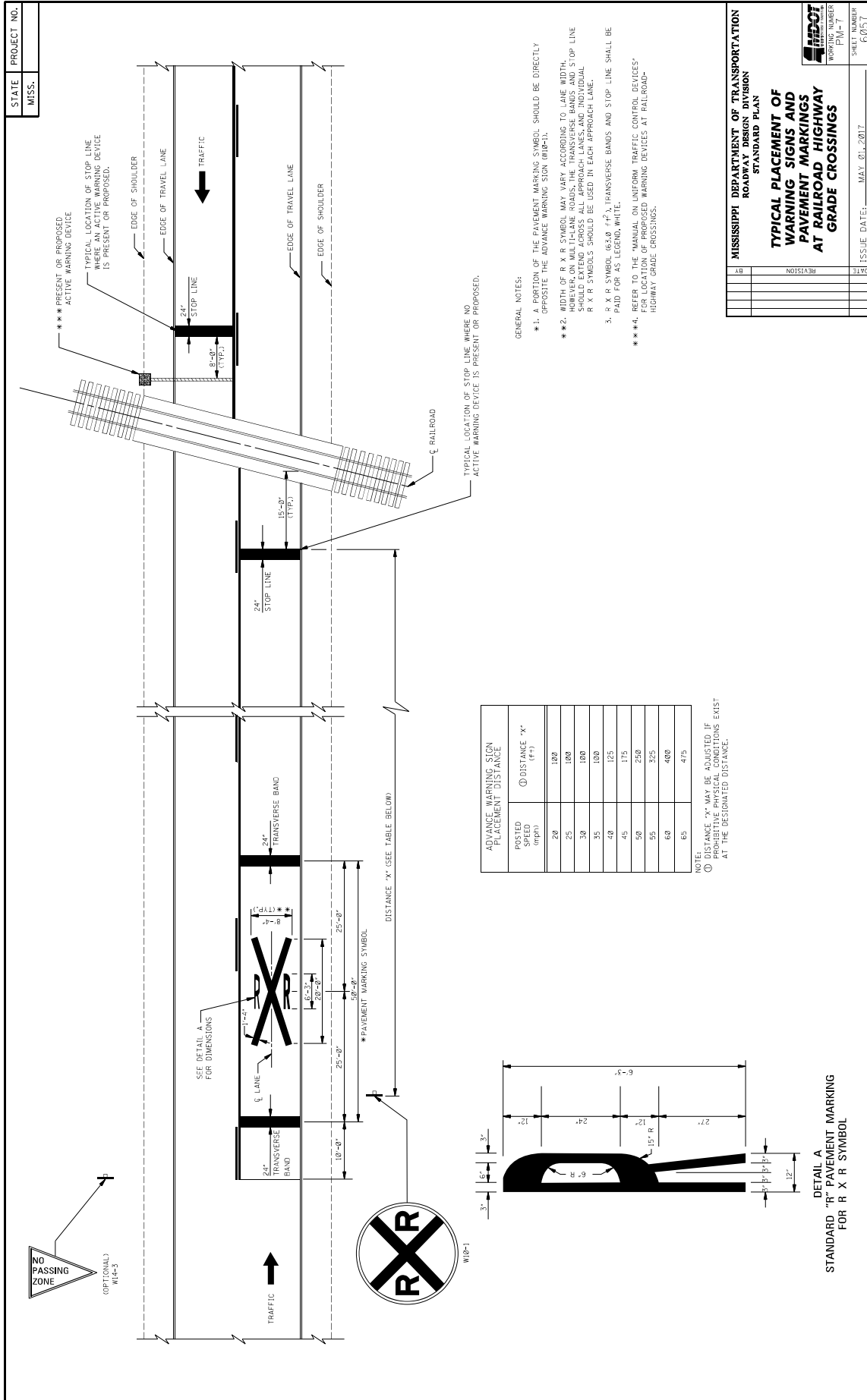

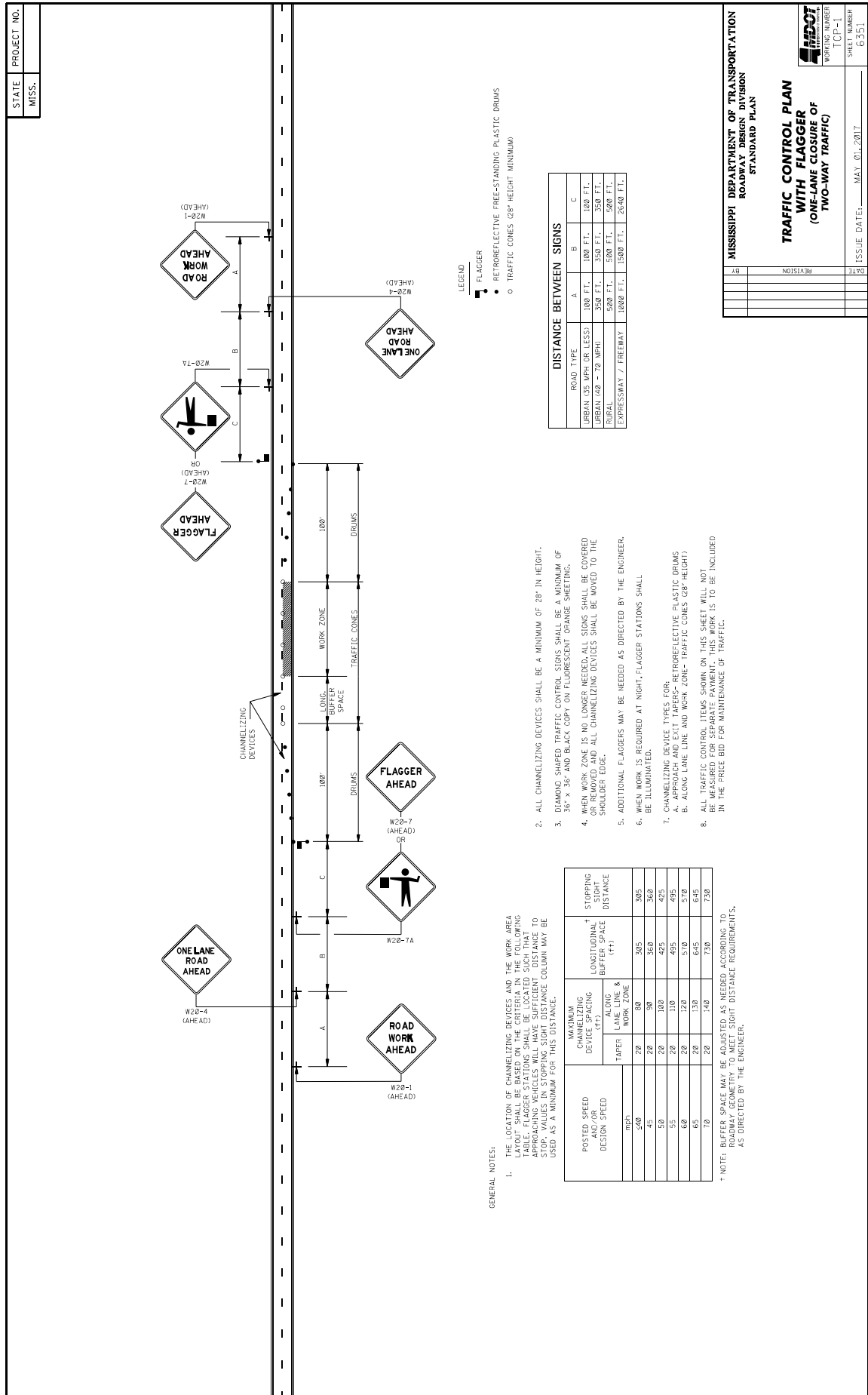
**MISSISSIPPI DEPARTMENT OF TRANSPORTATION**  
ROADWAY DESIGN DIVISION  
STANDARD PLAN

**TRAFFIC CONTROL PLAN**  
**WITH FLAGGER**  
**(ONE-LANE CLOSURE OF**  
**TWO-WAY TRAFFIC)**

WORKING NUMBER: [CP-1]  
SHEET NUMBER: 6351

ISSUE DATE: MAY 01, 2017

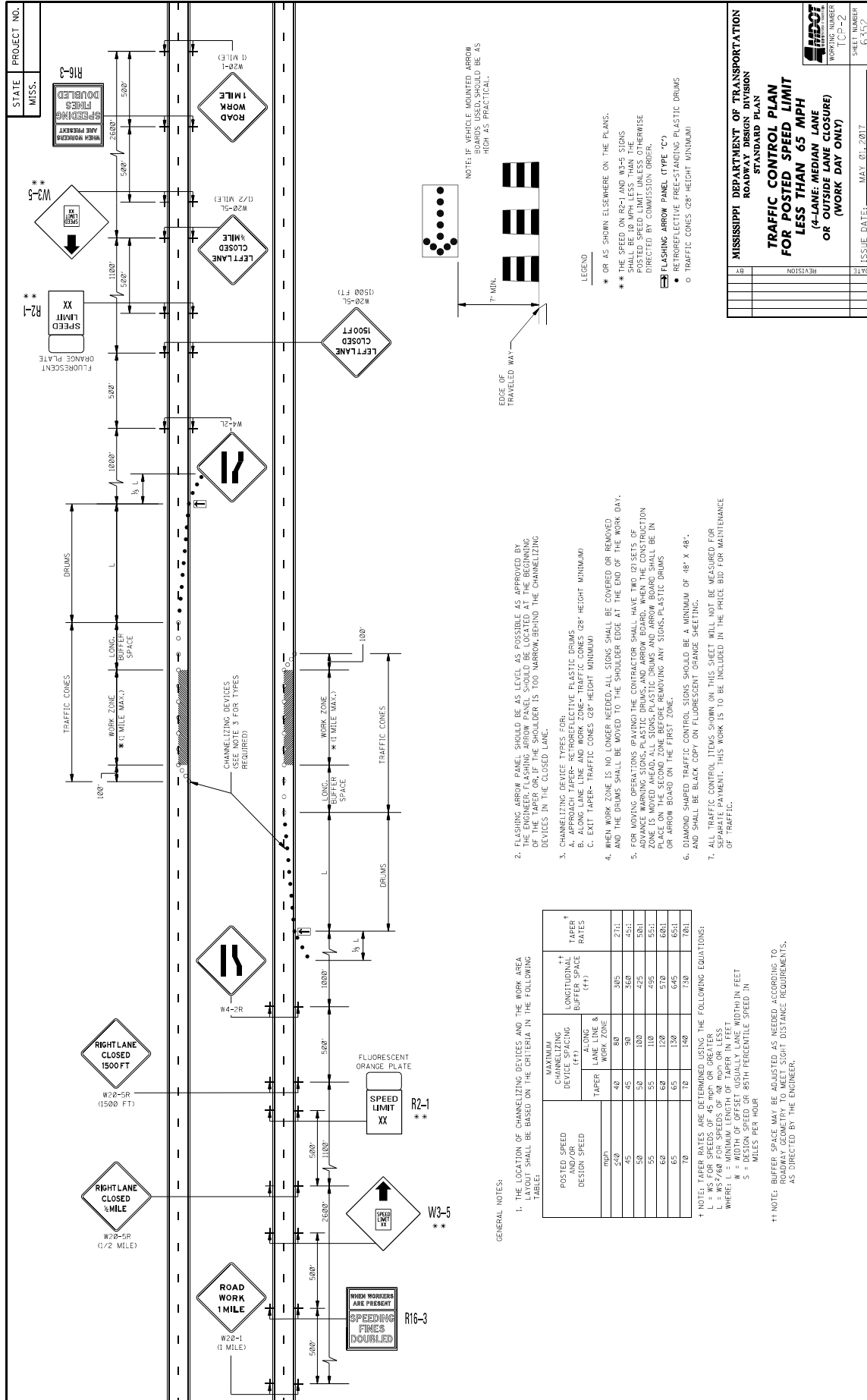

STATE PROJECT NO. MISS. R16-3

MISSISSIPPI DEPARTMENT OF TRANSPORTATION ROADWAY DESIGN DIVISION STANDARD PLAN	
<b>TRAFFIC CONTROL PLAN FOR POSTED SPEED LIMIT LESS THAN 65 MPH (4-LANE; MEDIAN LANE OR OUTSIDE LANE CLOSURE) OR (WORK DAY ONLY)</b>	
WORKING NUMBER	1CP-2
SHEET NUMBER	6052
ISSUE DATE:	MAY 01, 2017
DATE	REVISION

- GENERAL NOTES:
1. THE LOCATION OF CHANNELIZING DEVICES AND THE WORK AREA LAYOUT SHALL BE BASED ON THE CRITERIA IN THE FOLLOWING TABLE:
  2. FLASHING ARROW PANEL SHOULD BE AS LEVEL AS POSSIBLE AS APPROVED BY THE STATE. THE PANEL SHOULD BE LOCATED AT THE END OF THE TAPER OR IF THE SHOULDER IS TOO NARROW, BEHIND THE CHANNELIZING DEVICES IN THE CLOSED LANE.
  3. CHANNELIZING DEVICES TYPES FOR:
    - A. APPROACH TAPER- RETROREFLECTIVE PLASTIC DRUMS
    - B. ALONG LANE LINE AND WORK ZONE- TRAFFIC CONES (28" HEIGHT MINIMUM)
    - C. EXIT TAPER- TRAFFIC CONES (28" HEIGHT MINIMUM)
  4. WHEN WORK ZONE IS NO LONGER NEEDED, ALL SIGNS SHALL BE COVERED OR REMOVED.
  5. FOR MOVING OPERATIONS (PAVING) THE CONTRACTOR SHALL HAVE TWO (2) SETS OF ADVANCE WARNING SIGNS, PLASTIC DRUMS, AND ARROW BOARD. WHEN THE CONSTRUCTION ZONE IS MOVED AHEAD, ALL SIGNS, PLASTIC DRUMS AND ARROW BOARD SHALL BE IN PLACE ON THE SECOND ZONE BEFORE REMOVING ANY SIGNS, PLASTIC DRUMS OR ARROW BOARD ON THE FIRST ZONE.
  6. DIAMOND SHAPED TRAFFIC CONTROL SIGNS SHOULD BE A MINIMUM OF 48" X 48" AND SHALL BE BLACK COPY ON FLUORESCENT ORANGE SHEETING.
  7. ALL TRAFFIC CONTROL ITEMS SHOWN ON THIS SHEET WILL NOT BE MEASURED FOR PAYMENT. THIS WORK IS TO BE INCLUDED IN THE PRICE BID FOR MAINTENANCE OF TRAFFIC.

POSTED SPEED AND/OR DESIGN SPEED	MAXIMUM CHANNELIZING DEVICE SPACING (FT)		LONGITUDINAL BUFFER SPACE (FT)	TAPER RATES
	LANE LINE & WORK ZONE	EXIT TAPER		
45	40	80	305	27:1
50	45	90	360	45:1
55	50	100	425	50:1
60	55	110	495	55:1
65	60	120	570	60:1
70	65	130	645	65:1
75	70	140	730	70:1

† NOTE: TAPER RATES ARE DETERMINED USING THE FOLLOWING EQUATIONS:  
 L = WS FOR SPEEDS OF 45 MPH OR GREATER  
 L = WS FOR SPEEDS OF 50 MPH OR GREATER  
 WHERE: L = MINIMUM LENGTH OF TAPER IN FEET  
 W = WIDTH OF OFFSET (USUALLY LANE WIDTH IN FEET)  
 S = DESIGN SPEED OR 85TH PERCENTILE SPEED IN MILES PER HOUR

†† NOTE: BUFFER SPACE MAY BE ADJUSTED AS NEEDED ACCORDING TO ROADWAY GEOMETRY TO MEET SIGHT DISTANCE REQUIREMENTS, AS DIRECTED BY THE ENGINEER.

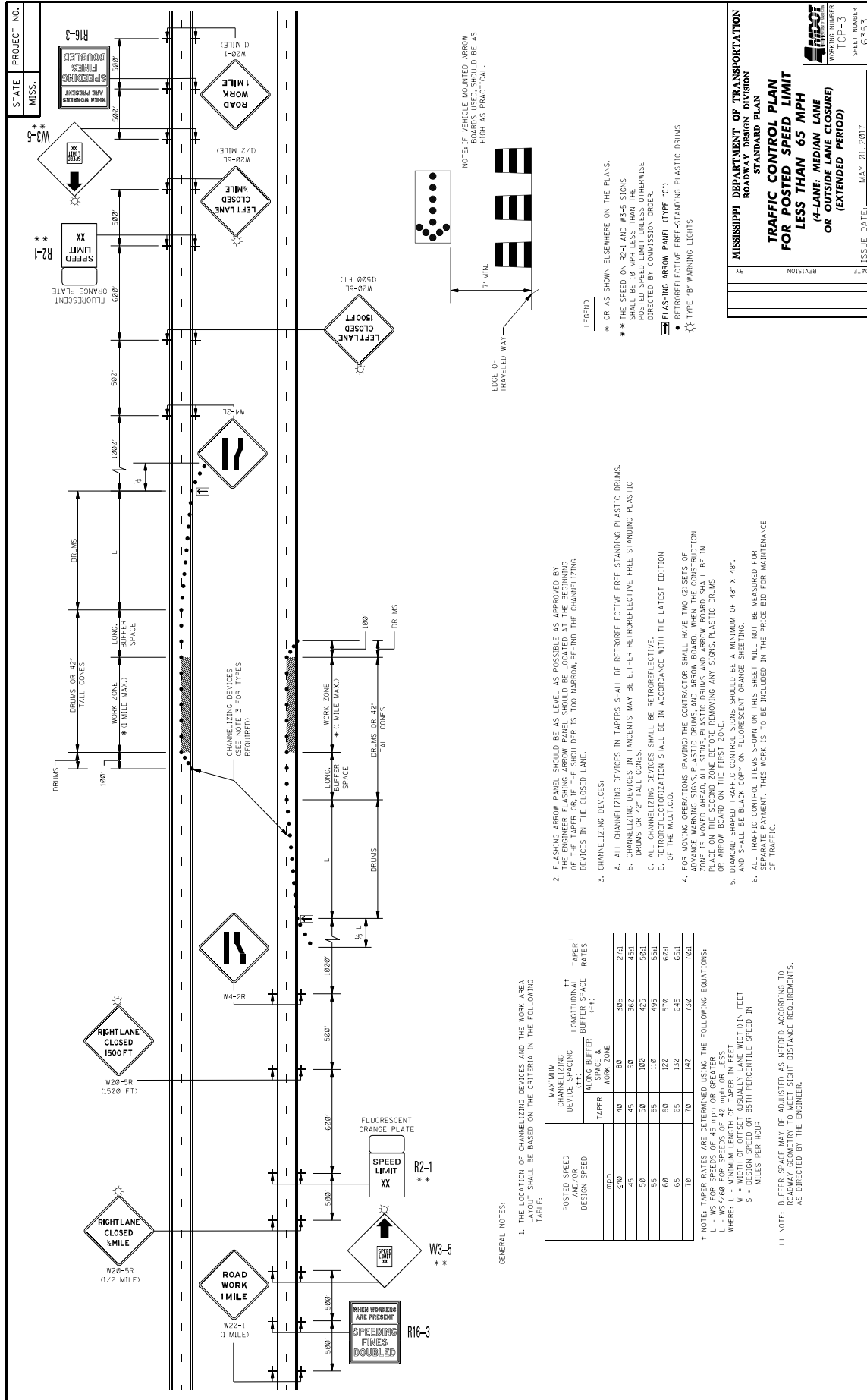

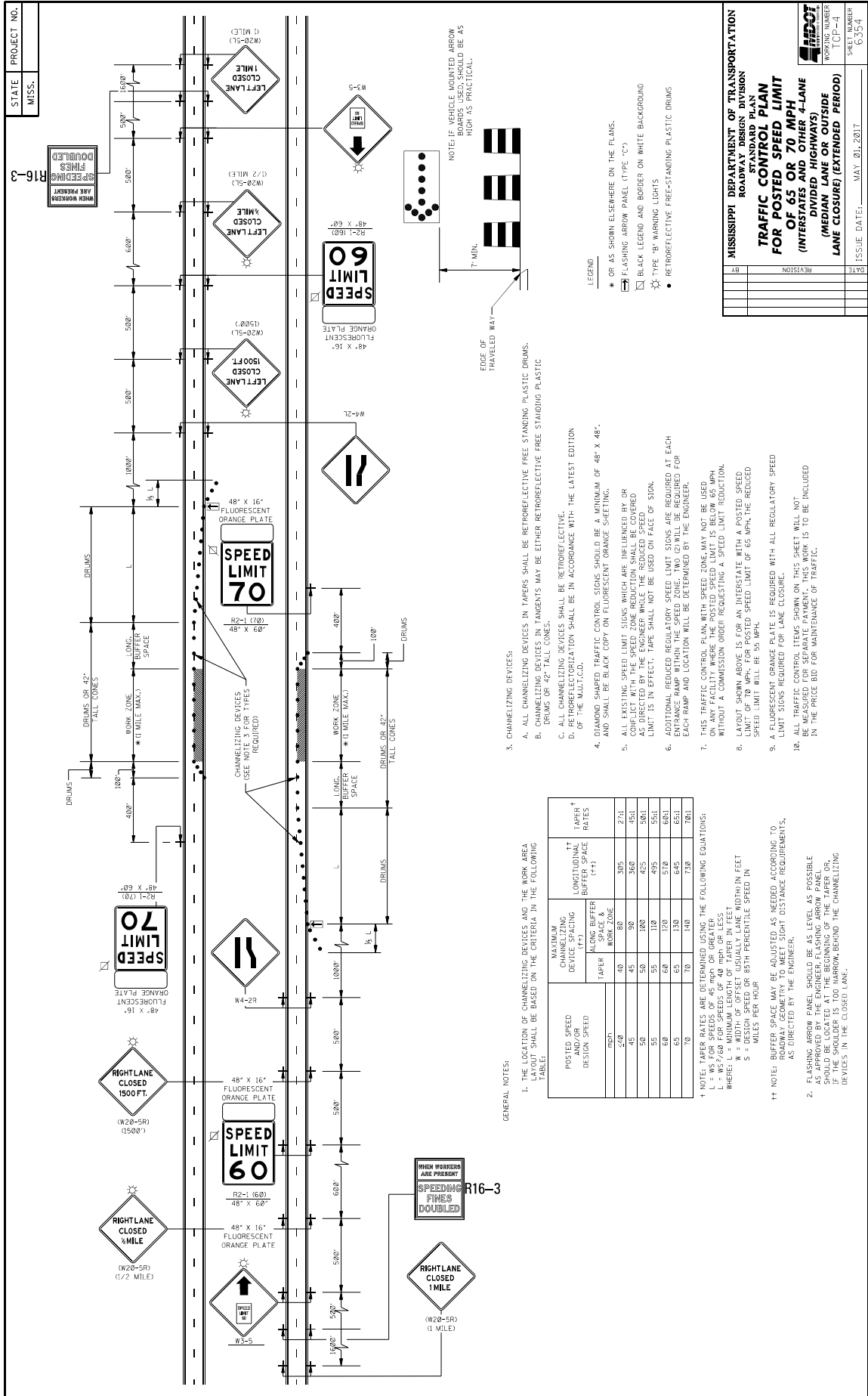

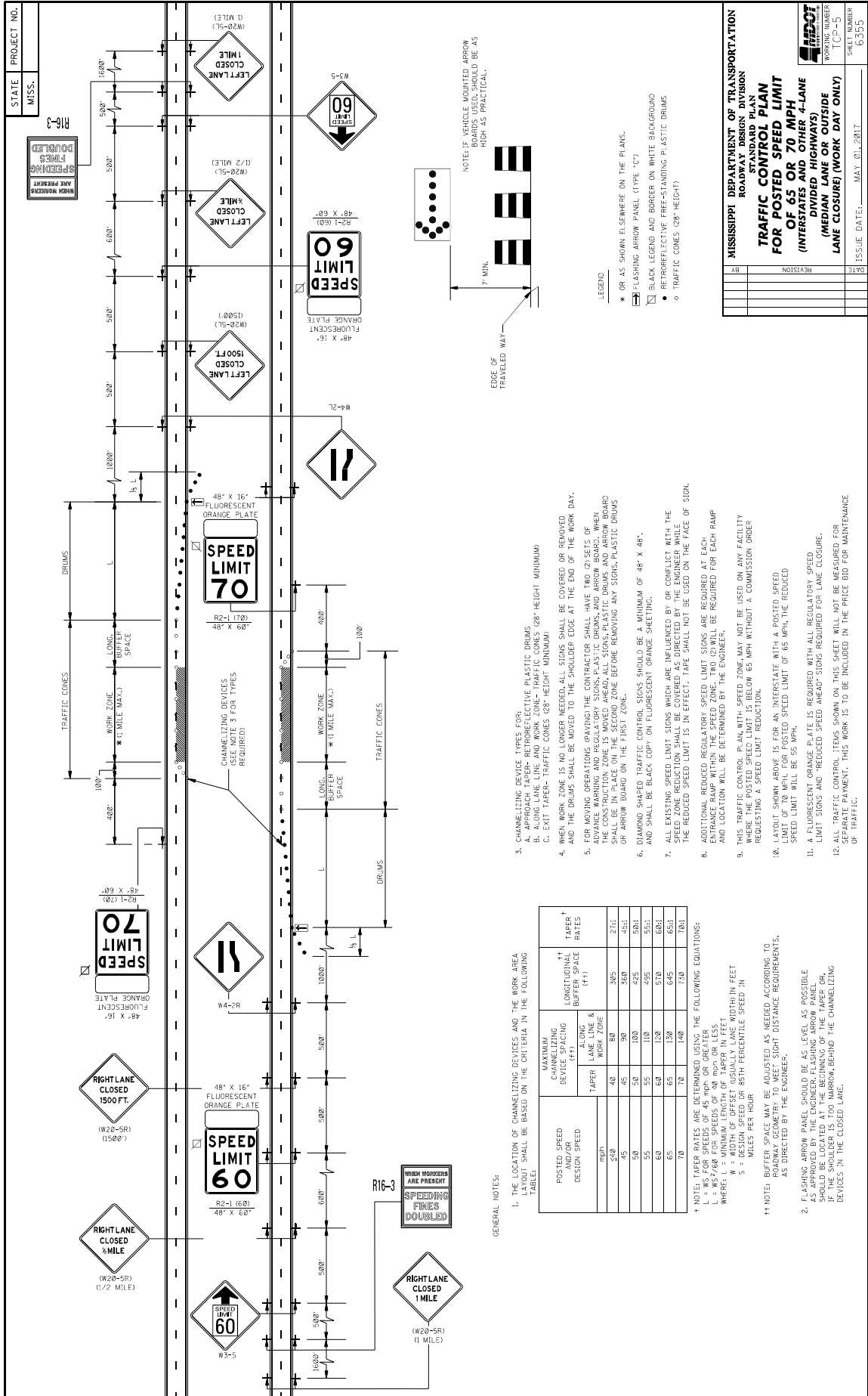

**GENERAL NOTES:**

1. THE LOCATION OF CHANNELIZING DEVICES AND THE WORK AREA LAYOUT SHALL BE BASED ON THE CRITERIA IN THE FOLLOWING TABLE:
- | POSTED SPEED AND/OR DESIGN SPEED (MPH) | MAXIMUM CHANNELIZING DEVICE SPACING (FT) |           | LONGITUDINAL BUFFER SPACE (FT) | TAPER RATES |
|--|--|-----------|--------------------------------|-------------|
|  | LANE LINE & WORK ZONE                    | WORK ZONE |                                |             |
| 40                                     | 80                                       | 270       | 305                            | 27:1        |
| 45                                     | 90                                       | 360       | 45:1                           | 45:1        |
| 50                                     | 100                                      | 425       | 50:1                           | 50:1        |
| 55                                     | 110                                      | 495       | 55:1                           | 55:1        |
| 60                                     | 120                                      | 570       | 60:1                           | 60:1        |
| 65                                     | 130                                      | 645       | 65:1                           | 65:1        |
| 70                                     | 140                                      | 730       | 70:1                           | 70:1        |
- † NOTE: TAPER RATES ARE DETERMINED USING THE FOLLOWING EQUATIONS:  
 $L = WS$  FOR SPEEDS OF 45 MPH OR GREATER  
 $L = WS^2$  FOR SPEEDS OF 40 MPH OR GREATER  
 WHERE: L = MINIMUM LENGTH OF TAPER IN FEET  
 W = WIDTH OF OFFSET (USUALLY LANE WIDTH IN FEET)  
 S = DESIGN SPEED OR 85TH PERCENTILE SPEED IN MILES PER HOUR
- †† NOTE: BUFFER SPACE MAY BE ADJUSTED AS NEEDED ACCORDING TO LOCAL LIGHT DISTANCE REQUIREMENTS, AS DIRECTED BY THE ENGINEER.
2. FLASHING ARROW PANEL SHOULD BE AS LEVEL AS POSSIBLE AND SHOULD BE LOCATED AT THE BEGINNING OF THE TAPER OR IF THE SHOULDER IS TOO NARROW BEHIND THE CHANNELIZING DEVICES IN THE CLOSED LANE.



STATE PROJECT NO.  
MISS.

WORKING NUMBER  
ICP-6  
G350

**WING BARRICADES**

- WING BARRICADES ARE TYPE III BARRICADES ERECTED ON THE SHOULDER OF ROADWAYS OR RESTRICTED ROADWAY. WING BARRICADES MAY BE USED AS A MOUNTING FOR THE ADVANCE WARNING SIGNS OR FLASHERS.
- WING BARRICADES SHOULD BE USED:
  - IN ADVANCE OF A CONSTRUCTION PROJECT EVEN WHEN NO PART OF THE ROADWAY IS ACTUALLY CLOSED.
  - IN ADVANCE OF ALL BRIDGE OR CULVERT WIDENING OPERATIONS.

**BARRICADE CLOSING A ROAD**

**BARRICADE CHARACTERISTICS**

	I	II	III
WIDTH OF RAIL **	8" MIN. - 12" MAX.	8" MIN. - 12" MAX.	8" MIN. - 12" MAX.
LENGTH OF RAIL **	24" MIN.	24" MIN.	48" MIN.
WIDTH OF STRIPE **	6"	6"	6"
HEIGHT	36" MIN.	36" MIN.	60" MIN.
NUMBER OF RETROREFLECTORIZED RAIL FACES	2 (ONE EACH DIRECTION)	4 (TWO EACH DIRECTION)	3 IF FACING TRAFFIC IN ONE DIRECTION 6 IF FACING TRAFFIC IN TWO DIRECTIONS

\* 1. FOR RAILS LESS THAN 36" LONG, 4" WIDE STRIPES MAY BE USED.  
 \*\* 2. BARRICADES INTENDED FOR USE ON EXPRESSWAYS, FREEWAYS AND OTHER HIGH SPEED ROADWAYS, SHALL HAVE A MINIMUM OF 270 IN<sup>2</sup> OF REFLECTIVE AREA FACING TRAFFIC.

**STANDARD BARRICADES**

- THE MARKING FOR BARRICADE RAILS SHALL BE ORANGE AND WHITE (SLOPING DOWNWARD AT AN ANGLE OF 45° IN THE DIRECTION TRAFFIC IS TO PASS).
- RAIL STRIPE SHALL BE 6 INCHES, EXCEPT THAT 4-INCH WIDE STRIPES MAY BE USED IF RAIL LENGTHS ARE LESS THAN 36 INCHES.
- DO NOT PLACE SANDBAGS OR OTHER DEVICES TO PROVIDE MASS ON THE BOTTOM RAIL THAT WILL BLOCK VIEW OR RAIL FACE.
- FOR ADDITIONAL INFORMATION OR DETAILS, SEE MUTCD, LATEST EDITION.
- BARRICADES ARE CLASSIFIED BY FHWA AS CATEGORY II WORK ZONE DEVICES WHICH REQUIRE SUCCESSFUL CRASH TESTING. A LIST OF CRASHWORTHY BARRICADES AND OTHER CATEGORY II DEVICES CAN BE FOUND ON FHWA'S WEBSITE: [http://safety.fhwa.dot.gov/roadway\\_dept/policy\\_guidance/road\\_hardware/cat2.cfm](http://safety.fhwa.dot.gov/roadway_dept/policy_guidance/road_hardware/cat2.cfm)

**CHEVRON SIGN DETAIL**

- A CHEVRON SIGN CONSISTS OF A BLACK CHEVRON TYPE MARKING ON AN ORANGE BACKGROUND AND SHALL POINT IN THE DIRECTION OF TRAFFIC FLOW.
- THE CHEVRON SIGN SHALL BE MOUNTED ON CRASHWORTHY SUPPORT.
- CHEVRON SIGNS MAY BE USED TO SUPPLEMENT OTHER STANDARD DEVICES WHERE ONE OR MORE LANES ARE CLOSED FOR CONSTRUCTION OR MAINTENANCE. THEY SHOULD BE PLACED APPROXIMATELY 2'-0" BEHIND THE LANE TRANSITION STRIPE.

**PLASTIC DRUM STRIPING DETAIL**

- PLASTIC DRUMS SHALL BE ON END AND USED AS AN EXPEDIENT METHOD FOR TRAFFIC CHANNELIZATION. THE COLOR AND MARKING OF DRUMS SHALL BE CONSISTENT WITH THE MARKING STRIPES OR STRIPES. THE PREDOMINANT COLOR OF DRUMS SHALL BE ORANGE WITH FOUR RETROREFLECTIVE, HORIZONTAL, CIRCUMFERENTIAL STRIPES (2 ORANGE & 2 WHITE) 6" WIDE.
- DRUMS SHOULD NEVER BE PLACED IN THE ROADWAY WITHOUT WARNING SIGNS.
- WHERE PRACTICAL PLASTIC DRUMS SHOULD BE PLACED NO CLOSER THAN 3'-0" FROM THE EDGE OF TRAVELED LANE.

**TYPE 3 OBJECT MARKER (OM-3R)**

- TYPE 3 OBJECT MARKERS SHALL BE USED AT ALL EXPOSED BRIDGE ABUTMENTS AND AT OTHER LOCATIONS AS DEEMED NECESSARY BY THE ENGINEER.
- THE OM-3R IS SHOWN. THE OM-3L IS SIMILAR EXCEPT THE STRIPES SLOPE DOWNWARD FROM THE UPPER LEFT SIDE TO THE LOWER RIGHT SIDE AND SHALL BE PLACED ON THE LEFT SIDE OF THE OBJECT.
- THE INSIDE EDGE OF THE MARKER SHALL BE IN LINE WITH THE INNER EDGE OF THE OBSTRUCTION.

REVISION

DATE	REVISION

ISSUE DATE: MAY 01, 2017

MISSISSIPPI DEPARTMENT OF TRANSPORTATION  
ROADWAY DESIGN DIVISION  
STANDARD PLAN  
**HIGHWAY SIGN AND BARRICADE DETAILS FOR CONSTRUCTION PROJECTS**

STATE MISS.	PROJECT NO.	
----------------	-------------	--

### MOBILE OPERATIONS ON MULTILANE ROAD

**MOBILE OPERATIONS ON MULTILANE ROAD**

### MOBILE OPERATIONS ON TWO-LANE ROAD

**MOBILE OPERATIONS ON TWO-LANE ROAD**

**NOTES FOR MULTILANE LANE OPERATION:**

- VEHICLES USED FOR THESE OPERATIONS SHOULD BE MADE HIGHLY VISIBLE WITH APPROPRIATE EQUIPMENT, SUCH AS FLASHING LIGHTS, ROTATING BEACONS, FLASERS, SIGNS, OR ARROW PANELS.
- SHADOW VEHICLE 2 SHOULD BE EQUIPPED WITH AN ARROW PANEL AND TRUCK MOUNTED ATTENUATOR (TMA), AN APPROPRIATE LANE CLOSURE SIGN SHOULD BE LEGIBLY MOUNTED ON SHADOW VEHICLE 2 SO AS NOT TO OBSCURE THE ARROW PANEL.
- SHADOW VEHICLE 1 SHOULD BE EQUIPPED WITH AN ARROW PANEL AND TRUCK-MOUNTED ATTENUATOR (TMA).
- SHADOW VEHICLE 2 SHOULD TRAVEL AT A VARYING DISTANCE FROM THE WORK OPERATION SO AS TO PROVIDE ADEQUATE SIGHT DISTANCE FOR TRAFFIC APPROACHING FROM THE REAR.
- WHEN ADEQUATE SHOULDER WIDTH IS NOT AVAILABLE, SHADOW VEHICLE 2 SHOULD BE ELIMINATED.
- ON HIGH-SPEED ROADWAYS, A THIRD SHADOW VEHICLE SHOULD BE USED (I.e., VEHICLE 3 ON THE SHOULDER OF PRACTICALLY, VEHICLE 2 IN THE CLOSED LANE, AND VEHICLE 1 IN THE CLOSED LANE).
- ARROW PANELS SHALL BE AS A MINIMUM TYPE B, 60" X 30" IN ACCORDANCE WITH THE CRITERIA PRESENTED IN THE MUTCD.
- WORK SHOULD NORMALLY BE DONE DURING OFF-PEAK HOURS.
- VEHICLE-MOUNTED SIGNS SHOULD BE MOUNTED WITH THE BOTTOM OF THE SIGN LOCATED AT A MINIMUM HEIGHT OF 48" ABOVE THE PAVEMENT AND SHALL NOT BE OBSCURED BY EQUIPMENT OR SUPPLIES. SIGN LEGENDS SHALL BE COVERED OR TURNED FROM VIEW WHEN WORK IS NOT IN PROGRESS.
- ALL TRAFFIC CONTROL ITEMS SHOWN ON THIS SHEET WILL NOT BE MEASURED FOR SEPARATE PAYMENT. THIS WORK IS TO BE INCLUDED IN THE PRICE BID FOR MAINTENANCE OF TRAFFIC.

**NOTES FOR TWO-LANE OPERATION:**

- WHERE PRACTICAL AND WHEN NEEDED, THE WORK AND SHADOW VEHICLES SHOULD PULL OVER PERIODICALLY TO ALLOW TRAFFIC TO PASS. IF THIS CAN NOT BE DONE FREQUENTLY AS AN ALTERNATIVE, A "DO NOT PASS" SIGN MAY BE PLACED ON THE REAR OF THE VEHICLE BLOCKING THE LANE.
- THE DISTANCE BETWEEN THE WORK AND SHADOW VEHICLES MAY VARY ACCORDING TO TERRAIN, PAINT DRYING TIME, AND OTHER FACTORS. SHADOW VEHICLES ARE USED TO WARN TRAFFIC OF THE OPERATION AHEAD. WHENEVER ADEQUATE SIGHT DISTANCE IS NOT AVAILABLE, SHADOW VEHICLES SHOULD MAINTAIN THE MINIMUM DISTANCE AND PROCEED AT THE SAME SPEED AS THE WORK VEHICLE. THE SHADOW VEHICLE SHOULD SLOW DOWN IN ADVANCE OF VERTICAL OR HORIZONTAL CURVES THAT RESTRICT SIGHT DISTANCE.
- ADDITIONAL SHADOW VEHICLES TO WARN AND REDUCE THE SPEED OF ONCOMING OR OPPOSING TRAFFIC MAY BE USED. POLICE PATROL CARS MAY BE USED FOR THIS PURPOSE.
- A TRUCK-MOUNTED ATTENUATOR (TMA) SHOULD BE USED ON THE SHADOW VEHICLE AND MAY BE USED ON THE WORK VEHICLE.
- THE WORK VEHICLE SHALL BE EQUIPPED WITH BEACONS, AND THE SHADOW VEHICLE SHALL BE EQUIPPED WITH BEACONS. HIGH-BEAM LIGHTS AND WORK LIGHTS MOUNTED ON THE REAR, ADJACENT TO THE SIGN, SHADOW AND WORK VEHICLES SHALL DISPLAY FLASHING OR ROTATING BEACONS BOTH FORWARD AND TO THE REAR.
- VEHICLE-MOUNTED SIGNS SHOULD BE MOUNTED WITH THE BOTTOM OF THE SIGN LOCATED AT A MINIMUM HEIGHT OF 48" ABOVE THE PAVEMENT AND SHALL NOT BE OBSCURED BY EQUIPMENT OR SUPPLIES. SIGN LEGENDS SHALL BE COVERED OR TURNED FROM VIEW WHEN WORK IS NOT IN PROGRESS.
- ARROW BOARD TO BE USED IN CAUTION MODE.
- ALL TRAFFIC CONTROL ITEMS SHOWN ON THIS SHEET WILL NOT BE MEASURED FOR SEPARATE PAYMENT. THIS WORK IS TO BE INCLUDED IN THE PRICE BID FOR MAINTENANCE OF TRAFFIC.

**MISSISSIPPI DEPARTMENT OF TRANSPORTATION**  
ROADWAY DESIGN DIVISION  
STANDARD PLAN

**TRAFFIC CONTROL PLAN**  
**MOBILE OPERATIONS**  
**MULTILANE ROADS**  
**TWO-LANE ROADS**

NO.	REVISION	DATE

ISSUE DATE: MAY 01, 2017

SHEET NUMBER TCP-9	PROJECT NUMBER G339
-----------------------	------------------------

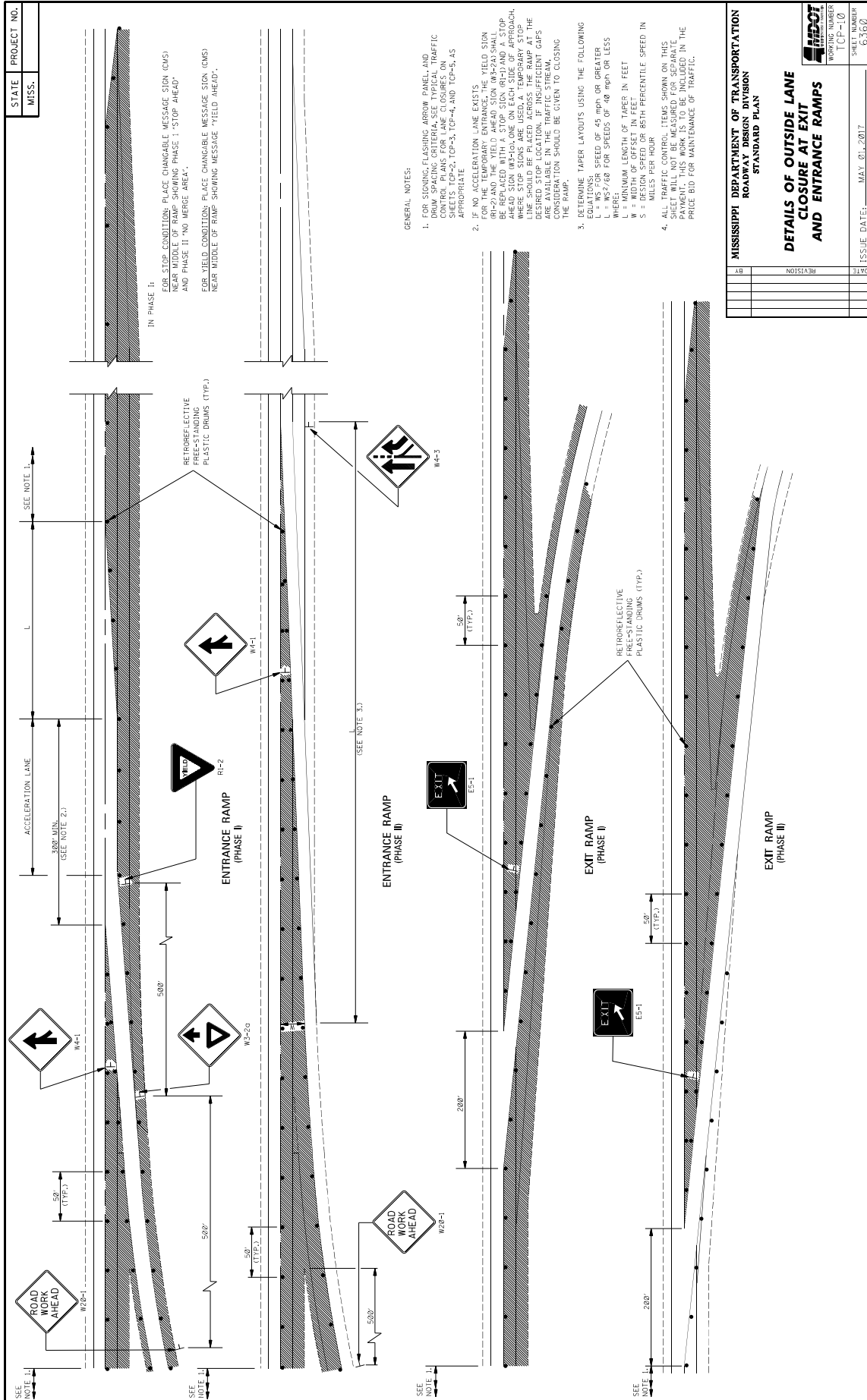

- GENERAL NOTES:
- FOR SIGNING FLASHING ARROW PANEL AND DRUM SPACING CRITERIA, SEE TYPICAL TRAFFIC CONTROL PLANS FOR LANE CLOSURES ON RAMP ENTRIES. W-2, TCF-3, TCF-4, AND TCF-5, AS APPROPRIATE.
  - IF NO ACCELERATION LANE EXISTS FOR THE TEMPORARY LANE ENTRIES (R4-2) AND THE YIELD AHEAD SIGN (W4-2A) SHALL BE REPLACED WITH A STOP SIGN (R4-1) AND A STOP LINE. STOP SIGNS ARE USED AT TEMPORARY STOP LINE SHOULD BE PLACED ACROSS THE RAMP AT THE DESIRED STOP LOCATION. IF INSUFFICIENT GAPS EXIST, THE STOP LINE SHOULD BE PLACED AT THE END OF THE RAMP. CONSIDERATION SHOULD BE GIVEN TO CLOSING THE RAMP.
  - DETERMINING TAPER LAYOUTS USING THE FOLLOWING EQUATIONS: SPEEDS OF 45 MPH OR GREATER  
 $L = WS^2/60$  FOR SPEEDS OF 40 MPH OR LESS  
 WHERE:  
 L = MINIMUM LENGTH OF TAPER IN FEET  
 S = DESIGN SPEED OR 80TH PERCENTILE SPEED IN MILES PER HOUR  
 W = DESIGN SPEED OR 80TH PERCENTILE SPEED IN MILES PER HOUR  
 ALL TRAFFIC CONTROL ITEMS SHOWN ON THIS SHEET WILL NOT BE MEASURED FOR SEPARATE BIDDING. THE BIDDING PRICE WILL BE ADDED IN THE PRICE BID FOR MAINTENANCE OF TRAFFIC.

STATE PROJECT NO.		MISS.	
MISSISSIPPI DEPARTMENT OF TRANSPORTATION ROADWAY DESIGN DIVISION STANDARD PLAN			
<b>DETAILS OF OUTSIDE LANE CLOSURE AT EXIT AND ENTRANCE RAMP</b>			
ISSUE DATE: MAY 01, 2017		SHEET NUMBER TCP-110 6360	
DATE	REVISION		

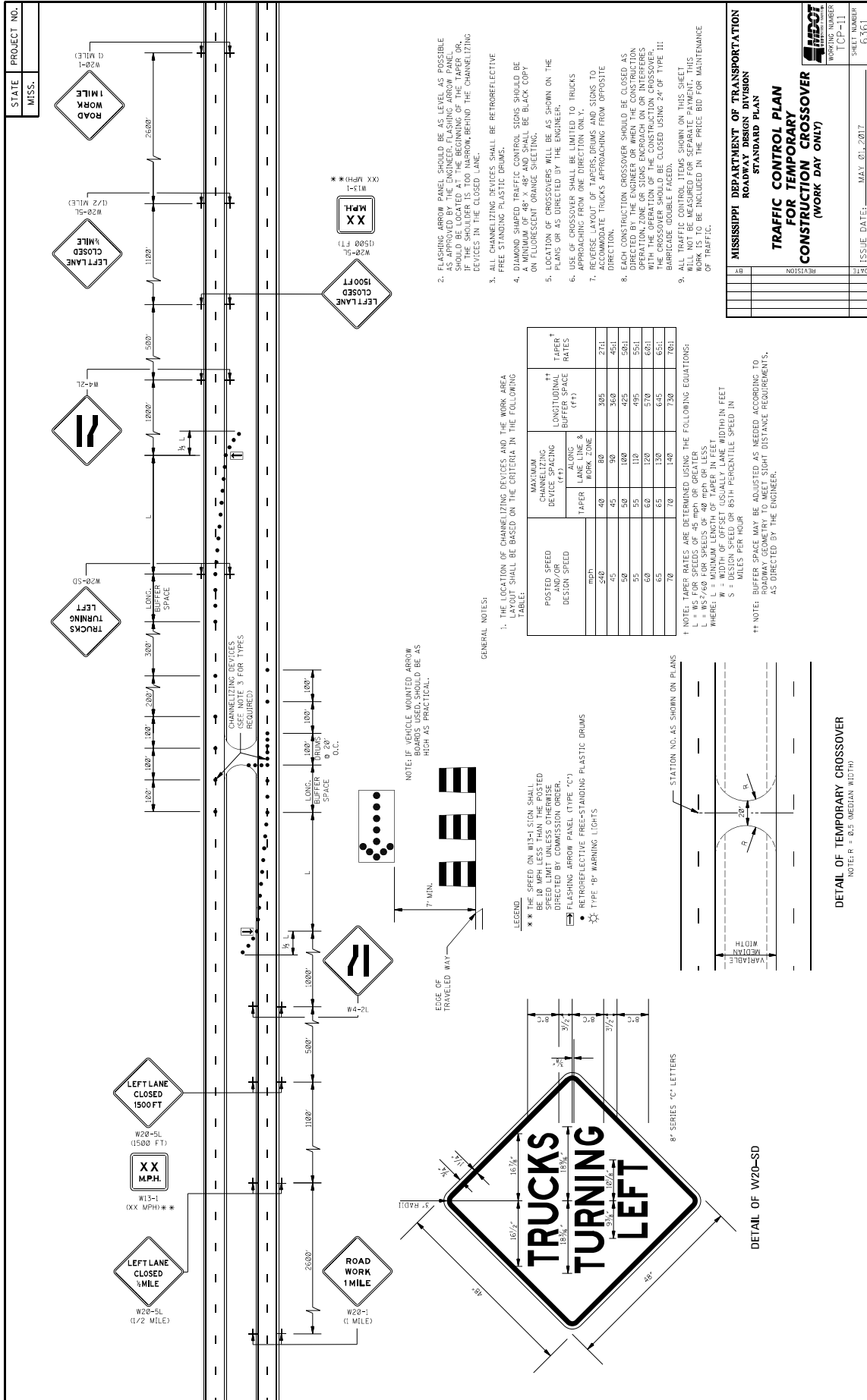

**MISSISSIPPI DEPARTMENT OF TRANSPORTATION**  
**ROADWAY DESIGN DIVISION**  
**STANDARD PLAN**  
**TRAFFIC CONTROL PLAN**  
**FOR TEMPORARY**  
**CONSTRUCTION CROSSOVER**  
**(WORK DAY ONLY)**

WORKING NUMBER: TCP-11  
 SHEET NUMBER: 6361

ISSUE DATE: MAY 01, 2017

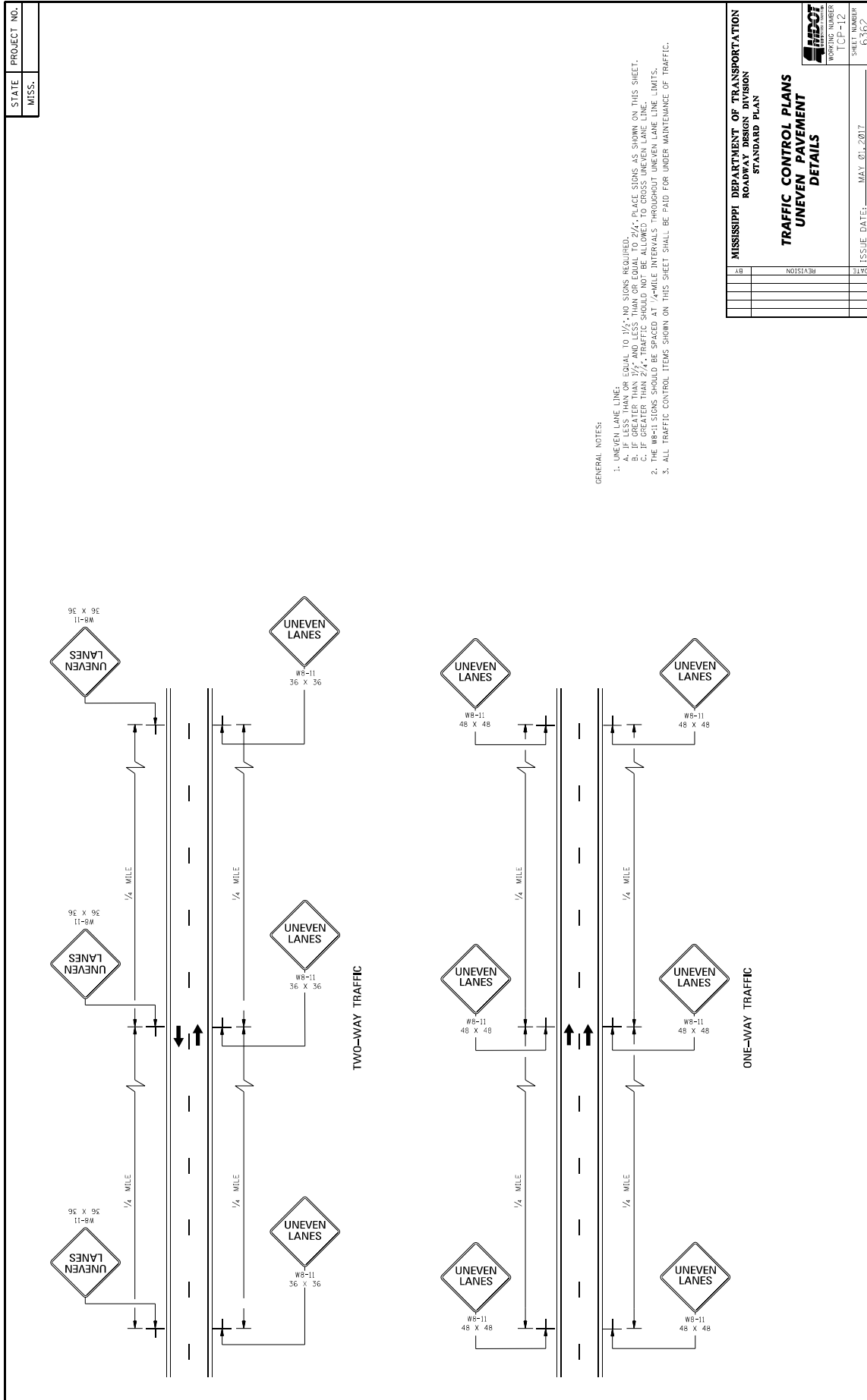

DATE	BY	REVISION	BY	DATE	BY	REVISION	BY	DATE	BY

MISSISSIPPI DEPARTMENT OF TRANSPORTATION  
ROADWAY DESIGN DIVISION  
STANDARD PLAN

**TRAFFIC CONTROL PLANS  
UNEVEN PAVEMENT  
DETAILS**

SHEET NUMBER  
TCP-12  
6262

ISSUE DATE: MAY 01, 2017

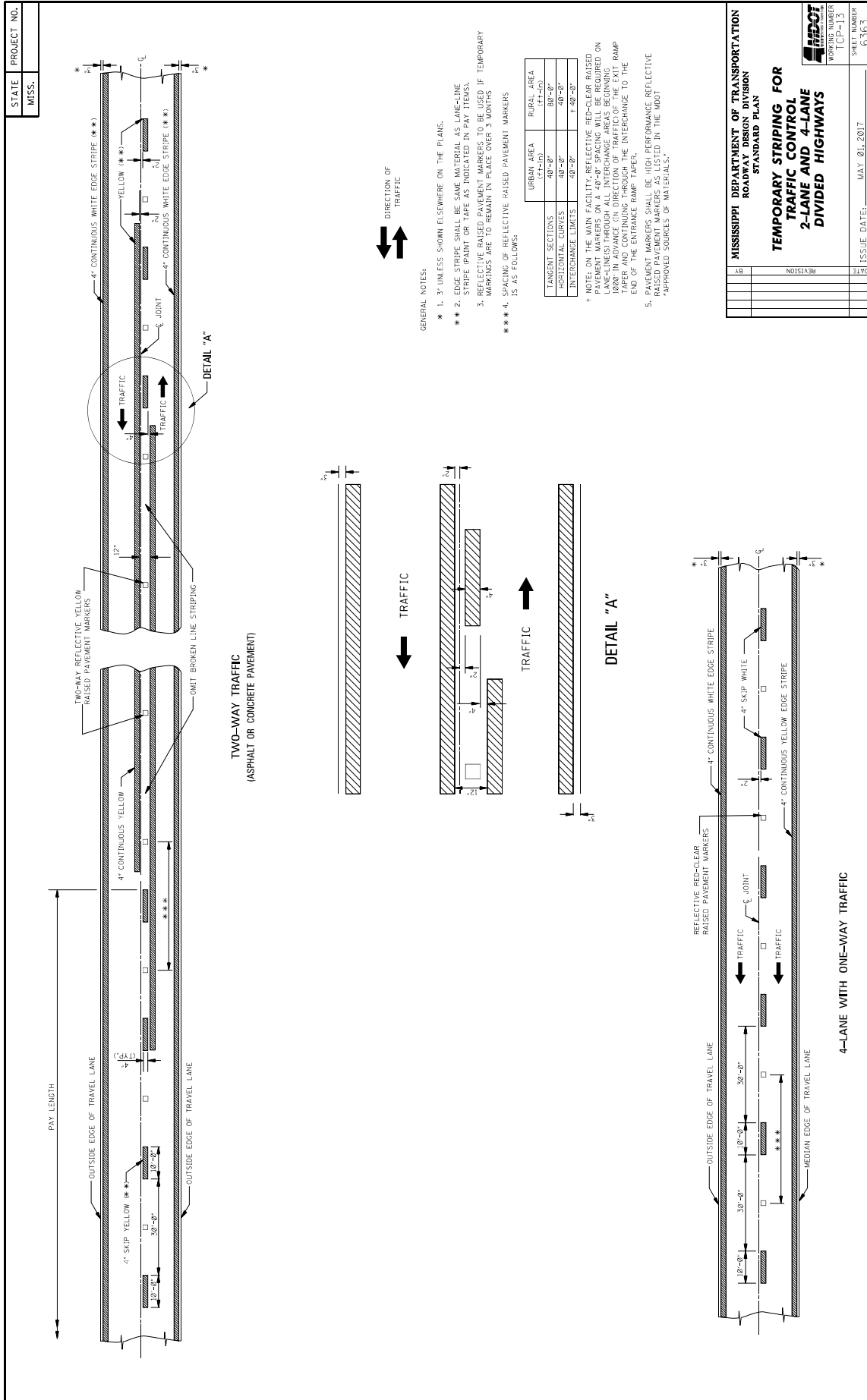







STATE MISS.	PROJECT NO.	
----------------	-------------	--

**TYPICAL SHOULDER CLOSURE**

(1) TO BE USED WITH EIGHT (8) FOOT OR GREATER WIDTH IMPROVED SHOULDER.  
(2) TO BE USED WHEN CONSTRUCTION VEHICLES (EQUIPMENT) ENCRUSHES ON OR WITHIN TWO (2) FEET OF THE SHOULDER BREAK.

**TYPICAL SHOULDER WORK #1**  
(SEE NOTE A-I THIS SHEET)

**TYPICAL SHOULDER WORK #2**

NOTE:  
WORK OUTSIDE TWO (2) FOOT AND WITHIN TEN (10) FEET OF THE SHOULDER BREAK MAY BE PROTECTED BY PLACING DRUMS ALONG THE SHOULDER EDGE 300 FEET PRIOR TO AND 50 FEET BEYOND THE WORK AREA, OR SEE NOTE A-3 THIS SHEET.

**TYPICAL SHOULDER WORK #2**

**DETAIL OF DRUM PLACEMENT AT PAVEMENT EDGE DROP-OFF**

GRANULAR MATERIAL REQUIRED (SAME CLASSIFICATION AS SHOULDER MATERIAL, SEE TYPICAL SECTIONS)

**NOTES:**

\* A. PAVEMENT EDGE DROP-OFF

1. IF LESS THAN TWO AND ONE QUARTER (2.25) INCHES-NO PROTECTION REQUIRED. PLACE A SHOULDER SIGN (W21-5) 500 FEET IN ADVANCE OF WORK ZONE SHOULDER AND A LOW SHOULDER SIGN (W8-9) AT THE BEGINNING AND THROUGHOUT THE WORK ZONE B (1538'+O.C.).

2. TWO AND ONE QUARTER TO THREE INCHES-PLACE DRUMS, VERTICAL PANELS OR BARRICADES EVERY 120 FEET ON TANGENT SECTIONS FOR SPEEDS OF 50 MILES PER HOUR OR GREATER. CONES MAY BE USED IN PLACE OF DRUMS, PANELS, AND BARRICADES DURING DAYLIGHT HOURS. FOR TANGENT SECTIONS WITH SPEEDS LESS THAN 50 MILES PER HOUR AND FOR CURVES, DEVICES SHOULD BE PLACED EVERY 50 FEET. SPACING FOR TAPERS SHOULD BE IN ACCORDANCE WITH THE MULTIPLIER  $L/3L$ , WHERE L IS THE TAPER LENGTH IN FEET.

3. GREATER THAN THREE (3) INCHES-POSITIVE SEPARATION OR WEDGE WITH 4:1 OR FLATTER SLOPE NEEDED. IF THERE IS EIGHT (8) FEET OR MORE DISTANCE BETWEEN THE EDGE OF TRAVEL LANE AND DROP-OFF, THEN DRUMS, PANELS OR BARRICADES MAY BE USED.

4. FOR TEMPORARY CONDITIONS, DROP-OFFS GREATER THAN THREE (3) INCHES MAY BE PROTECTED WITH DRUMS, VERTICAL PANELS OR BARRICADES FOR SHORT DISTANCES DURING DAYLIGHT HOURS WHILE WORK IS BEING DONE IN THE DROP-OFF AREA.

5. LESSER TREATMENTS THAN THOSE DESCRIBED ABOVE MAY BE CONSIDERED FOR LOW-VOLUME LOCAL STREETS.

**B. DRUM SPACING**

1. TANGENTS =  $2 \times S$   
 2. WHERE  $L > S \times W$   
 3. WHERE  $L < S \times W$   
 L = TAPER LENGTH IN FEET  
 S = SPEED IN MPH (POSTED OR 85 PERCENTILE)  
 W = WIDTH OF OFFSET IN FEET

**C. ALL TRAFFIC CONTROL ITEMS SHOWN ON THIS SHEET SHALL BE PAID FOR UNDER MAINTENANCE OF TRAFFIC.**

TABLE V-1 GUIDELINES FOR LENGTH OF LONGITUDINAL BUFFER SPACE

X * SPEED (MPH)	LENGTH (FEET)
25	35
30	45
35	55
40	65
45	75
50	85
55	95
60	105
65	115

\* \* POSTED SPEED, OFF-PEAK 85 PERCENTILE SPEED PRIOR TO WORK STARTING, OR THE ANTICIPATED OPERATING SPEED IN MPH.

**MISSISSIPPI DEPARTMENT OF TRANSPORTATION**  
**ROADWAY DESIGN DIVISION**  
**STANDARD PLAN**

**TRAFFIC CONTROL DETAILS**  
**DRUM PLACEMENT**  
**SHOULDER CLOSURE**

WORKING NUMBER  
TCP-16

SHEET NUMBER  
65/66

ISSUE DATE: MAY 01, 2017

STATE	PROJECT NO.
MISS.	

- GENERAL NOTES
- GROUND-IN RUMBLE STRIPES SHALL BE APPLIED ON LEFT AND RIGHT SHOULDERS OF ALL PAVED SHOULDERS ON THIS PROJECT.
  - GROUND-IN RUMBLE STRIPES SHALL BE APPLIED TO ALL PAVED SHOULDERS ON ROADWAYS OR OTHER INTERUPTIONS IN NORMAL SHOULDER WIDTH AS DIRECTED BY THE ENGINEER.
  - COST TO BE PAID FOR USING APPROPRIATE PAY ITEMS.
  - GROUND-IN RUMBLE STRIPES SHALL BE APPLIED TO:
    - MAINLINE
    - INTERSECTING ROADWAY IF OVERLAD OR RECONSTRUCTED BEYOND NORMAL MAINLINE R.O.W.
    - ANY ROADWAY WITH EXISTING RUMBLE STRIPES PRIOR TO CONSTRUCTION.
  - DO NOT USE WHERE TRAVEL LANE IS LESS THAN 11' WIDE.

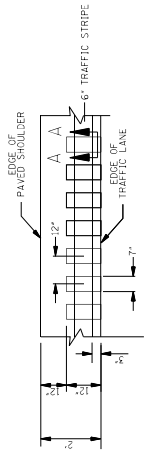

DETAIL "A"

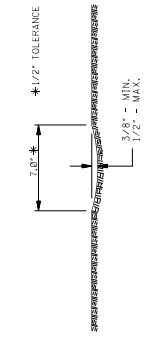

SECTION "A-A"

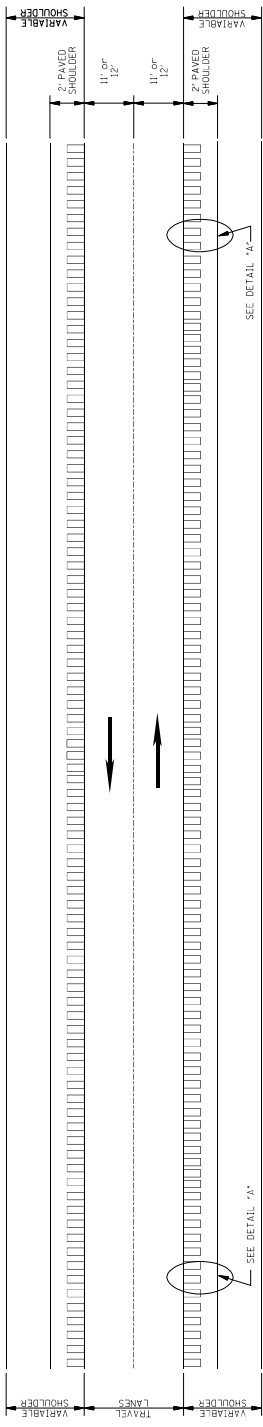

PLAN  
NOT TO SCALE

MISSISSIPPI DEPARTMENT OF TRANSPORTATION ROADWAY DESIGN DIVISION STANDARD PLAN	
<b>RUMBLE STRIPES 2-LANE HIGHWAYS (ASPHALT LANES, 2-FT ASPHALT SHOULDERS)</b>	
WORKING NUMBER RS-1	SHEET NUMBER 606-1
DATE	ISSUE DATE: MAY 21, 2017
BY	REVISION



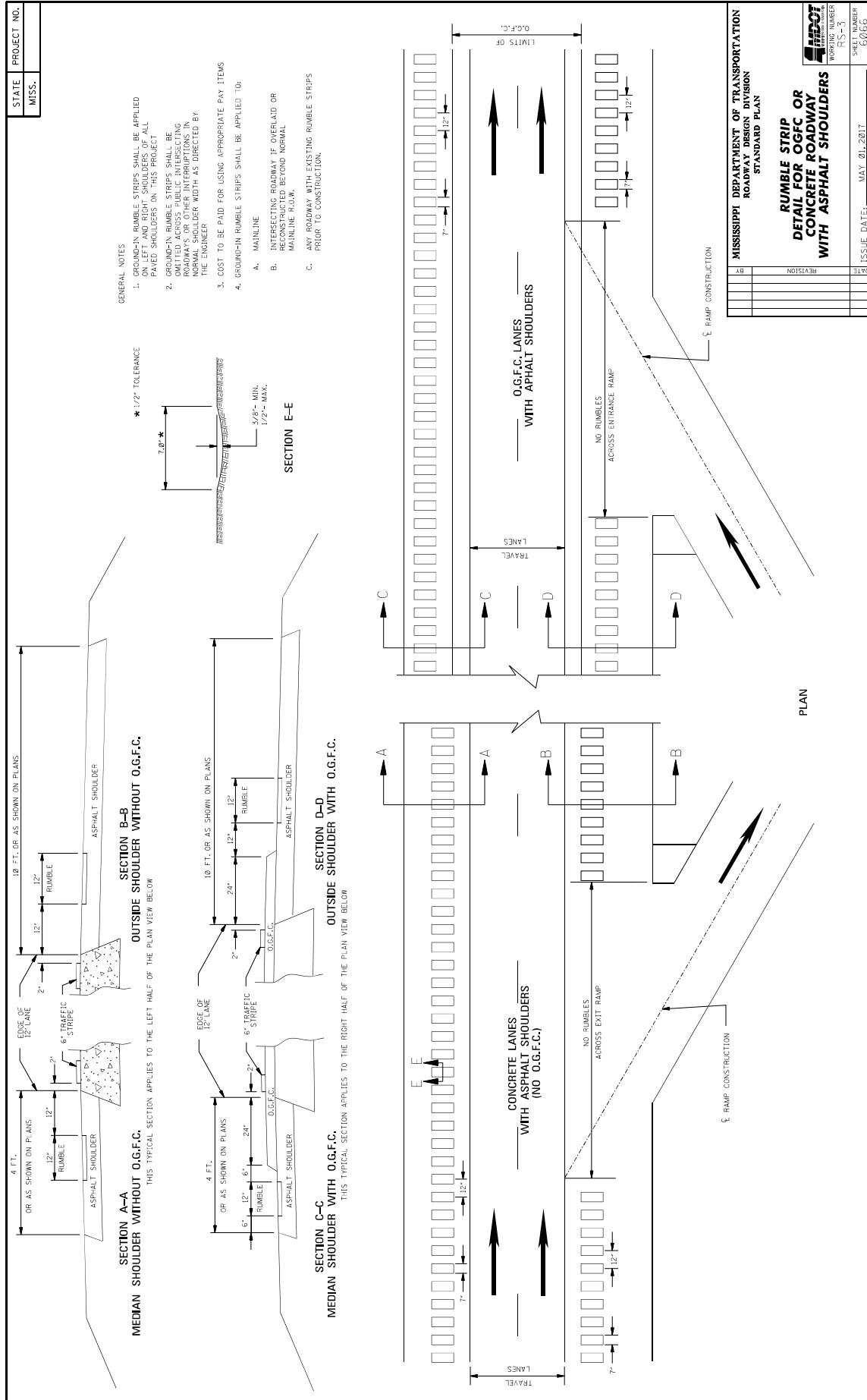

**MISSISSIPPI DEPARTMENT OF TRANSPORTATION**

**SECTION 904 - NOTICE TO BIDDERS NO. 445**

**CODE: (SP)**

**DATE: 10/10/2017**

**SUBJECT: Mississippi Agent or Qualified Nonresident Agent**

Bidders are hereby advised of the requirements of Subsections 102.08, 103.05.2, and 107.14.2.1 of the *2017 Standard Specifications for Road and Bridge Construction* as it refers to bonding agents. Proposal guaranties, bonds, and liability insurance policies must be signed by a **Mississippi Agent or Qualified Nonresident Agent.**

## MISSISSIPPI DEPARTMENT OF TRANSPORTATION

SECTION 904 - NOTICE TO BIDDERS NO. 516

CODE: (IS)

DATE: 11/28/2017

SUBJECT: Errata and Modifications to the 2017 Standard Specifications

<u>Page</u>	<u>Subsection</u>	<u>Change</u>
16	102.06	In the seventh full paragraph, change “Engineer” to “Director.”
33	105.05.1	In the sixth sentence, change “Contract Administration Engineer” to “Contract Administration Director.”
34	105.05.2.1	In subparagraph 2, change “SWPPP, ECP” to “SWPPP and the ECP”
35	105.05.2.2	In subparagraphs 2, add “ and” to the end of the sentence. In subparagraph 3, remove “, and” and add “.”.
90	109.04.2	In the last paragraph of subparagraph (a), place a period “.” at the end of the sentence.
93	109.04.2	In the last paragraph of subparagraph (g), place a period “.” at the end of the sentence. Also, in the first paragraph of subparagraph (h), place a period “.” at the end of the sentence.
97	109.07	Under ADJUSTMENT CODE, subparagraph (A1), change “HMA mixture” to “Asphalt mixtures.”
98	109.11	In the third sentence, change “Engineer” to “Director.”
219	308.04	In the last sentence of the last paragraph, change “Contractor’s decision” to “Engineer’s decision.”
300	405.02.5.9	In the first sentence of the second paragraph, change “Hot Mix Asphalt” to “Asphalt Mixtures.”
502	630.01.1	In the first paragraph, change “AASHTO” to “AASHTO’s LRFD”.
636	646.05	Change “each” to “per each” for the pay item units of payment.
640	656.02.6.2	In item 7), change “down stream” to “downstream”.
688	630.03.2	Change the subsection number from “630.03.2” to “680.03.2.”

725      702.08.3      In the second sentence of the first paragraph, change “hot-mix” to “asphalt.”

954      804.02.13.1.6      In the definition for “M” in the % Reduction formulas, change “paragraph 7.3” to “paragraph 5.3.”

**MISSISSIPPI DEPARTMENT OF TRANSPORTATION**

**SECTION 904 - NOTICE TO BIDDERS NO. 796**

**CODE: (SP)**

**DATE: 3/27/2018**

**SUBJECT: Contract Time**

**PROJECT: STP-0015-02(123) / 107798301 – Covington County**

The completion of work to be performed by the Contractor for this project will not be a specified date but shall be when all allowable working days are assessed, or any extension thereto as provided in Subsection 108.06. It is anticipated that the Notice of Award will be issued no later than **June 12, 2018** and the date for Notice to Proceed / Beginning of Contract Time will be **July 12, 2018**.

Should the Contractor request a Notice to Proceed earlier than **July 12, 2018** and it is agreeable with the Department for an early Notice to Proceed, the requested date will become the new Notice to Proceed date.

**52** Working Days have been allowed for the completion of work on this project.



## MISSISSIPPI DEPARTMENT OF TRANSPORTATION

SECTION 904 - NOTICE TO BIDDERS NO. 797

DATE: 3/26/2018

SUBJECT: Specialty Items

PROJECT: STP-0015-02(123)/107798301 - COVINGTON

Pursuant to the provisions of Section 108, the following work items are hereby designated as "Specialty Items" for this contract. Bidders are reminded that these items must be subcontracted in order to be considered as specialty items.

### CATEGORY: DISPOSAL OF BUILDINGS, RIGHT OF WAY CLEARING & GRUBBING

---

Line No	Pay Item	Description
0010	202-B240	Removal of Traffic Stripe

### CATEGORY: GUARDRAIL, GUIDERAIL

---

Line No	Pay Item	Description
0310	907-606-PP007	Remove and Replace Guard Rail Blockouts

### CATEGORY: PAVEMENT STRIPING AND MARKING

---

Line No	Pay Item	Description
0190	626-A004	6" Thermoplastic Traffic Stripe, Skip White
0200	626-C002	6" Thermoplastic Double Drop Edge Stripe, Continuous White
0210	626-F001	6" Thermoplastic Double Drop Edge Stripe, Continuous Yellow
0220	626-G002	Thermoplastic Detail Stripe, White
0230	626-G003	Thermoplastic Detail Stripe, Yellow
0240	626-H004	Thermoplastic Legend, White
0250	626-H005	Thermoplastic Legend, White
0260	627-J001	Two-Way Clear Reflective High Performance Raised Markers
0270	627-K001	Red-Clear Reflective High Performance Raised Markers
0280	627-L001	Two-Way Yellow Reflective High Performance Raised Markers
0320	907-624-A003	6" Inverted Profile Thermoplastic Traffic Stripe, Skip White, High Contrast
0330	907-624-B003	6" Inverted Profile Thermoplastic Traffic Stripe, Continuous White, High Contrast
0340	907-624-D001	6" Inverted Profile Thermoplastic Traffic Stripe, Continuous Yellow, High Contrast
0350	628-G001	6" High Performance Cold Plastic Traffic Stripe, Skip White
0360	628-H001	6" High Performance Cold Plastic Traffic Stripe, Continuous White
0370	628-J001	6" High Performance Cold Plastic Traffic Stripe, Continuous Yellow

### CATEGORY: TRAFFIC CONTROL - PERMANENT

---

Line No	Pay Item	Description
0290	630-F006	Delineators, Guard Rail, White
0300	630-F007	Delineators, Guard Rail, Yellow

CATEGORY: TRAFFIC CONTROL - TEMPORARY

---

Line No	Pay Item	Description
0130	619-A1001	Temporary Traffic Stripe, Continuous White
0140	619-A2001	Temporary Traffic Stripe, Continuous Yellow
0150	619-A3001	Temporary Traffic Stripe, Skip White
0160	619-A5001	Temporary Traffic Stripe, Detail
0170	619-A6002	Temporary Traffic Stripe, Legend

**MISSISSIPPI DEPARTMENT OF TRANSPORTATION**

**SECTION 904 - NOTICE TO BIDDERS NO. 798**

**CODE: (SP)**

**DATE: 3/22/2018**

**SUBJECT: Cooperation Between Contractors**

**PROJECT: STP-0015-02(123) / 107798301 – Covington County**

The Bidder's attention is hereby called to Subsection 105.07, Cooperation between Contractors, of the 2017 Edition of the Mississippi Standard Specifications for Road and Bridge Construction.

The Bidder is advised that this project is adjacent to the following project that is currently under construction:

**NH-0015-02(100) / 107602301 – Covington County, Overlay Approximately 4 miles of US 84 beginning at Terrible Creek East to the Junction of SR 184 West**

The Contractor shall cooperate in all respects and shall coordinate construction of all phases of work with the Contractor of the adjoining projects. Failure to coordinate work schedules, such as but not limited to lane closures, shall not be reason to modify contract time.

## MISSISSIPPI DEPARTMENT OF TRANSPORTATION

**SECTION 904 - NOTICE TO BIDDERS NO. 799**

**CODE: (SP)**

**DATE: 3/20/2018**

**SUBJECT: Scope of Work**

**PROJECT: STP-0015-02(123) / 107798301 - Covington County**

The contract documents do not include an official set of construction plans, but may, by reference, include some Standard Drawings when so specified in a Notice to Bidders entitled, "Standard Drawings". All other references to plans in the contract documents and Standard Specifications for Road and Bridge Construction are to be disregarded.

The work to be accomplished using the pay items and corresponding specifications set forth in the contract is to overlay a 9.2-mile section of U.S. Highway 84 (Eastbound lane only) beginning at the JCT of SR 588 (Collins) and proceed East 9.2 miles to the Jones County Line.

Work on the Project shall consist of the following:

1. The Contractor shall erect and maintain construction signing, provide all signs, set up night time lane closures (if needed), and traffic handling devices in accordance with the Traffic Control Plan. The cost for this work is to be included in the price bid for pay item number 618-A, Maintenance of Traffic. All traffic control devices on this project should comply with the latest version of the MUTCD. Fluorescent orange sheeting shall be used on all construction and traffic control signs except for those designated in the standards to be black legend and border on white background.
2. Prior to the overlay, the existing shoulders shall be clipped and surplus material shall be spread along the edge of the shoulders, fore slopes, or other adjacent areas as directed by the Project Engineer, and cost will be absorbed in other bid items. Any excess material that can't be spread in the above mentioned areas shall be hauled off the project and paid for as 203-G: Excess Excavation.
3. It shall be the responsibility of the Contractor to protect the roadway and all existing structures, such as bridges, culverts, signs, and curb, from damage occurring as a result of the Contractor's operations. Damages to existing structures caused by the Contractor's operations shall be repaired or replaced at no cost to the Department.
4. Incidental work such as removing vegetation, shaping and compaction of shoulders, removing excess asphalt material, project clean-up, and other incidental work necessary to complete the project will not be measured for separate payment, but cost will be absorbed in other bid items.
5. It is the Contractor's responsibility to insure the drainage of surface water from milled

areas. Temporary wedges (paper joints) of full lane width asphalt shall be placed by the Contractor immediately after the milling process to allow the safe transition of traffic. These wedges shall be maintained in a satisfactory condition by the Contractor until the permanent asphalt is placed cost to be absorbed in other bid items.

6. The Contractor shall first perform Pre-Grinding according to Section 412 of the Standard Specifications.
7. The Contractor shall then perform fine milling to remove a 1½" and variable depth at the BOP (36+35) 150', the EOP (534+61) 150', the intersections with concrete islands & concrete curb, bridge ends, and the "patch areas" prior to leveling. Asphalt operations shall commence within 48 hours of the completion of the first days milling operation.
8. The Contractor shall then perform pre-leveling operations of ¾ and variable of 9.5-mm, HT, Polymer Modified, Leveling asphalt as directed by the Engineer.

The Contractor shall take due care to maintain a uniform outside edge of pavement, and shall place asphalt to establish an approximate vertical face in order for granular material to be placed directly against an approximate vertical surface and not on a shelf of an underlying course. A rubber tire roller shall be used in lieu of a steel wheel roller in obtaining compaction on this leveling lift of asphalt.

9. The Contractor shall then place a 1½" and variable of 9.5-mm, HT, Polymer Modified asphalt, (14' wide) on the roadway left and right of the centerline. The finish cross-slope is to be 2% in tangent sections and the appropriate super elevation rate in horizontal curves.

Place 1½" and variable of 9.5-mm, ST, asphalt on the left turn lanes, intersections, local roads, streets and driveways ramps (as applicable).

Driveway aprons shall be paved ten feet wide as per the attached drawing and as directed by the Engineer. All turnouts shall be paved to the normal right of way line or as directed by the Engineer.

The Contractor shall remove existing pavement markers prior to placing asphalt. The cost of removing these pavement markers is to be absorbed in other items.

Note: The Contractor shall be responsible for traffic control while MDOT personnel conduct density testing on the asphalt. The cost is to be included in the price bid or pay item No. 618-A, Maintenance of Traffic.

10. The Contractor shall then place granular material on the shoulders to raise the existing shoulders to the new grade, bladed, shaped, and compacted to a minimum slope of 4%. Granular material will not be allowed to be placed directly on the surface lift of asphalt, but must be placed directly on the gravel shoulder or a road widener machine used and approved by the Project Engineer. Light blading or mowing of the shoulders will be required prior to placement of the granular material.

11. The Contractor shall then place all permanent pavement markings. Place rumble edge stripe (90 mill edge stripe) (spray and double drop beads) on both sides of the roadway from BOP (36+35) to EOP (534+61) or as directed by the Engineer.
12. The Contractor shall remove and replace all guardrail blockouts and guardrail delineators on the EB Lane within the project limits.

Incidental work that is necessary to complete the work will not be paid for in direct compensation and will be considered included in the bid prices for the listed items.

An asphalt taper shall be placed at the temporary joints caused by the milling or overlay in order to provide for the safe movement of traffic. The taper shall be three feet (3') in length per one inch (1") of depth and will be an absorbed item.

Temporary stripe is required immediately after milling, preliminary leveling, and overlaying operations and prior to opening the area to traffic. Temporary stripe shall be placed in the same location and layout as permanent stripe.

The Contractor shall provide all signs and traffic handling devices necessary to safely maintain traffic around or through the work areas.

All asphalt and concrete curbs along ramps, local roads, etc. from BOP to EOP shall be painted (two applications) with white traffic paint and traffic beads; cost to be absorbed in other pay items.



## GENERAL NOTES

- ① THE LOCATION AND SPACING OF SIGNS AS SHOWN ON THE TRAFFIC CONTROL PLANS ARE APPROXIMATE AND MAY BE ADJUSTED AS NECESSARY TO FIT FIELD CONDITIONS.
- ② ALL TRAFFIC CONTROL DEVICES ON THIS PROJECT SHALL COMPLY WITH PART VI(OF THE MUTCD (LATEST EDITION).
- ③ FLUORESCENT ORANGE SHEETING SHALL BE USED ON ALL CONSTRUCTION AND TRAFFIC CONTROL SIGNS EXCEPT FOR THOSE DESIGNATED ON THE PLANS TO BE BLACK LEGEND AND BORDER ON WHITE BACKGROUND.
- ④ ALL PLASTIC DRUMS SHALL HAVE A BALLASTING COLLAR MADE FROM RECYCLED TRUCK TIRES OR SUITABLE MATERIAL.
- ⑤ ALL SIGNS AND DELINEATORS THAT CONFLICT WITH THE CONSTRUCTION OF THIS PROJECT SHALL BE REMOVED AND RESET BY THE CONTRACTOR; COST TO BE ABSORBED IN OTHER PAY ITEMS.
- ⑥ THE GRASS ON EXISTING SHOULDERS SHALL BE REMOVED PRIOR TO THE PLACEMENT OF SHOULDER MATERIAL BY LIGHTLY BLADING OR CLOSELY MOWING; COST TO BE ABSORBED IN OTHER PAY ITEMS.
- ⑦ WHERE MILLING OF THE ROADWAY IS REQUIRED, THE CONTRACTOR SHALL PROVIDE OUTLETS IN THE EXISTING SHOULDER AT SUFFICIENT INTERVALS TO PREVENT POOLING OR STANDING WATER ON MILLED SURFACE; COST TO BE ABSORBED IN OTHER PAY ITEMS.
- ⑧ IT SHALL BE THE RESPONSIBILITY OF THE CONTRACTOR TO PROTECT EXISTING STRUCTURES SUCH AS PIPES, INLETS, APRONS, BRIDGES, ETC., FROM DAMAGE WHICH MIGHT OCCUR DURING CONSTRUCTION. THE CONTRACTOR SHALL REPLACE OR REPAIR, AS DIRECTED BY THE ENGINEER, ANY STRUCTURES DAMAGED DURING THE LIFE OF THE CONTRACT. NO PAYMENT WILL BE MADE FOR REPLACEMENT OR REPAIR OF DAMAGED ITEMS.
- ⑨ THE CONTRACTOR SHALL REMOVE EXISTING PAVEMENT MARKERS PRIOR TO PLACING ASPHALT; COST TO BE ABSORBED IN OTHER PAY ITEMS.
- ⑩ TEMPORARY STRIPING IS REQUIRED AFTER THE OVERLAYING OPERATION; WEATHER PERMITTED OR PRIOR TO OPENING THE AREA TO TRAFFIC. TEMPORARY STRIPING SHALL BE PLACED IN THE SAME LOCATION AND LAYOUT AS PERMANENT STRIPE.
- ⑪ ALL ASPHALT AND CONCRETE CURBS ALONG RAMPS, LOCAL ROADS, ETC. FROM B.O.P. TO E.O.P. SHALL BE PAINTED ( TWO APPLICATIONS ) WITH WHITE TRAFFIC PAINT AND TRAFFIC BEADS ; COST TO BE ABSORBED IN OTHER PAY ITEMS.
- ⑫ IF THE ASPHALT CURB ALONG THE LOCAL ROAD IS SEVERELY DAMAGED, THE ENTIRE ASPHALT CURB WILL BE REMOVED AS DIRECTED BY THE ENGINEER; COST TO BE ABSORBED IN OTHER PAY ITEMS.
- ⑬ ALL LOCAL ROADS TO BE PAVED TO THE R.O.W. LIMITS OR AS DIRECTED BY THE ENGINEER.
- ⑭ ALL RAMPS AND DRIVEWAYS TO BE PAVED TO THE SHOULDER LINE, MINIMUM, OR FURTHER, AS DIRECTED BY THE ENGINEER WITHIN THE LIMITS OF THE R.O.W.

- ⑮ BIDDERS ARE ADVISED THAT HARD COPIES OF ANY ADDENDA FOR THIS PROJECT WILL NO LONGER BE MAILED. ALL ADDENDA FOR THIS PROJECT WILL BE POSTED ON WWW.MDOT.MS.GOV UNDER THE PROPOSAL ADDENDA COLUMN. IT IS THE BIDDER'S RESPONSIBILITY TO CHECK AND SEE IF ANY ADDENDA HAVE BEEN POSTED FOR THIS PROJECT. PLEASE CONTACT CONTRACT ADMINISTRATION DIVISION AT 601-359-7700 FOR ANY QUESTIONS REGARDING ELECTRONIC ADDENDA.
- ⑯ GRANULAR MATERIAL WILL NOT BE PLACED DIRECTLY ON THE SURFACE LIFT OF ASPHALT, BUT MUST BE PLACED DIRECTLY ON THE GRAVEL SHOULDER OR A ROAD WIDENER MACHINE USED AND APPROVED BY THE PROJECT ENGINEER.
- ⑰ STORAGE OF FLAMMABLE MATERIALS WILL NOT BE ALLOWED UNDER ANY BRIDGE STRUCTURE.
- ⑱ INSTALLATION DATES SHALL BE CLEARLY WRITTEN IN BOLD BLACK MARKINGS ON THE BACK BOTTOM HALF OF ALL SIGNS WITH A PERMANENT MARKING STICK THAT IS WATERPROOF, FADE RESISTANT AND MARKS ON WET OR DRY SURFACES.
- ⑲ ALL POST, PIPE, AND I-BEAM LENGTHS IN THESE PLANS ARE ESTIMATES. POST LENGTHS FOR ALL SIGNS SHALL BE VERIFIED IN THE FIELD BY THE CONTRACTOR PRIOR TO FABRICATION.
- ⑳ ALL EXISTING SIGNS WHICH ARE TO BE REMOVED AS A PART OF THIS PROJECT THAT ARE NOT IN CONFLICT WITH CONSTRUCTION SHALL REMAIN IN PLACE UNTIL NEW SIGNS ARE INSTALLED UNLESS NOTED OR DIRECTED OTHERWISE BY THE PROJECT ENGINEER. ROADWAY SIGNS THAT ARE IN CONFLICT WITH CONSTRUCTION SHALL BE REMOVED AND RELOCATED BY THE CONTRACTOR AS DIRECTED BY THE ENGINEER, THE COST OF WHICH SHALL BE ABSORBED IN OTHER ITEMS BID.
- ㉑ ALL EXISTING SIGNS AND SUPPORTS REMOVED UNDER THIS PROJECT SHALL BECOME THE PROPERTY OF THE CONTRACTOR AND ARE NOT A SEPARATE PAY ITEM WITH THE EXCEPTION OF THE GUIDE SIGN (0625) OVERLAY PANELS WHICH SHALL BECOME THE PROPERTY OF MDOT. CONTRACTOR SHALL ARRANGE WITH THE PROJECT ENGINEER A SUITABLE TIME FOR PICK-UP BY MDOT. MDOT RESERVES THE RIGHT TO REFUSE ANY MATERIAL THAT IS DAMAGED OR UNSUITABLE FOR REURBISHMENT.
- ㉒ DIRECT - APPLIED LEGEND, BORDER AND/OR SHIELDS ARE TO BE USED ON ALL GUIDE SIGNS. DIGITALLY PRODUCED SIGN COPY, SHIELDS, LEGENDS, SYMBOLS, OR IMAGES WILL NOT BE ALLOWED WITHOUT WRITTEN APPROVAL FROM MDOT'S PROJECT ENGINEER.
- ㉓ AFTER THE PERMANENT SIGNS HAVE BEEN INSTALLED, THE CONTRACTOR SHALL SUBMIT TO THE PROJECT ENGINEER A DIGITAL COPY OF A MICROSOFT EXCEL SPREADSHEET WITH THE FOLLOWING INVENTORY DATA CAPTURED FOR EACH SIGN: LOCATION OF SIGN (LATITUDE - LONGITUDE GPS COORDINATES), MUTCD SIGN CODE, SIZE, BACKGROUND AND LEGEND COLORS, SUPPORT TYPE (POST, PIPE, SQUARE POST, OR I-BEAM), NUMBER OF SUPPORT, DATE OF INSTALLATION, SIGN FACE DIRECTION, ROUTE NAME OR NUMBER, DIRECTION OF VEHICLE TRAVEL, AND LEGEND ON SIGN IF APPLICABLE. EACH SIGN SHALL BE ASSIGNED UNIQUE ID NUMBER AND A DIGITAL PHOTO OF EACH SIGN SHALL BE SUBMITTED IN BITMAP FORMAT. THE PHOTO FILENAME SHALL CORRESPOND WITH THE UNIQUE ID NUMBER.
- ㉔ ASPHALT WILL BE REQUIRED UNDER ALL GUARDRAILS AS SHOWN ON SDRG-IMOD.

MISSISSIPPI DEPARTMENT OF TRANSPORTATION	
	WORKING NUMBER <b>GN-C</b>
GENERAL NOTES	
PROJ. NO.: STP-0015-02(123)	
COUNTY: COVINGTON	
SHEET NUMBER 123	DATE
DESIGNER SERVSON	DATE



**U.S. 84  
 EB**

**WB**  
 125' & VAR.

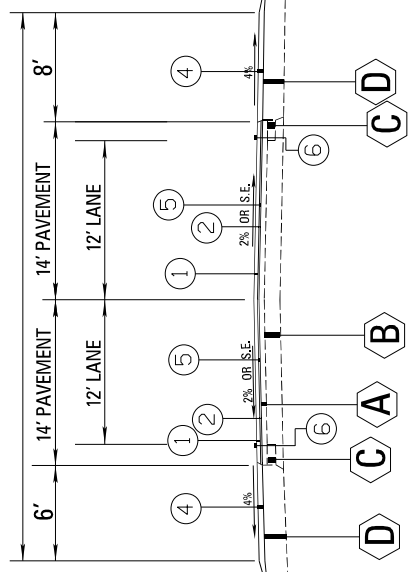
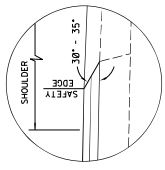

**ORIGINAL GROUND  
 LINE**

**U.S. 84  
 EASTBOUND**

**B.O.P. STA. 36 + 35 - E.O.P. STA. 534 + 61**

- ① 1.5" ASPHALT, HT, (9.5 mm MIXTURE) (1 @ 1.5") POLYMER MODIFIED REQD
- ② TACK COAT REQD.
- ③ FINE MILLING (1.5" & VAR.) WHERE REQUIRED.
- ④ 1.5" & VAR. DEPTH GRANULAR MATERIAL (CLASS 6, GROUP D) REQD.
- ⑤ 0.75" & VAR. ASPHALT HT (9.5mm MIXTURE) POLYMER MODIFIED (SPOT LEVELING) WHERE REQD.
- ⑥ RUMBLE STRIPE REQD.

- Ⓐ 1.5" EXISTING ASPHALT, HT (9.5 mm MIXTURE) POLYMER MODIFIED (1 @ 1.5")
- Ⓑ 4.5" & VAR. EXISTING BITUMINOUS PAVEMENT
- Ⓒ 3" EXISTING ASPHALT, HT (19mm MIXTURE) (1 @ 3")
- Ⓓ 5.5" & VAR. EXISTING GRANULAR MATERIAL (CLASS 6, GROUP D)

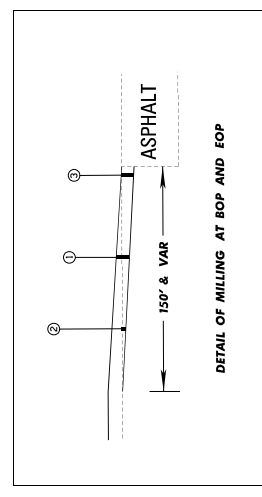
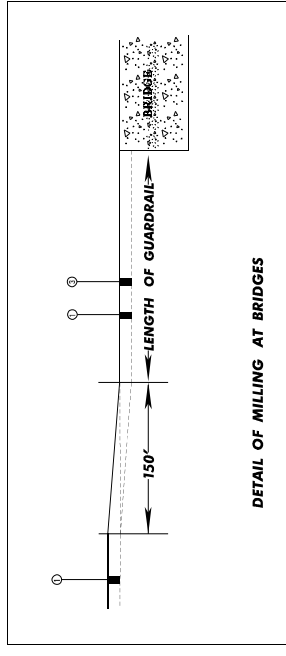

Notice To Bidders To

DATE	REVISION	BY	CHKD

MISSISSIPPI DEPARTMENT OF TRANSPORTATION  
**TYPICAL SECTION**  
**U.S. 84 MAINLINE**  
**4 - LANE SECTION**  
**(EASTBOUND LANE ONLY)**

PROJECT NUMBER: STP-0015-02(123)  
 COUNTY: COVINGTON  
 DESIGN TEAM: **CS-1**  
 SHEET NUMBER: **SPGS**  
 FILE NAME: **SERVS**  
 DESIGN TEAM: **CS-1**  
 DATE:

FMS CON: 107798.30100  
 STATE PROJECT NO. MISS. STP-0015-02(123)

MISSISSIPPI DEPARTMENT OF TRANSPORTATION	
TYPICAL SECTION CROSSOVERS	
WORKING NUMBER	TS-2
PROJ. NO.:	STP-0015-02(123)
COUNTY:	COVINGTON
FILE NAME:	TS-2.dwg
SHEET NUMBER	SP-1
DESIGN TEAM	DATE
DESIGNED	CHECKED

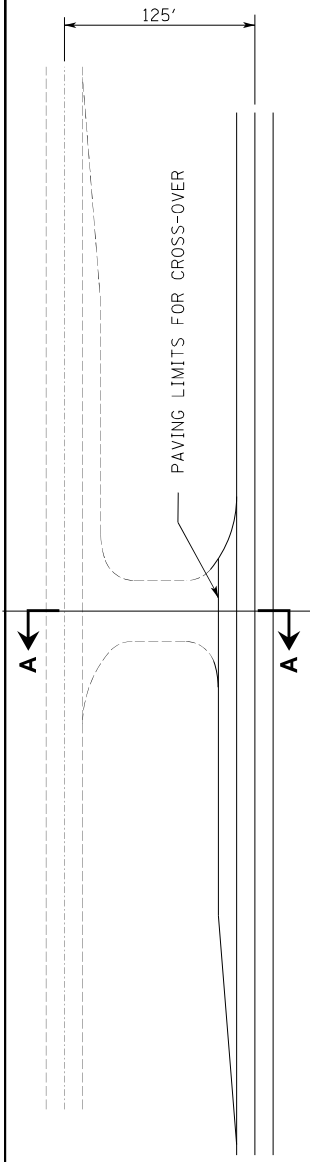

**TYPICAL CROSS-OVER SECTION**

PLAN VIEW

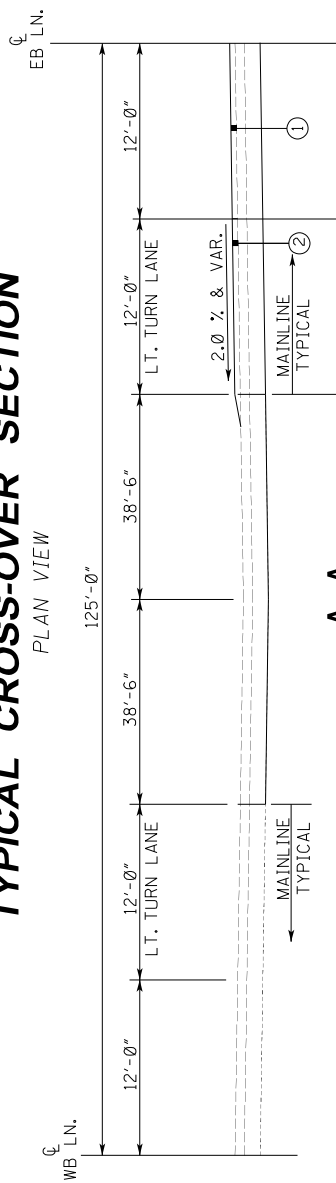

A-A

**PROPOSED**

- ① 1.5" ASPHALT, HT (9.5mm MIXTURE) (1 @ 1.5") POLYMER MODIFIED REQ'D.
- ② 1.5" ASPHALT, ST (9.5mm MIXTURE) (1 @ 1.5") REQ'D.
- ③ 1.5" AND VARIABLE DEPTH GRANULAR MATERIAL (CLASS 6, GROUP D) REQ'D

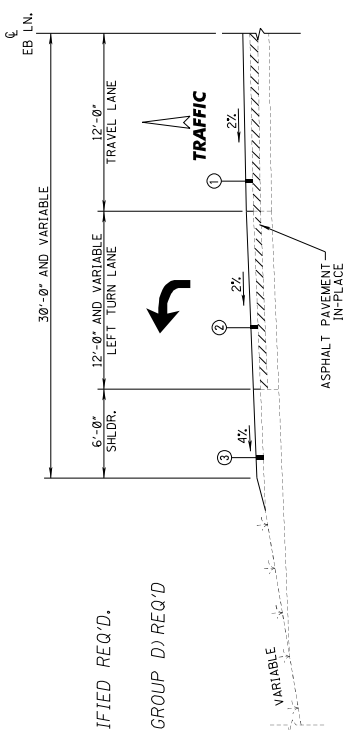

ASPHALT PAVEMENT IN-PLACE  
**PARTIAL SECTION**  
**US 84 (EB L.T. TURN LANE)**

FMS CON:10798/301000  
 PROJECT NO.  
 STATE MISS, STP-0015-02(123)

PAVEMENT MARKING			
SYMBOL	DESCRIPTION	TYPE	QUANTITY
1	TWO-WAY CLEAR REFL. RAISED MARKERS	EACH	
2	TWO-WAY YELLOW REFL. RAISED MARKERS	EACH	
3	TWO-WAY YELLOW REFL. RAISED MARKERS	EACH	
4	TWO-WAY YELLOW REFL. RAISED MARKERS	EACH	
5	6" TRAFFIC SKIP WHITE (10'-30')	PLASTIC	
6	6" CONTINUOUS EDGE WHITE (SOLID)	PLASTIC	
7	6" CONTINUOUS TRAFFIC YELLOW (SOLID)	PLASTIC	
8	6" CONTINUOUS TRAFFIC WHITE (SOLID)	PLASTIC	
9	6" DETAIL STRIPE WHITE (SOLID)	PLASTIC	
10	6" DETAIL STRIPE YELLOW (SOLID)	PLASTIC	
11	6" DETAIL STRIPE WHITE (SOLID)	PLASTIC	
12	6" DETAIL STRIPE WHITE (SOLID)	PLASTIC	
13	24" THERMO LEGEND WHITE (STOP BAR)	PLASTIC	
14	24" THERMO LEGEND WHITE (YIELD BAR)	PLASTIC	

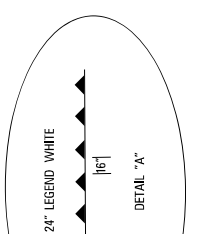
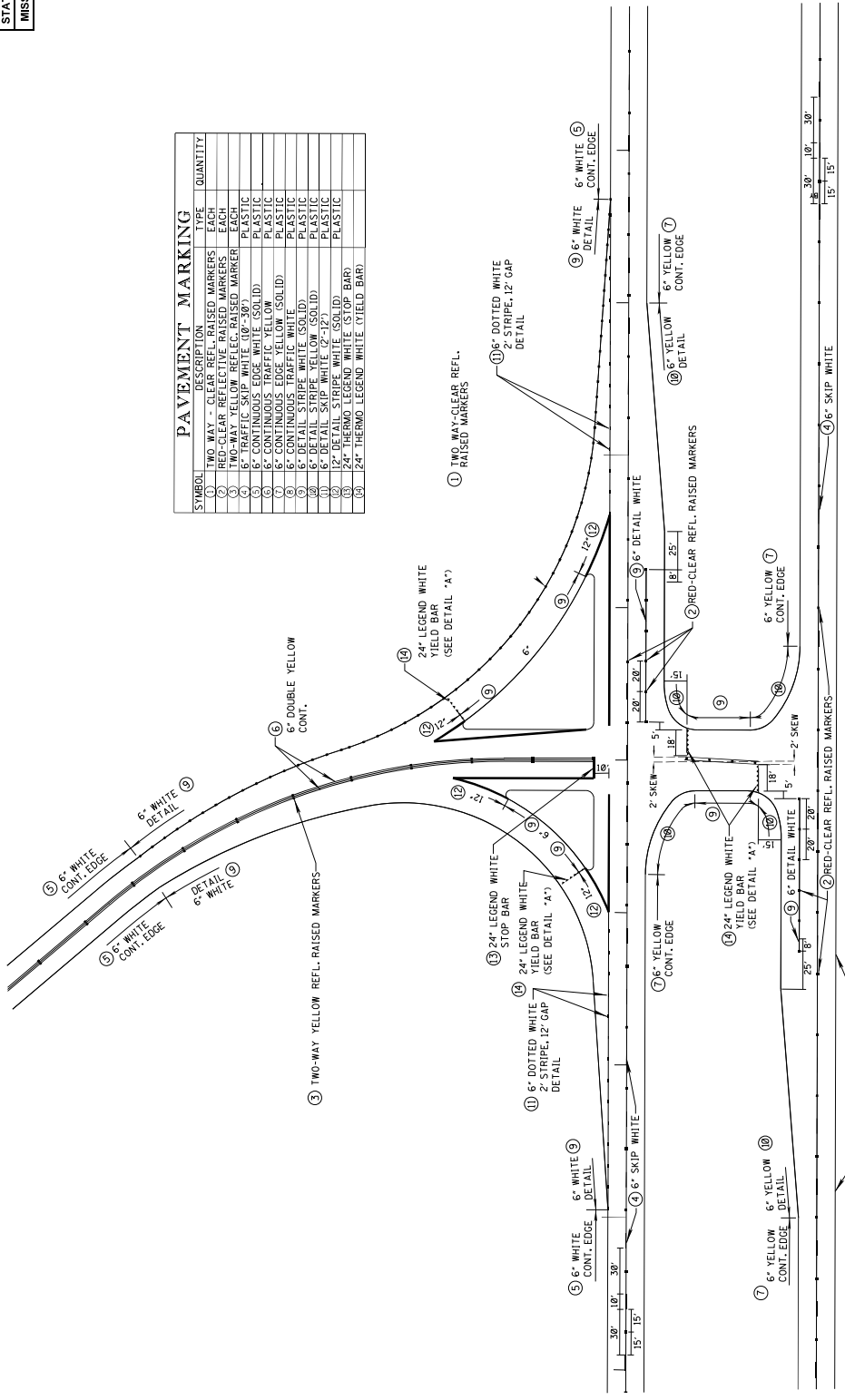

MISSISSIPPI DEPARTMENT OF TRANSPORTATION

**DETAIL OF STRIPING  
 CHANNELIZED  
 INTERSECTION  
 4 - LANE**

PROJECT NO.: STP-0015-02(123)  
 COUNTY: COVINGTON

WORKING NUMBER: PWD-4  
 SHEET NUMBER: 84  
 FILE NAME: PWD-4.dgn  
 DESIGN TEAM: [ ]  
 DATE: [ ]



FMS CON-107798-301000  
 STATE PROJECT NO. MISS. STP-0015-02(123)

MISSISSIPPI DEPARTMENT OF TRANSPORTATION  
 TYPICAL PAVEMENT MARKING  
 DETAIL FOR MEDIAN CROSSOVERS

WORKING NUMBER: SDX00  
 SHEET NUMBER: 50  
 PROJECT NO.: STP-0015-02(123)  
 COUNTY: COVINGTON  
 FILE NAME: L281SDX00-1.dwg  
 DESIGNED: DATE: \_\_\_\_\_  
 CHECKED: DATE: \_\_\_\_\_

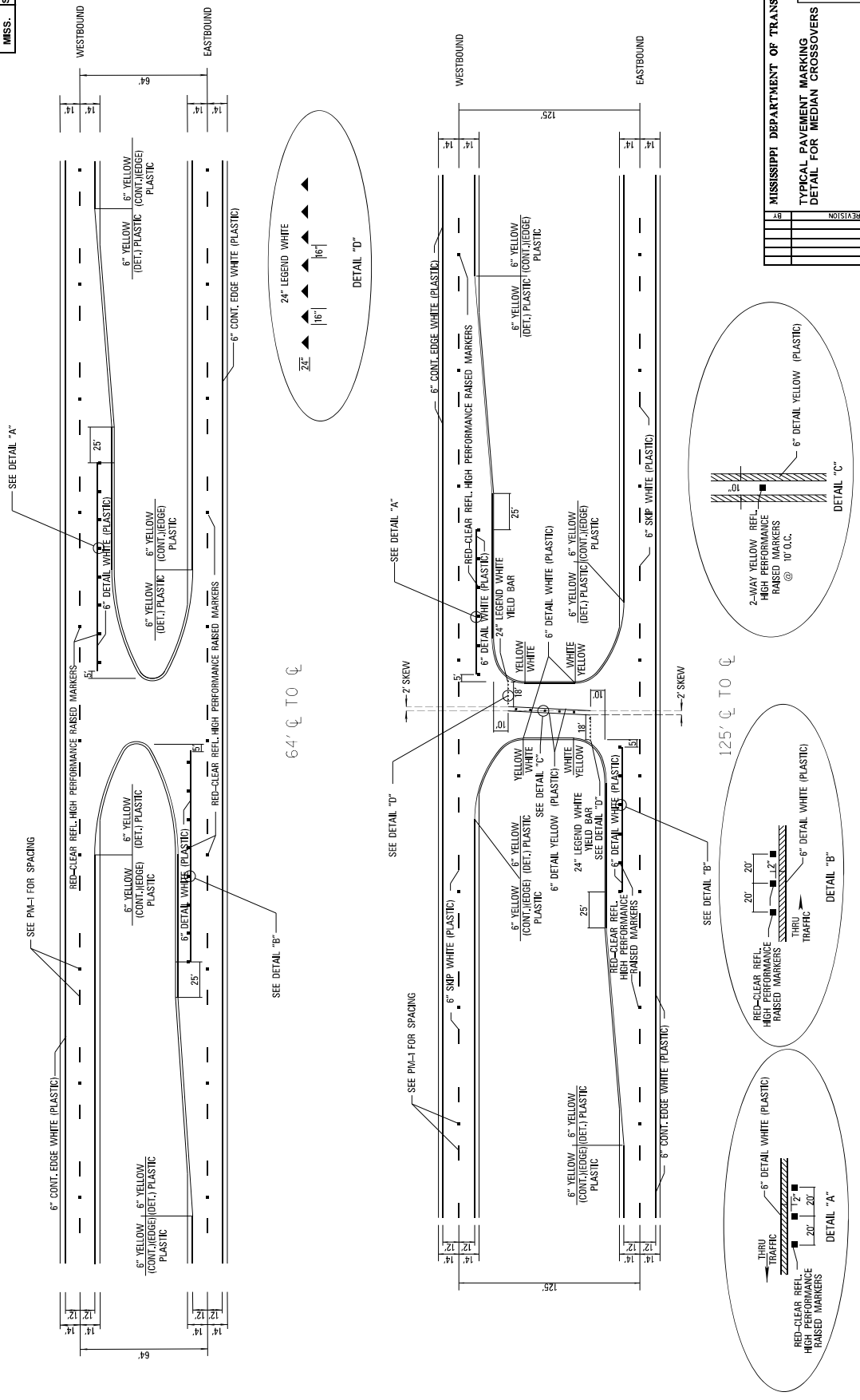

FMS CON:107798/30100  
 STATE PROJECT NO. STP-0015-02(123)  
 MISS. SHEET NUMBER

MISSISSIPPI DEPARTMENT OF TRANSPORTATION  
 WORKING NUMBER SDX02  
 SHEET NUMBER 5P-01  
 DATE  
 DESIGN TEAM

PROJ. NO.: STP-0015-02(123)  
 COUNTY: COVINGTON  
 FILE NAME: SDX02-4800

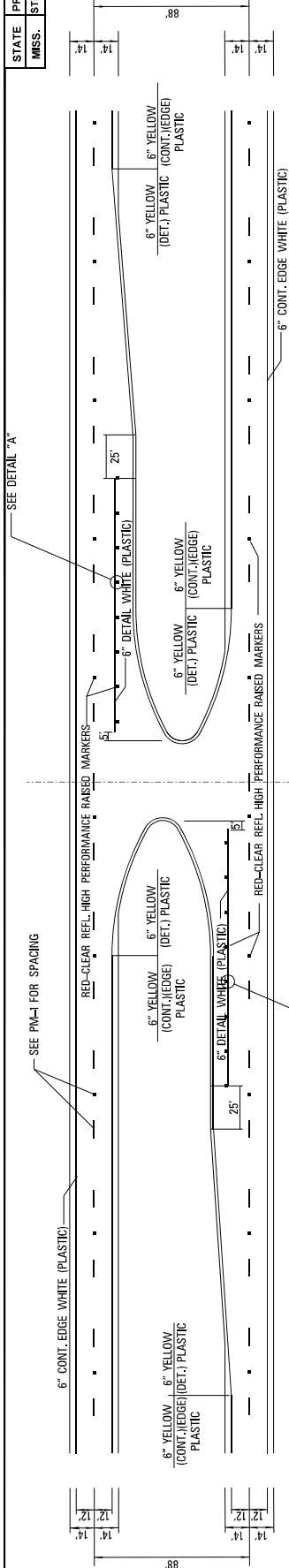

88' ± TO CL

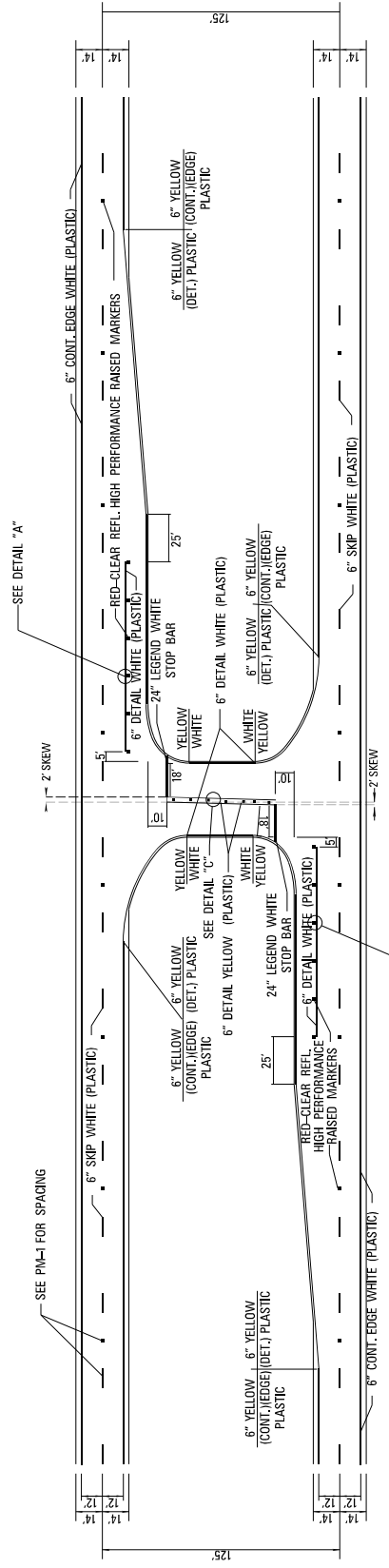

125' ± TO CL

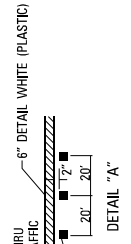
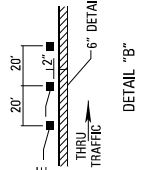
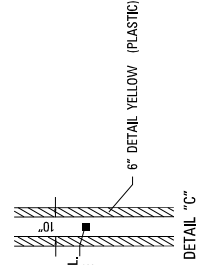

PRIVATE DRIVEWAY DETAIL

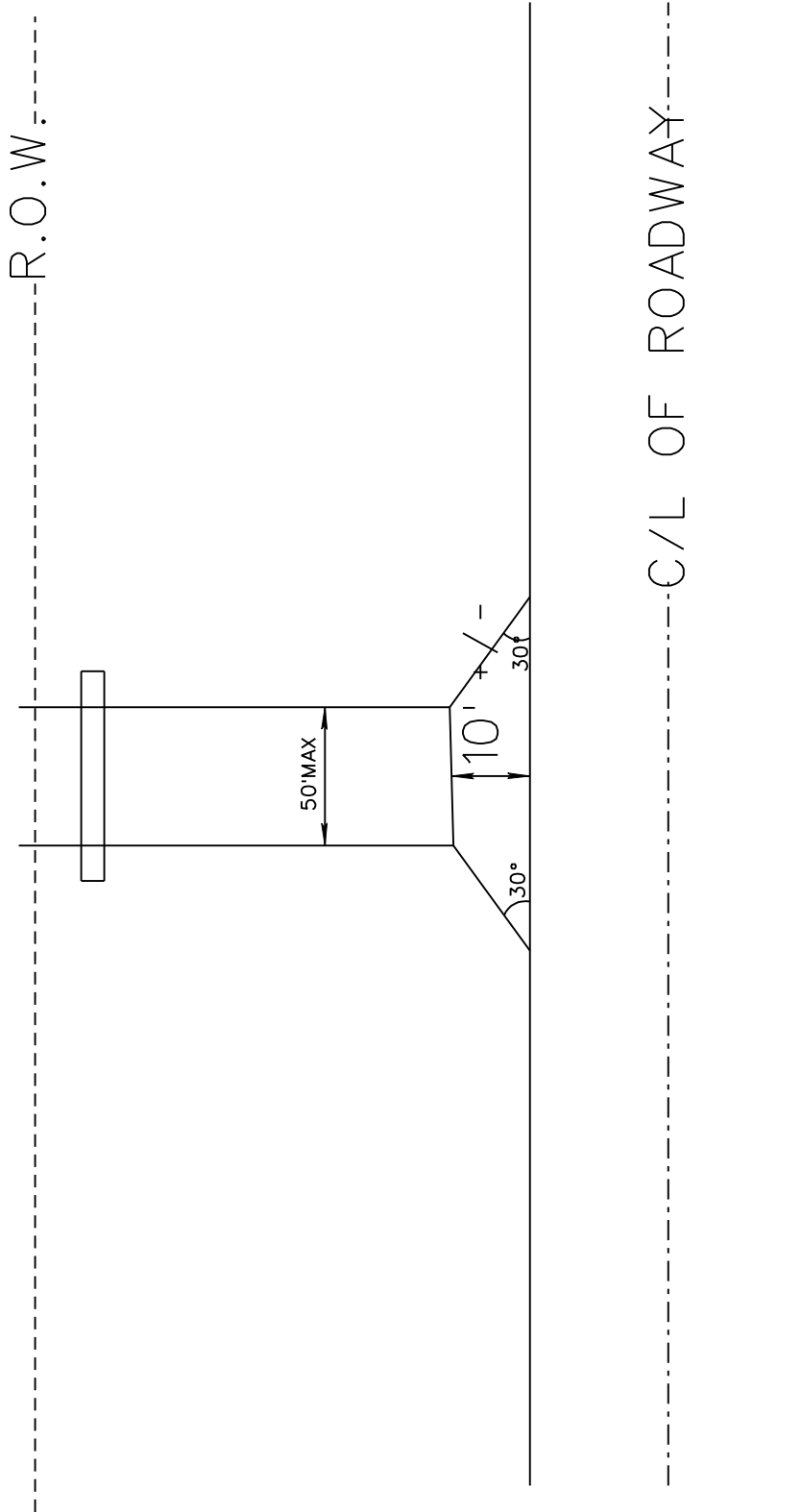







PROJECT NO. BR-0015-2(6.9)  
STATE MISS.  
DATE

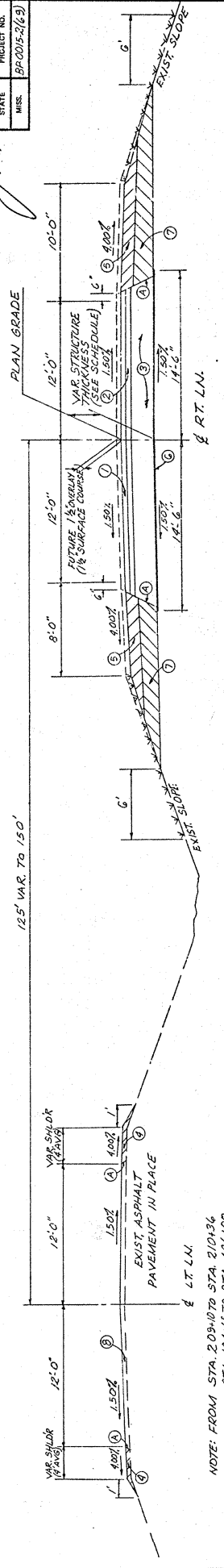

TYPICAL SECTION  
STA 60+00 TO STA 495+00

TYPICAL SECTION  
STA 203+00 TO STA 210+36  
STA. 484+65 TO STA. 486+00

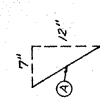

TYPICAL ANGLE  
OF REPOSE

- NOTES:
- ① INDICATES AREA REQUIRING EROSION CONTROL TREATMENT (SEE VEGETATION SCHEDULE, SH. NO. 66)
  - ② ANGLE OF REPOSE PERMITTED
  - ③ 1 1/2" HOT BITUMINOUS PAVEMENT REQ'D SURFACE COURSE
  - ④ 1 1/2" HOT BITUMINOUS PAVEMENT REQ'D BINDER COURSE
  - ⑤ VAR. DEPTH PLANT MIX BITUMINOUS BASE COURSE REQ'D (SEE SCHEDULE)
  - ⑥ 1 1/2" VAR. GRANULAR MATERIAL (CLASS "6", GROUP "D") REQ'D
  - ⑦ 4" VAR. GRANULAR MATERIAL (CLASS "6", GROUP "D") REQ'D
  - ⑧ BITUMINOUS PRIME COAT REQ'D (MAY BE DELETED WHEN PERMITTED BY THE ENGINEER)
  - ⑨ VAR. DEPTH GRANULAR MATERIAL (CLASS "9", GROUP "D") REQ'D (SEE SCHEDULE)
  - ⑩ 1 1/2" VAR. HOT BITUMINOUS PAVEMENT REQ'D SURFACE COURSE
  - ⑪ VAR. DEPTH MATERIAL FROM UNDERCUT AREA

STA. TO STA.	STRUCTURE THICKNESS SCHEDULE	
	BITUMINOUS PAVEMENT BASE (12.3.00)	STRUCTURE THICKNESS
60+00 - 79+00	3"	5 1/2"
79+00 - 86+00	3"	7"
86+00 - 160+00	3"	5 1/2"
160+00 - 163+00	3"	7"
163+00 - 212+00	3"	5 1/2"
212+00 - 214+00	3"	7"
214+00 - 230+00	3"	5 1/2"
230+00 - 232+00	3"	7"
232+00 - 287+00	3"	5 1/2"
287+00 - 289+00	3"	7"
289+00 - 313+29 1/2	3"	5 1/2"
313+29 1/2 - 317+00	3"	7"
317+00 - 330+00	3"	5 1/2"
330+00 - 333+00	3"	7"
333+00 - 367+00	3"	5 1/2"
367+00 - 377+00	3"	7"
377+00 - E.O.P.	3"	5 1/2"

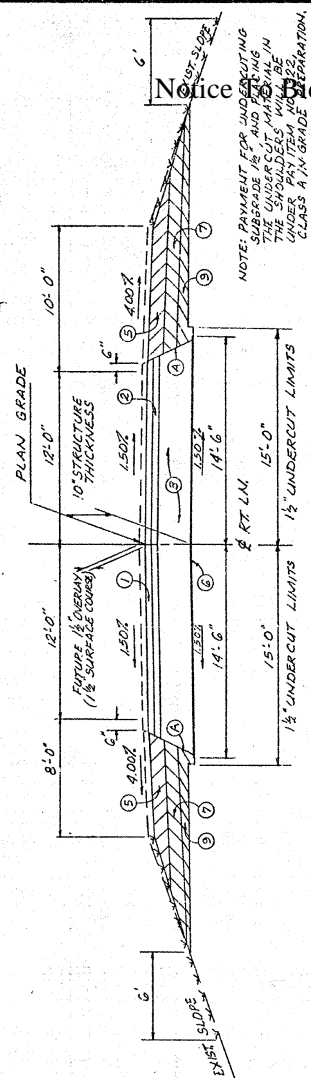

TYPICAL SECTION  
1 1/2" UNDERCUT AREAS  
FOR 10" STRUCTURE THICKNESS

Notice of Proposed Rule Making  
Mississippi State Highway Department  
Project No. 799  
Covington & Jones Counties

DATE	REVISION	BY	CHKD.	THICK.	DATE

MISSISSIPPI STATE HIGHWAY DEPARTMENT  
TYPICAL SECTION  
PROJECT NO. BR-0015-2(6.9)  
COVINGTON & JONES COUNTIES

DESIGNED: \_\_\_\_\_  
CHECKED: \_\_\_\_\_  
DATE: \_\_\_\_\_  
THICK: \_\_\_\_\_  
DATE: \_\_\_\_\_  
SHEET NUMBER: 3

PROJECT NO. BR 0015-2(2-3)  
 STATE MISS  
 DATE

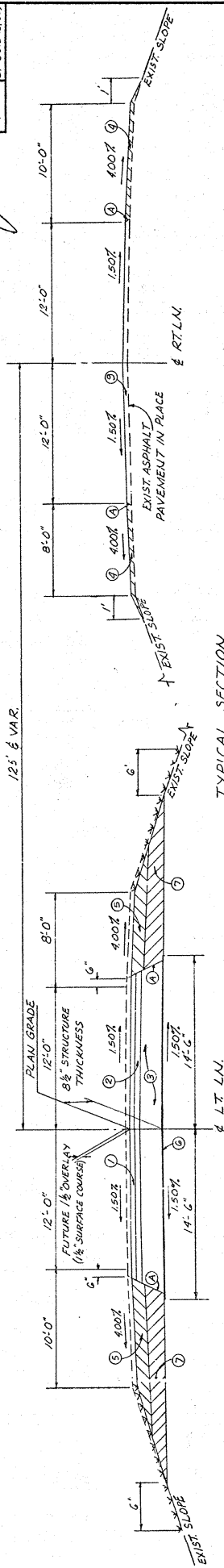

TYPICAL SECTION  
 STA. 502+81 & LT.LN TO STA. 525+84.25 & LT.LN.

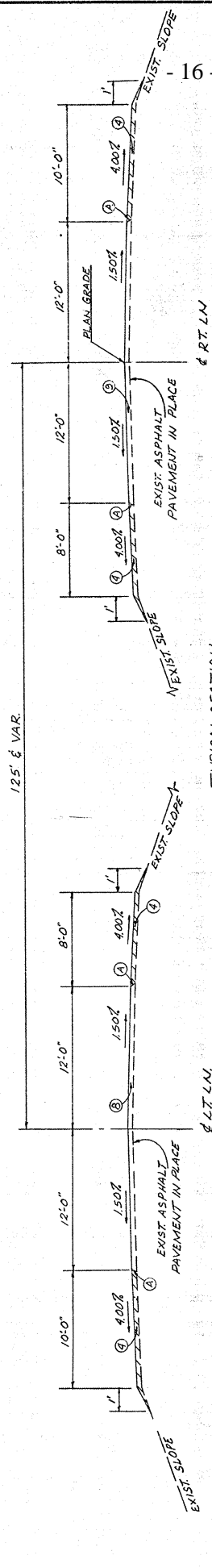

TYPICAL SECTION  
 STA. 495+00 TO STA. 502+81.75 & LT.LN  
 STA. 525+84.25 & LT.LN TO E.O.P.

NOTE: FROM STA. 526+87.25 & LT.LN TO COUNTY LINE, FULL DEPTH SHOULDERS REQD. ON LT. LN. AS INDICATED BY TYPICAL SECTION FOR STA. 502+81.75 & LT.LN TO STA. 525+87.25 & LT.LN.

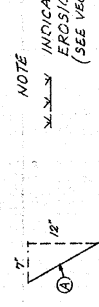

TYPICAL ANGLE OF REPOSE

NOTE: INDICATES AREA REQUIRING EROSION CONTROL TREATMENT. (SEE VEGETATION SCHEDULE, SA NO. 66)

- (A) ANGLE OF REPOSE PERMITTED
- (1) 1 1/2" HOT BITUMINOUS PAVEMENT REQD. SURFACE COURSE
- (2) 1 1/2" HOT BITUMINOUS PAVEMENT REQD. BINDER COURSE
- (3) 5% PLANT MIX BITUMINOUS BASE COURSE REQD.
- (4) 1 1/2" VAR. GRANULAR MATERIAL (CLASS "C" GROUP "D") REQD.
- (5) 4" VAR. GRANULAR MATERIAL (CLASS "C" GROUP "D") REQD.
- (6) BITUMINOUS PRIME COAT REQD. (MAY BE DELETED WHEN PERMITTED BY THE OWNER)
- (7) 4 1/2" VAR. GRANULAR MATERIAL (CLASS "D" GROUP "D") REQD.
- (8) 1 1/2" VAR. HOT BITUMINOUS PAVEMENT REQD. SURFACE COURSE
- (9) 1 1/2" VAR. HOT BITUMINOUS PAVEMENT REQD. SURFACE COURSE

MISSISSIPPI STATE HIGHWAY DEPARTMENT	
TYPICAL SECTION	
PROJECT NO. BR 0015-2(2-3)	
COVINGTON COUNTY	
FORM NO. 75-2	SHEET NUMBER 1
DATE	SCALE
REVISIONS	DATE

STATE MISS. PROJECT NO. BR-0015-2(3)

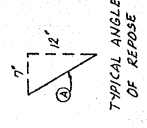
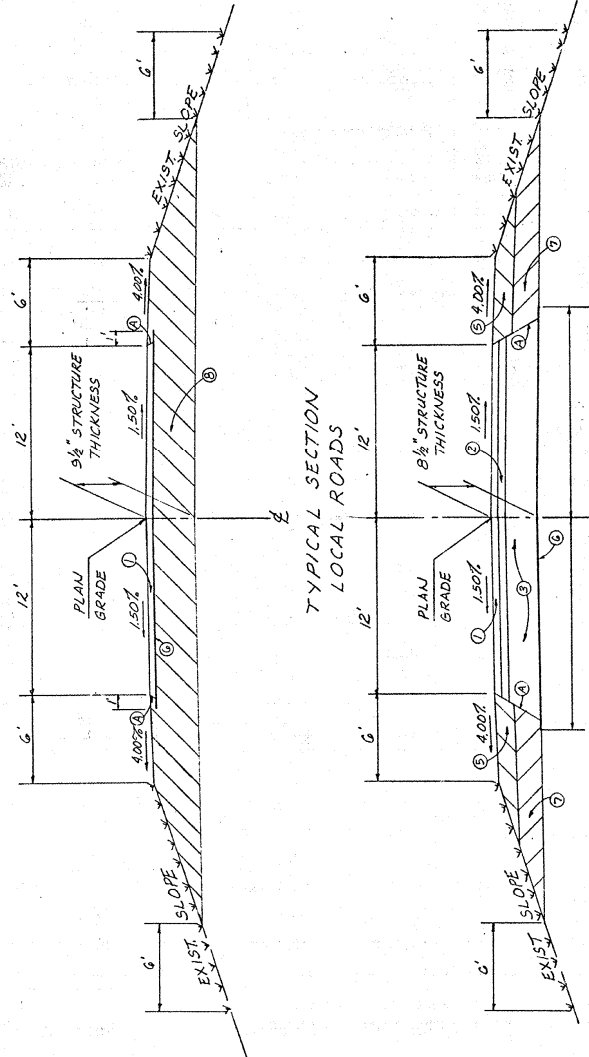

- ANGLE OF REPOSE PERMITTED
- ① 1 1/2" HOT BITUMINOUS PAVEMENT RECD. SURFACE COURSE
  - ② 1 1/2" HOT BITUMINOUS PAVEMENT RECD. BINDER COURSE
  - ③ 5 1/2" PLANT MIX BITUMINOUS BASE COURSE RECD.
  - ④ 4" & VAR. GRANULAR MATERIAL (CLASS "G", GROUP "D") RECD.
  - ⑤ BITUMINOUS PRIME COAT RECD. (MAY BE DELETED WHEN REQUIRED BY THE DESIGNER)
  - ⑥ 4 1/2" & VAR. GRANULAR MATERIAL (CLASS "G", GROUP "D") RECD.
  - ⑦ 8" GRANULAR MATERIAL (CLASS "G", GROUP "D") RECD.

NOTE: INDICATES AREA REQUIRING EROSION CONTROL TREATMENT (SEE VEGETATION SCHEDULE, SH NO. 66)

MISSISSIPPI STATE HIGHWAY DEPARTMENT	
TYPICAL SECTION LOCAL ROADS	
PROJECT NO. BR-0015-2(3)	
COUNTY & JONES COUNTY	
DESIGNED	DRAWN
INTEGRATED	DATE
SHEET NUMBER	OF

STATE PROJECT NO.  
MISS. BP-0015-2(39)  
REVISIONS  
DATE BY

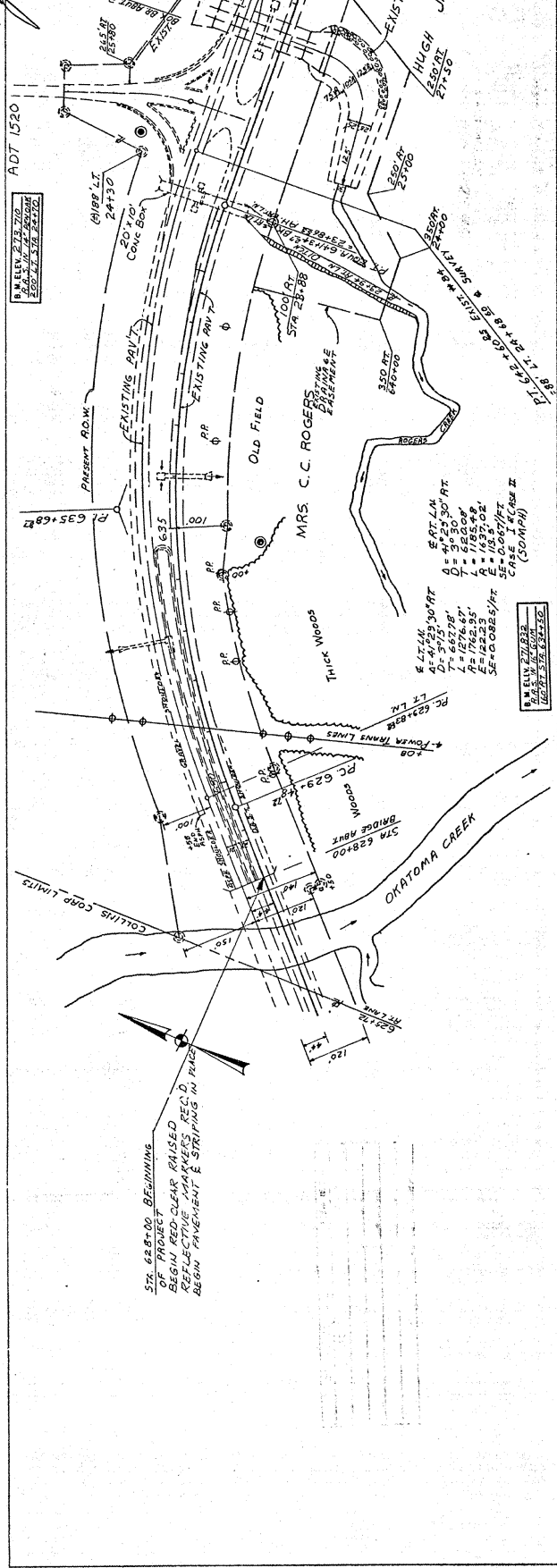

STATIONING DATA:  
 STA 628+00  
 STA 628+10  
 STA 628+20  
 STA 628+30  
 STA 628+40  
 STA 628+50  
 STA 629+00  
 STA 629+10  
 STA 629+20  
 STA 629+30  
 STA 629+40  
 STA 629+50  
 STA 630+00  
 STA 630+10  
 STA 630+20  
 STA 630+30  
 STA 630+40  
 STA 630+50  
 STA 631+00  
 STA 631+10  
 STA 631+20  
 STA 631+30  
 STA 631+40  
 STA 631+50  
 STA 632+00  
 STA 632+10  
 STA 632+20  
 STA 632+30  
 STA 632+40  
 STA 632+50  
 STA 633+00  
 STA 633+10  
 STA 633+20  
 STA 633+30  
 STA 633+40  
 STA 633+50  
 STA 634+00  
 STA 634+10  
 STA 634+20  
 STA 634+30  
 STA 634+40  
 STA 634+50  
 STA 635+00

VERT. CURVE DATA:  
 V.C. 1  
 L = 1276.60'  
 ELEVATION AT 1/4 L = 127.66'  
 ELEVATION AT 1/2 L = 127.66'  
 ELEVATION AT 3/4 L = 127.66'  
 ELEVATION AT END = 127.66'  
 SE = 0.0025/FT  
 (EXAMPLE)

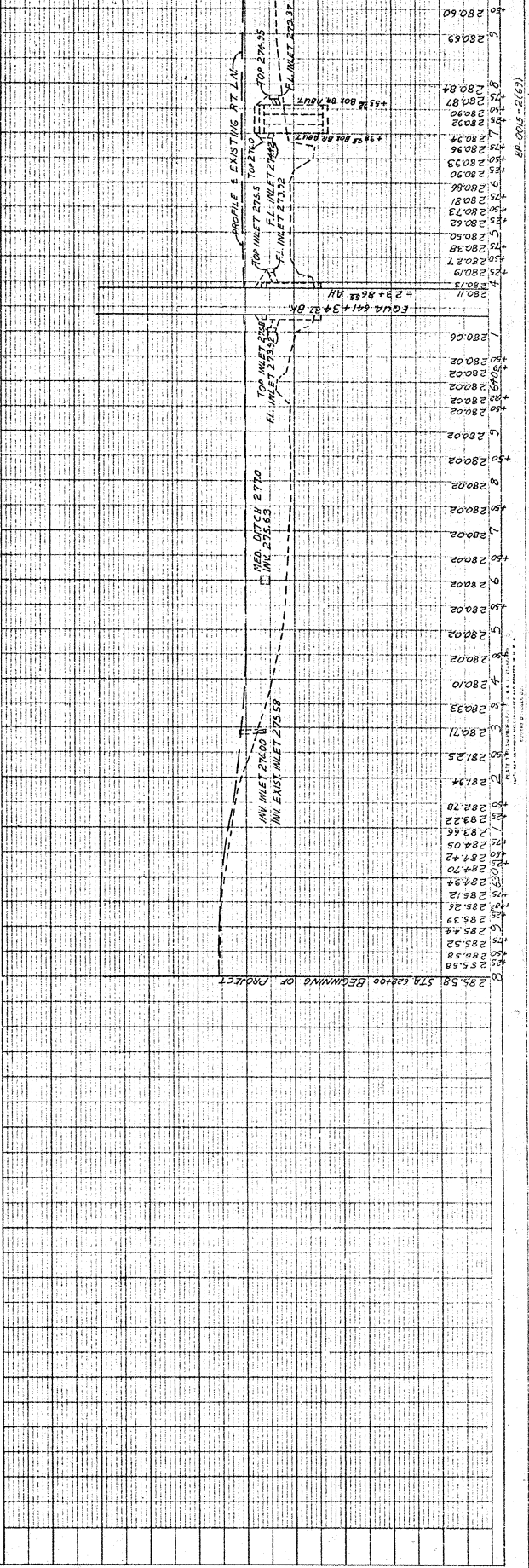

BP-0015-2(39)  
 CARLSTON & JONES CO.

NO.	DATE	BY	DESCRIPTION

NO.	DATE	BY	DESCRIPTION

PROJECT NO.	602
STATE	MISS.
DATE	10/2/05
REVISIONS	
DATE BY	

B.M. ELEV. 205.63  
 205.63  
 205.63  
 205.63

B.M. ELEV. 205.63  
 205.63  
 205.63  
 205.63

B.M. ELEV. 205.63  
 205.63  
 205.63  
 205.63

B.M. ELEV. 205.63  
 205.63  
 205.63  
 205.63

B.M. ELEV. 205.63  
 205.63  
 205.63  
 205.63

B.M. ELEV. 205.63  
 205.63  
 205.63  
 205.63

B.M. ELEV. 205.63  
 205.63  
 205.63  
 205.63

B.M. ELEV. 205.63  
 205.63  
 205.63  
 205.63

B.M. ELEV. 205.63  
 205.63  
 205.63  
 205.63

B.M. ELEV. 205.63  
 205.63  
 205.63  
 205.63

B.M. ELEV. 205.63  
 205.63  
 205.63  
 205.63

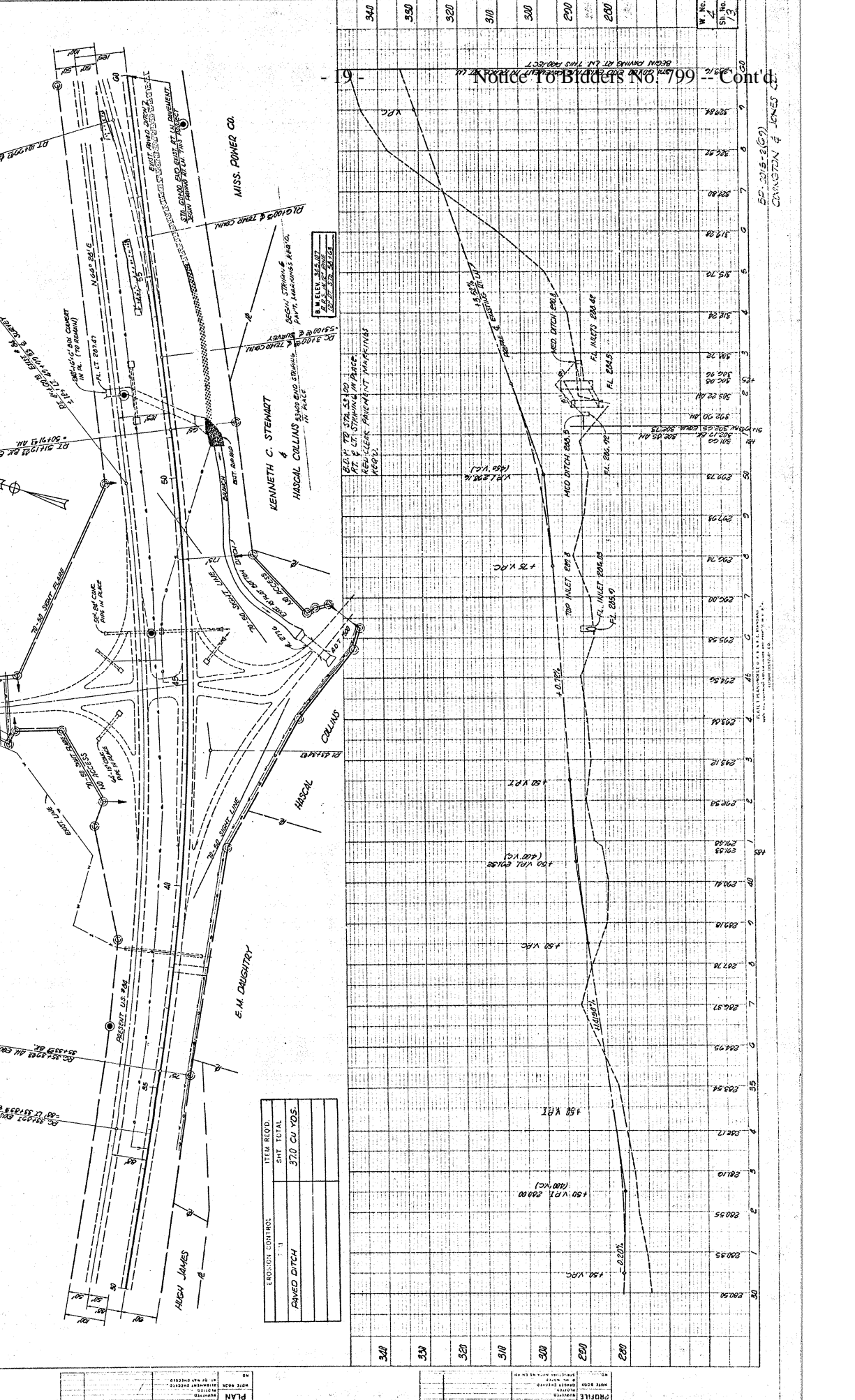

ITEM REQD.	SHT TOTAL
PAVED DITCH	370 CU YDS.

EROSION CONTROL	11
-----------------	----

PLAN	DATE
DATE	BY

PROFILE	DATE
DATE	BY

DATE	BY
------	----

DATE	BY
------	----

DATE	BY
------	----

DATE	BY
------	----

Notice to Bidders No. 799 - Cont'd

B.P. 2015-2(57)  
 COMANSTON & JONES



PROJECT NO.	BP-0015-2(69)
STATE	MISS.
DATE BY	
REVISIONS	

R.M. ELEV. 244.54  
 82'-11" IN DIAM.  
 100' L.G. 100' L.G.

R.M. ELEV. 244.54  
 82'-11" IN DIAM.  
 100' L.G. 100' L.G.

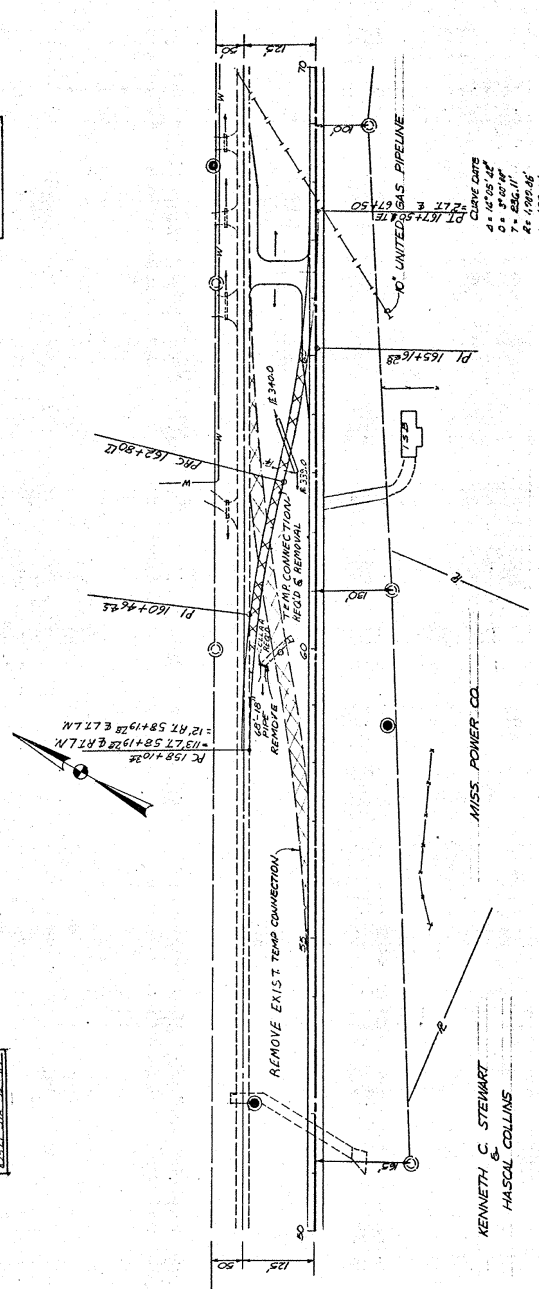

CLONE DATA  
 4" 14'05" 4"  
 0" 5'07" 4"  
 7" 8'06" 11"  
 4" 1'00" 05"  
 2" 4'05" 08"

R.M. ELEV. 244.54  
 82'-11" IN DIAM.  
 100' L.G. 100' L.G.

R.M. ELEV. 244.54  
 82'-11" IN DIAM.  
 100' L.G. 100' L.G.

STATION	ELEVATION	DESCRIPTION	REMARKS
2+00	244.54	EXIST. TEMP CONNECTION	
2+05	244.54	REMOVE EXIST. TEMP CONNECTION	
2+10	244.54	REMOVE EXIST. TEMP CONNECTION	
2+15	244.54	REMOVE EXIST. TEMP CONNECTION	
2+20	244.54	REMOVE EXIST. TEMP CONNECTION	
2+25	244.54	REMOVE EXIST. TEMP CONNECTION	
2+30	244.54	REMOVE EXIST. TEMP CONNECTION	
2+35	244.54	REMOVE EXIST. TEMP CONNECTION	
2+40	244.54	REMOVE EXIST. TEMP CONNECTION	
2+45	244.54	REMOVE EXIST. TEMP CONNECTION	
2+50	244.54	REMOVE EXIST. TEMP CONNECTION	
2+55	244.54	REMOVE EXIST. TEMP CONNECTION	
2+60	244.54	REMOVE EXIST. TEMP CONNECTION	
2+65	244.54	REMOVE EXIST. TEMP CONNECTION	
2+70	244.54	REMOVE EXIST. TEMP CONNECTION	
2+75	244.54	REMOVE EXIST. TEMP CONNECTION	
2+80	244.54	REMOVE EXIST. TEMP CONNECTION	
2+85	244.54	REMOVE EXIST. TEMP CONNECTION	
2+90	244.54	REMOVE EXIST. TEMP CONNECTION	
2+95	244.54	REMOVE EXIST. TEMP CONNECTION	
3+00	244.54	REMOVE EXIST. TEMP CONNECTION	
3+05	244.54	REMOVE EXIST. TEMP CONNECTION	
3+10	244.54	REMOVE EXIST. TEMP CONNECTION	
3+15	244.54	REMOVE EXIST. TEMP CONNECTION	
3+20	244.54	REMOVE EXIST. TEMP CONNECTION	
3+25	244.54	REMOVE EXIST. TEMP CONNECTION	
3+30	244.54	REMOVE EXIST. TEMP CONNECTION	
3+35	244.54	REMOVE EXIST. TEMP CONNECTION	
3+40	244.54	REMOVE EXIST. TEMP CONNECTION	
3+45	244.54	REMOVE EXIST. TEMP CONNECTION	
3+50	244.54	REMOVE EXIST. TEMP CONNECTION	
3+55	244.54	REMOVE EXIST. TEMP CONNECTION	
3+60	244.54	REMOVE EXIST. TEMP CONNECTION	
3+65	244.54	REMOVE EXIST. TEMP CONNECTION	
3+70	244.54	REMOVE EXIST. TEMP CONNECTION	
3+75	244.54	REMOVE EXIST. TEMP CONNECTION	
3+80	244.54	REMOVE EXIST. TEMP CONNECTION	
3+85	244.54	REMOVE EXIST. TEMP CONNECTION	
3+90	244.54	REMOVE EXIST. TEMP CONNECTION	
3+95	244.54	REMOVE EXIST. TEMP CONNECTION	
4+00	244.54	REMOVE EXIST. TEMP CONNECTION	

Notice To Bidders No. 799 -- Cont'd.

BP-0015-E(69)  
 COVINGTON & JONES COUNTY

PLAN	DATE	BY

PROFILE	DATE	BY





REVISION	DATE BY

SHEET NO. 202222  
 STATE PROJECT NO. 87-0015-2 (63)  
 MISS. 87-0015-2 (63)  
 DATE 12-11-63

SHEET NO. 202221  
 STATE PROJECT NO. 87-0015-2 (63)  
 MISS. 87-0015-2 (63)  
 DATE 12-11-63

SHEET NO. 202220  
 STATE PROJECT NO. 87-0015-2 (63)  
 MISS. 87-0015-2 (63)  
 DATE 12-11-63

SHEET NO. 202219  
 STATE PROJECT NO. 87-0015-2 (63)  
 MISS. 87-0015-2 (63)  
 DATE 12-11-63

SHEET NO. 202218  
 STATE PROJECT NO. 87-0015-2 (63)  
 MISS. 87-0015-2 (63)  
 DATE 12-11-63

SHEET NO. 202217  
 STATE PROJECT NO. 87-0015-2 (63)  
 MISS. 87-0015-2 (63)  
 DATE 12-11-63

SHEET NO. 202216  
 STATE PROJECT NO. 87-0015-2 (63)  
 MISS. 87-0015-2 (63)  
 DATE 12-11-63

SHEET NO. 202215  
 STATE PROJECT NO. 87-0015-2 (63)  
 MISS. 87-0015-2 (63)  
 DATE 12-11-63

SHEET NO. 202214  
 STATE PROJECT NO. 87-0015-2 (63)  
 MISS. 87-0015-2 (63)  
 DATE 12-11-63

SHEET NO. 202213  
 STATE PROJECT NO. 87-0015-2 (63)  
 MISS. 87-0015-2 (63)  
 DATE 12-11-63

SHEET NO. 202212  
 STATE PROJECT NO. 87-0015-2 (63)  
 MISS. 87-0015-2 (63)  
 DATE 12-11-63

SHEET NO. 202211  
 STATE PROJECT NO. 87-0015-2 (63)  
 MISS. 87-0015-2 (63)  
 DATE 12-11-63

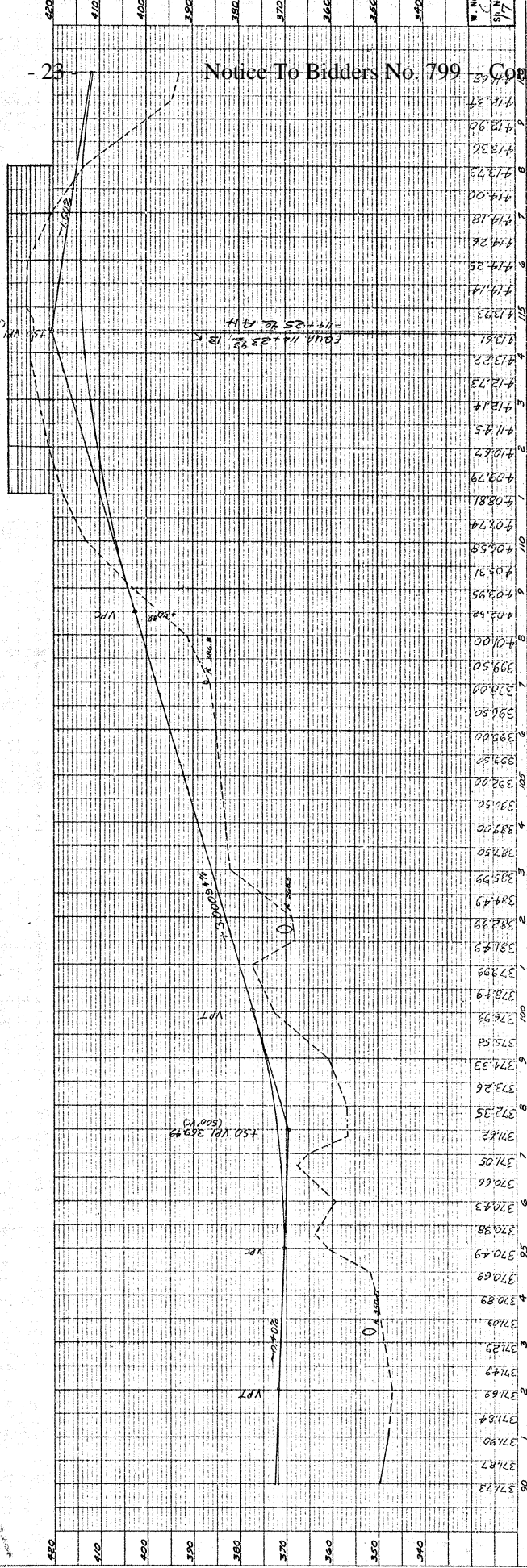
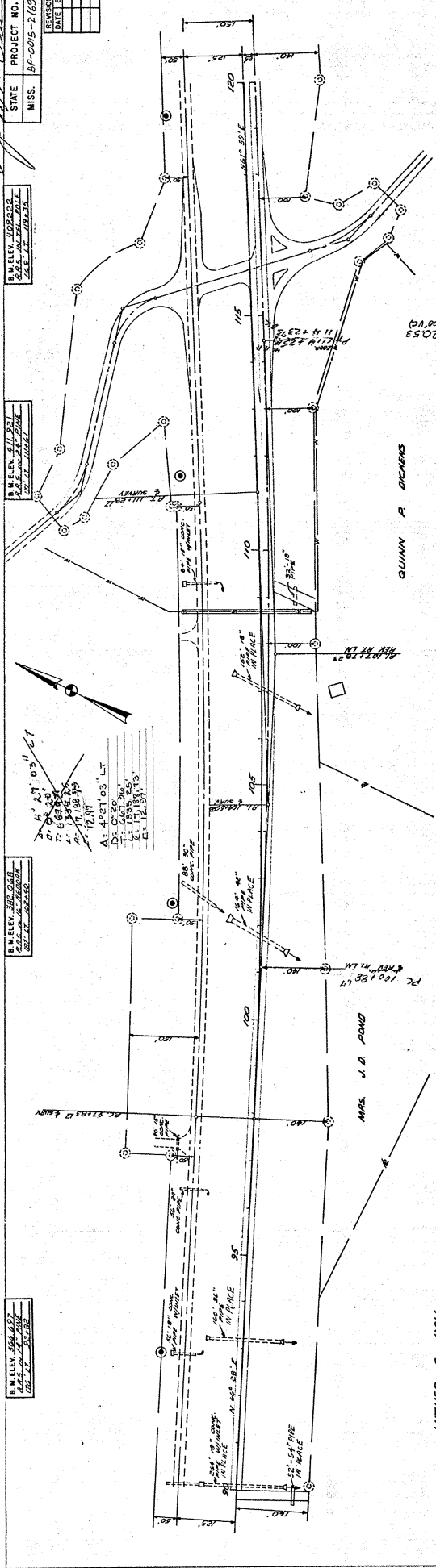

- 23 -

Notice To Bidders No. 799 - Cont'd

87-0015-2 (63)

COVINGTON & JONES COUNTY







STATE	PROJECT NO.
MISS.	BR-2015-2(69)
REVISIONS	DATE
1	02/11/15
2	02/12/15
3	03/25/15

8 M ELEV. 202.292  
 202.292  
 202.292  
 202.292

100' TRANSITION  
 SHOULDER LINE  
 10' SHOULDER  
 10' SHOULDER  
 10' SHOULDER

DEPTH OF GUARDRAIL & SHOULDER  
 WIDENING STR. 200+58 TO 200+41E  
 AT 70°/0.90'E

NO ACCESS LIMITS  
 10' SHOULDER  
 10' SHOULDER

ITEM BIDD  
 SHIT TOTAL  
 20 YD  
 20 YD

EROSION CONTROL  
 ITEM  
 PAVED DITCH

PLAN  
 NORTH  
 DATE

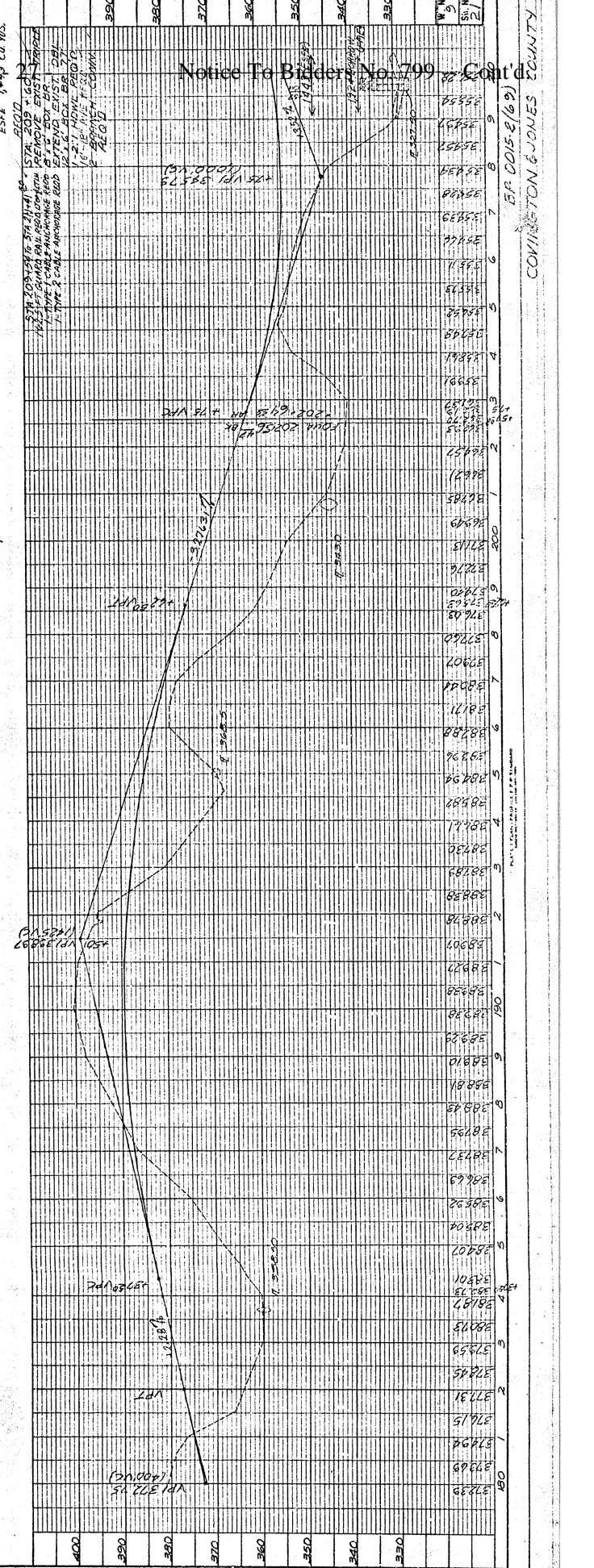
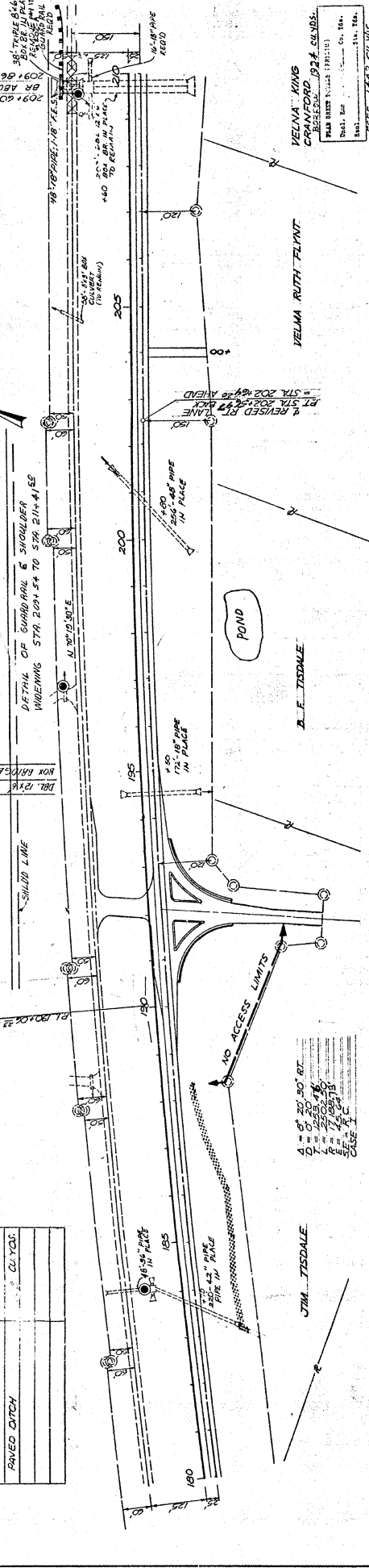

STATION	ELEVATION
200+00	372.95
200+05	373.65
200+10	374.15
200+15	374.75
200+20	375.55
200+25	376.55
200+30	377.75
200+35	379.15
200+40	380.75
200+45	382.55
200+50	384.55
200+55	386.75
200+60	388.78

Notice To Bidder No. 799 - Cont'd

BR-2015-2(69)  
 COVINGTON & JONES COUNTY



STATE PROJECT NO.  
MISS. BR-0015-2(13)  
REVISIONS  
DATE BY

S.M. ELEV. 356.724  
% 1.11%  
% 2.22%  
% 3.33%  
% 4.44%  
% 5.55%

S.M. ELEV. 353.832  
% 1.11%  
% 2.22%  
% 3.33%  
% 4.44%  
% 5.55%

S.M. ELEV. 351.724  
% 1.11%  
% 2.22%  
% 3.33%  
% 4.44%  
% 5.55%

EROSION CONTROL ITEM	ITEM REQ'D.	SHT. TOTAL
PAVED DITCH		

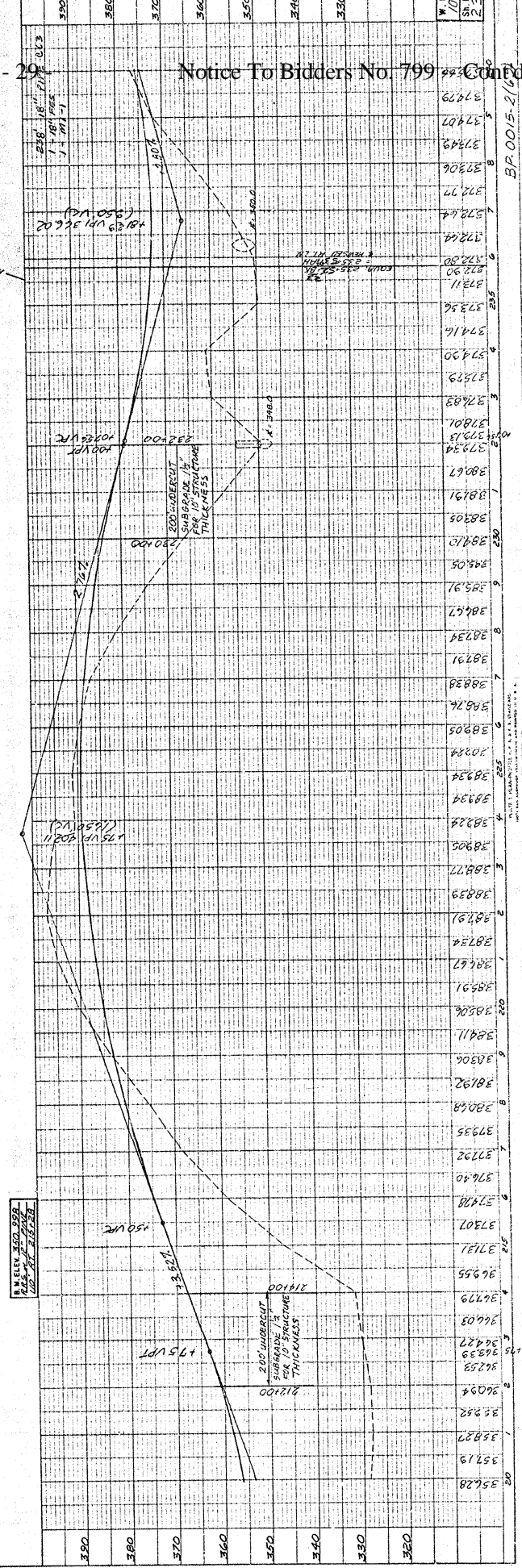
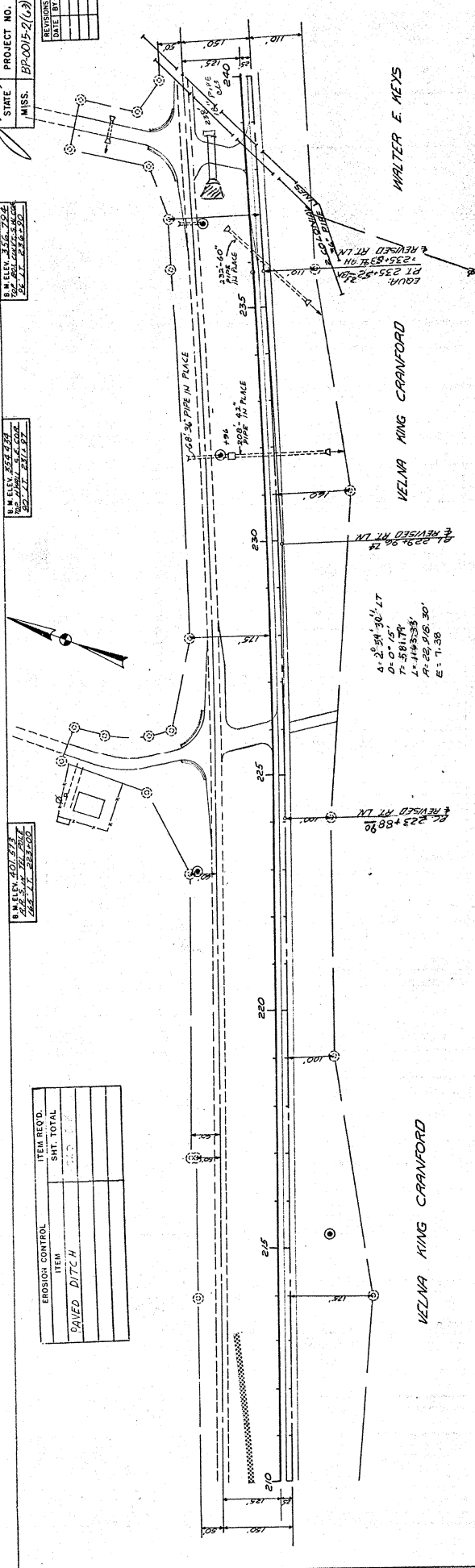

Notice To Bidders No. 799 Cont'd

BR 0015-2(13)

COVINGTON & JONES COUNTY















PROJECT NO. MISS. BP-0015-2(69)

REVISIONS	DATE	BY

B.M. STATION 345.270  
 200+00.00  
 200+00.00

B.M. ELEV. 345.270  
 200+00.00  
 200+00.00

B.M. ELEV. 345.270  
 200+00.00  
 200+00.00

B.M. ELEV. 345.270  
 200+00.00  
 200+00.00

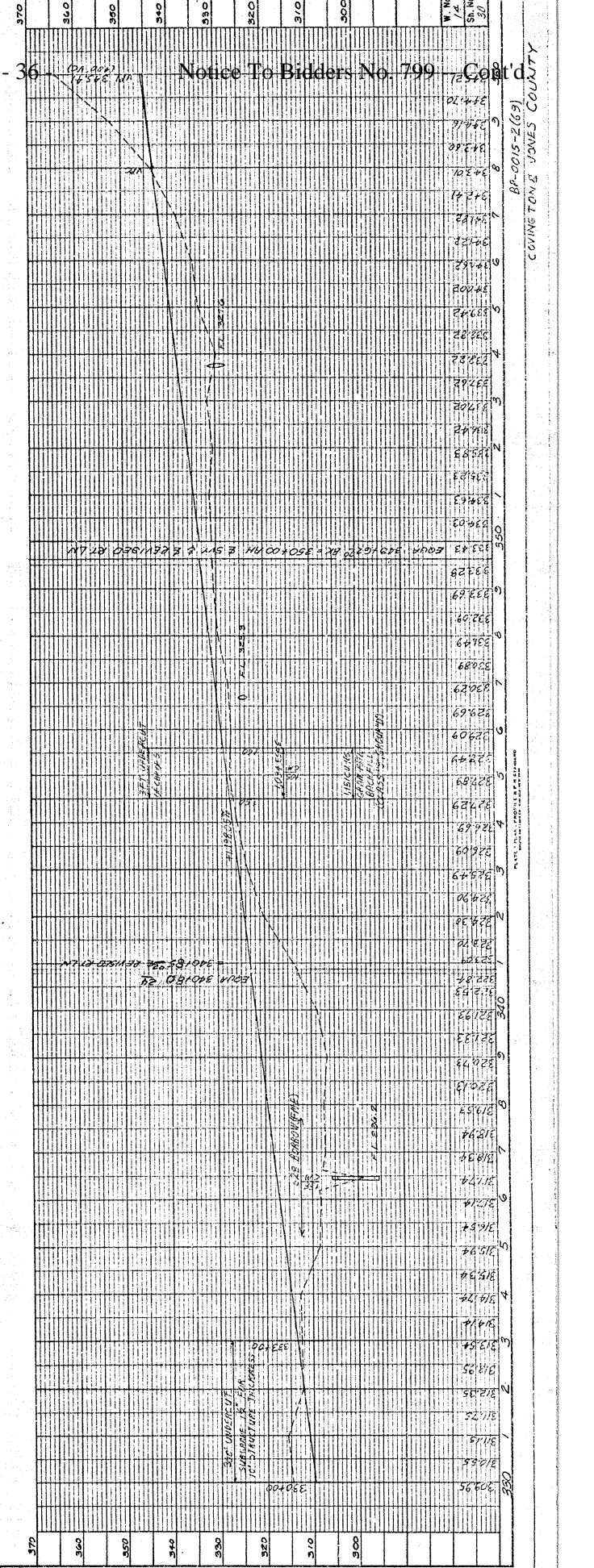
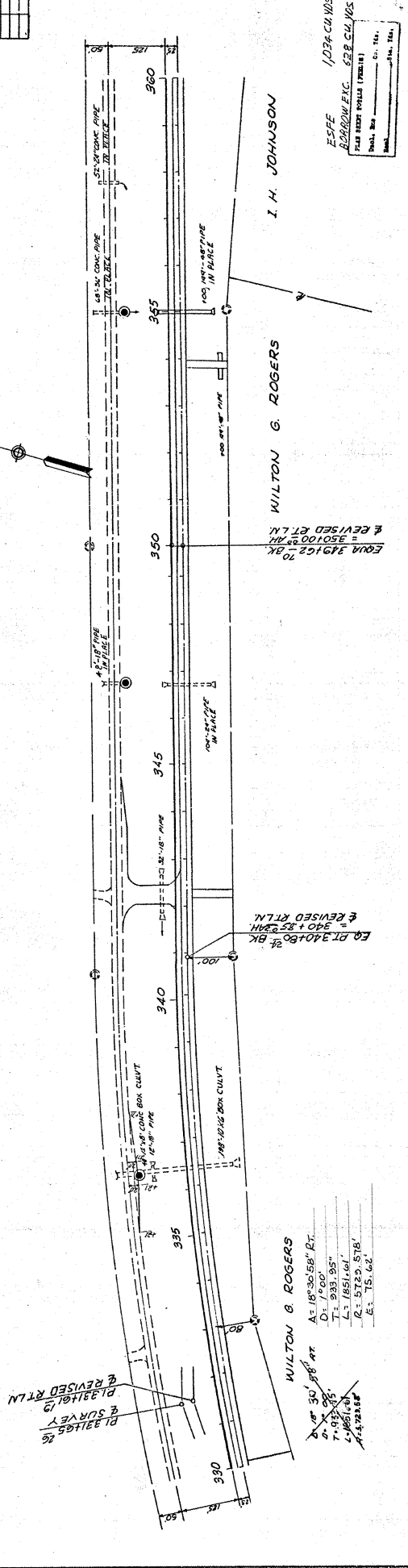

PLAN

NOTE BOOK

PL 3185 26 & SURVEY & REVISED RTLN

PL 3185 19 & SURVEY & REVISED RTLN

WILTON G. ROGERS

I. H. JOHNSON

NOTICE TO BIDDERS NO. 799

CONTRACT NO. 0015-2(69)

MISSISSIPPI

PROJECT NO.	BP-005-2(69)
STATE	MISS.
DATE	BT
REVISIONS	

B.M. STATION 305.720  
 200+00.00  
 200+00.00  
 200+00.00

B.M. STATION 305.720  
 200+00.00  
 200+00.00  
 200+00.00

B.M. STATION 305.720  
 200+00.00  
 200+00.00  
 200+00.00

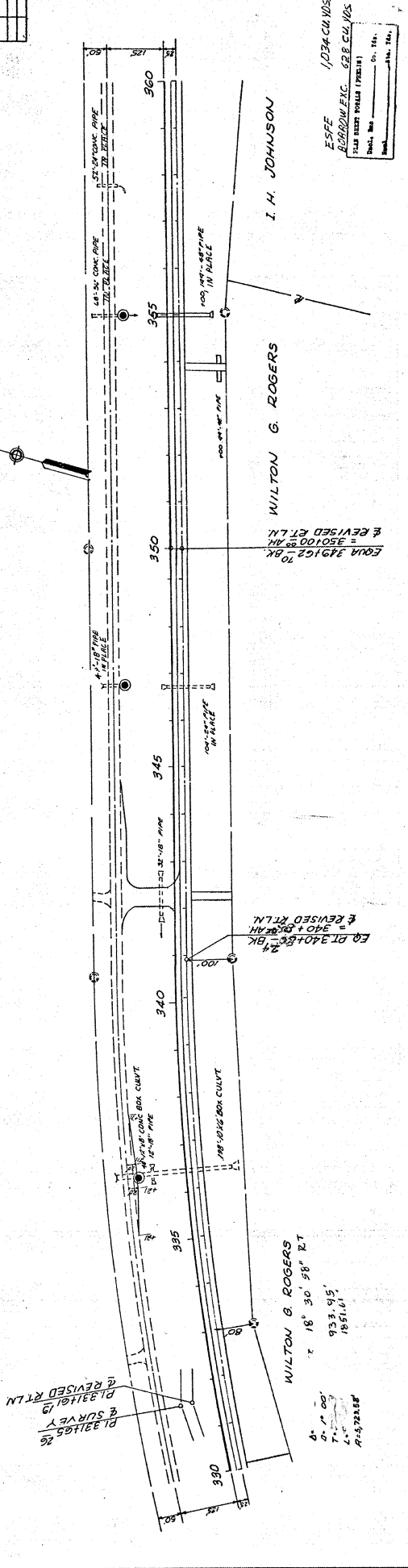

STATION	ELEVATION
330+00	320.95
331+00	318.55
332+00	317.75
333+00	317.35
334+00	317.15
335+00	317.05
336+00	317.00
337+00	316.95
338+00	316.90
339+00	316.85
340+00	316.80
341+00	316.75
342+00	316.70
343+00	316.65
344+00	316.60
345+00	316.55
346+00	316.50
347+00	316.45
348+00	316.40
349+00	316.35
350+00	316.30
351+00	316.25
352+00	316.20
353+00	316.15
354+00	316.10
355+00	316.05
356+00	316.00
357+00	315.95
358+00	315.90
359+00	315.85
360+00	315.80
361+00	315.75
362+00	315.70
363+00	315.65
364+00	315.60
365+00	315.55
366+00	315.50
367+00	315.45
368+00	315.40
369+00	315.35
370+00	315.30

NOTICE TO BIDDERS NO. 799 - CONT'D  
 BP-005-2(69)  
 CORNINGTON & JONES COUNTY



REVISIONS	DATE BY

PROJECT NO. BP-0015-2 (P2)  
STATE MISS.  
DATE BY

PLAN ELEV. 350.00  
DATE BY

PLAN ELEV. 350.00  
DATE BY

PLAN ELEV. 350.00  
DATE BY

PLAN ELEV. 350.00  
DATE BY

PLAN ELEV. 350.00  
DATE BY

PLAN ELEV. 350.00  
DATE BY

PLAN ELEV. 350.00  
DATE BY

PLAN ELEV. 350.00  
DATE BY

PLAN ELEV. 350.00  
DATE BY

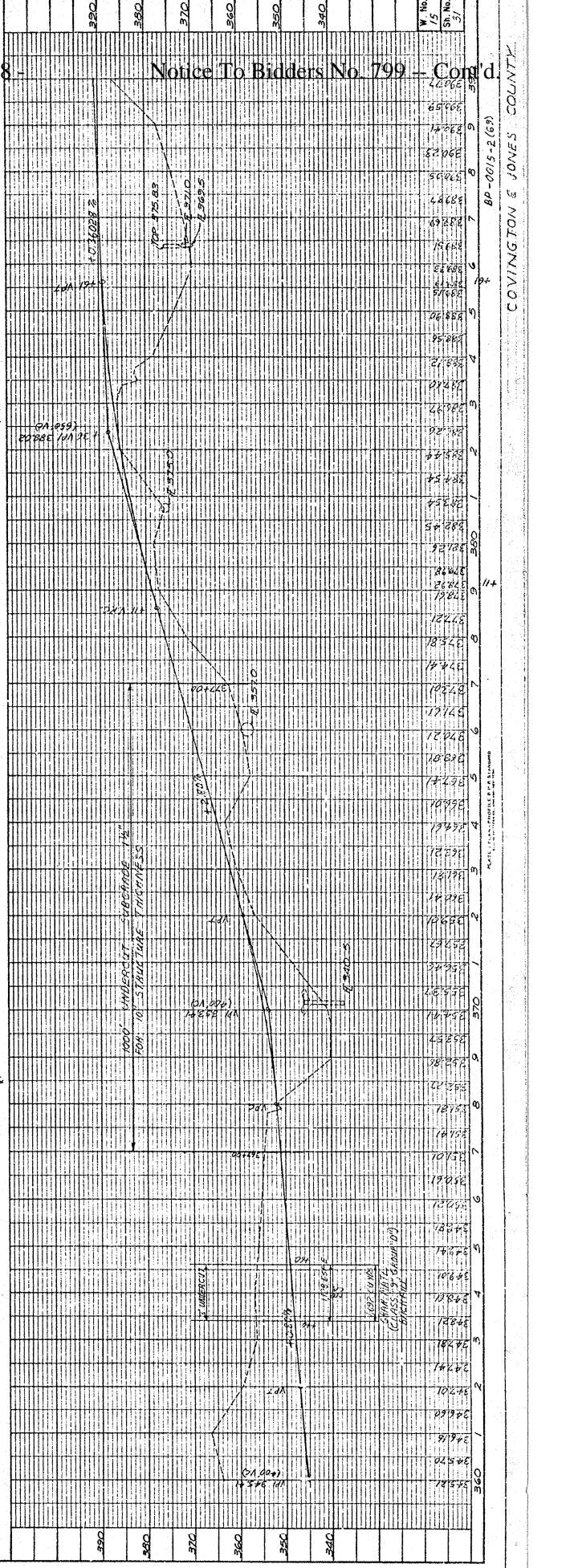
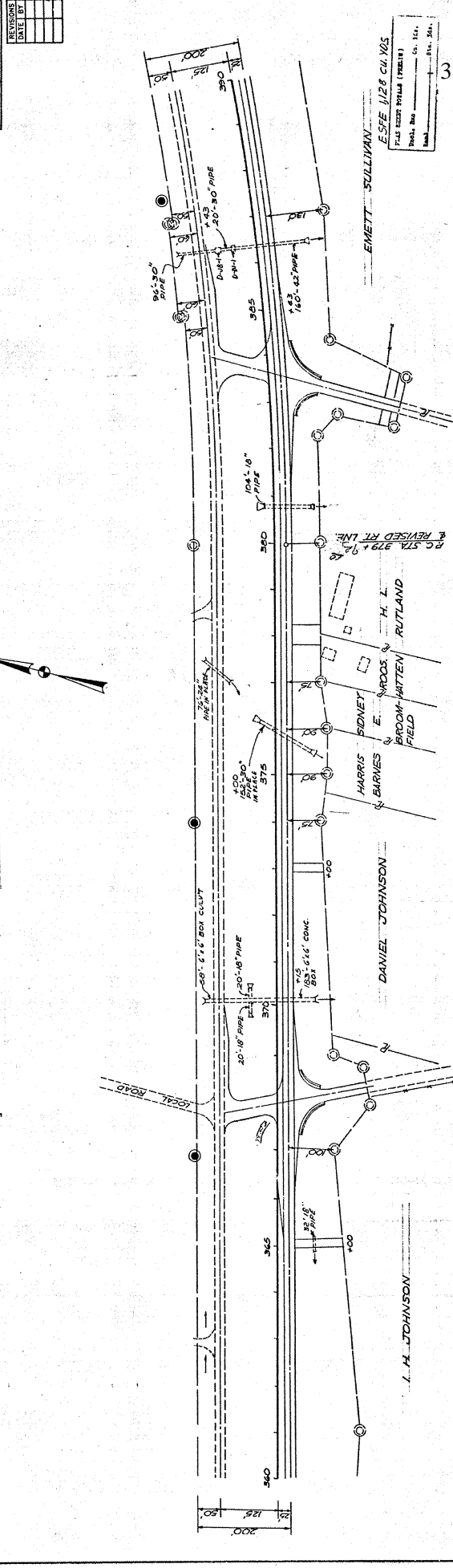

DATE	
BY	
CHECKED	
APPROVED	

PROJECT NO.	BP-0015-2 (P2)
STATE	MISS.
DATE BY	

COVINGTON & JONES COUNTY

Notice To Bidders No. 799 - Cont'd

EMETT SULLIVAN  
ESPE 1128 CU 1005  
PLS REFER TO FILE (PROJECT)  
Sheet No. 96 of 121



PROJECT NO. MISS. 8A-0015-2(6)  
 STATE PROJECT NO. MISS. 8A-0015-2(6)  
 DATE BY

8 M. ELEV. 273.230  
 20.5' IN. 40' DIAM.  
 200' IN. 24" DIA.

8 M. ELEV. 327.824  
 20.5' IN. 40' DIAM.  
 200' IN. 24" DIA.

8 M. ELEV. 400.603  
 20.5' IN. 40' DIAM.  
 200' IN. 24" DIA.

4 = 2.16 20.01' CT  
 5 = 1.23 13.0  
 6 = 0.22 2.43 3.0  
 S.F. = 0.039/FT  
 CASE I

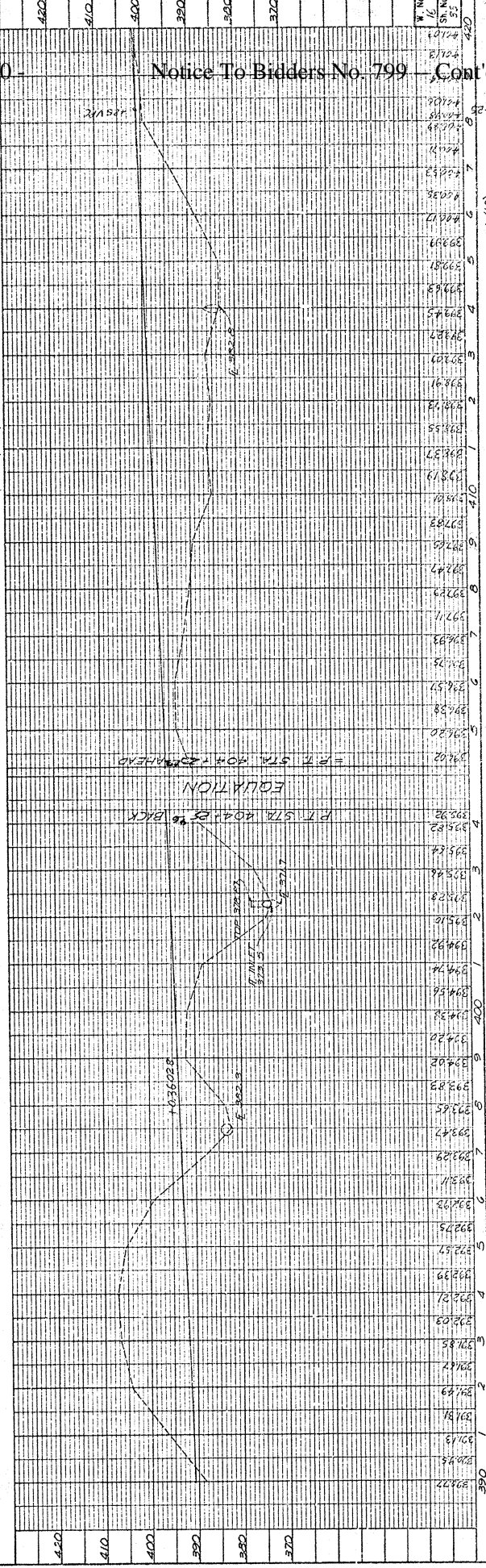
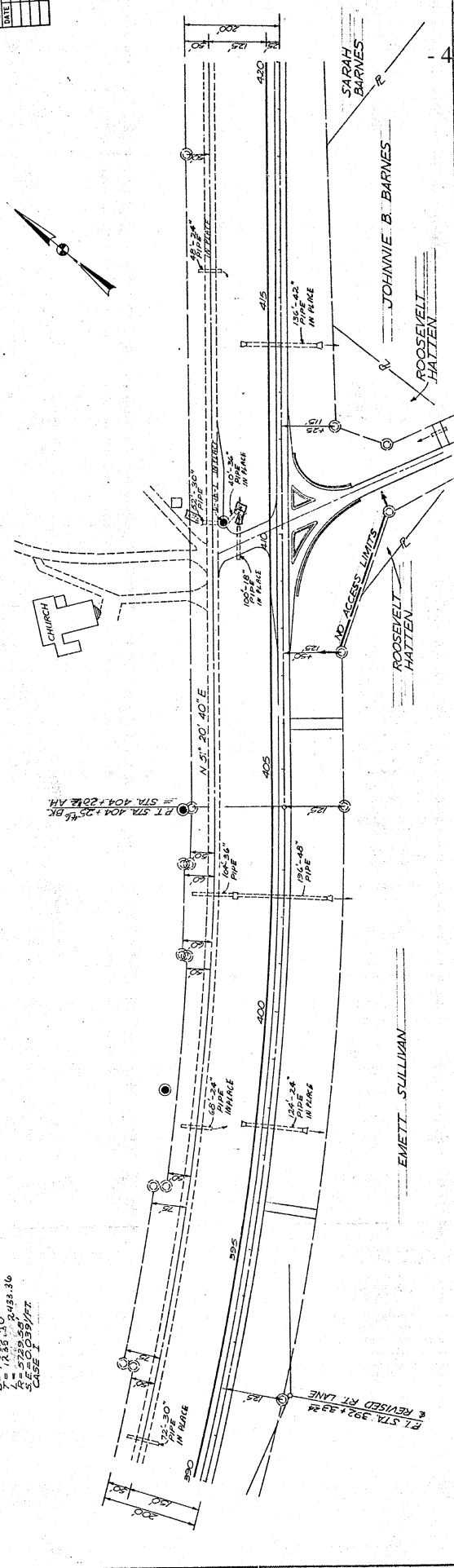

PROFILE

DATE	BY
SCALE	VERTICAL
SCALE	HORIZONTAL
NOTE	SEE DRAWING

PLAN

DATE	BY
SCALE	VERTICAL
SCALE	HORIZONTAL
NOTE	SEE DRAWING

PA-0015-2 (65)  
 COVINGTON & JONES COUNTY

STATE	PROJECT NO.
MISS.	BP-0015-2(2)
REVISIONS	DATE BY

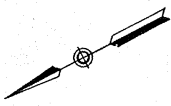
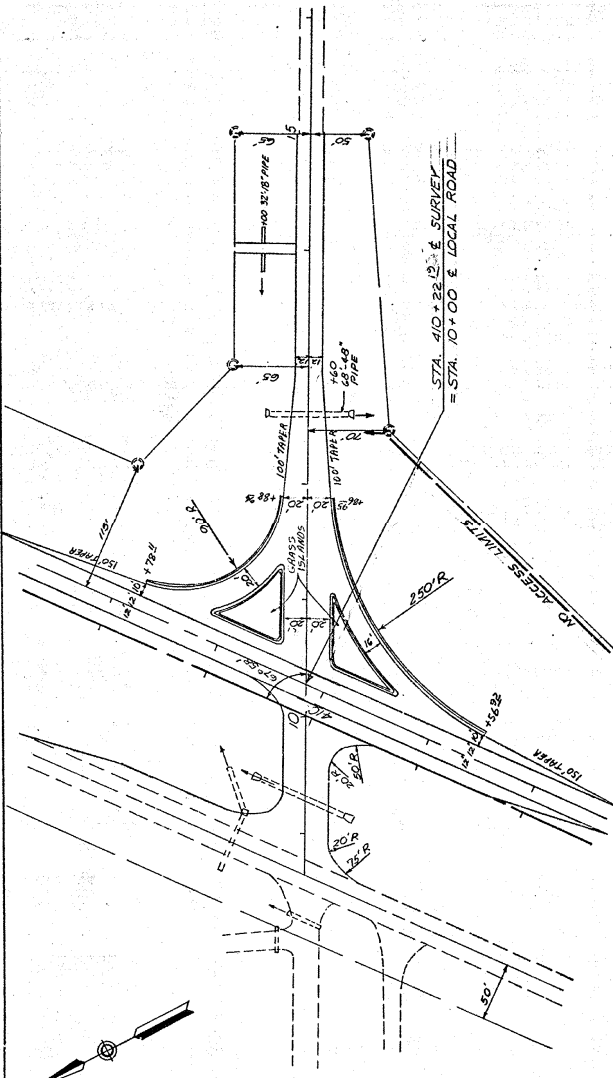

DATE	BY

69

DATE	BY

- 41 - Notice To Bidders No. 799 - Cont'd

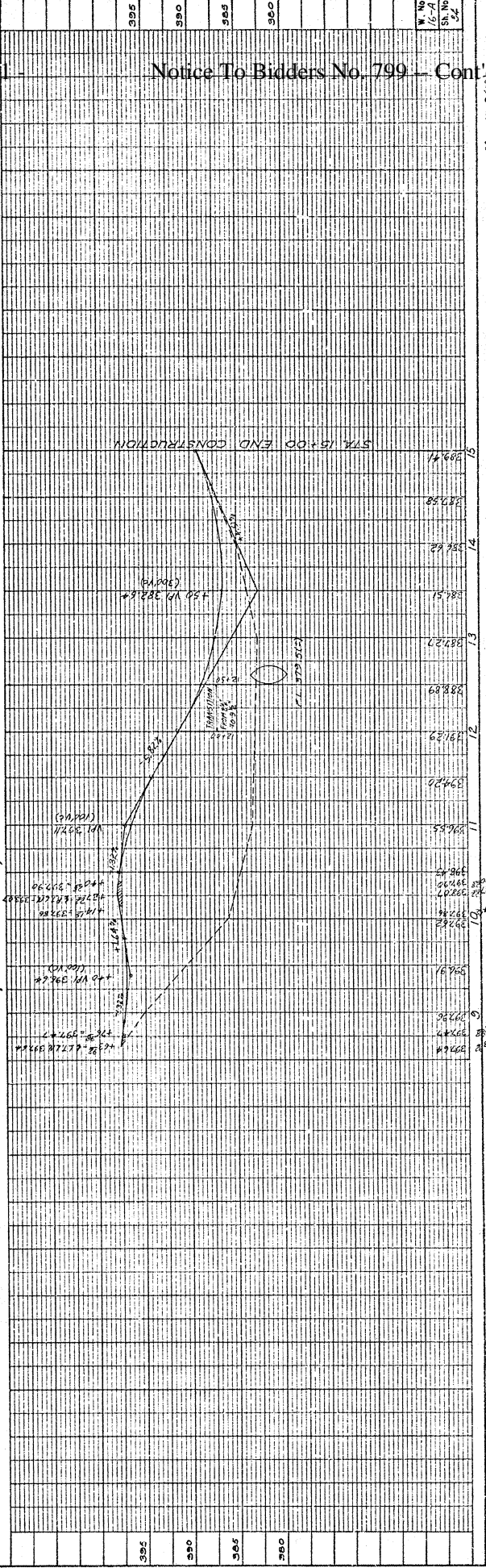

BP-005-2(2)  
LOCAL RD. @ STA. 410+05.3  
COMINGTON & JONES CO.

PROJECT NO.   
 DATE   
 MISS. B.F. 005-2(69)   
 REVISIONS   
 DATE BY

B.M. ELEV. 335.712   
 335.712   
 335.712

B.M. ELEV. 335.712   
 335.712   
 335.712

B.M. ELEV. 335.712   
 335.712   
 335.712

B.M. ELEV. 335.712   
 335.712   
 335.712

B.M. ELEV. 335.712   
 335.712   
 335.712

B.M. ELEV. 335.712   
 335.712   
 335.712

B.M. ELEV. 335.712   
 335.712   
 335.712

B.M. ELEV. 335.712   
 335.712   
 335.712

B.M. ELEV. 335.712   
 335.712   
 335.712

B.M. ELEV. 335.712   
 335.712   
 335.712

B.M. ELEV. 335.712   
 335.712   
 335.712

B.M. ELEV. 335.712   
 335.712   
 335.712

B.M. ELEV. 335.712   
 335.712   
 335.712

B.M. ELEV. 335.712   
 335.712   
 335.712

EROSION CONTROL ITEM	ITEM REQ'D.	SHT.	TOTAL
PAVED DITCH		2	1

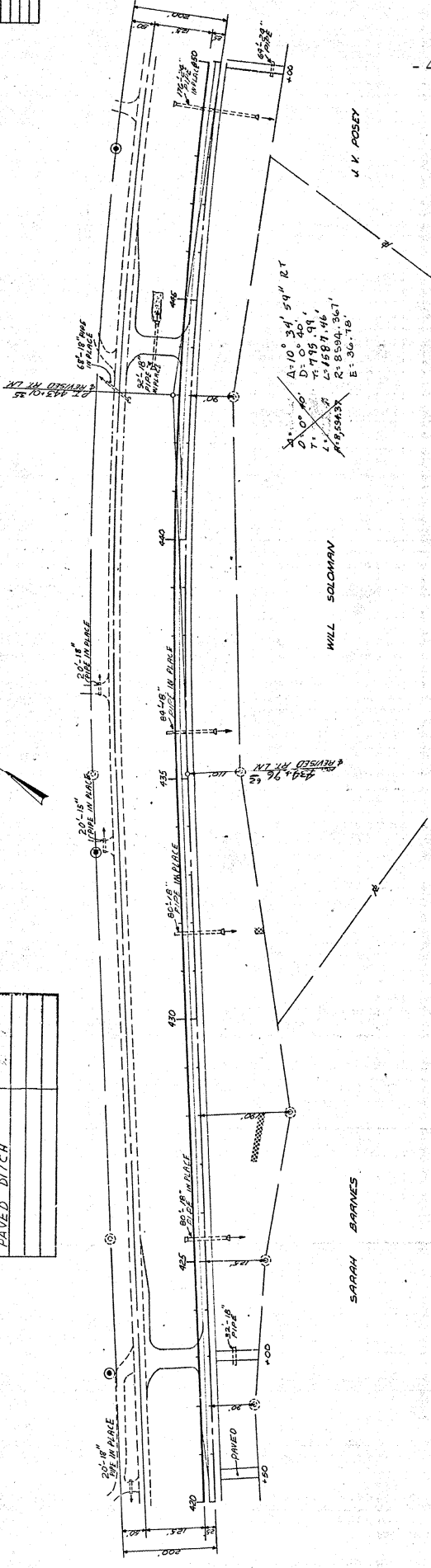

- 42 -

Notice To Bidders No. 799 - Cont'd

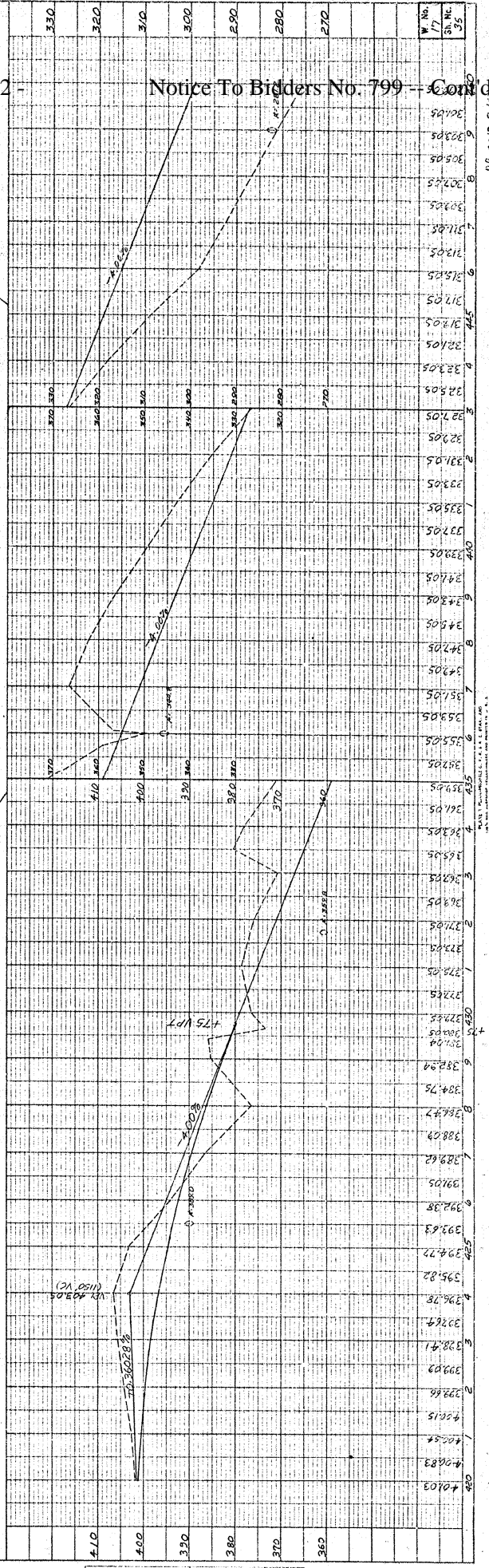

W. No.   
 17   
 155

B.F. 005-2(69)   
 COVINGTON & JONES COUNTY

PLAN	DATE

PROFILE	DATE

STATE PROJECT NO.  
MISS. 5P-0015-2(69)

DATE: 12/11/69  
BY: [Signature]

B.M. ELEV. 227.024  
201' N. 87° 15' W. 127.75'

B.M. ELEV. 227.024  
201' N. 87° 15' W. 127.75'

B.M. ELEV. 227.024  
201' N. 87° 15' W. 127.75'

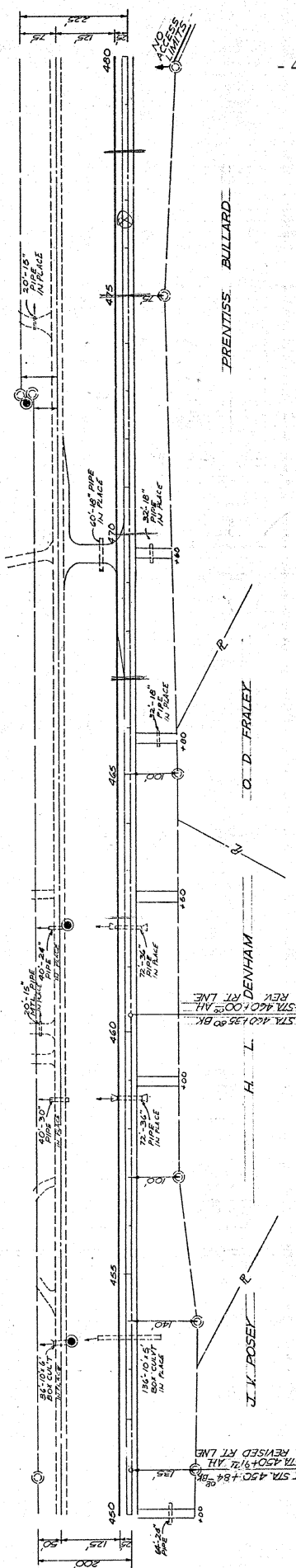

STATION	ELEVATION	W. No.	L. No.	S. No.	35
450	229.05	466	27	9	9
451	229.23	466	27	9	9
452	229.41	466	27	9	9
453	229.59	466	27	9	9
454	229.77	466	27	9	9
455	229.95	466	27	9	9
456	230.13	466	27	9	9
457	230.31	466	27	9	9
458	230.49	466	27	9	9
459	230.67	466	27	9	9
460	230.85	466	27	9	9
461	231.03	466	27	9	9
462	231.21	466	27	9	9
463	231.39	466	27	9	9
464	231.57	466	27	9	9
465	231.75	466	27	9	9
466	231.93	466	27	9	9
467	232.11	466	27	9	9
468	232.29	466	27	9	9
469	232.47	466	27	9	9
470	232.65	466	27	9	9
471	232.83	466	27	9	9
472	233.01	466	27	9	9
473	233.19	466	27	9	9
474	233.37	466	27	9	9
475	233.55	466	27	9	9
476	233.73	466	27	9	9
477	233.91	466	27	9	9
478	234.09	466	27	9	9
479	234.27	466	27	9	9
480	234.45	466	27	9	9
481	234.63	466	27	9	9
482	234.81	466	27	9	9
483	234.99	466	27	9	9
484	235.17	466	27	9	9
485	235.35	466	27	9	9
486	235.53	466	27	9	9
487	235.71	466	27	9	9
488	235.89	466	27	9	9
489	236.07	466	27	9	9
490	236.25	466	27	9	9
491	236.43	466	27	9	9
492	236.61	466	27	9	9
493	236.79	466	27	9	9
494	236.97	466	27	9	9
495	237.15	466	27	9	9
496	237.33	466	27	9	9
497	237.51	466	27	9	9
498	237.69	466	27	9	9
499	237.87	466	27	9	9
500	238.05	466	27	9	9

BP-0015-2(69)  
COMINGTON & JONES COUNTY

1981

PROJECT NO. MISS. 5P-0015-2(62)  
 DATE BY

PLAN ELEV. 250.00  
 250.00  
 250.00

PLAN ELEV. 250.00  
 250.00  
 250.00

PLAN ELEV. 250.00  
 250.00  
 250.00

PLAN ELEV. 250.00  
 250.00  
 250.00

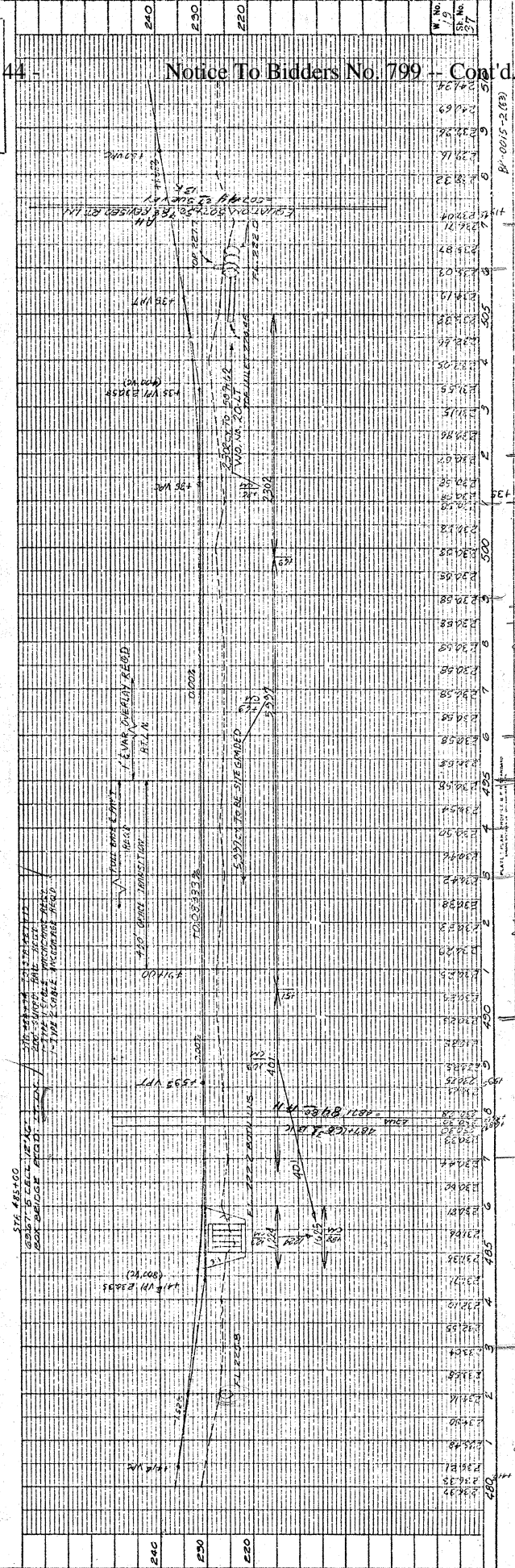
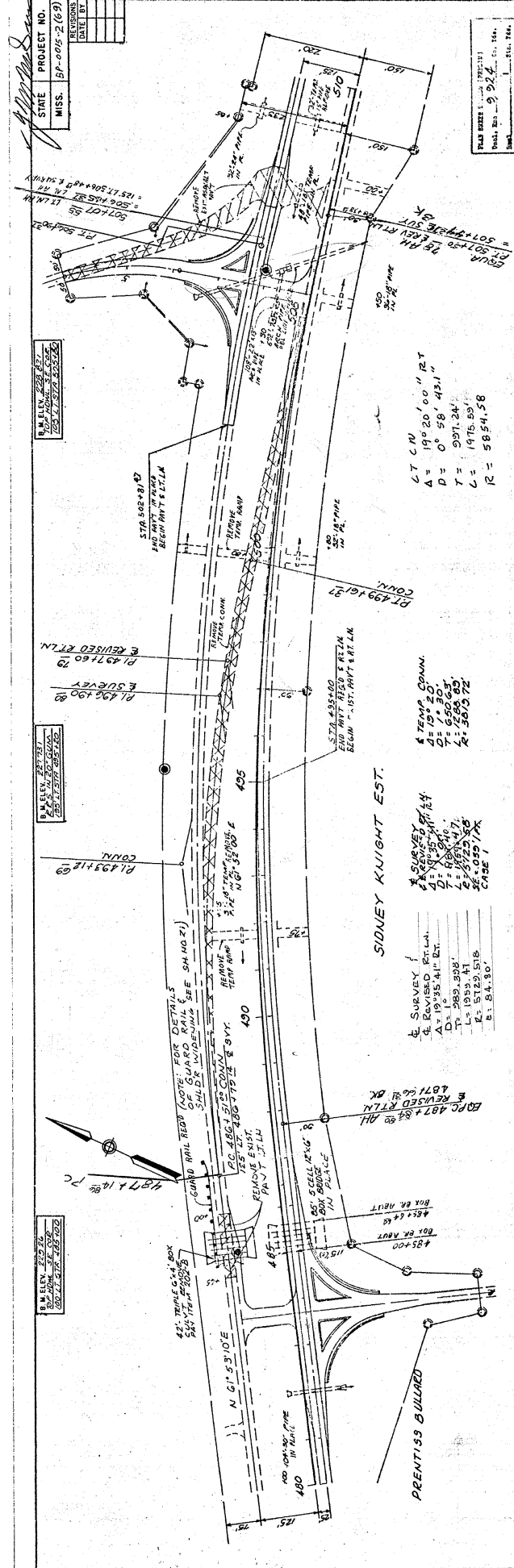

Notice To Bidders No. 799 - Cont'd

MISSISSIPPI  
 JONES COUNTY

MAN  
 DATE  
 TIME







PROJECT NO. MISS. BF-005-2 (62)  
 DATE BY

B. B. ELEY, INC.  
 1000 N. W. 10th St.  
 Ft. Lauderdale, Fla. 33304

1 SURVEY  
 Δ 11° 25' LT  
 D = 571.49  
 L = 740.50  
 R = 369.71

SUPER EL. 0.250 FT. WITH  
 EXTRA WIDTH ON INSIDE Δ PT  
 SEE ENG. SECT. CASE 1

2 SURVEY  
 Δ 11° 25' LT  
 D = 571.49  
 L = 740.50  
 R = 369.71

B. B. ELEY, INC.  
 1000 N. W. 10th St.  
 Ft. Lauderdale, Fla. 33304

DATE  
 DRAWN BY  
 CHECKED BY  
 PROJECT ENGINEER

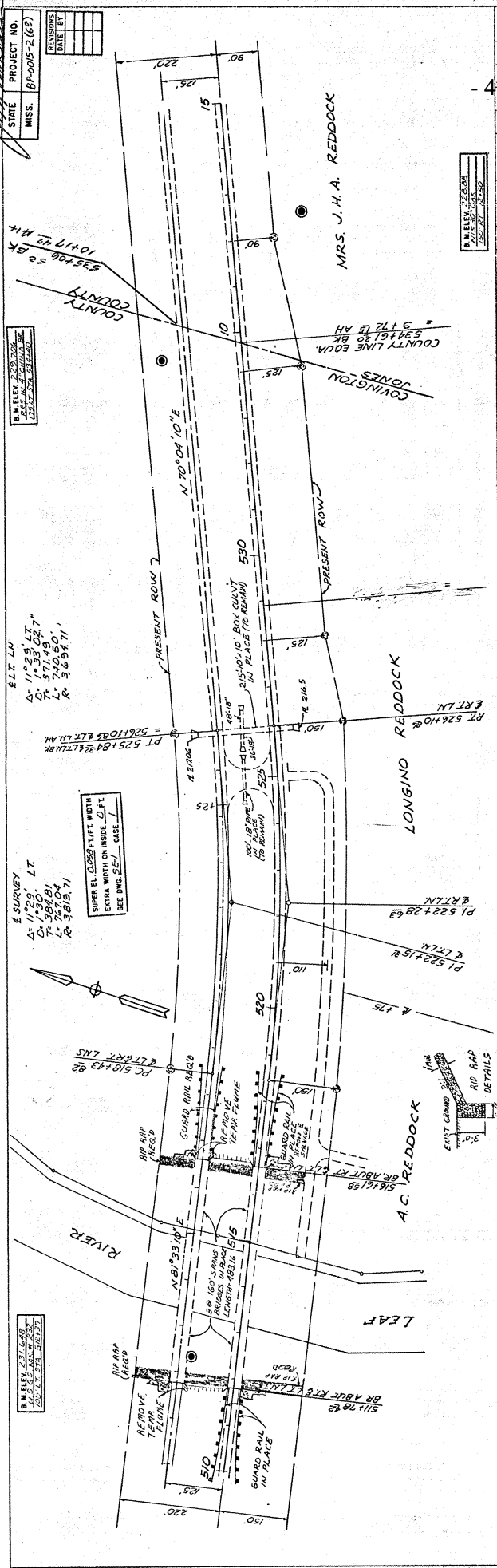

- 47 -

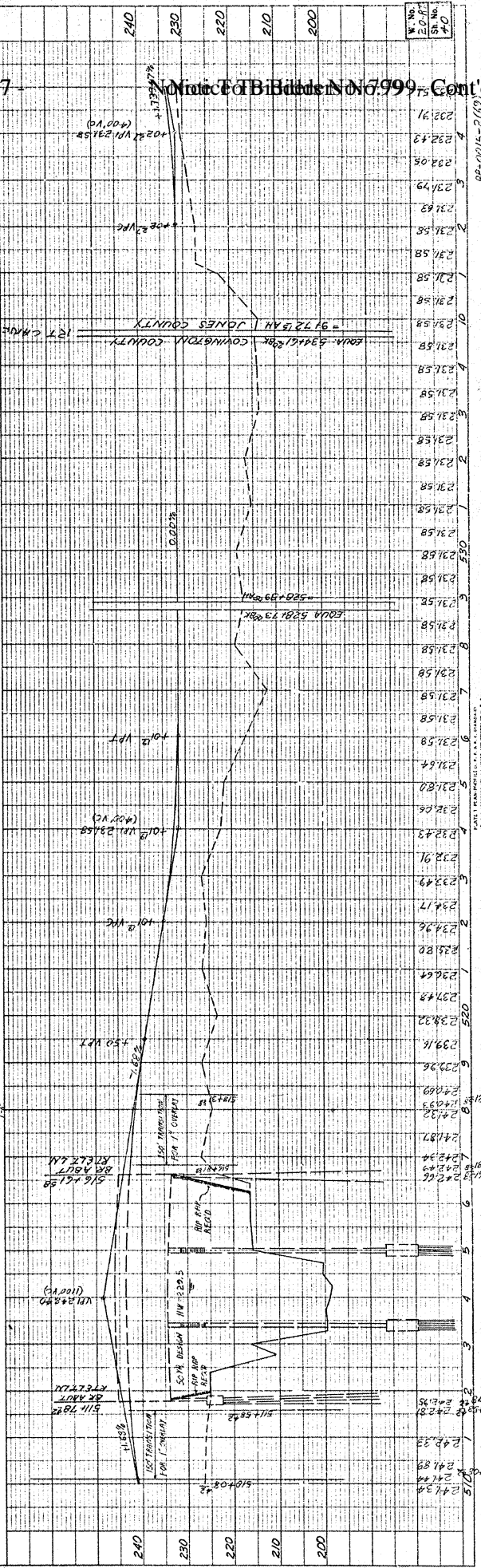

PROJECT NO. MISS. BF-005-2 (62)

B. B. ELEY, INC.  
 1000 N. W. 10th St.  
 Ft. Lauderdale, Fla. 33304

1 SURVEY  
 Δ 11° 25' LT  
 D = 571.49  
 L = 740.50  
 R = 369.71

B. B. ELEY, INC.  
 1000 N. W. 10th St.  
 Ft. Lauderdale, Fla. 33304

DATE  
 DRAWN BY  
 CHECKED BY  
 PROJECT ENGINEER



PROJECT NO.	STATE	MISS.
202-003-2(6)	MISS.	202-003-2(6)
REVISIONS	DATE	BY

SUPER ELEV. 0.25 FT/FT W/TH  
EXTRA WIDTH ON INSIDE 0. FT  
SEE ENG. SE-1 CASE 1

SHOULDER & LT LN  
4 = 11' 00" LT  
D = 17' 30"  
7 = 364.01'  
L = 740.80'  
R = 3,610.71'



N. M. ELEV. 511.76  
511.76  
511.76

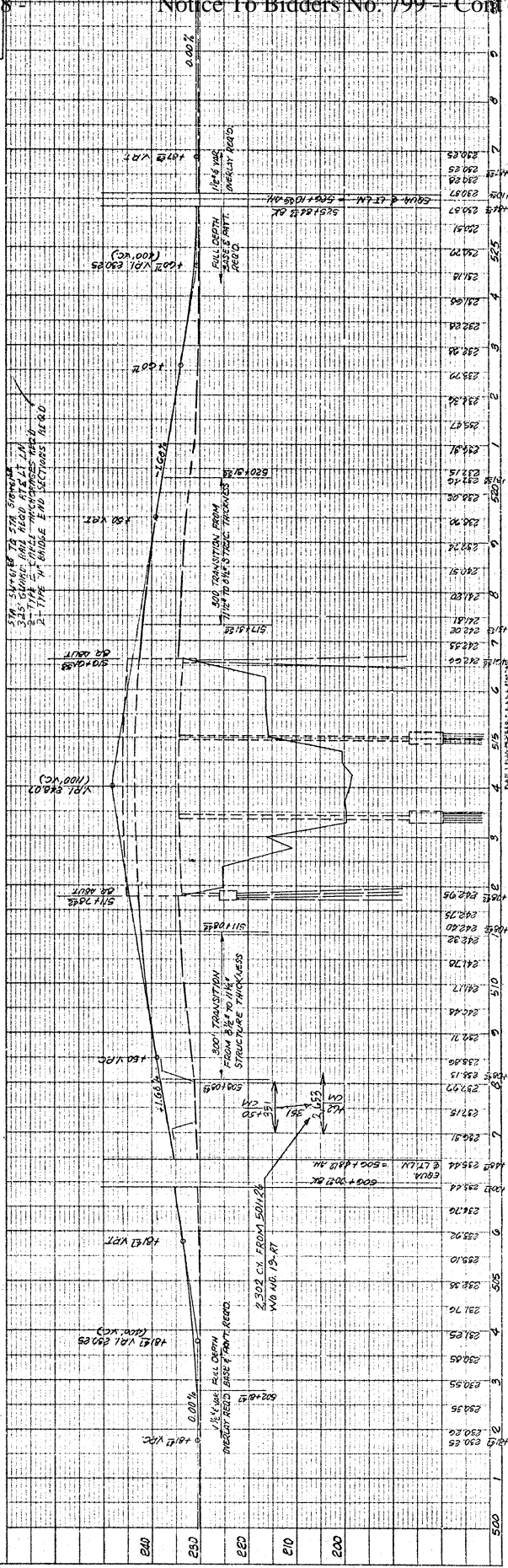
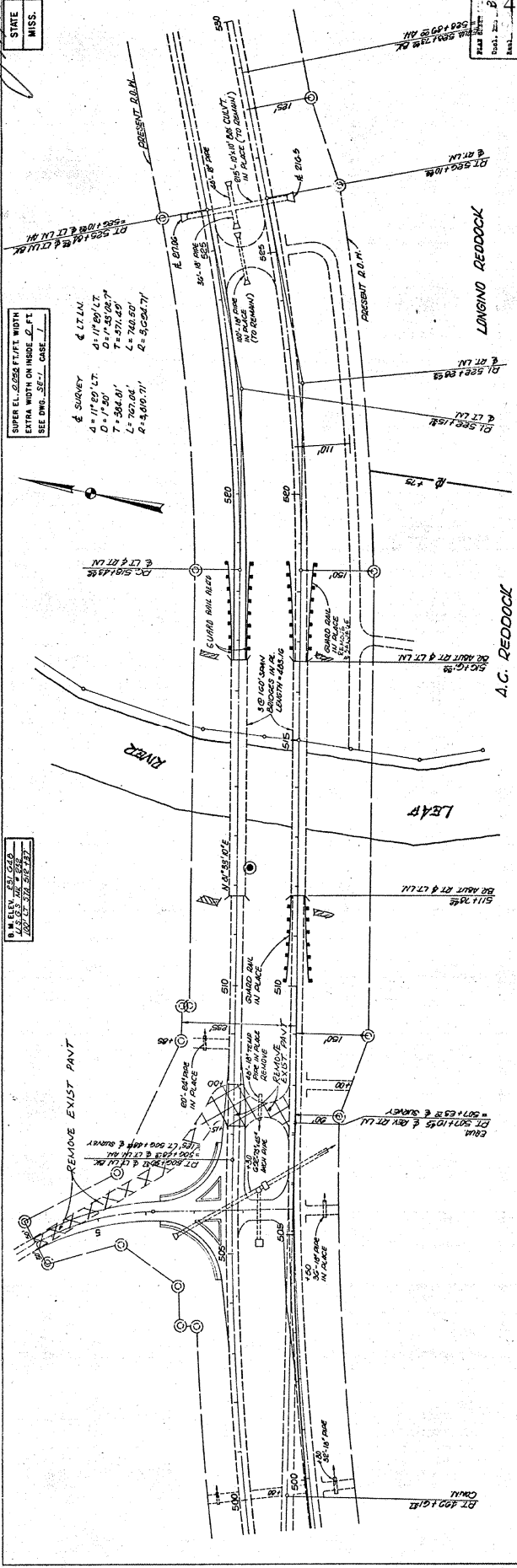

# Notice To Bidders No. 799 - Cont.

STATE OF MISSISSIPPI  
COUNTY OF JONES COUNTY

NO.	DATE	REVISION
1		
2		

NO.	DATE	REVISION
1		
2		

STATE PROJECT NO. MISS. BP-0015-2(3)  
 REVISIONS DATE BY

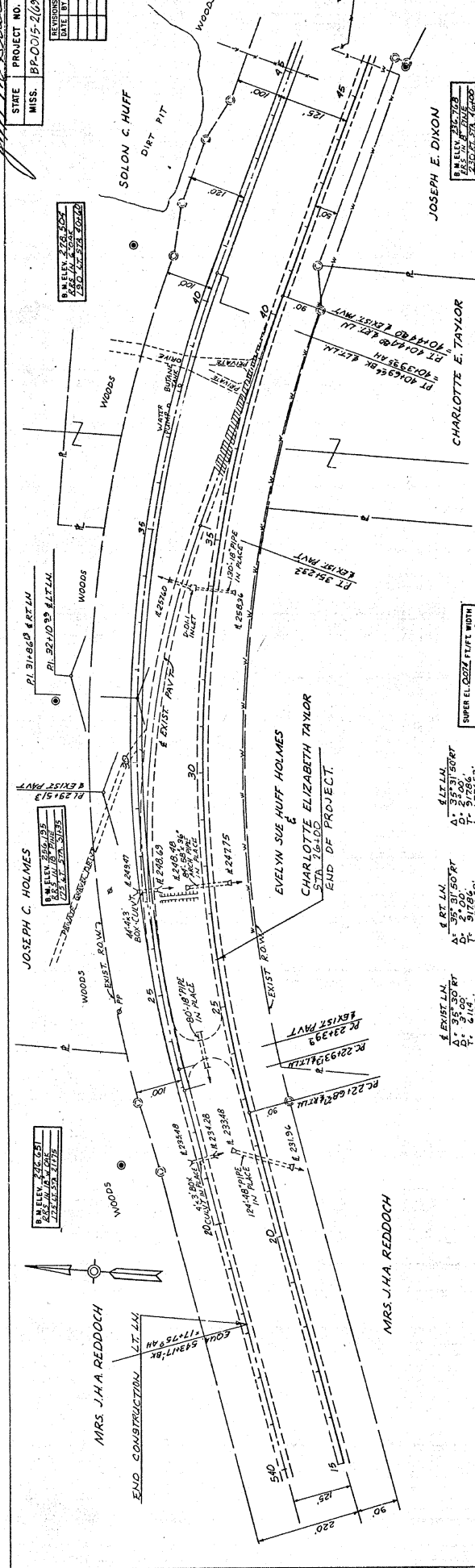

49

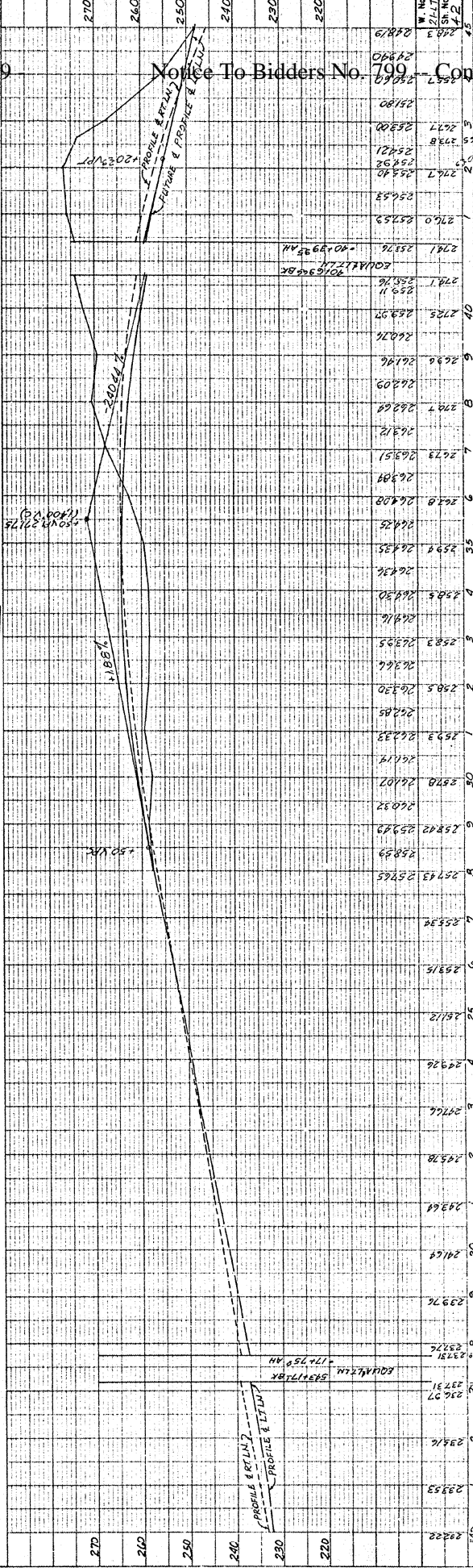

STATION	ELEVATION
270+00	268.79
269+50	268.69
269+00	268.00
268+50	267.77
268+00	267.42
267+50	266.53
267+00	266.53
266+50	266.53
266+00	266.53
265+50	266.53
265+00	266.53
264+50	266.53
264+00	266.53
263+50	266.53
263+00	266.53
262+50	266.53
262+00	266.53
261+50	266.53
261+00	266.53
260+50	266.53
260+00	266.53
259+50	266.53
259+00	266.53
258+50	266.53
258+00	266.53
257+50	266.53
257+00	266.53
256+50	266.53
256+00	266.53
255+50	266.53
255+00	266.53
254+50	266.53
254+00	266.53
253+50	266.53
253+00	266.53
252+50	266.53
252+00	266.53
251+50	266.53
251+00	266.53
250+50	266.53
250+00	266.53
249+50	266.53
249+00	266.53
248+50	266.53
248+00	266.53
247+50	266.53
247+00	266.53
246+50	266.53
246+00	266.53
245+50	266.53
245+00	266.53
244+50	266.53
244+00	266.53
243+50	266.53
243+00	266.53
242+50	266.53
242+00	266.53
241+50	266.53
241+00	266.53
240+50	266.53
240+00	266.53
239+50	266.53
239+00	266.53
238+50	266.53
238+00	266.53
237+50	266.53
237+00	266.53
236+50	266.53
236+00	266.53
235+50	266.53
235+00	266.53
234+50	266.53
234+00	266.53
233+50	266.53
233+00	266.53
232+50	266.53
232+00	266.53
231+50	266.53
231+00	266.53
230+50	266.53
230+00	266.53
229+50	266.53
229+00	266.53
228+50	266.53
228+00	266.53
227+50	266.53
227+00	266.53
226+50	266.53
226+00	266.53
225+50	266.53
225+00	266.53
224+50	266.53
224+00	266.53
223+50	266.53
223+00	266.53
222+50	266.53
222+00	266.53
221+50	266.53
221+00	266.53
220+50	266.53
220+00	266.53

BP-0015-2(3)  
 COVINGTON & JONES COUNTY

STRE PROJECT NO.  
MISS. BP-0015-2(63)

DATE BY	DATE BY

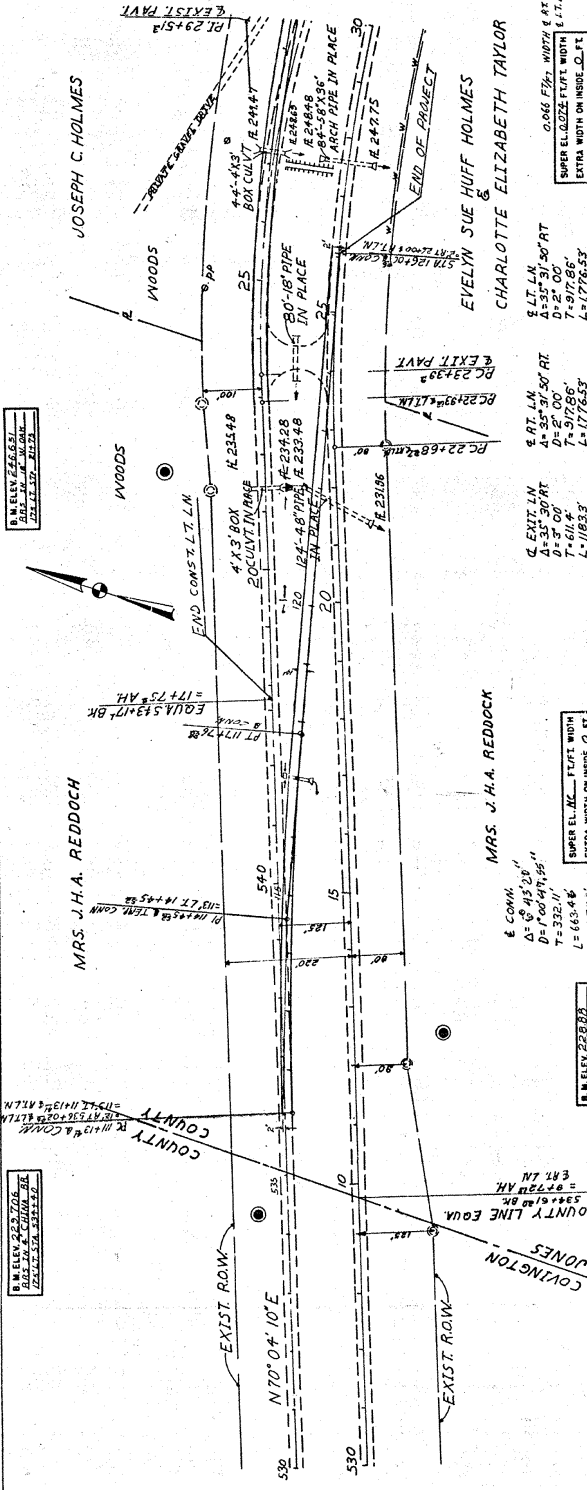

B.M. ELEV. 226.52  
226.52  
226.52  
226.52

B.M. ELEV. 222.706  
222.706  
222.706  
222.706

BEFORE 2.26.57  
PLAN REFER TO THIS (PHE-13)  
Sheet No. 2206

8.01 L.M.  
A=357.51, 50' AT  
D=2' 00"  
T=917.86'  
L=1778.33'  
A=2,869.75'

8.01 L.M.  
A=357.51, 50' AT  
D=2' 00"  
T=917.86'  
L=1778.33'  
A=2,869.75'

8.01 L.M.  
A=357.51, 50' AT  
D=2' 00"  
T=917.86'  
L=1778.33'  
A=2,869.75'

8.01 L.M.  
A=357.51, 50' AT  
D=2' 00"  
T=917.86'  
L=1778.33'  
A=2,869.75'

8.01 L.M.  
A=357.51, 50' AT  
D=2' 00"  
T=917.86'  
L=1778.33'  
A=2,869.75'

8.01 L.M.  
A=357.51, 50' AT  
D=2' 00"  
T=917.86'  
L=1778.33'  
A=2,869.75'

8.01 L.M.  
A=357.51, 50' AT  
D=2' 00"  
T=917.86'  
L=1778.33'  
A=2,869.75'

8.01 L.M.  
A=357.51, 50' AT  
D=2' 00"  
T=917.86'  
L=1778.33'  
A=2,869.75'

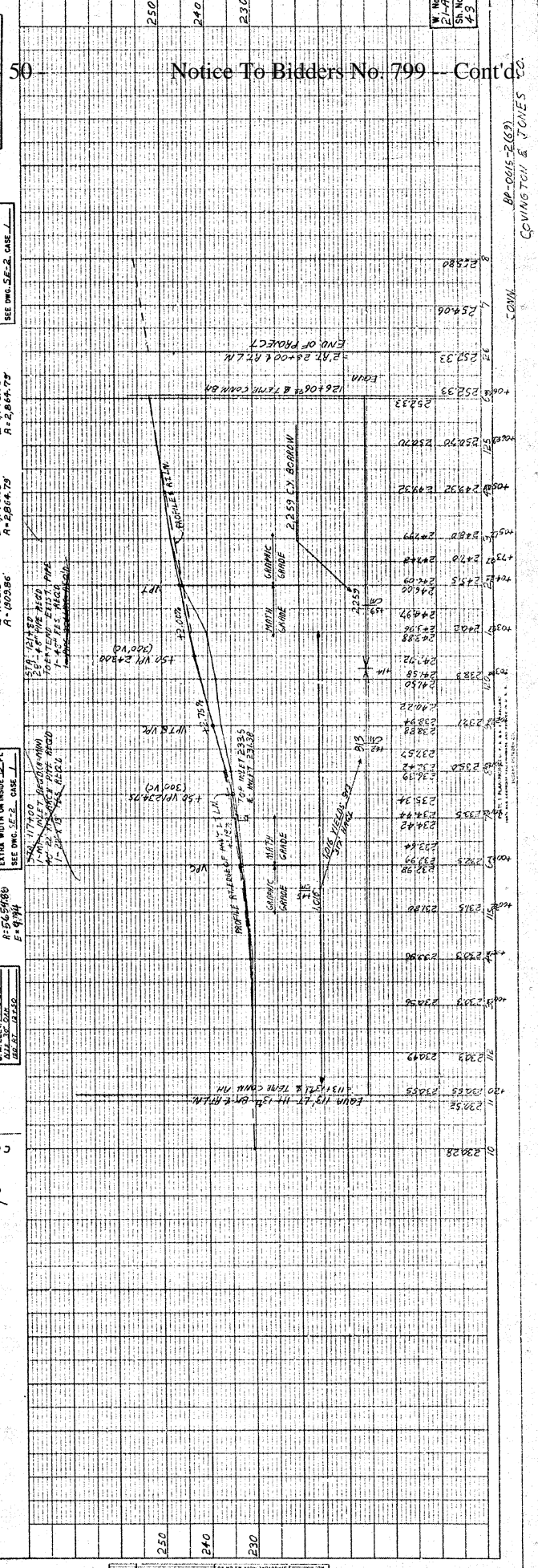

STATION	ELEVATION
23028	230.28
23032	230.32
23036	230.36
23040	230.40
23044	230.44
23048	230.48
23052	230.52
23056	230.56
23060	230.60
23064	230.64
23068	230.68
23072	230.72
23076	230.76
23080	230.80
23084	230.84
23088	230.88
23092	230.92
23096	230.96
23100	231.00
23104	231.04
23108	231.08
23112	231.12
23116	231.16
23120	231.20
23124	231.24
23128	231.28
23132	231.32
23136	231.36
23140	231.40
23144	231.44
23148	231.48
23152	231.52
23156	231.56
23160	231.60
23164	231.64
23168	231.68
23172	231.72
23176	231.76
23180	231.80
23184	231.84
23188	231.88
23192	231.92
23196	231.96
23200	232.00
23204	232.04
23208	232.08
23212	232.12
23216	232.16
23220	232.20
23224	232.24
23228	232.28
23232	232.32
23236	232.36
23240	232.40
23244	232.44
23248	232.48
23252	232.52
23256	232.56
23260	232.60
23264	232.64
23268	232.68
23270	232.70

DATE

PLAN

PROFILE

General Decision Number: MS180228 01/05/2018 MS228

Superseded General Decision Number: MS20170228

State: Mississippi

Construction Type: Highway

Counties: Claiborne, Covington, Franklin, Issaquena, Sharkey, Walthall and Wilkinson Counties in Mississippi.

#### HIGHWAY CONSTRUCTION PROJECTS

Note: Under Executive Order (EO) 13658, an hourly minimum wage of \$10.35 for calendar year 2018 applies to all contracts subject to the Davis-Bacon Act for which the contract is awarded (and any solicitation was issued) on or after January 1, 2015. If this contract is covered by the EO, the contractor must pay all workers in any classification listed on this wage determination at least \$10.35 per hour (or the applicable wage rate listed on this wage determination, if it is higher) for all hours spent performing on the contract in calendar year 2018. The EO minimum wage rate will be adjusted annually. Please note that this EO applies to the above-mentioned types of contracts entered into by the federal government that are subject to the Davis-Bacon Act itself, but it does not apply to contracts subject only to the Davis-Bacon Related Acts, including those set forth at 29 CFR 5.1(a)(2)-(60). Additional information on contractor requirements and worker protections under the EO is available at [www.dol.gov/whd/govcontracts](http://www.dol.gov/whd/govcontracts).

Modification Number	Publication Date
0	01/05/2018

SUMS2010-047 08/04/2014

	Rates	Fringes
CARPENTER (Form Work Only).....	\$ 12.26	0.12
CARPENTER, Excludes Form Work....	\$ 14.21	0.00
CEMENT MASON/CONCRETE FINISHER...	\$ 13.23	0.00
ELECTRICIAN.....	\$ 22.64	7.73
HIGHWAY/PARKING LOT STRIPING:		
Truck Driver (Line Striping Truck).....	\$ 12.63	0.00
INSTALLER - GUARDRAIL.....	\$ 11.42	0.00
INSTALLER - SIGN.....	\$ 12.04	0.00
IRONWORKER, REINFORCING.....	\$ 16.43	0.00

LABORER: Asphalt, Includes Raker, Shoveler, Spreader and Distributor.....	\$ 10.26	0.00
LABORER: Common or General, including concrete work.....	\$ 10.24	0.00
LABORER: Flagger.....	\$ 9.83	0.00
LABORER: Grade Checker.....	\$ 10.67	0.00
LABORER: Landscape.....	\$ 9.82	0.00
LABORER: Mason Tender - Cement/Concrete.....	\$ 11.69	0.00
LABORER: Pipelayer.....	\$ 13.13	0.00
LABORER: Laborer-Cones/ Barricades/Barrels - Setter/Mover/Sweeper.....	\$ 10.53	0.00
OPERATOR: Asphalt Spreader.....	\$ 16.13	0.00
OPERATOR: Backhoe/Excavator/Trackhoe.....	\$ 13.28	0.00
OPERATOR: Broom/Sweeper.....	\$ 10.17	0.00
OPERATOR: Bulldozer.....	\$ 13.30	0.00
OPERATOR: Concrete Saw.....	\$ 13.60	0.00
OPERATOR: Crane.....	\$ 16.00	0.00
OPERATOR: Distributor.....	\$ 11.70	0.00
OPERATOR: Drill.....	\$ 19.22	0.00
OPERATOR: Grader/Blade.....	\$ 13.84	0.00
OPERATOR: Loader.....	\$ 11.73	0.00
OPERATOR: Mechanic.....	\$ 16.28	0.00
OPERATOR: Milling Machine.....	\$ 15.38	0.00
OPERATOR: Mixer.....	\$ 14.85	0.00
OPERATOR: Oiler.....	\$ 13.08	0.48
OPERATOR: Paver (Asphalt, Aggregate, and Concrete).....	\$ 13.01	0.00
OPERATOR: Piledriver.....	\$ 15.13	0.00
OPERATOR: Roller (All Types)....	\$ 11.05	0.00
OPERATOR: Scraper.....	\$ 12.63	0.00

OPERATOR: Tractor.....	\$ 9.98	0.00
OPERATOR: Trencher.....	\$ 15.00	0.00
TRUCK DRIVER: Flatbed Truck.....	\$ 13.29	0.00
TRUCK DRIVER: Lowboy Truck.....	\$ 12.49	0.00
TRUCK DRIVER: Mechanic.....	\$ 12.35	0.00
TRUCK DRIVER: Off the Road Truck.....	\$ 12.31	0.00
TRUCK DRIVER: Water Truck.....	\$ 13.15	0.00
TRUCK DRIVER: Dump Truck (All Types).....	\$ 11.64	0.00
TRUCK DRIVER: Semi/Trailer Truck.....	\$ 17.34	0.00

-----

WELDERS - Receive rate prescribed for craft performing operation to which welding is incidental.

=====

Note: Executive Order (EO) 13706, Establishing Paid Sick Leave for Federal Contractors applies to all contracts subject to the Davis-Bacon Act for which the contract is awarded (and any solicitation was issued) on or after January 1, 2017. If this contract is covered by the EO, the contractor must provide employees with 1 hour of paid sick leave for every 30 hours they work, up to 56 hours of paid sick leave each year. Employees must be permitted to use paid sick leave for their own illness, injury or other health-related needs, including preventive care; to assist a family member (or person who is like family to the employee) who is ill, injured, or has other health-related needs, including preventive care; or for reasons resulting from, or to assist a family member (or person who is like family to the employee) who is a victim of, domestic violence, sexual assault, or stalking. Additional information on contractor requirements and worker protections under the EO is available at [www.dol.gov/whd/govcontracts](http://www.dol.gov/whd/govcontracts).

Unlisted classifications needed for work not included within the scope of the classifications listed may be added after award only as provided in the labor standards contract clauses (29CFR 5.5 (a) (1) (ii)).

-----

The body of each wage determination lists the classification and wage rates that have been found to be prevailing for the cited type(s) of construction in the area covered by the wage determination. The classifications are listed in alphabetical order of "identifiers" that indicate whether the particular rate is a union rate (current union negotiated rate for local),



a survey rate (weighted average rate) or a union average rate (weighted union average rate).

#### Union Rate Identifiers

A four letter classification abbreviation identifier enclosed in dotted lines beginning with characters other than "SU" or "UAVG" denotes that the union classification and rate were prevailing for that classification in the survey. Example: PLUM0198-005 07/01/2014. PLUM is an abbreviation identifier of the union which prevailed in the survey for this classification, which in this example would be Plumbers. 0198 indicates the local union number or district council number where applicable, i.e., Plumbers Local 0198. The next number, 005 in the example, is an internal number used in processing the wage determination. 07/01/2014 is the effective date of the most current negotiated rate, which in this example is July 1, 2014.

Union prevailing wage rates are updated to reflect all rate changes in the collective bargaining agreement (CBA) governing this classification and rate.

#### Survey Rate Identifiers

Classifications listed under the "SU" identifier indicate that no one rate prevailed for this classification in the survey and the published rate is derived by computing a weighted average rate based on all the rates reported in the survey for that classification. As this weighted average rate includes all rates reported in the survey, it may include both union and non-union rates. Example: SULA2012-007 5/13/2014. SU indicates the rates are survey rates based on a weighted average calculation of rates and are not majority rates. LA indicates the State of Louisiana. 2012 is the year of survey on which these classifications and rates are based. The next number, 007 in the example, is an internal number used in producing the wage determination. 5/13/2014 indicates the survey completion date for the classifications and rates under that identifier.

Survey wage rates are not updated and remain in effect until a new survey is conducted.

#### Union Average Rate Identifiers

Classification(s) listed under the UAVG identifier indicate that no single majority rate prevailed for those classifications; however, 100% of the data reported for the classifications was union data. EXAMPLE: UAVG-OH-0010 08/29/2014. UAVG indicates that the rate is a weighted union average rate. OH indicates the state. The next number, 0010 in the example, is an internal number used in producing the wage determination. 08/29/2014 indicates the survey completion date for the classifications and rates under that identifier.

A UAVG rate will be updated once a year, usually in January of each year, to reflect a weighted average of the current negotiated/CBA rate of the union locals from which the rate is based.

-----  
WAGE DETERMINATION APPEALS PROCESS

1.) Has there been an initial decision in the matter? This can be:

- \* an existing published wage determination
- \* a survey underlying a wage determination
- \* a Wage and Hour Division letter setting forth a position on a wage determination matter
- \* a conformance (additional classification and rate) ruling

On survey related matters, initial contact, including requests for summaries of surveys, should be with the Wage and Hour Regional Office for the area in which the survey was conducted because those Regional Offices have responsibility for the Davis-Bacon survey program. If the response from this initial contact is not satisfactory, then the process described in 2.) and 3.) should be followed.

With regard to any other matter not yet ripe for the formal process described here, initial contact should be with the Branch of Construction Wage Determinations. Write to:

Branch of Construction Wage Determinations  
Wage and Hour Division  
U.S. Department of Labor  
200 Constitution Avenue, N.W.  
Washington, DC 20210

2.) If the answer to the question in 1.) is yes, then an interested party (those affected by the action) can request review and reconsideration from the Wage and Hour Administrator (See 29 CFR Part 1.8 and 29 CFR Part 7). Write to:

Wage and Hour Administrator  
U.S. Department of Labor  
200 Constitution Avenue, N.W.  
Washington, DC 20210

The request should be accompanied by a full statement of the interested party's position and by any information (wage payment data, project description, area practice material, etc.) that the requestor considers relevant to the issue.

3.) If the decision of the Administrator is not favorable, an interested party may appeal directly to the Administrative Review Board (formerly the Wage Appeals Board). Write to:

Administrative Review Board  
U.S. Department of Labor  
200 Constitution Avenue, N.W.  
Washington, DC 20210

4.) All decisions by the Administrative Review Board are final.

=====

END OF GENERAL DECISION

**SUPPLEMENT TO FORM FHWA-1273**

**DATE:** 01/06/2016

**SUBJECT:** Final Certificate and Contract Provisions for Subcontracts

All subcontracts shall be in writing and contain all pertinent provisions and requirements of the prime contract.

Each "Request for Permission to Subcontract" (Mississippi Department of Transportation Form CAD-720) shall include a copy of subcontract upon request for review by the Mississippi Department of Transportation. The federal contract provisions may be omitted from the subcontract copy submitted for review provided the Contractor certifies that the provisions will be physically incorporated into the agreement furnished to the Subcontractor.

In lieu of submitting a copy of the subcontract for review, the Contractor may certify that the subcontract agreement is in writing and that it contains all the requirements and pertinent provisions of the prime contract.

Each Subcontractor will be required to provide a copy of the subcontract agreement for contract compliance reviews, along with physical evidence (copy of FHWA-1273) that requirements and pertinent provisions have been provided for review and adherence.

The Contractor is hereby advised of the requirements set forth in the following Attachment (Title 46 - Shipping) as it pertains to the implementation of Cargo Preference Act (CPA) requirements in the Federal-aid Highway Program.

By signing this contract, the Contractor agrees to conform to the requirements of the CPA.

## Attachment

### Title 46- Shipping

Volume: 8

Date: 2014-10-01

Original Date: 2014-10-01

Title: Section 381.7 - Federal Grant, Guaranty, Loan and Advance at Funds Agreements.

Context: Title 46- Shipping. CHAPTER II- MARITIME ADMINISTRATION, DEPARTMENT OF TRANSPORTATION. SUBCHAPTER J - MISCELLANEOUS. PART 381 - CARGO PREFERENCE-U.S.- FLAG VESSELS.

#### **§ 381.7 Federal Grant, Guaranty, Loan and Advance of Funds Agreements.**

In order to insure a fair and reasonable participation by privately owned United States-flag commercial vessels in transporting cargoes which are subject to the Cargo Preference Act of 1954 and which are generated by U.S. Government Grant, Guaranty, Loan and/or Advance of Funds Programs, the head of each affected department or agency shall require appropriate clauses to be inserted in those Grant, Guaranty, Loan and/or Advance of Funds Agreements and all third party contracts executed between the borrower/grantee and other parties, where the possibility exists for ocean transportation of items procured, contracted for or otherwise obtained by or on behalf of the grantee, borrower, or any of their contractors or subcontractors. The clauses required by this part shall provide that at least 50 percent of the freight revenue and tonnage of cargo generated by the U.S. Government Grant, Guaranty, Loan or Advance of Funds be transported on privately owned United States-flag commercial vessels. These clauses shall also require that all parties provide to the Maritime Administration the necessary shipment information as set forth in § 381.3. A copy of the appropriate clauses required by this part shall be submitted by each affected agency or department to the Secretary, Maritime Administration, for approval no later than 30 days after the effective date of this part. The following are suggested acceptable clauses with respect to the use of United States-flag vessels to be incorporated in the Grant, Guaranty, Loan and/or Advance of Funds Agreements as well as contracts and subcontracts resulting therefrom:

(a) *Agreement Clauses.* "Use of United States-flag vessels:

"(1) Pursuant to Pub. L 664 (43 U.S.C. 1241(b)) at least 50 percent of any equipment, materials or commodities procured, contracted for or otherwise obtained with funds granted, guaranteed, loaned, or advanced by the U.S. Government under this agreement, and which may be transported by ocean vessel, shall be transported on privately owned United States-flag commercial vessels, if available.

"(2) Within 20 days following the date of loading for shipments originating within the United States or within 30 working days following the date of loading for shipments originating outside the United States, a legible copy of a rated, 'on-board' commercial ocean bill-of-lading in English for each shipment of cargo described in paragraph (a)(1) of this section shall be furnished to both the Contracting Officer (through the prime contractor in the case of subcontractor bills-of-lading) and to the Division of National Cargo, Office of Market Development, Maritime Administration, Washington, DC 20590."

(b) *Contractor and Subcontractor Clauses.* "Use of United States-flag vessels: The contractor agrees --

"(1) To utilize privately owned United States-flag commercial vessels to ship at least 50 percent of the gross tonnage (computed separately for dry bulk carriers, dry cargo liners, and tankers) involved, whenever shipping any equipment, material, or commodities pursuant to this contract, to the extent such vessels are available at fair and reasonable rates for United States-flag commercial vessels.

"(2) To furnish within 20 days following the date of loading for shipments originating within the United

States or within 30 working days following the date of loading for shipments originating outside the United States, a legible copy of a rated, 'on-board' commercial ocean bill-of-lading in English for each shipment of cargo described in paragraph (b) (1) of this section to both the Contracting Officer (through the prime contractor in the case of subcontractor bills-of-lading) and to the Division of National Cargo, Office of Market Development, Maritime Administration, Washington, DC 20590.

"(3) To insert the substance of the provisions of this clause in all subcontracts issued pursuant to this contract."

(Reorganization Plans No.21 of 1950(64 Stat. 1273) and No. 7 of 1961 (75 Stat. 840) as amended by Pub. L 91.469 (84 Stat 1036) and Department of Commerce Organization Order 10-8 (38 FR 19707, July 23, 1973)) (42 FR 57126, Nov. 1, 1977]

**REQUIRED CONTRACT PROVISIONS  
FEDERAL-AID CONSTRUCTION CONTRACTS**

---

- I. General
- II. Nondiscrimination
- III. Nonsegregated Facilities
- IV. Davis-Bacon and Related Act Provisions
- V. Contract Work Hours and Safety Standards Act Provisions
- VI. Subletting or Assigning the Contract
- VII. Safety: Accident Prevention
- VIII. False Statements Concerning Highway Projects
- IX. Implementation of Clean Air Act and Federal Water Pollution Control Act
- X. Compliance with Governmentwide Suspension and Debarment Requirements
- XI. Certification Regarding Use of Contract Funds for Lobbying

**ATTACHMENTS**

A. Employment and Materials Preference for Appalachian Development Highway System or Appalachian Local Access Road Contracts (included in Appalachian contracts only)

**I. GENERAL**

1. Form FHWA-1273 must be physically incorporated in each construction contract funded under Title 23 (excluding emergency contracts solely intended for debris removal). The contractor (or subcontractor) must insert this form in each subcontract and further require its inclusion in all lower tier subcontracts (excluding purchase orders, rental agreements and other agreements for supplies or services).

The applicable requirements of Form FHWA-1273 are incorporated by reference for work done under any purchase order, rental agreement or agreement for other services. The prime contractor shall be responsible for compliance by any subcontractor, lower-tier subcontractor or service provider.

Form FHWA-1273 must be included in all Federal-aid design-build contracts, in all subcontracts and in lower tier subcontracts (excluding subcontracts for design services, purchase orders, rental agreements and other agreements for supplies or services). The design-builder shall be responsible for compliance by any subcontractor, lower-tier subcontractor or service provider.

Contracting agencies may reference Form FHWA-1273 in bid proposal or request for proposal documents, however, the Form FHWA-1273 must be physically incorporated (not referenced) in all contracts, subcontracts and lower-tier subcontracts (excluding purchase orders, rental agreements and other agreements for supplies or services related to a construction contract).

2. Subject to the applicability criteria noted in the following sections, these contract provisions shall apply to all work performed on the contract by the contractor's own organization and with the assistance of workers under the contractor's immediate superintendence and to all work performed on the contract by piecework, station work, or by subcontract.

3. A breach of any of the stipulations contained in these Required Contract Provisions may be sufficient grounds for withholding of progress payments, withholding of final payment, termination of the contract, suspension / debarment or any other action determined to be appropriate by the contracting agency and FHWA.

4. Selection of Labor: During the performance of this contract, the contractor shall not use convict labor for any purpose within the limits of a construction project on a Federal-aid highway unless it is labor performed by convicts who are on parole, supervised release, or probation. The term Federal-aid highway does not include roadways functionally classified as local roads or rural minor collectors.

**II. NONDISCRIMINATION**

The provisions of this section related to 23 CFR Part 230 are applicable to all Federal-aid construction contracts and to all related construction subcontracts of \$10,000 or more. The provisions of 23 CFR Part 230 are not applicable to material supply, engineering, or architectural service contracts.

In addition, the contractor and all subcontractors must comply with the following policies: Executive Order 11246, 41 CFR 60, 29 CFR 1625-1627, Title 23 USC Section 140, the Rehabilitation Act of 1973, as amended (29 USC 794), Title VI of the Civil Rights Act of 1964, as amended, and related regulations including 49 CFR Parts 21, 26 and 27; and 23 CFR Parts 200, 230, and 633.

The contractor and all subcontractors must comply with: the requirements of the Equal Opportunity Clause in 41 CFR 60-1.4(b) and, for all construction contracts exceeding \$10,000, the Standard Federal Equal Employment Opportunity Construction Contract Specifications in 41 CFR 60-4.3.

Note: The U.S. Department of Labor has exclusive authority to determine compliance with Executive Order 11246 and the policies of the Secretary of Labor including 41 CFR 60, and 29 CFR 1625-1627. The contracting agency and the FHWA have the authority and the responsibility to ensure compliance with Title 23 USC Section 140, the Rehabilitation Act of 1973, as amended (29 USC 794), and Title VI of the Civil Rights Act of 1964, as amended, and related regulations including 49 CFR Parts 21, 26 and 27; and 23 CFR Parts 200, 230, and 633.

The following provision is adopted from 23 CFR 230, Appendix A, with appropriate revisions to conform to the U.S. Department of Labor (US DOL) and FHWA requirements.

**1. Equal Employment Opportunity:** Equal employment opportunity (EEO) requirements not to discriminate and to take affirmative action to assure equal opportunity as set forth under laws, executive orders, rules, regulations (28 CFR 35, 29 CFR 1630, 29 CFR 1625-1627, 41 CFR 60 and 49 CFR 27) and orders of the Secretary of Labor as modified by the provisions prescribed herein, and imposed pursuant to 23 U.S.C. 140 shall constitute the EEO and specific affirmative action standards for the contractor's project activities under

this contract. The provisions of the Americans with Disabilities Act of 1990 (42 U.S.C. 12101 et seq.) set forth under 28 CFR 35 and 29 CFR 1630 are incorporated by reference in this contract. In the execution of this contract, the contractor agrees to comply with the following minimum specific requirement activities of EEO:

a. The contractor will work with the contracting agency and the Federal Government to ensure that it has made every good faith effort to provide equal opportunity with respect to all of its terms and conditions of employment and in their review of activities under the contract.

b. The contractor will accept as its operating policy the following statement:

"It is the policy of this Company to assure that applicants are employed, and that employees are treated during employment, without regard to their race, religion, sex, color, national origin, age or disability. Such action shall include: employment, upgrading, demotion, or transfer; recruitment or recruitment advertising; layoff or termination; rates of pay or other forms of compensation; and selection for training, including apprenticeship, pre-apprenticeship, and/or on-the-job training."

**2. EEO Officer:** The contractor will designate and make known to the contracting officers an EEO Officer who will have the responsibility for and must be capable of effectively administering and promoting an active EEO program and who must be assigned adequate authority and responsibility to do so.

**3. Dissemination of Policy:** All members of the contractor's staff who are authorized to hire, supervise, promote, and discharge employees, or who recommend such action, or who are substantially involved in such action, will be made fully cognizant of, and will implement, the contractor's EEO policy and contractual responsibilities to provide EEO in each grade and classification of employment. To ensure that the above agreement will be met, the following actions will be taken as a minimum:

a. Periodic meetings of supervisory and personnel office employees will be conducted before the start of work and then not less often than once every six months, at which time the contractor's EEO policy and its implementation will be reviewed and explained. The meetings will be conducted by the EEO Officer.

b. All new supervisory or personnel office employees will be given a thorough indoctrination by the EEO Officer, covering all major aspects of the contractor's EEO obligations within thirty days following their reporting for duty with the contractor.

c. All personnel who are engaged in direct recruitment for the project will be instructed by the EEO Officer in the contractor's procedures for locating and hiring minorities and women.

d. Notices and posters setting forth the contractor's EEO policy will be placed in areas readily accessible to employees, applicants for employment and potential employees.

e. The contractor's EEO policy and the procedures to implement such policy will be brought to the attention of employees by means of meetings, employee handbooks, or other appropriate means.

**4. Recruitment:** When advertising for employees, the contractor will include in all advertisements for employees the notation: "An Equal Opportunity Employer." All such advertisements will be placed in publications having a large circulation among minorities and women in the area from which the project work force would normally be derived.

a. The contractor will, unless precluded by a valid bargaining agreement, conduct systematic and direct recruitment through public and private employee referral sources likely to yield qualified minorities and women. To meet this requirement, the contractor will identify sources of potential minority group employees, and establish with such identified sources procedures whereby minority and women applicants may be referred to the contractor for employment consideration.

b. In the event the contractor has a valid bargaining agreement providing for exclusive hiring hall referrals, the contractor is expected to observe the provisions of that agreement to the extent that the system meets the contractor's compliance with EEO contract provisions. Where implementation of such an agreement has the effect of discriminating against minorities or women, or obligates the contractor to do the same, such implementation violates Federal nondiscrimination provisions.

c. The contractor will encourage its present employees to refer minorities and women as applicants for employment. Information and procedures with regard to referring such applicants will be discussed with employees.

**5. Personnel Actions:** Wages, working conditions, and employee benefits shall be established and administered, and personnel actions of every type, including hiring, upgrading, promotion, transfer, demotion, layoff, and termination, shall be taken without regard to race, color, religion, sex, national origin, age or disability. The following procedures shall be followed:

a. The contractor will conduct periodic inspections of project sites to insure that working conditions and employee facilities do not indicate discriminatory treatment of project site personnel.

b. The contractor will periodically evaluate the spread of wages paid within each classification to determine any evidence of discriminatory wage practices.

c. The contractor will periodically review selected personnel actions in depth to determine whether there is evidence of discrimination. Where evidence is found, the contractor will promptly take corrective action. If the review indicates that the discrimination may extend beyond the actions reviewed, such corrective action shall include all affected persons.

d. The contractor will promptly investigate all complaints of alleged discrimination made to the contractor in connection with its obligations under this contract, will attempt to resolve such complaints, and will take appropriate corrective action within a reasonable time. If the investigation indicates that the discrimination may affect persons other than the complainant, such corrective action shall include such other persons. Upon completion of each investigation, the contractor will inform every complainant of all of their avenues of appeal.

**6. Training and Promotion:**

a. The contractor will assist in locating, qualifying, and increasing the skills of minorities and women who are



applicants for employment or current employees. Such efforts should be aimed at developing full journey level status employees in the type of trade or job classification involved.

b. Consistent with the contractor's work force requirements and as permissible under Federal and State regulations, the contractor shall make full use of training programs, i.e., apprenticeship, and on-the-job training programs for the geographical area of contract performance. In the event a special provision for training is provided under this contract, this subparagraph will be superseded as indicated in the special provision. The contracting agency may reserve training positions for persons who receive welfare assistance in accordance with 23 U.S.C. 140(a).

c. The contractor will advise employees and applicants for employment of available training programs and entrance requirements for each.

d. The contractor will periodically review the training and promotion potential of employees who are minorities and women and will encourage eligible employees to apply for such training and promotion.

**7. Unions:** If the contractor relies in whole or in part upon unions as a source of employees, the contractor will use good faith efforts to obtain the cooperation of such unions to increase opportunities for minorities and women. Actions by the contractor, either directly or through a contractor's association acting as agent, will include the procedures set forth below:

a. The contractor will use good faith efforts to develop, in cooperation with the unions, joint training programs aimed toward qualifying more minorities and women for membership in the unions and increasing the skills of minorities and women so that they may qualify for higher paying employment.

b. The contractor will use good faith efforts to incorporate an EEO clause into each union agreement to the end that such union will be contractually bound to refer applicants without regard to their race, color, religion, sex, national origin, age or disability.

c. The contractor is to obtain information as to the referral practices and policies of the labor union except that to the extent such information is within the exclusive possession of the labor union and such labor union refuses to furnish such information to the contractor, the contractor shall so certify to the contracting agency and shall set forth what efforts have been made to obtain such information.

d. In the event the union is unable to provide the contractor with a reasonable flow of referrals within the time limit set forth in the collective bargaining agreement, the contractor will, through independent recruitment efforts, fill the employment vacancies without regard to race, color, religion, sex, national origin, age or disability; making full efforts to obtain qualified and/or qualifiable minorities and women. The failure of a union to provide sufficient referrals (even though it is obligated to provide exclusive referrals under the terms of a collective bargaining agreement) does not relieve the contractor from the requirements of this paragraph. In the event the union referral practice prevents the contractor from meeting the obligations pursuant to Executive Order 11246, as amended, and these special provisions, such contractor shall immediately notify the contracting agency.

**8. Reasonable Accommodation for Applicants / Employees with Disabilities:** The contractor must be familiar

with the requirements for and comply with the Americans with Disabilities Act and all rules and regulations established there under. Employers must provide reasonable accommodation in all employment activities unless to do so would cause an undue hardship.

**9. Selection of Subcontractors, Procurement of Materials and Leasing of Equipment:** The contractor shall not discriminate on the grounds of race, color, religion, sex, national origin, age or disability in the selection and retention of subcontractors, including procurement of materials and leases of equipment. The contractor shall take all necessary and reasonable steps to ensure nondiscrimination in the administration of this contract.

a. The contractor shall notify all potential subcontractors and suppliers and lessors of their EEO obligations under this contract.

b. The contractor will use good faith efforts to ensure subcontractor compliance with their EEO obligations.

**10. Assurance Required by 49 CFR 26.13(b):**

a. The requirements of 49 CFR Part 26 and the State DOT's U.S. DOT-approved DBE program are incorporated by reference.

b. The contractor or subcontractor shall not discriminate on the basis of race, color, national origin, or sex in the performance of this contract. The contractor shall carry out applicable requirements of 49 CFR Part 26 in the award and administration of DOT-assisted contracts. Failure by the contractor to carry out these requirements is a material breach of this contract, which may result in the termination of this contract or such other remedy as the contracting agency deems appropriate.

**11. Records and Reports:** The contractor shall keep such records as necessary to document compliance with the EEO requirements. Such records shall be retained for a period of three years following the date of the final payment to the contractor for all contract work and shall be available at reasonable times and places for inspection by authorized representatives of the contracting agency and the FHWA.

a. The records kept by the contractor shall document the following:

(1) The number and work hours of minority and non-minority group members and women employed in each work classification on the project;

(2) The progress and efforts being made in cooperation with unions, when applicable, to increase employment opportunities for minorities and women; and

(3) The progress and efforts being made in locating, hiring, training, qualifying, and upgrading minorities and women;

b. The contractors and subcontractors will submit an annual report to the contracting agency each July for the duration of the project, indicating the number of minority, women, and non-minority group employees currently engaged in each work classification required by the contract work. This information is to be reported on [Form FHWA-1391](#). The staffing data should represent the project work force on board in all or any part of the last payroll period preceding the end of July. If on-the-job training is being required by special provision, the contractor

will be required to collect and report training data. The employment data should reflect the work force on board during all or any part of the last payroll period preceding the end of July.

### III. NONSEGREGATED FACILITIES

This provision is applicable to all Federal-aid construction contracts and to all related construction subcontracts of \$10,000 or more.

The contractor must ensure that facilities provided for employees are provided in such a manner that segregation on the basis of race, color, religion, sex, or national origin cannot result. The contractor may neither require such segregated use by written or oral policies nor tolerate such use by employee custom. The contractor's obligation extends further to ensure that its employees are not assigned to perform their services at any location, under the contractor's control, where the facilities are segregated. The term "facilities" includes waiting rooms, work areas, restaurants and other eating areas, time clocks, restrooms, washrooms, locker rooms, and other storage or dressing areas, parking lots, drinking fountains, recreation or entertainment areas, transportation, and housing provided for employees. The contractor shall provide separate or single-user restrooms and necessary dressing or sleeping areas to assure privacy between sexes.

### IV. DAVIS-BACON AND RELATED ACT PROVISIONS

This section is applicable to all Federal-aid construction projects exceeding \$2,000 and to all related subcontracts and lower-tier subcontracts (regardless of subcontract size). The requirements apply to all projects located within the right-of-way of a roadway that is functionally classified as Federal-aid highway. This excludes roadways functionally classified as local roads or rural minor collectors, which are exempt. Contracting agencies may elect to apply these requirements to other projects.

The following provisions are from the U.S. Department of Labor regulations in 29 CFR 5.5 "Contract provisions and related matters" with minor revisions to conform to the FHWA-1273 format and FHWA program requirements.

#### 1. Minimum wages

a. All laborers and mechanics employed or working upon the site of the work, will be paid unconditionally and not less often than once a week, and without subsequent deduction or rebate on any account (except such payroll deductions as are permitted by regulations issued by the Secretary of Labor under the Copeland Act (29 CFR part 3)), the full amount of wages and bona fide fringe benefits (or cash equivalents thereof) due at time of payment computed at rates not less than those contained in the wage determination of the Secretary of Labor which is attached hereto and made a part hereof, regardless of any contractual relationship which may be alleged to exist between the contractor and such laborers and mechanics.

Contributions made or costs reasonably anticipated for bona fide fringe benefits under section 1(b)(2) of the Davis-Bacon Act on behalf of laborers or mechanics are considered wages

paid to such laborers or mechanics, subject to the provisions of paragraph 1.d. of this section; also, regular contributions made or costs incurred for more than a weekly period (but not less often than quarterly) under plans, funds, or programs which cover the particular weekly period, are deemed to be constructively made or incurred during such weekly period. Such laborers and mechanics shall be paid the appropriate wage rate and fringe benefits on the wage determination for the classification of work actually performed, without regard to skill, except as provided in 29 CFR 5.5(a)(4). Laborers or mechanics performing work in more than one classification may be compensated at the rate specified for each classification for the time actually worked therein: Provided, That the employer's payroll records accurately set forth the time spent in each classification in which work is performed. The wage determination (including any additional classification and wage rates conformed under paragraph 1.b. of this section) and the Davis-Bacon poster (WH-1321) shall be posted at all times by the contractor and its subcontractors at the site of the work in a prominent and accessible place where it can be easily seen by the workers.

b. (1) The contracting officer shall require that any class of laborers or mechanics, including helpers, which is not listed in the wage determination and which is to be employed under the contract shall be classified in conformance with the wage determination. The contracting officer shall approve an additional classification and wage rate and fringe benefits therefore only when the following criteria have been met:

(i) The work to be performed by the classification requested is not performed by a classification in the wage determination; and

(ii) The classification is utilized in the area by the construction industry; and

(iii) The proposed wage rate, including any bona fide fringe benefits, bears a reasonable relationship to the wage rates contained in the wage determination.

(2) If the contractor and the laborers and mechanics to be employed in the classification (if known), or their representatives, and the contracting officer agree on the classification and wage rate (including the amount designated for fringe benefits where appropriate), a report of the action taken shall be sent by the contracting officer to the Administrator of the Wage and Hour Division, Employment Standards Administration, U.S. Department of Labor, Washington, DC 20210. The Administrator, or an authorized representative, will approve, modify, or disapprove every additional classification action within 30 days of receipt and so advise the contracting officer or will notify the contracting officer within the 30-day period that additional time is necessary.

(3) In the event the contractor, the laborers or mechanics to be employed in the classification or their representatives, and the contracting officer do not agree on the proposed classification and wage rate (including the amount designated for fringe benefits, where appropriate), the contracting officer shall refer the questions, including the views of all interested parties and the recommendation of the contracting officer, to the Wage and Hour Administrator for determination. The Wage and Hour Administrator, or an authorized representative, will issue a determination within 30 days of receipt and so advise

the contracting officer or will notify the contracting officer within the 30-day period that additional time is necessary.

(4) The wage rate (including fringe benefits where appropriate) determined pursuant to paragraphs 1.b.(2) or 1.b.(3) of this section, shall be paid to all workers performing work in the classification under this contract from the first day on which work is performed in the classification.

c. Whenever the minimum wage rate prescribed in the contract for a class of laborers or mechanics includes a fringe benefit which is not expressed as an hourly rate, the contractor shall either pay the benefit as stated in the wage determination or shall pay another bona fide fringe benefit or an hourly cash equivalent thereof.

d. If the contractor does not make payments to a trustee or other third person, the contractor may consider as part of the wages of any laborer or mechanic the amount of any costs reasonably anticipated in providing bona fide fringe benefits under a plan or program, Provided, That the Secretary of Labor has found, upon the written request of the contractor, that the applicable standards of the Davis-Bacon Act have been met. The Secretary of Labor may require the contractor to set aside in a separate account assets for the meeting of obligations under the plan or program.

## 2. Withholding

The contracting agency shall upon its own action or upon written request of an authorized representative of the Department of Labor, withhold or cause to be withheld from the contractor under this contract, or any other Federal contract with the same prime contractor, or any other federally-assisted contract subject to Davis-Bacon prevailing wage requirements, which is held by the same prime contractor, so much of the accrued payments or advances as may be considered necessary to pay laborers and mechanics, including apprentices, trainees, and helpers, employed by the contractor or any subcontractor the full amount of wages required by the contract. In the event of failure to pay any laborer or mechanic, including any apprentice, trainee, or helper, employed or working on the site of the work, all or part of the wages required by the contract, the contracting agency may, after written notice to the contractor, take such action as may be necessary to cause the suspension of any further payment, advance, or guarantee of funds until such violations have ceased.

## 3. Payrolls and basic records

a. Payrolls and basic records relating thereto shall be maintained by the contractor during the course of the work and preserved for a period of three years thereafter for all laborers and mechanics working at the site of the work. Such records shall contain the name, address, and social security number of each such worker, his or her correct classification, hourly rates of wages paid (including rates of contributions or costs anticipated for bona fide fringe benefits or cash equivalents thereof of the types described in section 1(b)(2)(B) of the Davis-Bacon Act), daily and weekly number of hours worked, deductions made and actual wages paid. Whenever the Secretary of Labor has found under 29 CFR 5.5(a)(1)(iv) that the wages of any laborer or mechanic include the amount of any costs reasonably anticipated in providing benefits under a plan or program described in section 1(b)(2)(B) of the Davis-

Bacon Act, the contractor shall maintain records which show that the commitment to provide such benefits is enforceable, that the plan or program is financially responsible, and that the plan or program has been communicated in writing to the laborers or mechanics affected, and records which show the costs anticipated or the actual cost incurred in providing such benefits. Contractors employing apprentices or trainees under approved programs shall maintain written evidence of the registration of apprenticeship programs and certification of trainee programs, the registration of the apprentices and trainees, and the ratios and wage rates prescribed in the applicable programs.

b. (1) The contractor shall submit weekly for each week in which any contract work is performed a copy of all payrolls to the contracting agency. The payrolls submitted shall set out accurately and completely all of the information required to be maintained under 29 CFR 5.5(a)(3)(i), except that full social security numbers and home addresses shall not be included on weekly transmittals. Instead the payrolls shall only need to include an individually identifying number for each employee ( e.g. , the last four digits of the employee's social security number). The required weekly payroll information may be submitted in any form desired. Optional Form WH-347 is available for this purpose from the Wage and Hour Division Web site at <http://www.dol.gov/esa/whd/forms/wh347instr.htm> or its successor site. The prime contractor is responsible for the submission of copies of payrolls by all subcontractors. Contractors and subcontractors shall maintain the full social security number and current address of each covered worker, and shall provide them upon request to the contracting agency for transmission to the State DOT, the FHWA or the Wage and Hour Division of the Department of Labor for purposes of an investigation or audit of compliance with prevailing wage requirements. It is not a violation of this section for a prime contractor to require a subcontractor to provide addresses and social security numbers to the prime contractor for its own records, without weekly submission to the contracting agency..

(2) Each payroll submitted shall be accompanied by a "Statement of Compliance," signed by the contractor or subcontractor or his or her agent who pays or supervises the payment of the persons employed under the contract and shall certify the following:

(i) That the payroll for the payroll period contains the information required to be provided under §5.5 (a)(3)(ii) of Regulations, 29 CFR part 5, the appropriate information is being maintained under §5.5 (a)(3)(i) of Regulations, 29 CFR part 5, and that such information is correct and complete;

(ii) That each laborer or mechanic (including each helper, apprentice, and trainee) employed on the contract during the payroll period has been paid the full weekly wages earned, without rebate, either directly or indirectly, and that no deductions have been made either directly or indirectly from the full wages earned, other than permissible deductions as set forth in Regulations, 29 CFR part 3;

(iii) That each laborer or mechanic has been paid not less than the applicable wage rates and fringe benefits or cash equivalents for the classification of work performed, as specified in the applicable wage determination incorporated into the contract.

(3) The weekly submission of a properly executed certification set forth on the reverse side of Optional Form WH-347 shall satisfy the requirement for submission of the "Statement of Compliance" required by paragraph 3.b.(2) of this section.

(4) The falsification of any of the above certifications may subject the contractor or subcontractor to civil or criminal prosecution under section 1001 of title 18 and section 231 of title 31 of the United States Code.

c. The contractor or subcontractor shall make the records required under paragraph 3.a. of this section available for inspection, copying, or transcription by authorized representatives of the contracting agency, the State DOT, the FHWA, or the Department of Labor, and shall permit such representatives to interview employees during working hours on the job. If the contractor or subcontractor fails to submit the required records or to make them available, the FHWA may, after written notice to the contractor, the contracting agency or the State DOT, take such action as may be necessary to cause the suspension of any further payment, advance, or guarantee of funds. Furthermore, failure to submit the required records upon request or to make such records available may be grounds for debarment action pursuant to 29 CFR 5.12.

#### 4. Apprentices and trainees

##### a. Apprentices (programs of the USDOL).

Apprentices will be permitted to work at less than the predetermined rate for the work they performed when they are employed pursuant to and individually registered in a bona fide apprenticeship program registered with the U.S. Department of Labor, Employment and Training Administration, Office of Apprenticeship Training, Employer and Labor Services, or with a State Apprenticeship Agency recognized by the Office, or if a person is employed in his or her first 90 days of probationary employment as an apprentice in such an apprenticeship program, who is not individually registered in the program, but who has been certified by the Office of Apprenticeship Training, Employer and Labor Services or a State Apprenticeship Agency (where appropriate) to be eligible for probationary employment as an apprentice.

The allowable ratio of apprentices to journeymen on the job site in any craft classification shall not be greater than the ratio permitted to the contractor as to the entire work force under the registered program. Any worker listed on a payroll at an apprentice wage rate, who is not registered or otherwise employed as stated above, shall be paid not less than the applicable wage rate on the wage determination for the classification of work actually performed. In addition, any apprentice performing work on the job site in excess of the ratio permitted under the registered program shall be paid not less than the applicable wage rate on the wage determination for the work actually performed. Where a contractor is performing construction on a project in a locality other than that in which its program is registered, the ratios and wage rates (expressed in percentages of the journeyman's hourly rate) specified in the contractor's or subcontractor's registered program shall be observed.

Every apprentice must be paid at not less than the rate specified in the registered program for the apprentice's level of progress, expressed as a percentage of the journeymen hourly

rate specified in the applicable wage determination. Apprentices shall be paid fringe benefits in accordance with the provisions of the apprenticeship program. If the apprenticeship program does not specify fringe benefits, apprentices must be paid the full amount of fringe benefits listed on the wage determination for the applicable classification. If the Administrator determines that a different practice prevails for the applicable apprentice classification, fringes shall be paid in accordance with that determination.

In the event the Office of Apprenticeship Training, Employer and Labor Services, or a State Apprenticeship Agency recognized by the Office, withdraws approval of an apprenticeship program, the contractor will no longer be permitted to utilize apprentices at less than the applicable predetermined rate for the work performed until an acceptable program is approved.

##### b. Trainees (programs of the USDOL).

Except as provided in 29 CFR 5.16, trainees will not be permitted to work at less than the predetermined rate for the work performed unless they are employed pursuant to and individually registered in a program which has received prior approval, evidenced by formal certification by the U.S. Department of Labor, Employment and Training Administration.

The ratio of trainees to journeymen on the job site shall not be greater than permitted under the plan approved by the Employment and Training Administration.

Every trainee must be paid at not less than the rate specified in the approved program for the trainee's level of progress, expressed as a percentage of the journeyman hourly rate specified in the applicable wage determination. Trainees shall be paid fringe benefits in accordance with the provisions of the trainee program. If the trainee program does not mention fringe benefits, trainees shall be paid the full amount of fringe benefits listed on the wage determination unless the Administrator of the Wage and Hour Division determines that there is an apprenticeship program associated with the corresponding journeyman wage rate on the wage determination which provides for less than full fringe benefits for apprentices. Any employee listed on the payroll at a trainee rate who is not registered and participating in a training plan approved by the Employment and Training Administration shall be paid not less than the applicable wage rate on the wage determination for the classification of work actually performed. In addition, any trainee performing work on the job site in excess of the ratio permitted under the registered program shall be paid not less than the applicable wage rate on the wage determination for the work actually performed.

In the event the Employment and Training Administration withdraws approval of a training program, the contractor will no longer be permitted to utilize trainees at less than the applicable predetermined rate for the work performed until an acceptable program is approved.

c. Equal employment opportunity. The utilization of apprentices, trainees and journeymen under this part shall be in conformity with the equal employment opportunity requirements of Executive Order 11246, as amended, and 29 CFR part 30.

d. Apprentices and Trainees (programs of the U.S. DOT).

Apprentices and trainees working under apprenticeship and skill training programs which have been certified by the Secretary of Transportation as promoting EEO in connection with Federal-aid highway construction programs are not subject to the requirements of paragraph 4 of this Section IV. The straight time hourly wage rates for apprentices and trainees under such programs will be established by the particular programs. The ratio of apprentices and trainees to journeymen shall not be greater than permitted by the terms of the particular program.

**5. Compliance with Copeland Act requirements.** The contractor shall comply with the requirements of 29 CFR part 3, which are incorporated by reference in this contract.

**6. Subcontracts.** The contractor or subcontractor shall insert Form FHWA-1273 in any subcontracts and also require the subcontractors to include Form FHWA-1273 in any lower tier subcontracts. The prime contractor shall be responsible for the compliance by any subcontractor or lower tier subcontractor with all the contract clauses in 29 CFR 5.5.

**7. Contract termination: debarment.** A breach of the contract clauses in 29 CFR 5.5 may be grounds for termination of the contract, and for debarment as a contractor and a subcontractor as provided in 29 CFR 5.12.

**8. Compliance with Davis-Bacon and Related Act requirements.** All rulings and interpretations of the Davis-Bacon and Related Acts contained in 29 CFR parts 1, 3, and 5 are herein incorporated by reference in this contract.

**9. Disputes concerning labor standards.** Disputes arising out of the labor standards provisions of this contract shall not be subject to the general disputes clause of this contract. Such disputes shall be resolved in accordance with the procedures of the Department of Labor set forth in 29 CFR parts 5, 6, and 7. Disputes within the meaning of this clause include disputes between the contractor (or any of its subcontractors) and the contracting agency, the U.S. Department of Labor, or the employees or their representatives.

**10. Certification of eligibility.**

a. By entering into this contract, the contractor certifies that neither it (nor he or she) nor any person or firm who has an interest in the contractor's firm is a person or firm ineligible to be awarded Government contracts by virtue of section 3(a) of the Davis-Bacon Act or 29 CFR 5.12(a)(1).

b. No part of this contract shall be subcontracted to any person or firm ineligible for award of a Government contract by virtue of section 3(a) of the Davis-Bacon Act or 29 CFR 5.12(a)(1).

c. The penalty for making false statements is prescribed in the U.S. Criminal Code, 18 U.S.C. 1001.

**V. CONTRACT WORK HOURS AND SAFETY STANDARDS ACT**

The following clauses apply to any Federal-aid construction contract in an amount in excess of \$100,000 and subject to the overtime provisions of the Contract Work Hours and Safety Standards Act. These clauses shall be inserted in addition to the clauses required by 29 CFR 5.5(a) or 29 CFR 4.6. As used in this paragraph, the terms laborers and mechanics include watchmen and guards.

**1. Overtime requirements.** No contractor or subcontractor contracting for any part of the contract work which may require or involve the employment of laborers or mechanics shall require or permit any such laborer or mechanic in any workweek in which he or she is employed on such work to work in excess of forty hours in such workweek unless such laborer or mechanic receives compensation at a rate not less than one and one-half times the basic rate of pay for all hours worked in excess of forty hours in such workweek.

**2. Violation; liability for unpaid wages; liquidated damages.** In the event of any violation of the clause set forth in paragraph (1.) of this section, the contractor and any subcontractor responsible therefor shall be liable for the unpaid wages. In addition, such contractor and subcontractor shall be liable to the United States (in the case of work done under contract for the District of Columbia or a territory, to such District or to such territory), for liquidated damages. Such liquidated damages shall be computed with respect to each individual laborer or mechanic, including watchmen and guards, employed in violation of the clause set forth in paragraph (1.) of this section, in the sum of \$10 for each calendar day on which such individual was required or permitted to work in excess of the standard workweek of forty hours without payment of the overtime wages required by the clause set forth in paragraph (1.) of this section.

**3. Withholding for unpaid wages and liquidated damages.** The FHWA or the contacting agency shall upon its own action or upon written request of an authorized representative of the Department of Labor withhold or cause to be withheld, from any moneys payable on account of work performed by the contractor or subcontractor under any such contract or any other Federal contract with the same prime contractor, or any other federally-assisted contract subject to the Contract Work Hours and Safety Standards Act, which is held by the same prime contractor, such sums as may be determined to be necessary to satisfy any liabilities of such contractor or subcontractor for unpaid wages and liquidated damages as provided in the clause set forth in paragraph (2.) of this section.

**4. Subcontracts.** The contractor or subcontractor shall insert in any subcontracts the clauses set forth in paragraph (1.) through (4.) of this section and also a clause requiring the subcontractors to include these clauses in any lower tier subcontracts. The prime contractor shall be responsible for compliance by any subcontractor or lower tier subcontractor with the clauses set forth in paragraphs (1.) through (4.) of this section.

## VI. SUBLETTING OR ASSIGNING THE CONTRACT

This provision is applicable to all Federal-aid construction contracts on the National Highway System.

1. The contractor shall perform with its own organization contract work amounting to not less than 30 percent (or a greater percentage if specified elsewhere in the contract) of the total original contract price, excluding any specialty items designated by the contracting agency. Specialty items may be performed by subcontract and the amount of any such specialty items performed may be deducted from the total original contract price before computing the amount of work required to be performed by the contractor's own organization (23 CFR 635.116).

a. The term "perform work with its own organization" refers to workers employed or leased by the prime contractor, and equipment owned or rented by the prime contractor, with or without operators. Such term does not include employees or equipment of a subcontractor or lower tier subcontractor, agents of the prime contractor, or any other assignees. The term may include payments for the costs of hiring leased employees from an employee leasing firm meeting all relevant Federal and State regulatory requirements. Leased employees may only be included in this term if the prime contractor meets all of the following conditions:

(1) the prime contractor maintains control over the supervision of the day-to-day activities of the leased employees;

(2) the prime contractor remains responsible for the quality of the work of the leased employees;

(3) the prime contractor retains all power to accept or exclude individual employees from work on the project; and

(4) the prime contractor remains ultimately responsible for the payment of predetermined minimum wages, the submission of payrolls, statements of compliance and all other Federal regulatory requirements.

b. "Specialty Items" shall be construed to be limited to work that requires highly specialized knowledge, abilities, or equipment not ordinarily available in the type of contracting organizations qualified and expected to bid or propose on the contract as a whole and in general are to be limited to minor components of the overall contract.

2. The contract amount upon which the requirements set forth in paragraph (1) of Section VI is computed includes the cost of material and manufactured products which are to be purchased or produced by the contractor under the contract provisions.

3. The contractor shall furnish (a) a competent superintendent or supervisor who is employed by the firm, has full authority to direct performance of the work in accordance with the contract requirements, and is in charge of all construction operations (regardless of who performs the work) and (b) such other of its own organizational resources (supervision, management, and engineering services) as the contracting officer determines is necessary to assure the performance of the contract.

4. No portion of the contract shall be sublet, assigned or otherwise disposed of except with the written consent of the contracting officer, or authorized representative, and such consent when given shall not be construed to relieve the contractor of any responsibility for the fulfillment of the contract. Written consent will be given only after the

contracting agency has assured that each subcontract is evidenced in writing and that it contains all pertinent provisions and requirements of the prime contract.

5. The 30% self-performance requirement of paragraph (1) is not applicable to design-build contracts; however, contracting agencies may establish their own self-performance requirements.

## VII. SAFETY: ACCIDENT PREVENTION

This provision is applicable to all Federal-aid construction contracts and to all related subcontracts.

1. In the performance of this contract the contractor shall comply with all applicable Federal, State, and local laws governing safety, health, and sanitation (23 CFR 635). The contractor shall provide all safeguards, safety devices and protective equipment and take any other needed actions as it determines, or as the contracting officer may determine, to be reasonably necessary to protect the life and health of employees on the job and the safety of the public and to protect property in connection with the performance of the work covered by the contract.

2. It is a condition of this contract, and shall be made a condition of each subcontract, which the contractor enters into pursuant to this contract, that the contractor and any subcontractor shall not permit any employee, in performance of the contract, to work in surroundings or under conditions which are unsanitary, hazardous or dangerous to his/her health or safety, as determined under construction safety and health standards (29 CFR 1926) promulgated by the Secretary of Labor, in accordance with Section 107 of the Contract Work Hours and Safety Standards Act (40 U.S.C. 3704).

3. Pursuant to 29 CFR 1926.3, it is a condition of this contract that the Secretary of Labor or authorized representative thereof, shall have right of entry to any site of contract performance to inspect or investigate the matter of compliance with the construction safety and health standards and to carry out the duties of the Secretary under Section 107 of the Contract Work Hours and Safety Standards Act (40 U.S.C.3704).

## VIII. FALSE STATEMENTS CONCERNING HIGHWAY PROJECTS

This provision is applicable to all Federal-aid construction contracts and to all related subcontracts.

In order to assure high quality and durable construction in conformity with approved plans and specifications and a high degree of reliability on statements and representations made by engineers, contractors, suppliers, and workers on Federal-aid highway projects, it is essential that all persons concerned with the project perform their functions as carefully, thoroughly, and honestly as possible. Willful falsification, distortion, or misrepresentation with respect to any facts related to the project is a violation of Federal law. To prevent any misunderstanding regarding the seriousness of these and similar acts, Form FHWA-1022 shall be posted on each Federal-aid highway project (23 CFR 635) in one or more places where it is readily available to all persons concerned with the project:

18 U.S.C. 1020 reads as follows:

"Whoever, being an officer, agent, or employee of the United States, or of any State or Territory, or whoever, whether a person, association, firm, or corporation, knowingly makes any false statement, false representation, or false report as to the character, quality, quantity, or cost of the material used or to be used, or the quantity or quality of the work performed or to be performed, or the cost thereof in connection with the submission of plans, maps, specifications, contracts, or costs of construction on any highway or related project submitted for approval to the Secretary of Transportation; or

Whoever knowingly makes any false statement, false representation, false report or false claim with respect to the character, quality, quantity, or cost of any work performed or to be performed, or materials furnished or to be furnished, in connection with the construction of any highway or related project approved by the Secretary of Transportation; or

Whoever knowingly makes any false statement or false representation as to material fact in any statement, certificate, or report submitted pursuant to provisions of the Federal-aid Roads Act approved July 1, 1916, (39 Stat. 355), as amended and supplemented;

Shall be fined under this title or imprisoned not more than 5 years or both."

#### **IX. IMPLEMENTATION OF CLEAN AIR ACT AND FEDERAL WATER POLLUTION CONTROL ACT**

This provision is applicable to all Federal-aid construction contracts and to all related subcontracts.

By submission of this bid/proposal or the execution of this contract, or subcontract, as appropriate, the bidder, proposer, Federal-aid construction contractor, or subcontractor, as appropriate, will be deemed to have stipulated as follows:

1. That any person who is or will be utilized in the performance of this contract is not prohibited from receiving an award due to a violation of Section 508 of the Clean Water Act or Section 306 of the Clean Air Act.

2. That the contractor agrees to include or cause to be included the requirements of paragraph (1) of this Section X in every subcontract, and further agrees to take such action as the contracting agency may direct as a means of enforcing such requirements.

#### **X. CERTIFICATION REGARDING DEBARMENT, SUSPENSION, INELIGIBILITY AND VOLUNTARY EXCLUSION**

This provision is applicable to all Federal-aid construction contracts, design-build contracts, subcontracts, lower-tier subcontracts, purchase orders, lease agreements, consultant contracts or any other covered transaction requiring FHWA approval or that is estimated to cost \$25,000 or more – as defined in 2 CFR Parts 180 and 1200.

##### **1. Instructions for Certification – First Tier Participants:**

a. By signing and submitting this proposal, the prospective first tier participant is providing the certification set out below.

b. The inability of a person to provide the certification set out below will not necessarily result in denial of participation in this

covered transaction. The prospective first tier participant shall submit an explanation of why it cannot provide the certification set out below. The certification or explanation will be considered in connection with the department or agency's determination whether to enter into this transaction. However, failure of the prospective first tier participant to furnish a certification or an explanation shall disqualify such a person from participation in this transaction.

c. The certification in this clause is a material representation of fact upon which reliance was placed when the contracting agency determined to enter into this transaction. If it is later determined that the prospective participant knowingly rendered an erroneous certification, in addition to other remedies available to the Federal Government, the contracting agency may terminate this transaction for cause of default.

d. The prospective first tier participant shall provide immediate written notice to the contracting agency to whom this proposal is submitted if any time the prospective first tier participant learns that its certification was erroneous when submitted or has become erroneous by reason of changed circumstances.

e. The terms "covered transaction," "debarred," "suspended," "ineligible," "participant," "person," "principal," and "voluntarily excluded," as used in this clause, are defined in 2 CFR Parts 180 and 1200. "First Tier Covered Transactions" refers to any covered transaction between a grantee or subgrantee of Federal funds and a participant (such as the prime or general contractor). "Lower Tier Covered Transactions" refers to any covered transaction under a First Tier Covered Transaction (such as subcontracts). "First Tier Participant" refers to the participant who has entered into a covered transaction with a grantee or subgrantee of Federal funds (such as the prime or general contractor). "Lower Tier Participant" refers any participant who has entered into a covered transaction with a First Tier Participant or other Lower Tier Participants (such as subcontractors and suppliers).

f. The prospective first tier participant agrees by submitting this proposal that, should the proposed covered transaction be entered into, it shall not knowingly enter into any lower tier covered transaction with a person who is debarred, suspended, declared ineligible, or voluntarily excluded from participation in this covered transaction, unless authorized by the department or agency entering into this transaction.

g. The prospective first tier participant further agrees by submitting this proposal that it will include the clause titled "Certification Regarding Debarment, Suspension, Ineligibility and Voluntary Exclusion-Lower Tier Covered Transactions," provided by the department or contracting agency, entering into this covered transaction, without modification, in all lower tier covered transactions and in all solicitations for lower tier covered transactions exceeding the \$25,000 threshold.

h. A participant in a covered transaction may rely upon a certification of a prospective participant in a lower tier covered transaction that is not debarred, suspended, ineligible, or voluntarily excluded from the covered transaction, unless it knows that the certification is erroneous. A participant is responsible for ensuring that its principals are not suspended, debarred, or otherwise ineligible to participate in covered transactions. To verify the eligibility of its principals, as well as the eligibility of any lower tier prospective participants, each participant may, but is not required to, check the Excluded Parties List System website (<https://www.epls.gov/>), which is compiled by the General Services Administration.

i. Nothing contained in the foregoing shall be construed to require the establishment of a system of records in order to render in good faith the certification required by this clause. The knowledge and information of the prospective participant is not required to exceed that which is normally possessed by a prudent person in the ordinary course of business dealings.

j. Except for transactions authorized under paragraph (f) of these instructions, if a participant in a covered transaction knowingly enters into a lower tier covered transaction with a person who is suspended, debarred, ineligible, or voluntarily excluded from participation in this transaction, in addition to other remedies available to the Federal Government, the department or agency may terminate this transaction for cause or default.

\* \* \* \* \*

## **2. Certification Regarding Debarment, Suspension, Ineligibility and Voluntary Exclusion – First Tier Participants:**

a. The prospective first tier participant certifies to the best of its knowledge and belief, that it and its principals:

(1) Are not presently debarred, suspended, proposed for debarment, declared ineligible, or voluntarily excluded from participating in covered transactions by any Federal department or agency;

(2) Have not within a three-year period preceding this proposal been convicted of or had a civil judgment rendered against them for commission of fraud or a criminal offense in connection with obtaining, attempting to obtain, or performing a public (Federal, State or local) transaction or contract under a public transaction; violation of Federal or State antitrust statutes or commission of embezzlement, theft, forgery, bribery, falsification or destruction of records, making false statements, or receiving stolen property;

(3) Are not presently indicted for or otherwise criminally or civilly charged by a governmental entity (Federal, State or local) with commission of any of the offenses enumerated in paragraph (a)(2) of this certification; and

(4) Have not within a three-year period preceding this application/proposal had one or more public transactions (Federal, State or local) terminated for cause or default.

b. Where the prospective participant is unable to certify to any of the statements in this certification, such prospective participant shall attach an explanation to this proposal.

### **2. Instructions for Certification - Lower Tier Participants:**

(Applicable to all subcontracts, purchase orders and other lower tier transactions requiring prior FHWA approval or estimated to cost \$25,000 or more - 2 CFR Parts 180 and 1200)

a. By signing and submitting this proposal, the prospective lower tier is providing the certification set out below.

b. The certification in this clause is a material representation of fact upon which reliance was placed when this transaction was entered into. If it is later determined that the prospective lower tier participant knowingly rendered an erroneous certification, in addition to other remedies available to the Federal Government, the department, or agency with which

this transaction originated may pursue available remedies, including suspension and/or debarment.

c. The prospective lower tier participant shall provide immediate written notice to the person to which this proposal is submitted if at any time the prospective lower tier participant learns that its certification was erroneous by reason of changed circumstances.

d. The terms "covered transaction," "debarred," "suspended," "ineligible," "participant," "person," "principal," and "voluntarily excluded," as used in this clause, are defined in 2 CFR Parts 180 and 1200. You may contact the person to which this proposal is submitted for assistance in obtaining a copy of those regulations. "First Tier Covered Transactions" refers to any covered transaction between a grantee or subgrantee of Federal funds and a participant (such as the prime or general contract). "Lower Tier Covered Transactions" refers to any covered transaction under a First Tier Covered Transaction (such as subcontracts). "First Tier Participant" refers to the participant who has entered into a covered transaction with a grantee or subgrantee of Federal funds (such as the prime or general contractor). "Lower Tier Participant" refers any participant who has entered into a covered transaction with a First Tier Participant or other Lower Tier Participants (such as subcontractors and suppliers).

e. The prospective lower tier participant agrees by submitting this proposal that, should the proposed covered transaction be entered into, it shall not knowingly enter into any lower tier covered transaction with a person who is debarred, suspended, declared ineligible, or voluntarily excluded from participation in this covered transaction, unless authorized by the department or agency with which this transaction originated.

f. The prospective lower tier participant further agrees by submitting this proposal that it will include this clause titled "Certification Regarding Debarment, Suspension, Ineligibility and Voluntary Exclusion-Lower Tier Covered Transaction," without modification, in all lower tier covered transactions and in all solicitations for lower tier covered transactions exceeding the \$25,000 threshold.

g. A participant in a covered transaction may rely upon a certification of a prospective participant in a lower tier covered transaction that is not debarred, suspended, ineligible, or voluntarily excluded from the covered transaction, unless it knows that the certification is erroneous. A participant is responsible for ensuring that its principals are not suspended, debarred, or otherwise ineligible to participate in covered transactions. To verify the eligibility of its principals, as well as the eligibility of any lower tier prospective participants, each participant may, but is not required to, check the Excluded Parties List System website (<https://www.epls.gov/>), which is compiled by the General Services Administration.

h. Nothing contained in the foregoing shall be construed to require establishment of a system of records in order to render in good faith the certification required by this clause. The knowledge and information of participant is not required to exceed that which is normally possessed by a prudent person in the ordinary course of business dealings.

i. Except for transactions authorized under paragraph e of these instructions, if a participant in a covered transaction knowingly enters into a lower tier covered transaction with a person who is suspended, debarred, ineligible, or voluntarily excluded from participation in this transaction, in addition to other remedies available to the Federal Government, the



department or agency with which this transaction originated may pursue available remedies, including suspension and/or debarment.

\* \* \* \* \*

**Certification Regarding Debarment, Suspension, Ineligibility and Voluntary Exclusion--Lower Tier Participants:**

1. The prospective lower tier participant certifies, by submission of this proposal, that neither it nor its principals is presently debarred, suspended, proposed for debarment, declared ineligible, or voluntarily excluded from participating in covered transactions by any Federal department or agency.

2. Where the prospective lower tier participant is unable to certify to any of the statements in this certification, such prospective participant shall attach an explanation to this proposal.

\* \* \* \* \*

**XI. CERTIFICATION REGARDING USE OF CONTRACT FUNDS FOR LOBBYING**

This provision is applicable to all Federal-aid construction contracts and to all related subcontracts which exceed \$100,000 (49 CFR 20).

1. The prospective participant certifies, by signing and submitting this bid or proposal, to the best of his or her knowledge and belief, that:

a. No Federal appropriated funds have been paid or will be paid, by or on behalf of the undersigned, to any person for influencing or attempting to influence an officer or employee of any Federal agency, a Member of Congress, an officer or employee of Congress, or an employee of a Member of Congress in connection with the awarding of any Federal contract, the making of any Federal grant, the making of any Federal loan, the entering into of any cooperative agreement, and the extension, continuation, renewal, amendment, or modification of any Federal contract, grant, loan, or cooperative agreement.

b. If any funds other than Federal appropriated funds have been paid or will be paid to any person for influencing or attempting to influence an officer or employee of any Federal agency, a Member of Congress, an officer or employee of Congress, or an employee of a Member of Congress in connection with this Federal contract, grant, loan, or cooperative agreement, the undersigned shall complete and submit Standard Form-LLL, "Disclosure Form to Report Lobbying," in accordance with its instructions.

2. This certification is a material representation of fact upon which reliance was placed when this transaction was made or entered into. Submission of this certification is a prerequisite for making or entering into this transaction imposed by 31 U.S.C. 1352. Any person who fails to file the required certification shall be subject to a civil penalty of not less than \$10,000 and not more than \$100,000 for each such failure.

3. The prospective participant also agrees by submitting its bid or proposal that the participant shall require that the language of this certification be included in all lower tier subcontracts, which exceed \$100,000 and that all such recipients shall certify and disclose accordingly.

**NOTICE OF REQUIREMENTS FOR AFFIRMATIVE  
ACTION TO ENSURE EQUAL EMPLOYMENT  
OPPORTUNITY (EXECUTIVE ORDER 11246)**

1. The Offeror's or Bidder's attention is called to the "Equal Opportunity Clause" and the "Standard Federal Equal Employment Opportunity Construction Contract Specifications" set forth herein.

2. The goal for female participation, expressed in percentage terms for the Contractor's aggregate workforce in each trade on all construction work, is 6.9%.

Until further notice Goals for minority participation for each trade (percent)

SHSA Cities:  
 Pascagoula - Moss Point ----- 16.9  
 Biloxi - Gulfport ----- 19.2  
 Jackson ----- 30.3

SMSA Counties:  
 Desoto ----- 32.3  
 Hancock, Harrison, Stone ----- 19.2  
 Hinds, Rankin ----- 30.3  
 Jackson ----- 16.9

Non-SMSA Counties:  
 George, Greene ----- 26.4

Alcorn, Benton, Bolivar, Calhoun, Carroll, Chickasaw, Clay, Coahoma, Grenada, Itawamba, Lafayette, Lee, Leflore, Marshall, Monroe, Montgomery, Panola, Pontotoc, Prentiss, Quitman, Sunflower, Tallahatchie, Tate, Tippah, Tishomingo, Tunica, Union, Washington, Webster, Yalobusha ----- 26.5

Attala, Choctaw, Claiborne, Clarke, Copiah, Covington, Franklin, Holmes, Humphreys, Issaquena, Jasper, Jefferson, Jefferson Davis, Jones Kemper, Lauderdale, Lawrence, Leake, Lincoln, Lowndes, Madison, Neshoba, Newton, Noxubee, Oktibbeha, Scott, Sharkey, Simpson, Smith, Warren, Wayne, Winston, Yazoo ----- 32.0

Forrest, Lamar, Marion, Pearl River, Perry, Pike, Walthall ----- 27.7

Adams, Amite, Wilkinson ----- 30.4

These goals are applicable to all the Contractor's construction work (whether or not it is Federal or federally assisted) performed in the covered area. If the contractor performs construction work in a geographical area located outside of the covered area, it shall apply the goals established for such geographical area where the work is actually performed. With regard to this second area, the contractor also is subject to the goals for both its federally involved and nonfederally involved construction.

The Contractor's compliance with the Executive Order and the regulations in CFR Part 60-4 shall be based on its implementation of the Equal Opportunity clause, specific affirmative action obligations required by the specifications set forth in 41 CFR 60-4.3(a), and its efforts to meet the goals. The hours of minority and female employment and training must be substantially uniform throughout the length of the contract, and in each trade, and the Contractor shall make a good faith effort to employ minorities and women evenly on each of its projects. The transfer of minority or female employees or trainees from Contractor to Contractor or from project to project for the sole purpose of meeting the Contractor's goals shall be a violation of the contract, the Executive Order and the regulations in 41 CFR Part 60-4.2(d). Compliance with the goals will be measured against the total work hours performed.

3. The Contractor shall provide written notification to the Director of the Office of Federal Contract Compliance Programs within 10 working days of award of any construction subcontract in excess of \$10,000 at any tier for construction work under the contract resulting from this solicitation. The notification shall list the name, address and telephone number of the subcontractor, employer identification number of the subcontractor, estimated dollar amount of the subcontract; estimated starting and completion dates of the subcontract; and the geographical area in which the subcontract is to be performed.

4. As used in this Notice, and in the contract resulting from this solicitation, the "covered area" is to the county and city (if any), stated in the advertisement.

5. The notification required in Paragraph 3 shall be addressed to the following:

Contract Compliance Officer  
 Mississippi Department of Transportation  
 P.O. Box 1850  
 Jackson, Mississippi 39215-1850

(06/28/2012)

**MISSISSIPPI DEPARTMENT OF TRANSPORTATION**

**SPECIAL PROVISION NO. 907-102-2**

**CODE: (IS)**

**DATE: 11/22/2017**

**SUBJECT: Bidding Requirements and Conditions**

Section 102, Bidding Requirements and Conditions, of the 2017 Edition of the Mississippi Standard Specifications for Road and Bridge Construction is hereby amended as follows.

**907-102.01--Prequalification of Bidders.** Delete the last sentence of the third paragraph of Subsection 102.01 on page 13, and substitute the following.

The Bidder's Certificate of Responsibility number must be on file with the Department's Contract Administration Division prior to request for permission to bid.

**907-102.02--Contents of Proposal Forms.** Delete the fourth paragraph in Subsection 102.02 on page 13, and substitute the following.

Prospective bidders must complete an online request for permission to be eligible to bid a project. Upon approval, the bidder will be authorized to submit a bid electronically using Bid Express at <http://bidx.com>.

## MISSISSIPPI DEPARTMENT OF TRANSPORTATION

SPECIAL PROVISION NO. 907-103-2

CODE: (SP)

DATE: 06/22/2017

SUBJECT: Award and Execution of Contract

Section 103, Award and Execution of Contract, of the 2017 Edition of the Mississippi Standard Specifications for Road and Bridge Construction is hereby amended as follows.

**907-103.01--Consideration of Proposal.** Delete the second and third paragraphs of Subsection 103.01 on page 19, and substitute the following.

**907-103.01.1--For Projects Constructed Without Federal Funds.** Resident Contractors actually domiciled in Mississippi are to be granted preference over nonresidents in awarding of Contracts financed 100% with State funds.

In consideration of proposals that are equal to or in excess of \$50,000 and financed 100% with State funds, a nonresident bidder domiciled in a state having laws granting preference to local Contractors will be considered for such contracts on the same basis as the nonresident bidder's state awards contracts to Mississippi Contractors bidding under similar circumstances. When a nonresident Contractor submits a bid equal to or in excess of \$50,000 on a contract financed 100% with State funds, a copy of the current laws from the state of domicile and an explanation thereof pertaining to treatment of nonresident Contractors shall be attached. If no preferential treatment is provided for Contractors in the state of domicile and contracts are awarded to the lowest responsible bidder, a statement to this effect shall be attached. Should the attachment not accompany the bid when submitted, the Contractor shall have 10 days following the opening of the bids to furnish the required information to the Contract Administration Director for attachment to the bid. Failure to provide the attachment within 10 days will result in the nonresident Contractor's bid being rejected and not considered for award. As used herein, the term "resident Contractor" includes a nonresident person, firm or corporation that has been qualified to do business in this State and has maintained a permanent full-time office in the State of Mississippi for two years prior to the submission of the bid, and the subsidiaries and affiliates of such a person, firm or corporation.

**MISSISSIPPI DEPARTMENT OF TRANSPORTATION**

**SUPPLEMENT TO SPECIAL PROVISION NO. 907-618-4**

**DATE: 03/20/2018**

**PROJECT: STP-0015-02(123) / 107798301 -- Covington County**

After the first paragraph of Subsection 907-618.01.2 on page 1, add the following.

Additional traffic control devices will be required as follows.



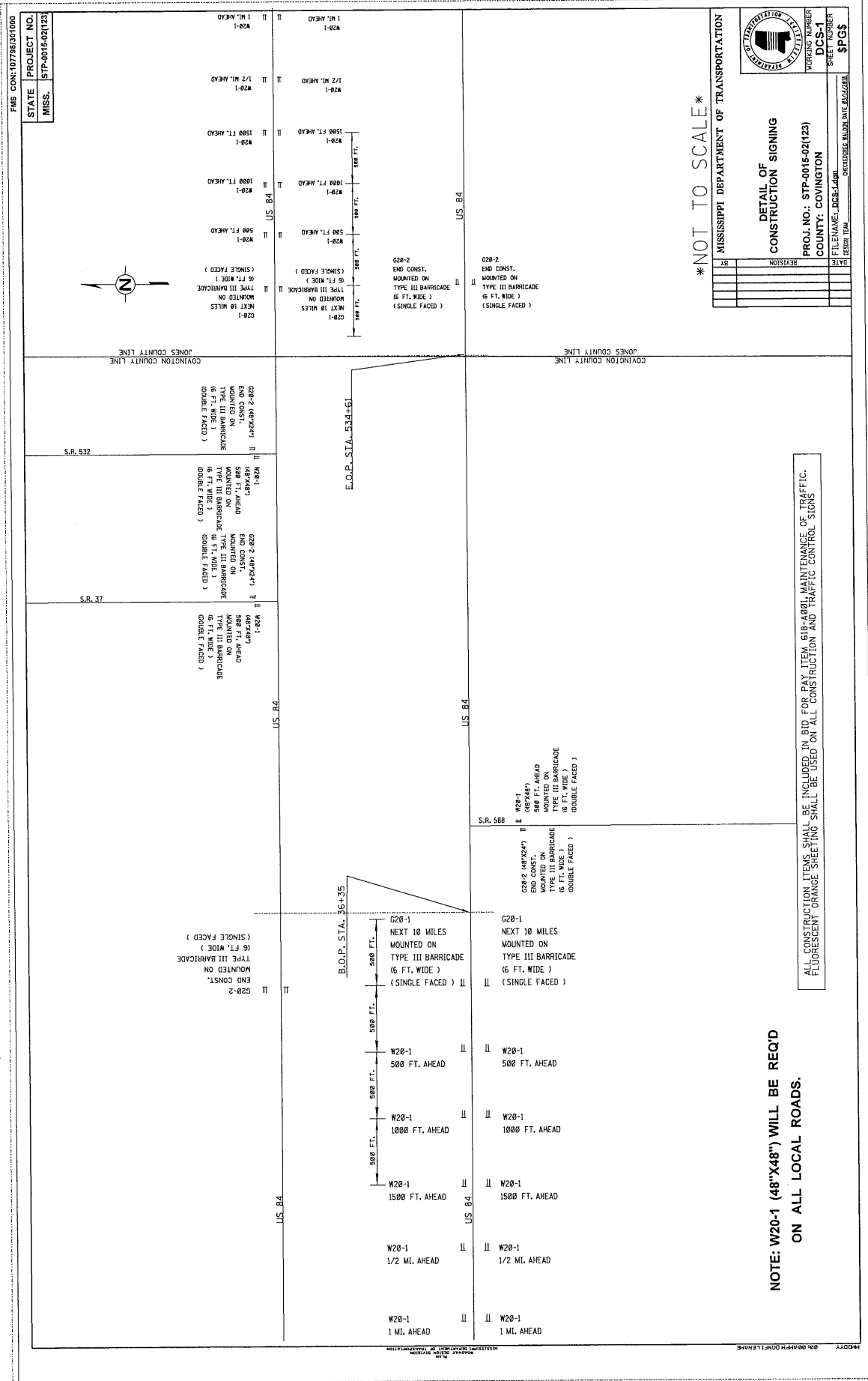

## MISSISSIPPI DEPARTMENT OF TRANSPORTATION

SPECIAL PROVISION NO. 907-618-4

CODE: (SP)

DATE: 02/01/2018

SUBJECT: Additional Signing Requirements

Section 618, Maintenance of Traffic and Traffic Control Plan, of the 2017 Edition of the Mississippi Standard Specifications for Road and Bridge Construction is hereby amended as follows.

**907-618.01.2--Traffic Control Plan.** At the end of Subsection 618.01.2 on page 441, add the following:

For compliance with the traffic control plan, the Contractor will be required to install and maintain traffic control devices at various locations throughout the project. Payment for these devices will be included in the price bid for pay item no. 618-A, Maintenance of Traffic per lump sum.



## MISSISSIPPI DEPARTMENT OF TRANSPORTATION

SPECIAL PROVISION NO. 907-624-1

CODE: (SP)

DATE: 01/17/2017

SUBJECT: Inverted Profile Thermoplastic Traffic Stripe

Section 907-624, Inverted Profile Thermoplastic Traffic Stripe, is hereby added to and made part of the 2017 Edition of the Mississippi Standard Specifications for Road and Bridge Construction as follows.

**907-624.01--Description.** Inverted profile thermoplastic pavement markings consists of furnishing materials and placing inverted profile thermoplastic pavement markings in reasonably close conformity with these specifications and the details shown on the plans or established.

Inverted profile thermoplastic pavement markings, high contract, shall consist of furnishing materials and placing inverted profile thermoplastic pavement markings over a black thermoplastic pavement marking in order to enhance the marking's visibility.

**907-624.02--Materials.**

**907-624.02.1--General.** The inverted profile thermoplastic marking material shall consist of an alkyd/maleic or hydrocarbon based formulation. The material shall be so manufactured as to be applied to the pavement in a molten form, with internal and surface application of glass spheres, and upon cooling to normal pavement temperature, shall produce an adherent, reflectorized pavement marking of specified thickness and width, capable of resisting deformation.

Materials shall be obtained from approved sources as listed on the Department's "List of Approved Sources" for Inverted Profile Thermoplastic Pavement Marking Materials. The material shall not scorch, break down, discolor, or deteriorate when held at the application temperature for four hours or when reheated four times to the application temperature. Temperature-vs-viscosity characteristics of the plastic material shall remain constant when reheated four times, and shall be the same from batch to batch.

The thermoplastic material shall be a product especially compounded for pavement markings. The pavement markings shall maintain their original dimension and shall not smear or spread under normal traffic at temperatures below 140°F. The markings shall have a uniform cross section. Pigment shall be evenly dispersed throughout its thickness. The exposed surface shall be free from tack and shall not be slippery when wet. The material shall not lift from pavement in freezing weather. Cold ductility of the material shall be such as to permit normal movement with the pavement surface without chipping or cracking.

Black thermoplastic compound for the placement of inverted profile thermoplastic pavement markings, high contract, shall consist of a hydrocarbon or alkyd/maleic based formulation.

The manufacturers of the thermoplastic compound, glass beads and epoxy primer sealer shall furnish to the Engineer three copies of certified test reports showing results of all tests specified herein and shall further certify that the materials meet all requirements. The Contractor shall provide the warranty as specified herein to the Engineer.

**907-624.02.2--Inverted Profile Thermoplastic Material.** The thermoplastic material shall consist of homogeneously mixed pigments, fillers, resins and glass beads, and shall be available in both white and yellow. The material shall be free from all skins, dirt, and foreign objects. Materials shall conform to AASHTO M 249 with the following modifications:

**907-624.02.2.1--Intermixed Glass Beads.** The thermoplastic material shall contain a minimum of 40 percent Class H glass beads by weight. Class H glass beads shall meet the requirements of ASTM D 1155, and shall be coated with an adhesion promoting coating which shall also provide moisture resistance as tested by AASHTO M 247, Section 4.4.2. Class H beads shall have a minimum of 70 percent true spheres and the +20 sieve shall be tested visually.

The gradation of the Class H beads shall meet the following:

<u>U. S. Standard Sieve</u>	<u>% Passing</u>
12	100
14	95 - 100
16	80 - 100
18	30 - 100
20	15 - 100
30	10 - 100
50	0 - 50
100	0 - 5

**907-624.02.2.2--Binder Content.** The binder content of the thermoplastic material shall be 19 percent minimum.

**907-624.02.2.3--Titanium Dioxide.** The titanium dioxide shall meet ASTM D 476, Type II, Rutile grade - 10 percent minimum titanium content.

**907-624.02.2.4--Yellow Pigment.** The yellow pigment for the yellow thermoplastic material shall be five (5) percent minimum.

**907-624.02.2.5--Specific Gravity.** The specific gravity of the thermoplastic pavement marking material shall not exceed 2.35.

**907-624.02.2.6--Flow Characteristics.**

**907-624.02.2.6.1--Flowability.** After heating the thermoplastic material for four (4) hours ±5 minutes at 425 ±3°F and testing flowability, the white thermoplastic shall have a maximum percent residue of 22 percent and the yellow thermoplastic shall have a maximum residue of 24 percent.

**907-624.02.2.6.2--Flow Resistance.** The material shall exhibit a maximum flow of 10%. The material's ability to form ribs on the markings shall be evaluated by casting a disc of material approximately 3.5 inches wide by 1.0 inch long by and 0.60 inch deep. After the material is cooled to ambient temperature, measure the exact height. The material shall then be stored at 190°F for four (4) hours. After the material is cooled to ambient temperature, re-measure the exact height and express the flow resistance as a flow percentage.

**907-624.02.2.7--Reflectivity.** The initial reflectance for the in-place marking shall have a minimum reflectance value of 450 mcd/ft<sup>2</sup> for white and 350 mcd/ft<sup>2</sup> for yellow, when measured with a MiroLux Ultra 30 retroreflectometer, or approved equal.

**907-624.02.2.8--Wet Reflectivity.** The initial reflectance for the in-place marking when wet shall have a minimum reflectance value of 200 mcd/ft<sup>2</sup> for white and 175 mcd/ft<sup>2</sup> for yellow, when measured with an approved retroreflectometer. The stripe shall be wetted utilizing a pump type sprayer for five (5) seconds. After 30 seconds, place the retroreflectometer on the stripe and measure the reflectance.

**907-624.02.2.9--Inverted Profile.** The thermoplastic pavement marking material shall be applied to have individual profiles having a minimum height of 0.140 inches with the recessed inverted profiles having a thickness of 0.025 to 0.050 inches. The profiles shall be well defined, spaced approximately one (1) inch apart, and not excessively run back together.

**907-624.02.3--Black Pavement Marking Material for High Contrast Inverted Profile Pavement Markings.**

**907-624.02.3.1--General.** In the molten state, the material shall not give off fumes that are toxic or otherwise injurious to persons or property. The manufacturer shall provide material safety data sheets for the product.

The temperature versus viscosity characteristic of the plastic material shall remain constant and the material shall not deteriorate in any manner during three reheating processes. There shall be no obvious change in color of the material as a result of up to three reheatings, or in maintaining the material at application temperature up to an aggregate time of four (4) hours, or from batch to batch. The maximum elapsed time after application at which normal traffic will leave no impression or imprint on the new stripe shall be 30 seconds when the air and road surface temperature is approximately 68 ±5°F. The applied stripe shall remain free from tack and shall not lift from the pavement under normal traffic conditions within a road temperature range of -20°F to 150°F. The stripe shall maintain its original dimensions and placement. Cold ductility of the material shall be such as to permit normal dimensional distortion as a result of tire impact within the temperature range specified.

The material shall provide a stripe that has a uniform thickness throughout its cross section.

**907-624.02.3.2--Binder.** The binder shall be hydrocarbon or alkyd/maleic based. The binder shall consist of a homogeneous mixture of pigment, fillers, resins, waxes and plasticizers. The total

binder content shall be well distributed throughout the compound. The binder shall be free from all foreign objects or ingredients that would cause bleeding, staining or discoloration. The binder shall be 19 percent minimum by weight of the thermoplastic compound.

**907-624.02.3.3--Pigment.** The pigment used for black pavement marking compound shall be as required and shall be uniformly distributed throughout the marking compound.

**907-624.02.3.4--Filler.** The filler to be incorporated with the resins shall be a white calcium carbonate, silica or any approved substitute.

**907-624.02.3.5--Specific Gravity.** The specific gravity of the marking compound shall not exceed 2.0.

**907-624.02.3.6--Softening Point.** After heating the marking compound for 4 hours  $\pm$ 5 minutes at  $375 \pm 3^\circ\text{F}$  and testing in accordance with ASTM E 28, the material shall have a minimum softening point of  $180^\circ\text{F}$  as measured by the ring and ball method.

**907-624.02.3.7--Tensile Bond Strength.** After heating the marking compound for 4 hours  $\pm$ 5 minutes at  $375 \pm 3^\circ\text{F}$ , the tensile bond strength shall exceed 180 psi when tested in accordance with ASTM D 4806. The material shall be applied to unprimed, sandblasted Portland cement concrete block at a thickness of 0.0625-inch and at a temperature of  $375 \pm 3^\circ\text{F}$ . The test shall be conducted at room temperature.

**907-624.02.3.8--Impact Resistance.** After heating the marking compound for 4 hours  $\pm$ 5 minutes at  $375 \pm 3^\circ\text{F}$ , the impact resistance shall be a minimum of 50 inch-pounds minimum when tested in accordance with ASTM D 2794. No cracks or bond loss shall occur when a 0.0625-inch thick film drawdown is made at  $375 \pm 3^\circ\text{F}$  on an unprimed sandblasted Portland cement concrete block. The sample is tested with a male indenter 5/8-inch and no female Die at room temperature.

**907-624.02.3.9--Identification.** Each package of material shall be stenciled with the manufacturer's name, the type of material and specification number, the month and year the material was packaged and lot number. The letters and numbers used in the stencils shall be a minimum of 1/2 inch in height.

**907-624.02.3.10--Packaging.** The material shall be packaged in suitable containers that will not adhere to the product during shipment and storage. The container of pavement marking material shall weigh approximately 50 lbs. Each container shall designate the color, type of resin, type of application and user information. The label shall warn the user that the material shall be heated in the range of  $350^\circ$  to  $425^\circ\text{F}$ .

**907-624.02.3.11--Storage Life.** The material shall meet the requirements of this specification for a period of one year. The material must also meet uniformly with no evidence of skins or unmelted particles for this one-year period. The manufacturer shall replace any material not meeting the above requirements.

**907-624.02.3.12--Certifications.** The material manufacturer shall furnish a certified copy of material test reports to the Engineer.

**907-624.02.4--Drop-On Glass Beads.** Drop-on glass beads shall be separated into two (2) classes, as follows:

**907-624.02.4.1--Class G Glass Beads.** Class G glass beads shall be coated with an adhesion promoting coating which shall also provide moisture resistance as tested by AASHTO M 247, Section 4.4.2 and shall exhibit the following characteristics:

- **Color and Clarity:** The glass beads shall be colorless and clear, and shall be free of carbon residues.
- **Index of Refraction:** minimum 1.50
- **Roundness:** The glass beads shall have a minimum of 80% true spheres per screen for the two highest sieve quantities, determined visually, and a maximum of 3% angular particles per sieve, determined visually. The remaining sieves shall have a minimum of 75% true spheres, determined visually per aspect ratio using microfiche reader.
- **Air Inclusions:** 10% maximum
- **Specific Gravity:** The specific gravity of the glass beads shall be a minimum of 2.50.
- **Gradation:** The gradation of Class G glass beads shall be as follows:

<u>U. S. Standard Sieve</u>	<u>% Passing</u>
12	100
14	100 - 95
16	100 - 80
18	100 - 20
20	90 - 20
30	100 - 50
Pan	100 - 90

All Class G glass beads shall be coated with an adhesion promoting coating.

**907-624.02.4.2--Class H Glass Beads.** Class H glass beads shall meet the requirements of ASTM D 1155, and shall be coated with an adhesion promoting coating which shall also provide moisture resistance as tested by AASHTO M 247, Section 4.4.2. Class H beads shall have a minimum of 70 percent true spheres and the +20 sieve shall be tested visually.

The gradation of the Class H beads shall meet the following:

<u>U. S. Standard Sieve</u>	<u>% Passing</u>
16	99 - 100
20	75 - 100
30	55 - 95
50	10 - 35
100	0 - 5

**907-624.03--Construction Requirements.**

**907-624.03.1--Equipment.** The application equipment shall be specifically designed for placing thermoplastic material in a hot molten state on the pavement surface utilizing a pressure type application method. The thermoplastic stripe shall be formed by a die that is allowed to drag along in proximity with the pavement surface. The die is pulled forward by a special linkage that will allow it to automatically level itself as to float and remain parallel with the pavement surface. The traffic stripe shall be formed by reason that the hot thermoplastic material is forced under pressure through four sides to the die onto the pavement surface. The top of the die shall be enclosed and provide entry means for the hot molten thermoplastic material to enter the die cavity. The bottom of the die shall contain a movable door that is remote controlled so as to start or stop the flow of thermoplastic material onto the pavement surface. When the movable door is open, thermoplastic material can flow through the die and will apply a thermoplastic stripe that will be formed rearward of the advancing die. The pavement surface shall be at the bottom of the die enclosure. Thermoplastic material shall be fed to the die under pressure through flexible oil-jacketed stainless steel hoses. The thermoplastic material must be either pumped or fed from a pressure vessel to the die under pressure in order to obtain the proper adhesion with the pavement surface.

The system shall consist of a low pressure drop-on type glass bead gun, (bead coat #1). The thermoplastic die shall be oil-jacketed on four (4) sides and is formed from a single solid block of steel. The glass bead gun shall dispense glass beads onto the hot thermoplastic stripe from a height of approximately one (1) inch above the pavement surface. The point at which the glass beads strike the surface of the stripe shall be approximately three inches (3”) behind the strike point of the thermoplastic material itself. This reflective bead coat #1 shall utilize Class G glass beads as specified herein, and shall provide a surface coating of 50 percent of the thermoplastic stripe surface. Of this 50 percent stripe coverage, at least 50 percent of the beads shall be embedded to a depth of 60 percent of their diameter.

A second curtain coater, low pressure drop-on type glass bead gun capable of applying a continuous sheet or ribbon of glass beads, shall follow at an interval of approximately 10 inches behind the first bead gun. This second glass bead gun shall apply bead coat #2 which will form a continuous drop-on coat of Class H glass beads immediately in front of the profiling device. This second curtain of glass beads shall have a low impact speed so that they are not forced into the stripe under pressure.

A special rotatable wheel profiling device shall be located approximately eight (8) inches behind bead gun #2. This rotatable wheel device shall be approximately seven (7) inches in diameter and shall have a plurality of spaced projections located around its circumference. The profiling device shall be wider than the stripe being applied in order that the stripe shall be adequately covered. The projections on the rotatable profiling device shall have an angular profiling surface set at an angle to the pavement surface. The rotatable profile device shall be mounted with an automatic leveling device to the same carriage assembly as the thermoplastic gun. This is required so that a traffic stripe of accurate and uniform definition can be obtained. The inverted profile grooves shall be pressed into the hot molten thermoplastic stripe within one (1) second of the thermoplastic material application in order to insure proper bead adhesion to the stripe. Using rollers to place grooves in the traffic stripe utilizing a separate vehicle or grooves that are not pressed within one

(1) second of the thermoplastic material application will not be allowed. To insure that no thermoplastic material adheres to the wheel as it rotates and profiles the stripe, a small air atomizer water jet shall apply a thin mist coat of water to the rotatable profile wheel. It is the intent of this specification that a minimum amount of water be used and that no water puddles greater than ¼ inch in diameter be allowed to accumulate on the pavement surface in proximity to the freshly placed stripe. Excess water on the pavement surface can cause bond failure of the thermoplastic material.

All parts of the thermoplastic holding tank including manifolds, hoses, pipes, dies, etc., shall be oil-jacketed to insure accurate temperature control. The thermoplastic material shall be preheated in kettles designed specifically for that purpose. Each kettle of preheated thermoplastic material shall be properly mixed and heated to the correct application temperature. The preheated material shall then be fed to the thermoplastic gun for application.

The striping machine shall contain enough glass beads and water to apply one full kettle of thermoplastic material.

**907-624.03.2--Cleaning of Pavement Surface.** Immediately before application, the areas to receive markings shall be cleaned thoroughly using equipment capable of cleaning without damaging the pavement surface. This will include, but not be limited to, all vegetation, loose soil, oils, and other debris. On areas of pavement cured with compound, the membrane shall be removed completely by "shot" blasting, sand blasting or other approved method. Striping shall follow as closely as practical after the pavement surface has been cleaned.

**907-624.03.3--Application Over Existing Striping.** Where shown on the plans or directed by the Engineer, the existing traffic stripe shall be removed by grinding or sandblasting. When placing inverted profile thermoplastic pavement markings on existing pavement that has more than one light coat (pavement not showing through stripe) of striping material, the existing stripe shall be removed to the point that 80 percent of the pavement surface is visible.

Removal of existing stripe will be paid for as a separate item of work.

Where unsatisfactory striping performed by the Contractor must be removed and replaced in accordance with these specifications, the Contractor shall use the removal method described above. No payment will be made for removal or replacement of the Contractor's unsatisfactory striping.

**907-624.03.4--Surface Conditions.** When placing inverted profile thermoplastic pavement markings, no striping shall be permitted when the pavement surface temperature is less than 60°F. A non-contact infrared pyrometer shall be furnished by the Contractor for use by the Engineer for verification of the temperature. Striping shall not be performed when there is moisture on the pavement surface or when winds exceed 12 mph. When unseen moisture is suspected to be present, a moisture test shall be performed. The test shall be as follows:

- 1) Place a piece of roofing felt on the pavement surface.
- 2) Pour 0.5 gallon of thermoplastic material at application temperature onto the paper.

- 3) After two (2) minutes, lift the paper and inspect to see if moisture has been drawn from the pavement.
- 4) If moisture is present, striping is not to begin until the surface is moist free.

Documentation of weather and pavement conditions shall be recorded as part of completing the MDOT Inverted Profile Thermoplastic Pavement Marking Inspectors Report.

**907-624.03.5--Application.** Prior to the placement of pavement markings, the Contractor shall furnish the Engineer three copies of the manufacturer's warranty stating that the manufacturer will guarantee the pavement marking to meet the requirements of this specification.

The thermoplastic material shall be preheated and thoroughly mixed. The application temperature of the thermoplastic material shall be between 400°F and 430°F. A digital thermometer complete with a 24-inch probe shall be furnished by the Contractor for use by the Engineer for verification of the temperature.

When measured at the highest point of the profile, the cold thickness of the in-place thermoplastic stripe shall be a minimum of 0.140 inch for Inverted Profile Thermoplastic Pavement Markings. The thickness of the thermoplastic material in the bottom of the profiles shall range from 0.025 to 0.050 inch. The individual profiles shall be located transversely across the stripe at intervals of approximately one (1) inch. The bottoms of these intervals shall be between 3/32 inch and 5/16 inch wide. In order to drain water and to reflect light, it is normal for the top surface of the inverted profiles to be irregular. The application rate of thermoplastic material for Inverted Profile Thermoplastic Pavement Markings shall be a minimum of 2700± pounds per mile for a continuous 6-inch stripe.

The application rate for Class G glass beads (bead coat #1) shall be 300± pounds per mile for 6-inch continuous stripe.

The application rate for Class H glass beads (bead coat #2) shall be 300± pounds per mile for 6-inch continuous stripe.

The thickness of the striping materials shall be verified periodically (at least every 1320 feet) and any thickness more than five (5) percent under the designated thickness shall be reworked. A consistent, uncorrected under-run will not be allowed and the Contractor will be required to install the specified minimum thickness of 0.140 inch. A wet thickness gauge and cold thickness gauge shall be furnished by the Contractor for use by the Engineer for the verification of film thickness.

When striping over existing painted stripe (one light coat), on old oxidized asphalt, on all concrete surfaces or on asphalt surfaces when ambient temperatures are below 70°F, a two component epoxy primer sealer shall be used and installed as recommended in writing by the thermoplastic material manufacturer. The epoxy primer sealer shall be EX255/EX256 as manufactured by Crown Paint Company of Oklahoma City, Oklahoma, or approved equal. The Contractor shall furnish certification of compatibility of the epoxy primer sealer to be used with the thermoplastic material supplied. If an alternate epoxy primer sealer to the EX255/EX256 is used, the Contractor



shall furnish a mill analysis and proof of adequate performance of the alternate epoxy primer sealer when used with thermoplastic pavement markings.

**907-624.03.6--Inverted Profile Thermoplastic Traffic Stripe, High Contrast.** Before applying the black pavement marking material, the Contractor shall remove any dirt, glaze, grease or any other material that would reduce the adhesion of the thermoplastic to the pavement.

The pavement marking material shall be installed in a molten state by the spray method at a minimum temperature of 350°F and a maximum temperature of 425°F. Scorching or discoloration of material shall be cause for rejection by the Engineer. The machinery shall be constructed so that all mixing and conveying parts, up to and including the thermoplastic gun, maintain the material in the molten state.

The pavement marking materials shall not be applied when air and pavement surface temperatures are below 60°F or when the surface of the pavement contains any evidence of moisture.

The pavement marking material shall be applied at a thickness of not less than 0.040-inch.

The equipment used to install hot applied pavement marking material shall provide continuous mixing and agitation of the material while maintaining a minimum temperature exceeding 400°F. A strainer shall be in place between the main material reservoir and the gun to prevent accumulation and clogging. The equipment shall be constructed for easy accessibility to parts requiring cleaning and maintenance.

After the black thermoplastic pavement markings are applied, inverted profile thermoplastic markings shall be placed over the black thermoplastic pavement markings in accordance with the specifications and to the dimensions and details shown on the plans or established.

**907-624.03.7--Warranty.** The manufacturer shall warrant that the inverted profile thermoplastic markings will meet the minimum performance level of 150 mcd/fc/sq. ft. dry and 75 mcd/fc/sq. ft. wet for a period of 48 months from the date of final inspection when exposed to normal roadway conditions regardless of the average daily traffic. Failure to meet this requirement will result in the total replacement of the portion of the stripe shown to be below these minimums. All costs of labor, material and other incidentals necessary for the replacement of unacceptable pavement markings shall be at no additional costs to the State.

Compliance will be determined by an average brightness reading over a minimum zone marking length of 300 linear feet, using an approved reflectometer. The zone of measurement referred to includes centerline stripe, edge lines and skip lines.

<b>Performance Requirements:</b>	<b>White</b>		<b>Yellow</b>	
	<b><u>Dry</u></b>	<b><u>Wet</u></b>	<b><u>Dry</u></b>	<b><u>Wet</u></b>
Initial Reflectivity, mcd/fc/sq. ft.	450	200	350	175
48-Month Retained Reflectivity	150	75	150	75

The measurement procedure for this warranty will entail a visual night inspection by a manufacturer representative and a MDOT representative to identify areas of the installation, which appear to be below the specified minimum, warranted reflectance value. All reflectance measurements for dry conditions shall be made on a clean dry surface at a minimum temperature of 40°F. All reflectance measurements for wet conditions shall be made using the setting conditions of Subsection 907-624.02.2.8 at a minimum temperature of 40°F.

Measurement intervals for installations with areas less than, or equal to, three (3) miles shall be at a minimum of three (3) check points for each zone. These check points should include the start point, approximate mid-point and the end point.

Measurement intervals for installations with areas greater than three (3) miles shall be at a minimum of three (3) check points, one at the start point, one at the end point and additional measurements spaced at 3-mile intervals between the start and end points of the area in question.

The number of measurements at each check point for each zone will be as follows:

- (A) Skip Lines: Eighteen (18) measurements, distributed over six (6) skip lines, shall be made at each check point.
- (B) Center Lines and/or Edge Lines: Eighteen (18) measurements shall be made over 300 linear feet of continuous stripe.

When taking reflectivity measurements, the value of the measurement shall be determined by averaging three measurements; one at the left edge of the stripe, one at the center of the stripe and one at the right edge of the stripe.

In addition, the reflectance values measured at each check point shall be averaged by zone to determine conformance to the minimum warranted reflective values.

**907-624.04--Method of Measurement.** Inverted profile thermoplastic traffic stripe of the type specified will be measured by the mile or by the linear foot, as indicated, from end-to-end of individual stripes. In the case of skip lines the measurement will include skips. The length used to measure centerline and edge stripes will be the horizontal length computed along the stationed control line. Inverted profile thermoplastic detail traffic stripe will be measured by the linear foot from end-to-end of individual stripes. Measurements will be made along the surface of each stripe and will exclude skip intervals where skips are specified. Stripes more than six (6) inches in width will be converted to equivalent lengths of six-inch widths.

**907-624.05--Basis of Payment.** Inverted profile thermoplastic traffic stripe, measured as prescribed above, will be paid for at the contract unit price per mile or linear foot, as applicable, which shall be full compensation for completing the work.

Payment will be made under:

907-624-A:	6" Inverted Profile Thermoplastic Traffic Stripe, Skip White *	- per linear foot or mile
907-624-B:	6" Inverted Profile Thermoplastic Traffic Stripe, Continuous White *	- per linear foot or mile
907-624-C:	6" Inverted Profile Thermoplastic Traffic Stripe, Skip Yellow *	- per linear foot or mile
907-624-D:	6" Inverted Profile Thermoplastic Traffic Stripe, Continuous Yellow *	- per linear foot or mile
907-624-E:	Inverted Profile Thermoplastic Detail Traffic Stripe, <u>Color</u> *	- per linear foot

\* High Contrast may be specified

# SECTION 905 - PROPOSAL

Date \_\_\_\_\_

Mississippi Transportation Commission  
Jackson, Mississippi

Sirs: The following proposal is made on behalf of \_\_\_\_\_  
\_\_\_\_\_ of \_\_\_\_\_  
\_\_\_\_\_

for constructing the following designated project(s) within the time(s) hereinafter specified.

The plans are composed of drawings and blue prints on file in the offices of the Mississippi Department of Transportation, Jackson, Mississippi.

The Specifications are the current Standard Specifications of the Mississippi Department of Transportation approved by the Federal Highway Administration, except where superseded or amended by the plans, Special Provisions and Notice(s) to Bidders attached hereto and made a part thereof.

I (We) certify that I (we) possess a copy of said Standard and any Supplemental Specifications.

Evidence of my (our) authority to submit the Proposal is hereby furnished. The proposal is made without collusion on the part of any person, firm or corporation. I (We) certify that I (we) have carefully examined the Plans, the Specifications, including the Special Provisions and Notice(s) to Bidders, herein, and have personally examined the site of the work. On the basis of the Specifications, Special Provisions, Notice(s) to Bidders, and Plans, I (we) propose to furnish all necessary machinery, tools, apparatus and other means of construction and do all the work and furnish all the materials in the manner specified. I (We) understand that the quantities mentioned herein are approximate only and are subject to either increase or decrease, and hereby propose to perform any increased or decreased quantities of work at the unit prices bid, in accordance with the above.

I (We) acknowledge that this proposal will be found irregular and/or non-responsive unless a certified check, cashier's check, or Proposal Guaranty Bond in the amount as required in the Advertisement (or, by law) is submitted electronically with the proposal or is delivered to the Contract Administration Engineer prior to the bid opening time specified in the advertisement.

**INSTRUCTION TO BIDDERS: Alternate and Optional Items on Bid Schedule.**

1. Two or more items entered opposite a single unit quantity WITHOUT DEFINITE DESIGNATION AS "ALTERNATE ITEMS" are considered as "OPTIONAL ITEMS". Bidders may or may not indicate on bids the Optional Item proposed to be furnished or performed WITHOUT PREJUDICE IN REGARD TO IRREGULARITY OF BIDS.
2. Items classified on the bid schedule as "ALTERNATE ITEMS" and/or "ALTERNATE TYPES OF CONSTRUCTION" must be preselected and indicated on bids. However, "Alternate Types of Construction" may include Optional Items to be treated as set out in Paragraph 1, above.
3. Optional items not preselected and indicated on the bid schedule MUST be designated in accordance with Subsection 102.06 prior to or at the time of execution of the contract.
4. Optional and Alternate items designated must be used throughout the project.

I (We) further propose to perform all "force account or extra work" that may be required of me (us) on the basis provided in the Specifications and to give such work my (our) personal attention in order to see that it is economically performed.

I (We) further propose to execute the attached contract agreement (Section 902) as soon as the work is awarded to me (us), and to begin and complete the work within the time limit(s) provided for in the Specifications and Advertisement. I (We) also propose to execute the attached contract bond (Section 903) in an amount not less than one hundred (100) percent of the total of my (our) part, but also to guarantee the excellence of both workmanship and materials until the work is finally accepted.

I (We) shall submit electronically with our proposal or deliver prior to the bid opening time a certified check, cashier's check or bid bond for **five percent (5%) of total bid** and hereby agree that in case of my (our) failure to execute the contract and furnish bond within Ten (10) days after notice of award, the amount of this check (bid bond) will be forfeited to the State of Mississippi as liquidated damages arising out of my (our) failure to execute the contract as proposed. It is understood that in case I am (we are) not awarded the work, the check will be returned as provided in the Specifications.

**SECTION 905 -- PROPOSAL (CONTINUED)**

I (We) hereby certify by digital signature and electronic submission via Bid Express of the Section 905 proposal below, that all certifications, disclosures and affidavits incorporated herein are deemed to be duly executed in the aggregate, fully enforceable and binding upon delivery of the bid proposal. I (We) further acknowledge that this certification shall not extend to the bid bond or alternate security which must be separately executed for the benefit of the Commission. This signature does not cure deficiencies in any required certifications, disclosures and/or affidavits. I (We) also acknowledge the right of the Commission to require full and final execution on any certification, disclosure or affidavit contained in the proposal at the Commission's election upon award. Failure to so execute at the Commission's request within the time allowed in the Standard Specifications for execution of all contract documents will result in forfeiture of the bid bond or alternate security.

Respectfully Submitted,

DATE \_\_\_\_\_

\_\_\_\_\_  
Contractor

BY \_\_\_\_\_  
Signature

TITLE \_\_\_\_\_

ADDRESS \_\_\_\_\_

CITY, STATE, ZIP \_\_\_\_\_

PHONE \_\_\_\_\_

FAX \_\_\_\_\_

E-MAIL \_\_\_\_\_

(To be filled in if a corporation)

Our corporation is chartered under the Laws of the State of \_\_\_\_\_ and the names, titles and business addresses of the executives are as follows:

\_\_\_\_\_  
President Address

\_\_\_\_\_  
Secretary Address

\_\_\_\_\_  
Treasurer Address

The following is my (our) itemized proposal.

Overlay approximately 10 miles of US 84 (East Bound Lanes Only) from SR 588 to the Jones County Line, known as Federal Aid Project No. STP-0015-02(123) / 107798301 in Covington County.

Line no.	Item Code	Adj Code	Quantity	Units	Description[Fixed Unit Price]
<b>Roadway Items</b>					
0010	202-B240		2,170	Linear Feet	Removal of Traffic Stripe
0020	203-G002	(E)	180	Cubic Yard	Excess Excavation, LVM, AH
0030	304-A008	(GY)	5,311	Cubic Yard	Granular Material, LVM, Class 6, Group D
0040	403-A015	(BA1)	1,259	Ton	9.5-mm, ST, Asphalt Pavement
0050	403-D007	(BA1)	12,510	Ton	9.5-mm, HT, Asphalt Pavement, Polymer Modified
0060	403-E004	(BA1)	923	Ton	9.5-mm, HT, Asphalt Pavement, Polymer Modified, Leveling
0070	406-D001		9,855	Square Yard	Fine Milling of Bituminous Pavement, All Depths
0080	407-A001	(A2)	14,158	Gallon	Asphalt for Tack Coat
0090	412-A001		2,232	Square Feet	Pre-Grinding (\$3.25)
0100	423-A001		16	Mile	Rumble Strips, Ground In
0110	618-A001		1	Lump Sum	Maintenance of Traffic
0120	618-B001		1	Square Feet	Additional Construction Signs (\$10.00)
0130	619-A1001		12	Mile	Temporary Traffic Stripe, Continuous White
0140	619-A2001		9	Mile	Temporary Traffic Stripe, Continuous Yellow
0150	619-A3001		11	Mile	Temporary Traffic Stripe, Skip White
0160	619-A5001		34,148	Linear Feet	Temporary Traffic Stripe, Detail
0170	619-A6002		850	Linear Feet	Temporary Traffic Stripe, Legend
0180	620-A001		1	Lump Sum	Mobilization
0190	626-A004		9	Mile	6" Thermoplastic Traffic Stripe, Skip White
0200	626-C002		11	Mile	6" Thermoplastic Double Drop Edge Stripe, Continuous White
0210	626-F001		8	Mile	6" Thermoplastic Double Drop Edge Stripe, Continuous Yellow
0220	626-G002		21,600	Linear Feet	Thermoplastic Detail Stripe, White
0230	626-G003		12,548	Linear Feet	Thermoplastic Detail Stripe, Yellow
0240	626-H004		118	Square Feet	Thermoplastic Legend, White
0250	626-H005		850	Linear Feet	Thermoplastic Legend, White
0260	627-J001		600	Each	Two-Way Clear Reflective High Performance Raised Markers
0270	627-K001		1,213	Each	Red-Clear Reflective High Performance Raised Markers
0280	627-L001		142	Each	Two-Way Yellow Reflective High Performance Raised Markers
0290	630-F006		31	Each	Delineators, Guard Rail, White
0300	630-F007		31	Each	Delineators, Guard Rail, Yellow
0310	907-606-PP007		158	Each	Remove and Replace Guard Rail Blockouts
<b>ALTERNATE GROUP AA NUMBER 1</b>					
0320	907-624-A003		960	Linear Feet	6" Inverted Profile Thermoplastic Traffic Stripe, Skip White, High Contrast
0330	907-624-B003		960	Linear Feet	6" Inverted Profile Thermoplastic Traffic Stripe, Continuous White, High Contrast

Line no.	Item Code	Adj Code	Quantity	Units	Description[Fixed Unit Price]
0340	907-624-D001		960	Linear Feet	6" Inverted Profile Thermoplastic Traffic Stripe, Continous Yellow, High Contrast
<b>ALTERNATE GROUP AA NUMBER 2</b>					
0350	628-G001		960	Linear Feet	6" High Performance Cold Plastic Traffic Stripe, Skip White
0360	628-H001		960	Linear Feet	6" High Performance Cold Plastic Traffic Stripe, Continuous White
0370	628-J001		960	Linear Feet	6" High Performance Cold Plastic Traffic Stripe, Continuous Yellow

For Informational Purposes Only

SECTION 905 - COMBINATION BID PROPOSAL (Continued)

**CONDITIONS FOR COMBINATION BID**

If a bidder elects to submit a combined bid for two or more of the contracts listed for this month's letting, the bidder must complete and execute these sheets of the proposal in each of the individual proposals to constitute a combination bid. In addition to this requirement, each individual contract shall be completed, executed and submitted in the usual specified manner.

Failure to execute this Combination Bid Proposal in each of the contracts combined will be just cause for each proposal to be received and evaluated as a separate bid.

It is understood that the Mississippi Transportation Commission not only reserves the right to reject any and all proposals, but also the right to award contracts upon the basis of lowest separate bids or combination bids most advantageous to the State.

It is further understood and agreed that the Combination Bid Proposal is for comparison of bids only and that each contract shall operate in every respect as a separate contract in accordance with its proposal and contract documents.

I (We) agree to complete each contract on or before its specified completion date.

\*\*\*\*\*

**COMBINATION BID PROPOSAL**

This proposal is tendered as one part of a Combination Bid Proposal utilizing option \_\_\_\* of Subsection 102.11 on the following contracts:

\* Option to be shown as either (a), (b), or (c).

	<u>Project No.</u>	<u>County</u>	<u>Project No.</u>	<u>County</u>
1.	_____	_____	6.	_____
2.	_____	_____	7.	_____
3.	_____	_____	8.	_____
4.	_____	_____	9.	_____
5.	_____	_____	10.	_____

(a) If Combination A has been selected, your Combination Bid is complete.

(b) If Combination B has been selected, then complete the following page.



SECTION 905 - COMBINATION BID PROPOSAL (Continued)

Project Number	Pay Item Number	Unit	Unit Price Reduction	Total Item Reduction	Total Contract Reduction
1.					
2.					
3.					
4.					
5.					
6.					
7.					
8.					

For Informational Purposes Only

SECTION 905 - COMBINATION BID PROPOSAL (Continued)

Project Number	Pay Item Number	Unit	Unit Price Reduction	Total Item Reduction	Total Contract Reduction
9.					
10.					

(c) If Combination C has been selected, then initial and complete ONE of the following.

\_\_\_\_\_ I (We) desire to be awarded work not to exceed a total monetary value of \$ \_\_\_\_\_.

\_\_\_\_\_ I (We) desire to be awarded work not to exceed \_\_\_\_\_ number of contracts.



**Certification with regard to the Performance of Previous  
Contracts or Subcontracts subject to the Equal Opportunity  
Clause and the filing of Required Reports**

The Bidder hereby certifies that he has \_\_\_\_\_, has not \_\_\_\_\_, participated in a previous contract or subcontract subject to the Equal Opportunity Clause, as required by Executive Orders 10925, 11114, or 11246, and that he has \_\_\_\_\_, has not \_\_\_\_\_, filed with the Joint Reporting Committee, the Director of the Office of Federal Contract Compliance, a Federal Government contracting or administering agency, or the former President's Committee on Equal Employment Opportunity, all reports due under the applicable filing requirements.

\_\_\_\_\_  
(COMPANY)

DATE: \_\_\_\_\_

NOTE: The above certification is required by the Equal Employment Opportunity Regulations of the Secretary of Labor (41 CFR 60-1.7 (b) (1)), and must be submitted by bidders and proposed subcontractors only in connection with contracts and subcontracts which are subject to the Equal Opportunity Clause. Contracts and Subcontracts which are exempt from the Equal Opportunity Clause are set forth in 41 CFR 60-1.5. (Generally only contracts or subcontracts of \$10,000 or under are exempt.)

Currently, Standard Form 100 (EEO-1) is the only report required by the Executive Orders or their implementing regulations.

Proposed prime Contractors and Subcontractors who have participated in a previous contract or subcontract subject to the Executive orders and have not filed the required reports should note that 41 CFR 60-1.7 (b) (1) prevents the award of contracts and subcontracts unless such Contractors submit a report covering the delinquent period or such other period specified by the Federal Highway Administration or by the Director, Office of Federal Contract Compliance, U. S. Department of Labor.

**MISSISSIPPI DEPARTMENT OF TRANSPORTATION**  
**CERTIFICATION**

I, \_\_\_\_\_,  
(Name of person signing bid)

individually, and in my capacity as \_\_\_\_\_ of  
(Title of person signing bid)

\_\_\_\_\_ do hereby certify under  
(Name of Firm, partnership, or Corporation)

penalty of perjury under the laws of the United States and the State of Mississippi that \_\_\_\_\_

\_\_\_\_\_, Bidder  
(Name of Firm, Partnership, or Corporation)

on Project No. **STP-0015-02(123)/ 107798301000**

in Covington County(ies), Mississippi, has not either

directly or indirectly entered into any agreement, participated in any collusion; or otherwise taken any action in restraint of free competitive bidding in connection with this contract; nor have any of its corporate officers or principal owners.

Except as noted hereafter, it is further certified that said legal entity and its corporate officers, principal owners, managers, auditors and others in a position of administering federal funds:

- a) Are not presently debarred, suspended, proposed for debarment, declared ineligible, or voluntarily excluded from covered transactions by any Federal department or agency;
- b) Have not within a three-year period preceding this proposal been convicted of or had a civil judgment rendered against them for commission of fraud or a criminal offense in connection with obtaining, attempting to obtain, or performing a public (Federal, State or local) transaction or contract under a public transaction; violation of Federal or State antitrust statutes or commission of embezzlement, theft, forgery, bribery, falsification or destruction of records, making false statements, or receiving stolen property;
- c) Are not presently indicted for or otherwise criminally or civilly charged by a governmental entity (Federal, State or local) with commission of any of the offenses enumerated in (b) above; and
- d) Have not within a three-year period preceding this application/ proposal had one or more public transactions (Federal, State or local) terminated for cause or default.

Do exceptions exist and are made a part thereof? Yes / No

Any exceptions shall address to whom it applies, initiating agency and dates of such action.

Note: Exceptions will not necessarily result in denial of award but will be considered in determining bidder responsibility. Providing false information may result in criminal prosecution or administrative sanctions.

The bidder further certifies that the certification requirements contained in Section XI of Form FHWA 1273, will be or have been included in all subcontracts, material supply agreements, purchase orders, etc. except those procurement contracts for goods or services that are expected to be less than the Federal procurement small purchase threshold fixed at 10 U.S.C. 2304(g) and 41 U.S.C. 253(g) (currently \$25,000) which are excluded from the certification requirements.

The bidder further certifies, to the best of his or her knowledge and belief, that:

1) No Federal appropriated funds have been paid or will be paid to any person for influencing or attempting to influence an officer or employee of any Federal agency, a Member of Congress, an officer or employee of Congress, or an employee of a Member of Congress in connection with the awarding of any Federal contract, the making of any Federal grant, the making of any Federal loan, the entering into of any cooperative agreement, and the extension, continuation, renewal, amendment, or modification of any Federal contract, grant, loan, or cooperative agreement.

2) If any funds other than Federal appropriated funds have been paid or will be paid to any person for influencing or attempting to influence an officer or employee of any Federal agency, a Member of Congress, an officer or employee of Congress, or an employee of a Member of Congress in connection with this contract, Standard Form-LLL, Disclosure Form to Report Lobbying, in accordance with its instructions will be completed and submitted.

The certification contained in (1) and (2) above is a material representation of fact upon which reliance is placed and a prerequisite imposed by Section 1352, Title 31, U.S. Code prior to entering into this contract. Failure to comply shall be subject to a civil penalty of not less than \$10,000 and not more than \$100,000. The bidder shall include the language of the certification in all subcontracts exceeding \$100,000 and all subcontractors shall certify and disclose accordingly.

All of the foregoing is true and correct.

Executed on \_\_\_\_\_

\_\_\_\_\_  
Signature

**MISSISSIPPI DEPARTMENT OF TRANSPORTATION**

SAM.GOV Registration and DUNS Number

Bidders are advised that the Prime Contractor must maintain current registration in the **System for Award Management** (<http://www.sam.gov>) at all times during the project. A Dun and Bradstreet Data Universal Numbering System (DUNS) Number (<http://www.dnb.com>) is one of the requirements for registration in the System for Award Management.

Bidders are advised that prior to the award of this contract, they **MUST** be registered in the System for Award Management.

I (We) acknowledge that this contract cannot be awarded if I (We) are not registered in the System for Award Management prior to the award of this contract. \_\_\_\_\_ (Yes / No)

I (We) have a DUNS Number . \_\_\_\_\_ (Yes / No)

DUNS Number: \_\_\_\_\_

Company Name: \_\_\_\_\_

Company e-mail address: \_\_\_\_\_

(6/2015F)

For Informational Purposes Only

SECTION 902

CONTRACT FOR STP-0015-02(123)/ 107798301000

LOCATED IN THE COUNTY(IES) OF Covington

STATE OF MISSISSIPPI,  
COUNTY OF HINDS

This contract entered into by and between the Mississippi Transportation Commission on one hand, and the undersigned contractor, on the other witnesseth;

That, in consideration of the payment by the Mississippi Transportation Commission of the prices set out in the proposal hereto attached, to the undersigned contractor, such payment to be made in the manner and at the time of times specified in the specifications and the special provisions, if any, the undersigned contractor hereby agrees to accept the prices stated in the proposal in full compensation for the furnishing of all materials and equipment and the executing of all the work contemplated in this contract.

It is understood and agreed that the advertising according to law, the Advertisement, the instructions to bidders, the proposal for the contract, the specifications, the revisions of the specifications, the special provisions, and also the plans for the work herein contemplated, said plans showing more particularly the details of the work to be done, shall be held to be, and are hereby made a part of this contract by specific reference thereto and with like effect as if each and all of said instruments had been set out fully herein in words and figures.

It is further agreed that for the same consideration the undersigned contractor shall be responsible for all loss or damage arising out of the nature of the work aforesaid; or from the action of the elements and unforeseen obstructions or difficulties which may be encountered in the prosecution of the same and for all risks of every description connected with the work, exceptions being those specifically set out in the contract; and for faithfully completing the whole work in good and workmanlike manner according to the approved Plans, Specifications, Special Provisions, Notice(s) to Bidders and requirements of the Mississippi Department of Transportation.

It is further agreed that the work shall be done under the direct supervision and to the complete satisfaction of the Executive Director of the Mississippi Department of Transportation, or his authorized representatives, and when Federal Funds are involved subject to inspection at all times and approval by the Federal Highway Administration, or its agents as the case may be, or the agents of any other Agency whose funds are involved in accordance with those Acts of the Legislature of the State of Mississippi approved by the Governor and such rules and regulations issued pursuant thereto by the Mississippi Transportation Commission and the authorized Federal Agencies.

The Contractor agrees that all labor as outlined in the Special Provisions may be secured from list furnished by

It is agreed and understood that each and every provision of law and clause required by law to be inserted in this contract shall be deemed to be inserted herein and this contract shall be read and enforced as though it were included herein, and, if through mere mistake or otherwise any such provision is not inserted, then upon the application of either party hereto, the contract shall forthwith be physically amended to make such insertion.

The Contractor agrees that he has read each and every clause of this Contract, and fully understands the meaning of same and that he will comply with all the terms, covenants and agreements therein set forth.

Witness our signatures this the \_\_\_ day of \_\_\_\_\_, \_\_\_\_\_.

\_\_\_\_\_  
Contractor(s)

By \_\_\_\_\_

MISSISSIPPI TRANSPORTATION COMMISSION

Title \_\_\_\_\_

By \_\_\_\_\_

Signed and sealed in the presence of:  
(names and addresses of witnesses)

Executive Director

\_\_\_\_\_

Secretary to the Commission

Award authorized by the Mississippi Transportation Commission in session on the \_\_\_ day of \_\_\_\_\_, \_\_\_\_\_, Minute Book No. \_\_\_\_\_, Page No. \_\_\_\_\_.

Revised 8/06/2003

**SECTION 903**  
**PERFORMANCE AND PAYMENT BOND**

CONTRACT BOND FOR: STP-0015-02(123)/ 107798301000

LOCATED IN THE COUNTY(IES) OF: Covington

STATE OF MISSISSIPPI,  
COUNTY OF HINDS

Know all men by these presents: that we, \_\_\_\_\_  
\_\_\_\_\_  
Principal, a \_\_\_\_\_ (Contractor)

residing at \_\_\_\_\_ in the State of \_\_\_\_\_

and \_\_\_\_\_  
\_\_\_\_\_  
(Surety)

residing at \_\_\_\_\_ in the State of \_\_\_\_\_,

authorized to do business in the State of Mississippi, under the laws thereof, as surety, effective as of the contract date

shown below, are held and firmly bound unto the State of Mississippi in the sum of \_\_\_\_\_

\_\_\_\_\_ Dollars, lawful money of the United States of America, to be paid to it for which payment well and truly to be made, we bind ourselves, our heirs, administrators, successors, or assigns jointly and severally by these presents.

The conditions of this bond are such, that whereas the said \_\_\_\_\_

\_\_\_\_\_ principal, has (have) entered into a contract with the Mississippi Transportation Commission, bearing the date of \_\_\_\_\_ day of \_\_\_\_\_ A.D. \_\_\_\_\_ hereto annexed, for the construction of certain projects(s) in the State of Mississippi as mentioned in said contract in accordance with the Contract Documents therefor, on file in the offices of the Mississippi Department of Transportation, Jackson, Mississippi.

Now therefore, if the above bounden \_\_\_\_\_ in all things shall stand to and abide by and well and truly observe, do keep and perform all and singular the terms, covenants, conditions, guarantees and agreements in said contract, contained on his (their) part to be observed, done, kept and performed and each of them, at the time and in the manner and form and furnish all of the material and equipment specified in said contract in strict accordance with the terms of said contract which said plans, specifications and special provisions are included in and form a part of said contract and shall maintain the said work contemplated until its final completion and acceptance as specified in Subsection 109.11 of the approved specifications, and save harmless said Mississippi Transportation Commission from any loss or damage arising out of or occasioned by the negligence, wrongful or criminal act, overcharge, fraud, or any other loss or damage whatsoever, on the part of said principal (s), his (their) agents, servants, or employees in the performance of said work or in any manner connected therewith, and shall be liable and responsible in a civil action instituted by the State at the instance of the Mississippi Transportation Commission or any officer of the State authorized in such cases, for double any amount in money or property, the State may lose or be overcharged or otherwise defrauded of, by reason of wrongful or criminal act, if any, of the Contractor(s), his (their) agents or employees, and shall promptly pay the said agents, servants and employees and all persons furnishing labor, material, equipment or supplies therefor, including premiums incurred, for Surety Bonds, Liability Insurance, and Workmen's Compensation Insurance; with the additional obligation that such Contractor shall promptly make payment of all taxes, licenses, assessments, contributions, damages,



any liquidated damages which may arise prior to any termination of said principal's contract, any liquidated damages which may arise after termination of the said principal's contract due to default on the part of said principal, penalties and interest thereon, when and as the same may be due this state, or any county, municipality, board, department, commission or political subdivision: in the course of the performance of said work and in accordance with Sections 31-5-51 et seq. Mississippi Code of 1972, and other State statutes applicable thereto, and shall carry out to the letter and to the satisfaction of the Executive Director of the Mississippi Department of Transportation, all, each and every one of the stipulations, obligations, conditions, covenants and agreements and terms of said contract in accordance with the terms thereof and all of the expense and cost and attorney's fee that may be incurred in the enforcement of the performance of said contract, or in the enforcement of the conditions and obligations of this bond, then this obligation shall be null and void, otherwise to be and remain in full force and virtue.

_____	_____
(Contractors) Principal	Surety
By _____	By _____
	(Signature) Attorney in Fact
	Address _____
	_____
Title _____	_____
(Contractor's Seal)	(Printed) MS Agent
	_____
	(Signature) MS Agent
	Address _____
	_____
	_____
	(Surety Seal)
	_____
	Mississippi Insurance ID Number



# BID BOND

KNOW ALL MEN BY THESE PRESENTS, that we \_\_\_\_\_  
Contractor

\_\_\_\_\_  
Address

\_\_\_\_\_  
City, State ZIP

As principal, hereinafter called the Principal, and \_\_\_\_\_  
Surety

a corporation duly organized under the laws of the state of \_\_\_\_\_

as Surety, hereinafter called the Surety, are held and firmly bound unto State of Mississippi, Jackson, Mississippi

As Obligee, hereinafter called Obligee, in the sum of **Five Per Cent (5%) of Amount Bid**

Dollars(\$ \_\_\_\_\_ )

for the payment of which sum will and truly to be made, the said Principal and said Surety, bind ourselves, our heirs, executors, administrators, successors and assigns, jointly and severally, firmly by these presents.

WHEREAS, the Principal has submitted a bid for **Overlay approximately 10 miles of US 84 (East Bound Lanes Only) from SR 588 to the Jones County Line, known as Federal Aid Project No. STP-0015-02(123) / 107798301 in Covington County.**

NOW THEREFORE, the condition of this obligation is such that if the aforesaid Principal shall be awarded the contract, the said Principal will, within the time required, enter into a formal contract and give a good and sufficient bond to secure the performance of the terms and conditions of the contract, then this obligation to be void; otherwise the Principal and Surety will pay unto the Obligee the difference in money between the amount of the bid of the said Principal and the amount for which the Obligee legally contracts with another party to perform the work if the latter amount be in excess of the former, but in no event shall liability hereunder exceed the penal sum hereof.

Signed and sealed this \_\_\_\_\_ day of \_\_\_\_\_, 20\_\_

\_\_\_\_\_  
(Witness)

\_\_\_\_\_  
(Principal) (Seal)

By: \_\_\_\_\_  
(Name) (Title)

\_\_\_\_\_  
(Witness)

\_\_\_\_\_  
(Surety) (Seal)

By: \_\_\_\_\_  
(Attorney-in-Fact)

\_\_\_\_\_  
(MS Agent)

\_\_\_\_\_  
Mississippi Insurance ID Number

MISSISSIPPI DEPARTMENT OF TRANSPORTATION  
OFFICE OF CIVIL RIGHTS  
JACKSON, MISSISSIPPI

LIST OF FIRMS SUBMITTING QUOTES

I/we received quotes from the following firms on:

Letting Date: **May 22, 2018**

Project No: **STP-0015-02(123)/ 107798301000**

County: **Covington**

Disadvantaged Business Enterprise (DBE) Regulations as stated in 49 CFR 26.11 require the Mississippi Department of Transportation (MDOT) to create and maintain a comprehensive list of all firms quoting/bidding subcontracts on prime contracts and quoting/bidding subcontracts on federally-funded transportation projects. For every firm, we require the following information:

Firm Name: \_\_\_\_\_  
Contact Name/Title: \_\_\_\_\_  
Firm Mailing Address: \_\_\_\_\_  
Phone Number: \_\_\_\_\_  
\_\_\_\_\_ DBE Firm \_\_\_\_\_ Non-DBE Firm

Firm Name: \_\_\_\_\_  
Contact Name/Title: \_\_\_\_\_  
Firm Mailing Address: \_\_\_\_\_  
Phone Number: \_\_\_\_\_  
\_\_\_\_\_ DBE Firm \_\_\_\_\_ Non-DBE Firm

Firm Name: \_\_\_\_\_  
Contact Name/Title: \_\_\_\_\_  
Firm Mailing Address: \_\_\_\_\_  
Phone Number: \_\_\_\_\_  
\_\_\_\_\_ DBE Firm \_\_\_\_\_ Non-DBE Firm

Firm Name: \_\_\_\_\_  
Contact Name/Title: \_\_\_\_\_  
Firm Mailing Address: \_\_\_\_\_  
Phone Number: \_\_\_\_\_  
\_\_\_\_\_ DBE Firm \_\_\_\_\_ Non-DBE Firm

Firm Name: \_\_\_\_\_  
Contact Name/Title: \_\_\_\_\_  
Firm Mailing Address: \_\_\_\_\_  
Phone Number: \_\_\_\_\_  
\_\_\_\_\_ DBE Firm \_\_\_\_\_ Non-DBE Firm

