

MDOT Use Only

Checked \_\_\_\_\_

Loaded \_\_\_\_\_

Keyed \_\_\_\_\_

01 -



SM No. CNHAP007801011

# PROPOSAL AND CONTRACT DOCUMENTS

## FOR THE CONSTRUCTION OF

01

Grade, Drain, Bridge, & Pave 4-Lane approximately 9 miles of APD Corridor "V" between Fairview & SR 23, known as Federal Aid Project No. NH-APD-0078-01 (011)N / 102076301 in Itawamba County.

Project Completion: 06/30/2023

**(PROJECT OF DIVISION INTEREST)**

### NOTICE

**BIDDERS MUST COMPLETE AN ONLINE REQUEST  
FOR PERMISSION TO BID THIS PROJECT.**

Electronic addendum updates will be posted on [www.gomdot.com](http://www.gomdot.com)

**SECTION 900  
OF THE CURRENT  
2017 STANDARD SPECIFICATIONS  
FOR ROAD AND BRIDGE CONSTRUCTION  
JACKSON, MISSISSIPPI**

**MISSISSIPPI DEPARTMENT OF TRANSPORTATION  
TABLE OF CONTENTS**

**PROJECT: NHAPD-0078-01(011)N/102076301 - Itawamba**

Section 901 - Advertisement

Section 904 - Notice to Bidders

#1	Governing Specification
#2	Status of ROW, w/ Attachments
#3	Final Cleanup
#6	Storm Water Discharge Associated with Construction Activity (> 5 Acres)
#7	Disadvantaged Business Enterprise In Federal-Aid Highway Construction, w/ Supplement
#9	Federal Bridge Formula
#13	Safety Edge
#21	Intermediate Diaphragms
#23	Exposure to Moderate Sulfate Areas Below Ground Level
#113	Tack Coat
#114	Right-of-Way Plat
#296	Reduced Speed Limit Signs
#445	Mississippi Agent and Qualified Nonresident Agent
#516	Errata and Modifications to the 2017 Standard Specifications
#757	Additional Erosion Control Requirements
#977	DUNS Requirement For Federal Funded Projects
#1206	MASH Compliant Devices
#1225	Early Notice to Proceed
#1226	Material Storage Under Bridges
#1241	Fuel and Material Adjustments
#1434	Erosion Control Plan
#1963	Guardrail Pads
#2061	Reflective Sheeting for Signs
#2064	Contract Time
#2065	Specialty Items
#2066	Placement of Fill Material in Federally Regulated Areas
#2067	Floc Blocks
#2068	Disturbed Area
906	Required Federal Contract Provisions - FHWA 1273, w/ Supplements, and Attachment A

Section 907 - Special Provisions

907-102-2	Bidding Requirements and Conditions
907-107-2	Contractor's Erosion Control Plan
907-109-1	Measurement and Payment
907-228-1	Erosion Control Blankets
907-241-1	Floc Blocks
907-253-1	Coir Fiber Baffle
907-619-5	Traffic Control for Construction Zones
907-624-1	Inverted Profile Thermoplastic Traffic Stripe

**PROJECT: NHAPD-0078-01(011)N/102076301 - Itawamba**

907-626-9	Audible Thermoplastic Traffic Markings
907-626-10	Audible Bump Thermoplastic Traffic Markings
907-630-3	LED Enhanced Traffic Sign
907-701-1	Hydraulic Cement
907-702-4	Bituminous Materials
907-703-1	Gradation
907-705-1	Stone Riprap
907-707-2	Joint Material
907-708-2	Reinforced Concrete Pipe
907-711-2	Plain Steel Wire
907-720-2	Acceptance Procedure for Glass Beads
907-721-1	Materials for Signing
907-803-4	Test Piles
907-804-6	Concrete Bridges and Structures
906-8	Training Special Provisions

Section 905 - Proposal, Proposal Bid Items, Combination Bid Proposal  
Certification of Performance - Prior Federal-Aid Contracts  
Certification Regarding Non-Collusion, Debarment and Suspension  
SAM.GOV Registration and DUNS Number  
Section 902 - Contract Form  
Section 903 - Contract Bond Forms  
Form -- OCR-485

Pile and Driving Equipment Data Form

(REVISIONS TO THE ABOVE WILL BE INDICATED ON THE SECOND SHEET  
OF SECTION 905 AS ADDENDA)

12/19/2019 08:46 AM

# MISSISSIPPI DEPARTMENT OF TRANSPORTATION

## SECTION 901 - ADVERTISEMENT

Electronic bids will be received by the Mississippi Transportation Commission at 10:00 o'clock A.M., Tuesday, February 25, 2020, from the Bid Express Service and shortly thereafter publicly read on the Sixth Floor for:

Grade, Drain, Bridge, & Pave 4-Lane approximately 9 miles of APD Corridor "V" between Fairview & SR 23, known as Federal Aid Project No. NH-APD-0078-01(011)N / 102076301 in Itawamba County.

The attention of bidders is directed to the Contract Provisions governing selection and employment of labor. Minimum wage rates have been predetermined by the Secretary of Labor and are subject to Public Law 87-581, Work Hours Act of 1962, as set forth in the Contract Provisions.

The Mississippi Department of Transportation hereby notifies all bidders that it will affirmatively insure that in any contract entered into pursuant to this advertisement, disadvantaged business enterprises will be afforded full opportunity to submit bids in response to this invitation and will not be discriminated against on the grounds of race, color, sex, age, disability, religion or national origin in consideration for an award.

**The award of this contract will be contingent upon the Contractor satisfying the DBE requirements.**

Contractors may request permission to bid online at <http://shopmdot.ms.gov> at no cost. Upon approval, Contractors shall be eligible to submit a bid using Bid Express at <http://bidx.com>. Specimen proposals may be viewed and downloaded online at no cost at <http://mdot.ms.gov> or purchased online at <http://shopmdot.ms.gov> at a cost of Ten Dollars (\$10.00) per proposal plus a small convenience fee. Cash or checks will not be accepted as payment.

Plans must be purchased online at <https://shopmdot.ms.gov>. Costs of plans will be on a per sheet basis plus a small convenience fee. If you have any questions, you can contact the MDOT Plans Print Shop at (601) 359-7460, or e-mail at [plans@mdot.state.ms.us](mailto:plans@mdot.state.ms.us). Plans will be shipped upon receipt of payment. Cash or checks will not be accepted as payment.

Bid bond, signed or countersigned by a Mississippi Agent or Qualified Nonresident Agent, with Power of Attorney attached, a Cashier's check or Certified Check for five (5%) percent of bid, payable to STATE OF MISSISSIPPI, must accompany each proposal.

The attention of bidders is directed to the provisions of Subsection 102.07 pertaining to irregular proposals and rejection of bids.

MELINDA L. MCGRATH  
EXECUTIVE DIRECTOR

# MISSISSIPPI DEPARTMENT OF TRANSPORTATION

**SECTION 904 - NOTICE TO BIDDERS NO. 1**

**CODE: (IS)**

**DATE: 03/01/2017**

**SUBJECT: Governing Specifications**

The current (2017) Edition of the Standard Specifications for Road and Bridge Construction adopted by the Mississippi Transportation Commission is made a part hereof fully and completely as if it were attached hereto, except where superseded by special provisions, or amended by revisions of the Specifications contained within this proposal. Copies of the specification book may be purchased from the MDOT Construction Division, or online at [shopmdot/default.aspx?StoreIndex=1](http://shopmdot/default.aspx?StoreIndex=1).

A reference in any contract document to controlling requirements in another portion of the contract documents shall be understood to apply equally to any revision or amendment thereof included in the contract.

In the event the plans or proposal contain references to the 2004 Edition of the Standard Specifications for Road and Bridge Construction, it is to be understood that such references shall mean the comparable provisions of the 2017 Edition of the Standard Specifications.

## MISSISSIPPI DEPARTMENT OF TRANSPORTATION

**SECTION 904 - NOTICE TO BIDDERS NO. 2**

**CODE: (IS)**

**DATE: 03/01/2017**

**SUBJECT: Status of Right-of-Way**

Although it is desirable to have acquired all rights-of-way and completed all railroad agreements, utility adjustments and work to be performed by others prior to receiving bids, sometimes it is not considered to be in the public interest to wait until each and every such clearance has been obtained. The bidder is hereby advised of possible unacquired rights-of-way, relocations, railroad agreements and utilities adjustments which have not been completed.

The status of right-of-way acquisition, utility adjustments, encroachments, potentially contaminated sites, railroad facilities, improvements, and asbestos contamination are set forth in the following attachments.

In the event right of entry is not available to ALL parcels of right-of-way and/or all work that is to be accomplished by others on the date set forth in the contract for the Notice to Proceed is not complete, the Department will issue a restricted Notice to Proceed.

**STATUS OF RIGHT-OF-WAY**

NH-APD-0078-01(011)N

102076/301000

Itawamba County

November 19, 2019

All rights of way and legal rights of entry have been acquired, **except**

None

ASBESTOS CONTAMINATION STATUS OF BUILDINGS  
TO BE REMOVED BY THE CONTRACTOR  
NH-APD-0078-01(011) N  
102076-301000  
Itawamba County  
November 19, 2019

Reference is made to notices to bidders entitled "Asbestos National Emission Standards for Hazardous Air Pollutants (NESHAP)" and "Removal of Obstructions".

The following pertinent information is furnished concerning asbestos containing materials (ACMs), if any, found in buildings to be removed by the Contractor.

There are no buildings in the contract to be removed.



STATUS OF POTENTIALLY CONTAMINATED SITES  
NH-APD-0078-01(011) N  
102076-301000  
Itawamba County  
November 19, 2019

This project has been inspected and there was no visible indication of potentially contaminated sites within the proposed right of way.

# MISSISSIPPI DEPARTMENT OF TRANSPORTATION

## *Inter-Departmental Memorandum*

TO: ROW Division  
Trudi Loflin

DATE: November 19, 2019

FROM: District 1  
Jamie McDonald *J.M*

SUBJECT OR PROJECT NO: NH-APD-0078-01(011)N  
102076/301000

INFORMATION COPY TO:

COUNTY: Itawamba

Asst. Chief Engineer – Pre Construction  
District Engineer (Holley)  
Project Engineer  
Project File

### District 1 Status Report

1. **STATUS OF RIGHT OF WAY:** All ROW necessary for construction has be acquired.
2. **RIGHT OF WAY CLEARANCE:** There are no known encroachments.
3. **STATUS OF AFFECTED RAILROAD OPERATING FACILITIES:** None affected.
4. **STATUS OF REQUIRED UTILITY RELOCATIONS:** All utilities known to be in conflict with construction have been relocated. There are no known conflicts with construction.
5. **STATUS OF CONSTRUCTION AGREEMENT:** The construction agreement has been executed with Itawamba County.

Improvements to be included in Notice to Bidders to be removed by the Construction Contractor  
FMS Construction Project No: 102076-301000  
FMS ROW Project No: 102075-201000  
External ROW No: NH-APD-0078-01(011) N

Parcel No:  
Station No:  
Property Owner:  
Description/Pictures:

**NA**

**MISSISSIPPI DEPARTMENT OF TRANSPORTATION**

**SECTION 904 - NOTICE TO BIDDERS NO. 3**

**CODE: (SP)**

**DATE: 01/17/2017**

**SUBJECT: Final Clean-Up**

Immediately prior to final inspection for release of maintenance, the Contractor shall pick up, load, transport and properly dispose of all litter from the entire highway right-of-way that is within the termini of the project.

Litter shall include, but not be limited to, solid wastes such a glass, paper products, tires, wood products, metal, synthetic materials and other miscellaneous debris.

Litter removal is considered incidental to other items of work and will not be measured for separate payment.

## MISSISSIPPI DEPARTMENT OF TRANSPORTATION

**SECTION 904 - NOTICE TO BIDDERS NO. 6**

**CODE: (SP)**

**DATE: 12/09/2019**

**SUBJECT: Storm Water Discharge Associated with Construction Activity  
(≥ 5 Acres)**

**PROJECT: NH-APD-0078-01(011)N / 102076301 - Itawamba County**

A Construction Storm Water General NPDES Permit to discharge storm water associated with construction activity is required.

The Department has acquired Certificate of Permit Coverage MSR-108091 under the Mississippi Department of Environmental Quality's (MDEQ) Storm Water Large Construction General Permit. Projects issued a certificate of permit coverage are granted permission to discharge treated storm water associated with construction activity into State waters. Copies of said permit, completed Large Construction Notice of Intent (LCNOI), and Storm Water Pollution Prevention Plan (SWPPP) are on file with the Department.

Prior to the execution of the contract, the successful bidder shall execute and deliver to the Executive Director an original signed copy of the completed Prime Contractor Certification Forms.

Failure of the bidder to execute and file the completed Prime Contractor Certification Forms shall be just cause for the cancellation of the award.

The executed Prime Contractor Certification Forms shall be prima facie evidence that the bidder has examined the permit, is satisfied as to the terms and conditions contained therein, and that the bidder has the primary responsibility for meeting all permit terms including, but not limited to, the inspection and reporting requirements. For this project, the Contractor shall furnish, set up and read, as needed, an on-site rain gauge.

The Contractor shall make inspections in accordance with condition No. S-5, page 23, and shall furnish the Project Engineer with the results of each weekly inspection as soon as possible following the date of inspection. A copy of the inspection form is provided with the packet. The weekly inspections must be documented monthly on the Inspection and Certification Form. The Contractor's representative and the Project Engineer shall jointly review and discuss the results of the inspections so that corrective action can be taken. The Project Engineer shall retain copies of the inspection reports.

The Engineer will have the authority to suspend all work and/or withhold payments for failure of the Contractor to carry out provisions of MDEQ's Storm Water Construction General Permit, the erosion control plan, updates to the erosion control plan, and /or proper maintenance of the BMPs.

Upon successful completion of all permanent erosion and sediment controls, accepted and documented by the full maintenance release, the Construction Division shall submit a completed Request for Termination (RFT) of Coverage to the Office of Pollution Control.

Securing a permit (s) for storm water discharge associated with the Contractor's activity on any other regulated area the Contractor occupies, shall be the responsibility of the Contractor.

## MISSISSIPPI DEPARTMENT OF TRANSPORTATION

### SUPPLEMENT TO NOTICE TO BIDDERS NO. 7

**DATE:** 01/17/2017

The goal is 5 percent for the Disadvantaged Business Enterprise. The low bidder is required to submit Form OCR-481 for all DBEs. Bidders are advised to check the bid tabulation link for this project on the MDOT website at:

<http://sp.gomdot.com/Contract%20Administration/BidSystems/Pages/letting%20calendar.aspx>

Bid tabulations are usually posted by 3:00 pm on Letting Day.

# MISSISSIPPI DEPARTMENT OF TRANSPORTATION

**SECTION 904 - NOTICE TO BIDDERS NO. 7**

**CODE: (IS)**

**DATE: 03/01/2017**

**SUBJECT: Disadvantaged Business Enterprises In Federal-Aid Highway Construction**

This contract is subject to the "Moving Ahead for Progress in the 21<sup>st</sup> Century Act (MAP-21)" and applicable requirements of "Part 26, Title 49, Code of Federal Regulations". Portions of the Act are set forth in this Notice as applicable to compliance by the Contractor and all of the Act, and the MDOT DBE Program, is incorporated by reference herein.

The Department has developed a Disadvantaged Business Enterprise Program that is applicable to this contract and is made a part thereof by reference.

Copies of the program may be obtained from:

Office of Civil Rights  
Mississippi Department of Transportation  
P. O. Box 1850  
Jackson, Mississippi 39215-1850

## **POLICY**

It is the policy of the Mississippi Department of Transportation to provide a level playing field, to foster equal opportunity in all federally assisted contracts, to improve the flexibility of the DBE Program, to reduce the burdens on small businesses, and to achieve that amount of participation that would be obtained in a non-discriminatory market place. In doing so, it is the policy of MDOT that there will be no discrimination in the award and performance of federally assisted contracts on the basis of race, color, sex, age, religion, national origin, or any handicap.

## **ASSURANCES THAT CONTRACTORS MUST TAKE**

MDOT will require that each contract which MDOT signs with a sub-recipient or a Contractor, and each subcontract the Prime Contractor signs with a Subcontractor, includes the following assurances:

“The Contractor, sub-recipient or Subcontractor shall not discriminate on the basis of race, color, national origin, or sex in the performance of this contract. The Contractor shall carry out applicable requirements of 49 CFR 26 in the award and administration of federally assisted contracts. Failure by the Contractor to carry out these requirements is a material breach of this contract, which may result in the termination of this contract or such other remedy as MDOT deems appropriate.”

## **DEFINITIONS**

For purposes of this provision the following definitions will apply:

"Disadvantaged Business" means a small business concern: (a) which is at least 51 percent owned by one or more socially and economically disadvantaged individual(s) or in the case of any publicly owned business, at least 51 percent of the stock of which is owned by one or more socially and economically disadvantaged individual(s); and (b) whose management and daily business operations are controlled by one or more of the socially and economically disadvantaged individual(s) who own it. It is important to note that the business owners themselves must control the operations of the business. Absentee ownership or title ownership by an individual who does not take an active role in controlling the business is not consistent with eligibility as a DBE under CFR 49 Part 26.71.

### **CONTRACTOR'S OBLIGATION**

The Contractor and all Subcontractors shall take all necessary and reasonable steps to ensure that DBE firms can compete for and participate in the performance of a portion of the work in this contract and shall not discriminate on the basis of race, color, national origin, religion or sex. Failure on the part of the Contractor to carry out the DBE requirements of this contract constitutes a breach of contract and after proper notification the Department may terminate the contract or take other appropriate action as determined by the Department.

When a contract requires a zero percent (0%) DBE goal, the Contractor still has the responsibility to take all necessary and reasonable steps to ensure that DBE firms can compete for and participate in the performance of the work in the contract. In this case, all work performed by a certified DBE firm is considered to be a "race neutral" measure and the Department will receive DBE credit towards the overall State goals when the DBE firm is paid for their work. If the Prime Contractor is a certified DBE firm, the Department can receive DBE credit only for the work performed by the Prime Contractor's work force or any work subcontracted to another DBE firm. Work performance by a non-DBE Subcontractor is not eligible for DBE credit.

### **CONTRACT GOAL**

The goal for participation by DBEs is established for this contract in the attached Supplement. The Contractor shall exercise all necessary and reasonable steps to ensure that participation is equal to or exceeds the contract goal.

If the percentage of the contract that is proposed for DBEs is 1% or greater, the Contractor shall agree to meet or exceed the contract goal on the last bid sheet of the proposal.

The apparent lowest responsive bidder shall submit to the Office of Civil Rights Form OCR-481, signed by the Prime Contractor and the DBE Subcontractors, no later than the 3<sup>rd</sup> business day after opening of the bids.

Form OCR-481 is available on the MDOT website at GoMDOT.com, then Divisions, Civil Rights, Forms, DBE, MDOT Projects, or by calling 601-359-7466.

The OCR-481 Form must contain the following information:

The name and address of each certified DBE Contractor / Supplier;



The Reference Number, percent of work and the dollar amount of each item. If a portion of an item is subcontracted, a breakdown of that item including quantities and unit price must be attached, detailing what part of the item the DBE firm is to perform and who will perform the remainder of the item.

If the DBE Commitment shown on the last bid sheet of the proposal, does not equal or exceed the contract goal, the bidder must submit, to MDOT Contract Administration Division prior to bid opening, information to satisfy the Department that adequate good faith efforts have been made to meet the contract goal.

Failure of the lowest bidder to furnish acceptable proof of good faith efforts, submitted to MDOT Contract Administration Division prior to bid opening, shall be just cause for rejection of the proposal. Award may then be made to the next lowest responsive bidder or the work may be re-advertised.

The following factors are illustrative of matters the Department will consider in judging whether or not the bidder has made adequate good faith effort to satisfy the contract goal.

- (1) Whether the bidder attended the pre-bid meeting that was scheduled by the Department to inform DBEs of subcontracting opportunities;
- (2) Whether the bidder advertised in general circulation, trade association, and minority-focus media concerning the subcontracting opportunities;
- (3) Whether the bidder provided written notice to a reasonable number of specific DBEs that their interest in the contract is being solicited;
- (4) Whether the bidder followed up initial solicitations of interest by contacting DBEs to determine with certainty whether they were interested;
- (5) Whether the bidder selected portions of the work to be performed by DBEs in order to increase the likelihood of meeting the contract goal;
- (6) Whether the bidder provided interested DBEs with adequate information about the plans, specifications and requirements of the contract;
- (7) Whether the bidder negotiated in good faith with interested DBEs and did not reject them as unqualified without sound reasons based on a thorough investigation of their capabilities; and
- (8) Whether the bidder made efforts to assist interested DBEs in obtaining any required bonding or insurance.
- (9) Whether the bidder has written notification to certified DBE Contractors soliciting subcontracting for items of work in the contract.
- (10) Whether the bidder has a statement of why an agreement was not reached.

The bidder’s execution of the signature portion of the proposal shall constitute execution of the following assurance:

The bidder hereby gives assurance pursuant to the applicable requirements of "Moving Ahead for Progress in the 21<sup>st</sup> Century Act (MAP-21)" and applicable requirements of "Part 26, Title 49, Code of Federal Regulations" that the bidder has made a good faith effort to meet the contract goal for DBE participation for which this proposal is submitted.

### **DIRECTORY**

A list of “Certified DBE Contractors” which have been certified as such by the Mississippi Department of Transportation and other Unified Certification Partners (UPC) can be found on the Mississippi Department of Transportation website at [www.gomdot.com](http://www.gomdot.com). The list is in the top left corner of the current Letting Calendar under Contracts & Letting. The DBE firm must be certified at the time the project is let and approved by MDOT to count towards meeting the DBE goal.

### **REPLACEMENT**

If a DBE Subcontractor cannot perform satisfactorily, and this causes the OCR-481 commitment to fall below the contract goal, the Contractor shall take all necessary reasonable steps to replace the DBE with another certified DBE Subcontractor or submit information to satisfy the Mississippi Department of Transportation that adequate good faith efforts have been made to replace the DBE. The replacement DBE must be a DBE who was on the Department's list of "Certified DBE Contractors" when the job was let, and who is still active. All DBE replacements must be approved by the Department.

Under no circumstances shall the Prime or any Subcontractor perform the DBE's work (as shown on the OCR-481) without prior written approval from the Department. See "Sanctions" at the end of this document for penalties for performing DBE's work.

When a Contractor proposes to substitute/replace/terminate a DBE that was originally named on the OCR-481, the Contractor must obtain a release, in writing, from the named DBE explaining why the DBE Subcontractor cannot perform the work. A copy of the original DBE's release must be attached to the Contractor's written request to substitute/replace/terminate along with appropriate Subcontract Forms for the substitute/replacement/terminated Subcontractor, all of which must be submitted to the DBE Coordinator and approved, in advance, by MDOT.

### **GOOD FAITH EFFORTS**

To demonstrate good faith efforts to replace any DBE that is unable to perform successfully, the Contractor must document steps taken to subcontract with another certified DBE Contractor. Such documentation shall include no less than the following:

- (1) Proof of written notification to certified DBE Contractors by certified mail that their interest is solicited in subcontracting the work defaulted by the previous DBE or in subcontracting other items of work in the contract.

- (2) If the Prime Contractor is a certified DBE firm, only the value of the work actually performed by the DBE Prime can be counted towards the project goal, along with any work subcontracted to a certified DBE firm.
- (3) If the Contractor is not a DBE, the work subcontracted to a certified DBE Contractor will be counted toward the goal.
- (4) The Contractor may count toward the goal a portion of the total dollar value of a contract with a joint venture eligible under the standards of this provision equal to the percentage of the DBE partner in the joint venture.
- (5) Expenditures to DBEs that perform a commercially useful function may be counted toward the goal. A business is considered to perform a commercially useful function when it is responsible for the execution of a distinct element of the work and carries out its responsibilities by actually performing, managing, and supervising the work involved.
- (6) The Contractor may count 100% of the expenditures for materials and supplies obtained from certified DBE suppliers and manufacturers that produce goods from raw materials or substantially alters them for resale provided the suppliers and manufacturers assume the actual and contractual responsibility for the provision of the materials and supplies. The Contractor may count sixty percent (60%) of the expenditures to suppliers that are not manufacturers, provided the supplier performs a commercially useful function in the supply process. Within 30 days after receipt of the materials, the Contractor shall furnish to the DBE Coordinator invoices from the certified supplier to verify the DBE goal.
- (7) Any work that a certified DBE firm subcontracts or sub-subcontracts to a non-DBE firm will not count towards the DBE goal.
- (8) Only the dollars actually paid to the DBE firm may be counted towards the DBE goal.

Failure of the Contractor to demonstrate good faith efforts to replace a DBE Subcontractor that cannot perform as intended with another DBE Subcontractor, when required, shall be a breach of contract and may be just cause to be disqualified from further bidding for a period of up to 12 months after notification by certified mail.

### **PRE-BID MEETING**

A pre-bid meeting will be held in Amphitheater 1 & 2 of the Hilton Jackson located at I-55 and County Line Road, Jackson, Mississippi at 2:00 P.M. on the day preceding the date of the bid opening.

This meeting is to inform DBE firms of subcontracting and material supply opportunities. Attendance at this meeting is considered of prime importance in demonstrating good faith effort to meet the contract goal.

### **PARTICIPATION / DBE CREDIT**

Participation shall be counted toward meeting the goal in this contract as follows:

- (1) If the Prime Contractor is a certified DBE firm, only the value of the work actually performed by the DBE Prime can be counted towards the project goal, along with any work subcontracted to a certified DBE firm.
- (2) If the Contractor is not a DBE, the work subcontracted to a certified DBE Contractor will be counted toward the goal.
- (3) The Contractor may count toward the goal a portion of the total dollar value of a contract with a joint venture eligible under the standards of this provision equal to the percentage of the DBE partner in the joint venture.
- (4) Expenditures to DBEs that perform a commercially useful function may be counted toward the goal. A business is considered to perform a commercially useful function when it is responsible for the execution of a distinct element of the work and carries out its responsibilities by actually performing, managing, and supervising the work involved.
- (5) The Contractor may count 100% of the expenditures for materials and supplies obtained from certified DBE suppliers and manufacturers that produce goods from raw materials or substantially alters them for resale provided the suppliers and manufacturers assume the actual and contractual responsibility for the provision of the materials and supplies. The Contractor may count sixty percent (60%) of the expenditures to suppliers that are not manufacturers, provided the supplier performs a commercially useful function in the supply process. Within 30 days after receipt of the materials, the Contractor shall furnish to the DBE Coordinator invoices from the certified supplier to verify the DBE goal.
- (6) Any work that a certified DBE firm subcontracts or sub-subcontracts to a non-DBE firm will not count towards the DBE goal.
- (7) Only the dollars actually paid to the DBE firm may be counted towards the DBE goal. The participation of a DBE Firm cannot be counted towards the Prime Contractor's DBE goal until the amount being counted towards the goal has been paid to the DBE.

### **AWARD**

Award of this contract to the low bidder will be contingent upon the following conditions:

- (1) Concurrence from Federal Highway Administration, when applicable.
- (2) Bidder must submit to the Office of Civil Rights for approval, Form OCR-481 (DBE Commitment) no later than the 3<sup>rd</sup> business day after opening of the bids to satisfy the Department and that adequate good faith efforts have been made to meet the contract goal. For answers to questions regarding Form OCR-481, contact the MDOT Office of Civil Rights at (601) 359-7466.
- (3) Bidder must include OCR-485 information with their bid proposal listing all firms that submitted quotes for material supplies or items to be subcontracted. OCR-485 information

must be included with the bid proposal. If the OCR-485 information is not included as part of bid proposal, your bid will be deemed irregular.

Prior to the start of any work, the bidder must notify the Project Engineer, in writing, of the name of the designated "DBE Liaison Officer" for this project. This notification must be posted on the bulletin board at the project site.

### **DEFAULT**

If the contract goal established by MDOT in this proposal is 1% or greater, it must be met to fulfill the terms of the contract. The Contractor may list DBE Subcontractors and items that exceed MDOT's contract goal, but should unforeseen problems arise that would prevent a DBE from completing its total commitment percentage, the Contractor will meet the terms of the contract as long as it meets or exceeds MDOT's Contract Goal. For additional information, refer to "Replacement" section of this Notice.

### **DBE REPORTS**

- (1) OCR-481: Refer to "CONTRACT GOAL" section of this Notice to Bidders for information regarding this form.
- (2) OCR-482: OCR-482: At the conclusion of the project, before the final estimate is paid and the project is closed out, the Prime Contractor will submit to the Project Engineer for verification of quantities and further handling Form OCR-482 whereby the Contractor certifies to the amounts of payments made to all Contractors / Suppliers over the life of the contract. The Project Engineer shall submit the completed Form OCR-482 to the DBE Coordinator (Office of Civil Rights). Final acceptance of the project is dependent upon Contract Administration Division's receipt of completed Form OCR-482 which they will receive from the Office of Civil Rights.
- (3) OCR-483: The Project Engineer/Inspector will complete Form OCR-483, the Commercially Useful Function (CUF) Performance Report, in accordance with MDOT S.O.P. No. OCR-03-09-01-483. Evaluations reported on this form are used to determine whether or not the DBE firm is performing a CUF. The Prime Contractor should take corrective action when the report contains any negative evaluations. DBE credit may be disallowed and/or other sanctions imposed if it is determined the DBE firm is not performing a CUF. This form should also be completed and returned to the DBE Coordinator (Office of Civil Rights).
- (4) OCR-484: Each month, the Prime Contractor will submit to the Project Engineer OCR-484 that certifies payments to all Subcontractors and shows all firms even if the Prime Contractor has paid no monies to the firm during that estimate period (negative report). The Project Engineer will attach the form to the monthly estimate before forwarding to the Contract Administration Division for further processing. Failure of the Contractor to submit the OCR-484 will result in the estimate not being processed and paid.

- (5) OCR-485: ALL BIDDERS must submit signed form with bid proposal of all firms that submitted quotes for material supplies or items to be subcontracted. If the OCR-485 information is not included as part of bid proposal, the bid will be deemed irregular.
- (6) OCR-487: Only used by Prime Contractors that are certified DBE firms. This form is used in determining the exact percentage of DBE credit for the specified project. It should be returned to MDOT with the OCR-481 form, or can also be returned with the Permission to Subcontract Forms (CAD-720, CAD-725 and CAD-521).

DBE Forms, can be obtained from the Office of Civil Rights Division, MDOT Administration Building, 401 North West Street, Jackson, MS, or at [www.gomdot.com](http://www.gomdot.com) under Divisions, Civil Rights, and Forms.

**SANCTIONS**

The Department has the option to enforce any of the following penalties for failure of the Prime Contractor to fulfill the DBE goal as stated on the OCR-481 form or any violations of the DBE program guidelines:

- (1) Disallow credit towards the DBE goal
- (2) Withhold progress estimate payments
- (3) Deduct from the final estimate or recover an amount equal to the unmet portion of the DBE goal which may include additional monetary penalties as outlined below based on the number of offenses and the severity of the violation as determined by MDOT.

1 <sup>st</sup> Offense	10% of unmet portion of goal	or	\$5,000 lump sum payment	or	Both
2 <sup>nd</sup> Offense	20% of unmet portion of goal	or	\$10,000 lump sum payment	or	Both
3 <sup>rd</sup> Offense	40% of unmet portion of goal	or	\$20,000 lump sum payment	or	\$20,000 lump sum payment and debarment

- (4) Debar the Contractor involved from bidding on MDOT federally funded projects.

**MISSISSIPPI DEPARTMENT OF TRANSPORTATION**

**SECTION 904 - NOTICE TO BIDDERS NO. 9**

**CODE: (IS)**

**DATE: 03/01/2017**

**SUBJECT: Federal Bridge Formula**

Bidders are hereby advised that the latest revision of Federal Highway Administration Publication No. FHWA-HOP-06-105, **BRIDGE FORMULA WEIGHTS**, dated August 2006, is made a part of this contract when applicable.

Prior to the preconstruction conference, the Contractor shall advise the Engineer, in writing, what materials, if any, will be delivered to the jobsite via Interstate route(s).

Copies of the **BRIDGE FORMULA WEIGHTS** publication may be obtained by contacting:

Federal Highway Administration  
400 7<sup>th</sup> Street, SW  
Washington, DC 20590  
(202) 366-2212

or

[http://www.ops.fhwa.dot.gov/Freight/publications/brdg\\_frm\\_wgths/bridge\\_formula\\_all\\_rev.pdf](http://www.ops.fhwa.dot.gov/Freight/publications/brdg_frm_wgths/bridge_formula_all_rev.pdf)

An on line **BRIDGE FORMULA WEIGHTS CALCULATOR** is available at

[http://ops.fhwa.dot.gov/freight/sw/brdgcalc/calc\\_page.htm](http://ops.fhwa.dot.gov/freight/sw/brdgcalc/calc_page.htm)

**MISSISSIPPI DEPARTMENT OF TRANSPORTATION**

**SECTION 904 - NOTICE TO BIDDERS NO. 13**

**CODE: (IS)**

**DATE: 03/01/2017**

**SUBJECT: Safety Edge**

Bidders are hereby advised that the Shoulder Wedge (Safety Edge) specified in Section 401, Asphalt Pavements, shall only apply to the top two (2) lifts of asphalt. Open Graded Friction Courses (OGFC) are not to be considered a lift as it pertains to safety edge. Attached is a drawing showing the safety edge. Note that the shoulder dimensions in the bottom two drawings will be less than three feet (3').



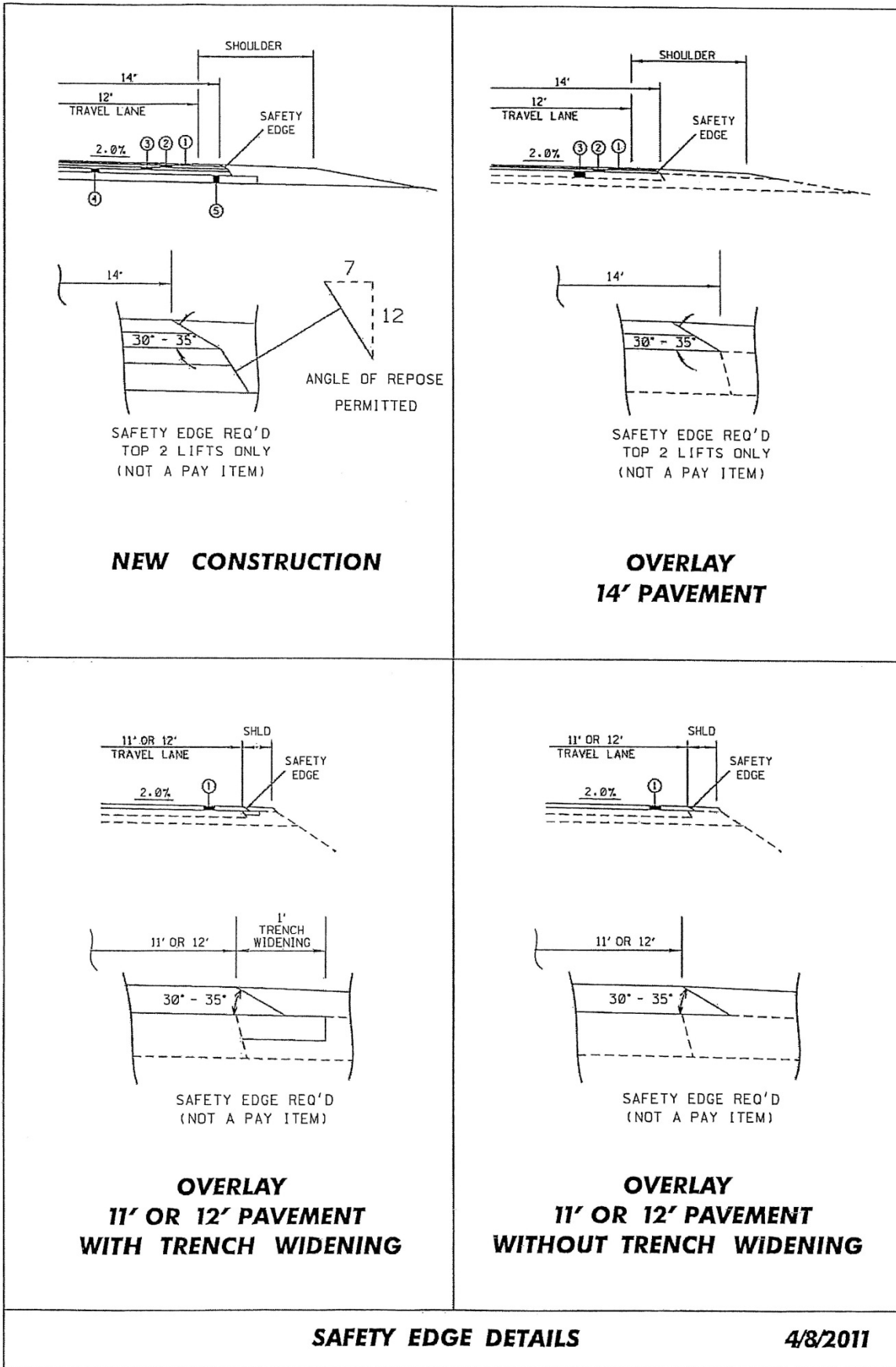

## MISSISSIPPI DEPARTMENT OF TRANSPORTATION

**SECTION 904 - NOTICE TO BIDDERS NO. 21**

**CODE: (SP)**

**DATE: 03/01/2017**

**SUBJECT: Intermediate Concrete Diaphragms**

Bidders are advised that the bridge plans for this project indicates that intermediate concrete diaphragms are required between the beams. If the bridge is designed using Load and Resistance Factor Design (LRFD), the intermediate concrete diaphragms may be eliminated at the Contractor's option. If the Contractor desires to make this change, a written request shall be sent to the Project Engineer who will forward it to the Bridge Division for concurrence. If eliminated, any concrete and reinforcement shown on the plans for intermediate diaphragms will not be included in the measurement and payment of concrete and reinforcement.

If the intermediate concrete diaphragms are eliminated, the Contractor shall temporarily brace the beams in accordance with the attached detail sheet.

This bracing shall be addressed in the Contractor's written request to eliminated intermediate diaphragms.

STATE	PROJECT NO.
MISS.	

**NOTE TO CONTRACTOR:**  
 The Contractor Shall Employ The Services Of A MS Registered Professional Engineer To Design The Temporary Steel Bracing System For The Bridge Design. The Temporary Steel Bracing System Shall Be Designed In Accordance With The Latest Edition Of The Same Design Specifications For Bridge Temporary Works, As Published By A.S.T.M. The Temporary Bracing System Shall Not Interfere With Drainage, Retaining Structures, Or Show In The Precast Beam Shape Formwork. The Temporary Steel Bracing System Shall Be Designed To Carry The Full Dead Weight Of The Span On This Steel And For Information Only And Do Not Remove The Contractor Of The Structure For The Adequacy Of The Design And The Safety Of The Structure. The Temporary Bracing System Shall Have A Minimum Of Two (2) Support Points, Temporary Bracing Locations, Connections, Bracing Members, And Other Details Shall Be Submitted To The Design Engineer For Review. The Contractor Shall Specify The Number, Location, And After Configuration Of The Temporary Bracing, And Prior To Commencing Any Other Work On The Bridge, The Contractor Shall Provide MDT Written Approval For The Temporary Bracing Was In Full Accordance With The Design Plans.

**GRADE SEPARATION BRIDGES GENERAL NOTES:**  
 Specifications, MISSDOT Standard Specifications For Road And Bridge Structures, Section 1000, Shall Apply To The Design And Construction Of The Temporary Steel Bracing System. The Temporary Steel Bracing System Shall Be Designed In Accordance With The Latest Edition Of The Same Design Specifications For Bridge Temporary Works, As Published By A.S.T.M. The Temporary Bracing System Shall Not Interfere With Drainage, Retaining Structures, Or Show In The Precast Beam Shape Formwork. The Temporary Steel Bracing System Shall Be Designed To Carry The Full Dead Weight Of The Span On This Steel And For Information Only And Do Not Remove The Contractor Of The Structure For The Adequacy Of The Design And The Safety Of The Structure. The Temporary Bracing System Shall Have A Minimum Of Two (2) Support Points, Temporary Bracing Locations, Connections, Bracing Members, And Other Details Shall Be Submitted To The Design Engineer For Review. The Contractor Shall Specify The Number, Location, And After Configuration Of The Temporary Bracing, And Prior To Commencing Any Other Work On The Bridge, The Contractor Shall Provide MDT Written Approval For The Temporary Bracing Was In Full Accordance With The Design Plans.

**HYDRAULIC BRIDGES GENERAL NOTES:**  
 Temporary Bracing Systems On Hydraulic Bridges Shall Conform To The Minimum Other Specifications, With The Contractor May Refer To Use Temporary Steel Bracing Systems.

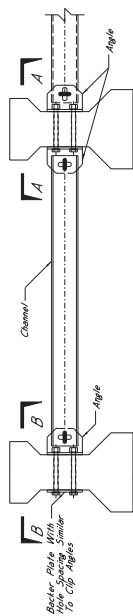

TEMPORARY STEEL BRACING DETAILS  
 AASHTO Type-1A, 2, 3, 4, 5, & Type-1A, 2 Beams

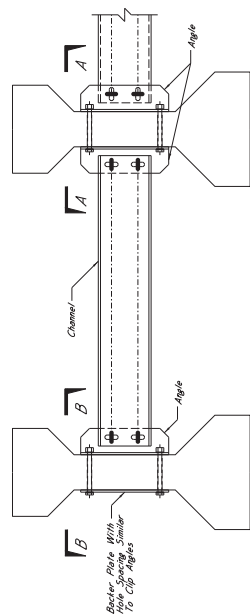

TEMPORARY STEEL BRACING DETAILS  
 AASHTO Type-III & Type-IV Beams

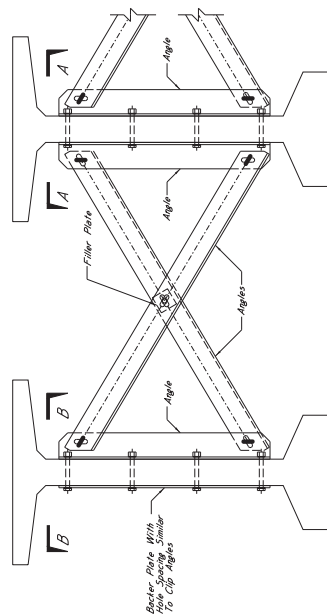

TEMPORARY STEEL BRACING DETAILS  
 Dual-T Beams

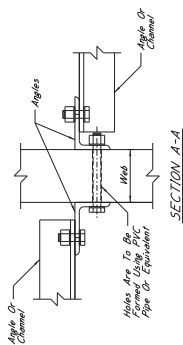

SECTION A-A

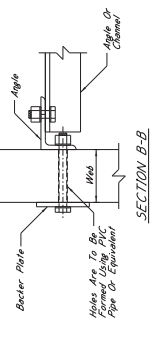

SECTION B-B

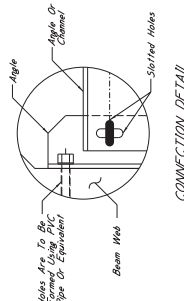

CONNECTION DETAIL

MISSISSIPPI DEPARTMENT OF TRANSPORTATION	
TEMPORARY STEEL BRACING	
REVISION	
DATE	
CHECKED	
DESIGNED	
DRAWN	
PROJECT NUMBER:	
COUNTY:	
FPM:	
WORKING NUMBER:	
SHEET NUMBER:	



# MISSISSIPPI DEPARTMENT OF TRANSPORTATION

**SECTION 904 - NOTICE TO BIDDERS NO. 23**

**CODE: (IS)**

**DATE: 03/01/2017**

**SUBJECT: Exposure to Moderate Sulfate Areas Below Ground Level**

Bidders are hereby advised that this project, or portions of this project, is located in areas considered as moderate sulfate exposure and will require certain restrictions on the cementitious materials. A geotechnical investigation has indicated the presence of moderate sulfate soils below the ground surface. Therefore, the cementitious materials used in concrete mixtures for the construction items of work listed below shall conform to the requirements listed in Subsection 701.02 for moderate sulfate and seawater sulfate exposure.

Items of work requiring restrictions on the cementitious materials are as follows:

- 1) Drilled Shafts
- 2) Precast/prestressed Piling
- 3) Spread Footings
- 4) Box Culverts & Box Bridges

Unless otherwise specified, no other restrictions on the cementitious materials shall apply to other concrete items or structures.

**MISSISSIPPI DEPARTMENT OF TRANSPORTATION**

**SECTION 904 - NOTICE TO BIDDERS NO. 113**

**CODE: (SP)**

**DATE: 04/18/2017**

**SUBJECT: Tack Coat**

Bidders are advised that in addition to the products listed on the Department's APL as referenced in Subsection 401.03.1.2 on page 256, the Contractor may use one of the following as a tack coat.

- CSS-1
- CSS-1h
- SS-1
- SS-1h

**MISSISSIPPI DEPARTMENT OF TRANSPORTATION**

**SECTION 904 - NOTICE TO BIDDERS NO. 114**

**CODE: (SP)**

**DATE: 04/18/2017**

**SUBJECT: Right-of-Way Plat**

Bidders are advised that pay item 617-A, Right-of-Way Marker not only addresses the requirements for furnishing and placing right-of-way markers but also includes the preparation and submittal of a ROW Plat by a Licensed Professional Surveyor. Since the submittal of the plat is considered a part of the pay item and the pay item is not complete until the plat is received, contract time will not be suspended while waiting on the Contractor to submit the plat.

**MISSISSIPPI DEPARTMENT OF TRANSPORTATION**

**SECTION 904 - NOTICE TO BIDDERS NO. 296**

**CODE: (SP)**

**DATE: 07/25/2017**

**SUBJECT: Reduced Speed Limit Signs**

Bidders are advised that when the plans or contract documents require the speed limit on a project to be reduced, the Contractor shall begin work within 48 hours of installing the reduced speed limit signs. Should the Contractor not start work or have no plans to start work within 48 hours of installing the signs, the reduced speed limit signs shall be covered and existing speed limit signs uncovered.

**MISSISSIPPI DEPARTMENT OF TRANSPORTATION**

**SECTION 904 - NOTICE TO BIDDERS NO. 445**

**CODE: (SP)**

**DATE: 10/10/2017**

**SUBJECT: Mississippi Agent or Qualified Nonresident Agent**

Bidders are hereby advised of the requirements of Subsections 102.08, 103.05.2, and 107.14.2.1 of the *2017 Standard Specifications for Road and Bridge Construction* as it refers to bonding agents. Proposal guaranties, bonds, and liability insurance policies must be signed by a **Mississippi Agent or Qualified Nonresident Agent.**



## MISSISSIPPI DEPARTMENT OF TRANSPORTATION

SECTION 904 - NOTICE TO BIDDERS NO. 516

CODE: (IS)

DATE: 11/28/2017

SUBJECT: Errata and Modifications to the 2017 Standard Specifications

<u>Page</u>	<u>Subsection</u>	<u>Change</u>
16	102.06	In the seventh full paragraph, change “Engineer” to “Director.”
33	105.05.1	In the sixth sentence, change “Contract Administration Engineer” to “Contract Administration Director.”
34	105.05.2.1	In subparagraph 2, change “SWPPP, ECP” to “SWPPP and the ECP”
35	105.05.2.2	In subparagraphs 2, add “ and” to the end of the sentence. In subparagraph 3, remove “, and” and add “.”.
90	109.04.2	In the last paragraph of subparagraph (a), place a period “.” at the end of the sentence.
93	109.04.2	In the last paragraph of subparagraph (g), place a period “.” at the end of the sentence. Also, in the first paragraph of subparagraph (h), place a period “.” at the end of the sentence.
97	109.07	Under ADJUSTMENT CODE, subparagraph (A1), change “HMA mixture” to “Asphalt mixtures.”
98	109.11	In the third sentence, change “Engineer” to “Director.”
219	308.04	In the last sentence of the last paragraph, change “Contractor’s decision” to “Engineer’s decision.”
300	405.02.5.9	In the first sentence of the second paragraph, change “Hot Mix Asphalt” to “Asphalt Mixtures.”
502	630.01.1	In the first paragraph, change “AASHTO” to “AASHTO’s LRFD”.
636	646.05	Change “each” to “per each” for the pay item units of payment.
640	656.02.6.2	In item 7), change “down stream” to “downstream”.
688	630.03.2	Change the subsection number from “630.03.2” to “680.03.2.”

725      702.08.3      In the second sentence of the first paragraph, change “hot-mix” to “asphalt.”

954      804.02.13.1.6      In the definition for “M” in the % Reduction formulas, change “paragraph 7.3” to “paragraph 5.3.”

## MISSISSIPPI DEPARTMENT OF TRANSPORTATION

SECTION 904 - NOTICE TO BIDDERS NO. 757

CODE: (IS)

DATE: 03/20/2018

SUBJECT: Additional Erosion Control Requirements

Bidders are hereby advised of the following requirements that relate to erosion control activities on the project.

**THE MAXIMUM TOTAL ACREAGE THAT CAN BE DISTURBED, AT ONE TIME, ON THE PROJECT IS NINETEEN (19) ACRES. THE CONTRACTOR SHALL BE REQUIRED TO STABILIZE DISTURBED AREAS PRIOR TO OPENING UP ADDITIONAL SECTIONS OF THE PROJECT. STABILIZED SHALL BE WHEN THE DISTURBED AREA MEETS ONE OF THE FOLLOWING CRITERIA:**

- **THE AREA HAS BEEN SEEDED, EITHER TEMPORARY OR PERMANENT, AND MULCHED ACCORDING TO THE SPECIFICATIONS, OR**
- **A CRUSHED STONE COURSE OR A LIFT OF ASPHALT PAVEMENT HAS BEEN PLACED, OR**
- **THE AREA HAS BEEN CHEMICALLY TREATED USING PORTLAND CEMENT OR LIME-FLY ASH, AND SEALED.**

**DISTURBED AREAS INCLUDE THE ROADBED, SLOPES AND REMAINING AREA OUT TO THE ROW LINE.**

**Clearing and Grubbing:** Prior to beginning any clearing and grubbing operations on the project, controls shall be in place to address areas such as drainage structures, wetlands, streams, steep slopes and any other sensitive areas in accordance with the approved Erosion Control Plan or as directed by the Engineer. Clearing and grubbing should be limited to the minimum area necessary to construct the project. Grubbing operations should be minimized in areas outside the construction limits and stumps should be cut off flush with the existing ground elevations. A buffer area of at least fifteen (15) feet or as shown in the Plans shall be in place adjacent to the right-of-way line. The buffer area can either be the existing vegetation that is left undisturbed or re-established by planting new vegetation if clearing and grubbing was required. *As applicable, see the Riparian Buffer Erosion Control sheet(s) in the Plans for clearing and grubbing limits adjacent to stream banks.*

**Unclassified Excavation:** Cut sections shall be graded in accordance with the typical sections and plan grades. Permanent erosion control BMP's should be placed as soon as possible after the cut material has been moved. Fill sections that are completed shall have permanent erosion control BMP's placed. Fill sections that are not completed shall be either permanently or temporarily seeded until additional material is made available to complete these sections. All unclassified excavation on the project is be required to be moved prior to incorporating any borrow excavation. The Contractor may have to stockpile unclassified excavation in order to comply with the nineteen (19) acre requirement. No additional compensation will be made for stockpiling operations.

Disturbed areas that remain inactive for a period of more than fourteen (14) days shall be temporary grassed and mulched. Temporary grassing and mulching shall only be paid one time for a given area.

## MISSISSIPPI DEPARTMENT OF TRANSPORTATION

SECTION 904 - NOTICE TO BIDDERS NO. 977

CODE: (IS)

DATE: 07/25/2018

SUBJECT: DUNS Requirement for Federal Funded Projects

Bidders are advised that the Prime Contractor must maintain a current registration in the System for Award Management ( <http://www.sam.gov> ) at all times during this project. A Dun and Bradstreet Data Universal Numbering System (DUNS) Number ( <http://www.dnb.com> ) is one of the requirements for registration in the System for Award Management.

Bidders are also advised that prior to the award of this contract, they MUST be registered, active, and have no active exclusions in the System for Award Management.

## MISSISSIPPI DEPARTMENT OF TRANSPORTATION

SECTION 904 - NOTICE TO BIDDERS NO. 1206

CODE: (SP)

DATE: 10/16/2018

SUBJECT: MASH Compliant Devices

Bidders are hereby advised that the Standard Specifications may require certain traffic control and permanent safety hardware devices to meet the requirements of the Manual for Assessing Safety Hardware (MASH). However, devices meeting the requirements of NCHRP Report 350 will be allowed until the mandatory effective date for MASH compliance. The following table shows the effective dates for MASH compliant devices.

Device	Effective Date for MASH Compliance
W-beam barriers, cast-in-place concrete barriers	December 31, 2017
W-beam terminals - non-flared	June 30, 2018
Crash cushions	December 31, 2018
Cable barriers, cable barrier terminals, bridge rails, transitions, all other longitudinal barriers including portable barriers installed permanently, W-beam terminals - flared, all other terminals, sign supports, all other breakaway hardware	December 31, 2019

Temporary work zone devices, including portable barriers manufactured after December 31, 2019, must have been successfully tested to the 2016 Edition of MASH. Such devices manufactured on or before this date and successfully tested to NCHRP Report 350 or the 2009 Edition of MASH may continue to be used throughout their normal service lives.

**MISSISSIPPI DEPARTMENT OF TRANSPORTATION**

**SECTION 904 - NOTICE TO BIDDERS NO. 1225**

**CODE: (SP)**

**DATE: 11/13/2018**

**SUBJECT: Early Notice to Proceed**

Bidders are advised that if an early notice to proceed is allowed by the Department and the Contractor experiences problems or delays between the early notice to proceed date and the original notice to proceed date, this shall not be justification for any monetary compensation or an extension of contract time.

**MISSISSIPPI DEPARTMENT OF TRANSPORTATION**

**SECTION 904 - NOTICE TO BIDDERS NO. 1226**

**CODE: (SP)**

**DATE: 11/16/2018**

**SUBJECT: Material Storage Under Bridges**

Bidders are advised that Subsection 106.08 of the Standard Specifications allows the Contractor to store materials and equipment on portions of the right-of-way. However, the Contractor will not be allowed to store or stockpile materials under bridges without written permission from the Project Engineer. The Contractor shall submit a detailed request of all proposed materials to be stored under bridges to the Engineer a minimum of 14 calendar days prior to anticipated storage. This detail shall include, but not limited to, bridge location, material type, material quantity, and duration of storage. The Project Engineer and any other needed Division will review this information and determine whether to grant approval. The Contractor shall not store any material under any bridge without written approval from the Project Engineer.

**MISSISSIPPI DEPARTMENT OF TRANSPORTATION**

**SECTION 904 - NOTICE TO BIDDERS NO. 1241**

**CODE: (SP)**

**DATE: 11/27/2018**

**SUBJECT: Fuel and Material Adjustments**

Bidder's attention is brought to the last paragraph of Subsection 109.07 of the Standard Specifications which states that no fuel or material adjustment will be made after the completion of contract time. Any fuels consumed or materials incorporated into the work during the monthly estimate period falling wholly after the expiration of contract time will not be subject a fuel or material adjustment.



**MISSISSIPPI DEPARTMENT OF TRANSPORTATION**

**SECTION 904 - NOTICE TO BIDDERS NO. 1434**

**CODE: (SP)**

**DATE: 03/06/2019**

**SUBJECT: Erosion Control Plan**

Bidders are advised that the Best Management Practices (BMPs) shown at sensitive areas on the Erosion Control Sheets in the Plans shall be shown on the Contractor's Erosion Control Plan and shall be used in the field as indicated on the original plans sheets. Should the installation of these BMPs produce an unsatisfactory result, the Contractor shall submit to the Engineer alternate BMPs for approval. Once approved, the Contractor shall revise the Contractor's Erosion Control Plan to include these changes.

**MISSISSIPPI DEPARTMENT OF TRANSPORTATION**

**SECTION 904 - NOTICE TO BIDDERS NO. 1963**

**CODE: (SP)**

**DATE: 9/23/2019**

**SUBJECT: Guardrail Pads**

Bidders are hereby advised that prior to construction of the guardrail pads, the Contractor shall coordinate with the guardrail Subcontractor to determine the guardrail pad dimensions necessary to meet MASH compliance.

# MISSISSIPPI DEPARTMENT OF TRANSPORTATION

SECTION 904 - NOTICE TO BIDDERS NO. 2061

CODE: (SP)

DATE: 11/05/2019

SUBJECT: Reflective Sheeting for Signs

Bidders are hereby advised that the retroreflective sign sheeting used for signs on this project shall be as listed below and shall meet the requirements of Subsection 721.06.

### **Temporary Construction Signs**

Temporary traffic control (orange) sign sheeting shall be a minimum Type IX Fluorescent Orange sheeting.

### **Permanent Signs**

Permanent signs, except signs on traffic signal poles/mast arms, shall be as follows:

- Brown background sheeting on guide signs shall be a minimum Type VIII sheeting,
- Green and blue background sheeting on guide signs shall be a minimum Type IX sheeting, and
- All white, yellow, fluorescent yellow, and fluorescent yellow/green sheeting shall be Type XI sheeting.

**MISSISSIPPI DEPARTMENT OF TRANSPORTATION**

**SECTION 904 - NOTICE TO BIDDERS NO. 2064**

**CODE: (SP)**

**DATE: 11/26/2019**

**SUBJECT: Contract Time**

**PROJECT: NH-APD-0078-01(011)N / 102076301 - Itawamba County**

The calendar date for completion of work to be performed by the Contractor for this project shall be **June 30, 2023** which date or extended date as provided in Subsection 108.06 shall be the end of contract time. It is anticipated that the Notice of Award will be issued no later than **March 10, 2020** and the effective date of the Notice to Proceed / Beginning of Contract Time will be **May 11, 2020**.

Should the Contractor request a Notice to Proceed earlier than **May 11, 2020** and it is agreeable with the Department for an early Notice to Proceed, the requested date will become the new Notice to Proceed date.

All requests for an early Notice to Proceed shall be sent to the Project Engineer who will forward it to the Contract Administration Division.

**Note: Contract time has been established assuming multiple crews working simultaneously for the duration of the project.**

## MISSISSIPPI DEPARTMENT OF TRANSPORTATION

SECTION 904 - NOTICE TO BIDDERS NO. 2065

DATE: 11/15/2019

SUBJECT: Specialty Items

PROJECT: NHAPD-0078-01(011)N/102076301 - ITAWAMBA

Pursuant to the provisions of Section 108, the following work items are hereby designated as "Specialty Items" for this contract. Bidders are reminded that these items must be subcontracted in order to be considered as specialty items.

### CATEGORY: CURBING, SIDEWALKS, GUTTERS

---

Line No	Pay Item	Description
1180	609-D004	Combination Concrete Curb and Gutter Type 2 Modified

### CATEGORY: DISPOSAL OF BUILDINGS, RIGHT OF WAY CLEARING & GRUBBING

---

Line No	Pay Item	Description
0100	202-B240	Removal of Traffic Stripe

### CATEGORY: EROSION CONTROL

---

Line No	Pay Item	Description
0200	213-C001	Superphosphate
0210	216-A001	Solid Sodding
0220	217-A001	Ditch Liner
0230	219-A001	Watering
0240	220-A001	Insect Pest Control
0250	221-A001	Concrete Paved Ditch
0260	223-A001	Mowing
0270	224-A001	Soil Reinforcing Mat
0280	225-A001	Grassing
0290	225-B001	Agricultural Limestone
0300	225-C001	Mulch, Vegetative Mulch
0310	226-A001	Temporary Grassing
0320	229-A001	Erosion Mat
0330	234-A001	Temporary Silt Fence
0340	234-C001	Super Silt Fence
0350	234-D001	Inlet Siltation Guard
0360	234-E001	Reset Inlet Siltation Guard
0370	235-A001	Temporary Erosion Checks
0380	236-A008	Silt Basin, Type D
0390	237-A001	Wattles, 12"
0400	237-A002	Wattles, 20"
0410	239-A001	Temporary Slope Drains
0420	245-A001	Silt Dike
0430	246-B002	Rockbags

CATEGORY: EROSION CONTROL

---

Line No	Pay Item	Description
0440	247-A001	Temporary Stream Diversion
0450	249-A001	Riprap for Erosion Control
1800	907-228-A002	Erosion Control Blanket, Type II
1810	907-241-A001	Floc Blocks
1820	907-253-A001	Coir Fiber Baffle

CATEGORY: GUARDRAIL, GUIDERAIL

---

Line No	Pay Item	Description
1150	606-B001	Guard Rail, Class A, Type 1
1160	606-D022	Guard Rail, Bridge End Section, Type I
1170	606-E001	Guard Rail, Terminal End Section

CATEGORY: MISCELLANEOUS/ SPECIALTY WORK ITEMS

---

Line No	Pay Item	Description
0660	423-A001	Rumble Strips, Ground In

CATEGORY: PAVEMENT STRIPING AND MARKING

---

Line No	Pay Item	Description
1460	626-A004	6" Thermoplastic Traffic Stripe, Skip White
1470	626-C004	6" Thermoplastic Edge Stripe, Continuous White
1480	626-E004	6" Thermoplastic Traffic Stripe, Continuous Yellow
1490	626-F003	6" Thermoplastic Edge Stripe, Continuous Yellow
1500	626-G002	Thermoplastic Detail Stripe, White
1510	626-G003	Thermoplastic Detail Stripe, Yellow
1520	626-H004	Thermoplastic Legend, White
1530	626-H005	Thermoplastic Legend, White
1540	627-J001	Two-Way Clear Reflective High Performance Raised Markers
1550	627-K001	Red-Clear Reflective High Performance Raised Markers
1560	627-L001	Two-Way Yellow Reflective High Performance Raised Markers
1920	907-624-A002	6" Inverted Profile Thermoplastic Traffic Stripe, Skip White
1930	907-624-B002	6" Inverted Profile Thermoplastic Traffic Stripe, Continuous White
1940	907-624-D002	6" Inverted Profile Thermoplastic Traffic Stripe, Continuous Yellow
1950	628-G001	6" High Performance Cold Plastic Traffic Stripe, Skip White
1960	628-H001	6" High Performance Cold Plastic Traffic Stripe, Continuous White
1970	628-J001	6" High Performance Cold Plastic Traffic Stripe, Continuous Yellow
1980	907-626-C008	Thermoplastic Audible Edge Stripe
1990	907-626-C009	Thermoplastic Audible Bump Edge Stripe

CATEGORY: SURVEY AND STAKING

---

Line No	Pay Item	Description
---------	----------	-------------

CATEGORY: SURVEY AND STAKING

---

Line No	Pay Item	Description
1750	699-A001	Roadway Construction Stakes

CATEGORY: TRAFFIC CONTROL - PERMANENT

---

Line No	Pay Item	Description
1570	630-A001	Standard Roadside Signs, Sheet Aluminum, 0.080" Thickness
1580	630-A003	Standard Roadside Signs, Sheet Aluminum, 0.125" Thickness
1590	630-A005	Standard Roadside Signs, Sheet Aluminum, 0.1" Thickness
1600	630-B002	Interstate Directional Signs, Bolted Extruded Aluminum Panels, Ground Mounted
1610	630-C002	Steel U-Section Posts, 2.0 lb/ft
1620	630-C003	Steel U-Section Posts, 3.0 lb/ft
1630	630-D008	Structural Steel Beams, W6 x 9
1640	630-E002	Structural Steel Angles & Bars, 3" x 3" x 1/4" Angles
1650	630-E004	Structural Steel Angles & Bars, 7/16" x 2 1/2" Flat Bar
1660	630-F002	Delineators, Flexible Post Mounted, Crossover, Type I, Yellow
1670	630-F003	Delineators, Flexible Post Mounted, Crossover, Type II
1680	630-F006	Delineators, Guard Rail, White
1690	630-F007	Delineators, Guard Rail, Yellow
1700	630-G004	Type 3 Object Markers, OM-3R or OM-3L
1710	630-K001	Welded & Seamless Steel Pipe Posts, 3 1/2"
1720	630-K002	Welded & Seamless Steel Pipe Posts, 3"
1730	630-K003	Welded & Seamless Steel Pipe Posts, 4"
1740	638-A002	Flashing Assembly, Advanced Warning
1840	907-630-A001	Standard Roadside Signs, LED Enhanced

CATEGORY: TRAFFIC CONTROL - TEMPORARY

---

Line No	Pay Item	Description
1250	619-A1001	Temporary Traffic Stripe, Continuous White
1260	619-A1006	Temporary Traffic Stripe, Continuous White, Type 1 Tape
1270	619-A2001	Temporary Traffic Stripe, Continuous Yellow
1280	619-A2005	Temporary Traffic Stripe, Continuous Yellow, Type 1 Tape
1290	619-A5001	Temporary Traffic Stripe, Detail
1300	619-A5003	Temporary Traffic Stripe, Detail, Type 1 Tape
1310	619-A6002	Temporary Traffic Stripe, Legend
1320	619-A6005	Temporary Traffic Stripe, Legend, Type 1 Tape
1330	619-C7001	Two-Way Yellow Reflective High Performance Raised Marker
1340	619-D1001	Standard Roadside Construction Signs, Less than 10 Square Feet
1350	619-D2001	Standard Roadside Construction Signs, 10 Square Feet or More
1360	619-E1001	Flashing Arrow Panel, Type C
1370	619-F1001	Concrete Median Barrier, Precast
1380	619-F2001	Remove and Reset Concrete Median Barrier, Precast
1390	619-G4001	Barricades, Type III, Double Faced

CATEGORY: TRAFFIC CONTROL - TEMPORARY

---

Line No	Pay Item	Description
1400	619-G5001	Free Standing Plastic Drums
1410	619-G7001	Warning Lights, Type "B"
1420	619-J1002	Impact Attenuator, 45 MPH
1430	619-J3001	Remove and Reset Impact Attenuator
1830	907-619-E3001	Changeable Message Sign



**MISSISSIPPI DEPARTMENT OF TRANSPORTATION**

**SECTION 904 - NOTICE TO BIDDERS NO. 2066**

**CODE (SP)**

**DATE: 12/09/2019**

**SUBJECT: Placement of Fill Material in Federally Regulated Areas**

**PROJECT: NH-APD-0078-01(011)N / 102076301 - Itawamba County**

A Permit (404, General, Nationwide, etc.) for placing fill material in federally regulated sites is required on this project.

The Department has acquired the following permits for permanently filling at regulated sites that are identified during project development:

<b>General Permit No. 46 (Wetlands &amp; Waters of the U.S.) (ID No. SAM-XXXXXXX)</b>	<b>All Sites</b>
---	------------------

Copies of said permit(s) are available at the below referenced link for the appropriate letting date under the column titled "Permit Doc."

<http://mdot.ms.gov/Applications/BidSystem/Home.aspx>

The permit may have plan sheets attached as reference but these sheets are not to be used for construction. Official plans sheets are those included in the Project Plans.

**MISSISSIPPI DEPARTMENT OF TRANSPORTATION**

**SECTION 904 - NOTICE TO BIDDERS NO. 2067**

**CODE: (SP)**

**DATE: 12/09/2019**

**SUBJECT: Use of Flocc Blocks**

**PROJECT: NH-APD-0078-01(011)N / 102076301 – Itawamba County**

Bidders are advised that prior to the use of Flocc Blocks, written notification shall be included in the Storm Water Pollution Prevention Plan (SWPPP). The placement locations, functionality, maintenance and removal shall be clearly depicted within the SWPPP. Flocc Blocks shall meet the requirements of Special Provision 907-241, and meet all requirements of the Mississippi Department of Environmental Quality's regulations. Polyacrylamide **shall not** be discharged into waters of the state.

**MISSISSIPPI DEPARTMENT OF TRANSPORTATION**

**SECTION 904 - NOTICE TO BIDDERS NO. 2068**

**CODE: (SP)**

**DATE: 12/11/2019**

**SUBJECT: Disturbed Area**

**PROJECT: NH-APD-0078-01(011)N/102076301 – Itawamba County**

Bidders are advised of Notice to Bidders No. 757 and Special Provision No. 907-107-2 that limit the maximum total acreage that can be disturbed at one time to 19 acres. However, if the Contractor provides a schedule for earthwork activity by means of haul-mass diagrams or similar methodology, the expansion of the 19-acre limit will be considered. A written request with supporting documentation shall be submitted to the Project Engineer who will review the request before submitting it to Construction Division for approval. MDOT reserves the right to decrease the acreage requested by the Contractor based on the Contractor's erosion control performance and the complexity of the project.

Time associated with the submittal, review, and approval/denial of this change will run concurrent with the 60 days set aside in Special Provision No. 907-107-2 for the approval of the Contractor's Erosion Control Plan.

General Decision Number: MS190091 01/04/2019 MS91

Superseded General Decision Number: MS20180195

State: Mississippi

Construction Type: Highway

County: Itawamba County in Mississippi.

HIGHWAY CONSTRUCTION PROJECTS

Note: Under Executive Order (EO) 13658, an hourly minimum wage of \$10.60 for calendar year 2019 applies to all contracts subject to the Davis-Bacon Act for which the contract is awarded (and any solicitation was issued) on or after January 1, 2015. If this contract is covered by the EO, the contractor must pay all workers in any classification listed on this wage determination at least \$10.60 per hour (or the applicable wage rate listed on this wage determination, if it is higher) for all hours spent performing on the contract in calendar year 2019. If this contract is covered by the EO and a classification considered necessary for performance of work on the contract does not appear on this wage determination, the contractor must pay workers in that classification at least the wage rate determined through the conformance process set forth in 29 CFR 5.5(a)(1)(ii) (or the EO minimum wage rate, if it is higher than the conformed wage rate). The EO minimum wage rate will be adjusted annually. Please note that this EO applies to the above-mentioned types of contracts entered into by the federal government that are subject to the Davis-Bacon Act itself, but it does not apply to contracts subject only to the Davis-Bacon Related Acts, including those set forth at 29 CFR 5.1(a)(2)-(60). Additional information on contractor requirements and worker protections under the EO is available at [www.dol.gov/whd/govcontracts](http://www.dol.gov/whd/govcontracts).

Modification Number	Publication Date
0	01/04/2019

SUMS2010-014 08/04/2014

	Rates	Fringes
CARPENTER (Form Work Only).....	\$ 14.13	0.00
CARPENTER, Excludes Form Work....	\$ 13.49	0.00
CEMENT MASON/CONCRETE FINISHER...	\$ 13.70	0.00
ELECTRICIAN.....	\$ 21.80	7.93
HIGHWAY/PARKING LOT STRIPING:		
Truck Driver (Line Striping		
Truck).....	\$ 15.48	0.00

INSTALLER - GUARDRAIL.....	\$ 11.51	0.00
IRONWORKER, REINFORCING.....	\$ 14.82	0.00
LABORER: Asphalt, Includes Raker, Shoveler, Spreader and Distributor.....	\$ 10.39	0.00
LABORER: Common or General.....	\$ 10.22	0.00
LABORER: Concrete Worker.....	\$ 10.69	0.00
LABORER: Flagger.....	\$ 8.00	0.00
LABORER: Grade Checker.....	\$ 12.77	0.00
LABORER: Landscape.....	\$ 9.83	0.00
LABORER: Mason Tender - Cement/Concrete.....	\$ 11.08	0.00
LABORER: Pipelayer.....	\$ 10.76	0.00
LABORER: Laborer-Cones/ Barricades/Barrels - Setter/Mover/Sweeper.....	\$ 10.38	0.00
OPERATOR: Asphalt Spreader.....	\$ 16.03	0.00
OPERATOR: Backhoe/Excavator/Trackhoe.....	\$ 13.42	0.00
OPERATOR: Boring Machine.....	\$ 15.14	0.00
OPERATOR: Broom/Sweeper.....	\$ 10.94	0.00
OPERATOR: Bulldozer.....	\$ 14.38	0.00
OPERATOR: Concrete Saw.....	\$ 15.68	0.00
OPERATOR: Crane.....	\$ 18.32	0.00
OPERATOR: Distributor.....	\$ 12.59	0.00
OPERATOR: Drill.....	\$ 19.22	0.00
OPERATOR: Grader/Blade.....	\$ 14.13	0.00
OPERATOR: Loader.....	\$ 11.05	0.00
OPERATOR: Mechanic.....	\$ 16.00	0.00
OPERATOR: Milling Machine.....	\$ 15.12	0.00
OPERATOR: Oiler.....	\$ 12.33	0.00
OPERATOR: Paver (Asphalt, Aggregate, and Concrete).....	\$ 16.47	0.00

OPERATOR: Piledriver.....	\$ 15.13	0.00
OPERATOR: Roller (All Types)....	\$ 11.54	0.00
OPERATOR: Scraper.....	\$ 13.15	0.00
OPERATOR: Tractor.....	\$ 10.22	0.00
OPERATOR: Trencher.....	\$ 15.00	0.00
TRUCK DRIVER: Flatbed Truck.....	\$ 13.79	0.00
TRUCK DRIVER: Lowboy Truck.....	\$ 11.00	0.00
TRUCK DRIVER: Mechanic.....	\$ 14.23	0.00
TRUCK DRIVER: Off the Road Truck.....	\$ 12.29	0.00
TRUCK DRIVER: Water Truck.....	\$ 10.58	0.00
TRUCK DRIVER: Dump Truck (All Types).....	\$ 10.49	0.00
TRUCK DRIVER: Semi/Trailer Truck.....	\$ 15.81	0.00

-----

WELDERS - Receive rate prescribed for craft performing operation to which welding is incidental.

=====

Note: Executive Order (EO) 13706, Establishing Paid Sick Leave for Federal Contractors applies to all contracts subject to the Davis-Bacon Act for which the contract is awarded (and any solicitation was issued) on or after January 1, 2017. If this contract is covered by the EO, the contractor must provide employees with 1 hour of paid sick leave for every 30 hours they work, up to 56 hours of paid sick leave each year. Employees must be permitted to use paid sick leave for their own illness, injury or other health-related needs, including preventive care; to assist a family member (or person who is like family to the employee) who is ill, injured, or has other health-related needs, including preventive care; or for reasons resulting from, or to assist a family member (or person who is like family to the employee) who is a victim of, domestic violence, sexual assault, or stalking. Additional information on contractor requirements and worker protections under the EO is available at [www.dol.gov/whd/govcontracts](http://www.dol.gov/whd/govcontracts).

Unlisted classifications needed for work not included within the scope of the classifications listed may be added after award only as provided in the labor standards contract clauses (29CFR 5.5 (a) (1) (ii)).

-----

The body of each wage determination lists the classification and wage rates that have been found to be prevailing for the cited type(s) of construction in the area covered by the wage determination. The classifications are listed in alphabetical order of "identifiers" that indicate whether the particular rate is a union rate (current union negotiated rate for local), a survey rate (weighted average rate) or a union average rate (weighted union average rate).

#### Union Rate Identifiers

A four letter classification abbreviation identifier enclosed in dotted lines beginning with characters other than "SU" or "UAVG" denotes that the union classification and rate were prevailing for that classification in the survey. Example: PLUM0198-005 07/01/2014. PLUM is an abbreviation identifier of the union which prevailed in the survey for this classification, which in this example would be Plumbers. 0198 indicates the local union number or district council number where applicable, i.e., Plumbers Local 0198. The next number, 005 in the example, is an internal number used in processing the wage determination. 07/01/2014 is the effective date of the most current negotiated rate, which in this example is July 1, 2014.

Union prevailing wage rates are updated to reflect all rate changes in the collective bargaining agreement (CBA) governing this classification and rate.

#### Survey Rate Identifiers

Classifications listed under the "SU" identifier indicate that no one rate prevailed for this classification in the survey and the published rate is derived by computing a weighted average rate based on all the rates reported in the survey for that classification. As this weighted average rate includes all rates reported in the survey, it may include both union and non-union rates. Example: SULA2012-007 5/13/2014. SU indicates the rates are survey rates based on a weighted average calculation of rates and are not majority rates. LA indicates the State of Louisiana. 2012 is the year of survey on which these classifications and rates are based. The next number, 007 in the example, is an internal number used in producing the wage determination. 5/13/2014 indicates the survey completion date for the classifications and rates under that identifier.

Survey wage rates are not updated and remain in effect until a new survey is conducted.

#### Union Average Rate Identifiers

Classification(s) listed under the UAVG identifier indicate that no single majority rate prevailed for those classifications; however, 100% of the data reported for the classifications was union data. EXAMPLE: UAVG-OH-0010 08/29/2014. UAVG indicates that the rate is a weighted union average rate. OH indicates the state. The next number, 0010 in the example, is an internal number used in producing the wage determination. 08/29/2014 indicates the survey completion date for the classifications and rates under that identifier.

A UAVG rate will be updated once a year, usually in January of each year, to reflect a weighted average of the current negotiated/CBA rate of the union locals from which the rate is based.

-----

WAGE DETERMINATION APPEALS PROCESS

1.) Has there been an initial decision in the matter? This can be:

- \* an existing published wage determination
- \* a survey underlying a wage determination
- \* a Wage and Hour Division letter setting forth a position on a wage determination matter
- \* a conformance (additional classification and rate) ruling

On survey related matters, initial contact, including requests for summaries of surveys, should be with the Wage and Hour Regional Office for the area in which the survey was conducted because those Regional Offices have responsibility for the Davis-Bacon survey program. If the response from this initial contact is not satisfactory, then the process described in 2.) and 3.) should be followed.

With regard to any other matter not yet ripe for the formal process described here, initial contact should be with the Branch of Construction Wage Determinations. Write to:

Branch of Construction Wage Determinations  
Wage and Hour Division  
U.S. Department of Labor  
200 Constitution Avenue, N.W.  
Washington, DC 20210

2.) If the answer to the question in 1.) is yes, then an interested party (those affected by the action) can request review and reconsideration from the Wage and Hour Administrator (See 29 CFR Part 1.8 and 29 CFR Part 7). Write to:

Wage and Hour Administrator  
U.S. Department of Labor  
200 Constitution Avenue, N.W.  
Washington, DC 20210

The request should be accompanied by a full statement of the interested party's position and by any information (wage payment data, project description, area practice material, etc.) that the requestor considers relevant to the issue.

3.) If the decision of the Administrator is not favorable, an interested party may appeal directly to the Administrative Review Board (formerly the Wage Appeals Board). Write to:

Administrative Review Board  
U.S. Department of Labor



200 Constitution Avenue, N.W.  
Washington, DC 20210

4.) All decisions by the Administrative Review Board are final.

=====

END OF GENERAL DECISION

**SUPPLEMENT TO FORM FHWA-1273**

**DATE:** 10/10/2018

**SUBJECT:** Federal Contract Provisions for Subcontracts and Cargo Preference Act

**Federal Contract Provisions for Subcontracts**

All subcontracts shall be in writing and contain all pertinent provisions and requirements of the prime contract.

Each “Request for Permission to Subcontract” (Mississippi Department of Transportation Form CAD-720) shall include a copy of the subcontract. The federal contract provisions (FHWA-1273, SUPPLEMENT TO FORM FHWA-1273, NOTICE OF REQUIREMENT FOR AFFIRMATIVE ACTION TO ENSURE EQUAL EMPLOYMENT OPPORTUNITY (EXECUTIVE ORDER 11246), DAVIS-BACON AND RELATED ACT PROVISIONS (WAGE RATES)) must be physically incorporated as part of the subcontract. A completed Mississippi Department of Transportation Form CAD-521 and Form CAD-725 must be attached to the CAD-720.

**Cargo Preference Act**

The Contractor is hereby advised of the requirements set forth in the following Attachment (Title 46 - Shipping) as it pertains to the implementation of Cargo Preference Act (CPA) requirements in the Federal-aid Highway Program.

By signing this contract, the Contractor agrees to conform to the requirements of the CPA.

## Attachment

### Title 46- Shipping

Volume: 8

Date: 2014-10-01

Original Date: 2014-10-01

Title: Section 381.7 - Federal Grant, Guaranty, Loan and Advance at Funds Agreements.

Context: Title 46- Shipping. CHAPTER II- MARITIME ADMINISTRATION, DEPARTMENT OF TRANSPORTATION. SUBCHAPTER J - MISCELLANEOUS. PART 381 - CARGO PREFERENCE-U.S.-FLAG VESSELS.

#### § 381.7 Federal Grant, Guaranty, Loan and Advance of Funds Agreements.

In order to insure a fair and reasonable participation by privately owned United States-flag commercial vessels in transporting cargoes which are subject to the Cargo Preference Act of 1954 and which are generated by U.S. Government Grant, Guaranty, Loan and/or Advance of Funds Programs, the head of each affected department or agency shall require appropriate clauses to be inserted in those Grant, Guaranty, Loan and/or Advance of Funds Agreements and all third party contracts executed between the borrower/grantee and other parties, where the possibility exists for ocean transportation of items procured, contracted for or otherwise obtained by or on behalf of the grantee, borrower, or any of their contractors or subcontractors. The clauses required by this part shall provide that at least 50 percent of the freight revenue and tonnage of cargo generated by the U.S. Government Grant, Guaranty, Loan or Advance of Funds be transported on privately owned United States-flag commercial vessels. These clauses shall also require that all parties provide to the Maritime Administration the necessary shipment information as set forth in § 381.3. A copy of the appropriate clauses required by this part shall be submitted by each affected agency or department to the Secretary, Maritime Administration, for approval no later than 30 days after the effective date of this part. The following are suggested acceptable clauses with respect to the use of United States-flag vessels to be incorporated in the Grant, Guaranty, Loan and/or Advance of Funds Agreements as well as contracts and subcontracts resulting therefrom:

(a) *Agreement Clauses.* "Use of United States-flag vessels:

"(1) Pursuant to Pub. L 664 (43 U.S.C. 1241(b)) at least 50 percent of any equipment, materials or commodities procured, contracted for or otherwise obtained with funds granted, guaranteed, loaned, or advanced by the U.S. Government under this agreement, and which may be transported by ocean vessel, shall be transported on privately owned United States-flag commercial vessels, if available.

"(2) Within 20 days following the date of loading for shipments originating within the United States or within 30 working days following the date of loading for shipments originating outside the United States, a legible copy of a rated, 'on-board' commercial ocean bill-of-lading in English for each shipment of cargo described in paragraph (a)(1) of this section shall be furnished to both the Contracting Officer (through the prime contractor in the case of subcontractor bills-of-lading) and to the Division of National Cargo, Office of Market Development, Maritime Administration, Washington, DC 20590."

(b) *Contractor and Subcontractor Clauses.* "Use of United States-flag vessels: The contractor agrees --

"(1) To utilize privately owned United States-flag commercial vessels to ship at least 50 percent of the gross tonnage (computed separately for dry bulk carriers, dry cargo liners, and tankers) involved, whenever shipping any equipment, material, or commodities pursuant to this contract, to the extent such vessels are available at fair and reasonable rates for United States-flag commercial vessels.

"(2) To furnish within 20 days following the date of loading for shipments originating within the United

States or within 30 working days following the date of loading for shipments originating outside the United States, a legible copy of a rated, 'on-board' commercial ocean bill-of-lading in English for each shipment of cargo described in paragraph (b) (1) of this section to both the Contracting Officer (through the prime contractor in the case of subcontractor bills-of-lading) and to the Division of National Cargo, Office of Market Development, Maritime Administration, Washington, DC 20590.

"(3) To insert the substance of the provisions of this clause in all subcontracts issued pursuant to this contract."

(Reorganization Plans No.21 of 1950(64 Stat. 1273) and No. 7 of 1961 (75 Stat. 840) as amended by Pub. L 91.469 (84 Stat 1036) and Department of Commerce Organization Order 10-8 (38 FR 19707, July 23, 1973)) (42 FR 57126, Nov. 1, 1977]

**ATTACHMENT A - EMPLOYMENT AND MATERIALS PREFERENCE FOR  
APPALACHIAN DEVELOPMENT HIGHWAY SYSTEM OR  
APPALACHIAN LOCAL ACCESS ROAD CONTRACTS**

This provision is applicable to all Federal-aid projects funded under the Appalachian Regional Development Act of 1965.

1. During the performance of this contract, the contractor undertaking to do work which is, or reasonably may be, done as on-site work, shall give preference to qualified persons who regularly reside in the labor area as designated by the DOL wherein the contract work is situated, or the subregion, or the Appalachian counties of the State wherein the contract work is situated, except:

a. To the extent that qualified persons regularly residing in the area are not available.

b. For the reasonable needs of the contractor to employ supervisory or specially experienced personnel necessary to assure an efficient execution of the contract work.

c. For the obligation of the contractor to offer employment to present or former employees as the result of a lawful collective bargaining contract, provided that the number of nonresident persons employed under this subparagraph (1c) shall not exceed 20 percent of the total number of employees employed by the contractor on the contract work, except as provided in subparagraph (4) below.

2. The contractor shall place a job order with the State Employment Service indicating (a) the classifications of the laborers, mechanics and other employees required to perform the contract work, (b) the number of employees required in each classification, (c) the date on which the participant estimates such employees will be required, and (d) any other pertinent information required by the State Employment Service to complete the job order form. The job order may be placed with the State Employment Service in writing or by telephone. If during the course of the contract work, the information submitted by the contractor in the original job order is substantially modified, the participant shall promptly notify the State Employment Service.

3. The contractor shall give full consideration to all qualified job applicants referred to him by the State Employment Service. The contractor is not required to grant employment to any job applicants who, in his opinion, are not qualified to perform the classification of work required.

4. If, within one week following the placing of a job order by the contractor with the State Employment Service, the State Employment Service is unable to refer any qualified job applicants to the contractor, or less than the number requested, the State Employment Service will forward a certificate to the contractor indicating the unavailability of applicants. Such certificate shall be made a part of the contractor's permanent project records. Upon receipt of this certificate, the contractor may employ persons who do not normally reside in the labor area to fill positions covered by the certificate, notwithstanding the provisions of subparagraph (1c) above.

5. The provisions of 23 CFR 633.207(e) allow the contracting agency to provide a contractual preference for the use of mineral resource materials native to the Appalachian region.

6. The contractor shall include the provisions of Sections 1 through 4 of this Attachment A in every subcontract for work which is, or reasonably may be, done as on-site work.

**REQUIRED CONTRACT PROVISIONS  
FEDERAL-AID CONSTRUCTION CONTRACTS**

---

- I. General
- II. Nondiscrimination
- III. Nonsegregated Facilities
- IV. Davis-Bacon and Related Act Provisions
- V. Contract Work Hours and Safety Standards Act Provisions
- VI. Subletting or Assigning the Contract
- VII. Safety: Accident Prevention
- VIII. False Statements Concerning Highway Projects
- IX. Implementation of Clean Air Act and Federal Water Pollution Control Act
- X. Compliance with Governmentwide Suspension and Debarment Requirements
- XI. Certification Regarding Use of Contract Funds for Lobbying

3. A breach of any of the stipulations contained in these Required Contract Provisions may be sufficient grounds for withholding of progress payments, withholding of final payment, termination of the contract, suspension / debarment or any other action determined to be appropriate by the contracting agency and FHWA.

4. Selection of Labor: During the performance of this contract, the contractor shall not use convict labor for any purpose within the limits of a construction project on a Federal-aid highway unless it is labor performed by convicts who are on parole, supervised release, or probation. The term Federal-aid highway does not include roadways functionally classified as local roads or rural minor collectors.

#### ATTACHMENTS

A. Employment and Materials Preference for Appalachian Development Highway System or Appalachian Local Access Road Contracts (included in Appalachian contracts only)

#### I. GENERAL

1. Form FHWA-1273 must be physically incorporated in each construction contract funded under Title 23 (excluding emergency contracts solely intended for debris removal). The contractor (or subcontractor) must insert this form in each subcontract and further require its inclusion in all lower tier subcontracts (excluding purchase orders, rental agreements and other agreements for supplies or services).

The applicable requirements of Form FHWA-1273 are incorporated by reference for work done under any purchase order, rental agreement or agreement for other services. The prime contractor shall be responsible for compliance by any subcontractor, lower-tier subcontractor or service provider.

Form FHWA-1273 must be included in all Federal-aid design-build contracts, in all subcontracts and in lower tier subcontracts (excluding subcontracts for design services, purchase orders, rental agreements and other agreements for supplies or services). The design-builder shall be responsible for compliance by any subcontractor, lower-tier subcontractor or service provider.

Contracting agencies may reference Form FHWA-1273 in bid proposal or request for proposal documents, however, the Form FHWA-1273 must be physically incorporated (not referenced) in all contracts, subcontracts and lower-tier subcontracts (excluding purchase orders, rental agreements and other agreements for supplies or services related to a construction contract).

2. Subject to the applicability criteria noted in the following sections, these contract provisions shall apply to all work performed on the contract by the contractor's own organization and with the assistance of workers under the contractor's immediate superintendence and to all work performed on the contract by piecework, station work, or by subcontract.

#### II. NONDISCRIMINATION

The provisions of this section related to 23 CFR Part 230 are applicable to all Federal-aid construction contracts and to all related construction subcontracts of \$10,000 or more. The provisions of 23 CFR Part 230 are not applicable to material supply, engineering, or architectural service contracts.

In addition, the contractor and all subcontractors must comply with the following policies: Executive Order 11246, 41 CFR 60, 29 CFR 1625-1627, Title 23 USC Section 140, the Rehabilitation Act of 1973, as amended (29 USC 794), Title VI of the Civil Rights Act of 1964, as amended, and related regulations including 49 CFR Parts 21, 26 and 27; and 23 CFR Parts 200, 230, and 633.

The contractor and all subcontractors must comply with: the requirements of the Equal Opportunity Clause in 41 CFR 60-1.4(b) and, for all construction contracts exceeding \$10,000, the Standard Federal Equal Employment Opportunity Construction Contract Specifications in 41 CFR 60-4.3.

Note: The U.S. Department of Labor has exclusive authority to determine compliance with Executive Order 11246 and the policies of the Secretary of Labor including 41 CFR 60, and 29 CFR 1625-1627. The contracting agency and the FHWA have the authority and the responsibility to ensure compliance with Title 23 USC Section 140, the Rehabilitation Act of 1973, as amended (29 USC 794), and Title VI of the Civil Rights Act of 1964, as amended, and related regulations including 49 CFR Parts 21, 26 and 27; and 23 CFR Parts 200, 230, and 633.

The following provision is adopted from 23 CFR 230, Appendix A, with appropriate revisions to conform to the U.S. Department of Labor (US DOL) and FHWA requirements.

**1. Equal Employment Opportunity:** Equal employment opportunity (EEO) requirements not to discriminate and to take affirmative action to assure equal opportunity as set forth under laws, executive orders, rules, regulations (28 CFR 35, 29 CFR 1630, 29 CFR 1625-1627, 41 CFR 60 and 49 CFR 27) and orders of the Secretary of Labor as modified by the provisions prescribed herein, and imposed pursuant to 23 U.S.C. 140 shall constitute the EEO and specific affirmative action standards for the contractor's project activities under

this contract. The provisions of the Americans with Disabilities Act of 1990 (42 U.S.C. 12101 et seq.) set forth under 28 CFR 35 and 29 CFR 1630 are incorporated by reference in this contract. In the execution of this contract, the contractor agrees to comply with the following minimum specific requirement activities of EEO:

a. The contractor will work with the contracting agency and the Federal Government to ensure that it has made every good faith effort to provide equal opportunity with respect to all of its terms and conditions of employment and in their review of activities under the contract.

b. The contractor will accept as its operating policy the following statement:

"It is the policy of this Company to assure that applicants are employed, and that employees are treated during employment, without regard to their race, religion, sex, color, national origin, age or disability. Such action shall include: employment, upgrading, demotion, or transfer; recruitment or recruitment advertising; layoff or termination; rates of pay or other forms of compensation; and selection for training, including apprenticeship, pre-apprenticeship, and/or on-the-job training."

**2. EEO Officer:** The contractor will designate and make known to the contracting officers an EEO Officer who will have the responsibility for and must be capable of effectively administering and promoting an active EEO program and who must be assigned adequate authority and responsibility to do so.

**3. Dissemination of Policy:** All members of the contractor's staff who are authorized to hire, supervise, promote, and discharge employees, or who recommend such action, or who are substantially involved in such action, will be made fully cognizant of, and will implement, the contractor's EEO policy and contractual responsibilities to provide EEO in each grade and classification of employment. To ensure that the above agreement will be met, the following actions will be taken as a minimum:

a. Periodic meetings of supervisory and personnel office employees will be conducted before the start of work and then not less often than once every six months, at which time the contractor's EEO policy and its implementation will be reviewed and explained. The meetings will be conducted by the EEO Officer.

b. All new supervisory or personnel office employees will be given a thorough indoctrination by the EEO Officer, covering all major aspects of the contractor's EEO obligations within thirty days following their reporting for duty with the contractor.

c. All personnel who are engaged in direct recruitment for the project will be instructed by the EEO Officer in the contractor's procedures for locating and hiring minorities and women.

d. Notices and posters setting forth the contractor's EEO policy will be placed in areas readily accessible to employees, applicants for employment and potential employees.

e. The contractor's EEO policy and the procedures to implement such policy will be brought to the attention of employees by means of meetings, employee handbooks, or other appropriate means.

**4. Recruitment:** When advertising for employees, the contractor will include in all advertisements for employees the notation: "An Equal Opportunity Employer." All such advertisements will be placed in publications having a large circulation among minorities and women in the area from which the project work force would normally be derived.

a. The contractor will, unless precluded by a valid bargaining agreement, conduct systematic and direct recruitment through public and private employee referral sources likely to yield qualified minorities and women. To meet this requirement, the contractor will identify sources of potential minority group employees, and establish with such identified sources procedures whereby minority and women applicants may be referred to the contractor for employment consideration.

b. In the event the contractor has a valid bargaining agreement providing for exclusive hiring hall referrals, the contractor is expected to observe the provisions of that agreement to the extent that the system meets the contractor's compliance with EEO contract provisions. Where implementation of such an agreement has the effect of discriminating against minorities or women, or obligates the contractor to do the same, such implementation violates Federal nondiscrimination provisions.

c. The contractor will encourage its present employees to refer minorities and women as applicants for employment. Information and procedures with regard to referring such applicants will be discussed with employees.

**5. Personnel Actions:** Wages, working conditions, and employee benefits shall be established and administered, and personnel actions of every type, including hiring, upgrading, promotion, transfer, demotion, layoff, and termination, shall be taken without regard to race, color, religion, sex, national origin, age or disability. The following procedures shall be followed:

a. The contractor will conduct periodic inspections of project sites to insure that working conditions and employee facilities do not indicate discriminatory treatment of project site personnel.

b. The contractor will periodically evaluate the spread of wages paid within each classification to determine any evidence of discriminatory wage practices.

c. The contractor will periodically review selected personnel actions in depth to determine whether there is evidence of discrimination. Where evidence is found, the contractor will promptly take corrective action. If the review indicates that the discrimination may extend beyond the actions reviewed, such corrective action shall include all affected persons.

d. The contractor will promptly investigate all complaints of alleged discrimination made to the contractor in connection with its obligations under this contract, will attempt to resolve such complaints, and will take appropriate corrective action within a reasonable time. If the investigation indicates that the discrimination may affect persons other than the complainant, such corrective action shall include such other persons. Upon completion of each investigation, the contractor will inform every complainant of all of their avenues of appeal.

**6. Training and Promotion:**

a. The contractor will assist in locating, qualifying, and increasing the skills of minorities and women who are

applicants for employment or current employees. Such efforts should be aimed at developing full journey level status employees in the type of trade or job classification involved.

b. Consistent with the contractor's work force requirements and as permissible under Federal and State regulations, the contractor shall make full use of training programs, i.e., apprenticeship, and on-the-job training programs for the geographical area of contract performance. In the event a special provision for training is provided under this contract, this subparagraph will be superseded as indicated in the special provision. The contracting agency may reserve training positions for persons who receive welfare assistance in accordance with 23 U.S.C. 140(a).

c. The contractor will advise employees and applicants for employment of available training programs and entrance requirements for each.

d. The contractor will periodically review the training and promotion potential of employees who are minorities and women and will encourage eligible employees to apply for such training and promotion.

**7. Unions:** If the contractor relies in whole or in part upon unions as a source of employees, the contractor will use good faith efforts to obtain the cooperation of such unions to increase opportunities for minorities and women. Actions by the contractor, either directly or through a contractor's association acting as agent, will include the procedures set forth below:

a. The contractor will use good faith efforts to develop, in cooperation with the unions, joint training programs aimed toward qualifying more minorities and women for membership in the unions and increasing the skills of minorities and women so that they may qualify for higher paying employment.

b. The contractor will use good faith efforts to incorporate an EEO clause into each union agreement to the end that such union will be contractually bound to refer applicants without regard to their race, color, religion, sex, national origin, age or disability.

c. The contractor is to obtain information as to the referral practices and policies of the labor union except that to the extent such information is within the exclusive possession of the labor union and such labor union refuses to furnish such information to the contractor, the contractor shall so certify to the contracting agency and shall set forth what efforts have been made to obtain such information.

d. In the event the union is unable to provide the contractor with a reasonable flow of referrals within the time limit set forth in the collective bargaining agreement, the contractor will, through independent recruitment efforts, fill the employment vacancies without regard to race, color, religion, sex, national origin, age or disability; making full efforts to obtain qualified and/or qualifiable minorities and women. The failure of a union to provide sufficient referrals (even though it is obligated to provide exclusive referrals under the terms of a collective bargaining agreement) does not relieve the contractor from the requirements of this paragraph. In the event the union referral practice prevents the contractor from meeting the obligations pursuant to Executive Order 11246, as amended, and these special provisions, such contractor shall immediately notify the contracting agency.

**8. Reasonable Accommodation for Applicants / Employees with Disabilities:** The contractor must be familiar

with the requirements for and comply with the Americans with Disabilities Act and all rules and regulations established there under. Employers must provide reasonable accommodation in all employment activities unless to do so would cause an undue hardship.

**9. Selection of Subcontractors, Procurement of Materials and Leasing of Equipment:** The contractor shall not discriminate on the grounds of race, color, religion, sex, national origin, age or disability in the selection and retention of subcontractors, including procurement of materials and leases of equipment. The contractor shall take all necessary and reasonable steps to ensure nondiscrimination in the administration of this contract.

a. The contractor shall notify all potential subcontractors and suppliers and lessors of their EEO obligations under this contract.

b. The contractor will use good faith efforts to ensure subcontractor compliance with their EEO obligations.

**10. Assurance Required by 49 CFR 26.13(b):**

a. The requirements of 49 CFR Part 26 and the State DOT's U.S. DOT-approved DBE program are incorporated by reference.

b. The contractor or subcontractor shall not discriminate on the basis of race, color, national origin, or sex in the performance of this contract. The contractor shall carry out applicable requirements of 49 CFR Part 26 in the award and administration of DOT-assisted contracts. Failure by the contractor to carry out these requirements is a material breach of this contract, which may result in the termination of this contract or such other remedy as the contracting agency deems appropriate.

**11. Records and Reports:** The contractor shall keep such records as necessary to document compliance with the EEO requirements. Such records shall be retained for a period of three years following the date of the final payment to the contractor for all contract work and shall be available at reasonable times and places for inspection by authorized representatives of the contracting agency and the FHWA.

a. The records kept by the contractor shall document the following:

(1) The number and work hours of minority and non-minority group members and women employed in each work classification on the project;

(2) The progress and efforts being made in cooperation with unions, when applicable, to increase employment opportunities for minorities and women; and

(3) The progress and efforts being made in locating, hiring, training, qualifying, and upgrading minorities and women;

b. The contractors and subcontractors will submit an annual report to the contracting agency each July for the duration of the project, indicating the number of minority, women, and non-minority group employees currently engaged in each work classification required by the contract work. This information is to be reported on [Form FHWA-1391](#). The staffing data should represent the project work force on board in all or any part of the last payroll period preceding the end of July. If on-the-job training is being required by special provision, the contractor



will be required to collect and report training data. The employment data should reflect the work force on board during all or any part of the last payroll period preceding the end of July.

### III. NONSEGREGATED FACILITIES

This provision is applicable to all Federal-aid construction contracts and to all related construction subcontracts of \$10,000 or more.

The contractor must ensure that facilities provided for employees are provided in such a manner that segregation on the basis of race, color, religion, sex, or national origin cannot result. The contractor may neither require such segregated use by written or oral policies nor tolerate such use by employee custom. The contractor's obligation extends further to ensure that its employees are not assigned to perform their services at any location, under the contractor's control, where the facilities are segregated. The term "facilities" includes waiting rooms, work areas, restaurants and other eating areas, time clocks, restrooms, washrooms, locker rooms, and other storage or dressing areas, parking lots, drinking fountains, recreation or entertainment areas, transportation, and housing provided for employees. The contractor shall provide separate or single-user restrooms and necessary dressing or sleeping areas to assure privacy between sexes.

### IV. DAVIS-BACON AND RELATED ACT PROVISIONS

This section is applicable to all Federal-aid construction projects exceeding \$2,000 and to all related subcontracts and lower-tier subcontracts (regardless of subcontract size). The requirements apply to all projects located within the right-of-way of a roadway that is functionally classified as Federal-aid highway. This excludes roadways functionally classified as local roads or rural minor collectors, which are exempt. Contracting agencies may elect to apply these requirements to other projects.

The following provisions are from the U.S. Department of Labor regulations in 29 CFR 5.5 "Contract provisions and related matters" with minor revisions to conform to the FHWA-1273 format and FHWA program requirements.

#### 1. Minimum wages

a. All laborers and mechanics employed or working upon the site of the work, will be paid unconditionally and not less often than once a week, and without subsequent deduction or rebate on any account (except such payroll deductions as are permitted by regulations issued by the Secretary of Labor under the Copeland Act (29 CFR part 3)), the full amount of wages and bona fide fringe benefits (or cash equivalents thereof) due at time of payment computed at rates not less than those contained in the wage determination of the Secretary of Labor which is attached hereto and made a part hereof, regardless of any contractual relationship which may be alleged to exist between the contractor and such laborers and mechanics.

Contributions made or costs reasonably anticipated for bona fide fringe benefits under section 1(b)(2) of the Davis-Bacon Act on behalf of laborers or mechanics are considered wages

paid to such laborers or mechanics, subject to the provisions of paragraph 1.d. of this section; also, regular contributions made or costs incurred for more than a weekly period (but not less often than quarterly) under plans, funds, or programs which cover the particular weekly period, are deemed to be constructively made or incurred during such weekly period. Such laborers and mechanics shall be paid the appropriate wage rate and fringe benefits on the wage determination for the classification of work actually performed, without regard to skill, except as provided in 29 CFR 5.5(a)(4). Laborers or mechanics performing work in more than one classification may be compensated at the rate specified for each classification for the time actually worked therein: Provided, That the employer's payroll records accurately set forth the time spent in each classification in which work is performed. The wage determination (including any additional classification and wage rates conformed under paragraph 1.b. of this section) and the Davis-Bacon poster (WH-1321) shall be posted at all times by the contractor and its subcontractors at the site of the work in a prominent and accessible place where it can be easily seen by the workers.

b. (1) The contracting officer shall require that any class of laborers or mechanics, including helpers, which is not listed in the wage determination and which is to be employed under the contract shall be classified in conformance with the wage determination. The contracting officer shall approve an additional classification and wage rate and fringe benefits therefore only when the following criteria have been met:

(i) The work to be performed by the classification requested is not performed by a classification in the wage determination; and

(ii) The classification is utilized in the area by the construction industry; and

(iii) The proposed wage rate, including any bona fide fringe benefits, bears a reasonable relationship to the wage rates contained in the wage determination.

(2) If the contractor and the laborers and mechanics to be employed in the classification (if known), or their representatives, and the contracting officer agree on the classification and wage rate (including the amount designated for fringe benefits where appropriate), a report of the action taken shall be sent by the contracting officer to the Administrator of the Wage and Hour Division, Employment Standards Administration, U.S. Department of Labor, Washington, DC 20210. The Administrator, or an authorized representative, will approve, modify, or disapprove every additional classification action within 30 days of receipt and so advise the contracting officer or will notify the contracting officer within the 30-day period that additional time is necessary.

(3) In the event the contractor, the laborers or mechanics to be employed in the classification or their representatives, and the contracting officer do not agree on the proposed classification and wage rate (including the amount designated for fringe benefits, where appropriate), the contracting officer shall refer the questions, including the views of all interested parties and the recommendation of the contracting officer, to the Wage and Hour Administrator for determination. The Wage and Hour Administrator, or an authorized representative, will issue a determination within 30 days of receipt and so advise

the contracting officer or will notify the contracting officer within the 30-day period that additional time is necessary.

(4) The wage rate (including fringe benefits where appropriate) determined pursuant to paragraphs 1.b.(2) or 1.b.(3) of this section, shall be paid to all workers performing work in the classification under this contract from the first day on which work is performed in the classification.

c. Whenever the minimum wage rate prescribed in the contract for a class of laborers or mechanics includes a fringe benefit which is not expressed as an hourly rate, the contractor shall either pay the benefit as stated in the wage determination or shall pay another bona fide fringe benefit or an hourly cash equivalent thereof.

d. If the contractor does not make payments to a trustee or other third person, the contractor may consider as part of the wages of any laborer or mechanic the amount of any costs reasonably anticipated in providing bona fide fringe benefits under a plan or program, Provided, That the Secretary of Labor has found, upon the written request of the contractor, that the applicable standards of the Davis-Bacon Act have been met. The Secretary of Labor may require the contractor to set aside in a separate account assets for the meeting of obligations under the plan or program.

## 2. Withholding

The contracting agency shall upon its own action or upon written request of an authorized representative of the Department of Labor, withhold or cause to be withheld from the contractor under this contract, or any other Federal contract with the same prime contractor, or any other federally-assisted contract subject to Davis-Bacon prevailing wage requirements, which is held by the same prime contractor, so much of the accrued payments or advances as may be considered necessary to pay laborers and mechanics, including apprentices, trainees, and helpers, employed by the contractor or any subcontractor the full amount of wages required by the contract. In the event of failure to pay any laborer or mechanic, including any apprentice, trainee, or helper, employed or working on the site of the work, all or part of the wages required by the contract, the contracting agency may, after written notice to the contractor, take such action as may be necessary to cause the suspension of any further payment, advance, or guarantee of funds until such violations have ceased.

## 3. Payrolls and basic records

a. Payrolls and basic records relating thereto shall be maintained by the contractor during the course of the work and preserved for a period of three years thereafter for all laborers and mechanics working at the site of the work. Such records shall contain the name, address, and social security number of each such worker, his or her correct classification, hourly rates of wages paid (including rates of contributions or costs anticipated for bona fide fringe benefits or cash equivalents thereof of the types described in section 1(b)(2)(B) of the Davis-Bacon Act), daily and weekly number of hours worked, deductions made and actual wages paid. Whenever the Secretary of Labor has found under 29 CFR 5.5(a)(1)(iv) that the wages of any laborer or mechanic include the amount of any costs reasonably anticipated in providing benefits under a plan or program described in section 1(b)(2)(B) of the Davis-

Bacon Act, the contractor shall maintain records which show that the commitment to provide such benefits is enforceable, that the plan or program is financially responsible, and that the plan or program has been communicated in writing to the laborers or mechanics affected, and records which show the costs anticipated or the actual cost incurred in providing such benefits. Contractors employing apprentices or trainees under approved programs shall maintain written evidence of the registration of apprenticeship programs and certification of trainee programs, the registration of the apprentices and trainees, and the ratios and wage rates prescribed in the applicable programs.

b. (1) The contractor shall submit weekly for each week in which any contract work is performed a copy of all payrolls to the contracting agency. The payrolls submitted shall set out accurately and completely all of the information required to be maintained under 29 CFR 5.5(a)(3)(i), except that full social security numbers and home addresses shall not be included on weekly transmittals. Instead the payrolls shall only need to include an individually identifying number for each employee (e.g., the last four digits of the employee's social security number). The required weekly payroll information may be submitted in any form desired. Optional Form WH-347 is available for this purpose from the Wage and Hour Division Web site at <http://www.dol.gov/esa/whd/forms/wh347instr.htm> or its successor site. The prime contractor is responsible for the submission of copies of payrolls by all subcontractors. Contractors and subcontractors shall maintain the full social security number and current address of each covered worker, and shall provide them upon request to the contracting agency for transmission to the State DOT, the FHWA or the Wage and Hour Division of the Department of Labor for purposes of an investigation or audit of compliance with prevailing wage requirements. It is not a violation of this section for a prime contractor to require a subcontractor to provide addresses and social security numbers to the prime contractor for its own records, without weekly submission to the contracting agency..

(2) Each payroll submitted shall be accompanied by a "Statement of Compliance," signed by the contractor or subcontractor or his or her agent who pays or supervises the payment of the persons employed under the contract and shall certify the following:

(i) That the payroll for the payroll period contains the information required to be provided under §5.5 (a)(3)(ii) of Regulations, 29 CFR part 5, the appropriate information is being maintained under §5.5 (a)(3)(i) of Regulations, 29 CFR part 5, and that such information is correct and complete;

(ii) That each laborer or mechanic (including each helper, apprentice, and trainee) employed on the contract during the payroll period has been paid the full weekly wages earned, without rebate, either directly or indirectly, and that no deductions have been made either directly or indirectly from the full wages earned, other than permissible deductions as set forth in Regulations, 29 CFR part 3;

(iii) That each laborer or mechanic has been paid not less than the applicable wage rates and fringe benefits or cash equivalents for the classification of work performed, as specified in the applicable wage determination incorporated into the contract.

(3) The weekly submission of a properly executed certification set forth on the reverse side of Optional Form WH-347 shall satisfy the requirement for submission of the "Statement of Compliance" required by paragraph 3.b.(2) of this section.

(4) The falsification of any of the above certifications may subject the contractor or subcontractor to civil or criminal prosecution under section 1001 of title 18 and section 231 of title 31 of the United States Code.

c. The contractor or subcontractor shall make the records required under paragraph 3.a. of this section available for inspection, copying, or transcription by authorized representatives of the contracting agency, the State DOT, the FHWA, or the Department of Labor, and shall permit such representatives to interview employees during working hours on the job. If the contractor or subcontractor fails to submit the required records or to make them available, the FHWA may, after written notice to the contractor, the contracting agency or the State DOT, take such action as may be necessary to cause the suspension of any further payment, advance, or guarantee of funds. Furthermore, failure to submit the required records upon request or to make such records available may be grounds for debarment action pursuant to 29 CFR 5.12.

#### 4. Apprentices and trainees

##### a. Apprentices (programs of the USDOL).

Apprentices will be permitted to work at less than the predetermined rate for the work they performed when they are employed pursuant to and individually registered in a bona fide apprenticeship program registered with the U.S. Department of Labor, Employment and Training Administration, Office of Apprenticeship Training, Employer and Labor Services, or with a State Apprenticeship Agency recognized by the Office, or if a person is employed in his or her first 90 days of probationary employment as an apprentice in such an apprenticeship program, who is not individually registered in the program, but who has been certified by the Office of Apprenticeship Training, Employer and Labor Services or a State Apprenticeship Agency (where appropriate) to be eligible for probationary employment as an apprentice.

The allowable ratio of apprentices to journeymen on the job site in any craft classification shall not be greater than the ratio permitted to the contractor as to the entire work force under the registered program. Any worker listed on a payroll at an apprentice wage rate, who is not registered or otherwise employed as stated above, shall be paid not less than the applicable wage rate on the wage determination for the classification of work actually performed. In addition, any apprentice performing work on the job site in excess of the ratio permitted under the registered program shall be paid not less than the applicable wage rate on the wage determination for the work actually performed. Where a contractor is performing construction on a project in a locality other than that in which its program is registered, the ratios and wage rates (expressed in percentages of the journeyman's hourly rate) specified in the contractor's or subcontractor's registered program shall be observed.

Every apprentice must be paid at not less than the rate specified in the registered program for the apprentice's level of progress, expressed as a percentage of the journeymen hourly

rate specified in the applicable wage determination. Apprentices shall be paid fringe benefits in accordance with the provisions of the apprenticeship program. If the apprenticeship program does not specify fringe benefits, apprentices must be paid the full amount of fringe benefits listed on the wage determination for the applicable classification. If the Administrator determines that a different practice prevails for the applicable apprentice classification, fringes shall be paid in accordance with that determination.

In the event the Office of Apprenticeship Training, Employer and Labor Services, or a State Apprenticeship Agency recognized by the Office, withdraws approval of an apprenticeship program, the contractor will no longer be permitted to utilize apprentices at less than the applicable predetermined rate for the work performed until an acceptable program is approved.

##### b. Trainees (programs of the USDOL).

Except as provided in 29 CFR 5.16, trainees will not be permitted to work at less than the predetermined rate for the work performed unless they are employed pursuant to and individually registered in a program which has received prior approval, evidenced by formal certification by the U.S. Department of Labor, Employment and Training Administration.

The ratio of trainees to journeymen on the job site shall not be greater than permitted under the plan approved by the Employment and Training Administration.

Every trainee must be paid at not less than the rate specified in the approved program for the trainee's level of progress, expressed as a percentage of the journeyman hourly rate specified in the applicable wage determination. Trainees shall be paid fringe benefits in accordance with the provisions of the trainee program. If the trainee program does not mention fringe benefits, trainees shall be paid the full amount of fringe benefits listed on the wage determination unless the Administrator of the Wage and Hour Division determines that there is an apprenticeship program associated with the corresponding journeyman wage rate on the wage determination which provides for less than full fringe benefits for apprentices. Any employee listed on the payroll at a trainee rate who is not registered and participating in a training plan approved by the Employment and Training Administration shall be paid not less than the applicable wage rate on the wage determination for the classification of work actually performed. In addition, any trainee performing work on the job site in excess of the ratio permitted under the registered program shall be paid not less than the applicable wage rate on the wage determination for the work actually performed.

In the event the Employment and Training Administration withdraws approval of a training program, the contractor will no longer be permitted to utilize trainees at less than the applicable predetermined rate for the work performed until an acceptable program is approved.

c. Equal employment opportunity. The utilization of apprentices, trainees and journeymen under this part shall be in conformity with the equal employment opportunity requirements of Executive Order 11246, as amended, and 29 CFR part 30.

d. Apprentices and Trainees (programs of the U.S. DOT).

Apprentices and trainees working under apprenticeship and skill training programs which have been certified by the Secretary of Transportation as promoting EEO in connection with Federal-aid highway construction programs are not subject to the requirements of paragraph 4 of this Section IV. The straight time hourly wage rates for apprentices and trainees under such programs will be established by the particular programs. The ratio of apprentices and trainees to journeymen shall not be greater than permitted by the terms of the particular program.

**5. Compliance with Copeland Act requirements.** The contractor shall comply with the requirements of 29 CFR part 3, which are incorporated by reference in this contract.

**6. Subcontracts.** The contractor or subcontractor shall insert Form FHWA-1273 in any subcontracts and also require the subcontractors to include Form FHWA-1273 in any lower tier subcontracts. The prime contractor shall be responsible for the compliance by any subcontractor or lower tier subcontractor with all the contract clauses in 29 CFR 5.5.

**7. Contract termination: debarment.** A breach of the contract clauses in 29 CFR 5.5 may be grounds for termination of the contract, and for debarment as a contractor and a subcontractor as provided in 29 CFR 5.12.

**8. Compliance with Davis-Bacon and Related Act requirements.** All rulings and interpretations of the Davis-Bacon and Related Acts contained in 29 CFR parts 1, 3, and 5 are herein incorporated by reference in this contract.

**9. Disputes concerning labor standards.** Disputes arising out of the labor standards provisions of this contract shall not be subject to the general disputes clause of this contract. Such disputes shall be resolved in accordance with the procedures of the Department of Labor set forth in 29 CFR parts 5, 6, and 7. Disputes within the meaning of this clause include disputes between the contractor (or any of its subcontractors) and the contracting agency, the U.S. Department of Labor, or the employees or their representatives.

**10. Certification of eligibility.**

a. By entering into this contract, the contractor certifies that neither it (nor he or she) nor any person or firm who has an interest in the contractor's firm is a person or firm ineligible to be awarded Government contracts by virtue of section 3(a) of the Davis-Bacon Act or 29 CFR 5.12(a)(1).

b. No part of this contract shall be subcontracted to any person or firm ineligible for award of a Government contract by virtue of section 3(a) of the Davis-Bacon Act or 29 CFR 5.12(a)(1).

c. The penalty for making false statements is prescribed in the U.S. Criminal Code, 18 U.S.C. 1001.

**V. CONTRACT WORK HOURS AND SAFETY STANDARDS ACT**

The following clauses apply to any Federal-aid construction contract in an amount in excess of \$100,000 and subject to the overtime provisions of the Contract Work Hours and Safety Standards Act. These clauses shall be inserted in addition to the clauses required by 29 CFR 5.5(a) or 29 CFR 4.6. As used in this paragraph, the terms laborers and mechanics include watchmen and guards.

**1. Overtime requirements.** No contractor or subcontractor contracting for any part of the contract work which may require or involve the employment of laborers or mechanics shall require or permit any such laborer or mechanic in any workweek in which he or she is employed on such work to work in excess of forty hours in such workweek unless such laborer or mechanic receives compensation at a rate not less than one and one-half times the basic rate of pay for all hours worked in excess of forty hours in such workweek.

**2. Violation; liability for unpaid wages; liquidated damages.** In the event of any violation of the clause set forth in paragraph (1.) of this section, the contractor and any subcontractor responsible therefor shall be liable for the unpaid wages. In addition, such contractor and subcontractor shall be liable to the United States (in the case of work done under contract for the District of Columbia or a territory, to such District or to such territory), for liquidated damages. Such liquidated damages shall be computed with respect to each individual laborer or mechanic, including watchmen and guards, employed in violation of the clause set forth in paragraph (1.) of this section, in the sum of \$10 for each calendar day on which such individual was required or permitted to work in excess of the standard workweek of forty hours without payment of the overtime wages required by the clause set forth in paragraph (1.) of this section.

**3. Withholding for unpaid wages and liquidated damages.** The FHWA or the contacting agency shall upon its own action or upon written request of an authorized representative of the Department of Labor withhold or cause to be withheld, from any moneys payable on account of work performed by the contractor or subcontractor under any such contract or any other Federal contract with the same prime contractor, or any other federally-assisted contract subject to the Contract Work Hours and Safety Standards Act, which is held by the same prime contractor, such sums as may be determined to be necessary to satisfy any liabilities of such contractor or subcontractor for unpaid wages and liquidated damages as provided in the clause set forth in paragraph (2.) of this section.

**4. Subcontracts.** The contractor or subcontractor shall insert in any subcontracts the clauses set forth in paragraph (1.) through (4.) of this section and also a clause requiring the subcontractors to include these clauses in any lower tier subcontracts. The prime contractor shall be responsible for compliance by any subcontractor or lower tier subcontractor with the clauses set forth in paragraphs (1.) through (4.) of this section.

## VI. SUBLETTING OR ASSIGNING THE CONTRACT

This provision is applicable to all Federal-aid construction contracts on the National Highway System.

1. The contractor shall perform with its own organization contract work amounting to not less than 30 percent (or a greater percentage if specified elsewhere in the contract) of the total original contract price, excluding any specialty items designated by the contracting agency. Specialty items may be performed by subcontract and the amount of any such specialty items performed may be deducted from the total original contract price before computing the amount of work required to be performed by the contractor's own organization (23 CFR 635.116).

a. The term "perform work with its own organization" refers to workers employed or leased by the prime contractor, and equipment owned or rented by the prime contractor, with or without operators. Such term does not include employees or equipment of a subcontractor or lower tier subcontractor, agents of the prime contractor, or any other assignees. The term may include payments for the costs of hiring leased employees from an employee leasing firm meeting all relevant Federal and State regulatory requirements. Leased employees may only be included in this term if the prime contractor meets all of the following conditions:

(1) the prime contractor maintains control over the supervision of the day-to-day activities of the leased employees;

(2) the prime contractor remains responsible for the quality of the work of the leased employees;

(3) the prime contractor retains all power to accept or exclude individual employees from work on the project; and

(4) the prime contractor remains ultimately responsible for the payment of predetermined minimum wages, the submission of payrolls, statements of compliance and all other Federal regulatory requirements.

b. "Specialty Items" shall be construed to be limited to work that requires highly specialized knowledge, abilities, or equipment not ordinarily available in the type of contracting organizations qualified and expected to bid or propose on the contract as a whole and in general are to be limited to minor components of the overall contract.

2. The contract amount upon which the requirements set forth in paragraph (1) of Section VI is computed includes the cost of material and manufactured products which are to be purchased or produced by the contractor under the contract provisions.

3. The contractor shall furnish (a) a competent superintendent or supervisor who is employed by the firm, has full authority to direct performance of the work in accordance with the contract requirements, and is in charge of all construction operations (regardless of who performs the work) and (b) such other of its own organizational resources (supervision, management, and engineering services) as the contracting officer determines is necessary to assure the performance of the contract.

4. No portion of the contract shall be sublet, assigned or otherwise disposed of except with the written consent of the contracting officer, or authorized representative, and such consent when given shall not be construed to relieve the contractor of any responsibility for the fulfillment of the contract. Written consent will be given only after the

contracting agency has assured that each subcontract is evidenced in writing and that it contains all pertinent provisions and requirements of the prime contract.

5. The 30% self-performance requirement of paragraph (1) is not applicable to design-build contracts; however, contracting agencies may establish their own self-performance requirements.

## VII. SAFETY: ACCIDENT PREVENTION

This provision is applicable to all Federal-aid construction contracts and to all related subcontracts.

1. In the performance of this contract the contractor shall comply with all applicable Federal, State, and local laws governing safety, health, and sanitation (23 CFR 635). The contractor shall provide all safeguards, safety devices and protective equipment and take any other needed actions as it determines, or as the contracting officer may determine, to be reasonably necessary to protect the life and health of employees on the job and the safety of the public and to protect property in connection with the performance of the work covered by the contract.

2. It is a condition of this contract, and shall be made a condition of each subcontract, which the contractor enters into pursuant to this contract, that the contractor and any subcontractor shall not permit any employee, in performance of the contract, to work in surroundings or under conditions which are unsanitary, hazardous or dangerous to his/her health or safety, as determined under construction safety and health standards (29 CFR 1926) promulgated by the Secretary of Labor, in accordance with Section 107 of the Contract Work Hours and Safety Standards Act (40 U.S.C. 3704).

3. Pursuant to 29 CFR 1926.3, it is a condition of this contract that the Secretary of Labor or authorized representative thereof, shall have right of entry to any site of contract performance to inspect or investigate the matter of compliance with the construction safety and health standards and to carry out the duties of the Secretary under Section 107 of the Contract Work Hours and Safety Standards Act (40 U.S.C.3704).

## VIII. FALSE STATEMENTS CONCERNING HIGHWAY PROJECTS

This provision is applicable to all Federal-aid construction contracts and to all related subcontracts.

In order to assure high quality and durable construction in conformity with approved plans and specifications and a high degree of reliability on statements and representations made by engineers, contractors, suppliers, and workers on Federal-aid highway projects, it is essential that all persons concerned with the project perform their functions as carefully, thoroughly, and honestly as possible. Willful falsification, distortion, or misrepresentation with respect to any facts related to the project is a violation of Federal law. To prevent any misunderstanding regarding the seriousness of these and similar acts, Form FHWA-1022 shall be posted on each Federal-aid highway project (23 CFR 635) in one or more places where it is readily available to all persons concerned with the project:

18 U.S.C. 1020 reads as follows:

"Whoever, being an officer, agent, or employee of the United States, or of any State or Territory, or whoever, whether a person, association, firm, or corporation, knowingly makes any false statement, false representation, or false report as to the character, quality, quantity, or cost of the material used or to be used, or the quantity or quality of the work performed or to be performed, or the cost thereof in connection with the submission of plans, maps, specifications, contracts, or costs of construction on any highway or related project submitted for approval to the Secretary of Transportation; or

Whoever knowingly makes any false statement, false representation, false report or false claim with respect to the character, quality, quantity, or cost of any work performed or to be performed, or materials furnished or to be furnished, in connection with the construction of any highway or related project approved by the Secretary of Transportation; or

Whoever knowingly makes any false statement or false representation as to material fact in any statement, certificate, or report submitted pursuant to provisions of the Federal-aid Roads Act approved July 1, 1916, (39 Stat. 355), as amended and supplemented;

Shall be fined under this title or imprisoned not more than 5 years or both."

#### **IX. IMPLEMENTATION OF CLEAN AIR ACT AND FEDERAL WATER POLLUTION CONTROL ACT**

This provision is applicable to all Federal-aid construction contracts and to all related subcontracts.

By submission of this bid/proposal or the execution of this contract, or subcontract, as appropriate, the bidder, proposer, Federal-aid construction contractor, or subcontractor, as appropriate, will be deemed to have stipulated as follows:

1. That any person who is or will be utilized in the performance of this contract is not prohibited from receiving an award due to a violation of Section 508 of the Clean Water Act or Section 306 of the Clean Air Act.

2. That the contractor agrees to include or cause to be included the requirements of paragraph (1) of this Section X in every subcontract, and further agrees to take such action as the contracting agency may direct as a means of enforcing such requirements.

#### **X. CERTIFICATION REGARDING DEBARMENT, SUSPENSION, INELIGIBILITY AND VOLUNTARY EXCLUSION**

This provision is applicable to all Federal-aid construction contracts, design-build contracts, subcontracts, lower-tier subcontracts, purchase orders, lease agreements, consultant contracts or any other covered transaction requiring FHWA approval or that is estimated to cost \$25,000 or more – as defined in 2 CFR Parts 180 and 1200.

##### **1. Instructions for Certification – First Tier Participants:**

a. By signing and submitting this proposal, the prospective first tier participant is providing the certification set out below.

b. The inability of a person to provide the certification set out below will not necessarily result in denial of participation in this

covered transaction. The prospective first tier participant shall submit an explanation of why it cannot provide the certification set out below. The certification or explanation will be considered in connection with the department or agency's determination whether to enter into this transaction. However, failure of the prospective first tier participant to furnish a certification or an explanation shall disqualify such a person from participation in this transaction.

c. The certification in this clause is a material representation of fact upon which reliance was placed when the contracting agency determined to enter into this transaction. If it is later determined that the prospective participant knowingly rendered an erroneous certification, in addition to other remedies available to the Federal Government, the contracting agency may terminate this transaction for cause of default.

d. The prospective first tier participant shall provide immediate written notice to the contracting agency to whom this proposal is submitted if any time the prospective first tier participant learns that its certification was erroneous when submitted or has become erroneous by reason of changed circumstances.

e. The terms "covered transaction," "debarred," "suspended," "ineligible," "participant," "person," "principal," and "voluntarily excluded," as used in this clause, are defined in 2 CFR Parts 180 and 1200. "First Tier Covered Transactions" refers to any covered transaction between a grantee or subgrantee of Federal funds and a participant (such as the prime or general contractor). "Lower Tier Covered Transactions" refers to any covered transaction under a First Tier Covered Transaction (such as subcontracts). "First Tier Participant" refers to the participant who has entered into a covered transaction with a grantee or subgrantee of Federal funds (such as the prime or general contractor). "Lower Tier Participant" refers any participant who has entered into a covered transaction with a First Tier Participant or other Lower Tier Participants (such as subcontractors and suppliers).

f. The prospective first tier participant agrees by submitting this proposal that, should the proposed covered transaction be entered into, it shall not knowingly enter into any lower tier covered transaction with a person who is debarred, suspended, declared ineligible, or voluntarily excluded from participation in this covered transaction, unless authorized by the department or agency entering into this transaction.

g. The prospective first tier participant further agrees by submitting this proposal that it will include the clause titled "Certification Regarding Debarment, Suspension, Ineligibility and Voluntary Exclusion-Lower Tier Covered Transactions," provided by the department or contracting agency, entering into this covered transaction, without modification, in all lower tier covered transactions and in all solicitations for lower tier covered transactions exceeding the \$25,000 threshold.

h. A participant in a covered transaction may rely upon a certification of a prospective participant in a lower tier covered transaction that is not debarred, suspended, ineligible, or voluntarily excluded from the covered transaction, unless it knows that the certification is erroneous. A participant is responsible for ensuring that its principals are not suspended, debarred, or otherwise ineligible to participate in covered transactions. To verify the eligibility of its principals, as well as the eligibility of any lower tier prospective participants, each participant may, but is not required to, check the Excluded Parties List System website (<https://www.epls.gov/>), which is compiled by the General Services Administration.

i. Nothing contained in the foregoing shall be construed to require the establishment of a system of records in order to render in good faith the certification required by this clause. The knowledge and information of the prospective participant is not required to exceed that which is normally possessed by a prudent person in the ordinary course of business dealings.

j. Except for transactions authorized under paragraph (f) of these instructions, if a participant in a covered transaction knowingly enters into a lower tier covered transaction with a person who is suspended, debarred, ineligible, or voluntarily excluded from participation in this transaction, in addition to other remedies available to the Federal Government, the department or agency may terminate this transaction for cause or default.

\* \* \* \* \*

## **2. Certification Regarding Debarment, Suspension, Ineligibility and Voluntary Exclusion – First Tier Participants:**

a. The prospective first tier participant certifies to the best of its knowledge and belief, that it and its principals:

(1) Are not presently debarred, suspended, proposed for debarment, declared ineligible, or voluntarily excluded from participating in covered transactions by any Federal department or agency;

(2) Have not within a three-year period preceding this proposal been convicted of or had a civil judgment rendered against them for commission of fraud or a criminal offense in connection with obtaining, attempting to obtain, or performing a public (Federal, State or local) transaction or contract under a public transaction; violation of Federal or State antitrust statutes or commission of embezzlement, theft, forgery, bribery, falsification or destruction of records, making false statements, or receiving stolen property;

(3) Are not presently indicted for or otherwise criminally or civilly charged by a governmental entity (Federal, State or local) with commission of any of the offenses enumerated in paragraph (a)(2) of this certification; and

(4) Have not within a three-year period preceding this application/proposal had one or more public transactions (Federal, State or local) terminated for cause or default.

b. Where the prospective participant is unable to certify to any of the statements in this certification, such prospective participant shall attach an explanation to this proposal.

### **2. Instructions for Certification - Lower Tier Participants:**

(Applicable to all subcontracts, purchase orders and other lower tier transactions requiring prior FHWA approval or estimated to cost \$25,000 or more - 2 CFR Parts 180 and 1200)

a. By signing and submitting this proposal, the prospective lower tier is providing the certification set out below.

b. The certification in this clause is a material representation of fact upon which reliance was placed when this transaction was entered into. If it is later determined that the prospective lower tier participant knowingly rendered an erroneous certification, in addition to other remedies available to the Federal Government, the department, or agency with which

this transaction originated may pursue available remedies, including suspension and/or debarment.

c. The prospective lower tier participant shall provide immediate written notice to the person to which this proposal is submitted if at any time the prospective lower tier participant learns that its certification was erroneous by reason of changed circumstances.

d. The terms "covered transaction," "debarred," "suspended," "ineligible," "participant," "person," "principal," and "voluntarily excluded," as used in this clause, are defined in 2 CFR Parts 180 and 1200. You may contact the person to which this proposal is submitted for assistance in obtaining a copy of those regulations. "First Tier Covered Transactions" refers to any covered transaction between a grantee or subgrantee of Federal funds and a participant (such as the prime or general contract). "Lower Tier Covered Transactions" refers to any covered transaction under a First Tier Covered Transaction (such as subcontracts). "First Tier Participant" refers to the participant who has entered into a covered transaction with a grantee or subgrantee of Federal funds (such as the prime or general contractor). "Lower Tier Participant" refers any participant who has entered into a covered transaction with a First Tier Participant or other Lower Tier Participants (such as subcontractors and suppliers).

e. The prospective lower tier participant agrees by submitting this proposal that, should the proposed covered transaction be entered into, it shall not knowingly enter into any lower tier covered transaction with a person who is debarred, suspended, declared ineligible, or voluntarily excluded from participation in this covered transaction, unless authorized by the department or agency with which this transaction originated.

f. The prospective lower tier participant further agrees by submitting this proposal that it will include this clause titled "Certification Regarding Debarment, Suspension, Ineligibility and Voluntary Exclusion-Lower Tier Covered Transaction," without modification, in all lower tier covered transactions and in all solicitations for lower tier covered transactions exceeding the \$25,000 threshold.

g. A participant in a covered transaction may rely upon a certification of a prospective participant in a lower tier covered transaction that is not debarred, suspended, ineligible, or voluntarily excluded from the covered transaction, unless it knows that the certification is erroneous. A participant is responsible for ensuring that its principals are not suspended, debarred, or otherwise ineligible to participate in covered transactions. To verify the eligibility of its principals, as well as the eligibility of any lower tier prospective participants, each participant may, but is not required to, check the Excluded Parties List System website (<https://www.epls.gov/>), which is compiled by the General Services Administration.

h. Nothing contained in the foregoing shall be construed to require establishment of a system of records in order to render in good faith the certification required by this clause. The knowledge and information of participant is not required to exceed that which is normally possessed by a prudent person in the ordinary course of business dealings.

i. Except for transactions authorized under paragraph e of these instructions, if a participant in a covered transaction knowingly enters into a lower tier covered transaction with a person who is suspended, debarred, ineligible, or voluntarily excluded from participation in this transaction, in addition to other remedies available to the Federal Government, the

department or agency with which this transaction originated may pursue available remedies, including suspension and/or debarment.

\* \* \* \* \*

**Certification Regarding Debarment, Suspension, Ineligibility and Voluntary Exclusion--Lower Tier Participants:**

1. The prospective lower tier participant certifies, by submission of this proposal, that neither it nor its principals is presently debarred, suspended, proposed for debarment, declared ineligible, or voluntarily excluded from participating in covered transactions by any Federal department or agency.

2. Where the prospective lower tier participant is unable to certify to any of the statements in this certification, such prospective participant shall attach an explanation to this proposal.

\* \* \* \* \*

**XI. CERTIFICATION REGARDING USE OF CONTRACT FUNDS FOR LOBBYING**

This provision is applicable to all Federal-aid construction contracts and to all related subcontracts which exceed \$100,000 (49 CFR 20).

1. The prospective participant certifies, by signing and submitting this bid or proposal, to the best of his or her knowledge and belief, that:

a. No Federal appropriated funds have been paid or will be paid, by or on behalf of the undersigned, to any person for influencing or attempting to influence an officer or employee of any Federal agency, a Member of Congress, an officer or employee of Congress, or an employee of a Member of Congress in connection with the awarding of any Federal contract, the making of any Federal grant, the making of any Federal loan, the entering into of any cooperative agreement, and the extension, continuation, renewal, amendment, or modification of any Federal contract, grant, loan, or cooperative agreement.

b. If any funds other than Federal appropriated funds have been paid or will be paid to any person for influencing or attempting to influence an officer or employee of any Federal agency, a Member of Congress, an officer or employee of Congress, or an employee of a Member of Congress in connection with this Federal contract, grant, loan, or cooperative agreement, the undersigned shall complete and submit Standard Form-LLL, "Disclosure Form to Report Lobbying," in accordance with its instructions.

2. This certification is a material representation of fact upon which reliance was placed when this transaction was made or entered into. Submission of this certification is a prerequisite for making or entering into this transaction imposed by 31 U.S.C. 1352. Any person who fails to file the required certification shall be subject to a civil penalty of not less than \$10,000 and not more than \$100,000 for each such failure.

3. The prospective participant also agrees by submitting its bid or proposal that the participant shall require that the language of this certification be included in all lower tier subcontracts, which exceed \$100,000 and that all such recipients shall certify and disclose accordingly.



**NOTICE OF REQUIREMENTS FOR AFFIRMATIVE  
ACTION TO ENSURE EQUAL EMPLOYMENT  
OPPORTUNITY (EXECUTIVE ORDER 11246)**

1. The Offeror's or Bidder's attention is called to the "Equal Opportunity Clause" and the "Standard Federal Equal Employment Opportunity Construction Contract Specifications" set forth herein.

2. The goal for female participation, expressed in percentage terms for the Contractor's aggregate workforce in each trade on all construction work, is 6.9%.

Until further notice  
Goals for minority participation for each trade (percent)

**SHSA Cities:**

Pascagoula - Moss Point -----	16.9
Biloxi - Gulfport -----	19.2
Jackson -----	30.3

**SMSA Counties:**

Desoto-----	32.3
Hancock, Harrison, Stone -----	19.2
Hinds, Rankin-----	30.3
Jackson -----	16.9

**Non-SMSA Counties:**

George, Greene -----	26.4
----------------------	------

Alcorn, Benton, Bolivar, Calhoun, Carroll, Chickasaw, Clay, Coahoma, Grenada, Itawamba, Lafayette, Lee, Leflore, Marshall, Monroe, Montgomery, Panola, Pontotoc, Prentiss, Quitman, Sunflower, Tallahatchie, Tate, Tippah, Tishomingo, Tunica, Union, Washington, Webster, Yalobusha -----	26.5
---	------

Attala, Choctaw, Claiborne, Clarke, Copiah, Covington, Franklin, Holmes, Humphreys, Issaquena, Jasper, Jefferson, Jefferson Davis, Jones Kemper, Lauderdale, Lawrence, Leake, Lincoln, Lowndes, Madison, Neshoba, Newton, Noxubee, Oktibbeha, Scott, Sharkey, Simpson, Smith, Warren, Wayne, Winston, Yazoo-----	32.0
---	------

Forrest, Lamar, Marion, Pearl River, Perry, Pike, Walthall -----	27.7
---	------

Adams, Amite, Wilkinson-----	30.4
------------------------------	------

These goals are applicable to all the Contractor's construction work (whether or not it is Federal or federally assisted) performed in the covered area. If the contractor performs construction work in a geographical area located outside of the covered area, it shall apply the goals established for such geographical area where the work is actually performed. With regard to this second area, the contractor also is subject to the goals for both its federally involved and nonfederally involved construction.

The Contractor's compliance with the Executive Order and the regulations in CFR Part 60-4 shall be based on its implementation of the Equal Opportunity clause, specific affirmative action obligations required by the specifications set forth in 41 CFR 60-4.3(a), and its efforts to meet the goals. The hours of minority and female employment and training must be substantially uniform throughout the length of the contract, and in each trade, and the Contractor shall make a good faith effort to employ minorities and women evenly on each of its projects. The transfer of minority or female employees or trainees from Contractor to Contractor or from project to project for the sole purpose of meeting the Contractor's goals shall be a violation of the contract, the Executive Order and the regulations in 41 CFR Part 60-4.2(d). Compliance with the goals will be measured against the total work hours performed.

3. The Contractor shall provide written notification to the Director of the Office of Federal Contract Compliance Programs within 10 working days of award of any construction subcontract in excess of \$10,000 at any tier for construction work under the contract resulting from this solicitation. The notification shall list the name, address and telephone number of the subcontractor, employer identification number of the subcontractor, estimated dollar amount of the subcontract; estimated starting and completion dates of the subcontract; and the geographical area in which the subcontract is to be performed.

4. As used in this Notice, and in the contract resulting from this solicitation, the "covered area" is to the county and city (if any), stated in the advertisement.

5. The notification required in Paragraph 3 shall be addressed to the following:

Contract Compliance Officer  
Mississippi Department of Transportation  
P.O. Box 1850  
Jackson, Mississippi 39215-1850

(06/28/2012)

## MISSISSIPPI DEPARTMENT OF TRANSPORTATION

SPECIAL PROVISION NO. 907-102-2

CODE: (IS)

DATE: 11/22/2017

SUBJECT: **Bidding Requirements and Conditions**

Section 102, Bidding Requirements and Conditions, of the 2017 Edition of the Mississippi Standard Specifications for Road and Bridge Construction is hereby amended as follows.

**907-102.01--Prequalification of Bidders.** Delete the last sentence of the third paragraph of Subsection 102.01 on page 13, and substitute the following.

The Bidder's Certificate of Responsibility number must be on file with the Department's Contract Administration Division prior to request for permission to bid.

**907-102.02--Contents of Proposal Forms.** Delete the fourth paragraph in Subsection 102.02 on page 13, and substitute the following.

Prospective bidders must complete an online request for permission to be eligible to bid a project. Upon approval, the bidder will be authorized to submit a bid electronically using Bid Express at <http://bidx.com>.

**MISSISSIPPI DEPARTMENT OF TRANSPORTATION**

**SPECIAL PROVISION NO. 907-107-2**

**CODE: (SP)**

**DATE: 01/31/2018**

**SUBJECT: Contractor's Erosion Control Plan**

Section 107, Legal Relations and Responsibility to Public, of the 2017 Edition of the Mississippi Standard Specifications for Road and Bridge Construction is hereby amended as follows.

**907-107.22--Environmental Protection.**

**907-107.22.1--Contractor's Erosion Control Plan (ECP).** After the first sentence of the first paragraph of Subsection 107.22.1 on page 63, add the following.

The ECP shall be submitted electronically to the Project Engineer who will forward it to the appropriate MDOT Divisions.

Delete the example Narrative in Subsection 107.22.1 on page 65, and substitute the following.

**EXAMPLE**  
**MISSISSIPPI DEPARTMENT OF TRANSPORTATION**  
**Storm Water Pollution Prevention Plan (SWPPP)**  
**Narrative**

General Permit Coverage No: MSR \_\_\_\_\_  
Project Number: \_\_\_\_\_  
County: \_\_\_\_\_  
Route: \_\_\_\_\_

**SITE INFORMATION**

This project consists of grading and installing drainage structures necessary to construct approximately 6 miles of parallel lanes on SR 31 between the Hinds County Line and the Rankin County Line.

**SEDIMENT AND EROSION CONTROLS**

- a) **Vegetative Controls:** Clearing and grubbing areas will be minimized to comply with the buffer zones (minimum of 15 feet along the ROW lines and 5 feet along creeks) as per the contract documents. A combination of temporary and permanent grassing will be used to protect slopes as construction progresses. **Should a disturbed area be left undisturbed for 14 days or more, placement of temporary BMPs (seeding & mulching, silt fences, basins, ditch checks, slope drains, etc.) or permanent erosion control measures (seeding & mulching, riprap, paved ditch, flumes, etc.) will be initiated by the next working day after the land disturbing activities have stopped.**
- b) **Structural Controls:** Gravel construction entrance/exit will be installed near Stations 145+50, 159+50, 164+50 & 172+50. Riprap ditch checks will be constructed at Stations 144+50, 151+75, 162+00 & 166+25. The Concrete washout area will be at Stations 140+25, 152+00 & 168+50.
- c) **Housekeeping Practices:** Structural BMPs will be cleaned out when sediment reaches 1/3 to 1/2 of the height of the BMP. Maintenance and repair of equipment will be performed off-site, material wash out will occur either off-site or within designated wash out areas.
- d) **Post-Construction Control Measures:** As construction is completed, permanent vegetative growth will be established on disturbed soils to improve soil stability and provide a buffer zone for loose material. Paved ditches and flumes will be placed as specified in the ECP to reduce erosion in concentrated flow areas and rip rap will be placed as specified to dissipate flow energy and reduce flow velocity.

**IMPLEMENTATION SEQUENCE**

Perimeter controls will be installed first. Clearing and grubbing will be performed in 19-acre sections beginning at the BOP and temporary grassing will be installed as needed. Temporary erosion control BMPs will be installed at the drainage structures prior/during construction of the drainage structures. Grading activities will commence at the BOP and proceed towards the EOP, fill slopes will be permanently grassed in stages for fill heights that exceed 5 feet. Base materials will be installed on completed grading sections with the paving to follow.

**MAINTENANCE PLAN**

All erosion and sediment control practices will be checked for stability and operation following every rainfall but in no case less than once every week. Any needed repairs will be made immediately to maintain all practices as designed. Sediment basins will be cleaned out when the level of sediment reaches 2.0 feet below the top of the riser. Sediment will be removed from the front/upstream end of the BMPs when it becomes about 1/3 to 1/2 height of BMP.

\_\_\_\_\_  
Prime Contractor's Signature

\_\_\_\_\_  
Date

\_\_\_\_\_  
Printed Name

\_\_\_\_\_  
Title

**MISSISSIPPI DEPARTMENT OF TRANSPORTATION**

**SPECIAL PROVISION NO. 907-109-1**

**CODE: (SP)**

**DATE: 05/08/2019**

**SUBJECT: Measurement and Payment**

Section 109, Measurement and Payment, of the 2017 Edition of the Mississippi Standard Specifications for Road and Bridge Construction is hereby amended as follows.

**907-109.01--Measurement of Quantities.** Delete the sixth full paragraph of Subsection 109.01 on page 88, and substitute the following.

If appropriate based on the specific circumstances of the project, the Contractor may request that material specified to be measured by the cubic yard or ton be converted to the other measure. The Contractor must submit this request to the Engineer. The Engineer will provide an approval or denial in writing. The decision is in the sole discretion of the Engineer. If approved, factors for this conversion will be determined by the District Materials Engineer and agreed to by the Contractor. The conversion of the materials along with the conversion factor will be incorporated into the Contract by supplemental agreement. The supplemental agreement must be executed before such method of measurement is used.

**MISSISSIPPI DEPARTMENT OF TRANSPORTATION**

**SPECIAL PROVISION NO. 907-228-1**

**CODE: (SP)**

**DATE: 10/10/2018**

**SUBJECT: Erosion Control Blankets**

Section 228, Erosion Control Blankets, of the 2017 Edition of the Mississippi Standard Specifications for Road and Bridge Construction is hereby amended as follows.

**907-228.02--Materials.**

**907-228.02.1--Blanket Types.** Delete Note \*\*\* at the end of Subsection 228.02.1 on page 165, and substitute the following.

\*\*\* Per ASTM D 6818

**907-228.05--Basis of Payment.** Delete the pay item at the end of Subsection 228.05 on page 166, and substitute the following.

907-228-A: Erosion Control Blanket, Type \_\_ - per square yard

# MISSISSIPPI DEPARTMENT OF TRANSPORTATION

SPECIAL PROVISION NO. 907-241-1

CODE: (SP)

DATE: 12/7/2007

SUBJECT: Floc Blocks

Section 907-241, Floc Blocks, is hereby added to and made a part of the 2004 Edition of the Mississippi Standard Specifications for Road and Bridge Construction as follows.

## SECTION 907-241 - FLOC BLOCKS

**907-241.01--Description.** This work consists of furnishing, installing and maintaining flocculation devices (floc blocks) in accordance to the specifications and/or as directed by the Engineer. The floc blocks shall cause small, suspended materials in the runoff water to stick to each other to form “flocs” or “flakes” which will cause suspended clays and fine silts to settle out of the water quickly reducing the Nephelometric Turbidity Units (NTU).

Since different floc blocks are used for different soil conditions, each site location shall be evaluated individually to make sure the correct floc block is used for the particular type of soil in the area. It will be the Contractor’s responsibility to have soil samples taken and sent to the manufacture, or the manufacturer’s representative, for determining the correct floc block to use at each site.

Floc blocks are not a replacement for normal siltation control devices such as silt fence, silt basins, erosion control checks, wattles, etc. The floc blocks should be used in conjunction with these traditional erosion control devices.

**907-241.02--Materials.** The chemical floc block for this project shall be a non-toxic polyacrylamide (PAM). The PAM shall be a solid block, or group of blocks, connected by a rope to anchor the block(s) in place. One of the ingredients used to make PAM is acrylamide, which is a known carcinogen. The floc blocks and runoff from the floc blocks shall be non-toxic to fish, aquatic organisms, wildlife, and the environment.

The Contractor shall furnish the Engineer with three copies of a certification stating the floc blocks used on this project meet the requirements of this specification.

### **907-241.03--Construction Requirements.**

#### **907-241.03.1--General.**

When the location of the floc blocks is not shown on the plans or directed by the Engineer, the Contractor will be responsible for determining the placement location of the floc blocks. One of the key factors in making a floc block work is to ensure that it is dissolved and thoroughly mixed with the runoff water. This can be accomplished by introducing the PAM to the runoff at a point

of high velocity to provide the turbulence and mixing needed to maximize the suspended sediment exposure to the large PAM molecules. Such locations can be storm drain junction box where a pipe is dropping water, inside a slope drain, or other areas of falling or fast moving water upslope from a sediment trap or basin.

The floc blocks are designed to be placed in flowing water to dissolve the PAM from the block somewhat proportionately to flow. The amount of PAM released is not adjustable, so the Contractor may have to adjust the system by moving or adding blocks to get the desired effect.

**907-241.03.2--Maintenance and Removal.** Once properly functioning, maintenance requirements should be minimal. However, because the PAM is sticky when wet, it can accumulate materials from the runoff and become clogged, releasing little PAM. The blocks tend to harden when allowed to dry. This causes less PAM to be released initially during the next runoff until the block becomes moist again. To avoid these problems, the Contractor should do the following to ensure PAM releases from the block:

- Monitor sediment load in the runoff upstream of the PAM location. Reducing sediment loads upstream helps avoid burying the PAM under accumulated sediment.
- Take measures to create constant flow across or onto the solid PAM. The flow will help dissolve and mix the PAM as well as prevent suspended solids from sticking to the PAM product.

Cleanout of collected sediments and floc from the sediment trap or basin should be conducted, as needed, to ensure that adequate storm water detention or retention is maintained.

**907-241.04--Method of Measurement.** Floc blocks will be measured per each block. Each block, when multiple blocks are attached to one rope, will be measured separately.

**907-241.05--Basis of Payment.** Floc blocks, measured as prescribed above, will be paid for at the contract unit price per each, which price shall be full compensation for furnishing, installing and maintaining the blocks, and all labor, equipment and tolls and incidentals necessary to complete the work.

Payment will be made under:

907-241-A: Floc Blocks - per each



MISSISSIPPI DEPARTMENT OF TRANSPORTATION

SPECIAL PROVISION NO. 907-253-1

CODE: (SP)

DATE: 01/17/2017

SUBJECT: Coir Fiber Baffle

Section 907-253, Coir Fiber Baffle, is hereby added to and made a part of the 2017 Edition of the Mississippi Standard Specifications for Road and Bridge Construction as follows.

**SECTION 907-253 -- COIR FIBER BAFFLE**

**907-253.01--Description.** This work consists of furnishing materials, installing, and maintaining coir fiber baffles according to the details in the plans or in locations as directed. Coir fiber baffles shall be installed in silt basins.

**907-253.02--Materials.**

**907-253.02.1--Coir Fiber Mat.** Matting shall be provided to meet the requirements of Table 1.

**TABLE 1  
COIR FIBER MAT PROPERTIES**

<b>Property</b>	<b>Requirement</b>	<b>Method</b>
Composition	100% coconut fiber (coir) twine woven into high strength matrix	-
Weight, ounces per square yard	20	ASTM D 5261
Open Area, Measured, percent	50	-

In addition to the above, the product shall be on the Department’s APL, or an approved equal.

**907-253.02.2--Staples.** Staples shall be made of 0.125-inch diameter new steel wire formed into a U-shape not less than 12 inches in length with a throat of one inch (1") in width.

**907-253.02.3--Posts.** Posts shall meet the requirements of Subsection 714.13.2.2.

**907-253.02.4--Tension Wire.** The tension wire shall be 9-gauge high tension wire strand of variable lengths.

**907-253.02.5--Wire Mesh.** The wire mesh for the woven wore backing shall meet the requirements of Subsection 714.13.2.1.

**907-253.02.6--Attachment Device.** The attachment devices shall be No. 9 staples with at least 1½ inches in length, or an approved equal.

**907-253.03--Construction Requirements.** The coir fiber baffles shall be placed immediately

upon construction of sediment dams and basins. Three (3) baffles shall be placed in the basins with a spacing of 1/4 the basin length and according to the detail sheets. Two (2) coir fiber baffles shall be placed in basins less than 20 feet in length with a spacing of 1/3 the basin length.

Steel posts shall be installed to a depth of two feet (2') below the basin floor, with spacing of no more than four feet (4'). The top height of the coir fiber baffles shall not be below the elevation of the emergency spillway base of dams and basins. A tension wire strand shall be attached to the steel posts at a height of three feet (3') with plastic ties or wire fasteners. A steel post shall be installed into the side of the basin at a variable depth and a height of three feet (3') from the bottom of the basin to anchor coir fiber mat. The anchor post shall be secured to the upright steel post in basin with wire fasteners.

The coir fiber mat shall be draped over the wire strand with at least three feet (3') of material on each side of the strand. The coir fiber mat shall be secured to the posts and wire strand with wire staples or other acceptable methods. Staples shall be placed across the matting at ends and junctions approximately one foot (1') apart at the bottom and side slopes of basin. The matting shall be overlaid at least six inches (6") where two (2) or more widths of matting are installed side by side. The Engineer may require adjustments in the stapling requirements to fit individual site conditions.

**907-253.04--Method of Measurement.** Coir fiber baffle will be measured per linear feet of coir fiber baffle.

**907-253.05--Basis of Payment.** Coir fiber baffle, measured as prescribed above, will be paid for at the contract unit prices per linear feet, which price shall be full compensation for all materials, labor, equipment, placing, securing, excavating, and backfilling of coir fiber baffles, and incidentals necessary to complete the work.

Payment will be made under:

907-253-A: Coir Fiber Baffle - per linear foot

# MISSISSIPPI DEPARTMENT OF TRANSPORTATION

SPECIAL PROVISION NO. 907-619-5

CODE: (IS)

DATE: 01/17/2018

SUBJECT: Traffic Control for Construction Zones

Section 619, Traffic Control for Construction Zones, of the 2017 Edition of the Mississippi Standard Specifications for Road and Bridge Construction is hereby amended as follows.

## 907-619.02--Materials.

907-619.02.8--Traffic Signals and Flashers. Delete Subsection 619.02.8.1 on pages 452 thru 455, and substitute the following.

907-619.02.8.1-Portable Traffic Signals. Portable traffic signals shall be trailer or pedestal mounted units that provide for easy, legal transportation and quick setup and deployment. Each unit shall be self-contained. The types of portable traffic signals are as follows.

- Type 1 portable traffic signal shall include two signal heads per trailer with one signal head mounted on an overhead mast arm that can be extended over the travel lane, and the other signal head shall be mounted on the vertical upright of the trailer.
- Type 2 portable traffic signal shall include one signal head that is mounted on the vertical upright of the pedestal/cart or trailer. Pedestal/Cart mounted shall be designated as Type 2A and Trailer mounted shall be designated as Type 2B. Type 2 portable traffic signals shall be tested to MASH Standards or NCHRP Test Level 3 crash testing requirements by an accredited independent test facility, with supporting documentation available upon request.
- Type 3 portable traffic signal shall be the same as Type 1 mentioned above but with enhanced capabilities as mentioned in each applicable section below.

The portable traffic signals shall be MUTCD Compliant and utilize standard ITE signal heads, and adhere to the ITE Specifications and Standards for Vehicle Traffic Control Signal Heads, Light Emitting Diode (LED) Circular Signal Supplement. The units shall be battery powered with a solar charging system, and be equipped with an onboard battery charger capable of being used with a 120V AC power source. Portable traffic signals shall be able to communicate with other portable signals via 900 MHz or other accepted wireless communications. If wireless connectivity is not feasible, hardwired connectivity shall be an acceptable alternative, as approved by the Engineer. Portable Traffic Signals shall include all the major components listed below or be able to perform the functions of these components. The major components of the unit shall include, but are not limited to, the trailer or pedestal/cart, telescoping mast arm (on Type 1 and 3), signal head(s) and back plates, traffic signal controller with operating software, solar charging system with batteries, input and output devices, vehicle detection, flasher units, conflict monitor, relays,

communications system and other equipment required for the safe operation and installation of the unit.

**907-619.02.8.1.1--Signal Heads.** The signal heads and all applicable components of the portable traffic signal shall meet the physical display and operational requirements of conventional traffic signals as specific in the Manual on Uniform Traffic Control Devices (MUTCD). The signal heads shall be cast aluminum or polycarbonate and shall meet the requirements laid out in the Mississippi Standard Specification for traffic signal heads and associated MDOT material specifications for traffic signal heads. The signal heads shall accommodate standard 12-inch LED indications meeting the ITE Specification “Vehicle Traffic Control Signal Heads” and ITE Specifications and Standards for Vehicle Traffic Control Signal Heads, Light Emitting Diode (LED) Circular Signal Supplement.

For Type 1, Type 2 and Type 3 portable traffic signals, the signal heads shall have the ability to be rotated 180 degrees to face in the opposite direction and shall have the ability to rotate and lock in approximately 10 degree increments to position the signal head for the optimum visibility to motorists.

For Type 1 portable traffic signals, each unit shall contain two signal heads with one signal head mounted on an overhead mast arm that can be extended over the travel lane with a minimum clearance of 17 feet measured from the bottom of the signal head unit to the road surface. The lower signal head shall be mounted to the vertical upright of the trailer at a minimum height of eight feet (8') from the bottom of the signal head unit to the road surface.

For Type 2 portable traffic signals, the signal head shall be mounted to the vertical upright of the trailer at a minimum height of eight feet (8') from the bottom of the signal head unit to the road surface.

For Type 3 portable traffic signals, each unit shall be the same as Type 1 mentioned above but with enhanced capabilities as mentioned below.

**907-619.02.8.1.2--Controller and Operating Requirements.** The portable traffic signal (Types 1, 2, and 3) shall include a solid state Controller Unit (CU) that is in compliance with NEMA TS 5 Performance Standard. The CU shall have an easy to read front panel backlit display for viewing and programming the configuration settings and CU status. The CU shall be capable of operating the portable traffic signal system in a fixed time, traffic actuated or manual control mode. Multiple portable traffic signals shall have the capability to be interconnected to form a portable traffic signal system. Each portable traffic signal within a connected system shall have the capability to serve as either the master or remote signal. Each portable traffic signal shall include a Conflict Monitor Unit (CMU), or Malfunction Management Unit (MMU) to ensure phase conflicts do not exist during operation.

For Type 1 and Type 2 portable traffic signals, a minimum of five (5) automatic time-of-day timing plans within a 24-hour period should be available in fixed time mode. The CU should have the ability to control a minimum of four (4) traffic phases with programmable cycle time adjustments and user adjustable red, amber, minimum green and maximum green times. The CU shall have

the capability of programming green and red times from 1 to 999 seconds and yellow times up to 15 seconds in one-second increments. The CU shall also have the capability of facilitating standby modes of red, red flash and yellow flash.

For Type 3 portable traffic signals, a minimum of ten (10) automatic time-of-day timing plans within a 24-hour period should be available in fixed time mode. The CU should have the ability to control a minimum of 16 traffic phases with programmable cycle time adjustments and user adjustable red, amber, minimum green and maximum green times. The CU shall have the capability of programming green and red times from 1 to 999 seconds and yellow times up to 15 seconds in one-second increments. The CU shall also have the capability of facilitating standby modes of red, red flash and yellow flash.

The system shall also have the ability to operate in vehicle actuation mode when vehicle detection components are used. The operating system shall have the capability to allow the Portable Traffic Signal to be connected to and controlled by a standard NEMA controller.

The system shall have the capability to be controlled remotely using a hardwired or wireless remote. The wireless radio remote shall be capable of communicating at a clear line of site distance up to ¼ mile from the master.

The CU shall have the capability of interfacing with a Remote Monitoring System (RMS) capable of reporting signal location, battery voltage, and system faults. The RMS shall include a password-protected web site, viewable via an internet connection. In the event of a system fault, the RMS shall provide specific information concerning the cause of the system fault (example: "red lamp on signal number 1 out"). The RMS shall immediately contact previously designated individuals via SMS text messaging or email, upon a fault event.

The active timing program operating the PTS system shall be available and viewable through the RMS website at all times. The RMS shall maintain a history of the operating system in each signal including total operating hours, alerts, and the location of the PTS trailer.

**907-619.02.8.1.3--Wireless Communications.** The portable traffic signals shall communicate with other portable traffic signals within the signal system via license-free wireless 900 MHZ radio link communications as specified in Subsection 662.02.2 of the radio Interconnect System specification. The radio units shall maintain communications at a minimum distance of one (1) mile. The radio system shall conform to the applicable Federal Communications Commission requirements and all applicable state and local requirements.

The portable traffic signals shall be in direct communication at all times either by wireless or hardware connection to provide for the required conflict monitoring / malfunction management system.

**907-619.02.8.1.4--Power Requirements.** Each Portable Traffic Signal shall be equipped with a power source consisting of a solar collection array, solar controller and/or charging unit and batteries sufficient to operate the signal system. The number and size of batteries shall be sufficient to operate the Type 1 and Type 3 signals for a minimum of 30 days and Type 2A signals for

minimum of five (5) days, and Type 2B signals for minimum of 15 days without additional charging or assist from the solar array. An on-board battery charger shall be compatible with both the solar array and with a 120V AC power source.

For Type 1 signals, the solar panel array shall provide for a minimum of 440 watts of solar collection capability.

For Type 2A signals, the solar panel array shall provide for a minimum of 90 watts of solar collection capability.

For Type 2B signals, the solar panel array shall provide for a minimum of 110 watts of solar collection capability.

For Type 3 signals, the solar panel array shall provide for a minimum of 480 watts of solar collection capability and shall include a tilt and rotate system to optimally position the panels.

All instrumentation for the electrical system and battery compartment shall be contained in a lockable weatherproof enclosure. Solar panels shall be secured to the mounting brackets for theft prevention.

**907-619.02.8.1.5--Trailer and Lift System.** The trailer or pedestal/cart and all mounted components shall conform to the wind loading requirements as follows: 100 mph minimum for Type 1 portable traffic signals, 55 mph minimum for Type 2A portable traffic signals, 75 mph minimum for Type 2B portable traffic signals, and 90 mph minimum for Type 3 portable traffic signals as described in the AASHTO *Standard Specifications for Highway Signs, Luminaries and Traffic Signals*, as specified in the plans including all interims and updates. At the request of the Engineer, proof of conformance to these wind load ratings shall be verified by a third-party. No additional loose ballast shall be used to meet these wind load requirements. The trailer shall be made of structural steel and shall include four (4) leveling/stabilizer jacks capable of lifting the trailer a minimum of six inches (6”).

The trailer or pedestal shall be equipped with a mechanical, hydraulic or electric lift system sufficient for one person to be able to raise and lower the vertical upright and/or horizontal mast arm to and from the operating position.

For Type 1, 2B, and Type 3 signals, the trailer shall be equipped to provide legal and safe transport on the public highway system at speeds up to 55 mph.

All exterior metal surfaces, except signal heads and back plates, shall be powder-coat painted highway safety orange.

**907-619.02.9--Impact Attenuators.** Delete the sentence in the first paragraph of Subsection 619.02.9 on page 455, and substitute the following.

Impact attenuators must be listed on the Department's APL.

**907-619.02.11--Snap-Back Delineators.** Delete the sentence in the paragraph of Subsection 619.02.11 on page 456, and substitute the following.

Snap-back delineators shall be selected from the list of surface mounted flexible delineator posts as shown on the Department's APL.

**907-619.02.14--Changeable Message Sign.**

**907-619.02.14.5--PCMS Controller and Storage Cabinets.** Delete the fifth sentence in the first paragraph of Subsection 619.02.14.5 on pages 462 and 463, and substitute the following.

The controller cabinet shall be illuminated.

**907-619.05--Basis of Payment.** Add the following to the list of pay items ending on page 480.

907-619-E3: Changeable Message Sign \*\*\*\*\* - per each

907-619-H2: Traffic Signal, Portable, Type \_\_\_\_ - per each

# MISSISSIPPI DEPARTMENT OF TRANSPORTATION

SPECIAL PROVISION NO. 907-624-1

CODE: (SP)

DATE: 01/17/2017

SUBJECT: Inverted Profile Thermoplastic Traffic Stripe

Section 907-624, Inverted Profile Thermoplastic Traffic Stripe, is hereby added to and made part of the 2017 Edition of the Mississippi Standard Specifications for Road and Bridge Construction as follows.

**907-624.01--Description.** Inverted profile thermoplastic pavement markings consists of furnishing materials and placing inverted profile thermoplastic pavement markings in reasonably close conformity with these specifications and the details shown on the plans or established.

Inverted profile thermoplastic pavement markings, high contract, shall consist of furnishing materials and placing inverted profile thermoplastic pavement markings over a black thermoplastic pavement marking in order to enhance the marking's visibility.

**907-624.02--Materials.**

**907-624.02.1--General.** The inverted profile thermoplastic marking material shall consist of an alkyd/maleic or hydrocarbon based formulation. The material shall be so manufactured as to be applied to the pavement in a molten form, with internal and surface application of glass spheres, and upon cooling to normal pavement temperature, shall produce an adherent, reflectorized pavement marking of specified thickness and width, capable of resisting deformation.

Materials shall be obtained from approved sources as listed on the Department's "List of Approved Sources" for Inverted Profile Thermoplastic Pavement Marking Materials. The material shall not scorch, break down, discolor, or deteriorate when held at the application temperature for four hours or when reheated four times to the application temperature. Temperature-vs-viscosity characteristics of the plastic material shall remain constant when reheated four times, and shall be the same from batch to batch.

The thermoplastic material shall be a product especially compounded for pavement markings. The pavement markings shall maintain their original dimension and shall not smear or spread under normal traffic at temperatures below 140°F. The markings shall have a uniform cross section. Pigment shall be evenly dispersed throughout its thickness. The exposed surface shall be free from tack and shall not be slippery when wet. The material shall not lift from pavement in freezing weather. Cold ductility of the material shall be such as to permit normal movement with the pavement surface without chipping or cracking.

Black thermoplastic compound for the placement of inverted profile thermoplastic pavement markings, high contract, shall consist of a hydrocarbon or alkyd/maleic based formulation.



The manufacturers of the thermoplastic compound, glass beads and epoxy primer sealer shall furnish to the Engineer three copies of certified test reports showing results of all tests specified herein and shall further certify that the materials meet all requirements. The Contractor shall provide the warranty as specified herein to the Engineer.

**907-624.02.2--Inverted Profile Thermoplastic Material.** The thermoplastic material shall consist of homogeneously mixed pigments, fillers, resins and glass beads, and shall be available in both white and yellow. The material shall be free from all skins, dirt, and foreign objects. Materials shall conform to AASHTO M 249 with the following modifications:

**907-624.02.2.1--Intermixed Glass Beads.** The thermoplastic material shall contain a minimum of 40 percent Class H glass beads by weight. Class H glass beads shall meet the requirements of ASTM D 1155, and shall be coated with an adhesion promoting coating which shall also provide moisture resistance as tested by AASHTO M 247, Section 4.4.2. Class H beads shall have a minimum of 70 percent true spheres and the +20 sieve shall be tested visually.

The gradation of the Class H beads shall meet the following:

<b><u>U. S. Standard Sieve</u></b>	<b><u>% Passing</u></b>
12	100
14	95 - 100
16	80 - 100
18	30 - 100
20	15 - 100
30	10 - 100
50	0 - 50
100	0 - 5

**907-624.02.2.2--Binder Content.** The binder content of the thermoplastic material shall be 19 percent minimum.

**907-624.02.2.3--Titanium Dioxide.** The titanium dioxide shall meet ASTM D 476, Type II, Rutile grade - 10 percent minimum titanium content.

**907-624.02.2.4--Yellow Pigment.** The yellow pigment for the yellow thermoplastic material shall be five (5) percent minimum.

**907-624.02.2.5--Specific Gravity.** The specific gravity of the thermoplastic pavement marking material shall not exceed 2.35.

**907-624.02.2.6--Flow Characteristics.**

**907-624.02.2.6.1--Flowability.** After heating the thermoplastic material for four (4) hours ±5 minutes at 425 ±3°F and testing flowability, the white thermoplastic shall have a maximum percent residue of 22 percent and the yellow thermoplastic shall have a maximum residue of 24 percent.

**907-624.02.2.6.2--Flow Resistance.** The material shall exhibit a maximum flow of 10%. The material's ability to form ribs on the markings shall be evaluated by casting a disc of material approximately 3.5 inches wide by 1.0 inch long by and 0.60 inch deep. After the material is cooled to ambient temperature, measure the exact height. The material shall then be stored at 190°F for four (4) hours. After the material is cooled to ambient temperature, re-measure the exact height and express the flow resistance as a flow percentage.

**907-624.02.2.7--Reflectivity.** The initial reflectance for the in-place marking shall have a minimum reflectance value of 450 mcd/ft<sup>2</sup> for white and 350 mcd/ft<sup>2</sup> for yellow, when measured with a MiroLux Ultra 30 retroreflectometer, or approved equal.

**907-624.02.2.8--Wet Reflectivity.** The initial reflectance for the in-place marking when wet shall have a minimum reflectance value of 200 mcd/ft<sup>2</sup> for white and 175 mcd/ft<sup>2</sup> for yellow, when measured with an approved retroreflectometer. The stripe shall be wetted utilizing a pump type sprayer for five (5) seconds. After 30 seconds, place the retroreflectometer on the stripe and measure the reflectance.

**907-624.02.2.9--Inverted Profile.** The thermoplastic pavement marking material shall be applied to have individual profiles having a minimum height of 0.140 inches with the recessed inverted profiles having a thickness of 0.025 to 0.050 inches. The profiles shall be well defined, spaced approximately one (1) inch apart, and not excessively run back together.

**907-624.02.3--Black Pavement Marking Material for High Contrast Inverted Profile Pavement Markings.**

**907-624.02.3.1--General.** In the molten state, the material shall not give off fumes that are toxic or otherwise injurious to persons or property. The manufacturer shall provide material safety data sheets for the product.

The temperature versus viscosity characteristic of the plastic material shall remain constant and the material shall not deteriorate in any manner during three reheating processes. There shall be no obvious change in color of the material as a result of up to three reheatings, or in maintaining the material at application temperature up to an aggregate time of four (4) hours, or from batch to batch. The maximum elapsed time after application at which normal traffic will leave no impression or imprint on the new stripe shall be 30 seconds when the air and road surface temperature is approximately 68 ±5°F. The applied stripe shall remain free from tack and shall not lift from the pavement under normal traffic conditions within a road temperature range of -20°F to 150°F. The stripe shall maintain its original dimensions and placement. Cold ductility of the material shall be such as to permit normal dimensional distortion as a result of tire impact within the temperature range specified.

The material shall provide a stripe that has a uniform thickness throughout its cross section.

**907-624.02.3.2--Binder.** The binder shall be hydrocarbon or alkyd/maleic based. The binder shall consist of a homogeneous mixture of pigment, fillers, resins, waxes and plasticizers. The total

binder content shall be well distributed throughout the compound. The binder shall be free from all foreign objects or ingredients that would cause bleeding, staining or discoloration. The binder shall be 19 percent minimum by weight of the thermoplastic compound.

**907-624.02.3.3--Pigment.** The pigment used for black pavement marking compound shall be as required and shall be uniformly distributed throughout the marking compound.

**907-624.02.3.4--Filler.** The filler to be incorporated with the resins shall be a white calcium carbonate, silica or any approved substitute.

**907-624.02.3.5--Specific Gravity.** The specific gravity of the marking compound shall not exceed 2.0.

**907-624.02.3.6--Softening Point.** After heating the marking compound for 4 hours  $\pm$ 5 minutes at  $375 \pm 3^\circ\text{F}$  and testing in accordance with ASTM E 28, the material shall have a minimum softening point of  $180^\circ\text{F}$  as measured by the ring and ball method.

**907-624.02.3.7--Tensile Bond Strength.** After heating the marking compound for 4 hours  $\pm$ 5 minutes at  $375 \pm 3^\circ\text{F}$ , the tensile bond strength shall exceed 180 psi when tested in accordance with ASTM D 4806. The material shall be applied to unprimed, sandblasted Portland cement concrete block at a thickness of 0.0625-inch and at a temperature of  $375 \pm 3^\circ\text{F}$ . The test shall be conducted at room temperature.

**907-624.02.3.8--Impact Resistance.** After heating the marking compound for 4 hours  $\pm$ 5 minutes at  $375 \pm 3^\circ\text{F}$ , the impact resistance shall be a minimum of 50 inch-pounds minimum when tested in accordance with ASTM D 2794. No cracks or bond loss shall occur when a 0.0625-inch thick film drawdown is made at  $375 \pm 3^\circ\text{F}$  on an unprimed sandblasted Portland cement concrete block. The sample is tested with a male indenter 5/8-inch and no female Die at room temperature.

**907-624.02.3.9--Identification.** Each package of material shall be stenciled with the manufacturer's name, the type of material and specification number, the month and year the material was packaged and lot number. The letters and numbers used in the stencils shall be a minimum of 1/2 inch in height.

**907-624.02.3.10--Packaging.** The material shall be packaged in suitable containers that will not adhere to the product during shipment and storage. The container of pavement marking material shall weigh approximately 50 lbs. Each container shall designate the color, type of resin, type of application and user information. The label shall warn the user that the material shall be heated in the range of  $350^\circ$  to  $425^\circ\text{F}$ .

**907-624.02.3.11--Storage Life.** The material shall meet the requirements of this specification for a period of one year. The material must also meet uniformly with no evidence of skins or unmelted particles for this one-year period. The manufacturer shall replace any material not meeting the above requirements.

**907-624.02.3.12--Certifications.** The material manufacturer shall furnish a certified copy of material test reports to the Engineer.

**907-624.02.4--Drop-On Glass Beads.** Drop-on glass beads shall be separated into two (2) classes, as follows:

**907-624.02.4.1--Class G Glass Beads.** Class G glass beads shall be coated with an adhesion promoting coating which shall also provide moisture resistance as tested by AASHTO M 247, Section 4.4.2 and shall exhibit the following characteristics:

- **Color and Clarity:** The glass beads shall be colorless and clear, and shall be free of carbon residues.
- **Index of Refraction:** minimum 1.50
- **Roundness:** The glass beads shall have a minimum of 80% true spheres per screen for the two highest sieve quantities, determined visually, and a maximum of 3% angular particles per sieve, determined visually. The remaining sieves shall have a minimum of 75% true spheres, determined visually per aspect ratio using microfiche reader.
- **Air Inclusions:** 10% maximum
- **Specific Gravity:** The specific gravity of the glass beads shall be a minimum of 2.50.
- **Gradation:** The gradation of Class G glass beads shall be as follows:

<u>U. S. Standard Sieve</u>	<u>% Passing</u>
12	100
14	100 - 95
16	100 - 80
18	100 - 20
20	90 - 20
30	100 - 50
Pan	100 - 90

All Class G glass beads shall be coated with an adhesion promoting coating.

**907-624.02.4.2--Class H Glass Beads.** Class H glass beads shall meet the requirements of ASTM D 1155, and shall be coated with an adhesion promoting coating which shall also provide moisture resistance as tested by AASHTO M 247, Section 4.4.2. Class H beads shall have a minimum of 70 percent true spheres and the +20 sieve shall be tested visually.

The gradation of the Class H beads shall meet the following:

<u>U. S. Standard Sieve</u>	<u>% Passing</u>
16	99 - 100
20	75 - 100
30	55 - 95
50	10 - 35
100	0 - 5

**907-624.03--Construction Requirements.**

**907-624.03.1--Equipment.** The application equipment shall be specifically designed for placing thermoplastic material in a hot molten state on the pavement surface utilizing a pressure type application method. The thermoplastic stripe shall be formed by a die that is allowed to drag along in proximity with the pavement surface. The die is pulled forward by a special linkage that will allow it to automatically level itself as to float and remain parallel with the pavement surface. The traffic stripe shall be formed by reason that the hot thermoplastic material is forced under pressure through four sides to the die onto the pavement surface. The top of the die shall be enclosed and provide entry means for the hot molten thermoplastic material to enter the die cavity. The bottom of the die shall contain a movable door that is remote controlled so as to start or stop the flow of thermoplastic material onto the pavement surface. When the movable door is open, thermoplastic material can flow through the die and will apply a thermoplastic stripe that will be formed rearward of the advancing die. The pavement surface shall be at the bottom of the die enclosure. Thermoplastic material shall be fed to the die under pressure through flexible oil-jacketed stainless steel hoses. The thermoplastic material must be either pumped or fed from a pressure vessel to the die under pressure in order to obtain the proper adhesion with the pavement surface.

The system shall consist of a low pressure drop-on type glass bead gun, (bead coat #1). The thermoplastic die shall be oil-jacketed on four (4) sides and is formed from a single solid block of steel. The glass bead gun shall dispense glass beads onto the hot thermoplastic stripe from a height of approximately one (1) inch above the pavement surface. The point at which the glass beads strike the surface of the stripe shall be approximately three inches (3”) behind the strike point of the thermoplastic material itself. This reflective bead coat #1 shall utilize Class G glass beads as specified herein, and shall provide a surface coating of 50 percent of the thermoplastic stripe surface. Of this 50 percent stripe coverage, at least 50 percent of the beads shall be embedded to a depth of 60 percent of their diameter.

A second curtain coater, low pressure drop-on type glass bead gun capable of applying a continuous sheet or ribbon of glass beads, shall follow at an interval of approximately 10 inches behind the first bead gun. This second glass bead gun shall apply bead coat #2 which will form a continuous drop-on coat of Class H glass beads immediately in front of the profiling device. This second curtain of glass beads shall have a low impact speed so that they are not forced into the stripe under pressure.

A special rotatable wheel profiling device shall be located approximately eight (8) inches behind bead gun #2. This rotatable wheel device shall be approximately seven (7) inches in diameter and shall have a plurality of spaced projections located around its circumference. The profiling device shall be wider than the stripe being applied in order that the stripe shall be adequately covered. The projections on the rotatable profiling device shall have an angular profiling surface set at an angle to the pavement surface. The rotatable profile device shall be mounted with an automatic leveling device to the same carriage assembly as the thermoplastic gun. This is required so that a traffic stripe of accurate and uniform definition can be obtained. The inverted profile grooves shall be pressed into the hot molten thermoplastic stripe within one (1) second of the thermoplastic material application in order to insure proper bead adhesion to the stripe. Using rollers to place grooves in the traffic stripe utilizing a separate vehicle or grooves that are not pressed within one

(1) second of the thermoplastic material application will not be allowed. To insure that no thermoplastic material adheres to the wheel as it rotates and profiles the stripe, a small air atomizer water jet shall apply a thin mist coat of water to the rotatable profile wheel. It is the intent of this specification that a minimum amount of water be used and that no water puddles greater than ¼ inch in diameter be allowed to accumulate on the pavement surface in proximity to the freshly placed stripe. Excess water on the pavement surface can cause bond failure of the thermoplastic material.

All parts of the thermoplastic holding tank including manifolds, hoses, pipes, dies, etc., shall be oil-jacketed to insure accurate temperature control. The thermoplastic material shall be preheated in kettles designed specifically for that purpose. Each kettle of preheated thermoplastic material shall be properly mixed and heated to the correct application temperature. The preheated material shall then be fed to the thermoplastic gun for application.

The striping machine shall contain enough glass beads and water to apply one full kettle of thermoplastic material.

**907-624.03.2--Cleaning of Pavement Surface.** Immediately before application, the areas to receive markings shall be cleaned thoroughly using equipment capable of cleaning without damaging the pavement surface. This will include, but not be limited to, all vegetation, loose soil, oils, and other debris. On areas of pavement cured with compound, the membrane shall be removed completely by "shot" blasting, sand blasting or other approved method. Striping shall follow as closely as practical after the pavement surface has been cleaned.

**907-624.03.3--Application Over Existing Striping.** Where shown on the plans or directed by the Engineer, the existing traffic stripe shall be removed by grinding or sandblasting. When placing inverted profile thermoplastic pavement markings on existing pavement that has more than one light coat (pavement not showing through stripe) of striping material, the existing stripe shall be removed to the point that 80 percent of the pavement surface is visible.

Removal of existing stripe will be paid for as a separate item of work.

Where unsatisfactory striping performed by the Contractor must be removed and replaced in accordance with these specifications, the Contractor shall use the removal method described above. No payment will be made for removal or replacement of the Contractor's unsatisfactory striping.

**907-624.03.4--Surface Conditions.** When placing inverted profile thermoplastic pavement markings, no striping shall be permitted when the pavement surface temperature is less than 60°F. A non-contact infrared pyrometer shall be furnished by the Contractor for use by the Engineer for verification of the temperature. Striping shall not be performed when there is moisture on the pavement surface or when winds exceed 12 mph. When unseen moisture is suspected to be present, a moisture test shall be performed. The test shall be as follows:

- 1) Place a piece of roofing felt on the pavement surface.
- 2) Pour 0.5 gallon of thermoplastic material at application temperature onto the paper.

- 3) After two (2) minutes, lift the paper and inspect to see if moisture has been drawn from the pavement.
- 4) If moisture is present, striping is not to begin until the surface is moist free.

Documentation of weather and pavement conditions shall be recorded as part of completing the MDOT Inverted Profile Thermoplastic Pavement Marking Inspectors Report.

**907-624.03.5--Application.** Prior to the placement of pavement markings, the Contractor shall furnish the Engineer three copies of the manufacturer's warranty stating that the manufacturer will guarantee the pavement marking to meet the requirements of this specification.

The thermoplastic material shall be preheated and thoroughly mixed. The application temperature of the thermoplastic material shall be between 400°F and 430°F. A digital thermometer complete with a 24-inch probe shall be furnished by the Contractor for use by the Engineer for verification of the temperature.

When measured at the highest point of the profile, the cold thickness of the in-place thermoplastic stripe shall be a minimum of 0.140 inch for Inverted Profile Thermoplastic Pavement Markings. The thickness of the thermoplastic material in the bottom of the profiles shall range from 0.025 to 0.050 inch. The individual profiles shall be located transversely across the stripe at intervals of approximately one (1) inch. The bottoms of these intervals shall be between 3/32 inch and 5/16 inch wide. In order to drain water and to reflect light, it is normal for the top surface of the inverted profiles to be irregular. The application rate of thermoplastic material for Inverted Profile Thermoplastic Pavement Markings shall be a minimum of 2700± pounds per mile for a continuous 6-inch stripe.

The application rate for Class G glass beads (bead coat #1) shall be 300± pounds per mile for 6-inch continuous stripe.

The application rate for Class H glass beads (bead coat #2) shall be 300± pounds per mile for 6-inch continuous stripe.

The thickness of the striping materials shall be verified periodically (at least every 1320 feet) and any thickness more than five (5) percent under the designated thickness shall be reworked. A consistent, uncorrected under-run will not be allowed and the Contractor will be required to install the specified minimum thickness of 0.140 inch. A wet thickness gauge and cold thickness gauge shall be furnished by the Contractor for use by the Engineer for the verification of film thickness.

When striping over existing painted stripe (one light coat), on old oxidized asphalt, on all concrete surfaces or on asphalt surfaces when ambient temperatures are below 70°F, a two component epoxy primer sealer shall be used and installed as recommended in writing by the thermoplastic material manufacturer. The epoxy primer sealer shall be EX255/EX256 as manufactured by Crown Paint Company of Oklahoma City, Oklahoma, or approved equal. The Contractor shall furnish certification of compatibility of the epoxy primer sealer to be used with the thermoplastic material supplied. If an alternate epoxy primer sealer to the EX255/EX256 is used, the Contractor

shall furnish a mill analysis and proof of adequate performance of the alternate epoxy primer sealer when used with thermoplastic pavement markings.

**907-624.03.6--Inverted Profile Thermoplastic Traffic Stripe, High Contrast.** Before applying the black pavement marking material, the Contractor shall remove any dirt, glaze, grease or any other material that would reduce the adhesion of the thermoplastic to the pavement.

The pavement marking material shall be installed in a molten state by the spray method at a minimum temperature of 350°F and a maximum temperature of 425°F. Scorching or discoloration of material shall be cause for rejection by the Engineer. The machinery shall be constructed so that all mixing and conveying parts, up to and including the thermoplastic gun, maintain the material in the molten state.

The pavement marking materials shall not be applied when air and pavement surface temperatures are below 60°F or when the surface of the pavement contains any evidence of moisture.

The pavement marking material shall be applied at a thickness of not less than 0.040-inch.

The equipment used to install hot applied pavement marking material shall provide continuous mixing and agitation of the material while maintaining a minimum temperature exceeding 400°F. A strainer shall be in place between the main material reservoir and the gun to prevent accumulation and clogging. The equipment shall be constructed for easy accessibility to parts requiring cleaning and maintenance.

After the black thermoplastic pavement markings are applied, inverted profile thermoplastic markings shall be placed over the black thermoplastic pavement markings in accordance with the specifications and to the dimensions and details shown on the plans or established.

**907-624.03.7--Warranty.** The manufacturer shall warrant that the inverted profile thermoplastic markings will meet the minimum performance level of 150 mcd/fc/sq. ft. dry and 75 mcd/fc/sq. ft. wet for a period of 48 months from the date of final inspection when exposed to normal roadway conditions regardless of the average daily traffic. Failure to meet this requirement will result in the total replacement of the portion of the stripe shown to be below these minimums. All costs of labor, material and other incidentals necessary for the replacement of unacceptable pavement markings shall be at no additional costs to the State.

Compliance will be determined by an average brightness reading over a minimum zone marking length of 300 linear feet, using an approved reflectometer. The zone of measurement referred to includes centerline stripe, edge lines and skip lines.

<b>Performance Requirements:</b>	<b>White</b>		<b>Yellow</b>	
	<b><u>Dry</u></b>	<b><u>Wet</u></b>	<b><u>Dry</u></b>	<b><u>Wet</u></b>
Initial Reflectivity, mcd/fc/sq. ft.	450	200	350	175
48-Month Retained Reflectivity	150	75	150	75



The measurement procedure for this warranty will entail a visual night inspection by a manufacturer representative and a MDOT representative to identify areas of the installation, which appear to be below the specified minimum, warranted reflectance value. All reflectance measurements for dry conditions shall be made on a clean dry surface at a minimum temperature of 40°F. All reflectance measurements for wet conditions shall be made using the setting conditions of Subsection 907-624.02.2.8 at a minimum temperature of 40°F.

Measurement intervals for installations with areas less than, or equal to, three (3) miles shall be at a minimum of three (3) check points for each zone. These check points should include the start point, approximate mid-point and the end point.

Measurement intervals for installations with areas greater than three (3) miles shall be at a minimum of three (3) check points, one at the start point, one at the end point and additional measurements spaced at 3-mile intervals between the start and end points of the area in question.

The number of measurements at each check point for each zone will be as follows:

- (A) Skip Lines: Eighteen (18) measurements, distributed over six (6) skip lines, shall be made at each check point.
- (B) Center Lines and/or Edge Lines: Eighteen (18) measurements shall be made over 300 linear feet of continuous stripe.

When taking reflectivity measurements, the value of the measurement shall be determined by averaging three measurements; one at the left edge of the stripe, one at the center of the stripe and one at the right edge of the stripe.

In addition, the reflectance values measured at each check point shall be averaged by zone to determine conformance to the minimum warranted reflective values.

**907-624.04--Method of Measurement.** Inverted profile thermoplastic traffic stripe of the type specified will be measured by the mile or by the linear foot, as indicated, from end-to-end of individual stripes. In the case of skip lines the measurement will include skips. The length used to measure centerline and edge stripes will be the horizontal length computed along the stationed control line. Inverted profile thermoplastic detail traffic stripe will be measured by the linear foot from end-to-end of individual stripes. Measurements will be made along the surface of each stripe and will exclude skip intervals where skips are specified. Stripes more than six (6) inches in width will be converted to equivalent lengths of six-inch widths.

**907-624.05--Basis of Payment.** Inverted profile thermoplastic traffic stripe, measured as prescribed above, will be paid for at the contract unit price per mile or linear foot, as applicable, which shall be full compensation for completing the work.

Payment will be made under:

907-624-A:	6" Inverted Profile Thermoplastic Traffic Stripe, Skip White *	- per linear foot or mile
907-624-B:	6" Inverted Profile Thermoplastic Traffic Stripe, Continuous White *	- per linear foot or mile
907-624-C:	6" Inverted Profile Thermoplastic Traffic Stripe, Skip Yellow *	- per linear foot or mile
907-624-D:	6" Inverted Profile Thermoplastic Traffic Stripe, Continuous Yellow *	- per linear foot or mile
907-624-E:	Inverted Profile Thermoplastic Detail Traffic Stripe, <u>Color</u> *	- per linear foot

\* High Contrast may be specified

## MISSISSIPPI DEPARTMENT OF TRANSPORTATION

SPECIAL PROVISION NO. 907-626-9

CODE: (SP)

DATE: 09/05/2018

SUBJECT: Audible Thermoplastic Traffic Markings

Section 626, Thermoplastic Traffic Markings, of the 2017 Edition of the Mississippi Standard Specifications for Road and Bridge Construction is hereby amended as follows.

**907-626.01--Description.** After the first paragraph of Subsection 626.01 on page 492, add the following.

This work may also consist of placing a profile (raised shape) marking system on centerline or edge line that provides audible and vibratory warning when driven over. The markings system shall be a road marking system of the dimensions indicated at regular and predetermined intervals. When placed on centerline, the markings system shall consist of an extruded black transverse thermoplastic bars of the dimensions indicated at regular and predetermined intervals.

**907-626.02--Materials.**

**907-626.02.1--Thermoplastic Material.** After the paragraph in Subsection 626.02.1 on page 493, add the following.

Thermoplastic material for edge line transverse bars shall be white thermoplastic meeting the above requirements. Thermoplastic material for centerline transverse bars shall meet the above requirements but shall be black in color. The black color must be acceptable to the Engineer.

**907-626.03--Construction Requirements.**

**907-626.03.1--Thermoplastic Stripe.** After Subsection 626.03.1.2 on page 495, add the following.

**907-626.03.1.3--Transverse Bars.** The length of transverse bars is the measurement lateral to the travel way, also known as transverse width. The width of transverse bars is the measurement parallel to the travel way.

Transverse bars on centerline shall have a length of 10 inches, a width of three inches (3"), and a height of 350 mils (0.35"). Transverse bars on centerline shall be placed on 2-foot centers through no-passing zones and 5-foot centers through passing zones.

Transverse bars on edge line shall have a length of six inches (6"), a width of three inches (3"), and a height of 350 mils (0.35"). Transverse bars on edge lines shall be placed on 2-foot centers. The above dimensions are based on 6-inch stripe application.

The tolerance for the length and width measurements shall be 0.25 inch (1/4”), and the tolerance for height shall be 50 mils (0.05”).

Transverse bars may be placed in advance of permanent thermoplastic markings or after placement of the permanent stripe. This may be accomplished in multiple-pass operations or in a single-pass operation. Regardless of which method is used, the required thicknesses and tolerances shall be met.

**907-626.04--Method of Measurements.** After the first paragraph of Subsection 626.04 on page 495, add the following.

Thermoplastic audible centerline skip stripe will be measured by the linear foot or mile. Measurements will be made along the surface from end-to-end of the stripe and will include skip intervals. The length used to measure audible centerline stripe will be the horizontal length computed along the stationed control line. The length measured for thermoplastic audible centerline skip stripe will not include the permanent centerline continuous or skip stripe. Permanent centerline continuous and skip stripe will be measured for payment under separate pay items.

Thermoplastic audible edge stripe will be measured by the linear foot or mile. Measurements will be made along the surface from end-to-end of the stripe. The length used to measure thermoplastic audible edge stripe will be the horizontal length computed along the stationed control line. The length measured for thermoplastic audible edge stripe will not include the permanent thermoplastic edge stripe. Permanent thermoplastic edge stripe will be measured for payment under a separate pay item.

**907-626.05--Basis of Payment.** Add the following to the list of pay items on pages 495 and 496.

907-626-A: Thermoplastic Audible Traffic Stripe, Centerline Skip - \* - per linear foot or mile

907-626-C: Thermoplastic Audible Edge Stripe - per linear foot or mile

\* Indicate Passing Zone, or No-Passing Zone

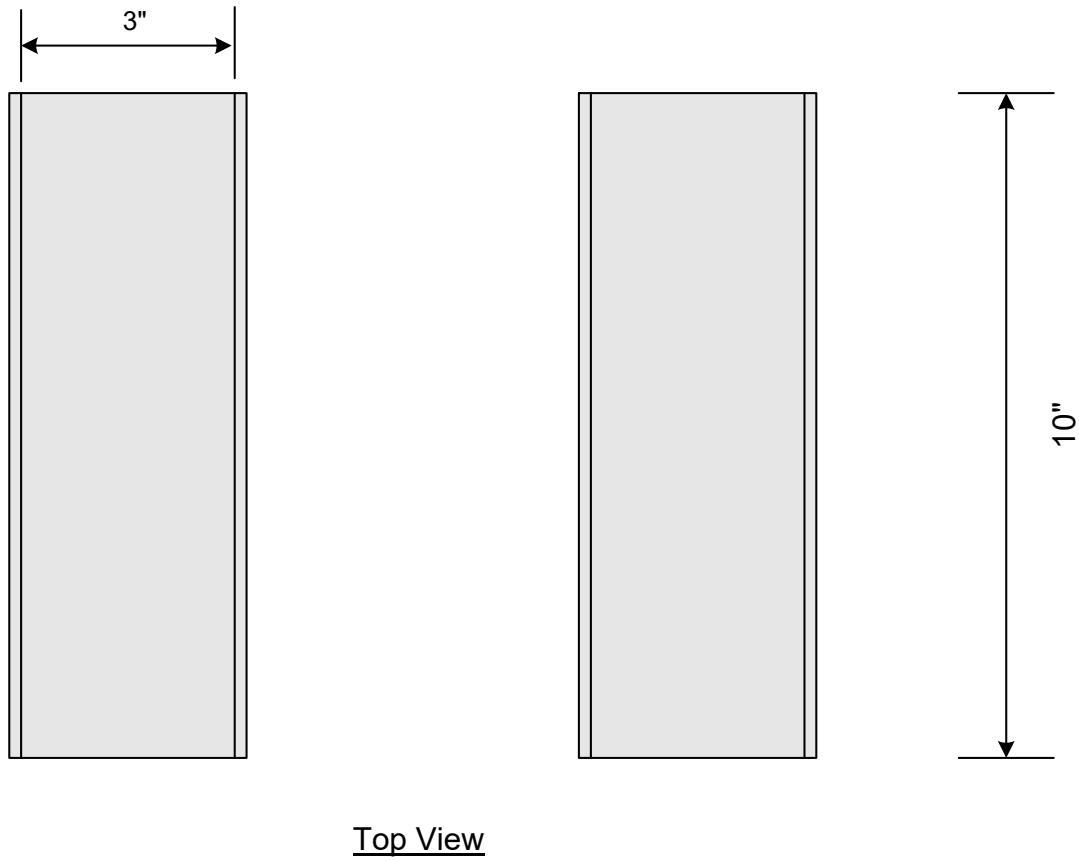
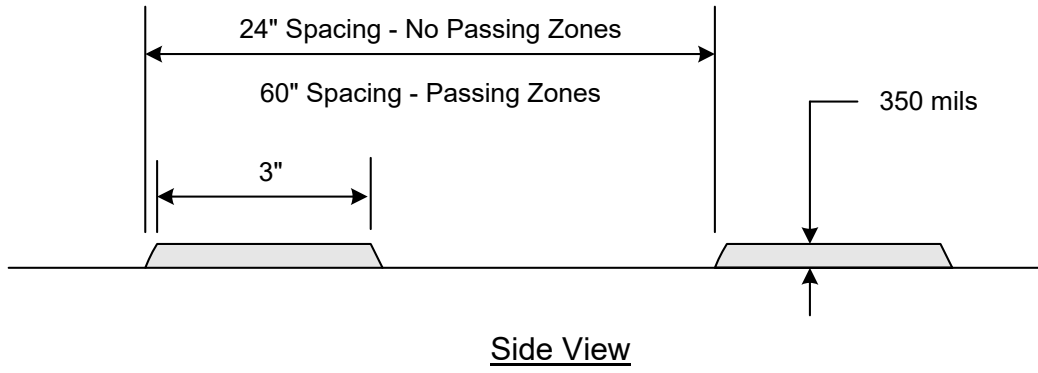

### Detail of Audible Centerline Markings

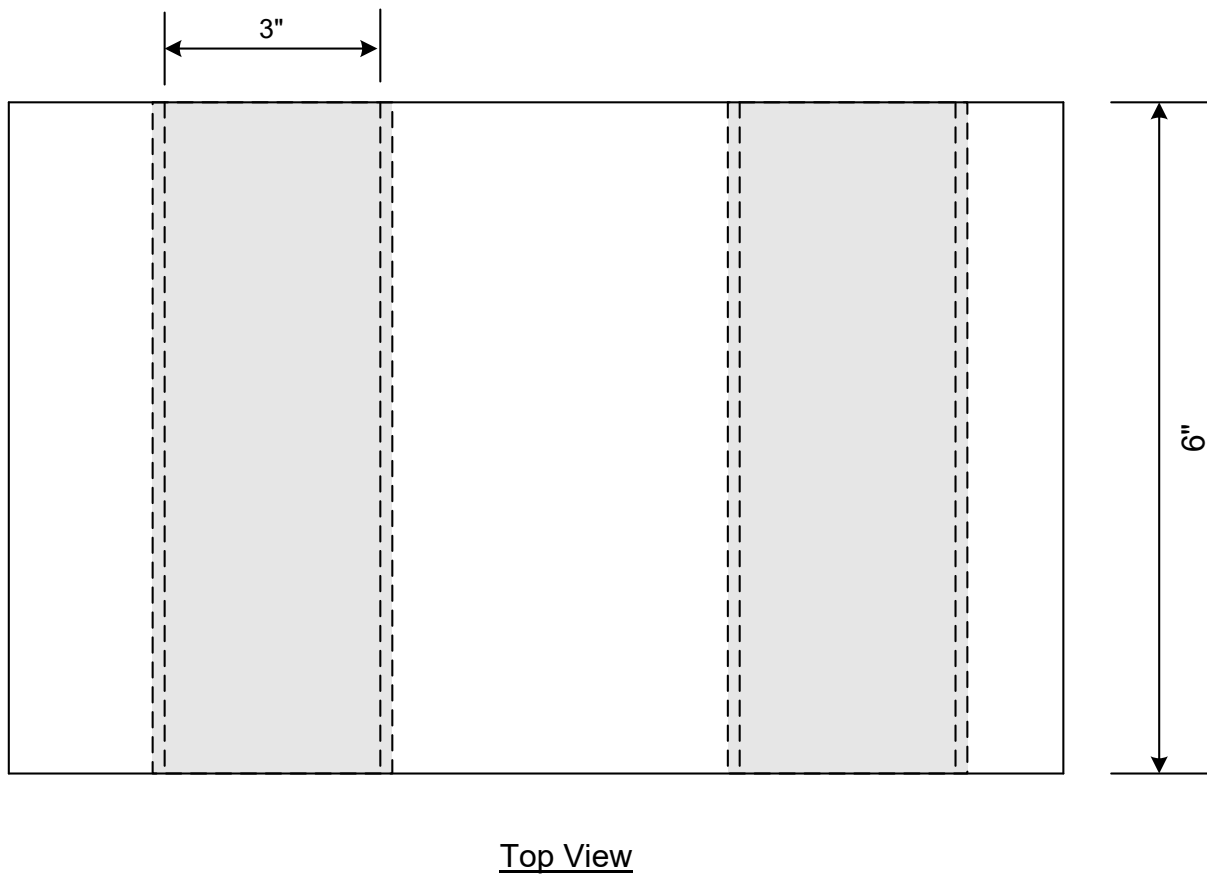
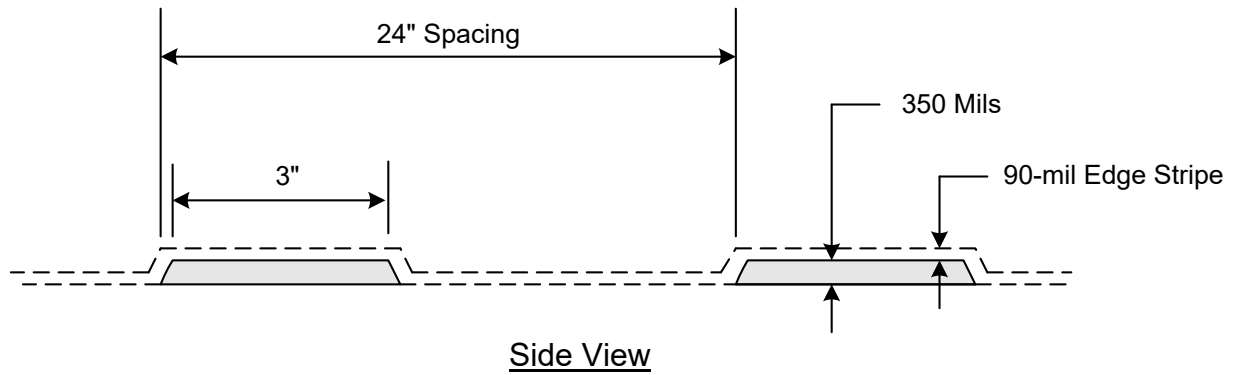

## Detail of Audible Edge Line Markings

Note: The above detail shows the transverse bars being place before the permanent [edge stripe](#). Placement of transverse bars before or after the permanent [edge stripe](#) is acceptable. [Permanent edge stripe will be paid for separately from the audible edge stripe.](#)

# MISSISSIPPI DEPARTMENT OF TRANSPORTATION

SPECIAL PROVISION NO. 907-626-10

CODE: (SP)

DATE: 09/12/2018

SUBJECT: Audible Bump Thermoplastic Traffic Markings

Section 626, Thermoplastic Traffic Markings, of the 2017 Edition of the Mississippi Standard Specifications for Road and Bridge Construction is hereby amended as follows.

**907-626.01--Description.** After the first paragraph of Subsection 626.01 on page 492, add the following.

This work may also consist of placing an audible bump (puck) marking system on the edge line that provides audible and vibratory warning when driven over. The markings system shall be a road marking system of the dimensions indicated at regular and predetermined intervals.

**907-626.02--Materials.** After Subsection 626.02.2 on page 493, add the following.

**907-626.02.3--Audible Bumps.** Audible bumps shall have a profile such that the leading and trailing edges are sloped at a sufficient angle to create an audible and vibratory warning.

Audible bumps shall be at least 0.45 inches above the pavement surface at the highest point of the bump. The height shall be measured after the application of drop-on beads. The bumps shall have a minimum dimension of two and one-half inches (2½”) in both transverse and longitudinal directions. The bumps may have a drainage channel. The width of each drainage channel shall not exceed ¼ of an inch at the bottom of the channel.

**907-626.03--Construction Requirements.**

**907-626.03.1.1--Equipment.** After the last paragraph of Subsection 626.03.1.1 on page 494, add the following.

The equipment for placing the audible bumps shall be an automated device attached to the striper that will dispense and seat the bumps in the center of the freshly placed thermoplastic marking at a spacing of 30 inches.

**907-626.04--Method of Measurements.** After the last sentence of the first paragraph of Subsection 626.04 on page 495, add the following.

The length measured for thermoplastic audible bump edge stripe will not include the permanent thermoplastic edge stripe. Permanent thermoplastic edge stripe will be measured for payment under a separate pay item.

**907-626.05--Basis of Payment.** Add the following to the list of pay items on pages 495 and 496.

907-626-C: Thermoplastic Audible Bump Edge Stripe - per linear foot or mile

**MISSISSIPPI DEPARTMENT OF TRANSPORTATION**

**SPECIAL PROVISION NO. 907-630-3**

**CODE: (SP)**

**DATE: 01/03/2018**

**SUBJECT: LED Enhanced Traffic Sign**

Section 630, Traffic Signs and Delineators, of the 2017 Edition of the Mississippi Standard Specifications for Road and Bridge Construction is hereby amended as follows.

**907-630.01--Description.** After the first paragraph of Subsection 630.01 on page 502, add the following.

This work may also include furnishing and installing an LED enhanced traffic sign in accordance with the requirements shown on the plans and set out in these specifications.

**907-630.02--Materials.** Delete Subsection 630.02.6 on page 505, and substitute the following.

**907-630.02.6--LED Enhanced Traffic Sign.** LED enhanced signs must meet the requirements of the Manual on Uniform Traffic Control Devices (MUTCD) latest edition, Section 2A.07. LED units may only be used individually within the legend or symbol of a standard roadside sign and in the border of a sign.

The LEDs shall be the same color as the sign legend, border, or background. LED enhanced signs may be solar powered or hard wired per plans.

The LED's on the sign shall have a maximum diameter of ¼ inch and shall be the following colors based on the type of sign:

- A. STOP or YIELD signs ..... White or red
- B. Regulatory signs other than STOP or YIELD signs ..... White
- C. Warning signs ..... White or yellow
- D. School Area signs ..... White or yellow

The LEDs may be set to flash or operate in steady mode in accordance with the contract documents. If flashed, all LED units shall flash simultaneously at a rate of more than 50 and less than 60 times per minute. LEDs may be illuminated 24 hours a day, or be activated by vehicles or pedestrians in accordance with contract documents.

The uniformity of the sign shall be maintained without any decrease in visibility, legibility, or driver comprehension during either daytime or nighttime conditions.

**907-630.05--Basis of Payment.** Add the following to the list of pay items beginning on page 510.

907-630-A: Standard Roadside Signs, LED Enhanced - per square foot



## MISSISSIPPI DEPARTMENT OF TRANSPORTATION

SPECIAL PROVISION NO. 907-701-1

CODE: (SP)

DATE: 10/23/2018

SUBJECT: Hydraulic Cement

Section 701, Hydraulic Cement, of the 2017 Edition of the Mississippi Standard Specifications for Road and Bridge Construction is hereby amended as follows.

**907-701.01--General.** In the first sentence of the third paragraph of Subsection 701.01 on page 718, change “mills” to “plants.”

In the second sentence of the seventh paragraph of Subsection 701.01 on pages 718 and 719, change “shall” to “will.”

**907-701.02--Portland Cement.**

**907-701.02.1-General.**

**907-701.02.1.2--Alkali Content.** Delete the sentence in Subsection 701.02.1.2 on page 719, and substitute the following.

The Equivalent alkali content for all cement types in this Subsection shall not exceed 0.60%.

**907-701.02.2--Replacement by Other Cementitious Materials.** Delete the paragraph in Subsection 701.02.2 on page 719, and substitute the following.

The maximum replacement of cement by weight is 25% for fly ash or 50% for ground granulated blast furnace slag (GGBFS). Replacement contents below 20% for fly ash or 45% for GGBFS may be used, but will not be given any special considerations, such as the maximum acceptance temperature for portland cement concrete containing pozzolans in Subsection 804.02.13.1.5. Special considerations shall only apply for replacement of cement by fly ash or GGBFS.

Delete Subsection 701.02.2.1 on pages 719 and 720, and substitute the following.

**907-701.02.2.1--Portland Cement Concrete Exposed to Soluble Sulfate Conditions or Seawater.**

When portland cement concrete is exposed to moderate or severe soluble sulfate conditions, or to seawater, cement types and replacement of cement by Class F fly ash or GGBFS shall be as follows in Table 1. Class C fly ash shall not be used as a replacement for cement in any of the sulfate exposure conditions listed in Table 1.

**Table 1- Cementitious Materials for Soluble Sulfate Conditions or Seawater**

Sulfate Exposure	Water-soluble sulfate (SO <sub>4</sub> ) in soil, % by mass	Sulfate (SO <sub>4</sub> ) in water, ppm	Cementitious material required
Moderate and Seawater	0.10 - 0.20	150 - 1,500	Type I cement with one of the following replacements of cement by weight: 24.5 - 25.0% Class F fly ash, or 49.5 - 50.0% GGBFS or Type II <sup>*,**</sup> cement
Severe	0.20 - 2.00	1,500 - 10,000	Type I cement with a replacement by weight of 49.5 - 50.0% GGBFS, or Type II <sup>*</sup> cement with one of the following replacements of cement by weight: 24.5 - 25.0% Class F fly ash, or 49.5 - 50.0% GGBFS

\* Type III cement conforming to AASHTO M85 with a maximum 8% tricalcium aluminate (C<sub>3</sub>A) may be used in lieu of Type II cement as allowed in Subsection 701.02.1; this cement is given the designation “Type III(MS).”

\*\* Class F fly ash or GGBFS may be added as a replacement for cement as allowed in Subsection 907-701.02.2.

Delete Subsection 701.02.2.2 on page 720, and substitute the following.

**907-701.02.2.2--Portland Cement for Soil Stabilization Exposed to Soluble Sulfate Conditions or Seawater.** When portland cement for use in soil stabilization is exposed to moderate or severe soluble sulfate conditions, or to seawater, cement types and replacement of cement by Class F fly ash or GGBFS shall meet the requirements of Subsection 701.02.2.1.

**907-701.04--Blended Hydraulic Cement.**

**907-701.04.1--General.** Delete Subsection 701.04.1.1 on page 720, and substitute the following.

**907-701.04.1.1--Types of Blended Hydraulic Cement.** Blended hydraulic cements (blended cements) shall be of the following types and conform to AASHTO M 240:

- Type IL – Portland-limestone cement
- Type IP – Portland-pozzolan cement
- Type IS – Portland blast-furnace slag cement

Blended cement Types IL, IP, and IS meeting the “MS” sulfate resistance requirement listed in AASHTO M 240, Table 3 shall have the “(MS)” suffix added to the type designation.

**907-701.04.1.2--Alkali Content.** Delete the sentence in Subsection 701.04.1.2 on page 720, and substitute the following.

All blended cement types shall be made with clinker that would result in cement meeting the requirements of Subsection 701.02.1.2 when used in the production of AASHTO M 85, Type I or Type II cement.

**907-701.04.2--Replacement by Other Cementitious Materials.** Delete the paragraph in Subsection 701.04.2 on page 720, and substitute the following.

The maximum replacement of blended cement Type IL by weight is 35% for fly ash or 50% for GGBFS. Replacement contents below 20% for fly ash or 45% for GGBFS may be used, but will not be given any special considerations, such as the maximum acceptance temperature for blended cement concrete containing pozzolans in Subsection 804.02.13.1.5. Special considerations shall only apply for replacement of blended cement by fly ash or GGBFS.

No additional cementitious materials, such as portland cement, blended cement, fly ash, GGBFS, or others, shall be added to or as a replacement for blended cement Types IP and IS.

Delete Subsection 701.04.2.1 on pages 720 and 721, and substitute the following.

**907-701.04.2.1--Blended Cement Concrete Exposed to Soluble Sulfate Conditions or Seawater.** When blended cement concrete is exposed to moderate or severe soluble sulfate conditions, or to seawater, cement types and replacement of cement by Class F fly ash or GGBFS shall be as follows in Table 2. Class C fly ash shall not be used as a replacement for cement in any of the sulfate exposure conditions listed in Table 2.

**Table 2- Cementitious Materials for Soluble Sulfate Conditions or Seawater**

Sulfate Exposure	Water-soluble sulfate (SO <sub>4</sub> ) in soil, % by mass	Sulfate (SO <sub>4</sub> ) in water, ppm	Cementitious material required
Moderate and Seawater	0.10 - 0.20	150 - 1,500	Type IL (MS)* cement, Type IL cement with one of the following replacements of cement by weight: 24.5 - 35.0% Class F fly ash, or 49.5 - 50.0% GGBFS, Type IP (MS) cement, or Type IS (MS) cement
Severe	0.20 - 2.00	1,500 - 10,000	Type IL cement with a replacement of cement by weight of 49.5 - 50.0% GGBFS, or Type IL (MS) cement with one of following replacements of cement by weight: 24.5 - 35.0% Class F fly ash, or 49.5 - 50.0% GGBFS

- \* Class F fly ash or GGBFS may be added as a replacement for cement as allowed in Subsection 907-701.04.2.

Delete Subsection 701.04.2.2 on page 721, and substitute the following.

**907-701.04.2.2--Blended Cement for Soil Stabilization Exposed to Soluble Sulfate Conditions or Seawater.** When blended cement for use in soil stabilization is exposed to moderate or severe soluble sulfate conditions, or to seawater, cement types and replacement of cement by Class F fly ash or GGBFS shall meet the requirements of Subsection 701.04.2.1.

Delete Subsection 701.04.3 on page 721.

**MISSISSIPPI DEPARTMENT OF TRANSPORTATION**

**SPECIAL PROVISION NO. 907-702-4**

**CODE: (IS)**

**DATE: 09/11/2018**

**SUBJECT: Bituminous Materials**

Section 702, Bituminous Materials, of the 2017 Edition of the Mississippi Standard Specifications for Road and Bridge Construction is hereby amended as follows.

**907-702.04--Sampling.** Delete the sentence in Subsection 702.04 on page 722, and substitute the following.

Sampling of bituminous materials shall be as set out in AASHTO R 66.

**907-702.07--Emulsified Asphalt.** Delete the last sentence in Subsection 702.07 on page 724, and substitute the following.

Asphalt for fog seal shall conform to the requirements of Subsection 907-702.12, Table V.

**907-702.12--Tables.** Delete Table V in Subsection 702.12 on page 729, and substitute the following.

**TABLE V  
SPECIFICATION FOR FOG SEAL**

Test Requirements	LD-7		CHPF-1		Test Method
	Min.	Max.	Min.	Max.	
Viscosity, Saybolt Furol, @ 25°C, Sec.	10	100	-	100	AASHTO T 72
Storage Stability Test, 24 hr, %	-	1	-	1	AASHTO T 59
Settlement, 5 day, %	-	5	-	-	AASHTO T 59
Oil Distillate, %	-	1	-	-	AASHTO T 59
Sieve Test, % *	-	0.3	-	0.1	AASHTO T 59
Residue by Distillation, %	40	-	40	-	AASHTO T 59
<b>Test on Residue from Distillation</b>					
Penetration @ 25°C, 100g, 5 sec	-	20	40	90	AASHTO T 49
Softening Point, °C	65	-	-	-	ASTM D 36
Solubility in trichloroethylene, %	97.5	-	-	-	AASHTO T 44
Elastic Recovery @ 25°C, %	-	-	40	-	AASHTO T 301
Original DSR @ 82° (G*/Sinδ, 10 rad/sec)	1	-	-	-	AASHTO T 111

\* The Sieve Test result is tested for reporting purposes only and may be waived if no application problems are present in the field.

**MISSISSIPPI DEPARTMENT OF TRANSPORTATION**

**SPECIAL PROVISION NO. 907-703-1**

**CODE: (IS)**

**DATE: 06/13/2018**

**SUBJECT: Gradation**

Section 703, Aggregates, of the 2017 Edition of the Mississippi Standard Specifications for Road and Bridge Construction is hereby amended as follows.

**907-703.03--Course Aggregates for Hydraulic Cement Concrete.**

**907-703.03.2--Detail Requirements.**

**907-703.03.2.4--Gradation.** In the table in Subsection 703.03.2.4 on page 734, add 100 for the percent passing by weight on the 1½-inch sieve for Size No. 67 aggregates.

**MISSISSIPPI DEPARTMENT OF TRANSPORTATION**

**SPECIAL PROVISION NO. 907-705-1**

**CODE: (IS)**

**DATE: 06/13/2018**

**SUBJECT: Stone Riprap**

Section 705, Stone Blanket Protection and Filter Blanket Materials, of the 2017 Edition of the Mississippi Standard Specifications for Road and Bridge Construction is hereby amended as follows.

**907-705.04--Stone Riprap.** Delete the last sentence of the first paragraph of Subsection 705.04 on page 750, and substitute the following.

Quality requirements for rock to be furnished under these specifications will come from a pre-approved source and be visually approved prior to use.

## MISSISSIPPI DEPARTMENT OF TRANSPORTATION

SPECIAL PROVISION NO. 907-707-2

CODE: (SP)

DATE: 06/05/2019

SUBJECT: Joint Materials

Section 707, Joint Materials, of the 2017 Edition of the Mississippi Standard Specifications for Road and Bridge Construction is hereby amended as follows.

**907-707.02.3--Wood.** Delete paragraph (b) of Subsection 707.02.3 on page 755, and substitute the following:

- (b) Dimensions shall be as shown on the plans. Dimensions shown on the plans are “dressed” sizes in accordance with Table 3 of the American Softwood Lumber Standard, SP-20. At the discretion of the Engineer, a 3/4-inch dressed board may be used in lieu of a 1-inch dressed board. A tolerance of plus or minus 1/16 inch thickness and plus or minus 1/8 inch width will be permitted. For slip-form paving a tolerance of minus 1/4 inch on each end in length will be permitted.

**907-707.06--Flexible Plastic Gasket for Joining Conduit.** Delete the third paragraph of Subsection 707.06 on page 756, and substitute the following.

The Department may require the performance test described in ASTM C 990.



## MISSISSIPPI DEPARTMENT OF TRANSPORTATION

SPECIAL PROVISION NO. 907-708-2

CODE: (SP)

DATE: 11/07/2018

SUBJECT: Reinforced Concrete Pipe

Section 708, Non-Metal Structures and Cattlepasses, of the 2017 Edition of the Mississippi Standard Specifications for Road and Bridge Construction is hereby amended as follows.

**907-708.02--Concrete Pipe.**

**907-708.02.3--Exceptions to AASHTO Standard Specifications.** After Subsection 708.02.3.7 on page 760, add the following.

**907-708.02.3.8--Lifting Device.** In lieu of lift holes, the producer may cast an approved lifting device in the pipe during the manufacturing process. Should a lifting device be included with the pipe, the Contractor shall cut off the lifting device flush with the pipe after placement of the pipe. The area around the lifting device shall be coated with a sealer approved by the Engineer.

**907-708.02.5--Reinforced Concrete Pipe.** Delete the second paragraph in Subsection 708.02.5 on page 760, and substitute the following.

**907-708.02.5.1--Class V Pipe With Diameter 54 Inches and Greater.** Class V pipe with diameters of 54 inches and larger shall meet the requirements of AASHTO M 170 or M 242 as modified by Subsection 708.02 and herein.

**MISSISSIPPI DEPARTMENT OF TRANSPORTATION**

**SPECIAL PROVISION NO. 907-711-2**

**CODE: (IS)**

**DATE: 09/11/2018**

**SUBJECT: Plain Steel Wire**

Section 711, Reinforcement and Wire Rope, of the 2017 Edition of the Mississippi Standard Specifications for Road and Bridge Construction is hereby amended as follows.

**907-711.02--Deformed and Plain Carbon-Steel Bars for Concrete Reinforcing.**

**907-711.02.3--Steel Welded and Non-Welded Wire Reinforcement, Plain and Deformed, for Concrete.**

**907-711.02.3.1--Plain Steel Wire.** Delete the sentence in Subsection 711.02.3.1 on pages 780 and 781, and substitute the following.

Plain steel wire and plain steel welded wire shall conform to the requirements of AASHTO M 336.

**MISSISSIPPI DEPARTMENT OF TRANSPORTATION**

**SPECIAL PROVISION NO. 907-720-2**

**CODE: (IS)**

**DATE: 09/11/2018**

**SUBJECT: Acceptance Procedure for Glass Beads**

Section 720, Pavement Marking Materials, of the 2017 Edition of the Mississippi Standard Specifications for Road and Bridge Construction is hereby amended as follows.

**907-720.01--Glass Beads.**

**907-720.01.4--Acceptance Procedures.** Delete the last sentence of the paragraph in Subsection 720.01.4 on page 841, and substitute the following.

Acceptance sampling and testing of glass beads will be in accordance with the Department's Materials Division Inspection, Testing, and Certification Manual, Section 2.9.2 -- Glass Beads.

**MISSISSIPPI DEPARTMENT OF TRANSPORTATION**

**SPECIAL PROVISION NO. 907-721-1**

**CODE: (SP)**

**DATE: 11/05/2019**

**SUBJECT: Materials for Signing**

Section 721, Materials for Signing, of the 2017 Edition of the Mississippi Standard Specifications for Road and Bridge Construction is hereby amended as follows.

**907-721.06--Reflective Sheeting.**

**907-720.06.2--Performance Requirements.** Delete Table 4 and Table 5 in Subsection 721.06.2 on pages 860 & 861, and substitute the following.

**MINIMUM COEFFICIENTS OF RETROREFLECTION  
Candela per foot candle per square foot (cd/ft<sup>2</sup>)  
Per ASTM Designation D4956**

**TABLE 4  
Type IX Sheeting**

Observation Angle	Entrance Angle	White	Yellow	Green	Red	Blue	Fluorescent Yellow/Green	Fluorescent Yellow	Fluorescent Orange
0.2°	-4.0°	380	285	38	76	17	300	230	115
0.2°	+30.0°	215	162	22	43	10	170	130	65
0.5°	-4.0°	240	180	24	48	11	190	145	72
0.5°	+30.0°	135	100	14	27	6.0	110	81	41
1.0°	-4.0°	80	60	8.0	16	3.6	64	48	24
1.0°	+30.0°	45	34	4.5	9.0	2.0	36	27	14

**TABLE 5  
Type XI Sheeting**

Observation Angle	Entrance Angle	White	Yellow	Green	Red	Blue	Brown	Fluorescent Yellow/Green	Fluorescent Yellow	Fluorescent Orange
0.2°	-4.0°	580	435	58	87	26	17	460	350	175
0.2°	+30.0°	220	165	22	33	10	7.0	180	130	66
0.5°	-4.0°	420	315	42	63	19	13	340	250	125
0.5°	+30.0°	150	110	15	23	7.0	5.0	120	90	45
1.0°	-4.0°	120	90	12	18	5.0	4.0	96	72	36
1.0°	+30.0°	45	34	5.0	7.0	2.0	1.0	36	27	14

# MISSISSIPPI DEPARTMENT OF TRANSPORTATION

SPECIAL PROVISION NO. 907-803-4

CODE: (SP)

DATE: 04/03/2019

SUBJECT: Test Piles

Section 803, Deep Foundations, of the 2017 Edition of the Mississippi Standard Specifications for Road and Bridge Construction is hereby amended as follows.

## 907-803.03--Construction Requirement

### 907-803.03.1--Driven Piles.

#### 907-803.03.1.9--Determination of Bearing Value of Piling.

##### 907-803.03.1.9.3--Determination of Bearing Value by PDA Monitoring (Dynamic Load Testing).

###### 907-803.03.1.9.3.3--PDA Monitored Driving and/or Restrike of Piling.

907-803.03.1.9.3.3.3--Driving Requirements. Delete the first two sentences of the first paragraph of Subsection 803.03.1.9.3.3.3 on page 907, and substitute the following.

Piles to be used in the determination of pile bearing by PDA monitoring shall be driven with PDA instrumentation attached to the pile and shall have a PDA monitored 1-day restrike performed after the initial pile driving. The Engineer may modify the waiting periods that are required before the restrikes are performed. The Engineer may require additional restrikes after the 1-day restrike if deemed necessary when it is determined pile bearing requirements have not be met. Additional restrikes required by the Engineer will be paid for as a PDA restrike.

## 907-803.04--Method of Measurement.

907-803.04.12--PDA Test Pile. Delete the second paragraph of Subsection 803.04.12 on page 932 and substitute the following.

Completion of this pay item shall include the 1-day restrike after initial driving and individual components will not be considered separately. Any additional restrike required by the Engineer on this type test pile will be paid for as a Pile Restrike.

## 907-803.05--Basis of Payment.

907-803.05.2--Conventional Pile Load Tests. Delete the paragraph in Subsection 803.05.2 on page 933 and substitute the following.

Conventional static pile load tests, measured as prescribed above, will be paid for at the contract fixed unit price per each.

Delete pay items 803-B, 803-I, and 803-J on page 935 and substitute the following.

- 907-803-B: Conventional Static Pile Load Test - per each
- 907-803-I: PDA Test Pile - per each
- 907-803-J: Pile Restrike - per each

**MISSISSIPPI DEPARTMENT OF TRANSPORTATION**

**SPECIAL PROVISION NO. 907-804-6**

**CODE: (SP)**

**DATE: 02/13/2019**

**SUBJECT: Concrete Bridges and Structures**

Section 804, Concrete Bridges and Structures, of the 2017 Edition of the Mississippi Standard Specifications for Road and Bridge Construction is hereby amended as follows.

**907-804.02--Materials.**

**907-804.02.3—Non-Quality Control / Quality Assurance Concrete.**

Delete the third sentence of the first paragraph on page 936 and substitute the following.

The Contractor is required to submit mixture designs to accomplish this work in accordance with Section 804 and perform normal Quality Control functions in accordance with Table 4, Items A and B.

**907-804.02.6--Classification and Uses of Concrete.** After the last class of concrete listed in Section 804.02.6 on page 938, add the following.

- 10) Class BDX - Concrete for bridge decks (4,500 psi)

**907-804.02.10--Hydraulic Cement Concrete Mixture Design.** Add the following to Table 3 in Subsection 804.02.10 on page 941.

BDX	Bridge Deck <sup>1</sup>	57 or 67	0.42-0.45	4500	5 [-2.5]	4.5±1.5 6.5±1.5	N/A
-----	--------------------------	----------	-----------	------	----------	--------------------	-----

Delete footnote 1 of Table 3 in Subsection 804.02.10 on pages 941 & 942 and substitute the following.

<sup>1</sup> An approved synthetic structural fiber meeting the requirements of Subsection 711.04 shall be incorporated into the mixture at 1.25 times the approved dosage rate. For each additional pound of fibers per cubic yard added in excess of the requirement stated above, an additional inch of slump will be allowed up to a maximum permitted slump of eight (8) inches.

For Class BD, the maximum cementitious material content shall be 550 pounds per cubic yard

For Class BDX, the maximum cementitious material content shall be 564 pounds per cubic yard.

Delete footnote 3 of Table 3 in Subsection 804.02.10 on page 942 and substitute the following:

<sup>3</sup> The design slump selected by the Contractor for the mixture design approval is the maximum slump permitted.

Delete the last sentence of the first paragraph on page 942 and substitute the following.

Other hydraulic cements may be used in accordance with the specifications listed in Section 701. Other small coarse aggregate sizes meeting the requirements of Subsection 703.03.2.4 may be used in conjunction with the coarse aggregate sizes listed in Table 3.

**907-804.02.13.1.4--Yield.** Delete the first sentence of Subsection 804.02.13.1.4 on page 953 and substitute the following.

If the yield of the concrete mixture is more than plus or minus three percent ( $\pm 3\%$ ) of the design volume, the mixture design shall be adjusted by a Class III Certified Technician representing the Contractor to yield the correct volume, plus or minus three percent ( $\pm 3\%$ ).

**907.804.02.13.1.7--Static Segregation.** Delete the second sentence of Subsection 804.02.13.1.7 on page 954 and substitute the following.

If the static segregation of the concrete mixture design exceeds this requirement, the mixture design shall be adjusted by a Class III Certified Technician representing the Contractor to ensure a static segregation in conformance with the requirement in Table 3.

**907-804.03--Construction Requirements.** Delete Subsection 804.03.16.1 on pages 970 & 971, and substitute the following.

**907-804.03.16.1--Cold Weather Concreting.**

**907-804.03.16.1.1--Mixture Acceptance Temperature.** For the purpose of job site acceptance temperature in accordance with Subsection 804.02.13.1.5, in cold weather, the acceptance temperature of the concrete when delivered to the job site shall conform to the temperature limitations of “Temperature Limitations on Concrete when Delivered to Job Site” listed in Table 8 below. For the purpose of job site acceptance temperature in accordance with Subsection 804.02.13.1.5, cold weather is defined as three consecutive days when there is a probability that the daily average of the highest and lowest ambient temperatures is expected to be less than 40°F. This three-day forecast shall be based on the latest information available from the National Weather Service.

**TABLE 8  
COLD WEATHER TEMPERATURE LIMITATIONS ON CONCRETE  
WHEN DELIVERED TO JOB SITE**

Section thickness in the least dimension inches	Jobsite Acceptance Temperature Range °F
Less than 12	55 to 75
12 to 36	50 to 70
36 to 72	45 to 65
Greater than 72	40 to 60



When this definition of cold weather does not apply, there is no minimum job site acceptance temperature and the maximum job site acceptance temperature shall meet the requirements of Subsection 804.02.13.1.5.

**907-804.03.16.1.2--Structural Protection.** The Contractor shall assume all risk and added cost connected with the placing and protecting of concrete during cold weather. Permission given by the Engineer to place concrete during such time will in no way relieve the Contractor of responsibility for satisfactory results. Should it be determined at any time that the concrete placed under such conditions is unsatisfactory, it shall be removed and replaced with satisfactory concrete by the Contractor without extra compensation.

When the Contractor proposes to place concrete during seasons when there is a probability of ambient temperatures lower than 40°F, the Contractor shall have available on the project the approved facilities necessary to enclose uncured concrete and to keep the temperature of the air inside the enclosure within the ranges and for the minimum periods specified herein.

The Contractor shall assume all risk and added cost connected with the placing and protecting of concrete during cold weather. Permission given by the Engineer to place concrete during such time will in no way relieve the Contractor of responsibility for satisfactory results. Should it be determined at any time that the concrete placed under such conditions is unsatisfactory, it shall be removed and replaced with satisfactory concrete by the Contractor without extra compensation.

When there are indications of temperatures of less than 40°F during the first four days after placement of the concrete, the concrete shall be protected from cold temperatures by maintaining a temperature between 50°F and 100°F for at least four days after placement and between 40°F and 100°F for at least three additional days. The Contractor shall use such heating equipment such as stoves, salamanders, or steam equipment as deemed necessary to protect the concrete. When dry heat is used, means of maintaining atmospheric moisture shall be provided.

At the option of the Contractor with the approval of the Engineer, when concrete is placed during cold weather and there is a probability of ambient temperatures lower than 40°F, an approved maturity meter may be used to determine concrete strengths by inserting probes into concrete placed in a structure. The minimum number of maturity meter probes required for each structural component shall be in accordance with Table 7. An approved insulating blanketing material shall be used to protect the work when ambient temperatures are less than 40°F and shall remain in place until the required concrete strength in Table 6 is achieved. Procedures for using the maturity meter and developing the strength/maturity relationship shall follow the requirements of AASHTO T 325 and ASTM C 1074 specifications. Technicians using the maturity meter or calculating strength/maturity graphs shall be required to have at least two hours of training prior to using the maturity equipment.

Before placing concrete, all ice or frost shall be removed from the forms and reinforcement.

In the case of concrete placed directly on or in the ground, such as for footings or bottom slabs, protection and curing during cold weather may be provided as set for concrete pavement under Subsection 501.03.20.3.

**907-804.03.16.1.3--Batching Considerations.** One or more of the aggregates and/or mixing water may be heated. The aggregates may be heated by steam, dry heat, or by placing in the mixing

water that has been heated. Frozen aggregates shall not be used. When either aggregates or water are heated above 100°F, the aggregates and water shall be combined first in the mixer before the cement is added to avoid flash set. Cement shall not be mixed with water or with a mixture of water and aggregate having a temperature greater than 100°F.

The use of salt or other chemical admixtures in lieu of heating will not be permitted.

**907-804.03.17--Curing Concrete.**

**907-804.03.17.1--Water with Waterproof Cover.** In the second sentence of the fourth paragraph of Subsection 804.03.17.1 on page 973, delete the word “due”.

Delete the first sentence of the fifth paragraph of Subsection 804.03.17.1 on page 973, and substitute the following.

The Contractor shall maintain the burlap in a fully wet condition using powered fogging equipment, such as a commercially available pressure washer, which is capable of producing a fog spray of atomized droplets of water (i.e., producing a very fine and gentle mist that looks like a foggy morning) until the concrete has gained sufficient strength to allow foot traffic without the foot traffic marring the surface of the concrete.

In the second sentence of the eighth paragraph of Subsection 804.03.17.1 on page 973, replace the word “like” with “such as”.

**907-804.03.17.1.2--Liquid Membrane.** In the first sentence of the first paragraph of Subsection 804.03.17.1 on page 973, replace “polyethylene sheets” with “white polyethylene sheets.”

**907-804.05--Basis of Payment.** Delete the first and second pay items listed on page 999, and substitute the following.

907-804-A: Bridge Concrete, Class \_\_\_\_\_ - per cubic yard

907-804-B: Box Bridge Concrete, Class \_\_\_\_\_ - per cubic yard

## **SPECIAL PROVISION NO. 906-8**

### **Training Special Provision**

This Training Special Provision supersedes subparagraph 7b of the Special Provision entitled "Specific Equal Employment Opportunity Responsibilities," (Attachment 1), and is in implementation of 23 U.S.C. 140(a). Additional information regarding On the Job Training (OJT), Forms, and *Exhibits* are available at the following website.

<http://www.gomdot.com/Divisions/CivilRights/Resources.aspx>

As part of the Contractor's equal employment opportunity affirmative action program training shall be provided as follows:

The Contractor shall provide on-the-job training aimed at developing full journeymen in the type of trade or job classification involved.

The number of trainee hours to be trained under this special provision will be as indicated in the bid schedule of the contract.

In the event that a Contractor subcontracts a portion of the contract work, the Contractor shall determine how many, if any, of the trainee hours are to be trained by the Subcontractor, provided, however, that the Contractor shall retain the primary responsibility for meeting the training requirements imposed by this special provision. The Contractor shall also insure that this training special provision is made applicable to such subcontract. Where feasible, 25 percent of apprentices or trainees in each occupation shall be in their first year of apprenticeship or training.

The number of trainees shall be distributed among the work classifications on the basis of the Contractor's needs and the availability of journeymen in the various classifications within a reasonable area of recruitment. Prior to commencing construction, the Contractor shall submit to the State transportation agency for approval an OJT Trainee Schedule Form indicating the number of trainees to be trained in each selected classification, training program to be used and start date of training for each classification. Furthermore, the Contractor shall provide a Trainee Enrollment Form for each trainee enrolled. The Contractor will be credited for each trainee employed on the contract work who is currently enrolled or becomes enrolled in an approved program and will be reimbursed for such trainees as provided hereinafter.

Training and upgrading of minorities and women toward journeymen status is a primary objective of this Training Special Provision. Accordingly, the Contractor shall make every effort to enroll minority trainees and women (e.g., by conducting systematic and direct recruitment through public and private sources likely to yield minority and women trainees) to the extent that such persons are available within a reasonable area of recruitment. The Contractor will be responsible for demonstrating the steps that they take in pursuance thereof, prior to a determination as to whether the Contractor is in compliance with this Training Special Provision. This training commitment is not intended, and shall not be used, to discriminate against any applicant for training, whether a member of a minority group or not.

No employee shall be employed as a trainee in any classification in which he/she has successfully completed a training course leading to journeyman status or in which he/she has been employed as a journeyman. The Contractor should satisfy this requirement by including appropriate questions in the employee application or by other suitable means. Regardless of the method used the Contractor's records should document the findings in each case.

The minimum length and type of training for each classification will be as established in the training program selected by the Contractor and approved by the State highway agency and the

Federal Highway Administration. The State transportation agency and the Federal Highway Administration shall approve a program if it is reasonably calculated to meet the equal employment opportunity obligations of the Contractor and to qualify the average trainee for journeyman status in the classification concerned by the end of the training period. Furthermore, apprenticeship programs registered with the U.S. Department of Labor, Bureau of Apprenticeship and Training, or with a State apprenticeship agency recognized by the Bureau and training programs approved but not necessarily sponsored by the U.S. Department of Labor, Manpower Administration, Bureau of Apprenticeship and Training shall also be considered acceptable provided it is being administered in a manner consistent with the equal employment obligations of Federal-aid highway construction contracts. Approval or acceptance of a training program shall be obtained from the State prior to commencing work on the classification covered by the program. It is the intention of these provisions that training is to be provided in the construction crafts rather than clerk-typists or secretarial-type positions. Training is permissible in lower level management positions such as office engineers, estimators, timekeepers, etc., where the training is oriented toward construction applications. Training in the laborer classification may be permitted provided that significant and meaningful training is provided and approved by the division office.

Except as otherwise noted below, the Contractor will be reimbursed \$5.00 per hour of training given an employee on this contract in accordance with an approved training program. As approved by the engineer, reimbursement will be made for training persons in excess of the number specified herein.

No payment shall be made to the Contractor if failure to provide the required training is caused by the Contractor and evidences a lack of good faith on the part of the Contractor in meeting the requirements of this Training Special Provision. It is normally expected that a trainee will begin training on the project as soon as feasible after start of work utilizing the skill involved and remain on the project as long as training opportunities exist in the work classification or until the trainee has completed the training program. It is not required that all trainees be on board for the entire length of the contract. A Contractor's responsibility will have been fulfilled under this Training Special Provision if the Contractor has provided acceptable training to the number of trainees specified. The number trained shall be determined on the basis of the total number enrolled on the contract for a significant period.

Trainees will be paid at least 60 percent of the appropriate minimum journeyman's rate specified in the contract for the first half of the training period, 75 percent for the third quarter of the training period, and 90 percent for the last quarter of the training period, unless apprentices or trainees in an approved existing program are enrolled as trainees on this project. In that case, the appropriate rates approved by the Departments of Labor or Transportation in connection with the existing program shall apply to all trainees being trained for the same classification who are covered by this Training Special Provision.

The Contractor shall furnish the trainee a copy of the program being followed in providing the training. The Contractor shall provide each trainee with a certification showing the type and length of training satisfactorily completed.

The Contractor will provide for the maintenance of records and furnish periodic reports to include an OJT Trainee Monthly Report form and an OJT Trainee Termination Report form when appropriately documenting performance under this Training Special Provision.

### **Contractor's Responsibility**

1. Provide On-the-Job Training aimed at developing full journeymen in the type of trade or job classification involved. Accordingly, the Contractor shall make every effort to enroll minority trainees and women (e.g., conducting systematic and direct recruitment through public and private sources likely to yield minority and women trainees) to the extent that such persons are available within a reasonable area of recruitment.
2. Contractors are expected to fulfill their obligations under the Training Special Provisions. Those obligations will be considered fulfilled if Contractors have provided acceptable training to the number of trainees specified in the OJT Plan.
3. Upon deciding to sub-contract out a portion of the contract work, determine how many, if any, of the trainees are to be trained by the sub-Contractor. The Contractor however, shall retain the primary responsibility for meeting the training requirements imposed by the special provision. Additionally, the Contractor will ensure that the Training Special Provision is made applicable to such sub-contract. Training and upgrading of minorities and women toward journeymen status is a primary objective of the Training Special Provision.
4. Prior to commencing construction (no more than 60 days from the date of the Notice to Proceed), the Contractor shall submit to the State Transportation Agency (STA) (MDOT) for approval the Trainee Schedule Form indicating the number of trainees to be trained in each selected classification and any appropriate attachments representing their training program or OJT Plan (*See Exhibit 1*) to be used. The Contractor shall also submit Trainee Enrollment Forms for each trainee to be trained (*See Exhibit 2*). Contractors should submit the above-mentioned forms as their OJT Plan to the Project Engineer who will in turn forward on to the Office of Civil Rights for Approval.
5. Designate and make known at the preconstruction conference to the Office of Civil Rights and the Project Engineer the name of the company **Equal Employment Officer (EEO Officer)/Designated Representative** who will have the responsibility for and must be capable of effectively administering and promoting an active Contractor program of equal employment opportunity and who must be assigned adequate authority and responsibility to do so. These individuals should have the authority to sign monthly trainee enrollment/time reports.
6. **Implement the EEO policy** and contractual responsibilities to provide equal employment opportunity in each grade and classification of employment. To assure that the preceding policy is adhered to, the following actions will be taken as a minimum:
  - a. Periodic meetings of supervisory and personnel office employees will be conducted before the start of work and then not less often than once every six (6) months.
  - b. Ensure that supervisors brief all employees which include trainees on company EEO Policies.
7. Utilize the following procedures to request additional training classifications not presently approved by the STA for assignment to the OJT for training.
  - a. Initially, for a “trainee” to be trained, there must be a “journeyman” on the project site to train the employee. The “trainer” can be a supervisor, foreman or another employee in the “trainee classification” who already is a “journeyman”.

- b. If a classification is not on the “Wage Determination” included in the contract, a written request for an additional classification should be submitted by the Contractor to the Project Engineer.
- c. Preferably, the request (written) should originate in the Project Office so that they will know that the Contractor has applied for the needed classification and that payrolls will not be delayed. The Project Office will ensure that they have been given the project number, Contractor, subcontractor, craft and rate and will submit to the Office of Civil Rights.

For documentation purposes it is recommended to the Contractor that the request for additional classifications should be written and addressed to the Office of Civil Rights that states in concise manner the need for the new classification in lieu of using an existing classification within the OJT Manual. In addition, the training program with required hours and job description similar to the OJT Manual.

- d. After receipt of the Request for Additional Classification, the OJT Coordinator will:
    - 1. Review for preliminary approval and submit a new Trainee Schedule Form to the Contractor for signature.
    - 2. Upon receipt of the signed form from the Project Office/Contractor, a cover letter is attached to the appropriate documentation. The cover letter and documentation are transmitted to Department of Labor (DOL) in Washington D.C. requesting concurrence of the new classification.
  - e. If an individual is hired for the requested classification during the time frame when the STA (OJT Coordinator) is awaiting approval, the individual will be paid at the proposed wage rate.
  - f. If the DOL does not agree with the proposed classification and wage rate, the DOL will make a determination on the appropriate wage rate for the classification. The Labor Compliance Officer will make a copy of the letter and attach a cover letter which cites the recommendation and rationale for the disapproval.
  - g. If the DOL approves the request, a letter will be sent to the STA (OJT Coordinator) citing approval and the accompanying wage rate. The OJT Coordinator will make a copy of the approval letter and attach a cover letter which cites the approval of the classification and wage rate. This letter is sent to the Contractor and all “paper copies” listed at the end of the cover letter.
8. Begin training as soon as possible after the start date indicated on the Trainee Schedule Form for work utilizing the skill involved. In addition, if training does not begin at the preceding time, a written explanation will be given to the Project Engineer citing the rationale and time frame when training will commence on the project. The trainee should be briefed (furnished a copy) at this juncture on the training program for which he/she has started to ensure understanding of the phases of work and wage rates within each section of the program.
9. After commencement of work at the project site, the Contractor shall implement the following **Trainee Wage Rates** according to the Davis Bacon rules.



Normally, trainees are paid a percentage of journeyman's wages (Davis Bacon rates). The following payment plan is required in the FHWA Training Special Provision;

- a. Sixty percent (60%) of the journeyman's wages for the first half of the training period;
  - b. Seventy-five percent (75%) of the journeyman's wages for the third quarter of the training period; and
  - c. Ninety percent (90%) of the journeyman's wages for the last quarter of the training period.
10. Indicate on the payroll records the trainer i.e. roller operator trainer for a given classification.
  11. Recruit a replacement for the trainee when training obligations have not been met on a project provided that there are enough work hours remaining on the project as well as time within the work phase to complete training. Contractors will document in writing all Good Faith Efforts (GFE) in accordance with FHWA Form 1273 Section II 4a- 4e Recruitment and 6a-6d Training and Promotions) (*See Exhibit 9*). The Contractor must submit documentation of GFE i.e. efforts made to hire replacements for trainees who terminated their training program to the Office of Civil Rights. The GFE will be compiled into a letter which is attached to the MDOT Monthly Training Report and submitted to the along a MDOT Termination Report (*See Exhibit 4*) that includes the names/reasons of individuals who separated from the company during the respective reporting period. The GFE will be evaluated to determine if it is sufficient or insufficient. The Project Engineer will forward documentation to the Office of Civil Rights within five (5) days of receipt.
  12. Transferring trainees from one federal-aid project to another.
    - a. Contractors are to make written requests for transferring trainees from one federal-aid project to another federal aid project and submit to the Project Engineer to be forwarded to the Office of Civil Rights for review and approval.
    - b. In addition, if trainees are approved for transfer, the gaining project must have the same training classification approved for that project. The Contractor must provide documentation i.e. written letter that the gaining project will have sufficient work time to complete training requirements.
    - c. All hours trained by employees on a project other than their originally assigned project without the proper transfer approval will not be counted towards the OJT obligation for that project. If the OJT obligation is not met, the prime Contractor will have to show good faith efforts in fulfilling this portion of the contract requirement.
  13. Utilize and submit monthly trainee reports (*See Exhibit 3*) to document training activities to the respective Project Engineer. Monthly training reports should be accurate, concise and include the following items:

- a. Report Period (month) – the date at the top of the training report reflects the month and year the trainee received the training (not the date the report was completed by the Contractor)
  - b. Project Number – project number on the certified payroll and training report should match
  - c. Contractor Name
  - d. County
  - e. Trainee Name
  - f. Job Classification/Hours Required – obtained from OJT Manual - certified payrolls and training reports should match
  - g. Hours required – obtained from OJT Manual should match the Job Classification
  - h. Date Training Started/Terminated – inserted by the Contractor
  - i. Hours trained for the month – training performed this month on federal aid projects and inserted by a respective week ending date i.e. Sunday
  - j. Hours to date – all training annotated on report for previous and current month
  - k. Hours training remaining – subtraction of total training hours to date from training hours required
  - l. Trainee wage rate – Contractor cite the appropriate wage rate for phase of training
  - m. Original signatures and dates for respective training period citing trainee, trainer, and Company EEO Officer/Designated Representative
  - n. Every applicable field on the training report is completed
14. Monthly training reports intended for submission to the MDOT Central Office should cite activities illustrated in the individual training forms received from project personnel. [Failure of the Contractor to submit monthly trainee reports may result in the estimate not being processed and paid.](#) Monthly Training Reports should be submitted to the Project Engineer within fifteen (15) days of the current month with data covering the previous month's activities. However, if monthly training reports are not submitted within this time frame, the Contractor will provide written explanation to the Project Engineer citing the reason for the delay. In addition, a copy of this documentation will be provided to the MDOT Office of Civil Rights within ten (10) days of receipt by the Project Engineer.
15. Provide the trainee with a certification (*See Exhibit 7*) showing the type and length of training satisfactorily completed.
16. Retain all EEO records, i.e. employment breakdown by race and craft on a project, recruitment and hiring of minority and females for a period of three (3) years following the completion of contract work and shall be available at reasonable times and places for inspection by authorized representatives of the STA and the FHWA.



17. Submit an annual report to the STA each July for the duration of the project, indicating the number of minority, women, and non-minority group employees currently engaged in each work classification required by the contract work. This information is to be reported on Form PR 1391 (*See Exhibit 8*). Contractors are provided an annual notice for this reporting requirement.
18. Periodically evaluate the effectiveness of their OJT Programs and trainees' progress within the training program. Based on these evaluations, forward comments / recommendations through the Project Engineer to the Office of Civil Rights for improving or correcting deficiencies in the training program.

# SECTION 905 - PROPOSAL

Date \_\_\_\_\_

Mississippi Transportation Commission  
Jackson, Mississippi

Sirs: The following proposal is made on behalf of \_\_\_\_\_  
\_\_\_\_\_ of \_\_\_\_\_  
\_\_\_\_\_

for constructing the following designated project(s) within the time(s) hereinafter specified.

The plans are composed of drawings and blue prints on file in the offices of the Mississippi Department of Transportation, Jackson, Mississippi.

The Specifications are the current Standard Specifications of the Mississippi Department of Transportation approved by the Federal Highway Administration, except where superseded or amended by the plans, Special Provisions and Notice(s) to Bidders attached hereto and made a part thereof.

I (We) certify that I (we) possess a copy of said Standard and any Supplemental Specifications.

Evidence of my (our) authority to submit the Proposal is hereby furnished. The proposal is made without collusion on the part of any person, firm or corporation. I (We) certify that I (we) have carefully examined the Plans, the Specifications, including the Special Provisions and Notice(s) to Bidders, herein, and have personally examined the site of the work. On the basis of the Specifications, Special Provisions, Notice(s) to Bidders, and Plans, I (we) propose to furnish all necessary machinery, tools, apparatus and other means of construction and do all the work and furnish all the materials in the manner specified. I (We) understand that the quantities mentioned herein are approximate only and are subject to either increase or decrease, and hereby propose to perform any increased or decreased quantities of work at the unit prices bid, in accordance with the above.

I (We) acknowledge that this proposal will be found irregular and/or non-responsive unless a certified check, cashier's check, or Proposal Guaranty Bond in the amount as required in the Advertisement (or, by law) is submitted electronically with the proposal or is delivered to the Contract Administration Engineer prior to the bid opening time specified in the advertisement.

**INSTRUCTION TO BIDDERS: Alternate and Optional Items on Bid Schedule.**

1. Two or more items entered opposite a single unit quantity WITHOUT DEFINITE DESIGNATION AS "ALTERNATE ITEMS" are considered as "OPTIONAL ITEMS". Bidders may or may not indicate on bids the Optional Item proposed to be furnished or performed WITHOUT PREJUDICE IN REGARD TO IRREGULARITY OF BIDS.
2. Items classified on the bid schedule as "ALTERNATE ITEMS" and/or "ALTERNATE TYPES OF CONSTRUCTION" must be preselected and indicated on bids. However, "Alternate Types of Construction" may include Optional Items to be treated as set out in Paragraph 1, above.
3. Optional items not preselected and indicated on the bid schedule MUST be designated in accordance with Subsection 102.06 prior to or at the time of execution of the contract.
4. Optional and Alternate items designated must be used throughout the project.

I (We) further propose to perform all "force account or extra work" that may be required of me (us) on the basis provided in the Specifications and to give such work my (our) personal attention in order to see that it is economically performed.

I (We) further propose to execute the attached contract agreement (Section 902) as soon as the work is awarded to me (us), and to begin and complete the work within the time limit(s) provided for in the Specifications and Advertisement. I (We) also propose to execute the attached contract bond (Section 903) in an amount not less than one hundred (100) percent of the total of my (our) part, but also to guarantee the excellence of both workmanship and materials until the work is finally accepted.

I (We) shall submit electronically with our proposal or deliver prior to the bid opening time a certified check, cashier's check or bid bond for **five percent (5%) of total bid** and hereby agree that in case of my (our) failure to execute the contract and furnish bond within Ten (10) days after notice of award, the amount of this check (bid bond) will be forfeited to the State of Mississippi as liquidated damages arising out of my (our) failure to execute the contract as proposed. It is understood that in case I am (we are) not awarded the work, the check will be returned as provided in the Specifications.

**SECTION 905 -- PROPOSAL (CONTINUED)**

I (We) hereby certify by digital signature and electronic submission via Bid Express of the Section 905 proposal below, that all certifications, disclosures and affidavits incorporated herein are deemed to be duly executed in the aggregate, fully enforceable and binding upon delivery of the bid proposal. I (We) further acknowledge that this certification shall not extend to the bid bond or alternate security which must be separately executed for the benefit of the Commission. This signature does not cure deficiencies in any required certifications, disclosures and/or affidavits. I (We) also acknowledge the right of the Commission to require full and final execution on any certification, disclosure or affidavit contained in the proposal at the Commission's election upon award. Failure to so execute at the Commission's request within the time allowed in the Standard Specifications for execution of all contract documents will result in forfeiture of the bid bond or alternate security.

Respectfully Submitted,

DATE \_\_\_\_\_

\_\_\_\_\_  
Contractor

BY \_\_\_\_\_  
Signature

TITLE \_\_\_\_\_

ADDRESS \_\_\_\_\_

CITY, STATE, ZIP \_\_\_\_\_

PHONE \_\_\_\_\_

FAX \_\_\_\_\_

E-MAIL \_\_\_\_\_

(To be filled in if a corporation)

Our corporation is chartered under the Laws of the State of \_\_\_\_\_ and the names, titles and business addresses of the executives are as follows:

\_\_\_\_\_  
President Address

\_\_\_\_\_  
Secretary Address

\_\_\_\_\_  
Treasurer Address

The following is my (our) itemized proposal.

Grade, Drain, Bridge, & Pave 4-Lane approximately 9 miles of APD Corridor "V" between Fairview & SR 23, known as Federal Aid Project No. NH-APD-0078-01(011)N / 102076301 in Itawamba County.

Line no.	Item Code	Adj Code	Quantity	Units	Description[Fixed Unit Price]
<b>Roadway Items</b>					
0010	201-A001		1	Lump Sum	Clearing and Grubbing
0020	201-B001		13	Acre	Clearing and Grubbing
0030	202-A001		1	Lump Sum	Removal of Obstructions
0040	202-B007		23,425	Square Yard	Removal of Asphalt Pavement, All Depths
0050	202-B011		120	Linear Feet	Removal of Barricade, All Types
0060	202-B063		375	Square Yard	Removal of Concrete Paved Ditch
0070	202-B165		3	Each	Removal of Inlets, All Sizes
0080	202-B172		77	Square Feet	Removal of Legend, All Types
0090	202-B191		243	Linear Feet	Removal of Pipe, 8" And Above
0100	202-B215		40	Each	Removal of Sign Including Post & Footing
0110	202-B240		9,000	Linear Feet	Removal of Traffic Stripe
0120	203-A001	(E)	2,768,838	Cubic Yard	Unclassified Excavation, FM, AH
0130	203-EX020	(E)	1,215,589	Cubic Yard	Borrow Excavation, AH, FME, Class B9
0140	203-EX021	(E)	86,135	Cubic Yard	Borrow Excavation, AH, FME, Class B9-6
0150	203-G001	(E)	358,038	Cubic Yard	Excess Excavation, FM, AH
0160	203-I002		23,379	Square Yard	Site Grading
0170	206-A001	(S)	9,064	Cubic Yard	Structure Excavation
0180	206-B001	(E)	610	Cubic Yard	Select Material for Undercuts, Contractor Furnished, FM
0190	209-A005		28,849	Square Yard	Geotextile Stabilization, Type V, Non-Woven
0200	211-B001	(E)	213,855	Cubic Yard	Topsoil for Slope Treatment, Contractor Furnished
0210	213-C001		268	Ton	Superphosphate
0220	216-A001		31,401	Square Yard	Solid Sodding
0230	217-A001		11,922	Square Yard	Ditch Liner
0240	219-A001		628	Thousand Gallon	Watering (\$20.00)
0250	220-A001		268	Acre	Insect Pest Control (\$30.00)
0260	221-A001	(S)	2,803	Cubic Yard	Concrete Paved Ditch
0270	223-A001		3,210	Acre	Mowing (\$50.00)
0280	224-A001		5,000	Square Yard	Soil Reinforcing Mat
0290	225-A001		536	Acre	Grassing
0300	225-B001		268	Ton	Agricultural Limestone
0310	225-C001		1,075	Ton	Mulch, Vegetative Mulch
0320	226-A001		536	Acre	Temporary Grassing
0330	229-A001		5,000	Square Yard	Erosion Mat
0340	234-A001		60,000	Linear Feet	Temporary Silt Fence
0350	234-C001		7,100	Linear Feet	Super Silt Fence

Line no.	Item Code	Adj Code	Quantity	Units	Description	Fixed Unit Price
0360	234-D001		81	Each	Inlet Siltation Guard	
0370	234-E001		81	Each	Reset Inlet Siltation Guard	
0380	235-A001		10,700	Each	Temporary Erosion Checks	
0390	236-A008		57	Each	Silt Basin, Type D	
0400	237-A001		500	Linear Feet	Wattles, 12"	
0410	237-A002		23,800	Linear Feet	Wattles, 20"	
0420	239-A001		16,000	Linear Feet	Temporary Slope Drains	
0430	245-A001		23,800	Linear Feet	Silt Dike	
0440	246-B002		24,200	Linear Feet	Rockbags	
0450	247-A001		6	Each	Temporary Stream Diversion	
0460	249-A001		10,000	Ton	Riprap for Erosion Control	
0470	304-B001	(GT)	76,555	Ton	Granular Material, Class 3, Group C	
0480	304-B009	(GT)	176,642	Ton	Granular Material, Class 9, Group C	
0490	307-B003	(M)	238,233	Square Yard	6" Soil-Lime-Water Mixing, Class B	
0500	307-D001		3,217	Ton	Lime	
0510	307-S001	(A3)	59,559	Gallon	Bituminous Curing Seal	
0520	308-A001		6,695	Ton	Cement	
0530	308-B002	(M)	367,635	Square Yard	Soil-Cement-Water Mixing, Optional Mixers, Base	
0540	308-B003	(M)	238,233	Square Yard	Soil-Cement-Water Mixing, Optional Mixers, Design Soil	
0550	308-S001	(A3)	151,468	Gallon	Bituminous Curing Seal	
0560	321-A001		2	Mile	12" In-Grade Preparation	
0570	403-A002	(BA1)	74,056	Ton	12.5-mm, MT, Asphalt Pavement	
0580	403-A003	(BA1)	2,967	Ton	12.5-mm, ST, Asphalt Pavement	
0590	403-A006	(BA1)	42,602	Ton	19-mm, ST, Asphalt Pavement	
0600	403-A014	(BA1)	28,717	Ton	9.5-mm, MT, Asphalt Pavement	
0610	403-A015	(BA1)	2,557	Ton	9.5-mm, ST, Asphalt Pavement	
0620	403-C003	(BA1)	193	Ton	19-mm, ST, Asphalt Pavement, Trench Widening	
0630	406-D001		21,500	Square Yard	Fine Milling of Bituminous Pavement, All Depths	
0640	407-A001	(A2)	106,310	Gallon	Asphalt for Tack Coat	
0650	408-A002	(A3)	1,879	Gallon	Asphalt for Prime Coat, Cut-Back MC-70 or Emulsified EA-1	
0660	413-E001		730	Linear Feet	Sawing and Sealing Transverse Joints in Asphalt Pavement	
0670	423-A001		30	Mile	Rumble Strips, Ground In	
0680	501-E001		730	Linear Feet	Expansion Joints, Without Dowels	
0690	502-A001	(C)	1,582	Square Yard	Reinforced Cement Concrete Bridge End Pavement	
0700	601-A001	(S)	2,040	Cubic Yard	Class "B" Structural Concrete	
0710	601-B001	(S)	127	Cubic Yard	Class "B" Structural Concrete, Minor Structures	
0720	602-A001	(S)	506,902	Pounds	Reinforcing Steel	
0730	603-ALT003	(S)	2,384	Linear Feet	18" Type A Alternate Pipe	

Line no.	Item Code	Adj Code	Quantity	Units	Description	Fixed Unit Price
0740	603-ALT006	(S)	440	Linear Feet	24" Type A Alternate Pipe	
0750	603-ALT011	(S)	192	Linear Feet	36" Type A Alternate Pipe	
0760	603-ALT014	(S)	128	Linear Feet	42" Type A Alternate Pipe	
0770	603-ALT018	(S)	88	Linear Feet	54" Type A Alternate Pipe	
0780	603-CA011	(S)	5,320	Linear Feet	18" Reinforced Concrete Pipe, Class III	
0790	603-CA013	(S)	256	Linear Feet	18" Reinforced Concrete Pipe, Class IV	
0800	603-CA020	(S)	584	Linear Feet	18" Reinforced Concrete Pipe, Class V, Class B Bedding	
0810	603-CA026	(S)	488	Linear Feet	24" Reinforced Concrete Pipe, Class III	
0820	603-CA029	(S)	552	Linear Feet	24" Reinforced Concrete Pipe, Class IV, Class B Bedding	
0830	603-CA040	(S)	192	Linear Feet	30" Reinforced Concrete Pipe, Class III	
0840	603-CA042	(S)	584	Linear Feet	30" Reinforced Concrete Pipe, Class IV	
0850	603-CA043	(S)	560	Linear Feet	30" Reinforced Concrete Pipe, Class IV, Class B Bedding	
0860	603-CA055	(S)	392	Linear Feet	36" Reinforced Concrete Pipe, Class III	
0870	603-CA057	(S)	232	Linear Feet	36" Reinforced Concrete Pipe, Class IV	
0880	603-CA058	(S)	248	Linear Feet	36" Reinforced Concrete Pipe, Class IV, Class B Bedding	
0890	603-CA068	(S)	240	Linear Feet	42" Reinforced Concrete Pipe, Class IV	
0900	603-CA069	(S)	328	Linear Feet	42" Reinforced Concrete Pipe, Class IV, Class B Bedding	
0910	603-CA073	(S)	336	Linear Feet	42" Reinforced Concrete Pipe, Class V, Class B Bedding	
0920	603-CA087	(S)	416	Linear Feet	54" Reinforced Concrete Pipe, Class III	
0930	603-CA089	(S)	344	Linear Feet	54" Reinforced Concrete Pipe, Class IV	
0940	603-CA095	(S)	360	Linear Feet	54" Reinforced Concrete Pipe, Class V, Class B Bedding	
0950	603-CA099	(S)	880	Linear Feet	60" Reinforced Concrete Pipe, Class III	
0960	603-CA102	(S)	264	Linear Feet	60" Reinforced Concrete Pipe, Class IV, Class B Bedding	
0970	603-CA107	(S)	264	Linear Feet	60" Reinforced Concrete Pipe, Class V, Class B Bedding,	
0980	603-CA119	(S)	272	Linear Feet	72" Reinforced Concrete Pipe, Class III	
0990	603-CA121	(S)	224	Linear Feet	72" Reinforced Concrete Pipe, Class IV	
1000	603-CB003	(S)	52	Each	18" Reinforced Concrete End Section	
1010	603-CB004	(S)	15	Each	24" Reinforced Concrete End Section	
1020	603-CB005	(S)	12	Each	30" Reinforced Concrete End Section	
1030	603-CB006	(S)	8	Each	36" Reinforced Concrete End Section	
1040	603-CB007	(S)	6	Each	42" Reinforced Concrete End Section	
1050	603-CB009	(S)	8	Each	54" Reinforced Concrete End Section	
1060	603-CB010	(S)	11	Each	60" Reinforced Concrete End Section	
1070	603-CB012	(S)	4	Each	72" Reinforced Concrete End Section	
1080	603-CE018	(S)	176	Linear Feet	44" x 27" Concrete Arch Pipe, Class A III	
1090	603-CF005	(S)	4	Each	44" x 27" Concrete Arch Pipe End Section	
1100	603-SB011	(S)	2	Each	18" Branch Connections, Stub into Box Bridge	
1110	604-B001		25,377	Pounds	Gratings	

Line no.	Item Code	Adj Code	Quantity	Units	Description Fixed Unit Price
1120	605-AA001	(S)	2,373	Square Yard	Geotextile for Subsurface Drainage, Type III
1130	605-O004	(S)	2,736	Linear Feet	6" Perforated Sewer Pipe for Underdrains, SDR 23.5
1140	605-P004	(S)	2,500	Linear Feet	6" Non-perforated Sewer Pipe for Underdrains, SDR 23.5
1150	605-W001	(GY)	177	Cubic Yard	Filter Material for Combination Storm Drain and/or Underdrains, Type A, FM
1160	606-B001		1,800	Linear Feet	Guard Rail, Class A, Type 1
1170	606-D022		16	Each	Guard Rail, Bridge End Section, Type 1
1180	606-E001		16	Each	Guard Rail, Terminal End Section
1190	609-D004	(S)	5,273	Linear Feet	Combination Concrete Curb and Gutter Type 2 Modified
1200	612-B001		33	Cubic Yard	Flowable Fill, Non-Excavatable
1210	615-A002	(S)	320	Linear Feet	Concrete Bridge End Barrier, 33.5"
1220	616-A001	(S)	215	Square Yard	Concrete Median and/or Island Pavement, 10-inch
1230	616-A004	(S)	1,048	Square Yard	Concrete Median and/or Island Pavement, 4-inch
1240	617-A001		240	Each	Right-of-Way Marker
1250	618-A001		1	Lump Sum	Maintenance of Traffic
1260	619-A1001		6	Mile	Temporary Traffic Stripe, Continuous White
1270	619-A1006		2	Mile	Temporary Traffic Stripe, Continuous White, Type 1 Tape
1280	619-A2001		6	Mile	Temporary Traffic Stripe, Continuous Yellow
1290	619-A2005		2	Mile	Temporary Traffic Stripe, Continuous Yellow, Type 1 Tape
1300	619-A5001		2,500	Linear Feet	Temporary Traffic Stripe, Detail
1310	619-A5003		105	Linear Feet	Temporary Traffic Stripe, Detail, Type 1 Tape
1320	619-A6002		1,665	Linear Feet	Temporary Traffic Stripe, Legend
1330	619-A6005		77	Linear Feet	Temporary Traffic Stripe, Legend, Type 1 Tape
1340	619-C7001		316	Each	Two-Way Yellow Reflective High Performance Raised Marker
1350	619-D1001		515	Square Feet	Standard Roadside Construction Signs, Less than 10 Square Feet
1360	619-D2001		3,278	Square Feet	Standard Roadside Construction Signs, 10 Square Feet or More
1370	619-E1001		1	Each	Flashing Arrow Panel, Type C
1380	619-F1001		500	Linear Feet	Concrete Median Barrier, Precast
1390	619-F2001		500	Linear Feet	Remove and Reset Concrete Median Barrier, Precast
1400	619-G4001		1,350	Linear Feet	Barricades, Type III, Double Faced
1410	619-G5001		397	Each	Free Standing Plastic Drums
1420	619-G7001		53	Each	Warning Lights, Type "B"
1430	619-J1002		2	Each	Impact Attenuator, 45 MPH
1440	619-J3001		2	Each	Remove and Reset Impact Attenuator
1450	620-A001		1	Lump Sum	Mobilization
1460	621-A001		1	Each	Field Laboratory
1470	626-A004		20	Mile	6" Thermoplastic Traffic Stripe, Skip White
1480	626-C004		20	Mile	6" Thermoplastic Edge Stripe, Continuous White
1490	626-E004		4	Mile	6" Thermoplastic Traffic Stripe, Continuous Yellow

Line no.	Item Code	Adj Code	Quantity	Units	Description[Fixed Unit Price]
1500	626-F003		15	Mile	6" Thermoplastic Edge Stripe, Continuous Yellow
1510	626-G002		31,643	Linear Feet	Thermoplastic Detail Stripe, White
1520	626-G003		27,377	Linear Feet	Thermoplastic Detail Stripe, Yellow
1530	626-H004		1,631	Square Feet	Thermoplastic Legend, White
1540	626-H005		4,974	Linear Feet	Thermoplastic Legend, White
1550	627-J001		544	Each	Two-Way Clear Reflective High Performance Raised Markers
1560	627-K001		2,497	Each	Red-Clear Reflective High Performance Raised Markers
1570	627-L001		348	Each	Two-Way Yellow Reflective High Performance Raised Markers
1580	630-A001		1,503	Square Feet	Standard Roadside Signs, Sheet Aluminum, 0.080" Thickness
1590	630-A003		623	Square Feet	Standard Roadside Signs, Sheet Aluminum, 0.125" Thickness
1600	630-A005		82	Square Feet	Standard Roadside Signs, Sheet Aluminum, 0.1" Thickness
1610	630-B002		383	Square Feet	Interstate Directional Signs, Bolted Extruded Aluminum Panels, Ground Mounted
1620	630-C002		117	Linear Feet	Steel U-Section Posts, 2.0 lb/ft
1630	630-C003		2,498	Linear Feet	Steel U-Section Posts, 3.0 lb/ft
1640	630-D008		477	Linear Feet	Structural Steel Beams, W6 x 9
1650	630-E002		510	Pounds	Structural Steel Angles & Bars, 3" x 3" x 1/4" Angles
1660	630-E004		2,872	Pounds	Structural Steel Angles & Bars, 7/16" x 2 1/2" Flat Bar
1670	630-F002		10	Each	Delineators, Flexible Post Mounted, Crossover, Type I, Yellow
1680	630-F003		46	Each	Delineators, Flexible Post Mounted, Crossover, Type II, Yellow
1690	630-F006		48	Each	Delineators, Guard Rail, White
1700	630-F007		48	Each	Delineators, Guard Rail, Yellow
1710	630-G004		16	Each	Type 3 Object Markers, OM-3R or OM-3L
1720	630-K001		166	Linear Feet	Welded & Seamless Steel Pipe Posts, 3 1/2"
1730	630-K002		31	Linear Feet	Welded & Seamless Steel Pipe Posts, 3"
1740	630-K003		391	Linear Feet	Welded & Seamless Steel Pipe Posts, 4"
1750	638-A002		2	Each	Flashing Assembly, Advanced Warning, Stop Ahead
1760	699-A001		1	Lump Sum	Roadway Construction Stakes
1770	815-A007	(S)	30,870	Ton	Loose Riprap, Size 300
1780	815-A009	(S)	30,500	Ton	Loose Riprap, Size 500
1790	815-E001	(S)	55,680	Square Yard	Geotextile under Riprap
1800	815-F002	(S)	4,283	Ton	Sediment Control Stone
1810	907-228-A002		24,000	Square Yard	Erosion Control Blanket, Type II
1820	907-241-A001		50	Each	Floc Blocks
1830	907-253-A001		9,994	Linear Feet	Coir Fiber Baffle
1840	907-619-E3001		8	Each	Changeable Message Sign
1850	907-630-A001		32	Square Feet	Standard Roadside Signs, LED Enhanced, R1-1
1860	907-804-B001	(S)	612	Cubic Yard	Box Bridge Concrete, Class B



Line no.	Item Code	Adj Code	Quantity	Units	Description[Fixed Unit Price]
1870	907-832-PP003		5,000	Square Yard	Concrete Mat
1880	907-906001		1,040	Hours	Trainees (\$5.00)
<b>ALTERNATE GROUP AA NUMBER 1</b>					
1890	304-F001	(GT)	8,629	Ton	3/4" and Down Crushed Stone Base
<b>ALTERNATE GROUP AA NUMBER 2</b>					
1900	304-F002	(GT)	8,629	Ton	Size 610 Crushed Stone Base
<b>ALTERNATE GROUP AA NUMBER 3</b>					
1910	304-F003	(GT)	8,629	Ton	Size 825B Crushed Stone Base
<b>ALTERNATE GROUP BB NUMBER 1</b>					
1920	605-W002	(GY)	2,723	Cubic Yard	Filter Material for Combination Storm Drain and/or Underdrains, Type B, FM
<b>ALTERNATE GROUP BB NUMBER 2</b>					
1930	605-W003	(GY)	2,723	Cubic Yard	Filter Material for Combination Storm Drain and/or Underdrains, Type C, FM
<b>ALTERNATE GROUP CC NUMBER 1</b>					
1940	907-624-A002		3,298	Linear Feet	6" Inverted Profile Thermoplastic Traffic Stripe, Skip White
1950	907-624-B002		3,298	Linear Feet	6" Inverted Profile Thermoplastic Traffic Stripe, Continuous White
1960	907-624-D002		3,298	Linear Feet	6" Inverted Profile Thermoplastic Traffic Stripe, Continuous Yellow
<b>ALTERNATE GROUP CC NUMBER 2</b>					
1970	628-G001		3,298	Linear Feet	6" High Performance Cold Plastic Traffic Stripe, Skip White
1980	628-H001		3,298	Linear Feet	6" High Performance Cold Plastic Traffic Stripe, Continuous White
1990	628-J001		3,298	Linear Feet	6" High Performance Cold Plastic Traffic Stripe, Continuous Yellow
<b>ALTERNATE GROUP DD NUMBER 1</b>					
2000	907-626-C008		4,790	Linear Feet	Thermoplastic Audible Edge Stripe
<b>ALTERNATE GROUP DD NUMBER 2</b>					
2010	907-626-C009		4,790	Linear Feet	Thermoplastic Audible Bump Edge Stripe
<b>Bridge Items</b>					
2020	501-K001		13,120	Square Yard	Transverse Grooving
2030	803-D006	(S)	12,430	Linear Feet	HP 14 x 73 Steel Piling
2040	803-D007	(S)	29,520	Linear Feet	HP 14 x 89 Steel Piling
2050	804-C002	(S)	4,788	Linear Feet	100' Prestressed Concrete Beam, Type IV
2060	804-C026	(S)	1,317	Linear Feet	110' Prestressed Concrete Beam, Type IV
2070	804-C051	(S)	1,557	Linear Feet	130' Prestressed Concrete Beam, Type BT-72
2080	804-C065	(S)	1,894	Linear Feet	40' Prestressed Concrete Beam, Type I+2
2090	804-C084	(S)	7,120	Linear Feet	60' Prestressed Concrete Beam, Type II+2
2100	804-C121	(S)	2,857	Linear Feet	80' Prestressed Concrete Beam, Type III
2110	805-A001	(S)	1,097,184	Pounds	Reinforcement
2120	813-A002	(S)	6,595	Linear Feet	Concrete Railing, 32"
2130	815-A007	(S)	14,441	Ton	Loose Riprap, Size 300
2140	815-E001	(S)	10,697	Square Yard	Geotextile under Riprap
2150	907-803-B001	(S)	8	Each	Conventional Static Pile Load Test (\$5000.00)
2160	907-803-I003	(S)	32	Each	PDA Test Pile, HP Steel Pile

<b>Line no.</b>	<b>Item Code</b>	<b>Adj Code</b>	<b>Quantity</b>	<b>Units</b>	<b>Description[Fixed Unit Price]</b>
2170	907-803-J001	(S)	32	Each	Pile Restrike
2180	907-804-A002	(S)	1,919	Cubic Yard	Bridge Concrete, Class AA
2190	907-804-A004	(S)	4,022	Cubic Yard	Bridge Concrete, Class BD

For Informational Purposes Only

SECTION 905 - COMBINATION BID PROPOSAL (Continued)

**CONDITIONS FOR COMBINATION BID**

If a bidder elects to submit a combined bid for two or more of the contracts listed for this month's letting, the bidder must complete and execute these sheets of the proposal in each of the individual proposals to constitute a combination bid. In addition to this requirement, each individual contract shall be completed, executed and submitted in the usual specified manner.

Failure to execute this Combination Bid Proposal in each of the contracts combined will be just cause for each proposal to be received and evaluated as a separate bid.

It is understood that the Mississippi Transportation Commission not only reserves the right to reject any and all proposals, but also the right to award contracts upon the basis of lowest separate bids or combination bids most advantageous to the State.

It is further understood and agreed that the Combination Bid Proposal is for comparison of bids only and that each contract shall operate in every respect as a separate contract in accordance with its proposal and contract documents.

I (We) agree to complete each contract on or before its specified completion date.

\*\*\*\*\*

**COMBINATION BID PROPOSAL**

This proposal is tendered as one part of a Combination Bid Proposal utilizing option \_\_\_\* of Subsection 102.11 on the following contracts:

\* Option to be shown as either (a), (b), or (c).

	<u>Project No.</u>	<u>County</u>	<u>Project No.</u>	<u>County</u>
1.	_____	_____	6.	_____
2.	_____	_____	7.	_____
3.	_____	_____	8.	_____
4.	_____	_____	9.	_____
5.	_____	_____	10.	_____

(a) If Combination A has been selected, your Combination Bid is complete.

(b) If Combination B has been selected, then complete the following page.

SECTION 905 - COMBINATION BID PROPOSAL (Continued)

Project Number	Pay Item Number	Unit	Unit Price Reduction	Total Item Reduction	Total Contract Reduction
1.					
2.					
3.					
4.					
5.					
6.					
7.					
8.					

For Informational Purposes Only

SECTION 905 - COMBINATION BID PROPOSAL (Continued)

Project Number	Pay Item Number	Unit	Unit Price Reduction	Total Item Reduction	Total Contract Reduction
9.					
10.					

(c) If Combination C has been selected, then initial and complete ONE of the following.

\_\_\_\_\_ I (We) desire to be awarded work not to exceed a total monetary value of \$ \_\_\_\_\_.

\_\_\_\_\_ I (We) desire to be awarded work not to exceed \_\_\_\_\_ number of contracts.



**Certification with regard to the Performance of Previous  
Contracts or Subcontracts subject to the Equal Opportunity  
Clause and the filing of Required Reports**

The Bidder hereby certifies that he has \_\_\_\_\_, has not \_\_\_\_\_, participated in a previous contract or subcontract subject to the Equal Opportunity Clause, as required by Executive Orders 10925, 11114, or 11246, and that he has \_\_\_\_\_, has not \_\_\_\_\_, filed with the Joint Reporting Committee, the Director of the Office of Federal Contract Compliance, a Federal Government contracting or administering agency, or the former President's Committee on Equal Employment Opportunity, all reports due under the applicable filing requirements.

\_\_\_\_\_  
(COMPANY)

DATE: \_\_\_\_\_

NOTE: The above certification is required by the Equal Employment Opportunity Regulations of the Secretary of Labor (41 CFR 60-1.7 (b) (1)), and must be submitted by bidders and proposed subcontractors only in connection with contracts and subcontracts which are subject to the Equal Opportunity Clause. Contracts and Subcontracts which are exempt from the Equal Opportunity Clause are set forth in 41 CFR 60-1.5. (Generally only contracts or subcontracts of \$10,000 or under are exempt.)

Currently, Standard Form 100 (EEO-1) is the only report required by the Executive Orders or their implementing regulations.

Proposed prime Contractors and Subcontractors who have participated in a previous contract or subcontract subject to the Executive orders and have not filed the required reports should note that 41 CFR 60-1.7 (b) (1) prevents the award of contracts and subcontracts unless such Contractors submit a report covering the delinquent period or such other period specified by the Federal Highway Administration or by the Director, Office of Federal Contract Compliance, U. S. Department of Labor.

**MISSISSIPPI DEPARTMENT OF TRANSPORTATION**  
**CERTIFICATION**

I, \_\_\_\_\_,  
(Name of person signing bid)

individually, and in my capacity as \_\_\_\_\_ of  
(Title of person signing bid)

\_\_\_\_\_ do hereby certify under  
(Name of Firm, partnership, or Corporation)

penalty of perjury under the laws of the United States and the State of Mississippi that \_\_\_\_\_

\_\_\_\_\_, Bidder  
(Name of Firm, Partnership, or Corporation)

on Project No. **NHAPD-0078-01(011)N/ 102076301000**

in **Itawamba** County(ies), Mississippi, has not either

directly or indirectly entered into any agreement, participated in any collusion; or otherwise taken any action in restraint of free competitive bidding in connection with this contract; nor have any of its corporate officers or principal owners.

Except as noted hereafter, it is further certified that said legal entity and its corporate officers, principal owners, managers, auditors and others in a position of administering federal funds:

- a) Are not presently debarred, suspended, proposed for debarment, declared ineligible, or voluntarily excluded from covered transactions by any Federal department or agency;
- b) Have not within a three-year period preceding this proposal been convicted of or had a civil judgment rendered against them for commission of fraud or a criminal offense in connection with obtaining, attempting to obtain, or performing a public (Federal, State or local) transaction or contract under a public transaction; violation of Federal or State antitrust statutes or commission of embezzlement, theft, forgery, bribery, falsification or destruction of records, making false statements, or receiving stolen property;
- c) Are not presently indicted for or otherwise criminally or civilly charged by a governmental entity (Federal, State or local) with commission of any of the offenses enumerated in (b) above; and
- d) Have not within a three-year period preceding this application/ proposal had one or more public transactions (Federal, State or local) terminated for cause or default.

Do exceptions exist and are made a part thereof? Yes / No

Any exceptions shall address to whom it applies, initiating agency and dates of such action.

Note: Exceptions will not necessarily result in denial of award but will be considered in determining bidder responsibility. Providing false information may result in criminal prosecution or administrative sanctions.

The bidder further certifies that the certification requirements contained in Section XI of Form FHWA 1273, will be or have been included in all subcontracts, material supply agreements, purchase orders, etc. except those procurement contracts for goods or services that are expected to be less than the Federal procurement small purchase threshold fixed at 10 U.S.C. 2304(g) and 41 U.S.C. 253(g) (currently \$25,000) which are excluded from the certification requirements.

The bidder further certifies, to the best of his or her knowledge and belief, that:

1) No Federal appropriated funds have been paid or will be paid to any person for influencing or attempting to influence an officer or employee of any Federal agency, a Member of Congress, an officer or employee of Congress, or an employee of a Member of Congress in connection with the awarding of any Federal contract, the making of any Federal grant, the making of any Federal loan, the entering into of any cooperative agreement, and the extension, continuation, renewal, amendment, or modification of any Federal contract, grant, loan, or cooperative agreement.

2) If any funds other than Federal appropriated funds have been paid or will be paid to any person for influencing or attempting to influence an officer or employee of any Federal agency, a Member of Congress, an officer or employee of Congress, or an employee of a Member of Congress in connection with this contract, Standard Form-LLL, Disclosure Form to Report Lobbying, in accordance with its instructions will be completed and submitted.

The certification contained in (1) and (2) above is a material representation of fact upon which reliance is placed and a prerequisite imposed by Section 1352, Title 31, U.S. Code prior to entering into this contract. Failure to comply shall be subject to a civil penalty of not less than \$10,000 and not more than \$100,000. The bidder shall include the language of the certification in all subcontracts exceeding \$100,000 and all subcontractors shall certify and disclose accordingly.

All of the foregoing is true and correct.

Executed on \_\_\_\_\_

\_\_\_\_\_  
Signature



**MISSISSIPPI DEPARTMENT OF TRANSPORTATION**

SAM.GOV Registration and DUNS Number

Bidders are advised that the Prime Contractor must maintain current registration in the **System for Award Management** (<http://www.sam.gov>) at all times during the project. A Dun and Bradstreet Data Universal Numbering System (DUNS) Number (<http://www.dnb.com>) is one of the requirements for registration in the System for Award Management.

Bidders are advised that prior to the award of this contract, they **MUST** be registered in the System for Award Management.

I (We) acknowledge that this contract cannot be awarded if I (We) are not registered in the System for Award Management prior to the award of this contract. \_\_\_\_\_ (Yes / No)

I (We) have a DUNS Number . \_\_\_\_\_ (Yes / No)

DUNS Number: \_\_\_\_\_

Company Name: \_\_\_\_\_

Company e-mail address: \_\_\_\_\_

(6/2015F)

For Informational Purposes Only

SECTION 902

CONTRACT FOR NHAPD-0078-01(011)N/ 102076301000

LOCATED IN THE COUNTY(IES) OF Itawamba

STATE OF MISSISSIPPI,  
COUNTY OF HINDS

This contract entered into by and between the Mississippi Transportation Commission on one hand, and the undersigned contractor, on the other witnesseth;

That, in consideration of the payment by the Mississippi Transportation Commission of the prices set out in the proposal hereto attached, to the undersigned contractor, such payment to be made in the manner and at the time of times specified in the specifications and the special provisions, if any, the undersigned contractor hereby agrees to accept the prices stated in the proposal in full compensation for the furnishing of all materials and equipment and the executing of all the work contemplated in this contract.

It is understood and agreed that the advertising according to law, the Advertisement, the instructions to bidders, the proposal for the contract, the specifications, the revisions of the specifications, the special provisions, and also the plans for the work herein contemplated, said plans showing more particularly the details of the work to be done, shall be held to be, and are hereby made a part of this contract by specific reference thereto and with like effect as if each and all of said instruments had been set out fully herein in words and figures.

It is further agreed that for the same consideration the undersigned contractor shall be responsible for all loss or damage arising out of the nature of the work aforesaid; or from the action of the elements and unforeseen obstructions or difficulties which may be encountered in the prosecution of the same and for all risks of every description connected with the work, exceptions being those specifically set out in the contract; and for faithfully completing the whole work in good and workmanlike manner according to the approved Plans, Specifications, Special Provisions, Notice(s) to Bidders and requirements of the Mississippi Department of Transportation.

It is further agreed that the work shall be done under the direct supervision and to the complete satisfaction of the Executive Director of the Mississippi Department of Transportation, or his authorized representatives, and when Federal Funds are involved subject to inspection at all times and approval by the Federal Highway Administration, or its agents as the case may be, or the agents of any other Agency whose funds are involved in accordance with those Acts of the Legislature of the State of Mississippi approved by the Governor and such rules and regulations issued pursuant thereto by the Mississippi Transportation Commission and the authorized Federal Agencies.

The Contractor agrees that all labor as outlined in the Special Provisions may be secured from list furnished by

It is agreed and understood that each and every provision of law and clause required by law to be inserted in this contract shall be deemed to be inserted herein and this contract shall be read and enforced as though it were included herein, and, if through mere mistake or otherwise any such provision is not inserted, then upon the application of either party hereto, the contract shall forthwith be physically amended to make such insertion.

The Contractor agrees that he has read each and every clause of this Contract, and fully understands the meaning of same and that he will comply with all the terms, covenants and agreements therein set forth.

Witness our signatures this the \_\_\_ day of \_\_\_\_\_, \_\_\_\_\_.

\_\_\_\_\_  
Contractor(s)

By \_\_\_\_\_

MISSISSIPPI TRANSPORTATION COMMISSION

Title \_\_\_\_\_

By \_\_\_\_\_

Signed and sealed in the presence of:  
(names and addresses of witnesses)

Executive Director

\_\_\_\_\_

Secretary to the Commission

Award authorized by the Mississippi Transportation Commission in session on the \_\_\_ day of \_\_\_\_\_, \_\_\_\_\_, Minute Book No. \_\_\_\_\_, Page No. \_\_\_\_\_.

**SECTION 903**  
**PERFORMANCE AND PAYMENT BOND**

CONTRACT BOND FOR: NHAPD-0078-01(011)N/102076301000

LOCATED IN THE COUNTY(IES) OF: Itawamba

STATE OF MISSISSIPPI,  
COUNTY OF HINDS

Know all men by these presents: that we, \_\_\_\_\_  
\_\_\_\_\_  
(Contractor)

Principal, a \_\_\_\_\_

residing at \_\_\_\_\_ in the State of \_\_\_\_\_

and \_\_\_\_\_

(Surety)  
residing at \_\_\_\_\_ in the State of \_\_\_\_\_,

authorized to do business in the State of Mississippi, under the laws thereof, as surety, effective as of the contract date

shown below, are held and firmly bound unto the State of Mississippi in the sum of \_\_\_\_\_

\_\_\_\_\_ Dollars, lawful money of the United States of America, to be paid to it for which payment well and truly to be made, we bind ourselves, our heirs, administrators, successors, or assigns jointly and severally by these presents.

The conditions of this bond are such, that whereas the said \_\_\_\_\_

principal, has (have) entered into a contract with the Mississippi Transportation Commission, bearing the date of

\_\_\_\_\_ day of \_\_\_\_\_ A.D. \_\_\_\_\_ hereto annexed, for the construction of certain projects(s) in

the State of Mississippi as mentioned in said contract in accordance with the Contract Documents therefor, on file in the

offices of the Mississippi Department of Transportation, Jackson, Mississippi.

Now therefore, if the above bounden \_\_\_\_\_

in all things shall stand to and abide by and well and truly observe, do keep and perform all and singular the terms, covenants, conditions, guarantees and agreements in said contract, contained on his (their) part to be observed, done, kept and performed and each of them, at the time and in the manner and form and furnish all of the material and equipment specified in said contract in strict accordance with the terms of said contract which said plans, specifications and special provisions are included in and form a part of said contract and shall maintain the said work contemplated until its final completion and acceptance as specified in Subsection 109.11 of the approved specifications, and save harmless said Mississippi Transportation Commission from any loss or damage arising out of or occasioned by the negligence, wrongful or criminal act, overcharge, fraud, or any other loss or damage whatsoever, on the part of said principal (s), his (their) agents, servants, or employees in the performance of said work or in any manner connected therewith, and shall be liable and responsible in a civil action instituted by the State at the instance of the Mississippi Transportation Commission or any officer of the State authorized in such cases, for double any amount in money or property, the State may lose or be overcharged or otherwise defrauded of, by reason of wrongful or criminal act, if any, of the Contractor(s), his (their) agents or employees, and shall promptly pay the said agents, servants and employees and all persons furnishing labor, material, equipment or supplies therefor, including premiums incurred, for Surety Bonds, Liability Insurance, and Workmen's Compensation Insurance; with the additional obligation that such Contractor shall promptly make payment of all taxes, licenses, assessments, contributions, damages,

any liquidated damages which may arise prior to any termination of said principal's contract, any liquidated damages which may arise after termination of the said principal's contract due to default on the part of said principal, penalties and interest thereon, when and as the same may be due this state, or any county, municipality, board, department, commission or political subdivision: in the course of the performance of said work and in accordance with Sections 31-5-51 et seq. Mississippi Code of 1972, and other State statutes applicable thereto, and shall carry out to the letter and to the satisfaction of the Executive Director of the Mississippi Department of Transportation, all, each and every one of the stipulations, obligations, conditions, covenants and agreements and terms of said contract in accordance with the terms thereof and all of the expense and cost and attorney's fee that may be incurred in the enforcement of the performance of said contract, or in the enforcement of the conditions and obligations of this bond, then this obligation shall be null and void, otherwise to be and remain in full force and virtue.

_____	_____
(Contractors) Principal	Surety
By _____	By _____
	(Signature) Attorney in Fact
	Address _____
	_____
Title _____	_____
(Contractor's Seal)	(Printed) MS Agent
	_____
	(Signature) MS Agent
	Address _____
	_____
	_____
	(Surety Seal)
	_____
	Mississippi Insurance ID Number



# BID BOND

KNOW ALL MEN BY THESE PRESENTS, that we \_\_\_\_\_  
Contractor

\_\_\_\_\_  
Address

\_\_\_\_\_  
City, State ZIP

As principal, hereinafter called the Principal, and \_\_\_\_\_  
Surety

a corporation duly organized under the laws of the state of \_\_\_\_\_

as Surety, hereinafter called the Surety, are held and firmly bound unto State of Mississippi, Jackson, Mississippi

As Obligee, hereinafter called Obligee, in the sum of **Five Per Cent (5%) of Amount Bid**

Dollars(\$ \_\_\_\_\_ )

for the payment of which sum will and truly to be made, the said Principal and said Surety, bind ourselves, our heirs, executors, administrators, successors and assigns, jointly and severally, firmly by these presents.

WHEREAS, the Principal has submitted a bid for **Grade, Drain, Bridge, & Pave 4-Lane approximately 9 miles of APD Corridor "V" between Fairview & SR 23, known as Federal Aid Project No. NH-APD-0078-01(011)N / 102076301 in Itawamba County.**

NOW THEREFORE, the condition of this obligation is such that if the aforesaid Principal shall be awarded the contract, the said Principal will, within the time required, enter into a formal contract and give a good and sufficient bond to secure the performance of the terms and conditions of the contract, then this obligation to be void; otherwise the Principal and Surety will pay unto the Obligee the difference in money between the amount of the bid of the said Principal and the amount for which the Obligee legally contracts with another party to perform the work if the latter amount be in excess of the former, but in no event shall liability hereunder exceed the penal sum hereof.

Signed and sealed this \_\_\_\_\_ day of \_\_\_\_\_, 20\_\_

\_\_\_\_\_  
(Witness)

\_\_\_\_\_  
(Principal) (Seal)

By: \_\_\_\_\_  
(Name) (Title)

\_\_\_\_\_  
(Witness)

\_\_\_\_\_  
(Surety) (Seal)

By: \_\_\_\_\_  
(Attorney-in-Fact)

\_\_\_\_\_  
(MS Agent)

\_\_\_\_\_  
Mississippi Insurance ID Number



**MISSISSIPPI DEPARTMENT OF TRANSPORTATION  
PILE AND DRIVING EQUIPMENT DATA FORM**

Project No.: \_\_\_\_\_ Bridge No.: \_\_\_\_\_  
 Contract No.: \_\_\_\_\_ Pile Driving Contractor: \_\_\_\_\_  
 Termini: \_\_\_\_\_ County: \_\_\_\_\_

Hammer Components

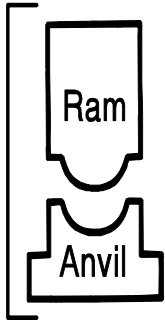

**Hammer**

Manufacturer: \_\_\_\_\_ Model No.: \_\_\_\_\_  
 Hammer Type: \_\_\_\_\_ Serial No.: \_\_\_\_\_  
 Manufacturer's Maximum Rated Energy: \_\_\_\_\_ ft-lbs  
 Stroke at Maximum Rated Energy: \_\_\_\_\_ ft  
 Range in Operating Energy: \_\_\_\_\_ to \_\_\_\_\_ ft-lbs  
 Range in Operating Stroke: \_\_\_\_\_ to \_\_\_\_\_ ft  
 Ram Weight: \_\_\_\_\_ kips  
 Modifications: \_\_\_\_\_  
 \_\_\_\_\_  
 \_\_\_\_\_

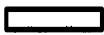

**Striker Plate**

Weight: \_\_\_\_\_ kips Diameter: \_\_\_\_\_ in.  
 Thickness: \_\_\_\_\_ in.



**Hammer Cushion**

	Material #1	Material #2 (for composite cushion)
Name: _____	Name: _____	Name: _____
Area: _____ in. <sup>2</sup>	Area: _____ in. <sup>2</sup>	Area: _____ in. <sup>2</sup>
Thickness/Plate: _____ in.	Thickness/Plate: _____ in.	Thickness/Plate: _____ in.
No. of Plates: _____	No. of Plates: _____	No. of Plates: _____
Total Thickness of Hammer Cushion: _____ in.		

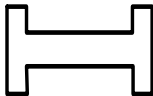

**Helmet (Drive Head)**

Weight: \_\_\_\_\_ including inserts, kips



**Pile Cushion**

Pile Cushion Material: \_\_\_\_\_  
 Area: \_\_\_\_\_ in.<sup>2</sup> Thickness/Sheet: \_\_\_\_\_ in.  
 No. of Sheets: \_\_\_\_\_  
 Total Thickness of Pile Cushion: \_\_\_\_\_ in.

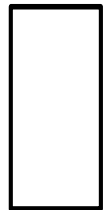

**Pile**

Pile Type: \_\_\_\_\_  
 Wall Thickness: \_\_\_\_\_ in. Taper: \_\_\_\_\_  
 Cross Sectional Area: \_\_\_\_\_ in.<sup>2</sup> Weight/ft: \_\_\_\_\_  
 Nominal Driving Resistance: \_\_\_\_\_ Kips  
 Driving Shoe/Closure Plate Description: \_\_\_\_\_  
 \_\_\_\_\_

Submitted By: \_\_\_\_\_ Date: \_\_\_\_\_  
 Telephone No.: \_\_\_\_\_ Fax No.: \_\_\_\_\_  
 Email Address: \_\_\_\_\_