

MDOT Use Only

Checked _____

Loaded _____

Keyed _____

10 -



SM No. CNHPP0472000192

PROPOSAL AND CONTRACT DOCUMENTS

FOR THE CONSTRUCTION OF

10

Bridge Preservation on US 80 over KCS Railroad (Bridge No. 107.8), known as
Federal Aid Project No. NHPP-0472-00(019) / 108283301 in Newton County.

Project Completion: 198 Working Days

(STATE DELEGATED)

NOTICE

**BIDDERS MUST COMPLETE AN ONLINE REQUEST
FOR PERMISSION TO BID THIS PROJECT.**

Electronic addendum updates will be posted on www.gomdot.com

SECTION 900

OF THE CURRENT 2017 STANDARD SPECIFICATIONS FOR ROAD AND BRIDGE CONSTRUCTION

JACKSON, MISSISSIPPI

MISSISSIPPI DEPARTMENT OF TRANSPORTATION

SECTION 904 - NOTICE TO BIDDERS NO. 3052

DATE: 1/22/2021

SUBJECT: Readvertisement

PROJECT: NHPP-0472-00(019)/ 108283301000 - Newton County(ies)

The contents of this proposal are the same as when advertised for the November 24, 2020 Letting, except as follows:

Revised Advertisement;

Revised Notice to Bidder No. 2881;

Revised Notice to Bidder No. 2882;

Revised Bid Items;

Revised Progress Schedule;

Added this Notice to Bidders No. 3052

**MISSISSIPPI DEPARTMENT OF TRANSPORTATION
TABLE OF CONTENTS**

PROJECT: NHPP-0472-00(019)/108283301 - Newton

RE-ADVERTISEMENT NOTICE TO BIDDERS NO. 3052

Section 901 - Advertisement

Section 904 - Notice to Bidders

#1	Governing Specification
#2	Status of ROW, w/ Attachments
#3	Final Cleanup
#9	Federal Bridge Formula
#14	Railway-Highway Provision, w/Supplement
#246	Kansas City Southern Construction Requirements
#296	Reduced Speed Limit Signs
#445	Mississippi Agent or Qualified Nonresident Agent
#516	Errata and Modifications to the 2017 Standard Specifications
#977	DUNS Requirement For Federal Funded Projects
#1225	Early Notice to Proceed
#1226	Material Storage Under Bridges
#1241	Fuel and Material Adjustments
#2206	MASH Compliant Devices
#2273	Mississippi Special Fuel Tax Law
#2611	Disadvantaged Business Enterprise In Federal-Aid Highway Construction, w/ Supplement
#2782	DBE Pre-Bid Meeting
#2881	Contract Time
#2882	Specialty Items
#2883	Temporary Construction Signs
#2884	Traffic Control
#2895	Exploratory Joint Cleanup
#2900	Underground Utilities
#2954	Reflective Sheeting for Signs
906	Required Federal Contract Provisions -- FHWA 1273, w/Supplements

Section 907 - Special Provisions

907-102-2	Bidding Requirements and Conditions
907-108-4	Subletting of Contract
907-109-1	Measurement and Payment
907-701-2	Hydraulic Cement
907-702-4	Bituminous Materials
907-703-1	Gradation
907-705-1	Stone Riprap
907-707-2	Joint Material
907-711-2	Plain Steel Wire

PROJECT: NHPP-0472-00(019)/108283301 - Newton

907-720-2	Acceptance Procedure for Glass Beads
907-721-2	Materials for Signs
907-804-10	Bridge Deck Overlay
907-808-1	Joint Repair
907-823-7	Preformed Joint Seal
907-845-2	Coating Existing Structural Steel
907-899-1	Railway-Highway Provisions

Section 905 - Proposal, Proposal Bid Items, Combination Bid Proposal

Certification of Performance - Prior Federal-Aid Contracts

Certification Regarding Non-Collusion, Debarment and Suspension

SAM.GOV Registration and DUNS Number

Section 902 - Contract Form

Section 903 - Contract Bond Forms

Form -- OCR-485

Progress Schedule

(REVISIONS TO THE ABOVE WILL BE INDICATED ON THE SECOND SHEET
OF SECTION 905 AS ADDENDA)

01/27/2021 01:11 PM

MISSISSIPPI DEPARTMENT OF TRANSPORTATION

SECTION 901 - ADVERTISEMENT

Electronic bids will be received by the Mississippi Transportation Commission at 10:00 o'clock A.M., Tuesday, February 23, 2021, from the Bid Express Service and shortly thereafter publicly read on the Sixth Floor for:

Bridge Preservation on US 80 over KCS Railroad (Bridge No. 107.8), known as Federal Aid Project No. NHPP-0472-00(019) / 108283301 in Newton County.

The attention of bidders is directed to the Contract Provisions governing selection and employment of labor. Minimum wage rates have been predetermined by the Secretary of Labor and are subject to Public Law 87-581, Work Hours Act of 1962, as set forth in the Contract Provisions.

The Mississippi Department of Transportation hereby notifies all bidders that it will affirmatively insure that in any contract entered into pursuant to this advertisement, disadvantaged business enterprises will be afforded full opportunity to submit bids in response to this invitation and will not be discriminated against on the grounds of race, color, sex, age, disability, religion or national origin in consideration for an award.

The award of this contract will be contingent upon the Contractor satisfying the DBE requirements.

Contractors may request permission to bid online at <http://shopmdot.ms.gov> at no cost. Upon approval, Contractors shall be eligible to submit a bid using Bid Express at <http://bidx.com>. Specimen proposals may be viewed and downloaded online at no cost at <http://mdot.ms.gov> or purchased online at <http://shopmdot.ms.gov> at a cost of Ten Dollars (\$10.00) per proposal plus a small convenience fee. Cash or checks will not be accepted as payment.

Plans must be purchased online at <https://shopmdot.ms.gov>. Costs of plans will be on a per sheet basis plus a small convenience fee. If you have any questions, you can contact the MDOT Plans Print Shop at (601) 359-7460, or e-mail at plans@mdot.state.ms.us. Plans will be shipped upon receipt of payment. Cash or checks will not be accepted as payment.

Bid bond, signed or countersigned by a Mississippi Agent or Qualified Nonresident Agent, with Power of Attorney attached, a Cashier's check or Certified Check for five (5%) percent of bid, payable to STATE OF MISSISSIPPI, must accompany each proposal.

The attention of bidders is directed to the provisions of Subsection 102.07 pertaining to irregular proposals and rejection of bids.

MELINDA L. MCGRATH
EXECUTIVE DIRECTOR

MISSISSIPPI DEPARTMENT OF TRANSPORTATION

SECTION 904 - NOTICE TO BIDDERS NO. 1

CODE: (IS)

DATE: 03/01/2017

SUBJECT: Governing Specifications

The current (2017) Edition of the Standard Specifications for Road and Bridge Construction adopted by the Mississippi Transportation Commission is made a part hereof fully and completely as if it were attached hereto, except where superseded by special provisions, or amended by revisions of the Specifications contained within this proposal. Copies of the specification book may be purchased from the MDOT Construction Division, or online at shopmdot/default.aspx?StoreIndex=1.

A reference in any contract document to controlling requirements in another portion of the contract documents shall be understood to apply equally to any revision or amendment thereof included in the contract.

In the event the plans or proposal contain references to the 2004 Edition of the Standard Specifications for Road and Bridge Construction, it is to be understood that such references shall mean the comparable provisions of the 2017 Edition of the Standard Specifications.

MISSISSIPPI DEPARTMENT OF TRANSPORTATION

SECTION 904 - NOTICE TO BIDDERS NO. 2

CODE: (IS)

DATE: 03/01/2017

SUBJECT: Status of Right-of-Way

Although it is desirable to have acquired all rights-of-way and completed all railroad agreements, utility adjustments and work to be performed by others prior to receiving bids, sometimes it is not considered to be in the public interest to wait until each and every such clearance has been obtained. The bidder is hereby advised of possible unacquired rights-of-way, relocations, railroad agreements and utilities adjustments which have not been completed.

The status of right-of-way acquisition, utility adjustments, encroachments, potentially contaminated sites, railroad facilities, improvements, and asbestos contamination are set forth in the following attachments.

In the event right of entry is not available to ALL parcels of right-of-way and/or all work that is to be accomplished by others on the date set forth in the contract for the Notice to Proceed is not complete, the Department will issue a restricted Notice to Proceed.

STATUS OF RIGHT-OF-WAY
NHPP-0472-00(019)
108283-301000
Newton County

All rights of way and legal rights of entry have been acquired **except:**

There will not be an easement or agreement needed from the Railroad; however, coordination will be required. See Notice to Bidders.

ASBESTOS CONTAMINATION STATUS OF BUILDINGS
TO BE REMOVED BY THE CONTRACTOR
NHPP-0472-00(019)
108283/301000
Newton County
May 8, 2020

Reference is made to notices to bidders entitled "Asbestos National Emission Standards for Hazardous Air Pollutants (NESHAP)" and "Removal of Obstructions".

The following pertinent information is furnished concerning asbestos containing materials (ACMs), if any, found in buildings to be removed by the Contractor.

There is no Right of Way required for this project. There are no buildings to be removed by the contractor.

STATUS OF POTENTIALLY CONTAMINATED SITES

NHPP-0472-00(019)

108283/301000

Newton County

May 8, 2020

THERE IS NO RIGHT OF WAY REQUIRED FOR THIS PROJECT. NO INITIAL SITE ASSESSMENT WILL BE PERFORMED. IF CONTAMINATION ON EXISTING RIGHT OF WAY IS DISCOVERED, IT WILL BE HANDLED BY THE DEPARTMENT.

MISSISSIPPI DEPARTMENT OF TRANSPORTATION

Inter-Departmental Memorandum

TO: Trudi Loflin
ROW Division

DATE: April 30, 2020

FROM: Christopher M. Nail
District Five



SUBJECT OR PROJECT NO: NHPP-0472-00(019) / 108283-301000
ROW Certification Documents

INFORMATION COPY TO:

COUNTY: Newton

Project File

District Status Report

1. STATUS OF RIGHT OF WAY: All work to be done within existing ROW.
2. RIGHT OF WAY CLEARANCE: There are no encroachments that conflict with construction.
3. STATUS OF AFFECTED RAILROAD OPERATING FACILITIES: The bridge structure spans an active railroad. It appears that this line is at the junction of the MS Southern (Watco) railroad and the Kansas City Southern railroad. The applicable railway provisions will be included in the contract.
4. STATUS OF REQUIRED UTILITY RELOCATIONS: There are no known utility conflicts. However, there are existing PVC drainage pipes attached to both sides of the bridge. The Contractor should coordinate his work to avoid damage to these pipes. Any applicable permits showing the approximate location of other utilities within or along the ROW are on file with the Department. The Department cannot and does not warrant that this information is complete and accurate. The contractor must coordinate directly with the involved utility owners to have underground utility lines field located in advance of construction.
5. STATUS OF CONSTRUCTION AGREEMENT: None required.

CMN:cmn

Improvements to be included in Notice to Bidders to be removed by the Construction Contractor
FMS Construction Project No: 108283-301000
External ROW No: NHPP-0472-00(019)

Parcel No:
Station No:
Property Owner:
Description/Pictures:

NA

MISSISSIPPI DEPARTMENT OF TRANSPORTATION

SECTION 904 - NOTICE TO BIDDERS NO. 3

CODE: (SP)

DATE: 01/17/2017

SUBJECT: Final Clean-Up

Immediately prior to final inspection for release of maintenance, the Contractor shall pick up, load, transport and properly dispose of all litter from the entire highway right-of-way that is within the termini of the project.

Litter shall include, but not be limited to, solid wastes such as glass, paper products, tires, wood products, metal, synthetic materials and other miscellaneous debris.

Litter removal is considered incidental to other items of work and will not be measured for separate payment.

MISSISSIPPI DEPARTMENT OF TRANSPORTATION

SECTION 904 - NOTICE TO BIDDERS NO. 9

CODE: (IS)

DATE: 03/01/2017

SUBJECT: Federal Bridge Formula

Bidders are hereby advised that the latest revision of Federal Highway Administration Publication No. FHWA-HOP-06-105, **BRIDGE FORMULA WEIGHTS**, dated August 2006, is made a part of this contract when applicable.

Prior to the preconstruction conference, the Contractor shall advise the Engineer, in writing, what materials, if any, will be delivered to the jobsite via Interstate route(s).

Copies of the **BRIDGE FORMULA WEIGHTS** publication may be obtained by contacting:

Federal Highway Administration
400 7th Street, SW
Washington, DC 20590
(202) 366-2212

or

http://www.ops.fhwa.dot.gov/Freight/publications/brdg_frm_wgths/bridge_formula_all_rev.pdf

An on line **BRIDGE FORMULA WEIGHTS CALCULATOR** is available at

http://ops.fhwa.dot.gov/freight/sw/brdgcalc/calc_page.htm

MISSISSIPPI DEPARTMENT OF TRANSPORTATION

SUPPLEMENT TO NOTICE TO BIDDERS NO. 14

DATE: 10/26/2020

PROJECT: NHPP-0472-00(019) / 108283301 – Newton County

After the second paragraph on page 1, add the following:

Name Insured: Meridian Speedway, LLC.

Description and Designation: Repair of Overhead Bridge: Intersection of the centerline of survey of US 80 and the centerline of track in Newton, Mississippi.

After the fourth paragraph on page 1, add the following:

Mr. Srikanth V. Honnur
Director, Track and Bridge Construction
Engineering Department
The Kansas City Southern Railway Company
427 West 12th Street
Kansas City, Missouri 64105

MISSISSIPPI DEPARTMENT OF TRANSPORTATION

SECTION 904 - NOTICE TO BIDDERS NO. 14

CODE: (SP)

DATE: 01/17/2017

SUBJECT: Railway-Highway Provisions

Prior to bidding, the Contractor shall contact the Railroad concerning insurance coverage required for this project. In case the railroad requires coverage over and above that required by the Standard Specifications, the railroad requirements shall be met.

The name insured, description of the work and designation of the job site to be shown on the Policy are as follows:

Notice of starting to work, completion of any required forms, and correspondence pertaining to railroad liability insurance shall be directed to the person below.

The Contractor shall not commence, or carry on, any work for installation, maintenance, repair, changing or renewal of any FACILITY, under, over or on RAILROAD property at any location without giving at least ten (10) working days prior notice to the RAILROAD authorized representative at the RAILROAD's office(s) below.

If in the opinion of the RAILROAD, the presence of an authorized representative of the RAILROAD is required to supervise the same, the RAILROAD shall render bills to the Contractor for all expenses incurred by it for such supervision. This includes all labor costs for flagmen or cable locate supplied by the RAILROAD to protect RAILROAD operation, and for the full cost of furnishing, installation and later removal of any temporary supports for said tracks, as the RAILROAD's Chief Engineer's Office may deem necessary.

It will be the Contractor's responsibility to pay all bills associated with railroad flagging and cable locating. Generally, the flagging rate is \$700.00 per day (1 to 8 hours) plus overtime at \$125.00 per hour, however, the Contractor shall contact the RAILROAD to verify all rates.

A flagman is required anytime a Contractor does any work on or near RAILROAD property within twenty-five (25) feet horizontally of the centerline or any work over any railroad track. The RAILROAD, however, also reserves the right to require a flagman for work on RAILROAD property, which is more than twenty-five (25) feet from the centerline of a railroad track when there are other conditions or considerations that would dictate the need for a flagman to safeguard the RAILROAD's operations, property and safety of working personnel.

A cable locate of RAILROAD owned facilities may be required to identify and protect Signal & Communication cables that have been installed to provide power, signal control, wayside communications. These cables are vital to a safe and reliable railway operation. The cable locate will be performed by a qualified RAILROAD employee.

Outside Contractors are prohibited from driving on, along, or across any track that does not have a RAILROAD installed crossing. They may utilize an existing public crossing. The practice of allowing rubber tired equipment to operate over track with no crossing has been banned.

Exceptions to this rule will require the express approval from the RAILROAD Engineers.

MISSISSIPPI DEPARTMENT OF TRANSPORTATION

SECTION 904 - NOTICE TO BIDDERS NO. 246

CODE: (SP)

DATE: 06/27/2017

SUBJECT: Kansas City Southern Construction Requirements

Bidders are hereby advised that provisions which are required as per the Notice to Bidders entitled “Railway-Highway Provisions” shall also include the following.

The Contractor shall submit to the Project Engineer and the Railroad detailed plans and design data for temporary construction clearances, stages of construction, erection plans, demolition plans, false-work plans, excavation plans, and temporary shoring plans and calculations, as required, and shall be sealed by a Mississippi Registered Professional Engineer. All submittals must be approved by the Railroad before excavation or construction can begin within Railroad Right-of-Way. All construction submittals for work performed within the Kansas City Southern Railway Company (KCS) right-of-way shall be made per the KCS “Guidelines for the Design and Construction of Railroad Overpasses and Underpasses” as updated in May 2008.

Prior to beginning any work on the KCS right-of-way, the Contractor shall obtain a Right of Entry Permit. To request a permit application, the Contractor should contact Sylvia Schmidt. Mrs. Schmidt’s contact information is as follows.

Sylvia Schmidt
Permit Manager
Jones Lang LaSalle Americas, Inc.
3017 Lou Menk Drive, Suite 100
Fort Worth, Texas 76131-2800
817-230-2688

The Contractor shall be responsible for payment of all application fees.

This project will require construction activities on the right-of-way of active railroad tracks which are currently owned and/or operated by KCS. When work requires that equipment or personnel be within the KCS right-of-way or the “foul zone” adjacent to the right-of-way, a qualified “Employee-in-Charge” (EIC) must be present for the purpose of providing on-track safety and flagging protection for the work crews. The EIC shall also be responsible for the coordination of the Contractor’s activities within the KCS right-of-way with the operation of the Railroad. The EIC must be certified under the KCS General Code of Operation Rules (GCOR) and must be approved by the local KCS Roadmaster prior to beginning work on the KCS right-of-way. The Contractor will be required to provide radios for the EIC, all equipment operators, supervisors, and foremen in charge of employees working within the KCS right-of-way. All personnel who must enter upon the KCS right-of-way must check in and out with the EIC and be logged in and out of the site.

All personnel who must work within the KCS right-of-way at any time shall be trained and certified as a KCS "Roadway Worker" and must at all times have their certification card with them and available for random inspection. The Contractor will be responsible for providing this training for Contractor employees or any subcontractor(s) employees. The Contractor shall contact Mr. Larry Slater of Track Sense Inc. at 330-847-8661 or 330-219-4721 (lslater@neo.rr.com) for approximate fees and scheduling the necessary training sessions. The Contractor shall also contact the MDOT Project Engineer to see if any MDOT employees need this training. If so, the Contractor shall include the MDOT employees in the list of participants for training. The Contractor shall bear the cost of training the MDOT employees. Costs for training the MDOT employees will be reimbursed to the Contractor by supplemental agreement.

Prior to commencing work, the Contractor shall provide to the Railroad Engineer or the Railroad Engineer's designated representative, [with copies to the Project Engineer](#), a detailed construction schedule for its work on Railroad's right-of-way, including the proposed temporary horizontal and vertical clearances and construction sequence for all work to be performed on Railroad right-of-way. This schedule shall also include the anticipated dates when the milestone events listed below will occur. The Contractor shall update the schedule for these milestone events as necessary, but at least monthly, and shall provide a copy of all updates to the Railroad so that site visits may be scheduled.

- Preconstruction meetings.
- Excavations, shoring placement/removal, pile driving, drilling of caissons or drilled shafts adjacent to tracks.
- Reinforcement and concrete placement for near track piers.
- Erection of precast concrete or steel overpass bridge superstructure.
- Reinforcement and concrete placement of overpass bridge decks.
- Completion of the bridge structure.

The Contractor shall so arrange and conduct construction operations in such a manner that there will be no interference with Railroad operations, including train, signal, telephone and telegraphic services, or damage to the property of the Railroad or to poles, cables or wires (whether overhead or underground) and other facilities or tenants on the rights-of-way of the Railroad. Before undertaking any work within Railroad right-of-way and before placing any obstruction over any track, the Contractor shall:

- Notify the Railroad's representative at least 72 hours in advance of the work.
- Provide assurance to the Railroad's representative that arrangements have been made for any required flagging service.
- Receive permission from the Railroad Engineer to proceed with the work.
- Ascertain that the Project Engineer has received copies of notice to the Railroad and the Railroad's response.

MISSISSIPPI DEPARTMENT OF TRANSPORTATION

SECTION 904 - NOTICE TO BIDDERS NO. 296

CODE: (SP)

DATE: 07/25/2017

SUBJECT: Reduced Speed Limit Signs

Bidders are advised that when the plans or contract documents require the speed limit on a project to be reduced, the Contractor shall begin work within 48 hours of installing the reduced speed limit signs. Should the Contractor not start work or have no plans to start work within 48 hours of installing the signs, the reduced speed limit signs shall be covered and existing speed limit signs uncovered.

MISSISSIPPI DEPARTMENT OF TRANSPORTATION

SECTION 904 - NOTICE TO BIDDERS NO. 445

CODE: (SP)

DATE: 10/10/2017

SUBJECT: Mississippi Agent or Qualified Nonresident Agent

Bidders are hereby advised of the requirements of Subsections 102.08, 103.05.2, and 107.14.2.1 of the *2017 Standard Specifications for Road and Bridge Construction* as it refers to bonding agents. Proposal guaranties, bonds, and liability insurance policies must be signed by a **Mississippi Agent or Qualified Nonresident Agent.**

MISSISSIPPI DEPARTMENT OF TRANSPORTATION

SECTION 904 - NOTICE TO BIDDERS NO. 516

CODE: (IS)

DATE: 11/28/2017

SUBJECT: Errata and Modifications to the 2017 Standard Specifications

<u>Page</u>	<u>Subsection</u>	<u>Change</u>
16	102.06	In the seventh full paragraph, change “Engineer” to “Director.”
33	105.05.1	In the sixth sentence, change “Contract Administration Engineer” to “Contract Administration Director.”
34	105.05.2.1	In subparagraph 2, change “SWPPP, ECP” to “SWPPP and the ECP”
35	105.05.2.2	In subparagraphs 2, add “ and” to the end of the sentence. In subparagraph 3, remove “, and” and add “.”.
90	109.04.2	In the last paragraph of subparagraph (a), place a period “.” at the end of the sentence.
93	109.04.2	In the last paragraph of subparagraph (g), place a period “.” at the end of the sentence. Also, in the first paragraph of subparagraph (h), place a period “.” at the end of the sentence.
97	109.07	Under ADJUSTMENT CODE, subparagraph (A1), change “HMA mixture” to “Asphalt mixtures.”
98	109.11	In the third sentence, change “Engineer” to “Director.”
219	308.04	In the last sentence of the last paragraph, change “Contractor’s decision” to “Engineer’s decision.”
300	405.02.5.9	In the first sentence of the second paragraph, change “Hot Mix Asphalt” to “Asphalt Mixtures.”
502	630.01.1	In the first paragraph, change “AASHTO” to “AASHTO’s LRFD”.
636	646.05	Change “each” to “per each” for the pay item units of payment.
640	656.02.6.2	In item 7), change “down stream” to “downstream”.
688	630.03.2	Change the subsection number from “630.03.2” to “680.03.2.”

725 702.08.3 In the second sentence of the first paragraph, change “hot-mix” to “asphalt.”

954 804.02.13.1.6 In the definition for “M” in the % Reduction formulas, change “paragraph 7.3” to “paragraph 5.3.”

MISSISSIPPI DEPARTMENT OF TRANSPORTATION

SECTION 904 - NOTICE TO BIDDERS NO. 977

CODE: (IS)

DATE: 07/25/2018

SUBJECT: DUNS Requirement for Federal Funded Projects

Bidders are advised that the Prime Contractor must maintain a current registration in the System for Award Management (<http://www.sam.gov>) at all times during this project. A Dun and Bradstreet Data Universal Numbering System (DUNS) Number (<http://www.dnb.com>) is one of the requirements for registration in the System for Award Management.

Bidders are also advised that prior to the award of this contract, they MUST be registered, active, and have no active exclusions in the System for Award Management.

MISSISSIPPI DEPARTMENT OF TRANSPORTATION

SECTION 904 - NOTICE TO BIDDERS NO. 1225

CODE: (SP)

DATE: 11/13/2018

SUBJECT: Early Notice to Proceed

Bidders are advised that if an early notice to proceed is allowed by the Department and the Contractor experiences problems or delays between the early notice to proceed date and the original notice to proceed date, this shall not be justification for any monetary compensation or an extension of contract time.

MISSISSIPPI DEPARTMENT OF TRANSPORTATION

SECTION 904 - NOTICE TO BIDDERS NO. 1226

CODE: (IS)

DATE: 11/16/2018

SUBJECT: Material Storage Under Bridges

Bidders are advised that Subsection 106.08 of the Standard Specifications allows the Contractor to store materials and equipment on portions of the right-of-way. However, the Contractor will not be allowed to store or stockpile materials under bridges without written permission from the Project Engineer. The Contractor shall submit a detailed request of all proposed materials to be stored under bridges to the Engineer a minimum of 14 calendar days prior to anticipated storage. This detail shall include, but not limited to, bridge location, material type, material quantity, and duration of storage. The Project Engineer and any other needed Division will review this information and determine whether to grant approval. The Contractor shall not store any material under any bridge without written approval from the Project Engineer.

MISSISSIPPI DEPARTMENT OF TRANSPORTATION

SECTION 904 - NOTICE TO BIDDERS NO. 1241

CODE: (IS)

DATE: 11/27/2018

SUBJECT: Fuel and Material Adjustments

Bidder's attention is brought to the last paragraph of Subsection 109.07 of the Standard Specifications which states that no fuel or material adjustment will be made after the completion of contract time. Any fuels consumed or materials incorporated into the work during the monthly estimate period falling wholly after the expiration of contract time will not be subject a fuel or material adjustment.

MISSISSIPPI DEPARTMENT OF TRANSPORTATION

SECTION 904 - NOTICE TO BIDDERS NO. 2206

CODE: (IS)

DATE: 01/14/2020

SUBJECT: MASH Compliant Devices

Bidders are hereby advised that compliance associated with the requirements of meeting either the National Cooperative Highway Research Program (NCHRP) Report 350 or the Manual for Assessing Safety Hardware (MASH) for installations of certain traffic control devices and permanent safety hardware devices (guardrails, guardrail terminals, permanent portable barriers, cast-in-place barriers, all other permanent longitudinal barriers, crash cushions, cable barriers, cable barrier terminals, bridge rails, bridge rail transitions, all other terminals, sign supports, and all other breakaway hardware) as listed throughout the Standard Specifications and/or the Standard Drawings, or both, is now replaced with the requirements of meeting the 2016 version of MASH after December 31, 2019. This change applies to new permanent installations and to full replacements of existing installations.

At the preconstruction conference or prior to starting any work on the project, the Contractor shall submit a letter stating that the traffic control devices and permanent safety hardware devices as outlined within the paragraph above that are to be used on the project are certified to meet MASH 2016.

When a MASH 2016-compliant device does not exist for the new permanent installations and/or full replacement installations of permanent safety hardware devices, as listed above, a MASH 2009-compliant or a NCHRP 350-compliant device may be proposed by the Contractor for the project. A written request for such instances must be submitted by the Contractor either at the preconstruction conference or prior to starting any work on the project. The Contractor shall submit the following items to the Project Engineer: (1) a detailed list of the proposed devices and locations thereof; and (2) certification letters indicating that the proposed devices are compliant with either MASH 2009 or NCHRP 350.

When a MASH 2016-compliant device does not exist for the temporary work zone traffic control devices (Category 1, Category 2, and Category 3 devices), a MASH 2009-compliant or a NCHRP 350-compliant device may be proposed by the Contractor for the project. Temporary work zone traffic control devices (Category 1, Category 2, and Category 3 devices) that are MASH 2009-compliant or NCHRP 350-compliant that have been in use prior to December 31, 2019, and that have a remaining service life may be proposed for use throughout their normal service life on the project by the Contractor. For either of these scenarios for temporary work zone traffic control devices, a written request must be submitted by the Contractor either at the preconstruction conference or prior to starting any work on the project. The Contractor shall submit the following items to the Project Engineer: (1) a detailed list of the proposed devices and locations thereof; and (2) certification letters indicating that the proposed devices are compliant with either MASH 2009 or NCHRP 350.

Work will only be allowed to proceed after the Department has granted written concurrence(s) with the proposed request(s) as listed above.

MISSISSIPPI DEPARTMENT OF TRANSPORTATION

SECTION 904 - NOTICE TO BIDDERS NO. 2273

CODE: (SP)

DATE: 02/12/2020

SUBJECT: Mississippi Special Fuel Tax Law

Bidder's attention is brought to the second paragraph of Subsection 107.02 of the Standard Specifications which states that all Contractors and Subcontractors must comply with all requirements contained in the Mississippi Special Fuel Tax Law, Section 27-55-501, *et seq.* Attached are two Fact Sheets provided by the Mississippi Department of Revenue (MDOR) with additional information.

Gasoline and Dyed Diesel Used for Non-Highway Purposes

Mississippi provides a reduced rate for gasoline and dyed diesel used for non-highway purposes. The reduced rates are 6.44 cents per gallon and 5.75 cents per gallon of gasoline or dyed diesel. These fuels are generally taxed at 18 cents per gallon if for on road use.

Gasoline Used for Non-Highway Purposes

You may be entitled to a refund of 11.56 cents per gallon (making this an equivalent to a tax rate of 6.44 cents per gallon) if you desire to purchase gasoline to be used off road. The gasoline must be used for agricultural, maritime, industrial, manufacturing, domestic or non-highway purposes only.

Examples of non-highway include gasoline used in boats, golf carts, machinery used for manufacturing or farm equipment used exclusively in plowing, planting or harvesting farm products.

Refund Gasoline User

The refund is based on the amount of gallons used. Before a refund is issued, you are required to...

1. Obtain a refund gasoline user's permit and a certificate for refund booklet from the Department of Revenue;
2. Have a storage tank marked "REFUND GASOLINE"; and,
3. Purchase the gasoline from someone who holds a refund gasoline dealer's permit.

No refund will be allowed for gasoline used in motor vehicles owned or operated by a government entity or used in Mississippi government contracts.

Refund Gasoline Dealer

You must obtain a refund gasoline dealer's permit from the Department of Revenue before selling refund gasoline. At no time should the gasoline be delivered to a tank that is not properly marked. The gasoline must be dyed a distinctive mahogany color at the time of delivery.

The Department of Revenue may waive the dye requirement if the dye may cause damage to the equipment. The refund gasoline user is required to obtain the waiver from the Department of Revenue.

Dyed Diesel Used for Non-Highway Purposes

Unlike gasoline, you are not required to apply for a refund if you desire to purchase dyed diesel to be used off road. Mississippi provides a reduced rate of 5.75 cents per gallon on dyed diesel used off road. Diesel used on road is subjected to 18 cents per gallon. Dyed diesel used in motor vehicles owned or operated by a government entity or used in Mississippi government contracts will be subjected to 18 cents per gallon.

Dyed Diesel Used on the Highway

Any person who purchases, receives, acquires or uses dyed diesel for highway use will be liable to pay 18 cents per gallon and subject to a penalty in the amount of \$1000.

Identifying Dyed Diesel

Storage facilities for dyed diesel must be plainly marked "NONHIGHWAY DIESEL FUEL" or "NONHIGHWAY KEROSENE". Retailers are also required to mark all pumps or dispensing equipment.



Special Fuel Used on Government Contracts

State and Local Government Contracts

Special fuel purchased, acquired or used in performing contracts with the State of Mississippi, counties, municipalities or any political subdivision is taxed at a rate of 18 cents per gallon. Special fuel includes but is not limited to the following:

- Dyed diesel fuel;
- Kerosene;
- Undyed diesel fuel; and,
- Fuel oil.

State and local government contracts include construction, reconstruction and maintenance or repairs of projects such as roads, bridges, water systems, sewer systems, buildings, drainage canals and recreational facilities. The Department of Revenue may require contractors to remit the excise tax directly to the state in lieu of paying the tax to a distributor.

Special Fuel Direct Pay Permit

Contractors that remit the excise tax to the state will be issued a Special Fuel Direct Pay Permit. This permit relieves the distributor from collecting the tax and requires the contractor to file a monthly special fuel return. The distributor should include the contractor’s permit number on all invoices that are related to tax-free sales.

The contractor is required to furnish a surety or cash bond guaranteeing the payment of the excise tax prior to receiving the Special Fuel Direct Pay Permit. The Department of Revenue may accept a contractors tax bond if the bond covers the excise tax levied on special fuel.

Special Fuel Distributors

If the contractor does not have a Special Fuel Direct Pay Permit, distributors are required to collect the 18 cents excise tax and remit the tax to the Department of Revenue. The additional 12.25 cents levied on special fuel (excluding undyed diesel) should be reported on schedules 5F and 5G of the special fuel return.

Environmental Protection Fee

Special fuel distributors are required to collect the environmental protection fee even if the contractor has a Special Fuel Direct Pay Permit. The fee is levied at 4/10^{ths} of a cent per gallon. The fee is suspended or reinstated when the trust fund has exceeded or fallen below the obligatory balance.

Penalties

Any person who knowingly and willfully purchases untaxed fuel for use in equipment utilized on a road or highway construction site in this state is guilty of a misdemeanor and, upon conviction, shall be fined not less than \$1,000 or more than \$100,000, or imprisoned in the county jail for not more than one year, or both.



MISSISSIPPI DEPARTMENT OF TRANSPORTATION

SUPPLEMENT TO NOTICE TO BIDDERS NO. 2611

DATE: 05/02/2020

The goal is 1 percent for the Disadvantaged Business Enterprise. All Bidders are required to submit Form OCR-481 for all DBEs. Bidders are advised to check the bid tabulation link for this project on the MDOT website at:

https://mdot.ms.gov/portal/current_letting

Bid tabulations are usually posted by 3:00 pm on Letting Day.

MISSISSIPPI DEPARTMENT OF TRANSPORTATION

SECTION 904 - NOTICE TO BIDDERS NO. 2611

CODE: (IS)

DATE: 05/21/2020

SUBJECT: Disadvantaged Business Enterprises In Federal-Aid Highway Construction

This contract is subject to the "Moving Ahead for Progress in the 21st Century Act (MAP-21)" and applicable requirements of "Title 49, Code of Federal Regulations, Part 26." Portions of the Act are set forth in this Notice as applicable to compliance by the Contractor and all of the Act, and the MDOT DBE Program, is incorporated by reference herein.

The Department has developed a Disadvantaged Business Enterprise Program that is applicable to this contract and is made a part thereof by reference.

Copies of the program may be obtained from:

Office of Civil Rights
Mississippi Department of Transportation
P. O. Box 1850
Jackson, Mississippi 39215-1850

POLICY

It is the policy of the Mississippi Department of Transportation to provide a level playing field, to foster equal opportunity in all federally assisted contracts, to improve the flexibility of the DBE Program, to reduce the burdens on small businesses, and to achieve that amount of participation that would be obtained in a non-discriminatory market place. In doing so, it is the policy of MDOT that there will be no discrimination in the award and performance of federally assisted contracts on the basis of race, color, sex, or national origin.

ASSURANCES THAT CONTRACTORS MUST TAKE

MDOT will require that each contract which MDOT signs with a sub-recipient or a Contractor, and each subcontract the Prime Contractor signs with a Subcontractor, includes the following assurances:

“The Contractor, sub-recipient or Subcontractor shall not discriminate on the basis of race, color, sex, or national origin in the performance of this contract. The Contractor shall carry out applicable requirements of 49 CFR 26 in the award and administration of federally assisted contracts. Failure by the Contractor to carry out these requirements is a material breach of this contract, which may result in the termination of this contract or such other remedy as MDOT deems appropriate.”

DEFINITIONS

For purposes of this provision the following definitions will apply:

"Disadvantaged Business" means a small business concern: (a) which is at least 51 percent owned by one or more socially and economically disadvantaged individual(s) or in the case of any publicly owned business, at least 51 percent of the stock of which is owned by one or more socially and economically disadvantaged individual(s); and (b) whose management and daily business operations are controlled by one or more of the socially and economically disadvantaged individual(s) who own it. It is important to note that the business owners themselves must control the operations of the business. Absentee ownership or title ownership by an individual who does not take an active role in controlling the business is not consistent with eligibility as a DBE under 49 CFR Part 26.71.

CONTRACTOR'S OBLIGATION

The Contractor and all Subcontractors shall take all necessary and reasonable steps to ensure that DBE firms can compete for and participate in the performance of a portion of the work in this contract and shall not discriminate on the basis of race, color, sex, or national origin. Failure on the part of the Contractor to carry out the DBE requirements of this contract constitutes a breach of contract and after proper notification the Department may terminate the contract or take other appropriate action as determined by the Department.

When a contract has a zero percent (0%) DBE goal, the Contractor still has the responsibility to take all necessary and reasonable steps to ensure that DBE firms can compete for and participate in the performance of the work in the contract. In this case, all work performed by a certified DBE firm is considered to be a "race neutral" measure and the Department will receive DBE credit towards the overall State goals when the DBE firm is paid for their work. If the Prime Contractor is a certified DBE firm, the Department can receive DBE credit only for the work performed by the Prime Contractor's work force or any work subcontracted to another DBE firm. Work performance by a non-DBE Subcontractor is not eligible for DBE credit.

CONTRACT GOAL

The goal for participation by DBEs is established for this contract in the attached Supplement. The Contractor shall exercise all necessary and reasonable steps to ensure that participation is equal to or exceeds the contract goal.

If the percentage of the contract that is proposed for DBEs is 1% or greater, the Contractor shall agree to meet or exceed the contract goal on the last bid sheet of the proposal.

All Bidders shall submit to the Office of Civil Rights Form OCR-481, signed by the Prime Contractor and the DBE Subcontractors, no later than the 3rd business day after opening of the bids.

Form OCR-481 is available on the MDOT website at www.mdot.ms.gov under the Civil Rights tab, or by calling 601-359-7466.

The OCR-481 Form must contain the following information:

The name and address of each certified DBE Contractor / Supplier;

The Reference Number, percent of work to be completed by the DBE subcontractor and the dollar amount of each item. If a portion of an item is subcontracted, a breakdown of that item including quantities and unit price must be attached, detailing what part of the item the DBE firm is to perform and who will perform the remainder of the item.

If the DBE Commitment shown on the last bid sheet of the proposal, does not equal or exceed the contract goal, the bidder must submit, to MDOT Contract Administration Division prior to bid opening, information to satisfy the Department that adequate good faith efforts have been made to meet the contract goal.

Failure of the lowest bidder to furnish acceptable proof of good faith efforts, submitted to MDOT Contract Administration Division prior to bid opening, shall be just cause for rejection of the proposal. Award may then be made to the next lowest responsive bidder or the project may be re-advertised.

GOOD FAITH EFFORTS

The following factors are illustrative of matters the Department will consider in judging whether or not the bidder has made adequate good faith effort to satisfy the contract goal.

- (1) Whether the bidder attended the pre-bid meeting that was scheduled by the Department to inform DBEs of subcontracting opportunities;
- (2) Whether the bidder advertised in general circulation, trade association, and minority-focus media concerning the subcontracting opportunities;
- (3) Whether the bidder provided written notice to a reasonable number of specific DBEs that their interest in the contract is being solicited;
- (4) Whether the bidder followed up initial solicitations of interest by contacting DBEs to determine with certainty whether they were interested;
- (5) Whether the bidder selected portions of the work to be performed by DBEs in order to increase the likelihood of meeting the contract goal;
- (6) Whether the bidder provided interested DBEs with adequate information about the plans, specifications and requirements of the contract;

- (7) Whether the bidder negotiated in good faith with interested DBEs and did not reject them as unqualified without sound reasons based on a thorough investigation of their capabilities; and
- (8) Whether the bidder made efforts to assist interested DBEs in obtaining any required bonding or insurance.
- (9) Whether the bidder has written notification to certified DBE Contractors soliciting subcontracting for items of work in the contract.
- (10) Whether the bidder has a statement of why an agreement was not reached.
- (11) Proof of written notification to certified DBE Contractors by certified mail that their interest is solicited in subcontracting the work defaulted by the previous DBE or in subcontracting other items of work in the contract.

The bidder’s execution of the signature portion of the proposal shall constitute execution of the following assurance:

The bidder hereby gives assurance pursuant to the applicable requirements of "Moving Ahead for Progress in the 21st Century Act (MAP-21)" and applicable requirements of "Title 49, Code of Federal Regulations, Part 26" that the bidder has made a good faith effort to meet the contract goal for DBE participation for which this proposal is submitted.

DIRECTORY

A list of “Certified DBE Contractors” which have been certified as such by the Mississippi Department of Transportation and other Unified Certification Partners (UPC) can be found on the Mississippi Department of Transportation website at www.mdot.ms.gov. The list is in the top left corner of the current Letting Calendar under Contracts & Letting. The DBE firm must be certified at the time the project is let and approved by MDOT to count towards meeting the DBE goal.

REPLACEMENT

If a DBE Subcontractor cannot perform satisfactorily, and this causes the OCR-481 commitment to fall below the contract goal, the Contractor shall take all necessary reasonable steps to replace the DBE with another certified DBE Subcontractor or submit information to satisfy the Mississippi Department of Transportation that adequate good faith efforts have been made to replace the DBE. The good faith efforts outlined previously in this document still apply. The replacement DBE must be a DBE who was on the Department's list of "Certified DBE Contractors" when the job was let, and who is still active. All DBE replacements must be approved by the Department.

Under no circumstances shall the Prime or any Subcontractor perform the DBE's work (as shown on the OCR-481) without prior written approval from the Department. See "Sanctions" at the end of this document for penalties for performing DBE's work.

When a Contractor proposes to substitute/replace/terminate a DBE that was originally named on the OCR-481, the Contractor must obtain a release, in writing, from the named DBE explaining why the DBE Subcontractor cannot perform the work. A copy of the original DBE's release must be attached to the Contractor's written request to substitute/replace/terminate along with appropriate Subcontract Forms for the substitute/replacement/terminated Subcontractor, all of which must be submitted to the DBE Coordinator and approved, in advance, by MDOT.

PRE-BID MEETING

A pre-bid meeting will be held in the Commission Room on the 1st Floor of the MDOT Administration Building in Jackson, at 2:00 P.M. on the day preceding the date of the bid opening.

This meeting is to inform DBE firms of subcontracting and material supply opportunities. Attendance at this meeting is considered of prime importance in demonstrating good faith effort to meet the contract goal.

PARTICIPATION / DBE CREDIT

Participation shall be counted toward meeting the goal in this contract as follows:

- (1) If the Prime Contractor is a certified DBE firm, only the value of the work actually performed by the DBE Prime can be counted towards the project goal, along with any work subcontracted to a certified DBE firm.
- (2) If the Contractor is not a DBE, the work subcontracted to a certified DBE Contractor will be counted toward the goal.
- (3) The Contractor may count toward the goal a portion of the total dollar value of a contract with a joint venture eligible under the standards of this provision equal to the percentage of the DBE partner in the joint venture.
- (4) Expenditures to DBEs that perform a commercially useful function may be counted toward the goal. A business is considered to perform a commercially useful function when it is responsible for the execution of a distinct element of the work and carries out its responsibilities by actually performing, managing, and supervising the work involved.
- (5) The Contractor may count 100% of the expenditures for materials and supplies obtained from certified DBE suppliers and manufacturers that produce goods from raw materials or substantially alters them for resale provided the suppliers and manufacturers assume the actual and contractual responsibility for the provision of the materials and supplies. The Contractor may count sixty percent (60%) of the expenditures to suppliers that are not

manufacturers, provided the supplier performs a commercially useful function in the supply process. Within 30 days after receipt of the materials, the Contractor shall furnish to the DBE Coordinator invoices from the certified supplier to verify the DBE goal.

- (6) Any work that a certified DBE firm subcontracts or sub-subcontracts to a non-DBE firm will not count towards the DBE goal.
- (7) Only the dollars actually paid to the DBE firm may be counted towards the DBE goal. The participation of a DBE Firm cannot be counted towards the Prime Contractor's DBE goal until the amount being counted towards the goal has been paid to the DBE.

AWARD

Award of this contract to the low bidder will be contingent upon the following conditions:

- (1) Concurrence from Federal Highway Administration, when applicable.
- (2) **All Bidders** must submit to the Office of Civil Rights for approval, Form OCR-481 (DBE Commitment) no later than the 3rd business day after opening of the bids to satisfy the Department and that adequate good faith efforts have been made to meet the contract goal. For answers to questions regarding Form OCR-481, contact the MDOT Office of Civil Rights at (601) 359-7466.
- (3) Bidder must include OCR-485 information with their bid proposal listing all firms that submitted quotes for material supplies or items to be subcontracted. OCR-485 information must be **signed and** included with the bid proposal. If the OCR-485 information is not included as part of bid proposal, your bid will be deemed irregular.

Prior to the start of any work, the bidder must notify the Project Engineer, in writing, of the name of the designated "DBE Liaison Officer" for this project. This notification must be posted on the bulletin board at the project site.

DEFAULT

If the contract goal established by MDOT in this proposal is 1% or greater, it must be met to fulfill the terms of the contract. The Contractor may list DBE Subcontractors and items that exceed MDOT's contract goal, but should unforeseen problems arise that would prevent a DBE from completing its total commitment percentage, the Contractor will meet the terms of the contract as long as it meets or exceeds MDOT's Contract Goal. For additional information, refer to "Replacement" section of this Notice.

DBE REPORTS

- (1) OCR-481: Refer to "CONTRACT GOAL" section of this Notice to Bidders for information regarding this form.

- (2) OCR-482: At the conclusion of the project, before the final estimate is paid and the project is closed out, the Prime Contractor will submit to the Project Engineer for verification of quantities and further handling Form OCR-482 whereby the Contractor certifies to the amounts of payments made to all Contractors / Suppliers over the life of the contract. The Project Engineer shall submit the completed Form OCR-482 to the DBE Coordinator (Office of Civil Rights). Final acceptance of the project is dependent upon Contract Administration Division's receipt of completed Form OCR-482 which they will receive from the Office of Civil Rights.
- (3) OCR-483: The Project Engineer/Inspector will complete Form OCR-483, the Commercially Useful Function (CUF) Performance Report, in accordance with MDOT S.O.P. No. OCR-03-05-02-483. Evaluations reported on this form are used to determine whether or not the DBE firm is performing a CUF. The Prime Contractor should take corrective action when the report contains any negative evaluations. DBE credit may be disallowed and/or other sanctions imposed if it is determined the DBE firm is not performing a CUF. This form should also be completed and returned to the DBE Coordinator (Office of Civil Rights).
- (4) OCR-484: Each month, the Prime Contractor will submit to the Project Engineer OCR-484 that certifies payments to all Subcontractors and shows all firms even if the Prime Contractor has paid no monies to the firm during that estimate period (negative report). The Project Engineer will attach the form to the monthly estimate before forwarding to the Contract Administration Division for further processing. Failure of the Contractor to submit the OCR-484 will result in the estimate not being processed and paid.
- (5) OCR-485: ALL BIDDERS must submit signed form with bid proposal of all firms that submitted quotes for material supplies or items to be subcontracted. If the OCR-485 information is not included as part of bid proposal, the bid will be deemed irregular.
- (6) OCR-487: Only used by Prime Contractors that are certified DBE firms. This form is used in determining the exact percentage of DBE credit for the specified project. The low Bidder should return this form to MDOT with the OCR-481 form, or can also be returned with the Permission to Subcontract Forms (CAD-720, CAD-725 and CAD-521).

DBE Forms, can be obtained from the Office of Civil Rights Division, MDOT Administration Building, 401 North West Street, Jackson, MS, or at www.mdot.ms.gov under the Civil Rights tab.

SANCTIONS

The Department has the option to enforce any of the following penalties for failure of the Prime Contractor to fulfill the DBE goal as stated on the OCR-481 form or any violations of the DBE program guidelines:

- (1) Disallow credit towards the DBE goal

(2) Withhold progress estimate payments

(3) Deduct from the final estimate or recover an amount equal to the unmet portion of the DBE goal which may include additional monetary penalties as outlined below based on the number of offenses and the severity of the violation as determined by MDOT.

1 st Offense	10% of unmet portion of goal	or	\$5,000 lump sum payment	or	Both
2 nd Offense	20% of unmet portion of goal	or	\$10,000 lump sum payment	or	Both
3 rd Offense	40% of unmet portion of goal	or	\$20,000 lump sum payment	or	\$20,000 lump sum payment and debarment

(4) Debar the Contractor involved from bidding on MDOT federally funded projects for a period of up to 12 months after notification by certified email.

MISSISSIPPI DEPARTMENT OF TRANSPORTATION

SECTION 904 - NOTICE TO BIDDERS NO. 2782

CODE: (SP)

DATE: 8/13/2020

SUBJECT: DBE Pre-Bid Meeting

Due to the COVID-19 pandemic and the Department not allowing visitors in the Administration Building at this time, the DBE Pre-Bid Meeting referenced on Page 5 of Notice to Bidders No. 2611 will be held by **video conference only**. The meeting will be held at 2:00 P.M. on the day preceding the date of the bid opening using Zoom video conferencing software. Anyone interested in participating can download Zoom and connect to the meeting at the below link.

<https://zoom.us/j/5548736403?pwd=SDh5S2hQSE5pNG5FOEkzR3NsUnBYQT09>

Password (if prompted): 272147

For those unable to participate via Zoom, the below teleconference number may be used instead.

1-888-227-7517

Conference Code: 404496

MISSISSIPPI DEPARTMENT OF TRANSPORTATION

SECTION 904 - NOTICE TO BIDDERS NO. 2881

CODE: (SP)

DATE: 1/13/2020

SUBJECT: Contract Time

PROJECT: NHPP-0472-00(019) / 108283301 – Newton County

The completion of work to be performed by the Contractor for this project will not be a specified date but shall be when all allowable working days are assessed, or any extension thereto as provided in Subsection 108.06. It is anticipated that the Notice of Award will be issued no later than March 9, 2021 and the date for Notice to Proceed / Beginning of Contract Time will be April 8, 2021.

Should the Contractor request a Notice to Proceed earlier than April 8, 2021 and it is agreeable with the Department for an early Notice to Proceed, the requested date will become the new Notice to Proceed date. Regardless of whether or not an early Notice to Proceed is granted, contract time will start at the original Notice to Proceed date.

All requests for an early Notice to Proceed shall be sent to the Project Engineer who will forward it to the Contract Administration Division.

198 Working Days have been allowed for the completion of work on this project.

MISSISSIPPI DEPARTMENT OF TRANSPORTATION

SECTION 904 - NOTICE TO BIDDERS NO. 2882

DATE: January 13, 2021

SUBJECT: Specialty Items

PROJECT: NHPP-0472-00(019)/108283301 - NEWTON

Pursuant to the provisions of Section 108, the following work items are hereby designated as "Specialty Items" for this contract. Bidders are reminded that these items must be subcontracted in order to be considered as specialty items.

CATEGORY: EROSION CONTROL

Line No	Pay Item	Description
0010	216-A001	Solid Sodding
0020	234-A001	Temporary Silt Fence

CATEGORY: PAVEMENT STRIPING AND MARKING

Line No	Pay Item	Description
0080	626-C001	6" Thermoplastic Double Drop Edge Stripe, Continuous White
0090	626-F002	6" Thermoplastic Double Drop Edge Stripe, Continuous Yellow
0100	627-L001	Two-Way Yellow Reflective High Performance Raised Markers

CATEGORY: TRAFFIC CONTROL - TEMPORARY

Line No	Pay Item	Description
0040	619-D1001	Standard Roadside Construction Signs, Less than 10 Square Feet
0050	619-D2001	Standard Roadside Construction Signs, 10 Square Feet or More
0060	619-G4001	Barricades, Type III, Double Faced

MISSISSIPPI DEPARTMENT OF TRANSPORTATION

SECTION 904 - NOTICE TO BIDDERS NO. 2883

CODE: (SP)

DATE: 06/18/2019

SUBJECT: Temporary Construction Signs

PROJECT: NHPP-0472-00(019) / 108283301 – Newton County

Bidders are hereby advised of the following regarding the Temporary Construction Signs required:

Should the Bidders elect to install Temporary Construction Signs by first driving short u-channel sections and then bolting the longer, correct height u-channel sections to them, the Bidders are advised that these short sections shall be a minimum of five (5) feet from the ground level when driven and the splice must consist of a minimum of eighteen (18) inches of overlap with a total of four (4) bolts. Bidders are also advised that it is mandatory that these short sections be removed at the completion of the project.

MISSISSIPPI DEPARTMENT OF TRANSPORTATION

SECTION 904 - NOTICE TO BIDDERS NO. 2884

CODE: (SP)

DATE: 10/26/2020

SUBJECT: Traffic Control

PROJECT: NHPP-0472-00(019) / 108283301 – Newton County

Bidders are hereby advised that Traffic Control for operations requiring painting, sand-blasting, or other large, stationary equipment is anticipated to be handled using single lane closures. If the Contractor proposes to use temporary traffic signals, a traffic control plan shall be submitted and approved prior to implementation. The cost of signal equipment, drums/barrels/cones, and temporary stripe required for temporary traffic signals shall be included in the cost of maintenance of traffic.

MISSISSIPPI DEPARTMENT OF TRANSPORTATION

SECTION 904 - NOTICE TO BIDDERS NO. 2895

CODE: (SP)

DATE: 10/14/2020

SUBJECT: Exploratory Joint Cleanout

Bidders are hereby advised that work on this project shall consist of exploratory investigation of bridge joints to determine the appropriate level of repair and will include removal of any trash and debris (including, but not limited to, compacted dirt, vegetation and trash) located at any depth within the joint. Costs of this work will be absorbed in the cost of other items of work if further joint repair work is not required.

MISSISSIPPI DEPARTMENT OF TRANSPORTATION

SECTION 904 - NOTICE TO BIDDERS NO. 2900

CODE: (SP)

DATE: 7/16/2019

SUBJECT: Underground Utilities

PROJECT: NHPP-0472-00(019) / 108283301 – Newton County

Bidders are hereby advised that utility lines owned and maintained by MDOT may be present within the project limits. These utilities are not located by Mississippi 811. It shall be the Contractor's responsibility to coordinate with MDOT to have the utility lines located and marked prior to beginning work. The Contractor shall give a minimum of three (3) working days of advance notice for locate requests. The contacts for MDOT utility lines are as follows:

Underground Power Lines:

Michael Lee – 601-683-3341 – mlee@mdot.ms.gov

Vince Herrington – 601-683-3341 – vherrington@mdot.ms.gov

Underground Communication Lines:

Kerby McFarland – 601-359-7450 – kmcfarland@mdot.ms.gov

Steven Newell – 601-359-7450 – snewell@mdot.ms.gov

Henry Lewis – 601-359-1454 – hlewis@mdot.ms.gov

Underground Signal Lines:

Amrik Singh – 601-359-1454 – asingh@mdot.ms.gov

Kenneth Welch – 601-359-1454 – kwelch@mdot.ms.gov

MISSISSIPPI DEPARTMENT OF TRANSPORTATION

SECTION 904 - NOTICE TO BIDDERS NO. 2954

CODE: (SP)

DATE: 12/01/2020

SUBJECT: Reflective Sheeting for Signs

Bidders are hereby advised that the retroreflective sign sheeting used for signs on this project shall be as listed below and shall meet the requirements of Subsection 721.06.

Temporary Construction Signs

Temporary traffic control (orange) sign sheeting shall be a minimum Type IX Fluorescent Orange sheeting as shown in Special Provision 907-721.

Permanent Signs

Permanent signs, except signs on traffic signal poles/mast arms, shall be as follows:

- Brown background sheeting on guide signs shall be a minimum Type VIII sheeting,
- Green and blue background sheeting on guide signs shall be a minimum Type IX sheeting, and
- All white, yellow, red, fluorescent yellow, and fluorescent yellow/green sheeting shall be Type XI sheeting.

INSTALLER - SIGN.....	\$ 12.08	0.00
IRONWORKER, REINFORCING.....	\$ 15.28	0.00
LABORER: Asphalt, Includes Raker, Shoveler, Spreader and Distributor.....	\$ 10.68	0.00
LABORER: Common or General.....	\$ 10.19	0.00
LABORER: Flagger.....	\$ 10.00	0.00
LABORER: Grade Checker.....	\$ 12.41	0.00
LABORER: Mason Tender - Cement/Concrete.....	\$ 11.30	0.00
LABORER: Pipelayer.....	\$ 12.27	0.00
LABORER: Laborer-Cones/ Barricades/Barrels - Setter/Mover/Sweeper.....	\$ 10.69	0.00
OPERATOR: Asphalt Spreader.....	\$ 15.33	0.00
OPERATOR: Backhoe/Excavator/Trackhoe.....	\$ 13.74	0.00
OPERATOR: Broom/Sweeper.....	\$ 10.17	0.00
OPERATOR: Bulldozer.....	\$ 14.23	0.00
OPERATOR: Concrete Saw.....	\$ 13.92	0.00
OPERATOR: Crane.....	\$ 20.10	0.00
OPERATOR: Distributor.....	\$ 12.00	0.00
OPERATOR: Drill.....	\$ 19.22	0.00
OPERATOR: Grader/Blade.....	\$ 15.13	0.00
OPERATOR: Loader.....	\$ 14.31	0.00
OPERATOR: Mechanic.....	\$ 16.25	0.00
OPERATOR: Milling Machine.....	\$ 14.96	0.00
OPERATOR: Mixer.....	\$ 12.42	0.00
OPERATOR: Oiler.....	\$ 13.00	0.00
OPERATOR: Paver (Asphalt, Aggregate, and Concrete).....	\$ 12.75	0.00
OPERATOR: Piledriver.....	\$ 15.13	0.00
OPERATOR: Roller (All Types)....	\$ 11.13	0.00
OPERATOR: Scraper.....	\$ 12.00	0.00
OPERATOR: Tractor.....	\$ 9.41	0.00
OPERATOR: Trencher.....	\$ 13.75	48 0.00

SURVEYOR (Staking, Marking and Brush Clearing).....	\$ 12.34	0.00
TRUCK DRIVER: Flatbed Truck.....	\$ 13.29	0.00
TRUCK DRIVER: Lowboy Truck.....	\$ 11.00	0.00
TRUCK DRIVER: Mechanic.....	\$ 12.15	0.00
TRUCK DRIVER: Off the Road Truck.....	\$ 12.31	0.00
TRUCK DRIVER: Water Truck.....	\$ 9.63	0.00
TRUCK DRIVER: Dump Truck (All Types).....	\$ 10.68	0.00
TRUCK DRIVER: Semi/Trailer Truck.....	\$ 12.50	0.00

WELDERS - Receive rate prescribed for craft performing operation to which welding is incidental.

=====

Note: Executive Order (EO) 13706, Establishing Paid Sick Leave for Federal Contractors applies to all contracts subject to the Davis-Bacon Act for which the contract is awarded (and any solicitation was issued) on or after January 1, 2017. If this contract is covered by the EO, the contractor must provide employees with 1 hour of paid sick leave for every 30 hours they work, up to 56 hours of paid sick leave each year. Employees must be permitted to use paid sick leave for their own illness, injury or other health-related needs, including preventive care; to assist a family member (or person who is like family to the employee) who is ill, injured, or has other health-related needs, including preventive care; or for reasons resulting from, or to assist a family member (or person who is like family to the employee) who is a victim of, domestic violence, sexual assault, or stalking. Additional information on contractor requirements and worker protections under the EO is available at www.dol.gov/whd/govcontracts.

Unlisted classifications needed for work not included within the scope of the classifications listed may be added after award only as provided in the labor standards contract clauses (29CFR 5.5 (a) (1) (ii)).

The body of each wage determination lists the classification and wage rates that have been found to be prevailing for the cited type(s) of construction in the area covered by the wage determination. The classifications are listed in alphabetical order of "identifiers" that indicate whether the particular rate is a union rate (current union negotiated rate for local), a survey rate (weighted average rate) or a union average rate (weighted union average rate).

Union Rate Identifiers

A four letter classification abbreviation identifier enclosed in dotted lines beginning with characters other than ""SU"" or ""UAVG"" denotes that the union classification and rate were prevailing for that classification in the survey. Example: PLUM0198-005 07/01/2014. PLUM is an abbreviation identifier of the union which prevailed in the survey for this classification, which in this example would be Plumbers. 0198 indicates the local union number or district council number where applicable, i.e., Plumbers Local 0198. The next number, 005 in the example, is an internal number used in processing the wage determination. 07/01/2014 is the effective date of the most current negotiated rate, which in this example is July 1, 2014.

Union prevailing wage rates are updated to reflect all rate changes in the collective bargaining agreement (CBA) governing this classification and rate.

Survey Rate Identifiers

Classifications listed under the ""SU"" identifier indicate that no one rate prevailed for this classification in the survey and the published rate is derived by computing a weighted average rate based on all the rates reported in the survey for that classification. As this weighted average rate includes all rates reported in the survey, it may include both union and non-union rates. Example: SULA2012-007 5/13/2014. SU indicates the rates are survey rates based on a weighted average calculation of rates and are not majority rates. LA indicates the State of Louisiana. 2012 is the year of survey on which these classifications and rates are based. The next number, 007 in the example, is an internal number used in producing the wage determination. 5/13/2014 indicates the survey completion date for the classifications and rates under that identifier.

Survey wage rates are not updated and remain in effect until a new survey is conducted.

Union Average Rate Identifiers

Classification(s) listed under the UAVG identifier indicate that no single majority rate prevailed for those classifications; however, 100% of the data reported for the classifications was union data. EXAMPLE: UAVG-OH-0010 08/29/2014. UAVG indicates that the rate is a weighted union average rate. OH indicates the state. The next number, 0010 in the example, is an internal number used in producing the wage determination. 08/29/2014 indicates the survey completion date for the classifications and rates under that identifier.

A UAVG rate will be updated once a year, usually in January of each year, to reflect a weighted average of the current negotiated/CBA rate of the union locals from which the rate is based.

WAGE DETERMINATION APPEALS PROCESS

1.) Has there been an initial decision in the matter? This can be:

* an existing published wage determination

- * a survey underlying a wage determination
- * a Wage and Hour Division letter setting forth a position on a wage determination matter
- * a conformance (additional classification and rate) ruling

On survey related matters, initial contact, including requests for summaries of surveys, should be with the Wage and Hour Regional Office for the area in which the survey was conducted because those Regional Offices have responsibility for the Davis-Bacon survey program. If the response from this initial contact is not satisfactory, then the process described in 2.) and 3.) should be followed.

With regard to any other matter not yet ripe for the formal process described here, initial contact should be with the Branch of Construction Wage Determinations. Write to:

Branch of Construction Wage Determinations
 Wage and Hour Division
 U.S. Department of Labor
 200 Constitution Avenue, N.W.
 Washington, DC 20210

2.) If the answer to the question in 1.) is yes, then an interested party (those affected by the action) can request review and reconsideration from the Wage and Hour Administrator (See 29 CFR Part 1.8 and 29 CFR Part 7). Write to:

Wage and Hour Administrator
 U.S. Department of Labor
 200 Constitution Avenue, N.W.
 Washington, DC 20210

The request should be accompanied by a full statement of the interested party's position and by any information (wage payment data, project description, area practice material, etc.) that the requestor considers relevant to the issue.

3.) If the decision of the Administrator is not favorable, an interested party may appeal directly to the Administrative Review Board (formerly the Wage Appeals Board). Write to:

Administrative Review Board
 U.S. Department of Labor
 200 Constitution Avenue, N.W.
 Washington, DC 20210

4.) All decisions by the Administrative Review Board are final.

=====

END OF GENERAL DECISION

..

SUPPLEMENT TO FORM FHWA-1273

DATE: 12/17/2018

SUBJECT: **Federal Contract Provisions for Subcontracts and Cargo Preference Act**

Federal Contract Provisions for Subcontracts

All subcontracts shall be in writing and contain all pertinent provisions and requirements of the prime contract.

Each “Request for Permission to Subcontract” (Mississippi Department of Transportation Form CAD-720) shall include a copy of the subcontract. The federal contract provisions (FHWA-1273, SUPPLEMENT TO FORM FHWA-1273, NOTICE OF REQUIREMENT FOR AFFIRMATIVE ACTION TO ENSURE EQUAL EMPLOYMENT OPPORTUNITY (EXECUTIVE ORDER 11246), DAVIS-BACON AND RELATED ACT PROVISIONS (WAGE RATES)) must be physically incorporated as part of the subcontract. A completed Mississippi Department of Transportation Form CAD-521 and Form CAD-725 must be attached to the CAD-720.

Cargo Preference Act

The Contractor is hereby advised of the requirements set forth in the following Attachment (Title 46 - Shipping) as it pertains to the implementation of Cargo Preference Act (CPA) requirements in the Federal-aid Highway Program.

By signing this contract, the Contractor agrees to conform to the requirements of the CPA.

Attachment

Title 46- Shipping

Volume: 8

Date: 2014-10-01

Original Date: 2014-10-01

Title: Section 381.7 - Federal Grant, Guaranty, Loan and Advance at Funds Agreements.

Context: Title 46- Shipping. CHAPTER II- MARITIME ADMINISTRATION, DEPARTMENT OF TRANSPORTATION. SUBCHAPTER J - MISCELLANEOUS. PART 381 - CARGO PREFERENCE-U.S.-FLAG VESSELS.

§ 381.7 Federal Grant, Guaranty, Loan and Advance of Funds Agreements.

In order to insure a fair and reasonable participation by privately owned United States-flag commercial vessels in transporting cargoes which are subject to the Cargo Preference Act of 1954 and which are generated by U.S. Government Grant, Guaranty, Loan and/or Advance of Funds Programs, the head of each affected department or agency shall require appropriate clauses to be inserted in those Grant, Guaranty, Loan and/or Advance of Funds Agreements and all third party contracts executed between the borrower/grantee and other parties, where the possibility exists for ocean transportation of items procured, contracted for or otherwise obtained by or on behalf of the grantee, borrower, or any of their contractors or subcontractors. The clauses required by this part shall provide that at least 50 percent of the freight revenue and tonnage of cargo generated by the U.S. Government Grant, Guaranty, Loan or Advance of Funds be transported on privately owned United States-flag commercial vessels. These clauses shall also require that all parties provide to the Maritime Administration the necessary shipment information as set forth in § 381.3. A copy of the appropriate clauses required by this part shall be submitted by each affected agency or department to the Secretary, Maritime Administration, for approval no later than 30 days after the effective date of this part. The following are suggested acceptable clauses with respect to the use of United States-flag vessels to be incorporated in the Grant, Guaranty, Loan and/or Advance of Funds Agreements as well as contracts and subcontracts resulting therefrom:

(a) *Agreement Clauses.* "Use of United States-flag vessels:

"(1) Pursuant to Pub. L 664 (43 U.S.C. 1241(b)) at least 50 percent of any equipment, materials or commodities procured, contracted for or otherwise obtained with funds granted, guaranteed, loaned, or advanced by the U.S. Government under this agreement, and which may be transported by ocean vessel, shall be transported on privately owned United States-flag commercial vessels, if available.

"(2) Within 20 days following the date of loading for shipments originating within the United States or within 30 working days following the date of loading for shipments originating outside the United States, a legible copy of a rated, 'on-board' commercial ocean bill-of-lading in English for each shipment of cargo described in paragraph (a)(1) of this section shall be furnished to both the Contracting Officer (through the prime contractor in the case of subcontractor bills-of-lading) and to the Division of National Cargo, Office of Market Development, Maritime Administration, Washington, DC 20590."

(b) *Contractor and Subcontractor Clauses.* "Use of United States-flag vessels: The contractor agrees --

"(1) To utilize privately owned United States-flag commercial vessels to ship at least 50 percent of the gross tonnage (computed separately for dry bulk carriers, dry cargo liners, and tankers) involved, whenever shipping any equipment, material, or commodities pursuant to this contract, to the extent such vessels are available at fair and reasonable rates for United States-flag commercial vessels.

"(2) To furnish within 20 days following the date of loading for shipments originating within the United

States or within 30 working days following the date of loading for shipments originating outside the United States, a legible copy of a rated, 'on-board' commercial ocean bill-of-lading in English for each shipment of cargo described in paragraph (b) (1) of this section to both the Contracting Officer (through the prime contractor in the case of subcontractor bills-of-lading) and to the Division of National Cargo, Office of Market Development, Maritime Administration, Washington, DC 20590.

"(3) To insert the substance of the provisions of this clause in all subcontracts issued pursuant to this contract."

(Reorganization Plans No.21 of 1950(64 Stat. 1273) and No. 7 of 1961 (75 Stat. 840) as amended by Pub. L 91.469 (84 Stat 1036) and Department of Commerce Organization Order 10-8 (38 FR 19707, July 23, 1973)) (42 FR 57126, Nov. 1, 1977]

**REQUIRED CONTRACT PROVISIONS
FEDERAL-AID CONSTRUCTION CONTRACTS**

- I. General
- II. Nondiscrimination
- III. Nonsegregated Facilities
- IV. Davis-Bacon and Related Act Provisions
- V. Contract Work Hours and Safety Standards Act Provisions
- VI. Subletting or Assigning the Contract
- VII. Safety: Accident Prevention
- VIII. False Statements Concerning Highway Projects
- IX. Implementation of Clean Air Act and Federal Water Pollution Control Act
- X. Compliance with Governmentwide Suspension and Debarment Requirements
- XI. Certification Regarding Use of Contract Funds for Lobbying

3. A breach of any of the stipulations contained in these Required Contract Provisions may be sufficient grounds for withholding of progress payments, withholding of final payment, termination of the contract, suspension / debarment or any other action determined to be appropriate by the contracting agency and FHWA.

4. Selection of Labor: During the performance of this contract, the contractor shall not use convict labor for any purpose within the limits of a construction project on a Federal-aid highway unless it is labor performed by convicts who are on parole, supervised release, or probation. The term Federal-aid highway does not include roadways functionally classified as local roads or rural minor collectors.

ATTACHMENTS

A. Employment and Materials Preference for Appalachian Development Highway System or Appalachian Local Access Road Contracts (included in Appalachian contracts only)

I. GENERAL

1. Form FHWA-1273 must be physically incorporated in each construction contract funded under Title 23 (excluding emergency contracts solely intended for debris removal). The contractor (or subcontractor) must insert this form in each subcontract and further require its inclusion in all lower tier subcontracts (excluding purchase orders, rental agreements and other agreements for supplies or services).

The applicable requirements of Form FHWA-1273 are incorporated by reference for work done under any purchase order, rental agreement or agreement for other services. The prime contractor shall be responsible for compliance by any subcontractor, lower-tier subcontractor or service provider.

Form FHWA-1273 must be included in all Federal-aid design-build contracts, in all subcontracts and in lower tier subcontracts (excluding subcontracts for design services, purchase orders, rental agreements and other agreements for supplies or services). The design-builder shall be responsible for compliance by any subcontractor, lower-tier subcontractor or service provider.

Contracting agencies may reference Form FHWA-1273 in bid proposal or request for proposal documents, however, the Form FHWA-1273 must be physically incorporated (not referenced) in all contracts, subcontracts and lower-tier subcontracts (excluding purchase orders, rental agreements and other agreements for supplies or services related to a construction contract).

2. Subject to the applicability criteria noted in the following sections, these contract provisions shall apply to all work performed on the contract by the contractor's own organization and with the assistance of workers under the contractor's immediate superintendence and to all work performed on the contract by piecework, station work, or by subcontract.

II. NONDISCRIMINATION

The provisions of this section related to 23 CFR Part 230 are applicable to all Federal-aid construction contracts and to all related construction subcontracts of \$10,000 or more. The provisions of 23 CFR Part 230 are not applicable to material supply, engineering, or architectural service contracts.

In addition, the contractor and all subcontractors must comply with the following policies: Executive Order 11246, 41 CFR 60, 29 CFR 1625-1627, Title 23 USC Section 140, the Rehabilitation Act of 1973, as amended (29 USC 794), Title VI of the Civil Rights Act of 1964, as amended, and related regulations including 49 CFR Parts 21, 26 and 27; and 23 CFR Parts 200, 230, and 633.

The contractor and all subcontractors must comply with: the requirements of the Equal Opportunity Clause in 41 CFR 60-1.4(b) and, for all construction contracts exceeding \$10,000, the Standard Federal Equal Employment Opportunity Construction Contract Specifications in 41 CFR 60-4.3.

Note: The U.S. Department of Labor has exclusive authority to determine compliance with Executive Order 11246 and the policies of the Secretary of Labor including 41 CFR 60, and 29 CFR 1625-1627. The contracting agency and the FHWA have the authority and the responsibility to ensure compliance with Title 23 USC Section 140, the Rehabilitation Act of 1973, as amended (29 USC 794), and Title VI of the Civil Rights Act of 1964, as amended, and related regulations including 49 CFR Parts 21, 26 and 27; and 23 CFR Parts 200, 230, and 633.

The following provision is adopted from 23 CFR 230, Appendix A, with appropriate revisions to conform to the U.S. Department of Labor (US DOL) and FHWA requirements.

1. Equal Employment Opportunity: Equal employment opportunity (EEO) requirements not to discriminate and to take affirmative action to assure equal opportunity as set forth under laws, executive orders, rules, regulations (28 CFR 35, 29 CFR 1630, 29 CFR 1625-1627, 41 CFR 60 and 49 CFR 27) and orders of the Secretary of Labor as modified by the provisions prescribed herein, and imposed pursuant to 23 U.S.C. 140 shall constitute the EEO and specific affirmative action standards for the contractor's project activities under

this contract. The provisions of the Americans with Disabilities Act of 1990 (42 U.S.C. 12101 et seq.) set forth under 28 CFR 35 and 29 CFR 1630 are incorporated by reference in this contract. In the execution of this contract, the contractor agrees to comply with the following minimum specific requirement activities of EEO:

a. The contractor will work with the contracting agency and the Federal Government to ensure that it has made every good faith effort to provide equal opportunity with respect to all of its terms and conditions of employment and in their review of activities under the contract.

b. The contractor will accept as its operating policy the following statement:

"It is the policy of this Company to assure that applicants are employed, and that employees are treated during employment, without regard to their race, religion, sex, color, national origin, age or disability. Such action shall include: employment, upgrading, demotion, or transfer; recruitment or recruitment advertising; layoff or termination; rates of pay or other forms of compensation; and selection for training, including apprenticeship, pre-apprenticeship, and/or on-the-job training."

2. EEO Officer: The contractor will designate and make known to the contracting officers an EEO Officer who will have the responsibility for and must be capable of effectively administering and promoting an active EEO program and who must be assigned adequate authority and responsibility to do so.

3. Dissemination of Policy: All members of the contractor's staff who are authorized to hire, supervise, promote, and discharge employees, or who recommend such action, or who are substantially involved in such action, will be made fully cognizant of, and will implement, the contractor's EEO policy and contractual responsibilities to provide EEO in each grade and classification of employment. To ensure that the above agreement will be met, the following actions will be taken as a minimum:

a. Periodic meetings of supervisory and personnel office employees will be conducted before the start of work and then not less often than once every six months, at which time the contractor's EEO policy and its implementation will be reviewed and explained. The meetings will be conducted by the EEO Officer.

b. All new supervisory or personnel office employees will be given a thorough indoctrination by the EEO Officer, covering all major aspects of the contractor's EEO obligations within thirty days following their reporting for duty with the contractor.

c. All personnel who are engaged in direct recruitment for the project will be instructed by the EEO Officer in the contractor's procedures for locating and hiring minorities and women.

d. Notices and posters setting forth the contractor's EEO policy will be placed in areas readily accessible to employees, applicants for employment and potential employees.

e. The contractor's EEO policy and the procedures to implement such policy will be brought to the attention of employees by means of meetings, employee handbooks, or other appropriate means.

4. Recruitment: When advertising for employees, the contractor will include in all advertisements for employees the notation: "An Equal Opportunity Employer." All such advertisements will be placed in publications having a large circulation among minorities and women in the area from which the project work force would normally be derived.

a. The contractor will, unless precluded by a valid bargaining agreement, conduct systematic and direct recruitment through public and private employee referral sources likely to yield qualified minorities and women. To meet this requirement, the contractor will identify sources of potential minority group employees, and establish with such identified sources procedures whereby minority and women applicants may be referred to the contractor for employment consideration.

b. In the event the contractor has a valid bargaining agreement providing for exclusive hiring hall referrals, the contractor is expected to observe the provisions of that agreement to the extent that the system meets the contractor's compliance with EEO contract provisions. Where implementation of such an agreement has the effect of discriminating against minorities or women, or obligates the contractor to do the same, such implementation violates Federal nondiscrimination provisions.

c. The contractor will encourage its present employees to refer minorities and women as applicants for employment. Information and procedures with regard to referring such applicants will be discussed with employees.

5. Personnel Actions: Wages, working conditions, and employee benefits shall be established and administered, and personnel actions of every type, including hiring, upgrading, promotion, transfer, demotion, layoff, and termination, shall be taken without regard to race, color, religion, sex, national origin, age or disability. The following procedures shall be followed:

a. The contractor will conduct periodic inspections of project sites to insure that working conditions and employee facilities do not indicate discriminatory treatment of project site personnel.

b. The contractor will periodically evaluate the spread of wages paid within each classification to determine any evidence of discriminatory wage practices.

c. The contractor will periodically review selected personnel actions in depth to determine whether there is evidence of discrimination. Where evidence is found, the contractor will promptly take corrective action. If the review indicates that the discrimination may extend beyond the actions reviewed, such corrective action shall include all affected persons.

d. The contractor will promptly investigate all complaints of alleged discrimination made to the contractor in connection with its obligations under this contract, will attempt to resolve such complaints, and will take appropriate corrective action within a reasonable time. If the investigation indicates that the discrimination may affect persons other than the complainant, such corrective action shall include such other persons. Upon completion of each investigation, the contractor will inform every complainant of all of their avenues of appeal.

6. Training and Promotion:

a. The contractor will assist in locating, qualifying, and increasing the skills of minorities and women who are

applicants for employment or current employees. Such efforts should be aimed at developing full journey level status employees in the type of trade or job classification involved.

b. Consistent with the contractor's work force requirements and as permissible under Federal and State regulations, the contractor shall make full use of training programs, i.e., apprenticeship, and on-the-job training programs for the geographical area of contract performance. In the event a special provision for training is provided under this contract, this subparagraph will be superseded as indicated in the special provision. The contracting agency may reserve training positions for persons who receive welfare assistance in accordance with 23 U.S.C. 140(a).

c. The contractor will advise employees and applicants for employment of available training programs and entrance requirements for each.

d. The contractor will periodically review the training and promotion potential of employees who are minorities and women and will encourage eligible employees to apply for such training and promotion.

7. Unions: If the contractor relies in whole or in part upon unions as a source of employees, the contractor will use good faith efforts to obtain the cooperation of such unions to increase opportunities for minorities and women. Actions by the contractor, either directly or through a contractor's association acting as agent, will include the procedures set forth below:

a. The contractor will use good faith efforts to develop, in cooperation with the unions, joint training programs aimed toward qualifying more minorities and women for membership in the unions and increasing the skills of minorities and women so that they may qualify for higher paying employment.

b. The contractor will use good faith efforts to incorporate an EEO clause into each union agreement to the end that such union will be contractually bound to refer applicants without regard to their race, color, religion, sex, national origin, age or disability.

c. The contractor is to obtain information as to the referral practices and policies of the labor union except that to the extent such information is within the exclusive possession of the labor union and such labor union refuses to furnish such information to the contractor, the contractor shall so certify to the contracting agency and shall set forth what efforts have been made to obtain such information.

d. In the event the union is unable to provide the contractor with a reasonable flow of referrals within the time limit set forth in the collective bargaining agreement, the contractor will, through independent recruitment efforts, fill the employment vacancies without regard to race, color, religion, sex, national origin, age or disability; making full efforts to obtain qualified and/or qualifiable minorities and women. The failure of a union to provide sufficient referrals (even though it is obligated to provide exclusive referrals under the terms of a collective bargaining agreement) does not relieve the contractor from the requirements of this paragraph. In the event the union referral practice prevents the contractor from meeting the obligations pursuant to Executive Order 11246, as amended, and these special provisions, such contractor shall immediately notify the contracting agency.

8. Reasonable Accommodation for Applicants / Employees with Disabilities: The contractor must be familiar

with the requirements for and comply with the Americans with Disabilities Act and all rules and regulations established there under. Employers must provide reasonable accommodation in all employment activities unless to do so would cause an undue hardship.

9. Selection of Subcontractors, Procurement of Materials and Leasing of Equipment: The contractor shall not discriminate on the grounds of race, color, religion, sex, national origin, age or disability in the selection and retention of subcontractors, including procurement of materials and leases of equipment. The contractor shall take all necessary and reasonable steps to ensure nondiscrimination in the administration of this contract.

a. The contractor shall notify all potential subcontractors and suppliers and lessors of their EEO obligations under this contract.

b. The contractor will use good faith efforts to ensure subcontractor compliance with their EEO obligations.

10. Assurance Required by 49 CFR 26.13(b):

a. The requirements of 49 CFR Part 26 and the State DOT's U.S. DOT-approved DBE program are incorporated by reference.

b. The contractor or subcontractor shall not discriminate on the basis of race, color, national origin, or sex in the performance of this contract. The contractor shall carry out applicable requirements of 49 CFR Part 26 in the award and administration of DOT-assisted contracts. Failure by the contractor to carry out these requirements is a material breach of this contract, which may result in the termination of this contract or such other remedy as the contracting agency deems appropriate.

11. Records and Reports: The contractor shall keep such records as necessary to document compliance with the EEO requirements. Such records shall be retained for a period of three years following the date of the final payment to the contractor for all contract work and shall be available at reasonable times and places for inspection by authorized representatives of the contracting agency and the FHWA.

a. The records kept by the contractor shall document the following:

(1) The number and work hours of minority and non-minority group members and women employed in each work classification on the project;

(2) The progress and efforts being made in cooperation with unions, when applicable, to increase employment opportunities for minorities and women; and

(3) The progress and efforts being made in locating, hiring, training, qualifying, and upgrading minorities and women;

b. The contractors and subcontractors will submit an annual report to the contracting agency each July for the duration of the project, indicating the number of minority, women, and non-minority group employees currently engaged in each work classification required by the contract work. This information is to be reported on [Form FHWA-1391](#). The staffing data should represent the project work force on board in all or any part of the last payroll period preceding the end of July. If on-the-job training is being required by special provision, the contractor

will be required to collect and report training data. The employment data should reflect the work force on board during all or any part of the last payroll period preceding the end of July.

III. NONSEGREGATED FACILITIES

This provision is applicable to all Federal-aid construction contracts and to all related construction subcontracts of \$10,000 or more.

The contractor must ensure that facilities provided for employees are provided in such a manner that segregation on the basis of race, color, religion, sex, or national origin cannot result. The contractor may neither require such segregated use by written or oral policies nor tolerate such use by employee custom. The contractor's obligation extends further to ensure that its employees are not assigned to perform their services at any location, under the contractor's control, where the facilities are segregated. The term "facilities" includes waiting rooms, work areas, restaurants and other eating areas, time clocks, restrooms, washrooms, locker rooms, and other storage or dressing areas, parking lots, drinking fountains, recreation or entertainment areas, transportation, and housing provided for employees. The contractor shall provide separate or single-user restrooms and necessary dressing or sleeping areas to assure privacy between sexes.

IV. DAVIS-BACON AND RELATED ACT PROVISIONS

This section is applicable to all Federal-aid construction projects exceeding \$2,000 and to all related subcontracts and lower-tier subcontracts (regardless of subcontract size). The requirements apply to all projects located within the right-of-way of a roadway that is functionally classified as Federal-aid highway. This excludes roadways functionally classified as local roads or rural minor collectors, which are exempt. Contracting agencies may elect to apply these requirements to other projects.

The following provisions are from the U.S. Department of Labor regulations in 29 CFR 5.5 "Contract provisions and related matters" with minor revisions to conform to the FHWA-1273 format and FHWA program requirements.

1. Minimum wages

a. All laborers and mechanics employed or working upon the site of the work, will be paid unconditionally and not less often than once a week, and without subsequent deduction or rebate on any account (except such payroll deductions as are permitted by regulations issued by the Secretary of Labor under the Copeland Act (29 CFR part 3)), the full amount of wages and bona fide fringe benefits (or cash equivalents thereof) due at time of payment computed at rates not less than those contained in the wage determination of the Secretary of Labor which is attached hereto and made a part hereof, regardless of any contractual relationship which may be alleged to exist between the contractor and such laborers and mechanics.

Contributions made or costs reasonably anticipated for bona fide fringe benefits under section 1(b)(2) of the Davis-Bacon Act on behalf of laborers or mechanics are considered wages

paid to such laborers or mechanics, subject to the provisions of paragraph 1.d. of this section; also, regular contributions made or costs incurred for more than a weekly period (but not less often than quarterly) under plans, funds, or programs which cover the particular weekly period, are deemed to be constructively made or incurred during such weekly period. Such laborers and mechanics shall be paid the appropriate wage rate and fringe benefits on the wage determination for the classification of work actually performed, without regard to skill, except as provided in 29 CFR 5.5(a)(4). Laborers or mechanics performing work in more than one classification may be compensated at the rate specified for each classification for the time actually worked therein: Provided, That the employer's payroll records accurately set forth the time spent in each classification in which work is performed. The wage determination (including any additional classification and wage rates conformed under paragraph 1.b. of this section) and the Davis-Bacon poster (WH-1321) shall be posted at all times by the contractor and its subcontractors at the site of the work in a prominent and accessible place where it can be easily seen by the workers.

b. (1) The contracting officer shall require that any class of laborers or mechanics, including helpers, which is not listed in the wage determination and which is to be employed under the contract shall be classified in conformance with the wage determination. The contracting officer shall approve an additional classification and wage rate and fringe benefits therefore only when the following criteria have been met:

(i) The work to be performed by the classification requested is not performed by a classification in the wage determination; and

(ii) The classification is utilized in the area by the construction industry; and

(iii) The proposed wage rate, including any bona fide fringe benefits, bears a reasonable relationship to the wage rates contained in the wage determination.

(2) If the contractor and the laborers and mechanics to be employed in the classification (if known), or their representatives, and the contracting officer agree on the classification and wage rate (including the amount designated for fringe benefits where appropriate), a report of the action taken shall be sent by the contracting officer to the Administrator of the Wage and Hour Division, Employment Standards Administration, U.S. Department of Labor, Washington, DC 20210. The Administrator, or an authorized representative, will approve, modify, or disapprove every additional classification action within 30 days of receipt and so advise the contracting officer or will notify the contracting officer within the 30-day period that additional time is necessary.

(3) In the event the contractor, the laborers or mechanics to be employed in the classification or their representatives, and the contracting officer do not agree on the proposed classification and wage rate (including the amount designated for fringe benefits, where appropriate), the contracting officer shall refer the questions, including the views of all interested parties and the recommendation of the contracting officer, to the Wage and Hour Administrator for determination. The Wage and Hour Administrator, or an authorized representative, will issue a determination within 30 days of receipt and so advise

the contracting officer or will notify the contracting officer within the 30-day period that additional time is necessary.

(4) The wage rate (including fringe benefits where appropriate) determined pursuant to paragraphs 1.b.(2) or 1.b.(3) of this section, shall be paid to all workers performing work in the classification under this contract from the first day on which work is performed in the classification.

c. Whenever the minimum wage rate prescribed in the contract for a class of laborers or mechanics includes a fringe benefit which is not expressed as an hourly rate, the contractor shall either pay the benefit as stated in the wage determination or shall pay another bona fide fringe benefit or an hourly cash equivalent thereof.

d. If the contractor does not make payments to a trustee or other third person, the contractor may consider as part of the wages of any laborer or mechanic the amount of any costs reasonably anticipated in providing bona fide fringe benefits under a plan or program, Provided, That the Secretary of Labor has found, upon the written request of the contractor, that the applicable standards of the Davis-Bacon Act have been met. The Secretary of Labor may require the contractor to set aside in a separate account assets for the meeting of obligations under the plan or program.

2. Withholding

The contracting agency shall upon its own action or upon written request of an authorized representative of the Department of Labor, withhold or cause to be withheld from the contractor under this contract, or any other Federal contract with the same prime contractor, or any other federally-assisted contract subject to Davis-Bacon prevailing wage requirements, which is held by the same prime contractor, so much of the accrued payments or advances as may be considered necessary to pay laborers and mechanics, including apprentices, trainees, and helpers, employed by the contractor or any subcontractor the full amount of wages required by the contract. In the event of failure to pay any laborer or mechanic, including any apprentice, trainee, or helper, employed or working on the site of the work, all or part of the wages required by the contract, the contracting agency may, after written notice to the contractor, take such action as may be necessary to cause the suspension of any further payment, advance, or guarantee of funds until such violations have ceased.

3. Payrolls and basic records

a. Payrolls and basic records relating thereto shall be maintained by the contractor during the course of the work and preserved for a period of three years thereafter for all laborers and mechanics working at the site of the work. Such records shall contain the name, address, and social security number of each such worker, his or her correct classification, hourly rates of wages paid (including rates of contributions or costs anticipated for bona fide fringe benefits or cash equivalents thereof of the types described in section 1(b)(2)(B) of the Davis-Bacon Act), daily and weekly number of hours worked, deductions made and actual wages paid. Whenever the Secretary of Labor has found under 29 CFR 5.5(a)(1)(iv) that the wages of any laborer or mechanic include the amount of any costs reasonably anticipated in providing benefits under a plan or program described in section 1(b)(2)(B) of the Davis-

Bacon Act, the contractor shall maintain records which show that the commitment to provide such benefits is enforceable, that the plan or program is financially responsible, and that the plan or program has been communicated in writing to the laborers or mechanics affected, and records which show the costs anticipated or the actual cost incurred in providing such benefits. Contractors employing apprentices or trainees under approved programs shall maintain written evidence of the registration of apprenticeship programs and certification of trainee programs, the registration of the apprentices and trainees, and the ratios and wage rates prescribed in the applicable programs.

b. (1) The contractor shall submit weekly for each week in which any contract work is performed a copy of all payrolls to the contracting agency. The payrolls submitted shall set out accurately and completely all of the information required to be maintained under 29 CFR 5.5(a)(3)(i), except that full social security numbers and home addresses shall not be included on weekly transmittals. Instead the payrolls shall only need to include an individually identifying number for each employee (e.g. , the last four digits of the employee's social security number). The required weekly payroll information may be submitted in any form desired. Optional Form WH-347 is available for this purpose from the Wage and Hour Division Web site at <http://www.dol.gov/esa/whd/forms/wh347instr.htm> or its successor site. The prime contractor is responsible for the submission of copies of payrolls by all subcontractors. Contractors and subcontractors shall maintain the full social security number and current address of each covered worker, and shall provide them upon request to the contracting agency for transmission to the State DOT, the FHWA or the Wage and Hour Division of the Department of Labor for purposes of an investigation or audit of compliance with prevailing wage requirements. It is not a violation of this section for a prime contractor to require a subcontractor to provide addresses and social security numbers to the prime contractor for its own records, without weekly submission to the contracting agency..

(2) Each payroll submitted shall be accompanied by a "Statement of Compliance," signed by the contractor or subcontractor or his or her agent who pays or supervises the payment of the persons employed under the contract and shall certify the following:

(i) That the payroll for the payroll period contains the information required to be provided under §5.5 (a)(3)(ii) of Regulations, 29 CFR part 5, the appropriate information is being maintained under §5.5 (a)(3)(i) of Regulations, 29 CFR part 5, and that such information is correct and complete;

(ii) That each laborer or mechanic (including each helper, apprentice, and trainee) employed on the contract during the payroll period has been paid the full weekly wages earned, without rebate, either directly or indirectly, and that no deductions have been made either directly or indirectly from the full wages earned, other than permissible deductions as set forth in Regulations, 29 CFR part 3;

(iii) That each laborer or mechanic has been paid not less than the applicable wage rates and fringe benefits or cash equivalents for the classification of work performed, as specified in the applicable wage determination incorporated into the contract.

(3) The weekly submission of a properly executed certification set forth on the reverse side of Optional Form WH-347 shall satisfy the requirement for submission of the "Statement of Compliance" required by paragraph 3.b.(2) of this section.

(4) The falsification of any of the above certifications may subject the contractor or subcontractor to civil or criminal prosecution under section 1001 of title 18 and section 231 of title 31 of the United States Code.

c. The contractor or subcontractor shall make the records required under paragraph 3.a. of this section available for inspection, copying, or transcription by authorized representatives of the contracting agency, the State DOT, the FHWA, or the Department of Labor, and shall permit such representatives to interview employees during working hours on the job. If the contractor or subcontractor fails to submit the required records or to make them available, the FHWA may, after written notice to the contractor, the contracting agency or the State DOT, take such action as may be necessary to cause the suspension of any further payment, advance, or guarantee of funds. Furthermore, failure to submit the required records upon request or to make such records available may be grounds for debarment action pursuant to 29 CFR 5.12.

4. Apprentices and trainees

a. Apprentices (programs of the USDOL).

Apprentices will be permitted to work at less than the predetermined rate for the work they performed when they are employed pursuant to and individually registered in a bona fide apprenticeship program registered with the U.S. Department of Labor, Employment and Training Administration, Office of Apprenticeship Training, Employer and Labor Services, or with a State Apprenticeship Agency recognized by the Office, or if a person is employed in his or her first 90 days of probationary employment as an apprentice in such an apprenticeship program, who is not individually registered in the program, but who has been certified by the Office of Apprenticeship Training, Employer and Labor Services or a State Apprenticeship Agency (where appropriate) to be eligible for probationary employment as an apprentice.

The allowable ratio of apprentices to journeymen on the job site in any craft classification shall not be greater than the ratio permitted to the contractor as to the entire work force under the registered program. Any worker listed on a payroll at an apprentice wage rate, who is not registered or otherwise employed as stated above, shall be paid not less than the applicable wage rate on the wage determination for the classification of work actually performed. In addition, any apprentice performing work on the job site in excess of the ratio permitted under the registered program shall be paid not less than the applicable wage rate on the wage determination for the work actually performed. Where a contractor is performing construction on a project in a locality other than that in which its program is registered, the ratios and wage rates (expressed in percentages of the journeyman's hourly rate) specified in the contractor's or subcontractor's registered program shall be observed.

Every apprentice must be paid at not less than the rate specified in the registered program for the apprentice's level of progress, expressed as a percentage of the journeymen hourly

rate specified in the applicable wage determination. Apprentices shall be paid fringe benefits in accordance with the provisions of the apprenticeship program. If the apprenticeship program does not specify fringe benefits, apprentices must be paid the full amount of fringe benefits listed on the wage determination for the applicable classification. If the Administrator determines that a different practice prevails for the applicable apprentice classification, fringes shall be paid in accordance with that determination.

In the event the Office of Apprenticeship Training, Employer and Labor Services, or a State Apprenticeship Agency recognized by the Office, withdraws approval of an apprenticeship program, the contractor will no longer be permitted to utilize apprentices at less than the applicable predetermined rate for the work performed until an acceptable program is approved.

b. Trainees (programs of the USDOL).

Except as provided in 29 CFR 5.16, trainees will not be permitted to work at less than the predetermined rate for the work performed unless they are employed pursuant to and individually registered in a program which has received prior approval, evidenced by formal certification by the U.S. Department of Labor, Employment and Training Administration.

The ratio of trainees to journeymen on the job site shall not be greater than permitted under the plan approved by the Employment and Training Administration.

Every trainee must be paid at not less than the rate specified in the approved program for the trainee's level of progress, expressed as a percentage of the journeyman hourly rate specified in the applicable wage determination. Trainees shall be paid fringe benefits in accordance with the provisions of the trainee program. If the trainee program does not mention fringe benefits, trainees shall be paid the full amount of fringe benefits listed on the wage determination unless the Administrator of the Wage and Hour Division determines that there is an apprenticeship program associated with the corresponding journeyman wage rate on the wage determination which provides for less than full fringe benefits for apprentices. Any employee listed on the payroll at a trainee rate who is not registered and participating in a training plan approved by the Employment and Training Administration shall be paid not less than the applicable wage rate on the wage determination for the classification of work actually performed. In addition, any trainee performing work on the job site in excess of the ratio permitted under the registered program shall be paid not less than the applicable wage rate on the wage determination for the work actually performed.

In the event the Employment and Training Administration withdraws approval of a training program, the contractor will no longer be permitted to utilize trainees at less than the applicable predetermined rate for the work performed until an acceptable program is approved.

c. Equal employment opportunity. The utilization of apprentices, trainees and journeymen under this part shall be in conformity with the equal employment opportunity requirements of Executive Order 11246, as amended, and 29 CFR part 30.

d. Apprentices and Trainees (programs of the U.S. DOT).

Apprentices and trainees working under apprenticeship and skill training programs which have been certified by the Secretary of Transportation as promoting EEO in connection with Federal-aid highway construction programs are not subject to the requirements of paragraph 4 of this Section IV. The straight time hourly wage rates for apprentices and trainees under such programs will be established by the particular programs. The ratio of apprentices and trainees to journeymen shall not be greater than permitted by the terms of the particular program.

5. Compliance with Copeland Act requirements. The contractor shall comply with the requirements of 29 CFR part 3, which are incorporated by reference in this contract.

6. Subcontracts. The contractor or subcontractor shall insert Form FHWA-1273 in any subcontracts and also require the subcontractors to include Form FHWA-1273 in any lower tier subcontracts. The prime contractor shall be responsible for the compliance by any subcontractor or lower tier subcontractor with all the contract clauses in 29 CFR 5.5.

7. Contract termination: debarment. A breach of the contract clauses in 29 CFR 5.5 may be grounds for termination of the contract, and for debarment as a contractor and a subcontractor as provided in 29 CFR 5.12.

8. Compliance with Davis-Bacon and Related Act requirements. All rulings and interpretations of the Davis-Bacon and Related Acts contained in 29 CFR parts 1, 3, and 5 are herein incorporated by reference in this contract.

9. Disputes concerning labor standards. Disputes arising out of the labor standards provisions of this contract shall not be subject to the general disputes clause of this contract. Such disputes shall be resolved in accordance with the procedures of the Department of Labor set forth in 29 CFR parts 5, 6, and 7. Disputes within the meaning of this clause include disputes between the contractor (or any of its subcontractors) and the contracting agency, the U.S. Department of Labor, or the employees or their representatives.

10. Certification of eligibility.

a. By entering into this contract, the contractor certifies that neither it (nor he or she) nor any person or firm who has an interest in the contractor's firm is a person or firm ineligible to be awarded Government contracts by virtue of section 3(a) of the Davis-Bacon Act or 29 CFR 5.12(a)(1).

b. No part of this contract shall be subcontracted to any person or firm ineligible for award of a Government contract by virtue of section 3(a) of the Davis-Bacon Act or 29 CFR 5.12(a)(1).

c. The penalty for making false statements is prescribed in the U.S. Criminal Code, 18 U.S.C. 1001.

V. CONTRACT WORK HOURS AND SAFETY STANDARDS ACT

The following clauses apply to any Federal-aid construction contract in an amount in excess of \$100,000 and subject to the overtime provisions of the Contract Work Hours and Safety Standards Act. These clauses shall be inserted in addition to the clauses required by 29 CFR 5.5(a) or 29 CFR 4.6. As used in this paragraph, the terms laborers and mechanics include watchmen and guards.

1. Overtime requirements. No contractor or subcontractor contracting for any part of the contract work which may require or involve the employment of laborers or mechanics shall require or permit any such laborer or mechanic in any workweek in which he or she is employed on such work to work in excess of forty hours in such workweek unless such laborer or mechanic receives compensation at a rate not less than one and one-half times the basic rate of pay for all hours worked in excess of forty hours in such workweek.

2. Violation; liability for unpaid wages; liquidated damages. In the event of any violation of the clause set forth in paragraph (1.) of this section, the contractor and any subcontractor responsible therefor shall be liable for the unpaid wages. In addition, such contractor and subcontractor shall be liable to the United States (in the case of work done under contract for the District of Columbia or a territory, to such District or to such territory), for liquidated damages. Such liquidated damages shall be computed with respect to each individual laborer or mechanic, including watchmen and guards, employed in violation of the clause set forth in paragraph (1.) of this section, in the sum of \$10 for each calendar day on which such individual was required or permitted to work in excess of the standard workweek of forty hours without payment of the overtime wages required by the clause set forth in paragraph (1.) of this section.

3. Withholding for unpaid wages and liquidated damages. The FHWA or the contacting agency shall upon its own action or upon written request of an authorized representative of the Department of Labor withhold or cause to be withheld, from any moneys payable on account of work performed by the contractor or subcontractor under any such contract or any other Federal contract with the same prime contractor, or any other federally-assisted contract subject to the Contract Work Hours and Safety Standards Act, which is held by the same prime contractor, such sums as may be determined to be necessary to satisfy any liabilities of such contractor or subcontractor for unpaid wages and liquidated damages as provided in the clause set forth in paragraph (2.) of this section.

4. Subcontracts. The contractor or subcontractor shall insert in any subcontracts the clauses set forth in paragraph (1.) through (4.) of this section and also a clause requiring the subcontractors to include these clauses in any lower tier subcontracts. The prime contractor shall be responsible for compliance by any subcontractor or lower tier subcontractor with the clauses set forth in paragraphs (1.) through (4.) of this section.

VI. SUBLETTING OR ASSIGNING THE CONTRACT

This provision is applicable to all Federal-aid construction contracts on the National Highway System.

1. The contractor shall perform with its own organization contract work amounting to not less than 30 percent (or a greater percentage if specified elsewhere in the contract) of the total original contract price, excluding any specialty items designated by the contracting agency. Specialty items may be performed by subcontract and the amount of any such specialty items performed may be deducted from the total original contract price before computing the amount of work required to be performed by the contractor's own organization (23 CFR 635.116).

a. The term "perform work with its own organization" refers to workers employed or leased by the prime contractor, and equipment owned or rented by the prime contractor, with or without operators. Such term does not include employees or equipment of a subcontractor or lower tier subcontractor, agents of the prime contractor, or any other assignees. The term may include payments for the costs of hiring leased employees from an employee leasing firm meeting all relevant Federal and State regulatory requirements. Leased employees may only be included in this term if the prime contractor meets all of the following conditions:

(1) the prime contractor maintains control over the supervision of the day-to-day activities of the leased employees;

(2) the prime contractor remains responsible for the quality of the work of the leased employees;

(3) the prime contractor retains all power to accept or exclude individual employees from work on the project; and

(4) the prime contractor remains ultimately responsible for the payment of predetermined minimum wages, the submission of payrolls, statements of compliance and all other Federal regulatory requirements.

b. "Specialty Items" shall be construed to be limited to work that requires highly specialized knowledge, abilities, or equipment not ordinarily available in the type of contracting organizations qualified and expected to bid or propose on the contract as a whole and in general are to be limited to minor components of the overall contract.

2. The contract amount upon which the requirements set forth in paragraph (1) of Section VI is computed includes the cost of material and manufactured products which are to be purchased or produced by the contractor under the contract provisions.

3. The contractor shall furnish (a) a competent superintendent or supervisor who is employed by the firm, has full authority to direct performance of the work in accordance with the contract requirements, and is in charge of all construction operations (regardless of who performs the work) and (b) such other of its own organizational resources (supervision, management, and engineering services) as the contracting officer determines is necessary to assure the performance of the contract.

4. No portion of the contract shall be sublet, assigned or otherwise disposed of except with the written consent of the contracting officer, or authorized representative, and such consent when given shall not be construed to relieve the contractor of any responsibility for the fulfillment of the contract. Written consent will be given only after the

contracting agency has assured that each subcontract is evidenced in writing and that it contains all pertinent provisions and requirements of the prime contract.

5. The 30% self-performance requirement of paragraph (1) is not applicable to design-build contracts; however, contracting agencies may establish their own self-performance requirements.

VII. SAFETY: ACCIDENT PREVENTION

This provision is applicable to all Federal-aid construction contracts and to all related subcontracts.

1. In the performance of this contract the contractor shall comply with all applicable Federal, State, and local laws governing safety, health, and sanitation (23 CFR 635). The contractor shall provide all safeguards, safety devices and protective equipment and take any other needed actions as it determines, or as the contracting officer may determine, to be reasonably necessary to protect the life and health of employees on the job and the safety of the public and to protect property in connection with the performance of the work covered by the contract.

2. It is a condition of this contract, and shall be made a condition of each subcontract, which the contractor enters into pursuant to this contract, that the contractor and any subcontractor shall not permit any employee, in performance of the contract, to work in surroundings or under conditions which are unsanitary, hazardous or dangerous to his/her health or safety, as determined under construction safety and health standards (29 CFR 1926) promulgated by the Secretary of Labor, in accordance with Section 107 of the Contract Work Hours and Safety Standards Act (40 U.S.C. 3704).

3. Pursuant to 29 CFR 1926.3, it is a condition of this contract that the Secretary of Labor or authorized representative thereof, shall have right of entry to any site of contract performance to inspect or investigate the matter of compliance with the construction safety and health standards and to carry out the duties of the Secretary under Section 107 of the Contract Work Hours and Safety Standards Act (40 U.S.C.3704).

VIII. FALSE STATEMENTS CONCERNING HIGHWAY PROJECTS

This provision is applicable to all Federal-aid construction contracts and to all related subcontracts.

In order to assure high quality and durable construction in conformity with approved plans and specifications and a high degree of reliability on statements and representations made by engineers, contractors, suppliers, and workers on Federal-aid highway projects, it is essential that all persons concerned with the project perform their functions as carefully, thoroughly, and honestly as possible. Willful falsification, distortion, or misrepresentation with respect to any facts related to the project is a violation of Federal law. To prevent any misunderstanding regarding the seriousness of these and similar acts, Form FHWA-1022 shall be posted on each Federal-aid highway project (23 CFR 635) in one or more places where it is readily available to all persons concerned with the project:

18 U.S.C. 1020 reads as follows:

"Whoever, being an officer, agent, or employee of the United States, or of any State or Territory, or whoever, whether a person, association, firm, or corporation, knowingly makes any false statement, false representation, or false report as to the character, quality, quantity, or cost of the material used or to be used, or the quantity or quality of the work performed or to be performed, or the cost thereof in connection with the submission of plans, maps, specifications, contracts, or costs of construction on any highway or related project submitted for approval to the Secretary of Transportation; or

Whoever knowingly makes any false statement, false representation, false report or false claim with respect to the character, quality, quantity, or cost of any work performed or to be performed, or materials furnished or to be furnished, in connection with the construction of any highway or related project approved by the Secretary of Transportation; or

Whoever knowingly makes any false statement or false representation as to material fact in any statement, certificate, or report submitted pursuant to provisions of the Federal-aid Roads Act approved July 1, 1916, (39 Stat. 355), as amended and supplemented;

Shall be fined under this title or imprisoned not more than 5 years or both."

IX. IMPLEMENTATION OF CLEAN AIR ACT AND FEDERAL WATER POLLUTION CONTROL ACT

This provision is applicable to all Federal-aid construction contracts and to all related subcontracts.

By submission of this bid/proposal or the execution of this contract, or subcontract, as appropriate, the bidder, proposer, Federal-aid construction contractor, or subcontractor, as appropriate, will be deemed to have stipulated as follows:

1. That any person who is or will be utilized in the performance of this contract is not prohibited from receiving an award due to a violation of Section 508 of the Clean Water Act or Section 306 of the Clean Air Act.

2. That the contractor agrees to include or cause to be included the requirements of paragraph (1) of this Section X in every subcontract, and further agrees to take such action as the contracting agency may direct as a means of enforcing such requirements.

X. CERTIFICATION REGARDING DEBARMENT, SUSPENSION, INELIGIBILITY AND VOLUNTARY EXCLUSION

This provision is applicable to all Federal-aid construction contracts, design-build contracts, subcontracts, lower-tier subcontracts, purchase orders, lease agreements, consultant contracts or any other covered transaction requiring FHWA approval or that is estimated to cost \$25,000 or more – as defined in 2 CFR Parts 180 and 1200.

1. Instructions for Certification – First Tier Participants:

a. By signing and submitting this proposal, the prospective first tier participant is providing the certification set out below.

b. The inability of a person to provide the certification set out below will not necessarily result in denial of participation in this

covered transaction. The prospective first tier participant shall submit an explanation of why it cannot provide the certification set out below. The certification or explanation will be considered in connection with the department or agency's determination whether to enter into this transaction. However, failure of the prospective first tier participant to furnish a certification or an explanation shall disqualify such a person from participation in this transaction.

c. The certification in this clause is a material representation of fact upon which reliance was placed when the contracting agency determined to enter into this transaction. If it is later determined that the prospective participant knowingly rendered an erroneous certification, in addition to other remedies available to the Federal Government, the contracting agency may terminate this transaction for cause of default.

d. The prospective first tier participant shall provide immediate written notice to the contracting agency to whom this proposal is submitted if any time the prospective first tier participant learns that its certification was erroneous when submitted or has become erroneous by reason of changed circumstances.

e. The terms "covered transaction," "debarred," "suspended," "ineligible," "participant," "person," "principal," and "voluntarily excluded," as used in this clause, are defined in 2 CFR Parts 180 and 1200. "First Tier Covered Transactions" refers to any covered transaction between a grantee or subgrantee of Federal funds and a participant (such as the prime or general contractor). "Lower Tier Covered Transactions" refers to any covered transaction under a First Tier Covered Transaction (such as subcontracts). "First Tier Participant" refers to the participant who has entered into a covered transaction with a grantee or subgrantee of Federal funds (such as the prime or general contractor). "Lower Tier Participant" refers any participant who has entered into a covered transaction with a First Tier Participant or other Lower Tier Participants (such as subcontractors and suppliers).

f. The prospective first tier participant agrees by submitting this proposal that, should the proposed covered transaction be entered into, it shall not knowingly enter into any lower tier covered transaction with a person who is debarred, suspended, declared ineligible, or voluntarily excluded from participation in this covered transaction, unless authorized by the department or agency entering into this transaction.

g. The prospective first tier participant further agrees by submitting this proposal that it will include the clause titled "Certification Regarding Debarment, Suspension, Ineligibility and Voluntary Exclusion-Lower Tier Covered Transactions," provided by the department or contracting agency, entering into this covered transaction, without modification, in all lower tier covered transactions and in all solicitations for lower tier covered transactions exceeding the \$25,000 threshold.

h. A participant in a covered transaction may rely upon a certification of a prospective participant in a lower tier covered transaction that is not debarred, suspended, ineligible, or voluntarily excluded from the covered transaction, unless it knows that the certification is erroneous. A participant is responsible for ensuring that its principals are not suspended, debarred, or otherwise ineligible to participate in covered transactions. To verify the eligibility of its principals, as well as the eligibility of any lower tier prospective participants, each participant may, but is not required to, check the Excluded Parties List System website (<https://www.epls.gov/>), which is compiled by the General Services Administration.

i. Nothing contained in the foregoing shall be construed to require the establishment of a system of records in order to render in good faith the certification required by this clause. The knowledge and information of the prospective participant is not required to exceed that which is normally possessed by a prudent person in the ordinary course of business dealings.

j. Except for transactions authorized under paragraph (f) of these instructions, if a participant in a covered transaction knowingly enters into a lower tier covered transaction with a person who is suspended, debarred, ineligible, or voluntarily excluded from participation in this transaction, in addition to other remedies available to the Federal Government, the department or agency may terminate this transaction for cause or default.

* * * * *

2. Certification Regarding Debarment, Suspension, Ineligibility and Voluntary Exclusion – First Tier Participants:

a. The prospective first tier participant certifies to the best of its knowledge and belief, that it and its principals:

(1) Are not presently debarred, suspended, proposed for debarment, declared ineligible, or voluntarily excluded from participating in covered transactions by any Federal department or agency;

(2) Have not within a three-year period preceding this proposal been convicted of or had a civil judgment rendered against them for commission of fraud or a criminal offense in connection with obtaining, attempting to obtain, or performing a public (Federal, State or local) transaction or contract under a public transaction; violation of Federal or State antitrust statutes or commission of embezzlement, theft, forgery, bribery, falsification or destruction of records, making false statements, or receiving stolen property;

(3) Are not presently indicted for or otherwise criminally or civilly charged by a governmental entity (Federal, State or local) with commission of any of the offenses enumerated in paragraph (a)(2) of this certification; and

(4) Have not within a three-year period preceding this application/proposal had one or more public transactions (Federal, State or local) terminated for cause or default.

b. Where the prospective participant is unable to certify to any of the statements in this certification, such prospective participant shall attach an explanation to this proposal.

2. Instructions for Certification - Lower Tier Participants:

(Applicable to all subcontracts, purchase orders and other lower tier transactions requiring prior FHWA approval or estimated to cost \$25,000 or more - 2 CFR Parts 180 and 1200)

a. By signing and submitting this proposal, the prospective lower tier is providing the certification set out below.

b. The certification in this clause is a material representation of fact upon which reliance was placed when this transaction was entered into. If it is later determined that the prospective lower tier participant knowingly rendered an erroneous certification, in addition to other remedies available to the Federal Government, the department, or agency with which

this transaction originated may pursue available remedies, including suspension and/or debarment.

c. The prospective lower tier participant shall provide immediate written notice to the person to which this proposal is submitted if at any time the prospective lower tier participant learns that its certification was erroneous by reason of changed circumstances.

d. The terms "covered transaction," "debarred," "suspended," "ineligible," "participant," "person," "principal," and "voluntarily excluded," as used in this clause, are defined in 2 CFR Parts 180 and 1200. You may contact the person to which this proposal is submitted for assistance in obtaining a copy of those regulations. "First Tier Covered Transactions" refers to any covered transaction between a grantee or subgrantee of Federal funds and a participant (such as the prime or general contract). "Lower Tier Covered Transactions" refers to any covered transaction under a First Tier Covered Transaction (such as subcontracts). "First Tier Participant" refers to the participant who has entered into a covered transaction with a grantee or subgrantee of Federal funds (such as the prime or general contractor). "Lower Tier Participant" refers any participant who has entered into a covered transaction with a First Tier Participant or other Lower Tier Participants (such as subcontractors and suppliers).

e. The prospective lower tier participant agrees by submitting this proposal that, should the proposed covered transaction be entered into, it shall not knowingly enter into any lower tier covered transaction with a person who is debarred, suspended, declared ineligible, or voluntarily excluded from participation in this covered transaction, unless authorized by the department or agency with which this transaction originated.

f. The prospective lower tier participant further agrees by submitting this proposal that it will include this clause titled "Certification Regarding Debarment, Suspension, Ineligibility and Voluntary Exclusion-Lower Tier Covered Transaction," without modification, in all lower tier covered transactions and in all solicitations for lower tier covered transactions exceeding the \$25,000 threshold.

g. A participant in a covered transaction may rely upon a certification of a prospective participant in a lower tier covered transaction that is not debarred, suspended, ineligible, or voluntarily excluded from the covered transaction, unless it knows that the certification is erroneous. A participant is responsible for ensuring that its principals are not suspended, debarred, or otherwise ineligible to participate in covered transactions. To verify the eligibility of its principals, as well as the eligibility of any lower tier prospective participants, each participant may, but is not required to, check the Excluded Parties List System website (<https://www.epls.gov/>), which is compiled by the General Services Administration.

h. Nothing contained in the foregoing shall be construed to require establishment of a system of records in order to render in good faith the certification required by this clause. The knowledge and information of participant is not required to exceed that which is normally possessed by a prudent person in the ordinary course of business dealings.

i. Except for transactions authorized under paragraph e of these instructions, if a participant in a covered transaction knowingly enters into a lower tier covered transaction with a person who is suspended, debarred, ineligible, or voluntarily excluded from participation in this transaction, in addition to other remedies available to the Federal Government, the

department or agency with which this transaction originated may pursue available remedies, including suspension and/or debarment.

* * * * *

Certification Regarding Debarment, Suspension, Ineligibility and Voluntary Exclusion--Lower Tier Participants:

1. The prospective lower tier participant certifies, by submission of this proposal, that neither it nor its principals is presently debarred, suspended, proposed for debarment, declared ineligible, or voluntarily excluded from participating in covered transactions by any Federal department or agency.

2. Where the prospective lower tier participant is unable to certify to any of the statements in this certification, such prospective participant shall attach an explanation to this proposal.

* * * * *

XI. CERTIFICATION REGARDING USE OF CONTRACT FUNDS FOR LOBBYING

This provision is applicable to all Federal-aid construction contracts and to all related subcontracts which exceed \$100,000 (49 CFR 20).

1. The prospective participant certifies, by signing and submitting this bid or proposal, to the best of his or her knowledge and belief, that:

a. No Federal appropriated funds have been paid or will be paid, by or on behalf of the undersigned, to any person for influencing or attempting to influence an officer or employee of any Federal agency, a Member of Congress, an officer or employee of Congress, or an employee of a Member of Congress in connection with the awarding of any Federal contract, the making of any Federal grant, the making of any Federal loan, the entering into of any cooperative agreement, and the extension, continuation, renewal, amendment, or modification of any Federal contract, grant, loan, or cooperative agreement.

b. If any funds other than Federal appropriated funds have been paid or will be paid to any person for influencing or attempting to influence an officer or employee of any Federal agency, a Member of Congress, an officer or employee of Congress, or an employee of a Member of Congress in connection with this Federal contract, grant, loan, or cooperative agreement, the undersigned shall complete and submit Standard Form-LLL, "Disclosure Form to Report Lobbying," in accordance with its instructions.

2. This certification is a material representation of fact upon which reliance was placed when this transaction was made or entered into. Submission of this certification is a prerequisite for making or entering into this transaction imposed by 31 U.S.C. 1352. Any person who fails to file the required certification shall be subject to a civil penalty of not less than \$10,000 and not more than \$100,000 for each such failure.

3. The prospective participant also agrees by submitting its bid or proposal that the participant shall require that the language of this certification be included in all lower tier subcontracts, which exceed \$100,000 and that all such recipients shall certify and disclose accordingly.

**NOTICE OF REQUIREMENTS FOR AFFIRMATIVE
ACTION TO ENSURE EQUAL EMPLOYMENT
OPPORTUNITY (EXECUTIVE ORDER 11246)**

1. The Offeror’s or Bidder’s attention is called to the “Equal Opportunity Clause” and the “Standard Federal Equal Employment Opportunity Construction Contract Specifications” set forth herein.

2. The goal for female participation, expressed in percentage terms for the Contractor’s aggregate workforce in each trade on all construction work, is 6.9%.

Until further notice	Goals for minority participation for each trade (percent)
----------------------	---

SHSA Cities:	
Pascagoula - Moss Point -----	16.9
Biloxi - Gulfport -----	19.2
Jackson -----	30.3

SMSA Counties:	
Desoto -----	32.3
Hancock, Harrison, Stone-----	19.2
Hinds, Rankin -----	30.3
Jackson -----	16.9

Non-SMSA Counties:	
George, Greene-----	26.4

Alcorn, Benton, Bolivar, Calhoun, Carroll, Chickasaw, Clay, Coahoma, Grenada, Itawamba, Lafayette, Lee, Leflore, Marshall, Monroe, Montgomery, Panola, Pontotoc, Prentiss, Quitman, Sunflower, Tallahatchie, Tate, Tippah, Tishomingo, Tunica, Union, Washington, Webster, Yalobusha -----	26.5
--	------

Attala, Choctaw, Claiborne, Clarke, Copiah, Covington, Franklin, Holmes, Humphreys, Issaquena, Jasper, Jefferson, Jefferson Davis, Jones Kemper, Lauderdale, Lawrence, Leake, Lincoln, Lowndes, Madison, Neshoba, Newton, Noxubee, Oktibbeha, Scott, Sharkey, Simpson, Smith, Warren, Wayne, Winston, Yazoo-----	32.0
--	------

Forrest, Lamar, Marion, Pearl River, Perry, Pike, Walthall-----	27.7
---	------

Adams, Amite, Wilkinson -----	30.4
-------------------------------	------

These goals are applicable to all the Contractor’s construction work (whether or not it is Federal or federally assisted) performed in the covered area. If the contractor performs construction work in a geographical area located outside of the covered area, it shall apply the goals established for such geographical area where the work is actually performed. With regard to this second area, the contractor also is subject to the goals for both its federally involved and nonfederally involved construction.

The Contractor’s compliance with the Executive Order and the regulations in 41 CFR Part 60-4 shall be based on its implementation of the Equal Opportunity clause, specific affirmative action obligations required by the specifications set forth in 41 CFR 60-4.3(a), and its efforts to meet the goals. The hours of minority and female employment and training must be substantially uniform throughout the length of the contract, and in each trade, and the Contractor shall make a good faith effort to employ minorities and women evenly on each of its projects. The transfer of minority or female employees or trainees from Contractor to Contractor or from project to project for the sole purpose of meeting the Contractor’s goals shall be a violation of the contract, the Executive Order and the regulations in 41 CFR Part 60-4.2(d). Compliance with the goals will be measured against the total work hours performed.

3. The Contractor shall provide written notification to the Director of the Office of Federal Contract Compliance Programs within 10 working days of award of any construction subcontract in excess of \$10,000 at any tier for construction work under the contract resulting from this solicitation. The notification shall list the name, address and telephone number of the subcontractor, employer identification number of the subcontractor, estimated dollar amount of the subcontract; estimated starting and completion dates of the subcontract; and the geographical area in which the subcontract is to be performed.

4. As used in this Notice, and in the contract resulting from this solicitation, the “covered area” is to the county and city (if any), stated in the advertisement.

5. The notification required in Paragraph 3 shall be addressed to the following:

Contract Compliance Officer
Mississippi Department of Transportation
P.O. Box 1850
Jackson, Mississippi 39215-1850

(12/04/2018)

MISSISSIPPI DEPARTMENT OF TRANSPORTATION

SPECIAL PROVISION NO. 907-102-2

CODE: (IS)

DATE: 11/22/2017

SUBJECT: **Bidding Requirements and Conditions**

Section 102, Bidding Requirements and Conditions, of the 2017 Edition of the Mississippi Standard Specifications for Road and Bridge Construction is hereby amended as follows.

907-102.01--Prequalification of Bidders. Delete the last sentence of the third paragraph of Subsection 102.01 on page 13, and substitute the following.

The Bidder's Certificate of Responsibility number must be on file with the Department's Contract Administration Division prior to request for permission to bid.

907-102.02--Contents of Proposal Forms. Delete the fourth paragraph in Subsection 102.02 on page 13, and substitute the following.

Prospective bidders must complete an online request for permission to be eligible to bid a project. Upon approval, the bidder will be authorized to submit a bid electronically using Bid Express at <http://bidx.com>.

MISSISSIPPI DEPARTMENT OF TRANSPORTATION

SPECIAL PROVISION NO. 907-108-4

CODE: (SP)

DATE: 10/07/2020

SUBJECT: Subletting of Contract

Section 108, Prosecution and Progress, of the 2017 Edition of the Mississippi Standard Specifications for Road and Bridge Construction is hereby amended as follows.

907-108.01--Subletting of Contract.

907-108.01.1--General. Delete the third sentence of the tenth paragraph of Subsection 108.01.1 on the bottom of page 72.

MISSISSIPPI DEPARTMENT OF TRANSPORTATION

SPECIAL PROVISION NO. 907-109-1

CODE: (IS)

DATE: 05/08/2019

SUBJECT: Measurement and Payment

Section 109, Measurement and Payment, of the 2017 Edition of the Mississippi Standard Specifications for Road and Bridge Construction is hereby amended as follows.

907-109.01--Measurement of Quantities. Delete the sixth full paragraph of Subsection 109.01 on page 88, and substitute the following.

If appropriate based on the specific circumstances of the project, the Contractor may request that material specified to be measured by the cubic yard or ton be converted to the other measure. The Contractor must submit this request to the Engineer. The Engineer will provide an approval or denial in writing. The decision is in the sole discretion of the Engineer. If approved, factors for this conversion will be determined by the District Materials Engineer and agreed to by the Contractor. The conversion of the materials along with the conversion factor will be incorporated into the Contract by supplemental agreement. The supplemental agreement must be executed before such method of measurement is used.

MISSISSIPPI DEPARTMENT OF TRANSPORTATION

SPECIAL PROVISION NO. 907-701-2

CODE: (IS)

DATE: 01/08/2020

SUBJECT: Hydraulic Cement

Section 701, Hydraulic Cement, of the 2017 Edition of the Mississippi Standard Specifications for Road and Bridge Construction is hereby amended as follows.

907-701.01--General. In the first sentence of the second paragraph of Subsection 701.01 on page 718, change “mills” to “plants.”

In the second sentence of the sixth paragraph of Subsection 701.01 on pages 718 and 719, change “shall” to “will.”

907-701.02--Portland Cement.

907-701.02.1-General.

907-701.02.1.2--Alkali Content. Delete the sentence in Subsection 701.02.1.2 on page 719, and substitute the following.

The Equivalent alkali content for all cement types in this Subsection shall not exceed 0.60%.

907-701.02.2--Replacement by Other Cementitious Materials. Delete the paragraph in Subsection 701.02.2 on page 719, and substitute the following.

The maximum replacement of cement by weight is 25% for fly ash or 50% for ground granulated blast furnace slag (GGBFS). Replacement contents below 20% for fly ash or 45% for GGBFS may be used, but will not be given any special considerations, such as the maximum acceptance temperature for portland cement concrete containing pozzolans in Subsection 804.02.13.1.5. Special considerations shall only apply for replacement of cement by fly ash or GGBFS.

Delete Subsection 701.02.2.1 on pages 719 and 720, and substitute the following.

907-701.02.2.1--Portland Cement Concrete Exposed to Soluble Sulfate Conditions or Seawater.

When portland cement concrete is exposed to moderate or severe soluble sulfate conditions, or to seawater, cement types and replacement of cement by Class F fly ash or GGBFS shall be as follows in Table 1. Class C fly ash shall not be used as a replacement for cement in any of the sulfate exposure conditions listed in Table 1.

Table 1- Cementitious Materials for Soluble Sulfate Conditions or Seawater

Sulfate Exposure	Water-soluble sulfate (SO ₄) in soil, % by mass	Sulfate (SO ₄) in water, ppm	Cementitious material required
Moderate and Seawater	0.10 - 0.20	150 - 1,500	Type I cement with one of the following replacements of cement by weight: 24.5 - 25.0% Class F fly ash, or 49.5 - 50.0% GGBFS or Type II ^{*,**} cement
Severe	0.20 - 2.00	1,500 - 10,000	Type I cement with a replacement by weight of 49.5 - 50.0% GGBFS, or Type II [*] cement with one of the following replacements of cement by weight: 24.5 - 25.0% Class F fly ash, or 49.5 - 50.0% GGBFS

* Type III cement conforming to AASHTO M85 with a maximum 8% tricalcium aluminate (C₃A) may be used in lieu of Type II cement as allowed in Subsection 701.02.1; this cement is given the designation “Type III(MS).”

** Class F fly ash or GGBFS may be added as a replacement for cement as allowed in Subsection 907-701.02.2.

Delete Subsection 701.02.2.2 on page 720, and substitute the following.

907-701.02.2.2--Portland Cement for Soil Stabilization Exposed to Soluble Sulfate Conditions or Seawater. When portland cement for use in soil stabilization is exposed to moderate or severe soluble sulfate conditions, or to seawater, cement types and replacement of cement by Class F fly ash or GGBFS shall meet the requirements of Subsection 701.02.2.1.

907-701.04--Blended Hydraulic Cement.

907-701.04.1--General. Delete Subsection 701.04.1.1 on page 720, and substitute the following.

907-701.04.1.1--Types of Blended Hydraulic Cement. Blended hydraulic cements (blended cements) shall be of the following types and conform to AASHTO M 240:

- Type IL – Portland-limestone cement
- Type IP – Portland-pozzolan cement
- Type IS – Portland blast-furnace slag cement

Blended cement Types IL, IP, and IS meeting the “MS” sulfate resistance requirement listed in AASHTO M 240, Table 3 shall have the “(MS)” suffix added to the type designation.

907-701.04.1.2--Alkali Content. Delete the sentence in Subsection 701.04.1.2 on page 720, and substitute the following.

All blended cement types shall be made with clinker that would result in cement meeting the requirements of Subsection 701.02.1.2 when used in the production of AASHTO M 85, Type I or Type II cement.

907-701.04.2--Replacement by Other Cementitious Materials. Delete the paragraph in Subsection 701.04.2 on page 720, and substitute the following.

The maximum replacement of blended cement Type IL by weight is 35% for fly ash or 50% for GGBFS. Replacement contents below 20% for fly ash or 45% for GGBFS may be used, but will not be given any special considerations, such as the maximum acceptance temperature for blended cement concrete containing pozzolans in Subsection 804.02.13.1.5. Special considerations shall only apply for replacement of blended cement by fly ash or GGBFS.

No additional cementitious materials, such as portland cement, blended cement, fly ash, GGBFS, or others, shall be added to or as a replacement for blended cement Types IP and IS.

Delete Subsection 701.04.2.1 on pages 720 and 721, and substitute the following.

907-701.04.2.1--Blended Cement Concrete Exposed to Soluble Sulfate Conditions or Seawater. When blended cement concrete is exposed to moderate or severe soluble sulfate conditions, or to seawater, cement types and replacement of cement by Class F fly ash or GGBFS shall be as follows in Table 2. Class C fly ash shall not be used as a replacement for cement in any of the sulfate exposure conditions listed in Table 2.

Table 2- Cementitious Materials for Soluble Sulfate Conditions or Seawater

Sulfate Exposure	Water-soluble sulfate (SO ₄) in soil, % by mass	Sulfate (SO ₄) in water, ppm	Cementitious material required
Moderate and Seawater	0.10 - 0.20	150 - 1,500	Type IL (MS)* cement, Type IL cement with one of the following replacements of cement by weight: 24.5 - 35.0% Class F fly ash, or 49.5 - 50.0% GGBFS, Type IP (MS) cement, or Type IS (MS) cement
Severe	0.20 - 2.00	1,500 - 10,000	Type IL cement with a replacement of cement by weight of 49.5 - 50.0% GGBFS, or Type IL (MS) cement with one of following replacements of cement by weight: 24.5 - 35.0% Class F fly ash, or 49.5 - 50.0% GGBFS

- * Class F fly ash or GGBFS may be added as a replacement for cement as allowed in Subsection 907-701.04.2.

Delete Subsection 701.04.2.2 on page 721, and substitute the following.

907-701.04.2.2--Blended Cement for Soil Stabilization Exposed to Soluble Sulfate Conditions or Seawater. When blended cement for use in soil stabilization is exposed to moderate or severe soluble sulfate conditions, or to seawater, cement types and replacement of cement by Class F fly ash or GGBFS shall meet the requirements of Subsection 701.04.2.1.

Delete Subsection 701.04.3 on page 721.

MISSISSIPPI DEPARTMENT OF TRANSPORTATION

SPECIAL PROVISION NO. 907-702-4

CODE: (IS)

DATE: 09/11/2018

SUBJECT: Bituminous Materials

Section 702, Bituminous Materials, of the 2017 Edition of the Mississippi Standard Specifications for Road and Bridge Construction is hereby amended as follows.

907-702.04--Sampling. Delete the sentence in Subsection 702.04 on page 722, and substitute the following.

Sampling of bituminous materials shall be as set out in AASHTO R 66.

907-702.07--Emulsified Asphalt. Delete the last sentence in Subsection 702.07 on page 724, and substitute the following.

Asphalt for fog seal shall conform to the requirements of Subsection 907-702.12, Table V.

907-702.12--Tables. Delete Table V in Subsection 702.12 on page 729, and substitute the following.

**TABLE V
SPECIFICATION FOR FOG SEAL**

Test Requirements	LD-7		CHPF-1		Test Method
	Min.	Max.	Min.	Max.	
Viscosity, Saybolt Furol, @ 25°C, Sec.	10	100	-	100	AASHTO T 72
Storage Stability Test, 24 hr, %	-	1	-	1	AASHTO T 59
Settlement, 5 day, %	-	5	-	-	AASHTO T 59
Oil Distillate, %	-	1	-	-	AASHTO T 59
Sieve Test, % *	-	0.3	-	0.1	AASHTO T 59
Residue by Distillation, %	40	-	40	-	AASHTO T 59
Test on Residue from Distillation					
Penetration @ 25°C, 100g, 5 sec	-	20	40	90	AASHTO T 49
Softening Point, °C	65	-	-	-	ASTM D 36
Solubility in trichloroethylene, %	97.5	-	-	-	AASHTO T 44
Elastic Recovery @ 25°C, %	-	-	40	-	AASHTO T 301
Original DSR @ 82° (G*/Sinδ, 10 rad/sec)	1	-	-	-	AASHTO T 111

* The Sieve Test result is tested for reporting purposes only and may be waived if no application problems are present in the field.

MISSISSIPPI DEPARTMENT OF TRANSPORTATION

SPECIAL PROVISION NO. 907-703-1

CODE: (IS)

DATE: 06/13/2018

SUBJECT: Gradation

Section 703, Aggregates, of the 2017 Edition of the Mississippi Standard Specifications for Road and Bridge Construction is hereby amended as follows.

907-703.03--Course Aggregates for Hydraulic Cement Concrete.

907-703.03.2--Detail Requirements.

907-703.03.2.4--Gradation. In the table in Subsection 703.03.2.4 on page 734, add 100 for the percent passing by weight on the 1½-inch sieve for Size No. 67 aggregates.

MISSISSIPPI DEPARTMENT OF TRANSPORTATION

SPECIAL PROVISION NO. 907-705-1

CODE: (IS)

DATE: 06/13/2018

SUBJECT: Stone Riprap

Section 705, Stone Blanket Protection and Filter Blanket Materials, of the 2017 Edition of the Mississippi Standard Specifications for Road and Bridge Construction is hereby amended as follows.

907-705.04--Stone Riprap. Delete the last sentence of the first paragraph of Subsection 705.04 on page 750, and substitute the following.

Quality requirements for rock to be furnished under these specifications will come from a pre-approved source and be visually approved prior to use.

MISSISSIPPI DEPARTMENT OF TRANSPORTATION

SPECIAL PROVISION NO. 907-707-2

CODE: (IS)

DATE: 06/05/2019

SUBJECT: Joint Materials

Section 707, Joint Materials, of the 2017 Edition of the Mississippi Standard Specifications for Road and Bridge Construction is hereby amended as follows.

907-707.02.3--Wood. Delete paragraph (b) of Subsection 707.02.3 on page 755, and substitute the following:

- (b) Dimensions shall be as shown on the plans. Dimensions shown on the plans are “dressed” sizes in accordance with Table 3 of the American Softwood Lumber Standard, SP-20. At the discretion of the Engineer, a 3/4-inch dressed board may be used in lieu of a 1-inch dressed board. A tolerance of plus or minus 1/16 inch thickness and plus or minus 1/8 inch width will be permitted. For slip-form paving a tolerance of minus 1/4 inch on each end in length will be permitted.

907-707.06--Flexible Plastic Gasket for Joining Conduit. Delete the third paragraph of Subsection 707.06 on page 756, and substitute the following.

The Department may require the performance test described in ASTM C 990.

MISSISSIPPI DEPARTMENT OF TRANSPORTATION

SPECIAL PROVISION NO. 907-711-2

CODE: (IS)

DATE: 09/11/2018

SUBJECT: Plain Steel Wire

Section 711, Reinforcement and Wire Rope, of the 2017 Edition of the Mississippi Standard Specifications for Road and Bridge Construction is hereby amended as follows.

907-711.02--Deformed and Plain Carbon-Steel Bars for Concrete Reinforcing.

907-711.02.3--Steel Welded and Non-Welded Wire Reinforcement, Plain and Deformed, for Concrete.

907-711.02.3.1--Plain Steel Wire. Delete the sentence in Subsection 711.02.3.1 on pages 780 and 781, and substitute the following.

Plain steel wire and plain steel welded wire shall conform to the requirements of AASHTO M 336.

MISSISSIPPI DEPARTMENT OF TRANSPORTATION

SPECIAL PROVISION NO. 907-720-2

CODE: (IS)

DATE: 09/11/2018

SUBJECT: Acceptance Procedure for Glass Beads

Section 720, Pavement Marking Materials, of the 2017 Edition of the Mississippi Standard Specifications for Road and Bridge Construction is hereby amended as follows.

907-720.01--Glass Beads.

907-720.01.4--Acceptance Procedures. Delete the last sentence of the paragraph in Subsection 720.01.4 on page 841, and substitute the following.

Acceptance sampling and testing of glass beads will be in accordance with the Department's Materials Division Inspection, Testing, and Certification Manual, Section 2.9.2 -- Glass Beads.

MISSISSIPPI DEPARTMENT OF TRANSPORTATION

SPECIAL PROVISION NO. 907-721-2

CODE: (IS)

DATE: 01/08/2020

SUBJECT: Materials for Signing

Section 721, Materials for Signing, of the 2017 Edition of the Mississippi Standard Specifications for Road and Bridge Construction is hereby amended as follows.

907-721.06--Reflective Sheeting.

907-721.06.2--Performance Requirements. Delete Table 4 and Table 5 in Subsection 721.06.2 on pages 860 & 861, and substitute the following.

**MINIMUM COEFFICIENTS OF RETROREFLECTION
Candela per foot candle per square foot (cd/ft²)
Per ASTM Designation D4956**

**TABLE 4
Type IX Sheeting**

Observation Angle	Entrance Angle	White	Yellow	Green	Red	Blue	Fluorescent Yellow/Green	Fluorescent Yellow	Fluorescent Orange
0.2°	-4.0°	380	285	38	76	17	300	230	115
0.2°	+30.0°	215	162	22	43	10	170	130	65
0.5°	-4.0°	240	180	24	48	11	190	145	72
0.5°	+30.0°	135	100	14	27	6.0	110	81	41
1.0°	-4.0°	80	60	8.0	16	3.6	64	48	24
1.0°	+30.0°	45	34	4.5	9.0	2.0	36	27	14

**TABLE 5
Type XI Sheeting**

Observation Angle	Entrance Angle	White	Yellow	Green	Red	Blue	Brown	Fluorescent Yellow/Green	Fluorescent Yellow	Fluorescent Orange
0.2°	-4.0°	580	435	58	87	26	17	460	350	175
0.2°	+30.0°	220	165	22	33	10	7.0	180	130	66
0.5°	-4.0°	420	315	42	63	19	13	340	250	125
0.5°	+30.0°	150	110	15	23	7.0	5.0	120	90	45
1.0°	-4.0°	120	90	12	18	5.0	4.0	96	72	36
1.0°	+30.0°	45	34	5.0	7.0	2.0	1.0	36	27	14

MISSISSIPPI DEPARTMENT OF TRANSPORTATION

SPECIAL PROVISION NO. 907-804-10

CODE: (SP)

DATE: 07/28/2020

SUBJECT: Bridge Deck Overlay

Section 804, Concrete Bridges and Structures, of the 2017 Edition of the Mississippi Standard Specifications for Road and Bridge Construction as modified by this special provision is applicable to Bridge Deck Overlays Only.

907-804.01--General. This work consists of placing a concrete overlay over an existing bridge deck or a bridge deck that has been partially removed by hydrodemolition, or other methods of removal, to the line, grade and cross-section shown on the plans or as directed by the Engineer.

907-804.02--Materials.

907-804.02.1--General. Concrete produced and controlled from this specification will be accepted upon proper certification of concrete production through verification by job site acceptance criteria performed by Department personnel.

The materials for partial depth repair of concrete, when sampled and tested in accordance with Subsection 700.03, shall meet the requirements of the following Subsections:

Portland Cement	701.01 and 701.02
Fine Aggregate	703.02
Coarse Aggregate	703.03
Joint Material	707.01, 707.02, and 707.07
Reinforcing Steel	711.02
Structural Synthetic Fibers	711.04
Liquid Membrane Compound	713.01.02
Admixtures	713.02
Fly Ash	714.05
Water	714.01.1 and 714.01.2

907-804.02.2--Mixture Design. The concrete mixture shall be designed by a technician holding a current MDOT Certified Class III certification representing the Contractor to meet the requirements set out in the following:

Minimum Cementitious Content	564 lbs/cy
Minimum Fly Ash Replacement Required	15%
Coarse Aggregate Size	#7, #8, or #78
Coarse Aggregate Type	see Subsection 907-804.02.2.1
Synthetic Structural Fibers	see Subsection 907-804.02.2.2
Total Air Content	3 - 6%
Maximum Slump	6 inches
Required Compressive Strength	2,500 psi in 24 hours

Either a Type F or Type G water reducing chemical admixture shall be used in the concrete mixture. Type S admixtures may be used. No other water reducing chemical admixtures shall be used in the mixture.

907-804.02.2.1--Coarse Aggregate Requirements. The coarse aggregate for areas of concrete repair which will be milled to obtain the final grade requirements shall be limestone. All other areas may use either limestone or gravel as the coarse aggregate.

907-804.02.2.2--Synthetic Structural Fiber Requirements. Concrete mixture used on bridge decks or for other single areas of concrete repair 25 square feet or greater shall contain synthetic structural fibers added in accordance with the requirements of Subsection 711.04 based on the dosage required for the applicable synthetic structural fiber per the Department’s Approved Products List.

907-804.02.2.3--Basis of Proportioning. The Contractor shall establish the proportions based on a laboratory trial mixture in accordance with the requirements of Subsection 804.02.10.1.2 with the following exception: the minimum required average strength of the laboratory trail mixture listed in Subsection 804.02.10.1.2.e shall not be required.

907-804.02.3--Sampling & Testing. Sampling and testing of plastic concrete will be performed by Department personnel having the applicable certifications in Table 2 in Section 804 and in accordance with the applicable test methods listed in Table 1 in Section 804 at the following sampling and testing frequency.

The slump, temperature, and total air content will be determined on the first batch each production day and other subsequent batches until requirements for these plastic properties are met. Slump, temperature, and total air content shall be determined at a minimum frequency of one (1) per each 50 cubic yards of concrete repair, or fraction thereof, but more often if the slump, temperature, or total air content are in question on subsequent batches. Once a batch has been determined to meet the requirements for slump, temperature, and total air content, additional testing on the batch is not required.

At least three concrete test cylinders for acceptance will be cast per day per section of lane for which an individual lane closure is affected and concrete is replaced. The slump, temperature, and total air content will be determined for the concrete test cylinders. The concrete test cylinders will be made from approximately the last batch of concrete produced each day.

Compressive strength cylinders for opening to traffic shall be cast and tested by the Contractor in accordance with Subsection 804.03.

907-804.02.4--Basis of Acceptance. The slump of plastic concrete mixture shall meet the requirements of Subsection 907-804.02.2 with the minus slump limits of AASHTO M157.

Sampling shall meet the requirements of AASHTO T141. For additional information concerning sampling concrete, see the Department’s *Concrete Field Manual*.

The total air content of the plastic concrete mixture shall meet the requirements of Subsection 907-

804.02.2.

The maximum plastic concrete acceptance temperature shall be 90°F. Plastic concrete with a temperature exceeding 90°F shall be rejected and not used in Department work. The minimum acceptance temperature shall meet the requirements of Subsection 804.03.16.1 for Cold Weather Concreting.

A check test shall be made on another portion of the obtained sample before rejection of any batch.

The compressive strength shall meet the requirements of Subsection 907-804.02.2.

907-804.03--Construction Requirements. When the overlay is to be placed on a bridge deck that has been partially removed, the bridge deck overlay shall begin as soon as practical following the deck removal and cleaning of the bridge deck. Any bridge deck repairs shall be performed prior to or concurrent with the placement of the overlay. Any damage to the reinforcing steel as a result of the Contractor's operations shall be corrected to the satisfaction of the Engineer at no additional costs to the State.

During placement of the overlay, the concrete shall be thoroughly consolidated by internal vibration. Finishing may be performed by either machine or hand methods. The concrete shall be screeded longitudinally unless otherwise permitted by the Engineer. The screed shall be metal of a type normally used on bridge deck pours. The overlay shall be checked longitudinally and transversely in order to meet a 1/8-inch in 10 feet smoothness requirement.

After the screeding and floating has been completed and while the concrete is still plastic, the surface of the concrete shall be tested with a 10-foot straightedge. For this purpose the Contractor shall furnish and use an accurate 10-foot straightedge swung from handles three feet longer than one-half the width of the slab. The straightedge shall be held in contact with the surface in successive positions parallel to the road centerline and the whole area gone over from one side of the slab to the other as necessary. Advance along the road shall be in successive stages of not more than one-half the length of the straightedge. All depressions found shall be immediately filled with freshly mixed concrete, struck off, consolidated, and refinished. High areas shall be cut down and refinished. Special attention shall be given to assure that the surface across joints meets any requirements for smoothness. Straightedge testing and surface corrections shall continue until the entire surface is found to be free from observable departures from the straightedge, and the slab conforms to the required grade and cross section.

The concrete surface shall be protected from premature drying by covering as soon as possible with wetted burlap. It shall be cured with Class 3 burlap, or its equivalent, covered with plastic sheeting. The burlap shall be kept continuously and thoroughly wet. Careful attention shall be given to the proper curing and protection of the concrete, and curing shall continue until the 2,500 psi strength is attained. Twelve (12) test cylinders for verifying strength requirements shall be made and cured under the same conditions as the bridge deck. Three (3) test cylinders shall be tested and the results averaged to represent a test break. Traffic shall not be allowed on the concrete overlay until the required 2,500 psi strength is attained.

907-804.04--Method of Measurement. Bridge deck overlay concrete, complete and accepted, will be measured by the cubic yard, determined by calculating the theoretical volume of bridge

deck overlay plus any additional concrete placed. Additional concrete placed with the overlay will be calculated by subtracting the theoretical volume of bridge deck overlay from the total ticketed volume of concrete delivered minus the volume estimated by the Engineer of any wasted concrete.

907-804.05--Basis of Payment. Bridge deck overlay concrete, measured as prescribed above, will be paid for at the contract unit price per cubic yard, which price shall be full compensation for all materials, tools, equipment, labor, and incidentals necessary to complete the work.

Payment will be made under:

907-804-O: Bridge Deck Overlay Concrete - per cubic yard

MISSISSIPPI DEPARTMENT OF TRANSPORTATION

SPECIAL PROVISION NO. 907-808-1

CODE: (IS)

DATE: 11/01/2018

SUBJECT: Joint Repair

Section 808, Joint Repair, of the 2017 Edition of the Mississippi Standard Specifications for Road and Bridge Construction is hereby amended as follows.

907-808.04--Method of Measurement. Delete the paragraph in Subsection 808.04 on page 1009, and substitute the following.

When a pay item is included in the plans, joint repair will be measured by the linear foot and mortar mix will be measured by the gallon. The volume of measurement for the epoxy/sand mortar mix will be determined from the summation of the volumes of the epoxy components and the volume of sand will not be measured for payment.

907-808.05--Basis of Payment. Delete the paragraph in Subsection 808.05 on page 1009, and substitute the following.

When a pay item is included in the plans, joint repair, measured as prescribed above, will be paid for at the contract unit price per linear foot, which price shall be full compensation for furnishing and placing all materials, labor, tools, equipment, and all incidentals necessary to complete the work.

When a pay item is included in the plans, mortar mix, measured as prescribed above, will be paid for at the contract unit price per gallon, which price shall be full compensation for furnishing all materials including sand and forming materials, and all incidentals necessary to complete the work. No payment will be made for the sand used in the epoxy mortar mix.

The price bid for each item of work shall include the cost of continuous maintenance of traffic and protective services as required by the Department's Traffic Control Plan. This shall include all required individual traffic control devices.

Payment will be made under:

907-808-A: Joint Repair - per linear foot

907-808-B: Mortar Mix - per gallon

MISSISSIPPI DEPARTMENT OF TRANSPORTATION

SPECIAL PROVISIONS NO. 907-823-7

CODE: (SP)

DATE: 10/13/2020

SUBJECT: **Preformed Joint Seal**

Section 907-823, Preformed Joint Seal, is hereby added to and becomes a part of the 2017 Edition of the Mississippi Standard Specifications for Road and Bridge Construction as follows.

SECTION 907-823--PREFORMED JOINT SEAL

907-823.01--Description. This work consists of furnishing and installing preformed joint seals in accordance with these specifications and the details shown in the Plans or drawings provided.

907-823.02--Materials. The Contractor shall furnish a manufacturer's certification stating that the material used meets the requirements of this specification.

The preformed joint seal shall be one of the following, or an approved equal. The size of the seal, Type I or Type II, shall be determined based on the size of the joint opening, as detailed in the Plans or drawings provided. It is the Contractor's responsibility to ensure that the size selected is appropriate for the width of the joint. Type I shall be used for joint openings less than two inches (2"). Type II shall be used for joint openings greater than two inches (2"), with the maximum joint opening being two and one-half inches (2½"). In cases where the joint opening is greater than two and one-half inches (2½"), another type of expansion material shall be required as directed by the Director of Structures, State Bridge Engineer.

1. Silicoflex Joint Sealing System
Manufactured by R.J. Watson, Inc. in Alden, NY
www.rjwatson.com
2. Wabo@SPS Joint System
Manufactured by Watson Bowman Acme Corporation in Amherst, NY
www.wbacorp.com
3. Silspec SSS Silicone Strip Seal
Manufactured by SSI Commercial & Highway Construction Materials in Tulsa, OK
www.ssicm.com

907-823.03--Construction Methods. Preformed joint seals shall be installed in accordance with the manufacturer's recommendations. The material shall seal the deck surface, gutters, and curbs to prevent moisture or other contaminants from leaking through the joints. The joint seal shall be installed in such a manner that the top surface of the material is within the minimum and maximum depths below the roadway or bridge surface recommended by the manufacturer.

Saw cutting for the joint repair shall be accomplished by sawing at the locations and depth shown

on the joint repair detail sheets in the plans or in the contract documents. Saw cuts shall be as near vertical as possible at the saw line of the repair area. The saw cut depth shall be equivalent to the installation depth required by the manufacturer's specifications, and the type specified shall be the same as the type specified for preformed joint seal.

907-823.04--Method of Measurement. Preformed joint seal of the type specified will be measured in linear feet along the length of the centerline joint.

Saw cuts of the type specified will be measured by the linear foot along the length of the bridge deck on each side of the centerline joint.

907-823.05--Basis of Payment. Preformed joint seal, measured as prescribed above, will be paid for at the contract unit price per linear foot, which shall be full compensation for furnishing all labor, equipment, tools, materials, and incidentals necessary to complete the work.

Saw cuts, measured as prescribed above, will be paid for at the contract unit price per linear foot, which shall be full compensation for furnishing all labor, equipment, tools, materials, and incidentals necessary to complete the work.

Payment will be made under:

907-823-A: Preformed Joint Seal, Type ____ - per linear foot

907-823-B: Saw Cut, Type _____ - per linear foot

NOTES ON ASSOCIATED ITEMS OF WORK:

907-808-4002 JOINT REPAIR
 Description: Shall include the work necessary to repair joints in preparation for the placement of new expansion material. Preparation for the placement of new expansion material shall also be included under this item of work. Removal of existing silicone sealant, compression and AC sealed joint materials will not be paid for. Directly and shall be considered as part of the joint repair. Removal of debris and any trash and debris (including but not limited to compacted dirt, vegetation and trash) located at any depth within the joint shall be included under this item of work. All other requirements shall be included under the appropriate repair item. Refer to Section 808 of the specifications and any other sections specified therein.

Basis of Payment:
 The Accepted Quantities Will Be Paid For In Linear Feet At The Contract Unit Price Along The Length Of The Bridge Deck On Each Side Of The Centerline Joint.

907-808-4003 JOINT REPAIR WITHOUT EPOXY

Description: Shall include the work necessary to repair joints in preparation for the placement of new expansion material, as designated in the detail drawings. Provide removal of existing silicone sealant, compression and AC sealed joint materials shall be included under this item of work. Removal of joint materials and any trash and debris (including but not limited to compacted dirt, vegetation and trash) located at any depth within the joint shall be included under this item of work. All other requirements shall be in accordance with the applicable provisions of Section 808 of the specifications and any other sections specified therein.

Basis of Payment:
 The Accepted Quantities Will Be Paid For In Linear Feet At The Contract Unit Price Along The Length Of The Bridge Deck On Each Side Of The Centerline Joint.

907-823-8001 SAW CUT, TYPE 1 & 907-823-8002 SAW CUT, TYPE II

Description: The Saw Cut Depth Shall Be Equivalent To The Installation Depth Required By The Manufacturer's Specifications. The Saw Cut Type Shall Be The Same As The Preformed Joint Seal Selected.

Basis of Payment:
 The Accepted Quantities Will Be Paid For In Linear Feet At The Contract Unit Price Along The Length Of The Bridge Deck On Each Side Of The Centerline Joint. It Is The Contractor's Responsibility To Ensure That The Proper Depth Is Selected Based On The Manufacturer's Recommendations.

907-823-4001 PREFORMED JOINT SEAL, TYPE I

Description: Shall include the manufacturer's required joint preparation including sandblasting both sides of the joint and blowing the joint free of debris with compressed air and placement of the new preformed joint seal.

Basis of Payment:
 The Accepted Quantities Will Be Paid For In Linear Feet At The Contract Unit Price Along The Length Of The Centerline Joint.

EPOXY MORTAR AND POLYMER CONCRETE NOTES:

Either Epoxy Mortar Or Polymer Concrete May Be Used. Guidelines For Selection Of Materials Can Be Found In Section 808 of the Specifications.

GENERAL NOTES:

1. Specifications: Mississippi Standard Specifications For Road And Bridge Construction, 2017.
2. Approval: Approval of the Manufacturer's Proposed Joint Seal Material, Approved Of The Director Of Structures, State Bridge Engineer. Minor Changes To Detail Of Design Or Construction Procedure May Be Authorized By The Bridge Engineer Provided Such Changes Do Not Affect The Structural Integrity Of The Joint. Work For Which No Pay Item Is Provided In The Proposal Will Not Be Paid For Directly And Shall Therefore Be Considered An Assorted Item of Work.

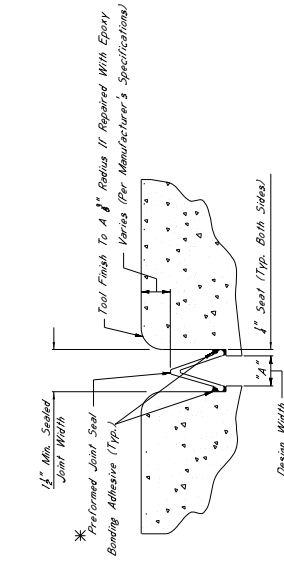

TYPICAL SECTION AT SAWCUT & SEALED JOINT
 Showing Sealed Joint After Sawcut

***NOTES:**

1. The Preformed Joint Seal Shall Be One Of The Following, Installed According To The Manufacturer's Specifications:
 A. SilicoFlex Joint Sealing System Manufactured By R.J. Watson, Inc. In Alden, NY www.rjwatson.com
 B. Mido SPS Joint Sealing System Manufactured By SSI Commercial & Highway Construction Materials www.ssi.com
 C. Silosec SSS Silicone Strip Seal Manufactured By SSI Commercial & Highway Construction Materials www.ssi.com
2. For Estimating Purposes, The R.J. Watson SilicoFlex Joint Sealing System Seal Selected, However, Should Another Supplier Be Chosen, It Is The Contractor's Responsibility To Provide The Manufacturer's Specifications For The Seal. For Joint Preparation, Installation Depth And Width, Adhesive Sealing Times, And Any Variances Between The Specifications Provided By The Manufacturer, To Ensure That The Contractor Is Properly Schooled In Installation Of The Joint Material.
3. Joints Shall Be Sealed At Their Design Widths, Dimension "A", Which Is Defined As The Actual Width Of The Joint Opening. This Width Does Not Account For The Sealant Thickness. The Sealant Thickness Shall Be Determined By The Manufacturer. For Design Widths Greater Than Or Equal To 2" Sealant Thickness Shall Be Used For Design Widths Less Than Or Equal To 2". With The Maximum Design Width Of Expansion Material Seal Be Required As Directed By The Director Of Structures, State Bridge Engineer. It Is The Contractor's Responsibility To Ensure That The Size Selected Is Appropriate For The Width Of The Joint.

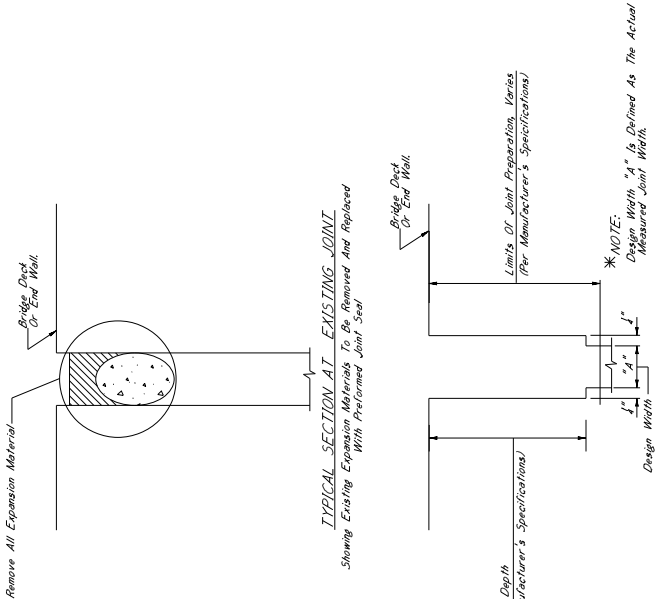

TYPICAL SECTION AT EXISTING JOINT
 Showing Existing Expansion Materials To Be Removed And Replaced With Preformed Joint Seal

TYPICAL SECTION AT JOINT AFTER REMOVAL OF EXISTING SEAL AND SAWCUT

Showing Limits Of Joint Preparation For Application Of New Joint Seal Materials And Sawcut

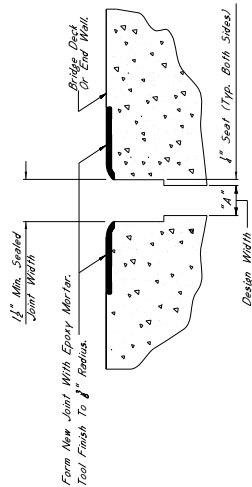

TYPICAL SECTION AT SAWCUT & JOINT REPAIR
 Showing Area Where Repairs Are Made After Sawcut With Epoxy Mortar Or Approved Equivalent

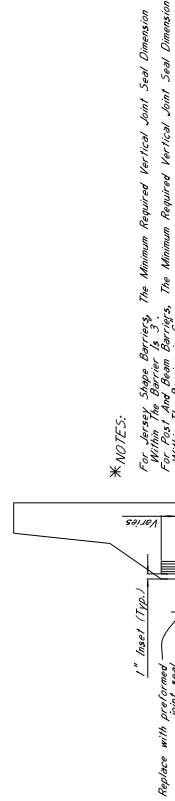

ELEVATION AT END OF SPAN

NOTES ON ASSOCIATED ITEMS OF WORK:

JOINT REPAIR

Description: Shall include the work necessary to repair joints in preparation for the placement of new expansion material. Joint materials and any trash and debris (including but not limited to compacted dirt, vegetation and trash) located at any depth within the joint shall be included under this item of work. Epoxy mortar shall also be included under this item of work. Epoxy mortar shall be placed in accordance with the provisions of Section 808 of the Specifications and shall be considered as absorbed under this item of work. All other requirements shall be in accordance with the applicable provisions of Section 808 of the Specifications and any other sections specified therein.

Basis of Payment: The Accepted Quantities Will Be Paid For In Linear Feet At The Contract Unit Price Along The Length Of The Bridge Deck On Each Side Of The Centerline Joint.

JOINT REPAIR WITHOUT EPOXY

Description: Shall include the work necessary to repair joints in preparation for the placement of new expansion material. Joint materials and any trash and debris (including but not limited to compacted dirt, vegetation and trash) located at any depth within the joint shall be included under this item of work. Materials shall be included under this item of work, removal of joint materials and any trash and debris (including but not limited to compacted dirt, vegetation and trash) located at any depth within the joint shall be included under this item of work. All other requirements shall be in accordance with the provisions of Section 808 of the Specifications and any other sections specified therein.

Basis of Payment: The Accepted Quantities Will Be Paid For In Linear Feet At The Contract Unit Price Along The Length Of The Bridge Deck On Each Side Of The Centerline Joint.

907-823-8001 SAW CUT, TYPE I & 907-823-8002 SAW CUT, TYPE II

Description: The Saw Cut Depth Shall Be Equivalent To The Installation Depth Required By The Manufacturer's Specifications. The Saw Cut Type Shall Be The Same As The Performer Joint Seal Selected.

Basis of Payment: The Accepted Quantities Will Be Paid For In Linear Feet At The Contract Unit Price Along The Length Of The Bridge Deck On Each Side Of The Centerline Joint. It Is The Contractor's Responsibility To Ensure That The Proposed Seal Is Selected Based On The Manufacturer's Recommendations.

907-823-4001 PREFORMED JOINT SEAL, TYPE I
907-823-4002 PREFORMED JOINT SEAL, TYPE II

Description: Shall include the manufacturer's required joint preparation including sandblasting both sides of the joint and blowing the joint free of debris. The contractor shall provide and place the preformed joint seal.

Basis of Payment: The Accepted Quantities Will Be Paid For In Linear Feet At The Contract Unit Price Along The Length Of The Centerline Joint.

EPOXY MORTAR AND POLYMER CONCRETE NOTES:

1. Specifications, Mississippi Standard Specifications For Road Construction, Section 808.01.
2. No Change Of Plans Will Be Permitted Except By Written Approval Of The Director Of Structures, State Bridge Engineer. Minor Changes To Detail Or Design Or Construction Procedure Will Not Be Considered For Contract Price Adjustment. Work For Which No Pay Item Is Provided In The Proposal Will Not Be Paid For Directly And Shall Therefore Be Considered An Absorbed Item Of Work.

GENERAL NOTES:

1. Specifications, Mississippi Standard Specifications For Road Construction, Section 808.01.
2. No Change Of Plans Will Be Permitted Except By Written Approval Of The Director Of Structures, State Bridge Engineer. Minor Changes To Detail Or Design Or Construction Procedure Will Not Be Considered For Contract Price Adjustment. Work For Which No Pay Item Is Provided In The Proposal Will Not Be Paid For Directly And Shall Therefore Be Considered An Absorbed Item Of Work.

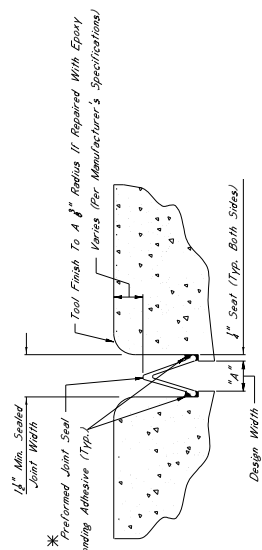

TYPICAL SECTION AT SAWCUT & SEALED JOINT

Showing Sealed Joint After Sawcut And Repair With Epoxy Mortar

***NOTES:**

1. The Preformed Joint Seal Shall Be One Of The Following, Installed According To The Manufacturer's Specifications:
 A. Silcoflex Joint Sealing System
 www.gmwalson.com
 B. Wika SBS Joint Sealing System
 www.wika.com
 C. Silgoc SSS Silicone Strip Seal
 Manufactured By SSI Commercial & Highway Construction Materials
 www.ssi.com
 D. Wika SBS Joint Sealing System
 Manufactured By Wika
 www.wika.com
 E. Silgoc SSS Silicone Strip Seal
 Manufactured By SSI Commercial & Highway Construction Materials
 www.ssi.com
2. For Estimating Purposes, The R.J. Walston Silcoflex Joint Sealing System Was Used For Joint Preparation, Installation Depth, and Widths, Adhesive Sealing Times, and Manufacturer Recommendations. The Contractor Shall Be Responsible For Ensuring That The Manufacturer's Recommendations Are Followed To Ensure That The Contractor Is Properly Schooled In Installation Of The Joint Material.
3. Joints Shall Be Sealed At Their Design Widths, Dimension "A", Which Is Defined As The Actual Width Both Sides Of The Joint. The Contractor Shall Be Responsible For Ensuring That The Manufacturer's Recommendations Are Followed For Joint Preparation, Installation Depth, and Widths, Adhesive Sealing Times, and Manufacturer Recommendations. The Contractor Shall Be Responsible For Ensuring That The Manufacturer's Recommendations Are Followed To Ensure That The Contractor Is Properly Schooled In Installation Of The Joint Material.

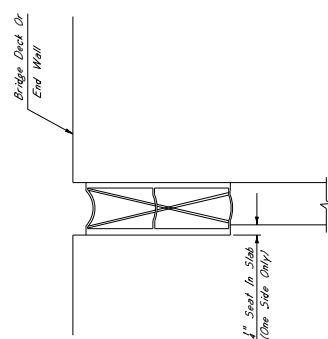

TYPICAL SECTION AT EXISTING JOINT

Showing Existing Expansion Device To Be Removed And Replaced With Preformed Joint Seal

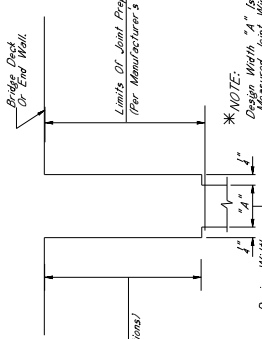

TYPICAL SECTION AT JOINT AFTER REMOVAL OF EXISTING SEAL AND SAWCUT

Showing Limits Of Joint Preparation For Application Of New Joint Seal Materials And Sawcut

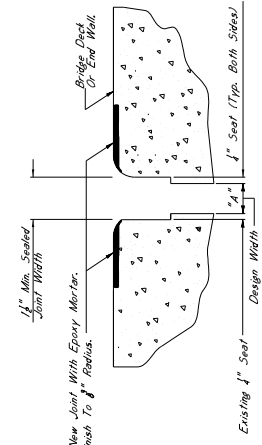

TYPICAL SECTION AT SAWCUT & JOINT REPAIR

Showing Limits Of Joint Preparation For Application Of New Joint Seal Materials And Sawcut

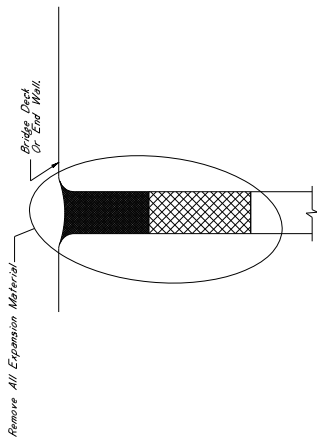

TYPICAL SECTION AT EXISTING JOINT
Showing Existing Expansion Material To Be Removed And Replaced With Preformed Joint Seal

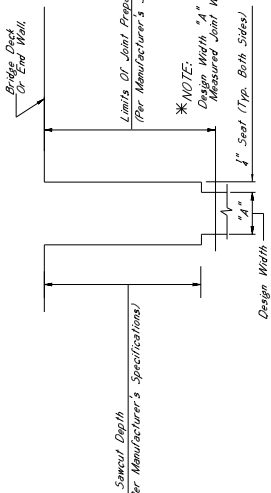

TYPICAL SECTION AT JOINT AFTER REMOVAL OF EXISTING SEAL AND SAWCUT
Showing Limits Of Joint Preparation For Application Of New Joint Seal Materials And Saws



TYPICAL SECTION AT SAWCUT & JOINT REPAIR
Showing Area Where Repairs Are Made After Saws Cut With Epoxy Mortar Or Approved Equivalent

NOTES ON ASSOCIATED ITEMS OF WORK:

907-808-4002 JOINT REPAIR

Description:

Shall include the work necessary to repair joints in preparation for the placement of new expansion material, as designated in the detail drawings provided. Epoxy mortar shall be used for the repair of joints. The use of epoxy mortar of existing silicone based, compression, and A.C. sealed joint materials will not be paid for directly. And shall be considered as absorbed under this item of work. Removal of joint materials shall be included under this item of work. All other requirements shall be included under this item of work. All other requirements shall be included under this item of work. All other requirements shall be included under this item of work. All other requirements shall be included under this item of work.

Basis Of Payment:

The Accepted Quantities Will Be Paid For In Linear Feet At The Contract Unit Price Along The Length Of The Bridge Deck On Each Side Of The Centerline Joint.

907-808-4003 JOINT REPAIR WITHOUT EPDM

Description:

Shall include the work necessary to repair joints in preparation for the placement of new expansion material, as designated in the detail drawings provided. Epoxy mortar shall be used for the repair of joints. The use of epoxy mortar of existing silicone based, compression, and A.C. sealed joint materials will not be paid for directly and shall be considered as absorbed under this item of work. Removal of joint materials shall be included under this item of work. All other requirements shall be included under this item of work. All other requirements shall be included under this item of work. All other requirements shall be included under this item of work.

Basis Of Payment:

The Accepted Quantities Will Be Paid For In Linear Feet At The Contract Unit Price Along The Length Of The Bridge Deck On Each Side Of The Centerline Joint.

907-823-8001 SAW CUT, TYPE I & 907-823-8002 SAW CUT, TYPE II

Description:

The Saw Cut Depth Shall Be Equivalent To The Installation Depth Required By The Manufacturer's Specifications. The Saw Cut Type Shall Be The Same As The Preformed Joint Seal Selection.

Basis Of Payment:

The Accepted Quantities Will Be Paid For In Linear Feet At The Contract Unit Price Along The Length Of The Bridge Deck On Each Side Of The Centerline Joint. It Is The Contractor's Responsibility To Provide The Joint Seal Material With Is Selected Based On The Manufacturer's Recommendations.

907-823-4001 PREFORMED JOINT SEAL, TYPE I

Description:

Shall include the manufacturer's required joint preparation including sandblasting both sides of the joint and blowing the joint free of debris with compressed air and placement of the new preformed joint seal.

Basis Of Payment:

The Accepted Quantities Will Be Paid For In Linear Feet At The Contract Unit Price Along The Length Of The Centerline Joint.

EPDM MORTAR AND POLYMER CONCRETE NOTES:

Either Epoxy Mortar Or Polymer Concrete May Be Used. Guidelines For Use Of Materials Can Be Found In Section 608 of the Specifications.

GENERAL NOTES:

1. Specifications: Mississippi Standard Specifications For Road And Bridge Construction, Section 707.
2. Approval: The Director Of Structures, State Bridge Engineer, May Be Authorized By The Bridge Engineer To Issue Such Changes To The Specifications As He Deems Necessary For The Work For Which He Is Authorized To Issue Changes. The Bridge Engineer Will Not Be Paid For Directly And Shall Therefore Be Considered An Absorbed Item Of Work.

***NOTES:**
1. The Preformed Joint Seal Shall Be One Of The Following, Installed According To The Manufacturer's Specifications:
A. Silcolux Joint Sealing System
www.silcolux.com
B. Wicks SFS Joint System
Manufactured By Wabson Bannan Acme Corporation In Amherst, NY
www.wabcorp.com
C. Silseal SSS Silicone Strip Seal
Manufactured By SSI Commercial & Highway Construction Materials
www.ssiem.com

2. For Estimating Purposes, The RJ Watson Silcolux Joint Sealing System Works Responsibility To Ensure That The Manufacturer's Recommendations Are Followed For Joint Preparation, Installation Details And Details, Adhesive Setting Times, And Cure Times. The Contractor Shall Be Responsible For Obtaining The Manufacturer's Representative Shall Be Present At The Time Joint Sealing Begins To Ensure That The Contractor Is Properly Schooled In Installation Of The Joint Material.

3. Joints Shall Be Sealed At Their Design Widths, Dimension "A" Which Is Defined As Seal Width On Both Sides Of The Joint. The Preformed Joint Seal Shall Be Used For Design Widths Less Than 2". Preformed Joint Seal, Type II, Shall Be Used For Design Widths Greater Than 2". The Design Width Shall Be Measured From The Outside Face Of The Joint Material To The Outside Face Of The Joint Material. The Design Width Shall Be Greater Than The Design Width Of The Joint Material. The Design Width Shall Be Greater Than The Design Width Of The Joint Material. The Design Width Shall Be Greater Than The Design Width Of The Joint Material.

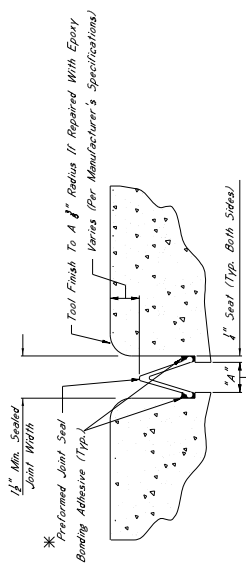

TYPICAL SECTION AT SAWCUT & SEALED JOINT
Showing Sealed Joint After Saws Cut And Repair With Epoxy Mortar

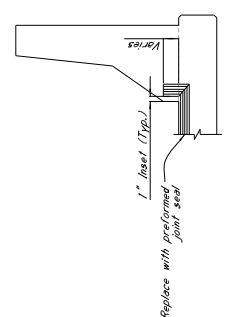

ELEVATION AT END OF SPAN

*** 1" SAWCUT NOTES:**

All 1" Sawcuts Shall Be Considered An Absorbed Item of Work. The Contractor Shall Verify Depth of Reinforcing Steel Before Making Any Sawcuts. The Depth of the Reinforcing Steel Shall Be Repaired To The Satisfaction Of The Engineer At No Cost To The State.

*** CONCRETE REMOVAL BLOCKOUT NOTES**

Removal Of The Concrete Blockout Area Shall Be Considered An Absorbed Item Of Work Under Pay Item 202-B183. The Contractor Shall Use Hand Tools To Cut A Layer Than 3/8" Thick To Complete This Work.

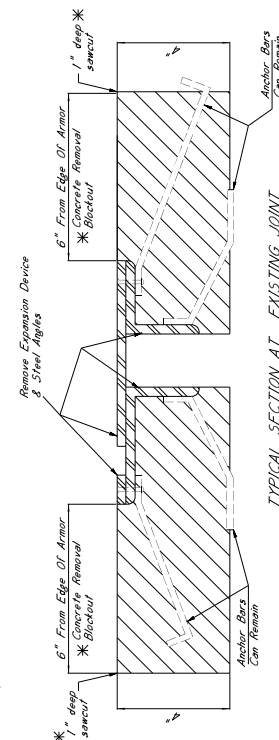

TYPICAL SECTION AT EXISTING JOINT
Showing Existing Expansion Device To Be Removed And Replaced With Performed Joint Seal

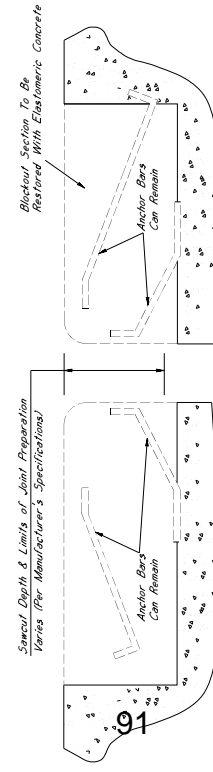

TYPICAL SECTION AT JOINT AFTER REMOVAL OF EXISTING SEAL
Showing Limits Of Joint Preparation For Application Of New Joint Seal Materials

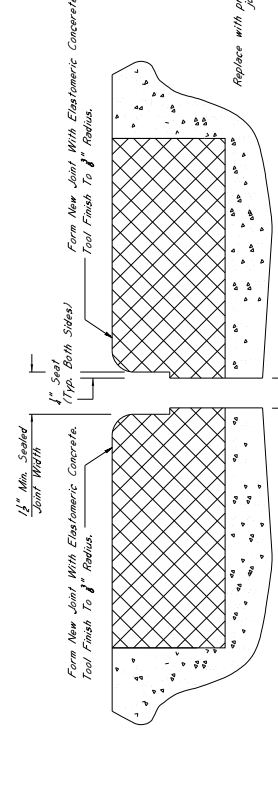

TYPICAL SECTION AT SAWCUT & JOINT REPAIR
Showing Area Where Repairs Are Made After Sawcut With Elastomeric Concrete

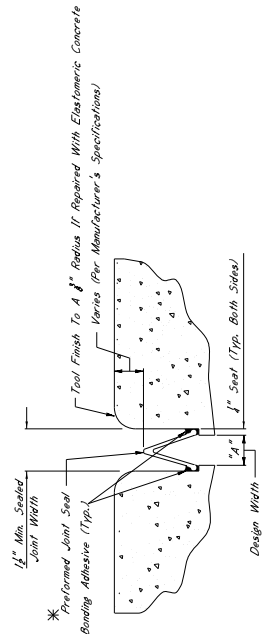

TYPICAL SECTION AT SAWCUT & SEALED JOINT
Showing Sealed Joint After Sawcut And Repair With Elastomeric Concrete

*** NOTES:**

- The Performed Joint Seal Shall Be One Of The Following, Installed According To The Manufacturer's Specifications:
 - Silicone Joint Sealing System Manufactured By R.J. Watson, Inc. In Alden, NY www.rjwatson.com
 - Wako SFS Joint System Manufactured By Watson Bowman Acme Corporation In Amherst, NY www.wbcorp.com
 - Silicone 555 Silicone Strip Seal Manufactured By 551 Commercial & Highway Construction Materials www.551corp.com
- Expanding Repairs: The R.J. Watson Silicone Joint Sealing System Who's Responsibility To Ensure That The Manufacturer's Recommendations Are Followed For Other Applications To All Types of Joints, Repairs, Sealing, and Other Applications. A Manufacturer Representative Shall Be Present At The Time Joint Sealing Begins To Ensure That The Contractor Is Properly Trained In Installation Of The Joint Material.
- Joints Shall Be Sealed At Their Design Width, Dimension "A", Which Is Defined As Seal Applied On Both Sides Of The Joint. Performed Joint Seal, Type I, Shall Be Used For Design Widths Less Than 2". Performed Joint Seal, Type II, Shall Be Used For Design Widths Greater Than 2". In Cases Where Design Widths Are Greater Than 2", Another Type Of Expansion Material Shall Be Required As Directed By The Director Of Structures, Selected As Appropriate For The Width Of The Joint.

*** NOTES:**

- For Any Signs, Barriers, The Minimum Required Vertical Joint Seal Dimension Within The Blockout Is 6".
- For Post And Beam Barriers, The Minimum Required Vertical Joint Seal Dimension Within The Barrier Is 6".

ELEVATION AT END OF SPAN

NOTES ON ASSOCIATED ITEMS OF WORK:

202-B183 REMOVAL OF EXISTING JOINT MATERIAL

Description: Shall Include The Removal Of Material Associated With Armor, Sliding Plates and Meagings Provided. Removal As Designated In The Detail Drawings Provided. Removal Of The Concrete Blockout Area Shall Be Absorbed Under This Item Of Work. The Joint Seal Type Shall Not Be Included Under This Item Of Work. The Contractor Shall Be Responsible For The Engineer's Removal of Joint Material And Any Trash And Debris (Including But Not Limited To Compacted Dirt, Vegetation And Trash) Located At Any Depth Within The Joint Shall Be Included Under This Item Of Work.

Items Of Payment: Removal of Armor and Sliding Plate Joint Material Will Be Paid For In Linear Feet At The Contract Unit Price For The Removal of the Material Will Only Be Paid For As The Length Along The Centerline Of The Joint.

907-823-8001 SAW CUT, TYPE I & 907-823-8002 SAW CUT, TYPE II

Description: The Saw Cut Depth Shall Be Equivalent To The Installation Depth Required For The Manufacturer's Specifications. The Saw Cut Type Shall Be The Same As The Performer Joint Seal Selected.

Items Of Payment: The Accepted Quantities Will Be Paid For In Linear Feet At The Contract Unit Price Along The Length Of The Bridge Deck On Each Side Of The Centerline Joint.

907-823-4001 REFORMED JOINT SEAL, TYPE I

Description: Shall Include The Manufacturer's Required Joint Preparation Including Sandblasting Both Sides Of The Joint And Blowing The Joint Free Of All Debris. The Contractor Shall Compress Air And Placement Of The New Performer Joint Seal.

Items Of Payment: The Accepted Quantities Will Be Paid For In Linear Feet At The Contract Unit Price Along The Length Of The Centerline Joint.

907-823-4002 REFORMED JOINT SEAL, TYPE II

Description: Shall Include The Manufacturer's Required Joint Preparation Including Sandblasting Both Sides Of The Joint And Blowing The Joint Free Of All Debris. The Contractor Shall Compress Air And Placement Of The New Performer Joint Seal.

Items Of Payment: The Accepted Quantities Will Be Paid For In Linear Feet At The Contract Unit Price Along The Length Of The Centerline Joint.

ELASTOMERIC CONCRETE NOTES

907-824-9907 BRIDGE REPAIR ELASTOMERIC CONCRETE

Description: Elastomeric Concrete Shall Be One Of The Following Products, Installed According To The Manufacturer's Specifications:

- Poly-Tec Elastomeric Concrete Manufactured By R.J. Watson, Inc. In Alden, NY www.rjwatson.com
- Wako SFS II Manufactured By Watson Bowman Acme Corporation In Amherst, NY www.wbcorp.com
- Decorative Elastomeric Concrete Manufactured By The G.S. Brown Company In North Baltimore, OH www.gsbrown.com

Items Of Payment: The Accepted Quantities Will Be Paid For In Cubic Yards At The Contract Unit Price.

GENERAL NOTES:

- Specifications: Mississippi Standard Specifications For Road And Bridge Construction, 2017.
- No Change Of Plans Will Be Permitted Except By Written Approval Of The Director Of Structures, State Bridge Engineer. Any Change Of Plans, Materials, Methods, or Specifications May Be Authorized By The Bridge Engineer Provided Such Changes Will Not Be Cause For Contract Price Adjustment. Work For Which No Pay Item Is Provided In The Proposal Will Be Considered An Absorbed Item of Work.

NOTES ON ASSOCIATED ITEMS OF WORK:

202-8169 REMOVAL OF EXISTING JOINT MATERIAL

Description: Shall include the removal of material associated with armor, sliding plate, and neoprene expansion joints, as designated in the detail drawings provided. Removal of material from other joint types shall not be included under this item of work unless otherwise directed by the Engineer. Removal of joint material and any trash, vegetation, and debris shall be included under this item of work. Joint shall be included under this item of work.

Basis of Payment:

Removal of armor and sliding plate joint material will be paid for in linear feet at the contract unit price along the length of the bridge deck on each side of the material will only be paid for as the length along the centerline of the joint.

907-823-8001 SAW CUT, TYPE I & 907-823-8002 SAW CUT, TYPE II

Description: The saw cut depth shall be equivalent to the installation depth required by the manufacturer's specifications. The saw cut type shall be the same as the preformed joint seal selected.

Basis of Payment:

The accepted quantities will be paid for in linear feet at the contract unit price along the length of the bridge deck on each side of the centerline of the joint.

907-823-4001 PREFORMED JOINT SEAL, TYPE I

907-823-4002 PREFORMED JOINT SEAL, TYPE II

Description: Shall include the manufacturer's required joint preparation including sandblasting both sides of the joint and blowing the joint free of debris with compressed air and placement of the new preformed joint seal.

Basis of Payment:

The accepted quantities will be paid for in linear feet at the contract unit price along the length of the centerline of the joint.

ELASTOMERIC CONCRETE REPAIR ELASTOMERIC CONCRETE

Description: Elastomeric concrete shall be one of the following products installed according to the manufacturer's specifications:

- A. Poly-Ton Elastomeric Concrete
Manufactured by R.J. Watson, Inc. in Alden, NY
www.rjwatson.com
- B. Waka-Crete II
Manufactured by Watson Bowman Acme Corporation in Amherst, NY
www.wbcorp.com
- C. Dabcrete Elastomeric Concrete
Manufactured by The D.S. Brown Company in North Baltimore, OH
www.dsbrown.com

Basis of Payment:

The accepted quantities will be paid for in cubic yards at the contract unit price.

GENERAL NOTES:

1. Specifications: Mississippi Standard Specifications For Road And Bridge Construction, 2017.
2. No change of items will be permitted except by written approval of the Engineer. Any change of items shall be subject to minor changes to detail of design or construction procedure. Any change to detail of design or construction procedure will not be cause for contract price adjustment. Approval will not be paid for directly and shall therefore be considered an absorbed item of work.

*** CONCRETE REMOVAL BLOCKOUT NOTES**

Removal of the concrete blockout area shall be considered an absorbed item of work. The contractor shall use a hammer No. 10 or larger than 30 lbs to complete this work.

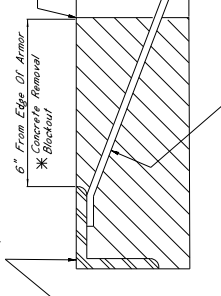

TYPICAL SECTION AT EXISTING JOINT

Showing Existing Existing Joints To Be Removed And Replaced With Preformed Joint Seal

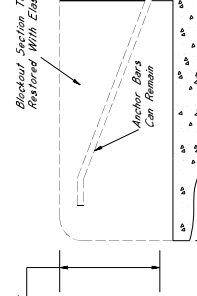

TYPICAL SECTION AT JOINT AFTER REMOVAL OF EXISTING SEAL

Showing Limits of Joint Preparation For Application of New Joint Seal Materials

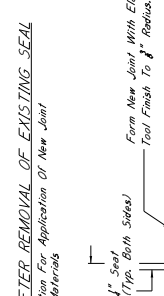

TYPICAL SECTION AT SAWCUT & JOINT REPAIR

Showing Area Where Repairs Are Made After Sawcut With Elastomeric Concrete

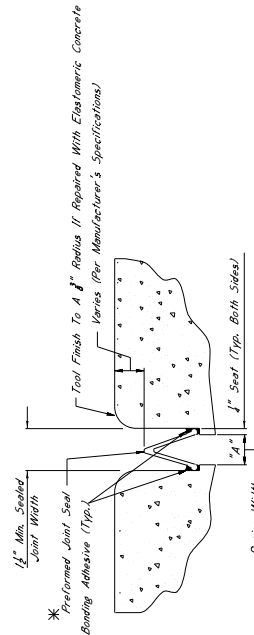
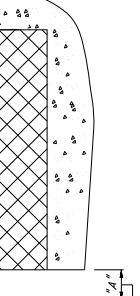

TYPICAL SECTION AT SAWCUT & SEALED JOINT

Showing Sawcut Joint After Sawcut and Repair With Elastomeric Concrete

*** NOTES:**

1. The preformed joint seal shall be one of the following installed according to the manufacturer's specifications:
 - A. Silcolite Joint Sealing System
Manufactured by R.J. Watson, Inc. in Alden, NY
www.rjwatson.com
 - B. Waka SP3 Joint Sealing System
Manufactured by Watson Bowman Acme Corporation in Amherst, NY
www.wbcorp.com
 - C. Silseal 555 Silicone Strip Seal
Manufactured by SSI Commercial & Highway Construction Materials
www.ssi.com
2. For estimating purposes, the R.J. Watson Silcolite Joint Sealing System was selected. However, should another supplier be chosen, it is the contractor's responsibility to verify the installation depth and width, adhesive setting times, and any other variances between the specifications provided by the manufacturer, to ensure that the contractor is properly schooled in installation of the joint material.
3. Joints shall be sealed at their design widths, dimension "A", which is defined as the actual width of the joint opening. This width does not account for the seal. The seal shall be applied to the joint opening. The preformed joint seal shall be used for design widths greater than or equal to 2" with the maximum design width of 6". For design widths less than 2", the preformed joint seal type "A" shall be used. The contractor shall be responsible for ensuring that the contractor's responsibility to ensure that the size selected is appropriate for the width of the joint.

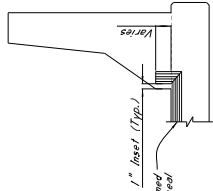

ELEVATION AT END OF SPAN

*** NOTES:**
For Jersey Slab Barring, The Minimum Required Vertical Joint Seal Dimension Within The Slab Barring, The Minimum Required Vertical Joint Seal Dimension Within The Barrier is 6".

*** 1" SAWCUT NOTES:**

All 1" Sawcuts Shall Be Considered An Absorbed Item of Work. The Contractor Shall Verify Depth of Reinforcing Steel, and Sizing of Steel, to Minimum Depth of the Sawcut. The Contractor Shall Be Responsible For Repairing Any Damage To Reinforcing Steel Shall Be Replaced To The Satisfaction Of The Engineer At No Cost To The State.

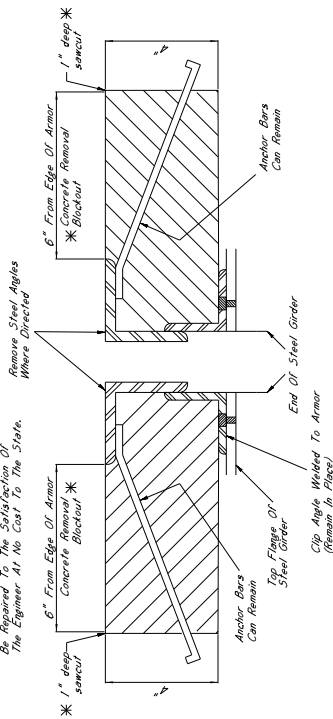

TYPICAL SECTION AT EXISTING JOINT

Showing Existing Existing Joint Seal, To Be Replaced And Replaced With Preformed Joint Seal

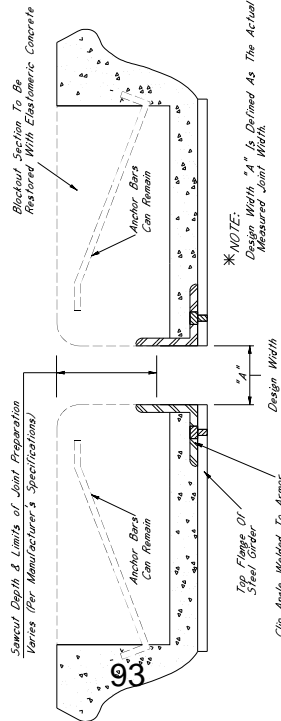

TYPICAL SECTION AT JOINT AFTER REMOVAL OF EXISTING SEAL

Showing Limits Of Joint Preparation For Application Of New Joint Seal Materials

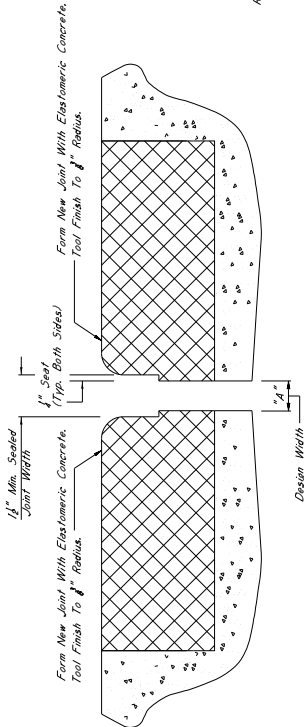

TYPICAL SECTION AT SAWCUT & JOINT REPAIR

Showing Area Where Repairs Are Made After Sawcut With Elastomeric Concrete

*** CONCRETE REMOVAL BLOCKOUT NOTES**

Removal Of The Concrete Blockout Area Shall Be Considered An Absorbed Item Of Work Under Item 202-8169. The Contractor Shall Be Responsible For Removing More Than 30 Lbs To Complete This Work.

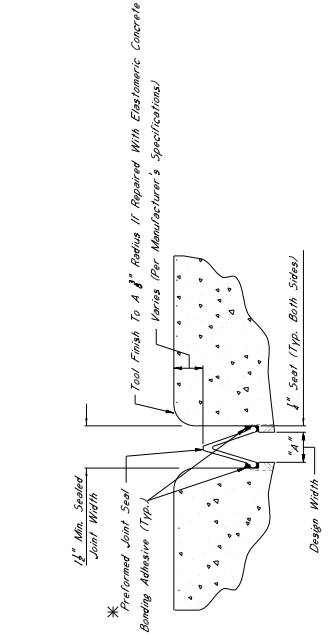

TYPICAL SECTION AT SAWCUT & SEALED JOINT

Showing Sealed Joint After Sawcut And Repair With Elastomeric Concrete

*** NOTES:**

- The Preformed Joint Seal Shall Be One Of The Following, Installed According To The Manufacturer's Specifications:
 - A. Silflex Joint Sealing System Manufactured By R.J. Watson, Inc. In Alden, NY www.rjwatson.com
 - B. Wale SP3 Joint System Manufactured By Watson Bowman Acme Corporation In Amherst, NY www.watson-bowman.com
 - C. Sigaic 355 Silicone Strip Seal Manufactured By SSI Commercial & Highway Construction Materials www.ssi.com
- For Estimating Purposes, The R.J. Watson Silicone Joint Sealing System Was Selected. However, Should Another Supplier Be Chosen, It Is The Contractor's Responsibility To Ensure That The Manufacturer's Recommendations Are Followed. Any Other Arrangements Between The Contractor And The Manufacturer, Including Any Other Arrangements Between The Specifications Provided By The Manufacturer, A Manufacturer Representative, Shall Be Present At The Time Joint Sealing Begins. Material That The Contractor Is Properly Sealed In Installation Of The Joint.
- Joints Shall Be Sealed At Their Design Widths, Dimension "A", Which Is Defined As The Actual Width Of The Joint Opening. This Width Does Not Account For The Seal Required On Both Sides Of The Joint. Preformed Joint Seal, Strip Seal, Or Silicone Strip Seal Shall Be Installed In The Joint With The Maximum Design Width For Design Widths Greater Than Or Equal To 2" With The Maximum Design Width Being 2". In Cases Where Design Widths Are Greater Than 2", Another Type Of Seal Shall Be Selected At The Discretion Of The Contractor. The State Bridge Engineer, Upon Is The Contractor's Responsibility To Ensure That The Size Selected Is Appropriate For The Width Of The Joint.

*** NOTES:**

For Heavy Slope Embankments, The Minimum Required Vertical Joint Seal Dimension Within The Area Where Repairs Are Made After Sawcut Within The Barrier Is 6".

ELEVATION AT END OF SPAN

NOTES ON ASSOCIATED ITEMS OF WORK:

202-8169 REMOVAL OF EXISTING JOINT MATERIAL

Description:

Shall Include The Removal Of Material Associated With Armor, Sliding Plates, And Neoprene Expansion Joints, As Well As The Concrete Blockout Area. The Contractor Shall Be Responsible For Removing More Than 30 Lbs To Complete This Work. Other Joint Types Shall Not Be Included Under This Item Of Work Unless Otherwise Directed By The Engineer. The Contractor Shall Be Responsible For Removing Vegetation And Trash Located At Any Depth Within The Joint Shall Be Included Under This Item Of Work.

Basis Of Payment:

Removal Of Armor And Sliding Plate Joint Material Will Be Paid For In Linear Feet At The Contract Unit Price Of The Length Of The Bridge Deck On Each Side Of The Material Will Only Be Paid For As The Length Along The Centerline Of The Joint.

907-823-8001 SAW CUT, TYPE I & 907-823-8002 SAW CUT, TYPE II

Description:

The Saw Cut Depth Shall Be Equivalent To The Installation Depth Required By The Manufacturer's Specifications. The Saw Cut Type Shall Be The Same As The Preformed Joint Seal Selected.

Basis Of Payment:

The Accepted Quantities Will Be Paid For In Linear Feet At The Contract Unit Price Along The Length Of The Bridge Deck On Each Side Of The Centerline Joint.

907-823-4001 PREFORMED JOINT SEAL, TYPE I

Description:

Shall Include The Manufacturer's Required Joint Preparation Including Sandblasting Both Sides Of The Joint And Blowing The Joint Area Of Debris With Compressed Air And Placement Of The New Preformed Joint Seal.

Basis Of Payment:

The Accepted Quantities Will Be Paid For In Linear Feet At The Contract Unit Price Along The Length Of The Centerline Joint.

ELASTOMERIC CONCRETE NOTES

907-824-8007 BRIDGE REPAIR ELASTOMERIC CONCRETE

Description:

Elastomeric Concrete Shall Be One Of The Following Products, Installed According To The Manufacturer's Specifications:

- Poly-Top Elastomeric Concrete Manufactured By R.J. Watson, Inc. In Alden, NY www.rjwatson.com
- Wale-Crete II Manufactured By Watson Bowman Acme Corporation In Amherst, NY www.watson-bowman.com
- Decorative Elastomeric Concrete Manufactured By The U.S. Green Company In North Baltimore, OH www.usgreen.com

Basis Of Payment:

The Accepted Quantities Will Be Paid For In Cubic Yards At The Contract Unit Price.

GENERAL NOTES:

- Specifications: Massachusetts Standard Specifications For Road And Bridge Construction, 2017.
- No Change Of Plans Will Be Permitted Except By Written Approval Of The Director Of Structures, State Bridge Engineer.
- Work For Which No Pay Item Is Provided In The Proposal Will Not Be Authorized By The Bridge Engineer. Proposed Such Changes Will Not Be Cause For Contract Price Adjustment.

*** 1" SAWCUT NOTES:**

1. All 1" sawcuts shall be considered in accordance with the specifications. The contractor shall verify depth of reinforcing steel before making any sawcuts. The depth of the sawcut shall be no less than 1/2" and no more than 1/2" from the top of the concrete. Any damage to reinforcing steel shall be repaired to the satisfaction of the Engineer at no cost to the State.

*** CONCRETE REMOVAL BLOCKOUT NOTES**

1. All concrete removal shall be considered in accordance with the specifications. The contractor shall verify depth of reinforcing steel before making any sawcuts. The depth of the sawcut shall be no less than 1/2" and no more than 1/2" from the top of the concrete. Any damage to reinforcing steel shall be repaired to the satisfaction of the Engineer at no cost to the State.

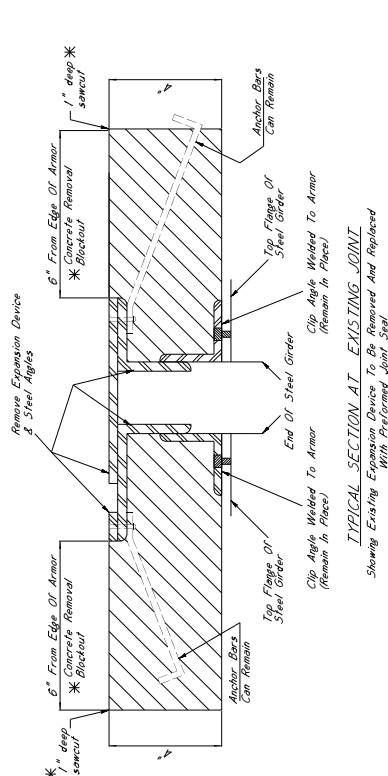

TYPICAL SECTION AT EXISTING JOINT
Showing Existing Expansion Device To Be Removed And Replaced With Preformed Joint Seal

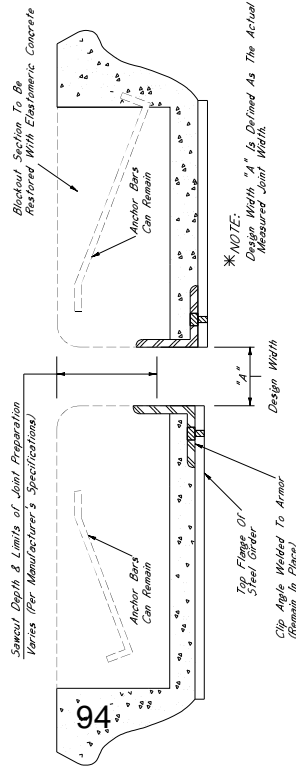

TYPICAL SECTION AT JOINT AFTER REMOVAL OF EXISTING SEAL
Showing Limits Of Joint Preparation For Application Of New Joint Seal Materials

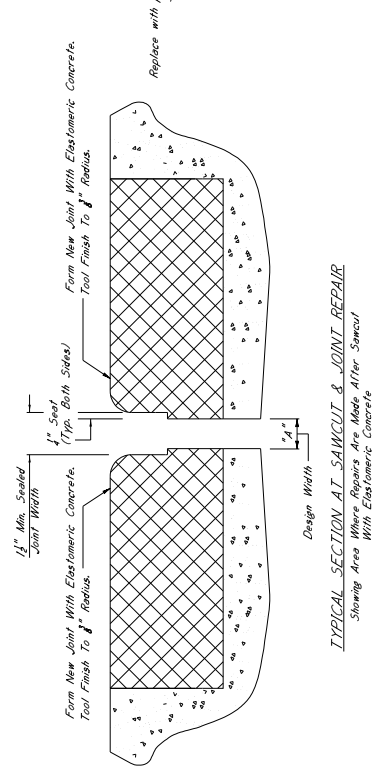

TYPICAL SECTION AT SAWCUT & JOINT REPAIR
Showing Area Where Repairs Are Made After Sawcut With Elastomeric Concrete

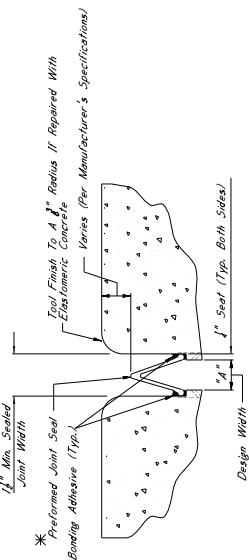

TYPICAL SECTION AT SAWCUT & SEALED JOINT
Showing Sealed Joint After Sawcut And Repair With Elastomeric Concrete

*** NOTES:**
1. The Preformed Joint Seal Shall Be One Of The Following, Installed According To The Manufacturer's Specifications:
A. Silcoflex Joint Sealing System
B. Welo SPS Joint System
C. Silagoc SSS Silicone Strip Seal

2. For Estimating Purposes, The R.J. Watson Silcoflex Joint Sealing System Was Used For Joint Preparation, Installation, Sealing, And Maintenance. The Contractor Shall Be Responsible To Ensure That The Manufacturer's Recommendations Are Followed For Joint Preparation, Installation, Sealing, And Maintenance. The Contractor Shall Be Responsible To Ensure That The Manufacturer's Representative Shall Be Present At The Time Joint Sealing Begins To Ensure That The Contractor Is Properly Schooled In Installation Of The Joint Material.
3. Joints Shall Be Sealed At Their Design Widths, Dimension "A", Which Is Defined As Seal Required On Both Sides Of The Joint. The Preformed Joint Seal Type I Shall Be Used For Design Widths Less Than 2". Preformed Joint Seal Type II Shall Be Used For Design Widths Greater Than 2". In Cases Where Design Widths Are Greater Than 2", The Contractor Shall Be Responsible To Ensure That The Contractor Is Properly Schooled In Installation Of The Joint Material.

4. The Contractor Shall Be Responsible For The Design Widths, Dimension "A", Which Is Defined As Seal Required On Both Sides Of The Joint. The Preformed Joint Seal Type I Shall Be Used For Design Widths Less Than 2". Preformed Joint Seal Type II Shall Be Used For Design Widths Greater Than 2". In Cases Where Design Widths Are Greater Than 2", The Contractor Shall Be Responsible To Ensure That The Contractor Is Properly Schooled In Installation Of The Joint Material.

5. The Contractor Shall Be Responsible For The Design Widths, Dimension "A", Which Is Defined As Seal Required On Both Sides Of The Joint. The Preformed Joint Seal Type I Shall Be Used For Design Widths Less Than 2". Preformed Joint Seal Type II Shall Be Used For Design Widths Greater Than 2". In Cases Where Design Widths Are Greater Than 2", The Contractor Shall Be Responsible To Ensure That The Contractor Is Properly Schooled In Installation Of The Joint Material.

6. The Contractor Shall Be Responsible For The Design Widths, Dimension "A", Which Is Defined As Seal Required On Both Sides Of The Joint. The Preformed Joint Seal Type I Shall Be Used For Design Widths Less Than 2". Preformed Joint Seal Type II Shall Be Used For Design Widths Greater Than 2". In Cases Where Design Widths Are Greater Than 2", The Contractor Shall Be Responsible To Ensure That The Contractor Is Properly Schooled In Installation Of The Joint Material.

7. The Contractor Shall Be Responsible For The Design Widths, Dimension "A", Which Is Defined As Seal Required On Both Sides Of The Joint. The Preformed Joint Seal Type I Shall Be Used For Design Widths Less Than 2". Preformed Joint Seal Type II Shall Be Used For Design Widths Greater Than 2". In Cases Where Design Widths Are Greater Than 2", The Contractor Shall Be Responsible To Ensure That The Contractor Is Properly Schooled In Installation Of The Joint Material.

8. The Contractor Shall Be Responsible For The Design Widths, Dimension "A", Which Is Defined As Seal Required On Both Sides Of The Joint. The Preformed Joint Seal Type I Shall Be Used For Design Widths Less Than 2". Preformed Joint Seal Type II Shall Be Used For Design Widths Greater Than 2". In Cases Where Design Widths Are Greater Than 2", The Contractor Shall Be Responsible To Ensure That The Contractor Is Properly Schooled In Installation Of The Joint Material.

9. The Contractor Shall Be Responsible For The Design Widths, Dimension "A", Which Is Defined As Seal Required On Both Sides Of The Joint. The Preformed Joint Seal Type I Shall Be Used For Design Widths Less Than 2". Preformed Joint Seal Type II Shall Be Used For Design Widths Greater Than 2". In Cases Where Design Widths Are Greater Than 2", The Contractor Shall Be Responsible To Ensure That The Contractor Is Properly Schooled In Installation Of The Joint Material.

10. The Contractor Shall Be Responsible For The Design Widths, Dimension "A", Which Is Defined As Seal Required On Both Sides Of The Joint. The Preformed Joint Seal Type I Shall Be Used For Design Widths Less Than 2". Preformed Joint Seal Type II Shall Be Used For Design Widths Greater Than 2". In Cases Where Design Widths Are Greater Than 2", The Contractor Shall Be Responsible To Ensure That The Contractor Is Properly Schooled In Installation Of The Joint Material.

11. The Contractor Shall Be Responsible For The Design Widths, Dimension "A", Which Is Defined As Seal Required On Both Sides Of The Joint. The Preformed Joint Seal Type I Shall Be Used For Design Widths Less Than 2". Preformed Joint Seal Type II Shall Be Used For Design Widths Greater Than 2". In Cases Where Design Widths Are Greater Than 2", The Contractor Shall Be Responsible To Ensure That The Contractor Is Properly Schooled In Installation Of The Joint Material.

12. The Contractor Shall Be Responsible For The Design Widths, Dimension "A", Which Is Defined As Seal Required On Both Sides Of The Joint. The Preformed Joint Seal Type I Shall Be Used For Design Widths Less Than 2". Preformed Joint Seal Type II Shall Be Used For Design Widths Greater Than 2". In Cases Where Design Widths Are Greater Than 2", The Contractor Shall Be Responsible To Ensure That The Contractor Is Properly Schooled In Installation Of The Joint Material.

13. The Contractor Shall Be Responsible For The Design Widths, Dimension "A", Which Is Defined As Seal Required On Both Sides Of The Joint. The Preformed Joint Seal Type I Shall Be Used For Design Widths Less Than 2". Preformed Joint Seal Type II Shall Be Used For Design Widths Greater Than 2". In Cases Where Design Widths Are Greater Than 2", The Contractor Shall Be Responsible To Ensure That The Contractor Is Properly Schooled In Installation Of The Joint Material.

14. The Contractor Shall Be Responsible For The Design Widths, Dimension "A", Which Is Defined As Seal Required On Both Sides Of The Joint. The Preformed Joint Seal Type I Shall Be Used For Design Widths Less Than 2". Preformed Joint Seal Type II Shall Be Used For Design Widths Greater Than 2". In Cases Where Design Widths Are Greater Than 2", The Contractor Shall Be Responsible To Ensure That The Contractor Is Properly Schooled In Installation Of The Joint Material.

15. The Contractor Shall Be Responsible For The Design Widths, Dimension "A", Which Is Defined As Seal Required On Both Sides Of The Joint. The Preformed Joint Seal Type I Shall Be Used For Design Widths Less Than 2". Preformed Joint Seal Type II Shall Be Used For Design Widths Greater Than 2". In Cases Where Design Widths Are Greater Than 2", The Contractor Shall Be Responsible To Ensure That The Contractor Is Properly Schooled In Installation Of The Joint Material.

16. The Contractor Shall Be Responsible For The Design Widths, Dimension "A", Which Is Defined As Seal Required On Both Sides Of The Joint. The Preformed Joint Seal Type I Shall Be Used For Design Widths Less Than 2". Preformed Joint Seal Type II Shall Be Used For Design Widths Greater Than 2". In Cases Where Design Widths Are Greater Than 2", The Contractor Shall Be Responsible To Ensure That The Contractor Is Properly Schooled In Installation Of The Joint Material.

NOTES ON ASSOCIATED ITEMS OF WORK:

202-9169 REMOVAL OF EXISTING JOINT MATERIAL

Description: Shall include the removal of material associated with armor, sliding plate, and neoprene expansion joints, as designated in the detail drawings provided. Removal of material shall include the removal of joint material, any trash, vegetation, and debris located at any depth within the joint shall be included under this item of work.

Basis Of Payment: Removal of armor and sliding plate material will be paid for in linear feet along the length of the bridge deck on each side of the centerline joint, while removal of neoprene joint material will only be paid for as the length along the centerline of the joint.

907-823-0001 SAW CUT, TYPE I & 907-823-0002 SAW CUT, TYPE II

Description: The saw cut depth shall be equivalent to the installation depth of the joint seal. The saw cut shall be the same as the preformed joint seal selected.

Basis Of Payment: The accepted quantities will be paid for in linear feet at each side of the centerline joint.

907-823-0001 REFORMED JOINT SEAL, TYPE I

Description: Shall include the manufacturer's required joint preparation, removal of joint seal, and placement of the new preformed joint seal.

Basis Of Payment: The accepted quantities will be paid for in linear feet at each side of the centerline joint.

907-823-0002 REFORMED JOINT SEAL, TYPE II

Description: Shall include the manufacturer's required joint preparation, removal of joint seal, and placement of the new preformed joint seal.

Basis Of Payment: The accepted quantities will be paid for in linear feet at each side of the centerline joint.

ELASTOMERIC CONCRETE NOTES

907-824-0007 BRIDGE REPAIR, ELASTOMERIC CONCRETE

Description: Elastomeric concrete shall be one of the following products, installed according to the manufacturer's specifications:
A. Poly-Ton Elastomeric Concrete
B. WeloCrete II
C. Dytrete Elastomeric Concrete

Basis Of Payment: The accepted quantities will be paid for in cubic yards of concrete.

GENERAL NOTES:

1. Specifications: Massachusetts Standard Specifications For Road And Bridge Construction, 2017.
2. No Change Of Plans Will Be Permitted Except By Written Approval Of The Director Of Structures, State Bridge Engineer. Any Change To The Specifications Shall Be Made In Accordance With The Contract Price Adjustment. Such Changes Will Not Be Cause For Contract Price Adjustment. Work For Which No Item Is Provided In The Proposal Will Be Considered An Absorbed Item Of Work.

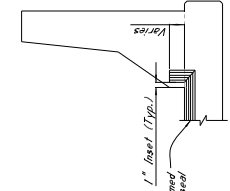

ELEVATION AT END OF SPAN

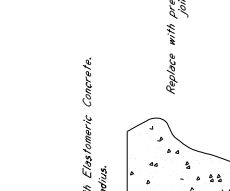

ELEVATION AT END OF SPAN

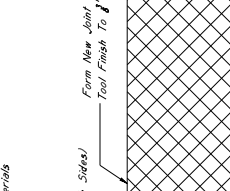

ELEVATION AT END OF SPAN

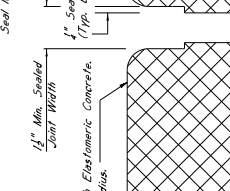

ELEVATION AT END OF SPAN

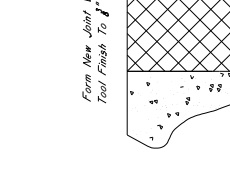

ELEVATION AT END OF SPAN

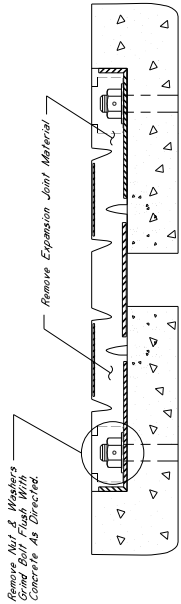

TYPICAL SECTION AT EXISTING JOINT
Showing Existing Expansion Device To Be Removed and Replaced With Preformed Joint Seal

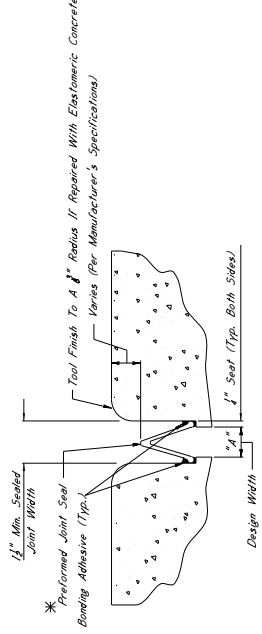

TYPICAL SECTION AT SAWCUT & SEALED JOINT
Showing Sawcut Joint After Sawcut and Repair With Elastomeric Concrete

*NOTES:

- The Preformed Joint Seal Shall Be One Of The Following, Installed According To The Manufacturer's Specifications:
 - SilicoFlex Joint Sealing System Manufactured By R.J. Watson, Inc. In Aloha, NY www.rjwatson.com
 - Wells 395 Joint Sealing System Manufactured By Wells Bowman Acme Corporation In Amherst, NY www.wbcorp.com
 - Silgaps SSS Silicone Strip Seal Manufactured By SSI Commercial & Highway Construction Materials www.ssi.com
- For Estimating Purposes, The R.J. Watson SilicoFlex Joint Sealing System Was Selected. However, Should Another Supplier Be Chosen, It Is The Contractor's Responsibility To Verify That The Selected System Meets The Performance Requirements For Joint Preparation, Installation Details And Methods, Adhesive Setting Times, And Any Other Parameters Between The Specifications Provided By The Manufacturer, To Ensure That The Contractor Is Properly Schooled In Installation Of The Joint Material.
- Joints Shall Be Sealed At Their Design Widths, Dimension "A", Which Is Defined As The Actual Width Of The Joint Opening. This Width Does Not Account For The Expansion Of The Sealant Material. The Sealant Material Shall Be Applied To The Joint For Design Widths Greater Than Or Equal To 2". With The Minimum Design Width Of Expansion Material Shall Be Prepared As Directed By The Director Of Structures, State Bridge Engineer. It Is The Contractor's Responsibility To Ensure That The Size Selected Is Appropriate For The Width Of The Joint.

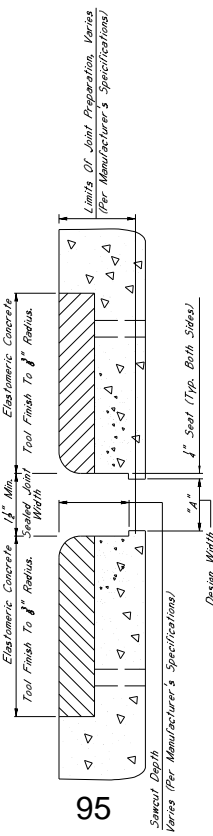

TYPICAL SECTION AT JOINT AFTER REMOVAL OF EXISTING SEAL
Showing Limits Of Joint Preparation For Application Of New Joint Seal Materials

*NOTE:
Design Width "A" Is Defined As The Actual Measured Joint Width.

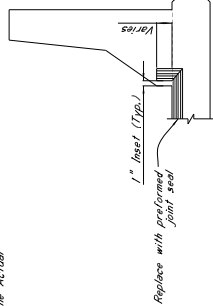

ELEVATION AT END OF SPAN

*NOTES:

- For Jersey Shape Barriers, The Minimum Required Vertical Joint Seal Dimension Will Be 1.5 Times The Barrier Height.
- For Wall and Abutment Barriers, The Minimum Required Vertical Joint Seal Dimension Within The Barrier Is 6".

NOTES ON ASSOCIATED ITEMS OF WORK:

- 202-0169 REMOVAL OF EXISTING JOINT MATERIAL
Description: Shall Include The Removal Of Material Associated With Armor, Siding Plugs, And Nonpre-Expansion Joints, As Designated In The Detail Drawings Provided. Other Work Shall Be Done As Directed By The Engineer. Work Unless Otherwise Directed By The Engineer, Removal Of Joint Material And Any Trash And Debris (Including But Not Limited To, Compacted Dirt, Gravel, Etc.) Shall Be Included Under This Item Of Work.
- Basis Of Payment: Removal Of Armor And Siding Plug Joint Material Will Be Paid For In Linear Feet At The Contract Unit Price Along The Length Of The Bridge Deck On Each Side Of The Expansion Joint. Material Will Only Be Paid For As The Length Along The Centerline Of The Joint.
- 907-823-0001 SAW CUT, TYPE I & 907-823-0002 SAW CUT, TYPE II
Description: The Saw Cut Depth Shall Be Equivalent To The Installation Depth Required By The Manufacturer's Specifications. The Saw Cut Type Shall Be The Same As The Preformed Joint Seal Selected.
- Basis Of Payment: The Accepted Quantities Will Be Paid For In Linear Feet At The Contract Unit Price Along The Length Of The Bridge Deck On Each Side Of The Centerline Joint.
- 907-823-4001 PREFORMED JOINT SEAL, TYPE I
907-823-4002 PREFORMED JOINT SEAL, TYPE II
Description: Shall Include The Manufacturer's Required Joint Preparation Including Sandblasting Both Sides Of The Joint And Blowing The Joint Free Of Debris With Compressed Air And Placement Of The New Preformed Joint Seal.
- Basis Of Payment: The Accepted Quantities Will Be Paid For In Linear Feet At The Contract Unit Price Along The Length Of The Centerline Joint.
- 10 - ELASTOMERIC CONCRETE NOTES
Description: Elastomeric Concrete Shall Be One Of The Following Products, Installed According To The Manufacturer's Specifications.
- Pol-Ton Elastomeric Concrete Manufactured By R.J. Watson, Inc. In Aloha, NY www.rjwatson.com
 - WellsCrete II Manufactured By Wells Bowman Acme Corporation In Amherst, NY www.wbcorp.com
 - Delcrete Elastomeric Concrete Manufactured By The D.S. Brown Company In North Baltimore, OH www.dsbrown.com
- Basis Of Payment: The Accepted Quantities Will Be Paid For In Cubic Yards At The Contract Unit Price.

GENERAL NOTES:

- See Wisconsin Masterlist: Standard Specifications For Road And Bridge Construction 2017.
- No Change Of Plans Will Be Permitted Except By Written Approval Of The Director Of Structures, State Bridge Engineer. Minor Changes To Detail Drawings, Construction Procedures, Materials, Or Methods, Shall Be Permitted Only If Such Changes Will Not Be Cause For Contract Price Adjustment. Work For Which No Pay Item Is Provided In The Proposal Will Not Be Paid For Directly And Shall Therefore Be Considered An Absorbed Item Of Work.

NOTES ON ASSOCIATED ITEMS OF WORK:
 907-824-PP008 BRIDGE REPAIR, ENDWALL REPAIR

Description: Shall include the Work Necessary To Remove And Replace The Damaged Concrete On The End Wall Of The Bridge Deck, To Remove The Existing Epoxy Underlayment Limiting The Repair To The Damaged Section, The Specified Depth Of Endwall Shall Be Removed Along The Entire Width Of The Bridge Deck.
Basis of Payment: The Associated Quantities Will Be Paid For In Linear Feet At The Contract Unit Price Along The Width Of The Bridge Deck.
 Damage Caused To Other Elements Of The Structure Or Roadway While Completing Work Of Work Shall Be Repaired By The Contractor At NO COST TO THE Department.
 Prior To Placing New Concrete, All Concrete Surfaces That Will Be In Contact With The New Concrete Shall Be Painted With An Approved Epoxy Underlayment To Bond New Concrete To Old.
 New Concrete Shall Be High Early Strength Bridge Concrete, As Follows:
 The concrete mixture design shall be furnished by the Contractor for approval by the materials Division. Mixture design parameters are as follows:
 Required Strength: 5000 psi
 Maximum Slump: 6 inches
 Non-chloride based accelerator may be used if the ambient temperature is 50°F or less, but shall not be used if the ambient temperature is greater than 50°F. Synthetic structural fibers shall be used. The Contractor shall select a manufacturer from ADOT's Approved Products List, and the manufacturer's recommendations shall be followed for the dosage rate.
 Curing to be continuous until 2500 psi is attained. Traffic is to be diverted from the repair area until this value is reached. The Contractor may use the Ministry of Transportation 207 subgrade to estimate the concrete strength. However, final acceptance of the in-place concrete shall be determined using eight concrete test cylinders, which shall be cured in a container next to the concrete placement. Two cylinders are to be tested at 3, 16, and 28-hour intervals. The remaining six cylinders shall be used to determine the 28-day compressive strength of the concrete.
 The Removal Of Existing Expansion Material May Require Any Number Of Vite Pay Corresponding Joint Repair Detail Sheet For Additional Details On The Associated Items Of Work.

GENERAL NOTES:
 1. No Change Of Plans Will Be Permitted Except By Writing. Approval Changes To Detail Of Design Construction May Be Authorized By The Bridge Engineer Provided Such Changes Will Not Be Cause For Contract Price Adjustment. Payment Will Not Be Paid For Directly And Shall Therefore Be Considered An Absorbed Item Of Work.
 2. And Bridge Construction 2017.
 3. Approved By The Bridge Engineer.

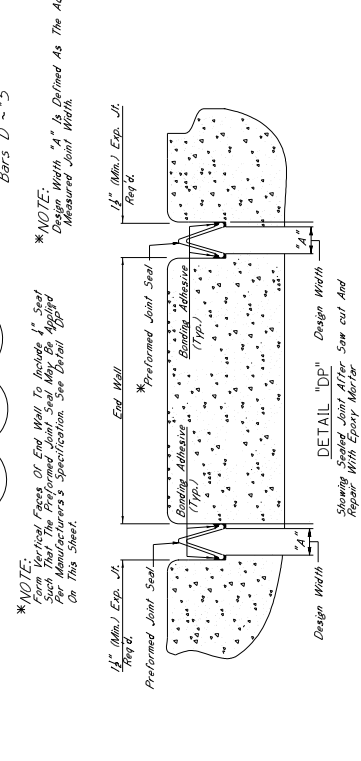
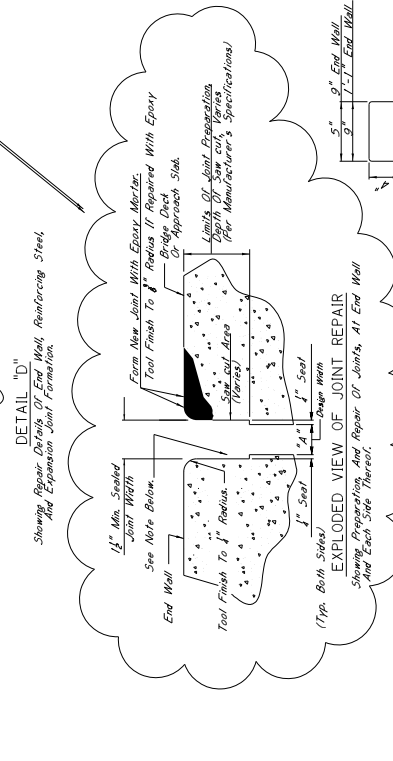
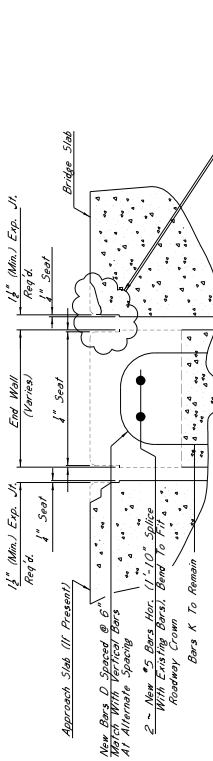

***NOTE:**
 Design Width 'A' Is Defined As The Actual Measured Joint Width.
 *NOTE:
 Vertical Faces Of End Wall To Be Sealed With Sealant For Manufacturer's Specification. See Detail Above On This Sheet.
 *NOTE:
 Vertical Faces Of End Wall To Be Sealed With Sealant For Manufacturer's Specification. See Detail Above On This Sheet.
 *NOTE:
 Vertical Faces Of End Wall To Be Sealed With Sealant For Manufacturer's Specification. See Detail Above On This Sheet.

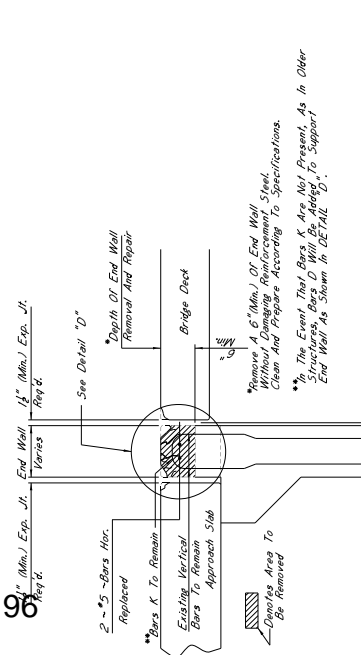
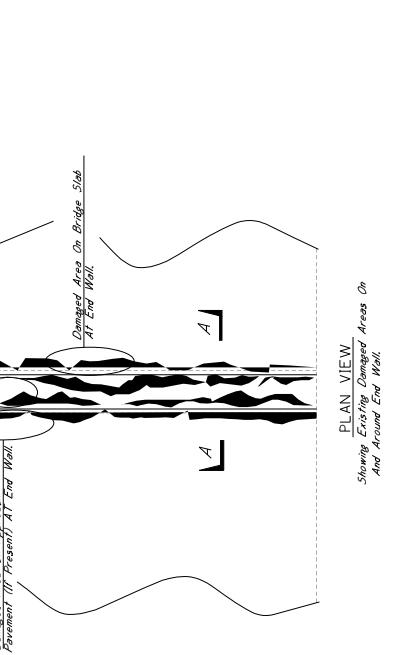
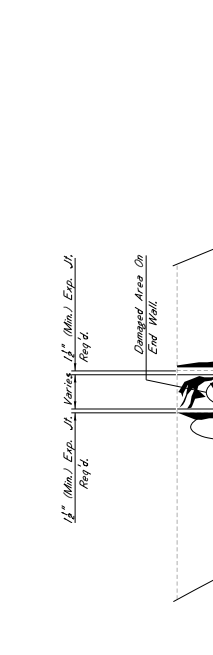

***NOTES:**
 1. The Preformed Joint Seal Shall Be One Of The Following, Installed According To The Manufacturer's Specifications:
 A. Silcaflex Joint Sealing System
 B. Wicks SSS Joint Sealer
 C. Silogac SSS Silicone Strip Seal
 2. For Estimating Purposes, The RJ Wilson Silcaflex Joint Sealing System Was Used For Design Widths Less Than 2'.
 3. Joints Shall Be Sealed At Their Design Widths, Dimension 'A', Which Is Defined As The Actual Measured Joint Width. The Preformed Joint Seal Type I Shall Be Used For Design Widths Less Than 2'.
 4. Expansion Material Shall Be Applied As Directed By The Contractor To Ensure That The Sealant Is Properly Sealed To The Joint.

MISSISSIPPI DEPARTMENT OF TRANSPORTATION

SPECIAL PROVISION NO. 907-845-2

CODE: (SP)

DATE: 05/09/2019

SUBJECT: Coating Existing Structural Steel

Section 907-845, Coating Existing Structural Steel, is hereby added to and made a part of the 2017 Edition of the Mississippi Standard Specifications for Road and Bridge Construction as follows.

SECTION 907-845 – COATING EXISTING STRUCTURAL STEEL

907-845.01--Description. This work consists of furnishing all labor, material, and equipment required for coating existing structural steel in accordance with the requirements of this Section, by removing and replacing the existing coating where shown in the plans or described herein.

907-845.02--Materials.

907-845.02.1--Coating Systems. One of the following organic zinc/epoxy/urethane three-coat systems, or an approved equal, shall be used for removal and replacement of paint.

	1st	2nd	3rd
Carboline	Carbozinc 859 dft = 3-5 mils	Carbogaurd 888 dft = 3-5 mils	Carbothane 133LH dft = 3-5 mils
Ameron	Amercoat 68HS dft = 3-5 mils	Amercoat 399 dft = 4-8 mils	Amercoat 450H dft = 3-5 mils
Sherwin Williams	Zinc Clad III HS dft = 3-5 mils	Macropoxy 646 dft = 5-10 mils	Acrolon 218HS dft = 3-6 mils

907-845.02.2--Thinners, Solvents and Cleaners. Only thinners, solvents and cleaners listed on the coating manufacturer’s product data sheet shall be used.

907-845.02.3--Caulking. Only Caulks that are paintable, compatible with the coating system, and recommended by the coating manufacturer as part of the coating system shall be used.

907-845.02.4--Soluble Salts Test Kit. Soluble salts test kit shall be in accordance with SSPC-Guide 15 utilizing a Class A retrieval method. The test sleeve or cell shall create a sealed, encapsulated environment during ion extraction and be suitable for testing all structural steel surfaces.

907-845.02.5--Abrasives. Properly sized abrasives shall be used to achieve the required cleanliness and surface profile. Abrasives shall meet the requirements of SSPC-AB 1, Mineral and Slag Abrasives, SSPC-AB 2, Cleanliness of Recycled Ferrous Metallic Abrasives, or SSPC-AB 3, Ferrous Metallic Abrasive and shall not introduce any contamination that interferes with the coating application and performance. The Contractor shall provide a certification to the Engineer that the

abrasives used meet the requirements of this specification and do not contain any chlorides and other salts.

For recycled abrasives, the Contractor shall verify compliance with the conductivity and cleanliness requirements of SSPC-AB 2 after each recycling or more frequently if required by the Engineer. A sample shall be selected from each recycling machine in use and water-soluble contaminant and oil content tests conducted as outlined in SSPC-AB 2 at least one time each week or more frequently if directed by the Engineer. The non-abrasive residue and lead content tests shall be conducted as directed by the Engineer. If test results do not meet requirements, the Engineer shall be notified immediately, the abrasive shall be removed and replaced, the recycling equipment shall be cleaned, and tests conducted each day to confirm the equipment is functioning properly. Testing shall return to the weekly testing interval as directed by the Engineer.

907-845.02.6--Rust Preventative Compound. The rust preventative compound shall be a Class 3 compound meeting the requirements of Military Specification MIL-C-11796C, Corrosion Preventative Compound, Petrolatum, Hot Applied.

907-845.02.7--Storage. Materials shall be stored in conformance with the manufacturer's recommendations.

907-845.03--Construction Requirements.

907-845.03.1--Compressed Air. The compressed air system shall be capable of delivering clean, dry, continuous nozzle pressure to achieve the required surface cleanliness and profile or spray pattern. The system must comply with the instructions and recommendations of the manufacturer of the abrasive blasting system or coating application system.

907-845.03.2--Abrasive Blasting System. The blasting system shall be designed to produce the specified cleanliness and profile.

907-845.03.3--Coating Application System. The coating application equipment shall be approved by and in accordance with the Coating Manufacturer's technical data requirements.

907-845.03.4--Quality Control. The Contractor shall provide a current Corporate Quality Control Plan approved by either SSPC under the SSPC QP1 and SSPC QP2 certifications or NIICAP AS-1 and AS-2 certifications as appropriate and a site specific Coating Quality Control Plan to the Engineer at least 14 calendar days prior to beginning coatings work. The Contractor shall not begin coatings work until the site specific Coating Quality Control Plan has been approved by the Engineer.

The Contractor shall submit a specific traffic control plan for each phase of the work that conforms to the project plans and specifications. The Contractor shall not begin work until the traffic control plan is approved by the Department.

907-845.03.5--Inspection. All inspection equipment shall be maintained in accordance with the manufacturer's instructions, calibrated, and in good working condition. All activities shall be observed and approved by a quality control coatings inspector meeting the requirements of this

specification. Daily inspection reports shall be maintained at the job site for review by the Engineer. All daily inspection reports shall be proved to the Engineer upon completion of the project, or more frequently as requested by the Engineer.

907-845.03.6--Qualifications.

907-845.03.6.1--Field Contractor. The Field Contractor shall provide documentation to the Engineer at least 14 days prior to beginning work that the field contractor performing any work in accordance with this specification is certified by either SSPC to the requirements of SSPC-QP1 and/or SSPC-QP2 or NIICAP to the requirements of AS-1 and/or AS-2, as appropriate.

907-845.03.6.2--Quality Control Inspectors in the Shop and Field. The Contractor shall provide documentation to the Engineer that all personnel performing quality control inspections are certified at a minimum as a National Association of Corrosion Engineers (NACE) Coating Inspector Level I or a SSPC Level 1 Bridge Coating Inspector, and that they report directly to a Quality Control Supervisor who is certified either as a NACE Coating Inspector Level 3 or a SSPC Level 2 Bridge Coating Inspector.

907-845.03.6.3--Certifications. Certifications shall be maintained for the duration of the Contract. If the certifications expire, no work shall be performed until certifications are reissued. The Engineer shall be notified of any change in certification status.

907-845.03.7--Surface Preparation.

907-845.03.7.1--General. The portions of the existing coating designated to be removed and replaced shall be cleaned, washed, tested, and soluble salts removed. This shall be accomplished by abrasive blasting or hand and power tool cleaning to remove all existing coating and corrosion in the intended locations. The edges of all existing coating shall be feathered back to remain a minimum of three inches (3") around the area of existing coating to provide a smooth transition. The edges of the existing coating shall be intact and verified by probing with a dull putty knife in accordance with SSPC SP 2. The existing coating in the feathered area shall be roughened to ensure proper adhesion of the new coating. The Engineer shall be notified immediately when any structural steel appears to be defective.

The portions of the existing coating to remain shall be cleaned, washed, tested, and soluble salts removed. All surfaces to be coated shall be clean, dry, and free from oil, grease, dirt, dust, soluble salts, corrosion, peeling, caulking, weld spatter, mill scale and any other surface contaminants. The surface preparations and coating operations shall be performed so that freshly applied coatings will not be contaminated by dust or foreign matter. The Contractor shall protect all equipment and adjacent surfaces not to be coated from surface preparation operations. In the event that any rusting or contamination occurs after the completion of the surface preparation, the surfaces shall be prepared again to the initial requirements. Surface preparation work shall be performed only when the temperature of the steel surface is at least 5°F above the dew point temperature.

907-845.03.7.2--Mechanical Removal of Surface Defects. All corners resulting from sawing, burning, or shearing shall be broke. In areas where burning has been used, the flame hardened

surface of the steel shall be removed to the extent necessary to achieve the required surface profile after abrasive blast cleaning. All weld slag and weld spatter shall be removed. In addition, all pack rust shall be removed prior to solvent cleaning. All of this work shall be conducted in accordance with AASHTO/NSBA Steel Bridge Collaboration S 8.1.

907-845.03.7.3--Cleaning. All steel surfaces shall be cleaned in accordance with the requirements of SSPC-SP 1.

907-845.03.7.4--Washing. All steel surfaces shall be washed during removal of soluble salts in accordance with the requirements of SSPC-SP WJ-4.

907-845.03.7.5--Soluble Salts Detection and Removal. The chloride, sulfate and nitrate concentrations shall be determined on all steel surfaces using soluble salts test kits meeting the requirements of subsection 907-845.02.4. The concentration levels shall be measured using the method described in SSPC-TU 4. The tests shall be performed after washing and after each applied coat of the coating system. Five random locations shall be tested in the first 1,000 square feet and one random location for each subsequent 1,000 square feet. The non-visible surface contaminant concentrations on blast-cleaned surfaces shall not exceed $7 \mu\text{g}/\text{cm}^2$ for chloride ions, $10 \mu\text{g}/\text{cm}^2$ for ferrous ions, $17 \mu\text{g}/\text{cm}^2$ for sulfate ions, and $10 \mu\text{g}/\text{cm}^2$ for nitrate ions. When any concentration exceeds these levels, the entire surface area shall be rewashed and retested. If additional washing does not reduce the concentration to the acceptable level, a surface treatment or water additive may be used. Surface treatment or water additive shall be approved by the coating system supplier and the Engineer.

907-845.03.7.6--Abrasive Blast Cleaning. Steel shall be prepared by abrasive blast cleaning to "Near-White" metal condition as defined in SSPC-SP 10. SSPC VIS 1 shall be used as an aid in establishing cleanliness. After abrasive blast cleaning, the surface profile shall meet the requirements of the coating manufacturer's product data sheet. The surface profile shall be determined by using replica tape in accordance with ASTM D 4417, Method C.

All abrasive blast cleaning shall be performed within a containment system to ensure confinement of all particulates. The containment system shall be designed to comply with all applicable Federal, State, and Local regulations. The abrasive blast cleaning shall not produce holes, cause distortion, remove metal, or cause thinning of the substrate.

907-845.03.7.7--Hand and Power Tool Cleaning. Steel shall be prepared by power and hand tool cleaning as defined in SSPC-SP 11, SSPC-SP 3, and SSPC-SP 2 for touch up and repair when approved by the Engineer. SSPC-VIS 3 shall be used as an aid in establishing cleanliness.

907-845.03.8--Application.

907-845.03.8.1--General. All of the paint on the exposed steel surfaces shall be removed and re-coated, unless otherwise noted or otherwise directed by the Engineer. A coating of rust preventative compound shall be applied to all machine finished or similar surfaces not to be coated as directed by the Engineer. Prior to the application of any coating, the substrate shall be inspected for contamination and defects, and the surface prepared before application of the next coat. Each coat

including a stripe coat shall be applied in a color that contrasts with the substrate or preceding coat.

907-845.03.8.2--Weather and Temperature Limitations. Spray coating shall not be performed when the measured wind speed in the immediate coating area is above 15 miles per hour. Coatings shall not be applied when contamination from rainfall is imminent or when the ambient air temperature, relative humidity, dew point temperature, or temperature of the steel is outside limits of the coating manufacturer's product data sheet.

907-845.03.8.3--Sealing Using Caulk. The perimeter of all faying surfaces, cracks and crevices, joints open less than 1/2 inch, and skip-welded joints shall be completely sealed using caulk. The caulk shall be applied to the joint following the caulk manufacturer's recommendations. The caulk bead shall have a smooth and uniform finish and be cured according to the caulk manufacturer's recommendation prior to the application of the coating system.

907-845.03.8.4--Protection of Adjacent Surfaces. All surfaces and working mechanisms not intended to be coated during the application of coatings shall be protected. Surfaces that have been contaminated with coatings shall be cleaned until all traces of the coating have been removed. Material from cleaning and coating operations shall not be dispersed outside the work site.

907-845.03.8.5--Mixing and Thinning. All coatings shall be mixed in accordance with the manufacturer's product data sheet. Only complete kits shall be mixed. Thinners and solvents shall be in accordance with the requirements of the coating manufacturer's product data sheet. The amount of thinner added shall not exceed any State and Federal regulations regarding Volatile Organic Compounds (VOC). All mixing operations shall be performed over an impervious surface with provisions to prevent runoff to grade of any spilled material.

907-845.03.8.6--Application Methods. The Contractor shall use coating application equipment and apply coatings per the coating manufacturer's product data sheet. Application with brushes may be permitted for minor touchup of spray applications, stripe coats, or when otherwise approved by the Engineer. Spray equipment shall be adjusted to produce an even, wet coat with minimum overspray. Coatings shall be applied in even, parallel passes, overlapping fifty percent (50%). Coatings shall be agitated during application as required by the coating manufacturer's product data sheet.

907-845.03.8.7--Stripe Coating. Stripe coats shall be applied to achieve complete coverage and proper thickness on welds, corners, crevices, sharp edges, bolts, nuts, rivets, and rough or pitted surfaces.

907-845.03.8.8--Thickness of Coats. Coatings shall be applied to the thickness as identified in the manufacturer's product data sheet. After application of each coat, the surfaces shall be thoroughly inspected and the dry film thickness (DFT) measured in accordance with SSPC-PA 2. When the DFT is deficient or excessive, corrections shall be made in accordance with the coating manufacturer's recommendations and retest the area.

907-845.03.8.9--Coating Drying, and Curing. Coatings shall be applied within the time specified by the coating manufacturer's product data sheet for drying and recoating. Before handling, cure shall be tested in accordance with the manufacturer's recommended method. When the

manufacturer's technical data sheet does not state a specified cure test, the requirements of ASTM D 5402 for organic zinc primers shall be met. The Contractor shall obtain the acceptance criteria from the coating manufacturer and report the results to the Engineer.

907-845.03.8.10--Coating Finish. Each coat shall be applied free of runs, sags, blisters, bubbles, and mud cracking; variations in color, gloss, or texture, holidays, excessive film buildup, foreign contaminants, orange peeling, and overspray.

907-845.03.9--Touchup and Repair. All welds, rivets, bolts, and all damaged or defective coating and rusted areas shall be cleaned and coated. Upon approval by the Engineer, aluminum mastic may be used in accordance with the manufacturer's recommendations. Aluminum mastic shall contain aluminum pigment and minimum 80% volume solids.

907-845.03.10--Protection of the Environment, Public, and Workers.

907-845.03.10.1--General. Plans and programs shall be established to protect the environment, public, contractor employees, and other workers from exposure to toxic heavy metals as well as releases and emissions of hazardous materials and nuisance dusts. All coating application and removal operations shall be conducted in compliance with EPA, OSHA, and other applicable Federal, State and local regulations. A contingency plan shall be provided for the remediation of water and land in the event of contamination by solid or liquid paint and contaminated water.

907-845.03.10.2--Environmental Protection. Plans and programs for the protection of the environment and public based on the applicable EPA requirements, the requirements of this Specification, and the Contract Documents shall be prepared and submitted to the Engineer. The plans and programs shall also include the protection of the air, soil/ground, and water.

907-845.03.10.2.1--Pollution Control. The Contractor shall submit a written pollution control and monitoring plan at the preconstruction meeting or as directed by the Engineer which clearly describes the means for complying with all Local, State and Federal regulations including pollution control provisions specified herein. The written plan shall be in accordance with SSPC Project Design: Industrial Lead Paint Removal Handbook, Volume II, Phase 6, Environmental Monitoring, and specifically include, but not be limited to, providing a scaled map of the work site layout showing the proposed number and location of soil sampling, Total Suspended Particulate (TSP) monitoring sites, waste storage areas, staging areas, temporary waste storage areas, and ambient air and personnel sampling frequency.

The Contractor shall comply with all applicable Federal, State, and Local rules and regulations. In the event a violation of any environmental regulation or a failure to properly execute any pollution control provisions occurs, the Contractor shall immediately cease all operations. Operations shall only resume after written proposed corrective procedures have been submitted to and approved by the Engineer and implemented.

907-845.03.10.2.2--Permits. The Contractor shall submit all required permits from all applicable regulatory agencies to the Engineer prior to the commencement of any work. The Contractor shall seek permit determination from these regulatory agencies to avoid any potential permit non-

compliance issues during work activities. The Contractor shall be responsible for all liability resulting from non-compliance with pertinent rules and regulations including permit requirements.

907-845.03.10.2.3--Ambient Air Quality Compliance and Protection of the Air.

907-845.03.10.2.3.1--Visible Emissions. The visible emissions shall be accessed using EPA Method 22, Timing of Emissions as defined by 40 CFR 60, Appendix A, Standards of Performance for New Stationary Sources. During abrasive blasting, the Contractor shall not allow visible emissions from a containment to exceed a random cumulative duration of more than one percent (1%) of the workday (SSPC Guide 6, Level 1 Emissions). During pressurized water cleaning for removal of soluble salts, The Contractor shall not allow visible emissions from a containment to exceed a random cumulative duration of more than ten percent (10%) of the workday (SSPC Guide 6, Level 3 Emissions).

907-865.03.10.2.3.2--Total Suspended Particulate (TSP) Matter. Emissions from the containment area shall be controlled to prevent exceeding the TSP Lead of 1.5 µg/m³ over a 90-day period, or the daily and adjusted daily allowances of SSPC-TU 7. TSP Lead monitoring shall be conducted in accordance with 40 CFR 50, Appendix B, Reference Method for Determination of TSP Matter in the Atmosphere (high volume sampler required), and 40 CFR 50, Appendix G, Reference Method for Determination of TSP Matter Collected from Ambient Air. The TSP Lead monitoring equipment shall be positioned in general accordance with 40 CFR 58, Ambient Air Quality Surveillance.

When lead is present in the coating, TSP Lead background monitoring shall be performed for a period of three (3) days prior to the beginning of abrasive blast cleaning operations. The results from background monitoring and the first week of monitoring during abrasive blast cleaning shall be submitted to the Engineer for review within five (5) calendar days after the first week of work. Monitoring shall continue unless otherwise directed by the Engineer.

907-865.03.10.2.3.3--Regulated Area. A regulated area around the work site shall be established to prohibit unauthorized persons from areas where exposure to hazardous airborne metals may exceed the following action levels:

<u>Airborne Metals</u>	<u>Action Level</u>
Lead	30 µg/m ³
Cadmium	2.5 µg/m ³
Arsenic	5 µg/m ³
Hexavalent Chromium (Cr6+)	2.5 µg/m ³

Monitoring shall be conducted in accordance with the National Institute for Occupational Safety and Health (NIOSH) procedures upon initiation of dust producing operations and the test results shall be submitted to the Engineer within 72 hours of sampling. Sample results shall be reported as 8-hour Time Weighted Averages (TWA). The regulated area shall be re-established and additional sampling shall be performed when the results exceed the action levels or when directed by the Engineer. All pertinent data shall be documented in a field logbook. Air-sampling pumps shall be positioned around the project perimeter where the public or personnel can approach the work area.

Sampler inlets shall be placed at breathing height. The regulated area shall be clearly marked by the use of warning signs, rope, barrier tape, or temporary construction fencing.

907-845.03.10.2.4--Soil/Ground Quality. The ground beneath and in proximity to the structure shall be inspected in the presence of the Engineer for visible paint chips to establish an initial job site cleanliness standard. When heavy metals are in the existing coatings, soil samples shall be tested prior to the beginning of operations and after project completion for heavy metals. The number and specific locations where the initial samples are taken shall be documented as outlined in the SSPC Project Design-Industrial Lead Paint Removal Handbook, Volume 2 to ensure the post samples are collected from the same locations. All samples shall be submitted to the Engineer for review. If the project activities increase the heavy metal content in soil to more than 20% above the pre-job geometric mean or 100% at any one location, the site shall be returned to the pre-job levels. Additional soil testing shall be conducted as necessary to determine the extent of contamination.

In addition, a pre- and post-soil sampling plan shall be submitted for storage areas identifying the sample location, depth, analyses list, lab certification, and turnaround time. Once approved by the Engineer, sampling results shall be submitted along with a scaled drawing indicating designated sample locations.

907-845.03.10.2.5--Water Quality. The Contractor shall not release, discharge or otherwise cause hazardous materials, debris, waste, or paint chips to enter the water. The Contractor shall also protect against releases due to rain and methods of surface preparation from reaching rivers, streams, lakes, storm drains, or other bodies of water.

907-845.03.10.3--Containment System. The Contractor shall submit a written containment system design plan in accordance with this subsection and the contract documents at the pre-construction conference or as directed by the Engineer which clearly describes the proposed containment system applicable to the intended removal method and in accordance with the requirements outlined herein and SSPC Guide 6, Guide for Containing Debris Generated During Paint Removal Activities. The plan shall include, but is not limited to, removal method; methods for collecting debris; and containment enclosure components. Fire retardant materials shall be used. Containment drawings, calculations, and assumptions, including ventilation criteria if applicable, shall be provided signed and sealed by the Contractor's Engineer of Record experienced with containment systems. A complete structural impact analysis prepared by a Specialty Engineer shall be provided to verify the existing structure can withstand the dead, live and wind loads imposed upon the structure due to the containment system. The lighting inside the containment shall be in accordance with SSPC Guide 12, Guide for Illumination of Industrial Painting Projects. Lighting shall have a minimum intensity of 10 ft-cd for general, 20 ft-cd for work, and 50 ft-cd for inspection. All drawings and calculations shall be submitted and accepted before any work begins. A clear description of the ventilation system components and information shall be provided including the fan curve and design point on the proposed dust collector. The Design shall provide ventilation according to the notes provided in SSPC Guide 6: 100 feet per minute for cross draft and 50-60 feet per minute for downdraft.

The immediate area of the structure shall be isolated to ensure compliance with current and permit requirements for air, water, soil, and pollution prevention. The containment system shall be protected from vehicular and pedestrian traffic. Paint, paint chips, or other debris shall not fall

outside of the containment area under any circumstances. Any damage created by fastening, bracing, or handling the scaffolding and staging shall be repaired. If a suspended platform is constructed, rigid or flexible materials shall be used as needed to create an air and dust impenetrable enclosure. The platform and its components shall be designed and constructed to support at least four (4) times its maximum intended load without failure, with wire cables capable of supporting at least six (6) times their maximum intended load without failure. The Contractor shall strictly comply with all applicable OSHA regulations regarding scaffolding. The category and class of containment shall be as required in the Contract Documents.

907-845.03.10.4--Protection of Adjacent Areas. All areas adjacent to abrasive blast cleaning, including machinery and deck grating, shall be protected. Before the commencement of any cleaning and coating operations, a control plan shall be provided for the protection of adjacent surfaces from damage by nearby blasting and coating to the Engineer for review. Any damage to adjacent areas shall be repaired. The repair procedure shall be submitted to the Engineer for acceptance prior to any remediation.

907-845.03.10.5--Worker Protection. The Contractor shall be responsible for complying with all current OSHA regulations regarding worker protection as it relates to the duties required by this Specification. Appropriate safety procedures shall be implemented for all hazards on the job site whether specifically identified herein or not.

907-845.03.11--Waste Handling and Management.

907-845.03.11.1--General. A waste management program plan shall be prepared which addresses the applicable requirements from EPA regulations for hazardous waste management and the Contract Documents. Include provisions for the handling and disposal of non-hazardous waste. The Contractor shall dispose of all waste in accordance with all federal, state, and local laws and regulations.

907-845.03.11.2--Collection and Handling of Waste. All paint removal debris, both solid and liquid, shall be properly classified, packaged and stored in accordance with SSPC Guide 7, Guide for the Disposal of Lead-Contaminated Surface Preparation Debris, the Federal Water Pollution Control Act with amendments, and all other current government regulations and guidelines. The Contractor shall comply with the Resource Conservation and Recovery Act to include, at a minimum, CFR 40 260 through CFR 40 268. Prior to identification and storage, the Contractor shall separate solid and liquid waste, and separate individual waste streams.

907-845.03.11.3--Testing and Analysis. Laboratory analyses for all waste stream and environmental samples shall be conducted by an EPA certified, independent laboratory with an approved Quality Assurance Plan. Laboratory analyses for worker monitoring and regulated area samples shall be conducted by an American Industrial Hygiene Association (AIHA) metals accredited laboratory. A copy of all sampling and test reports shall be provided no later than 72 hours after collection of samples.

907-845.03.11.4--Waste Identification. Samples shall be collected in accordance with EPA SW 846, Test Methods for Evaluating Solid Waste - Physical/Chemical Methods. A random and

representative sampling technique shall be used. A minimum of four representative samples shall be collected of each waste stream. These waste streams shall include, but are not limited to, water, paint chips, dust, and paint chips mixed with disposable abrasives and debris. The Contractor shall complete the initial sampling of each waste stream immediately upon filling the first drum, but shall not allow waste to accumulate for longer than seven (7) days before sampling.

After the representative samples are collected, they shall be sent immediately to the EPA certified laboratory for analysis. Unless otherwise directed by the Engineer, required by State regulations, or required by the waste recycling or disposal facility, once each waste stream is sampled, tested, and classified, additional sampling and analysis will not be required for subsequent shipments unless the waste stream changes. Samples shall be submitted to an approved laboratory to be tested for arsenic, barium, cadmium, hexavalent chromium, lead, mercury, selenium, and silver in accordance with EPA Method 3050 and Method 6010 (content) and EPA Method 1311, Toxicity Characteristics Leaching Procedures (TCLP). Each sample shall be clearly marked with sample number, date and time of sampling, name of collector, and location of collection.

Chain of custody forms shall be maintained for each sample. Each sample shall be entered on a sample analysis request form. The sample numbers, type of waste, amount of each sample, distribution of samples, signature and all other information shall be entered into field logbook.

907-845.03.11.5--Waste Storage. Waste from the control devices, equipment, and all work surfaces shall be collected on a daily basis. Hazardous and non-hazardous waste shall be kept separate. Blasting debris shall not be mixed with any other type of waste. Waste shall be placed in approved storage drums.

All hazardous waste within a regulated area shall be located. The maximum weight for each drum, when filled, shall be 821 lbs. All drums shall be properly sealed and labeled. Waste storage drums shall be transported to a secured, marked, temporary storage area. The temporary storage area shall be located on well-drained ground not susceptible to flooding or storm water run-off. Drums shall be placed on pallets and covered with fiber reinforced, impermeable tarpaulins. Drums shall be stored no more than two drums wide and two drums high. Drums shall be arranged so that labels are easily readable. Waste shall not be stored in the temporary storage area longer than 90 days.

907-845.03.11.6--Waste Disposal. All hazardous and non-hazardous waste shall be transported, treated and disposed of. The Engineer shall be notified a minimum of three (3) weeks prior to the date of shipment of any waste to an off-site facility. The Engineer shall be provided with documentation that the receiving disposal facilities are properly licensed. Manifests shall be provided for all hazardous and non-hazardous waste shipments. Any waste disposal subcontractors shall be identified and provide the Engineer with a copy of their licensing to perform waste disposal and transport operations.

907-845.03.11.7--Permits. The Contractor shall be responsible for all liability resulting from non-compliance with pertinent rules and regulations including permit requirements.

907-845.04--Method of Measurement. Coating Existing Structural Steel will be measured as a lump sum quantity.

907-845.05--Basis of Payment. Coating Existing Structural Steel, measured as prescribed above, will be paid for at the contract lump sum price which shall be full compensation for all materials, labor, tools, equipment, containment systems, testing, removal and disposal of the existing coating, and all incidentals necessary for completing the work as described herein.

Payment will be made under:

907-845-A: Coating Existing Structural Steel

- lump sum

MISSISSIPPI DEPARTMENT OF TRANSPORTATION

SPECIAL PROVISION NO. 907-899-1

CODE: (SP)

DATE: 01/17/2017

SUBJECT: Railway-Highway Provisions

Section 907-899, Railway-Highway Provisions, is hereby added to and made part of the 2017 Edition of the Mississippi Standard Specifications for Road and Bridge Construction as follows:

SECTION 907-899--RAILWAY-HIGHWAY PROVISIONS

907-899.01--Description. This special provision addresses the Contractor's involvement with railroad flagging, Contractor Safety Orientation, Contractor Background Investigation, Contractor Roadway Worker on Track Safety Program and Safety Action Plan, and any other requirements set forth by the Railroad and any attached Exhibits.

Prior to bidding, the Contractor shall read and comply with the requirements of the Railroad and any attached Exhibits. The Contractor shall contact the Railroad concerning insurance coverage requirements, Railroad flagging costs, Contractor Safety Orientation, Contractor Background Investigation, Contractor Roadway Worker on Track Safety Program and Safety Action Plan, and any other requirements set forth by the Railroad and any attached Exhibits. In case the railroad requires coverage over and above that required by the Standard Specifications, the railroad requirements shall be met.

If in the opinion of the RAILROAD, the presence of an authorized representative of the RAILROAD is required to supervise the same, the RAILROAD shall render bills to the Contractor for all expenses incurred by it for such supervision. This includes all labor costs for flagmen or cable locate supplied by the RAILROAD to protect RAILROAD operation, and for the full cost of furnishing, installation and later removal of any temporary supports for said tracks, as the RAILROAD's Chief Engineer's Office may deem necessary.

It will be the Contractor's responsibility to pay all bills associated with the Railroad requirements and any attached Exhibits.

A cable locate of RAILROAD owned facilities may be required to identify and protect Signal & Communication cables that have been installed to provide power, signal control, wayside communications. These cables are vital to a safe and reliable railway operation. The cable locate will be performed by a qualified RAILROAD employee.

Outside Contractors are prohibited from driving on, along, or across any track that does not have a RAILROAD installed crossing. They may utilize an existing public crossing. The practice of allowing rubber tired equipment to operate over track with no crossing has been banned.

The Contractor shall complete and process any required forms addressed by the Railroad or any attached Exhibits. The Contractor shall not commence or carry on any form of work on, under, above or within the designated distance from the Railroad track prior to getting approval from the Railroad.

907-899.02--Blank.

907-899.03--Construction Requirements. The Contractor shall read and comply with the requirements of the Railroad and any attached Exhibits.

907-899.04--Method of Measurement. Railway-highway provisions will be measured as a unit lump sum quantity. Measurement for payment will be in accordance with the following schedule:

- a) On the first estimate, twenty five percent (25%) of the amount bid for Railway Highway Provision will be paid.
- b) When twenty five percent (25%) of the original contract amount is earned from all direct pay items, fifty percent (50%) of the amount bid for Railway Highway Provision will be paid.
- c) When fifty percent (50%) of the original contract amount is earned from all direct pay items, one hundred percent (100%) of the amount bid for Railway Highway Provision will be paid.

907-899.05--Basis of Payment. Railway-highway provisions, measured as prescribed above, will be paid for at the contract lump sum price, which price shall be payment in full for all insurance coverage requirements, railroad flagging costs, Contractor safety orientation, Contractor background investigation, Contractor safety programs and plans, and any other requirements set forth by the Railroad and any attached Exhibits, and other incidentals necessary to complete the requirements of this work.

Payment will be made under:

907-899-A: Railway-Highway Provisions

- lump sum

SECTION 905 - PROPOSAL

Date _____

Mississippi Transportation Commission
Jackson, Mississippi

Sirs: The following proposal is made on behalf of _____
_____ of _____

for constructing the following designated project(s) within the time(s) hereinafter specified.

The plans are composed of drawings and blue prints on file in the offices of the Mississippi Department of Transportation, Jackson, Mississippi.

The Specifications are the current Standard Specifications of the Mississippi Department of Transportation approved by the Federal Highway Administration, except where superseded or amended by the plans, Special Provisions and Notice(s) to Bidders attached hereto and made a part thereof.

I (We) certify that I (we) possess a copy of said Standard and any Supplemental Specifications.

Evidence of my (our) authority to submit the Proposal is hereby furnished. The proposal is made without collusion on the part of any person, firm or corporation. I (We) certify that I (we) have carefully examined the Plans, the Specifications, including the Special Provisions and Notice(s) to Bidders, herein, and have personally examined the site of the work. On the basis of the Specifications, Special Provisions, Notice(s) to Bidders, and Plans, I (we) propose to furnish all necessary machinery, tools, apparatus and other means of construction and do all the work and furnish all the materials in the manner specified. I (We) understand that the quantities mentioned herein are approximate only and are subject to either increase or decrease, and hereby propose to perform any increased or decreased quantities of work at the unit prices bid, in accordance with the above.

I (We) acknowledge that this proposal will be found irregular and/or non-responsive unless a certified check, cashier's check, or Proposal Guaranty Bond in the amount as required in the Advertisement (or, by law) is submitted electronically with the proposal or is delivered to the Contract Administration Engineer prior to the bid opening time specified in the advertisement.

INSTRUCTION TO BIDDERS: Alternate and Optional Items on Bid Schedule.

1. Two or more items entered opposite a single unit quantity WITHOUT DEFINITE DESIGNATION AS "ALTERNATE ITEMS" are considered as "OPTIONAL ITEMS". Bidders may or may not indicate on bids the Optional Item proposed to be furnished or performed WITHOUT PREJUDICE IN REGARD TO IRREGULARITY OF BIDS.
2. Items classified on the bid schedule as "ALTERNATE ITEMS" and/or "ALTERNATE TYPES OF CONSTRUCTION" must be preselected and indicated on bids. However, "Alternate Types of Construction" may include Optional Items to be treated as set out in Paragraph 1, above.
3. Optional items not preselected and indicated on the bid schedule MUST be designated in accordance with Subsection 102.06 prior to or at the time of execution of the contract.
4. Optional and Alternate items designated must be used throughout the project.

I (We) further propose to perform all "force account or extra work" that may be required of me (us) on the basis provided in the Specifications and to give such work my (our) personal attention in order to see that it is economically performed.

I (We) further propose to execute the attached contract agreement (Section 902) as soon as the work is awarded to me (us), and to begin and complete the work within the time limit(s) provided for in the Specifications and Advertisement. I (We) also propose to execute the attached contract bond (Section 903) in an amount not less than one hundred (100) percent of the total of my (our) part, but also to guarantee the excellence of both workmanship and materials until the work is finally accepted.

I (We) shall submit electronically with our proposal or deliver prior to the bid opening time a certified check, cashier's check or bid bond for **five percent (5%) of total bid** and hereby agree that in case of my (our) failure to execute the contract and furnish bond within Ten (10) days after notice of award, the amount of this check (bid bond) will be forfeited to the State of Mississippi as liquidated damages arising out of my (our) failure to execute the contract as proposed. It is understood that in case I am (we are) not awarded the work, the check will be returned as provided in the Specifications.

SECTION 905 -- PROPOSAL (CONTINUED)

I (We) hereby certify by digital signature and electronic submission via Bid Express of the Section 905 proposal below, that all certifications, disclosures and affidavits incorporated herein are deemed to be duly executed in the aggregate, fully enforceable and binding upon delivery of the bid proposal. I (We) further acknowledge that this certification shall not extend to the bid bond or alternate security which must be separately executed for the benefit of the Commission. This signature does not cure deficiencies in any required certifications, disclosures and/or affidavits. I (We) also acknowledge the right of the Commission to require full and final execution on any certification, disclosure or affidavit contained in the proposal at the Commission's election upon award. Failure to so execute at the Commission's request within the time allowed in the Standard Specifications for execution of all contract documents will result in forfeiture of the bid bond or alternate security.

Respectfully Submitted,

DATE _____

Contractor

BY _____
Signature

TITLE _____

ADDRESS _____

CITY, STATE, ZIP _____

PHONE _____

FAX _____

E-MAIL _____

(To be filled in if a corporation)

Our corporation is chartered under the Laws of the State of _____ and the names, titles and business addresses of the executives are as follows:

President Address

Secretary Address

Treasurer Address

The following is my (our) itemized proposal.

Bridge Preservation on US 80 over KCS Railroad (Bridge No. 107.8), known as Federal Aid Project No. NHPP-0472-00(019) / 108283301 in Newton County.

Line no.	Item Code	Adj Code	Quantity	Units	Description[Fixed Unit Price]
Roadway Items					
0010	216-A001		570	Square Yard	Solid Sodding
0020	234-A001		200	Linear Feet	Temporary Silt Fence
0030	618-A001		1	Lump Sum	Maintenance of Traffic
0040	619-D1001		16	Square Feet	Standard Roadside Construction Signs, Less than 10 Square Feet
0050	619-D2001		112	Square Feet	Standard Roadside Construction Signs, 10 Square Feet or More
0060	619-G4001		24	Linear Feet	Barricades, Type III, Double Faced
0070	620-A001		1	Lump Sum	Mobilization
0080	626-C001		290	Linear Feet	6" Thermoplastic Double Drop Edge Stripe, Continuous White
0090	626-F002		290	Linear Feet	6" Thermoplastic Double Drop Edge Stripe, Continuous Yellow
0100	627-L001		7	Each	Two-Way Yellow Reflective High Performance Raised Markers
0110	907-899-A001		1	Lump Sum	Railway-Highway Provisions
Bridge Items					
0120	815-A002	(S)	1,351	Ton	Loose Riprap, Size 100
0130	815-A007	(S)	300	Ton	Loose Riprap, Size 300
0140	907-808-A002	(S)	513	Linear Feet	Joint Repair Without Epoxy
0150	907-823-A001		257	Linear Feet	Preformed Joint Seal, Type I
0160	907-824-PP006		9	Each	Bridge Repair, Cap Cleaning, Per Plans
0170	907-824-PP006		10	Each	Bridge Repair, End & Midspan Diaphragm Replacement, Per Plans
0180	907-824-PP006		9	Each	Bridge Repair, Install Girder Support and Angles, 40 Foot Spans, Per Plans
0190	907-824-PP006		9	Each	Bridge Repair, Install Girder Support Plates and Angles, 30 Foot Spans, Per Plans
0200	907-824-PP006		6	Each	Bridge Repair, Install Girder Support Plates and Angles, 60 Foot Spans, Per Plans
0210	907-824-PP006		1	Each	Bridge Repair, Install Girder Support Plates and Angles, Beam 60-5, Per Plans
0220	907-824-PP006		14	Each	Bridge Repair, Pile Repair Plate & Encasement, Per Plans
0230	907-824-PP006		10	Each	Bridge Repair, Remove Blast Plates from Span No. 3
0240	907-824-PP006		12	Each	Bridge Repair, Steel Riser & Bearing Assembly, Per Plans
0250	907-845-A001	(S)	1	Lump Sum	Coating Existing Structural Steel

SECTION 905 - COMBINATION BID PROPOSAL (Continued)

CONDITIONS FOR COMBINATION BID

If a bidder elects to submit a combined bid for two or more of the contracts listed for this month's letting, the bidder must complete and execute these sheets of the proposal in each of the individual proposals to constitute a combination bid. In addition to this requirement, each individual contract shall be completed, executed and submitted in the usual specified manner.

Failure to execute this Combination Bid Proposal in each of the contracts combined will be just cause for each proposal to be received and evaluated as a separate bid.

It is understood that the Mississippi Transportation Commission not only reserves the right to reject any and all proposals, but also the right to award contracts upon the basis of lowest separate bids or combination bids most advantageous to the State.

It is further understood and agreed that the Combination Bid Proposal is for comparison of bids only and that each contract shall operate in every respect as a separate contract in accordance with its proposal and contract documents.

I (We) agree to complete each contract on or before its specified completion date.

COMBINATION BID PROPOSAL

This proposal is tendered as one part of a Combination Bid Proposal utilizing option ___* of Subsection 102.11 on the following contracts:

* Option to be shown as either (a), (b), or (c).

	<u>Project No.</u>	<u>County</u>	<u>Project No.</u>	<u>County</u>
1.	_____	_____	6.	_____
2.	_____	_____	7.	_____
3.	_____	_____	8.	_____
4.	_____	_____	9.	_____
5.	_____	_____	10.	_____

(a) If Combination A has been selected, your Combination Bid is complete.

(b) If Combination B has been selected, then complete the following page.

SECTION 905 - COMBINATION BID PROPOSAL (Continued)

Project Number	Pay Item Number	Unit	Unit Price Reduction	Total Item Reduction	Total Contract Reduction
1.					
2.					
3.					
4.					
5.					
6.					
7.					
8.					

For Informational Purposes Only

SECTION 905 - COMBINATION BID PROPOSAL (Continued)

Project Number	Pay Item Number	Unit	Unit Price Reduction	Total Item Reduction	Total Contract Reduction
9.					
10.					

(c) If Combination C has been selected, then initial and complete ONE of the following.

_____ I (We) desire to be awarded work not to exceed a total monetary value of \$ _____.

_____ I (We) desire to be awarded work not to exceed _____ number of contracts.



**Certification with regard to the Performance of Previous
Contracts or Subcontracts subject to the Equal Opportunity
Clause and the filing of Required Reports**

The Bidder hereby certifies that he has _____, has not _____, participated in a previous contract or subcontract subject to the Equal Opportunity Clause, as required by Executive Orders 10925, 11114, or 11246, and that he has _____, has not _____, filed with the Joint Reporting Committee, the Director of the Office of Federal Contract Compliance, a Federal Government contracting or administering agency, or the former President's Committee on Equal Employment Opportunity, all reports due under the applicable filing requirements.

(COMPANY)

DATE: _____

NOTE: The above certification is required by the Equal Employment Opportunity Regulations of the Secretary of Labor (41 CFR 60-1.7 (b) (1)), and must be submitted by bidders and proposed subcontractors only in connection with contracts and subcontracts which are subject to the Equal Opportunity Clause. Contracts and Subcontracts which are exempt from the Equal Opportunity Clause are set forth in 41 CFR 60-1.5. (Generally only contracts or subcontracts of \$10,000 or under are exempt.)

Currently, Standard Form 100 (EEO-1) is the only report required by the Executive Orders or their implementing regulations.

Proposed prime Contractors and Subcontractors who have participated in a previous contract or subcontract subject to the Executive orders and have not filed the required reports should note that 41 CFR 60-1.7 (b) (1) prevents the award of contracts and subcontracts unless such Contractors submit a report covering the delinquent period or such other period specified by the Federal Highway Administration or by the Director, Office of Federal Contract Compliance, U. S. Department of Labor.

MISSISSIPPI DEPARTMENT OF TRANSPORTATION
CERTIFICATION

I, _____,
(Name of person signing bid)

individually, and in my capacity as _____ of
(Title of person signing bid)

_____ do hereby certify under
(Name of Firm, partnership, or Corporation)

penalty of perjury under the laws of the United States and the State of Mississippi that _____

_____, Bidder
(Name of Firm, Partnership, or Corporation)

on Project No. **NHPP-0472-00(019)/ 108283301000**

in **Newton** County(ies), Mississippi, has not either

directly or indirectly entered into any agreement, participated in any collusion; or otherwise taken any action in restraint of free competitive bidding in connection with this contract; nor have any of its corporate officers or principal owners.

Except as noted hereafter, it is further certified that said legal entity and its corporate officers, principal owners, managers, auditors and others in a position of administering federal funds:

- a) Are not presently debarred, suspended, proposed for debarment, declared ineligible, or voluntarily excluded from covered transactions by any Federal department or agency;
- b) Have not within a three-year period preceding this proposal been convicted of or had a civil judgment rendered against them for commission of fraud or a criminal offense in connection with obtaining, attempting to obtain, or performing a public (Federal, State or local) transaction or contract under a public transaction; violation of Federal or State antitrust statutes or commission of embezzlement, theft, forgery, bribery, falsification or destruction of records, making false statements, or receiving stolen property;
- c) Are not presently indicted for or otherwise criminally or civilly charged by a governmental entity (Federal, State or local) with commission of any of the offenses enumerated in (b) above; and
- d) Have not within a three-year period preceding this application/ proposal had one or more public transactions (Federal, State or local) terminated for cause or default.

Do exceptions exist and are made a part thereof? Yes / No

Any exceptions shall address to whom it applies, initiating agency and dates of such action.

Note: Exceptions will not necessarily result in denial of award but will be considered in determining bidder responsibility. Providing false information may result in criminal prosecution or administrative sanctions.

The bidder further certifies that the certification requirements contained in Section XI of Form FHWA 1273, will be or have been included in all subcontracts, material supply agreements, purchase orders, etc. except those procurement contracts for goods or services that are expected to be less than the Federal procurement small purchase threshold fixed at 10 U.S.C. 2304(g) and 41 U.S.C. 253(g) (currently \$25,000) which are excluded from the certification requirements.

The bidder further certifies, to the best of his or her knowledge and belief, that:

1) No Federal appropriated funds have been paid or will be paid to any person for influencing or attempting to influence an officer or employee of any Federal agency, a Member of Congress, an officer or employee of Congress, or an employee of a Member of Congress in connection with the awarding of any Federal contract, the making of any Federal grant, the making of any Federal loan, the entering into of any cooperative agreement, and the extension, continuation, renewal, amendment, or modification of any Federal contract, grant, loan, or cooperative agreement.

2) If any funds other than Federal appropriated funds have been paid or will be paid to any person for influencing or attempting to influence an officer or employee of any Federal agency, a Member of Congress, an officer or employee of Congress, or an employee of a Member of Congress in connection with this contract, Standard Form-LLL, Disclosure Form to Report Lobbying, in accordance with its instructions will be completed and submitted.

The certification contained in (1) and (2) above is a material representation of fact upon which reliance is placed and a prerequisite imposed by Section 1352, Title 31, U.S. Code prior to entering into this contract. Failure to comply shall be subject to a civil penalty of not less than \$10,000 and not more than \$100,000. The bidder shall include the language of the certification in all subcontracts exceeding \$100,000 and all subcontractors shall certify and disclose accordingly.

All of the foregoing is true and correct.

Executed on _____

Signature

MISSISSIPPI DEPARTMENT OF TRANSPORTATION

SAM.GOV Registration and DUNS Number

Bidders are advised that the Prime Contractor must maintain current registration in the **System for Award Management** (<http://www.sam.gov>) at all times during the project. A Dun and Bradstreet Data Universal Numbering System (DUNS) Number (<http://www.dnb.com>) is one of the requirements for registration in the System for Award Management.

Bidders are advised that prior to the award of this contract, they **MUST** be registered in the System for Award Management.

I (We) acknowledge that this contract cannot be awarded if I (We) are not registered in the System for Award Management prior to the award of this contract. _____ (Yes / No)

I (We) have a DUNS Number . _____ (Yes / No)

DUNS Number: _____

Company Name: _____

Company e-mail address: _____

(6/2015F)

For Informational Purposes Only

SECTION 902

CONTRACT FOR NHPP-0472-00(019)/ 108283301000

LOCATED IN THE COUNTY(IES) OF Newton

STATE OF MISSISSIPPI,
COUNTY OF HINDS

This contract entered into by and between the Mississippi Transportation Commission on one hand, and the undersigned contractor, on the other witnesseth;

That, in consideration of the payment by the Mississippi Transportation Commission of the prices set out in the proposal hereto attached, to the undersigned contractor, such payment to be made in the manner and at the time of times specified in the specifications and the special provisions, if any, the undersigned contractor hereby agrees to accept the prices stated in the proposal in full compensation for the furnishing of all materials and equipment and the executing of all the work contemplated in this contract.

It is understood and agreed that the advertising according to law, the Advertisement, the instructions to bidders, the proposal for the contract, the specifications, the revisions of the specifications, the special provisions, and also the plans for the work herein contemplated, said plans showing more particularly the details of the work to be done, shall be held to be, and are hereby made a part of this contract by specific reference thereto and with like effect as if each and all of said instruments had been set out fully herein in words and figures.

It is further agreed that for the same consideration the undersigned contractor shall be responsible for all loss or damage arising out of the nature of the work aforesaid; or from the action of the elements and unforeseen obstructions or difficulties which may be encountered in the prosecution of the same and for all risks of every description connected with the work, exceptions being those specifically set out in the contract; and for faithfully completing the whole work in good and workmanlike manner according to the approved Plans, Specifications, Special Provisions, Notice(s) to Bidders and requirements of the Mississippi Department of Transportation.

It is further agreed that the work shall be done under the direct supervision and to the complete satisfaction of the Executive Director of the Mississippi Department of Transportation, or his authorized representatives, and when Federal Funds are involved subject to inspection at all times and approval by the Federal Highway Administration, or its agents as the case may be, or the agents of any other Agency whose funds are involved in accordance with those Acts of the Legislature of the State of Mississippi approved by the Governor and such rules and regulations issued pursuant thereto by the Mississippi Transportation Commission and the authorized Federal Agencies.

The Contractor agrees that all labor as outlined in the Special Provisions may be secured from list furnished by

It is agreed and understood that each and every provision of law and clause required by law to be inserted in this contract shall be deemed to be inserted herein and this contract shall be read and enforced as though it were included herein, and, if through mere mistake or otherwise any such provision is not inserted, then upon the application of either party hereto, the contract shall forthwith be physically amended to make such insertion.

The Contractor agrees that he has read each and every clause of this Contract, and fully understands the meaning of same and that he will comply with all the terms, covenants and agreements therein set forth.

Witness our signatures this the ___ day of _____, _____.

Contractor(s)

By _____

MISSISSIPPI TRANSPORTATION COMMISSION

Title _____

By _____

Signed and sealed in the presence of:
(names and addresses of witnesses)

Executive Director

Secretary to the Commission

Award authorized by the Mississippi Transportation Commission in session on the ___ day of _____, _____, Minute Book No. _____, Page No. _____.

SECTION 903
PERFORMANCE AND PAYMENT BOND

CONTRACT BOND FOR: NHPP-0472-00(019)/ 108283301000

LOCATED IN THE COUNTY(IES) OF: Newton

STATE OF MISSISSIPPI,
COUNTY OF HINDS

Know all men by these presents: that we, _____

(Contractor)

Principal, a _____

residing at _____ in the State of _____

and _____

(Surety)
residing at _____ in the State of _____,

authorized to do business in the State of Mississippi, under the laws thereof, as surety, effective as of the contract date shown below, are held and firmly bound unto the State of Mississippi in the sum of _____

_____ Dollars, lawful money of the United States of America, to be paid to it for which payment well and truly to be made, we bind ourselves, our heirs, administrators, successors, or assigns jointly and severally by these presents.

The conditions of this bond are such, that whereas the said _____

_____ principal, has (have) entered into a contract with the Mississippi Transportation Commission, bearing the date of _____ day of _____ A.D. _____ hereto annexed, for the construction of certain projects(s) in the State of Mississippi as mentioned in said contract in accordance with the Contract Documents therefor, on file in the offices of the Mississippi Department of Transportation, Jackson, Mississippi.

Now therefore, if the above bounden _____ in all things shall stand to and abide by and well and truly observe, do keep and perform all and singular the terms, covenants, conditions, guarantees and agreements in said contract, contained on his (their) part to be observed, done, kept and performed and each of them, at the time and in the manner and form and furnish all of the material and equipment specified in said contract in strict accordance with the terms of said contract which said plans, specifications and special provisions are included in and form a part of said contract and shall maintain the said work contemplated until its final completion and acceptance as specified in Subsection 109.11 of the approved specifications, and save harmless said Mississippi Transportation Commission from any loss or damage arising out of or occasioned by the negligence, wrongful or criminal act, overcharge, fraud, or any other loss or damage whatsoever, on the part of said principal (s), his (their) agents, servants, or employees in the performance of said work or in any manner connected therewith, and shall be liable and responsible in a civil action instituted by the State at the instance of the Mississippi Transportation Commission or any officer of the State authorized in such cases, for double any amount in money or property, the State may lose or be overcharged or otherwise defrauded of, by reason of wrongful or criminal act, if any, of the Contractor(s), his (their) agents or employees, and shall promptly pay the said agents, servants and employees and all persons furnishing labor, material, equipment or supplies therefor, including premiums incurred, for Surety Bonds, Liability Insurance, and Workmen's Compensation Insurance; with the additional obligation that such Contractor shall promptly make payment of all taxes, licenses, assessments, contributions, damages,

any liquidated damages which may arise prior to any termination of said principal's contract, any liquidated damages which may arise after termination of the said principal's contract due to default on the part of said principal, penalties and interest thereon, when and as the same may be due this state, or any county, municipality, board, department, commission or political subdivision: in the course of the performance of said work and in accordance with Sections 31-5-51 et seq. Mississippi Code of 1972, and other State statutes applicable thereto, and shall carry out to the letter and to the satisfaction of the Executive Director of the Mississippi Department of Transportation, all, each and every one of the stipulations, obligations, conditions, covenants and agreements and terms of said contract in accordance with the terms thereof and all of the expense and cost and attorney's fee that may be incurred in the enforcement of the performance of said contract, or in the enforcement of the conditions and obligations of this bond, then this obligation shall be null and void, otherwise to be and remain in full force and virtue.

_____	_____
(Contractors) Principal	Surety
By _____	By _____
	(Signature) Attorney in Fact
	Address _____

Title _____	_____
(Contractor's Seal)	(Printed) MS Agent

	(Signature) MS Agent
	Address _____

	(Surety Seal)

	Mississippi Insurance ID Number



BID BOND

KNOW ALL MEN BY THESE PRESENTS, that we _____
Contractor

Address

City, State ZIP

As principal, hereinafter called the Principal, and _____
Surety

a corporation duly organized under the laws of the state of _____

as Surety, hereinafter called the Surety, are held and firmly bound unto **State of Mississippi, Jackson, Mississippi**

As Obligee, hereinafter called Obligee, in the sum of **Five Per Cent (5%) of Amount Bid**

Dollars(\$ _____)

for the payment of which sum will and truly to be made, the said Principal and said Surety, bind ourselves, our heirs, executors, administrators, successors and assigns, jointly and severally, firmly by these presents.

WHEREAS, the Principal has submitted a bid for **Bridge Preservation on US 80 over KCS Railroad (Bridge No. 107.8), known as Federal Aid Project No. NHPP-0472-00(019) / 108283301 in Newton County.**

NOW THEREFORE, the condition of this obligation is such that if the aforesaid Principal shall be awarded the contract, the said Principal will, within the time required, enter into a formal contract and give a good and sufficient bond to secure the performance of the terms and conditions of the contract, then this obligation to be void; otherwise the Principal and Surety will pay unto the Obligee the difference in money between the amount of the bid of the said Principal and the amount for which the Obligee legally contracts with another party to perform the work if the latter amount be in excess of the former, but in no event shall liability hereunder exceed the penal sum hereof.

Signed and sealed this _____ day of _____, 20__

(Witness)

(Principal) (Seal)

By: _____
(Name) (Title)

(Surety) (Seal)

(Witness)

By: _____
(Attorney-in-Fact)

(MS Agent)

Mississippi Insurance ID Number

MISSISSIPPI DEPARTMENT OF TRANSPORTATION
OFFICE OF CIVIL RIGHTS
JACKSON, MISSISSIPPI

LIST OF FIRMS SUBMITTING QUOTES

I/we received quotes from the following firms on:

Letting Date: **February 23, 2021**

Project No: **NHPP-0472-00(019)/ 108283301000**

County: **Newton**

Disadvantaged Business Enterprise (DBE) Regulations as stated in 49 CFR 26.11 require the Mississippi Department of Transportation (MDOT) to create and maintain a comprehensive list of all firms quoting/bidding subcontracts on prime contracts and quoting/bidding subcontracts on federally-funded transportation projects. For every firm, we require the following information:

Firm Name: _____
 Contact Name/Title: _____
 Firm Mailing Address: _____
 Phone Number: _____
 _____ DBE Firm _____ Non-DBE Firm

Firm Name: _____
 Contact Name/Title: _____
 Firm Mailing Address: _____
 Phone Number: _____
 _____ DBE Firm _____ Non-DBE Firm

Firm Name: _____
 Contact Name/Title: _____
 Firm Mailing Address: _____
 Phone Number: _____
 _____ DBE Firm _____ Non-DBE Firm

Firm Name: _____
 Contact Name/Title: _____
 Firm Mailing Address: _____
 Phone Number: _____
 _____ DBE Firm _____ Non-DBE Firm

Firm Name: _____
 Contact Name/Title: _____
 Firm Mailing Address: _____
 Phone Number: _____
 _____ DBE Firm _____ Non-DBE Firm

