

MDOT Use Only

Checked _____

Loaded _____

Keyed _____

19 -



SM No. CMP5015510211

PROPOSAL AND CONTRACT DOCUMENTS

FOR THE CONSTRUCTION OF

19

Mill & Overlay approximately 8 miles on SR 15 from Decatur to Henry Mack Smith Road, known as State Project No. MP-5015-51(021) / 307480301 in Newton County.

Project Completion: 120 Working Days

(STATE DELEGATED)

NOTICE

**BIDDERS MUST COMPLETE AN ONLINE REQUEST
FOR PERMISSION TO BID THIS PROJECT.**

Electronic addendum updates will be posted on www.gomdot.com

SECTION 900

OF THE CURRENT 2017 STANDARD SPECIFICATIONS FOR ROAD AND BRIDGE CONSTRUCTION

JACKSON, MISSISSIPPI

**MISSISSIPPI DEPARTMENT OF TRANSPORTATION
TABLE OF CONTENTS**

PROJECT: MP-5015-51(021)/307480301 - Newton

Section 901 - Advertisement

Section 904 - Notice to Bidders

#1	Governing Specification
#3	Final Cleanup
#9	Federal Bridge Formula
#13	Safety Edge
#113	Tack Coat
#296	Reduced Speed Limit Signs
#445	Mississippi Agent or Qualified Nonresident Agent
#447	Traffic on Milled Surface in Rural Areas
#516	Errata and Modifications to the 2017 Standard Specifications
#1225	Early Notice to Proceed
#1226	Material Storage Under Bridges
#1241	Fuel and Material Adjustments
#1963	Guardrail Pads
#2206	MASH Compliant Devices
#2273	Mississippi Special Fuel Tax Law
#2278	Smoothness Tolerances
#2954	Reflective Sheeting for Signs
#3117	Standard Drawings
#3302	Contract Time
#3303	Scope of Work
#3304	Temporary Construction Signs
#3305	Lane Closure Restrictions
#3306	Underground Utilities

Section 907 - Special Provisions

907-102-2	Bidding Requirements and Conditions
907-103-2	Award and Execution of Contract
907-619-6	Temporary Portable Rumble Strips
907-631-1	Traffic Signal Systems - General
907-632-1	Traffic Signal Cabinet Assemblies
907-641-1	Radar Vehicle Detection
907-701-2	Hydraulic Cement
907-702-4	Bituminous Materials
907-703-1	Gradation
907-705-1	Stone Riprap
907-707-2	Joint Material
907-711-2	Plain Steel Wire
907-720-2	Acceptance Procedure for Glass Beads
907-721-2	Materials for Signs
907-722-1	Materials for Traffic Signal Installation

Section 905 - Proposal, Proposal Bid Items, Combination Bid Proposal

PROJECT: MP-5015-51(021)/307480301 - Newton

State Board of Contractors Requirement

State Certification Regarding Non-Collusion, Debarment and Suspensions

Section 902 - Contract Form

Section 903 - Contract Bond Forms

Progress Schedule

(REVISIONS TO THE ABOVE WILL BE INDICATED ON THE SECOND SHEET
OF SECTION 905 AS ADDENDA)

04/29/2021 02:43 PM

MISSISSIPPI DEPARTMENT OF TRANSPORTATION

SECTION 901 - ADVERTISEMENT

Electronic bids will be received by the Mississippi Transportation Commission at 10:00 o'clock A.M., Tuesday, May 25, 2021, from the Bid Express Service and shortly thereafter publicly read on the Sixth Floor for:

Mill & Overlay approximately 8 miles on SR 15 from Decatur to Henry Mack Smith Road, known as State Project No. MP-5015-51(021) / 307480301 in Newton County.

The attention of bidders is directed to the predetermined minimum wage rate set by the U. S. Department of Labor under the Fair Labor Standards Act.

The Mississippi Department of Transportation hereby notifies all bidders that it will affirmatively insure that in any contract entered into pursuant to this advertisement, disadvantaged business enterprises will be afforded full opportunity to submit bids in response to this invitation and will not be discriminated against on the grounds of race, color, sex, age, disability, religion or national origin in consideration for an award.

The specifications are on file in the offices of the Mississippi Department of Transportation.

Contractors may request permission to bid online at <http://shopmdot.ms.gov> at no cost. Upon approval, Contractors shall be eligible to submit a bid using Bid Express at <http://bidx.com>. Specimen proposals may be viewed and downloaded online at no cost at <http://mdot.ms.gov> or purchased online at <http://shopmdot.ms.gov> at a cost of Ten Dollars (\$10.00) per proposal plus a small convenience fee. Cash or checks will not be accepted as payment.

Bid bond, signed or countersigned by a Mississippi Agent or Qualified Nonresident Agent, with Power of Attorney attached, a Cashier's check or Certified Check for five (5%) percent of bid, payable to STATE OF MISSISSIPPI, must accompany each proposal.

The attention of bidders is directed to the provisions of Subsection 102.07 pertaining to irregular proposals and rejection of bids.

JEFFREY C. ALTMAN
ACTING EXECUTIVE DIRECTOR

MISSISSIPPI DEPARTMENT OF TRANSPORTATION

SECTION 904 - NOTICE TO BIDDERS NO. 1

CODE: (IS)

DATE: 03/01/2017

SUBJECT: Governing Specifications

The current (2017) Edition of the Standard Specifications for Road and Bridge Construction adopted by the Mississippi Transportation Commission is made a part hereof fully and completely as if it were attached hereto, except where superseded by special provisions, or amended by revisions of the Specifications contained within this proposal. Copies of the specification book may be purchased from the MDOT Construction Division, or online at shopmdot/default.aspx?StoreIndex=1.

A reference in any contract document to controlling requirements in another portion of the contract documents shall be understood to apply equally to any revision or amendment thereof included in the contract.

In the event the plans or proposal contain references to the 2004 Edition of the Standard Specifications for Road and Bridge Construction, it is to be understood that such references shall mean the comparable provisions of the 2017 Edition of the Standard Specifications.

MISSISSIPPI DEPARTMENT OF TRANSPORTATION

SECTION 904 - NOTICE TO BIDDERS NO. 3

CODE: (SP)

DATE: 01/17/2017

SUBJECT: Final Clean-Up

Immediately prior to final inspection for release of maintenance, the Contractor shall pick up, load, transport and properly dispose of all litter from the entire highway right-of-way that is within the termini of the project.

Litter shall include, but not be limited to, solid wastes such as glass, paper products, tires, wood products, metal, synthetic materials and other miscellaneous debris.

Litter removal is considered incidental to other items of work and will not be measured for separate payment.

MISSISSIPPI DEPARTMENT OF TRANSPORTATION

SECTION 904 - NOTICE TO BIDDERS NO. 9

CODE: (IS)

DATE: 03/01/2017

SUBJECT: Federal Bridge Formula

Bidders are hereby advised that the latest revision of Federal Highway Administration Publication No. FHWA-HOP-06-105, **BRIDGE FORMULA WEIGHTS**, dated August 2006, is made a part of this contract when applicable.

Prior to the preconstruction conference, the Contractor shall advise the Engineer, in writing, what materials, if any, will be delivered to the jobsite via Interstate route(s).

Copies of the **BRIDGE FORMULA WEIGHTS** publication may be obtained by contacting:

Federal Highway Administration
400 7th Street, SW
Washington, DC 20590
(202) 366-2212

or

http://www.ops.fhwa.dot.gov/Freight/publications/brdg_frm_wgths/bridge_formula_all_rev.pdf

An on line **BRIDGE FORMULA WEIGHTS CALCULATOR** is available at

http://ops.fhwa.dot.gov/freight/sw/brdgcalc/calc_page.htm

MISSISSIPPI DEPARTMENT OF TRANSPORTATION

SECTION 904 - NOTICE TO BIDDERS NO. 13

CODE: (IS)

DATE: 03/01/2017

SUBJECT: Safety Edge

Bidders are hereby advised that the Shoulder Wedge (Safety Edge) specified in Section 401, Asphalt Pavements, shall only apply to the top two (2) lifts of asphalt. Open Graded Friction Courses (OGFC) are not to be considered a lift as it pertains to safety edge. Attached is a drawing showing the safety edge. Note that the shoulder dimensions in the bottom two drawings will be less than three feet (3').



SAFETY EDGE DETAILS

4/8/2011

MISSISSIPPI DEPARTMENT OF TRANSPORTATION

SECTION 904 - NOTICE TO BIDDERS NO. 113

CODE: (SP)

DATE: 04/18/2017

SUBJECT: Tack Coat

Bidders are advised that in addition to the products listed on the Department's APL as referenced in Subsection 401.03.1.2 on page 256, the Contractor may use one of the following as a tack coat.

- CSS-1
- CSS-1h
- SS-1
- SS-1h

MISSISSIPPI DEPARTMENT OF TRANSPORTATION

SECTION 904 - NOTICE TO BIDDERS NO. 296

CODE: (SP)

DATE: 07/25/2017

SUBJECT: Reduced Speed Limit Signs

Bidders are advised that when the plans or contract documents require the speed limit on a project to be reduced, the Contractor shall begin work within 48 hours of installing the reduced speed limit signs. Should the Contractor not start work or have no plans to start work within 48 hours of installing the signs, the reduced speed limit signs shall be covered and existing speed limit signs uncovered.

MISSISSIPPI DEPARTMENT OF TRANSPORTATION

SECTION 904 - NOTICE TO BIDDERS NO. 445

CODE: (SP)

DATE: 10/10/2017

SUBJECT: Mississippi Agent or Qualified Nonresident Agent

Bidders are hereby advised of the requirements of Subsections 102.08, 103.05.2, and 107.14.2.1 of the *2017 Standard Specifications for Road and Bridge Construction* as it refers to bonding agents. Proposal guaranties, bonds, and liability insurance policies must be signed by a **Mississippi Agent or Qualified Nonresident Agent.**

MISSISSIPPI DEPARTMENT OF TRANSPORTATION

SECTION 904 - NOTICE TO BIDDERS NO. 447

CODE: (SP)

DATE: 10/18/2017

SUBJECT: Traffic on Milled Surface in Rural Areas

Bidders are hereby advised that when the main lanes of a roadway are fine milled, traffic will be allowed to run on a milled surfaces for up to seven (7) calendar days. The Contractor will be assessed a penalty of **\$5,000 per calendar day** afterwards until the milled surfaces are covered with the next lift of asphalt. It shall be the Contractor's responsibility to ensure that the milling operations do not commence until such time as forecasted weather conditions are suitable enough to allow the placement of the asphalt pavement after the milling operations.

MISSISSIPPI DEPARTMENT OF TRANSPORTATION

SECTION 904 - NOTICE TO BIDDERS NO. 516

CODE: (IS)

DATE: 11/28/2017

SUBJECT: Errata and Modifications to the 2017 Standard Specifications

<u>Page</u>	<u>Subsection</u>	<u>Change</u>
16	102.06	In the seventh full paragraph, change “Engineer” to “Director.”
33	105.05.1	In the sixth sentence, change “Contract Administration Engineer” to “Contract Administration Director.”
34	105.05.2.1	In subparagraph 2, change “SWPPP, ECP” to “SWPPP and the ECP”
35	105.05.2.2	In subparagraphs 2, add “ and” to the end of the sentence. In subparagraph 3, remove “, and” and add “.”.
90	109.04.2	In the last paragraph of subparagraph (a), place a period “.” at the end of the sentence.
93	109.04.2	In the last paragraph of subparagraph (g), place a period “.” at the end of the sentence. Also, in the first paragraph of subparagraph (h), place a period “.” at the end of the sentence.
97	109.07	Under ADJUSTMENT CODE, subparagraph (A1), change “HMA mixture” to “Asphalt mixtures.”
98	109.11	In the third sentence, change “Engineer” to “Director.”
219	308.04	In the last sentence of the last paragraph, change “Contractor’s decision” to “Engineer’s decision.”
300	405.02.5.9	In the first sentence of the second paragraph, change “Hot Mix Asphalt” to “Asphalt Mixtures.”
502	630.01.1	In the first paragraph, change “AASHTO” to “AASHTO’s LRFD”.
636	646.05	Change “each” to “per each” for the pay item units of payment.
640	656.02.6.2	In item 7), change “down stream” to “downstream”.
688	630.03.2	Change the subsection number from “630.03.2” to “680.03.2.”

- | | | |
|-----|---------------|---|
| 725 | 702.08.3 | In the second sentence of the first paragraph, change “hot-mix” to “asphalt.” |
| 954 | 804.02.13.1.6 | In the definition for “M” in the % Reduction formulas, change “paragraph 7.3” to “paragraph 5.3.” |

MISSISSIPPI DEPARTMENT OF TRANSPORTATION

SECTION 904 - NOTICE TO BIDDERS NO. 1225

CODE: (SP)

DATE: 11/13/2018

SUBJECT: Early Notice to Proceed

Bidders are advised that if an early notice to proceed is allowed by the Department and the Contractor experiences problems or delays between the early notice to proceed date and the original notice to proceed date, this shall not be justification for any monetary compensation or an extension of contract time.

MISSISSIPPI DEPARTMENT OF TRANSPORTATION

SECTION 904 - NOTICE TO BIDDERS NO. 1226

CODE: (IS)

DATE: 11/16/2018

SUBJECT: Material Storage Under Bridges

Bidders are advised that Subsection 106.08 of the Standard Specifications allows the Contractor to store materials and equipment on portions of the right-of-way. However, the Contractor will not be allowed to store or stockpile materials under bridges without written permission from the Project Engineer. The Contractor shall submit a detailed request of all proposed materials to be stored under bridges to the Engineer a minimum of 14 calendar days prior to anticipated storage. This detail shall include, but not limited to, bridge location, material type, material quantity, and duration of storage. The Project Engineer and any other needed Division will review this information and determine whether to grant approval. The Contractor shall not store any material under any bridge without written approval from the Project Engineer.

MISSISSIPPI DEPARTMENT OF TRANSPORTATION

SECTION 904 - NOTICE TO BIDDERS NO. 1241

CODE: (IS)

DATE: 11/27/2018

SUBJECT: Fuel and Material Adjustments

Bidder's attention is brought to the last paragraph of Subsection 109.07 of the Standard Specifications which states that no fuel or material adjustment will be made after the completion of contract time. Any fuels consumed or materials incorporated into the work during the monthly estimate period falling wholly after the expiration of contract time will not be subject a fuel or material adjustment.

MISSISSIPPI DEPARTMENT OF TRANSPORTATION

SECTION 904 - NOTICE TO BIDDERS NO. 1963

CODE: (SP)

DATE: 9/23/2019

SUBJECT: Guardrail Pads

Bidders are hereby advised that prior to construction of the guardrail pads, the Contractor shall coordinate with the guardrail Subcontractor to determine the guardrail pad dimensions necessary to meet MASH compliance.

MISSISSIPPI DEPARTMENT OF TRANSPORTATION

SECTION 904 - NOTICE TO BIDDERS NO. 2206

CODE: (IS)

DATE: 01/14/2020

SUBJECT: MASH Compliant Devices

Bidders are hereby advised that compliance associated with the requirements of meeting either the National Cooperative Highway Research Program (NCHRP) Report 350 or the Manual for Assessing Safety Hardware (MASH) for installations of certain traffic control devices and permanent safety hardware devices (guardrails, guardrail terminals, permanent portable barriers, cast-in-place barriers, all other permanent longitudinal barriers, crash cushions, cable barriers, cable barrier terminals, bridge rails, bridge rail transitions, all other terminals, sign supports, and all other breakaway hardware) as listed throughout the Standard Specifications and/or the Standard Drawings, or both, is now replaced with the requirements of meeting the 2016 version of MASH after December 31, 2019. This change applies to new permanent installations and to full replacements of existing installations.

At the preconstruction conference or prior to starting any work on the project, the Contractor shall submit a letter stating that the traffic control devices and permanent safety hardware devices as outlined within the paragraph above that are to be used on the project are certified to meet MASH 2016.

When a MASH 2016-compliant device does not exist for the new permanent installations and/or full replacement installations of permanent safety hardware devices, as listed above, a MASH 2009-compliant or a NCHRP 350-compliant device may be proposed by the Contractor for the project. A written request for such instances must be submitted by the Contractor either at the preconstruction conference or prior to starting any work on the project. The Contractor shall submit the following items to the Project Engineer: (1) a detailed list of the proposed devices and locations thereof; and (2) certification letters indicating that the proposed devices are compliant with either MASH 2009 or NCHRP 350.

When a MASH 2016-compliant device does not exist for the temporary work zone traffic control devices (Category 1, Category 2, and Category 3 devices), a MASH 2009-compliant or a NCHRP 350-compliant device may be proposed by the Contractor for the project. Temporary work zone traffic control devices (Category 1, Category 2, and Category 3 devices) that are MASH 2009-compliant or NCHRP 350-compliant that have been in use prior to December 31, 2019, and that have a remaining service life may be proposed for use throughout their normal service life on the project by the Contractor. For either of these scenarios for temporary work zone traffic control devices, a written request must be submitted by the Contractor either at the preconstruction conference or prior to starting any work on the project. The Contractor shall submit the following items to the Project Engineer: (1) a detailed list of the proposed devices and locations thereof; and (2) certification letters indicating that the proposed devices are compliant with either MASH 2009 or NCHRP 350.

Work will only be allowed to proceed after the Department has granted written concurrence(s) with the proposed request(s) as listed above.

MISSISSIPPI DEPARTMENT OF TRANSPORTATION

SECTION 904 - NOTICE TO BIDDERS NO. 2273

CODE: (SP)

DATE: 02/12/2020

SUBJECT: Mississippi Special Fuel Tax Law

Bidder's attention is brought to the second paragraph of Subsection 107.02 of the Standard Specifications which states that all Contractors and Subcontractors must comply with all requirements contained in the Mississippi Special Fuel Tax Law, Section 27-55-501, *et seq.* Attached are two Fact Sheets provided by the Mississippi Department of Revenue (MDOR) with additional information.

Gasoline and Dyed Diesel Used for Non-Highway Purposes

Mississippi provides a reduced rate for gasoline and dyed diesel used for non-highway purposes. The reduced rates are 6.44 cents per gallon and 5.75 cents per gallon of gasoline or dyed diesel. These fuels are generally taxed at 18 cents per gallon if for on road use.

Gasoline Used for Non-Highway Purposes

You may be entitled to a refund of 11.56 cents per gallon (making this an equivalent to a tax rate of 6.44 cents per gallon) if you desire to purchase gasoline to be used off road. The gasoline must be used for agricultural, maritime, industrial, manufacturing, domestic or non-highway purposes only.

Examples of non-highway include gasoline used in boats, golf carts, machinery used for manufacturing or farm equipment used exclusively in plowing, planting or harvesting farm products.

Refund Gasoline User

The refund is based on the amount of gallons used. Before a refund is issued, you are required to...

1. Obtain a refund gasoline user's permit and a certificate for refund booklet from the Department of Revenue;
2. Have a storage tank marked "REFUND GASOLINE"; and,
3. Purchase the gasoline from someone who holds a refund gasoline dealer's permit.

No refund will be allowed for gasoline used in motor vehicles owned or operated by a government entity or used in Mississippi government contracts.

Refund Gasoline Dealer

You must obtain a refund gasoline dealer's permit from the Department of Revenue before selling refund gasoline. At no time should the gasoline be delivered to a tank that is not properly marked. The gasoline must be dyed a distinctive mahogany color at the time of delivery.

The Department of Revenue may waive the dye requirement if the dye may cause damage to the equipment. The refund gasoline user is required to obtain the waiver from the Department of Revenue.

Dyed Diesel Used for Non-Highway Purposes

Unlike gasoline, you are not required to apply for a refund if you desire to purchase dyed diesel to be used off road. Mississippi provides a reduced rate of 5.75 cents per gallon on dyed diesel used off road. Diesel used on road is subjected to 18 cents per gallon. Dyed diesel used in motor vehicles owned or operated by a government entity or used in Mississippi government contracts will be subjected to 18 cents per gallon.

Dyed Diesel Used on the Highway

Any person who purchases, receives, acquires or uses dyed diesel for highway use will be liable to pay 18 cents per gallon and subject to a penalty in the amount of \$1000.

Identifying Dyed Diesel

Storage facilities for dyed diesel must be plainly marked "NONHIGHWAY DIESEL FUEL" or "NONHIGHWAY KEROSENE". Retailers are also required to mark all pumps or dispensing equipment.



Special Fuel Used on Government Contracts

State and Local Government Contracts

Special fuel purchased, acquired or used in performing contracts with the State of Mississippi, counties, municipalities or any political subdivision is taxed at a rate of 18 cents per gallon. Special fuel includes but is not limited to the following:

- Dyed diesel fuel;
- Kerosene;
- Undyed diesel fuel; and,
- Fuel oil.

State and local government contracts include construction, reconstruction and maintenance or repairs of projects such as roads, bridges, water systems, sewer systems, buildings, drainage canals and recreational facilities. The Department of Revenue may require contractors to remit the excise tax directly to the state in lieu of paying the tax to a distributor.

Special Fuel Direct Pay Permit

Contractors that remit the excise tax to the state will be issued a Special Fuel Direct Pay Permit. This permit relieves the distributor from collecting the tax and requires the contractor to file a monthly special fuel return. The distributor should include the contractor's permit number on all invoices that are related to tax-free sales.

The contractor is required to furnish a surety or cash bond guaranteeing the payment of the excise tax prior to receiving the Special Fuel Direct Pay Permit. The Department of Revenue may accept a contractors tax bond if the bond covers the excise tax levied on special fuel.

Special Fuel Distributors

If the contractor does not have a Special Fuel Direct Pay Permit, distributors are required to collect the 18 cents excise tax and remit the tax to the Department of Revenue. The additional 12.25 cents levied on special fuel (excluding undyed diesel) should be reported on schedules 5F and 5G of the special fuel return.

Environmental Protection Fee

Special fuel distributors are required to collect the environmental protection fee even if the contractor has a Special Fuel Direct Pay Permit. The fee is levied at 4/10^{ths} of a cent per gallon. The fee is suspended or reinstated when the trust fund has exceeded or fallen below the obligatory balance.

Penalties

Any person who knowingly and willfully purchases untaxed fuel for use in equipment utilized on a road or highway construction site in this state is guilty of a misdemeanor and, upon conviction, shall be fined not less than \$1,000 or more than \$100,000, or imprisoned in the county jail for not more than one year, or both.



MISSISSIPPI DEPARTMENT OF TRANSPORTATION

SECTION 904- NOTICE TO BIDDERS NO. 2278

CODE: (SP)

DATE: 03/04/2020

SUBJECT: Smoothness Tolerances

Bidders are hereby advised that the smoothness tolerances for this project shall meet the requirements of a Category C project according to Subsection 403.03.2.1. Bidders are responsible for the collection of a preliminary smoothness profile prior to any work being performed.

MISSISSIPPI DEPARTMENT OF TRANSPORTATION

SECTION 904 - NOTICE TO BIDDERS NO. 2954

CODE: (SP)

DATE: 12/01/2020

SUBJECT: Reflective Sheeting for Signs

Bidders are hereby advised that the retroreflective sign sheeting used for signs on this project shall be as listed below and shall meet the requirements of Subsection 721.06.

Temporary Construction Signs

Temporary traffic control (orange) sign sheeting shall be a minimum Type IX Fluorescent Orange sheeting as shown in Special Provision 907-721.

Permanent Signs

Permanent signs, except signs on traffic signal poles/mast arms, shall be as follows:

- Brown background sheeting on guide signs shall be a minimum Type VIII sheeting,
- Green and blue background sheeting on guide signs shall be a minimum Type IX sheeting, and
- All white, yellow, red, fluorescent yellow, and fluorescent yellow/green sheeting shall be Type XI sheeting.

MISSISSIPPI DEPARTMENT OF TRANSPORTATION

SECTION 904 – NOTICE TO BIDDERS NO. 3117

CODE: (SP)

DATE: 02/23/2021

SUBJECT: Standard Drawings

Standard Drawings attached hereto shall govern appropriate items of required work.

Larger copies of Standard Drawings may be purchased from:

MDOT Plans Print Shop
MDOT Shop Complex, Building C, Room 114
2567 North West Street
P.O. Box 1850
Jackson, MS 39215-1850
Telephone: (601) 359-7460
or FAX: (601) 359-7461
or e-mail: plans@mdot.state.ms.us

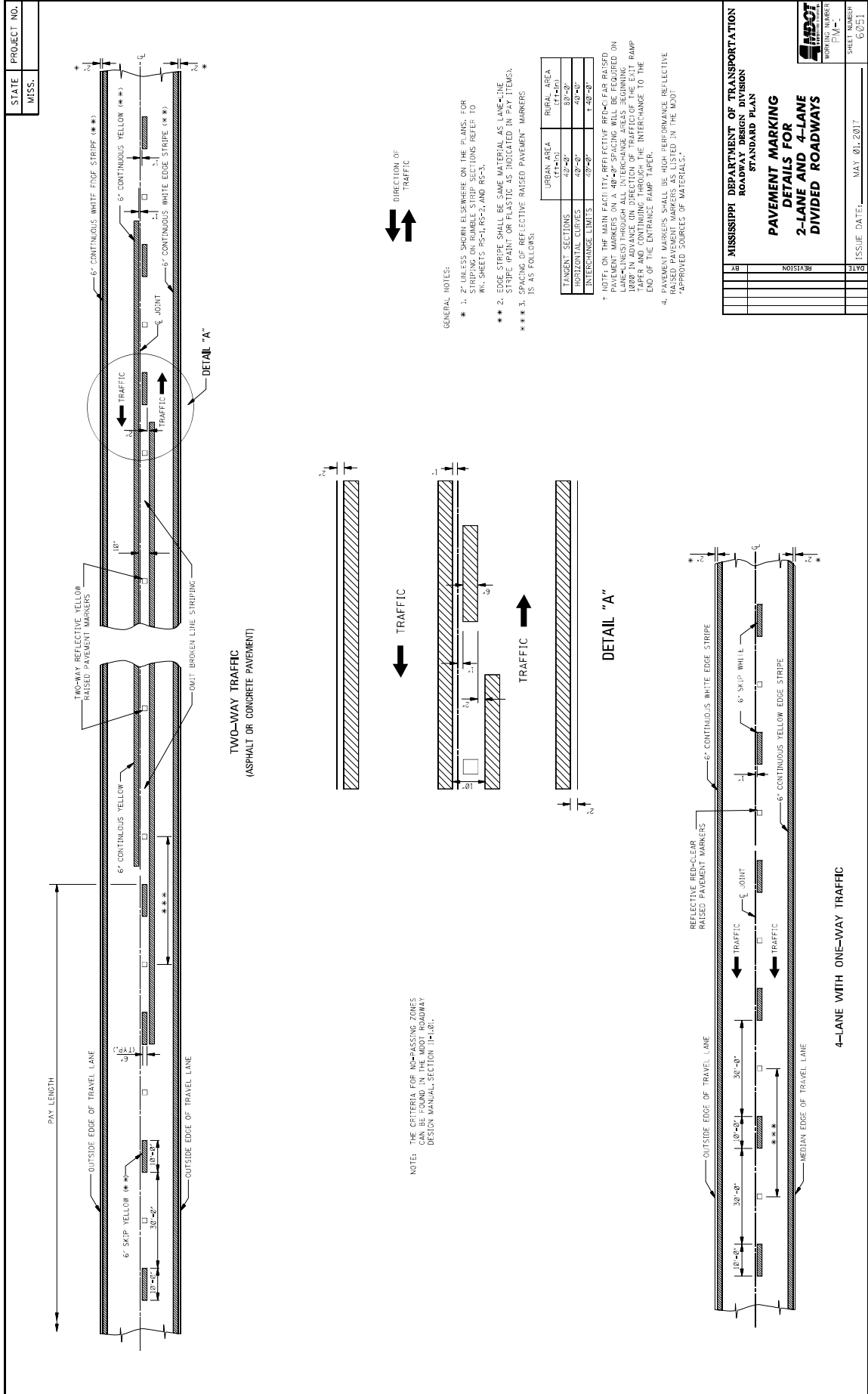

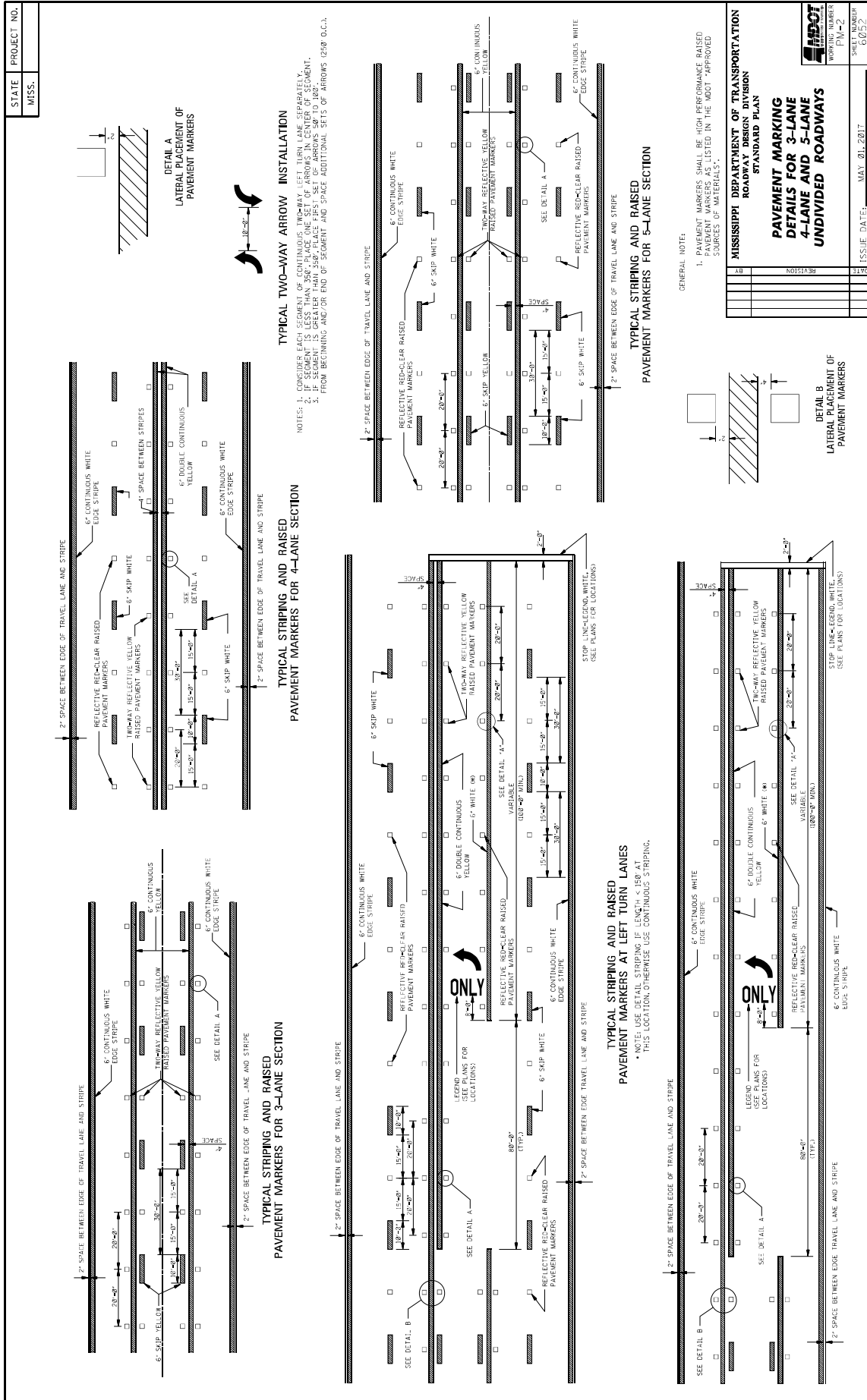

NOTES: 1. CONSIDER EACH SEGMENT OF CONTINUOUS TWO-WAY LEFT TURN LANE SEPARATELY.
 2. IF SEGMENT IS LONG ENOUGH TO ACCOMMODATE TWO-WAY LEFT TURN LANE STRIPING, STRIPING SHALL BE INSTALLED FROM BEGINNING AND/OR END OF SEGMENT AND SPACE ADDITIONAL SETS OF ARROWS (250' O.C.).

GENERAL NOTE:
 1. PAVEMENT MARKERS SHALL BE HIGH PERFORMANCE RAISED PAVEMENT MARKERS AS LISTED IN THE MOST APPROVED SOURCE OF MATERIALS.

MISSISSIPPI DEPARTMENT OF TRANSPORTATION	
ROADWAY DESIGN DIVISION	
STANDARD PLAN	
PAVEMENT MARKING	
DETAILS FOR 3-LANE	
4-LANE AND 3-LANE	
UNDIVIDED ROADWAYS	
SHEET NUMBER P-10-2	ISSUE DATE: MAY 20, 2017

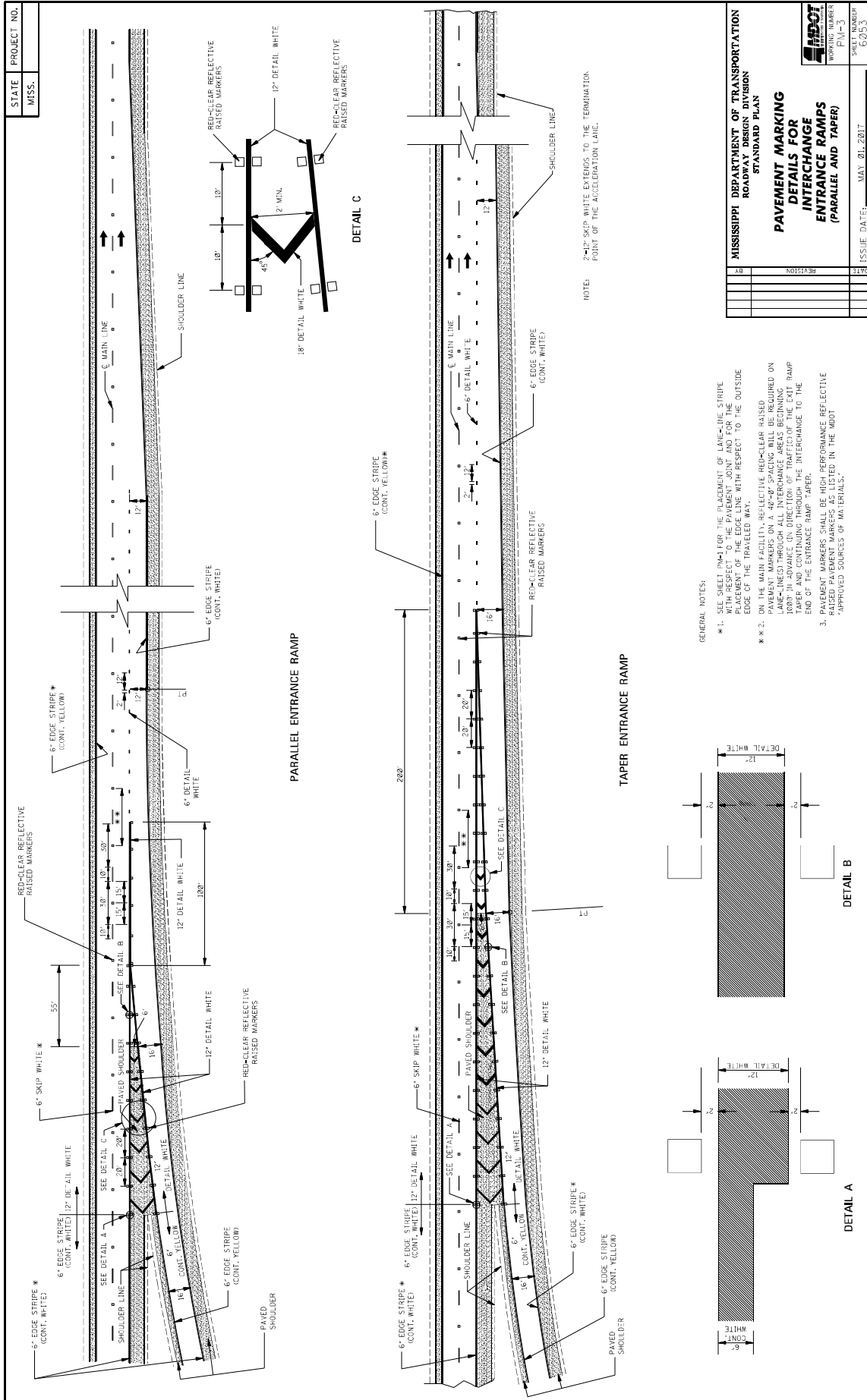

STATE PROJECT NO.		MISS. _____	
31	SECTION	32	SECTION
MISSISSIPPI DEPARTMENT OF TRANSPORTATION ROADWAY DESIGN DIVISION PAVEMENT MARKING DETAILS FOR INTERCHANGE RAMP (PARALLEL AND TAPER)		SHEET NUMBER FM-3	
		SHEET NUMBER 69353	
		ISSUE DATE: MAY 20, 2017	

NOTE: 24-INCH SKIP WHITE EXTENDS TO THE TERMINATION POINT OF THE ACCELERATION LANE.

GENERAL NOTES:

- * 1. SEE SHEET FM-1 FOR THE PLACEMENT OF LANE AND STRIPE WITH RESPECT TO THE PAVEMENT JOINT AND FOR THE PLACEMENT OF THE EDGE LINE WITH RESPECT TO THE EDGE OF THE TRAVELED WAY.
- * 2. ON THE MAIN FACILITY, REFLECTIVE RED-CLEAR RAISED PAVEMENT MARKERS ON A 40'-8" SPACING WILL BE REQUIRED ON THE APPROACH TO THE INTERCHANGE TO INDICATE THE TAPER AND CONTINUING THROUGH THE INTERCHANGE TO THE END OF THE ENTRANCE RAMP TAPER.
- 3. PAVEMENT MARKERS SHALL BE HIGH PERFORMANCE REFLECTIVE RAISED PAVEMENT MARKERS AS LISTED IN THE MOST APPROVED SOURCES OF MATERIALS.

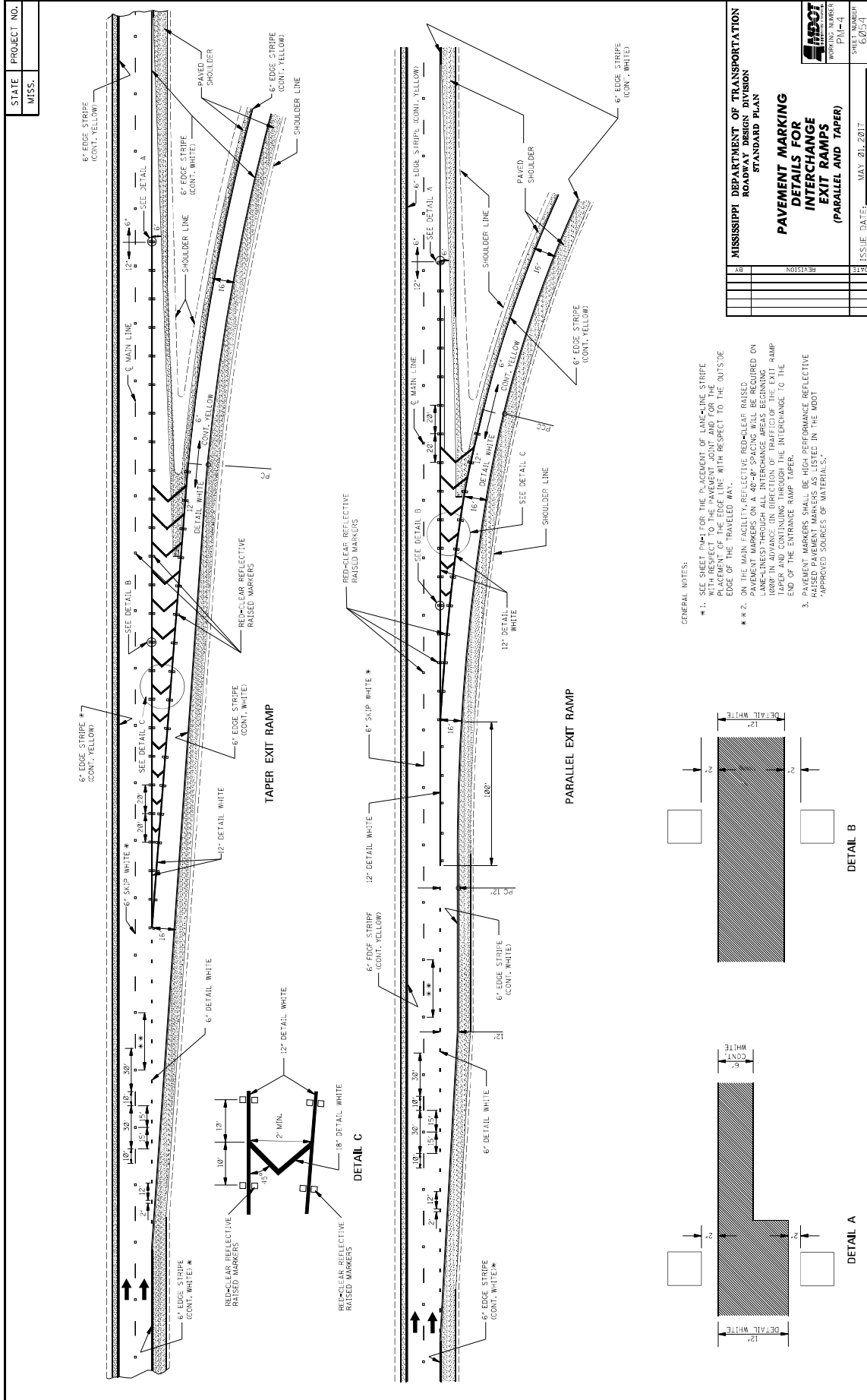

STATE MISS.	PROJECT NO.										
----------------	-------------	--	--	--	--	--	--	--	--	--	--

PAVE

TRAFFIC

STOP

SIGNAL

EXIT

RIGHT

YIELD

AHEAD

SCHOOL

GENERAL NOTES:

- TWO HORIZONTAL GAPS (CAUSED BY TEMPLATE CONNECTIONS) OF 1/2" SHALL BE SHOWN EXTENDING FULL WIDTH OF LETTERS.
- FOR OTHER DETAILS, SEE THE MANUAL ON UNIFORM TRAFFIC CONTROL DEVICES.
- PAY QUANTITIES FOR PAVEMENT MARKING LEGENDS ARE AS FOLLOWS:

LEGEND	AREA (sq ft)
STOP	246.6
RIGHT	286.6
LEFT	195.5
UP	227.2
DOWN	227.2
AHEAD	322.4
YIELD	268.8
EXIT	182.5
SIGNAL	322.5
SCHOOL	352.2

MISSISSIPPI DEPARTMENT OF TRANSPORTATION
ROADWAY DESIGN DIVISION
STANDARD PLAN

**PAVEMENT MARKING
LEGEND DETAILS**

ISSUE DATE: MAY 01, 2017

WORKING NUMBER: PM-5
SHEET NUMBER: 6035

STATE MISS.	PROJECT NO.		
----------------	-------------	--	--

ONLY: 8'-4" x 5'-10"

TURN: 8'-4" x 6'-4"

THRU: 10'-0" x 5'-4"

COMBINATION: 13'-4" x 7'-8"

LANE-REDUCTION: 17'-8" x 6'-6"

1-WAY: 25'-10" x 7'-2"

GENERAL NOTES:

- TWO HORIZONTAL GAPS (CAUSED BY TEMPLATE CONNECTIONS OF 1/8" OR LESS AND EXTENDING THE FULL WIDTH) ARE PERMITTED IN EACH LETTER.
- FOR OTHER DETAILS, SEE THE MANUAL ON UNIFORM TRAFFIC CONTROL DEVICES.
- DIMENSIONS OF THE YIELD LINE MAY VARY WITH APPROVAL OF THE ENGINEER. SEE MUTCD, LATEST EDITION, FOR ALLOWABLE DIMENSIONS.
- PAY QUANTITIES FOR PAVEMENT MARKING LEGENDS ARE AS FOLLOWS:

PAY QUANTITIES	
LEGEND/SYMBOL	AREA (FT ²)
ONLY	22.0
TURN ARROW	16.4
THRU ARROW	12.3
COMB. ARROW	27.5
LANE REDUCTION ARROW	40.0

**MISSISSIPPI DEPARTMENT OF TRANSPORTATION
ROADWAY DESIGN DIVISION
STANDARD PLAN**

**PAVEMENT MARKING
LEGEND DETAILS**

BY	DATE
REVISION	

ISSUE DATE: MAY 01, 2017
SHEET NUMBER: 60/56
PLAN: 6

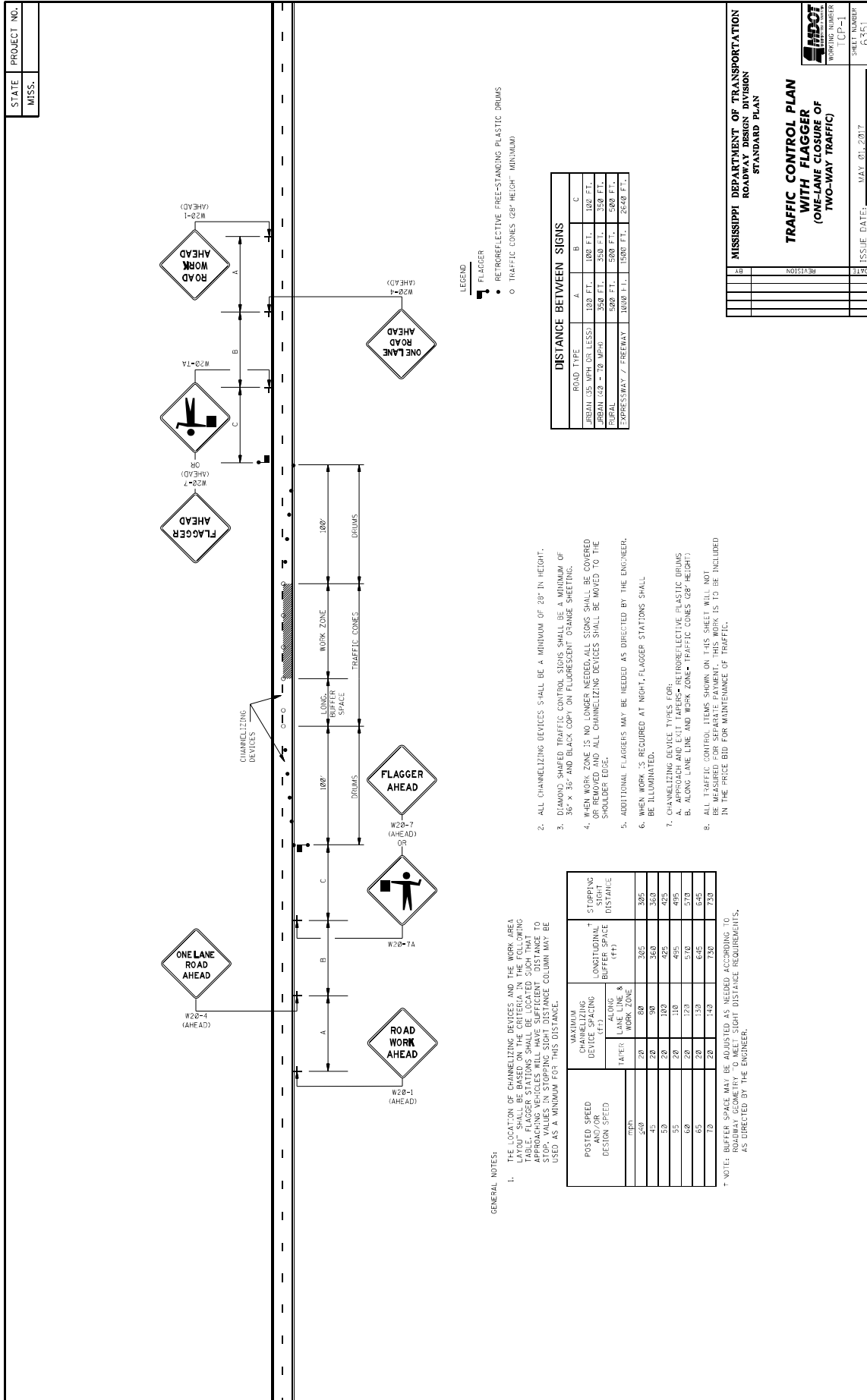

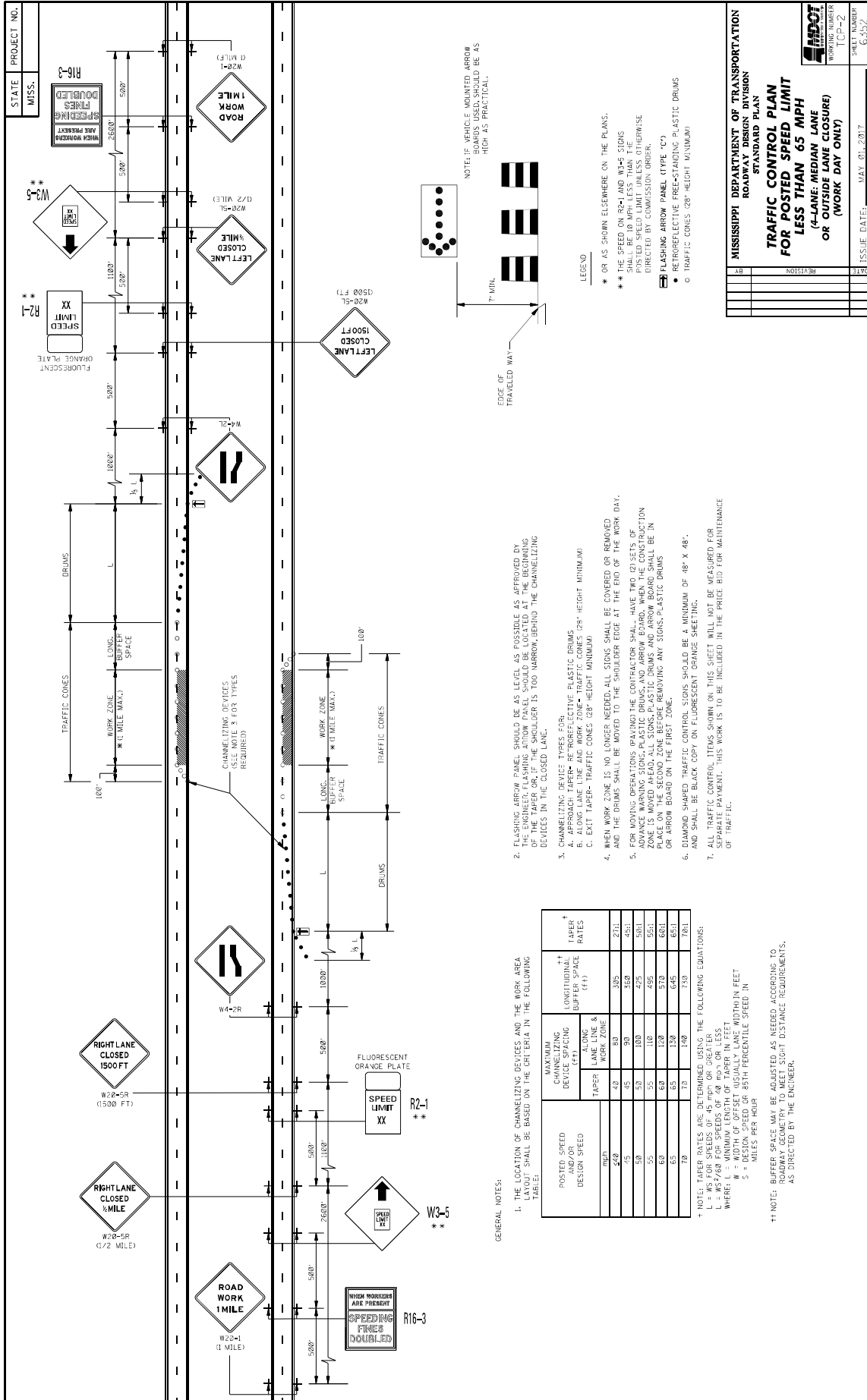

GENERAL NOTES:

1. THE LOCATION OF CHANNELIZING DEVICES AND THE WORK AREA LAYOUT SHALL BE BASED ON THE CRITERIA IN THE FOLLOWING TABLE:
- | POSTED SPEED AND/OR DESIGN SPEED | MAXIMUM CHANNELIZING DEVICE SPACING (FT) | | LONGITUDINAL BUFFER SPACE (FT) | TAPER RATES |
|----------------------------------|--|-----------|--------------------------------|-------------|
| | LANE LINE & WORK ZONE | WORK ZONE | | |
| 70 | 42 | 80 | 305 | 27:1 |
| 55 | 45 | 90 | 350 | 45:1 |
| 50 | 50 | 100 | 425 | 50:1 |
| 55 | 55 | 110 | 495 | 55:1 |
| 60 | 60 | 120 | 570 | 60:1 |
| 65 | 65 | 130 | 645 | 65:1 |
| 70 | 70 | 140 | 730 | 70:1 |
- † NOTE: TAPER RATES ARE DETERMINED USING THE FOLLOWING EQUATIONS:
 L = MS FOR SPEEDS OF 45 MPH OR GREATER
 L = MS FOR SPEEDS OF 30 MPH OR GREATER
 WHERE: L = MINIMUM LENGTH OF TAPER IN FEET
 M = WIDTH OF OFFSET (USUALLY LANE WIDTH) IN FEET
 S = DESIGN SPEED OR 85TH PERCENTILE SPEED IN MILES PER HOUR
- †† NOTE: BUFFER SPACE MAY BE ADJUSTED AS NEEDED ACCORDING TO ROADWAY GEOMETRY TO MEET SIGHT DISTANCE REQUIREMENTS, AS DIRECTED BY THE ENGINEER.

2. FLASHING ARROW PANEL SHOULD BE AS LEVEL AS POSSIBLE AS APPROVED BY THE ENGINEER. THE PANEL SHOULD BE LOCATED AT THE END OF THE WORK DAY. OF THE TAPER OR, IF THE SHOULDER IS TOO NARROW, BEHIND THE CHANNELIZING DEVICES IN THE CLOSED LANE.
3. CHANNELIZING DEVICES: TYPE: F30.
 A. APPROACH TAPER- RETROREFLECTIVE PLASTIC DRUMS
 B. ALONG LANE LINE AND WORK ZONE- TRAFFIC CONES (28" HEIGHT MINIMUM)
 C. EXIT TAPER- TRAFFIC CONES (28" HEIGHT MINIMUM)
4. WHEN WORK ZONE IS NO LONGER NEEDED, ALL SIGNS SHALL BE COVERED OR REMOVED.
5. FOR MOVING OPERATIONS (PAVING) THE CONTRACTOR SHALL HAVE TWO (2) SETS OF ADVANCE WARNING SIGNS- PLASTIC DRUMS AND ARROW BOARD. WHEN THE CONSTRUCTION ZONE IS MOVED AHEAD, ALL SIGNS- PLASTIC DRUMS AND ARROW BOARD SHALL BE IN PLACE ON THE SECOND ZONE BEFORE REMOVING ANY SIGNS- PLASTIC DRUMS OR ARROW BOARD ON THE FIRST ZONE.
6. DIAMOND SHAPED TRAFFIC CONTROL SIGNS SHOULD BE A MINIMUM OF 48" X 48" AND SHALL BE BLACK COPY ON FLUORESCENT ORANGE SHEETING.
7. ALL TRAFFIC CONTROL ITEMS SHOWN ON THIS SHEET WILL NOT BE MEASURED FOR PAYMENT. THIS WORK IS TO BE INCLUDED IN THE PRICE BID FOR MAINTENANCE OF TRAFFIC.

LEGEND

- * OR AS SHOWN ELSEWHERE ON THE PLANS.
- ** THE SPEED ON R2-1 AND W3-5 SIGNS SHALL BE 10 MPH LESS THAN THE POSTED SPEED LIMIT UNLESS OTHERWISE DIRECTED BY COMMISSION ORDER.
- ▢ FLASHING ARROW PANEL (TYPE "C")
- RETROREFLECTIVE FREE-STANDING PLASTIC DRUMS
- TRAFFIC CONES (28" HEIGHT MINIMUM)

NOTE: IF VEHICLE MOUNTED ARROW BOARD SHOULD BE AS HIGH AS PRACTICAL.

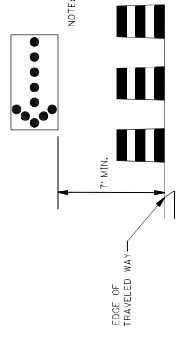

STATE PROJECT NO. MISS. R16-3

W20-3R (1500 FT) RIGHT LANE CLOSED 1500 FT

W20-5P (1/2 MILE) RIGHT LANE CLOSED 1/2 MILE

W20-1 (1 MILE) ROAD WORK 1 MILE

W20-5L (1/2 MILE) LEFT LANE CLOSED 1/2 MILE

W20-5L (1500 FT) LEFT LANE CLOSED 1500 FT

W4-2R

W3-5

R2-1

R16-3

MISSISSIPPI DEPARTMENT OF TRANSPORTATION
 ROADWAY DESIGN DIVISION
 STANDARD PLAN

**TRAFFIC CONTROL PLAN
 FOR POSTED SPEED LIMIT
 LESS THAN 65 MPH
 (4-LANE, MEDIAN LANE
 OR OUTSIDE LANE CLOSURE
 OR (WORK DAY ONLY)**

ISSUE DATE: MAY 01, 2017

WORKING NUMBER: 1CP-2

SHEET NUMBER: 6252

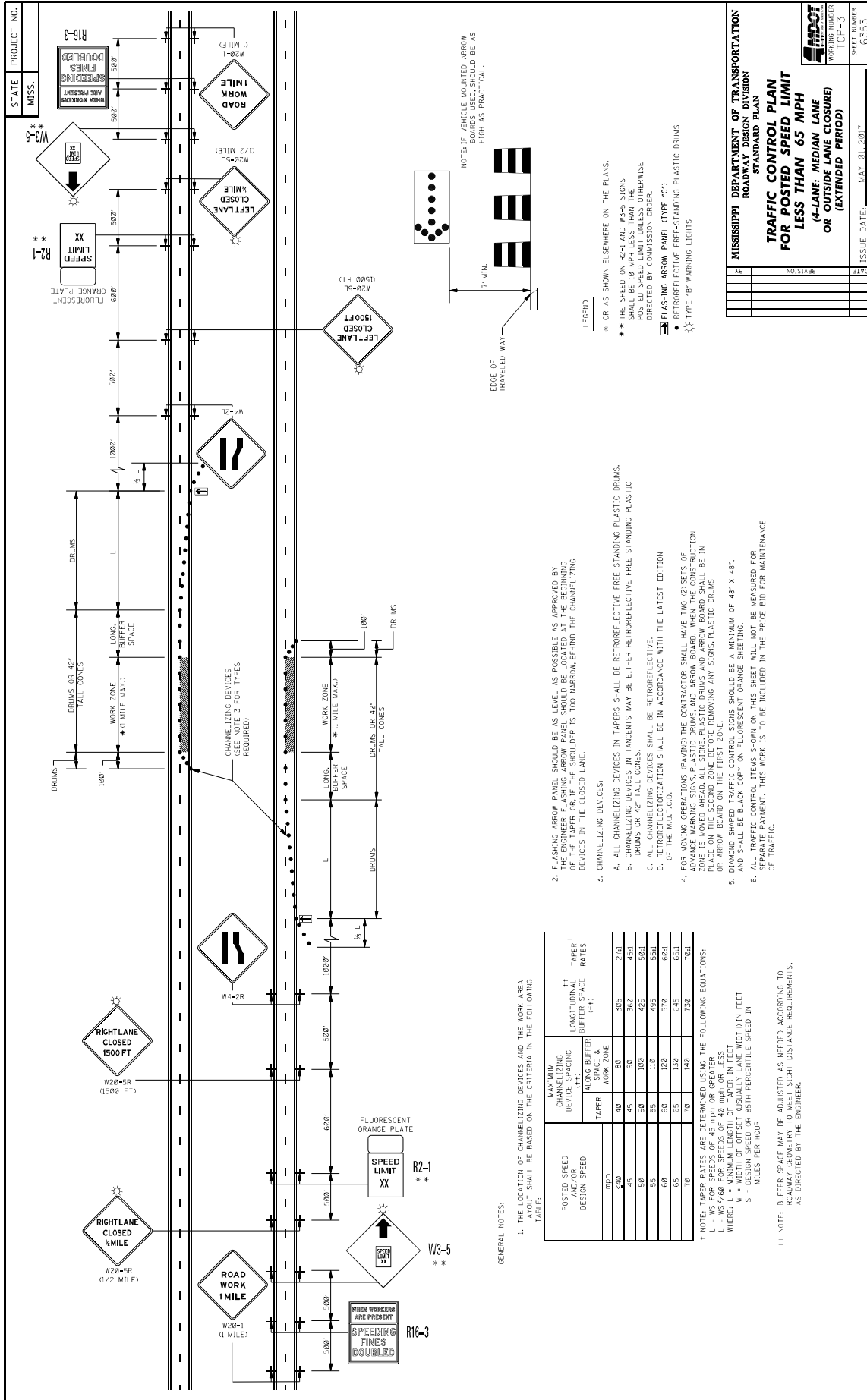

1. THE LOCATION OF CHANNELIZING DEVICES AND THE WORK AREA LAYOUT SHALL BE BASED ON THE CRITERIA IN THE FOLLOWING TABLE:

POSTED SPEED DESIGN SPEED	MAXIMUM CHANNELIZING DEVICE SPACING (FT)		LONGITUDINAL BUFFER SPACE (FT)	TAPER RATES
	ALONG BUFFER	WORK ZONE		
10	40	80	305	2:1
20	45	90	360	4:1
30	50	100	425	5:1
35	55	110	495	5:1
40	60	120	570	6:1
45	65	130	645	6:1
50	70	140	730	7:1

† NOTE: TAPER RATES ARE DETERMINED USING THE FOLLOWING EQUATIONS:
 L = AS FOR SPEEDS OF 45 MPH OR GREATER
 L = WS/60 FOR SPEEDS OF 40 MPH OR LESS
 WHERE: L = LENGTH OF TAPER IN FEET
 W = WIDTH OF OFFSET (USUALLY LANE WIDTH) IN FEET
 S = DESIGN SPEED OR 85TH PERCENTILE SPEED IN MILES PER HOUR

†† NOTE: BUFFER SPACE MAY BE ADJUSTED AS NECESSARY ACCORDING TO ROADWAY GEOMETRY TO MEET SIGHT DISTANCE REQUIREMENTS, AS DIRECTED BY THE ENGINEER.

GENERAL NOTES:

- LAYOUT SHALL BE BASED ON THE CRITERIA IN THE FOLLOWING TABLE:
- FLASHING ARROW PANEL SHOULD BE AS LEVEL AS POSSIBLE AS APPROVED BY THE ENGINEER. FLASHING ARROW PANEL SHOULD BE LOCATED AT THE BEGINNING OF THE WORK ZONE. BUFFER SHOULD BE 100' AHEAD OF THE CHANNELIZING DEVICES IN THE CLOSED LANE.
- CHANNELIZING DEVICES:
 - ALL CHANNELIZING DEVICES IN TAPERS SHALL BE RETROREFLECTIVE FREE STANDING PLASTIC DRUMS.
 - DRUMS OR 42" TALL CONES.
 - ALL CHANNELIZING DEVICES SHALL BE RETROREFLECTIVE.
 - RETROREFLECTORIZATION SHALL BE IN ACCORDANCE WITH THE LATEST EDITION OF THE M.I.T.S.D.C.
- FOR WORKING DRUMS, TAPERS THE CONTRACTOR SHALL HAVE TWO (2) FEET OF CHANNELIZING DEVICES (STANDING PLASTIC DRUMS AND ARROW BOARD) IN THE CONSTRUCTION ZONE IS MOVED AHEAD ALL STANDING PLASTIC DRUMS AND ARROW BOARD SHALL BE IN PLACE ON THE SECOND ZONE BEFORE REMOVING ANY STANDING PLASTIC DRUMS OR ARROW BOARD ON THE FIRST ZONE.
- ALL TRAFFIC CONTROL ITEMS SHOWN ON THIS SHEET WILL NOT BE MEASURED FOR SEPARATE PAYMENT. THIS WORK IS TO BE INCLUDED IN THE PRICE BID FOR MAINTENANCE OF TRAFFIC.

- LEGEND
- * OR AS SHOWN ELSEWHERE ON THE PLANS.
 - ** THE SPEED ON R2-1 AND R2-5 SIGNS SHALL BE 10 MPH LESS THAN THE POSTED SPEED LIMIT UNLESS OTHERWISE DIRECTED BY COMMISSION ORDER.
 - ◆ FLASHING ARROW PANEL (TYPE 'C')
 - RETROREFLECTIVE FREE-STANDING PLASTIC DRUMS
 - TYPE 'B' WARNING LIGHTS

MISSISSIPPI DEPARTMENT OF TRANSPORTATION
 ROADWAY DESIGN DIVISION
 STANDARD PLAN
**TRAFFIC CONTROL PLAN
 FOR POSTED SPEED LIMIT
 LESS THAN 65 MPH
 (4-LANE, MEDIAN LANE
 OR OUTSIDE LANE CLOSURE
 (EXTENDED PERIOD))**

WORKING NUMBER: TSP-3
 SHEET NUMBER: 6253

ISSUE DATE: MAY 01, 2017

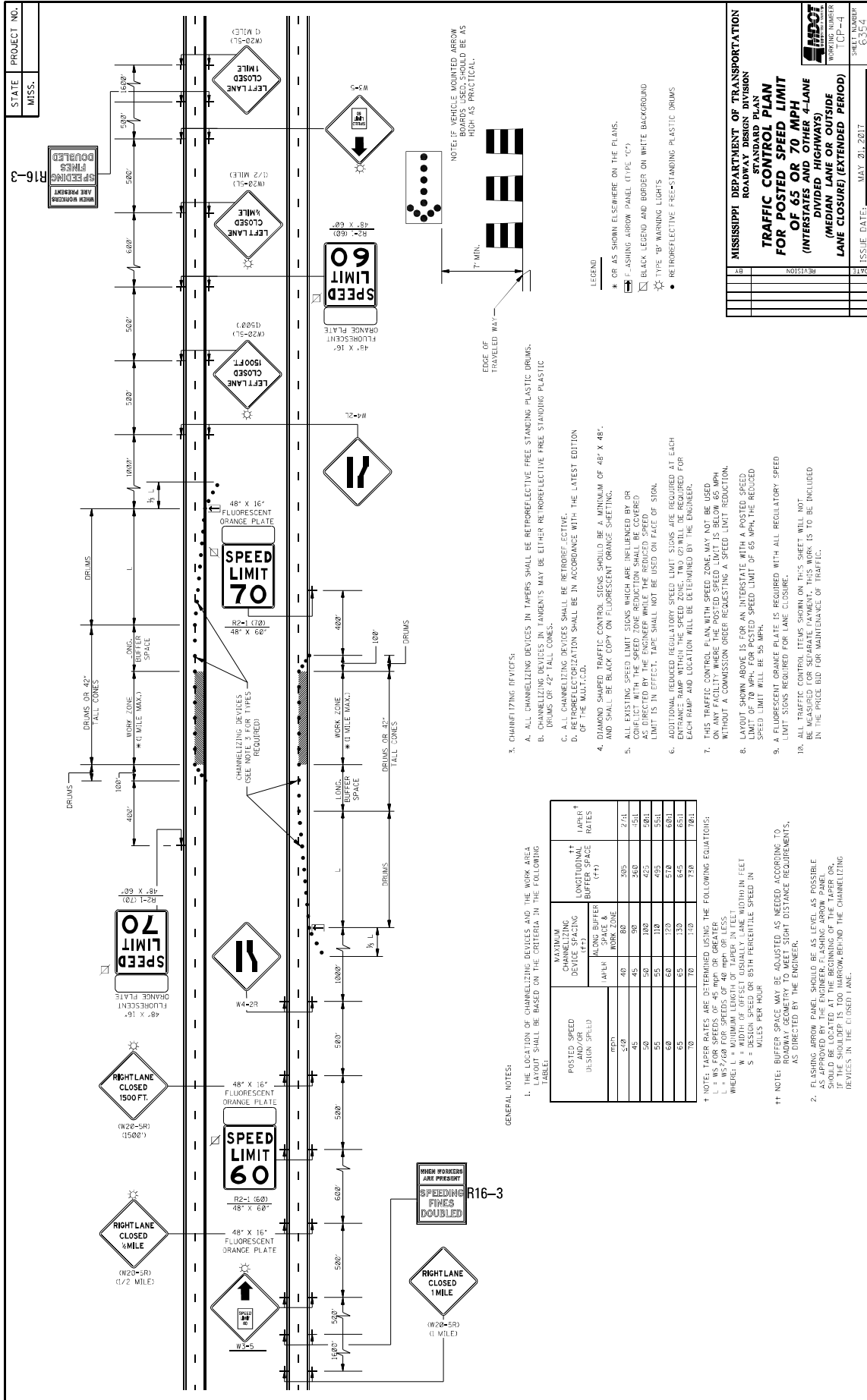

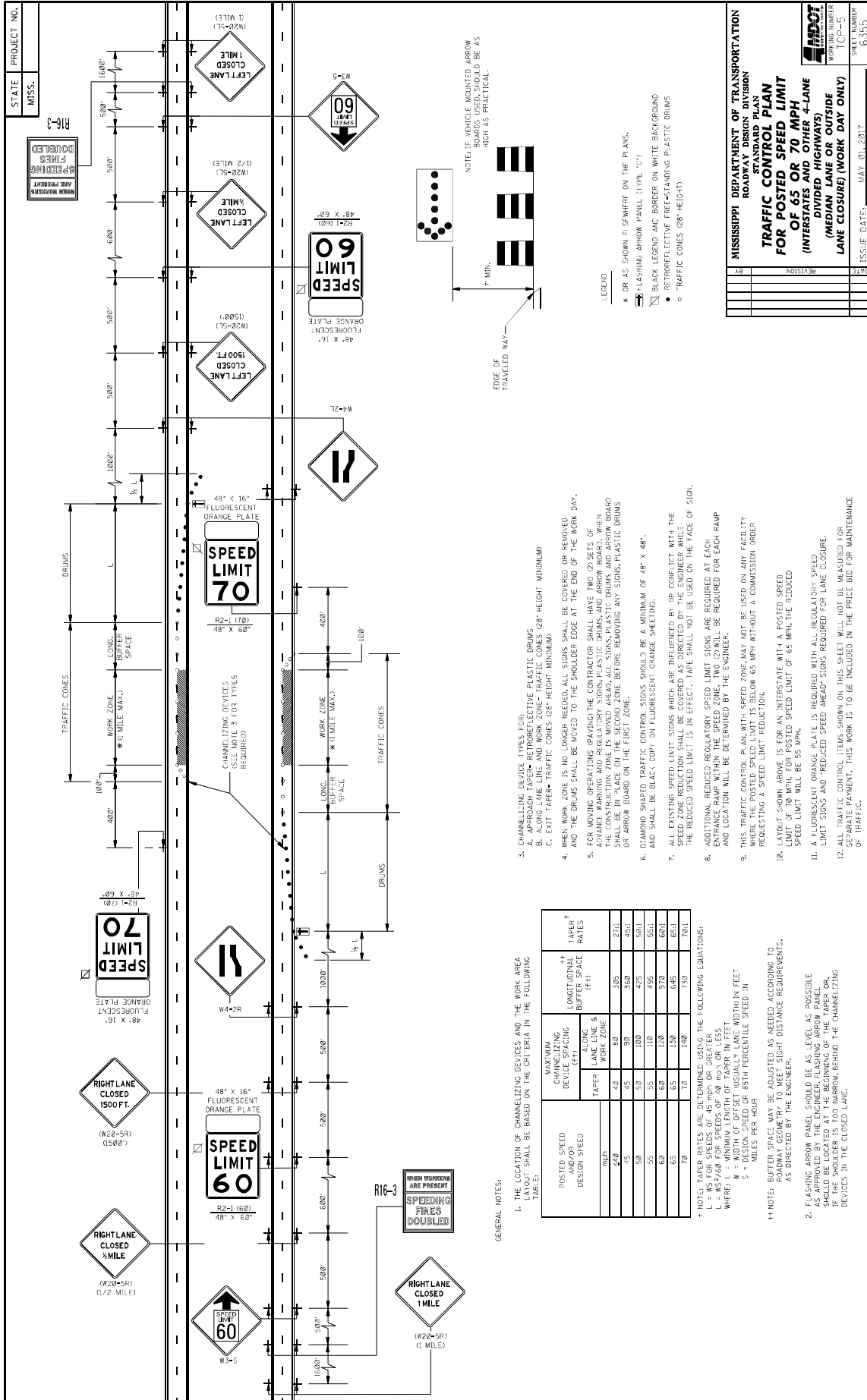

GENERAL NOTES:

1. THE LOCATION OF CHANNELIZING DEVICES AND THE WORK AREA LAYOUT SHALL BE BASED ON THE CRITERIA IN THE FOLLOWING TABLE:

POSTED SPEED AND/OR DESIGN SPEED	MAXIMUM CHANNELIZING DEVICE SPACING (FT)		LONGITUDINAL BUFFER SPACE (FT)	TAPER RATES
	LANE LINE & WORK ZONE	WORK ZONE		
40	42	80	305	27:1
45	45	90	350	45:1
50	50	100	425	50:1
55	55	110	495	55:1
60	60	120	570	60:1
65	65	130	645	65:1
70	70	140	730	70:1

† NOTE: TAPER RATES ARE DETERMINED USING THE FOLLOWING EQUATIONS:
L = WS FOR SPEEDS OF 45 MPH OR GREATER
L = WS FOR SPEEDS OF 30 MPH OR GREATER
WHERE: L = MINIMUM LENGTH OF TAPER IN FEET
S = DESIGN SPEED OR 85TH PERCENTILE SPEED IN MILES PER HOUR

†† NOTE: BUFFER SPACE MAY BE ADJUSTED AS NEEDED ACCORDING TO LOCAL RIGHT OF WAY DISTANCE REQUIREMENTS, AS DIRECTED BY THE ENGINEER.

2. FLASHING ARROW PANEL SHOULD BE AS LEVEL AS POSSIBLE AND LOCATED AT THE BEGINNING OF THE TAPER OR IF THE SHOULDER IS TOO NARROW BEHIND THE CHANNELIZING DEVICES IN THE CLOSED LANE.

3. CHANNELIZING DEVICE TYPES FOR:
 - A. APPROACH TAPER- RETROREFLECTIVE PLASTIC DRUMS
 - B. ALONG LANE LINE AND WORK ZONE- TRAFFIC CONES (28" HEIGHT MINIMUM)
 - C. EXIT TAPER- TRAFFIC CONES (28" HEIGHT MINIMUM)
4. WHEN WORK ZONE IS NO LONGER NEEDED- ALL SIGNS SHALL BE COVERED OR REMOVED AND THE DRUMS SHALL BE MOVED TO THE SHOULDER EDGE AT THE END OF THE WORK DAY.
5. FOR MOVING OPERATIONS (PAVING) THE CONTRACTOR SHALL HAVE TWO (2) SETS OF ADVANCE WARNING AND REGULATORY SIGNS, PLASTIC DRUMS, AND ARROW BOARDS. WHEN THE CONTRACTOR IS FINISHED WITH THE WORK, THE ADVANCE WARNING AND REGULATORY SIGNS SHALL BE IN PLACE ON THE SECOND ZONE BEFORE REMOVING ANY SIGNS, PLASTIC DRUMS OR ARROW BOARD ON THE FIRST ZONE.
6. DIAMOND SHAPED TRAFFIC CONTROL SIGNS SHOULD BE A MINIMUM OF 48" X 48".
7. ALL EXISTING SPEED LIMIT SIGNS WHICH ARE INDICATED BY AN ORANGE LETTER WITH THE SPEED ZONE REDUCTION SHALL BE COVERED AS DIRECTED BY THE ENGINEER WHILE THE REDUCED SPEED LIMIT IS IN EFFECT. TAPE SHALL NOT BE USED ON THE FACE OF SIGN.
8. ADDITIONAL REVISED REGULATORY SPEED LIMIT SIGNS ARE REQUIRED AT EACH ENTRANCE RAMP WITHIN THE SPEED ZONE. TWO (2) WILL BE REQUIRED FOR EACH RAMP AND LOCATION WILL BE DETERMINED BY THE ENGINEER.
9. THIS TRAFFIC CONTROL PLAN WITH SPEED ZONE MAY NOT BE USED ON ANY FACILITY REQUESTING A SPEED LIMIT REDUCTION.
10. LAYOUT SHOWN ABOVE IS FOR AN INTERSTATE WITH A POSTED SPEED LIMIT OF 70 MPH. FOR POSTED SPEED LIMIT OF 65 MPH, THE REDUCED SPEED LIMIT WILL BE 55 MPH.
11. A FLUORESCENT ORANGE PLATE IS REQUIRED WITH ALL REGULATORY SPEED LIMIT SIGNS AND "REDUCED SPEED AHEAD" SIGNS REQUIRED FOR LANE CLOSURE.
12. ALL TRAFFIC CONTROL ITEMS SHOWN ON THIS SHEET WILL NOT BE MEASURED FOR SEPARATE PAYMENT. THIS WORK IS TO BE INCLUDED IN THE PRICE BID FOR MAINTENANCE OF TRAFFIC.

STATE PROJECT NO.
MISS.

WORKING NUMBER
ICP-5
SHEET NUMBER
03500

WING BARRICADES

1. WING BARRICADES ARE TYPE II BARRICADES ERECTED ON THE SHOULDER OF A ROADWAY OR RESTRICTED ROADWAY. WING BARRICADES MAY BE USED AS A WARNING FOR THE ADVANCE WARNING SIGNS OR FLASHERS.

2. WING BARRICADES SHOULD BE USED:

A. IN ADVANCE OF A CONSTRUCTION PROJECT EVEN WHEN NO PART OF THE ROADWAY IS ACTUALLY CLOSED.

B. IN ADVANCE OF ALL BRIDGE OR CULVERT WIDENING OPERATIONS.

PLASTIC DRUM STRIPPING DETAIL

1. PLASTIC DRUMS SHALL BE ON END AND USED AS AN EXPEDITED METHOD FOR TRAFFIC CHANNELIZATION. THE COLOR AND MARKING OF DRUMS SHALL BE CONSISTENT WITH MARKING STANDARD FOR PLASTIC DRUMS. THE PREDOMINANT COLOR OF DRUMS SHALL BE WHITE WITH FOUR RETROREFLECTIVE, HORIZONTAL, CIRCUMFERENTIAL STRIPES (2 ORANGE & 2 WHITE) 6" WIDE.

2. DRUMS SHOULD NEVER BE PLACED IN THE ROADWAY WITHOUT WARNING SIGNS.

3. WHERE PRACTICAL PLASTIC DRUMS SHOULD BE PLACED NO CLOSER THAN 3'-0" FROM THE EDGE OF TRAVELED LANE.

BARRICADE CLOSING A ROAD

BARRICADE CHARACTERISTICS

	I	II	III
WIDTH OF RAIL **	8" MIN. - 12" MAX.	8" MIN. - 12" MAX.	8" MIN. - 12" MAX.
LENGTH OF RAIL **	24" MIN.	24" MIN.	48" MIN.
WIDTH OF STRIPE *	6"	6"	6"
HEIGHT	36" MIN.	36" MIN.	60" MIN.
NUMBER OF RETROREFLECTORIZED RAIL FACES	2 (ONE EACH DIRECTION)	4 (TWO EACH DIRECTION)	3 IF FACING TRAFFIC IN ONE DIRECTION AND 4 IN TWO DIRECTIONS

* 1. FOR RAILS LESS THAN 36" LONG, 4" WIDE STRIPES MAY BE USED.

** 2. BARRICADES INTENDED FOR USE ON EXPRESSWAYS, FREEWAYS AND OTHER HIGH SPEED ROADWAYS, SHALL HAVE A MINIMUM OF 270 IN² OF REFLECTIVE AREA FACING TRAFFIC.

STANDARD BARRICADES

1. THE MARKING FOR BARRICADE RAILS SHALL BE ORANGE AND WHITE (SLOPING DOWNWARD AT AN ANGLE OF 45° IN THE DIRECTION OF TRAFFIC IS TO PASS).

2. RAIL STRIPE SHALL BE 6 INCHES, EXCEPT THAT 4-INCH WIDE STRIPES MAY BE USED IF RAIL LENGTHS ARE LESS THAN 36 INCHES.

3. DO NOT PLACE SANDBAGS OR OTHER DEVICES TO PROVIDE MASS ON THE BOTTOM RAIL THAT WILL BLOCK VIEW OR RAIL FACE.

4. FOR ADDITIONAL INFORMATION OR DETAILS, SEE METHOD, LATEST EDITION.

5. BARRICADES ARE CLASSIFIED BY FHWA AS CATEGORY II. MOST ZONE DEVICES WHICH REQUIRE SUCCESSFULLY CRASH TESTED. A LIST OF CRASHWORTHY BARRICADES AND OTHER CATEGORY II DEVICES CAN BE FOUND ON FHWA'S WEBSITE: http://safety.fhwa.dot.gov/roadway_dept/pafety_guidance/road_hardware/cat2.cfm

TYPE 3 OBJECT MARKER (OM-3R)

1. TYPE 3 OBJECT MARKERS SHALL BE USED AT ALL EXPOSED BRIDGE ABUTMENTS AND AT OTHER LOCATIONS AS DETERMINED NECESSARY BY THE ENGINEER.

2. THE OM-3R IS SIMILAR EXCEPT THE STRIPES SLOPE DOWNWARD FROM THE UPPER LEFT SIDE TO THE LOWER RIGHT SIDE AND SHALL BE PLACED ON THE LEFT SIDE OF THE OBJECT.

3. THE INSIDE EDGE OF THE MARKER SHALL BE IN LINE WITH THE INNER EDGE OF THE OBSTRUCTION.

CHEVRON SIGN DETAIL

1. A CHEVRON SIGN CONSISTS OF A BLACK CHEVRON TYPE MARKING ON AN ORANGE BACKGROUND AND SHALL POINT IN THE DIRECTION OF TRAFFIC FLOW.

2. THE CHEVRON SIGN SHALL BE MOUNTED ON CRASHWORTHY SUPPORT.

3. CHEVRON SIGNS MAY BE USED TO SUPPLEMENT OTHER STANDARD DEVICES WHERE ONE OR MORE LANES ARE CLOSED FOR CONSTRUCTION OR MAINTENANCE. THEY SHOULD BE PLACED APPROXIMATELY 2'-0" BEHIND THE LANE TRANSITION STRIPE.

MISSISSIPPI DEPARTMENT OF TRANSPORTATION
ROADWAY DESIGN DIVISION
STANDARD PLAN

HIGHWAY SIGN AND BARRICADE DETAILS FOR CONSTRUCTION PROJECTS

DATE	REVISION

ISSUE DATE: MAY 20, 2017

STATE MISS.	PROJECT NO.	
----------------	-------------	--

MOBILE OPERATIONS ON MULTILANE ROAD

MOBILE OPERATIONS ON MULTILANE ROAD

NOTES FOR MULTILANE LANE OPERATION:

- VEHICLES USED FOR THESE OPERATIONS SHOULD BE MADE HIGHLY VISIBLE WITH APPROPRIATE EQUIPMENT, SUCH AS FLASHING LIGHTS, ROTATING BEACONS, FLASGS, SIGNS, OR ARROW PANELS.
- SHADOW VEHICLE 2 SHOULD BE EQUIPPED WITH AN ARROW PANEL AND TRUCK MOUNTED ATTENUATOR (TMA), AN APPROPRIATE LANE CLOSURE SIGN SHOULD BE PLACED BEHIND SHADOW VEHICLE 2 SO AS NOT TO OBSCURE THE ARROW PANEL.
- SHADOW VEHICLE 1 SHOULD BE EQUIPPED WITH AN ARROW PANEL AND TRUCK MOUNTED ATTENUATOR (TMA).
- SHADOW VEHICLE 2 SHOULD TRAVEL AT A VARYING DISTANCE FROM THE WORK OPERATION SO AS TO PROVIDE ADEQUATE SIGHT DISTANCE FOR TRAFFIC APPROACHING FROM THE REAR.
- WHEN ADEQUATE SHOULDER WIDTH IS NOT AVAILABLE, SHADOW VEHICLE 2 SHOULD BE ELIMINATED.
- ON HIGH-SPEED ROADWAYS, A THIRD SHADOW VEHICLE SHOULD BE USED (i.e., VEHICLE 3 ON THE SHOULDER OF PRACTICALLY, VEHICLE 2 IN THE CLOSED LANE, AND VEHICLE 1 IN THE CLOSED LANE).
- ARROW PANELS SHALL BE AS A MINIMUM, TYPE B, 60" X 30", IN ACCORDANCE WITH THE CRITERIA PRESENTED IN THE MUTCD.
- WORK SHOULD NORMALLY BE DONE DURING OFF-PEAK HOURS.
- VEHICLE-MOUNTED SIGNS SHOULD BE MOUNTED WITH THE BOTTOM OF THE SIGN LOCATED AT A MINIMUM HEIGHT OF 48" ABOVE THE PAVEMENT AND SHALL NOT BE OBTURED BY EQUIPMENT OR SUPPLEMENTARY SIGN LEGENDS SHALL BE COVERED OR TURNED FROM VIEW WHEN WORK IS NOT IN PROGRESS.
- ALL TRAFFIC CONTROL ITEMS SHOWN ON THIS SHEET WILL NOT BE MEASURED FOR SEPARATE PAYMENT. THIS WORK IS TO BE INCLUDED IN THE PRICE BID FOR MAINTENANCE OF TRAFFIC.

MOBILE OPERATIONS ON TWO-LANE ROAD

MOBILE OPERATIONS ON TWO-LANE ROAD

NOTES FOR TWO-LANE OPERATION:

- WHERE PRACTICAL AND WHEN NEEDED, THE WORK AND SHADOW VEHICLES SHOULD PULL OVER PERIODICALLY TO ALLOW TRAFFIC TO PASS. IF THIS CAN NOT BE DONE FREQUENTLY AS AN ALTERNATIVE, A "DO NOT PASS" SIGN MAY BE PLACED ON THE REAR OF THE VEHICLE BLOCKING THE LANE.
- THE DISTANCE BETWEEN THE WORK AND SHADOW VEHICLES MAY VARY ACCORDING TO TERRAIN, PAINT DRYING TIME, AND OTHER FACTORS. SHADOW VEHICLES ARE USED TO WARN TRAFFIC OF THE OPERATION AHEAD, WHENEVER ADEQUATE SIGHT DISTANCE CANNOT BE MAINTAINED. SHADOW VEHICLES SHOULD MAINTAIN THE MINIMUM DISTANCE AND PROCEED AT THE SAME SPEED AS THE WORK VEHICLE. THE SHADOW VEHICLE SHOULD SLOW DOWN IN ADVANCE OF VERTICAL OR HORIZONTAL CURVES THAT RESTRICT SIGHT DISTANCE.
- ADDITIONAL SHADOW VEHICLES TO WARN AND REDUCE THE SPEED OF ONCOMING OR OPPOSING TRAFFIC MAY BE USED. POLICE PATROL CARS MAY BE USED FOR THIS PURPOSE.
- A TRUCK-MOUNTED ATTENUATOR (TMA) SHOULD BE USED ON THE SHADOW VEHICLE AND MAY BE USED ON THE WORK VEHICLE.
- THE WORK VEHICLE SHALL BE EQUIPPED WITH BEACONS AND THE SHADOW VEHICLE SHALL BE EQUIPPED WITH BEACONS AND LIGHTS. TRUCK-MOUNTED LIGHTS MOUNTED ON THE REAR, ADJACENT TO THE SIGN, SHADOW AND WORK VEHICLES SHALL DISPLAY FLASHING OR ROTATING BEACONS BOTH FORWARD AND TO THE REAR.
- VEHICLE-MOUNTED SIGNS SHOULD BE MOUNTED WITH THE BOTTOM OF THE SIGN LOCATED AT A MINIMUM HEIGHT OF 48" ABOVE THE PAVEMENT AND SHALL NOT BE OBTURED BY EQUIPMENT OR SUPPLEMENTARY SIGN LEGENDS SHALL BE COVERED OR TURNED FROM VIEW WHEN WORK IS NOT IN PROGRESS.
- ARROW BOARD TO BE USED IN CAUTION MODE.
- ALL TRAFFIC CONTROL ITEMS SHOWN ON THIS SHEET WILL NOT BE MEASURED FOR SEPARATE PAYMENT. THIS WORK IS TO BE INCLUDED IN THE PRICE BID FOR MAINTENANCE OF TRAFFIC.

AB	REVISION	DATE	BY	CHECKED	DATE	BY	CHECKED	DATE	BY

MISSISSIPPI DEPARTMENT OF TRANSPORTATION
 ROADWAY DESIGN DIVISION
 STANDARD PLAN
TRAFFIC CONTROL PLAN
MOBILE OPERATIONS
MULTILANE ROADS
TWO-LANE ROADS

ISSUE DATE: MAY 01, 2017
 SHEET NUMBER: TCP-9
 PROJECT NUMBER: G333

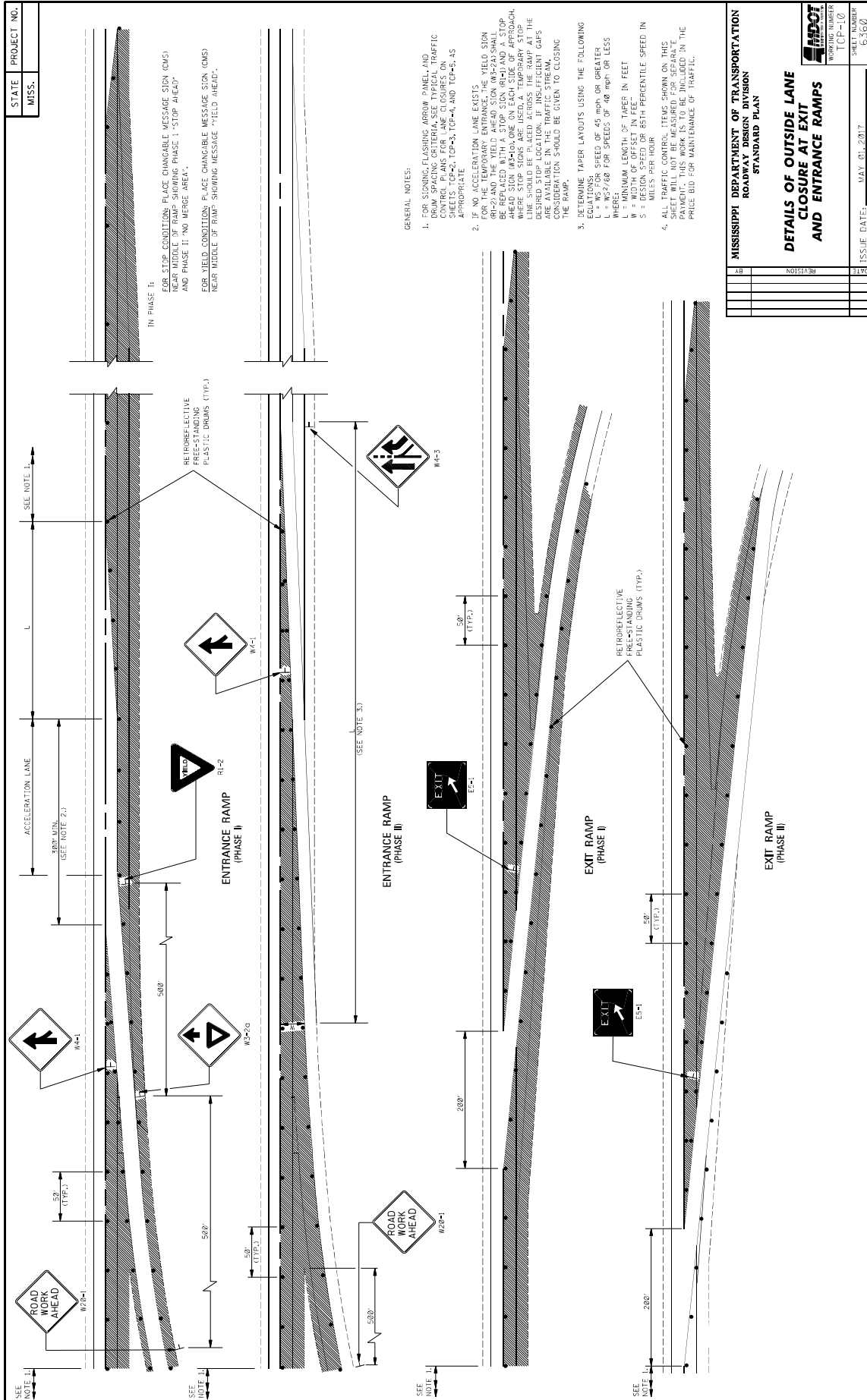

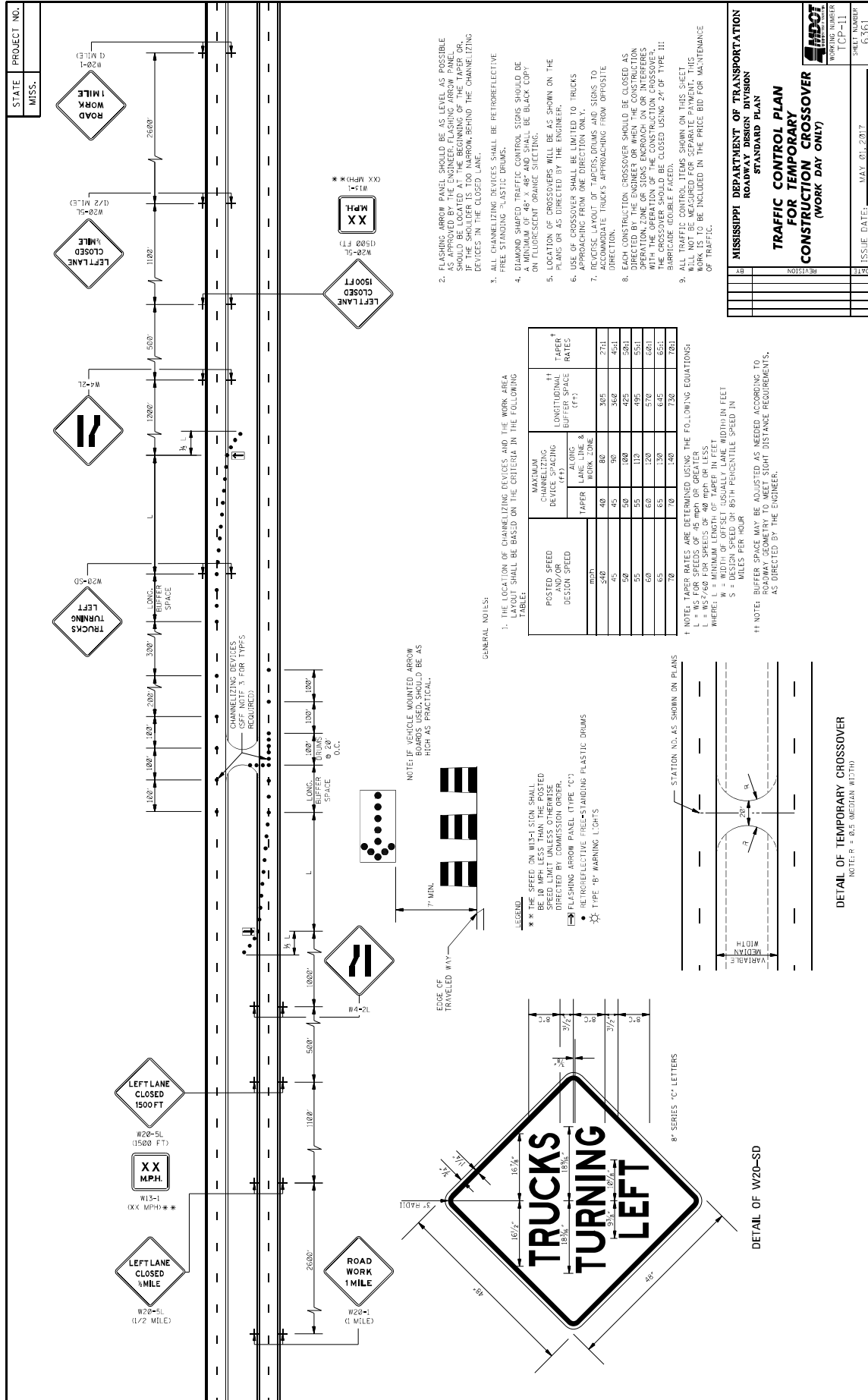

1. THE LOCATION OF CHANNELIZING DEVICES AND THE WORK AREA TAPERS SHALL BE BASED ON THE CRITERIA IN THE FOLLOWING TABLE:
2. FLASHING ARROW PANELS SHOULD BE AS LEVEL AS POSSIBLE AS APPROVED BY THE ENGINEER. FLASHING ARROW PANELS SHOULD BE LOCATED AT THE BEGINNING OF THE TAPER OR, IF THE SHOULDER IS TOO NARROW, BEHIND THE CHANNELIZING DEVICES IN THE CLOSED LANE.
3. ALL CHANNELIZING DEVICES SHALL BE RETROREFLECTIVE FREE STANDING PLASTIC DUMPS.
4. DIAMOND SHAPED TRAFFIC CONTROL SIGNS SHOULD BE BLACK COPY ON FLUORESCENT ORANGE SUCTING.
5. LOCATION OF CROSSOVERS WILL BE AS SHOWN ON THE PLANS OR AS DIRECTED BY THE ENGINEER.
6. USE OF CROSSOVERS SHALL BE LIMITED TO TRUCKS APPROACHING FROM ONE DIRECTION ONLY.
7. REVERSE LAYOUT OF TAPERS, DUMPS AND SIGNS TO ACCOMMODATE TRUCKS APPROACHING FROM OPPOSITE DIRECTION.
8. EACH CONSTRUCTION CROSSOVER SHOULD BE CLOSED AS EARLY AS POSSIBLE AND BE OPENED AS SOON AS POSSIBLE WITH THE OPERATION OF THE CONSTRUCTION CROSSOVER. THE CROSSOVER SHOULD BE CLOSED USING 24" OF TYPE III BITUMEN SEALANT.
9. ALL TRAFFIC CONTROL ITEMS SHOWN ON THIS SHEET WILL NOT BE MEASURED FOR SEPARATE PAYMENT. THIS WORK IS TO BE INCLUDED IN THE PRICE BID FOR MAINTENANCE OF TRAFFIC.

POSTED SPEED AND/OR DESIGN SPEED	MAXIMUM CHANNELIZING DEVICE SPACING	TAPER RATES	LONGITUDINAL BUFFER SPACE (FT)	TAPER RATES
45	49	82	305	274
50	45	80	368	464
55	50	100	425	501
60	55	112	495	551
65	60	120	570	601
70	65	130	645	651
75	70	140	730	701

NOTE: TAPER RATES ARE DETERMINED USING THE FOLLOWING EQUATIONS:
 W = WIDTH OF OFFSET USUALLY LANE WIDTH IN FEET
 L = MINIMUM LENGTH OF TAPER IN FEET
 S = MINIMUM LENGTH OF TAPER IN FEET
 WHERE: L = WSP/40 FOR SPEEDS OF 40 MPH OR LESS
 L = WSP/40 FOR SPEEDS OF 40 MPH OR LESS
 S = 65TH PERCENTILE SPEED IN MILES PER HOUR

NOTE: BUFFER SPACE MAY BE ADJUSTED AS NEEDED ACCORDING TO ROADWAY GEOMETRY TO MEET SIGHT DISTANCE REQUIREMENTS, AS DIRECTED BY THE ENGINEER.

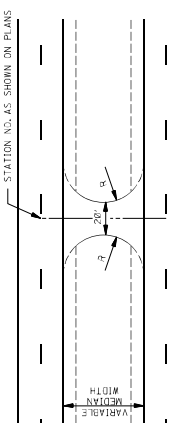

DETAIL OF TEMPORARY CROSSOVER
 NOTE: P = 65th PERCENTILE SPEED

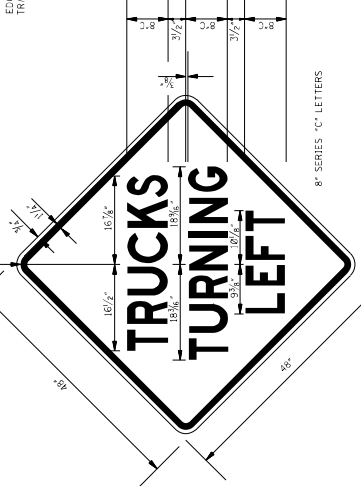

8" SERIES 'C' LETTERS
 DETAIL OF W20-SD

STATE PROJECT NO.
MISS.

MISSISSIPPI DEPARTMENT OF TRANSPORTATION
 ROADWAY DESIGN DIVISION
 STANDARD PLAN
**TRAFFIC CONTROL PLAN
 FOR TEMPORARY
 CONSTRUCTION CROSSOVER
 (WORK DAY ONLY)**

WORKING NUMBER: TCR-11
 SHEET NUMBER: 6361

ISSUE DATE: MAY 01, 2017

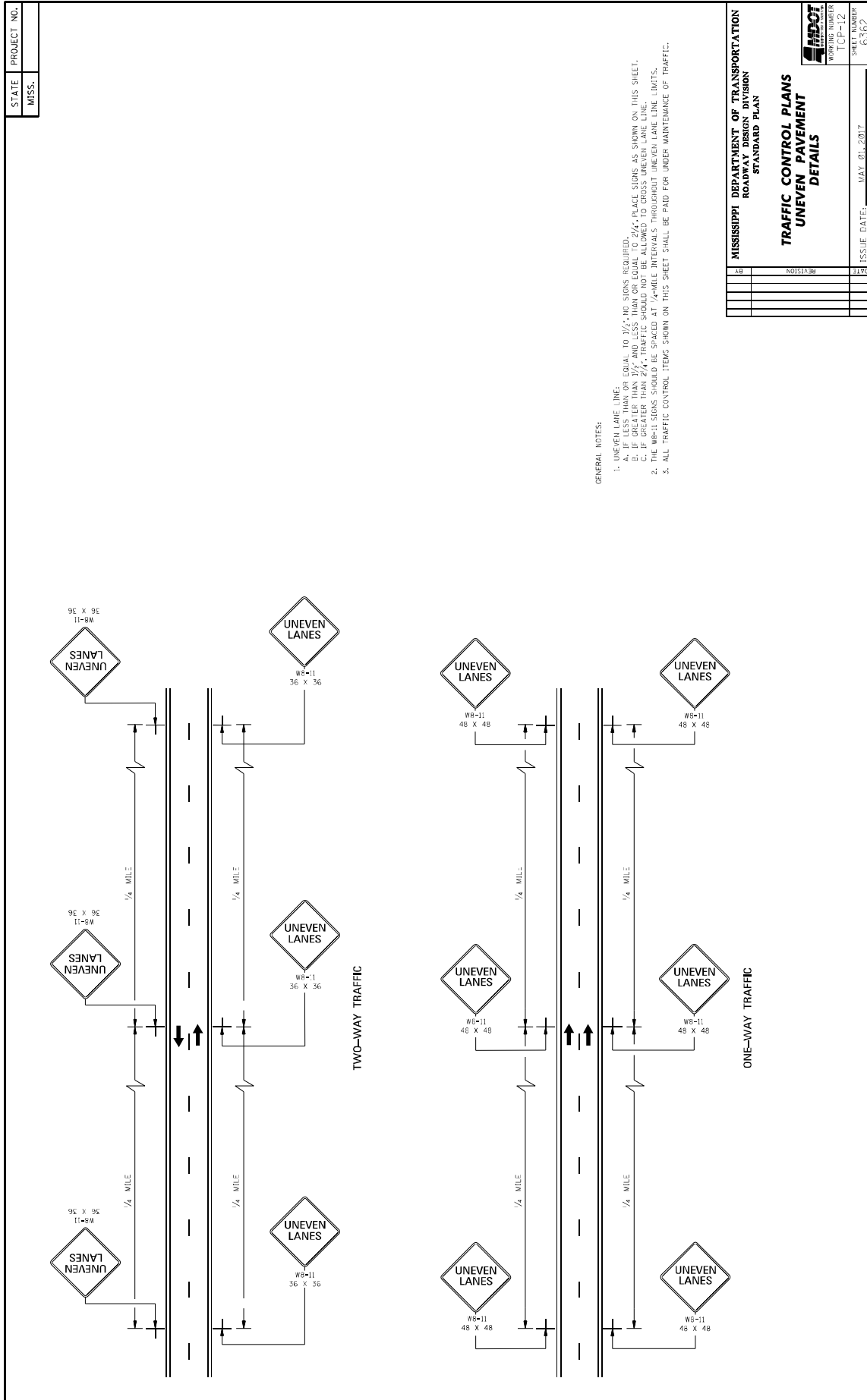

MISSISSIPPI DEPARTMENT OF TRANSPORTATION ROADWAY DESIGN DIVISION STANDARD PLAN	
TRAFFIC CONTROL PLANS UNEVEN PAVEMENT DETAILS	
ISSUE DATE: MAY 01, 2017	SHEET NUMBER TCP-12 6262
REVISION	DATE

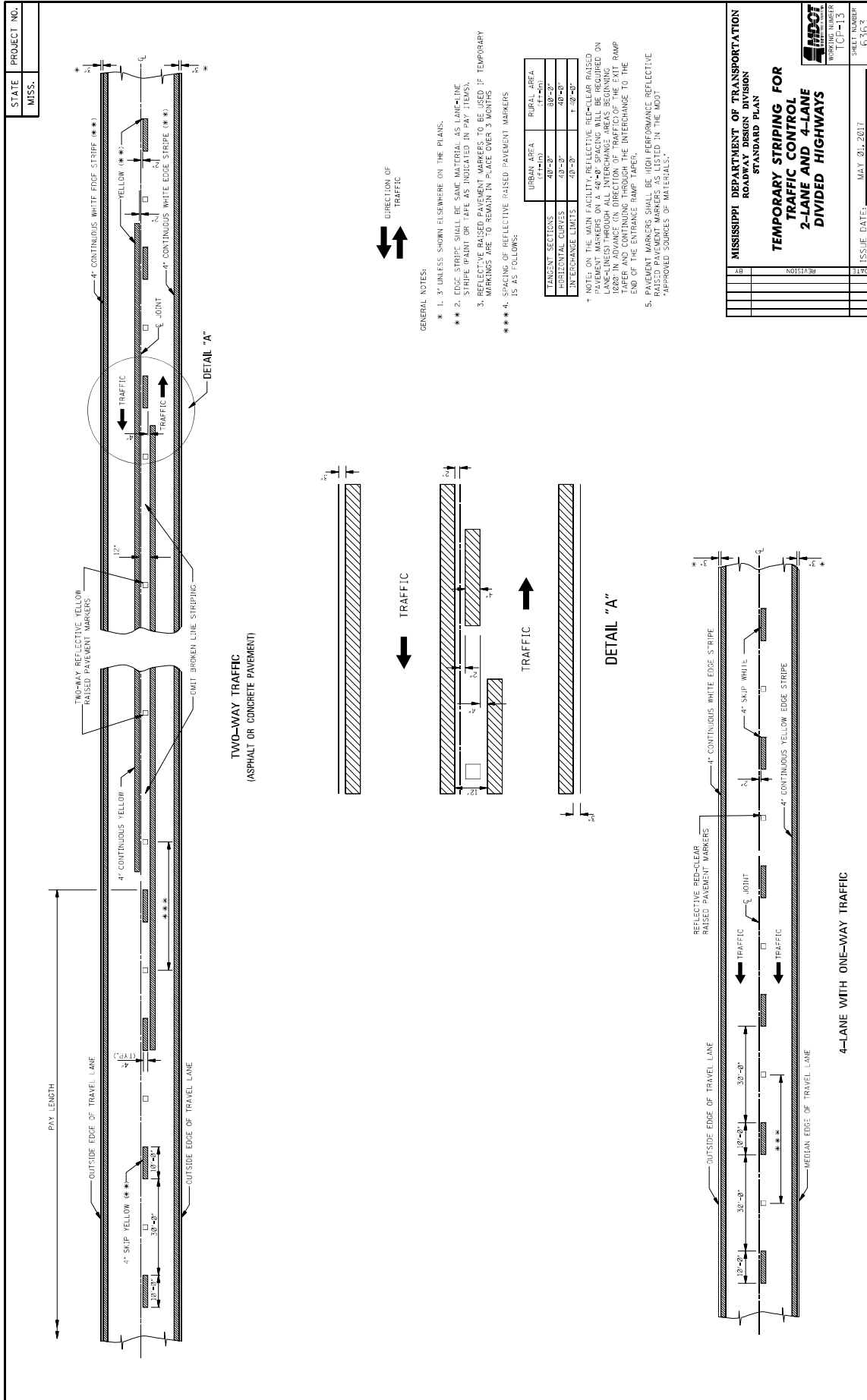

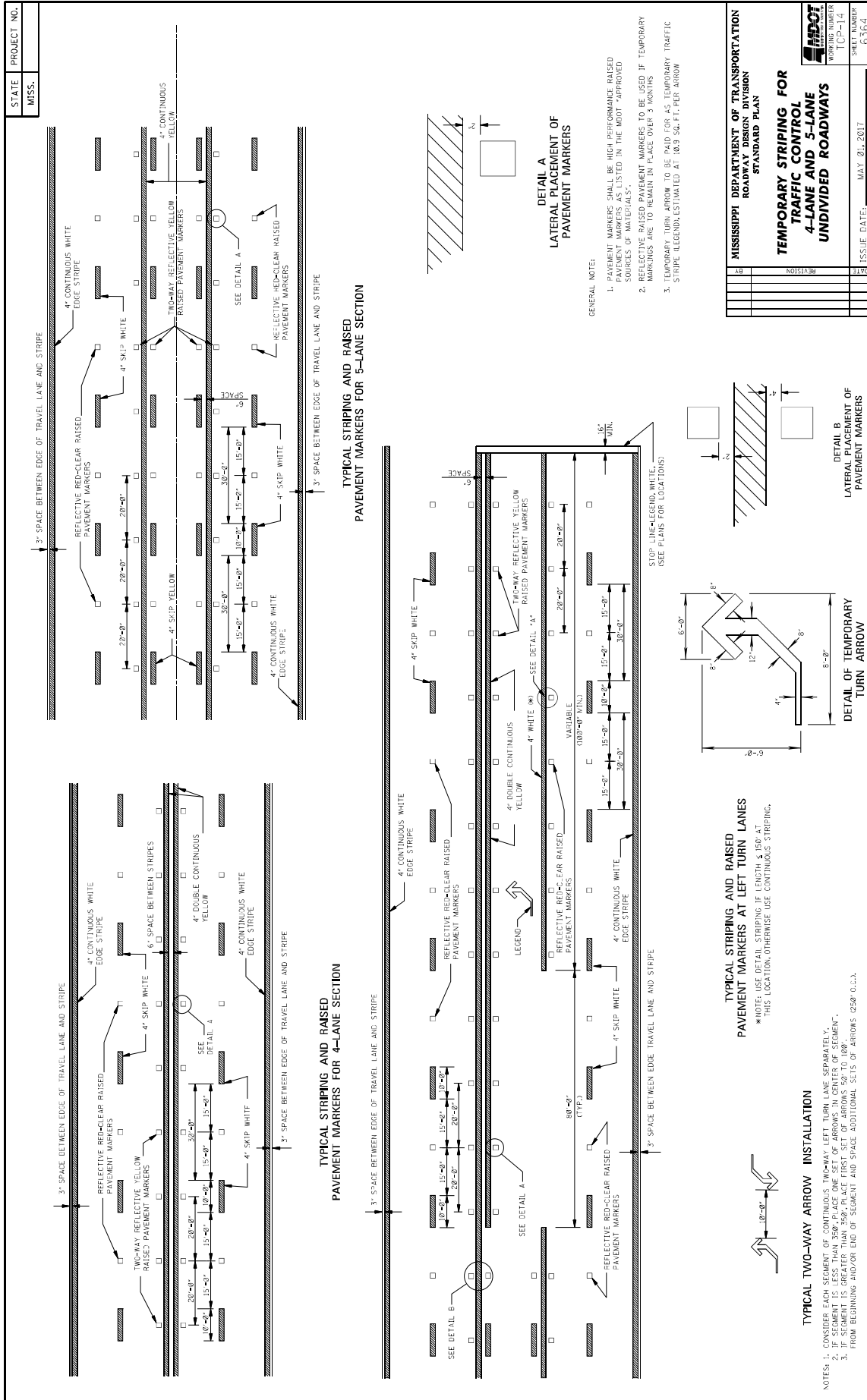

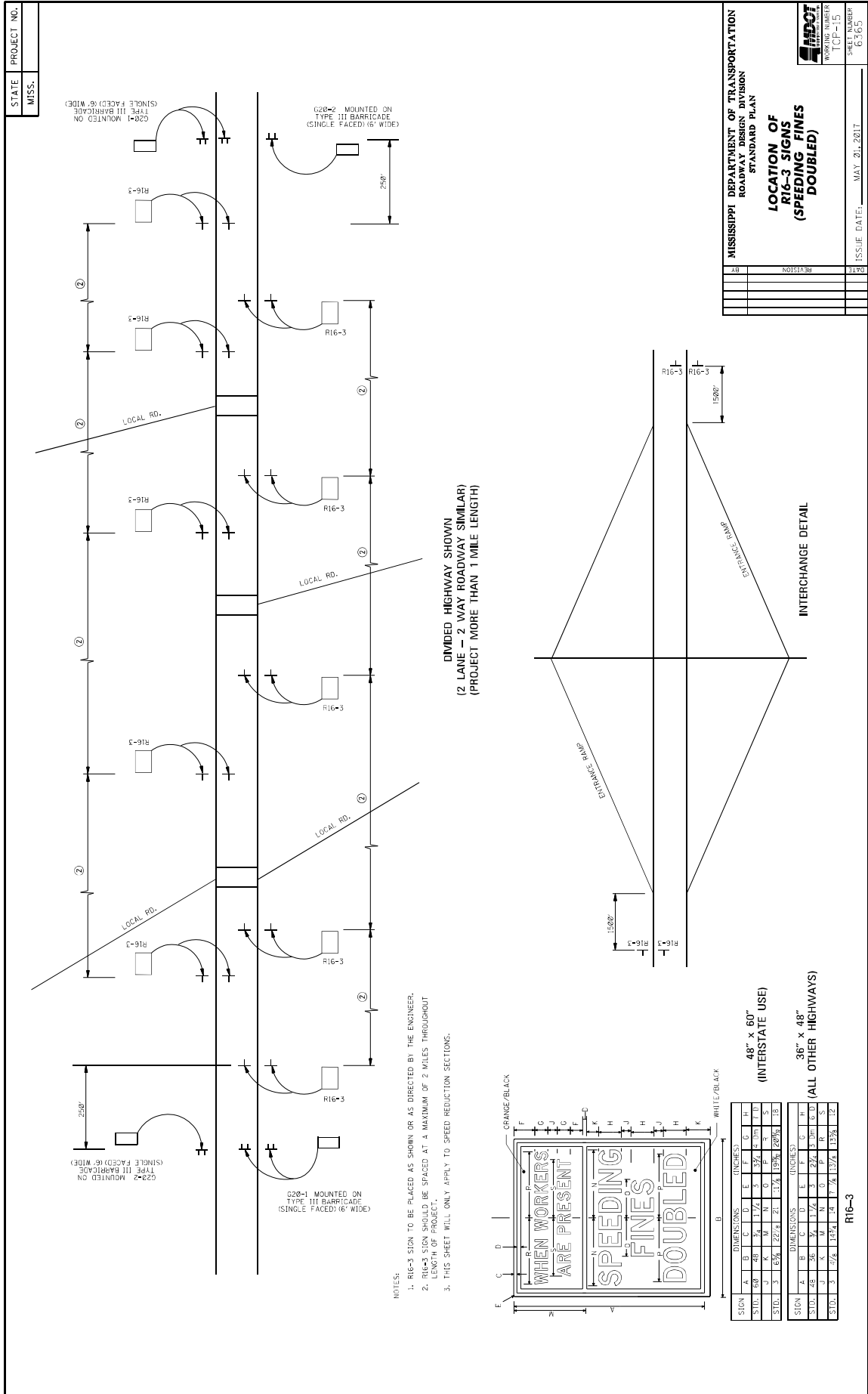

- NOTES:**
1. R16-3 SIGN TO BE PLACED AS SHOWN OR AS DIRECTED BY THE ENGINEER.
 2. R16-3 SIGN SHOULD BE SPACED AT A MAXIMUM OF 2 MILES THROUGHOUT LENGTH OF PROJECT.
 3. THIS SHEET WILL ONLY APPLY TO SPEED REDUCTION SECTIONS.

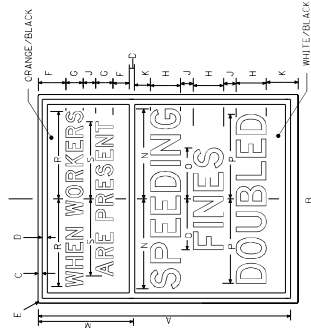

48" x 60"
(INTERSTATE USE)

36" x 48"
(ALL OTHER HIGHWAYS)

SIGN	A	B	C	D	E	F	G	H
ST10	60	48	36	1 1/2	5	5 1/2	4	1 1/2
ST11	48	36	24	1 1/2	3 1/2	4	3	1 1/2

SIGN	A	B	C	D	E	F	G	H
ST12	48	36	24	1 1/2	3 1/2	4	3	1 1/2
ST13	36	24	18	1 1/2	2 1/2	3	2	1 1/2

**MISSISSIPPI DEPARTMENT OF TRANSPORTATION
ROADWAY DESIGN DIVISION
STANDARD PLAN**

**LOCATION OF
R16-3 SIGNS
(SPEEDING FINES
DOUBLED)**

DATE	REVISION

ISSUE DATE: MAY 21, 2017
DRAWING NUMBER: ICF-15
SHEET NUMBER: 63-663

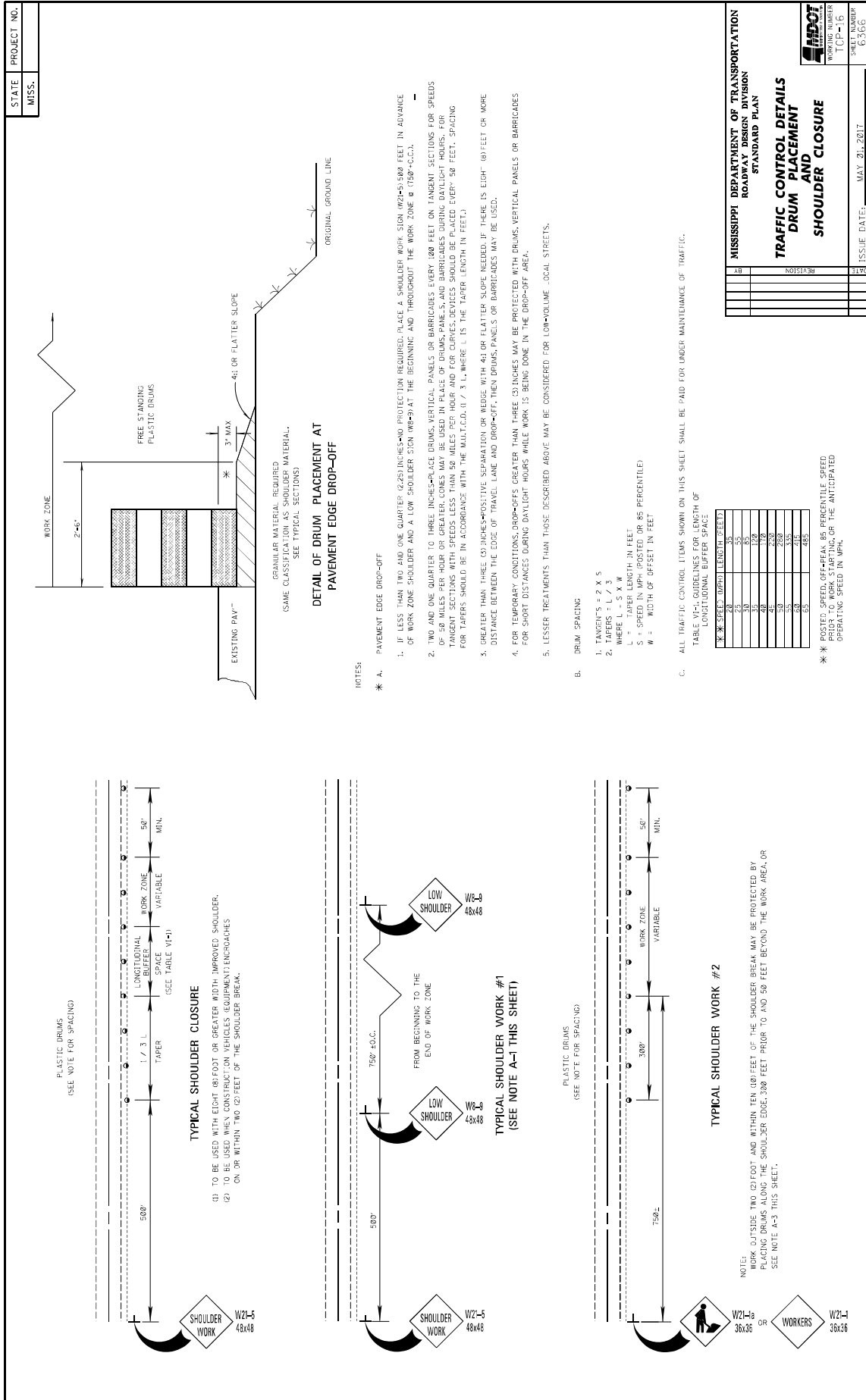

GENERAL NOTES

1. GROUND-IN RUMBLE STRIPES SHALL BE APPLIED TO ALL PAVED SHOULDERS OF ALL PAVED SHOULDERS ON THIS PROJECT.
2. GROUND-IN RUMBLE STRIPES SHALL BE APPLIED TO ALL EXISTING AND NEW ROADS, INCLUDING INTERSECTIONS, NORMAL SHOULDER WIDTH AS DIRECTED BY THE ENGINEER.
3. COST TO BE PAID FOR USING APPROPRIATE PAY ITEMS.
4. GROUND-IN RUMBLE STRIPES SHALL BE APPLIED TO:
 - A. MAINLINE
 - B. INTERSECTING ROADWAY IF OVERLAP OR RECONSTRUCTED BEYOND NORMAL MAINLINE R.O.W.
 - C. ANY ROADWAY WITH EXISTING RUMBLE STRIPES PRIOR TO CONSTRUCTION.
5. DO NOT USE WHERE TRAVEL LANE IS LESS THAN 11' WIDE.

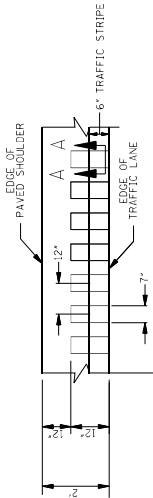

SECTION "A-A"

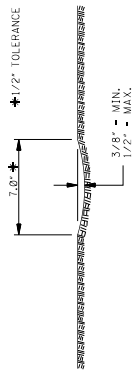

SECTION "A-A"

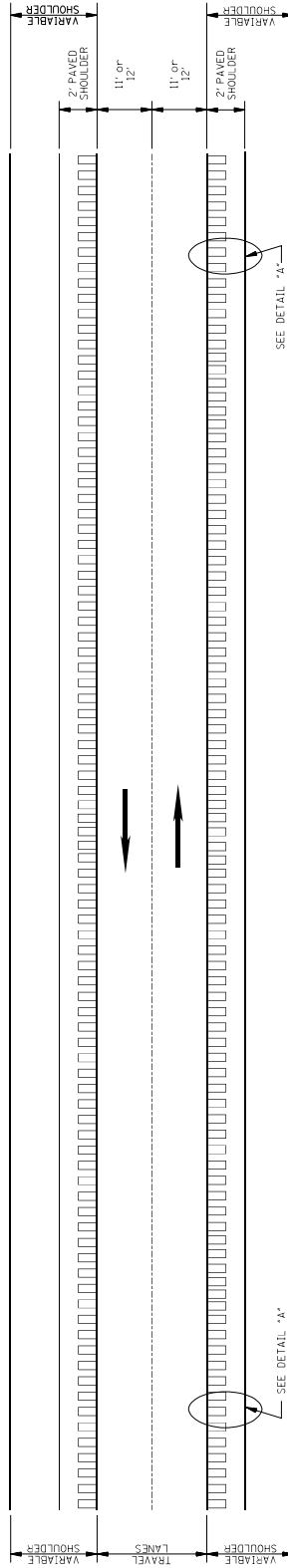

PLAN

NOT TO SCALE

MISSISSIPPI DEPARTMENT OF TRANSPORTATION			PROJECT NUMBER RS-1	DRAWING NUMBER 606-4
ROADWAY DESIGN DIVISION				
STANDARD PLAN		ISSUE DATE: AUGUST 01, 2017		
DATE	REVISION			
05/17	05/17			

**RUMBLE STRIPES
2-LANE HIGHWAYS
(ASPHALT LANES,
2-FT ASPHALT SHOULDERS)**

GENERAL NOTES

- GROUND-IN RUMBLE STRIPES SHALL BE APPLIED TO ALL PAVED SHOULDERS, ALL PAVED SHOULDERS ON THIS PROJECT.
- GROUND-IN RUMBLE STRIPES SHALL BE APPLIED TO ALL TRAFFIC LANE INTERSECTIONS, ROADWAYS, AND OTHER INTERSECTIONS IN NORMAL SHOULDER WIDTH AS DIRECTED BY THE ENGINEER.
- COST TO BE PAID FOR USING APPROPRIATE PAY ITEMS.
- GROUND-IN RUMBLE STRIPES SHALL BE APPLIED TO:
 - MAINLINE
 - INTERSECTING ROADWAY IF OVERLAP OR RECONSTRUCTED BEYOND NORMAL MAINLINE R.O.W.
 - ANY ROADWAY WITH EXISTING RUMBLE STRIPES PRIOR TO CONSTRUCTION.

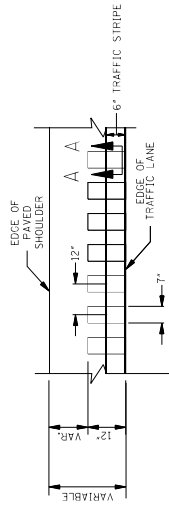
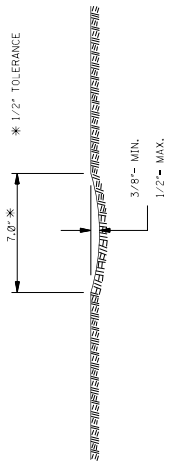

SECTION "A-A"

DETAIL "A"

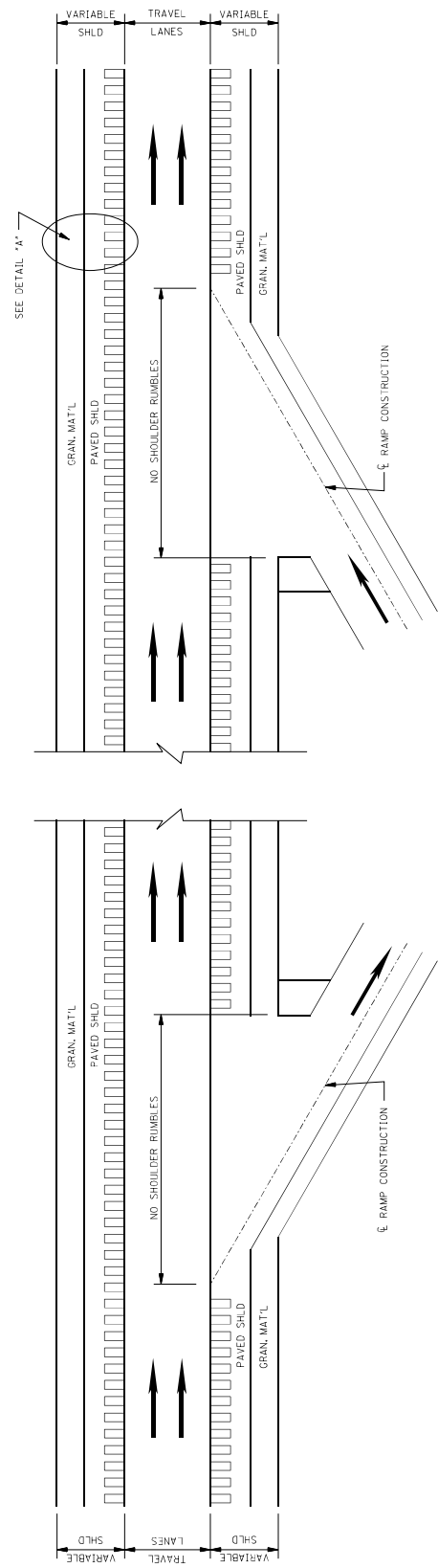

MISSISSIPPI DEPARTMENT OF TRANSPORTATION
ROADWAY DESIGN DIVISION
STANDARD PLAN

**RUMBLE STRIPES
4-LANE HIGHWAYS
(ASPHALT LANES,
2-FT OR WIDER,
ASPHALT SHOULDERS)**

DATE	REVISION
05/08	05/08
05/08	05/08
05/08	05/08
05/08	05/08

ISSUE DATE: AUGUST 01, 2017

NUMBER 6065

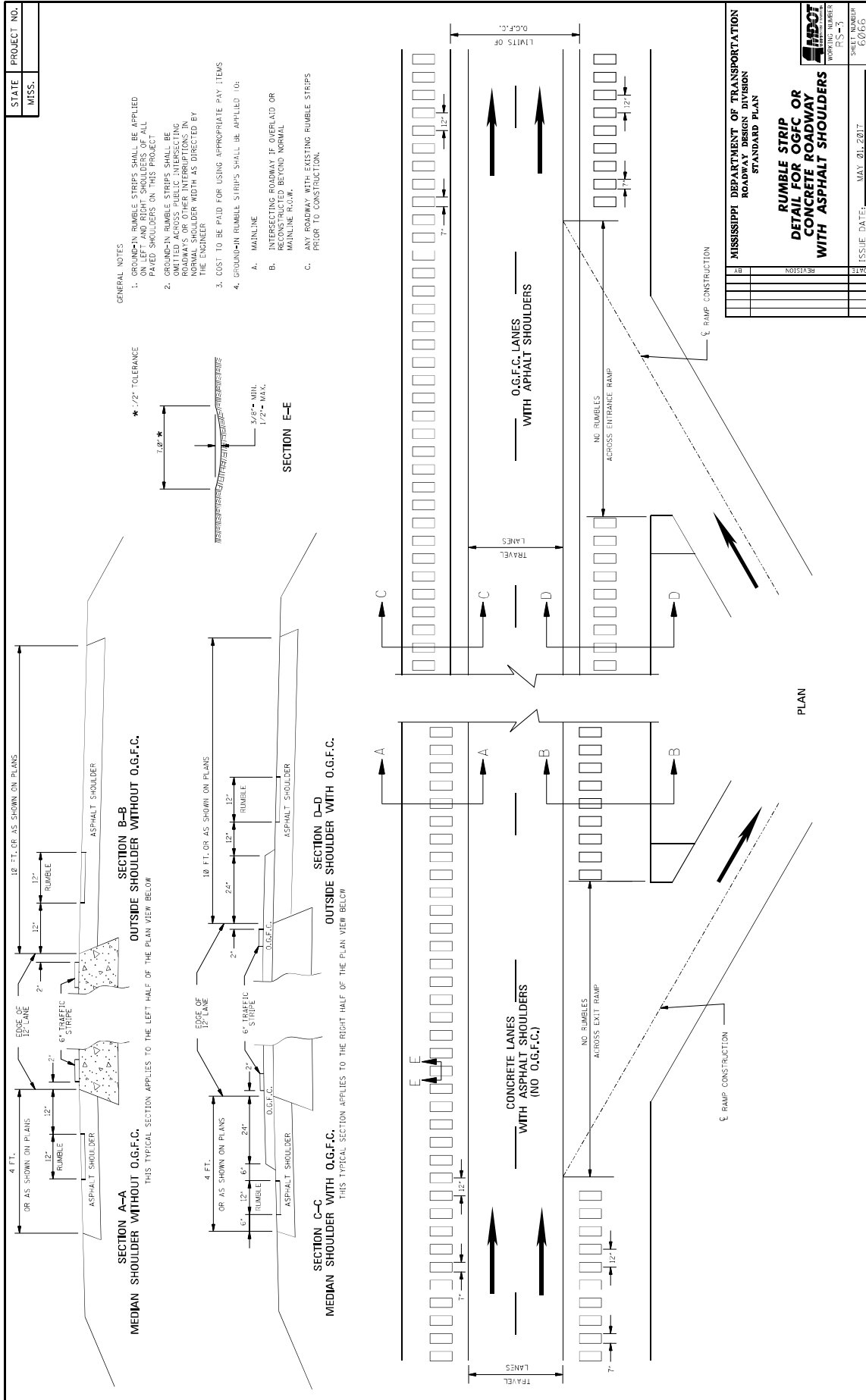

MISSISSIPPI DEPARTMENT OF TRANSPORTATION

SECTION 904 - NOTICE TO BIDDERS NO. 3302

CODE: (SP)

DATE: 4/20/2021

SUBJECT: Contract Time

PROJECT: MP-5015-51(021) / 307480301 – Newton County

The completion of work to be performed by the Contractor for this project will not be a specified date but shall be when all allowable working days are assessed, or any extension thereto as provided in Subsection 108.06. It is anticipated that the Notice of Award will be issued no later than **June 8, 2021** and the date for Notice to Proceed / Beginning of Contract Time will be **July 8, 2021**.

Should the Contractor request a Notice to Proceed earlier than **July 8, 2021** and it is agreeable with the Department for an early Notice to Proceed, the requested date will become the new Notice to Proceed date. Regardless of whether or not an early Notice to Proceed is granted, contract time will start at the original Notice to Proceed date.

All requests for an early Notice to Proceed shall be sent to the Project Engineer who will forward it to the Contract Administration Division.

120 Working Days have been allowed for the completion of work on this project.

MISSISSIPPI DEPARTMENT OF TRANSPORTATION

SECTION 904 - NOTICE TO BIDDERS NO. 3303

CODE: (SP)

DATE: 04/15/2021

SUBJECT: Scope of Work

PROJECT: MP-5015-51(021) / 307480301 – Newton County

The contract documents do not include an official set of construction plans but may, by reference, include some Standard Drawings when so specified in a Notice to Bidders entitled, “Standard Drawings”.

Work on this project shall consist of the following:

Mill and overlay approximately 7.5 miles of SR 15 from the pavement change south of Decatur (Station 10+00) to Henry Mack Smith Road (Station 408+38). Details of specific work are mentioned in the following sections.

SR 15 from Station 10+00 to Station 75+58

The Contractor shall mill 1½” of existing asphalt including turn lanes, county roads, and driveway pads; then overlay with an average depth of 2” using 12.5-mm, MT, asphalt. Where curb is present, asphalt shall be placed at 1½” on the outside edge to tie into curb line. The center turn lane in this section shall be milled in a manner to preserve the 2% crown in the tangent sections. Existing traffic loops shall be replaced with radar detection system at the intersection of SR 15 and West Broad Street according to the attached table.

At approximate Station 60+20 RRL, a 36” x 23” concrete class A III arch pipe and a 36”x 23” concrete arch pipe flared end section shall be removed and replaced prior to the start of milling and paving operations. Borrow material, Class B-15, shall be used to restore original shoulder grade after pipe is placed and rip-rap shall be placed at the outflow of the flared end section as directed by the Engineer. Class B minor structures concrete shall be used to pour a concrete collar around pipe junction and a toe wall at the end of the FES. All site grading and grassing needed in this area shall be absorbed in the removal and replacement of said pipe. The existing pipe shall become the property of the Contractor and removed from the project.

SR 15 from Station 75+58 to Station 81+30

The Contractor shall mill 1½” of existing asphalt including county roads, and driveway pads; then overlay with an average depth of 2” using 12.5-mm, MT, asphalt. Rumble strips shall be placed up to the 45 mph sign just north of Decatur.

SR 15 Station 81+30 to Station 408+38

Failed JRCP joints, listed in the attached table, shall be repaired full depth using 12.5-mm, MT, Leveling, asphalt. A minimum 3-inch width on either side of joint (6’ total width) removal of existing asphalt overlaid concrete shall be required. Repair of the existing pavement widening,

also listed in the attached table, shall be required full depth and replaced using 12.5-mm, MT, Leveling, asphalt. The top 1½” of existing asphalt on mainline shall be milled and overlay with 2” and variable of 12.5-mm, MT, asphalt. The joints in the asphalt over JRCP shall be sawed and sealed. The Contractor shall be responsible for identifying PCC joint locations. Guardrail listed in the attached table shall be replaced according to the attached standards. The guardrail located at Station 197+00 RT & LT shall be installed using the long-span two-way layout system in the attached details. Rumble strips shall be placed through the entire section.

Between approximate Station 337+25 & 341+75 RT lane, the existing ditch erosion shall be repaired with borrow excavation Class B-15 (See attached detail). In areas where the existing back slope has eroded into a shear face, material shall be cut back to a slope as directed by the Engineer before borrow material is added. Once the ditch is at a suitable ditch grade, 300-lb rip rap shall be used to plate the ditch line. Care shall be taken such that at no point does the rip rap at the top of foreslope stand above the shoulder elevation. Rip rap at this point shall be recessed into the shoulder. MS 811 shall be contacted to mark existing utilities in this area prior to repair. All site grading and grassing needed in this area shall be absorbed in other items bid.

GENERAL NOTES

Milling

Milling/paving shall not begin until an **approved** asphalt mix design has been received, nor until such time that, in the opinion of the Engineer, weather conditions have been consistently suitable enough to allow placement of the asphalt pavement after the milling operations.

The Reclaimed Asphalt Pavement (RAP) material removed by the milling operation shall become the property of the Contractor.

Where milling is required, the Contractor shall provide outlets in the existing shoulders at sufficient intervals to prevent pooling or standing water on the milled surface; the cost of which shall be absorbed in other items bid.

Milling and paving operations shall be performed such that a -2% slope from centerline is provided in normal crown roadway sections. Super-Elevation through curves shall be maintained as it currently exists or improved as directed.

Milling operations shall be performed in accordance with the Contract Documents and the MDOT Standard Specifications. Variable width and length transitions may be required for ties at ramps, local roads, and project limits.

Milling of driveway pads shall be conducted in a manner to prevent gouging or otherwise affecting the roadway pavement structure and slope. Milling of driveway pads shall not be performed in simultaneous path with main line milling.

Traffic will be allowed to travel on the milled surface for seven (7) days. Traffic will be allowed to run on all milled local roads for seven (7) days, unless otherwise stated. Approved mix designs must be on hand prior to milling. Milling operations shall not commence until such time that, in the opinion of the Engineer, weather conditions have been consistently suitable enough to allow the placement of the asphalt pavement after the milling operations

Paving

Prior to mainline milling and paving operations, failed areas in the existing pavement shall be removed and backfilled with 12.5-mm, MT, Leveling, asphalt as per the attached typical sections and details. Asphalt shall be placed in multiple lifts with a maximum lift thickness of 2.5”. Any granular/chemically treated/stone/etc. base or subgrade material deemed unsuitable by the Engineer shall be removed as directed and backfilled with 12.5-mm, MT, Leveling, asphalt. Payment for the excavation of the granular base and subgrade will be made using pay item 203-G: Excess Excavation. A list of the failed areas is shown in the attached tables. Pavement repairs shall be completed as a continuous operation in order to minimize traffic impacts. Lane closures shall remain in place until the failed area has been completely repaired. Lane closures shall not be left unattended.

Payment for saw cuts on failed areas will be made using the appropriate pay items. If milling techniques are used, the area will not require saw cuts but care should be exercised in order to create a neat removal line and to prevent damage to the adjacent pavement structure. If saw cuts are used in conjunction with milling, payment will be made using the appropriate items. Payment will not be made for saw cuts not performed.

Publicly maintained roads and streets should be paved to the existing right-of-way and in accordance with the attached drawings.

Privately owned entrances shall be paved to the shoulder line per the included typical drawing, unless otherwise directed. Pad dimensions shall match the existing lengths and widths, unless otherwise directed. Pads shall be shaped horizontally and vertically to prevent excessive drop-offs. Any new driveway pads deemed necessary by the Engineer shall be placed according to specifications.

Granular Shoulder Material

Any material excavated from the existing shoulder during pavement widening operations or as a result of shoulder blading shall be used on the existing shoulder to match the new pavement elevation and any surplus material shall be spread along the edge of the shoulders, fore slopes, or other adjacent areas as directed by the Engineer and will be an absorbed item. Material which cannot be suitably placed in adjacent areas and deemed to be excess excavation by the Engineer shall be removed from the project site. Payment for removal of excess material will be made using pay item 203-G: Excess Excavation.

Granular material (crushed stone) shall be provided around driveway pads as directed to prevent shoulder drop-offs and shall be placed in a timely manner. Drop-offs exceeding 2½” shall be corrected within two (2) calendar days of the placement of the pad.

Where applicable, the existing shoulders shall be raised to match the new pavement elevation by placing variable depth granular material (crushed stone). Placement of the granular material on the finished asphalt course shall not be permitted. The existing shoulder shall be scarified to allow incorporation of the new shoulder material. The material shall be bladed, rolled, and compacted to a finished slope of four percent (4%) in normal crown sections. Placement of this material shall be performed to provide a uniform and compacted shoulder with a minimum depth and width of material placed. Shoulders with adequate shoulder material in place shall be bladed to a slope of four percent (4%) in normal crown sections. The cost of blading will be an absorbed item and shall be included in the price of other items bid. Crushed concrete will not be allowed.

Temporary and Permanent Pavement Markings

Temporary traffic stripe will be required immediately after the milling and/or required overlay and prior to opening area to traffic. Temporary stripe shall be placed in the same location and configuration as the permanent stripe except that it may be offset as required for milling and paving operations. If temporary stripe is offset, the Contractor shall conduct operations in a manner to insure the final temporary stripe is placed at the required location of the permanent stripe. If removal of temporary offset stripe is required in order to achieve the correct location and alignment of permanent stripe, the cost of removal will be absorbed in other items bid. Placing double temporary centerline will not be allowed.

Temporary striping shall conform to finished stripe specifications for alignment, neatness, and straightness.

The use of short strips of traffic tape will not be allowed unless approved by the Engineer.

All permanent striping will be double drop thermoplastic, 90-mil thickness unless otherwise specified in Subsection 626.03.1.2. Edge lines will be placed to accommodate the lane widths shown on the attached applicable typical sections unless prevented by field conditions.

Guardrail

Guardrails shall be replaced at the locations shown on the attached table. Removal of guardrail shall consist of removal of bridge end section, w-beam/thrie beam, terminal end section, posts, and all other appurtenances. All guardrail removed shall be replaced the same day and prior to re-opening the adjacent lane of traffic. Voids created by the removal of posts, concrete anchors, footings, etc. shall be backfilled and tamped in accordance with Section 203 of the Standard Specifications.

Asphalt shall be extended under the guard rail and two feet (2') behind guard rail post as per the attached detail. The area to be paved shall be bladed to accommodate three inches (3") of asphalt. The elevation of the finished surface of the asphalt pavement shall provide for the required MASH guardrail height (see Standard Drawings). Pavement around guardrail posts shall be blocked out in accordance with the attached drawing. The excavated material shall be retained and used to raise the existing shoulder to match the new pavement elevation. The cost of blading will be an absorbed item and shall be included in the price of pay items bid. Material

which cannot be placed and blended in adjacent areas and deemed to be excess excavation by the Engineer shall be removed under pay item 203-G: Excess Excavation.

The asphalt guardrail pad shall be removed or milled and repaved prior to the placement of the new guardrail. Removal of the guardrail pad shall be paid for using the milling pay item. Guardrail posts shall not be completely surrounded by pavement (asphalt or concrete). The area surrounding the posts shall be treated as shown on the attached drawing. The work required to treat the guardrail post area will not be measured for separate payment and shall be absorbed in the cost of other items bid.

Guardrail lengths are based on terminal end length of 37.5'. If terminal of length other than this is used, an adjustment in w-beam length may be required.

Permanent Signs

Permanent signs as listed on the attached tables shall be replaced. Unless otherwise listed in the attached tables, existing posts, anchors, angles/bars, and other components shall be reused. The Contractor shall use new bolts, screws, washers, nuts, etc. of the required sizes in the installation of signs. If required as part of the sign replacement activities, all post, pipe, and I-beam lengths in these plans are estimated. Post lengths for all signs shall be verified in the field by the Contractor prior to fabrication. Installation dates shall be clearly written in bold black markings on the back bottom half off all signs with a permanent marking stick that is waterproof, fade resistant, and marks on wet or dry surfaces. The removal of damaged signs and posts, if necessary, shall be absorbed into other items bid. All existing signs which are to be removed as a part of this project that are not in conflict with construction shall remain in place until new signs are installed unless noted or directed otherwise by the project Engineer.

Radar Detection Systems

All existing vehicle loop assemblies in the attached table shall replace existing EPAC Controllers with new controllers. The existing EPAC controllers shall be salvaged and delivered to MDOT Signal Shop (601-359-1454). Contractor shall be responsible for transferring existing controller data to the new controllers. Radar units shall be mounted per manufacturer recommendations. Removal of existing loop assemblies shall be absorbed into other items bid. Contractor shall be responsible for setting up all new signal controllers and detection units to communicate with MDOT Network via existing network switch in each signal cabinet. MDOT shall provide the IP addresses. The Contractor may remove existing detection loop cable, if necessary. Cable quantities may be adjusted based on radar locations per manufacturer recommendations.

Traffic Control

The Contractor shall erect and maintain construction signing and provide all signs and traffic control devices necessary to safely maintain traffic around and through the work areas in accordance with the Traffic Control Plan and the MUTCD. The cost is to be included in the price bid for pay item 618-A: Maintenance of Traffic. Fluorescent orange sheeting shall be used on all construction and traffic control signs except those designated in the plans to be black legend and border on white background.

Standard roadside construction signs, barricades, etc. shall be placed in accordance to the attached tables, drawings, and as directed by the Engineer. W20-1 signs shall be placed on all public road approaches as shown or as directed. Payment for standard roadside construction signs, barricades, etc. will be made using the appropriate pay items.

On a daily basis, the Contractor shall remove all debris from within the roadway and a 30-foot clear zone which, in the opinion of the Engineer, is a hazard to the traveling public. This activity shall begin with the beginning of work or the beginning of the contract time, whichever comes first. No direct payment will be made for the debris removal; the cost shall be included in the prices of other items bid. Failure of the Contractor to remove the debris as prescribed herein shall be just cause for withholding the monthly progress estimate payment or suspending active operations until the debris is satisfactorily removed by the Contractor.

Temporary asphalt joints (aka paper joints) shall be employed at all locations requiring traffic to traverse an uneven, transverse, pavement joint. Paper joints shall be a minimum of nine feet (9') in length and for the full width of the milled/paved surface.

Potholes that may exist or occur in the existing pavement shall be patched in a timely manner as required. Patching of potholes shall be considered an absorbed item.

Miscellaneous Notes

It shall be the responsibility of the Contractor to protect existing structures such as pipes, inlets, aprons, bridges, etc. from damage which might occur during construction. The Contractor shall replace or repair, as directed by the Engineer, any structures damaged by the Contractor during the life of the contract. No payment will be made for replacement or repair of damaged items.

Any signs that are in conflict with construction of this project shall be removed and relocated by the Contractor as directed by the Engineer; the cost of which shall be absorbed in other items bid.

Removal of existing raised pavement markers shall be included in the prices for other items bid.

Incidental work such as removing vegetation, shaping and compacting shoulders, removing and resetting signs and/or mailboxes, removing excess asphalt material, project clean-up, and other items of incidental work necessary to complete the project will not be measured for separate payment and will be considered included in the prices of other items bid.

Temporary portable rumble strips paid for under pay item 907-619-B shall be used in accordance with detail shown. These rumble strips shall be retained by the department upon completion of the project. The rumble strips shall be delivered to the MDOT Newton Maintenance Yard, 7759 Highway 80, Newton, MS, 39345. It is responsibility of the Contractor to coordinate the delivery with MDOT Maintenance personnel Jay Franklin at 601-946-7820.

Prior to the final inspection, bridges, islands, and areas with curb shall be swept/cleaned. Care shall be taken to prevent milled asphalt, asphalt debris, vegetative/granular debris, etc. from entering drainage structures or clogging other drainage ways. Disposal of material will not be measured for separate payments

Following the overlaying operation, the transverse joints in the pavement shall be sawed and sealed within seven (7) days. The details for sawing and sealing transverse joints for this section are in the Standard Specifications. The width of the sawing and sealing operation will be 14 feet on each side of centerline, unless otherwise directed by the Engineer, to prevent “sympathy cracking.” It shall be the responsibility of the Contractor to locate and mark all existing joints that are to be sawed and sealed prior to the milling operation. The Contractor shall notify the Department when this is to take place so that they can oversee the work and determine the width that each joint will be sawed and sealed.

NEWTON COUNTY
MP-5015-51(021) 307480/301000
SR 15 FROM DECATUR TO HENRY MACK SMITH RD

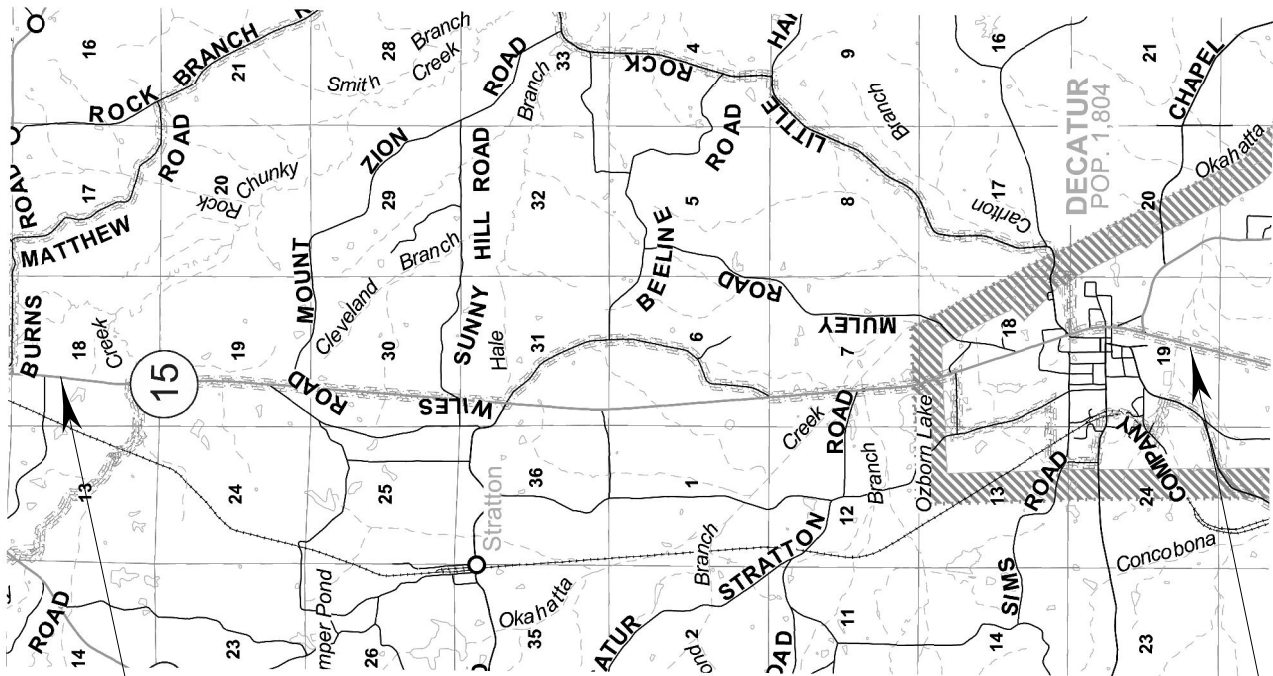



EOP 408+38

BOP 10+00

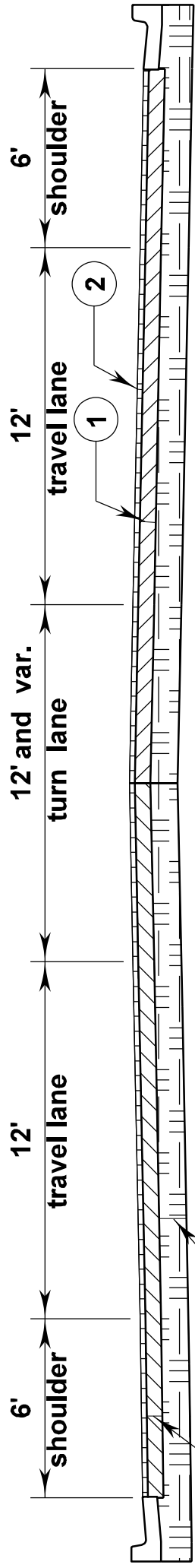
Typical Section 1
Sta. 10+00 - Sta. 56+00



EXISTING

- 1. Existing 6¹/₂" and variable hot mix asphalt.
- 2. 11" granular material.
-  - proposed asphalt
-  - existing asphalt
-  - granular material

PROPOSED

- 1. Mill existing asphalt 1¹/₂" and variable.
- 2. Place 2" and variable 12.5mm, Mix, MT.
 - lift thickness to be adjusted on outside to match curb.

Typical Section 2
Sta. 56+00 - Sta. 75+58

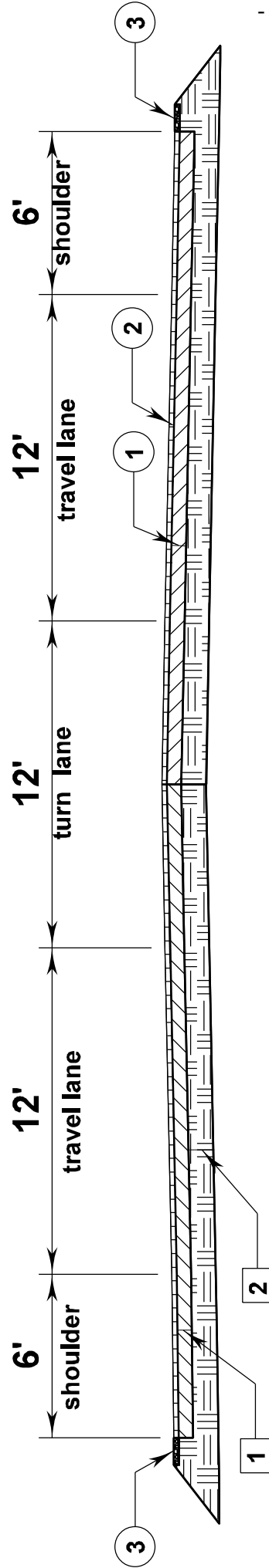

60

EXISTING

1. Existing 6¹/₂" and variable hot mix asphalt.

2. 11" granular material.

 - proposed asphalt

 - existing asphalt

 - granular material

 - crushed stone

PROPOSED

1. Mill existing asphalt 1¹/₂" and variable.

2. Place 2" and variable 12.5mm, Mix, MT.

3. Place variable depth crushed stone to bring shoulders to grade.

Typical Section 3
Sta. 75+58 - Sta. 81+30

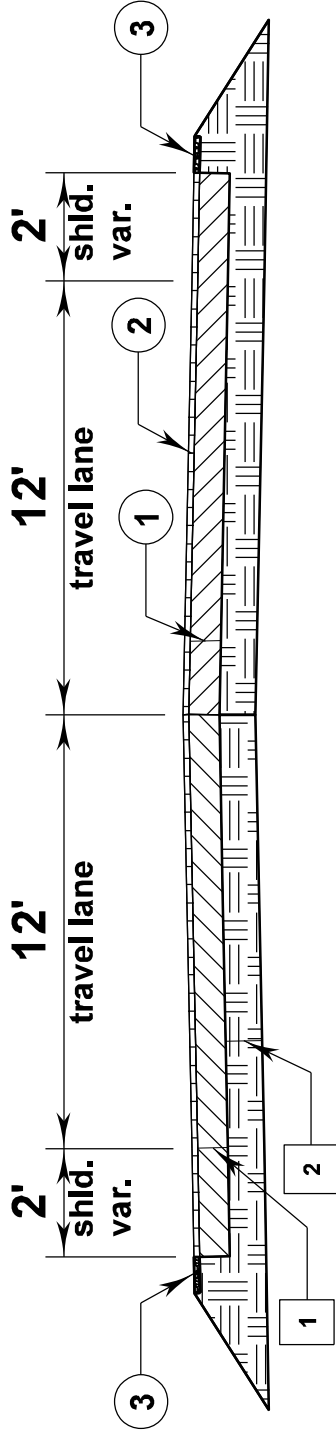

01

EXISTING

- 1. Existing 10" and variable hot mix asphalt.
- 2. 5" Granular material and variable.

- proposed asphalt
- existing asphalt
- granular material
- crushed stone

PROPOSED

- 1. Mill existing asphalt 1 1/2".
- 2. Place 2" and variable 12.5mm, Mix, MT.
- 3. Place variable depth crushed stone to bring shoulders to grade.

Typical Section 4
Sta. 81+30 - Sta. 408+38

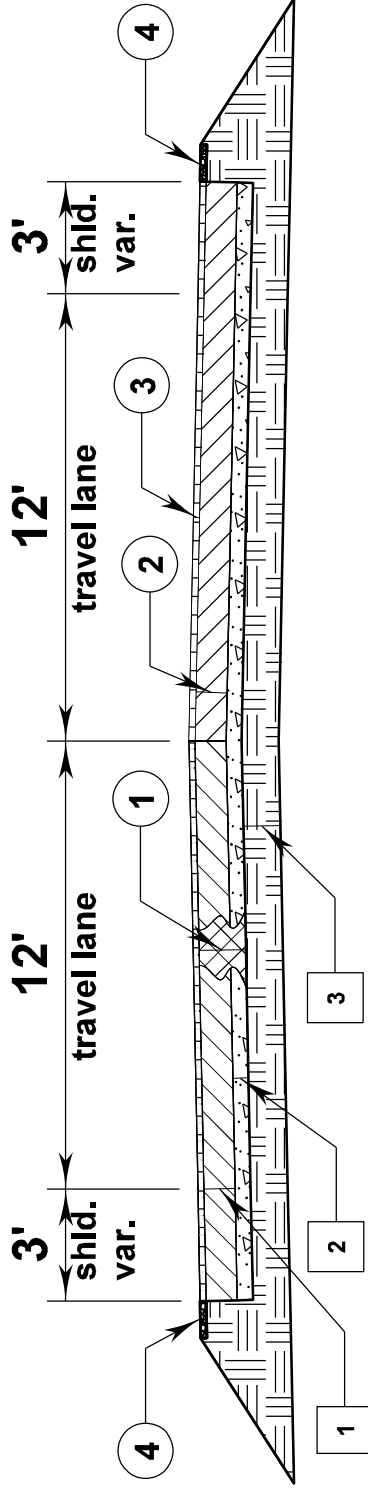

EXISTING

1. Existing 10" and variable hot mix asphalt.

2. 8" and variable JRC.P.

3. 12" clay gravel.

- proposed asphalt

- existing asphalt

- granular material

- failed area

- existing concrete

- crushed stone

PROPOSED

1. Repair failed areas full depth with 12.5mm, Mix, MT Leveling.

2. Mill existing asphalt 1 1/2".

3. Place 2" and variable 12.5mm, Mix, MT.

4. Place variable depth crushed stone to bring shoulders to grade.

Newton County
MP-5015-51(021) 307480/301000

STANDARD ROADSIDE SIGNS - 0.080" THICKNESS									
STATION	SIGN NUMBER	SIZE (in. x in.)	AREA (sf)	PIPE POSTS (lf)			U POST (lf)		REMARKS
				3"	3-1/2"	4"	5"	2 lb/ft	
28+10	M2-1	21x15	2.15					12.00	RL, JCT
28+10	M1-5	30x24	5.00					12.00	RL, 503
28+10	SN7923	24x30	5.00					12.00	RL, Weight Limit
Brand St	W1-8	18x24	3.00					12.00	
Brand St	W1-8	18x24	3.00					12.00	
29+75	R3-9B	24x36	6.00					12.00	
Total this sheet =			24.150	0.00	0.00	0.00	0.00	72.00	

*Signs attached to pipe post shall be mounted on the existing post and footing, removal and/or reinstallation of existing signs shall be absorbed in other items bid.

STANDARD ROADSIDE SIGNS - 0.125" THICKNESS									
STATION	SIGN NUMBER	SIZE (in. x in.)	AREA (sf)	PIPE POSTS (lf)			U POST (lf)		REMARKS
				3"	3-1/2"	4"	5"	2 lb/ft	
25+50								12.00	Remove Turkey Creek, Reinstall North 15 on new post
61+50	S1-1	36x36	9.00					12.00	RL, School Crosswalk
243+00	W2-1	30x30	6.25					12.00	RL, Intersection
Brand St	R1-1	36x36	9.00					12.00	STOP Sign
Total this sheet =			24.25	0.00	0.00	0.00	0.00	36.00	

*Signs attached to pipe post shall be mounted on the existing post and footing, removal and/or reinstallation of existing signs shall be absorbed in other items bid.

Newton County
MP-5015-51(021) 307480/301000

Removal of Concrete Failed Areas w/ variable Depth Overlay																	
Location	STA	Column1	Column2	Column4	Length (ft)	Width (ft)	Column5	Saw Cuts (ft)	Column6	Removal Area (SY)	Column7	Estimated Asphalt Req. (TONS)	Column8	Estimated Excess	Column9	REMARKS	
RT & LT	139+25		Column2	Column4	6	20	Column5	46	Column6	13.333	Column7	Column8	Column8	2.22	Column9	Column10	Joint Repair
RT & LT	141+23		Column2	Column4	6	20	Column5	46	Column6	13.333	Column7	Column8	Column8	2.22	Column9	Column10	Joint Repair
RT & LT	143+33		Column2	Column4	10	20	Column5	50	Column6	22.222	Column7	Column8	Column8	3.70	Column9	Column10	Joint Repair
RT & LT	147+20		Column2	Column4	6	20	Column5	46	Column6	13.333	Column7	Column8	Column8	2.22	Column9	Column10	Joint Repair
RT & LT	149+00		Column2	Column4	6	20	Column5	46	Column6	13.333	Column7	Column8	Column8	2.22	Column9	Column10	Joint Repair
RT & LT	154+75		Column2	Column4	6	20	Column5	46	Column6	13.333	Column7	Column8	Column8	2.22	Column9	Column10	Joint Repair
RT & LT	156+25		Column2	Column4	6	20	Column5	46	Column6	13.333	Column7	Column8	Column8	2.22	Column9	Column10	Joint Repair
RT & LT	161+30		Column2	Column4	7	20	Column5	47	Column6	15.556	Column7	Column8	Column8	2.59	Column9	Column10	Joint Repair
RT & LT	163+75		Column2	Column4	6	20	Column5	46	Column6	13.333	Column7	Column8	Column8	2.22	Column9	Column10	Joint Repair
RT & LT	168+75		Column2	Column4	6	20	Column5	46	Column6	13.333	Column7	Column8	Column8	2.22	Column9	Column10	Joint Repair
RT & LT	173+65		Column2	Column4	6	20	Column5	46	Column6	13.333	Column7	Column8	Column8	2.22	Column9	Column10	Joint Repair
RT & LT	187+05		Column2	Column4	10	20	Column5	50	Column6	22.222	Column7	Column8	Column8	3.70	Column9	Column10	Joint Repair
RT & LT	188+85		Column2	Column4	7	20	Column5	47	Column6	15.556	Column7	Column8	Column8	2.59	Column9	Column10	Joint Repair
RT & LT	194+60		Column2	Column4	6	20	Column5	46	Column6	13.333	Column7	Column8	Column8	2.22	Column9	Column10	Joint Repair
RT	197+25		Column2	Column4	10	10	Column5	30	Column6	11.111	Column7	Column8	Column8	1.85	Column9	Column10	Joint Repair
RT & LT	203+75		Column2	Column4	6	20	Column5	46	Column6	13.333	Column7	Column8	Column8	2.22	Column9	Column10	Joint Repair
RT	212+50		Column2	Column4	9	10	Column5	29	Column6	10.000	Column7	Column8	Column8	1.67	Column9	Column10	Joint Repair
LT	212+50		Column2	Column4	6	10	Column5	26	Column6	6.667	Column7	Column8	Column8	1.11	Column9	Column10	Joint Repair
RT & LT	221+20		Column2	Column4	6	20	Column5	46	Column6	13.333	Column7	Column8	Column8	2.22	Column9	Column10	Joint Repair
RT & LT	233+22		Column2	Column4	8	20	Column5	48	Column6	17.778	Column7	Column8	Column8	2.96	Column9	Column10	Joint Repair
RT & LT	241+00		Column2	Column4	6	20	Column5	46	Column6	13.333	Column7	Column8	Column8	2.22	Column9	Column10	Joint Repair
RT & LT	248+45		Column2	Column4	6	20	Column5	46	Column6	13.333	Column7	Column8	Column8	2.22	Column9	Column10	Joint Repair
RT & LT	272+00		Column2	Column4	6	20	Column5	46	Column6	13.333	Column7	Column8	Column8	2.22	Column9	Column10	Joint Repair
RT & LT	277+28		Column2	Column4	6	20	Column5	46	Column6	13.333	Column7	Column8	Column8	2.22	Column9	Column10	Joint Repair
RT & LT	279+50		Column2	Column4	6	20	Column5	46	Column6	13.333	Column7	Column8	Column8	2.22	Column9	Column10	Joint Repair
RT & LT	307+75		Column2	Column4	6	20	Column5	46	Column6	13.333	Column7	Column8	Column8	2.22	Column9	Column10	Joint Repair
RT & LT	309+80		Column2	Column4	6	20	Column5	46	Column6	13.333	Column7	Column8	Column8	2.22	Column9	Column10	Joint Repair
RT & LT	312+20		Column2	Column4	6	20	Column5	46	Column6	13.333	Column7	Column8	Column8	2.22	Column9	Column10	Joint Repair
RT & LT	314+00		Column2	Column4	6	20	Column5	46	Column6	13.333	Column7	Column8	Column8	2.22	Column9	Column10	Joint Repair
RT & LT	330+65		Column2	Column4	6	20	Column5	46	Column6	13.333	Column7	Column8	Column8	2.22	Column9	Column10	Joint Repair
RT & LT	332+30		Column2	Column4	6	20	Column5	46	Column6	13.333	Column7	Column8	Column8	2.22	Column9	Column10	Joint Repair
RT & LT	337+50		Column2	Column4	6	20	Column5	46	Column6	13.333	Column7	Column8	Column8	2.22	Column9	Column10	Joint Repair
RT & LT	338+35		Column2	Column4	6	20	Column5	46	Column6	13.333	Column7	Column8	Column8	2.22	Column9	Column10	Joint Repair
RT & LT	342+25		Column2	Column4	7	20	Column5	47	Column6	15.556	Column7	Column8	Column8	2.59	Column9	Column10	Joint Repair
RT & LT	343+90		Column2	Column4	6	20	Column5	46	Column6	13.333	Column7	Column8	Column8	2.22	Column9	Column10	Joint Repair
RT & LT	347+50		Column2	Column4	8	20	Column5	48	Column6	17.778	Column7	Column8	Column8	2.96	Column9	Column10	Joint Repair
RT & LT	357+15		Column2	Column4	6	20	Column5	46	Column6	13.333	Column7	Column8	Column8	2.22	Column9	Column10	Joint Repair
RT & LT	364+75		Column2	Column4	6	20	Column5	46	Column6	13.333	Column7	Column8	Column8	2.22	Column9	Column10	Joint Repair
RT & LT	392+42		Column2	Column4	6	20	Column5	46	Column6	13.333	Column7	Column8	Column8	2.22	Column9	Column10	Joint Repair
Totals										1756	541.111	456.563	90.185				

Newton County
MP-5015-51(021) 307480/301000

Removal of Asphalt Failed Areas, All Depths												
Location	STA	Column1	Column2	Column3	Column4	Column5	Column6	Column7	Column8	Column9	Column10	REMARKS
					Length (ft)	Width (ft)	Saw Cuts (ft)	Area (SY)	Estimated Asphalt Req. (TONS)	Estimated Excess		
RT & LT	139+25		Column2	Column3	Column4	Column5	Column6	Column7	Column8	Column9	Column10	Joint Repair
RT & LT	141+23	6	8	28	5.33	4.5	0.89	Joint Repair	0.89	Joint Repair		
RT & LT	143+33	6	8	28	5.33	4.5	0.89	Joint Repair	0.89	Joint Repair		
RT & LT	147+20	10	8	36	8.89	7.5	1.48	Joint Repair	1.48	Joint Repair		
RT & LT	149+00	6	8	28	5.33	4.5	0.89	Joint Repair	0.89	Joint Repair		
RT & LT	154+75	6	8	28	5.33	4.5	0.89	Joint Repair	0.89	Joint Repair		
RT & LT	156+25	6	8	28	5.33	4.5	0.89	Joint Repair	0.89	Joint Repair		
RT & LT	161+30	7	8	30	6.22	5.25	1.04	Joint Repair	1.04	Joint Repair		
RT & LT	163+75	6	8	28	5.33	4.5	0.89	Joint Repair	0.89	Joint Repair		
RT & LT	168+75	6	8	28	5.33	4.5	0.89	Joint Repair	0.89	Joint Repair		
RT & LT	173+65	6	8	28	5.33	4.5	0.89	Joint Repair	0.89	Joint Repair		
RT & LT	187+05	10	8	36	8.89	7.5	1.48	Joint Repair	1.48	Joint Repair		
RT & LT	188+85	7	8	30	6.22	5.25	1.04	Joint Repair	1.04	Joint Repair		
RT & LT	194+60	6	8	28	5.33	4.5	0.89	Joint Repair	0.89	Joint Repair		
RT	197+25	10	4	28	4.44	3.75	0.74	Joint Repair	0.74	Joint Repair		
RT & LT	203+75	6	8	28	5.33	4.5	0.89	Joint Repair	0.89	Joint Repair		
RT	212+50	9	4	26	4.00	3.375	0.67	Joint Repair	0.67	Joint Repair		
LT	212+50	6	4	20	2.67	2.25	0.44	Joint Repair	0.44	Joint Repair		
RT & LT	221+20	6	8	28	5.33	4.5	0.89	Joint Repair	0.89	Joint Repair		
RT & LT	233+22	8	8	32	7.11	6	1.19	Joint Repair	1.19	Joint Repair		
RT & LT	241+00	6	8	28	5.33	4.5	0.89	Joint Repair	0.89	Joint Repair		
RT & LT	248+45	6	8	28	5.33	4.5	0.89	Joint Repair	0.89	Joint Repair		
RT & LT	272+00	6	8	28	5.33	4.5	0.89	Joint Repair	0.89	Joint Repair		
RT & LT	277+28	6	8	28	5.33	4.5	0.89	Joint Repair	0.89	Joint Repair		
RT & LT	279+50	6	8	28	5.33	4.5	0.89	Joint Repair	0.89	Joint Repair		
RT & LT	307+75	6	8	28	5.33	4.5	0.89	Joint Repair	0.89	Joint Repair		
RT & LT	309+80	6	8	28	5.33	4.5	0.89	Joint Repair	0.89	Joint Repair		
RT & LT	312+20	6	8	28	5.33	4.5	0.89	Joint Repair	0.89	Joint Repair		
RT & LT	314+00	6	8	28	5.33	4.5	0.89	Joint Repair	0.89	Joint Repair		
RT & LT	330+65	6	8	28	5.33	4.5	0.89	Joint Repair	0.89	Joint Repair		
RT & LT	332+30	6	8	28	5.33	4.5	0.89	Joint Repair	0.89	Joint Repair		
RT & LT	337+50	6	8	28	5.33	4.5	0.89	Joint Repair	0.89	Joint Repair		
RT & LT	338+35	6	8	28	5.33	4.5	0.89	Joint Repair	0.89	Joint Repair		
RT & LT	342+25	7	8	30	6.22	5.3	1.04	Joint Repair	1.04	Joint Repair		
RT & LT	343+90	6	8	28	5.33	4.5	0.89	Joint Repair	0.89	Joint Repair		
RT & LT	347+50	8	8	32	7.11	6.0	1.19	Joint Repair	1.19	Joint Repair		
RT & LT	357+15	6	8	28	5.33	4.5	0.89	Joint Repair	0.89	Joint Repair		
RT & LT	364+75	6	8	28	5.33	4.5	0.89	Joint Repair	0.89	Joint Repair		
RT & LT	392+42	6	8	28	5.33	4.5	0.89	Joint Repair	0.89	Joint Repair		
LT,TWR	395+15	4	20	48	8.89	7.5	1.48	Trench Widening Repair	1.48	Trench Widening Repair		
LT,TWR	395+80	4	15	38	6.67	5.6	1.11	Trench Widening Repair	1.11	Trench Widening Repair		
LT,TWR	396+90	4	25	58	11.11	9.4	1.85	Trench Widening Repair	1.85	Trench Widening Repair		
RT ,TWR	399+25	4	25	58	11.11	9.4	1.85	Trench Widening Repair	1.85	Trench Widening Repair		
		Totals		1314	254.222	214.500	42.370					

* QUANTITIES TO BE USED AS DIRECTED BY THE ENGINEER.

GUARD RAIL QUANTITIES												
GUARDRAIL		TERMINAL END SECTION	Cable Anchor TYPE I (EA)	BRIDGE END SECTION		DELINEATORS		Type 3 Object Markers OM-3R,3L	Type 3 Object Markers OM-3R,3L 2 Markers Per Post	REMOVAL ITEMS		REMARKS
STATION	(W-BEAM) (LF)			Type "I" (EA)	Type "G" (EA)	TYPE "G" Modified (EA)	WHITE			YELLOW	GUARDRAIL	
123+29	162.5	1	1		8		1			221		RL
123+29	50	1	1		6		1			108.5		LL
124+71	37.5	1	1		6		1			112.5		RL
124+71	150	1	1		9		1			225		LL
197+00	137.5	2			7		1			196		LL
197+00	150	2			8		1			208.5		RL
292+00	137.5	2			8		1			212.5		LL
292+00	137.5	2			8		1			212.5		RL
344+50	50	2			7		1			125		LL
344+50	87.5	2			8		1			162.5		RL
350+60	137.5	2			8		1			212.5		LL
350+60	137.5	2			8		1			212.5		RL
372+28	162.5	1	1		10		1			221		RL
372+28	50	1	1		6		1			108.5		LL
373+70	50	1	1		6		1			108.5		RL
373+70	162.5	1	1		8		1			221		LL
TOTAL =	1800	24	0	0	121	0	8	8	8	2868		
	L.F.	EA.	EA.	EA.	EA.	EA.	EA.	EA.	EA.	LF.		MP-5015-51(021)

* ALL EXISTING TERMINAL END SECTIONS WERE MEASURED AT 37.5'. W-BEAM MAY HAVE TO BE ADJUSTED BASED OFF NEW TERMINAL END LENGTHS.
 * REMOVAL OF ALL GUARDRAIL (BRIDGE END SECTIONS, W-BEAM, TYPE I CABLE ANCHORAGE, TERMINAL END SECTIONS, ETC.) WILL BE PAID UNDER PAY ITEM 202-B REMOVAL OF GUARD RAIL.
 * REMOVAL OF GUARDRAIL DELINEATORS ARE CONSIDERED INCIDENTAL TO THE REMOVAL OF GUARDRAIL AND WILL NOT BE MEASURED AS A SEPARATE PAY ITEM.
 * REMOVAL OF OBJECT MARKERS WILL NOT BE MEASURED AS A SEPARATE PAY ITEM AS SHALL BE ABSORBED IN OTHER ITEMS

CONSTRUCTION SIGN DETAIL

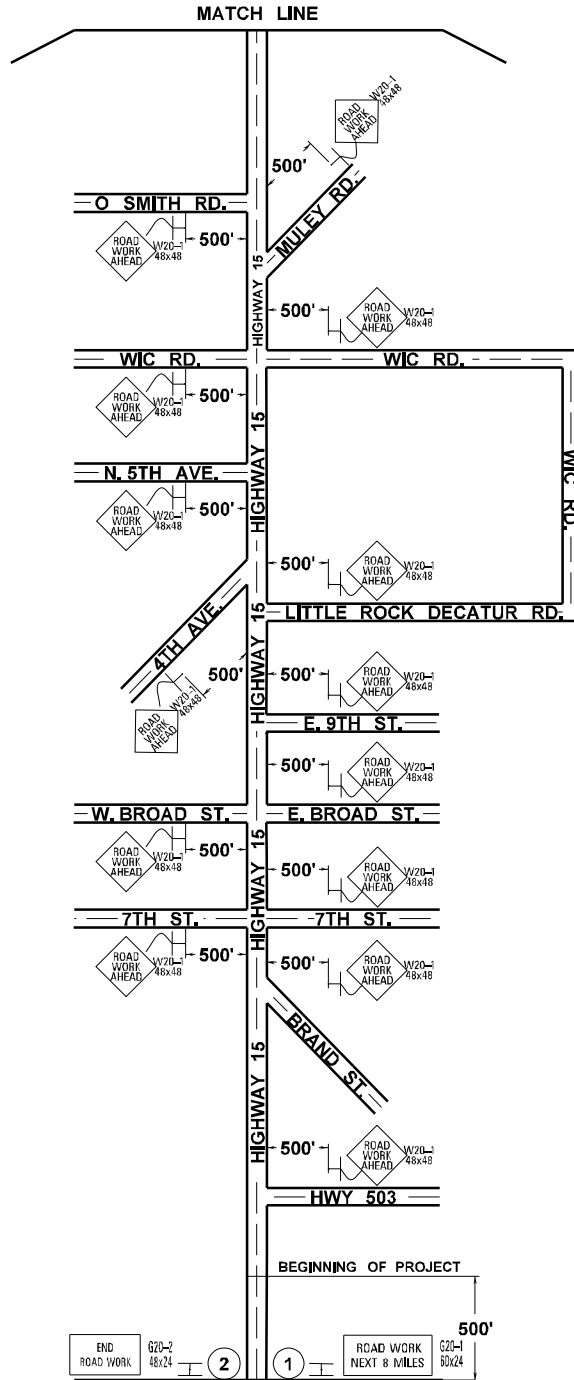

SIGN LEGEND	
NUMBER	DESCRIPTION
1	ROAD WORK NEXT 8 MILES G20-1 60x24
2	END ROAD WORK G20-2 48x24
3	ROAD WORK AHEAD W20-1 46x48

TRAFFIC CONTROL SIGNS REQUIRED

- 2 - G20-1 "ROAD WORK NEXT MILE"
- 2 - G20-2 "END ROAD WORK"
- 4 - TYPE III DOUBLE FACED BARRICADES
- 25 - W20-1 "ROAD WORK AHEAD"
- 63 - R4-1 "DO NOT PASS"
- 16 - R4-2 "PASS WITH CARE"
- 19 - W14-3 "NO PASSING ZONE"

NOTES:

ONE (1) W20-1 "ROAD WORK AHEAD SIGN IS REQUIRED AT EACH LOCAL ROAD, STREET, OR HIGHWAY ENTERING THE PROJECT.

G20-1 AND G20-2 SIGNS MOUNTED ON TYPE III DOUBLE FACED BARRICADE.

FIELD CONDITIONS MAY REQUIRE SOME SIGNS ON THIS DETAIL TO BE ADJUSTED.

THE ABOVE SHOWN ITEMS WILL BE PAID UNDER THE APPROPRIATE PAY ITEMS.

LOCAL ROADS

*ROAD WORK AHEAD SIGNS ARE TO BE PLACED 500' BACK FROM EDGE OF PAVEMENT.

SEE STANDARD ROADSIDE CONSTRUCTION SIGN TABLE FOR LOCATIONS

CONSTRUCTION SIGN DETAIL

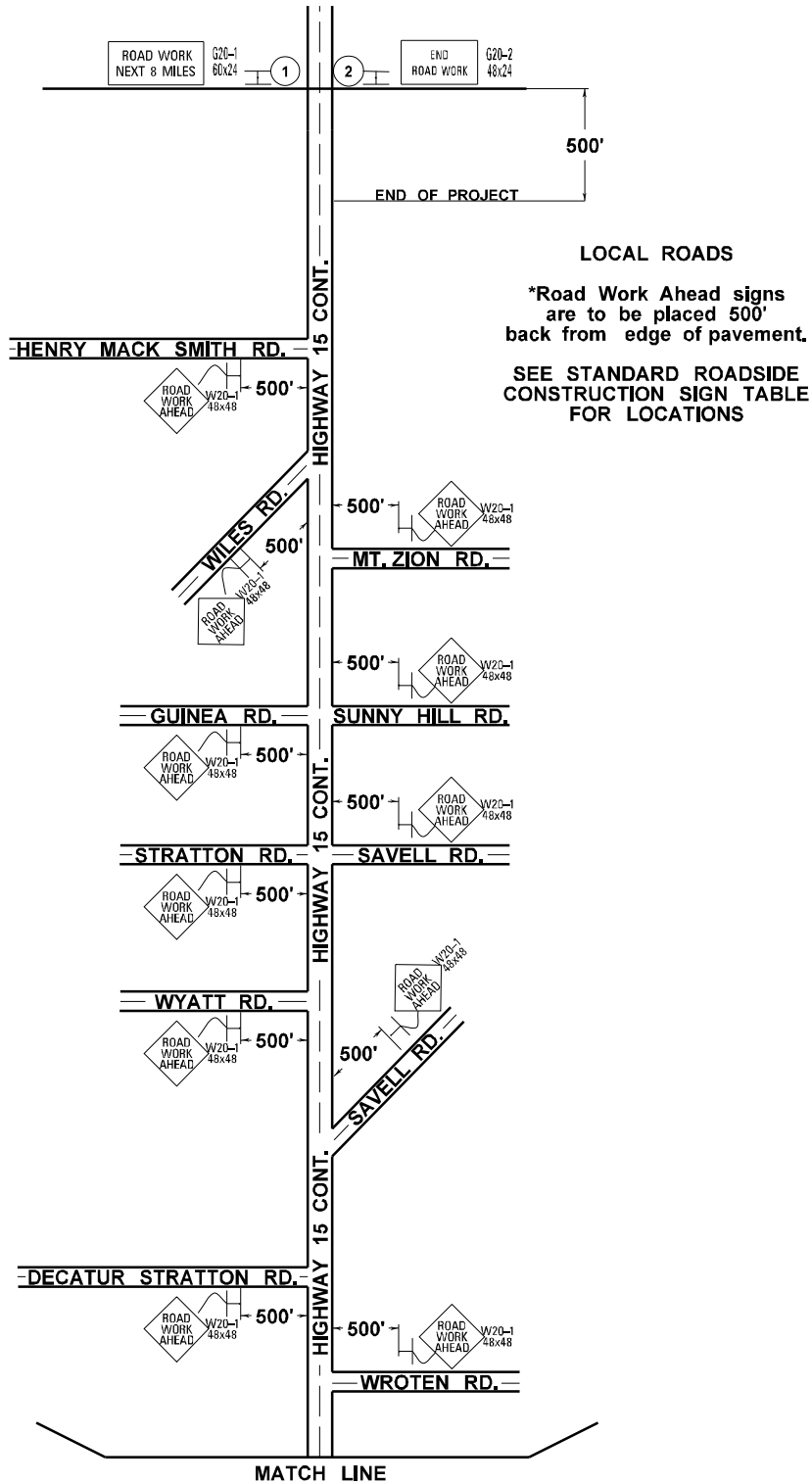

SIGN LEGEND	
NUMBER	DESCRIPTION
1	ROAD WORK NEXT 8 MILES G20-1 60x24
2	END ROAD WORK G20-2 48x24
3	ROAD WORK AHEAD W20-1 48x48

NEWTON
MP-5015-51(021) 307480/301000
CONCRETE PAVEMENT REPAIR DETAIL

69

VARIABLE WIDTH (6' MIN)

HMA

JRCP

12.5mm ASPHALT, MT
 LEVELING

6"

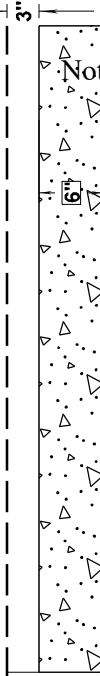

NEWTON COUNTY
MP-5015-51(021) 307480/301000

DRIVEWAY PAD DETAIL

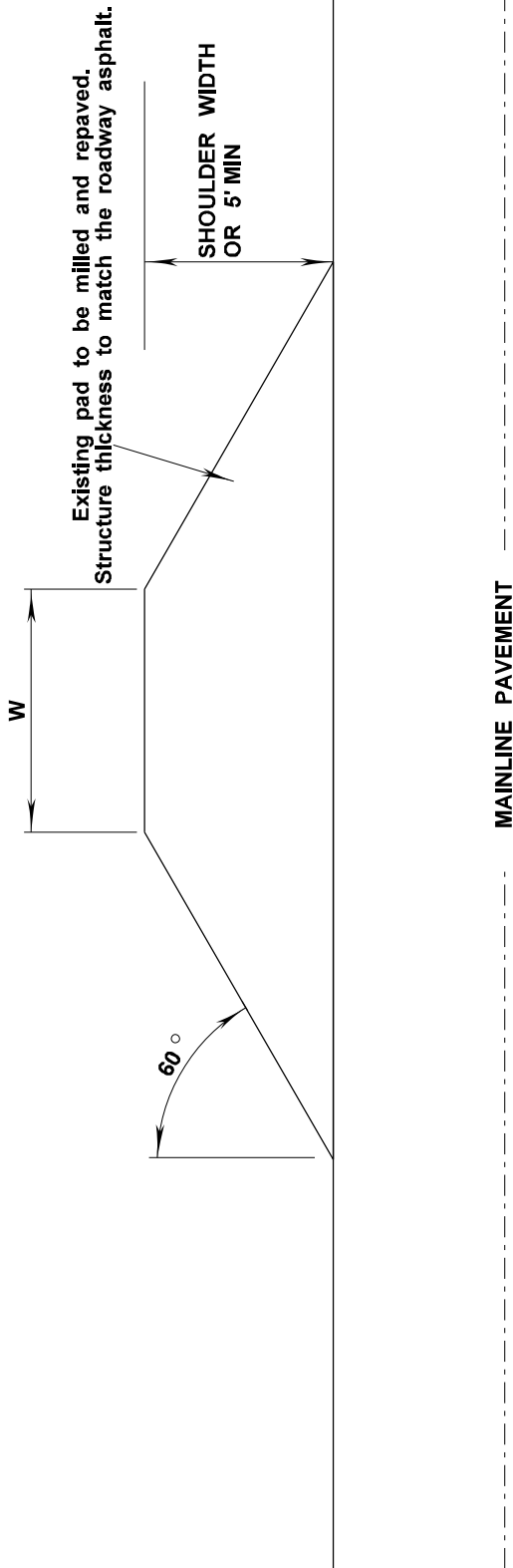

W = 16' MAX RESIDENTIAL
W = 30'-50' COMMERCIAL

NOTE:

THE ASPHALT ON THE EXISTING DRIVEWAY/RAMP PADS ARE TO REMAIN IN THEIR CURRENT SIZE AND LOCATION AND MILLED/OVERLAID. IF, IN THE OPINION OF THE ENGINEER, A PAD SHOULD BE MODIFIED OR REPLACED, PAYMENT WILL BE MADE FOR THE WORK USING THE APPROPRIATE PAY ITEMS. GRANULAR MATERIAL AND/OR STABILIZER AGGREGATE SHOULD BE PLACED AROUND THE PADS AS REQUIRED.

NEWTON COUNTY
MP-5015-51(021) 307480/301000

TYPICAL DETAIL OF ADDITIONAL SHOULDER PAVING
REQUIRED AT GUARDRAIL LOCATIONS

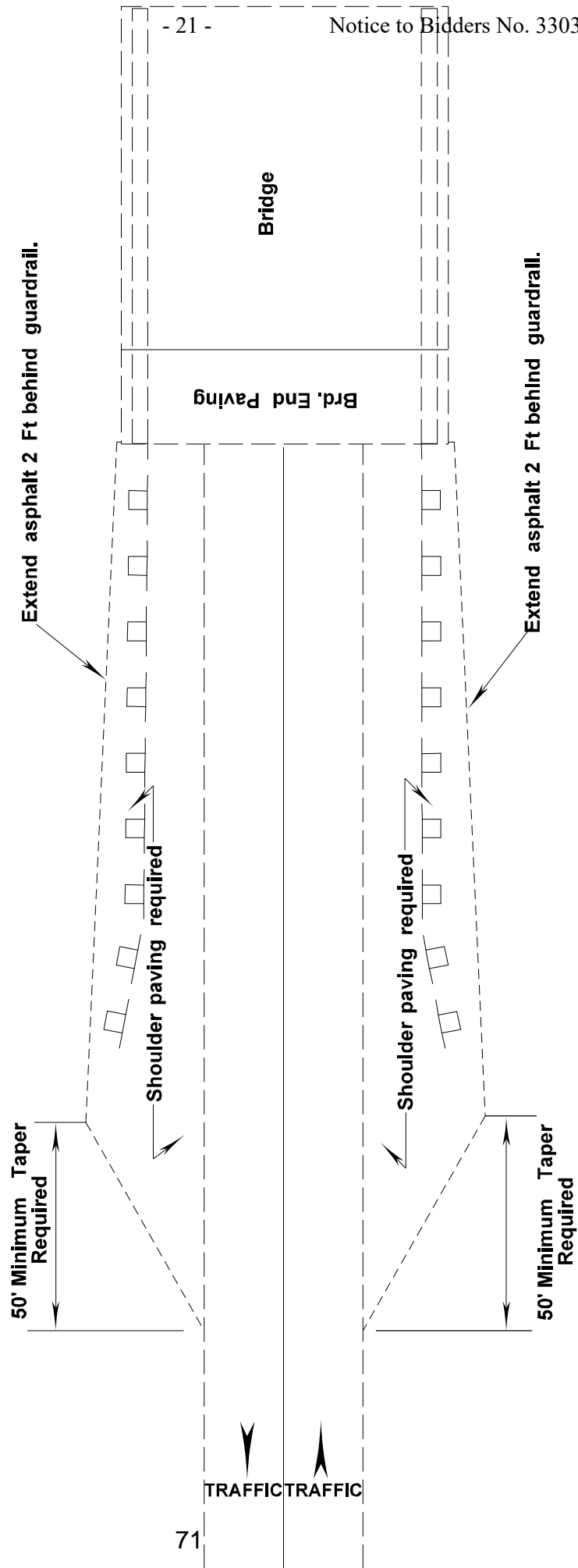

*Asphalt Thickness
See scope of work for additional details





POT St.G. 343+02.817

340

CROSS SECTIONAL VIEW OF
 FILL LOCATION FROM
 STA. 337+25 to STA. 341+75 RL
 NOTE: WORK IN THIS AREA WILL BE DONE
 ACCORDING TO SCOPE OF WORK.

POT St.G. 337+20.000

NEWTON COUNTY
 MP-5015-51(021) 307480/301000
 DITCH AREA FILL

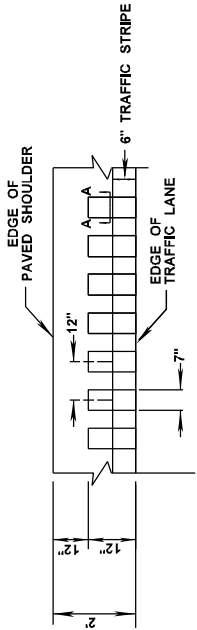

DETAIL "A"

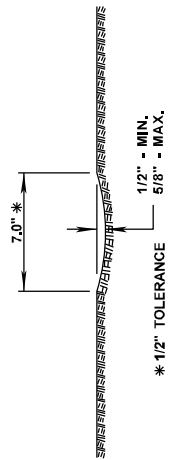

SECTION "A-A"

GENERAL NOTES

1. GROUND-IN RUMBLE STRIPES SHALL BE APPLIED ON LEFT AND RIGHT SHOULDERS OF ALL PAVED SHOULDERS ON THIS PROJECT

2. GROUND-IN RUMBLE STRIPES SHALL BE OMITTED ACROSS PRINCIPAL INTERSECTING ROADWAYS OR OTHER INTERRUPTIONS IN NORMAL SHOULDER WIDTH AS DIRECTED BY THE ENGINEER

3. COST TO BE PAID FOR USING APPROPRIATE PAY ITEMS

4. GROUND-IN RUMBLE STRIPES SHALL BE APPLIED TO MAINLINE ONLY.

5. DO NOT USE WHERE TRAVEL LANE IS LESS THAN 11' WIDE.

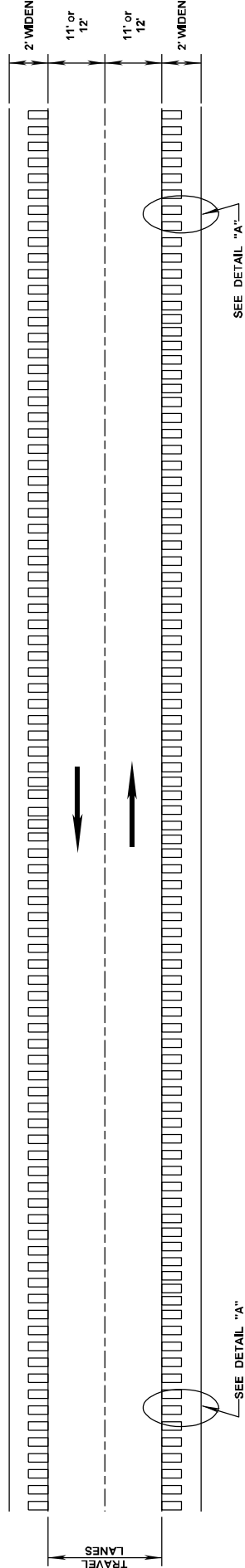

PLAN
 NOT TO SCALE

NEWTON COUNTY
MP-5015-51 (021) 307480/301000
SR15 FROM DECATUR TO HENRY MACK SMTH RD

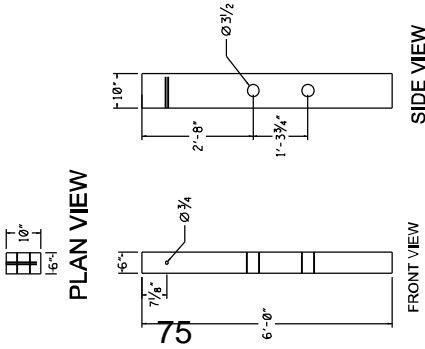

PLAN VIEW

SIDE VIEW

CRT WOOD POST

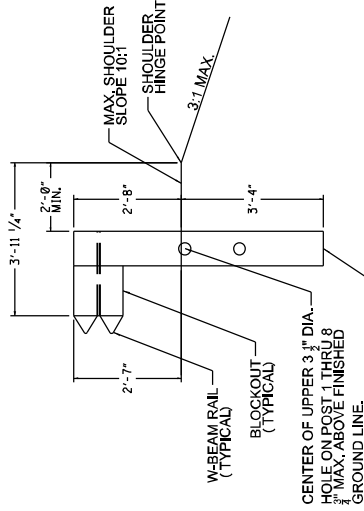

**SECTION B-B
POST NO. 1-3
SEE OTHER DETAILS**

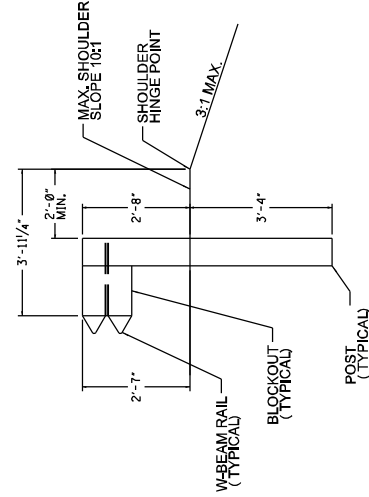

**SECTION A-A
POST NO. 4-8
SEE OTHER DEALS**

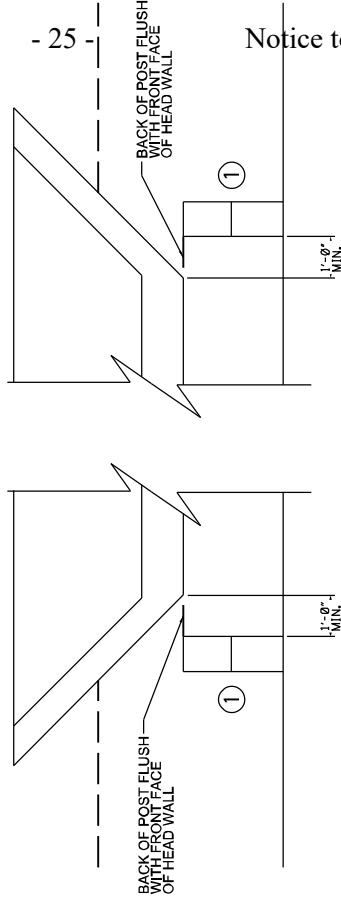

POST PLACEMENT DETAIL

NEWTON COUNTY
 MP-5015-51(021) 307480/301000
Guardrail Post Installation in Paved Areas

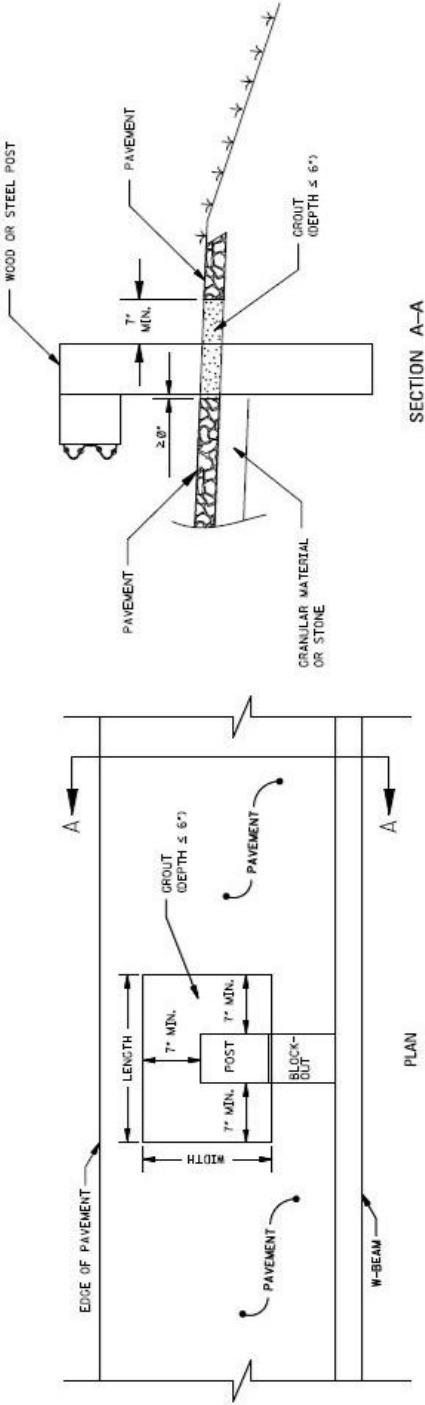

PAVEMENT LEAVE-OUT AREA FOR GUARDRAIL POSTS
 SINGLE-FACED GUARDRAIL

POST	MIN. PAV'T LEAVE-OUT AREA	
	SINGLE-FACED LENGTH (IN.)	DOUBLE-FACED LENGTH (IN.)
6" x 8" WOOD	28	28
6" x 8" WOOD	28	28
10" x 18" WOOD	24	24
#6 x 3 STEEL	18	18

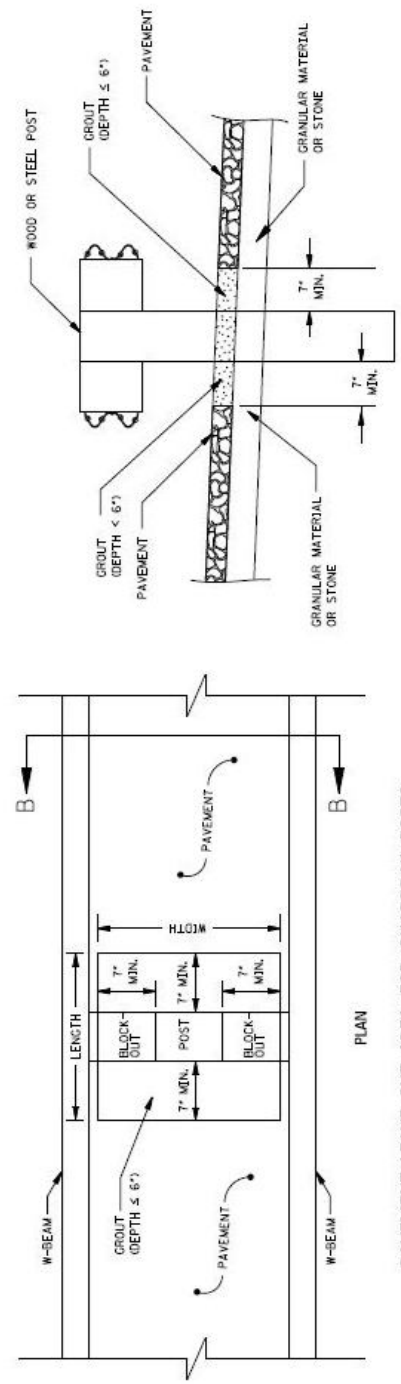

PAVEMENT LEAVE-OUT AREA FOR GUARDRAIL POSTS
 DOUBLE-FACED GUARDRAIL

GENERAL NOTES

1. GUARDRAIL POSTS SHALL NOT BE COMPLETELY SURROUNDED BY PAVEMENT. THE AREA BEHIND AND LATERAL OF THE POST SHALL HAVE A MINIMUM 7" CLEARANCE FROM THE PAVEMENT. THIS AREA SHALL BE FILLED WITH A LOW STRENGTH GROUT WITH A MAXIMUM 28 DAY COMPRESSIVE STRENGTH OF 120 PSI.
2. GROUT SHALL BE INSTALLED AT A DEPTH EQUAL TO THE SURROUNDING PAVEMENT UP TO A MAXIMUM OF 6". IF SURROUNDING PAVEMENT IS GREATER THAN 6", THE DIFFERENCE SHALL BE FILLED IN WITH SHOULDER GRANULAR MATERIAL.
3. COST OF GROUT SHALL BE ABSORBED IN THE COST OF OTHER ITEMS BID.
4. PAVEMENT LEAVE-OUT AREAS ARE REQUIRED FOR STEEL AND WOOD POSTS.
5. STANDARD EMBEDMENT DEPTHS STILL APPLY, MEASURED FROM THE TOP OF THE PROJECTED PAVEMENT SURFACE.

NEWTON COUNTY-HIGHWAY 15
 MP-5015-51 (021) 307480/301000
 (SR15 From Decatur to Henry Mack Smith Road)

GENERAL NOTES

POSTS 1 THROUGH 3 ARE CRT POSTS. ALL OTHER POSTS SHALL BE WOOD OR STEEL. SEE SDD14 B 42 FOR MORE DETAILS
 FLARE FOR MGS EAT SHOWN, IF INSTALLING MGS NO FLARE NEEDED.
 VALUES SHOWN ON DRAWING REPRESENT THE MAXIMUM LENGTH. SHORTER DIMENSIONS ARE POSSIBLE. SEE OTHER SECTION OF PLAN FOR MORE INFORMATION

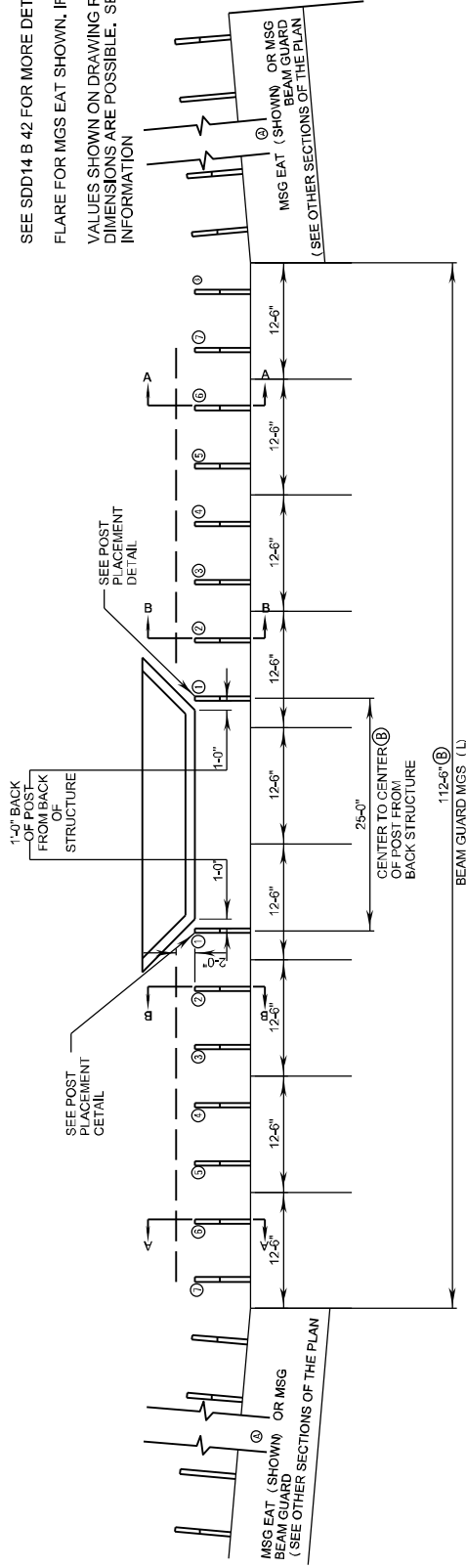

DIRECTION OF TRAVEL

PLAN VIEW

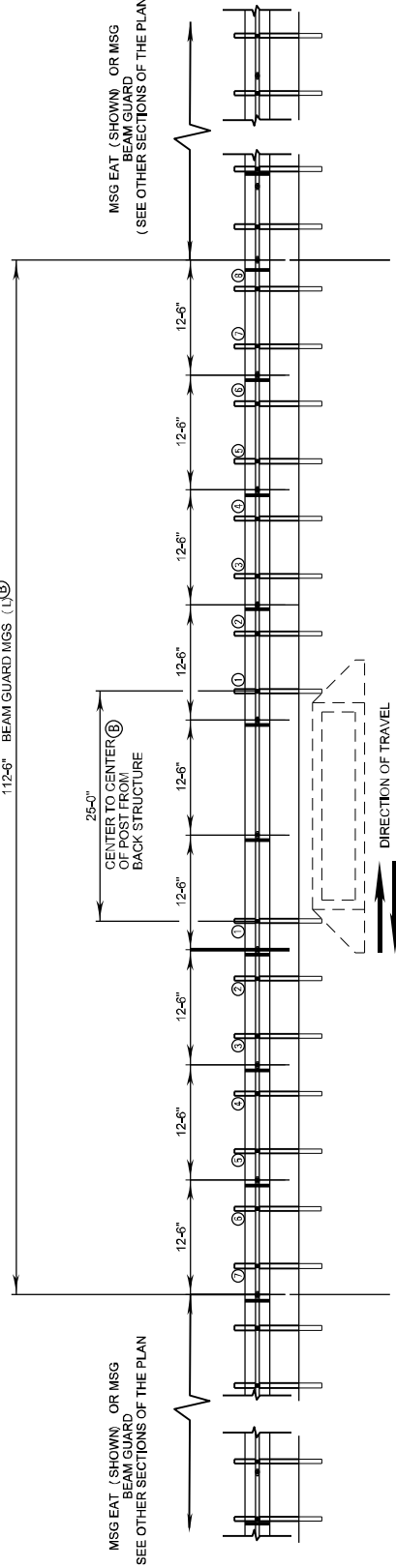

DIRECTION OF TRAVEL

ELEVATION VIEW

NEWTON COUNTY
MP-5015-51(021) 307480/301000

STATE	PROJECT NO.
MISS.	

REVISION	DATE

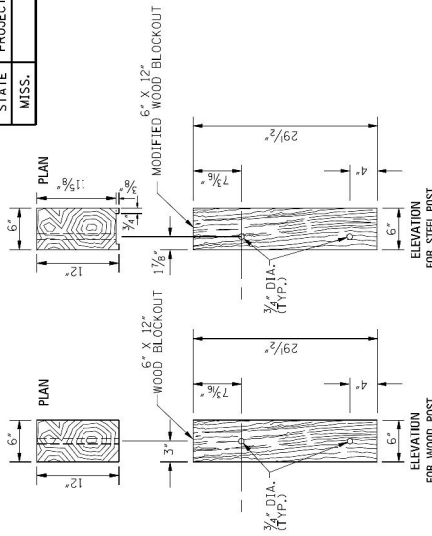

BLOCKOUT FOR POST 9 OF TYPE "I" BRIDGE END SECTION

CROSS-SECTION VIEW OF C6 X 8.2

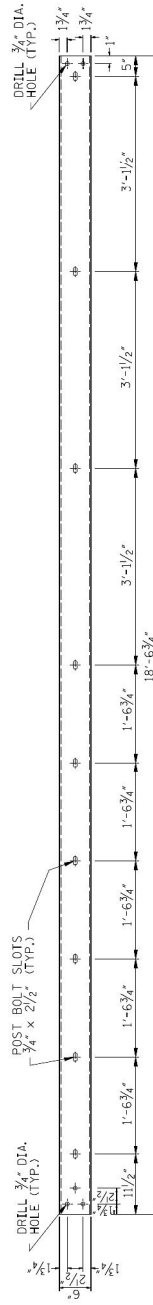

PROFILE VIEW OF POSTS

LONGITUDINAL RUB RAIL

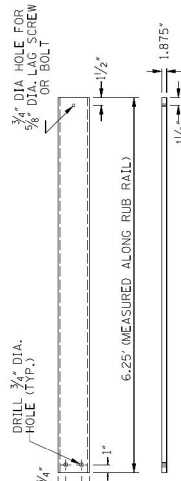

DIAGONAL RUB RAIL

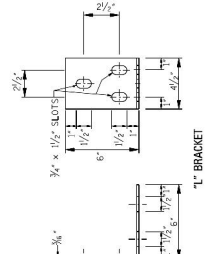

"I" BRACKET

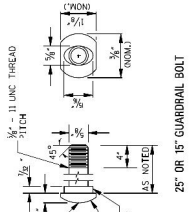

25" OR 15" GUARDRAIL BOLT

PLAIN ROUND WASHER "F"

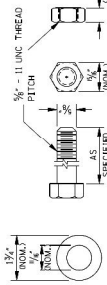

HEX NUT AND BOLT "F"

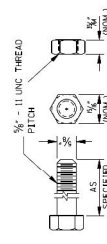

GENERAL NOTES:

1. POSTS 1 THROUGH 9 REQUIRE AN ADDITIONAL HOLE TO ATTACH LOWER BLOCKOUTS. STEEL POST REQUIRE 2 HOLES ON EITHER SIDE OF THE POST.
2. RUBRAIL BLOCKOUTS SHALL BE SECURED WITH 3/4" BUTTONHEAD BOLT FOR STEEL POST AND 20" BOLT FOR WOOD POST. (SEE PROFILE VIEW FOR LENGTHS)
3. RUBRAIL & LONG BLOCKOUT (POST 9) ARE NOT REQUIRED IN CURBS & GUTTER SECTIONS OF ROAD.
4. ATTACH RUBRAIL CONNECTOR PLATE AND RUBRAIL WITH 3/8" x 1 1/2" HEX HEAD BOLTS "F"

NEWTON COUNTY
MP-5015-51(021) 307480/301000
STRIPE DETAIL - COUNTY ROADS

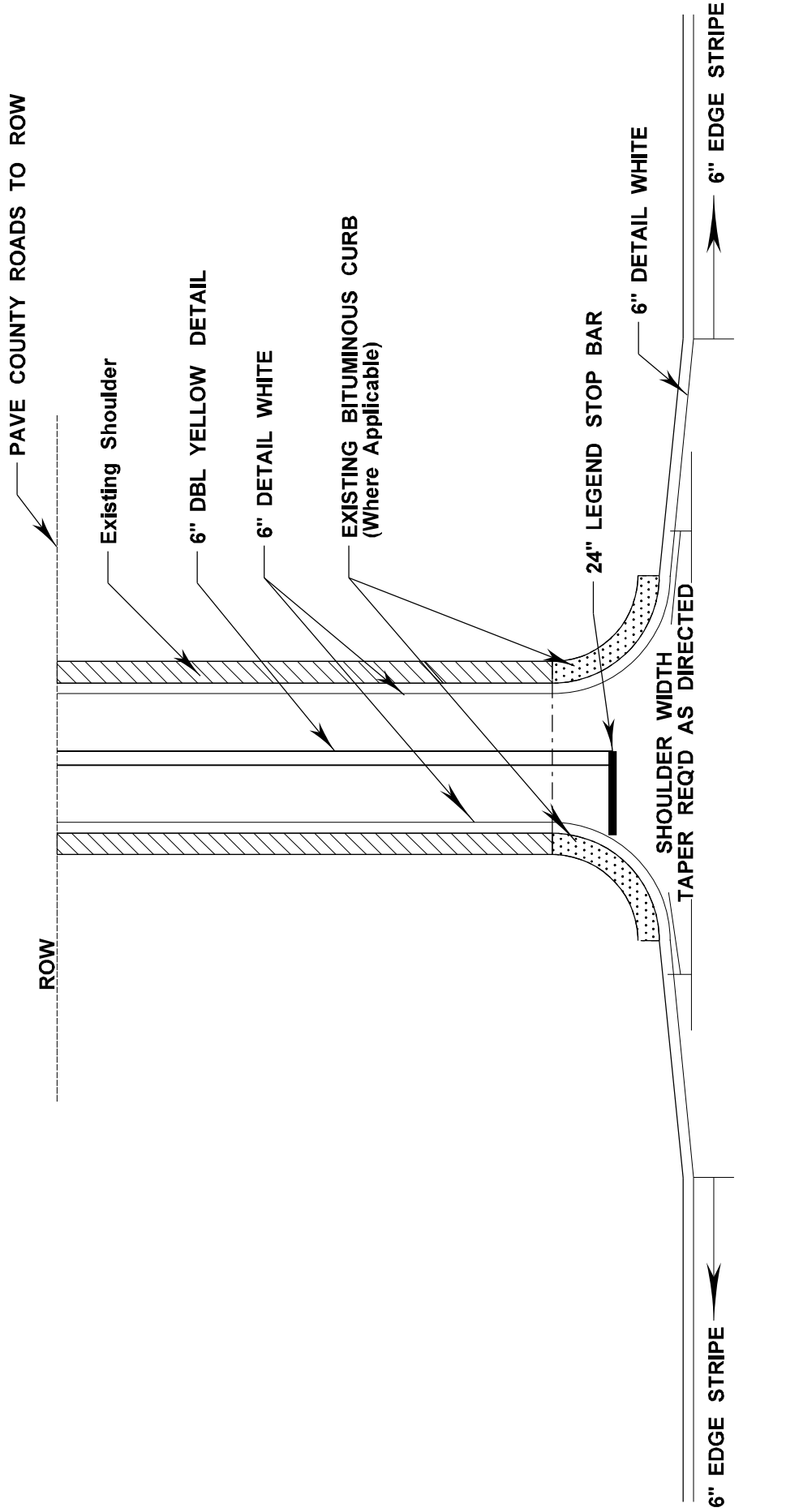

TYPICAL FOR RAISED PAVEMENT MARKERS
PLACED ON SIDE ROAD RADIUS

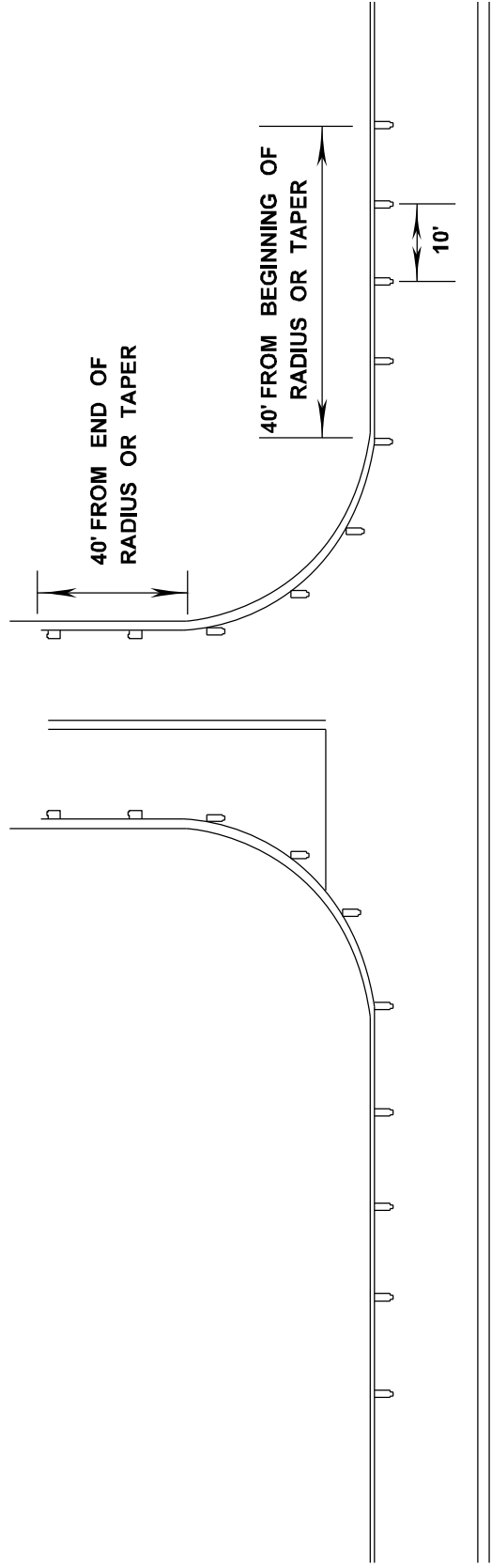

- NOTE 1. MARKERS SHALL BE PLACED EVERY 10 FEET.
- NOTE 2. MARKERS SHALL BE VISIBLE FROM THE TRAVELING MOTORIST ON STATE DESIGNATED HIGHWAYS.
- NOTE 3. MARKERS SHALL BE HIGH PERFORMANCE TWO WAY CLEAR.
- NOTE 4. FIVE (5) MARKERS SHALL BE PLACED ALONG MAINLINE EDGE STRIPE.
- NOTE 5. MARKERS FOR COUNTY ROADS SHALL CONTINUE DOWN THE EDGE STRIPE A DISTANCE OF 40 FEET.

MISSISSIPPI DEPARTMENT OF TRANSPORTATION

SECTION 904 - NOTICE TO BIDDERS NO. 3304

CODE: (SP)

DATE: 06/18/2019

SUBJECT: Temporary Construction Signs

PROJECT: MP-5015-51(021) / 307480301 – Newton County

Bidders are hereby advised of the following regarding the Temporary Construction Signs required:

Should the Bidders elect to install Temporary Construction Signs by first driving short u-channel sections and then bolting the longer, correct height u-channel sections to them, the Bidders are advised that these short sections shall be a minimum of five (5) feet from the ground level when driven and the splice must consist of a minimum of eighteen (18) inches of overlap with a total of four (4) bolts. Bidders are also advised that it is mandatory that these short sections be removed at the completion of the project.

MISSISSIPPI DEPARTMENT OF TRANSPORTATION

SECTION 904 - NOTICE TO BIDDERS NO. 3305

CODE: (SP)

DATE: 4/20/2021

SUBJECT: Lane Closure Restrictions

PROJECT: MP-5015-51(021) / 307480301 – Newton County

Bidders are hereby advised that lane closure restrictions on the above project shall be as follows:

Monday through Friday – During the time frame of August 1st until May 31st lane closures will NOT be allowed within the limits of the Town of Decatur between the hours of 7:30 AM to 8:30 AM or between the hours of 2:30 PM to 4:00 PM.

No exceptions to the above restrictions will be allowed unless specifically approved by the Project Engineer.

Also, no lane closures will be permitted on the following holidays or the day preceding them: New Year's Day, Memorial Day, Easter, Independence Day, Labor Day, Thanksgiving Day, and Christmas Day. In the event that one of the above mentioned holidays falls during the weekend or on a Monday, no lane closures will be allowed during that weekend or the Friday immediately preceding that holiday. In addition, no lane closures will be allowed the Friday, Saturday, and Sunday following Thanksgiving.

If the lane closure restriction listed above is violated, the Contractor will be charged a fee of **\$500.00** for each full or partial hour period until the roadway is back in compliance with the lane closure restriction requirement.

The Contractor shall notify the Project Engineer at least 48 hours in advance of any lane closures.

For the purposes of this contract, official time shall be the announced time available at the Jackson area telephone number (601) 355-9311.

MISSISSIPPI DEPARTMENT OF TRANSPORTATION

SECTION 904 - NOTICE TO BIDDERS NO. 3306

CODE: (SP)

DATE: 7/16/2019

SUBJECT: Underground Utilities

PROJECT: MP-5015-51(021) / 307480301 – Newton County

Bidders are hereby advised that utility lines owned and maintained by MDOT may be present within the project limits. These utilities are not located by Mississippi 811. It shall be the Contractor's responsibility to coordinate with MDOT to have the utility lines located and marked prior to beginning work. The Contractor shall give a minimum of three (3) working days of advance notice for locate requests. The contacts for MDOT utility lines are as follows:

Underground Power Lines:

Michael Lee – 601-683-3341 – mlee@mdot.ms.gov

Vince Herrington – 601-683-3341 – vherrington@mdot.ms.gov

Underground Communication Lines:

Kerby McFarland – 601-359-7450 – kmcfarland@mdot.ms.gov

Steven Newell – 601-359-7450 – snewell@mdot.ms.gov

Henry Lewis – 601-359-1454 – hlewis@mdot.ms.gov

Underground Signal Lines:

Amrik Singh – 601-359-1454 – asingh@mdot.ms.gov

Kenneth Welch – 601-359-1454 – kwelch@mdot.ms.gov

MISSISSIPPI DEPARTMENT OF TRANSPORTATION

SPECIAL PROVISION NO. 907-102-2

CODE: (IS)

DATE: 11/22/2017

SUBJECT: **Bidding Requirements and Conditions**

Section 102, Bidding Requirements and Conditions, of the 2017 Edition of the Mississippi Standard Specifications for Road and Bridge Construction is hereby amended as follows.

907-102.01--Prequalification of Bidders. Delete the last sentence of the third paragraph of Subsection 102.01 on page 13, and substitute the following.

The Bidder's Certificate of Responsibility number must be on file with the Department's Contract Administration Division prior to request for permission to bid.

907-102.02--Contents of Proposal Forms. Delete the fourth paragraph in Subsection 102.02 on page 13, and substitute the following.

Prospective bidders must complete an online request for permission to be eligible to bid a project. Upon approval, the bidder will be authorized to submit a bid electronically using Bid Express at <http://bidx.com>.

MISSISSIPPI DEPARTMENT OF TRANSPORTATION

SPECIAL PROVISION NO. 907-103-2

CODE: (SP)

DATE: 06/22/2017

SUBJECT: Award and Execution of Contract

Section 103, Award and Execution of Contract, of the 2017 Edition of the Mississippi Standard Specifications for Road and Bridge Construction is hereby amended as follows.

907-103.01--Consideration of Proposal. Delete the second and third paragraphs of Subsection 103.01 on page 19, and substitute the following.

907-103.01.1--For Projects Constructed Without Federal Funds. Resident Contractors actually domiciled in Mississippi are to be granted preference over nonresidents in awarding of Contracts financed 100% with State funds.

In consideration of proposals that are equal to or in excess of \$50,000 and financed 100% with State funds, a nonresident bidder domiciled in a state having laws granting preference to local Contractors will be considered for such contracts on the same basis as the nonresident bidder's state awards contracts to Mississippi Contractors bidding under similar circumstances. When a nonresident Contractor submits a bid equal to or in excess of \$50,000 on a contract financed 100% with State funds, a copy of the current laws from the state of domicile and an explanation thereof pertaining to treatment of nonresident Contractors shall be attached. If no preferential treatment is provided for Contractors in the state of domicile and contracts are awarded to the lowest responsible bidder, a statement to this effect shall be attached. Should the attachment not accompany the bid when submitted, the Contractor shall have 10 days following the opening of the bids to furnish the required information to the Contract Administration Director for attachment to the bid. Failure to provide the attachment within 10 days will result in the nonresident Contractor's bid being rejected and not considered for award. As used herein, the term "resident Contractor" includes a nonresident person, firm or corporation that has been qualified to do business in this State and has maintained a permanent full-time office in the State of Mississippi for two years prior to the submission of the bid, and the subsidiaries and affiliates of such a person, firm or corporation.

MISSISSIPPI DEPARTMENT OF TRANSPORTATION

SPECIAL PROVISION NO. 907-619-6

CODE: (SP)

DATE: 03/21/2018

SUBJECT: Temporary Portable Rumble Strips

Section 619, Traffic Control for Construction Zones, of the 2017 Edition of the Mississippi Standard Specifications for Road and Bridge Construction is hereby amended as follows.

907-619.02--Materials. After Subsection 619.02.15 on page 472, add the following.

907-619.02.16--Temporary Portable Rumble Strips. Temporary portable rumble strips shall be RoadQuake manufactured by PSS and meet the following requirements:

- capable of being installed without adhesives or bolts,
- have a minimum weight of 100 pounds,
- have a minimum overall length of 11 feet,
- have a minimum width of 12 inches, and
- have a maximum height of 3/4 inch.

Temporary portable rumble strips shall be installed in accordance with the attached details, or as directed by the Engineer.

907-619.03--Construction Requirements. After Subsection 619.03.11 on page 476, add the following.

907-619.03.16--Temporary Portable Rumble Strips. Temporary portable rumble strips shall be placed at locations shown on the traffic control plans, attached drawing, or as directed by the Engineer. The rumble strips shall be removed when lane closures are removed, relocated when lane closures are relocated, or as directed by the Engineer.

Prior to placement of the rumble strips, the roadway shall be cleaned to be free of dust, sand, and other materials that may cause slippage. The minimum roadway temperature at the time of installation shall be in accordance with manufacturer recommendations.

A minimum of three (3) temporary portable rumble strips shall be arranged in an array. The spacing of temporary portable rumble strips in each array shall be on 15-foot centers. One array of three (3) strips shall be used in each lane. The rumble strips shall be regularly monitored and maintained to ensure they stay in place under traffic.

907-619.04--Method of Measurement. At the end of Subsection 619.04 on page 478, add the following.

Temporary Portable Rumble Strips will be measured for payment by the linear foot only when a pay item for temporary portable rumble strips is included in the contract. Otherwise, temporary portable rumble strips will be included in the cost of pay item 618-A, Maintenance of Traffic. The quantity of temporary portable rumble strips will be the length of rumble strips approved by the Engineer to be in-place on the project at any one time.

907-619.05--Basis of Payment. After the fifth paragraph of Subsection 619.05 on page 478, add the following.

Temporary Portable Rumble Strips measured as prescribed above, will be paid for at the contract unit price per linear foot, which price shall be full compensation for cleaning the roadway surface, installing the rumble strips, maintenance and repair of the strips, cleaning and resetting of the strips, removal and replacement, and for all labor, equipment, tools, and incidentals necessary to complete the work.

After the last pay item listed on page 480, add the following.

907-619-B: Temporary Portable Rumble Strips - per linear foot

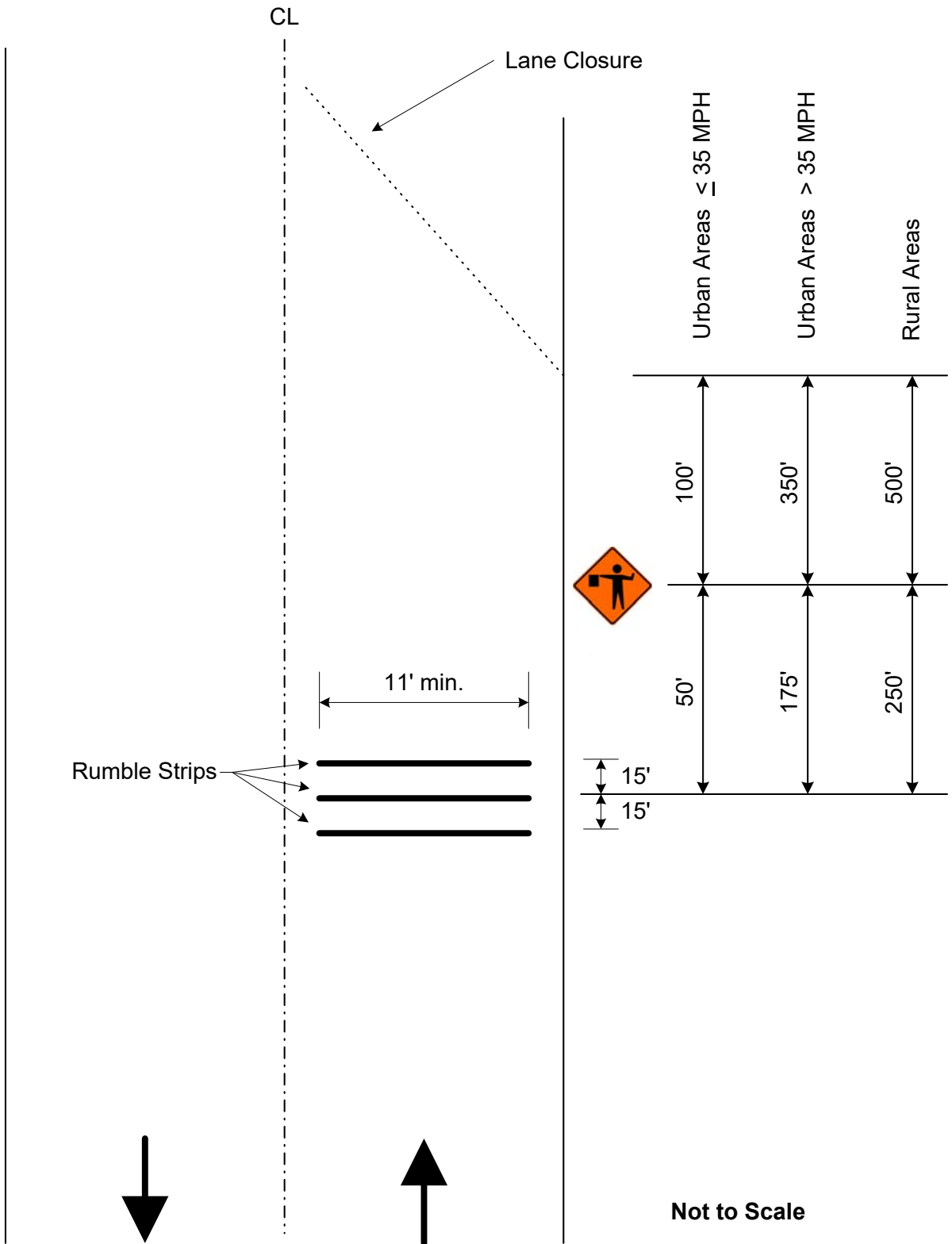

Detail of Temporary Portable Rumble Strips

MISSISSIPPI DEPARTMENT OF TRANSPORTATION

SPECIAL PROVISION NO. 907-631-1

CODE: (IS)

DATE: 11/15/2017

SUBJECT: Traffic Signal Systems - General

Section 631, Traffic Signal Systems - General, of the 2017 Edition of the Mississippi Standard Specifications for Road and Bridge Construction is hereby amended as follows.

907-631.02--Materials.

907-631.02.4--Operations. Delete the second paragraph in Subsection 631.02.4 on page 513 and substitute the following.

The Contractor shall conduct the work at all times in such a manner as to ensure the least possible inconvenience to the traveling public, and to property owners on the streets, alleys, and other public places where the construction will take place.

907-631.02.5--Electrical Service. Delete the first paragraph in Subsection 631.02.5 on page 515 and substitute the following.

It shall be the Contractor's responsibility to make the necessary arrangements with the local power company to provide the electrical service for any new installation. The Contractor shall pay for, at no cost to the Department, all deposits, hook-up charges, or other service fees required by the power company for the establishment of new service. The cost of all such fees shall be considered incidental and absorbed within existing pay items. The Department or the local agency will be responsible for payment of the monthly service bill for the new power service installation. It shall be the responsibility of the Contractor to swap the electrical service account over to the Department or local agency.

907-631.03--Construction Requirements.

907-631.03.2--Electrical Service Equipment. Delete the paragraphs of Subsection 631.03.2 on pages 515 and 516, and substitute the following.

The power supply assembly shall consist of all equipment mounted in a Power Service Pedestal as described in Subsection 722.13 or as otherwise shown in the plans. The configuration and installation of the equipment mounted on the assembly shall meet the safety requirements and approval of the utility company or municipality furnishing power for operation.

When required, service poles shall be provided by the Contractor and consist of wood poles with required pole line hardware, conduit, ground rods, guy wires and anchors and all other accessories and appurtenances mounted on the pole, except those items furnished by the utility company or

municipality, or as specified separately in the contract or plans. Costs of service poles shall be included in other items bids.

Main disconnect switches shall be separately housed on the power supply assembly. Circuit breaker cabinets and meters shall not be installed on the street or walk side of the pole or pedestal.

907-631.03.3--Performance Tests. Delete the second sentence of Subsection 631.03.3 on page 516.

MISSISSIPPI DEPARTMENT OF TRANSPORTATION

SPECIAL PROVISION NO. 907-632-1

CODE: (IS)

DATE: 11/15/2017

SUBJECT: Traffic Signal Cabinet Assemblies

Section 632, Traffic Signal Cabinet Assemblies, of the 2017 Edition of the Mississippi Standard Specifications for Road and Bridge Construction is hereby amended as follows.

Delete Section 632 on pages 517 thru 538, and substitute the following.

SECTION 907-632 - TRAFFIC SIGNAL CABINET ASSEMBLIES

907-632.01--Description. This work consists of furnishing, assembling, configuring and installing all component materials and software required to form completed traffic signal controller assemblies, closed loop master controller assemblies and signal system installation of the types specified, in conformity with these specifications, to ensure fully operational traffic signal installations as shown on the plans.

907-632.02--Materials.

907-632.02.1--Cabinet Assembly. Cabinet Assemblies shall meet the NEMA 3R requirements and be constructed principally of 0.125-inch thick, 5052-H32 aluminum. The aluminum shall have a mill finish per NEMA TS 2 7.7.3. Intermittent welds may be used for construction and any unwelded cabinet seams shall be sealed with clear RTV silicone. All external fasteners shall be stainless steel and no holes will be allowed in top of cabinet.

The door handles shall be stainless steel or cast aluminum. Door hinges shall be of the continuous type with a stainless steel hinge pin. Rivets are not be used to attach the hinge. The main door stop rod shall be constructed using stainless steel. The door stop mechanism shall be adjustable and capable of being securely latched in multiple opened positions including 90 degrees and a maximum of 120 degrees. The brackets attaching the stop rod to the door and cabinet shall be aluminum and welded in place. The main door cylinder lock shall be a #2 key type lock. Two (2) traffic industry standard No. 2 keys shall be provided with each cabinet and shall be made using heavy duty key blanks.

Extruded aluminum channels permanently attached to the right and left cabinet sides shall be provided for attaching adjustable shelving and mounting of other component panels. The cabinet shall have two (2) shelves installed. Both shelves shall be provided with the front edge pre-drilled with 0.25-inch holes located twelve (12) inches apart.

907-632.02.2--Physical Features.

907-632.02.2.1--Pull Out Drawer. A pull out drawer shall be installed and centered under the

bottom shelf. The drawer shall be made of 0.080-inch thick, 5052-H32 aluminum and come out on full extension drawer slides. The pull out drawer shall provide an approximate 16-inch x 14-inch working area and have the ability to bear a constant 25 pound burden. There shall be a compartment for document storage. The lid shall be hinged at the rear, to gain access to the storage area. The drawer will be used to store documents as well as support a notebook computer. The drawer slides shall be of the full extension ball bearing type. Dimensions of the drawer shall be large enough to support a notebook computer and a drawer of sufficient size to hold at least two (2) copies of the cabinet drawings and other related cabinet documentation. The surface of the lid shall have a non-slip surface.

907-632.02.2.2--Cabinet Lighting. Cabinets shall be provided with a minimum of two (2) white light LED modules. One (1) lighting module shall be installed along the front top section of the cabinet and the second lighting module shall be installed underneath the bottom cabinet shelf in such a location as to provide direct lighting of the load bay area of the cabinet but must not interfere with the cabinet drawer operation.

Both LED lighting modules shall be controlled by a NEMA rated, commercial quality, pushbutton door switch. The cabinet lighting shall turn on when the cabinet main door is opened and shall turn off when the main door is closed or an ON/OFF NEMA rated, commercial quality, toggle switch mounted on the inside cabinet door service panel shall be provided to turn both LED lighting modules on or off.

907-632.02.2.3--Police Panel Switches. Police panel switches shall be provided with all controller cabinets. All switches shall be hard wired and labeled as to their function.

NORMAL-FLASH: When this switch is in the FLASH position, all signal indications shall transfer to the flashing mode. AC power shall be removed from the load switches when the signal indications transfer to the flashing mode.

The controller unit shall operate in accordance with appropriate specifications during the flashing mode. When the switch is placed in the NORMAL position, transfer from the flash mode to normal operation shall be made in accordance with uniform code flash requirements.

SIGNAL ON-OFF: AC power shall be removed from the signal heads and the intersection will become dark when this switch is in the OFF position.

MANUAL CONTROL ON-OFF: When this switch is in the ON position, a logic ground shall be applied to the manual control enable input of the controller unit.

INTERVAL ADVANCE INPUT JACK: A manual jack shall be installed on the police panel. The jack shall inter-mate with a 3-circuit, ¼-inch diameter phone plug. The tip and ring (middle) circuits of the jack shall be connected to the logic ground and the interval advance inputs of the controller unit. When the manual hand cord is plugged into the jack and the pushbutton is pressed, logic ground shall be connected to the interval advance input of the controller unit.

When specified in the contract documents, an interval advance cord shall be provided. The cord

shall have a minimum length of three (3) feet. It shall have a 1/4-inch diameter, three circuit plug connected to one end and a manual pushbutton enclosed in a hand-held enclosure at the other end. A complete cycle (push-release) of the manual pushbutton shall terminate the controller unit interval which is active except the vehicular yellow and red clearance intervals. Cycling the push-button during the vehicular yellow or all red clearance intervals shall not terminate the timing of those intervals.

907-632.02.2.4--Service Panel Switches. Service panel switches shall be hard wired and clearly labeled to identify as to their functions. Service panel switches shall be mounted on the service panel located on the inside of the main cabinet door. Alternate switch locations may be described in the plans or contract documents but final switch design and location shall be approved by the Engineer prior to cabinet fabrication.

NORMAL-FLASH: When this switch is in the FLASH position, all signal indications shall transfer to the flashing mode. AC power shall be removed from the load switches when the signal indications transfer to the flashing mode.

The controller unit shall operate in accordance with appropriate specifications during the flashing mode. When the switch is placed in the NORMAL position transfer from the flash mode to normal operation shall be made in accordance with uniform code flash requirements.

CONTROLLER ON-OFF: When this switch is in the OFF position, AC power shall be removed from the controller. When this switch is returned to the ON position, the controller unit shall perform normal start up functions and resume normal operation in accordance with the applicable specification.

STOP TIME-RUN-NORMAL: A 3-position manual switch shall be provided which places the controller into Stop Time mode manually or through remote input.

VEHICLE DETECTORS: A 3-position switch shall be provided for each vehicle and pedestrian detector circuit. All switches shall be located on a panel mounted on the inside of the main cabinet door. The switch panel shall be labeled CALL SWITCH. Labeling of phase number and intended function (vehicles or pedestrian calls) shall be provided for each switch.

The vehicle detector switch functions are defined as follows:

- Locked Call Call is continually placed into the controller unit.
- Off (center) Vehicle detector is connected to the controller unit vehicle detector input, i.e. normal detector operation.
- Momentary Call Call is continuous as long as the switch is manually held in this position.

907-632.02.2.5--Police and Service Panel Locations. The police and service panels shall be constructed of 5052-H32 0.125-inch thick aluminum.

The police panel shall be located behind the police door which is enclosed within the main door.

The police door shall be hinged and provided with a neoprene gasket seal. Access to any portion or equipment contained behind the main cabinet door shall not be accessible through any part of the police panel. The police panel shall be of appropriate dimensions to accommodate all switch or devices described within this specification, the plans or contract document. The police door shall be provided with a treasury #2 key type lock and two (2) keys for the police door lock shall be provided with each cabinet.

The service panel shall be mounted on the inside portion of the main cabinet door, adjacent to the back side of the police panel or on the left hand side of the cabinet.

907-632.02.2.6--Cabinet Ventilation. Cabinets shall be vented to allow dissipation of the heat generated by the equipment contained within. All cabinets shall have a thermostatically controlled exhaust fan located at the top of the cabinet that is capable of 100 cubic feet per minute air displacement. The thermostat shall be mounted on the inside top of the cabinet and shall have a nominal temperature range from 80°F to 170°F.

The intake vent shall be louvered or equivalent design to prevent rain infiltration. The vent area will be located along the bottom portion of the cabinet door. A 16-inch x 12-inch x 1-inch disposable pleated air filter shall be provided on the inside portion of the cabinet and shall fully cover the vent area.

907-632.02.2.7--Air Filter Assembly. Air filters shall be one piece and shall be held firmly in place against the cabinet door in order to prevent dust from bypassing the perimeter of the filter and shall fully cover the vent area. Wing nuts or thumbscrews are preferred. Air filter shall be a 16-inch x 12-inch x 1-inch disposable pleated filter.

907-632.02.2.8--Cabinet Sizes.

907-632.02.2.8.1--Type I Cabinet. A Type I cabinet, 51”H x 30”W x 18”D, may be used for both pole and base mounted cabinets that require a maximum eight (8) position load bay. Pole mounted cabinets do not require rear access.

907-632.02.2.8.2--Type II Cabinet. A Type II cabinet, 51”H x 36”W x 18”D, may be used for both pole and base mounted cabinets that require a maximum twelve (12) position load bay. Pole mounted cabinets do not require rear access.

907-632.02.2.8.3--Type III Cabinet. A Type III cabinet, 56”H x 44”W x 27”D, shall be used for base mount installations and shall require a sixteen (16) position load bay and rear access door.

907-632.02.2.8.4--Type IV Cabinet. A Type IV dual chamber cabinet, 56”H x 57”W x 29”D, shall be used for base mount installations and shall require a sixteen (16) position load bay, rear access door, and external generator plug. When called for in the plans, a UPS shall be housed inside this cabinet.

907-632.02.2.8.5--Type V Cabinet. A Type V cabinet, 77”H x 44”W x 27”D, shall be used for base mount installations and shall require a sixteen (16) position load bay and rear access door.

907-632.02.3--Power Distribution Panel. The power panel shall be wired to provide the necessary power to all equipment. It shall be manufactured from 0.125-inch thick, 5052- H32 aluminum. The power panel shall house the following components: Main Breaker, Auxiliary Breakers, and Terminal Block. The panel shall be of such design so as to allow a technician to easily access the main and auxiliary breakers.

A 3-position terminal block with a removable insulated cover accepting up to AWG #4 stranded wire shall be supplied for accepting only the incoming power lines. This terminal block shall be in advance of and supply only the 30-amp main breaker, 10-amp and 5-amp Auxiliary breakers, AC neutral buss and earth ground buss.

907-632.02.3.1--Ground and Neutral Busbars. Cabinet grounding shall meet the requirements set forth in Subsection 722.09 for grounding and ground rods. A solid copper ground busbar shall be mounted on the side of the cabinet wall adjacent to the power panel for the connection of chassis ground wires. If more than one (1) ground busbar is used in a cabinet, a minimum of an AWG #6 copper wire shall be used to bond them.

The copper ground busbar shall have a minimum of thirteen (13) connector points, each capable of securing at least one (1) AWG #6 conductor.

A solid copper neutral busbar shall be mounted on the side of the cabinet wall adjacent to the power panel for the connection of AC neutral wires.

The copper neutral busbar shall have a minimum of thirteen (13) connector points, each capable of securing at least one (1) AWG #6 conductor.

907-632.02.3.2--Terminal Strips. Conductors shall be terminated on terminal strips with insulated terminal lugs. When two (2) or more conductors are terminated on field wiring terminal strip screws, a terminal ring lug shall be used for termination of those conductors. The voltage and current rating of terminal strips shall be greater than the voltage and current rating of the wire which is terminated on the terminal strip.

907-632.02.3.3--Cabinet Receptacles. A 3-wire 115 Volt AC (15A) Ground Fault Circuit Interrupt (GFCI) duplex receptacle shall be provided in the cabinet for maintenance use. It shall be securely mounted near the bottom right side of the cabinet and easily accessible.

Two (2) 3-wire 115 Volt AC (15A) non-GFCI protected outlets shall be installed, one on each side of the cabinet. These two (2) outlets are used for communication or other auxiliary equipment.

907-632.02.3.4--Operating Line Voltage. All equipment shall be designed to operate from a 120 volt, 60 cycle AC supply. Operation shall be satisfactory at voltages from 105 volts to 130 volts. All operating voltages into and out of the controller shall be NEMA level DC voltages except for the controller AC power source (Connector A, Pin p – AC-Control and Pin U – AC Common).

907-632.02.3.5--Circuit Breakers. Circuit breakers shall meet the requirements set forth in

Subsection 722.07. A 30-amp main breaker, with a minimum of 10,000 amp interrupting capacity, shall be provided for all cabinets to supply power to the controller, MMU, signals, and rack power supply.

Two (2) auxiliary breakers shall be provided. The first breaker, 10-amp, shall supply power to the fan, light, GFCI utility receptacle and two (2) auxiliary standard receptacles. The second breaker, 5-amp, shall be installed to supply power for the Controller Unit and MMU2. The above circuit breakers line side shall be jumpered together and will be fed from an external main circuit. A third 5-amp breaker shall be required if an ITS camera panel is called for in the plans.

907-632.02.3.6--Main Line Arrestors. Surge protection shall be provided that meets the requirements set forth in Subsection 722.12. A main line arrestor shall be provided to reduce the effects of voltage transients on the AC power line. It shall be installed after the circuit breaker. The main line arrestor shall be sufficient to protect all equipment and devices as per the plans and the following minimum specifications.

- Multi-stage Hybrid Design
- Series induction filtering
- Thermally protected Metal Oxide Varistors (TMOV's)
- Operating Voltage: 120 VAC
- Clamping Voltage: 395 VAC
- Operating Current: 15 A
- Peak Surge Current: 50 kA/Mode, 100 kA/Phase
- Operating Frequency: 47-63Hz
- EMI Attenuation: 40 dB Typ
- SPD Technology: TMOV's w/ W-C Filter
- Modes of Protection: L-N, L-G, N-G
- Status Indication: Power On & TMOV's Functional
- Connection Type: ¼-20 Stainless Steel Stud
- Operating Temperature: -40°F to +185°F

907-632.02.3.7--Solid State Main Line Relay (SSR). A normally-open, 75-amp, hybrid SSR shall be provided on the power distribution panel. The relay shall include a LED indicator to verify circuit power.

907-632.02.4--Terminal Facilities Board. The Terminal Facility shall be a hardwired load bay for NEMA TS 2 Type 1 actuated controllers. The load bay shall include either eight (8), twelve (12) or sixteen (16) load switch positions, as specified by the plans, and shall be centered along the back of the cabinet below the bottom shelf.

All wires terminated behind the backboard, as well as any additional panels, shall be soldered. No pressure or solderless connectors shall be used, unless they are soldered to the wire and tab after connection.

907-632.02.4.1--Load Switches and Flashers. Solid State Load Switches, compatible with low

wattage LED signals, shall be provided for the sequence called for on the plans. The load switch sockets shall be wired for triple-signal load switches conforming to NEMA TS 1-1994 and NEMA TS 2-2003 requirements.

The flasher socket shall be wired for and provided with a Type 3, two (2) circuit Solid State Flasher conforming to NEMA TS 1-1994 and NEMA TS 2-2003 requirements. It shall be possible to flash either the amber or red indication on any load switch outputs. It shall be possible to easily change the flash indication from the front side of the panel using readily available tools such as a screwdriver. A nominal flash rate of 50 to 60 FPM shall be provided. Flash rate shall be stable when used with generators or inverters.

Support(s) shall be provided to support the Flasher and Load Switches at some point approximately half of the total length from the panel surface. Sufficient area beneath the Load Switch or Flasher shall be clear in order to allow for free flow of air across the Load Switches or Flasher. Load Switches and Flashers must be provided with LED indicator lights on the side facing the cabinet door.

907-632.02.4.2--Flash Transfer Relay. All flash transfer relays, as a minimum, shall meet NEMA TS 1 requirements. The number of relays that shall be supplied with each cabinet shall accommodate the number of signal phases as indicated in the project plans. The coil of the flash transfer relay must be de-energized for flash operation.

907-632.02.5--Cabinet Wiring. Controller cabinets shall be wired in accordance with the signal phasing plans. If phases are indicated as omitted for future use, or if phases are not shown to be used in the plans, the cabinet shall be wired for use of the phases shown as future or unused. Load Switches shall not be provided for future or unused phases.

Wiring in the cabinets shall conform to the requirements of the National Electrical Code (NEC) and all of these specifications. All conductors in the cabinet shall be stranded copper. All wiring shall be laced. All wiring shall be in accordance as specified by Section 636 and Subsection 722.03 for Electric Cable and IMSA Specification 19 and/or 20 for Signal Wiring.

Connector harnesses for controller, conflict monitor, vehicle detectors, and accessory equipment (including NEMA defined Card Rack with power supply and pre-wired optical detection slots) shall be provided and wired into the cabinet circuitry. Connecting cables for controller and conflict monitor harnesses shall be sleeved in a braided mesh. All wires shall be securely terminated on terminal strips. The lay of the interconnect cable between the components must be such that when the door is closed, it does not press against the cables or force the cables against the various components inside the cabinets.

All communication wiring shall be bundled and routed independently of all other wiring. All live conductors shall be covered with suitable insulating material. All equipment grounds shall run directly and independently to the grounding bus.

All wires shall be cut and terminated as close as possible to the proper length before assembly. Consideration of equipment location adjustments must be made when determining appropriate

wire lengths. Excessive lengths of wire or cable shall not be allowed. All line voltage conductors used in controller cabinet shall conform to the following color code:

- AC Neutral: White
- AC Hot: Black
- Safety Ground: Green

907-632.02.5.1--Signal Terminal Arrestor Grounding Bar. A field terminal arrestor grounding bar shall be provided along the back portion of the cabinet for the installation of signal arrestors. This bar shall be attached using an AWG #10 stranded copper to the earth ground circuitry.

907-632.02.5.2--Signal Terminal Arrestors. The field terminal arrestor shall be a three (3) circuit protective device intended for use on traffic control load relay outputs. The arrestor shall be furnished with three (3) leads and a grounding stud which will be used to attach the arrestor to the grounding bar. The field terminal arrestor shall meet the following minimum specifications:

- Operating Voltage: 120 VAC
- Clamping Voltage: 475 VAC
- Peak Surge Current: 10 kA
- Operating Frequency: 47 – 63 Hz
- SPD Technology: MOV's
- Connection Type: Wire Leads
- Lead Wire: 14 AWG 12" Length
- Ground Stud: 10 x 32 5/8" Length
- Operating Temperature: -40°F to +185°F

907-632.02.6--Accessory Components.

907-632.02.6.1--Traffic Actuated Controller Unit. The fully actuated controller unit shall, at a minimum, meet the requirements of both NEMA TS 1-1989 and NEMA TS 2-2003 requirements for actuated controller units. The controller shall be of the TS 2 Type 2 configuration. The controller shall be provided with the multiple communication interface devices or properties as defined below.

- 10 Base-T Ethernet with front panel RJ-45 connector
- IEEE defined MAC address
- EIA-232 port
- External Serial Fiber options for both single and multi-mode (optional as per plans)
- External FSK 1200 bps modem (optional as per plans)
- D connector with 37 pin configuration for TS 1 compatibility
- USB port for signal controller database upload/download to the controller flash
- Controller
- ECOMM Compatible

The controller unit must have an alphanumeric backlit LCD display with a minimum of sixteen

(16) lines at 40 characters per line. The controller must be air-cooled with sufficient ventilation openings and capable of operating between -30°F and 165°F. The controller unit must be provided with a time-of-day clock, automatic daylight savings time adjustment and a power supply for maintaining SRAM during a power outage. The controller unit shall be capable of being used in a Closed-Loop System and must be capable of operating in the role of master controller in a Closed Loop System. The controller unit firmware shall be fully compatible with the Department's existing Traffic Signal Management Software. The Contractor shall ensure all controller firmware versions are compatible with the existing Traffic Signal Management Software that the Regional Department staff currently utilizes prior to submitting the controller for approval. The Contractor shall notify the Department if any special controller configuration or firmware is needed prior to submitting the controller for approval based on project requirements.

Where Flashing Yellow Arrow (FYA) operations are being used, all traffic signal controller firmware shall be capable of delaying the onset of the flashing yellow arrow.

All operator entered data shall be stored and backed up on to a flash memory device provided with the controller unit at no cost. This flash memory device shall require no battery to support value storage. No internal components of circuitry shall require battery support. The database shall be able to be backed up to a USB drive via the USB drive on the controller.

Traffic Actuated Controllers shall be of the Type shown on the plans. Type 1 Controllers shall have a Linux based processor and a minimum of one (1) USB port. Type 2 Controllers shall have the same features as Type 1 Controllers with the addition of an ATC backplane.

Type 3 Controllers shall have all features of the Type 2 Controller with the addition of the ATC module. All three (3) types of actuated controllers shall have Master controller capability, and if required shall be designated with 'M' in the plans.

907-632.02.6.2--Closed Loop Master Controller Unit. When called for in the plans, this work also consists of furnishing, installing and configuring the equipment, software and accessories necessary to connect one (1) traffic Closed-Loop Master Controller to its corresponding central or portable PC-based Traffic Computer Facility Control System via a communications connection. The communications or network connection device will be either existing or provided by the Contractor.

907-632.02.6.2.1--General. The Master shall monitor intersections in the system, display status and operational state and provide traffic flow data from intersection vehicle detectors. The Master shall include all communications equipment and software necessary to provide reporting to a remote terminal as well as upload/download of all local intersection data and provide timing synchronization. Communications to local controllers from the Master and from the Master to the central-office computer facility shall be by FSK, 900 MHz Radio, Broadband Radio, Serial Fiber, Ethernet, Fiber, Cell Modem or Leased Line, as indicated in the plans. The Master shall be able to run on the same controller simultaneously operating the intersection, with the local signal control software, on any given controller unit.

907-632.02.6.2.2--System Configuration. The system architecture shall be designed to minimize

the effect of equipment failures on system operation and performance. The system consists of four (4) principal elements:

- Local System Intersection Controllers
- Communication (Telemetry Links)
- On-Street Master(s)
- Central-Office Computer Software

907-632.02.6.2.3--Local System Intersection Controller. The local system intersection controllers connected to the Master controller unit shall be capable of controlling a fully actuated two (2) to sixteen (16) phase intersection and shall meet or exceed NEMA TS 1-1989 and TS 2-2003 standards for fully actuated traffic control units. The local controller shall have internal communication capability with direct access to the data memory. The local system controller shall be capable of processing controller and detector data and provide all necessary intersection control functions. The local system intersection controller shall meet the requirements of the Traffic Actuated Controller Unit.

907-632.02.6.2.4--Communications (Telemetry) Links. The communications links for the "Closed-Loop" System shall perform the following functions:

- Provide the medium (radio/fiber/hardwire/etc.) for two-way communications between the On-Street Master and the local intersection controllers.
- Provide the medium for two-way communication between the On-Street Master and the central-office computer facility.
- Error checking shall be included in both mediums to assure transmission and reception of valid data.

907-632.02.6.2.5--On-Street Master. The On-Street Master may be located at an intersection and connected via the communication network to at least 32 local intersection controllers. The Master shall be capable of implementing Traffic Responsive Control, Time Base Control, Manual Control or Remote Control modes of operation.

Analysis of sampling sensor data from at least 64 system detectors and corresponding selection of the best Traffic Responsive timing pattern shall be provided by the On-Street Master during the Traffic Responsive mode of operation.

Automatic and continuous monitoring of system activity shall be provided by the On-Street Master to include both Master and intersection alarm conditions.

System parameter entry shall be provided via the On-Street Master including all Master and local intersection assignment and group parameters. Master parameters shall include:

- System coordination setup and pattern data entry by group
- System time base event scheduler
- System traffic responsive computational and pattern selection setup by group
- Intersection system group and detector assignments

The On-Street Master shall provide comprehensive system report generation including, as a minimum: system, intersection, detector and failure status and history reports in addition to system performance reporting.

A RS-232C interface shall be provided on the On-Street Master to allow for printing of reports or for interconnecting to a remote central site.

To enhance overall system operation and increase system management flexibility, the On- Street Master shall also support two-way dial-up communications to a central office computer for control, monitoring, data collection and for timing pattern updating purposes, all from a remote central office location. Continuous, seven (7) days/week - 24 hours/day, system monitoring shall be enhanced by the On-Street Master's capability to automatically dial-up the central office computer upon detection of user defined critical alarm conditions.

907-632.02.6.2.6--System Functional Requirements.

907-632.02.6.2.6.1--Operator Interface. In order to provide ease in programming and operation, the system shall provide a simplified user-friendly menu format at each local, master and central office facility. No special programming skills shall be required for the user to fully access and operate this control and monitoring system at any level.

All programming, both of the local intersection controllers and the On-Street Master(s) shall be via a front panel keyboard and display, driven by English Language menus. All data change entries will be automatically verified against established ranges prior to acceptance to prevent programming data errors. Data access shall be controlled by user- definable access controls.

907-632.02.6.2.6.2--System Traffic Control. The system shall have the capability of controlling a minimum of sixteen (16) vehicle phases and eight (8) pedestrian phases. The system shall have the capability of implementing a minimum of four (4) timing rings, fifteen (15) alternate sequences, and sixteen (16) offsets.

The system shall provide the capability of selecting any of the following operational modes on a group basis:

- Traffic Responsive
- Time Base (Time-of-Day/Day-of-Week)
- Remote (External Command)
- Manual (Operator Entry)

The system shall be capable of implementing system FLASH and system FREE operation. The system shall have the capability to command, on/off based on time, up to eight (8) independent special functions.

907-632.02.6.2.6.3--Detectors. The system shall have the capability of accepting and processing data from at least 632 system detectors for Traffic Responsive program selection.

907-632.02.6.2.6.4--Pattern Selection. In addition to providing Manual and Remote program selection capability, the Master shall provide for Traffic Responsive and Time Base modes of operation for timing pattern selection.

907-632.02.6.2.6.4.1--Traffic Responsive Mode. Traffic plan selection in the Traffic Responsive mode shall be user-enabled and supplied with the controller, per the plans and specifications. The pattern selection shall be based on sampling detector volume and occupancy analysis by the On-Street Master.

907-632.02.6.2.6.4.2--Time Base Mode. The system shall provide the capability of implementing time-of-day, day-of-week and week-of-year control for each of the two (2) groups using an internal time clock referenced to the 60-Hz AC power line frequency for its time base. The Time Base mode shall contain automatic adjustment for leap year and daylight savings time changes.

The system Time Base mode shall provide, as a minimum, 100 events each capable of requesting any of the 48 traffic control patterns along with Traffic Responsive override enable or auxiliary events consisting of enable/disable any of up to four (4) system-wide special functions and setting sample and log interval time periods.

907-632.02.6.2.6.5--System Control Priority. The system coordination control (program-in-effect) for each group shall be selected on a priority basis. The priority from highest to lowest shall be as follows:

- Manual Control Entry
- External Control (Remote Command)
- Time Base Control (Time-of-Day/Day-of-Week) (Traffic Responsive control will prevail whenever Traffic Responsive Override Enable is active and the selected cycle length is greater than that being commanded by Time Base)
- Traffic Responsive Control

907-632.02.6.2.6.6--Measures of Effectiveness. The system shall have the capability to report selected Measures of Effectiveness (MOE's) on an intersection basis. MOE calculations shall be made on all phases by the local system intersection controller and as a minimum shall include measures such as: volume, number of stops, delays and green utilization. These measures shall be calculated on the basis of the active timing plan. Alternate ways of reporting MOE'S may be approved on a case-by-case review.

907-632.02.6.2.6.7--Uploading and Downloading. The system shall provide, for any selected local system intersection controller, the capability of uploading and downloading any or all, new or modified local intersection parameters from the central-office computer and the Department Central Traffic Signal Management Software, and shall include, as a minimum, all: Phase Timing and Unit Data; Coordination Data, Time Base Data; Preemption Data, System Communication Parameters, System Traffic Responsive Data, and any other System Data residing at the intersection such as Detector Diagnostic Values, Report Parameters and Speed Parameters.

During either uploading or downloading operations, normal traffic control operations shall not be suspended. All data shall be continually accessible and may be displayed at the On- Street Master or the central office computer.

907-632.02.6.2.6.8--System Monitoring and Diagnostics. The system shall automatically and continually monitor system activity and log/report occurrences of Master and intersection alarm conditions. All alarm condition events shall include at the intersection, (Master and central-office computer) an alpha-numeric description of the event as well as the time and date of occurrence.

As a minimum, monitored master alarms conditions shall include:

- Insufficient or Improper Data
- Failed Computational Channels
- Failed System Detectors
- Intersection Communication Failure
- Failed Controllers
- Minimum of six (6) special user defined alarms for user application flexibility
- Monitored intersection alarms conditions shall include as a minimum:
 - Cycle Faults and Failures
 - Coordination Failures
 - Voltage Monitor
 - Conflict, Local and Remote Flash Conditions
 - Preempt
 - Local Free
- Minimum of six (6) special user defined alarms for additional user flexibility.

When the Master detects a critical alarm condition, as defined by the user, it shall automatically dial-up the central office computer and report the condition. On a BUSY or NO ANSWER, the system may be programmed, at user option, to alert a secondary computer.

The system shall also automatically and continually monitor, verify and attempt to correct Sync Pulse, Time Base Clock and Pattern-In-Effect. The system shall provide capabilities to perform diagnostics on system and local detectors, communications and intersection operations. When a fault has been detected, an indication shall be provided. It shall be possible to isolate the fault to the failed unit from controls and indicators available on the Master unit. Auxiliary equipment such as a data terminal or CRT shall not be required to identify the failure.

907-632.02.6.2.6.9--Real Time Display. The Master shall provide for any selected local system intersection controller, real-time status information on its front panel. Real-time intersection status information shall include simultaneous display of: vehicle and pedestrian signal and detector status by phase, overlap signal status and cars waiting count by phase. Real-time controller status information shall include simultaneous display of: two (2) Ring Active timers, On/Next, Call/Recall and Hold/Omit Status by phase, Coordination, Preempt and Stop Time Status.

907-632.02.6.2.6.10--System Management. The system, without hardware changes but with its

ability to directly modify Master and intersection parameters, shall provide the user system configuration and operational controls of the following functions: add/delete controllers and system detectors, enable Traffic Responsive mode, assign intersections to groups, assign system detectors to computational channels and channels to pattern select routines, and assign special and/or standard detectors as system detectors for use with computational channels or to track activity.

907-632.02.6.2.6.11--System Logging and Reports. The system shall automatically and continually process system data and log/report on occurrence of changes in intersection status, system detector status, communications status, controller status and local detector status in addition to system program changes, Traffic Responsive computations, measures of effectiveness and performance.

907-632.02.6.2.6.12--Security. The On-Street Master shall provide for a user-specified security code entry before any data may be altered. In order to view any parameter, security code entry shall not be required. Security access shall be automatically rescinded approximately ten (10) minutes after either access was gained or the last parameter change was entered. The Master and local controller shall have the ability via keyboard to disable security code requirements, allowing for perpetual access without requiring hardware changes.

907-632.02.6.2.7--Design Characteristics. The On-Street Master shall be designed to operate in either an office or field environment and shall be suitably housed in a separate enclosure or in a local intersection cabinet. The Master shall be designed to meet the following electrical and mechanical requirements:

907-632.02.6.2.7.1--Programming and Security. Operator programmable data entry shall be accomplished through panel keyboard(s). The Master shall prevent the alteration of keyboard set variables prior to the user having entered a specific access code through the keyboard. The Master shall maintain user-programmable variables in non-volatile memory with a battery-backed RAM to assure continued efficient system operation.

907-632.02.6.2.7.2--Test and Repair. To enhance maintenance and trouble-shooting activities, On-Street Masters shall include resident diagnostics as a standard. No extender- cards, special tools or PROMs shall be necessary to fully maintain these components. The Master unit design shall ensure that all printed circuit boards be readily accessible for maintenance testing purposes. All fuses, connectors and controls shall be accessible from the front of the Master unit.

907-632.02.6.2.8--Traffic Signal System Software. All Traffic Signal System Software shall be compatible with the latest version of the Department's existing Master and local controllers and existing Traffic Signal Management Software for the Department region.

907-632.02.6.2.8.1--Traffic Signal Closed Loop Software. The Traffic Signal Closed-Loop Software shall provide the ability to manage Master and local controller databases including the uploading and downloading of data parameters. The software shall provide status information and provide reporting capabilities for Master and local controller data, alarms and logs.

907-632.02.6.2.8.2--Traffic Signal System Workstation Software. The Traffic Signal System Workstation shall provide the ability to manage Master and local controller databases including the uploading and downloading of data parameters. The software shall provide status information and provide reporting capabilities for Master and local controller data, alarms and logs.

The Traffic Signal System Workstation Software shall also be capable of operating as a network-connected user workstation to existing centralized signal systems and their associated databases.

When disconnected from the centralized signal system, the software shall be capable of running as a standalone system similar to the Closed-Loop Software. Under this mode, the software shall provide management, report and status functions for Master and local controllers. Under Standalone Mode of operation the software shall allow for its own database(s) for data management without the need for connecting to a centralized signal system database.

907-632.02.6.2.9--Services. Technical services shall be provided, as required, to assist in installation and initial setup of the Closed-Loop Master System and its sub-components. Technical assistance with database migration and/or setup, as well as the development of graphics (such as master maps and local intersection depictions) and the assignment of associated attributes such as detectors, phasing, signals, etc., shall be provided as required. Additionally, training shall be provided on a basic or advanced target user level, as required.

907-632.02.6.3--Malfunction Management Unit (MMU2). The Malfunction Management Unit (MMU2) shall be a shelf-mountable, sixteen (16) channel, solid-state, IP addressable MMU. The MMU2 shall accomplish the detection of, and response to, improper and conflicting signals and improper operating voltages in a traffic signal controller assembly, including support for four (4) section Flashing Yellow Arrow (FYA) left turn displays. The MMU2 shall be capable of running a minimum of twelve (12) different modes of FYA operation.

The MMU2 shall meet or exceed Section 4 requirements of the NEMA Standards Publication No. TS 2-2003 including NEMA TS 2 Amendment #4-2012 and provide downward compatibility to NEMA Standards Publication No. TS 1-1989: Type 12 Operation, in addition to those specifications set forth in this document.

The MMU2 shall include a graphics based Liquid Crystal Display (LCD) to view the current monitor status and navigate the unit's menus. An RJ-45 Ethernet Port shall be provided for communications.

A built-in Diagnostic Wizard shall be provided that displays detailed diagnostic information regarding the fault being analyzed. This mode shall provide a concise view of the signal states involved in the fault, pinpoint faulty signal inputs and provide guidance on how the technician should isolate the cause of the malfunction. The Diagnostic Wizard shall be automatically invoked when the MMU2 is in the fault mode and the HELP button is pressed. It shall also be automatically invoked when the MMU2 is in the Previous Fail (PF) event log display and the HELP button is pressed.

A built-in Setup Mode shall be provided that automatically configures the Dual Indication Enable, Field Check Enable, Red Fail Enable and Minimum Yellow Plus Red Clearance Enable parameters from user input consisting only of channel assignment and class (vehicle, ped, pp-turn, FYA, etc.) responses.

The MMU2 shall be capable of operating in the Type 12 mode with SDLC communications enabled on Port 1. The Channel Status display shall operate in the Type 12 configuration and provide the Field Check function for up to four (4) Pedestrian Walk inputs.

In the interest of reliability and repair ability, printed circuit board mounted MS connectors shall not be acceptable. Internal MS harness wire shall be a minimum of nineteen (19) strand AWG 22 wire.

907-632.02.6.4--NEMA defined Card Rack and Power Supply. A minimum of one (1) NEMA compliant detector card rack with five (5) slot positions (first slot for power supply and four (4) available slots) shall be provided in each cabinet. The detector rack shall be installed on the bottom shelf of the cabinet. The power supply for the NEMA defined card slots shall be provided as a 175W minimum with four (4) independent regulated channels of 24 VDC each rated at 0.75 amps over the full NEMA operating temperature range of -30°F to +165°F. The output should be regulated to 24 VDC +/- 15%. Each of the four (4) outputs shall be independently fused, each with a separate LED for displaying output and fuse status for each of the four (4) outputs. Each of the four (4) outputs shall be protected against voltage transients by a minimum 1500 watt suppressor. All card racks shall be wired for the type detection shown in the plan sheets.

Card Guides shall be provided on the top and bottom of the card rack for each connector position.

907-632.02.6.5--In-Cabinet Network.

907-632.02.6.5.1--Communications Arrestor. The Controller Cabinet network shall consist of an SDLC connection between the Controller Unit and MMU2. Surge suppression for this network shall meet the requirements set forth in Subsection 722.12 and the following minimum requirements below:

- Operating Voltage: 5 VDC
- Clamping Voltage: 8 VDC
- Operating Current: 1.5 A
- Peak Surge Current: 47 A (10x1000 μ s)
- Frequency Range: 0 to 20 MHz
- Insertion Loss: < 0.1 dB at 20 MHz
- SPD Technology: SAD
- Connection Type: DB-15
- Operating Temperature: -40°F to +185°F

907-632.02.6.6--System Communications.

907-632.02.6.6.1--Traffic Signal Ethernet Switch. When specified in the plans or contract

documents, a traffic signal Ethernet switch shall be installed in the cabinet assembly. It shall meet the requirements for the type specified in Section 907-663. Ethernet patch cables of sufficient length shall be provided for all supplied Ethernet ready cabinet components. The switch and all components shall be connected and configured.

907-632.02.6.6.2--Fiber Optic Patch Panel. When specified in the plans or contract documents, fiber optic attenuator patch cords shall be installed in the cabinet assembly as specified in Section 907-661.

907-632.02.6.6.3--Wireless Communications. When specified in the plans or contract documents, wireless communication components shall be installed in the cabinet assembly and shall be as specified in Section 907-662.

907-632.02.6.6.4--Serial Port Server or Terminal Server. When specified in the plans or contract documents, serial port servers shall be installed in the cabinet assembly and shall be as specified in Subsection 907-663.02.2.

907-632.02.6.6.5--GPS Clock. This work includes furnishing a Global Positioning System (GPS) Synchronization clock that can be used to sync the internal clocks in traffic signal controllers when coordination is desired, but communication is not necessary. The GPS Clock System shall provide GPS based time and date synchronization to provide coordination of traffic controllers to a common time base. The system shall process GPS Time data using a tamper/vandal resistant GPS antenna and correct for Time Zone, Daylight Savings Time, Leap Years, and GPS Leap Seconds. The processed time information shall be sent to the traffic controller in the native format for the respective controller. A contact closure synchronization pulse with variable pulse width shall be available for a once per day update. If the GPS antenna is blocked for up to one (1) hour prior to scheduled time of synchronization, the system shall synchronize the traffic controllers with less than 0.4 seconds variance from the accuracy provided under normal operation with GPS satellites in view.

- The GPS Clock shall also meet the following minimum specifications:
- Input Voltage: 9-24 VDC
- Current Draw: 150 mA (max) at 12 VDC: 125 mA (max) at 24 VDC
- Contact Closure: 750 mA at 30 VDC
- Temperature Rating: -29.4°F to +167°F

GPS unit shall be mounted to the traffic signal controller cabinet as per the manufacturer's recommendation. Any and all holes created in the cabinet for the purpose of mounting the GPS unit shall be sealed to the satisfaction of the Engineer at no direct pay.

907-632.02.6.6.6--Power-Over-Ethernet Arrestor. Surge suppression that meets the requirements set forth in Subsection 722.12 shall be provided. In addition, the following minimum specifications shall be supplied for loads that require Power-Over-Ethernet with isolated shielded or non-shielded cable:

- Operating Voltage: 48 VDC
- Clamping Voltage: 68 VDC
- Operating Current: 0.75 A per Pin Continuous
- Peak Surge Current: 10 kA
- Insertion Loss: < 0.1 dB
- SPD Technology: GDT, SAD, with series PTC
- Modes of Protection: All Lines (1-8) Protected (L-L) and (L-G): Signal High- Low; High-Ground; Low-Ground
- Transmission Speeds: 10BaseT; 100BaseT; 1000BaseT
- Connection Type: RJ-45
- Operating Temperature: -40°F to +185°F

907-632.02.7--Detector Panel. A vehicle detector harness shall be provided to connect the detector panel to the card rack. The detector panel shall accept the connection of sixteen (16) field loop inputs and four (4) pedestrian detector inputs.

907-632.02.7.1--Detector Input Arrestors. Field Loop and Pedestrian input arrestors shall meet the requirements set forth in Subsection 722.12. Field loop arrestors shall have differential and common mode protection and be provided with the following minimum specifications:

- Operating Voltage: 75 VDC
- Clamping Voltage: 130 VDC
- Peak Surge Current: 250 A
- SPD Technology: Silicon Break-Over
- Operating Temperature: -40°F to +185°F

Pedestrian input arrestors shall be a four (4) circuit device provided with the following minimum specifications:

- Operating Voltage: 30 VDC
- Clamping Voltage: 36 VDC
- Operating Current: 0.15 A
- Peak Surge Current: 10 kA (8 x 20 μs)
- Frequency Range: 0 to 20 MHz
- Insertion Loss: < 0.1 dB at 20 MHz
- SPD Technology: GDT, SAD, with Series PTC
- Connection Type: Terminal Block with compression lugs; Terminals accept up to 10 AWG
- Operating Temperature: -40°F to +185°F

907-632.02.8--System Detectors. The controller shall have the ability to receive input data from up to eight (8) special system detectors in addition to the normal actuated controller unit phase detectors. The user shall have the option to assign any of the phase detectors as “system detectors”.

907-632.02.9--Preemption. The cabinet shall be completely wired to accept and service calls from preemption phase selector modules, associated optical detector units and GPS units. Optical detector units and GPS unit cabinet components shall be as specified in Section 639. Provision for two (2) standard card modules shall be accommodated in a separate card rack for preemption. The preemption card rack shall provide a minimum of eight (8) channels.

Provisions shall also be made in the cabinet to accommodate Railroad Preemption when specified in the plans or contract documents. Railroad Preemption shall meet the requirements set forth in Section 639. While it is not necessary that a Railroad Preemption interface board be provided with the cabinet, the cabinet and back panel shall be designed so that a Railroad Preemption interface panel that uses a relay to isolate the track switch from the controller cabinet circuitry can be installed. Preempt 1 and 2, in the case of gate down preemption, shall be reserved for Railroad Preemptions; all subsequent preemptions shall be reserved for Emergency Vehicle, Fire Station, or Police Preemption.

907-632.02.10--Uninterruptable Power Supply. When specified in the plans or contract documents an Uninterruptable Power Supply (UPS) System shall be installed in the cabinet assembly. The UPS shall be installed in the cabinet and meet the requirements set forth in Section 633.

907-632.02.11--Power Service Pedestal. A Power Service Pedestal shall be provided as described in Section 631.03.2.

907-632.03--Construction Requirements.

907-632.03.1--Mounting. Traffic Signal Cabinet Assemblies shall be wall or pole mounted, base mounted on a concrete cabinet pad, or base mounted using a composite enclosure as specified below and as shown in the plans.

Power Service Pedestal shall be base mounted on a concrete cabinet pad or on a composite enclosure as specified below and as shown in the plans.

907-632.03.1.1--Wall or Pole Mounted. Wall or pole mount hardware shall be provided for mounting cabinets in specific installations as indicated in the design plans. Wall or pole mounted cabinets shall be manufactured with rigid tabs, rigid brackets or other acceptable configuration for attachment of the cabinet to the wall or pole support. Rigid attachment devices must allow for field alignment of cabinet to the wall or pole support.

907-632.03.1.2--Concrete Cabinet Pad. Concrete foundations shall be constructed of Class B concrete in specific installations as indicated in the design plans.

Cabinets for installation on a concrete base shall be manufactured with rigid tabs, rigid brackets or other acceptable configuration for attachment of the cabinet bottom to its flat support structure. Rigid attachment devices must allow for field alignment of cabinet with the support base. Concrete base construction details shall be provided in the design plan drawings.

907-632.03.1.3--Composite Enclosure. Cabinets for installation on a composite enclosure base shall be manufactured with rigid tabs, rigid brackets or other acceptable configuration for attachment of the cabinet bottom to its' flat support structure. Rigid attachment devices must allow for field alignment of cabinet with the composite enclosure. Composite enclosure attachment details shall be provided as shown in the plans.

907-632.03.2--Documentation. Documentation packages shall be delivered for each unit at the same time as the equipment to which it pertains.

A minimum of two (2) sets of complete schematic drawings and equipment documentation shall be supplied with each cabinet. The first copy shall be placed in a clear re-sealable print pouch of sufficient size to accommodate one (1) complete set of folded cabinet prints and placed in the pull-out drawer of the cabinet and the second copy shall be provided to the Department. Comprehensive controller data shall be included as part of the cabinet documentation package and shall be placed in the cabinet drawer pouch. Digital copies of all cabinet documentation shall be provided to the Department before final acceptance.

The documentation packages shall contain a schematic wiring diagram of the controller cabinet assembly and all auxiliary equipment. The schematic wiring diagram, including a symbols legend, shall show in detail all integrated circuits, transistors, resistors, capacitors, inductors as well as switches and indicators. All parts shown shall be easily identified on both in the cabinet and on the schematic diagram. Model numbers shall be used on schematic diagram when available.

A complete physical description of the signal cabinet assembly shall be provided to include at least the physical dimensions of the unit, weight, temperature ratings, voltage requirements, power requirements, material of construction, and complete performance specifications.

A complete set of operation guides, user manuals, and performance specifications shall be provided.

Detailed programming instructions, preventative maintenance requirements, and troubleshooting procedures shall also be provided for the controllers. These documents shall fully cover all programming procedures and programmable options capable of being made to the controllers and associated traffic control equipment. Instructions for modifications within the range of the capabilities of the unit such as changes in phases or sequences and programming matrix boards shall be included.

An intersection diagram shall be provided on the cabinet door showing geometric configuration, lane use assignments, controller cabinet and signal pole locations, vehicle and pedestrian signal head locations, vehicle and pedestrian detector zone locations, ring-barrier phasing diagram, and detector channel assignments. The intersection diagram shall be labeled with, at a minimum, a North Arrow, main street name(s), side street name(s), signal pole numbers, vehicle and pedestrian head type(s), detector zone designations, volume density and phase recall requirements, flash sequence. All field wires within the cabinet shall be labeled to coincide with those shown on the intersection diagram.

907-632.04--Method of Measurement. Traffic Signal Cabinet Assembly will be measured as a unit per each.

Remove and Replace Existing Traffic Signal Cabinet Assembly will be measured as unit per each.

Modify Existing Traffic Signal Cabinet will be measured as a unit per each.

Solid State Traffic Actuated Controller, of the type specified in the project plans, will be measured as a unit per each.

Signal Software License, of the type specified in the project plans, will be measured as a unit per each.

Malfunction Management Unit, of the type specified in the project plans, will be measured as a unit per each.

Card Rack, of the type specified in the project plans, will be measured as a unit per each.

GPS Clock, as specified in the project plans, will be measured as a unit per each.

Power Service Pedestal, as specified in the project plans, will be measured as a unit per each.

All pay items shall be inclusive of all materials, work, system integration, testing and incidentals necessary for a complete and operable unit in place and accepted. All removal, turn on, and acceptance of equipment, devices, traffic signals, and traffic signal assemblies shall follow Section 631 - Traffic Signal Systems-General prior to payment.

907-632.05--Basis of Payment. Traffic Signal Cabinet Assembly, measured as prescribed above, will be paid for at the contract unit price per each for each type(s) specified in the contract, which price shall be full compensation for furnishing, installing, configuring, wiring, testing, and mounting foundation construction, cabinets, relays, terminals, circuit breakers, modules, coordination and time base control programs, connectors wiring, overlap equipment, load switches, power cables, power supplies, controller mechanism and housing, MMU2, mounting material, all other materials, and all equipment, labor, tools, and incidentals necessary to complete the work.

Remove and Replace Existing Traffic Signal Cabinet Assembly, measured as prescribed above, will be paid for at the contract unit price per each for each type(s) specified in the contract, which price shall be full compensation for furnishing, installing, configuring, wiring, testing, cabinets, relays, terminals, circuit breakers, modules, coordination and time base control programs, connectors wiring, overlap equipment, load switches, power cables, power supplies, controller mechanism and housing, MMU2, mounting material, all other materials, removal, disposal, transfer, storage, and/or resetting of components that are existing, all other components included in the traffic signal cabinet, and all equipment, labor, tools, and incidentals necessary to complete the work.

Modify Existing Traffic Signal Cabinet, measured as prescribed above, will be paid for at the

contract unit price per each, which price shall be full compensation for furnishing, installing, configuring, and mounting all components, wiring, and devices; rewiring, reconfiguring, removal, disposal, transfer, storage, and/or resetting of existing components and devices, installing or changing coordination and time base control programs in the traffic signal cabinet assemblies, testing, final cleanup, all equipment, labor, tools, and incidentals necessary to complete the work.

Solid State Traffic Actuated Controller, measured as prescribed above, will be paid for at the contract unit price per each for each type(s) specified in the contract, which price shall be full compensation for all labor, equipment, tools, materials inclusive of the controller mechanism(s) and housing(s), all power cables, power supplies, wiring, factory and manufacturing inspection, attachment hardware, testing, storage, packaging, shipping, warranty, and all work, equipment, and appurtenances, and all incidentals necessary to provide a fully functional traffic controller ready for use. It shall also include all documentation including operations and maintenance manuals and other material necessary to document the operation of the traffic controller.

Signal Software Licenses, measured as prescribed above, will be paid for at the contract unit price per each for each type(s) specified in the contract, which price shall be full compensation for all labor, equipment, tools, materials inclusive of furnishing, installing and configuring the Signal Software, all power cables, power supplies, wiring, factory and manufacturing inspection, testing, storage, packaging, shipping, warranty, appurtenances, and all incidentals necessary to provide fully functional Signal Software ready for use. It shall also include all documentation including operations and maintenance manuals and other material necessary to document the operation of the Signal Software.

Malfunction Management Unit, measured as prescribed above, will be paid for at the contract unit price per each for each type(s) specified in the contract, which price shall be full compensation for all labor, equipment, tools, materials inclusive of furnishing, installing and configuring the Malfunction Management Unit (MMU2), all power cables, power supplies, wiring, attachment hardware, factory and manufacturing inspection, testing, storage, packaging, shipping, warranty, and all work, equipment, and appurtenances, and all incidentals necessary to provide a fully functional Malfunction Management Unit (MMU2) ready for use. It shall also include all documentation including operations and maintenance manuals and other material necessary to document the operation of the Malfunction Management Unit (MMU2).

Card Rack, measured as prescribed above, will be paid for at the contract unit price per each for each type(s) specified in the contract, which price shall be full compensation for all labor, equipment, tools, materials inclusive of furnishing, installing and configuring the Card Rack, all power cables, power supplies, wiring, attachment hardware, factory and manufacturing inspection, testing, storage, packaging, shipping, warranty, and all work, equipment, and appurtenances, and all incidentals necessary to provide a fully functional Card Rack ready for use. It shall also include all documentation including operations and maintenance manuals and other material necessary to document the operation of the Card Rack.

GPS Clock, measured as prescribed above, will be paid for at the contract unit price per each for each type(s) specified in the contract, which price shall be full compensation for all labor, equipment, tools, materials inclusive of furnishing, installing and configuring the Global

Positioning System (GPS) Clock(s), all power cables, power supplies, wiring, attachment hardware, factory and manufacturing inspection, testing, storage, packaging, shipping, warranty, and all incidentals necessary to provide a fully functional GPS Clock ready for use. It shall also include all documentation including operations and maintenance manuals and other material necessary to document the operation of the GPS Clock.

Power Service Pedestal, measured as prescribed above, will be paid for at the contract unit price per each for each type(s) specified in the contract, which price shall be full compensation for furnishing, installing, configuring, wiring, testing, and mounting foundation construction, cabinets, circuit breakers, connectors wiring, mounting material, all other materials, and all equipment, labor, tools, and incidentals necessary to complete the work.

Payment will be made under:

- 907-632-A: Solid State Traffic Signal Cabinet Assembly,
Type __ Cabinet, Type __ Controller - per each
- 907-632-B: Remove and Replace Existing Traffic Signal Cabinet Assembly,
Type __ Cabinet, Type __ Controller - per each
- 907-632-C: Modify Existing Traffic Signal Cabinet Assembly - per each
- 907-632-D: Solid State Traffic Actuated Controller, Type _____ - per each
- 907-632-E: Single-user Workstation Signal Software License - per each
- 907-632-F: Single-user Server Signal Software License - per each
- 907-632-G: Malfunction Management Unit - per each
- 907-632-H: Card Rack, ____ Position - per each
- 907-632-I: GPS Clock - per each
- 907-632-J: Power Service Pedestal - per each

MISSISSIPPI DEPARTMENT OF TRANSPORTATION

SPECIAL PROVISION NO. 907-641-1

CODE: (IS)

DATE: 11/15/2017

SUBJECT: Radar Vehicle Detection

Section 641, Radar Detection Systems, of the 2017 Edition of the Mississippi Standard Specifications for Road and Bridge Construction is hereby amended as follows.

Delete the title of Section 641 on page 584 and substitute the following.

SECTION 907-641 - RADAR VEHICLE DETECTION

Delete Subsection 641.01 on page 584, and substitute the following.

907-641.01--Description. This work shall consist of providing all labor, materials, equipment, and incidentals necessary to furnish, install, test, train and operate Radar Vehicle Detection, including Signal Radar Vehicle Detection (SRVD) and Intelligent Transportation Systems (ITS) Radar Vehicle Detection (IRVD). These systems will provide roadway monitoring capabilities via electromagnetic microwave radar signals through the air. The signals bounce off vehicles in their paths and the signal is returned to the detector. The returned signals are processed to determine traffic parameters.

907-641.01.1--Signal Radar Vehicle Detection. SRVD provide traffic parameters necessary to the traffic signal controller operation for vehicle detection. All Signal Radar Vehicle Detection shall be supplied from the same manufacturer per construction project.

Type 1 SRVD shall be used for basic vehicle detection at signalized intersections as described below in this specification. Type 2 SRVD shall have all of the functionality of the Type 1 SRVD with additional features described below in this specification.

Type 2 SRVD shall utilize a matrix of radar signals for two-dimensional coverage and shall track vehicles through each type of detection's specified Area of Coverage. The Type 2 SRVD shall report real-time detection of both moving and stopped vehicles.

907-641.01.2--ITS Radar Vehicle Detection. IRVD shall provide data, including, but not limited to speeds, volume, lane occupancy and classification.

907-641.02--Materials.

907-641.02.1--Radar Design. Delete the first sentence of the first paragraph of Subsection 641.02.1 on page 584, and substitute the following.

The IRVD and the SRVD stop bar microwave shall operate in the 24.0 to 24.25 GHz frequency band.

907-641.02.1.1--Cabinet Interface Unit (CIU) Design. Delete the last paragraph of Subsection 641.02.1.1 on page 585, and substitute the following.

The CIU shall operate in the harsh conditions of a signal cabinet, and comply with the applicable standards stated in the NEMA TS 2-2003 standard for shock, vibration, and temperature.

Delete Subsection 641.02.2 and 641.02.3 on pages 585 and 586, and substitute the following.

907-641.02.2--Area of Coverage--SRVD.

907-641.02.2.1--Stop Bar Radar Vehicle Detection. Type 1 SRVD stop bar radar sensor shall track vehicles through a field of view that extends out a minimum of 100 feet

The Type 1 SRVD stop bar radar sensor shall be able to detect and report presence in lanes located within a minimum 100-foot from the face of the detector. Any variance of the detectable area shall be approved by the Engineer.

The Type 1 SRVD stop bar radar sensor shall be able to detect up to four (4) lanes with eight (8) or sixteen (16) individual zones as indicated in the plans.

Type 2 SRVD stop bar radar sensor shall have all the functionality of the Type 1 SRVD stop bar sensor with the addition of the following:

- Type 2 SRVD stop bar radar sensor shall detect true presence of vehicles whether in motion or still without using Locking or Latching Algorithms.
- Type 2 SRVD stop bar radar sensor shall report presence in lanes with a minimum 90 degree arc from the face of the detector.
- Type 2 SRVD stop bar radar sensor shall be able to detect a minimum of ten (10) lanes.

907-641.02.2.2--Advanced Radar Vehicle Detection. The Type 1 SRVD advanced radar sensor shall be able to detect and report vehicle information such as range and speed when mounted within 50 feet of the center of the lanes of interest. Variance of this distance shall be approved by the Engineer per the application.

The Type 1 SRVD advanced radar sensor shall be forward fired and be able to detect and report vehicle information when mounted at heights above the road surface, as per manufacturer's recommendations.

The Type 1 SRVD advanced radar sensor shall be able to detect and report vehicles on the roadway up to 600 feet from the detector.

The Type 2 SRVD advanced radar sensor shall have all the functionality of the Type 1 SRVD advanced radar sensor with the following additions:

- Type 2 SRVD advanced radar sensor shall be able to detect and report heavy vehicles on the roadway up to 900 feet from the detector.
- Type 2 SRVD advanced radar sensor shall be able to detect Estimated Time of Arrival (ETA) for vehicles. The advanced radar sensors shall support user configurable upper and lower ETA filters for each zone. The sensors shall support the configuring of ETA filters in increments of 0.1 seconds.

907-641.02.3--Area of Coverage-IRVD. The IRVD's field of view shall cover an area with a minimum detection range of six (6) feet from the IRVD and a maximum detection range of 250 feet from the IRVD.

Delete the title of Subsection 641.02.4 on page 586, and substitute the following.

907-641.02.4--Detection Zones--SRVD.

Delete the title of Subsection 641.02.4.1 on page 586, and substitute the following.

907-641.02.4.1--Stop Bar Radar Vehicle Detection.

After the last sentence of the second paragraph of Subsection 641.02.4.1 on page 586, add the following.

A minimum of one (1) separate detection zone per lane is required.

Delete the title of Subsection 641.02.4.2 on page 586, and substitute the following.

907-641.02.4.2--Advanced Radar Vehicle Detection.

Delete the third paragraph of Subsection 641.02.4.2 on page 586, add the following.

The advanced radar sensors shall provide vehicle call and extend data on up to eight (8) channels that can connect to contact closure modules compliant with NEMA TS 1, NEMA TS 2, and 170/2070 controller cabinets.

Delete the title of Subsection 641.02.5 on page 586, and substitute the following.

907-641.02.5--Detection Zones--IRVD.

Delete the title of Subsection 641.02.6 on page 586, and substitute the following.

907-641.02.6--Capabilities--SRVD.

Delete the title of Subsection 641.02.6.1 on page 587, and substitute the following.

907-641.02.6.1--Stop Bar Radar Vehicle Detection.

Delete the title of Subsection 641.02.6.2 on page 587, and substitute the following.

907-641.02.6.2--Advanced Radar Vehicle Detection.

After item 2) of Subsection 641.02.6.2 on page 587, add the following.

- 3) Maintain a detection accuracy of 95% for each detection zone set-up on the graphical user interface.

Delete the title of Subsection 641.02.7 on page 587, and substitute the following.

907-641.02.7--Capabilities--IRVD.

Delete the first sentence of the first paragraph of Subsection 641.02.7 on page 587, and substitute the following.

The IRVD shall detect true presence of vehicles whether in motion or still without using Locking or Latching Algorithms.

Delete item 5) in Subsection 641.02.7 on page 587, and substitute the following.

- 5) IRVD in forward-looking configuration shall monitor traffic in one lane and be capable providing the following data: Volume, occupancy, average speed and travel direction in the lane.

907-641.02.8--Environmental Conditions and Protection. Delete the last sentence of the first paragraph of Subsection 641.02.8 on page 588, and substitute the following.

Except as stated otherwise herein, the equipment shall meet all its specified requirements during and after subjecting to any combination of the NEMA TS 2-2003 standard and the following:

907-641.02.10--Electrical. Delete the first paragraph of Subsection 641.02.10 on page 588, and substitute the following.

The radar sensors shall consume less than 10 W and shall operate with a DC input between 12 VDC and 28 VDC for IRVD and 9 VDC and 32 VDC for SRVD, or POE. POE injectors shall be approved by the Engineer.

Delete the title of Subsection 641.02.11 on page 589, and substitute the following.

907-641.02.11--Radar Design.

907-641.02.12--Communication Ports. Delete the second sentence of the first paragraph of Subsection 641.02.12 on page 589, and substitute the following.

The IRVD shall be upgradable (optional) to include integral 10/100 Base-T Ethernet supporting TCP, UDP, IP, ARP, ICMP.

Delete the second sentence of the second paragraph of Subsection 641.02.12 on page 589, and substitute the following.

For SRVD, any external device needed to convert serial to IP Ethernet within the cabinet for remote communications shall be provided with the radar sensor unit at no additional cost.

Delete Subsection 641.02.13 on page 589, and substitute the following.

907-641.02.13--Radar Detection Cabling. All Radar Detection cable shall be paid per the unit cost of the pay item for Radar Detection Cable, as shown on the plans or details. The manufacturer is responsible for obtaining plan sets and ensuring cable lengths are properly measured and accounted for in the bid price for each sensor unit and as shown on the plans.

The cable shall have a single continuous run with no splices, unless inside a manufacturer supplied junction box. The cable shall be terminated only on the two (2) farthest ends of the cable. The cable shall meet the requirements of the manufacturer.

Delete the title of Subsection 641.02.15 on page 590, and substitute the following.

907-641.02.15--Configuration--SRVD.

Delete the title of Subsection 641.02.15.1 on page 590, and substitute the following.

907-641.02.15.1--Stop Bar Radar Vehicle Detection.

Delete the title of Subsection 641.02.15.2 on page 590, and substitute the following.

907-641.02.15.2--Advanced Radar Vehicle Detection.

907-641.03--Construction Requirements. Delete the first sentence of the first paragraph of Subsection 641.03 on page 590, and substitute the following.

Radar Detection System shall be constructed to withstand and operate in sustained winds of up to 90 mph and a 30% gust factor.

Delete the title of Subsection 641.03.1 on page 590, and substitute the following.

907-641.03.1--SRVD Installation Requirements.

Delete the first sentence of the third paragraph of Subsection 641.03.1 on page 590, and substitute the following.

Unused conductors in the cable shall be ground or terminated in the cabinet in accordance with the manufacturer's recommendations.

Delete the last sentence of the third paragraph of Subsection 641.03.1 on page 590, and substitute the following.

If required by the plans and installation methods, impedance termination and testing of multi drop runs shall be required per RS485 multi-drop standards.

Delete the title of Subsection 641.03.2 on page 591, and substitute the following.

907-641.03.2--IRVD Installation Requirements.

Delete Items 1) and 2) of Subsection 641.03.2 on page 591, and substitute the following.

- 1) The IRVD shall be mounted in side-fired or front facing configuration on poles as shown in the plans, using mounting brackets. The brackets shall be attached with approved 3/4-inch wide stainless steel bands.
- 2) The Contractor shall install the detector unit on a pole at the manufacturer's recommended height above the road surface so that the masking of vehicles is minimized and that all detection zones are contained within the specified elevation angle as suggested by the manufacturer.

Delete Items 4) and 5) of Subsection 641.03.2 on page 591, and substitute the following.

- 4) The IRVD mode of operation, detection zones and other calibration and set up will be performed using a MS Windows™ based software and a Notebook PC. The software shall allow verification of correct setup and diagnostics. It shall include facilities for saving verification data and collected data as well as saving and retrieving sensor setup from disk file.
- 5) Unused conductors in the ITS Radar Vehicle Detector Cable shall be grounded or terminated in the cabinet in accordance with the manufacturer's recommendations. Terminated conductors shall be individually doubled back and taped, then loosely bundled and secured.

Delete Item 7) of Subsection 641.03.2 on page 591, and substitute the following.

- 7) Any new, additional or updated drivers required for the existing ATMS software to communicate and control new IRVD installed by the Contractor shall be the responsibility of the Contractor.

Delete Subsection 641.03.3 on pages 591 and 592, and substitute the following.

907-641.03.3--Blank.

Delete Subsection 641.03.4 on page 592, and substitute the following.

907-641.03.4--Blank.

907-641.04--Method of Measurement. Delete the paragraphs of Subsection 641.04 on page 593, and substitute the following.

The Radar Vehicle Detection Sensors, of the type specified, will be measured as a unit per each.

Radar Vehicle Detection Cable will be measured by the linear foot, measured horizontally along the conduit, messenger cable or mast arm and vertically along the pole.

Radar Vehicle Detection Training will be measured per lump sum.

907-641.05--Basis of Payment. Delete the paragraphs of Subsection 641.05 on pages 593 & 594, and substitute the following.

Radar Vehicle Detection Sensor, of the type specified, measured as prescribed above, will be paid for at the contract unit price bid per each, which price shall be full compensation for furnishing all materials, construction installation, connecting, testing, for all equipment, tools, labor and incidentals required to complete the work. Work shall include furnishing, installing, system integration, testing and training (if required) of complete radar sensor system that includes the unit, cabling between the unit and the cabinet, surge protection devices, communication converters (if required), all conduit, risers and weatherhead between the radar sensors and the cabinet, interconnection wiring, power supply, connections to support structures (includes all incidental components, attachment hardware, mounting brackets, mounting arms, bolts, or any other items to mount the radar sensor as intended), satisfactory completion of testing and training requirements and all work, equipment and appurtenances as required to effect the full operation including remote and local control of the radar site complete in place and ready to use. The price bid shall also include all system documentation including: shop drawings, operations and maintenance manuals, wiring diagrams, block diagrams and other material necessary to document the operation of the radar sensor. Cabinet Interface Units shall be provided, and installed as specified in the plans, which shall be inclusive of any testing, connections, terminations, and testing required for interfacing the radar sensors and signal controller within the signal cabinet environment.

Radar Vehicle Detection Cable will be paid at the contract unit price per linear foot, which price shall be full compensation for all labor, materials, equipment tools, furnishing, installing, system integration, connections, testing, and all incidentals necessary to complete the work.

Radar Vehicle Detection Training, measured as prescribed above, will be paid for as a lump sum unit price.

Delete the pay items listed on page 594, and substitute the following.

907-641-A: Signal Stop Bar Radar Vehicle Detection Sensor, Type _____ - per each

- 907-641-B: Signal Advanced Radar Vehicle Detection Sensor, Type _____ - per each
- 907-641-C: ITS Radar Vehicle Detection Sensor - per each
- 907-641-D: Radar Vehicle Detection Cable - linear foot
- 907-641-E: Radar Vehicle Detection Training - lump sum

MISSISSIPPI DEPARTMENT OF TRANSPORTATION

SPECIAL PROVISION NO. 907-701-2

CODE: (IS)

DATE: 01/08/2020

SUBJECT: Hydraulic Cement

Section 701, Hydraulic Cement, of the 2017 Edition of the Mississippi Standard Specifications for Road and Bridge Construction is hereby amended as follows.

907-701.01--General. In the first sentence of the second paragraph of Subsection 701.01 on page 718, change “mills” to “plants.”

In the second sentence of the sixth paragraph of Subsection 701.01 on pages 718 and 719, change “shall” to “will.”

907-701.02--Portland Cement.

907-701.02.1-General.

907-701.02.1.2--Alkali Content. Delete the sentence in Subsection 701.02.1.2 on page 719, and substitute the following.

The Equivalent alkali content for all cement types in this Subsection shall not exceed 0.60%.

907-701.02.2--Replacement by Other Cementitious Materials. Delete the paragraph in Subsection 701.02.2 on page 719, and substitute the following.

The maximum replacement of cement by weight is 25% for fly ash or 50% for ground granulated blast furnace slag (GGBFS). Replacement contents below 20% for fly ash or 45% for GGBFS may be used, but will not be given any special considerations, such as the maximum acceptance temperature for portland cement concrete containing pozzolans in Subsection 804.02.13.1.5. Special considerations shall only apply for replacement of cement by fly ash or GGBFS.

Delete Subsection 701.02.2.1 on pages 719 and 720, and substitute the following.

907-701.02.2.1--Portland Cement Concrete Exposed to Soluble Sulfate Conditions or Seawater.

When portland cement concrete is exposed to moderate or severe soluble sulfate conditions, or to seawater, cement types and replacement of cement by Class F fly ash or GGBFS shall be as follows in Table 1. Class C fly ash shall not be used as a replacement for cement in any of the sulfate exposure conditions listed in Table 1.

Table 1- Cementitious Materials for Soluble Sulfate Conditions or Seawater

Sulfate Exposure	Water-soluble sulfate (SO ₄) in soil, % by mass	Sulfate (SO ₄) in water, ppm	Cementitious material required
Moderate and Seawater	0.10 - 0.20	150 - 1,500	Type I cement with one of the following replacements of cement by weight: 24.5 - 25.0% Class F fly ash, or 49.5 - 50.0% GGBFS or Type II ^{*,**} cement
Severe	0.20 - 2.00	1,500 - 10,000	Type I cement with a replacement by weight of 49.5 - 50.0% GGBFS, or Type II [*] cement with one of the following replacements of cement by weight: 24.5 - 25.0% Class F fly ash, or 49.5 - 50.0% GGBFS

* Type III cement conforming to AASHTO M85 with a maximum 8% tricalcium aluminate (C₃A) may be used in lieu of Type II cement as allowed in Subsection 701.02.1; this cement is given the designation “Type III(MS).”

** Class F fly ash or GGBFS may be added as a replacement for cement as allowed in Subsection 907-701.02.2.

Delete Subsection 701.02.2.2 on page 720, and substitute the following.

907-701.02.2.2--Portland Cement for Soil Stabilization Exposed to Soluble Sulfate Conditions or Seawater. When portland cement for use in soil stabilization is exposed to moderate or severe soluble sulfate conditions, or to seawater, cement types and replacement of cement by Class F fly ash or GGBFS shall meet the requirements of Subsection 701.02.2.1.

907-701.04--Blended Hydraulic Cement.

907-701.04.1--General. Delete Subsection 701.04.1.1 on page 720, and substitute the following.

907-701.04.1.1--Types of Blended Hydraulic Cement. Blended hydraulic cements (blended cements) shall be of the following types and conform to AASHTO M 240:

- Type IL – Portland-limestone cement
- Type IP – Portland-pozzolan cement
- Type IS – Portland blast-furnace slag cement

Blended cement Types IL, IP, and IS meeting the “MS” sulfate resistance requirement listed in AASHTO M 240, Table 3 shall have the “(MS)” suffix added to the type designation.

907-701.04.1.2--Alkali Content. Delete the sentence in Subsection 701.04.1.2 on page 720, and substitute the following.

All blended cement types shall be made with clinker that would result in cement meeting the requirements of Subsection 701.02.1.2 when used in the production of AASHTO M 85, Type I or Type II cement.

907-701.04.2--Replacement by Other Cementitious Materials. Delete the paragraph in Subsection 701.04.2 on page 720, and substitute the following.

The maximum replacement of blended cement Type IL by weight is 35% for fly ash or 50% for GGBFS. Replacement contents below 20% for fly ash or 45% for GGBFS may be used, but will not be given any special considerations, such as the maximum acceptance temperature for blended cement concrete containing pozzolans in Subsection 804.02.13.1.5. Special considerations shall only apply for replacement of blended cement by fly ash or GGBFS.

No additional cementitious materials, such as portland cement, blended cement, fly ash, GGBFS, or others, shall be added to or as a replacement for blended cement Types IP and IS.

Delete Subsection 701.04.2.1 on pages 720 and 721, and substitute the following.

907-701.04.2.1--Blended Cement Concrete Exposed to Soluble Sulfate Conditions or Seawater. When blended cement concrete is exposed to moderate or severe soluble sulfate conditions, or to seawater, cement types and replacement of cement by Class F fly ash or GGBFS shall be as follows in Table 2. Class C fly ash shall not be used as a replacement for cement in any of the sulfate exposure conditions listed in Table 2.

Table 2- Cementitious Materials for Soluble Sulfate Conditions or Seawater

Sulfate Exposure	Water-soluble sulfate (SO ₄) in soil, % by mass	Sulfate (SO ₄) in water, ppm	Cementitious material required
Moderate and Seawater	0.10 - 0.20	150 - 1,500	Type IL (MS)* cement, Type IL cement with one of the following replacements of cement by weight: 24.5 - 35.0% Class F fly ash, or 49.5 - 50.0% GGBFS, Type IP (MS) cement, or Type IS (MS) cement
Severe	0.20 - 2.00	1,500 - 10,000	Type IL cement with a replacement of cement by weight of 49.5 - 50.0% GGBFS, or Type IL (MS) cement with one of following replacements of cement by weight: 24.5 - 35.0% Class F fly ash, or 49.5 - 50.0% GGBFS

- * Class F fly ash or GGBFS may be added as a replacement for cement as allowed in Subsection 907-701.04.2.

Delete Subsection 701.04.2.2 on page 721, and substitute the following.

907-701.04.2.2--Blended Cement for Soil Stabilization Exposed to Soluble Sulfate Conditions or Seawater. When blended cement for use in soil stabilization is exposed to moderate or severe soluble sulfate conditions, or to seawater, cement types and replacement of cement by Class F fly ash or GGBFS shall meet the requirements of Subsection 701.04.2.1.

Delete Subsection 701.04.3 on page 721.

MISSISSIPPI DEPARTMENT OF TRANSPORTATION

SPECIAL PROVISION NO. 907-702-4

CODE: (IS)

DATE: 09/11/2018

SUBJECT: Bituminous Materials

Section 702, Bituminous Materials, of the 2017 Edition of the Mississippi Standard Specifications for Road and Bridge Construction is hereby amended as follows.

907-702.04--Sampling. Delete the sentence in Subsection 702.04 on page 722, and substitute the following.

Sampling of bituminous materials shall be as set out in AASHTO R 66.

907-702.07--Emulsified Asphalt. Delete the last sentence in Subsection 702.07 on page 724, and substitute the following.

Asphalt for fog seal shall conform to the requirements of Subsection 907-702.12, Table V.

907-702.12--Tables. Delete Table V in Subsection 702.12 on page 729, and substitute the following.

**TABLE V
SPECIFICATION FOR FOG SEAL**

Test Requirements	LD-7		CHPF-1		Test Method
	Min.	Max.	Min.	Max.	
Viscosity, Saybolt Furol, @ 25°C, Sec.	10	100	-	100	AASHTO T 72
Storage Stability Test, 24 hr, %	-	1	-	1	AASHTO T 59
Settlement, 5 day, %	-	5	-	-	AASHTO T 59
Oil Distillate, %	-	1	-	-	AASHTO T 59
Sieve Test, % *	-	0.3	-	0.1	AASHTO T 59
Residue by Distillation, %	40	-	40	-	AASHTO T 59
Test on Residue from Distillation					
Penetration @ 25°C, 100g, 5 sec	-	20	40	90	AASHTO T 49
Softening Point, °C	65	-	-	-	ASTM D 36
Solubility in trichloroethylene, %	97.5	-	-	-	AASHTO T 44
Elastic Recovery @ 25°C, %	-	-	40	-	AASHTO T 301
Original DSR @ 82° (G*/Sinδ, 10 rad/sec)	1	-	-	-	AASHTO T 111

* The Sieve Test result is tested for reporting purposes only and may be waived if no application problems are present in the field.

MISSISSIPPI DEPARTMENT OF TRANSPORTATION

SPECIAL PROVISION NO. 907-703-1

CODE: (IS)

DATE: 06/13/2018

SUBJECT: Gradation

Section 703, Aggregates, of the 2017 Edition of the Mississippi Standard Specifications for Road and Bridge Construction is hereby amended as follows.

907-703.03--Course Aggregates for Hydraulic Cement Concrete.

907-703.03.2--Detail Requirements.

907-703.03.2.4--Gradation. In the table in Subsection 703.03.2.4 on page 734, add 100 for the percent passing by weight on the 1½-inch sieve for Size No. 67 aggregates.

MISSISSIPPI DEPARTMENT OF TRANSPORTATION

SPECIAL PROVISION NO. 907-705-1

CODE: (IS)

DATE: 06/13/2018

SUBJECT: Stone Riprap

Section 705, Stone Blanket Protection and Filter Blanket Materials, of the 2017 Edition of the Mississippi Standard Specifications for Road and Bridge Construction is hereby amended as follows.

907-705.04--Stone Riprap. Delete the last sentence of the first paragraph of Subsection 705.04 on page 750, and substitute the following.

Quality requirements for rock to be furnished under these specifications will come from a pre-approved source and be visually approved prior to use.

MISSISSIPPI DEPARTMENT OF TRANSPORTATION

SPECIAL PROVISION NO. 907-707-2

CODE: (IS)

DATE: 06/05/2019

SUBJECT: Joint Materials

Section 707, Joint Materials, of the 2017 Edition of the Mississippi Standard Specifications for Road and Bridge Construction is hereby amended as follows.

907-707.02.3--Wood. Delete paragraph (b) of Subsection 707.02.3 on page 755, and substitute the following:

- (b) Dimensions shall be as shown on the plans. Dimensions shown on the plans are “dressed” sizes in accordance with Table 3 of the American Softwood Lumber Standard, SP-20. At the discretion of the Engineer, a 3/4-inch dressed board may be used in lieu of a 1-inch dressed board. A tolerance of plus or minus 1/16 inch thickness and plus or minus 1/8 inch width will be permitted. For slip-form paving a tolerance of minus 1/4 inch on each end in length will be permitted.

907-707.06--Flexible Plastic Gasket for Joining Conduit. Delete the third paragraph of Subsection 707.06 on page 756, and substitute the following.

The Department may require the performance test described in ASTM C 990.

MISSISSIPPI DEPARTMENT OF TRANSPORTATION

SPECIAL PROVISION NO. 907-711-2

CODE: (IS)

DATE: 09/11/2018

SUBJECT: Plain Steel Wire

Section 711, Reinforcement and Wire Rope, of the 2017 Edition of the Mississippi Standard Specifications for Road and Bridge Construction is hereby amended as follows.

907-711.02--Deformed and Plain Carbon-Steel Bars for Concrete Reinforcing.

907-711.02.3--Steel Welded and Non-Welded Wire Reinforcement, Plain and Deformed, for Concrete.

907-711.02.3.1--Plain Steel Wire. Delete the sentence in Subsection 711.02.3.1 on pages 780 and 781, and substitute the following.

Plain steel wire and plain steel welded wire shall conform to the requirements of AASHTO M 336.

MISSISSIPPI DEPARTMENT OF TRANSPORTATION

SPECIAL PROVISION NO. 907-720-2

CODE: (IS)

DATE: 09/11/2018

SUBJECT: Acceptance Procedure for Glass Beads

Section 720, Pavement Marking Materials, of the 2017 Edition of the Mississippi Standard Specifications for Road and Bridge Construction is hereby amended as follows.

907-720.01--Glass Beads.

907-720.01.4--Acceptance Procedures. Delete the last sentence of the paragraph in Subsection 720.01.4 on page 841, and substitute the following.

Acceptance sampling and testing of glass beads will be in accordance with the Department's Materials Division Inspection, Testing, and Certification Manual, Section 2.9.2 -- Glass Beads.

MISSISSIPPI DEPARTMENT OF TRANSPORTATION

SPECIAL PROVISION NO. 907-721-2

CODE: (IS)

DATE: 01/08/2020

SUBJECT: Materials for Signing

Section 721, Materials for Signing, of the 2017 Edition of the Mississippi Standard Specifications for Road and Bridge Construction is hereby amended as follows.

907-721.06--Reflective Sheeting.

907-721.06.2--Performance Requirements. Delete Table 4 and Table 5 in Subsection 721.06.2 on pages 860 & 861, and substitute the following.

**MINIMUM COEFFICIENTS OF RETROREFLECTION
Candela per foot candle per square foot (cd/ft²)
Per ASTM Designation D4956**

**TABLE 4
Type IX Sheeting**

Observation Angle	Entrance Angle	White	Yellow	Green	Red	Blue	Fluorescent Yellow/Green	Fluorescent Yellow	Fluorescent Orange
0.2°	-4.0°	380	285	38	76	17	300	230	115
0.2°	+30.0°	215	162	22	43	10	170	130	65
0.5°	-4.0°	240	180	24	48	11	190	145	72
0.5°	+30.0°	135	100	14	27	6.0	110	81	41
1.0°	-4.0°	80	60	8.0	16	3.6	64	48	24
1.0°	+30.0°	45	34	4.5	9.0	2.0	36	27	14

**TABLE 5
Type XI Sheeting**

Observation Angle	Entrance Angle	White	Yellow	Green	Red	Blue	Brown	Fluorescent Yellow/Green	Fluorescent Yellow	Fluorescent Orange
0.2°	-4.0°	580	435	58	87	26	17	460	350	175
0.2°	+30.0°	220	165	22	33	10	7.0	180	130	66
0.5°	-4.0°	420	315	42	63	19	13	340	250	125
0.5°	+30.0°	150	110	15	23	7.0	5.0	120	90	45
1.0°	-4.0°	120	90	12	18	5.0	4.0	96	72	36
1.0°	+30.0°	45	34	5.0	7.0	2.0	1.0	36	27	14

MISSISSIPPI DEPARTMENT OF TRANSPORTATION

SPECIAL PROVISION NO. 907-722-1

CODE: (IS)

DATE: 11/15/2017

SUBJECT: **Materials for Traffic Signal Installation**

Section 722, Materials for Traffic Signal Installation, of the 2017 Edition of the Mississippi Standard Specifications for Road and Bridge Construction is hereby amended as follow.

907-722.02.3--Design Strength Requirements. Delete Subsection 722.02.3 on pages 864 thru 866, and substitute the following.

Unless specified otherwise in the plans, poles shall meet the requirements of the AASHTO *Standard Specifications for Structural Supports for Highway Signs, Luminaires, and Traffic Signals*, as specified in the plans with all interim supplements. All components of the assemblies shall be designed to the following:

- Importance Factor: 1.0; 50 year mean recurrence interval
- Basic Wind Speed (3 second gust): As shown on the project plans
- Minimum Gust Effect Factor: 1.14
- Fatigue Category: II
- Ice Loading: As shown on the project plans
- Natural Wind Gust Pressure Loads: Included
- Truck Induced Gust Pressure Loads: Not included
- Galloping: Not included

907-722.02.5--Mast Arms for Traffic Signal and Equipment Poles. Delete the first four sentences of the third paragraph of Subsection 722.02.5 on page 867, and substitute the following.

Anchor base plates must meet the minimum requirements of ASTM A36 or ASTM A709 Grade 36 or ASTM A572 Grade 50 and must be welded to the shaft by either telescoped with two continuous arc welds or by back up ring using full penetration welds.. Flange plate shall telescope the large end of the arm and be welded by either two (2) continuous arc welds, one (1) being on the outside of the plate, adjacent to the shaft, and the other one (1) on the inside at the end of the tubular cross section or by back up ring using full penetration welds. The thru-bolt flange plate or tapped flange plate supporting the mast arm shall be welded to the pole near the top and supported side plate tangent to the pole and gusset plates both top and bottom. The thru-bolt or tapped flange plate must be sufficient to develop the full capacity of the connecting bolts.

907-722.03--Electric Cable. Delete the paragraphs for Loop Detector Wire and Loop Detector Lead-in Cable in Subsection 722.03 on page 869.

Delete the first sentence of “Communication Cable” in Subsection 722.03 on page 870, and substitute the following.

Communication cables shall be as per the manufacturer's recommendation.

907-722.05.4--Type III or Type IV Rigid Non-Metallic Conduit. After the last sentence of Subsection 722.05.4 on page 871, add the following.

Schedule 40 conduit shall be used unless otherwise noted in the plans.

Delete the title of Subsection 722.13.3 on page 876, and substitute the following.

907-722.13.3--Power Service Pedestal.

Delete the first paragraph of Subsection 722.13.3 on page 876, and substitute the following.

The pedestal shall be of NEMA Type 3R rainproof construction and shall be UL Listed as "Enclosed Industrial Control Equipment" (UL 508A). External construction shall comply with UL50 requirements and shall be unpainted aluminum.

Nominal size of the pedestal shall be 48"H x 16"W x 16"D.

Pedestal shall have a voltage rating or 120v/240v single phase with an Amperage rating of 800A.

After the first sentence of the seventh paragraph of Subsection 722.13.3 on page 876, add the following.

An outdoor rated heavy duty combination lock shall be provided to lock the customer compartment door.

907-722.14.1.3--Optical System. Delete the sixteenth paragraph of Subsection 722.14.1.3 on page 879, and substitute the following.

The signal module on-board circuitry shall include voltage surge protection to withstand high-repetition noise transients and low-repetition high-energy transients as stated in Section 2.1.6, NEMA Standard TS 2, 1992.

Delete the last sentence of the seventeenth paragraph of Subsection 722.14.1.3 on page 879, and substitute the following.

Load switches shall be compatible with NEMA TS 1 or later, or Model 170-1989 or later.

Delete Subsection 722.14.5 on page 882, and substitute the following.

907-722.14.5--Blank.

Delete Subsections 722.14.7 and 722.14.8 on page 882.

SECTION 905 - PROPOSAL

Date _____

Mississippi Transportation Commission
Jackson, Mississippi

Sirs: The following proposal is made on behalf of _____
_____ of _____

for constructing the following designated project(s) within the time(s) hereinafter specified.

The plans are composed of drawings and blue prints on file in the offices of the Mississippi Department of Transportation, Jackson, Mississippi.

The Specifications are the current Standard Specifications of the Mississippi Department of Transportation approved by the Federal Highway Administration, except where superseded or amended by the plans, Special Provisions and Notice(s) to Bidders attached hereto and made a part thereof.

I (We) certify that I (we) possess a copy of said Standard and any Supplemental Specifications.

Evidence of my (our) authority to submit the Proposal is hereby furnished. The proposal is made without collusion on the part of any person, firm or corporation. I (We) certify that I (we) have carefully examined the Plans, the Specifications, including the Special Provisions and Notice(s) to Bidders, herein, and have personally examined the site of the work. On the basis of the Specifications, Special Provisions, Notice(s) to Bidders, and Plans, I (we) propose to furnish all necessary machinery, tools, apparatus and other means of construction and do all the work and furnish all the materials in the manner specified. I (We) understand that the quantities mentioned herein are approximate only and are subject to either increase or decrease, and hereby propose to perform any increased or decreased quantities of work at the unit prices bid, in accordance with the above.

I (We) acknowledge that this proposal will be found irregular and/or non-responsive unless a certified check, cashier's check, or Proposal Guaranty Bond in the amount as required in the Advertisement (or, by law) is submitted electronically with the proposal or is delivered to the Contract Administration Engineer prior to the bid opening time specified in the advertisement.

INSTRUCTION TO BIDDERS: Alternate and Optional Items on Bid Schedule.

1. Two or more items entered opposite a single unit quantity WITHOUT DEFINITE DESIGNATION AS "ALTERNATE ITEMS" are considered as "OPTIONAL ITEMS". Bidders may or may not indicate on bids the Optional Item proposed to be furnished or performed WITHOUT PREJUDICE IN REGARD TO IRREGULARITY OF BIDS.
2. Items classified on the bid schedule as "ALTERNATE ITEMS" and/or "ALTERNATE TYPES OF CONSTRUCTION" must be preselected and indicated on bids. However, "Alternate Types of Construction" may include Optional Items to be treated as set out in Paragraph 1, above.
3. Optional items not preselected and indicated on the bid schedule MUST be designated in accordance with Subsection 102.06 prior to or at the time of execution of the contract.
4. Optional and Alternate items designated must be used throughout the project.

I (We) further propose to perform all "force account or extra work" that may be required of me (us) on the basis provided in the Specifications and to give such work my (our) personal attention in order to see that it is economically performed.

I (We) further propose to execute the attached contract agreement (Section 902) as soon as the work is awarded to me (us), and to begin and complete the work within the time limit(s) provided for in the Specifications and Advertisement. I (We) also propose to execute the attached contract bond (Section 903) in an amount not less than one hundred (100) percent of the total of my (our) part, but also to guarantee the excellence of both workmanship and materials until the work is finally accepted.

I (We) shall submit electronically with our proposal or deliver prior to the bid opening time a certified check, cashier's check or bid bond for **five percent (5%) of total bid** and hereby agree that in case of my (our) failure to execute the contract and furnish bond within Ten (10) days after notice of award, the amount of this check (bid bond) will be forfeited to the State of Mississippi as liquidated damages arising out of my (our) failure to execute the contract as proposed. It is understood that in case I am (we are) not awarded the work, the check will be returned as provided in the Specifications.

SECTION 905 -- PROPOSAL (CONTINUED)

I (We) hereby certify by digital signature and electronic submission via Bid Express of the Section 905 proposal below, that all certifications, disclosures and affidavits incorporated herein are deemed to be duly executed in the aggregate, fully enforceable and binding upon delivery of the bid proposal. I (We) further acknowledge that this certification shall not extend to the bid bond or alternate security which must be separately executed for the benefit of the Commission. This signature does not cure deficiencies in any required certifications, disclosures and/or affidavits. I (We) also acknowledge the right of the Commission to require full and final execution on any certification, disclosure or affidavit contained in the proposal at the Commission's election upon award. Failure to so execute at the Commission's request within the time allowed in the Standard Specifications for execution of all contract documents will result in forfeiture of the bid bond or alternate security.

Respectfully Submitted,

DATE _____

Contractor

BY _____
Signature

TITLE _____

ADDRESS _____

CITY, STATE, ZIP _____

PHONE _____

FAX _____

E-MAIL _____

(To be filled in if a corporation)

Our corporation is chartered under the Laws of the State of _____ and the names, titles and business addresses of the executives are as follows:

President Address

Secretary Address

Treasurer Address

The following is my (our) itemized proposal.

Mill & Overlay approximately 8 miles on SR 15 from Decatur to Henry Mack Smith Road, known as State Project No. MP-5015-51(021) / 307480301 in Newton County.

Line no.	Item Code	Adj Code	Quantity	Units	Description[Fixed Unit Price]
Roadway Items					
0010	202-B007		215	Square Yard	Removal of Asphalt Pavement, All Depths
0020	202-B069		457	Square Yard	Removal of Concrete Pavement w/ Variable Depth Overlay
0030	202-B129		1	Each	Removal of Flared End Section, All Sizes
0040	202-B158		2,868	Linear Feet	Removal of Guard Rail, Including Rails, Posts and Terminal Ends
0050	202-B191		8	Linear Feet	Removal of Pipe, 8" And Above
0060	202-B240		530	Linear Feet	Removal of Traffic Stripe
0070	203-EX029	(E)	32	Cubic Yard	Borrow Excavation, AH, LVM, Class B15
0080	203-G002	(E)	187	Cubic Yard	Excess Excavation, LVM, AH
0090	304-D002	(GT)	1,650	Ton	Granular Material, Crushed Stone
0100	403-A002	(BA1)	19,071	Ton	12.5-mm, MT, Asphalt Pavement
0110	403-B002	(BA1)	700	Ton	12.5-mm, MT, Asphalt Pavement, Leveling
0120	406-D001		164,291	Square Yard	Fine Milling of Bituminous Pavement, All Depths
0130	407-A001	(A2)	16,429	Gallon	Asphalt for Tack Coat
0140	413-E001		28,196	Linear Feet	Sawing and Sealing Transverse Joints in Asphalt Pavement
0150	423-A001		13	Mile	Rumble Strips, Ground In
0160	503-C010		3,070	Linear Feet	Saw Cut, Full Depth
0170	601-B001	(S)	1	Cubic Yard	Class "B" Structural Concrete, Minor Structures
0180	603-CE013	(S)	8	Linear Feet	36" x 23" Concrete Arch Pipe, Class A III
0190	603-CF004	(S)	1	Each	36" x 23" Concrete Arch Pipe End Section
0200	606-B003		1,800	Linear Feet	Guard Rail, Class A, Type 1, 'W' Beam, Metal Post
0210	606-D023		8	Each	Guard Rail, Bridge End Section, Type I, Metal Post
0220	606-E007		24	Each	Guard Rail, Terminal End Section, Non-Flared
0230	618-A001		1	Lump Sum	Maintenance of Traffic
0240	619-A1001		28	Mile	Temporary Traffic Stripe, Continuous White
0250	619-A2001		18	Mile	Temporary Traffic Stripe, Continuous Yellow
0260	619-A4002		20	Mile	Temporary Traffic Stripe, Skip Yellow
0270	619-A5001		28,260	Linear Feet	Temporary Traffic Stripe, Detail
0280	619-A6002		5,600	Linear Feet	Temporary Traffic Stripe, Legend
0290	619-D1001		242	Square Feet	Standard Roadside Construction Signs, Less than 10 Square Feet
0300	619-D2001		420	Square Feet	Standard Roadside Construction Signs, 10 Square Feet or More
0310	619-F3001		121	Each	Delineators, Guard Rail, White
0320	619-G4001		24	Linear Feet	Barricades, Type III, Double Faced
0330	620-A001		1	Lump Sum	Mobilization
0340	626-B002		14	Mile	6" Thermoplastic Double Drop Traffic Stripe, Continuous White
0350	626-D003		6	Mile	6" Thermoplastic Traffic Stripe, Skip Yellow

Line no.	Item Code	Adj Code	Quantity	Units	Description Fixed Unit Price
0360	626-E001		10	Mile	6" Thermoplastic Double Drop Traffic Stripe, Continuous Yellow
0370	626-G004		13,600	Linear Feet	Thermoplastic Double Drop Detail Stripe, White
0380	626-G005		5,200	Linear Feet	Thermoplastic Double Drop Detail Stripe, Yellow
0390	626-H001		1,358	Square Feet	Thermoplastic Double Drop Legend, White
0400	626-H002		2,950	Linear Feet	Thermoplastic Double Drop Legend, White
0410	627-J001		880	Each	Two-Way Clear Reflective High Performance Raised Markers
0420	627-K001		50	Each	Red-Clear Reflective High Performance Raised Markers
0430	627-L001		1,530	Each	Two-Way Yellow Reflective High Performance Raised Markers
0440	630-A001		25	Square Feet	Standard Roadside Signs, Sheet Aluminum, 0.080" Thickness
0450	630-A003		25	Square Feet	Standard Roadside Signs, Sheet Aluminum, 0.125" Thickness
0460	630-C003		108	Linear Feet	Steel U-Section Posts, 3.0 lb/ft
0470	630-G004		8	Each	Type 3 Object Markers, OM-3R or OM-3L
0480	630-G006		8	Each	Type 3 Object Markers, OM-3R or OM-3L, 2 Markers Per Post, Post Mounted
0490	815-A007	(S)	385	Ton	Loose Riprap, Size 300
0500	815-E001	(S)	75	Square Yard	Geotextile under Riprap
0510	907-619-B001		198	Linear Feet	Temporary Portable Rumble Strips
0520	907-632-D001		1	Each	Solid State Traffic Actuated Controller, Type 1
0530	907-641-A002		4	Each	Signal Stop Bar Radar Vehicle Detection Sensor, Type 2
0540	907-641-D001		390	Linear Feet	Radar Vehicle Detection Cable

SECTION 905 - COMBINATION BID PROPOSAL (Continued)

CONDITIONS FOR COMBINATION BID

If a bidder elects to submit a combined bid for two or more of the contracts listed for this month's letting, the bidder must complete and execute these sheets of the proposal in each of the individual proposals to constitute a combination bid. In addition to this requirement, each individual contract shall be completed, executed and submitted in the usual specified manner.

Failure to execute this Combination Bid Proposal in each of the contracts combined will be just cause for each proposal to be received and evaluated as a separate bid.

It is understood that the Mississippi Transportation Commission not only reserves the right to reject any and all proposals, but also the right to award contracts upon the basis of lowest separate bids or combination bids most advantageous to the State.

It is further understood and agreed that the Combination Bid Proposal is for comparison of bids only and that each contract shall operate in every respect as a separate contract in accordance with its proposal and contract documents.

I (We) agree to complete each contract on or before its specified completion date.

COMBINATION BID PROPOSAL

This proposal is tendered as one part of a Combination Bid Proposal utilizing option ___* of Subsection 102.11 on the following contracts:

* Option to be shown as either (a), (b), or (c).

	<u>Project No.</u>	<u>County</u>	<u>Project No.</u>	<u>County</u>
1.	_____	_____	6.	_____
2.	_____	_____	7.	_____
3.	_____	_____	8.	_____
4.	_____	_____	9.	_____
5.	_____	_____	10.	_____

(a) If Combination A has been selected, your Combination Bid is complete.

(b) If Combination B has been selected, then complete the following page.

SECTION 905 - COMBINATION BID PROPOSAL (Continued)

Project Number	Pay Item Number	Unit	Unit Price Reduction	Total Item Reduction	Total Contract Reduction
1.					
2.					
3.					
4.					
5.					
6.					
7.					
8.					

For Informational Purposes Only

SECTION 905 - COMBINATION BID PROPOSAL (Continued)

Project Number	Pay Item Number	Unit	Unit Price Reduction	Total Item Reduction	Total Contract Reduction
9.					
10.					

(c) If Combination C has been selected, then initial and complete ONE of the following.

_____ I (We) desire to be awarded work not to exceed a total monetary value of \$ _____.

_____ I (We) desire to be awarded work not to exceed _____ number of contracts.



TO: EXECUTIVE DIRECTOR, MISSISSIPPI DEPARTMENT OF TRANSPORTATION
JACKSON, MISSISSIPPI

CERTIFICATE

If awarded this contract, I (we) contemplate that portions of the contract will be sublet. I (we) certify that those subcontracts which are equal to or in excess of fifty thousand dollars (\$50,000.00) will be in accordance with regulations promulgated and adopted by the Mississippi State Board of Contractors on September 8, 2011.

I (we) agree that this notification of intent DOES NOT constitute APPROVAL of the subcontracts.

_____	_____
(Individual or Firm)	(Address)
_____	_____
(Individual or Firm)	(Address)
_____	_____
(Individual or Firm)	(Address)
_____	_____
(Individual or Firm)	(Address)

NOTE: Failure to complete the above DOES NOT preclude subsequent subcontracts. Subsequent subcontracts, if any, equal to or in excess of fifty thousand dollars (\$50,000.00) will be in accordance with regulations promulgated and adopted by the Mississippi State Board of Contractors on September 8, 2011.

Contractor _____

MISSISSIPPI DEPARTMENT OF TRANSPORTATION
CERTIFICATION

I, _____,
(Name of person signing bid)

individually, and in my capacity as _____ of
(Title of person signing bid)

(Name of Firm, partnership, or Corporation)

do hereby certify under penalty of perjury under the laws of the United States and the State of Mississippi

that _____, Bidder
(Name of Firm, Partnership, or Corporation)

on Project No. **MP-5015-51(021)/ 307480301000**

in **Newton** County(ies), Mississippi, has not either directly or indirectly entered into any agreement, participated in any collusion; or otherwise taken any action in restraint of free competitive bidding in connection with this contract; nor have any of its corporate officers or principal owners.

Except as noted hereafter, it is further certified that said legal entity and its corporate officers, principal owners, managers, auditors and others in a position of administering federal funds are not currently under suspension, debarment, voluntary exclusion or determination of ineligibility; nor have a debarment pending; nor been suspended, debarred, voluntarily excluded or determined ineligible within the past three years by the Mississippi Transportation Commission, the State of Mississippi, any other State or a federal agency; nor been indicted, convicted or had a civil judgment rendered by a court of competent jurisdiction in any matter involving fraud or official misconduct within the past three years.

Do exceptions exist and are made a part thereof? Yes / No

Any exceptions shall address to whom it applies, initiating agency and dates of such action.

Note: Exceptions will not necessarily result in denial of award but will be considered in determining bidder responsibility. Providing false information may result in criminal prosecution or administrative sanctions.

All of the foregoing is true and correct.

(1/2016 S)

SECTION 902

CONTRACT FOR MP-5015-51(021)/ 307480301000

LOCATED IN THE COUNTY(IES) OF Newton

STATE OF MISSISSIPPI,
COUNTY OF HINDS

This contract entered into by and between the Mississippi Transportation Commission on one hand, and the undersigned contractor, on the other witnesseth;

That, in consideration of the payment by the Mississippi Transportation Commission of the prices set out in the proposal hereto attached, to the undersigned contractor, such payment to be made in the manner and at the time of times specified in the specifications and the special provisions, if any, the undersigned contractor hereby agrees to accept the prices stated in the proposal in full compensation for the furnishing of all materials and equipment and the executing of all the work contemplated in this contract.

It is understood and agreed that the advertising according to law, the Advertisement, the instructions to bidders, the proposal for the contract, the specifications, the revisions of the specifications, the special provisions, and also the plans for the work herein contemplated, said plans showing more particularly the details of the work to be done, shall be held to be, and are hereby made a part of this contract by specific reference thereto and with like effect as if each and all of said instruments had been set out fully herein in words and figures.

It is further agreed that for the same consideration the undersigned contractor shall be responsible for all loss or damage arising out of the nature of the work aforesaid; or from the action of the elements and unforeseen obstructions or difficulties which may be encountered in the prosecution of the same and for all risks of every description connected with the work, exceptions being those specifically set out in the contract; and for faithfully completing the whole work in good and workmanlike manner according to the approved Plans, Specifications, Special Provisions, Notice(s) to Bidders and requirements of the Mississippi Department of Transportation.

It is further agreed that the work shall be done under the direct supervision and to the complete satisfaction of the Executive Director of the Mississippi Department of Transportation, or his authorized representatives, and when Federal Funds are involved subject to inspection at all times and approval by the Federal Highway Administration, or its agents as the case may be, or the agents of any other Agency whose funds are involved in accordance with those Acts of the Legislature of the State of Mississippi approved by the Governor and such rules and regulations issued pursuant thereto by the Mississippi Transportation Commission and the authorized Federal Agencies.

The Contractor agrees that all labor as outlined in the Special Provisions may be secured from list furnished by

It is agreed and understood that each and every provision of law and clause required by law to be inserted in this contract shall be deemed to be inserted herein and this contract shall be read and enforced as though it were included herein, and, if through mere mistake or otherwise any such provision is not inserted, then upon the application of either party hereto, the contract shall forthwith be physically amended to make such insertion.

The Contractor agrees that he has read each and every clause of this Contract, and fully understands the meaning of same and that he will comply with all the terms, covenants and agreements therein set forth.

Witness our signatures this the ___ day of _____, _____.

Contractor(s)

By _____

MISSISSIPPI TRANSPORTATION COMMISSION

Title _____

By _____

Signed and sealed in the presence of:
(names and addresses of witnesses)

Executive Director

Secretary to the Commission

Award authorized by the Mississippi Transportation Commission in session on the ___ day of _____, _____, Minute Book No. _____, Page No. _____.

SECTION 903
PERFORMANCE AND PAYMENT BOND

CONTRACT BOND FOR: MP-5015-51(021)/307480301000

LOCATED IN THE COUNTY(IES) OF: Newton

STATE OF MISSISSIPPI,
COUNTY OF HINDS

Know all men by these presents: that we, _____
(Contractor)
_____ Principal, a _____

residing at _____ in the State of _____

and _____

(Surety)
residing at _____ in the State of _____,

authorized to do business in the State of Mississippi, under the laws thereof, as surety, effective as of the contract date shown below, are held and firmly bound unto the State of Mississippi in the sum of _____

_____ Dollars, lawful money of the United States of America, to be paid to it for which payment well and truly to be made, we bind ourselves, our heirs, administrators, successors, or assigns jointly and severally by these presents.

The conditions of this bond are such, that whereas the said _____

_____ principal, has (have) entered into a contract with the Mississippi Transportation Commission, bearing the date of _____ day of _____ A.D. _____ hereto annexed, for the construction of certain projects(s) in the State of Mississippi as mentioned in said contract in accordance with the Contract Documents therefor, on file in the offices of the Mississippi Department of Transportation, Jackson, Mississippi.

Now therefore, if the above bounden _____ in all things shall stand to and abide by and well and truly observe, do keep and perform all and singular the terms, covenants, conditions, guarantees and agreements in said contract, contained on his (their) part to be observed, done, kept and performed and each of them, at the time and in the manner and form and furnish all of the material and equipment specified in said contract in strict accordance with the terms of said contract which said plans, specifications and special provisions are included in and form a part of said contract and shall maintain the said work contemplated until its final completion and acceptance as specified in Subsection 109.11 of the approved specifications, and save harmless said Mississippi Transportation Commission from any loss or damage arising out of or occasioned by the negligence, wrongful or criminal act, overcharge, fraud, or any other loss or damage whatsoever, on the part of said principal (s), his (their) agents, servants, or employees in the performance of said work or in any manner connected therewith, and shall be liable and responsible in a civil action instituted by the State at the instance of the Mississippi Transportation Commission or any officer of the State authorized in such cases, for double any amount in money or property, the State may lose or be overcharged or otherwise defrauded of, by reason of wrongful or criminal act, if any, of the Contractor(s), his (their) agents or employees, and shall promptly pay the said agents, servants and employees and all persons furnishing labor, material, equipment or supplies therefor, including premiums incurred, for Surety Bonds, Liability Insurance, and Workmen's Compensation Insurance; with the additional obligation that such Contractor shall promptly make payment of all taxes, licenses, assessments, contributions, damages,

any liquidated damages which may arise prior to any termination of said principal's contract, any liquidated damages which may arise after termination of the said principal's contract due to default on the part of said principal, penalties and interest thereon, when and as the same may be due this state, or any county, municipality, board, department, commission or political subdivision: in the course of the performance of said work and in accordance with Sections 31-5-51 et seq. Mississippi Code of 1972, and other State statutes applicable thereto, and shall carry out to the letter and to the satisfaction of the Executive Director of the Mississippi Department of Transportation, all, each and every one of the stipulations, obligations, conditions, covenants and agreements and terms of said contract in accordance with the terms thereof and all of the expense and cost and attorney's fee that may be incurred in the enforcement of the performance of said contract, or in the enforcement of the conditions and obligations of this bond, then this obligation shall be null and void, otherwise to be and remain in full force and virtue.

_____	_____
(Contractors) Principal	Surety
By _____	By _____
	(Signature) Attorney in Fact
	Address _____

Title _____	_____
(Contractor's Seal)	(Printed) MS Agent

	(Signature) MS Agent
	Address _____

	(Surety Seal)

	Mississippi Insurance ID Number



BID BOND

KNOW ALL MEN BY THESE PRESENTS, that we _____
Contractor

Address

City, State ZIP

As principal, hereinafter called the Principal, and _____
Surety

a corporation duly organized under the laws of the state of _____

as Surety, hereinafter called the Surety, are held and firmly bound unto State of Mississippi, Jackson, Mississippi

As Obligee, hereinafter called Obligee, in the sum of **Five Per Cent (5%) of Amount Bid**

Dollars(\$ _____)

for the payment of which sum will and truly to be made, the said Principal and said Surety, bind ourselves, our heirs, executors, administrators, successors and assigns, jointly and severally, firmly by these presents.

WHEREAS, the Principal has submitted a bid for **Mill & Overlay approximately 8 miles on SR 15 from Decatur to Henry Mack Smith Road, known as State Project No. MP-5015-51(021) / 307480301 in Newton County.**

NOW THEREFORE, the condition of this obligation is such that if the aforesaid Principal shall be awarded the contract, the said Principal will, within the time required, enter into a formal contract and give a good and sufficient bond to secure the performance of the terms and conditions of the contract, then this obligation to be void; otherwise the Principal and Surety will pay unto the Obligee the difference in money between the amount of the bid of the said Principal and the amount for which the Obligee legally contracts with another party to perform the work if the latter amount be in excess of the former, but in no event shall liability hereunder exceed the penal sum hereof.

Signed and sealed this _____ day of _____, 20__

(Principal) (Seal)

(Witness) (Name) By: _____ (Title)

(Surety) (Seal)

(Witness) (Attorney-in-Fact) By: _____

(MS Agent)

Mississippi Insurance ID Number

