

MDOT Use Only

Checked \_\_\_\_\_

Loaded \_\_\_\_\_

Keyed \_\_\_\_\_

11 -



SM No. CSTP1164000181

# PROPOSAL AND CONTRACT DOCUMENTS

## FOR THE CONSTRUCTION OF

11

Widen, Level & Thin Lift Overlay approximately 5 miles on SR 589 from US 11 to 1.6 miles North of Old Highway 11, known as Federal Aid Project No. STP-1164-00 (018) / 108227301 in Lamar County.

Project Completion: Flexible

**(STATE DELEGATED)**

### NOTICE

**BIDDERS MUST COMPLETE AN ONLINE REQUEST  
FOR PERMISSION TO BID THIS PROJECT.**

Electronic addendum updates will be posted on [www.gomdot.com](http://www.gomdot.com)

**SECTION 900  
OF THE CURRENT  
2017 STANDARD SPECIFICATIONS  
FOR ROAD AND BRIDGE CONSTRUCTION  
JACKSON, MISSISSIPPI**

**MISSISSIPPI DEPARTMENT OF TRANSPORTATION  
TABLE OF CONTENTS**

**PROJECT: STP-1164-00(018)/108227301 - Lamar**

Section 901 - Advertisement

Section 904 - Notice to Bidders

#1	Governing Specification
#2	Status of ROW, w/ Attachments
#3	Final Cleanup
#9	Federal Bridge Formula
#13	Safety Edge
#113	Tack Coat
#296	Reduced Speed Limit Signs
#445	Mississippi Agent or Qualified Nonresident Agent
#516	Errata and Modifications to the 2017 Standard Specifications
#977	DUNS Requirement For Federal Funded Projects
#1225	Early Notice to Proceed
#1226	Material Storage Under Bridges
#1241	Fuel and Material Adjustments
#1963	Guardrail Pads
#2206	MASH Compliant Devices
#2273	Mississippi Special Fuel Tax Law
#2611	Disadvantaged Business Enterprise In Federal-Aid Highway Construction, w/ Supplement
#2782	DBE Pre-Bid Meeting
#2954	Reflective Sheeting for Signs
#3117	Standard Drawings
#3309	Contract Time
#3310	Specialty Items
#3311	Scope of Work
906	Required Federal Contract Provisions -- FHWA 1273, w/Supplements

Section 907 - Special Provisions

907-102-2	Bidding Requirements and Conditions
907-105-1	Authority of the Engineer
907-108-4	Subletting of Contract
907-109-3	Measurement and Payment
907-411-1	Material Transfer Equipment
907-618-4	Additional Signing Requirements, w/Supplement
907-619-6	Temporary Portable Rumble Strips
907-624-1	Inverted Profile Thermoplastic Traffic Stripe
907-630-1	Remove and Reset Signs
907-701-3	Hydraulic Cement
907-702-4	Bituminous Materials
907-703-1	Gradation
907-705-1	Stone Riprap
907-707-2	Joint Material

**PROJECT: STP-1164-00(018)/108227301 - Lamar**

907-711-2	Plain Steel Wire
907-714-1	Miscellaneous Materials
907-720-2	Acceptance Procedure for Glass Beads
907-721-2	Materials for Signs

Section 905 - Proposal, Proposal Bid Items, Combination Bid Proposal

Certification of Performance - Prior Federal-Aid Contracts

Certification Regarding Non-Collusion, Debarment and Suspension

SAM.GOV Registration and DUNS Number

Section 902 - Contract Form

Section 903 - Contract Bond Forms

Form -- OCR-485

Progress Schedule

(REVISIONS TO THE ABOVE WILL BE INDICATED ON THE SECOND SHEET  
OF SECTION 905 AS ADDENDA)

05/26/2021 03:00 PM

# MISSISSIPPI DEPARTMENT OF TRANSPORTATION

## SECTION 901 - ADVERTISEMENT

Electronic bids will be received by the Mississippi Transportation Commission at 10:00 o'clock A.M., Tuesday, June 22, 2021, from the Bid Express Service and shortly thereafter publicly read on the Sixth Floor For:

Widen, Level & Thin Lift Overlay approximately 5 miles on SR 589 from US 11 to 1.6 miles North of Old Highway 11, known as Federal Aid Project No. STP-1164-00(018) / 108227301 in Lamar County.

The attention of bidders is directed to the Contract Provisions governing selection and employment of labor. Minimum wage rates have been predetermined by the Secretary of Labor and are subject to Public Law 87-581, Work Hours Act of 1962, as set forth in the Contract Provisions.

The Mississippi Department of Transportation hereby notifies all bidders that it will affirmatively insure that in any contract entered into pursuant to this advertisement, disadvantaged business enterprises will be afforded full opportunity to submit bids in response to this invitation and will not be discriminated against on the grounds of race, color, sex, age, disability, religion or national origin in consideration for an award.

**The award of this contract will be contingent upon the Contractor satisfying the DBE requirements.**

The specifications are on file in the offices of the Mississippi Department of Transportation.

Contractors may request permission to bid online at <http://shopmdot.ms.gov> at no cost. Upon approval, Contractors shall be eligible to submit a bid using Bid Express at <http://bidx.com>. Specimen proposals may be viewed and downloaded online at no cost at <http://mdot.ms.gov> or purchased online at <http://shopmdot.ms.gov> at a cost of Ten Dollars (\$10.00) per proposal plus a small convenience fee. Cash or checks will not be accepted as payment.

Bid bond, signed or countersigned by a Mississippi Agent or Qualified Nonresident Agent, with Power of Attorney attached, a Cashier's check or Certified Check for five (5%) percent of bid, payable to STATE OF MISSISSIPPI, must accompany each proposal.

The attention of bidders is directed to the provisions of Subsection 102.07 pertaining to irregular proposals and rejection of bids.

JEFFREY C. ALTMAN  
ACTING EXECUTIVE DIRECTOR

# MISSISSIPPI DEPARTMENT OF TRANSPORTATION

**SECTION 904 - NOTICE TO BIDDERS NO. 1**

**CODE: (IS)**

**DATE: 03/01/2017**

**SUBJECT: Governing Specifications**

The current (2017) Edition of the Standard Specifications for Road and Bridge Construction adopted by the Mississippi Transportation Commission is made a part hereof fully and completely as if it were attached hereto, except where superseded by special provisions, or amended by revisions of the Specifications contained within this proposal. Copies of the specification book may be purchased from the MDOT Construction Division, or online at [shopmdot/default.aspx?StoreIndex=1](http://shopmdot/default.aspx?StoreIndex=1).

A reference in any contract document to controlling requirements in another portion of the contract documents shall be understood to apply equally to any revision or amendment thereof included in the contract.

In the event the plans or proposal contain references to the 2004 Edition of the Standard Specifications for Road and Bridge Construction, it is to be understood that such references shall mean the comparable provisions of the 2017 Edition of the Standard Specifications.

## MISSISSIPPI DEPARTMENT OF TRANSPORTATION

**SECTION 904 - NOTICE TO BIDDERS NO. 2**

**CODE: (IS)**

**DATE: 03/01/2017**

**SUBJECT: Status of Right-of-Way**

Although it is desirable to have acquired all rights-of-way and completed all railroad agreements, utility adjustments and work to be performed by others prior to receiving bids, sometimes it is not considered to be in the public interest to wait until each and every such clearance has been obtained. The bidder is hereby advised of possible unacquired rights-of-way, relocations, railroad agreements and utilities adjustments which have not been completed.

The status of right-of-way acquisition, utility adjustments, encroachments, potentially contaminated sites, railroad facilities, improvements, and asbestos contamination are set forth in the following attachments.

In the event right of entry is not available to ALL parcels of right-of-way and/or all work that is to be accomplished by others on the date set forth in the contract for the Notice to Proceed is not complete, the Department will issue a restricted Notice to Proceed.

**STATUS OF RIGHT-OF-WAY**

STP-1164-00(018)

108227/301000

Lamar County

All rights of way and legal rights of entry have been acquired **except:**

**None.**

ASBESTOS CONTAMINATION STATUS OF BUILDINGS  
TO BE REMOVED BY THE CONTRACTOR  
STP-1164-00(018)  
108227-301000  
Lamar County  
April 7, 2021

Reference is made to notices to bidders entitled "Asbestos National Emission Standards for Hazardous Air Pollutants (NESHAP)" and "Removal of Obstructions".

The following pertinent information is furnished concerning asbestos containing materials (ACMs), if any, found in buildings to be removed by the Contractor.

There is no Right of Way required for this project. There are no buildings to be removed by the contractor.



STATUS OF POTENTIALLY CONTAMINATED SITES

STP-1164-00(018)

108227-301000

Lamar County

April 7, 2021

THERE IS NO RIGHT OF WAY REQUIRED FOR THIS PROJECT. NO INITIAL SITE ASSESSMENT WILL BE PERFORMED. IF CONTAMINATION ON EXISTING RIGHT OF WAY IS DISCOVERED, IT WILL BE HANDLED BY THE DEPARTMENT.

# MISSISSIPPI DEPARTMENT OF TRANSPORTATION

## *Inter-Departmental Memorandum*

TO: Vicky Shows  
Right of Way Division

DATE: April 6, 2021

FROM: Cape Jones  
District Maintenance Engineer

SUBJECT OR PROJECT NO: STP-1164-00(018)  
108227/301000

INFORMATION COPY TO:  
File  
Trudi Loflin (84-01)

COUNTY: Lamar

### District Status Report

1. **STATUS OF RIGHT OF WAY:** All work to be done within existing ROW.
2. **RIGHT OF WAY CLEARANCE:** There are no encroachments.
3. **STATUS OF AFFECTED RAILROAD OPERATING FACILITIES:** None Affected.
4. **STATUS OF REQUIRED UTILITY RELOCATIONS:** No utility conflicts.
5. **STATUS OF CONSTRUCTION AGREEMENT:** None required.

Improvements to be included in Notice to Bidders to be removed by the Construction Contractor  
FMS Construction Project No: 108227-301000  
External ROW No: STP-1164-00(018)

Parcel No:  
Station No:  
Property Owner:  
Description/Pictures:

**NA**

**MISSISSIPPI DEPARTMENT OF TRANSPORTATION**

**SECTION 904 - NOTICE TO BIDDERS NO. 3**

**CODE: (SP)**

**DATE: 01/17/2017**

**SUBJECT: Final Clean-Up**

Immediately prior to final inspection for release of maintenance, the Contractor shall pick up, load, transport and properly dispose of all litter from the entire highway right-of-way that is within the termini of the project.

Litter shall include, but not be limited to, solid wastes such as glass, paper products, tires, wood products, metal, synthetic materials and other miscellaneous debris.

Litter removal is considered incidental to other items of work and will not be measured for separate payment.

**MISSISSIPPI DEPARTMENT OF TRANSPORTATION**

**SECTION 904 - NOTICE TO BIDDERS NO. 9**

**CODE: (IS)**

**DATE: 03/01/2017**

**SUBJECT: Federal Bridge Formula**

Bidders are hereby advised that the latest revision of Federal Highway Administration Publication No. FHWA-HOP-06-105, **BRIDGE FORMULA WEIGHTS**, dated August 2006, is made a part of this contract when applicable.

Prior to the preconstruction conference, the Contractor shall advise the Engineer, in writing, what materials, if any, will be delivered to the jobsite via Interstate route(s).

Copies of the **BRIDGE FORMULA WEIGHTS** publication may be obtained by contacting:

Federal Highway Administration  
400 7<sup>th</sup> Street, SW  
Washington, DC 20590  
(202) 366-2212

or

[http://www.ops.fhwa.dot.gov/Freight/publications/brdg\\_frm\\_wgths/bridge\\_formula\\_all\\_rev.pdf](http://www.ops.fhwa.dot.gov/Freight/publications/brdg_frm_wgths/bridge_formula_all_rev.pdf)

An on line **BRIDGE FORMULA WEIGHTS CALCULATOR** is available at

[http://ops.fhwa.dot.gov/freight/sw/brdgcalc/calc\\_page.htm](http://ops.fhwa.dot.gov/freight/sw/brdgcalc/calc_page.htm)

**MISSISSIPPI DEPARTMENT OF TRANSPORTATION**

**SECTION 904 - NOTICE TO BIDDERS NO. 13**

**CODE: (IS)**

**DATE: 03/01/2017**

**SUBJECT: Safety Edge**

Bidders are hereby advised that the Shoulder Wedge (Safety Edge) specified in Section 401, Asphalt Pavements, shall only apply to the top two (2) lifts of asphalt. Open Graded Friction Courses (OGFC) are not to be considered a lift as it pertains to safety edge. Attached is a drawing showing the safety edge. Note that the shoulder dimensions in the bottom two drawings will be less than three feet (3').



**MISSISSIPPI DEPARTMENT OF TRANSPORTATION**

**SECTION 904 - NOTICE TO BIDDERS NO. 113**

**CODE: (SP)**

**DATE: 04/18/2017**

**SUBJECT: Tack Coat**

Bidders are advised that in addition to the products listed on the Department's APL as referenced in Subsection 401.03.1.2 on page 256, the Contractor may use one of the following as a tack coat.

- CSS-1
- CSS-1h
- SS-1
- SS-1h



**MISSISSIPPI DEPARTMENT OF TRANSPORTATION**

**SECTION 904 - NOTICE TO BIDDERS NO. 296**

**CODE: (SP)**

**DATE: 07/25/2017**

**SUBJECT: Reduced Speed Limit Signs**

Bidders are advised that when the plans or contract documents require the speed limit on a project to be reduced, the Contractor shall begin work within 48 hours of installing the reduced speed limit signs. Should the Contractor not start work or have no plans to start work within 48 hours of installing the signs, the reduced speed limit signs shall be covered and existing speed limit signs uncovered.

**MISSISSIPPI DEPARTMENT OF TRANSPORTATION**

**SECTION 904 - NOTICE TO BIDDERS NO. 445**

**CODE: (SP)**

**DATE: 10/10/2017**

**SUBJECT: Mississippi Agent or Qualified Nonresident Agent**

Bidders are hereby advised of the requirements of Subsections 102.08, 103.05.2, and 107.14.2.1 of the *2017 Standard Specifications for Road and Bridge Construction* as it refers to bonding agents. Proposal guaranties, bonds, and liability insurance policies must be signed by a **Mississippi Agent or Qualified Nonresident Agent.**

## MISSISSIPPI DEPARTMENT OF TRANSPORTATION

SECTION 904 - NOTICE TO BIDDERS NO. 516

CODE: (IS)

DATE: 11/28/2017

SUBJECT: Errata and Modifications to the 2017 Standard Specifications

<u>Page</u>	<u>Subsection</u>	<u>Change</u>
16	102.06	In the seventh full paragraph, change “Engineer” to “Director.”
33	105.05.1	In the sixth sentence, change “Contract Administration Engineer” to “Contract Administration Director.”
34	105.05.2.1	In subparagraph 2, change “SWPPP, ECP” to “SWPPP and the ECP”
35	105.05.2.2	In subparagraphs 2, add “ and” to the end of the sentence. In subparagraph 3, remove “, and” and add “.”.
90	109.04.2	In the last paragraph of subparagraph (a), place a period “.” at the end of the sentence.
93	109.04.2	In the last paragraph of subparagraph (g), place a period “.” at the end of the sentence. Also, in the first paragraph of subparagraph (h), place a period “.” at the end of the sentence.
97	109.07	Under ADJUSTMENT CODE, subparagraph (A1), change “HMA mixture” to “Asphalt mixtures.”
98	109.11	In the third sentence, change “Engineer” to “Director.”
219	308.04	In the last sentence of the last paragraph, change “Contractor’s decision” to “Engineer’s decision.”
300	405.02.5.9	In the first sentence of the second paragraph, change “Hot Mix Asphalt” to “Asphalt Mixtures.”
502	630.01.1	In the first paragraph, change “AASHTO” to “AASHTO’s LRFD”.
636	646.05	Change “each” to “per each” for the pay item units of payment.
640	656.02.6.2	In item 7), change “down stream” to “downstream”.
688	630.03.2	Change the subsection number from “630.03.2” to “680.03.2.”

- |     |               |   |
|-----|---------------|---|
| 725 | 702.08.3      | In the second sentence of the first paragraph, change “hot-mix” to “asphalt.”                     |
| 954 | 804.02.13.1.6 | In the definition for “M” in the % Reduction formulas, change “paragraph 7.3” to “paragraph 5.3.” |

## MISSISSIPPI DEPARTMENT OF TRANSPORTATION

SECTION 904 - NOTICE TO BIDDERS NO. 977

CODE: (IS)

DATE: 07/25/2018

SUBJECT: DUNS Requirement for Federal Funded Projects

Bidders are advised that the Prime Contractor must maintain a current registration in the System for Award Management ( <http://www.sam.gov> ) at all times during this project. A Dun and Bradstreet Data Universal Numbering System (DUNS) Number ( <http://www.dnb.com> ) is one of the requirements for registration in the System for Award Management.

Bidders are also advised that prior to the award of this contract, they MUST be registered, active, and have no active exclusions in the System for Award Management.

**MISSISSIPPI DEPARTMENT OF TRANSPORTATION**

**SECTION 904 - NOTICE TO BIDDERS NO. 1225**

**CODE: (SP)**

**DATE: 11/13/2018**

**SUBJECT: Early Notice to Proceed**

Bidders are advised that if an early notice to proceed is allowed by the Department and the Contractor experiences problems or delays between the early notice to proceed date and the original notice to proceed date, this shall not be justification for any monetary compensation or an extension of contract time.

**MISSISSIPPI DEPARTMENT OF TRANSPORTATION**

**SECTION 904 - NOTICE TO BIDDERS NO. 1226**

**CODE: (IS)**

**DATE: 11/16/2018**

**SUBJECT: Material Storage Under Bridges**

Bidders are advised that Subsection 106.08 of the Standard Specifications allows the Contractor to store materials and equipment on portions of the right-of-way. However, the Contractor will not be allowed to store or stockpile materials under bridges without written permission from the Project Engineer. The Contractor shall submit a detailed request of all proposed materials to be stored under bridges to the Engineer a minimum of 14 calendar days prior to anticipated storage. This detail shall include, but not limited to, bridge location, material type, material quantity, and duration of storage. The Project Engineer and any other needed Division will review this information and determine whether to grant approval. The Contractor shall not store any material under any bridge without written approval from the Project Engineer.

**MISSISSIPPI DEPARTMENT OF TRANSPORTATION**

**SECTION 904 - NOTICE TO BIDDERS NO. 1241**

**CODE: (IS)**

**DATE: 11/27/2018**

**SUBJECT: Fuel and Material Adjustments**

Bidder's attention is brought to the last paragraph of Subsection 109.07 of the Standard Specifications which states that no fuel or material adjustment will be made after the completion of contract time. Any fuels consumed or materials incorporated into the work during the monthly estimate period falling wholly after the expiration of contract time will not be subject a fuel or material adjustment.



**MISSISSIPPI DEPARTMENT OF TRANSPORTATION**

**SECTION 904 - NOTICE TO BIDDERS NO. 1963**

**CODE: (SP)**

**DATE: 9/23/2019**

**SUBJECT: Guardrail Pads**

Bidders are hereby advised that prior to construction of the guardrail pads, the Contractor shall coordinate with the guardrail Subcontractor to determine the guardrail pad dimensions necessary to meet MASH compliance.

## MISSISSIPPI DEPARTMENT OF TRANSPORTATION

**SECTION 904 - NOTICE TO BIDDERS NO. 2206**

**CODE: (IS)**

**DATE: 01/14/2020**

**SUBJECT: MASH Compliant Devices**

Bidders are hereby advised that compliance associated with the requirements of meeting either the National Cooperative Highway Research Program (NCHRP) Report 350 or the Manual for Assessing Safety Hardware (MASH) for installations of certain traffic control devices and permanent safety hardware devices (guardrails, guardrail terminals, permanent portable barriers, cast-in-place barriers, all other permanent longitudinal barriers, crash cushions, cable barriers, cable barrier terminals, bridge rails, bridge rail transitions, all other terminals, sign supports, and all other breakaway hardware) as listed throughout the Standard Specifications and/or the Standard Drawings, or both, is now replaced with the requirements of meeting the 2016 version of MASH after December 31, 2019. This change applies to new permanent installations and to full replacements of existing installations.

At the preconstruction conference or prior to starting any work on the project, the Contractor shall submit a letter stating that the traffic control devices and permanent safety hardware devices as outlined within the paragraph above that are to be used on the project are certified to meet MASH 2016.

When a MASH 2016-compliant device does not exist for the new permanent installations and/or full replacement installations of permanent safety hardware devices, as listed above, a MASH 2009-compliant or a NCHRP 350-compliant device may be proposed by the Contractor for the project. A written request for such instances must be submitted by the Contractor either at the preconstruction conference or prior to starting any work on the project. The Contractor shall submit the following items to the Project Engineer: (1) a detailed list of the proposed devices and locations thereof; and (2) certification letters indicating that the proposed devices are compliant with either MASH 2009 or NCHRP 350.

When a MASH 2016-compliant device does not exist for the temporary work zone traffic control devices (Category 1, Category 2, and Category 3 devices), a MASH 2009-compliant or a NCHRP 350-compliant device may be proposed by the Contractor for the project. Temporary work zone traffic control devices (Category 1, Category 2, and Category 3 devices) that are MASH 2009-compliant or NCHRP 350-compliant that have been in use prior to December 31, 2019, and that have a remaining service life may be proposed for use throughout their normal service life on the project by the Contractor. For either of these scenarios for temporary work zone traffic control devices, a written request must be submitted by the Contractor either at the preconstruction conference or prior to starting any work on the project. The Contractor shall submit the following items to the Project Engineer: (1) a detailed list of the proposed devices and locations thereof; and (2) certification letters indicating that the proposed devices are compliant with either MASH 2009 or NCHRP 350.

Work will only be allowed to proceed after the Department has granted written concurrence(s) with the proposed request(s) as listed above.

**MISSISSIPPI DEPARTMENT OF TRANSPORTATION**

**SECTION 904 - NOTICE TO BIDDERS NO. 2273**

**CODE: (SP)**

**DATE: 02/12/2020**

**SUBJECT: Mississippi Special Fuel Tax Law**

Bidder's attention is brought to the second paragraph of Subsection 107.02 of the Standard Specifications which states that all Contractors and Subcontractors must comply with all requirements contained in the Mississippi Special Fuel Tax Law, Section 27-55-501, *et seq.* Attached are two Fact Sheets provided by the Mississippi Department of Revenue (MDOR) with additional information.

## Gasoline and Dyed Diesel Used for Non-Highway Purposes

*Mississippi provides a reduced rate for gasoline and dyed diesel used for non-highway purposes. The reduced rates are 6.44 cents per gallon and 5.75 cents per gallon of gasoline or dyed diesel. These fuels are generally taxed at 18 cents per gallon if for on road use.*

### Gasoline Used for Non-Highway Purposes

You may be entitled to a refund of 11.56 cents per gallon (making this an equivalent to a tax rate of 6.44 cents per gallon) if you desire to purchase gasoline to be used off road. The gasoline must be used for agricultural, maritime, industrial, manufacturing, domestic or non-highway purposes only.

Examples of non-highway include gasoline used in boats, golf carts, machinery used for manufacturing or farm equipment used exclusively in plowing, planting or harvesting farm products.

### Refund Gasoline User

The refund is based on the amount of gallons used. Before a refund is issued, you are required to...

1. Obtain a refund gasoline user's permit and a certificate for refund booklet from the Department of Revenue;
2. Have a storage tank marked "REFUND GASOLINE"; and,
3. Purchase the gasoline from someone who holds a refund gasoline dealer's permit.

No refund will be allowed for gasoline used in motor vehicles owned or operated by a government entity or used in Mississippi government contracts.

### Refund Gasoline Dealer

You must obtain a refund gasoline dealer's permit from the Department of Revenue before selling refund gasoline. At no time should the gasoline be delivered to a tank that is not properly marked. The gasoline must be dyed a distinctive mahogany color at the time of delivery.

The Department of Revenue may waive the dye requirement if the dye may cause damage to the equipment. The refund gasoline user is required to obtain the waiver from the Department of Revenue.

### Dyed Diesel Used for Non-Highway Purposes

Unlike gasoline, you are not required to apply for a refund if you desire to purchase dyed diesel to be used off road. Mississippi provides a reduced rate of 5.75 cents per gallon on dyed diesel used off road. Diesel used on road is subjected to 18 cents per gallon. Dyed diesel used in motor vehicles owned or operated by a government entity or used in Mississippi government contracts will be subjected to 18 cents per gallon.

### Dyed Diesel Used on the Highway

Any person who purchases, receives, acquires or uses dyed diesel for highway use will be liable to pay 18 cents per gallon and subject to a penalty in the amount of \$1000.

### Identifying Dyed Diesel

Storage facilities for dyed diesel must be plainly marked "NONHIGHWAY DIESEL FUEL" or "NONHIGHWAY KEROSENE". Retailers are also required to mark all pumps or dispensing equipment.



## Special Fuel Used on Government Contracts

### State and Local Government Contracts

Special fuel purchased, acquired or used in performing contracts with the State of Mississippi, counties, municipalities or any political subdivision is taxed at a rate of 18 cents per gallon. Special fuel includes but is not limited to the following:

- Dyed diesel fuel;
- Kerosene;
- Undyed diesel fuel; and,
- Fuel oil.

State and local government contracts include construction, reconstruction and maintenance or repairs of projects such as roads, bridges, water systems, sewer systems, buildings, drainage canals and recreational facilities. The Department of Revenue may require contractors to remit the excise tax directly to the state in lieu of paying the tax to a distributor.

### Special Fuel Direct Pay Permit

Contractors that remit the excise tax to the state will be issued a Special Fuel Direct Pay Permit. This permit relieves the distributor from collecting the tax and requires the contractor to file a monthly special fuel return. The distributor should include the contractor’s permit number on all invoices that are related to tax-free sales.

The contractor is required to furnish a surety or cash bond guaranteeing the payment of the excise tax prior to receiving the Special Fuel Direct Pay Permit. The Department of Revenue may accept a contractors tax bond if the bond covers the excise tax levied on special fuel.

### Special Fuel Distributors

If the contractor does not have a Special Fuel Direct Pay Permit, distributors are required to collect the 18 cents excise tax and remit the tax to the Department of Revenue. The additional 12.25 cents levied on special fuel (excluding undyed diesel) should be reported on schedules 5F and 5G of the special fuel return.

### Environmental Protection Fee

Special fuel distributors are required to collect the environmental protection fee even if the contractor has a Special Fuel Direct Pay Permit. The fee is levied at 4/10<sup>ths</sup> of a cent per gallon. The fee is suspended or reinstated when the trust fund has exceeded or fallen below the obligatory balance.

### Penalties

Any person who knowingly and willfully purchases untaxed fuel for use in equipment utilized on a road or highway construction site in this state is guilty of a misdemeanor and, upon conviction, shall be fined not less than \$1,000 or more than \$100,000, or imprisoned in the county jail for not more than one year, or both.



## MISSISSIPPI DEPARTMENT OF TRANSPORTATION

### SUPPLEMENT TO NOTICE TO BIDDERS NO. 2611

**DATE:**       **05/02/2020**

The goal is 5 percent for the Disadvantaged Business Enterprise. All Bidders are required to submit Form OCR-481 for all DBEs. Bidders are advised to check the bid tabulation link for this project on the MDOT website at:

[https://mdot.ms.gov/portal/current\\_letting](https://mdot.ms.gov/portal/current_letting)

Bid tabulations are usually posted by 3:00 pm on Letting Day.

## MISSISSIPPI DEPARTMENT OF TRANSPORTATION

SECTION 904 - NOTICE TO BIDDERS NO. 2611

CODE: (IS)

DATE: 05/21/2020

SUBJECT: Disadvantaged Business Enterprises In Federal-Aid Highway Construction

This contract is subject to the "Moving Ahead for Progress in the 21<sup>st</sup> Century Act (MAP-21)" and applicable requirements of "Title 49, Code of Federal Regulations, Part 26." Portions of the Act are set forth in this Notice as applicable to compliance by the Contractor and all of the Act, and the MDOT DBE Program, is incorporated by reference herein.

The Department has developed a Disadvantaged Business Enterprise Program that is applicable to this contract and is made a part thereof by reference.

Copies of the program may be obtained from:

Office of Civil Rights  
Mississippi Department of Transportation  
P. O. Box 1850  
Jackson, Mississippi 39215-1850

### POLICY

It is the policy of the Mississippi Department of Transportation to provide a level playing field, to foster equal opportunity in all federally assisted contracts, to improve the flexibility of the DBE Program, to reduce the burdens on small businesses, and to achieve that amount of participation that would be obtained in a non-discriminatory market place. In doing so, it is the policy of MDOT that there will be no discrimination in the award and performance of federally assisted contracts on the basis of race, color, sex, or national origin.

### ASSURANCES THAT CONTRACTORS MUST TAKE

MDOT will require that each contract which MDOT signs with a sub-recipient or a Contractor, and each subcontract the Prime Contractor signs with a Subcontractor, includes the following assurances:

“The Contractor, sub-recipient or Subcontractor shall not discriminate on the basis of race, color, sex, or national origin in the performance of this contract. The Contractor shall carry out applicable requirements of 49 CFR 26 in the award and administration of federally assisted contracts. Failure by the Contractor to carry out these requirements is a material breach of this contract, which may result in the termination of this contract or such other remedy as MDOT deems appropriate.”

**DEFINITIONS**

For purposes of this provision the following definitions will apply:

"Disadvantaged Business" means a small business concern: (a) which is at least 51 percent owned by one or more socially and economically disadvantaged individual(s) or in the case of any publicly owned business, at least 51 percent of the stock of which is owned by one or more socially and economically disadvantaged individual(s); and (b) whose management and daily business operations are controlled by one or more of the socially and economically disadvantaged individual(s) who own it. It is important to note that the business owners themselves must control the operations of the business. Absentee ownership or title ownership by an individual who does not take an active role in controlling the business is not consistent with eligibility as a DBE under 49 CFR Part 26.71.

**CONTRACTOR'S OBLIGATION**

The Contractor and all Subcontractors shall take all necessary and reasonable steps to ensure that DBE firms can compete for and participate in the performance of a portion of the work in this contract and shall not discriminate on the basis of race, color, sex, or national origin. Failure on the part of the Contractor to carry out the DBE requirements of this contract constitutes a breach of contract and after proper notification the Department may terminate the contract or take other appropriate action as determined by the Department.

When a contract has a zero percent (0%) DBE goal, the Contractor still has the responsibility to take all necessary and reasonable steps to ensure that DBE firms can compete for and participate in the performance of the work in the contract. In this case, all work performed by a certified DBE firm is considered to be a "race neutral" measure and the Department will receive DBE credit towards the overall State goals when the DBE firm is paid for their work. If the Prime Contractor is a certified DBE firm, the Department can receive DBE credit only for the work performed by the Prime Contractor's work force or any work subcontracted to another DBE firm. Work performance by a non-DBE Subcontractor is not eligible for DBE credit.

**CONTRACT GOAL**

The goal for participation by DBEs is established for this contract in the attached Supplement. The Contractor shall exercise all necessary and reasonable steps to ensure that participation is equal to or exceeds the contract goal.

If the percentage of the contract that is proposed for DBEs is 1% or greater, the Contractor shall agree to meet or exceed the contract goal on the last bid sheet of the proposal.

All Bidders shall submit to the Office of Civil Rights Form OCR-481, signed by the Prime Contractor and the DBE Subcontractors, no later than the 3<sup>rd</sup> business day after opening of the bids.



Form OCR-481 is available on the MDOT website at [www.mdot.ms.gov](http://www.mdot.ms.gov) under the Civil Rights tab, or by calling 601-359-7466.

The OCR-481 Form must contain the following information:

The name and address of each certified DBE Contractor / Supplier;

The Reference Number, percent of work to be completed by the DBE subcontractor and the dollar amount of each item. If a portion of an item is subcontracted, a breakdown of that item including quantities and unit price must be attached, detailing what part of the item the DBE firm is to perform and who will perform the remainder of the item.

If the DBE Commitment shown on the last bid sheet of the proposal, does not equal or exceed the contract goal, the bidder must submit, to MDOT Contract Administration Division prior to bid opening, information to satisfy the Department that adequate good faith efforts have been made to meet the contract goal.

Failure of the lowest bidder to furnish acceptable proof of good faith efforts, submitted to MDOT Contract Administration Division prior to bid opening, shall be just cause for rejection of the proposal. Award may then be made to the next lowest responsive bidder or the project may be re-advertised.

### **GOOD FAITH EFFORTS**

The following factors are illustrative of matters the Department will consider in judging whether or not the bidder has made adequate good faith effort to satisfy the contract goal.

- (1) Whether the bidder attended the pre-bid meeting that was scheduled by the Department to inform DBEs of subcontracting opportunities;
- (2) Whether the bidder advertised in general circulation, trade association, and minority-focus media concerning the subcontracting opportunities;
- (3) Whether the bidder provided written notice to a reasonable number of specific DBEs that their interest in the contract is being solicited;
- (4) Whether the bidder followed up initial solicitations of interest by contacting DBEs to determine with certainty whether they were interested;
- (5) Whether the bidder selected portions of the work to be performed by DBEs in order to increase the likelihood of meeting the contract goal;
- (6) Whether the bidder provided interested DBEs with adequate information about the plans, specifications and requirements of the contract;

- (7) Whether the bidder negotiated in good faith with interested DBEs and did not reject them as unqualified without sound reasons based on a thorough investigation of their capabilities; and
- (8) Whether the bidder made efforts to assist interested DBEs in obtaining any required bonding or insurance.
- (9) Whether the bidder has written notification to certified DBE Contractors soliciting subcontracting for items of work in the contract.
- (10) Whether the bidder has a statement of why an agreement was not reached.
- (11) Proof of written notification to certified DBE Contractors by certified mail that their interest is solicited in subcontracting the work defaulted by the previous DBE or in subcontracting other items of work in the contract.

The bidder’s execution of the signature portion of the proposal shall constitute execution of the following assurance:

The bidder hereby gives assurance pursuant to the applicable requirements of "Moving Ahead for Progress in the 21<sup>st</sup> Century Act (MAP-21)" and applicable requirements of "Title 49, Code of Federal Regulations, Part 26" that the bidder has made a good faith effort to meet the contract goal for DBE participation for which this proposal is submitted.

### **DIRECTORY**

A list of “Certified DBE Contractors” which have been certified as such by the Mississippi Department of Transportation and other Unified Certification Partners (UPC) can be found on the Mississippi Department of Transportation website at [www.mdot.ms.gov](http://www.mdot.ms.gov). The list is in the top left corner of the current Letting Calendar under Contracts & Letting. The DBE firm must be certified at the time the project is let and approved by MDOT to count towards meeting the DBE goal.

### **REPLACEMENT**

If a DBE Subcontractor cannot perform satisfactorily, and this causes the OCR-481 commitment to fall below the contract goal, the Contractor shall take all necessary reasonable steps to replace the DBE with another certified DBE Subcontractor or submit information to satisfy the Mississippi Department of Transportation that adequate good faith efforts have been made to replace the DBE. The good faith efforts outlined previously in this document still apply. The replacement DBE must be a DBE who was on the Department's list of "Certified DBE Contractors" when the job was let, and who is still active. All DBE replacements must be approved by the Department.

Under no circumstances shall the Prime or any Subcontractor perform the DBE's work (as shown on the OCR-481) without prior written approval from the Department. See "Sanctions" at the end of this document for penalties for performing DBE's work.

When a Contractor proposes to substitute/replace/terminate a DBE that was originally named on the OCR-481, the Contractor must obtain a release, in writing, from the named DBE explaining why the DBE Subcontractor cannot perform the work. A copy of the original DBE's release must be attached to the Contractor's written request to substitute/replace/terminate along with appropriate Subcontract Forms for the substitute/replacement/terminated Subcontractor, all of which must be submitted to the DBE Coordinator and approved, in advance, by MDOT.

### **PRE-BID MEETING**

A pre-bid meeting will be held in the [Commission Room on the 1<sup>st</sup> Floor](#) of the [MDOT Administration Building](#) in Jackson, at 2:00 P.M. on the day preceding the date of the bid opening.

This meeting is to inform DBE firms of subcontracting and material supply opportunities. Attendance at this meeting is considered of prime importance in demonstrating good faith effort to meet the contract goal.

### **PARTICIPATION / DBE CREDIT**

Participation shall be counted toward meeting the goal in this contract as follows:

- (1) If the Prime Contractor is a certified DBE firm, only the value of the work actually performed by the DBE Prime can be counted towards the project goal, along with any work subcontracted to a certified DBE firm.
- (2) If the Contractor is not a DBE, the work subcontracted to a certified DBE Contractor will be counted toward the goal.
- (3) The Contractor may count toward the goal a portion of the total dollar value of a contract with a joint venture eligible under the standards of this provision equal to the percentage of the DBE partner in the joint venture.
- (4) Expenditures to DBEs that perform a commercially useful function may be counted toward the goal. A business is considered to perform a commercially useful function when it is responsible for the execution of a distinct element of the work and carries out its responsibilities by actually performing, managing, and supervising the work involved.
- (5) The Contractor may count 100% of the expenditures for materials and supplies obtained from certified DBE suppliers and manufacturers that produce goods from raw materials or substantially alters them for resale provided the suppliers and manufacturers assume the actual and contractual responsibility for the provision of the materials and supplies. The Contractor may count sixty percent (60%) of the expenditures to suppliers that are not

manufacturers, provided the supplier performs a commercially useful function in the supply process. Within 30 days after receipt of the materials, the Contractor shall furnish to the DBE Coordinator invoices from the certified supplier to verify the DBE goal.

- (6) Any work that a certified DBE firm subcontracts or sub-subcontracts to a non-DBE firm will not count towards the DBE goal.
- (7) Only the dollars actually paid to the DBE firm may be counted towards the DBE goal. The participation of a DBE Firm cannot be counted towards the Prime Contractor's DBE goal until the amount being counted towards the goal has been paid to the DBE.

### **AWARD**

Award of this contract to the low bidder will be contingent upon the following conditions:

- (1) Concurrence from Federal Highway Administration, when applicable.
- (2) **All Bidders** must submit to the Office of Civil Rights for approval, Form OCR-481 (DBE Commitment) no later than the 3<sup>rd</sup> business day after opening of the bids to satisfy the Department and that adequate good faith efforts have been made to meet the contract goal. For answers to questions regarding Form OCR-481, contact the MDOT Office of Civil Rights at (601) 359-7466.
- (3) Bidder must include OCR-485 information with their bid proposal listing all firms that submitted quotes for material supplies or items to be subcontracted. OCR-485 information must be **signed and** included with the bid proposal. If the OCR-485 information is not included as part of bid proposal, your bid will be deemed irregular.

Prior to the start of any work, the bidder must notify the Project Engineer, in writing, of the name of the designated "DBE Liaison Officer" for this project. This notification must be posted on the bulletin board at the project site.

### **DEFAULT**

If the contract goal established by MDOT in this proposal is 1% or greater, it must be met to fulfill the terms of the contract. The Contractor may list DBE Subcontractors and items that exceed MDOT's contract goal, but should unforeseen problems arise that would prevent a DBE from completing its total commitment percentage, the Contractor will meet the terms of the contract as long as it meets or exceeds MDOT's Contract Goal. For additional information, refer to "Replacement" section of this Notice.

### **DBE REPORTS**

- (1) OCR-481: Refer to "CONTRACT GOAL" section of this Notice to Bidders for information regarding this form.

- (2) OCR-482: At the conclusion of the project, before the final estimate is paid and the project is closed out, the Prime Contractor will submit to the Project Engineer for verification of quantities and further handling Form OCR-482 whereby the Contractor certifies to the amounts of payments made to all Contractors / Suppliers over the life of the contract. The Project Engineer shall submit the completed Form OCR-482 to the DBE Coordinator (Office of Civil Rights). Final acceptance of the project is dependent upon Contract Administration Division's receipt of completed Form OCR-482 which they will receive from the Office of Civil Rights.
- (3) OCR-483: The Project Engineer/Inspector will complete Form OCR-483, the Commercially Useful Function (CUF) Performance Report, in accordance with MDOT S.O.P. No. OCR-03-05-02-483. Evaluations reported on this form are used to determine whether or not the DBE firm is performing a CUF. The Prime Contractor should take corrective action when the report contains any negative evaluations. DBE credit may be disallowed and/or other sanctions imposed if it is determined the DBE firm is not performing a CUF. This form should also be completed and returned to the DBE Coordinator (Office of Civil Rights).
- (4) OCR-484: Each month, the Prime Contractor will submit to the Project Engineer OCR-484 that certifies payments to all Subcontractors and shows all firms even if the Prime Contractor has paid no monies to the firm during that estimate period (negative report). The Project Engineer will attach the form to the monthly estimate before forwarding to the Contract Administration Division for further processing. Failure of the Contractor to submit the OCR-484 will result in the estimate not being processed and paid.
- (5) OCR-485: ALL BIDDERS must submit signed form with bid proposal of all firms that submitted quotes for material supplies or items to be subcontracted. If the OCR-485 information is not included as part of bid proposal, the bid will be deemed irregular.
- (6) OCR-487: Only used by Prime Contractors that are certified DBE firms. This form is used in determining the exact percentage of DBE credit for the specified project. The low Bidder should return this form to MDOT with the OCR-481 form, or can also be returned with the Permission to Subcontract Forms (CAD-720, CAD-725 and CAD-521).

DBE Forms, can be obtained from the Office of Civil Rights Division, MDOT Administration Building, 401 North West Street, Jackson, MS, or at [www.mdot.ms.gov](http://www.mdot.ms.gov) under the Civil Rights tab.

### SANCTIONS

The Department has the option to enforce any of the following penalties for failure of the Prime Contractor to fulfill the DBE goal as stated on the OCR-481 form or any violations of the DBE program guidelines:

- (1) Disallow credit towards the DBE goal

(2) Withhold progress estimate payments

(3) Deduct from the final estimate or recover an amount equal to the unmet portion of the DBE goal which may include additional monetary penalties as outlined below based on the number of offenses and the severity of the violation as determined by MDOT.

1 <sup>st</sup> Offense	10% of unmet portion of goal	or	\$5,000 lump sum payment	or	Both
2 <sup>nd</sup> Offense	20% of unmet portion of goal	or	\$10,000 lump sum payment	or	Both
3 <sup>rd</sup> Offense	40% of unmet portion of goal	or	\$20,000 lump sum payment	or	\$20,000 lump sum payment and debarment

(4) Debar the Contractor involved from bidding on MDOT federally funded projects for a period of up to 12 months after notification by certified email.

## MISSISSIPPI DEPARTMENT OF TRANSPORTATION

**SECTION 904 - NOTICE TO BIDDERS NO. 2782**

**CODE: (SP)**

**DATE: 8/13/2020**

**SUBJECT: DBE Pre-Bid Meeting**

Due to the COVID-19 pandemic and the Department not allowing visitors in the Administration Building at this time, the DBE Pre-Bid Meeting referenced on Page 5 of Notice to Bidders No. 2611 will be held by **video conference only**. The meeting will be held at 2:00 P.M. on the day preceding the date of the bid opening using Zoom video conferencing software. Anyone interested in participating can download Zoom and connect to the meeting at the below link.

<https://zoom.us/j/5548736403?pwd=SDh5S2hQSE5pNG5FOEkzR3NsUnBYQT09>

Password (if prompted): 272147

For those unable to participate via Zoom, the below teleconference number may be used instead.

1-888-227-7517

Conference Code: 404496

## MISSISSIPPI DEPARTMENT OF TRANSPORTATION

SECTION 904 - NOTICE TO BIDDERS NO. 2954

CODE: (SP)

DATE: 12/01/2020

SUBJECT: Reflective Sheeting for Signs

Bidders are hereby advised that the retroreflective sign sheeting used for signs on this project shall be as listed below and shall meet the requirements of Subsection 721.06.

### Temporary Construction Signs

Temporary traffic control (orange) sign sheeting shall be a minimum Type IX Fluorescent Orange sheeting as shown in Special Provision 907-721.

### Permanent Signs

Permanent signs, except signs on traffic signal poles/mast arms, shall be as follows:

- Brown background sheeting on guide signs shall be a minimum Type VIII sheeting,
- Green and blue background sheeting on guide signs shall be a minimum Type IX sheeting, and
- All white, yellow, red, fluorescent yellow, and fluorescent yellow/green sheeting shall be Type XI sheeting.



**MISSISSIPPI DEPARTMENT OF TRANSPORTATION**

**SECTION 904 – NOTICE TO BIDDERS NO. 3117**

**CODE: (SP)**

**DATE: 02/23/2021**

**SUBJECT: Standard Drawings**

Standard Drawings attached hereto shall govern appropriate items of required work.

Larger copies of Standard Drawings may be purchased from:

MDOT Plans Print Shop  
MDOT Shop Complex, Building C, Room 114  
2567 North West Street  
P.O. Box 1850  
Jackson, MS 39215-1850  
Telephone: (601) 359-7460  
or FAX: (601) 359-7461  
or e-mail: [plans@mdot.state.ms.us](mailto:plans@mdot.state.ms.us)

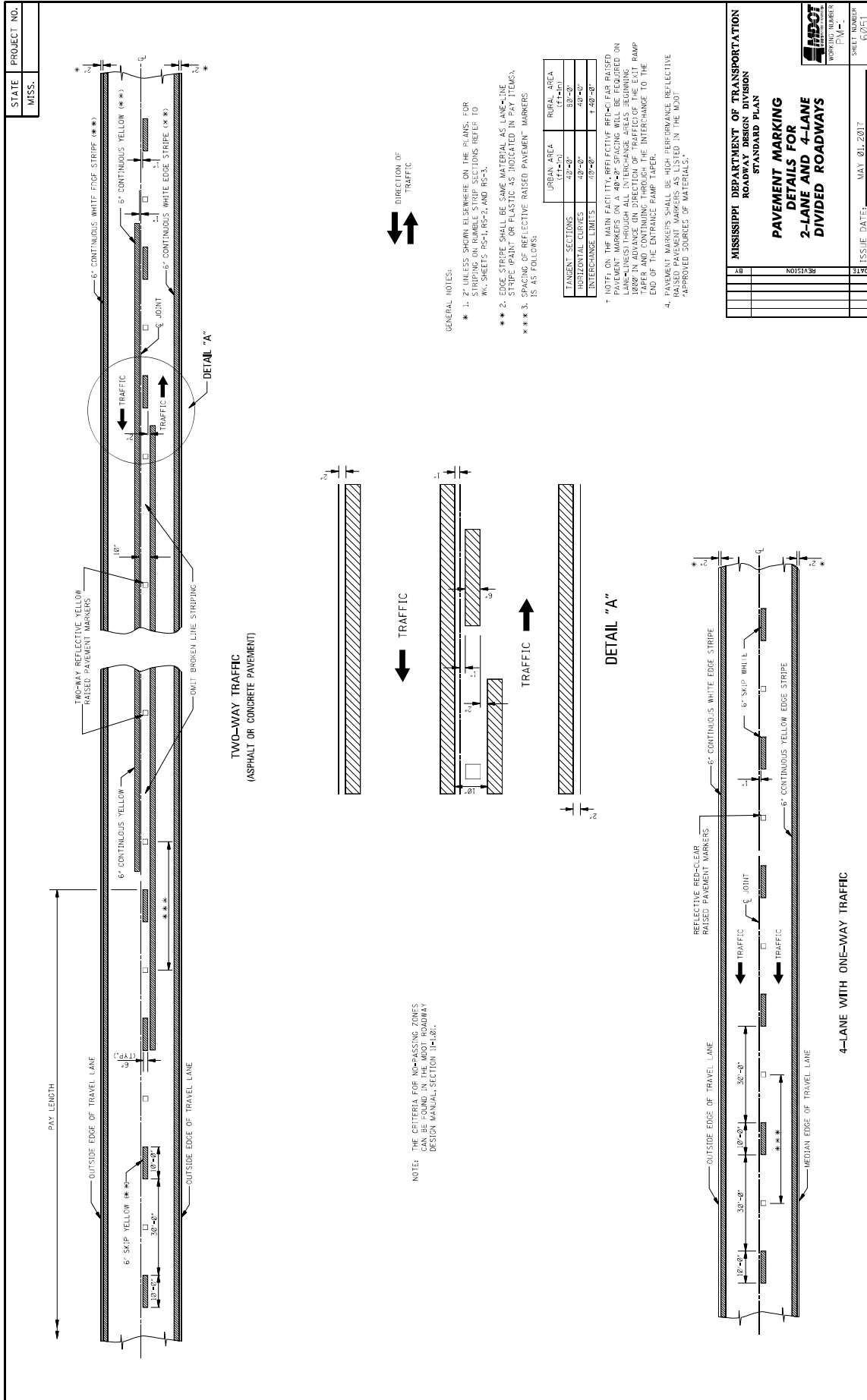

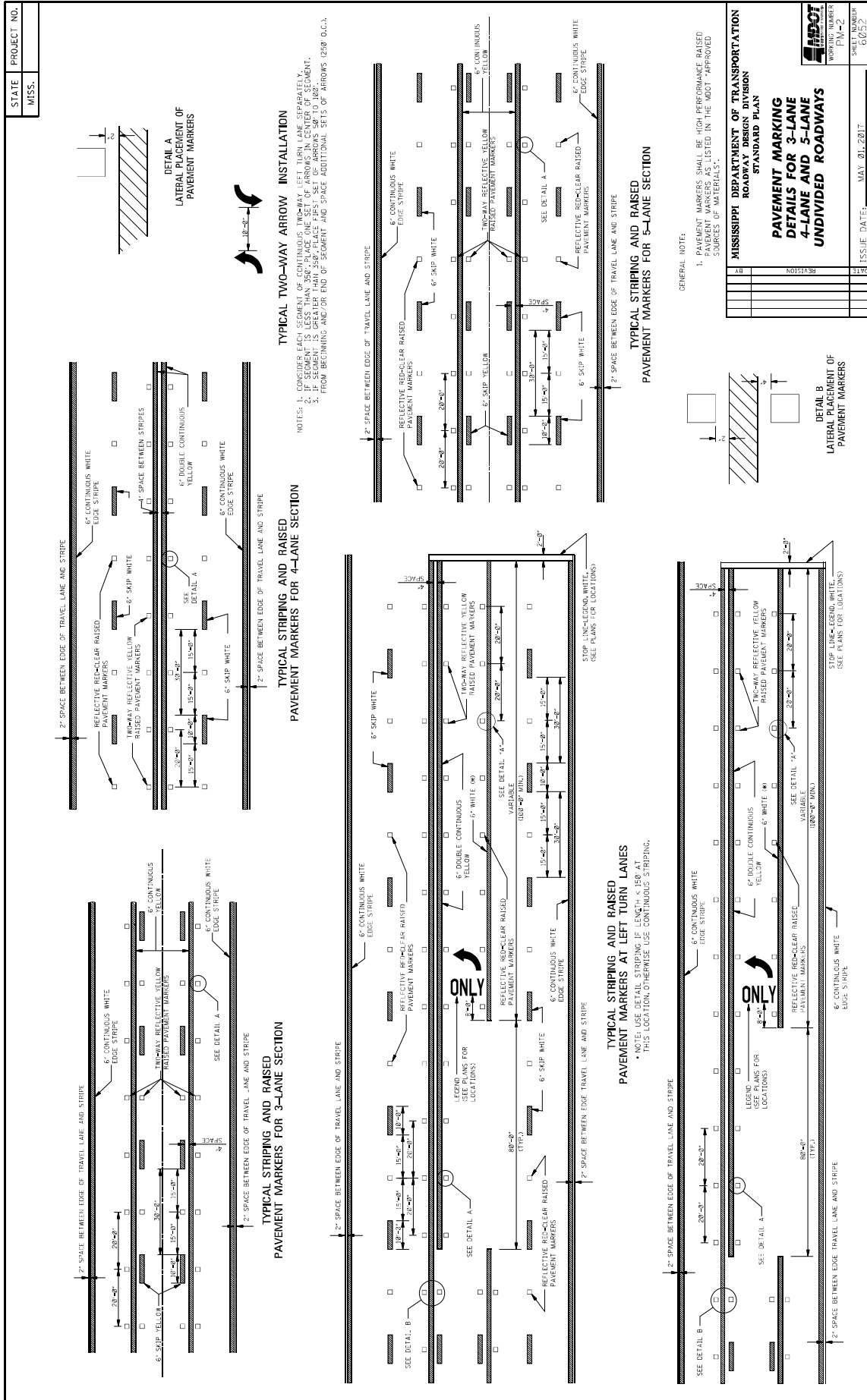

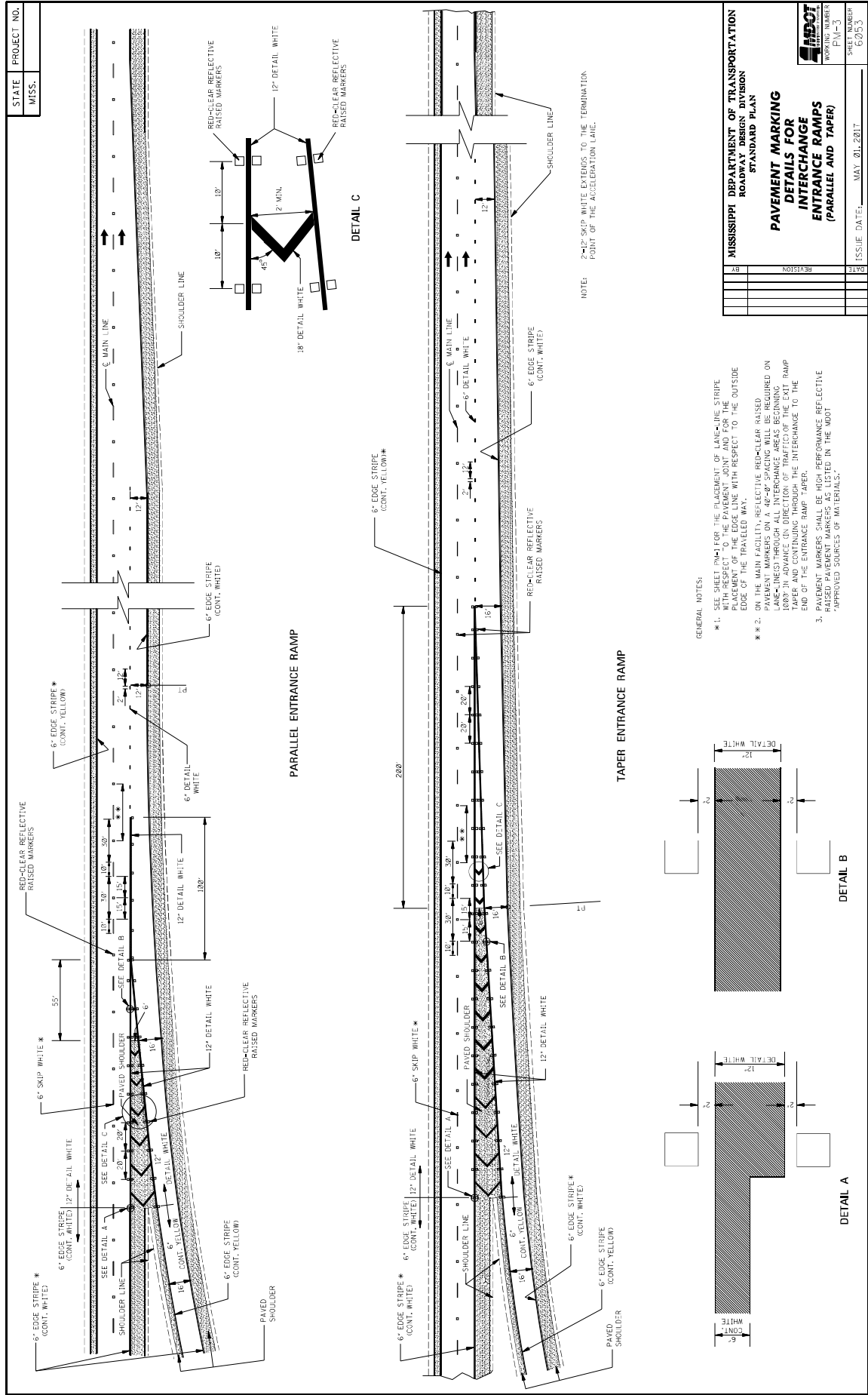

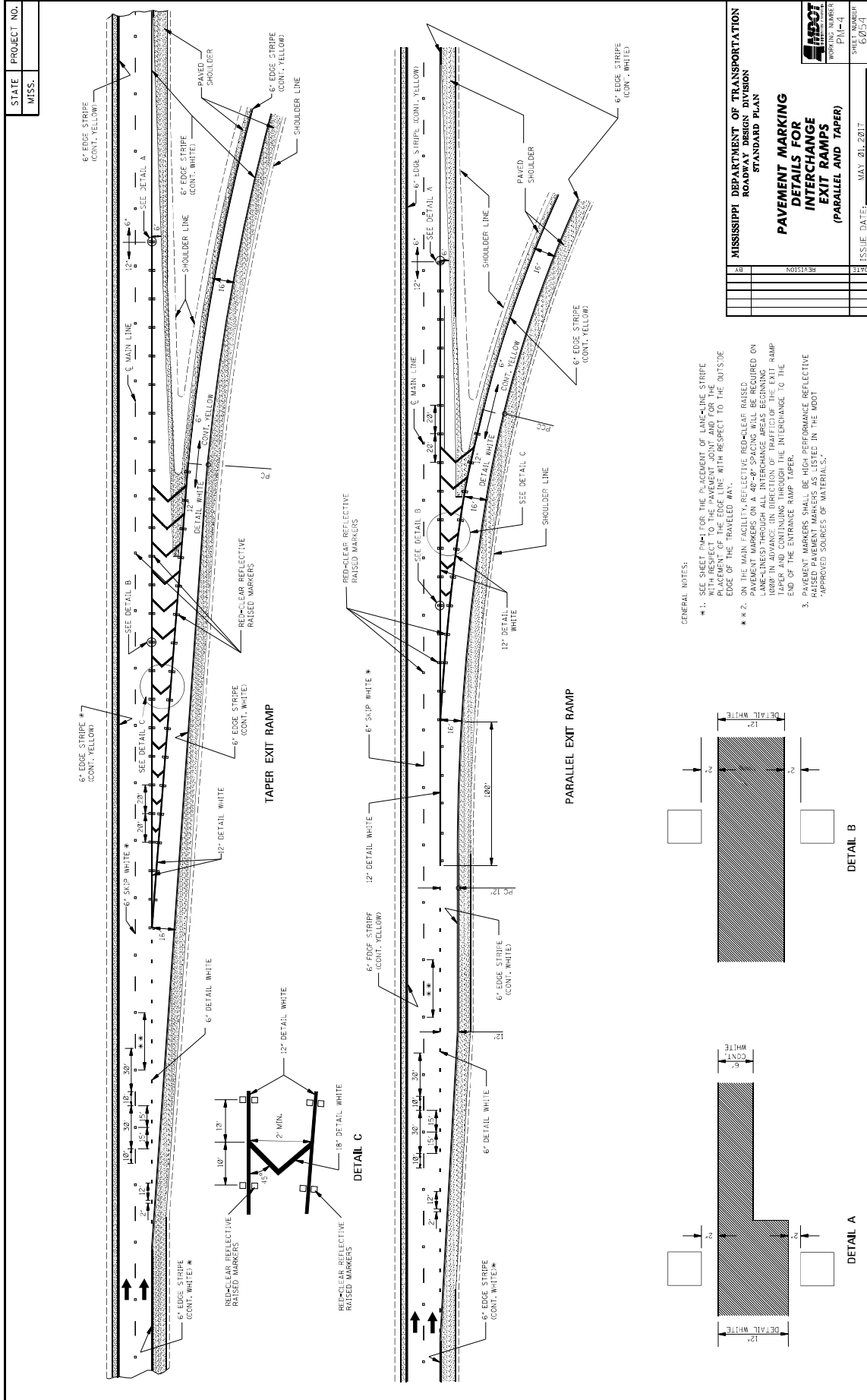

<b>MISSISSIPPI DEPARTMENT OF TRANSPORTATION</b>	
<b>ROADWAY DESIGN DIVISION</b>	
<b>STANDARD PLAN</b>	
<b>PAVEMENT MARKING</b>	
<b>INTERCHANGE</b>	
<b>EXIT RAMPS</b>	
<b>(PARALLEL AND TAPER)</b>	
WORKING NUMBER	PL-4
SHEET NUMBER	62/2-1
ISSUE DATE:	MAY 20, 2017

STATE MISS.	PROJECT NO.										
----------------	-------------	--	--	--	--	--	--	--	--	--	--

6'-4"

8'-4"

4"

6'-4"

8'-4"

4"

6'-4"

8'-4"

4"

5'-4"

8'-4"

4"

7'-0"

8'-4"

4"

7'-0"

8'-4"

4"

6'-4"

8'-4"

4"

8'-0"

8'-4"

4"

9'-8"

8'-4"

4"

GENERAL NOTES:

- TWO HORIZONTAL GAPS (CAUSED BY TEMPLATE CONNECTIONS) OF 1/2" SHALL BE SHOWN EXTENDING FULL WIDTH OF LETTERS.
- FOR OTHER DETAILS, SEE THE MANUAL ON UNIFORM TRAFFIC CONTROL DEVICES.
- PAY QUANTITIES FOR PAVEMENT MARKING LEGENDS ARE AS FOLLOWS:

LEGEND	AREA (sq ft)
STOP	246.6
RIGHT	286.6
LEFT	195.5
TRAFFIC	227.2
YIELD	268.8
EXIT	185.5
SIGNAL	352.5
SCHOOL	352.5

  

MISSISSIPPI DEPARTMENT OF TRANSPORTATION  
ROADWAY DESIGN DIVISION  
STANDARD PLAN

**PAVEMENT MARKING  
LEGEND DETAILS**

DATE	BY	REVISION								
ISSUE DATE: MAY 01, 2017										
SHEET NUMBER 60535										

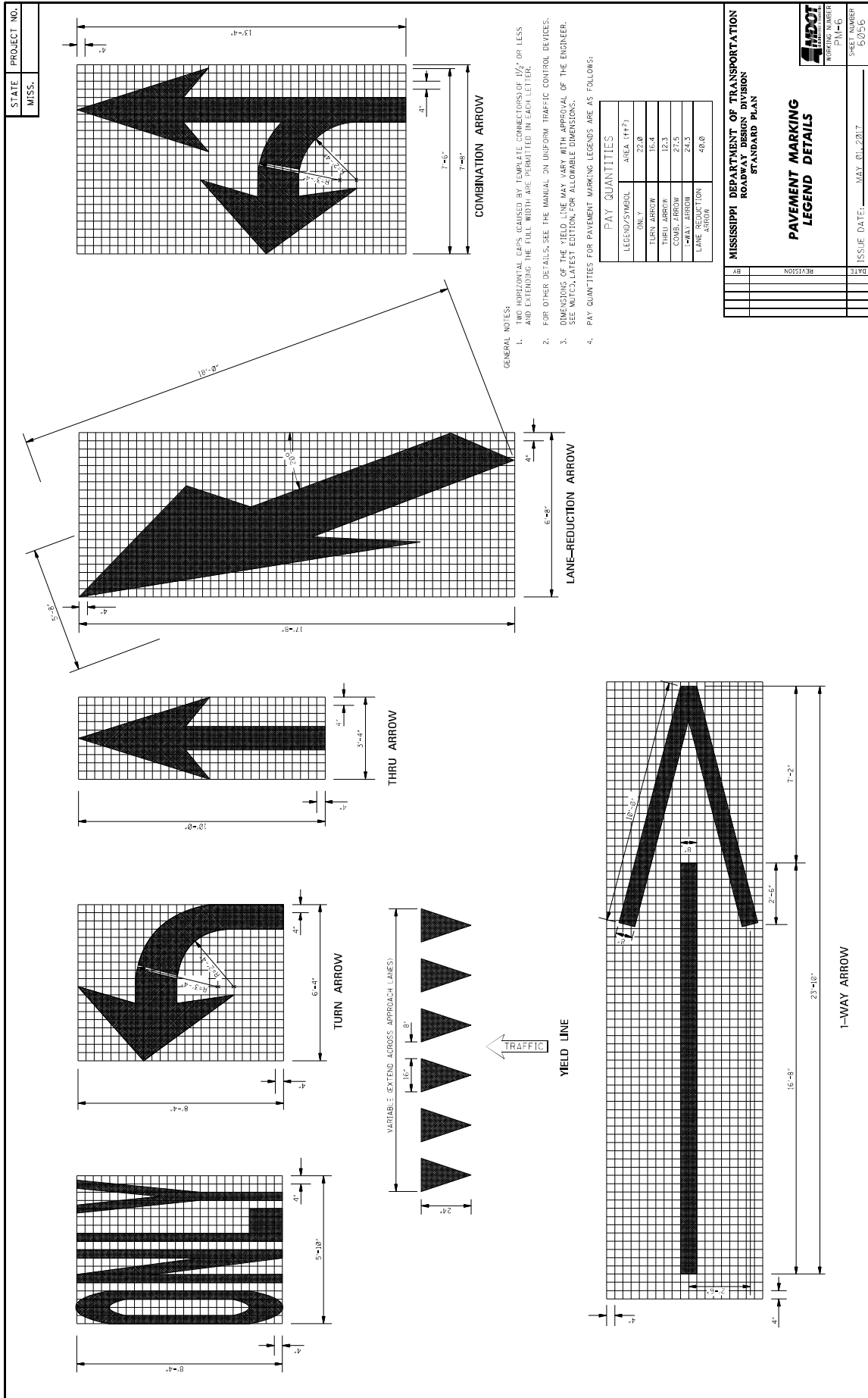

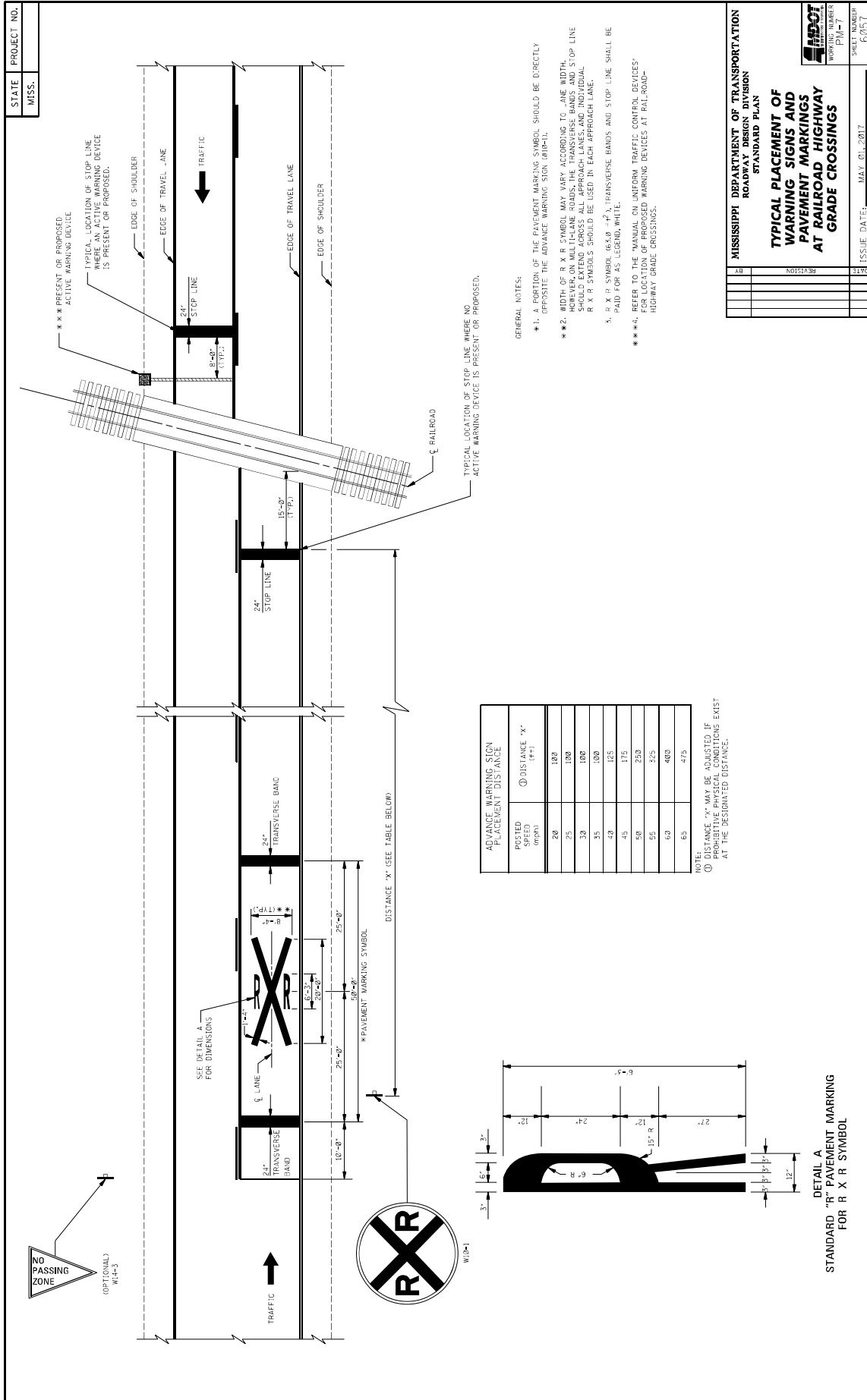



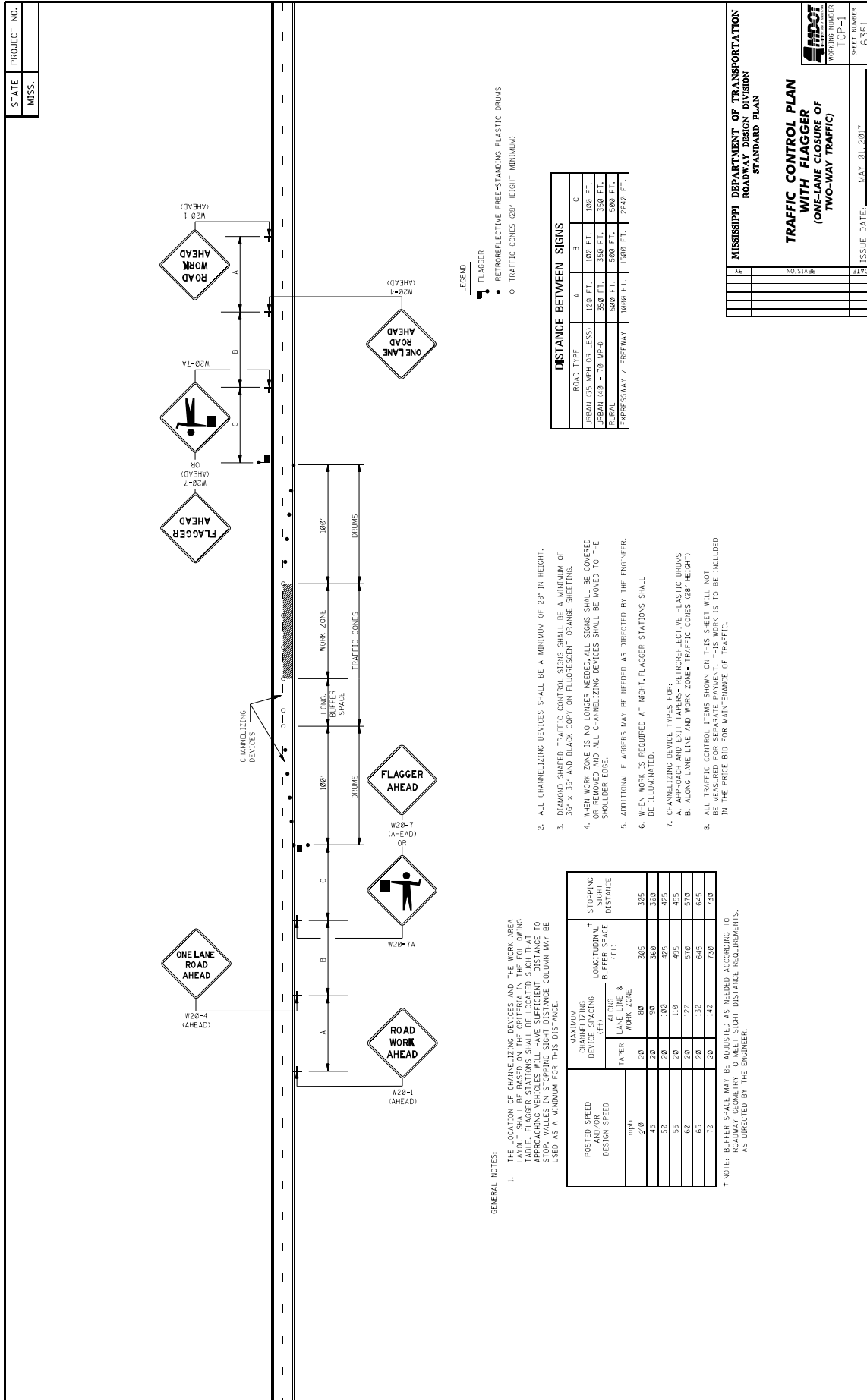

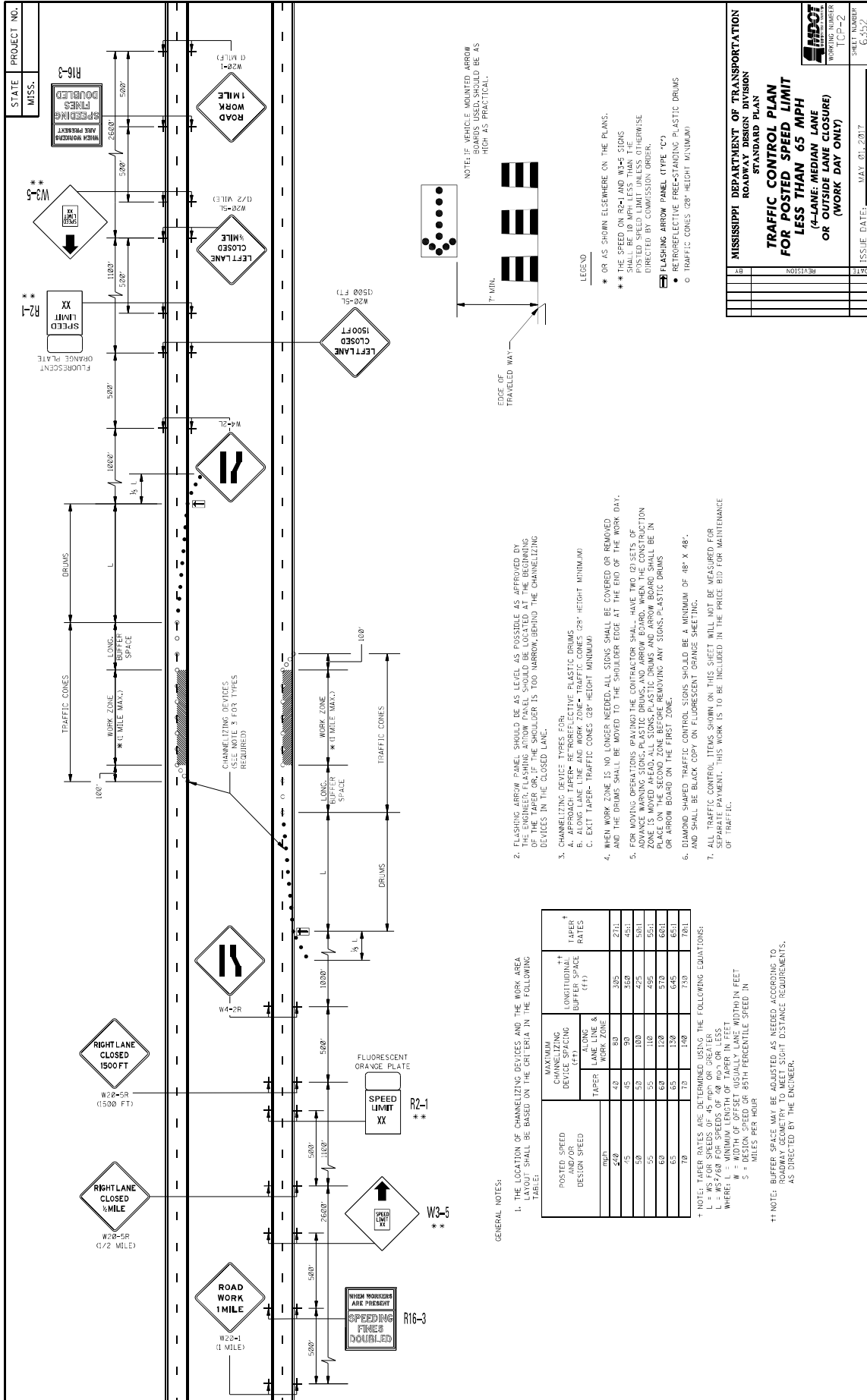

STATE PROJECT NO.  
MISS.  
R16-3

W20-1 (1 MILE)  
W20-5L (1/2 MILE)  
W20-5R (1/2 MILE)  
W20-2R (1500 FT)  
W20-5P (1/2 MILE)

R2-1  
SPEED LIMIT XX  
FLUORESCENT ORANGE PLATE

W4-2R

W3-5  
SPEED LIMIT XX

R16-3  
SPEEDING FINES DOUBLED

W20-1 (1 MILE)  
W20-5L (1/2 MILE)  
W20-5R (1/2 MILE)  
W20-2R (1500 FT)  
W20-5P (1/2 MILE)

MISSISSIPPI DEPARTMENT OF TRANSPORTATION  
ROADWAY DESIGN DIVISION  
STANDARD PLAN  
**TRAFFIC CONTROL PLAN  
FOR POSTED SPEED LIMIT  
LESS THAN 65 MPH  
(4-LANE; MEDIAN LANE  
OR OUTSIDE LANE CLOSURE)  
OR (WORK DAY ONLY)**

ISSUE DATE: MAY 01, 2017  
SHEET NUMBER 10  
WORKING NUMBER 10P-2  
G252

NOTE: IF VEHICLE MOUNTED ARROW SIGNS SHOULD BE AS HIGH AS PRACTICAL.

7' MIN.

EDGE OF TRAVELED WAY

LEGEND

\* OR AS SHOWN ELSEWHERE ON THE PLANS.

\*\* THE SPEED ON R2-1 AND W3-5 SIGNS SHALL BE 10 MPH LESS THAN THE POSTED SPEED LIMIT UNLESS OTHERWISE DIRECTED BY COMMISSION ORDER.

• FLASHING ARROW PANEL (TYPE 'C')  
• RETROREFLECTIVE FREE-STANDING PLASTIC DRUMS  
• TRAFFIC CONES (28" HEIGHT MINIMUM)

2. FLASHING ARROW PANEL SHOULD BE AS LEVEL AS POSSIBLE AS APPROVED BY THE ENGINEER. THE PANEL SHOULD BE LOCATED AT THE END OF THE WORK AREA OF THE TAPER OR, IF THE SHOULDER IS TOO NARROW, BEHIND THE CHANNELIZING DEVICES IN THE CLOSED LANE.

3. CHANNELIZING DEVICES (TYPE 'E')  
A. APPROACH TAPER- RETROREFLECTIVE PLASTIC DRUMS  
B. ALONG LANE LINE AND WORK ZONE- TRAFFIC CONES (28" HEIGHT MINIMUM)  
C. EXIT TAPER- TRAFFIC CONES (28" HEIGHT MINIMUM)

4. WHEN WORK ZONE IS NO LONGER NEEDED, ALL SIGNS SHALL BE COVERED OR REMOVED.  
5. FOR MOVING OPERATIONS (PAVING) THE CONTRACTOR SHALL HAVE TWO (2) SETS OF ADVANCE WARNING SIGNS (PLASTIC DRUMS AND ARROW BOARD). WHEN THE CONSTRUCTION ZONE IS MOVED AHEAD, ALL SIGNS, PLASTIC DRUMS AND ARROW BOARD SHALL BE IN PLACE ON THE SECOND ZONE BEFORE REMOVING ANY SIGNS, PLASTIC DRUMS OR ARROW BOARD ON THE FIRST ZONE.  
6. DIAMOND SHAPED TRAFFIC CONTROL SIGNS SHOULD BE A MINIMUM OF 48" X 48" AND SHALL BE BLACK COPY ON FLUORESCENT ORANGE SHEETING.  
7. ALL TRAFFIC CONTROL ITEMS SHOWN ON THIS SHEET WILL NOT BE MEASURED FOR PAYMENT. THIS WORK IS TO BE INCLUDED IN THE PRICE BID FOR MAINTENANCE OF TRAFFIC.

1. THE LOCATION OF CHANNELIZING DEVICES AND THE WORK AREA LAYOUT SHALL BE BASED ON THE CRITERIA IN THE FOLLOWING TABLE:

POSTED SPEED AND/OR DESIGN SPEED (MPH)	MAXIMUM CHANNELIZING DEVICE SPACING (FT)		LONGITUDINAL BUFFER SPACE (FT)	TAPER RATES
	LANE LINE & WORK ZONE	LANE LINE & WORK ZONE		
25	42	80	305	27:1
35	45	90	350	45:1
50	50	100	425	50:1
55	55	110	495	55:1
60	60	120	570	60:1
65	65	130	645	65:1
70	70	140	730	70:1

NOTE: TAPER RATES ARE DETERMINED USING THE FOLLOWING EQUATIONS:  
L = MS FOR SPEEDS OF 45 MPH OR GREATER  
L = MS FOR SPEEDS OF 30 MPH OR GREATER  
WHERE: L = MINIMUM LENGTH OF TAPER IN FEET  
S = DESIGN SPEED OR 85TH PERCENTILE SPEED IN MILES PER HOUR

†† NOTE: BUFFER SPACE MAY BE ADJUSTED AS NEEDED ACCORDING TO ROADWAY GEOMETRY TO MEET SIGHT DISTANCE REQUIREMENTS, AS DIRECTED BY THE ENGINEER.

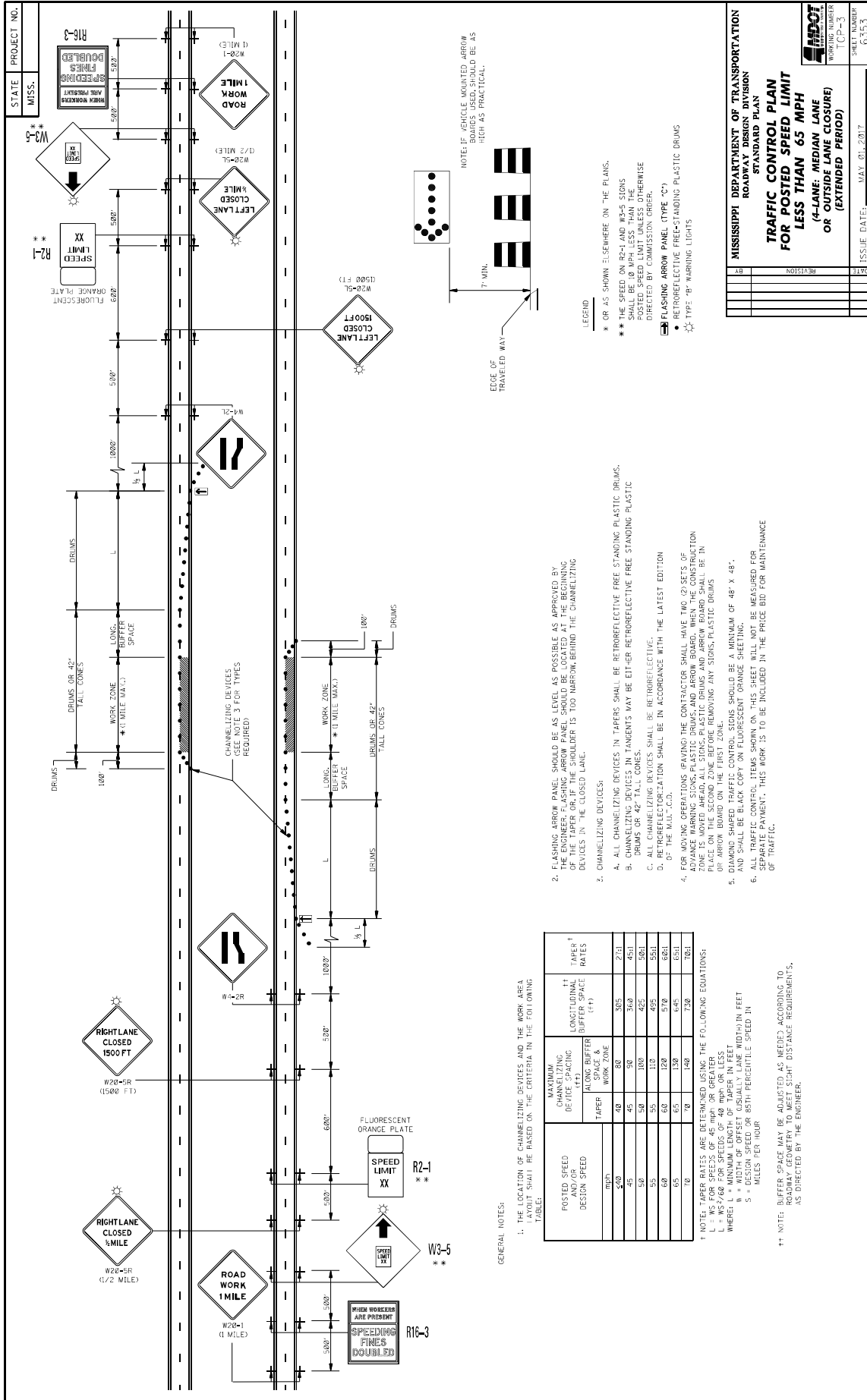

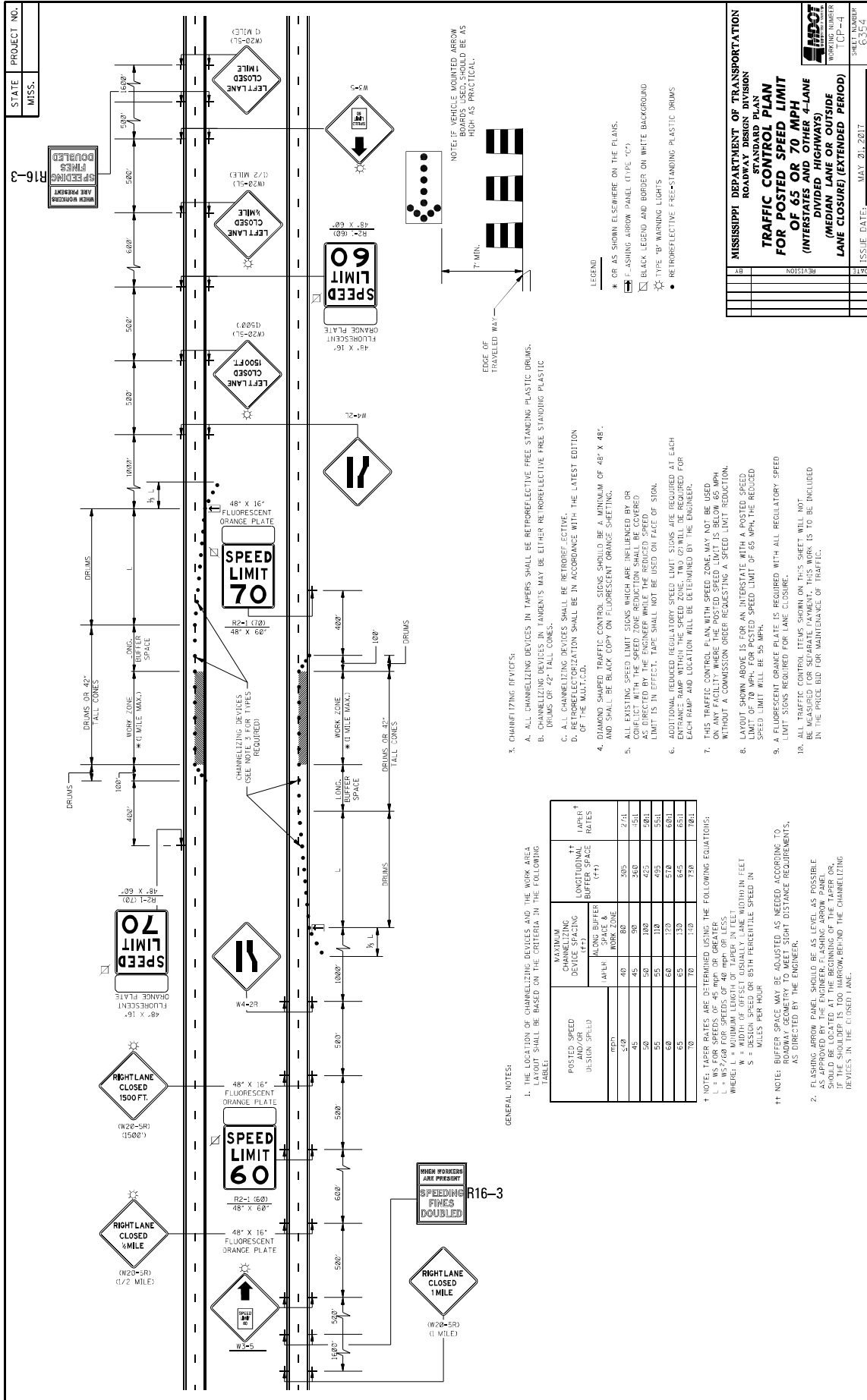

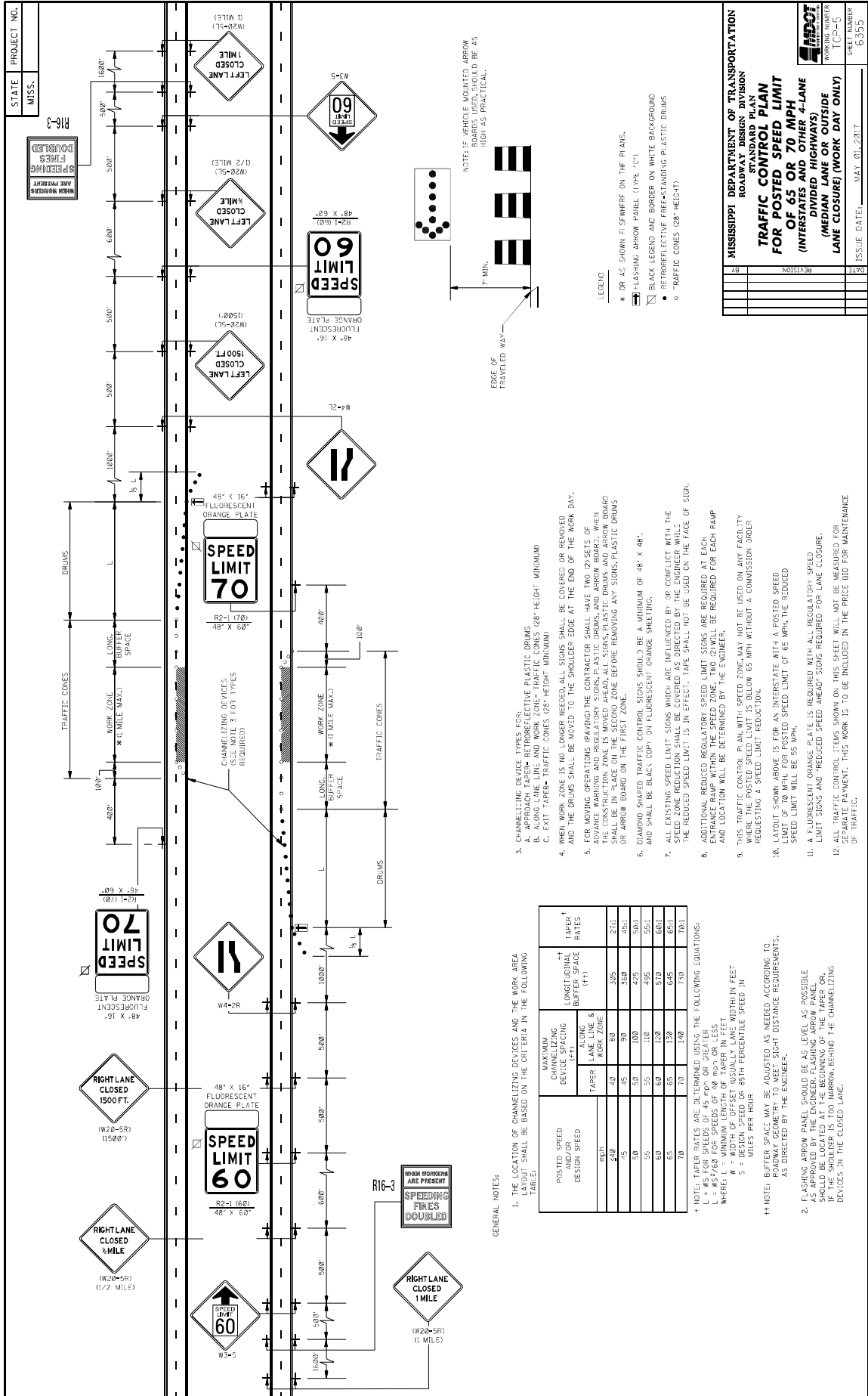

STATE MISS.	PROJECT NO.	
----------------	-------------	--

**WING BARRICADES**

1. WING BARRICADES ARE TYPE II BARRICADES ERECTED ON THE SHOULDER OF A ROADWAY OR RESTRICTED ROADWAY. WING BARRICADES MAY BE USED AS A MOUNTING FOR THE ADVANCE WARNING SIGNS OR FLASHERS.

2. WING BARRICADES SHOULD BE USED:

- A. IN ADVANCE OF A CONSTRUCTION PROJECT EVEN WHEN NO PART OF THE ROADWAY IS ACTUALLY CLOSED.
- B. IN ADVANCE OF ALL BRIDGE OR CULVERT WIDENING OPERATIONS.

**PLASTIC DRUM STRIPING DETAIL**

1. PLASTIC DRUMS SHALL BE ON END AND USED AS AN EXPEDITED METHOD FOR TRAFFIC CHANNELIZATION. THE COLOR AND MARKING OF DRUMS SHALL BE CONSISTENT WITH MANDATORY SAFETY REQUIREMENTS. THE PREFERRED COLOR OF DRUMS SHALL BE ORANGE WITH FOUR RETROREFLECTIVE, HORIZONTAL, CIRCUMFERENTIAL STRIPES (2 ORANGE & 2 WHITE) 6" WIDE.

2. DRUMS SHOULD NEVER BE PLACED IN THE ROADWAY WITHOUT WARNING SIGNS.

3. WHERE PRACTICAL PLASTIC DRUMS SHOULD BE PLACED NO CLOSER THAN 3'-0" FROM THE EDGE OF TRAVELED LANE.

**BARRICADE CLOSING A ROAD**

**BARRICADE CHARACTERISTICS**

	I	II	III
WIDTH OF RAIL **	8" MIN. - 12" MAX.	8" MIN. - 12" MAX.	8" MIN. - 12" MAX.
LENGTH OF RAIL **	24" MIN.	24" MIN.	48" MIN.
WIDTH OF STRIPE *	6"	6"	6"
HEIGHT	36" MIN.	36" MIN.	60" MIN.
NUMBER OF RETROREFLECTORIZED RAIL FACES	2 (ONE EACH DIRECTION)	4 (TWO EACH DIRECTION)	3 IF FACING TRAFFIC IN ONE DIRECTION 4 IF FACING TRAFFIC IN TWO DIRECTIONS

\* 1. FOR RAILS LESS THAN 36" LONG, 4" WIDE STRIPES MAY BE USED.

\*\* 2. BARRICADES INTENDED FOR USE ON EXPRESSWAYS, FREEWAYS AND OTHER HIGH SPEED ROADWAYS, SHALL HAVE A MINIMUM OF 270 IN<sup>2</sup> OF REFLECTIVE AREA FACING TRAFFIC.

**TYPE 3 OBJECT MARKER (OM-3R)**

1. TYPE 3 OBJECT MARKERS SHALL BE USED AT ALL EXPOSED BRIDGE ABUTMENTS AND AT OTHER LOCATIONS AS DETERMINED NECESSARY BY THE ENGINEER.

2. THE OM-3R IS SIMILAR EXCEPT THE STRIPES SLOPE DOWNWARD FROM THE UPPER LEFT SIDE TO THE LOWER RIGHT SIDE AND SHALL BE PLACED ON THE LEFT SIDE OF THE OBJECT.

3. THE INSIDE EDGE OF THE MARKER SHALL BE IN LINE WITH THE INNER EDGE OF THE OBSTRUCTION.

**STANDARD BARRICADES**

1. THE MARKING FOR BARRICADE RAILS SHALL BE ORANGE AND WHITE (SLOPING DOWNWARD AT AN ANGLE OF 45° IN THE DIRECTION TRAFFIC IS TO PASS).

2. RAIL STRIPE SHALL BE 6 INCHES EXCEPT THAT 4-INCH WIDE STRIPES MAY BE USED IF RAIL LENGTHS ARE LESS THAN 36 INCHES.

3. DO NOT PLACE SANDBAGS OR OTHER DEVICES TO PROVIDE MASS ON THE BOTTOM RAIL THAT WILL BLOCK VIEW OR RAIL FACE.

4. FOR ADDITIONAL INFORMATION OR DETAILS, SEE METHOD, LATEST EDITION.

5. BARRICADES ARE CLASSIFIED BY FHWA AS CATEGORY II, AND ZONE DEVICES WHICH REQUIRE SUCCESSFULLY CRASH TESTED. A LIST OF CRASHWORTHY BARRICADES AND OTHER CATEGORY II DEVICES CAN BE FOUND ON FHWA'S WEBSITE: [https://safety.fhwa.dot.gov/roadway\\_dept/pafety\\_guidance/road\\_aware/cat2.cfm](https://safety.fhwa.dot.gov/roadway_dept/pafety_guidance/road_aware/cat2.cfm)

**CHEVRON SIGN DETAIL**

1. A CHEVRON SIGN CONSISTS OF A BLACK CHEVRON TYPE MARKING ON AN ORANGE BACKGROUND AND SHALL POINT IN THE DIRECTION OF TRAFFIC FLOW.

2. THE CHEVRON SIGN SHALL BE MOUNTED ON CRASHWORTHY SUPPORT.

3. CHEVRON SIGNS MAY BE USED TO SUPPLEMENT OTHER STANDARD DEVICES WHERE ONE OR MORE LANES ARE CLOSED FOR CONSTRUCTION OR MAINTENANCE. THEY SHOULD BE PLACED APPROXIMATELY 2'-0" BEHIND THE LANE TRANSITION STRIPE.

MISSISSIPPI DEPARTMENT OF TRANSPORTATION ROADWAY DESIGN DIVISION STANDARD PLAN	
REVISION	DATE

**HIGHWAY SIGN AND BARRICADE DETAILS FOR CONSTRUCTION PROJECTS**

ISSUE DATE: MAY 20, 2017

SHEET NUMBER: ICP-5  
PROJECT NUMBER: 03350

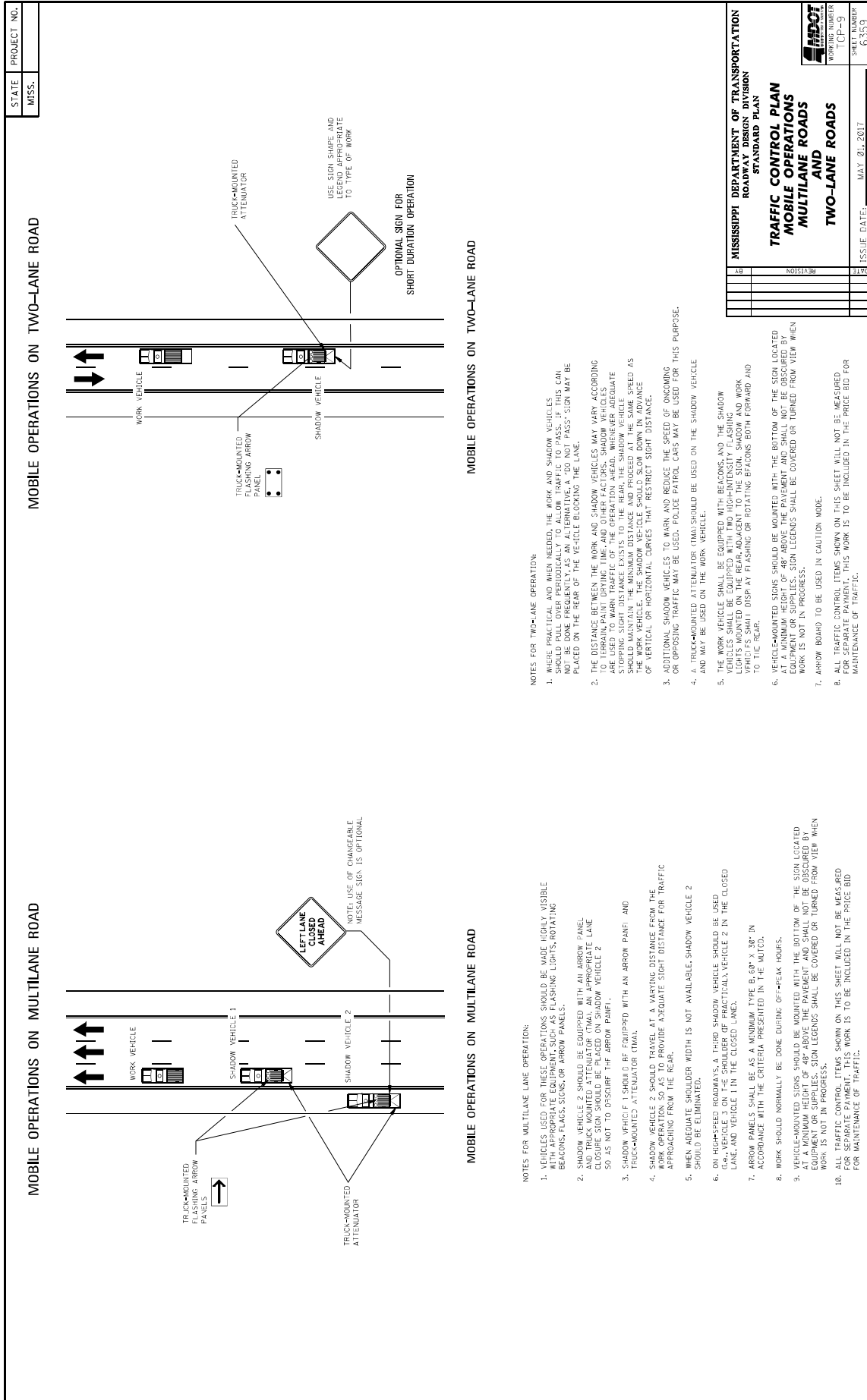

<p><b>MOBILE OPERATIONS ON TWO-LANE ROAD</b></p>	<p><b>MOBILE OPERATIONS ON MULTILANE ROAD</b></p>
--	---

**NOTES FOR MULTILANE LANE OPERATION:**

- VEHICLES USED FOR THESE OPERATIONS SHOULD BE MADE HIGHLY VISIBLE WITH APPROPRIATE EQUIPMENT, SUCH AS FLASHING LIGHTS, ROTATING BEACONS, FLASGS, SIGNS, OR ARROW PANELS.
- SHADOW VEHICLE 2 SHOULD BE EQUIPPED WITH AN ARROW PANEL AND TRUCK MOUNTED ATTENUATOR (TMA), AN APPROPRIATE LANE CLOSURE SIGN SHOULD BE USED BEHIND SHADOW VEHICLE 2 SO AS NOT TO OBSCURE THE ARROW PANEL.
- SHADOW VEHICLE 1 SHOULD BE EQUIPPED WITH AN ARROW PANEL AND TRUCK MOUNTED ATTENUATOR (TMA).
- SHADOW VEHICLE 2 SHOULD TRAVEL AT A VARYING DISTANCE FROM THE WORK OPERATION SO AS TO PROVIDE ADEQUATE SIGHT DISTANCE FOR TRAFFIC APPROACHING FROM THE REAR.
- WHEN ADEQUATE SHOULDER WIDTH IS NOT AVAILABLE, SHADOW VEHICLE 2 SHOULD BE ELIMINATED.
- ON HIGH-SPEED ROADWAYS, A THIRD SHADOW VEHICLE SHOULD BE USED (i.e., VEHICLE 3 ON THE SHOULDER OF PRACTICALLY, VEHICLE 2 IN THE CLOSED LANE, AND VEHICLE 1 IN THE CLOSED LANE).
- ARROW PANELS SHALL BE AS A MINIMUM TYPE B, 60" X 30" IN ACCORDANCE WITH THE CRITERIA PRESENTED IN THE MUTCD.
- WORK SHOULD NORMALLY BE DONE DURING OFF-PEAK HOURS.
- VEHICLE-MOUNTED SIGNS SHOULD BE MOUNTED WITH THE BOTTOM OF THE SIGN LOCATED AT A MINIMUM HEIGHT OF 48" ABOVE THE PAVEMENT AND SHALL NOT BE OBTURED BY EQUIPMENT OR STRUCTURES. SIGN LEGENDS SHALL BE COVERED OR TURNED FROM VIEW WHEN WORK IS NOT IN PROGRESS.
- ALL TRAFFIC CONTROL ITEMS SHOWN ON THIS SHEET WILL NOT BE MEASURED FOR SEPARATE PAYMENT. THIS WORK IS TO BE INCLUDED IN THE PRICE BID FOR MAINTENANCE OF TRAFFIC.

**NOTES FOR TWO-LANE OPERATION:**

- WHERE PRACTICAL AND WHEN NEEDED, THE WORK AND SHADOW VEHICLES SHOULD PULL OVER PERIODICALLY TO ALLOW TRAFFIC TO PASS. IF THIS CAN NOT BE DONE FREQUENTLY AS AN ALTERNATIVE, A "DO NOT PASS" SIGN MAY BE PLACED ON THE REAR OF THE VEHICLE BLOCKING THE LANE.
- THE DISTANCE BETWEEN THE WORK AND SHADOW VEHICLES MAY VARY ACCORDING TO TERRAIN, PAINT DRYING TIME, AND OTHER FACTORS. SHADOW VEHICLES ARE USED TO WARN TRAFFIC OF THE OPERATION AHEAD. WHENEVER ADEQUATE SHOULD MAINTAIN THE MINIMUM DISTANCE AND PROCEED AT THE SAME SPEED AS THE WORK VEHICLE. THE SHADOW VEHICLE SHOULD SLOW DOWN IN ADVANCE OF VERTICAL OR HORIZONTAL CURVES THAT RESTRICT SIGHT DISTANCE.
- ADDITIONAL SHADOW VEHICLES TO WARN AND REDUCE THE SPEED OF ONCOMING OR OPPOSING TRAFFIC MAY BE USED. POLICE PATROL CARS MAY BE USED FOR THIS PURPOSE.
- A TRUCK-MOUNTED ATTENUATOR (TMA) SHOULD BE USED ON THE SHADOW VEHICLE AND MAY BE USED ON THE WORK VEHICLE.
- THE WORK VEHICLE SHALL BE EQUIPPED WITH BEACONS AND THE SHADOW VEHICLE SHALL BE EQUIPPED WITH BEACONS AND LIGHTS. TRUCK-MOUNTED LIGHTS MOUNTED ON THE REAR, ADJACENT TO THE SIGN, SHADOW AND WORK VEHICLES SHALL DISPLAY FLASHING OR ROTATING BEACONS BOTH FORWARD AND TO THE REAR.
- VEHICLE-MOUNTED SIGNS SHOULD BE MOUNTED WITH THE BOTTOM OF THE SIGN LOCATED AT A MINIMUM HEIGHT OF 48" ABOVE THE PAVEMENT AND SHALL NOT BE OBTURED BY EQUIPMENT OR STRUCTURES. SIGN LEGENDS SHALL BE COVERED OR TURNED FROM VIEW WHEN WORK IS NOT IN PROGRESS.
- ARROW BOARD TO BE USED IN CAUTION MODE.
- ALL TRAFFIC CONTROL ITEMS SHOWN ON THIS SHEET WILL NOT BE MEASURED FOR SEPARATE PAYMENT. THIS WORK IS TO BE INCLUDED IN THE PRICE BID FOR MAINTENANCE OF TRAFFIC.

**MOBILE OPERATIONS ON TWO-LANE ROAD**

**MOBILE OPERATIONS ON MULTILANE ROAD**

<p><b>MOBILE OPERATIONS ON TWO-LANE ROAD</b></p>	<p><b>MOBILE OPERATIONS ON MULTILANE ROAD</b></p>
--	---

**NOTES FOR MULTILANE LANE OPERATION:**

- VEHICLES USED FOR THESE OPERATIONS SHOULD BE MADE HIGHLY VISIBLE WITH APPROPRIATE EQUIPMENT, SUCH AS FLASHING LIGHTS, ROTATING BEACONS, FLASGS, SIGNS, OR ARROW PANELS.
- SHADOW VEHICLE 2 SHOULD BE EQUIPPED WITH AN ARROW PANEL AND TRUCK MOUNTED ATTENUATOR (TMA), AN APPROPRIATE LANE CLOSURE SIGN SHOULD BE USED BEHIND SHADOW VEHICLE 2 SO AS NOT TO OBSCURE THE ARROW PANEL.
- SHADOW VEHICLE 1 SHOULD BE EQUIPPED WITH AN ARROW PANEL AND TRUCK MOUNTED ATTENUATOR (TMA).
- SHADOW VEHICLE 2 SHOULD TRAVEL AT A VARYING DISTANCE FROM THE WORK OPERATION SO AS TO PROVIDE ADEQUATE SIGHT DISTANCE FOR TRAFFIC APPROACHING FROM THE REAR.
- WHEN ADEQUATE SHOULDER WIDTH IS NOT AVAILABLE, SHADOW VEHICLE 2 SHOULD BE ELIMINATED.
- ON HIGH-SPEED ROADWAYS, A THIRD SHADOW VEHICLE SHOULD BE USED (i.e., VEHICLE 3 ON THE SHOULDER OF PRACTICALLY, VEHICLE 2 IN THE CLOSED LANE, AND VEHICLE 1 IN THE CLOSED LANE).
- ARROW PANELS SHALL BE AS A MINIMUM TYPE B, 60" X 30" IN ACCORDANCE WITH THE CRITERIA PRESENTED IN THE MUTCD.
- WORK SHOULD NORMALLY BE DONE DURING OFF-PEAK HOURS.
- VEHICLE-MOUNTED SIGNS SHOULD BE MOUNTED WITH THE BOTTOM OF THE SIGN LOCATED AT A MINIMUM HEIGHT OF 48" ABOVE THE PAVEMENT AND SHALL NOT BE OBTURED BY EQUIPMENT OR STRUCTURES. SIGN LEGENDS SHALL BE COVERED OR TURNED FROM VIEW WHEN WORK IS NOT IN PROGRESS.
- ALL TRAFFIC CONTROL ITEMS SHOWN ON THIS SHEET WILL NOT BE MEASURED FOR SEPARATE PAYMENT. THIS WORK IS TO BE INCLUDED IN THE PRICE BID FOR MAINTENANCE OF TRAFFIC.

**NOTES FOR TWO-LANE OPERATION:**

- WHERE PRACTICAL AND WHEN NEEDED, THE WORK AND SHADOW VEHICLES SHOULD PULL OVER PERIODICALLY TO ALLOW TRAFFIC TO PASS. IF THIS CAN NOT BE DONE FREQUENTLY AS AN ALTERNATIVE, A "DO NOT PASS" SIGN MAY BE PLACED ON THE REAR OF THE VEHICLE BLOCKING THE LANE.
- THE DISTANCE BETWEEN THE WORK AND SHADOW VEHICLES MAY VARY ACCORDING TO TERRAIN, PAINT DRYING TIME, AND OTHER FACTORS. SHADOW VEHICLES ARE USED TO WARN TRAFFIC OF THE OPERATION AHEAD. WHENEVER ADEQUATE SHOULD MAINTAIN THE MINIMUM DISTANCE AND PROCEED AT THE SAME SPEED AS THE WORK VEHICLE. THE SHADOW VEHICLE SHOULD SLOW DOWN IN ADVANCE OF VERTICAL OR HORIZONTAL CURVES THAT RESTRICT SIGHT DISTANCE.
- ADDITIONAL SHADOW VEHICLES TO WARN AND REDUCE THE SPEED OF ONCOMING OR OPPOSING TRAFFIC MAY BE USED. POLICE PATROL CARS MAY BE USED FOR THIS PURPOSE.
- A TRUCK-MOUNTED ATTENUATOR (TMA) SHOULD BE USED ON THE SHADOW VEHICLE AND MAY BE USED ON THE WORK VEHICLE.
- THE WORK VEHICLE SHALL BE EQUIPPED WITH BEACONS AND THE SHADOW VEHICLE SHALL BE EQUIPPED WITH BEACONS AND LIGHTS. TRUCK-MOUNTED LIGHTS MOUNTED ON THE REAR, ADJACENT TO THE SIGN, SHADOW AND WORK VEHICLES SHALL DISPLAY FLASHING OR ROTATING BEACONS BOTH FORWARD AND TO THE REAR.
- VEHICLE-MOUNTED SIGNS SHOULD BE MOUNTED WITH THE BOTTOM OF THE SIGN LOCATED AT A MINIMUM HEIGHT OF 48" ABOVE THE PAVEMENT AND SHALL NOT BE OBTURED BY EQUIPMENT OR STRUCTURES. SIGN LEGENDS SHALL BE COVERED OR TURNED FROM VIEW WHEN WORK IS NOT IN PROGRESS.
- ARROW BOARD TO BE USED IN CAUTION MODE.
- ALL TRAFFIC CONTROL ITEMS SHOWN ON THIS SHEET WILL NOT BE MEASURED FOR SEPARATE PAYMENT. THIS WORK IS TO BE INCLUDED IN THE PRICE BID FOR MAINTENANCE OF TRAFFIC.

**MOBILE OPERATIONS ON TWO-LANE ROAD**

**MOBILE OPERATIONS ON MULTILANE ROAD**



<p><b>MISSISSIPPI DEPARTMENT OF TRANSPORTATION</b> ROADWAY DESIGN DIVISION STANDARD PLAN</p>	
<p><b>TRAFFIC CONTROL PLAN</b> <b>MOBILE OPERATIONS</b> <b>MULTILANE ROADS</b> <b>TWO-LANE ROADS</b></p>	
<p>WORKING NUMBER TCP-9</p>	<p>SHEET NUMBER 6333</p>
<p>ISSUE DATE: MAY 01, 2017</p>	

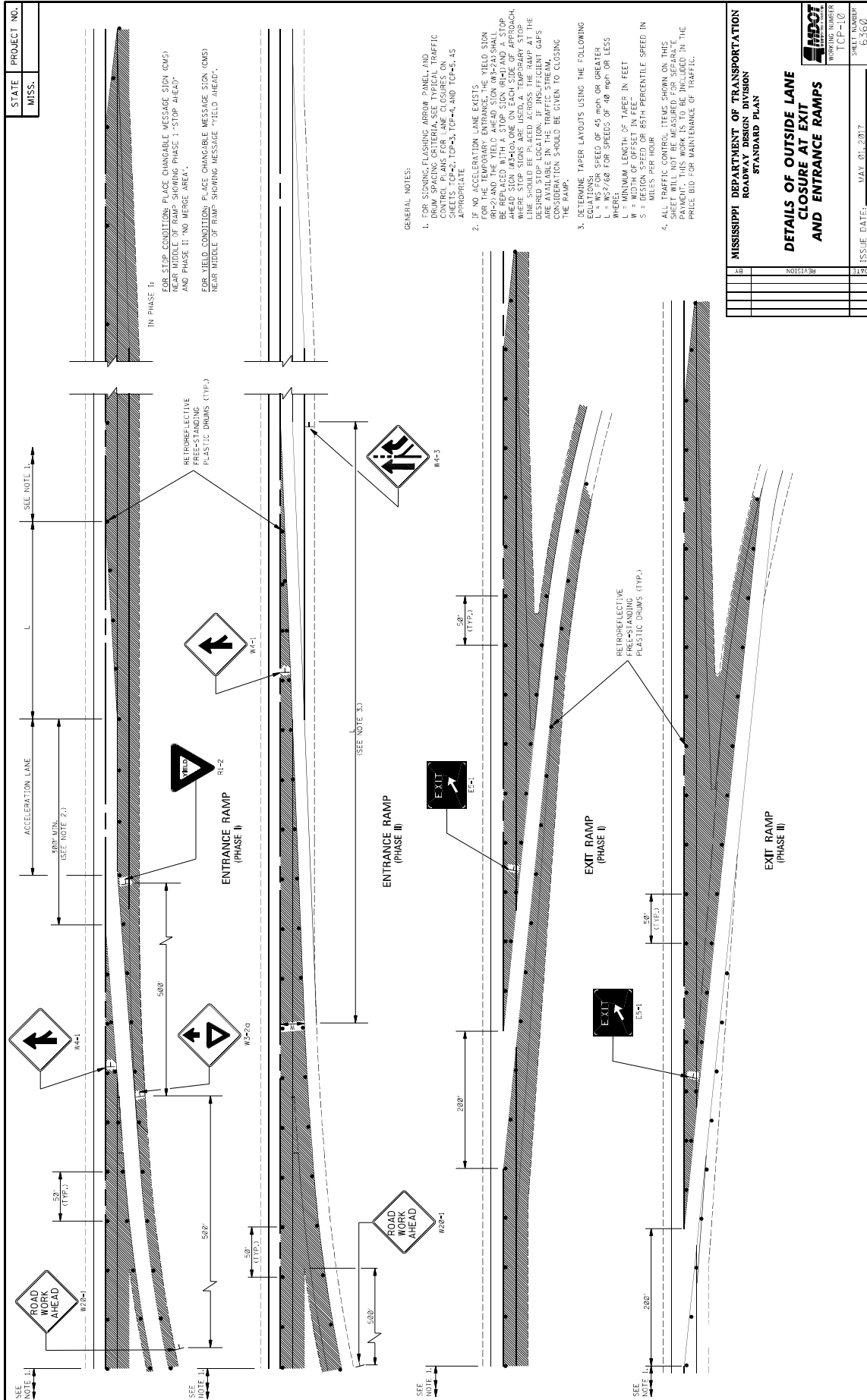

STATE PROJECT NO.  
MISS.

- GENERAL NOTES:
- FOR SIGNING FLASHING ARROW PANEL AND DRUM SPACING CRITERIA, SEE TYPICAL TRAFFIC CONTROL PLANS FOR LANE CLOSURES ON HIGHWAYS. SEE TYPICAL PLANS FOR TYPICAL APPROPRIATE.
  - IF NO ACCELERATION LANE EXISTS FOR THE TEMPORARY LANE CLOSURE, THE YIELD SIGN (R1-2) AND THE YIELD AHEAD SIGN (W2-2A) SHALL BE REPLACED WITH A STOP SIGN (R1-1) AND A STOP AHEAD SIGN (W2-2B). STOP SIGNS AND STOP AHEAD SIGNS SHOULD BE PLACED ACROSS THE RAMP AT THE DESIRED STOP LOCATION. INSUFFICIENT GAPS BETWEEN STOP SIGNS SHALL BE CORRECTED. CONSIDERATION SHOULD BE GIVEN TO CLOSING THE RAMP.
  - DETERMINE TAPER LAYOUTS USING THE FOLLOWING EQUATIONS: SPEEDS OF 45 MPH OR GREATER  
 $L = W^2/60$  FOR SPEEDS OF 40 MPH OR LESS  
 WHERE:  
 L = MINIMUM LENGTH OF TAPE IN FEET  
 W = DESIGN SPEED OF 85TH PERCENTILE SPEED IN MILES PER HOUR  
 S = DESIGN SPEED OF 85TH PERCENTILE SPEED IN MILES PER HOUR  
 ALL TRAFFIC CONTROL ITEMS SHOWN ON THIS SHEET WILL NOT BE MEASURED FOR SEPARATE PAYMENT. ITEMS SHOWN ON THIS SHEET WILL BE PAID IN THE PRICE BID FOR MAINTENANCE OF TRAFFIC.

MISSISSIPPI DEPARTMENT OF TRANSPORTATION ROADWAY DESIGN DIVISION STANDARD PLAN	
<b>DETAILS OF OUTSIDE LANE CLOSURE AT EXIT AND ENTRANCE RAMP</b>	
WORKING NUMBER TCP-110	SHEET NUMBER 6360
ISSUE DATE: MAY 01, 2017	
DATE	REVISION



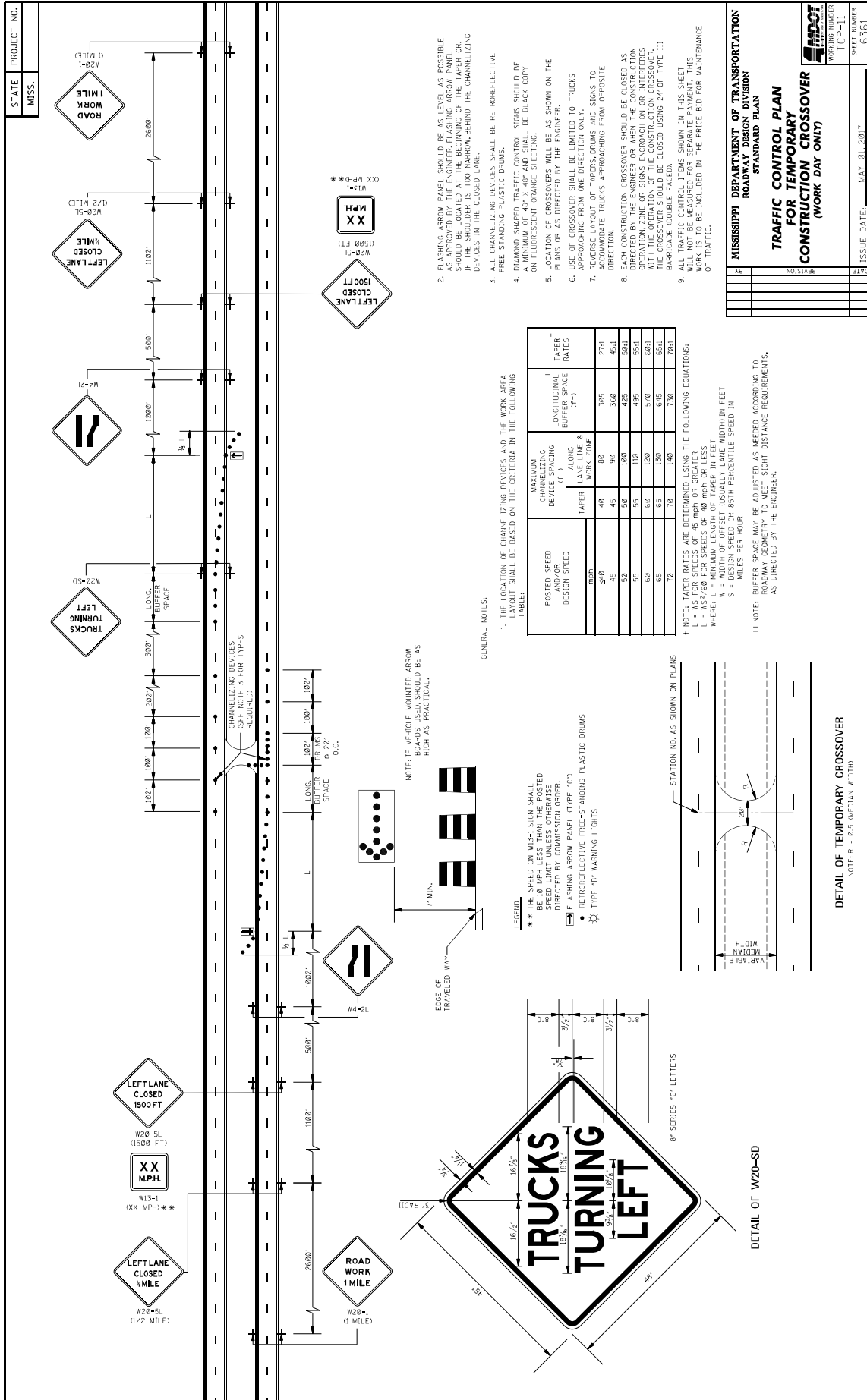

**MISSISSIPPI DEPARTMENT OF TRANSPORTATION**  
**ROADWAY DESIGN DIVISION**  
**STANDARD PLAN**  
**TRAFFIC CONTROL PLAN**  
**FOR TEMPORARY**  
**CONSTRUCTION CROSSOVER**  
**(WORK DAY ONLY)**

WORKING NUMBER: TCR-11  
 SHEET NUMBER: 6361

ISSUE DATE: MAY 01, 2017

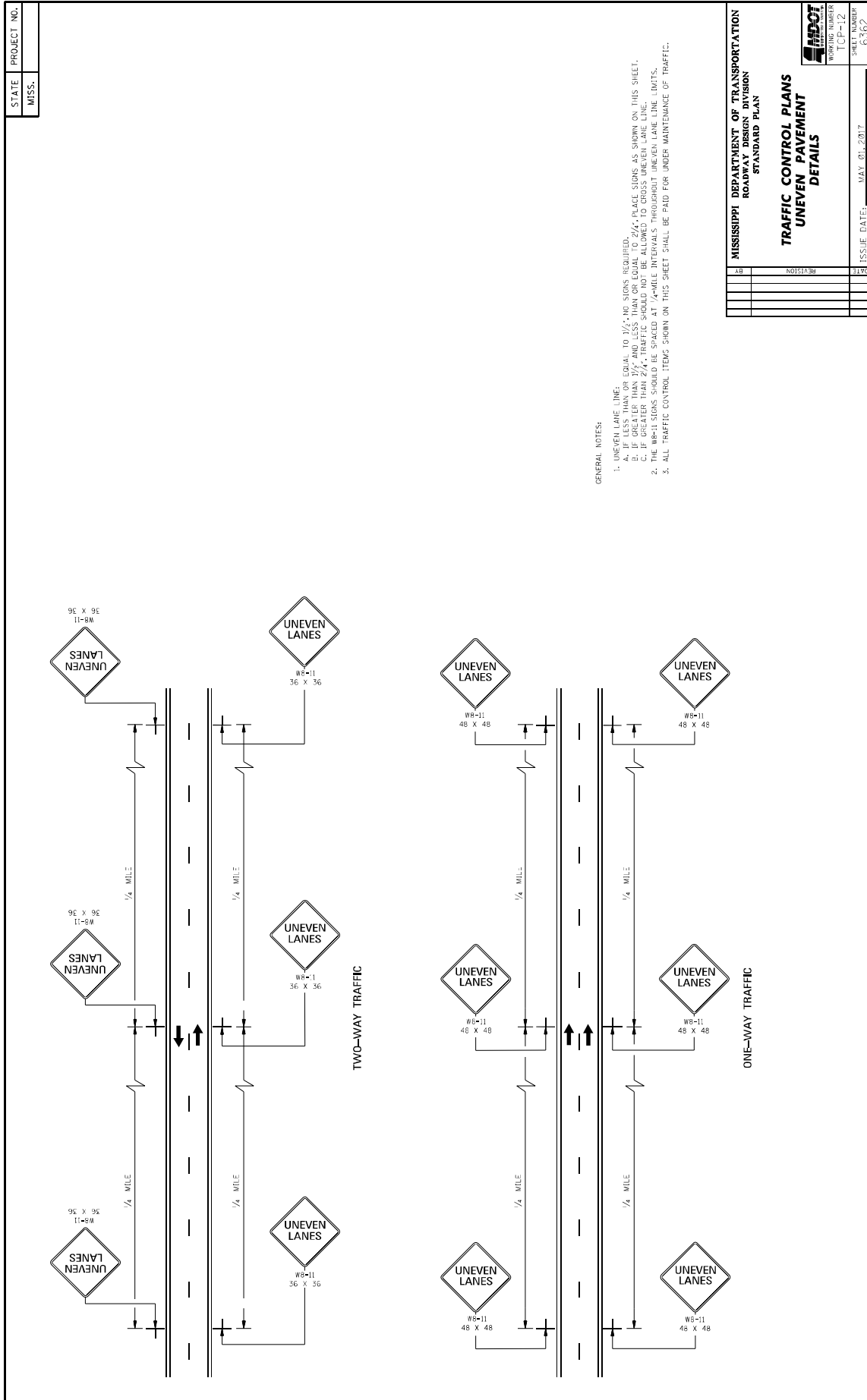

GENERAL NOTES:

1. UNEVEN LANE LINE.
  - A. IF LESS THAN OR EQUAL TO 1/2", NO SIGNS REQUIRED.
  - B. IF MORE THAN 1/2" AND LESS THAN 1/4", PLACE SIGNS AS SHOWN ON THIS SHEET.
  - C. IF GREATER THAN 1/4", TRAFFIC SHOULD NOT BE ALLOWED TO CROSS UNEVEN LANE LINE.
2. THE WB-11 SIGNS SHOULD BE SPACED AT 1/4-MILE INTERVALS THROUGHOUT UNEVEN LANE LINE LIMITS.
3. ALL TRAFFIC CONTROL ITEMS SHOWN ON THIS SHEET SHALL BE PAID FOR UNDER MAINTENANCE OF TRAFFIC.

STATE	PROJECT NO.
MISS.	

MISSISSIPPI DEPARTMENT OF TRANSPORTATION	
ROADWAY DESIGN DIVISION	
STANDARD PLAN	
<b>TRAFFIC CONTROL PLANS</b>	
<b>UNEVEN PAVEMENT</b>	
<b>DETAILS</b>	
WORKING NUMBER	ICP-12
SHEET NUMBER	6262
ISSUE DATE:	MAY 01, 2017
REVISION	
DATE	

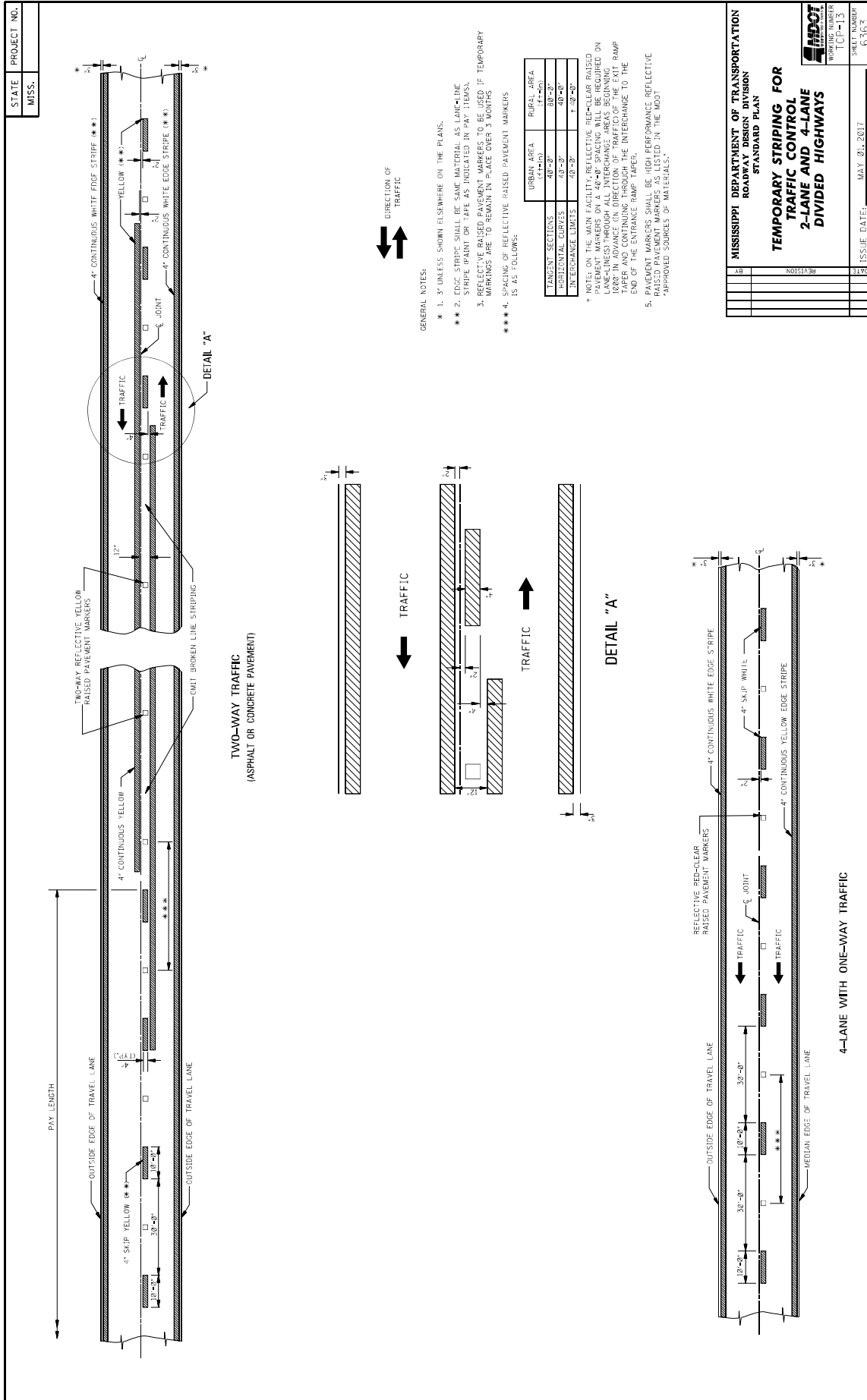

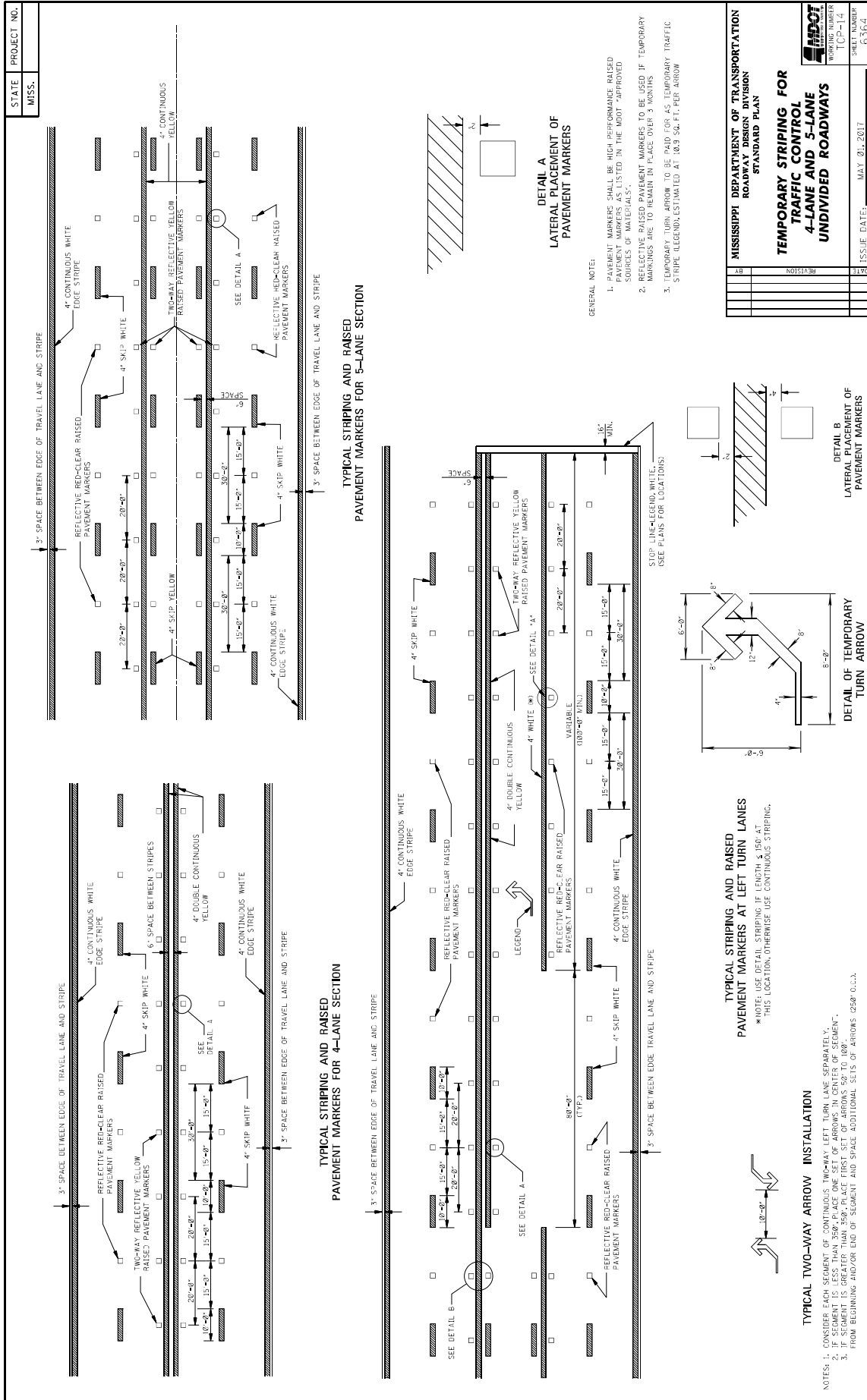

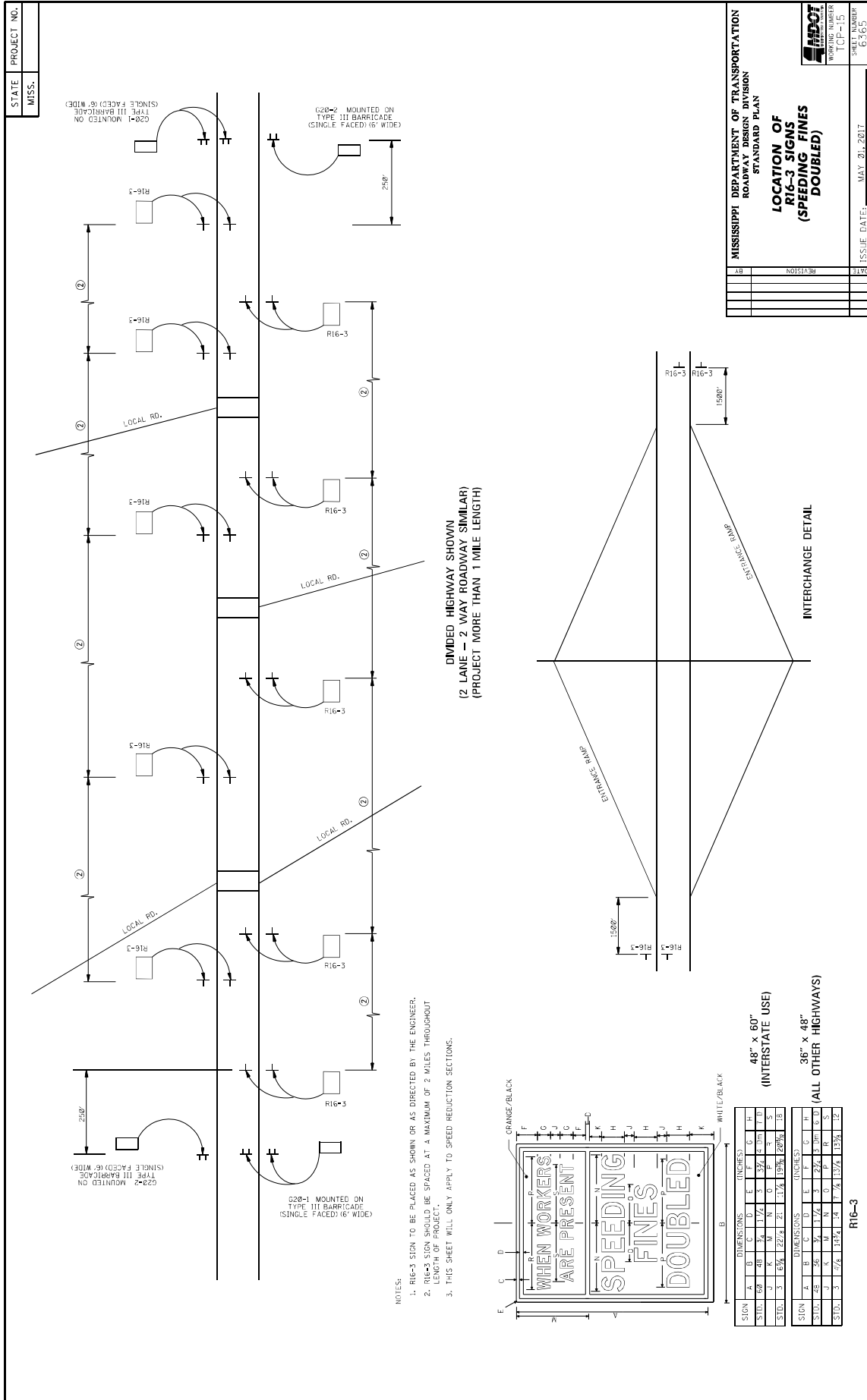

STATE PROJECT NO.  
MISS.

MISSISSIPPI DEPARTMENT OF TRANSPORTATION  
ROADWAY DESIGN DIVISION  
STANDARD PLAN  
**LOCATION OF  
R16-3 SIGNS  
(SPEEDING FINES  
DOUBLED)**

ISSUE DATE: MAY 21, 2017

WORKING NUMBER  
ICP-15

SHEET NUMBER  
63663

- NOTES:
1. R16-3 SIGN TO BE PLACED AS SHOWN OR AS DIRECTED BY THE ENGINEER.
  2. R16-3 SIGN SHOULD BE SPACED AT A MAXIMUM OF 2 MILES THROUGHOUT LENGTH OF PROJECT.
  3. THIS SHEET WILL ONLY APPLY TO SPEED REDUCTION SECTIONS.

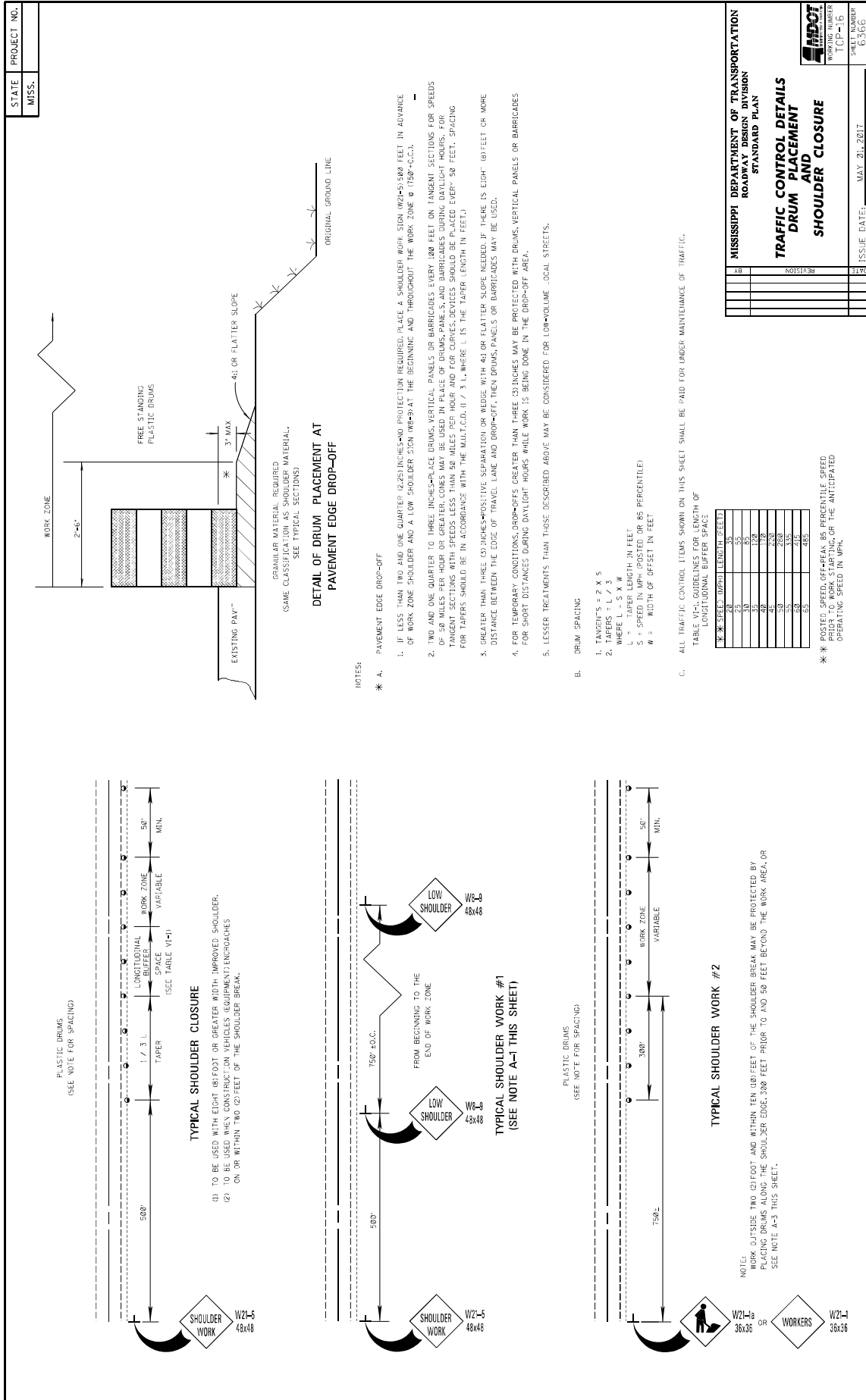

GENERAL NOTES

1. GROUND-IN RUMBLE STRIPES SHALL BE APPLIED TO ALL PAVED SHOULDERS OF ALL PAVED SHOULDERS ON THIS PROJECT.
2. GROUND-IN RUMBLE STRIPES SHALL BE APPLIED TO ALL EXISTING AND NEW ROADS, INCLUDING INTERSECTIONS, NORMAL SHOULDER WIDTH AS DIRECTED BY THE ENGINEER.
3. COST TO BE PAID FOR USING APPROPRIATE PAY ITEMS.
4. GROUND-IN RUMBLE STRIPES SHALL BE APPLIED TO:
  - A. MAINLINE
  - B. INTERSECTING ROADWAY IF OVERLAP OR RECONSTRUCTED BEYOND NORMAL MAINLINE R.O.W.
  - C. ANY ROADWAY WITH EXISTING RUMBLE STRIPES PRIOR TO CONSTRUCTION.
5. DO NOT USE WHERE TRAVEL LANE IS LESS THAN 11' WIDE.

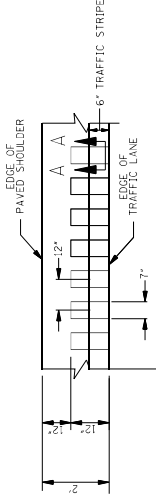

SECTION "A-A"

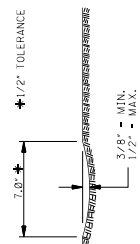

SECTION "A-A"

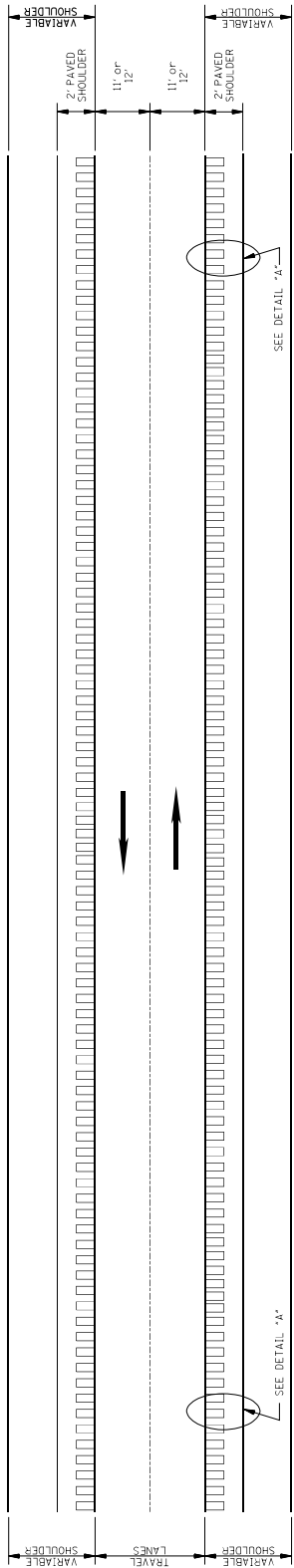

PLAN  
NOT TO SCALE

MISSISSIPPI DEPARTMENT OF TRANSPORTATION	
ROADWAY DESIGN DIVISION	
STANDARD PLAN	
DATE	ISSUE DATE: AUGUST 01, 2017
BY	
DESIGNED STRIPE LOCATION	
REVISION	
PROJECT NUMBER	60664
DISTRICT	1
PLAN NUMBER	RS-1

**RUMBLE STRIPES  
2-LANE HIGHWAYS  
(ASPHALT LANES,  
2-FT ASPHALT SHOULDERS)**

**GENERAL NOTES**

1. GROUND-IN RUMBLE STRIPES SHALL BE APPLIED TO ALL PAVED SHOULDERS, ALL PAVED SHOULDERS ON THIS PROJECT.
2. GROUND-IN RUMBLE STRIPES SHALL BE APPLIED TO ALL PAVED TRAFFIC LANES ON ROADWAYS WITH OTHER INTERSECTIONS IN NORMAL SHOULDER WIDTH AS DIRECTED BY THE ENGINEER.
3. COST TO BE PAID FOR USING APPROPRIATE PAY ITEMS.
4. GROUND-IN RUMBLE STRIPES SHALL BE APPLIED TO:
  - A. MAINLINE
  - B. INTERSECTING ROADWAY IF OVERLAP OR RECONSTRUCTED BEYOND NORMAL MAINLINE R.O.W.
  - C. ANY ROADWAY WITH EXISTING RUMBLE STRIPES PRIOR TO CONSTRUCTION.

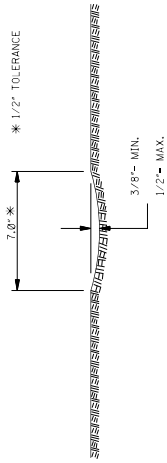

**SECTION "A-A"**

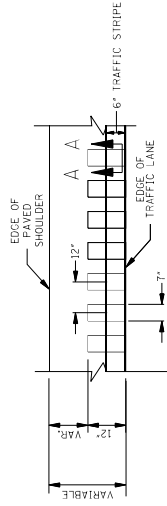

**DETAIL "A"**

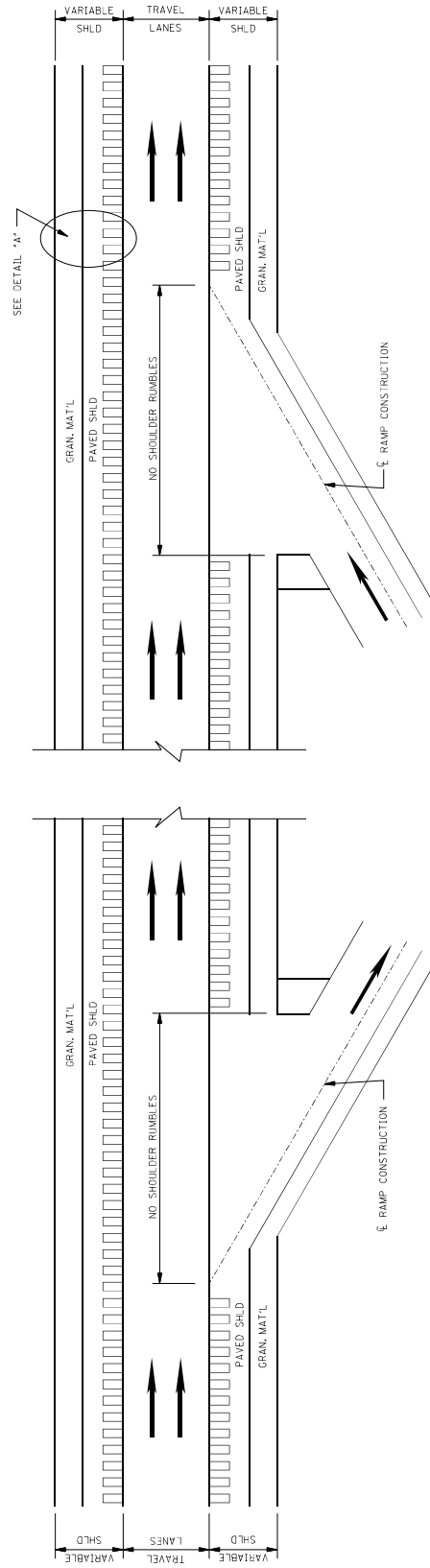

**PLAN**  
NOT TO SCALE

**DETAILS OF RUMBLE STRIPES**

MISSISSIPPI DEPARTMENT OF TRANSPORTATION ROADWAY DESIGN DIVISION STANDARD PLAN		
BY	REVISION	DATE
508	REVISED STRIPE LOCATION	
<b>RUMBLE STRIPES 4-LANE HIGHWAYS (ASPHALT LANES, 2-FT OR WIDER, ASPHALT SHOULDERS)</b>		
FIG. NUMBER	PROJECT NUMBER	DRAWING NUMBER
35-2		6065
ISSUE DATE:		AUGUST 01, 2017



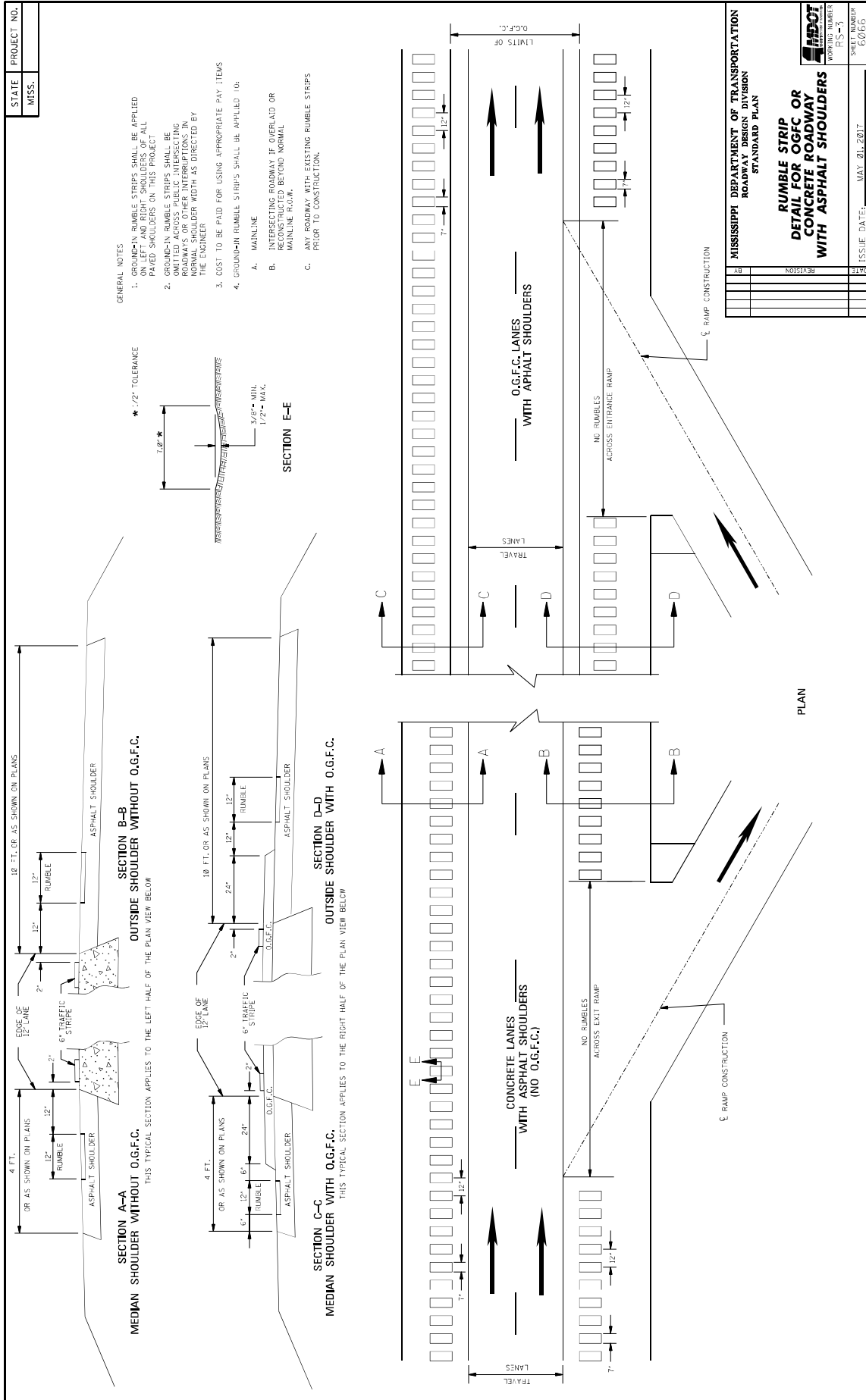

## MISSISSIPPI DEPARTMENT OF TRANSPORTATION

SECTION 904 - NOTICE TO BIDDERS NO. 3309

CODE: (SP)

DATE: 05/05/2021

SUBJECT: Contract Time

PROJECT: STP-1164-00(018) / 108227301 – Lamar County

The completion of work to be performed by the Contractor for this project will not be a specified date but shall be when all allowable working days are assessed, or any extension thereto as provided in Subsection 108.06. It is anticipated that the Notice of Award will be issued no later than **July 13, 2021**.

The Contractor shall request a Notice to Proceed/Beginning of Contract Time date between the dates of **August 12, 2021 and September 09, 2021**.

Should the Contractor request a Notice to Proceed earlier than **August 12, 2021** and it is agreeable with the Department for an early Notice to Proceed, the requested date will become the new Notice to Proceed and Beginning of Contract Time date.

Should the Contractor not request a Notice to Proceed by **September 09, 2021**, the date for the Notice to Proceed and Beginning of Contract Time will be **September 09, 2021**.

All requests for an early Notice to Proceed shall be sent to the Project Engineer who will forward it to the Contract Administration Division.

**33** Working Days have been allowed for the completion of work on this project.

The progress schedule for this project shows the Notice to Proceed and Beginning of Contract Time starting at the latest possible date. If the Contractor requests a Notice to Proceed earlier than this date, the Contractor shall submit a revised progress schedule showing the work beginning at the new Notice to Proceed and Beginning of Contract Time date.

## MISSISSIPPI DEPARTMENT OF TRANSPORTATION

SECTION 904 - NOTICE TO BIDDERS NO. 3310

DATE: 04/29/2021

SUBJECT: Specialty Items

PROJECT: STP-1164-00(018)/108227301 - LAMAR

Pursuant to the provisions of Section 108, the following work items are hereby designated as "Specialty Items" for this contract. Bidders are reminded that these items must be subcontracted in order to be considered as specialty items.

### CATEGORY: DISPOSAL OF BUILDINGS, RIGHT OF WAY CLEARING & GRUBBING

---

Line No	Pay Item	Description
0050	202-B240	Removal of Traffic Stripe

### CATEGORY: GUARDRAIL, GUIDERAIL

---

Line No	Pay Item	Description
0100	606-B003	Guard Rail, Class A, Type 1, 'W' Beam, Metal Post
0110	606-D001	Guard Rail, Bridge End Section
0120	606-E001	Guard Rail, Terminal End Section

### CATEGORY: MISCELLANEOUS/ SPECIALTY WORK ITEMS

---

Line No	Pay Item	Description
0090	423-A001	Rumble Strips, Ground In

### CATEGORY: PAVEMENT STRIPING AND MARKING

---

Line No	Pay Item	Description
0220	626-C002	6" Thermoplastic Double Drop Edge Stripe, Continuous White
0230	626-D003	6" Thermoplastic Traffic Stripe, Skip Yellow
0240	626-E004	6" Thermoplastic Traffic Stripe, Continuous Yellow
0250	626-G002	Thermoplastic Detail Stripe, White
0260	626-G003	Thermoplastic Detail Stripe, Yellow
0270	626-H004	Thermoplastic Legend, White
0280	626-H005	Thermoplastic Legend, White
0290	627-J001	Two-Way Clear Reflective High Performance Raised Markers
0300	627-K001	Red-Clear Reflective High Performance Raised Markers
0310	627-L001	Two-Way Yellow Reflective High Performance Raised Markers
0390	907-624-B002	6" Inverted Profile Thermoplastic Traffic Stripe, Continuous White
0400	907-624-D002	6" Inverted Profile Thermoplastic Traffic Stripe, Continuous Yellow
0410	628-H001	6" High Performance Cold Plastic Traffic Stripe, Continuous White
0420	628-J001	6" High Performance Cold Plastic Traffic Stripe, Continuous Yellow

### CATEGORY: TRAFFIC CONTROL - PERMANENT

---

Line No	Pay Item	Description
---------	----------	-------------

CATEGORY: TRAFFIC CONTROL - PERMANENT

---

Line No	Pay Item	Description
0320	630-F006	Delineators, Guard Rail, White
0330	630-G005	Type 3 Object Markers, OM-3R or OM-3L, Post Mounted
0350	907-630-O006	Remove and Reset Signs, Ground Mounted

CATEGORY: TRAFFIC CONTROL - TEMPORARY

---

Line No	Pay Item	Description
0150	619-A1001	Temporary Traffic Stripe, Continuous White
0160	619-A2001	Temporary Traffic Stripe, Continuous Yellow
0170	619-A4002	Temporary Traffic Stripe, Skip Yellow
0180	619-A5001	Temporary Traffic Stripe, Detail
0190	619-A6001	Temporary Traffic Stripe, Legend
0200	619-A6002	Temporary Traffic Stripe, Legend

**MISSISSIPPI DEPARTMENT OF TRANSPORTATION**

**SECTION 904 - NOTICE TO BIDDERS NO. 3311**

**CODE: (SP)**

**DATE: 04/13/2021**

**SUBJECT: Scope of Work**

**PROJECT: STP-1164-00(018) / 108227301 -- Lamar County**

The contract documents do not include an official set of construction plans but may, by reference, include some Standard Drawings when so specified in a Notice to Bidders entitled, "Standard Drawings".

Work on the project shall consist of the following:

**WIDEN, LEVEL, AND OVERLAY SR 589**  
**FROM US 11 to 1.6 MILES NORTH OF OLD HIGHWAY 11**  
**(10+00 TO 173+40)**

(A) Prior to the overlay, centerline alignment shall be determined by the Contractor by measuring the existing roadway at 500-foot intervals in tangent sections and 100-foot intervals in horizontal curves. The existing shoulders shall be clipped and surplus material shall be spread along the edge of the shoulders, fore slopes, or other adjacent areas as directed by the Project Engineer, and will be an absorbed item.

(B) The Contractor shall fine mill a depth of ¾" and variable on SR 589 at all the transitions including E.O.P., B.O.P., bridge approaches, and all tie-ins. All milled areas shall be backfilled with asphalt within seven (7) days of milling. All milled material shall become property of the Contractor.

(C) SR 589 shall be overlaid with ¾" of Ultra-Thin asphalt from US 11 (10+00) to 1.6 miles north of old Highway 11 (173+40) (Approximately 2,255 tons). Prior to the overlay, a leveling course of 1" and variable of 9.5-mm, MT, Leveling, asphalt shall be required from the BOP to the EOP. SR 589 shall be widened two feet (2') on each side from BOP to EOP. The foundation for widening the roadway shall be formed by trenching or excavating to the required depth and width (See Typical Drawings). Trenching or excavating for the trench widening will be absorbed. In the areas where MDOT Maintenance forces have previously widened the roadway with asphalt, this material shall be excavated in the normal trench widening operations (Not to be measured for separate pay). In the instance that the Contractor cannot, in the Project Engineer's opinion, adequately incorporate the excess asphalt material from the trench into the shoulder, the excess asphalt material shall be hauled off of the job site (Not to be measured for separate pay). The asphalt for trench widening shall be placed at the same time with the 1" leveling course. Approximately 3,420 tons has been set up for widening and leveling. The leveling and surface course shall meet smoothness tolerances for maximum deviation from a 10-foot straight edge as stated in Subsection 403.03.2 of the Standard Specifications. Publicly maintained roads or streets

shall be surfaced to the existing R.O.W.; privately owned entrances shall be surfaced a distance of 10 feet and variable from edge of pavement, and all guard rail pads shall be paved (Approximately 1,165 tons). Any site grading at local roads or drives will not be measured for separate payment but will be considered an absorbed item. Existing cross slopes of 2% in tangent sections or proper superelevation rates in curves shall be maintained. In sections with cross slopes that are less than 2% in tangents or less than the proper superelevation rate in curves, cross slopes shall be improved by adjusting the leveling course to a varying thickness between ½” and 1”. If water stands when project is complete, the Contractor shall correct at no additional cost to the State.

(D) The existing shoulders shall be raised to match the new pavement elevation by placing 1¾” and variable depth of crushed stone/concrete on the shoulders. Placement of the crushed material on the finished surface course shall not be permitted. The material shall be bladed, rolled and compacted to a finished slope of 4% where practical. Shoulders with existing adequate shoulder material in place shall be bladed to a slope of 4%; the cost of which shall be included in the prices of other items bid.

(E) The Contractor shall mill a 12-inch wide rumble strip along the inside of the shoulders as per sheet RS-UT. The rumble strip shall be milled to a depth of between ¼” and ⅜” due to the thickness of the surface asphalt. The traffic stripe will be placed on the inside six inches (6”) of the rumble strip.

(F) Temporary striping shall conform to finished stripe specifications for alignment, neatness, reflectivity, and straightness. All permanent pavement markings on asphalt are to be hot thermoplastic. Edge lines will be placed so as to maintain the original lane width. On all bridges and concrete sections, old traffic stripe shall be removed and replaced with high performance cold plastic or inverted profile stripe. Special care shall be taken for the placement of thermoplastic detail stripe along the edge of pavement at turn-outs on all local roads and along tapers where detail stripe is required as per sheet PMD-1.

(G) Regardless of the spacing shown on sheet PM-1, raised pavement markers shall be placed on 40-foot centers in both tangent sections and curve sections. Any removal of existing raised pavement markers or rumble bars shall be considered an absorbed item. Only flexible adhesive shall be allowed for placement of raised pavement markers meeting the requirements of Subsection 720.03.7.7.

(H) All the guardrail in the guardrail pad areas shall be removed and replaced. Removed guardrail shall become the property of the Contractor. All new guardrail shall be MASH compliant. The Contractor shall furnish the Project Engineer two (2) copies of the manufacture's installation instructions prior to beginning guardrail operations. All terminal end sections shall be marked with a Sanford Mean Streak grease pen or approved equal to identify type installed. Any site grading and all fill material necessary at the guardrail locations will not be measured for separate payment and all such costs shall be included in other guardrail pay items. Guard rail pads shall be overlaid prior to placing guardrail and will be paid for under pay item 907-411: Ultra-Thin Asphalt Pavement. Seeding, fertilizer and vegetative mulch shall be required on all disturbed areas at the guardrail site and will be considered an absorbed item. Application rate for Bermuda grass seed

will be 25 pounds per acre. Application rate for combination fertilizer (13-13-13) will be 1,000 pounds per acre. Application rate for mulch shall be two (2) tons per acre.

(I) If pavement section marking tape is encountered on this project, it shall be located prior to overlaying and placed back in the same location after paving operations have ceased. The section marking shall be 6-inch high performance cold plastic detail stripe and shall be four feet (4') in length. The marking shall be centered across the centerline stripe. The cost of this item shall be included in other bid items.

(J) Intersection improvements shall be performed at the following locations.

- **Morris Drive and Main Street:** Work at this intersection includes removing two concrete islands and curb & gutter. Once removed, the Contractor shall back fill with 6" of 9.5-mm, MT, Leveling asphalt (4 lifts at 1½" per lift). The four (4) stops signs shall be removed and reset as shown in the intersection sign detail. Once the surface asphalt is placed, permanent stripe shall be placed as per the intersection striping detail.
  
- **Old Highway 11:** Work at this intersection includes removing the flying "Y" entrance onto Old Highway 11. Before removal, the perpendicular access onto old highway 11 shall be widening to a width of 28 feet (12' travel lanes and 2' paved shoulders). Asphalt used for widening purposes shall be 9.5-mm, MT, Leveling asphalt. The intersection detail sheet shall be referenced for widening and removal areas. Any site grading and all fill material necessary in the removal area will not be measured for separate payment but will be absorbed in other pay items. Seeding, fertilizer and vegetative mulch are required on all disturbed areas and will be considered an absorbed item. Application rate for Bermuda grass seed will be 25 pounds per acre. Application rate for combination fertilizer (13-13-13) will be 1,000 pounds per acre. Application rate for mulch shall be two (2) tons per acre.

(K) The Contractor shall erect and maintain construction signing, and provide all signs and traffic handling devices, and shall provide two portable R16-3 signs per work zone or lane closure in addition to signs required by standard drawings in accordance with Manual Uniform Traffic Control Devices (MUTCD). The cost of this work shall be included in the price bid for pay item 618-A: Maintenance of Traffic).

(L) Incidental work such as removing vegetation, shaping and compaction of shoulder, removing excess asphalt material, project clean-up, and other incidental work necessary to complete the project will not be measured for separate payment, but will be included in other bid items, and must be performed during the operating hours for this project.

- 4 -  
SR 589 LAMAR COUNTY  
STP-1164-00(018)  
108277/301000

Notice to Bidders No. 3311 -- Cont'd.

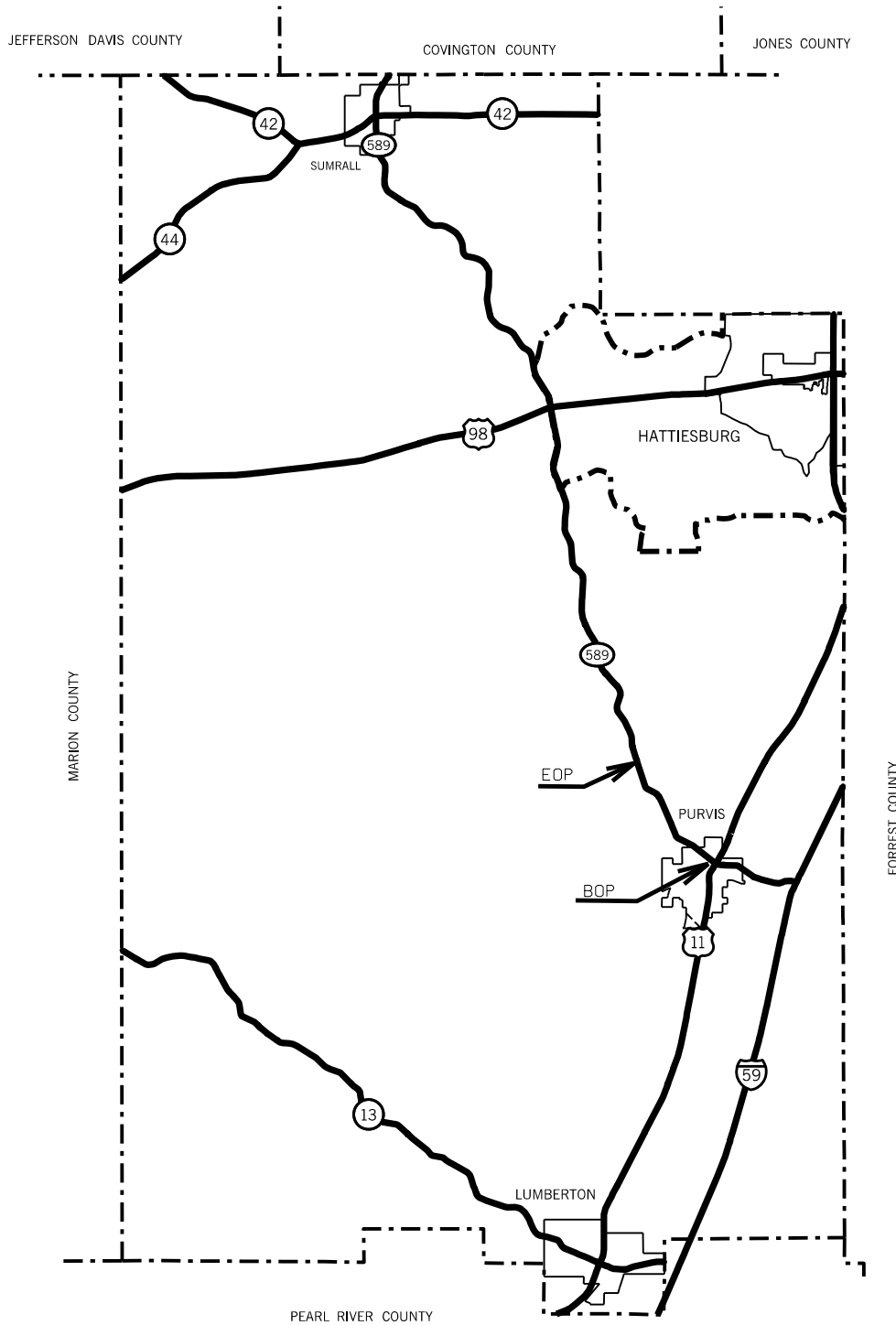

MARION COUNTY

FORREST COUNTY

PEARL RIVER COUNTY



MAINTENANCE MAP

**LAMAR**

**37**

MISSISSIPPI  
REVISED 07-30-2014

MISSISSIPPI DEPARTMENT OF TRANSPORTATION  
PLANNING DIVISION

SCALE IN KILOMETERS

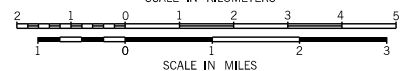

SCALE IN MILES



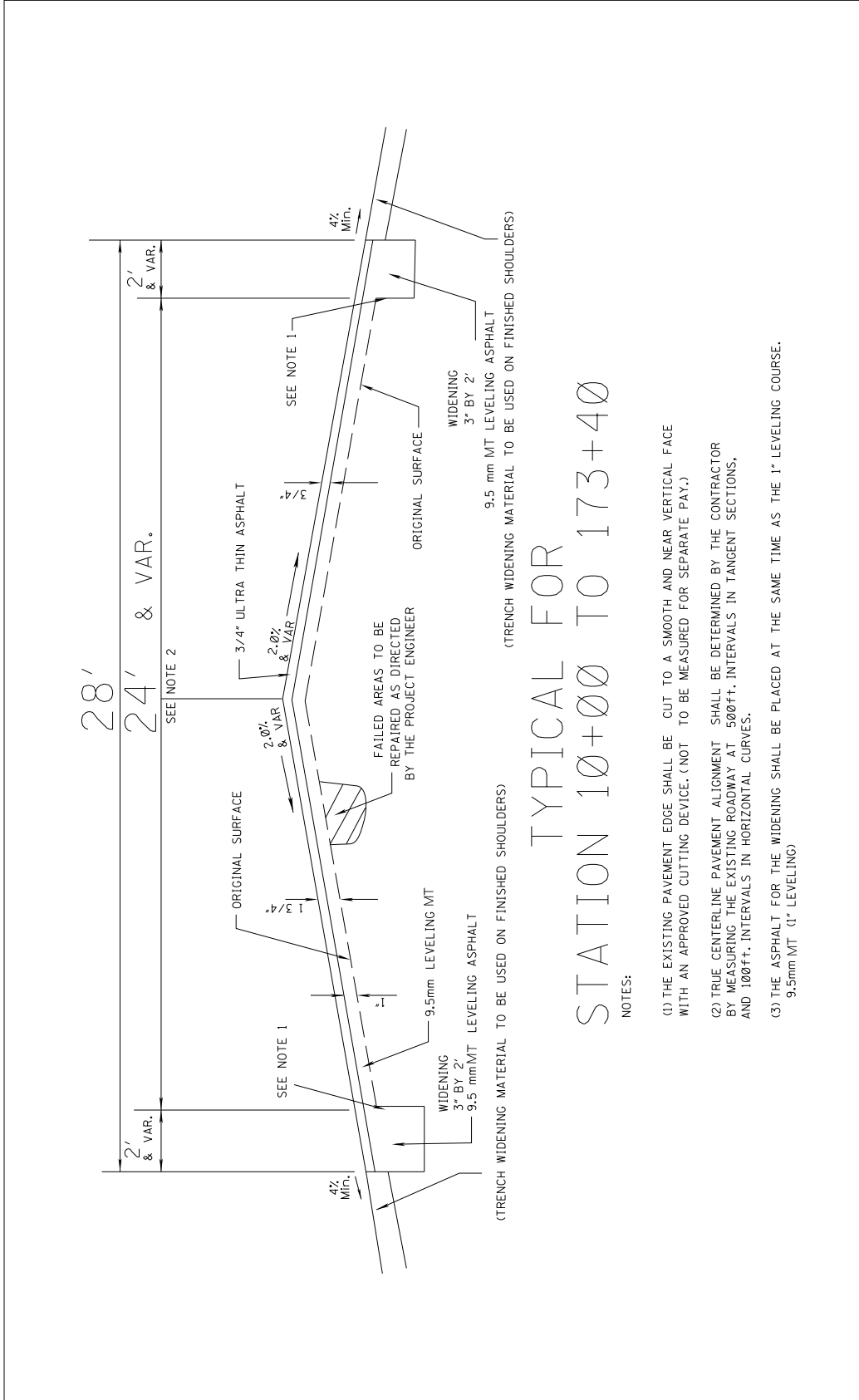

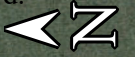

200 ft

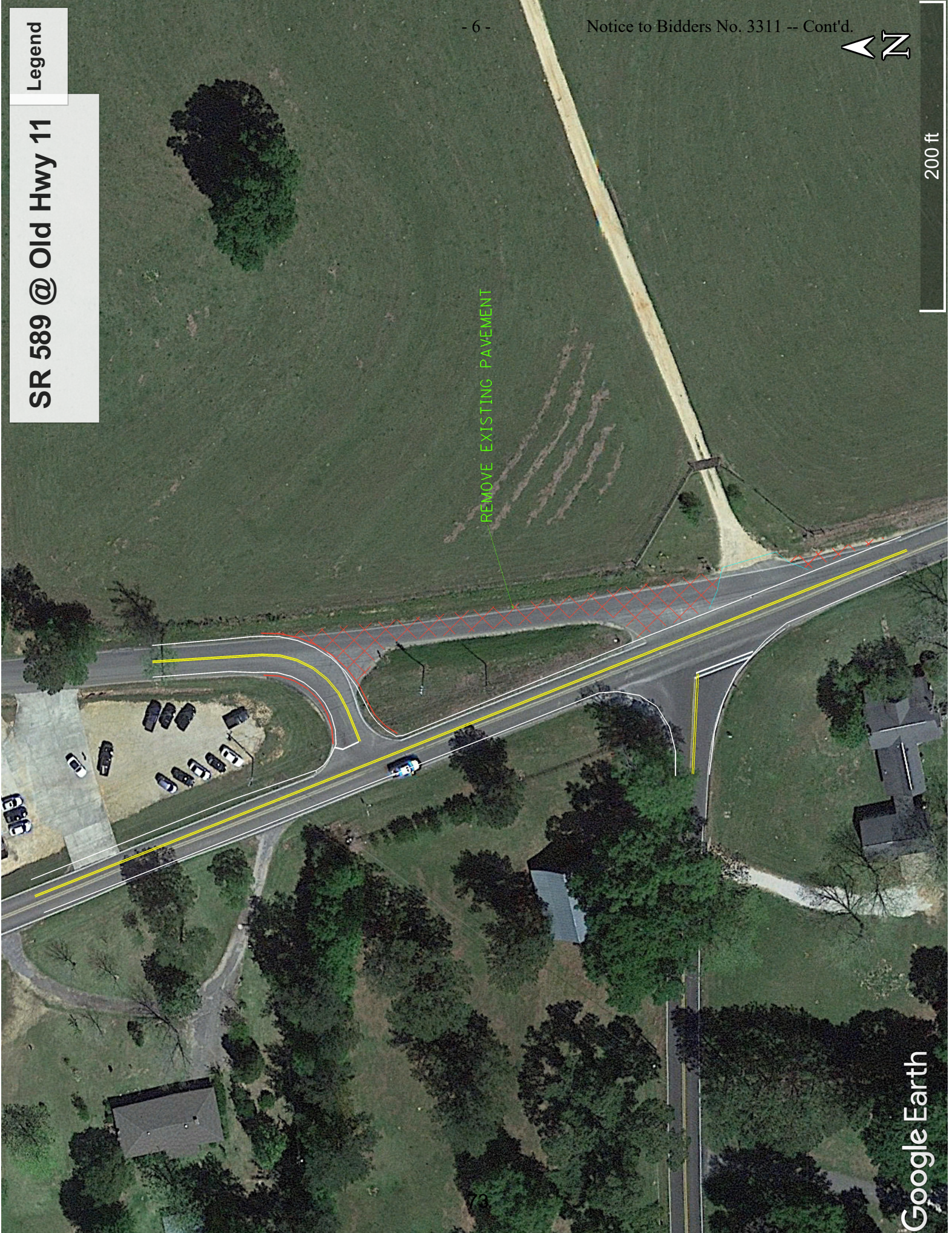

REMOVE EXISTING PAVEMENT

STATE	PROJECT NO.
MISS.	UPDATE

MISSISSIPPI DEPARTMENT OF TRANSPORTATION	
INTERSECTION IMPROVEMENTS	
HWY 589 & MORRIS ROAD	
SIGN DETAILS	
PROJ. NO.:	WORKSHEET NUMBER
COUNTY: LAMAR	
FILE NAME: Intersection Improvements at 589Mor	DATE: 12/22/2012
DESIGN TEAM: SMTH	CHECKED:

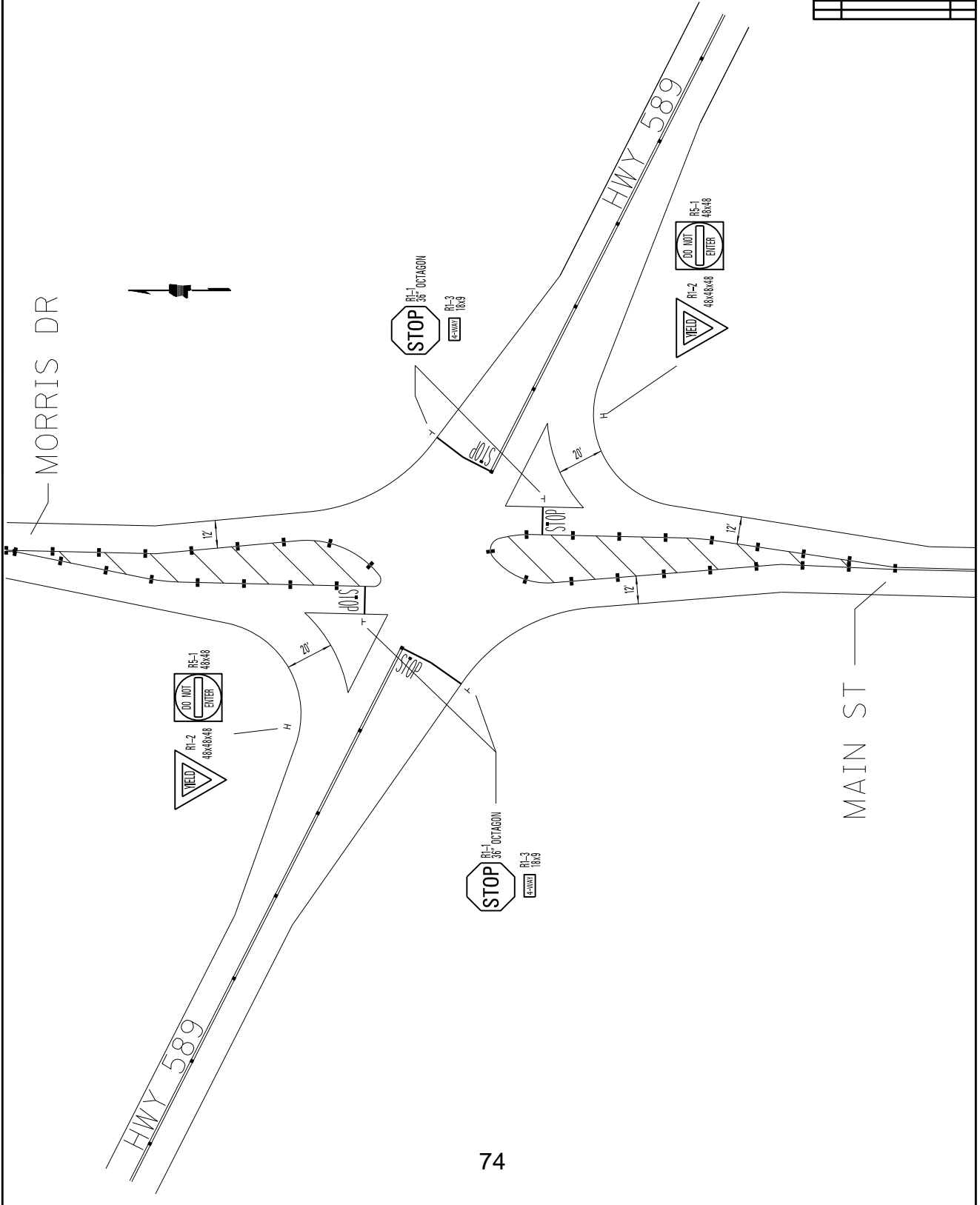

STATE	PROJECT NO.
MISS.	UPDATE

- 8 -

Notice to Bidders No.

1 - - Con d.

MISSISSIPPI DEPARTMENT OF TRANSPORTATION	
INTERSECTION IMPROVEMENTS	
HWY 589 & MORRIS ROAD	
STRIPING DETAILS	
PROJ. NO.:	WORKING NUMBER
COUNTY: LAMAR	FILENAME: Intersection Improvements at 589Morris
DESIGN TEAM: SKTH	DATE: 12/20/2017
DESIGNER: RIZ	CHECKER: RIZ

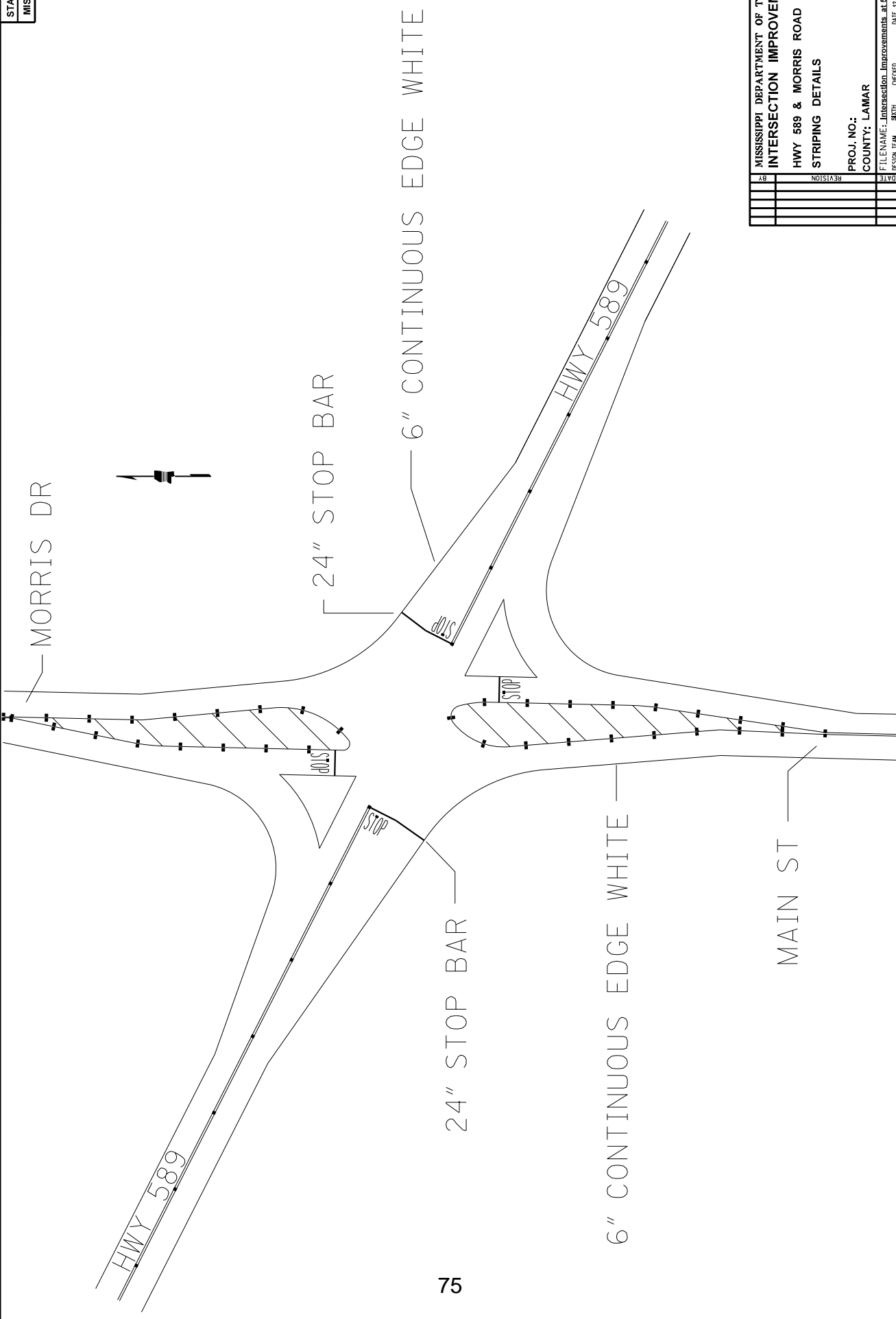

75

PAVEMENT MARKING			
SYMBOL	DESCRIPTION	TYPE	QUANTITY
(1)	LEFT TURN ARROW AND ONLY (TAPE & ) PAINT		
(2)	RED-CLEAR REFLECTIVE RAISED MARKERS EACH		
(3)	TWO-WAY YELLOW REFLECTIVE RAISED MARKERS EACH		
(4)	6" TRAFFIC SKIP WHITE (10'-30')	PLASTIC	
(5)	6" CONTINUOUS EDGE WHITE (SOLID)	PLASTIC	
(6)	6" CONTINUOUS TRAFFIC YELLOW (SOLID)	PLASTIC	
(7)	6" CONTINUOUS TRAFFIC WHITE (SOLID)	PLASTIC	
(8)	6" DETAIL STRIPE WHITE (SOLID)	PLASTIC	
(9)	6" DETAIL STRIPE YELLOW (SOLID)	PLASTIC	
(10)	6" DETAIL STRIPE WHITE (2'-12')	PLASTIC	
(11)	24" THERMO LEGEND (WHITE/STOP BAR)		
(12)	6" DOTTED WHITE 2' STRIPE, 12' GAP		
(13)	6" WHITE CONT. EDGE		
(14)	6" WHITE CONT. EDGE		
(15)	6" WHITE CONT. EDGE		
(16)	6" WHITE CONT. EDGE		
(17)	6" WHITE CONT. EDGE		
(18)	6" WHITE CONT. EDGE		
(19)	6" WHITE CONT. EDGE		
(20)	6" WHITE CONT. EDGE		
(21)	6" WHITE CONT. EDGE		
(22)	6" WHITE CONT. EDGE		
(23)	6" WHITE CONT. EDGE		
(24)	6" WHITE CONT. EDGE		
(25)	6" WHITE CONT. EDGE		
(26)	6" WHITE CONT. EDGE		
(27)	6" WHITE CONT. EDGE		
(28)	6" WHITE CONT. EDGE		
(29)	6" WHITE CONT. EDGE		
(30)	6" WHITE CONT. EDGE		
(31)	6" WHITE CONT. EDGE		
(32)	6" WHITE CONT. EDGE		
(33)	6" WHITE CONT. EDGE		
(34)	6" WHITE CONT. EDGE		
(35)	6" WHITE CONT. EDGE		
(36)	6" WHITE CONT. EDGE		
(37)	6" WHITE CONT. EDGE		
(38)	6" WHITE CONT. EDGE		
(39)	6" WHITE CONT. EDGE		
(40)	6" WHITE CONT. EDGE		
(41)	6" WHITE CONT. EDGE		
(42)	6" WHITE CONT. EDGE		
(43)	6" WHITE CONT. EDGE		
(44)	6" WHITE CONT. EDGE		
(45)	6" WHITE CONT. EDGE		
(46)	6" WHITE CONT. EDGE		
(47)	6" WHITE CONT. EDGE		
(48)	6" WHITE CONT. EDGE		
(49)	6" WHITE CONT. EDGE		
(50)	6" WHITE CONT. EDGE		
(51)	6" WHITE CONT. EDGE		
(52)	6" WHITE CONT. EDGE		
(53)	6" WHITE CONT. EDGE		
(54)	6" WHITE CONT. EDGE		
(55)	6" WHITE CONT. EDGE		
(56)	6" WHITE CONT. EDGE		
(57)	6" WHITE CONT. EDGE		
(58)	6" WHITE CONT. EDGE		
(59)	6" WHITE CONT. EDGE		
(60)	6" WHITE CONT. EDGE		
(61)	6" WHITE CONT. EDGE		
(62)	6" WHITE CONT. EDGE		
(63)	6" WHITE CONT. EDGE		
(64)	6" WHITE CONT. EDGE		
(65)	6" WHITE CONT. EDGE		
(66)	6" WHITE CONT. EDGE		
(67)	6" WHITE CONT. EDGE		
(68)	6" WHITE CONT. EDGE		
(69)	6" WHITE CONT. EDGE		
(70)	6" WHITE CONT. EDGE		
(71)	6" WHITE CONT. EDGE		
(72)	6" WHITE CONT. EDGE		
(73)	6" WHITE CONT. EDGE		
(74)	6" WHITE CONT. EDGE		
(75)	6" WHITE CONT. EDGE		
(76)	6" WHITE CONT. EDGE		
(77)	6" WHITE CONT. EDGE		
(78)	6" WHITE CONT. EDGE		
(79)	6" WHITE CONT. EDGE		
(80)	6" WHITE CONT. EDGE		
(81)	6" WHITE CONT. EDGE		
(82)	6" WHITE CONT. EDGE		
(83)	6" WHITE CONT. EDGE		
(84)	6" WHITE CONT. EDGE		
(85)	6" WHITE CONT. EDGE		
(86)	6" WHITE CONT. EDGE		
(87)	6" WHITE CONT. EDGE		
(88)	6" WHITE CONT. EDGE		
(89)	6" WHITE CONT. EDGE		
(90)	6" WHITE CONT. EDGE		
(91)	6" WHITE CONT. EDGE		
(92)	6" WHITE CONT. EDGE		
(93)	6" WHITE CONT. EDGE		
(94)	6" WHITE CONT. EDGE		
(95)	6" WHITE CONT. EDGE		
(96)	6" WHITE CONT. EDGE		
(97)	6" WHITE CONT. EDGE		
(98)	6" WHITE CONT. EDGE		
(99)	6" WHITE CONT. EDGE		
(100)	6" WHITE CONT. EDGE		

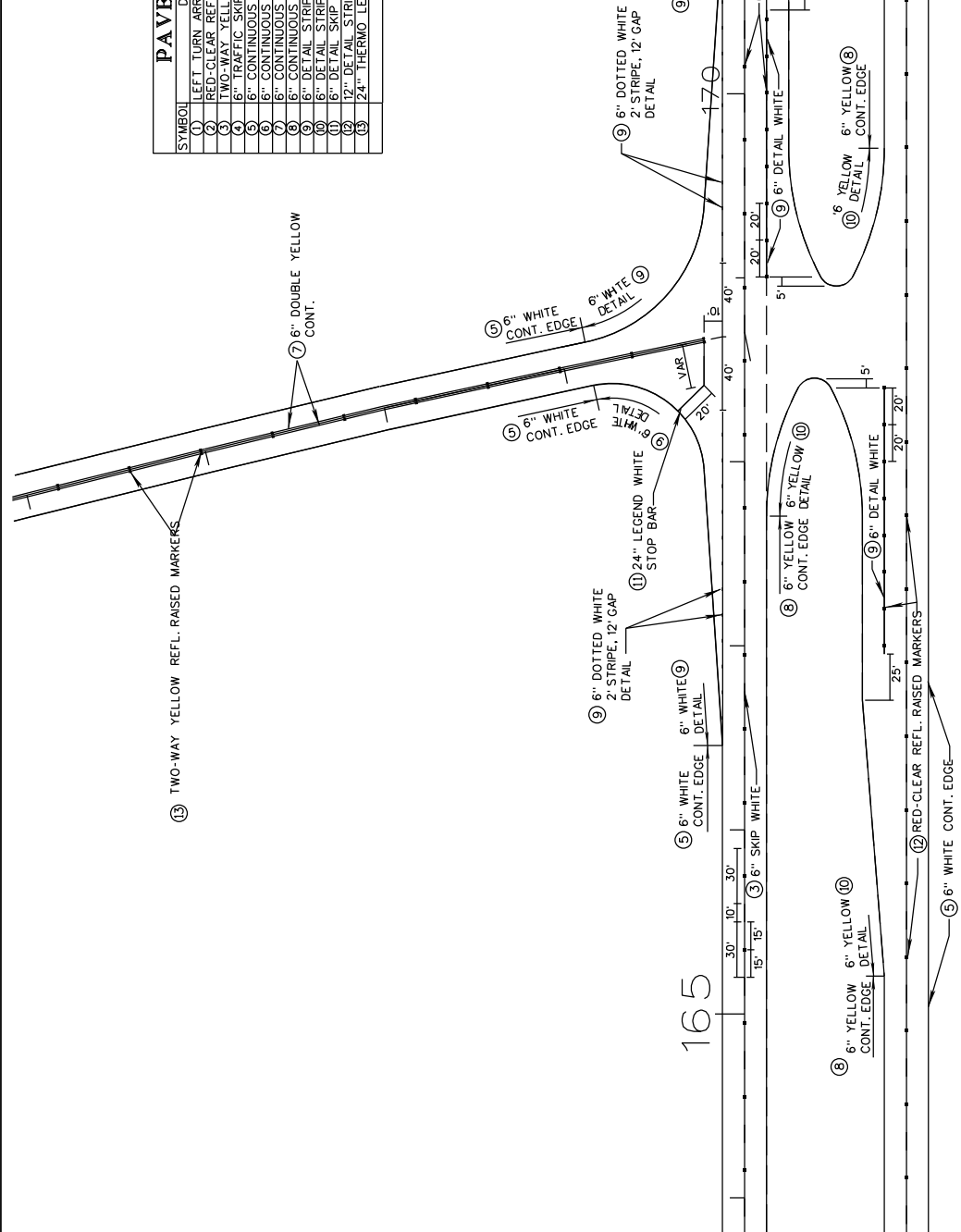

Notice to Bidders No. 311 -

MISSISSIPPI DEPARTMENT OF TRANSPORTATION  
 LOCAL RD. @ STA.

PROJECT NO:  
 COUNTY:  
 FILE NAME:  
 REVISION TEAM

WORKING NUMBER: PMD/ST  
 SHEET NUMBER: 55

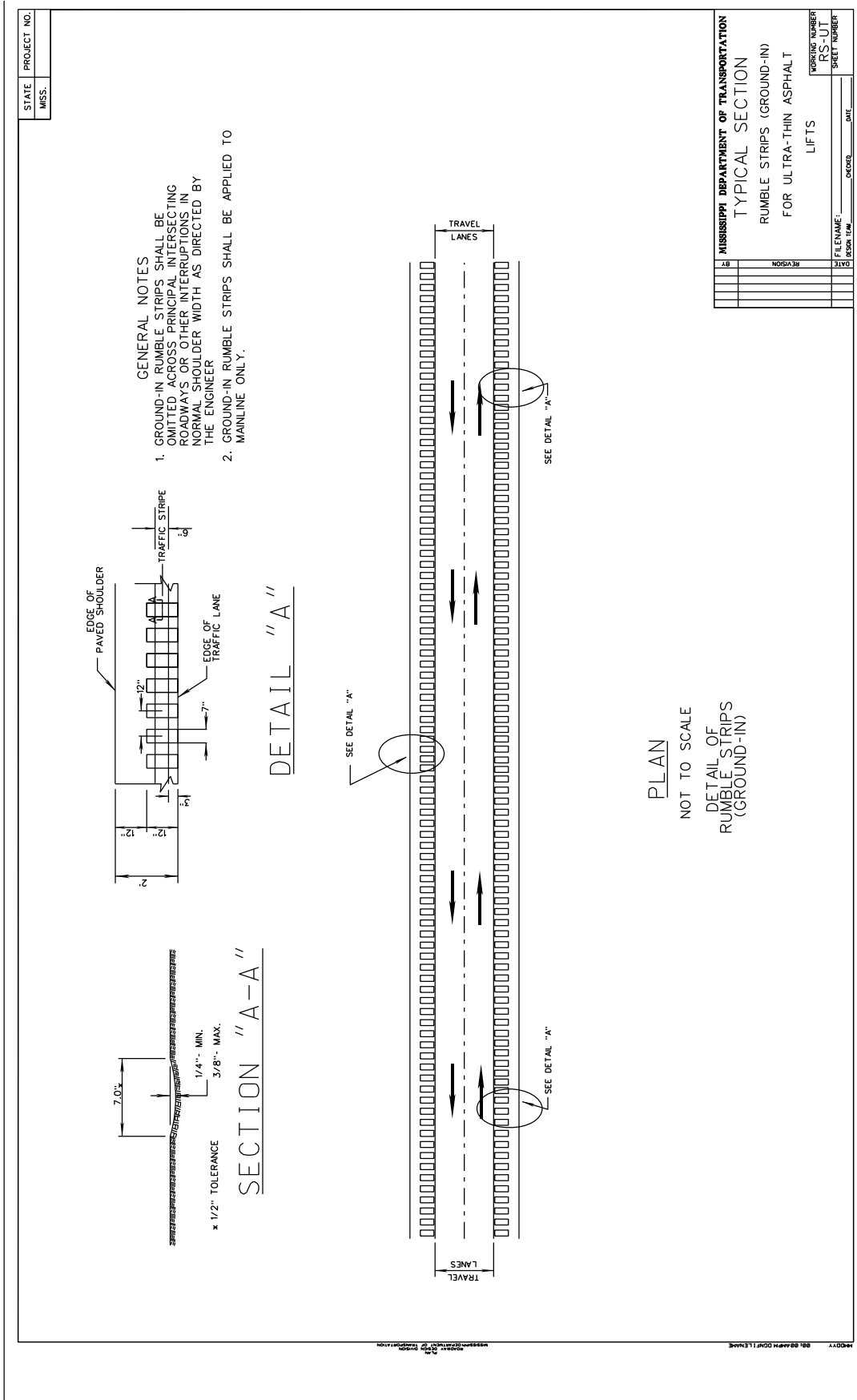

"General Decision Number: MS20210136 01/01/2021

Superseded General Decision Number: MS20200136

State: Mississippi

Construction Type: Highway

County: Lamar County in Mississippi.

HIGHWAY CONSTRUCTION PROJECTS

Note: Under Executive Order (EO) 13658, an hourly minimum wage of \$10.95 for calendar year 2021 applies to all contracts subject to the Davis-Bacon Act for which the contract is awarded (and any solicitation was issued) on or after January 1, 2015. If this contract is covered by the EO, the contractor must pay all workers in any classification listed on this wage determination at least \$10.95 per hour (or the applicable wage rate listed on this wage determination, if it is higher) for all hours spent performing on the contract in calendar year 2021. If this contract is covered by the EO and a classification considered necessary for performance of work on the contract does not appear on this wage determination, the contractor must pay workers in that classification at least the wage rate determined through the conformance process set forth in 29 CFR 5.5(a)(1)(ii) (or the EO minimum wage rate, if it is higher than the conformed wage rate). The EO minimum wage rate will be adjusted annually. Please note that this EO applies to the above-mentioned types of contracts entered into by the federal government that are subject to the Davis-Bacon Act itself, but it does not apply to contracts subject only to the Davis-Bacon Related Acts, including those set forth at 29 CFR 5.1(a)(2)-(60). Additional information on contractor requirements and worker protections under the EO is available at [www.dol.gov/whd/govcontracts](http://www.dol.gov/whd/govcontracts).

Modification Number	Publication Date
0	01/01/2021

SUMS2010-059 08/04/2014

	Rates	Fringes
CARPENTER (Form Work Only).....	\$ 12.72	0.00
CEMENT MASON/CONCRETE FINISHER...	\$ 11.54	1.63
ELECTRICIAN.....	\$ 26.68	0.00
HIGHWAY/PARKING LOT STRIPING: Truck Driver (Line Striping Truck).....	\$ 14.55	0.00
INSTALLER - SIGN.....	\$ 12.19	0.00

INSTALLER: Guardrail.....	\$ 12.39	0.00
IRONWORKER, REINFORCING.....	\$ 16.44	0.00
LABORER: Common or General, Including Asphalt Raking, Shoveling and Spreading; and Mason Tending Cement/Concrete....	\$ 11.00	0.00
LABORER: Flagger.....	\$ 11.42	0.00
LABORER: Grade Checker.....	\$ 14.82	0.00
LABORER: Luteman.....	\$ 12.88	0.00
LABORER: Pipelayer.....	\$ 14.50	0.00
LABORER: Laborer-Cones/ Barricades/Barrels - Setter/Mover/Sweeper.....	\$ 13.69	0.00
OPERATOR: Asphalt Spreader.....	\$ 14.71	0.00
OPERATOR: Backhoe/Excavator/Trackhoe.....	\$ 16.36	0.00
OPERATOR: Bobcat/Skid Steer/Skid Loader.....	\$ 11.86	0.00
OPERATOR: Broom/Sweeper.....	\$ 10.73	0.00
OPERATOR: Bulldozer.....	\$ 16.99	0.00
OPERATOR: Concrete Saw.....	\$ 14.55	0.00
OPERATOR: Crane.....	\$ 14.80	0.00
OPERATOR: Distributor.....	\$ 11.46	0.00
OPERATOR: Grader/Blade.....	\$ 15.60	0.00
OPERATOR: Loader.....	\$ 13.99	0.00
OPERATOR: Mechanic.....	\$ 13.00	0.00
OPERATOR: Milling Machine.....	\$ 12.83	0.00
OPERATOR: Oiler.....	\$ 12.22	0.00
OPERATOR: Paver (Asphalt, Aggregate, and Concrete).....	\$ 14.67	0.00
OPERATOR: Roller (All Types)....	\$ 10.82	0.00
OPERATOR: Scraper.....	\$ 14.00	0.00
OPERATOR: Tractor.....	\$ 10.71	0.00
SURVEYOR (Staking, Marking and Brush Clearing).....	\$ 11.56	0.00
TRUCK DRIVER: Flatbed Truck.....	\$ 14.72	0.00
TRUCK DRIVER: Lowboy Truck.....	\$ 14.07	0.00



TRUCK DRIVER: Mechanic.....	\$ 12.31	0.00
TRUCK DRIVER: Water Truck.....	\$ 17.08	0.00
TRUCK DRIVER: Dump Truck (All Types).....	\$ 14.26	0.00
TRUCK DRIVER: Semi/Trailer Truck.....	\$ 14.36	0.00

-----

WELDERS - Receive rate prescribed for craft performing operation to which welding is incidental.

=====

Note: Executive Order (EO) 13706, Establishing Paid Sick Leave for Federal Contractors applies to all contracts subject to the Davis-Bacon Act for which the contract is awarded (and any solicitation was issued) on or after January 1, 2017. If this contract is covered by the EO, the contractor must provide employees with 1 hour of paid sick leave for every 30 hours they work, up to 56 hours of paid sick leave each year. Employees must be permitted to use paid sick leave for their own illness, injury or other health-related needs, including preventive care; to assist a family member (or person who is like family to the employee) who is ill, injured, or has other health-related needs, including preventive care; or for reasons resulting from, or to assist a family member (or person who is like family to the employee) who is a victim of, domestic violence, sexual assault, or stalking. Additional information on contractor requirements and worker protections under the EO is available at [www.dol.gov/whd/govcontracts](http://www.dol.gov/whd/govcontracts).

Unlisted classifications needed for work not included within the scope of the classifications listed may be added after award only as provided in the labor standards contract clauses (29CFR 5.5 (a) (1) (ii)).

-----

The body of each wage determination lists the classification and wage rates that have been found to be prevailing for the cited type(s) of construction in the area covered by the wage determination. The classifications are listed in alphabetical order of ""identifiers"" that indicate whether the particular rate is a union rate (current union negotiated rate for local), a survey rate (weighted average rate) or a union average rate (weighted union average rate).

Union Rate Identifiers

A four letter classification abbreviation identifier enclosed in dotted lines beginning with characters other than ""SU"" or ""UAVG"" denotes that the union classification and rate were prevailing for that classification in the survey. Example: PLUM0198-005 07/01/2014. PLUM is an abbreviation identifier of the union which prevailed in the survey for this classification, which in this example would be Plumbers. 0198 indicates the local union number or district council number where applicable, i.e., Plumbers Local 0198. The next number, 005 in the example, is an internal number used in processing the wage determination. 07/01/2014 is the effective date of the

most current negotiated rate, which in this example is July 1, 2014.

Union prevailing wage rates are updated to reflect all rate changes in the collective bargaining agreement (CBA) governing this classification and rate.

#### Survey Rate Identifiers

Classifications listed under the ""SU"" identifier indicate that no one rate prevailed for this classification in the survey and the published rate is derived by computing a weighted average rate based on all the rates reported in the survey for that classification. As this weighted average rate includes all rates reported in the survey, it may include both union and non-union rates. Example: SULA2012-007 5/13/2014. SU indicates the rates are survey rates based on a weighted average calculation of rates and are not majority rates. LA indicates the State of Louisiana. 2012 is the year of survey on which these classifications and rates are based. The next number, 007 in the example, is an internal number used in producing the wage determination. 5/13/2014 indicates the survey completion date for the classifications and rates under that identifier.

Survey wage rates are not updated and remain in effect until a new survey is conducted.

#### Union Average Rate Identifiers

Classification(s) listed under the UAVG identifier indicate that no single majority rate prevailed for those classifications; however, 100% of the data reported for the classifications was union data. EXAMPLE: UAVG-OH-0010 08/29/2014. UAVG indicates that the rate is a weighted union average rate. OH indicates the state. The next number, 0010 in the example, is an internal number used in producing the wage determination. 08/29/2014 indicates the survey completion date for the classifications and rates under that identifier.

A UAVG rate will be updated once a year, usually in January of each year, to reflect a weighted average of the current negotiated/CBA rate of the union locals from which the rate is based.

---

#### WAGE DETERMINATION APPEALS PROCESS

1.) Has there been an initial decision in the matter? This can be:

- \* an existing published wage determination
- \* a survey underlying a wage determination
- \* a Wage and Hour Division letter setting forth a position on a wage determination matter
- \* a conformance (additional classification and rate) ruling

On survey related matters, initial contact, including requests for summaries of surveys, should be with the Wage and Hour Regional Office for the area in which the survey was conducted because those Regional Offices have responsibility for the Davis-Bacon survey program. If the response from this initial contact is not satisfactory, then the process described in 2.)

and 3.) should be followed.

With regard to any other matter not yet ripe for the formal process described here, initial contact should be with the Branch of Construction Wage Determinations. Write to:

Branch of Construction Wage Determinations  
Wage and Hour Division  
U.S. Department of Labor  
200 Constitution Avenue, N.W.  
Washington, DC 20210

2.) If the answer to the question in 1.) is yes, then an interested party (those affected by the action) can request review and reconsideration from the Wage and Hour Administrator (See 29 CFR Part 1.8 and 29 CFR Part 7). Write to:

Wage and Hour Administrator  
U.S. Department of Labor  
200 Constitution Avenue, N.W.  
Washington, DC 20210

The request should be accompanied by a full statement of the interested party's position and by any information (wage payment data, project description, area practice material, etc.) that the requestor considers relevant to the issue.

3.) If the decision of the Administrator is not favorable, an interested party may appeal directly to the Administrative Review Board (formerly the Wage Appeals Board). Write to:

Administrative Review Board  
U.S. Department of Labor  
200 Constitution Avenue, N.W.  
Washington, DC 20210

4.) All decisions by the Administrative Review Board are final.

=====

END OF GENERAL DECISION

"

## **SUPPLEMENT TO FORM FHWA-1273**

**DATE:** 12/17/2018

**SUBJECT:** **Federal Contract Provisions for Subcontracts and Cargo Preference Act**

### **Federal Contract Provisions for Subcontracts**

All subcontracts shall be in writing and contain all pertinent provisions and requirements of the prime contract.

Each “Request for Permission to Subcontract” (Mississippi Department of Transportation Form CAD-720) shall include a copy of the subcontract. The federal contract provisions (FHWA-1273, SUPPLEMENT TO FORM FHWA-1273, NOTICE OF REQUIREMENT FOR AFFIRMATIVE ACTION TO ENSURE EQUAL EMPLOYMENT OPPORTUNITY (EXECUTIVE ORDER 11246), DAVIS-BACON AND RELATED ACT PROVISIONS (WAGE RATES)) must be physically incorporated as part of the subcontract. A completed Mississippi Department of Transportation Form CAD-521 and Form CAD-725 must be attached to the CAD-720.

### **Cargo Preference Act**

The Contractor is hereby advised of the requirements set forth in the following Attachment (Title 46 - Shipping) as it pertains to the implementation of Cargo Preference Act (CPA) requirements in the Federal-aid Highway Program.

By signing this contract, the Contractor agrees to conform to the requirements of the CPA.

## Attachment

### Title 46- Shipping

Volume: 8

Date: 2014-10-01

Original Date: 2014-10-01

Title: Section 381.7 - Federal Grant, Guaranty, Loan and Advance at Funds Agreements.

Context: Title 46- Shipping. CHAPTER II- MARITIME ADMINISTRATION, DEPARTMENT OF TRANSPORTATION. SUBCHAPTER J - MISCELLANEOUS. PART 381 - CARGO PREFERENCE-U.S.-FLAG VESSELS.

#### § 381.7 Federal Grant, Guaranty, Loan and Advance of Funds Agreements.

In order to insure a fair and reasonable participation by privately owned United States-flag commercial vessels in transporting cargoes which are subject to the Cargo Preference Act of 1954 and which are generated by U.S. Government Grant, Guaranty, Loan and/or Advance of Funds Programs, the head of each affected department or agency shall require appropriate clauses to be inserted in those Grant, Guaranty, Loan and/or Advance of Funds Agreements and all third party contracts executed between the borrower/grantee and other parties, where the possibility exists for ocean transportation of items procured, contracted for or otherwise obtained by or on behalf of the grantee, borrower, or any of their contractors or subcontractors. The clauses required by this part shall provide that at least 50 percent of the freight revenue and tonnage of cargo generated by the U.S. Government Grant, Guaranty, Loan or Advance of Funds be transported on privately owned United States-flag commercial vessels. These clauses shall also require that all parties provide to the Maritime Administration the necessary shipment information as set forth in § 381.3. A copy of the appropriate clauses required by this part shall be submitted by each affected agency or department to the Secretary, Maritime Administration, for approval no later than 30 days after the effective date of this part. The following are suggested acceptable clauses with respect to the use of United States-flag vessels to be incorporated in the Grant, Guaranty, Loan and/or Advance of Funds Agreements as well as contracts and subcontracts resulting therefrom:

(a) *Agreement Clauses.* "Use of United States-flag vessels:

"(1) Pursuant to Pub. L 664 (43 U.S.C. 1241(b)) at least 50 percent of any equipment, materials or commodities procured, contracted for or otherwise obtained with funds granted, guaranteed, loaned, or advanced by the U.S. Government under this agreement, and which may be transported by ocean vessel, shall be transported on privately owned United States-flag commercial vessels, if available.

"(2) Within 20 days following the date of loading for shipments originating within the United States or within 30 working days following the date of loading for shipments originating outside the United States, a legible copy of a rated, 'on-board' commercial ocean bill-of-lading in English for each shipment of cargo described in paragraph (a)(1) of this section shall be furnished to both the Contracting Officer (through the prime contractor in the case of subcontractor bills-of-lading) and to the Division of National Cargo, Office of Market Development, Maritime Administration, Washington, DC 20590."

(b) *Contractor and Subcontractor Clauses.* "Use of United States-flag vessels: The contractor agrees --

"(1) To utilize privately owned United States-flag commercial vessels to ship at least 50 percent of the gross tonnage (computed separately for dry bulk carriers, dry cargo liners, and tankers) involved, whenever shipping any equipment, material, or commodities pursuant to this contract, to the extent such vessels are available at fair and reasonable rates for United States-flag commercial vessels.

"(2) To furnish within 20 days following the date of loading for shipments originating within the United

States or within 30 working days following the date of loading for shipments originating outside the United States, a legible copy of a rated, 'on-board' commercial ocean bill-of-lading in English for each shipment of cargo described in paragraph (b) (1) of this section to both the Contracting Officer (through the prime contractor in the case of subcontractor bills-of-lading) and to the Division of National Cargo, Office of Market Development, Maritime Administration, Washington, DC 20590.

"(3) To insert the substance of the provisions of this clause in all subcontracts issued pursuant to this contract."

(Reorganization Plans No.21 of 1950(64 Stat. 1273) and No. 7 of 1961 (75 Stat. 840) as amended by Pub. L 91.469 (84 Stat 1036) and Department of Commerce Organization Order 10-8 (38 FR 19707, July 23, 1973)) (42 FR 57126, Nov. 1, 1977]

**REQUIRED CONTRACT PROVISIONS  
FEDERAL-AID CONSTRUCTION CONTRACTS**

---

- I. General
- II. Nondiscrimination
- III. Nonsegregated Facilities
- IV. Davis-Bacon and Related Act Provisions
- V. Contract Work Hours and Safety Standards Act Provisions
- VI. Subletting or Assigning the Contract
- VII. Safety: Accident Prevention
- VIII. False Statements Concerning Highway Projects
- IX. Implementation of Clean Air Act and Federal Water Pollution Control Act
- X. Compliance with Governmentwide Suspension and Debarment Requirements
- XI. Certification Regarding Use of Contract Funds for Lobbying

**ATTACHMENTS**

A. Employment and Materials Preference for Appalachian Development Highway System or Appalachian Local Access Road Contracts (included in Appalachian contracts only)

**I. GENERAL**

1. Form FHWA-1273 must be physically incorporated in each construction contract funded under Title 23 (excluding emergency contracts solely intended for debris removal). The contractor (or subcontractor) must insert this form in each subcontract and further require its inclusion in all lower tier subcontracts (excluding purchase orders, rental agreements and other agreements for supplies or services).

The applicable requirements of Form FHWA-1273 are incorporated by reference for work done under any purchase order, rental agreement or agreement for other services. The prime contractor shall be responsible for compliance by any subcontractor, lower-tier subcontractor or service provider.

Form FHWA-1273 must be included in all Federal-aid design-build contracts, in all subcontracts and in lower tier subcontracts (excluding subcontracts for design services, purchase orders, rental agreements and other agreements for supplies or services). The design-builder shall be responsible for compliance by any subcontractor, lower-tier subcontractor or service provider.

Contracting agencies may reference Form FHWA-1273 in bid proposal or request for proposal documents, however, the Form FHWA-1273 must be physically incorporated (not referenced) in all contracts, subcontracts and lower-tier subcontracts (excluding purchase orders, rental agreements and other agreements for supplies or services related to a construction contract).

2. Subject to the applicability criteria noted in the following sections, these contract provisions shall apply to all work performed on the contract by the contractor's own organization and with the assistance of workers under the contractor's immediate superintendence and to all work performed on the contract by piecework, station work, or by subcontract.

3. A breach of any of the stipulations contained in these Required Contract Provisions may be sufficient grounds for withholding of progress payments, withholding of final payment, termination of the contract, suspension / debarment or any other action determined to be appropriate by the contracting agency and FHWA.

4. Selection of Labor: During the performance of this contract, the contractor shall not use convict labor for any purpose within the limits of a construction project on a Federal-aid highway unless it is labor performed by convicts who are on parole, supervised release, or probation. The term Federal-aid highway does not include roadways functionally classified as local roads or rural minor collectors.

**II. NONDISCRIMINATION**

The provisions of this section related to 23 CFR Part 230 are applicable to all Federal-aid construction contracts and to all related construction subcontracts of \$10,000 or more. The provisions of 23 CFR Part 230 are not applicable to material supply, engineering, or architectural service contracts.

In addition, the contractor and all subcontractors must comply with the following policies: Executive Order 11246, 41 CFR 60, 29 CFR 1625-1627, Title 23 USC Section 140, the Rehabilitation Act of 1973, as amended (29 USC 794), Title VI of the Civil Rights Act of 1964, as amended, and related regulations including 49 CFR Parts 21, 26 and 27; and 23 CFR Parts 200, 230, and 633.

The contractor and all subcontractors must comply with: the requirements of the Equal Opportunity Clause in 41 CFR 60-1.4(b) and, for all construction contracts exceeding \$10,000, the Standard Federal Equal Employment Opportunity Construction Contract Specifications in 41 CFR 60-4.3.

Note: The U.S. Department of Labor has exclusive authority to determine compliance with Executive Order 11246 and the policies of the Secretary of Labor including 41 CFR 60, and 29 CFR 1625-1627. The contracting agency and the FHWA have the authority and the responsibility to ensure compliance with Title 23 USC Section 140, the Rehabilitation Act of 1973, as amended (29 USC 794), and Title VI of the Civil Rights Act of 1964, as amended, and related regulations including 49 CFR Parts 21, 26 and 27; and 23 CFR Parts 200, 230, and 633.

The following provision is adopted from 23 CFR 230, Appendix A, with appropriate revisions to conform to the U.S. Department of Labor (US DOL) and FHWA requirements.

**1. Equal Employment Opportunity:** Equal employment opportunity (EEO) requirements not to discriminate and to take affirmative action to assure equal opportunity as set forth under laws, executive orders, rules, regulations (28 CFR 35, 29 CFR 1630, 29 CFR 1625-1627, 41 CFR 60 and 49 CFR 27) and orders of the Secretary of Labor as modified by the provisions prescribed herein, and imposed pursuant to 23 U.S.C. 140 shall constitute the EEO and specific affirmative action standards for the contractor's project activities under

this contract. The provisions of the Americans with Disabilities Act of 1990 (42 U.S.C. 12101 et seq.) set forth under 28 CFR 35 and 29 CFR 1630 are incorporated by reference in this contract. In the execution of this contract, the contractor agrees to comply with the following minimum specific requirement activities of EEO:

a. The contractor will work with the contracting agency and the Federal Government to ensure that it has made every good faith effort to provide equal opportunity with respect to all of its terms and conditions of employment and in their review of activities under the contract.

b. The contractor will accept as its operating policy the following statement:

"It is the policy of this Company to assure that applicants are employed, and that employees are treated during employment, without regard to their race, religion, sex, color, national origin, age or disability. Such action shall include: employment, upgrading, demotion, or transfer; recruitment or recruitment advertising; layoff or termination; rates of pay or other forms of compensation; and selection for training, including apprenticeship, pre-apprenticeship, and/or on-the-job training."

**2. EEO Officer:** The contractor will designate and make known to the contracting officers an EEO Officer who will have the responsibility for and must be capable of effectively administering and promoting an active EEO program and who must be assigned adequate authority and responsibility to do so.

**3. Dissemination of Policy:** All members of the contractor's staff who are authorized to hire, supervise, promote, and discharge employees, or who recommend such action, or who are substantially involved in such action, will be made fully cognizant of, and will implement, the contractor's EEO policy and contractual responsibilities to provide EEO in each grade and classification of employment. To ensure that the above agreement will be met, the following actions will be taken as a minimum:

a. Periodic meetings of supervisory and personnel office employees will be conducted before the start of work and then not less often than once every six months, at which time the contractor's EEO policy and its implementation will be reviewed and explained. The meetings will be conducted by the EEO Officer.

b. All new supervisory or personnel office employees will be given a thorough indoctrination by the EEO Officer, covering all major aspects of the contractor's EEO obligations within thirty days following their reporting for duty with the contractor.

c. All personnel who are engaged in direct recruitment for the project will be instructed by the EEO Officer in the contractor's procedures for locating and hiring minorities and women.

d. Notices and posters setting forth the contractor's EEO policy will be placed in areas readily accessible to employees, applicants for employment and potential employees.

e. The contractor's EEO policy and the procedures to implement such policy will be brought to the attention of employees by means of meetings, employee handbooks, or other appropriate means.

**4. Recruitment:** When advertising for employees, the contractor will include in all advertisements for employees the notation: "An Equal Opportunity Employer." All such advertisements will be placed in publications having a large circulation among minorities and women in the area from which the project work force would normally be derived.

a. The contractor will, unless precluded by a valid bargaining agreement, conduct systematic and direct recruitment through public and private employee referral sources likely to yield qualified minorities and women. To meet this requirement, the contractor will identify sources of potential minority group employees, and establish with such identified sources procedures whereby minority and women applicants may be referred to the contractor for employment consideration.

b. In the event the contractor has a valid bargaining agreement providing for exclusive hiring hall referrals, the contractor is expected to observe the provisions of that agreement to the extent that the system meets the contractor's compliance with EEO contract provisions. Where implementation of such an agreement has the effect of discriminating against minorities or women, or obligates the contractor to do the same, such implementation violates Federal nondiscrimination provisions.

c. The contractor will encourage its present employees to refer minorities and women as applicants for employment. Information and procedures with regard to referring such applicants will be discussed with employees.

**5. Personnel Actions:** Wages, working conditions, and employee benefits shall be established and administered, and personnel actions of every type, including hiring, upgrading, promotion, transfer, demotion, layoff, and termination, shall be taken without regard to race, color, religion, sex, national origin, age or disability. The following procedures shall be followed:

a. The contractor will conduct periodic inspections of project sites to insure that working conditions and employee facilities do not indicate discriminatory treatment of project site personnel.

b. The contractor will periodically evaluate the spread of wages paid within each classification to determine any evidence of discriminatory wage practices.

c. The contractor will periodically review selected personnel actions in depth to determine whether there is evidence of discrimination. Where evidence is found, the contractor will promptly take corrective action. If the review indicates that the discrimination may extend beyond the actions reviewed, such corrective action shall include all affected persons.

d. The contractor will promptly investigate all complaints of alleged discrimination made to the contractor in connection with its obligations under this contract, will attempt to resolve such complaints, and will take appropriate corrective action within a reasonable time. If the investigation indicates that the discrimination may affect persons other than the complainant, such corrective action shall include such other persons. Upon completion of each investigation, the contractor will inform every complainant of all of their avenues of appeal.

**6. Training and Promotion:**

a. The contractor will assist in locating, qualifying, and increasing the skills of minorities and women who are



applicants for employment or current employees. Such efforts should be aimed at developing full journey level status employees in the type of trade or job classification involved.

b. Consistent with the contractor's work force requirements and as permissible under Federal and State regulations, the contractor shall make full use of training programs, i.e., apprenticeship, and on-the-job training programs for the geographical area of contract performance. In the event a special provision for training is provided under this contract, this subparagraph will be superseded as indicated in the special provision. The contracting agency may reserve training positions for persons who receive welfare assistance in accordance with 23 U.S.C. 140(a).

c. The contractor will advise employees and applicants for employment of available training programs and entrance requirements for each.

d. The contractor will periodically review the training and promotion potential of employees who are minorities and women and will encourage eligible employees to apply for such training and promotion.

**7. Unions:** If the contractor relies in whole or in part upon unions as a source of employees, the contractor will use good faith efforts to obtain the cooperation of such unions to increase opportunities for minorities and women. Actions by the contractor, either directly or through a contractor's association acting as agent, will include the procedures set forth below:

a. The contractor will use good faith efforts to develop, in cooperation with the unions, joint training programs aimed toward qualifying more minorities and women for membership in the unions and increasing the skills of minorities and women so that they may qualify for higher paying employment.

b. The contractor will use good faith efforts to incorporate an EEO clause into each union agreement to the end that such union will be contractually bound to refer applicants without regard to their race, color, religion, sex, national origin, age or disability.

c. The contractor is to obtain information as to the referral practices and policies of the labor union except that to the extent such information is within the exclusive possession of the labor union and such labor union refuses to furnish such information to the contractor, the contractor shall so certify to the contracting agency and shall set forth what efforts have been made to obtain such information.

d. In the event the union is unable to provide the contractor with a reasonable flow of referrals within the time limit set forth in the collective bargaining agreement, the contractor will, through independent recruitment efforts, fill the employment vacancies without regard to race, color, religion, sex, national origin, age or disability; making full efforts to obtain qualified and/or qualifiable minorities and women. The failure of a union to provide sufficient referrals (even though it is obligated to provide exclusive referrals under the terms of a collective bargaining agreement) does not relieve the contractor from the requirements of this paragraph. In the event the union referral practice prevents the contractor from meeting the obligations pursuant to Executive Order 11246, as amended, and these special provisions, such contractor shall immediately notify the contracting agency.

**8. Reasonable Accommodation for Applicants / Employees with Disabilities:** The contractor must be familiar

with the requirements for and comply with the Americans with Disabilities Act and all rules and regulations established there under. Employers must provide reasonable accommodation in all employment activities unless to do so would cause an undue hardship.

**9. Selection of Subcontractors, Procurement of Materials and Leasing of Equipment:** The contractor shall not discriminate on the grounds of race, color, religion, sex, national origin, age or disability in the selection and retention of subcontractors, including procurement of materials and leases of equipment. The contractor shall take all necessary and reasonable steps to ensure nondiscrimination in the administration of this contract.

a. The contractor shall notify all potential subcontractors and suppliers and lessors of their EEO obligations under this contract.

b. The contractor will use good faith efforts to ensure subcontractor compliance with their EEO obligations.

**10. Assurance Required by 49 CFR 26.13(b):**

a. The requirements of 49 CFR Part 26 and the State DOT's U.S. DOT-approved DBE program are incorporated by reference.

b. The contractor or subcontractor shall not discriminate on the basis of race, color, national origin, or sex in the performance of this contract. The contractor shall carry out applicable requirements of 49 CFR Part 26 in the award and administration of DOT-assisted contracts. Failure by the contractor to carry out these requirements is a material breach of this contract, which may result in the termination of this contract or such other remedy as the contracting agency deems appropriate.

**11. Records and Reports:** The contractor shall keep such records as necessary to document compliance with the EEO requirements. Such records shall be retained for a period of three years following the date of the final payment to the contractor for all contract work and shall be available at reasonable times and places for inspection by authorized representatives of the contracting agency and the FHWA.

a. The records kept by the contractor shall document the following:

(1) The number and work hours of minority and non-minority group members and women employed in each work classification on the project;

(2) The progress and efforts being made in cooperation with unions, when applicable, to increase employment opportunities for minorities and women; and

(3) The progress and efforts being made in locating, hiring, training, qualifying, and upgrading minorities and women;

b. The contractors and subcontractors will submit an annual report to the contracting agency each July for the duration of the project, indicating the number of minority, women, and non-minority group employees currently engaged in each work classification required by the contract work. This information is to be reported on [Form FHWA-1391](#). The staffing data should represent the project work force on board in all or any part of the last payroll period preceding the end of July. If on-the-job training is being required by special provision, the contractor

will be required to collect and report training data. The employment data should reflect the work force on board during all or any part of the last payroll period preceding the end of July.

### III. NONSEGREGATED FACILITIES

This provision is applicable to all Federal-aid construction contracts and to all related construction subcontracts of \$10,000 or more.

The contractor must ensure that facilities provided for employees are provided in such a manner that segregation on the basis of race, color, religion, sex, or national origin cannot result. The contractor may neither require such segregated use by written or oral policies nor tolerate such use by employee custom. The contractor's obligation extends further to ensure that its employees are not assigned to perform their services at any location, under the contractor's control, where the facilities are segregated. The term "facilities" includes waiting rooms, work areas, restaurants and other eating areas, time clocks, restrooms, washrooms, locker rooms, and other storage or dressing areas, parking lots, drinking fountains, recreation or entertainment areas, transportation, and housing provided for employees. The contractor shall provide separate or single-user restrooms and necessary dressing or sleeping areas to assure privacy between sexes.

### IV. DAVIS-BACON AND RELATED ACT PROVISIONS

This section is applicable to all Federal-aid construction projects exceeding \$2,000 and to all related subcontracts and lower-tier subcontracts (regardless of subcontract size). The requirements apply to all projects located within the right-of-way of a roadway that is functionally classified as Federal-aid highway. This excludes roadways functionally classified as local roads or rural minor collectors, which are exempt. Contracting agencies may elect to apply these requirements to other projects.

The following provisions are from the U.S. Department of Labor regulations in 29 CFR 5.5 "Contract provisions and related matters" with minor revisions to conform to the FHWA-1273 format and FHWA program requirements.

#### 1. Minimum wages

a. All laborers and mechanics employed or working upon the site of the work, will be paid unconditionally and not less often than once a week, and without subsequent deduction or rebate on any account (except such payroll deductions as are permitted by regulations issued by the Secretary of Labor under the Copeland Act (29 CFR part 3)), the full amount of wages and bona fide fringe benefits (or cash equivalents thereof) due at time of payment computed at rates not less than those contained in the wage determination of the Secretary of Labor which is attached hereto and made a part hereof, regardless of any contractual relationship which may be alleged to exist between the contractor and such laborers and mechanics.

Contributions made or costs reasonably anticipated for bona fide fringe benefits under section 1(b)(2) of the Davis-Bacon Act on behalf of laborers or mechanics are considered wages

paid to such laborers or mechanics, subject to the provisions of paragraph 1.d. of this section; also, regular contributions made or costs incurred for more than a weekly period (but not less often than quarterly) under plans, funds, or programs which cover the particular weekly period, are deemed to be constructively made or incurred during such weekly period. Such laborers and mechanics shall be paid the appropriate wage rate and fringe benefits on the wage determination for the classification of work actually performed, without regard to skill, except as provided in 29 CFR 5.5(a)(4). Laborers or mechanics performing work in more than one classification may be compensated at the rate specified for each classification for the time actually worked therein: Provided, That the employer's payroll records accurately set forth the time spent in each classification in which work is performed. The wage determination (including any additional classification and wage rates conformed under paragraph 1.b. of this section) and the Davis-Bacon poster (WH-1321) shall be posted at all times by the contractor and its subcontractors at the site of the work in a prominent and accessible place where it can be easily seen by the workers.

b. (1) The contracting officer shall require that any class of laborers or mechanics, including helpers, which is not listed in the wage determination and which is to be employed under the contract shall be classified in conformance with the wage determination. The contracting officer shall approve an additional classification and wage rate and fringe benefits therefore only when the following criteria have been met:

(i) The work to be performed by the classification requested is not performed by a classification in the wage determination; and

(ii) The classification is utilized in the area by the construction industry; and

(iii) The proposed wage rate, including any bona fide fringe benefits, bears a reasonable relationship to the wage rates contained in the wage determination.

(2) If the contractor and the laborers and mechanics to be employed in the classification (if known), or their representatives, and the contracting officer agree on the classification and wage rate (including the amount designated for fringe benefits where appropriate), a report of the action taken shall be sent by the contracting officer to the Administrator of the Wage and Hour Division, Employment Standards Administration, U.S. Department of Labor, Washington, DC 20210. The Administrator, or an authorized representative, will approve, modify, or disapprove every additional classification action within 30 days of receipt and so advise the contracting officer or will notify the contracting officer within the 30-day period that additional time is necessary.

(3) In the event the contractor, the laborers or mechanics to be employed in the classification or their representatives, and the contracting officer do not agree on the proposed classification and wage rate (including the amount designated for fringe benefits, where appropriate), the contracting officer shall refer the questions, including the views of all interested parties and the recommendation of the contracting officer, to the Wage and Hour Administrator for determination. The Wage and Hour Administrator, or an authorized representative, will issue a determination within 30 days of receipt and so advise

the contracting officer or will notify the contracting officer within the 30-day period that additional time is necessary.

(4) The wage rate (including fringe benefits where appropriate) determined pursuant to paragraphs 1.b.(2) or 1.b.(3) of this section, shall be paid to all workers performing work in the classification under this contract from the first day on which work is performed in the classification.

c. Whenever the minimum wage rate prescribed in the contract for a class of laborers or mechanics includes a fringe benefit which is not expressed as an hourly rate, the contractor shall either pay the benefit as stated in the wage determination or shall pay another bona fide fringe benefit or an hourly cash equivalent thereof.

d. If the contractor does not make payments to a trustee or other third person, the contractor may consider as part of the wages of any laborer or mechanic the amount of any costs reasonably anticipated in providing bona fide fringe benefits under a plan or program, Provided, That the Secretary of Labor has found, upon the written request of the contractor, that the applicable standards of the Davis-Bacon Act have been met. The Secretary of Labor may require the contractor to set aside in a separate account assets for the meeting of obligations under the plan or program.

## 2. Withholding

The contracting agency shall upon its own action or upon written request of an authorized representative of the Department of Labor, withhold or cause to be withheld from the contractor under this contract, or any other Federal contract with the same prime contractor, or any other federally-assisted contract subject to Davis-Bacon prevailing wage requirements, which is held by the same prime contractor, so much of the accrued payments or advances as may be considered necessary to pay laborers and mechanics, including apprentices, trainees, and helpers, employed by the contractor or any subcontractor the full amount of wages required by the contract. In the event of failure to pay any laborer or mechanic, including any apprentice, trainee, or helper, employed or working on the site of the work, all or part of the wages required by the contract, the contracting agency may, after written notice to the contractor, take such action as may be necessary to cause the suspension of any further payment, advance, or guarantee of funds until such violations have ceased.

## 3. Payrolls and basic records

a. Payrolls and basic records relating thereto shall be maintained by the contractor during the course of the work and preserved for a period of three years thereafter for all laborers and mechanics working at the site of the work. Such records shall contain the name, address, and social security number of each such worker, his or her correct classification, hourly rates of wages paid (including rates of contributions or costs anticipated for bona fide fringe benefits or cash equivalents thereof of the types described in section 1(b)(2)(B) of the Davis-Bacon Act), daily and weekly number of hours worked, deductions made and actual wages paid. Whenever the Secretary of Labor has found under 29 CFR 5.5(a)(1)(iv) that the wages of any laborer or mechanic include the amount of any costs reasonably anticipated in providing benefits under a plan or program described in section 1(b)(2)(B) of the Davis-

Bacon Act, the contractor shall maintain records which show that the commitment to provide such benefits is enforceable, that the plan or program is financially responsible, and that the plan or program has been communicated in writing to the laborers or mechanics affected, and records which show the costs anticipated or the actual cost incurred in providing such benefits. Contractors employing apprentices or trainees under approved programs shall maintain written evidence of the registration of apprenticeship programs and certification of trainee programs, the registration of the apprentices and trainees, and the ratios and wage rates prescribed in the applicable programs.

b. (1) The contractor shall submit weekly for each week in which any contract work is performed a copy of all payrolls to the contracting agency. The payrolls submitted shall set out accurately and completely all of the information required to be maintained under 29 CFR 5.5(a)(3)(i), except that full social security numbers and home addresses shall not be included on weekly transmittals. Instead the payrolls shall only need to include an individually identifying number for each employee ( e.g. , the last four digits of the employee's social security number). The required weekly payroll information may be submitted in any form desired. Optional Form WH-347 is available for this purpose from the Wage and Hour Division Web site at <http://www.dol.gov/esa/whd/forms/wh347instr.htm> or its successor site. The prime contractor is responsible for the submission of copies of payrolls by all subcontractors. Contractors and subcontractors shall maintain the full social security number and current address of each covered worker, and shall provide them upon request to the contracting agency for transmission to the State DOT, the FHWA or the Wage and Hour Division of the Department of Labor for purposes of an investigation or audit of compliance with prevailing wage requirements. It is not a violation of this section for a prime contractor to require a subcontractor to provide addresses and social security numbers to the prime contractor for its own records, without weekly submission to the contracting agency..

(2) Each payroll submitted shall be accompanied by a "Statement of Compliance," signed by the contractor or subcontractor or his or her agent who pays or supervises the payment of the persons employed under the contract and shall certify the following:

(i) That the payroll for the payroll period contains the information required to be provided under §5.5 (a)(3)(ii) of Regulations, 29 CFR part 5, the appropriate information is being maintained under §5.5 (a)(3)(i) of Regulations, 29 CFR part 5, and that such information is correct and complete;

(ii) That each laborer or mechanic (including each helper, apprentice, and trainee) employed on the contract during the payroll period has been paid the full weekly wages earned, without rebate, either directly or indirectly, and that no deductions have been made either directly or indirectly from the full wages earned, other than permissible deductions as set forth in Regulations, 29 CFR part 3;

(iii) That each laborer or mechanic has been paid not less than the applicable wage rates and fringe benefits or cash equivalents for the classification of work performed, as specified in the applicable wage determination incorporated into the contract.

(3) The weekly submission of a properly executed certification set forth on the reverse side of Optional Form WH-347 shall satisfy the requirement for submission of the "Statement of Compliance" required by paragraph 3.b.(2) of this section.

(4) The falsification of any of the above certifications may subject the contractor or subcontractor to civil or criminal prosecution under section 1001 of title 18 and section 231 of title 31 of the United States Code.

c. The contractor or subcontractor shall make the records required under paragraph 3.a. of this section available for inspection, copying, or transcription by authorized representatives of the contracting agency, the State DOT, the FHWA, or the Department of Labor, and shall permit such representatives to interview employees during working hours on the job. If the contractor or subcontractor fails to submit the required records or to make them available, the FHWA may, after written notice to the contractor, the contracting agency or the State DOT, take such action as may be necessary to cause the suspension of any further payment, advance, or guarantee of funds. Furthermore, failure to submit the required records upon request or to make such records available may be grounds for debarment action pursuant to 29 CFR 5.12.

#### 4. Apprentices and trainees

##### a. Apprentices (programs of the USDOL).

Apprentices will be permitted to work at less than the predetermined rate for the work they performed when they are employed pursuant to and individually registered in a bona fide apprenticeship program registered with the U.S. Department of Labor, Employment and Training Administration, Office of Apprenticeship Training, Employer and Labor Services, or with a State Apprenticeship Agency recognized by the Office, or if a person is employed in his or her first 90 days of probationary employment as an apprentice in such an apprenticeship program, who is not individually registered in the program, but who has been certified by the Office of Apprenticeship Training, Employer and Labor Services or a State Apprenticeship Agency (where appropriate) to be eligible for probationary employment as an apprentice.

The allowable ratio of apprentices to journeymen on the job site in any craft classification shall not be greater than the ratio permitted to the contractor as to the entire work force under the registered program. Any worker listed on a payroll at an apprentice wage rate, who is not registered or otherwise employed as stated above, shall be paid not less than the applicable wage rate on the wage determination for the classification of work actually performed. In addition, any apprentice performing work on the job site in excess of the ratio permitted under the registered program shall be paid not less than the applicable wage rate on the wage determination for the work actually performed. Where a contractor is performing construction on a project in a locality other than that in which its program is registered, the ratios and wage rates (expressed in percentages of the journeyman's hourly rate) specified in the contractor's or subcontractor's registered program shall be observed.

Every apprentice must be paid at not less than the rate specified in the registered program for the apprentice's level of progress, expressed as a percentage of the journeymen hourly

rate specified in the applicable wage determination. Apprentices shall be paid fringe benefits in accordance with the provisions of the apprenticeship program. If the apprenticeship program does not specify fringe benefits, apprentices must be paid the full amount of fringe benefits listed on the wage determination for the applicable classification. If the Administrator determines that a different practice prevails for the applicable apprentice classification, fringes shall be paid in accordance with that determination.

In the event the Office of Apprenticeship Training, Employer and Labor Services, or a State Apprenticeship Agency recognized by the Office, withdraws approval of an apprenticeship program, the contractor will no longer be permitted to utilize apprentices at less than the applicable predetermined rate for the work performed until an acceptable program is approved.

##### b. Trainees (programs of the USDOL).

Except as provided in 29 CFR 5.16, trainees will not be permitted to work at less than the predetermined rate for the work performed unless they are employed pursuant to and individually registered in a program which has received prior approval, evidenced by formal certification by the U.S. Department of Labor, Employment and Training Administration.

The ratio of trainees to journeymen on the job site shall not be greater than permitted under the plan approved by the Employment and Training Administration.

Every trainee must be paid at not less than the rate specified in the approved program for the trainee's level of progress, expressed as a percentage of the journeyman hourly rate specified in the applicable wage determination. Trainees shall be paid fringe benefits in accordance with the provisions of the trainee program. If the trainee program does not mention fringe benefits, trainees shall be paid the full amount of fringe benefits listed on the wage determination unless the Administrator of the Wage and Hour Division determines that there is an apprenticeship program associated with the corresponding journeyman wage rate on the wage determination which provides for less than full fringe benefits for apprentices. Any employee listed on the payroll at a trainee rate who is not registered and participating in a training plan approved by the Employment and Training Administration shall be paid not less than the applicable wage rate on the wage determination for the classification of work actually performed. In addition, any trainee performing work on the job site in excess of the ratio permitted under the registered program shall be paid not less than the applicable wage rate on the wage determination for the work actually performed.

In the event the Employment and Training Administration withdraws approval of a training program, the contractor will no longer be permitted to utilize trainees at less than the applicable predetermined rate for the work performed until an acceptable program is approved.

c. Equal employment opportunity. The utilization of apprentices, trainees and journeymen under this part shall be in conformity with the equal employment opportunity requirements of Executive Order 11246, as amended, and 29 CFR part 30.

d. Apprentices and Trainees (programs of the U.S. DOT).

Apprentices and trainees working under apprenticeship and skill training programs which have been certified by the Secretary of Transportation as promoting EEO in connection with Federal-aid highway construction programs are not subject to the requirements of paragraph 4 of this Section IV. The straight time hourly wage rates for apprentices and trainees under such programs will be established by the particular programs. The ratio of apprentices and trainees to journeymen shall not be greater than permitted by the terms of the particular program.

**5. Compliance with Copeland Act requirements.** The contractor shall comply with the requirements of 29 CFR part 3, which are incorporated by reference in this contract.

**6. Subcontracts.** The contractor or subcontractor shall insert Form FHWA-1273 in any subcontracts and also require the subcontractors to include Form FHWA-1273 in any lower tier subcontracts. The prime contractor shall be responsible for the compliance by any subcontractor or lower tier subcontractor with all the contract clauses in 29 CFR 5.5.

**7. Contract termination: debarment.** A breach of the contract clauses in 29 CFR 5.5 may be grounds for termination of the contract, and for debarment as a contractor and a subcontractor as provided in 29 CFR 5.12.

**8. Compliance with Davis-Bacon and Related Act requirements.** All rulings and interpretations of the Davis-Bacon and Related Acts contained in 29 CFR parts 1, 3, and 5 are herein incorporated by reference in this contract.

**9. Disputes concerning labor standards.** Disputes arising out of the labor standards provisions of this contract shall not be subject to the general disputes clause of this contract. Such disputes shall be resolved in accordance with the procedures of the Department of Labor set forth in 29 CFR parts 5, 6, and 7. Disputes within the meaning of this clause include disputes between the contractor (or any of its subcontractors) and the contracting agency, the U.S. Department of Labor, or the employees or their representatives.

**10. Certification of eligibility.**

a. By entering into this contract, the contractor certifies that neither it (nor he or she) nor any person or firm who has an interest in the contractor's firm is a person or firm ineligible to be awarded Government contracts by virtue of section 3(a) of the Davis-Bacon Act or 29 CFR 5.12(a)(1).

b. No part of this contract shall be subcontracted to any person or firm ineligible for award of a Government contract by virtue of section 3(a) of the Davis-Bacon Act or 29 CFR 5.12(a)(1).

c. The penalty for making false statements is prescribed in the U.S. Criminal Code, 18 U.S.C. 1001.

**V. CONTRACT WORK HOURS AND SAFETY STANDARDS ACT**

The following clauses apply to any Federal-aid construction contract in an amount in excess of \$100,000 and subject to the overtime provisions of the Contract Work Hours and Safety Standards Act. These clauses shall be inserted in addition to the clauses required by 29 CFR 5.5(a) or 29 CFR 4.6. As used in this paragraph, the terms laborers and mechanics include watchmen and guards.

**1. Overtime requirements.** No contractor or subcontractor contracting for any part of the contract work which may require or involve the employment of laborers or mechanics shall require or permit any such laborer or mechanic in any workweek in which he or she is employed on such work to work in excess of forty hours in such workweek unless such laborer or mechanic receives compensation at a rate not less than one and one-half times the basic rate of pay for all hours worked in excess of forty hours in such workweek.

**2. Violation; liability for unpaid wages; liquidated damages.** In the event of any violation of the clause set forth in paragraph (1.) of this section, the contractor and any subcontractor responsible therefor shall be liable for the unpaid wages. In addition, such contractor and subcontractor shall be liable to the United States (in the case of work done under contract for the District of Columbia or a territory, to such District or to such territory), for liquidated damages. Such liquidated damages shall be computed with respect to each individual laborer or mechanic, including watchmen and guards, employed in violation of the clause set forth in paragraph (1.) of this section, in the sum of \$10 for each calendar day on which such individual was required or permitted to work in excess of the standard workweek of forty hours without payment of the overtime wages required by the clause set forth in paragraph (1.) of this section.

**3. Withholding for unpaid wages and liquidated damages.** The FHWA or the contacting agency shall upon its own action or upon written request of an authorized representative of the Department of Labor withhold or cause to be withheld, from any moneys payable on account of work performed by the contractor or subcontractor under any such contract or any other Federal contract with the same prime contractor, or any other federally-assisted contract subject to the Contract Work Hours and Safety Standards Act, which is held by the same prime contractor, such sums as may be determined to be necessary to satisfy any liabilities of such contractor or subcontractor for unpaid wages and liquidated damages as provided in the clause set forth in paragraph (2.) of this section.

**4. Subcontracts.** The contractor or subcontractor shall insert in any subcontracts the clauses set forth in paragraph (1.) through (4.) of this section and also a clause requiring the subcontractors to include these clauses in any lower tier subcontracts. The prime contractor shall be responsible for compliance by any subcontractor or lower tier subcontractor with the clauses set forth in paragraphs (1.) through (4.) of this section.

## VI. SUBLETTING OR ASSIGNING THE CONTRACT

This provision is applicable to all Federal-aid construction contracts on the National Highway System.

1. The contractor shall perform with its own organization contract work amounting to not less than 30 percent (or a greater percentage if specified elsewhere in the contract) of the total original contract price, excluding any specialty items designated by the contracting agency. Specialty items may be performed by subcontract and the amount of any such specialty items performed may be deducted from the total original contract price before computing the amount of work required to be performed by the contractor's own organization (23 CFR 635.116).

a. The term "perform work with its own organization" refers to workers employed or leased by the prime contractor, and equipment owned or rented by the prime contractor, with or without operators. Such term does not include employees or equipment of a subcontractor or lower tier subcontractor, agents of the prime contractor, or any other assignees. The term may include payments for the costs of hiring leased employees from an employee leasing firm meeting all relevant Federal and State regulatory requirements. Leased employees may only be included in this term if the prime contractor meets all of the following conditions:

(1) the prime contractor maintains control over the supervision of the day-to-day activities of the leased employees;

(2) the prime contractor remains responsible for the quality of the work of the leased employees;

(3) the prime contractor retains all power to accept or exclude individual employees from work on the project; and

(4) the prime contractor remains ultimately responsible for the payment of predetermined minimum wages, the submission of payrolls, statements of compliance and all other Federal regulatory requirements.

b. "Specialty Items" shall be construed to be limited to work that requires highly specialized knowledge, abilities, or equipment not ordinarily available in the type of contracting organizations qualified and expected to bid or propose on the contract as a whole and in general are to be limited to minor components of the overall contract.

2. The contract amount upon which the requirements set forth in paragraph (1) of Section VI is computed includes the cost of material and manufactured products which are to be purchased or produced by the contractor under the contract provisions.

3. The contractor shall furnish (a) a competent superintendent or supervisor who is employed by the firm, has full authority to direct performance of the work in accordance with the contract requirements, and is in charge of all construction operations (regardless of who performs the work) and (b) such other of its own organizational resources (supervision, management, and engineering services) as the contracting officer determines is necessary to assure the performance of the contract.

4. No portion of the contract shall be sublet, assigned or otherwise disposed of except with the written consent of the contracting officer, or authorized representative, and such consent when given shall not be construed to relieve the contractor of any responsibility for the fulfillment of the contract. Written consent will be given only after the

contracting agency has assured that each subcontract is evidenced in writing and that it contains all pertinent provisions and requirements of the prime contract.

5. The 30% self-performance requirement of paragraph (1) is not applicable to design-build contracts; however, contracting agencies may establish their own self-performance requirements.

## VII. SAFETY: ACCIDENT PREVENTION

This provision is applicable to all Federal-aid construction contracts and to all related subcontracts.

1. In the performance of this contract the contractor shall comply with all applicable Federal, State, and local laws governing safety, health, and sanitation (23 CFR 635). The contractor shall provide all safeguards, safety devices and protective equipment and take any other needed actions as it determines, or as the contracting officer may determine, to be reasonably necessary to protect the life and health of employees on the job and the safety of the public and to protect property in connection with the performance of the work covered by the contract.

2. It is a condition of this contract, and shall be made a condition of each subcontract, which the contractor enters into pursuant to this contract, that the contractor and any subcontractor shall not permit any employee, in performance of the contract, to work in surroundings or under conditions which are unsanitary, hazardous or dangerous to his/her health or safety, as determined under construction safety and health standards (29 CFR 1926) promulgated by the Secretary of Labor, in accordance with Section 107 of the Contract Work Hours and Safety Standards Act (40 U.S.C. 3704).

3. Pursuant to 29 CFR 1926.3, it is a condition of this contract that the Secretary of Labor or authorized representative thereof, shall have right of entry to any site of contract performance to inspect or investigate the matter of compliance with the construction safety and health standards and to carry out the duties of the Secretary under Section 107 of the Contract Work Hours and Safety Standards Act (40 U.S.C.3704).

## VIII. FALSE STATEMENTS CONCERNING HIGHWAY PROJECTS

This provision is applicable to all Federal-aid construction contracts and to all related subcontracts.

In order to assure high quality and durable construction in conformity with approved plans and specifications and a high degree of reliability on statements and representations made by engineers, contractors, suppliers, and workers on Federal-aid highway projects, it is essential that all persons concerned with the project perform their functions as carefully, thoroughly, and honestly as possible. Willful falsification, distortion, or misrepresentation with respect to any facts related to the project is a violation of Federal law. To prevent any misunderstanding regarding the seriousness of these and similar acts, Form FHWA-1022 shall be posted on each Federal-aid highway project (23 CFR 635) in one or more places where it is readily available to all persons concerned with the project:

18 U.S.C. 1020 reads as follows:

"Whoever, being an officer, agent, or employee of the United States, or of any State or Territory, or whoever, whether a person, association, firm, or corporation, knowingly makes any false statement, false representation, or false report as to the character, quality, quantity, or cost of the material used or to be used, or the quantity or quality of the work performed or to be performed, or the cost thereof in connection with the submission of plans, maps, specifications, contracts, or costs of construction on any highway or related project submitted for approval to the Secretary of Transportation; or

Whoever knowingly makes any false statement, false representation, false report or false claim with respect to the character, quality, quantity, or cost of any work performed or to be performed, or materials furnished or to be furnished, in connection with the construction of any highway or related project approved by the Secretary of Transportation; or

Whoever knowingly makes any false statement or false representation as to material fact in any statement, certificate, or report submitted pursuant to provisions of the Federal-aid Roads Act approved July 1, 1916, (39 Stat. 355), as amended and supplemented;

Shall be fined under this title or imprisoned not more than 5 years or both."

#### **IX. IMPLEMENTATION OF CLEAN AIR ACT AND FEDERAL WATER POLLUTION CONTROL ACT**

This provision is applicable to all Federal-aid construction contracts and to all related subcontracts.

By submission of this bid/proposal or the execution of this contract, or subcontract, as appropriate, the bidder, proposer, Federal-aid construction contractor, or subcontractor, as appropriate, will be deemed to have stipulated as follows:

1. That any person who is or will be utilized in the performance of this contract is not prohibited from receiving an award due to a violation of Section 508 of the Clean Water Act or Section 306 of the Clean Air Act.

2. That the contractor agrees to include or cause to be included the requirements of paragraph (1) of this Section X in every subcontract, and further agrees to take such action as the contracting agency may direct as a means of enforcing such requirements.

#### **X. CERTIFICATION REGARDING DEBARMENT, SUSPENSION, INELIGIBILITY AND VOLUNTARY EXCLUSION**

This provision is applicable to all Federal-aid construction contracts, design-build contracts, subcontracts, lower-tier subcontracts, purchase orders, lease agreements, consultant contracts or any other covered transaction requiring FHWA approval or that is estimated to cost \$25,000 or more – as defined in 2 CFR Parts 180 and 1200.

##### **1. Instructions for Certification – First Tier Participants:**

a. By signing and submitting this proposal, the prospective first tier participant is providing the certification set out below.

b. The inability of a person to provide the certification set out below will not necessarily result in denial of participation in this

covered transaction. The prospective first tier participant shall submit an explanation of why it cannot provide the certification set out below. The certification or explanation will be considered in connection with the department or agency's determination whether to enter into this transaction. However, failure of the prospective first tier participant to furnish a certification or an explanation shall disqualify such a person from participation in this transaction.

c. The certification in this clause is a material representation of fact upon which reliance was placed when the contracting agency determined to enter into this transaction. If it is later determined that the prospective participant knowingly rendered an erroneous certification, in addition to other remedies available to the Federal Government, the contracting agency may terminate this transaction for cause of default.

d. The prospective first tier participant shall provide immediate written notice to the contracting agency to whom this proposal is submitted if any time the prospective first tier participant learns that its certification was erroneous when submitted or has become erroneous by reason of changed circumstances.

e. The terms "covered transaction," "debarred," "suspended," "ineligible," "participant," "person," "principal," and "voluntarily excluded," as used in this clause, are defined in 2 CFR Parts 180 and 1200. "First Tier Covered Transactions" refers to any covered transaction between a grantee or subgrantee of Federal funds and a participant (such as the prime or general contractor). "Lower Tier Covered Transactions" refers to any covered transaction under a First Tier Covered Transaction (such as subcontracts). "First Tier Participant" refers to the participant who has entered into a covered transaction with a grantee or subgrantee of Federal funds (such as the prime or general contractor). "Lower Tier Participant" refers any participant who has entered into a covered transaction with a First Tier Participant or other Lower Tier Participants (such as subcontractors and suppliers).

f. The prospective first tier participant agrees by submitting this proposal that, should the proposed covered transaction be entered into, it shall not knowingly enter into any lower tier covered transaction with a person who is debarred, suspended, declared ineligible, or voluntarily excluded from participation in this covered transaction, unless authorized by the department or agency entering into this transaction.

g. The prospective first tier participant further agrees by submitting this proposal that it will include the clause titled "Certification Regarding Debarment, Suspension, Ineligibility and Voluntary Exclusion-Lower Tier Covered Transactions," provided by the department or contracting agency, entering into this covered transaction, without modification, in all lower tier covered transactions and in all solicitations for lower tier covered transactions exceeding the \$25,000 threshold.

h. A participant in a covered transaction may rely upon a certification of a prospective participant in a lower tier covered transaction that is not debarred, suspended, ineligible, or voluntarily excluded from the covered transaction, unless it knows that the certification is erroneous. A participant is responsible for ensuring that its principals are not suspended, debarred, or otherwise ineligible to participate in covered transactions. To verify the eligibility of its principals, as well as the eligibility of any lower tier prospective participants, each participant may, but is not required to, check the Excluded Parties List System website (<https://www.epls.gov/>), which is compiled by the General Services Administration.

i. Nothing contained in the foregoing shall be construed to require the establishment of a system of records in order to render in good faith the certification required by this clause. The knowledge and information of the prospective participant is not required to exceed that which is normally possessed by a prudent person in the ordinary course of business dealings.

j. Except for transactions authorized under paragraph (f) of these instructions, if a participant in a covered transaction knowingly enters into a lower tier covered transaction with a person who is suspended, debarred, ineligible, or voluntarily excluded from participation in this transaction, in addition to other remedies available to the Federal Government, the department or agency may terminate this transaction for cause or default.

\* \* \* \* \*

## **2. Certification Regarding Debarment, Suspension, Ineligibility and Voluntary Exclusion – First Tier Participants:**

a. The prospective first tier participant certifies to the best of its knowledge and belief, that it and its principals:

(1) Are not presently debarred, suspended, proposed for debarment, declared ineligible, or voluntarily excluded from participating in covered transactions by any Federal department or agency;

(2) Have not within a three-year period preceding this proposal been convicted of or had a civil judgment rendered against them for commission of fraud or a criminal offense in connection with obtaining, attempting to obtain, or performing a public (Federal, State or local) transaction or contract under a public transaction; violation of Federal or State antitrust statutes or commission of embezzlement, theft, forgery, bribery, falsification or destruction of records, making false statements, or receiving stolen property;

(3) Are not presently indicted for or otherwise criminally or civilly charged by a governmental entity (Federal, State or local) with commission of any of the offenses enumerated in paragraph (a)(2) of this certification; and

(4) Have not within a three-year period preceding this application/proposal had one or more public transactions (Federal, State or local) terminated for cause or default.

b. Where the prospective participant is unable to certify to any of the statements in this certification, such prospective participant shall attach an explanation to this proposal.

### **2. Instructions for Certification - Lower Tier Participants:**

(Applicable to all subcontracts, purchase orders and other lower tier transactions requiring prior FHWA approval or estimated to cost \$25,000 or more - 2 CFR Parts 180 and 1200)

a. By signing and submitting this proposal, the prospective lower tier is providing the certification set out below.

b. The certification in this clause is a material representation of fact upon which reliance was placed when this transaction was entered into. If it is later determined that the prospective lower tier participant knowingly rendered an erroneous certification, in addition to other remedies available to the Federal Government, the department, or agency with which

this transaction originated may pursue available remedies, including suspension and/or debarment.

c. The prospective lower tier participant shall provide immediate written notice to the person to which this proposal is submitted if at any time the prospective lower tier participant learns that its certification was erroneous by reason of changed circumstances.

d. The terms "covered transaction," "debarred," "suspended," "ineligible," "participant," "person," "principal," and "voluntarily excluded," as used in this clause, are defined in 2 CFR Parts 180 and 1200. You may contact the person to which this proposal is submitted for assistance in obtaining a copy of those regulations. "First Tier Covered Transactions" refers to any covered transaction between a grantee or subgrantee of Federal funds and a participant (such as the prime or general contract). "Lower Tier Covered Transactions" refers to any covered transaction under a First Tier Covered Transaction (such as subcontracts). "First Tier Participant" refers to the participant who has entered into a covered transaction with a grantee or subgrantee of Federal funds (such as the prime or general contractor). "Lower Tier Participant" refers any participant who has entered into a covered transaction with a First Tier Participant or other Lower Tier Participants (such as subcontractors and suppliers).

e. The prospective lower tier participant agrees by submitting this proposal that, should the proposed covered transaction be entered into, it shall not knowingly enter into any lower tier covered transaction with a person who is debarred, suspended, declared ineligible, or voluntarily excluded from participation in this covered transaction, unless authorized by the department or agency with which this transaction originated.

f. The prospective lower tier participant further agrees by submitting this proposal that it will include this clause titled "Certification Regarding Debarment, Suspension, Ineligibility and Voluntary Exclusion-Lower Tier Covered Transaction," without modification, in all lower tier covered transactions and in all solicitations for lower tier covered transactions exceeding the \$25,000 threshold.

g. A participant in a covered transaction may rely upon a certification of a prospective participant in a lower tier covered transaction that is not debarred, suspended, ineligible, or voluntarily excluded from the covered transaction, unless it knows that the certification is erroneous. A participant is responsible for ensuring that its principals are not suspended, debarred, or otherwise ineligible to participate in covered transactions. To verify the eligibility of its principals, as well as the eligibility of any lower tier prospective participants, each participant may, but is not required to, check the Excluded Parties List System website (<https://www.epls.gov/>), which is compiled by the General Services Administration.

h. Nothing contained in the foregoing shall be construed to require establishment of a system of records in order to render in good faith the certification required by this clause. The knowledge and information of participant is not required to exceed that which is normally possessed by a prudent person in the ordinary course of business dealings.

i. Except for transactions authorized under paragraph e of these instructions, if a participant in a covered transaction knowingly enters into a lower tier covered transaction with a person who is suspended, debarred, ineligible, or voluntarily excluded from participation in this transaction, in addition to other remedies available to the Federal Government, the



department or agency with which this transaction originated may pursue available remedies, including suspension and/or debarment.

\* \* \* \* \*

**Certification Regarding Debarment, Suspension, Ineligibility and Voluntary Exclusion--Lower Tier Participants:**

1. The prospective lower tier participant certifies, by submission of this proposal, that neither it nor its principals is presently debarred, suspended, proposed for debarment, declared ineligible, or voluntarily excluded from participating in covered transactions by any Federal department or agency.

2. Where the prospective lower tier participant is unable to certify to any of the statements in this certification, such prospective participant shall attach an explanation to this proposal.

\* \* \* \* \*

**XI. CERTIFICATION REGARDING USE OF CONTRACT FUNDS FOR LOBBYING**

This provision is applicable to all Federal-aid construction contracts and to all related subcontracts which exceed \$100,000 (49 CFR 20).

1. The prospective participant certifies, by signing and submitting this bid or proposal, to the best of his or her knowledge and belief, that:

a. No Federal appropriated funds have been paid or will be paid, by or on behalf of the undersigned, to any person for influencing or attempting to influence an officer or employee of any Federal agency, a Member of Congress, an officer or employee of Congress, or an employee of a Member of Congress in connection with the awarding of any Federal contract, the making of any Federal grant, the making of any Federal loan, the entering into of any cooperative agreement, and the extension, continuation, renewal, amendment, or modification of any Federal contract, grant, loan, or cooperative agreement.

b. If any funds other than Federal appropriated funds have been paid or will be paid to any person for influencing or attempting to influence an officer or employee of any Federal agency, a Member of Congress, an officer or employee of Congress, or an employee of a Member of Congress in connection with this Federal contract, grant, loan, or cooperative agreement, the undersigned shall complete and submit Standard Form-LLL, "Disclosure Form to Report Lobbying," in accordance with its instructions.

2. This certification is a material representation of fact upon which reliance was placed when this transaction was made or entered into. Submission of this certification is a prerequisite for making or entering into this transaction imposed by 31 U.S.C. 1352. Any person who fails to file the required certification shall be subject to a civil penalty of not less than \$10,000 and not more than \$100,000 for each such failure.

3. The prospective participant also agrees by submitting its bid or proposal that the participant shall require that the language of this certification be included in all lower tier subcontracts, which exceed \$100,000 and that all such recipients shall certify and disclose accordingly.

**NOTICE OF REQUIREMENTS FOR AFFIRMATIVE  
ACTION TO ENSURE EQUAL EMPLOYMENT  
OPPORTUNITY (EXECUTIVE ORDER 11246)**

1. The Offeror’s or Bidder’s attention is called to the “Equal Opportunity Clause” and the “Standard Federal Equal Employment Opportunity Construction Contract Specifications” set forth herein.

2. The goal for female participation, expressed in percentage terms for the Contractor’s aggregate workforce in each trade on all construction work, is 6.9%.

Until further notice	Goals for minority participation for each trade (percent)
----------------------	---

SHSA Cities:	
Pascagoula - Moss Point -----	16.9
Biloxi - Gulfport -----	19.2
Jackson -----	30.3

SMSA Counties:	
Desoto -----	32.3
Hancock, Harrison, Stone-----	19.2
Hinds, Rankin -----	30.3
Jackson -----	16.9

Non-SMSA Counties:	
George, Greene-----	26.4

Alcorn, Benton, Bolivar, Calhoun, Carroll, Chickasaw, Clay, Coahoma, Grenada, Itawamba, Lafayette, Lee, Leflore, Marshall, Monroe, Montgomery, Panola, Pontotoc, Prentiss, Quitman, Sunflower, Tallahatchie, Tate, Tippah, Tishomingo, Tunica, Union, Washington, Webster, Yalobusha -----	26.5
---	------

Attala, Choctaw, Claiborne, Clarke, Copiah, Covington, Franklin, Holmes, Humphreys, Issaquena, Jasper, Jefferson, Jefferson Davis, Jones Kemper, Lauderdale, Lawrence, Leake, Lincoln, Lowndes, Madison, Neshoba, Newton, Noxubee, Oktibbeha, Scott, Sharkey, Simpson, Smith, Warren, Wayne, Winston, Yazoo-----	32.0
---	------

Forrest, Lamar, Marion, Pearl River, Perry, Pike, Walthall-----	27.7
--	------

Adams, Amite, Wilkinson -----	30.4
-------------------------------	------

These goals are applicable to all the Contractor’s construction work (whether or not it is Federal or federally assisted) performed in the covered area. If the contractor performs construction work in a geographical area located outside of the covered area, it shall apply the goals established for such geographical area where the work is actually performed. With regard to this second area, the contractor also is subject to the goals for both its federally involved and nonfederally involved construction.

The Contractor’s compliance with the Executive Order and the regulations in 41 CFR Part 60-4 shall be based on its implementation of the Equal Opportunity clause, specific affirmative action obligations required by the specifications set forth in 41 CFR 60-4.3(a), and its efforts to meet the goals. The hours of minority and female employment and training must be substantially uniform throughout the length of the contract, and in each trade, and the Contractor shall make a good faith effort to employ minorities and women evenly on each of its projects. The transfer of minority or female employees or trainees from Contractor to Contractor or from project to project for the sole purpose of meeting the Contractor’s goals shall be a violation of the contract, the Executive Order and the regulations in 41 CFR Part 60-4.2(d). Compliance with the goals will be measured against the total work hours performed.

3. The Contractor shall provide written notification to the Director of the Office of Federal Contract Compliance Programs within 10 working days of award of any construction subcontract in excess of \$10,000 at any tier for construction work under the contract resulting from this solicitation. The notification shall list the name, address and telephone number of the subcontractor, employer identification number of the subcontractor, estimated dollar amount of the subcontract; estimated starting and completion dates of the subcontract; and the geographical area in which the subcontract is to be performed.

4. As used in this Notice, and in the contract resulting from this solicitation, the “covered area” is to the county and city (if any), stated in the advertisement.

5. The notification required in Paragraph 3 shall be addressed to the following:

Contract Compliance Officer  
Mississippi Department of Transportation  
P.O. Box 1850  
Jackson, Mississippi 39215-1850

(12/04/2018)

## MISSISSIPPI DEPARTMENT OF TRANSPORTATION

SPECIAL PROVISION NO. 907-102-2

CODE: (IS)

DATE: 11/22/2017

SUBJECT: **Bidding Requirements and Conditions**

Section 102, Bidding Requirements and Conditions, of the 2017 Edition of the Mississippi Standard Specifications for Road and Bridge Construction is hereby amended as follows.

**907-102.01--Prequalification of Bidders.** Delete the last sentence of the third paragraph of Subsection 102.01 on page 13, and substitute the following.

The Bidder's Certificate of Responsibility number must be on file with the Department's Contract Administration Division prior to request for permission to bid.

**907-102.02--Contents of Proposal Forms.** Delete the fourth paragraph in Subsection 102.02 on page 13, and substitute the following.

Prospective bidders must complete an online request for permission to be eligible to bid a project. Upon approval, the bidder will be authorized to submit a bid electronically using Bid Express at <http://bidx.com>.

**MISSISSIPPI DEPARTMENT OF TRANSPORTATION**

**SPECIAL PROVISION NO. 907-105-1**

**CODE: (SP)**

**DATE: 05/07/2021**

**SUBJECT: Authority of the Engineer**

Section 105, Control of Work, of the 2017 Edition of the Mississippi Standard Specifications for Road and Bridge Construction is hereby amended as follows.

**907-105.1--Authority of the Engineer.** Delete the first sentence of the second paragraph of Subsection 105.01 on page 31, and substitute the following.

The Engineer has the right to suspend the work wholly or in part and to withhold payments because of the Contractor's failure to correct conditions unsafe for workmen or the general public, for failure to carry out provisions of the Contract, or for failure to carry out orders.

**MISSISSIPPI DEPARTMENT OF TRANSPORTATION**

**SPECIAL PROVISION NO. 907-108-4**

**CODE: (SP)**

**DATE: 10/07/2020**

**SUBJECT: Subletting of Contract**

Section 108, Prosecution and Progress, of the 2017 Edition of the Mississippi Standard Specifications for Road and Bridge Construction is hereby amended as follows.

**907-108.01--Subletting of Contract.**

**907-108.01.1--General.** Delete the third sentence of the tenth paragraph of Subsection 108.01.1 on the bottom of page 72.

## MISSISSIPPI DEPARTMENT OF TRANSPORTATION

SPECIAL PROVISION NO. 907-109-3

CODE: (SP)

DATE: 02/23/2021

SUBJECT: Measurement and Payment

Section 109, Measurement and Payment, of the 2017 Edition of the Mississippi Standard Specifications for Road and Bridge Construction is hereby amended as follows.

**907-109.01--Measurement of Quantities.** Delete the sixth full paragraph of Subsection 109.01 on page 88, and substitute the following.

If appropriate based on the specific circumstances of the project, the Contractor may request that material specified to be measured by the cubic yard or ton be converted to the other measure. The Contractor must submit this request to the Engineer. The Engineer will provide an approval or denial in writing. The decision is in the sole discretion of the Engineer. If approved, factors for this conversion will be determined by the District Materials Engineer and agreed to by the Contractor. The conversion of the materials along with the conversion factor will be incorporated into the Contract by supplemental agreement. The supplemental agreement must be executed before such method of measurement is used.

**907-109.04--Extra Work.**

**907-109.04.1--Supplemental Agreement.** Delete the second paragraph of Subsection 109.04.1 on page 90.

**907-109.06--Partial Payment.**

**907-109.06.2--Advancement on Materials.** Delete the next to last paragraph of Subsection 109.06.2 on page 95, and substitute the following.

Materials for which an advanced payment has been allowed must be paid for by the Contractor within 30 days of the estimate on which the advanced payment was first allowed and proof of said payment must be verified by the supplier. If proof of payment is not furnished within the allowable 30 days, the advanced payment will be deducted on subsequent current estimates until such time that proof of payment is furnished.

**MISSISSIPPI DEPARTMENT OF TRANSPORTATION**

**SPECIAL PROVISION NO. 907-411-1**

**CODE: (IS)**

**DATE: 06/13/2018**

**SUBJECT: Material Transfer Equipment**

Section 411, Ultra-Thin Asphalt Pavement, of the 2017 Edition of the Mississippi Standard Specifications for Road and Bridge Construction is hereby amended as follows.

**907-411.03--Construction Requirements.** After Subsection 411.03.10 on page 327, add the following.

**907-411.03.11--Material Transfer Equipment.** Excluding the areas mentioned below, the material transferred from the hauling unit shall be remixed prior to being placed in the paver hopper or insert by using an approved Materials Transfer Device. Information on approved devices can be obtained from the State Construction Engineer. Areas excluded from this requirement include: temporary work of short duration, detours, bridge replacement projects having less than 1,000 feet of pavement on each side of the structure, acceleration and deceleration lanes less than 1,000 feet in length, tapered sections, transition sections (for width), shoulders less than 10 feet in width, crossovers, ramps, side street returns and other areas designated by the Engineer.

**907-411.05--Basis of Payment.** Add the “907” prefix to the pay item listed on page 328.

# MISSISSIPPI DEPARTMENT OF TRANSPORTATION

## SUPPLEMENT TO SPECIAL PROVISION NO. 907-618-4

**DATE:** 04/13/2021

**PROJECT:** STP-1164-00(018) / 108227301 – Lamar County

After the first paragraph of Subsection 907-618.01.2 on page 1, add the following.

Additional traffic control devices will be required as follows.

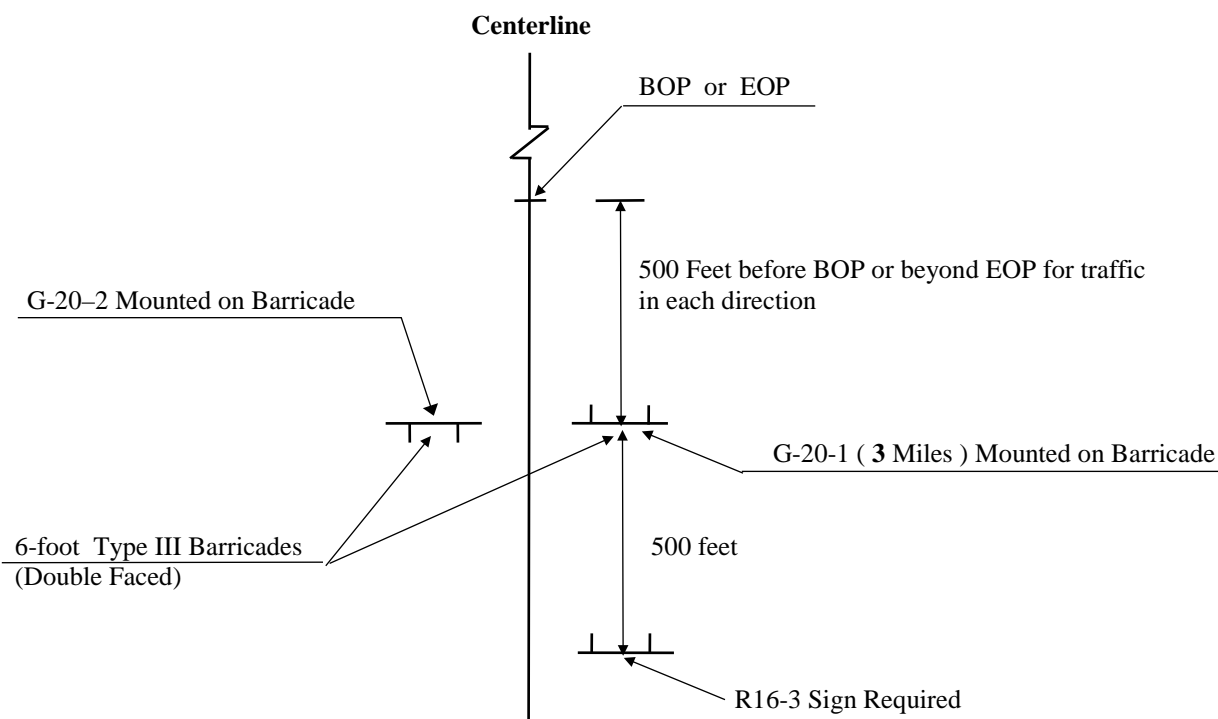

### ADDITIONAL TRAFFIC CONTROL SIGNS REQUIRED:

- 13 - W20-1 "AHEAD" signs required. One (1) W20-1 "AHEAD" sign is required at each local road or street entering the project.
- 42 - R4-1 "DO NOT PASS" signs required.
- 2 - R4-2 "PASS WITH CARE" signs required.
- 3 - W14-3 "NO PASSING ZONE" signs required.
- 4 - R16-3 "SPEEDING FINES DOUBLED" signs required.

R4-1 "DO NOT PASS", R4-2 "PASS WITH CARE", and W14-3 "NO PASSING ZONE" signs are required in accordance with Subsection 618.03.3, this drawing, and as specified in the Manual on Uniform Traffic Control Devices.

R16-3 signs shall be spaced in accordance with sheet titled "Location of R16-3 Signs".

All construction signs and barricades shown on this page shall be included in the bid price for Pay Item 618-A, Maintenance of Traffic. Fluorescent orange sheeting shall be used on all construction and traffic control signs except for R16-3, R4-1 and R4-2 signs which shall be black legend and border on white background.



STATE PROJECT NO.  
MISS.

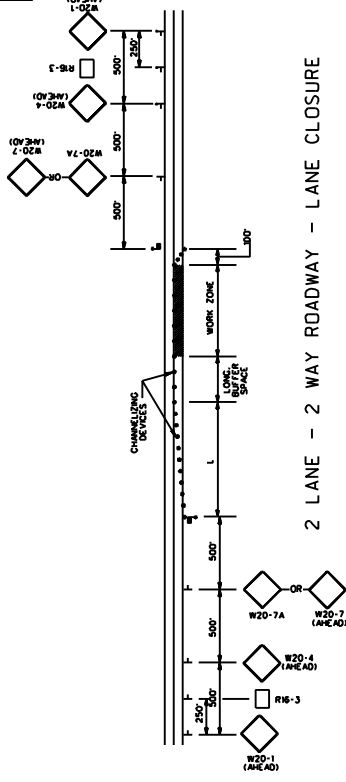

2 LANE - 2 WAY ROADWAY - LANE CLOSURE

DIVIDED HIGHWAY  
(PROJECTS LESS THAN 1 MILE LENGTH)

- NOTES
- 1. R16-3 SIGN TO BE PLACED AS SHOWN OR AS DIRECTED BY THE ENGINEER.
  - 2. R16-3 SIGN SHALL BE SPACED AT A MAXIMUM OF 2 MILES THROUGHOUT LENGTH OF PROJECT.

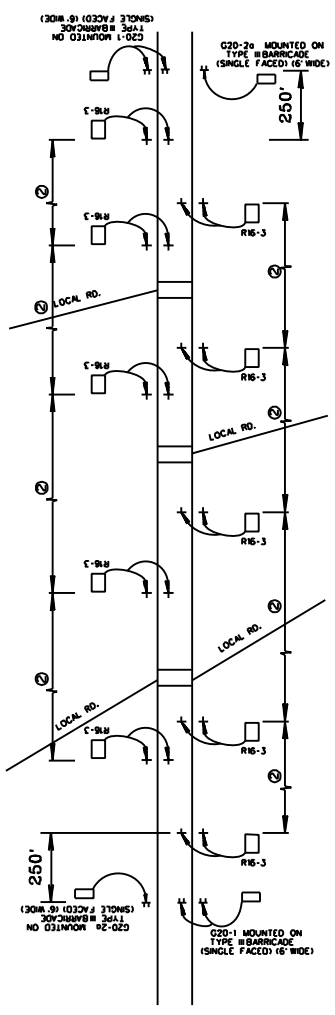

DIVIDED HIGHWAY SHOWN  
(2 LANE - 2 WAY ROADWAY SIMILAR)  
(PROJECT MORE THAN 1 MILE LENGTH)

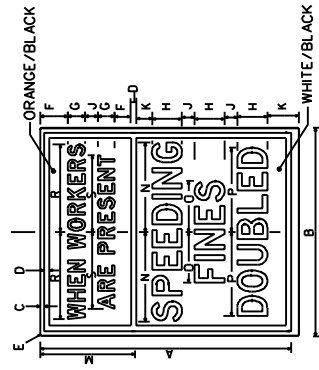
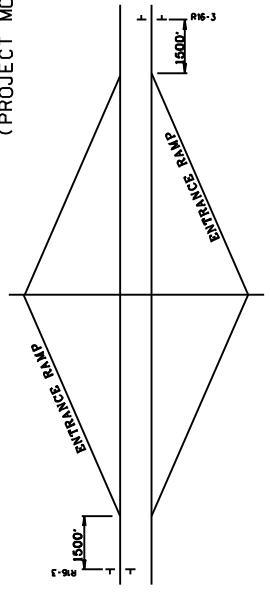

SIZE	A	B	C	D	E	F	G	H
STL 60	48	36	1 1/4	3/4	3/4	1 1/4	1 1/4	7 1/2
STL 72	60	48	1 1/4	3/4	3/4	1 1/4	1 1/4	9 1/2
STL 84	72	60	1 1/4	3/4	3/4	1 1/4	1 1/4	11 1/2

SIZE	A	B	C	D	E	F	G	H
STL 48	36	24	3/4	3/4	3/4	1 1/4	1 1/4	6 1/2
STL 60	48	36	3/4	3/4	3/4	1 1/4	1 1/4	8 1/2
STL 72	60	48	3/4	3/4	3/4	1 1/4	1 1/4	10 1/2

MISSISSIPPI DEPARTMENT OF TRANSPORTATION

LOCATION OF R16-3 SIGNS

REVISION	BY	DATE

WORKING NUMBER: \_\_\_\_\_  
SHEET NUMBER: \_\_\_\_\_  
CHECKED: \_\_\_\_\_  
DATE: 02/28/09

FILENAME: SPEED\_SIGN\_DETAIL.DWG  
PROJECT: \_\_\_\_\_

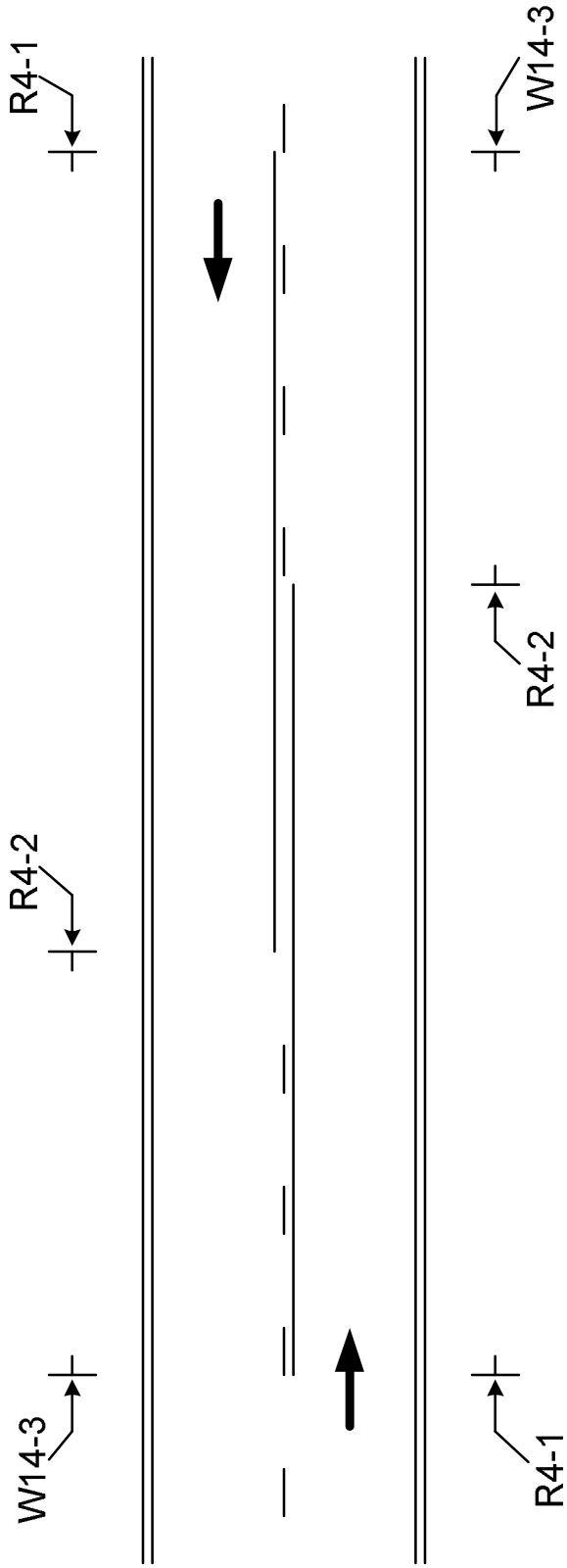

The W14-3, No Passing Zone sign, shall be placed on the left side of the road at the beginning of each no passing zone.

The R4-1, Do Not Pass signs, shall be placed on the right side of the road at the beginning of the no passing zone. Additional R4-1 signs shall be placed right and left in increments of 750 to 1000 feet throughout the length of the no passing zone.

The R4-2, Pass With Care sign, shall be placed on the right side of the road at the end of the no passing zone.

The R4-1, R4-2 and W14-3 signs are to be used when standard pavement markings are not in place. The signs may also be used to emphasize pavement markings.

**MISSISSIPPI DEPARTMENT OF TRANSPORTATION**

**SPECIAL PROVISION NO. 907-618-4**

**CODE: (SP)**

**DATE: 02/01/2018**

**SUBJECT: Additional Signing Requirements**

Section 618, Maintenance of Traffic and Traffic Control Plan, of the 2017 Edition of the Mississippi Standard Specifications for Road and Bridge Construction is hereby amended as follows.

**907-618.01.2--Traffic Control Plan.** At the end of Subsection 618.01.2 on page 441, add the following:

For compliance with the traffic control plan, the Contractor will be required to install and maintain **traffic control devices** at various locations throughout the project. Payment for these **devices** will be included in the price bid for pay item no. 618-A, Maintenance of Traffic per lump sum.

## MISSISSIPPI DEPARTMENT OF TRANSPORTATION

SPECIAL PROVISION NO. 907-619-6

CODE: (SP)

DATE: 03/21/2018

SUBJECT: Temporary Portable Rumble Strips

Section 619, Traffic Control for Construction Zones, of the 2017 Edition of the Mississippi Standard Specifications for Road and Bridge Construction is hereby amended as follows.

**907-619.02--Materials.** After Subsection 619.02.15 on page 472, add the following.

**907-619.02.16--Temporary Portable Rumble Strips.** Temporary portable rumble strips shall be RoadQuake manufactured by PSS and meet the following requirements:

- capable of being installed without adhesives or bolts,
- have a minimum weight of 100 pounds,
- have a minimum overall length of 11 feet,
- have a minimum width of 12 inches, and
- have a maximum height of 3/4 inch.

Temporary portable rumble strips shall be installed in accordance with the attached details, or as directed by the Engineer.

**907-619.03--Construction Requirements.** After Subsection 619.03.11 on page 476, add the following.

**907-619.03.16--Temporary Portable Rumble Strips.** Temporary portable rumble strips shall be placed at locations shown on the traffic control plans, attached drawing, or as directed by the Engineer. The rumble strips shall be removed when lane closures are removed, relocated when lane closures are relocated, or as directed by the Engineer.

Prior to placement of the rumble strips, the roadway shall be cleaned to be free of dust, sand, and other materials that may cause slippage. The minimum roadway temperature at the time of installation shall be in accordance with manufacturer recommendations.

A minimum of three (3) temporary portable rumble strips shall be arranged in an array. The spacing of temporary portable rumble strips in each array shall be on 15-foot centers. One array of three (3) strips shall be used in each lane. The rumble strips shall be regularly monitored and maintained to ensure they stay in place under traffic.

**907-619.04--Method of Measurement.** At the end of Subsection 619.04 on page 478, add the following.

Temporary Portable Rumble Strips will be measured for payment by the linear foot only when a pay item for temporary portable rumble strips is included in the contract. Otherwise, temporary portable rumble strips will be included in the cost of pay item 618-A, Maintenance of Traffic. The quantity of temporary portable rumble strips will be the length of rumble strips approved by the Engineer to be in-place on the project at any one time.

**907-619.05--Basis of Payment.** After the fifth paragraph of Subsection 619.05 on page 478, add the following.

Temporary Portable Rumble Strips measured as prescribed above, will be paid for at the contract unit price per linear foot, which price shall be full compensation for cleaning the roadway surface, installing the rumble strips, maintenance and repair of the strips, cleaning and resetting of the strips, removal and replacement, and for all labor, equipment, tools, and incidentals necessary to complete the work.

After the last pay item listed on page 480, add the following.

907-619-B: Temporary Portable Rumble Strips - per linear foot

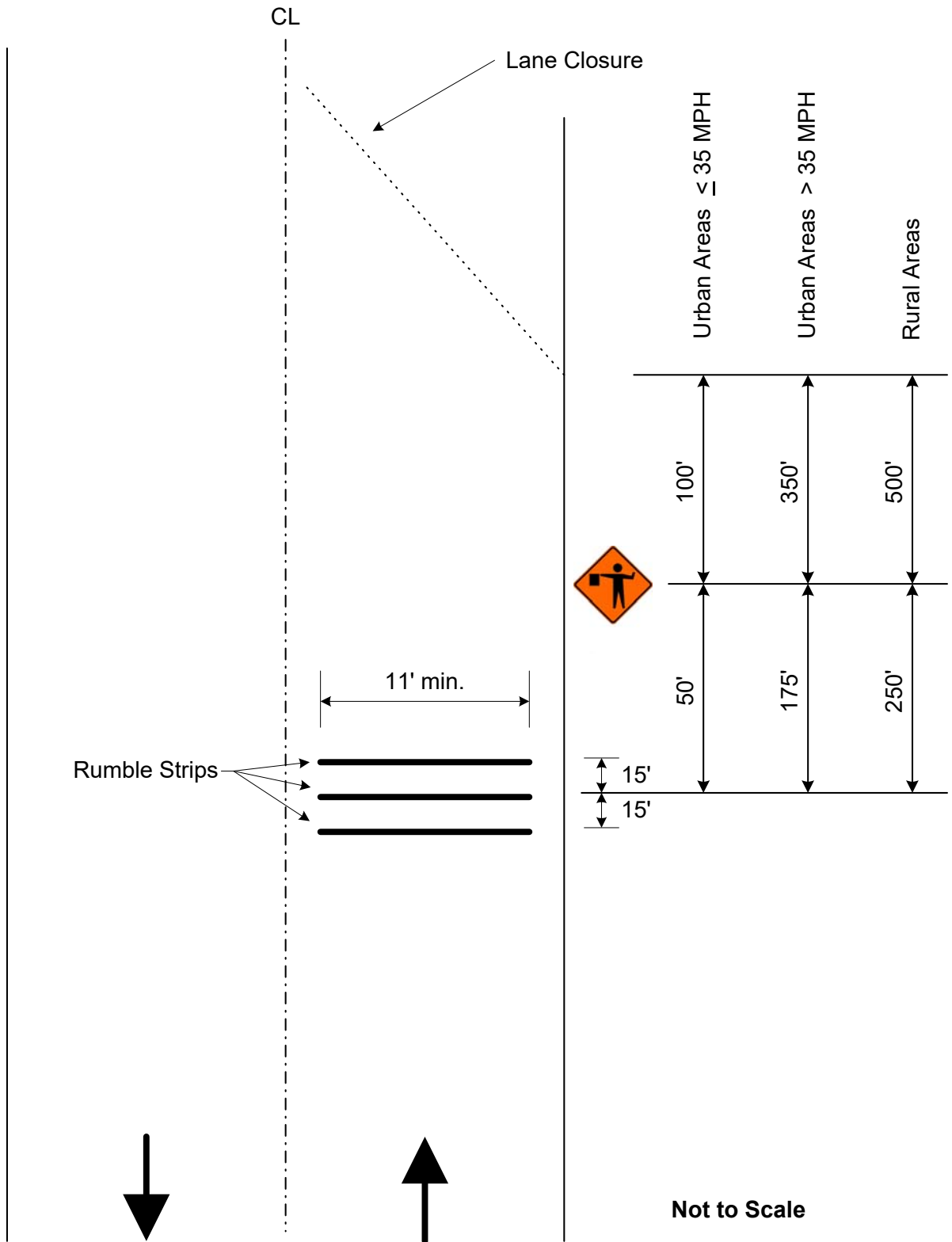

Not to Scale

**Detail of Temporary Portable Rumble Strips**

# MISSISSIPPI DEPARTMENT OF TRANSPORTATION

SPECIAL PROVISION NO. 907-624-1

CODE: (SP)

DATE: 01/17/2017

SUBJECT: **Inverted Profile Thermoplastic Traffic Stripe**

Section 907-624, Inverted Profile Thermoplastic Traffic Stripe, is hereby added to and made part of the 2017 Edition of the Mississippi Standard Specifications for Road and Bridge Construction as follows.

**907-624.01--Description.** Inverted profile thermoplastic pavement markings consists of furnishing materials and placing inverted profile thermoplastic pavement markings in reasonably close conformity with these specifications and the details shown on the plans or established.

Inverted profile thermoplastic pavement markings, high contract, shall consist of furnishing materials and placing inverted profile thermoplastic pavement markings over a black thermoplastic pavement marking in order to enhance the marking's visibility.

**907-624.02--Materials.**

**907-624.02.1--General.** The inverted profile thermoplastic marking material shall consist of an alkyd/maleic or hydrocarbon based formulation. The material shall be so manufactured as to be applied to the pavement in a molten form, with internal and surface application of glass spheres, and upon cooling to normal pavement temperature, shall produce an adherent, reflectorized pavement marking of specified thickness and width, capable of resisting deformation.

Materials shall be obtained from approved sources as listed on the Department's "List of Approved Sources" for Inverted Profile Thermoplastic Pavement Marking Materials. The material shall not scorch, break down, discolor, or deteriorate when held at the application temperature for four hours or when reheated four times to the application temperature. Temperature-vs-viscosity characteristics of the plastic material shall remain constant when reheated four times, and shall be the same from batch to batch.

The thermoplastic material shall be a product especially compounded for pavement markings. The pavement markings shall maintain their original dimension and shall not smear or spread under normal traffic at temperatures below 140°F. The markings shall have a uniform cross section. Pigment shall be evenly dispersed throughout its thickness. The exposed surface shall be free from tack and shall not be slippery when wet. The material shall not lift from pavement in freezing weather. Cold ductility of the material shall be such as to permit normal movement with the pavement surface without chipping or cracking.

Black thermoplastic compound for the placement of inverted profile thermoplastic pavement markings, high contract, shall consist of a hydrocarbon or alkyd/maleic based formulation.

The manufacturers of the thermoplastic compound, glass beads and epoxy primer sealer shall furnish to the Engineer three copies of certified test reports showing results of all tests specified herein and shall further certify that the materials meet all requirements. The Contractor shall provide the warranty as specified herein to the Engineer.

**907-624.02.2--Inverted Profile Thermoplastic Material.** The thermoplastic material shall consist of homogeneously mixed pigments, fillers, resins and glass beads, and shall be available in both white and yellow. The material shall be free from all skins, dirt, and foreign objects. Materials shall conform to AASHTO M 249 with the following modifications:

**907-624.02.2.1--Intermixed Glass Beads.** The thermoplastic material shall contain a minimum of 40 percent Class H glass beads by weight. Class H glass beads shall meet the requirements of ASTM D 1155, and shall be coated with an adhesion promoting coating which shall also provide moisture resistance as tested by AASHTO M 247, Section 4.4.2. Class H beads shall have a minimum of 70 percent true spheres and the +20 sieve shall be tested visually.

The gradation of the Class H beads shall meet the following:

<b><u>U. S. Standard Sieve</u></b>	<b><u>% Passing</u></b>
12	100
14	95 - 100
16	80 - 100
18	30 - 100
20	15 - 100
30	10 - 100
50	0 - 50
100	0 - 5

**907-624.02.2.2--Binder Content.** The binder content of the thermoplastic material shall be 19 percent minimum.

**907-624.02.2.3--Titanium Dioxide.** The titanium dioxide shall meet ASTM D 476, Type II, Rutile grade - 10 percent minimum titanium content.

**907-624.02.2.4--Yellow Pigment.** The yellow pigment for the yellow thermoplastic material shall be five (5) percent minimum.

**907-624.02.2.5--Specific Gravity.** The specific gravity of the thermoplastic pavement marking material shall not exceed 2.35.

**907-624.02.2.6--Flow Characteristics.**

**907-624.02.2.6.1--Flowability.** After heating the thermoplastic material for four (4) hours ±5 minutes at 425 ±3°F and testing flowability, the white thermoplastic shall have a maximum percent residue of 22 percent and the yellow thermoplastic shall have a maximum residue of 24 percent.



**907-624.02.2.6.2--Flow Resistance.** The material shall exhibit a maximum flow of 10%. The material's ability to form ribs on the markings shall be evaluated by casting a disc of material approximately 3.5 inches wide by 1.0 inch long by and 0.60 inch deep. After the material is cooled to ambient temperature, measure the exact height. The material shall then be stored at 190°F for four (4) hours. After the material is cooled to ambient temperature, re-measure the exact height and express the flow resistance as a flow percentage.

**907-624.02.2.7--Reflectivity.** The initial reflectance for the in-place marking shall have a minimum reflectance value of 450 mcd/ft<sup>2</sup> for white and 350 mcd/ft<sup>2</sup> for yellow, when measured with a MiroLux Ultra 30 retroreflectometer, or approved equal.

**907-624.02.2.8--Wet Reflectivity.** The initial reflectance for the in-place marking when wet shall have a minimum reflectance value of 200 mcd/ft<sup>2</sup> for white and 175 mcd/ft<sup>2</sup> for yellow, when measured with an approved retroreflectometer. The stripe shall be wetted utilizing a pump type sprayer for five (5) seconds. After 30 seconds, place the retroreflectometer on the stripe and measure the reflectance.

**907-624.02.2.9--Inverted Profile.** The thermoplastic pavement marking material shall be applied to have individual profiles having a minimum height of 0.140 inches with the recessed inverted profiles having a thickness of 0.025 to 0.050 inches. The profiles shall be well defined, spaced approximately one (1) inch apart, and not excessively run back together.

**907-624.02.3--Black Pavement Marking Material for High Contrast Inverted Profile Pavement Markings.**

**907-624.02.3.1--General.** In the molten state, the material shall not give off fumes that are toxic or otherwise injurious to persons or property. The manufacturer shall provide material safety data sheets for the product.

The temperature versus viscosity characteristic of the plastic material shall remain constant and the material shall not deteriorate in any manner during three reheating processes. There shall be no obvious change in color of the material as a result of up to three reheatings, or in maintaining the material at application temperature up to an aggregate time of four (4) hours, or from batch to batch. The maximum elapsed time after application at which normal traffic will leave no impression or imprint on the new stripe shall be 30 seconds when the air and road surface temperature is approximately 68 ±5°F. The applied stripe shall remain free from tack and shall not lift from the pavement under normal traffic conditions within a road temperature range of -20°F to 150°F. The stripe shall maintain its original dimensions and placement. Cold ductility of the material shall be such as to permit normal dimensional distortion as a result of tire impact within the temperature range specified.

The material shall provide a stripe that has a uniform thickness throughout its cross section.

**907-624.02.3.2--Binder.** The binder shall be hydrocarbon or alkyd/maleic based. The binder shall consist of a homogeneous mixture of pigment, fillers, resins, waxes and plasticizers. The total

binder content shall be well distributed throughout the compound. The binder shall be free from all foreign objects or ingredients that would cause bleeding, staining or discoloration. The binder shall be 19 percent minimum by weight of the thermoplastic compound.

**907-624.02.3.3--Pigment.** The pigment used for black pavement marking compound shall be as required and shall be uniformly distributed throughout the marking compound.

**907-624.02.3.4--Filler.** The filler to be incorporated with the resins shall be a white calcium carbonate, silica or any approved substitute.

**907-624.02.3.5--Specific Gravity.** The specific gravity of the marking compound shall not exceed 2.0.

**907-624.02.3.6--Softening Point.** After heating the marking compound for 4 hours  $\pm$ 5 minutes at  $375 \pm 3^\circ\text{F}$  and testing in accordance with ASTM E 28, the material shall have a minimum softening point of  $180^\circ\text{F}$  as measured by the ring and ball method.

**907-624.02.3.7--Tensile Bond Strength.** After heating the marking compound for 4 hours  $\pm$ 5 minutes at  $375 \pm 3^\circ\text{F}$ , the tensile bond strength shall exceed 180 psi when tested in accordance with ASTM D 4806. The material shall be applied to unprimed, sandblasted Portland cement concrete block at a thickness of 0.0625-inch and at a temperature of  $375 \pm 3^\circ\text{F}$ . The test shall be conducted at room temperature.

**907-624.02.3.8--Impact Resistance.** After heating the marking compound for 4 hours  $\pm$ 5 minutes at  $375 \pm 3^\circ\text{F}$ , the impact resistance shall be a minimum of 50 inch-pounds minimum when tested in accordance with ASTM D 2794. No cracks or bond loss shall occur when a 0.0625-inch thick film drawdown is made at  $375 \pm 3^\circ\text{F}$  on an unprimed sandblasted Portland cement concrete block. The sample is tested with a male indenter 5/8-inch and no female Die at room temperature.

**907-624.02.3.9--Identification.** Each package of material shall be stenciled with the manufacturer's name, the type of material and specification number, the month and year the material was packaged and lot number. The letters and numbers used in the stencils shall be a minimum of 1/2 inch in height.

**907-624.02.3.10--Packaging.** The material shall be packaged in suitable containers that will not adhere to the product during shipment and storage. The container of pavement marking material shall weigh approximately 50 lbs. Each container shall designate the color, type of resin, type of application and user information. The label shall warn the user that the material shall be heated in the range of  $350^\circ$  to  $425^\circ\text{F}$ .

**907-624.02.3.11--Storage Life.** The material shall meet the requirements of this specification for a period of one year. The material must also meet uniformly with no evidence of skins or unmelted particles for this one-year period. The manufacturer shall replace any material not meeting the above requirements.

**907-624.02.3.12--Certifications.** The material manufacturer shall furnish a certified copy of material test reports to the Engineer.

**907-624.02.4--Drop-On Glass Beads.** Drop-on glass beads shall be separated into two (2) classes, as follows:

**907-624.02.4.1--Class G Glass Beads.** Class G glass beads shall be coated with an adhesion promoting coating which shall also provide moisture resistance as tested by AASHTO M 247, Section 4.4.2 and shall exhibit the following characteristics:

- **Color and Clarity:** The glass beads shall be colorless and clear, and shall be free of carbon residues.
- **Index of Refraction:** minimum 1.50
- **Roundness:** The glass beads shall have a minimum of 80% true spheres per screen for the two highest sieve quantities, determined visually, and a maximum of 3% angular particles per sieve, determined visually. The remaining sieves shall have a minimum of 75% true spheres, determined visually per aspect ratio using microfiche reader.
- **Air Inclusions:** 10% maximum
- **Specific Gravity:** The specific gravity of the glass beads shall be a minimum of 2.50.
- **Gradation:** The gradation of Class G glass beads shall be as follows:

<u>U. S. Standard Sieve</u>	<u>% Passing</u>
12	100
14	100 - 95
16	100 - 80
18	100 - 20
20	90 - 20
30	100 - 50
Pan	100 - 90

All Class G glass beads shall be coated with an adhesion promoting coating.

**907-624.02.4.2--Class H Glass Beads.** Class H glass beads shall meet the requirements of ASTM D 1155, and shall be coated with an adhesion promoting coating which shall also provide moisture resistance as tested by AASHTO M 247, Section 4.4.2. Class H beads shall have a minimum of 70 percent true spheres and the +20 sieve shall be tested visually.

The gradation of the Class H beads shall meet the following:

<u>U. S. Standard Sieve</u>	<u>% Passing</u>
16	99 - 100
20	75 - 100
30	55 - 95
50	10 - 35
100	0 - 5

**907-624.03--Construction Requirements.**

**907-624.03.1--Equipment.** The application equipment shall be specifically designed for placing thermoplastic material in a hot molten state on the pavement surface utilizing a pressure type application method. The thermoplastic stripe shall be formed by a die that is allowed to drag along in proximity with the pavement surface. The die is pulled forward by a special linkage that will allow it to automatically level itself as to float and remain parallel with the pavement surface. The traffic stripe shall be formed by reason that the hot thermoplastic material is forced under pressure through four sides to the die onto the pavement surface. The top of the die shall be enclosed and provide entry means for the hot molten thermoplastic material to enter the die cavity. The bottom of the die shall contain a movable door that is remote controlled so as to start or stop the flow of thermoplastic material onto the pavement surface. When the movable door is open, thermoplastic material can flow through the die and will apply a thermoplastic stripe that will be formed rearward of the advancing die. The pavement surface shall be at the bottom of the die enclosure. Thermoplastic material shall be fed to the die under pressure through flexible oil-jacketed stainless steel hoses. The thermoplastic material must be either pumped or fed from a pressure vessel to the die under pressure in order to obtain the proper adhesion with the pavement surface.

The system shall consist of a low pressure drop-on type glass bead gun, (bead coat #1). The thermoplastic die shall be oil-jacketed on four (4) sides and is formed from a single solid block of steel. The glass bead gun shall dispense glass beads onto the hot thermoplastic stripe from a height of approximately one (1) inch above the pavement surface. The point at which the glass beads strike the surface of the stripe shall be approximately three inches (3”) behind the strike point of the thermoplastic material itself. This reflective bead coat #1 shall utilize Class G glass beads as specified herein, and shall provide a surface coating of 50 percent of the thermoplastic stripe surface. Of this 50 percent stripe coverage, at least 50 percent of the beads shall be embedded to a depth of 60 percent of their diameter.

A second curtain coater, low pressure drop-on type glass bead gun capable of applying a continuous sheet or ribbon of glass beads, shall follow at an interval of approximately 10 inches behind the first bead gun. This second glass bead gun shall apply bead coat #2 which will form a continuous drop-on coat of Class H glass beads immediately in front of the profiling device. This second curtain of glass beads shall have a low impact speed so that they are not forced into the stripe under pressure.

A special rotatable wheel profiling device shall be located approximately eight (8) inches behind bead gun #2. This rotatable wheel device shall be approximately seven (7) inches in diameter and shall have a plurality of spaced projections located around its circumference. The profiling device shall be wider than the stripe being applied in order that the stripe shall be adequately covered. The projections on the rotatable profiling device shall have an angular profiling surface set at an angle to the pavement surface. The rotatable profile device shall be mounted with an automatic leveling device to the same carriage assembly as the thermoplastic gun. This is required so that a traffic stripe of accurate and uniform definition can be obtained. The inverted profile grooves shall be pressed into the hot molten thermoplastic stripe within one (1) second of the thermoplastic material application in order to insure proper bead adhesion to the stripe. Using rollers to place grooves in the traffic stripe utilizing a separate vehicle or grooves that are not pressed within one

(1) second of the thermoplastic material application will not be allowed. To insure that no thermoplastic material adheres to the wheel as it rotates and profiles the stripe, a small air atomizer water jet shall apply a thin mist coat of water to the rotatable profile wheel. It is the intent of this specification that a minimum amount of water be used and that no water puddles greater than ¼ inch in diameter be allowed to accumulate on the pavement surface in proximity to the freshly placed stripe. Excess water on the pavement surface can cause bond failure of the thermoplastic material.

All parts of the thermoplastic holding tank including manifolds, hoses, pipes, dies, etc., shall be oil-jacketed to insure accurate temperature control. The thermoplastic material shall be preheated in kettles designed specifically for that purpose. Each kettle of preheated thermoplastic material shall be properly mixed and heated to the correct application temperature. The preheated material shall then be fed to the thermoplastic gun for application.

The striping machine shall contain enough glass beads and water to apply one full kettle of thermoplastic material.

**907-624.03.2--Cleaning of Pavement Surface.** Immediately before application, the areas to receive markings shall be cleaned thoroughly using equipment capable of cleaning without damaging the pavement surface. This will include, but not be limited to, all vegetation, loose soil, oils, and other debris. On areas of pavement cured with compound, the membrane shall be removed completely by "shot" blasting, sand blasting or other approved method. Striping shall follow as closely as practical after the pavement surface has been cleaned.

**907-624.03.3--Application Over Existing Striping.** Where shown on the plans or directed by the Engineer, the existing traffic stripe shall be removed by grinding or sandblasting. When placing inverted profile thermoplastic pavement markings on existing pavement that has more than one light coat (pavement not showing through stripe) of striping material, the existing stripe shall be removed to the point that 80 percent of the pavement surface is visible.

Removal of existing stripe will be paid for as a separate item of work.

Where unsatisfactory striping performed by the Contractor must be removed and replaced in accordance with these specifications, the Contractor shall use the removal method described above. No payment will be made for removal or replacement of the Contractor's unsatisfactory striping.

**907-624.03.4--Surface Conditions.** When placing inverted profile thermoplastic pavement markings, no striping shall be permitted when the pavement surface temperature is less than 60°F. A non-contact infrared pyrometer shall be furnished by the Contractor for use by the Engineer for verification of the temperature. Striping shall not be performed when there is moisture on the pavement surface or when winds exceed 12 mph. When unseen moisture is suspected to be present, a moisture test shall be performed. The test shall be as follows:

- 1) Place a piece of roofing felt on the pavement surface.
- 2) Pour 0.5 gallon of thermoplastic material at application temperature onto the paper.

- 3) After two (2) minutes, lift the paper and inspect to see if moisture has been drawn from the pavement.
- 4) If moisture is present, striping is not to begin until the surface is moist free.

Documentation of weather and pavement conditions shall be recorded as part of completing the MDOT Inverted Profile Thermoplastic Pavement Marking Inspectors Report.

**907-624.03.5--Application.** Prior to the placement of pavement markings, the Contractor shall furnish the Engineer three copies of the manufacturer's warranty stating that the manufacturer will guarantee the pavement marking to meet the requirements of this specification.

The thermoplastic material shall be preheated and thoroughly mixed. The application temperature of the thermoplastic material shall be between 400°F and 430°F. A digital thermometer complete with a 24-inch probe shall be furnished by the Contractor for use by the Engineer for verification of the temperature.

When measured at the highest point of the profile, the cold thickness of the in-place thermoplastic stripe shall be a minimum of 0.140 inch for Inverted Profile Thermoplastic Pavement Markings. The thickness of the thermoplastic material in the bottom of the profiles shall range from 0.025 to 0.050 inch. The individual profiles shall be located transversely across the stripe at intervals of approximately one (1) inch. The bottoms of these intervals shall be between 3/32 inch and 5/16 inch wide. In order to drain water and to reflect light, it is normal for the top surface of the inverted profiles to be irregular. The application rate of thermoplastic material for Inverted Profile Thermoplastic Pavement Markings shall be a minimum of 2700± pounds per mile for a continuous 6-inch stripe.

The application rate for Class G glass beads (bead coat #1) shall be 300± pounds per mile for 6-inch continuous stripe.

The application rate for Class H glass beads (bead coat #2) shall be 300± pounds per mile for 6-inch continuous stripe.

The thickness of the striping materials shall be verified periodically (at least every 1320 feet) and any thickness more than five (5) percent under the designated thickness shall be reworked. A consistent, uncorrected under-run will not be allowed and the Contractor will be required to install the specified minimum thickness of 0.140 inch. A wet thickness gauge and cold thickness gauge shall be furnished by the Contractor for use by the Engineer for the verification of film thickness.

When striping over existing painted stripe (one light coat), on old oxidized asphalt, on all concrete surfaces or on asphalt surfaces when ambient temperatures are below 70°F, a two component epoxy primer sealer shall be used and installed as recommended in writing by the thermoplastic material manufacturer. The epoxy primer sealer shall be EX255/EX256 as manufactured by Crown Paint Company of Oklahoma City, Oklahoma, or approved equal. The Contractor shall furnish certification of compatibility of the epoxy primer sealer to be used with the thermoplastic material supplied. If an alternate epoxy primer sealer to the EX255/EX256 is used, the Contractor

shall furnish a mill analysis and proof of adequate performance of the alternate epoxy primer sealer when used with thermoplastic pavement markings.

**907-624.03.6--Inverted Profile Thermoplastic Traffic Stripe, High Contrast.** Before applying the black pavement marking material, the Contractor shall remove any dirt, glaze, grease or any other material that would reduce the adhesion of the thermoplastic to the pavement.

The pavement marking material shall be installed in a molten state by the spray method at a minimum temperature of 350°F and a maximum temperature of 425°F. Scorching or discoloration of material shall be cause for rejection by the Engineer. The machinery shall be constructed so that all mixing and conveying parts, up to and including the thermoplastic gun, maintain the material in the molten state.

The pavement marking materials shall not be applied when air and pavement surface temperatures are below 60°F or when the surface of the pavement contains any evidence of moisture.

The pavement marking material shall be applied at a thickness of not less than 0.040-inch.

The equipment used to install hot applied pavement marking material shall provide continuous mixing and agitation of the material while maintaining a minimum temperature exceeding 400°F. A strainer shall be in place between the main material reservoir and the gun to prevent accumulation and clogging. The equipment shall be constructed for easy accessibility to parts requiring cleaning and maintenance.

After the black thermoplastic pavement markings are applied, inverted profile thermoplastic markings shall be placed over the black thermoplastic pavement markings in accordance with the specifications and to the dimensions and details shown on the plans or established.

**907-624.03.7--Warranty.** The manufacturer shall warrant that the inverted profile thermoplastic markings will meet the minimum performance level of 150 mcd/fc/sq. ft. dry and 75 mcd/fc/sq. ft. wet for a period of 48 months from the date of final inspection when exposed to normal roadway conditions regardless of the average daily traffic. Failure to meet this requirement will result in the total replacement of the portion of the stripe shown to be below these minimums. All costs of labor, material and other incidentals necessary for the replacement of unacceptable pavement markings shall be at no additional costs to the State.

Compliance will be determined by an average brightness reading over a minimum zone marking length of 300 linear feet, using an approved reflectometer. The zone of measurement referred to includes centerline stripe, edge lines and skip lines.

<b>Performance Requirements:</b>	<b>White</b>		<b>Yellow</b>	
	<b><u>Dry</u></b>	<b><u>Wet</u></b>	<b><u>Dry</u></b>	<b><u>Wet</u></b>
Initial Reflectivity, mcd/fc/sq. ft.	450	200	350	175
48-Month Retained Reflectivity	150	75	150	75

The measurement procedure for this warranty will entail a visual night inspection by a manufacturer representative and a MDOT representative to identify areas of the installation, which appear to be below the specified minimum, warranted reflectance value. All reflectance measurements for dry conditions shall be made on a clean dry surface at a minimum temperature of 40°F. All reflectance measurements for wet conditions shall be made using the setting conditions of Subsection 907-624.02.2.8 at a minimum temperature of 40°F.

Measurement intervals for installations with areas less than, or equal to, three (3) miles shall be at a minimum of three (3) check points for each zone. These check points should include the start point, approximate mid-point and the end point.

Measurement intervals for installations with areas greater than three (3) miles shall be at a minimum of three (3) check points, one at the start point, one at the end point and additional measurements spaced at 3-mile intervals between the start and end points of the area in question.

The number of measurements at each check point for each zone will be as follows:

- (A) Skip Lines: Eighteen (18) measurements, distributed over six (6) skip lines, shall be made at each check point.
- (B) Center Lines and/or Edge Lines: Eighteen (18) measurements shall be made over 300 linear feet of continuous stripe.

When taking reflectivity measurements, the value of the measurement shall be determined by averaging three measurements; one at the left edge of the stripe, one at the center of the stripe and one at the right edge of the stripe.

In addition, the reflectance values measured at each check point shall be averaged by zone to determine conformance to the minimum warranted reflective values.

**907-624.04--Method of Measurement.** Inverted profile thermoplastic traffic stripe of the type specified will be measured by the mile or by the linear foot, as indicated, from end-to-end of individual stripes. In the case of skip lines the measurement will include skips. The length used to measure centerline and edge stripes will be the horizontal length computed along the stationed control line. Inverted profile thermoplastic detail traffic stripe will be measured by the linear foot from end-to-end of individual stripes. Measurements will be made along the surface of each stripe and will exclude skip intervals where skips are specified. Stripes more than six (6) inches in width will be converted to equivalent lengths of six-inch widths.

**907-624.05--Basis of Payment.** Inverted profile thermoplastic traffic stripe, measured as prescribed above, will be paid for at the contract unit price per mile or linear foot, as applicable, which shall be full compensation for completing the work.



Payment will be made under:

907-624-A:	6" Inverted Profile Thermoplastic Traffic Stripe, Skip White *	- per linear foot or mile
907-624-B:	6" Inverted Profile Thermoplastic Traffic Stripe, Continuous White *	- per linear foot or mile
907-624-C:	6" Inverted Profile Thermoplastic Traffic Stripe, Skip Yellow *	- per linear foot or mile
907-624-D:	6" Inverted Profile Thermoplastic Traffic Stripe, Continuous Yellow *	- per linear foot or mile
907-624-E:	Inverted Profile Thermoplastic Detail Traffic Stripe, <u>Color</u> *	- per linear foot

\* High Contrast may be specified

## MISSISSIPPI DEPARTMENT OF TRANSPORTATION

SPECIAL PROVISION NO. 907-630-1

CODE: (SP)

DATE: 01/17/2017

SUBJECT: Remove and Reset Signs

Section 630, Traffic Signs and Delineators of the Mississippi Standard Specifications for Road and Bridge Construction, 2017 Edition, is hereby amended as follows.

**907-630.01--Description.** After the last paragraph of Subsection 630.01 on page 503, add the following.

Selected existing, temporarily installed, and/or permanently installed signs other than construction traffic control signs shall be removed and reset as shown on the plans, in the contract documents, or as directed by the Engineer. Removing and resetting of signs may include provisions of continuous sign visibility by the traveling public before, during, and after the operation. The Contractor shall provide all materials necessary to remove and reset the sign, including any footings, supports, brackets, hardware, breakaway features and other incidentals. All installations within 30 feet of the pavement edge of temporary or permanent thru lanes shall include breakaway support features certified to meet NCHRP Report 350 prior to the removal and resetting of the sign.

Selected existing overhead sign shall be removed and reset as shown on the plans, in the contract documents, or as directed by the Engineer. The Contractor shall provide all materials necessary to remove and reset the sign, including any supports, brackets, hardware, and other incidentals. The Contractor shall take all precautions necessary when removing, transporting, storing, and re-installing to protect the sign from any damage to the sign panel or reflective sign surface.

**907-630.04--Method of Measurement.** After the last paragraph of Subsection 630.04 on page 510, add the following.

Remove and reset signs will be measured per each or square foot.

If a sign assembly is removed and temporarily placed in storage, then later reset as directed by the Engineer, measurement for payment will be made one time only, after the stored sign is reset.

No separate measurement will be made for removal only of a sign assembly, as said removal shall be included in the appropriate pay item for removal of signs.

**907-630.05--Basis of Payment.** After the first paragraph of Subsection 630.05 on page 510, add the following.

Remove and reset sign, measured as prescribed above, will be paid for at the contract unit price per each or square foot, which price shall be full compensation for furnishing and placing all

materials necessary to effect the removal and resetting, including footings, supports, brackets, hardware, breakaway features, transporting, storage, and for all labor, equipment, tools and incidentals necessary to complete the work.

Add the following to the list of pay items on pages 510 & 511.

907-630-O: Remove and Reset Sign, Description - per each or square foot

MISSISSIPPI DEPARTMENT OF TRANSPORTATION

SPECIAL PROVISION NO. 907-701-3

CODE: (SP)

DATE: 05/04/2021

SUBJECT: Hydraulic Cement

Section 701, Hydraulic Cement, of the 2017 Edition of the Mississippi Standard Specifications for Road and Bridge Construction is hereby amended as follows.

**907-701.01--General.** In the first sentence of the second paragraph of Subsection 701.01 on page 718, change “mills” to “plants.”

In the second sentence of the sixth paragraph of Subsection 701.01 on pages 718 and 719, change “shall” to “will.”

**907-701.02--Portland Cement.**

**907-701.02.1-General.**

**907-701.02.1.2--Alkali Content.** Delete the sentence in Subsection 701.02.1.2 on page 719, and substitute the following.

When used in portland cement concrete, the total alkali contribution from all cement types in this Subsection shall not exceed 4.0 lb. per cubic yard of concrete calculated as follows:

$$\text{lb alkali per cu Yd} = \frac{(\text{lb cement per cu Yd}) \times (\% \text{Na}_2\text{O equivalent in cement})}{100}$$

In the above calculation, the maximum cement alkali content reported on the cement mill certificate shall be used. An example calculation can be found in the Department’s *Concrete Field Manual*.

**907-701.02.2--Replacement by Other Cementitious Materials.** Delete the paragraph in Subsection 701.02.2 on page 719, and substitute the following.

The maximum replacement of cement by weight is 25% for fly ash or 50% for ground granulated blast furnace slag (GGBFS). Replacement contents below 20% for fly ash or 45% for GGBFS may be used, but will not be given any special considerations, such as the maximum acceptance temperature for portland cement concrete containing pozzolans in Subsection 804.02.13.1.5. Special considerations shall only apply for replacement of cement by fly ash or GGBFS.

Delete Subsection 701.02.2.1 on pages 719 and 720, and substitute the following.

**907-701.02.2.1--Portland Cement Concrete Exposed to Soluble Sulfate Conditions or Seawater.**

When portland cement concrete is exposed to moderate or severe soluble sulfate conditions, or to seawater, cement types and replacement of cement by Class F fly ash or GGBFS shall be as follows in Table 1. Class C fly ash shall not be used as a replacement for cement in any of the sulfate exposure conditions listed in Table 1.

**Table 1- Cementitious Materials for Soluble Sulfate Conditions or Seawater**

Sulfate Exposure	Water-soluble sulfate (SO <sub>4</sub> ) in soil, % by mass	Sulfate (SO <sub>4</sub> ) in water, ppm	Cementitious material required
Moderate and Seawater	0.10 - 0.20	150 - 1,500	Type I cement with one of the following replacements of cement by weight: 24.5 - 25.0% Class F fly ash, or 49.5 - 50.0% GGBFS or Type II <sup>**</sup> cement
Severe	0.20 - 2.00	1,500 - 10,000	Type I cement with a replacement by weight of 49.5 - 50.0% GGBFS, or Type II <sup>*</sup> cement with one of the following replacements of cement by weight: 24.5 - 25.0% Class F fly ash, or 49.5 - 50.0% GGBFS

\* Type III cement conforming to AASHTO M85 with a maximum 8% tricalcium aluminate (C<sub>3</sub>A) may be used in lieu of Type II cement as allowed in Subsection 701.02.1; this cement is given the designation “Type III(MS).”

\*\* Class F fly ash or GGBFS may be added as a replacement for cement as allowed in Subsection 907-701.02.2.

Delete Subsection 701.02.2.2 on page 720, and substitute the following.

**907-701.02.2.2--Portland Cement for Soil Stabilization Exposed to Soluble Sulfate Conditions or Seawater.** When portland cement for use in soil stabilization is exposed to moderate or severe soluble sulfate conditions, or to seawater, cement types and replacement of cement by Class F fly ash or GGBFS shall meet the requirements of Subsection 701.02.2.1.

**907-701.04--Blended Hydraulic Cement.**

**907-701.04.1--General.** Delete Subsection 701.04.1.1 on page 720, and substitute the following.

**907-701.04.1.1--Types of Blended Hydraulic Cement.** Blended hydraulic cements (blended cements) shall be of the following types and conform to AASHTO M 240:

- Type II – Portland-limestone cement
- Type IP – Portland-pozzolan cement
- Type IS – Portland blast-furnace slag cement

Blended cement Types II, IP, and IS meeting the “MS” sulfate resistance requirement listed in AASHTO M 240, Table 3 shall have the “(MS)” suffix added to the type designation.

**907-701.04.1.2--Alkali Content.** Delete the sentence in Subsection 701.04.1.2 on page 720, and substitute the following.

All blended cement types shall be made with clinker that would result in cement meeting the requirements of Subsection 701.02.1.2 when used in the production of AASHTO M 85, Type I or Type II cement.

The blended cement manufacturer shall include the percent equivalent alkalis as Na<sub>2</sub>O on their cement mill reports.

When calculating the total alkali contribution with blended cements, use the equivalent alkali content of the base portland cement. An example calculation for cases where blended cements are used can be found in the Department’s *Concrete Field Manual*.

**907-701.04.2--Replacement by Other Cementitious Materials.** Delete the paragraph in Subsection 701.04.2 on page 720, and substitute the following.

The maximum replacement of blended cement Type II by weight is 35% for fly ash or 50% for GGBFS. Replacement contents below 20% for fly ash or 45% for GGBFS may be used, but will not be given any special considerations, such as the maximum acceptance temperature for blended cement concrete containing pozzolans in Subsection 804.02.13.1.5. Special considerations shall only apply for replacement of blended cement by fly ash or GGBFS.

No additional cementitious materials, such as portland cement, blended cement, fly ash, GGBFS, or others, shall be added to or as a replacement for blended cement Types IP and IS.

Delete Subsection 701.04.2.1 on pages 720 and 721, and substitute the following.

**907-701.04.2.1--Blended Cement Concrete Exposed to Soluble Sulfate Conditions or Seawater.** When blended cement concrete is exposed to moderate or severe soluble sulfate conditions, or to seawater, cement types and replacement of cement by Class F fly ash or GGBFS shall be as follows in Table 2. Class C fly ash shall not be used as a replacement for cement in any of the sulfate exposure conditions listed in Table 2.

**Table 2- Cementitious Materials for Soluble Sulfate Conditions or Seawater**

Sulfate Exposure	Water-soluble sulfate (SO <sub>4</sub> ) in soil, % by mass	Sulfate (SO <sub>4</sub> ) in water, ppm	Cementitious material required
Moderate and Seawater	0.10 - 0.20	150 - 1,500	Type IL (MS) * cement, Type IL cement with one of the following replacements of cement by weight: 24.5 - 35.0% Class F fly ash, or 49.5 - 50.0% GGBFS, Type IP (MS) cement, or Type IS (MS) cement
Severe	0.20 - 2.00	1,500 - 10,000	Type IL cement with a replacement of cement by weight of 49.5 - 50.0% GGBFS, or Type IL (MS) cement with one of following replacements of cement by weight: 24.5 - 35.0% Class F fly ash, or 49.5 - 50.0% GGBFS

\* Class F fly ash or GGBFS may be added as a replacement for cement as allowed in Subsection 907-701.04.2.

Delete Subsection 701.04.2.2 on page 721, and substitute the following.

**907-701.04.2.2--Blended Cement for Soil Stabilization Exposed to Soluble Sulfate Conditions or Seawater.** When blended cement for use in soil stabilization is exposed to moderate or severe soluble sulfate conditions, or to seawater, cement types and replacement of cement by Class F fly ash or GGBFS shall meet the requirements of Subsection 701.04.2.1.

Delete Subsection 701.04.3 on page 721.

**MISSISSIPPI DEPARTMENT OF TRANSPORTATION**

**SPECIAL PROVISION NO. 907-702-4**

**CODE: (IS)**

**DATE: 09/11/2018**

**SUBJECT: Bituminous Materials**

Section 702, Bituminous Materials, of the 2017 Edition of the Mississippi Standard Specifications for Road and Bridge Construction is hereby amended as follows.

**907-702.04--Sampling.** Delete the sentence in Subsection 702.04 on page 722, and substitute the following.

Sampling of bituminous materials shall be as set out in AASHTO R 66.

**907-702.07--Emulsified Asphalt.** Delete the last sentence in Subsection 702.07 on page 724, and substitute the following.

Asphalt for fog seal shall conform to the requirements of Subsection 907-702.12, Table V.

**907-702.12--Tables.** Delete Table V in Subsection 702.12 on page 729, and substitute the following.

**TABLE V  
SPECIFICATION FOR FOG SEAL**

Test Requirements	LD-7		CHPF-1		Test Method
	Min.	Max.	Min.	Max.	
Viscosity, Saybolt Furol, @ 25°C, Sec.	10	100	-	100	AASHTO T 72
Storage Stability Test, 24 hr, %	-	1	-	1	AASHTO T 59
Settlement, 5 day, %	-	5	-	-	AASHTO T 59
Oil Distillate, %	-	1	-	-	AASHTO T 59
Sieve Test, % *	-	0.3	-	0.1	AASHTO T 59
Residue by Distillation, %	40	-	40	-	AASHTO T 59
<b>Test on Residue from Distillation</b>					
Penetration @ 25°C, 100g, 5 sec	-	20	40	90	AASHTO T 49
Softening Point, °C	65	-	-	-	ASTM D 36
Solubility in trichloroethylene, %	97.5	-	-	-	AASHTO T 44
Elastic Recovery @ 25°C, %	-	-	40	-	AASHTO T 301
Original DSR @ 82° (G*/Sinδ, 10 rad/sec)	1	-	-	-	AASHTO T 111

\* The Sieve Test result is tested for reporting purposes only and may be waived if no application problems are present in the field.



**MISSISSIPPI DEPARTMENT OF TRANSPORTATION**

**SPECIAL PROVISION NO. 907-703-1**

**CODE: (IS)**

**DATE: 06/13/2018**

**SUBJECT: Gradation**

Section 703, Aggregates, of the 2017 Edition of the Mississippi Standard Specifications for Road and Bridge Construction is hereby amended as follows.

**907-703.03--Course Aggregates for Hydraulic Cement Concrete.**

**907-703.03.2--Detail Requirements.**

**907-703.03.2.4--Gradation.** In the table in Subsection 703.03.2.4 on page 734, add 100 for the percent passing by weight on the 1½-inch sieve for Size No. 67 aggregates.

**MISSISSIPPI DEPARTMENT OF TRANSPORTATION**

**SPECIAL PROVISION NO. 907-705-1**

**CODE: (IS)**

**DATE: 06/13/2018**

**SUBJECT: Stone Riprap**

Section 705, Stone Blanket Protection and Filter Blanket Materials, of the 2017 Edition of the Mississippi Standard Specifications for Road and Bridge Construction is hereby amended as follows.

**907-705.04--Stone Riprap.** Delete the last sentence of the first paragraph of Subsection 705.04 on page 750, and substitute the following.

Quality requirements for rock to be furnished under these specifications will come from a pre-approved source and be visually approved prior to use.

## MISSISSIPPI DEPARTMENT OF TRANSPORTATION

SPECIAL PROVISION NO. 907-707-2

CODE: (IS)

DATE: 06/05/2019

SUBJECT: Joint Materials

Section 707, Joint Materials, of the 2017 Edition of the Mississippi Standard Specifications for Road and Bridge Construction is hereby amended as follows.

**907-707.02.3--Wood.** Delete paragraph (b) of Subsection 707.02.3 on page 755, and substitute the following:

- (b) Dimensions shall be as shown on the plans. Dimensions shown on the plans are “dressed” sizes in accordance with Table 3 of the American Softwood Lumber Standard, SP-20. At the discretion of the Engineer, a 3/4-inch dressed board may be used in lieu of a 1-inch dressed board. A tolerance of plus or minus 1/16 inch thickness and plus or minus 1/8 inch width will be permitted. For slip-form paving a tolerance of minus 1/4 inch on each end in length will be permitted.

**907-707.06--Flexible Plastic Gasket for Joining Conduit.** Delete the third paragraph of Subsection 707.06 on page 756, and substitute the following.

The Department may require the performance test described in ASTM C 990.

**MISSISSIPPI DEPARTMENT OF TRANSPORTATION**

**SPECIAL PROVISION NO. 907-711-2**

**CODE: (IS)**

**DATE: 09/11/2018**

**SUBJECT: Plain Steel Wire**

Section 711, Reinforcement and Wire Rope, of the 2017 Edition of the Mississippi Standard Specifications for Road and Bridge Construction is hereby amended as follows.

**907-711.02--Deformed and Plain Carbon-Steel Bars for Concrete Reinforcing.**

**907-711.02.3--Steel Welded and Non-Welded Wire Reinforcement, Plain and Deformed, for Concrete.**

**907-711.02.3.1--Plain Steel Wire.** Delete the sentence in Subsection 711.02.3.1 on pages 780 and 781, and substitute the following.

Plain steel wire and plain steel welded wire shall conform to the requirements of AASHTO M 336.

## MISSISSIPPI DEPARTMENT OF TRANSPORTATION

SPECIAL PROVISION NO. 907-714-1

CODE: (SP)

DATE: 05/25/2021

SUBJECT: Miscellaneous Materials

Section 714, Miscellaneous Materials, of the 2017 Edition of the Mississippi Standard Specifications for Road and Bridge Construction is hereby amended as follows.

### 907-714.01--Water.

907-714.01.1--General. Delete the last sentence of the second paragraph in Subsection 714.01.1 on page 794.

907-714.01.2--Water for Use in Concrete. Delete Subsection 714.01.2 on page 794, and substitute the following:

Water from municipal sources is permitted be used as mixing water in concrete, mortar, and grout without Department testing. Water from non-municipal water sources used in mixing of concrete, mortar, and grout which does not meet the requirements in Subsection 714.01.1 shall be tested for conformance as required in AASHTO M157, Table 1 and Table 2.

907-714.01.3--Water for Use in Chemically Stabilized Based. Delete the first sentence of first paragraph in Subsection 714.01.3 on page 794, and substitute the following:

Water used in the construction of bases that contain cement, lime, or other chemical additive shall be as set out in Subsection 714.01.1. Water from municipal sources is permitted to be used without testing for conformance to the requirements below. If water is not from a municipal source, it shall not contain impurities in excess of the following limits:

Delete Subsection 714.01.6 on page 795, and substitute the following.

### 907-714.01.6--Blank.

Delete Subsection 714.15 on pages 816 and 817 and substitute the following.

### 907-714.15--Geogrids.

907-714.15.1--General. A geogrid is defined as a geosynthetic formed by a regular network of connected elements with apertures greater than 0.25 inch to allow interlocking with surrounding soil, rock, and other surrounding materials to function primarily as reinforcement.

Geogrid shall be manufactured from an expanded strain hardened monolithic polymer sheet

composed of one or more synthetic polymers and shall be mildew resistant and inert to biological degradation and naturally encountered chemicals, alkalis and acids. The geogrid shall contain stabilizers and/or inhibitors, or a resistance finish or covering to make it resistant to deterioration from direct sunlight, ultraviolet rays, and heat.

Geogrid manufacturers shall participate in and be in compliance with the American Association of State Highway Transportation Officials (AASHTO) National Transportation Product Evaluation Program's (NTPEP) Geosynthetics audit program. Geogrid shall meet the requirements of Table II for the application and type shown on the plans and shall be selected from the Department's Approved Lists.

**907-714.15.1.1--Geogrid for Retaining Walls and Reinforced Soil Slopes.** Geogrid for retaining walls and reinforced soil slopes shall be creep tested in accordance with AASHTO R69 and meet Long Term Design Load, Minimum Ultimate Tensile Strength, and open area criteria listed in Table II. Manufacturers shall perform at least one long-term creep test for no less than 10,000 hours in accordance to ASTM D 5262 for each polymer or composition of polymers from which the geogrid is produced. The long-term design load that shall be reported for design use, shall be that load at which no more than 10% strain occurs over a 100-year design life of the geogrid, as calculated in accordance with AASHTO R69. Long-term design loads shall be reported unfactored, and the AASHTO strength reduction factors (Durability and Installation, and safety factors) will be considered by the Department's Geotechnical Branch on a site specific design basis.

**907-714.15.1.2--Geogrid for Subgrade Stabilization.** Geogrid for subgrade stabilization shall meet Minimum Ultimate Tensile Strength and open area criteria listed in Table II.

**907-714.15.2--Marking, Shipment, and Storage.** Each roll or container of geogrid shall be visibly labeled with the name of the manufacturer, trade name of the product, lot number, and quantity of material. In addition, each roll or container shall be clearly tagged to show the type designation that corresponds to that required by the plans. During shipment and storage the geogrid shall be protected from direct sunlight, and temperatures above 120°F or below 0°F. The geogrid shall either be wrapped and maintained in a heavy duty protective covering or stored in a safe enclosed area to protect from damage during prolonged storage.

**907-714.15.3--Manufacturer Certification.** The Contractor shall furnish the Engineer three copies of the manufacturer's certified test reports indicating that the geogrid furnished conforms to the requirements of the specifications and is of the same composition as the originally approved by the Department.

**907-714.15.4--Acceptance Sampling and Testing.** Final acceptance of each shipment will be based upon results of tests performed by the Department on verification samples submitted from the project, as compared to the manufacturer's certified test reports. The Engineer will select one roll or container at random from each shipment for sampling. As sample extending full width of the randomly selected roll or container and being at least five (5) square yards in area will be obtained and submitted by the Engineer. All material samples shall be provided at no cost to the State.

**TABLE II  
GEOGRIDS**

Physical Properties	Type Designation						Test Method
	I	II	III	IV	V	VI	
Long Term Design Load <sup>1</sup> , pounds per foot, Machine Direction	250	500	750	1500	2500	3500	AASHTO R69, ASTM D5262
Minimum Ultimate Tensile Strength <sup>2</sup> , pounds per foot, Machine Direction	500	1000	1500	3000	5000	7000	ASTM D6637
Open Area, percent	70	70	50	50	50	50	Direct Measurement

<sup>1</sup> Minimum design criteria requirement.

<sup>2</sup> Minimum Average Roll Value (MARV).

**MISSISSIPPI DEPARTMENT OF TRANSPORTATION**

**SPECIAL PROVISION NO. 907-720-2**

**CODE: (IS)**

**DATE: 09/11/2018**

**SUBJECT: Acceptance Procedure for Glass Beads**

Section 720, Pavement Marking Materials, of the 2017 Edition of the Mississippi Standard Specifications for Road and Bridge Construction is hereby amended as follows.

**907-720.01--Glass Beads.**

**907-720.01.4--Acceptance Procedures.** Delete the last sentence of the paragraph in Subsection 720.01.4 on page 841, and substitute the following.

Acceptance sampling and testing of glass beads will be in accordance with the Department's Materials Division Inspection, Testing, and Certification Manual, Section 2.9.2 -- Glass Beads.



**MISSISSIPPI DEPARTMENT OF TRANSPORTATION**

**SPECIAL PROVISION NO. 907-721-2**

**CODE: (IS)**

**DATE: 01/08/2020**

**SUBJECT: Materials for Signing**

Section 721, Materials for Signing, of the 2017 Edition of the Mississippi Standard Specifications for Road and Bridge Construction is hereby amended as follows.

**907-721.06--Reflective Sheeting.**

**907-721.06.2--Performance Requirements.** Delete Table 4 and Table 5 in Subsection 721.06.2 on pages 860 & 861, and substitute the following.

**MINIMUM COEFFICIENTS OF RETROREFLECTION  
Candela per foot candle per square foot (cd/ft<sup>2</sup>)  
Per ASTM Designation D4956**

**TABLE 4  
Type IX Sheeting**

Observation Angle	Entrance Angle	White	Yellow	Green	Red	Blue	Fluorescent Yellow/Green	Fluorescent Yellow	Fluorescent Orange
0.2°	-4.0°	380	285	38	76	17	300	230	115
0.2°	+30.0°	215	162	22	43	10	170	130	65
0.5°	-4.0°	240	180	24	48	11	190	145	72
0.5°	+30.0°	135	100	14	27	6.0	110	81	41
1.0°	-4.0°	80	60	8.0	16	3.6	64	48	24
1.0°	+30.0°	45	34	4.5	9.0	2.0	36	27	14

**TABLE 5  
Type XI Sheeting**

Observation Angle	Entrance Angle	White	Yellow	Green	Red	Blue	Brown	Fluorescent Yellow/Green	Fluorescent Yellow	Fluorescent Orange
0.2°	-4.0°	580	435	58	87	26	17	460	350	175
0.2°	+30.0°	220	165	22	33	10	7.0	180	130	66
0.5°	-4.0°	420	315	42	63	19	13	340	250	125
0.5°	+30.0°	150	110	15	23	7.0	5.0	120	90	45
1.0°	-4.0°	120	90	12	18	5.0	4.0	96	72	36
1.0°	+30.0°	45	34	5.0	7.0	2.0	1.0	36	27	14

# SECTION 905 - PROPOSAL

Date \_\_\_\_\_

Mississippi Transportation Commission  
Jackson, Mississippi

Sirs: The following proposal is made on behalf of \_\_\_\_\_  
\_\_\_\_\_ of \_\_\_\_\_  
\_\_\_\_\_

for constructing the following designated project(s) within the time(s) hereinafter specified.

The plans are composed of drawings and blue prints on file in the offices of the Mississippi Department of Transportation, Jackson, Mississippi.

The Specifications are the current Standard Specifications of the Mississippi Department of Transportation approved by the Federal Highway Administration, except where superseded or amended by the plans, Special Provisions and Notice(s) to Bidders attached hereto and made a part thereof.

I (We) certify that I (we) possess a copy of said Standard and any Supplemental Specifications.

Evidence of my (our) authority to submit the Proposal is hereby furnished. The proposal is made without collusion on the part of any person, firm or corporation. I (We) certify that I (we) have carefully examined the Plans, the Specifications, including the Special Provisions and Notice(s) to Bidders, herein, and have personally examined the site of the work. On the basis of the Specifications, Special Provisions, Notice(s) to Bidders, and Plans, I (we) propose to furnish all necessary machinery, tools, apparatus and other means of construction and do all the work and furnish all the materials in the manner specified. I (We) understand that the quantities mentioned herein are approximate only and are subject to either increase or decrease, and hereby propose to perform any increased or decreased quantities of work at the unit prices bid, in accordance with the above.

I (We) acknowledge that this proposal will be found irregular and/or non-responsive unless a certified check, cashier's check, or Proposal Guaranty Bond in the amount as required in the Advertisement (or, by law) is submitted electronically with the proposal or is delivered to the Contract Administration Engineer prior to the bid opening time specified in the advertisement.

**INSTRUCTION TO BIDDERS: Alternate and Optional Items on Bid Schedule.**

1. Two or more items entered opposite a single unit quantity WITHOUT DEFINITE DESIGNATION AS "ALTERNATE ITEMS" are considered as "OPTIONAL ITEMS". Bidders may or may not indicate on bids the Optional Item proposed to be furnished or performed WITHOUT PREJUDICE IN REGARD TO IRREGULARITY OF BIDS.
2. Items classified on the bid schedule as "ALTERNATE ITEMS" and/or "ALTERNATE TYPES OF CONSTRUCTION" must be preselected and indicated on bids. However, "Alternate Types of Construction" may include Optional Items to be treated as set out in Paragraph 1, above.
3. Optional items not preselected and indicated on the bid schedule MUST be designated in accordance with Subsection 102.06 prior to or at the time of execution of the contract.
4. Optional and Alternate items designated must be used throughout the project.

I (We) further propose to perform all "force account or extra work" that may be required of me (us) on the basis provided in the Specifications and to give such work my (our) personal attention in order to see that it is economically performed.

I (We) further propose to execute the attached contract agreement (Section 902) as soon as the work is awarded to me (us), and to begin and complete the work within the time limit(s) provided for in the Specifications and Advertisement. I (We) also propose to execute the attached contract bond (Section 903) in an amount not less than one hundred (100) percent of the total of my (our) part, but also to guarantee the excellence of both workmanship and materials until the work is finally accepted.

I (We) shall submit electronically with our proposal or deliver prior to the bid opening time a certified check, cashier's check or bid bond for **five percent (5%) of total bid** and hereby agree that in case of my (our) failure to execute the contract and furnish bond within Ten (10) days after notice of award, the amount of this check (bid bond) will be forfeited to the State of Mississippi as liquidated damages arising out of my (our) failure to execute the contract as proposed. It is understood that in case I am (we are) not awarded the work, the check will be returned as provided in the Specifications.

**SECTION 905 -- PROPOSAL (CONTINUED)**

I (We) hereby certify by digital signature and electronic submission via Bid Express of the Section 905 proposal below, that all certifications, disclosures and affidavits incorporated herein are deemed to be duly executed in the aggregate, fully enforceable and binding upon delivery of the bid proposal. I (We) further acknowledge that this certification shall not extend to the bid bond or alternate security which must be separately executed for the benefit of the Commission. This signature does not cure deficiencies in any required certifications, disclosures and/or affidavits. I (We) also acknowledge the right of the Commission to require full and final execution on any certification, disclosure or affidavit contained in the proposal at the Commission's election upon award. Failure to so execute at the Commission's request within the time allowed in the Standard Specifications for execution of all contract documents will result in forfeiture of the bid bond or alternate security.

Respectfully Submitted,

DATE \_\_\_\_\_

\_\_\_\_\_  
Contractor

BY \_\_\_\_\_  
Signature

TITLE \_\_\_\_\_

ADDRESS \_\_\_\_\_

CITY, STATE, ZIP \_\_\_\_\_

PHONE \_\_\_\_\_

FAX \_\_\_\_\_

E-MAIL \_\_\_\_\_

(To be filled in if a corporation)

Our corporation is chartered under the Laws of the State of \_\_\_\_\_ and the names, titles and business addresses of the executives are as follows:

\_\_\_\_\_  
President Address

\_\_\_\_\_  
Secretary Address

\_\_\_\_\_  
Treasurer Address

The following is my (our) itemized proposal.

Widen, Level & Thin Lift Overlay approximately 5 miles on SR 589 from US 11 to 1.6 miles North of Old Highway 11, known as Federal Aid Project No. STP-1164-00(018) / 108227301 in Lamar County.

Line no.	Item Code	Adj Code	Quantity	Units	Description[Fixed Unit Price]
<b>Roadway Items</b>					
0010	202-B007		663	Square Yard	Removal of Asphalt Pavement, All Depths
0020	202-B050		139	Linear Feet	Removal of Concrete Combination Curb & Gutter
0030	202-B059		40	Square Yard	Removal of Concrete Median & Island Pavement, All Depths
0040	202-B158		661	Linear Feet	Removal of Guard Rail, Including Rails, Posts and Terminal Ends
0050	202-B240		2,016	Linear Feet	Removal of Traffic Stripe
0060	403-B011	(BA1)	4,350	Ton	9.5-mm, MT, Asphalt Pavement, Leveling
0070	406-D001		92,036	Square Yard	Fine Milling of Bituminous Pavement, All Depths
0080	407-A001	(A2)	7,800	Gallon	Asphalt for Tack Coat
0090	423-A001		6	Mile	Rumble Strips, Ground In
0100	606-B003		421	Linear Feet	Guard Rail, Class A, Type 1, 'W' Beam, Metal Post
0110	606-D001		4	Each	Guard Rail, Bridge End Section
0120	606-E001		4	Each	Guard Rail, Terminal End Section
0130	618-A001		1	Lump Sum	Maintenance of Traffic
0140	618-B001		1	Square Feet	Additional Construction Signs (\$10.00)
0150	619-A1001		12	Mile	Temporary Traffic Stripe, Continuous White
0160	619-A2001		12	Mile	Temporary Traffic Stripe, Continuous Yellow
0170	619-A4002		1	Mile	Temporary Traffic Stripe, Skip Yellow
0180	619-A5001		11,500	Linear Feet	Temporary Traffic Stripe, Detail
0190	619-A6001		77	Square Feet	Temporary Traffic Stripe, Legend
0200	619-A6002		1,190	Linear Feet	Temporary Traffic Stripe, Legend
0210	620-A001		1	Lump Sum	Mobilization
0220	626-C002		6	Mile	6" Thermoplastic Double Drop Edge Stripe, Continuous White
0230	626-D003		1	Mile	6" Thermoplastic Traffic Stripe, Skip Yellow
0240	626-E004		6	Mile	6" Thermoplastic Traffic Stripe, Continuous Yellow
0250	626-G002		5,500	Linear Feet	Thermoplastic Detail Stripe, White
0260	626-G003		6,000	Linear Feet	Thermoplastic Detail Stripe, Yellow
0270	626-H004		77	Square Feet	Thermoplastic Legend, White
0280	626-H005		1,190	Linear Feet	Thermoplastic Legend, White
0290	627-J001		260	Each	Two-Way Clear Reflective High Performance Raised Markers
0300	627-K001		25	Each	Red-Clear Reflective High Performance Raised Markers
0310	627-L001		550	Each	Two-Way Yellow Reflective High Performance Raised Markers
0320	630-F006		22	Each	Delineators, Guard Rail, White
0330	630-G005		16	Each	Type 3 Object Markers, OM-3R or OM-3L, Post Mounted
0340	907-411-A001	(BA1)	3,420	Ton	Ultra Thin Asphalt Pavement
0350	907-630-O006		4	Each	Remove and Reset Signs, Ground Mounted

**ALTERNATE GROUP AA NUMBER 1**

Line no.	Item Code	Adj Code	Quantity	Units	Description[Fixed Unit Price]
0360	304-D001	(GT)	2,000	Ton	Granular Material, Crushed Concrete
<b>ALTERNATE GROUP AA NUMBER 2</b>					
0370	304-F002	(GT)	2,000	Ton	Size 610 Crushed Stone Base
<b>ALTERNATE GROUP AA NUMBER 3</b>					
0380	304-F003	(GT)	2,000	Ton	Size 825B Crushed Stone Base
<b>ALTERNATE GROUP BB NUMBER 1</b>					
0390	907-624-B002		1,008	Linear Feet	6" Inverted Profile Thermoplastic Traffic Stripe, Continuous White
0400	907-624-D002		1,008	Linear Feet	6" Inverted Profile Thermoplastic Traffic Stripe, Continuous Yellow
<b>ALTERNATE GROUP BB NUMBER 2</b>					
0410	628-H001		1,008	Linear Feet	6" High Performance Cold Plastic Traffic Stripe, Continuous White
0420	628-J001		1,008	Linear Feet	6" High Performance Cold Plastic Traffic Stripe, Continuous Yellow

SECTION 905 - COMBINATION BID PROPOSAL (Continued)

**CONDITIONS FOR COMBINATION BID**

If a bidder elects to submit a combined bid for two or more of the contracts listed for this month's letting, the bidder must complete and execute these sheets of the proposal in each of the individual proposals to constitute a combination bid. In addition to this requirement, each individual contract shall be completed, executed and submitted in the usual specified manner.

Failure to execute this Combination Bid Proposal in each of the contracts combined will be just cause for each proposal to be received and evaluated as a separate bid.

It is understood that the Mississippi Transportation Commission not only reserves the right to reject any and all proposals, but also the right to award contracts upon the basis of lowest separate bids or combination bids most advantageous to the State.

It is further understood and agreed that the Combination Bid Proposal is for comparison of bids only and that each contract shall operate in every respect as a separate contract in accordance with its proposal and contract documents.

I (We) agree to complete each contract on or before its specified completion date.

\*\*\*\*\*

**COMBINATION BID PROPOSAL**

This proposal is tendered as one part of a Combination Bid Proposal utilizing option \_\_\_\* of Subsection 102.11 on the following contracts:

\* Option to be shown as either (a), (b), or (c).

	<u>Project No.</u>	<u>County</u>	<u>Project No.</u>	<u>County</u>
1.	_____	_____	6.	_____
2.	_____	_____	7.	_____
3.	_____	_____	8.	_____
4.	_____	_____	9.	_____
5.	_____	_____	10.	_____

(a) If Combination A has been selected, your Combination Bid is complete.

(b) If Combination B has been selected, then complete the following page.

SECTION 905 - COMBINATION BID PROPOSAL (Continued)

Project Number	Pay Item Number	Unit	Unit Price Reduction	Total Item Reduction	Total Contract Reduction
1.					
2.					
3.					
4.					
5.					
6.					
7.					
8.					

For Informational Purposes Only

SECTION 905 - COMBINATION BID PROPOSAL (Continued)

Project Number	Pay Item Number	Unit	Unit Price Reduction	Total Item Reduction	Total Contract Reduction
9.					
10.					

(c) If Combination C has been selected, then initial and complete ONE of the following.

\_\_\_\_\_ I (We) desire to be awarded work not to exceed a total monetary value of \$ \_\_\_\_\_.

\_\_\_\_\_ I (We) desire to be awarded work not to exceed \_\_\_\_\_ number of contracts.





**Certification with regard to the Performance of Previous  
Contracts or Subcontracts subject to the Equal Opportunity  
Clause and the filing of Required Reports**

The Bidder hereby certifies that he has \_\_\_\_\_, has not \_\_\_\_\_, participated in a previous contract or subcontract subject to the Equal Opportunity Clause, as required by Executive Orders 10925, 11114, or 11246, and that he has \_\_\_\_\_, has not \_\_\_\_\_, filed with the Joint Reporting Committee, the Director of the Office of Federal Contract Compliance, a Federal Government contracting or administering agency, or the former President's Committee on Equal Employment Opportunity, all reports due under the applicable filing requirements.

\_\_\_\_\_  
(COMPANY)

DATE: \_\_\_\_\_

NOTE: The above certification is required by the Equal Employment Opportunity Regulations of the Secretary of Labor (41 CFR 60-1.7 (b) (1)), and must be submitted by bidders and proposed subcontractors only in connection with contracts and subcontracts which are subject to the Equal Opportunity Clause. Contracts and Subcontracts which are exempt from the Equal Opportunity Clause are set forth in 41 CFR 60-1.5. (Generally only contracts or subcontracts of \$10,000 or under are exempt.)

Currently, Standard Form 100 (EEO-1) is the only report required by the Executive Orders or their implementing regulations.

Proposed prime Contractors and Subcontractors who have participated in a previous contract or subcontract subject to the Executive orders and have not filed the required reports should note that 41 CFR 60-1.7 (b) (1) prevents the award of contracts and subcontracts unless such Contractors submit a report covering the delinquent period or such other period specified by the Federal Highway Administration or by the Director, Office of Federal Contract Compliance, U. S. Department of Labor.

**MISSISSIPPI DEPARTMENT OF TRANSPORTATION**  
**CERTIFICATION**

I, \_\_\_\_\_,  
(Name of person signing bid)

individually, and in my capacity as \_\_\_\_\_ of  
(Title of person signing bid)

\_\_\_\_\_ do hereby certify under  
(Name of Firm, partnership, or Corporation)

penalty of perjury under the laws of the United States and the State of Mississippi that \_\_\_\_\_

\_\_\_\_\_, Bidder  
(Name of Firm, Partnership, or Corporation)

on Project No. **STP-1164-00(018)/ 108227301000**

in **Lamar** \_\_\_\_\_ County(ies), Mississippi, has not either

directly or indirectly entered into any agreement, participated in any collusion; or otherwise taken any action in restraint of free competitive bidding in connection with this contract; nor have any of its corporate officers or principal owners.

Except as noted hereafter, it is further certified that said legal entity and its corporate officers, principal owners, managers, auditors and others in a position of administering federal funds:

- a) Are not presently debarred, suspended, proposed for debarment, declared ineligible, or voluntarily excluded from covered transactions by any Federal department or agency;
- b) Have not within a three-year period preceding this proposal been convicted of or had a civil judgment rendered against them for commission of fraud or a criminal offense in connection with obtaining, attempting to obtain, or performing a public (Federal, State or local) transaction or contract under a public transaction; violation of Federal or State antitrust statutes or commission of embezzlement, theft, forgery, bribery, falsification or destruction of records, making false statements, or receiving stolen property;
- c) Are not presently indicted for or otherwise criminally or civilly charged by a governmental entity (Federal, State or local) with commission of any of the offenses enumerated in (b) above; and
- d) Have not within a three-year period preceding this application/ proposal had one or more public transactions (Federal, State or local) terminated for cause or default.

Do exceptions exist and are made a part thereof? Yes / No

Any exceptions shall address to whom it applies, initiating agency and dates of such action.

Note: Exceptions will not necessarily result in denial of award but will be considered in determining bidder responsibility. Providing false information may result in criminal prosecution or administrative sanctions.

The bidder further certifies that the certification requirements contained in Section XI of Form FHWA 1273, will be or have been included in all subcontracts, material supply agreements, purchase orders, etc. except those procurement contracts for goods or services that are expected to be less than the Federal procurement small purchase threshold fixed at 10 U.S.C. 2304(g) and 41 U.S.C. 253(g) (currently \$25,000) which are excluded from the certification requirements.

The bidder further certifies, to the best of his or her knowledge and belief, that:

1) No Federal appropriated funds have been paid or will be paid to any person for influencing or attempting to influence an officer or employee of any Federal agency, a Member of Congress, an officer or employee of Congress, or an employee of a Member of Congress in connection with the awarding of any Federal contract, the making of any Federal grant, the making of any Federal loan, the entering into of any cooperative agreement, and the extension, continuation, renewal, amendment, or modification of any Federal contract, grant, loan, or cooperative agreement.

2) If any funds other than Federal appropriated funds have been paid or will be paid to any person for influencing or attempting to influence an officer or employee of any Federal agency, a Member of Congress, an officer or employee of Congress, or an employee of a Member of Congress in connection with this contract, Standard Form-LLL, Disclosure Form to Report Lobbying, in accordance with its instructions will be completed and submitted.

The certification contained in (1) and (2) above is a material representation of fact upon which reliance is placed and a prerequisite imposed by Section 1352, Title 31, U.S. Code prior to entering into this contract. Failure to comply shall be subject to a civil penalty of not less than \$10,000 and not more than \$100,000. The bidder shall include the language of the certification in all subcontracts exceeding \$100,000 and all subcontractors shall certify and disclose accordingly.

All of the foregoing is true and correct.

Executed on \_\_\_\_\_

\_\_\_\_\_  
Signature

**MISSISSIPPI DEPARTMENT OF TRANSPORTATION**

SAM.GOV Registration and DUNS Number

Bidders are advised that the Prime Contractor must maintain current registration in the **System for Award Management** (<http://www.sam.gov>) at all times during the project. A Dun and Bradstreet Data Universal Numbering System (DUNS) Number (<http://www.dnb.com>) is one of the requirements for registration in the System for Award Management.

Bidders are advised that prior to the award of this contract, they **MUST** be registered in the System for Award Management.

I (We) acknowledge that this contract cannot be awarded if I (We) are not registered in the System for Award Management prior to the award of this contract. \_\_\_\_\_ (Yes / No)

I (We) have a DUNS Number . \_\_\_\_\_ (Yes / No)

DUNS Number: \_\_\_\_\_

Company Name: \_\_\_\_\_

Company e-mail address: \_\_\_\_\_

(6/2015F)

For Informational Purposes Only

SECTION 902

CONTRACT FOR STP-1164-00(018)/ 108227301000

LOCATED IN THE COUNTY(IES) OF Lamar

STATE OF MISSISSIPPI,  
COUNTY OF HINDS

This contract entered into by and between the Mississippi Transportation Commission on one hand, and the undersigned contractor, on the other witnesseth;

That, in consideration of the payment by the Mississippi Transportation Commission of the prices set out in the proposal hereto attached, to the undersigned contractor, such payment to be made in the manner and at the time of times specified in the specifications and the special provisions, if any, the undersigned contractor hereby agrees to accept the prices stated in the proposal in full compensation for the furnishing of all materials and equipment and the executing of all the work contemplated in this contract.

It is understood and agreed that the advertising according to law, the Advertisement, the instructions to bidders, the proposal for the contract, the specifications, the revisions of the specifications, the special provisions, and also the plans for the work herein contemplated, said plans showing more particularly the details of the work to be done, shall be held to be, and are hereby made a part of this contract by specific reference thereto and with like effect as if each and all of said instruments had been set out fully herein in words and figures.

It is further agreed that for the same consideration the undersigned contractor shall be responsible for all loss or damage arising out of the nature of the work aforesaid; or from the action of the elements and unforeseen obstructions or difficulties which may be encountered in the prosecution of the same and for all risks of every description connected with the work, exceptions being those specifically set out in the contract; and for faithfully completing the whole work in good and workmanlike manner according to the approved Plans, Specifications, Special Provisions, Notice(s) to Bidders and requirements of the Mississippi Department of Transportation.

It is further agreed that the work shall be done under the direct supervision and to the complete satisfaction of the Executive Director of the Mississippi Department of Transportation, or his authorized representatives, and when Federal Funds are involved subject to inspection at all times and approval by the Federal Highway Administration, or its agents as the case may be, or the agents of any other Agency whose funds are involved in accordance with those Acts of the Legislature of the State of Mississippi approved by the Governor and such rules and regulations issued pursuant thereto by the Mississippi Transportation Commission and the authorized Federal Agencies.

The Contractor agrees that all labor as outlined in the Special Provisions may be secured from list furnished by

It is agreed and understood that each and every provision of law and clause required by law to be inserted in this contract shall be deemed to be inserted herein and this contract shall be read and enforced as though it were included herein, and, if through mere mistake or otherwise any such provision is not inserted, then upon the application of either party hereto, the contract shall forthwith be physically amended to make such insertion.

The Contractor agrees that he has read each and every clause of this Contract, and fully understands the meaning of same and that he will comply with all the terms, covenants and agreements therein set forth.

Witness our signatures this the \_\_\_ day of \_\_\_\_\_, \_\_\_\_\_.

\_\_\_\_\_  
Contractor(s)

By \_\_\_\_\_

MISSISSIPPI TRANSPORTATION COMMISSION

Title \_\_\_\_\_

By \_\_\_\_\_

Signed and sealed in the presence of:  
(names and addresses of witnesses)

Executive Director

\_\_\_\_\_

Secretary to the Commission

Award authorized by the Mississippi Transportation Commission in session on the \_\_\_ day of \_\_\_\_\_, \_\_\_\_\_, Minute Book No. \_\_\_\_\_, Page No. \_\_\_\_\_.

Revised 8/06/2003

**SECTION 903**  
**PERFORMANCE AND PAYMENT BOND**

CONTRACT BOND FOR: STP-1164-00(018)/ 108227301000

LOCATED IN THE COUNTY(IES) OF: Lamar

STATE OF MISSISSIPPI,  
COUNTY OF HINDS

Know all men by these presents: that we, \_\_\_\_\_  
(Contractor)  
\_\_\_\_\_ Principal, a \_\_\_\_\_

residing at \_\_\_\_\_ in the State of \_\_\_\_\_

and \_\_\_\_\_

(Surety)  
residing at \_\_\_\_\_ in the State of \_\_\_\_\_,

authorized to do business in the State of Mississippi, under the laws thereof, as surety, effective as of the contract date shown below, are held and firmly bound unto the State of Mississippi in the sum of \_\_\_\_\_

\_\_\_\_\_ Dollars, lawful money of the United States of America, to be paid to it for which payment well and truly to be made, we bind ourselves, our heirs, administrators, successors, or assigns jointly and severally by these presents.

The conditions of this bond are such, that whereas the said \_\_\_\_\_

\_\_\_\_\_ principal, has (have) entered into a contract with the Mississippi Transportation Commission, bearing the date of \_\_\_\_\_ day of \_\_\_\_\_ A.D. \_\_\_\_\_ hereto annexed, for the construction of certain projects(s) in the State of Mississippi as mentioned in said contract in accordance with the Contract Documents therefor, on file in the offices of the Mississippi Department of Transportation, Jackson, Mississippi.

Now therefore, if the above bounden \_\_\_\_\_ in all things shall stand to and abide by and well and truly observe, do keep and perform all and singular the terms, covenants, conditions, guarantees and agreements in said contract, contained on his (their) part to be observed, done, kept and performed and each of them, at the time and in the manner and form and furnish all of the material and equipment specified in said contract in strict accordance with the terms of said contract which said plans, specifications and special provisions are included in and form a part of said contract and shall maintain the said work contemplated until its final completion and acceptance as specified in Subsection 109.11 of the approved specifications, and save harmless said Mississippi Transportation Commission from any loss or damage arising out of or occasioned by the negligence, wrongful or criminal act, overcharge, fraud, or any other loss or damage whatsoever, on the part of said principal (s), his (their) agents, servants, or employees in the performance of said work or in any manner connected therewith, and shall be liable and responsible in a civil action instituted by the State at the instance of the Mississippi Transportation Commission or any officer of the State authorized in such cases, for double any amount in money or property, the State may lose or be overcharged or otherwise defrauded of, by reason of wrongful or criminal act, if any, of the Contractor(s), his (their) agents or employees, and shall promptly pay the said agents, servants and employees and all persons furnishing labor, material, equipment or supplies therefor, including premiums incurred, for Surety Bonds, Liability Insurance, and Workmen's Compensation Insurance; with the additional obligation that such Contractor shall promptly make payment of all taxes, licenses, assessments, contributions, damages,

any liquidated damages which may arise prior to any termination of said principal's contract, any liquidated damages which may arise after termination of the said principal's contract due to default on the part of said principal, penalties and interest thereon, when and as the same may be due this state, or any county, municipality, board, department, commission or political subdivision: in the course of the performance of said work and in accordance with Sections 31-5-51 et seq. Mississippi Code of 1972, and other State statutes applicable thereto, and shall carry out to the letter and to the satisfaction of the Executive Director of the Mississippi Department of Transportation, all, each and every one of the stipulations, obligations, conditions, covenants and agreements and terms of said contract in accordance with the terms thereof and all of the expense and cost and attorney's fee that may be incurred in the enforcement of the performance of said contract, or in the enforcement of the conditions and obligations of this bond, then this obligation shall be null and void, otherwise to be and remain in full force and virtue.

_____	_____
(Contractors) Principal	Surety
By _____	By _____
	(Signature) Attorney in Fact
	Address _____
	_____
Title _____	_____
(Contractor's Seal)	(Printed) MS Agent
	_____
	(Signature) MS Agent
	Address _____
	_____
	_____
	(Surety Seal)
	_____
	Mississippi Insurance ID Number



# BID BOND

KNOW ALL MEN BY THESE PRESENTS, that we \_\_\_\_\_  
Contractor

\_\_\_\_\_ Address

\_\_\_\_\_ City, State ZIP

As principal, hereinafter called the Principal, and \_\_\_\_\_  
Surety

a corporation duly organized under the laws of the state of \_\_\_\_\_

as Surety, hereinafter called the Surety, are held and firmly bound unto State of Mississippi, Jackson, Mississippi

As Obligee, hereinafter called Obligee, in the sum of **Five Per Cent (5%) of Amount Bid**

Dollars(\$ \_\_\_\_\_ )

for the payment of which sum will and truly to be made, the said Principal and said Surety, bind ourselves, our heirs, executors, administrators, successors and assigns, jointly and severally, firmly by these presents.

WHEREAS, the Principal has submitted a bid for **Widen, Level & Thin Lift Overlay approximately 5 miles on SR 589 from US 11 to 1.6 miles North of Old Highway 11, known as Federal Aid Project No. STP-1164-00(018) / 108227301 in Lamar County.**

NOW THEREFORE, the condition of this obligation is such that if the aforesaid Principal shall be awarded the contract, the said Principal will, within the time required, enter into a formal contract and give a good and sufficient bond to secure the performance of the terms and conditions of the contract, then this obligation to be void; otherwise the Principal and Surety will pay unto the Obligee the difference in money between the amount of the bid of the said Principal and the amount for which the Obligee legally contracts with another party to perform the work if the latter amount be in excess of the former, but in no event shall liability hereunder exceed the penal sum hereof.

Signed and sealed this \_\_\_\_\_ day of \_\_\_\_\_, 20\_\_

\_\_\_\_\_  
(Principal)

(Seal)

\_\_\_\_\_  
(Witness) (Name) By: \_\_\_\_\_ (Title)

\_\_\_\_\_  
(Surety) (Seal)

\_\_\_\_\_  
(Witness) (Attorney-in-Fact) By: \_\_\_\_\_

\_\_\_\_\_  
(MS Agent)

\_\_\_\_\_  
Mississippi Insurance ID Number



MISSISSIPPI DEPARTMENT OF TRANSPORTATION  
OFFICE OF CIVIL RIGHTS  
JACKSON, MISSISSIPPI

**LIST OF FIRMS SUBMITTING QUOTES**

I/we received quotes from the following firms on:

Letting Date: **June 22, 2021**

Project No: **STP-1164-00(018)/ 108227301000**

County: **Lamar**

Disadvantaged Business Enterprise (DBE) Regulations as stated in 49 CFR 26.11 require the Mississippi Department of Transportation (MDOT) to create and maintain a comprehensive list of all firms quoting/bidding subcontracts on prime contracts and quoting/bidding subcontracts on federally-funded transportation projects. For every firm, we require the following information:

Firm Name: \_\_\_\_\_  
Contact Name/Title: \_\_\_\_\_  
Firm Mailing Address: \_\_\_\_\_  
Phone Number: \_\_\_\_\_  
\_\_\_\_\_ DBE Firm \_\_\_\_\_ Non-DBE Firm

Firm Name: \_\_\_\_\_  
Contact Name/Title: \_\_\_\_\_  
Firm Mailing Address: \_\_\_\_\_  
Phone Number: \_\_\_\_\_  
\_\_\_\_\_ DBE Firm \_\_\_\_\_ Non-DBE Firm

Firm Name: \_\_\_\_\_  
Contact Name/Title: \_\_\_\_\_  
Firm Mailing Address: \_\_\_\_\_  
Phone Number: \_\_\_\_\_  
\_\_\_\_\_ DBE Firm \_\_\_\_\_ Non-DBE Firm

Firm Name: \_\_\_\_\_  
Contact Name/Title: \_\_\_\_\_  
Firm Mailing Address: \_\_\_\_\_  
Phone Number: \_\_\_\_\_  
\_\_\_\_\_ DBE Firm \_\_\_\_\_ Non-DBE Firm

Firm Name: \_\_\_\_\_  
Contact Name/Title: \_\_\_\_\_  
Firm Mailing Address: \_\_\_\_\_  
Phone Number: \_\_\_\_\_  
\_\_\_\_\_ DBE Firm \_\_\_\_\_ Non-DBE Firm

\_\_\_\_\_  
SUBMITTED BY (Signature)

\_\_\_\_\_  
FIRM NAME

