

MDOT Use Only

Checked _____

Loaded _____

Keyed _____

11 -



SM No. CIM0055022491

PROPOSAL AND CONTRACT DOCUMENTS

FOR THE CONSTRUCTION OF

11

Mill & Overlay approximately 7 miles on I-55 from approximately 2 miles north of SR 22 to the Yazoo County Line, known as Federal Aid Project No. IM-0055-02 (249) / 107577301 in Madison County.

Project Completion: 129 Working Days

(STATE DELEGATED)

NOTICE

**BIDDERS MUST COMPLETE AN ONLINE REQUEST
FOR PERMISSION TO BID THIS PROJECT.**

Electronic addendum updates will be posted on www.gomdot.com

SECTION 900

OF THE CURRENT

2017 STANDARD SPECIFICATIONS

FOR ROAD AND BRIDGE CONSTRUCTION

JACKSON, MISSISSIPPI

**MISSISSIPPI DEPARTMENT OF TRANSPORTATION
TABLE OF CONTENTS**

PROJECT: IM-0055-02(249)/107577301 - Madison

Section 901 - Advertisement

Section 904 - Notice to Bidders

#1	Governing Specification, w/ Supplement
#2	Status of ROW, w/ Attachments
#3	Final Cleanup
#9	Federal Bridge Formula
#13	Safety Edge
#113	Tack Coat
#296	Reduced Speed Limit Signs
#445	Mississippi Agent or Qualified Nonresident Agent
#446	Traffic on Milled Surface in Urban Areas
#516	Errata and Modifications to the 2017 Standard Specifications
#977	DUNS Requirement For Federal Funded Projects
#1225	Early Notice to Proceed
#1226	Material Storage Under Bridges
#1241	Fuel and Material Adjustments
#1963	Guardrail Pads
#2206	MASH Compliant Devices
#2273	Mississippi Special Fuel Tax Law
#2611	Disadvantaged Business Enterprise In Federal-Aid Highway Construction, w/ Supplement
#2782	DBE Pre-Bid Meeting
#2954	Reflective Sheeting for Signs
#3599	Standard Drawings
#3676	Asphalt Gyrotory Compactor Internal Angle Calibration
#3744	Contract Time
#3745	Specialty items
#3746	Scope of Work
#3747	Temporary Construction Signs
#3748	Underground Utilities
906	Required Federal Contract Provisions -- FHWA 1273, w/Supplements

Section 907 - Special Provisions

907-102-2	Bidding Requirements and Conditions
907-105-1	Authority of the Engineer
907-108-4	Subletting of Contract
907-109-3	Measurement and Payment
907-402-5	Open Graded Friction Course (OGFC)
907-405-1	Stone Matrix Asphalt
907-701-3	Hydraulic Cement
907-702-4	Bituminous Materials
907-703-1	Gradation
907-705-1	Stone Riprap

PROJECT: IM-0055-02(249)/107577301 - Madison

907-707-3	Joint Materials
907-711-2	Plain Steel Wire
907-714-3	Miscellaneous Materials
907-720-2	Acceptance Procedure for Glass Beads
907-721-2	Materials for Signs

Section 905 - Proposal, Proposal Bid Items, Combination Bid Proposal

Certification of Performance - Prior Federal-Aid Contracts

Certification Regarding Non-Collusion, Debarment and Suspension

SAM.GOV Registration and DUNS Number

Section 902 - Contract Form

Section 903 - Contract Bond Forms

Form -- OCR-485

Progress Schedule

(REVISIONS TO THE ABOVE WILL BE INDICATED ON THE SECOND SHEET
OF SECTION 905 AS ADDENDA)

12/22/2021 11:45 AM

MISSISSIPPI DEPARTMENT OF TRANSPORTATION

SECTION 901 - ADVERTISEMENT

Electronic bids will be received by the Mississippi Transportation Commission at 10:00 o'clock A.M., Tuesday, January 25, 2022, from the Bid Express Service and shortly thereafter publicly read on the Sixth Floor For:

Mill & Overlay approximately 7 miles on I-55 from approximately 2 miles north of SR 22 to the Yazoo County Line, known as Federal Aid Project No. IM-0055-02(249) / 107577301 in Madison County.

The attention of bidders is directed to the Contract Provisions governing selection and employment of labor. Minimum wage rates have been predetermined by the Secretary of Labor and are subject to Public Law 87-581, Work Hours Act of 1962, as set forth in the Contract Provisions.

The Mississippi Department of Transportation hereby notifies all bidders that it will affirmatively insure that in any contract entered into pursuant to this advertisement, disadvantaged business enterprises will be afforded full opportunity to submit bids in response to this invitation and will not be discriminated against on the grounds of race, color, sex, age, disability, religion or national origin in consideration for an award.

The award of this contract will be contingent upon the Contractor satisfying the DBE requirements.

The specifications are on file in the offices of the Mississippi Department of Transportation.

Contractors may request permission to bid online at <http://shopmdot.ms.gov> at no cost. Upon approval, Contractors shall be eligible to submit a bid using Bid Express at <http://bidx.com>. Specimen proposals may be viewed and downloaded online at no cost at <http://mdot.ms.gov> or purchased online at <http://shopmdot.ms.gov> at a cost of Ten Dollars (\$10.00) per proposal plus a small convenience fee. Cash or checks will not be accepted as payment.

Bid bond, signed or countersigned by a Mississippi Agent or Qualified Nonresident Agent, with Power of Attorney attached, a Cashier's check or Certified Check for five (5%) percent of bid, payable to STATE OF MISSISSIPPI, must accompany each proposal.

The attention of bidders is directed to the provisions of Subsection 102.07 pertaining to irregular proposals and rejection of bids.

BRAD WHITE
EXECUTIVE DIRECTOR

MISSISSIPPI DEPARTMENT OF TRANSPORTATION

SUPPLEMENT TO NOTICE TO BIDDERS NO. 1

DATE: 06/08/2021

SUBJECT: Governing Specifications

Change the web address at the end of the first paragraph to the following.

<https://shop.mdot.ms.gov/default.aspx?StoreIndex=1>

MISSISSIPPI DEPARTMENT OF TRANSPORTATION

SECTION 904 - NOTICE TO BIDDERS NO. 1

CODE: (IS)

DATE: 03/01/2017

SUBJECT: Governing Specifications

The current (2017) Edition of the Standard Specifications for Road and Bridge Construction adopted by the Mississippi Transportation Commission is made a part hereof fully and completely as if it were attached hereto, except where superseded by special provisions, or amended by revisions of the Specifications contained within this proposal. Copies of the specification book may be purchased from the MDOT Construction Division, or online at shopmdot/default.aspx?StoreIndex=1.

A reference in any contract document to controlling requirements in another portion of the contract documents shall be understood to apply equally to any revision or amendment thereof included in the contract.

In the event the plans or proposal contain references to the 2004 Edition of the Standard Specifications for Road and Bridge Construction, it is to be understood that such references shall mean the comparable provisions of the 2017 Edition of the Standard Specifications.

MISSISSIPPI DEPARTMENT OF TRANSPORTATION

SECTION 904 - NOTICE TO BIDDERS NO. 2

CODE: (IS)

DATE: 03/01/2017

SUBJECT: Status of Right-of-Way

Although it is desirable to have acquired all rights-of-way and completed all railroad agreements, utility adjustments and work to be performed by others prior to receiving bids, sometimes it is not considered to be in the public interest to wait until each and every such clearance has been obtained. The bidder is hereby advised of possible unacquired rights-of-way, relocations, railroad agreements and utilities adjustments which have not been completed.

The status of right-of-way acquisition, utility adjustments, encroachments, potentially contaminated sites, railroad facilities, improvements, and asbestos contamination are set forth in the following attachments.

In the event right of entry is not available to ALL parcels of right-of-way and/or all work that is to be accomplished by others on the date set forth in the contract for the Notice to Proceed is not complete, the Department will issue a restricted Notice to Proceed.

STATUS OF POTENTIALLY CONTAMINATED SITES

IM-0055-02(249)

107577-301000

Madison County

August 7, 2019

THERE IS NO RIGHT OF WAY REQUIRED FOR THIS PROJECT. NO INITIAL SITE ASSESSMENT WILL BE PERFORMED. IF CONTAMINATION ON EXISTING RIGHT OF WAY IS DISCOVERED, IT WILL BE HANDLED BY THE DEPARTMENT.

MISSISSIPPI DEPARTMENT OF TRANSPORTATION

Inter-Departmental Memorandum

TO: Trudi Loflin
ROW Division

DATE: August 7, 2019

FROM: Christopher M. Nail
District Five

SUBJECT OR PROJECT NO: IM-0055-02(249) / 107577-301000
ROW Certification Documents

INFORMATION COPY TO:

COUNTY: Madison

Project File

District Status Report

1. STATUS OF RIGHT OF WAY: All work to be done within existing ROW.
2. RIGHT OF WAY CLEARANCE: There are no encroachments.
3. STATUS OF AFFECTED RAILROAD OPERATING FACILITIES: None
4. STATUS OF REQUIRED UTILITY RELOCATIONS: There are no known utility conflicts. Permits showing the approximate location of utilities within or along the ROW are on file with the Department. The Department cannot and does not warrant that this information is complete and accurate. The contractor must coordinate directly with the involved utility owners to have underground utility lines field located in advance of construction.
5. STATUS OF CONSTRUCTION AGREEMENT: None required.

CMN:cmn

Improvements to be included in Notice to Bidders to be removed by the Construction Contractor
FMS Construction Project No: 107577-301000
External ROW No: IM-0055-02(249)

Parcel No:
Station No:
Property Owner:
Description/Pictures:

NA

MISSISSIPPI DEPARTMENT OF TRANSPORTATION

SECTION 904 - NOTICE TO BIDDERS NO. 3

CODE: (SP)

DATE: 01/17/2017

SUBJECT: Final Clean-Up

Immediately prior to final inspection for release of maintenance, the Contractor shall pick up, load, transport and properly dispose of all litter from the entire highway right-of-way that is within the termini of the project.

Litter shall include, but not be limited to, solid wastes such a glass, paper products, tires, wood products, metal, synthetic materials and other miscellaneous debris.

Litter removal is considered incidental to other items of work and will not be measured for separate payment.

MISSISSIPPI DEPARTMENT OF TRANSPORTATION

SECTION 904 - NOTICE TO BIDDERS NO. 9

CODE: (IS)

DATE: 03/01/2017

SUBJECT: Federal Bridge Formula

Bidders are hereby advised that the latest revision of Federal Highway Administration Publication No. FHWA-HOP-06-105, **BRIDGE FORMULA WEIGHTS**, dated August 2006, is made a part of this contract when applicable.

Prior to the preconstruction conference, the Contractor shall advise the Engineer, in writing, what materials, if any, will be delivered to the jobsite via Interstate route(s).

Copies of the **BRIDGE FORMULA WEIGHTS** publication may be obtained by contacting:

Federal Highway Administration
400 7th Street, SW
Washington, DC 20590
(202) 366-2212

or

http://www.ops.fhwa.dot.gov/Freight/publications/brdg_frm_wgths/bridge_formula_all_rev.pdf

An on line **BRIDGE FORMULA WEIGHTS CALCULATOR** is available at

http://ops.fhwa.dot.gov/freight/sw/brdgcalc/calc_page.htm

MISSISSIPPI DEPARTMENT OF TRANSPORTATION

SECTION 904 - NOTICE TO BIDDERS NO. 13

CODE: (IS)

DATE: 03/01/2017

SUBJECT: Safety Edge

Bidders are hereby advised that the Shoulder Wedge (Safety Edge) specified in Section 401, Asphalt Pavements, shall only apply to the top two (2) lifts of asphalt. Open Graded Friction Courses (OGFC) are not to be considered a lift as it pertains to safety edge. Attached is a drawing showing the safety edge. Note that the shoulder dimensions in the bottom two drawings will be less than three feet (3').

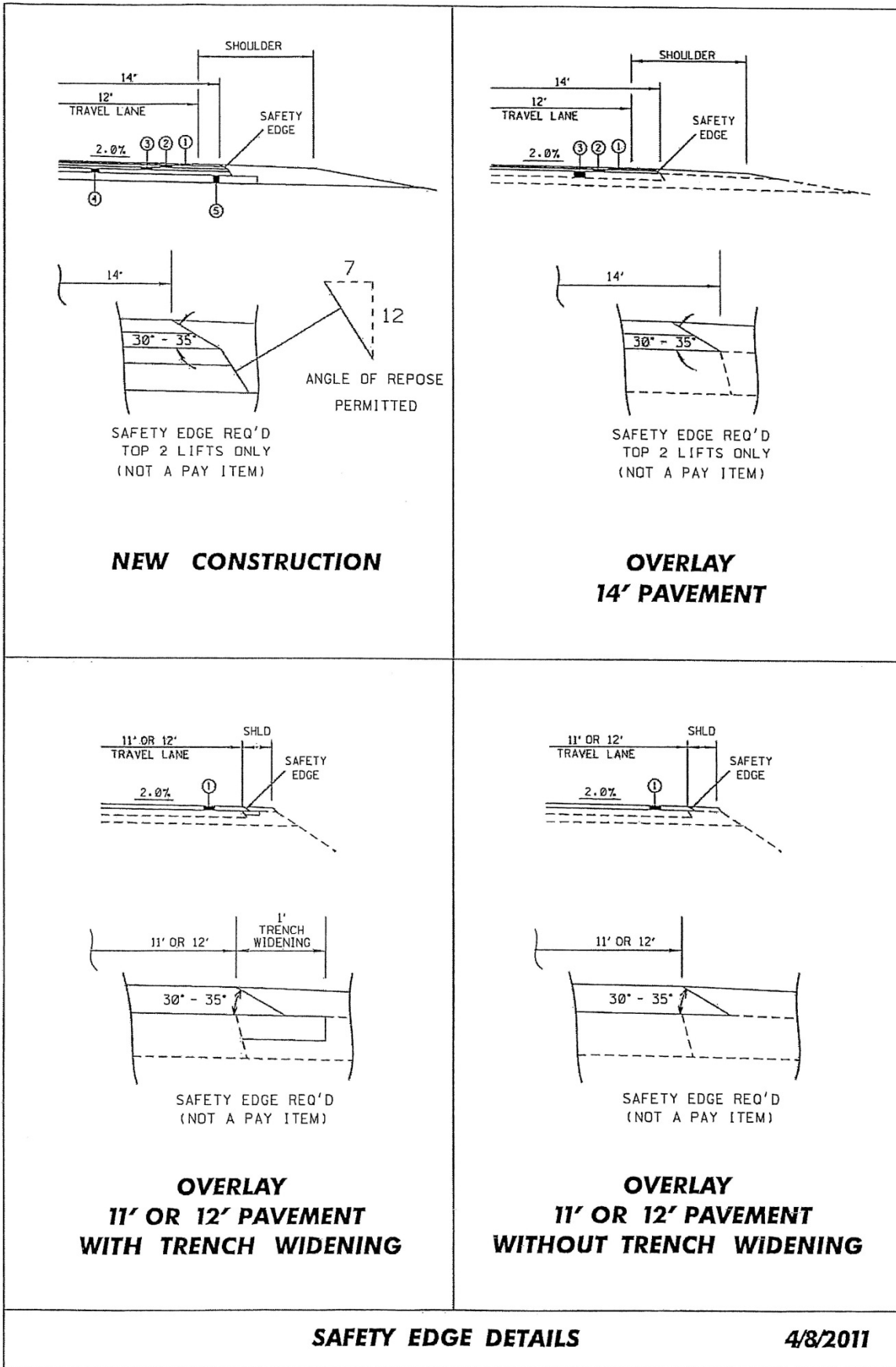

MISSISSIPPI DEPARTMENT OF TRANSPORTATION

SECTION 904 - NOTICE TO BIDDERS NO. 113

CODE: (SP)

DATE: 04/18/2017

SUBJECT: Tack Coat

Bidders are advised that in addition to the products listed on the Department's APL as referenced in Subsection 401.03.1.2 on page 256, the Contractor may use one of the following as a tack coat.

- CSS-1
- CSS-1h
- SS-1
- SS-1h

MISSISSIPPI DEPARTMENT OF TRANSPORTATION

SECTION 904 - NOTICE TO BIDDERS NO. 296

CODE: (SP)

DATE: 07/25/2017

SUBJECT: Reduced Speed Limit Signs

Bidders are advised that when the plans or contract documents require the speed limit on a project to be reduced, the Contractor shall begin work within 48 hours of installing the reduced speed limit signs. Should the Contractor not start work or have no plans to start work within 48 hours of installing the signs, the reduced speed limit signs shall be covered and existing speed limit signs uncovered.

MISSISSIPPI DEPARTMENT OF TRANSPORTATION

SECTION 904 - NOTICE TO BIDDERS NO. 445

CODE: (SP)

DATE: 10/10/2017

SUBJECT: Mississippi Agent or Qualified Nonresident Agent

Bidders are hereby advised of the requirements of Subsections 102.08, 103.05.2, and 107.14.2.1 of the *2017 Standard Specifications for Road and Bridge Construction* as it refers to bonding agents. Proposal guaranties, bonds, and liability insurance policies must be signed by a **Mississippi Agent or Qualified Nonresident Agent.**

MISSISSIPPI DEPARTMENT OF TRANSPORTATION

SECTION 904 - NOTICE TO BIDDERS NO. 446

CODE: (SP)

DATE: 10/18/2017

SUBJECT: Traffic on Milled Surface in Urban Areas

Bidders are hereby advised that when the main lanes of a roadway are fine milled, traffic will be allowed to run on a milled surfaces for up to five (5) calendar days. The Contractor will be assessed a penalty of **\$5,000 per calendar day** afterwards until the milled surfaces are covered with the next lift of asphalt. It shall be the Contractor's responsibility to ensure that the milling operations do not commence until such time as forecasted weather conditions are suitable enough to allow the placement of the asphalt pavement after the milling operations.

MISSISSIPPI DEPARTMENT OF TRANSPORTATION

SECTION 904 - NOTICE TO BIDDERS NO. 516

CODE: (IS)

DATE: 11/28/2017

SUBJECT: Errata and Modifications to the 2017 Standard Specifications

<u>Page</u>	<u>Subsection</u>	<u>Change</u>
16	102.06	In the seventh full paragraph, change “Engineer” to “Director.”
33	105.05.1	In the sixth sentence, change “Contract Administration Engineer” to “Contract Administration Director.”
34	105.05.2.1	In subparagraph 2, change “SWPPP, ECP” to “SWPPP and the ECP”
35	105.05.2.2	In subparagraphs 2, add “ and” to the end of the sentence. In subparagraph 3, remove “, and” and add “.”.
90	109.04.2	In the last paragraph of subparagraph (a), place a period “.” at the end of the sentence.
93	109.04.2	In the last paragraph of subparagraph (g), place a period “.” at the end of the sentence. Also, in the first paragraph of subparagraph (h), place a period “.” at the end of the sentence.
97	109.07	Under ADJUSTMENT CODE, subparagraph (A1), change “HMA mixture” to “Asphalt mixtures.”
98	109.11	In the third sentence, change “Engineer” to “Director.”
219	308.04	In the last sentence of the last paragraph, change “Contractor’s decision” to “Engineer’s decision.”
300	405.02.5.9	In the first sentence of the second paragraph, change “Hot Mix Asphalt” to “Asphalt Mixtures.”
502	630.01.1	In the first paragraph, change “AASHTO” to “AASHTO’s LRFD”.
636	646.05	Change “each” to “per each” for the pay item units of payment.
640	656.02.6.2	In item 7), change “down stream” to “downstream”.
688	630.03.2	Change the subsection number from “630.03.2” to “680.03.2.”

725 702.08.3 In the second sentence of the first paragraph, change “hot-mix” to “asphalt.”

954 804.02.13.1.6 In the definition for “M” in the % Reduction formulas, change “paragraph 7.3” to “paragraph 5.3.”

MISSISSIPPI DEPARTMENT OF TRANSPORTATION

SECTION 904 - NOTICE TO BIDDERS NO. 977

CODE: (IS)

DATE: 07/25/2018

SUBJECT: DUNS Requirement for Federal Funded Projects

Bidders are advised that the Prime Contractor must maintain a current registration in the System for Award Management (<http://www.sam.gov>) at all times during this project. A Dun and Bradstreet Data Universal Numbering System (DUNS) Number (<http://www.dnb.com>) is one of the requirements for registration in the System for Award Management.

Bidders are also advised that prior to the award of this contract, they MUST be registered, active, and have no active exclusions in the System for Award Management.

MISSISSIPPI DEPARTMENT OF TRANSPORTATION

SECTION 904 - NOTICE TO BIDDERS NO. 1225

CODE: (SP)

DATE: 11/13/2018

SUBJECT: Early Notice to Proceed

Bidders are advised that if an early notice to proceed is allowed by the Department and the Contractor experiences problems or delays between the early notice to proceed date and the original notice to proceed date, this shall not be justification for any monetary compensation or an extension of contract time.

MISSISSIPPI DEPARTMENT OF TRANSPORTATION

SECTION 904 - NOTICE TO BIDDERS NO. 1226

CODE: (IS)

DATE: 11/16/2018

SUBJECT: Material Storage Under Bridges

Bidders are advised that Subsection 106.08 of the Standard Specifications allows the Contractor to store materials and equipment on portions of the right-of-way. However, the Contractor will not be allowed to store or stockpile materials under bridges without written permission from the Project Engineer. The Contractor shall submit a detailed request of all proposed materials to be stored under bridges to the Engineer a minimum of 14 calendar days prior to anticipated storage. This detail shall include, but not limited to, bridge location, material type, material quantity, and duration of storage. The Project Engineer and any other needed Division will review this information and determine whether to grant approval. The Contractor shall not store any material under any bridge without written approval from the Project Engineer.

MISSISSIPPI DEPARTMENT OF TRANSPORTATION

SECTION 904 - NOTICE TO BIDDERS NO. 1241

CODE: (IS)

DATE: 11/27/2018

SUBJECT: Fuel and Material Adjustments

Bidder's attention is brought to the last paragraph of Subsection 109.07 of the Standard Specifications which states that no fuel or material adjustment will be made after the completion of contract time. Any fuels consumed or materials incorporated into the work during the monthly estimate period falling wholly after the expiration of contract time will not be subject a fuel or material adjustment.

MISSISSIPPI DEPARTMENT OF TRANSPORTATION

SECTION 904 - NOTICE TO BIDDERS NO. 1963

CODE: (SP)

DATE: 9/23/2019

SUBJECT: Guardrail Pads

Bidders are hereby advised that prior to construction of the guardrail pads, the Contractor shall coordinate with the guardrail Subcontractor to determine the guardrail pad dimensions necessary to meet MASH compliance.

MISSISSIPPI DEPARTMENT OF TRANSPORTATION

SECTION 904 - NOTICE TO BIDDERS NO. 2206

CODE: (IS)

DATE: 01/14/2020

SUBJECT: MASH Compliant Devices

Bidders are hereby advised that compliance associated with the requirements of meeting either the National Cooperative Highway Research Program (NCHRP) Report 350 or the Manual for Assessing Safety Hardware (MASH) for installations of certain traffic control devices and permanent safety hardware devices (guardrails, guardrail terminals, permanent portable barriers, cast-in-place barriers, all other permanent longitudinal barriers, crash cushions, cable barriers, cable barrier terminals, bridge rails, bridge rail transitions, all other terminals, sign supports, and all other breakaway hardware) as listed throughout the Standard Specifications and/or the Standard Drawings, or both, is now replaced with the requirements of meeting the 2016 version of MASH after December 31, 2019. This change applies to new permanent installations and to full replacements of existing installations.

At the preconstruction conference or prior to starting any work on the project, the Contractor shall submit a letter stating that the traffic control devices and permanent safety hardware devices as outlined within the paragraph above that are to be used on the project are certified to meet MASH 2016.

When a MASH 2016-compliant device does not exist for the new permanent installations and/or full replacement installations of permanent safety hardware devices, as listed above, a MASH 2009-compliant or a NCHRP 350-compliant device may be proposed by the Contractor for the project. A written request for such instances must be submitted by the Contractor either at the preconstruction conference or prior to starting any work on the project. The Contractor shall submit the following items to the Project Engineer: (1) a detailed list of the proposed devices and locations thereof; and (2) certification letters indicating that the proposed devices are compliant with either MASH 2009 or NCHRP 350.

When a MASH 2016-compliant device does not exist for the temporary work zone traffic control devices (Category 1, Category 2, and Category 3 devices), a MASH 2009-compliant or a NCHRP 350-compliant device may be proposed by the Contractor for the project. Temporary work zone traffic control devices (Category 1, Category 2, and Category 3 devices) that are MASH 2009-compliant or NCHRP 350-compliant that have been in use prior to December 31, 2019, and that have a remaining service life may be proposed for use throughout their normal service life on the project by the Contractor. For either of these scenarios for temporary work zone traffic control devices, a written request must be submitted by the Contractor either at the preconstruction conference or prior to starting any work on the project. The Contractor shall submit the following items to the Project Engineer: (1) a detailed list of the proposed devices and locations thereof; and (2) certification letters indicating that the proposed devices are compliant with either MASH 2009 or NCHRP 350.

Work will only be allowed to proceed after the Department has granted written concurrence(s) with the proposed request(s) as listed above.

MISSISSIPPI DEPARTMENT OF TRANSPORTATION

SECTION 904 - NOTICE TO BIDDERS NO. 2273

CODE: (SP)

DATE: 02/12/2020

SUBJECT: Mississippi Special Fuel Tax Law

Bidder's attention is brought to the second paragraph of Subsection 107.02 of the Standard Specifications which states that all Contractors and Subcontractors must comply with all requirements contained in the Mississippi Special Fuel Tax Law, Section 27-55-501, *et seq.* Attached are two Fact Sheets provided by the Mississippi Department of Revenue (MDOR) with additional information.

Gasoline and Dyed Diesel Used for Non-Highway Purposes

Mississippi provides a reduced rate for gasoline and dyed diesel used for non-highway purposes. The reduced rates are 6.44 cents per gallon and 5.75 cents per gallon of gasoline or dyed diesel. These fuels are generally taxed at 18 cents per gallon if for on road use.

Gasoline Used for Non-Highway Purposes

You may be entitled to a refund of 11.56 cents per gallon (making this an equivalent to a tax rate of 6.44 cents per gallon) if you desire to purchase gasoline to be used off road. The gasoline must be used for agricultural, maritime, industrial, manufacturing, domestic or non-highway purposes only.

Examples of non-highway include gasoline used in boats, golf carts, machinery used for manufacturing or farm equipment used exclusively in plowing, planting or harvesting farm products.

Refund Gasoline User

The refund is based on the amount of gallons used. Before a refund is issued, you are required to...

1. Obtain a refund gasoline user's permit and a certificate for refund booklet from the Department of Revenue;
2. Have a storage tank marked "REFUND GASOLINE"; and,
3. Purchase the gasoline from someone who holds a refund gasoline dealer's permit.

No refund will be allowed for gasoline used in motor vehicles owned or operated by a government entity or used in Mississippi government contracts.

Refund Gasoline Dealer

You must obtain a refund gasoline dealer's permit from the Department of Revenue before selling refund gasoline. At no time should the gasoline be delivered to a tank that is not properly marked. The gasoline must be dyed a distinctive mahogany color at the time of delivery.

The Department of Revenue may waive the dye requirement if the dye may cause damage to the equipment. The refund gasoline user is required to obtain the waiver from the Department of Revenue.

Dyed Diesel Used for Non-Highway Purposes

Unlike gasoline, you are not required to apply for a refund if you desire to purchase dyed diesel to be used off road. Mississippi provides a reduced rate of 5.75 cents per gallon on dyed diesel used off road. Diesel used on road is subjected to 18 cents per gallon. Dyed diesel used in motor vehicles owned or operated by a government entity or used in Mississippi government contracts will be subjected to 18 cents per gallon.

Dyed Diesel Used on the Highway

Any person who purchases, receives, acquires or uses dyed diesel for highway use will be liable to pay 18 cents per gallon and subject to a penalty in the amount of \$1000.

Identifying Dyed Diesel

Storage facilities for dyed diesel must be plainly marked "NONHIGHWAY DIESEL FUEL" or "NONHIGHWAY KEROSENE". Retailers are also required to mark all pumps or dispensing equipment.



Special Fuel Used on Government Contracts

State and Local Government Contracts

Special fuel purchased, acquired or used in performing contracts with the State of Mississippi, counties, municipalities or any political subdivision is taxed at a rate of 18 cents per gallon. Special fuel includes but is not limited to the following:

- Dyed diesel fuel;
- Kerosene;
- Undyed diesel fuel; and,
- Fuel oil.

State and local government contracts include construction, reconstruction and maintenance or repairs of projects such as roads, bridges, water systems, sewer systems, buildings, drainage canals and recreational facilities. The Department of Revenue may require contractors to remit the excise tax directly to the state in lieu of paying the tax to a distributor.

Special Fuel Direct Pay Permit

Contractors that remit the excise tax to the state will be issued a Special Fuel Direct Pay Permit. This permit relieves the distributor from collecting the tax and requires the contractor to file a monthly special fuel return. The distributor should include the contractor’s permit number on all invoices that are related to tax-free sales.

The contractor is required to furnish a surety or cash bond guaranteeing the payment of the excise tax prior to receiving the Special Fuel Direct Pay Permit. The Department of Revenue may accept a contractors tax bond if the bond covers the excise tax levied on special fuel.

Special Fuel Distributors

If the contractor does not have a Special Fuel Direct Pay Permit, distributors are required to collect the 18 cents excise tax and remit the tax to the Department of Revenue. The additional 12.25 cents levied on special fuel (excluding undyed diesel) should be reported on schedules 5F and 5G of the special fuel return.

Environmental Protection Fee

Special fuel distributors are required to collect the environmental protection fee even if the contractor has a Special Fuel Direct Pay Permit. The fee is levied at 4/10^{ths} of a cent per gallon. The fee is suspended or reinstated when the trust fund has exceeded or fallen below the obligatory balance.

Penalties

Any person who knowingly and willfully purchases untaxed fuel for use in equipment utilized on a road or highway construction site in this state is guilty of a misdemeanor and, upon conviction, shall be fined not less than \$1,000 or more than \$100,000, or imprisoned in the county jail for not more than one year, or both.



MISSISSIPPI DEPARTMENT OF TRANSPORTATION

SUPPLEMENT TO NOTICE TO BIDDERS NO. 2611

DATE: 05/02/2020

The goal is 4 percent for the Disadvantaged Business Enterprise. All Bidders are required to submit Form OCR-481 for all DBEs. Bidders are advised to check the bid tabulation link for this project on the MDOT website at:

https://mdot.ms.gov/portal/current_letting

Bid tabulations are usually posted by 3:00 pm on Letting Day.

MISSISSIPPI DEPARTMENT OF TRANSPORTATION

SECTION 904 - NOTICE TO BIDDERS NO. 2611

CODE: (IS)

DATE: 05/21/2020

SUBJECT: Disadvantaged Business Enterprises In Federal-Aid Highway Construction

This contract is subject to the "Moving Ahead for Progress in the 21st Century Act (MAP-21)" and applicable requirements of "Title 49, Code of Federal Regulations, Part 26." Portions of the Act are set forth in this Notice as applicable to compliance by the Contractor and all of the Act, and the MDOT DBE Program, is incorporated by reference herein.

The Department has developed a Disadvantaged Business Enterprise Program that is applicable to this contract and is made a part thereof by reference.

Copies of the program may be obtained from:

Office of Civil Rights
Mississippi Department of Transportation
P. O. Box 1850
Jackson, Mississippi 39215-1850

POLICY

It is the policy of the Mississippi Department of Transportation to provide a level playing field, to foster equal opportunity in all federally assisted contracts, to improve the flexibility of the DBE Program, to reduce the burdens on small businesses, and to achieve that amount of participation that would be obtained in a non-discriminatory market place. In doing so, it is the policy of MDOT that there will be no discrimination in the award and performance of federally assisted contracts on the basis of race, color, sex, or national origin.

ASSURANCES THAT CONTRACTORS MUST TAKE

MDOT will require that each contract which MDOT signs with a sub-recipient or a Contractor, and each subcontract the Prime Contractor signs with a Subcontractor, includes the following assurances:

“The Contractor, sub-recipient or Subcontractor shall not discriminate on the basis of race, color, sex, or national origin in the performance of this contract. The Contractor shall carry out applicable requirements of 49 CFR 26 in the award and administration of federally assisted contracts. Failure by the Contractor to carry out these requirements is a material breach of this contract, which may result in the termination of this contract or such other remedy as MDOT deems appropriate.”

DEFINITIONS

For purposes of this provision the following definitions will apply:

"Disadvantaged Business" means a small business concern: (a) which is at least 51 percent owned by one or more socially and economically disadvantaged individual(s) or in the case of any publicly owned business, at least 51 percent of the stock of which is owned by one or more socially and economically disadvantaged individual(s); and (b) whose management and daily business operations are controlled by one or more of the socially and economically disadvantaged individual(s) who own it. It is important to note that the business owners themselves must control the operations of the business. Absentee ownership or title ownership by an individual who does not take an active role in controlling the business is not consistent with eligibility as a DBE under 49 CFR Part 26.71.

CONTRACTOR'S OBLIGATION

The Contractor and all Subcontractors shall take all necessary and reasonable steps to ensure that DBE firms can compete for and participate in the performance of a portion of the work in this contract and shall not discriminate on the basis of race, color, sex, or national origin. Failure on the part of the Contractor to carry out the DBE requirements of this contract constitutes a breach of contract and after proper notification the Department may terminate the contract or take other appropriate action as determined by the Department.

When a contract has a zero percent (0%) DBE goal, the Contractor still has the responsibility to take all necessary and reasonable steps to ensure that DBE firms can compete for and participate in the performance of the work in the contract. In this case, all work performed by a certified DBE firm is considered to be a "race neutral" measure and the Department will receive DBE credit towards the overall State goals when the DBE firm is paid for their work. If the Prime Contractor is a certified DBE firm, the Department can receive DBE credit only for the work performed by the Prime Contractor's work force or any work subcontracted to another DBE firm. Work performance by a non-DBE Subcontractor is not eligible for DBE credit.

CONTRACT GOAL

The goal for participation by DBEs is established for this contract in the attached Supplement. The Contractor shall exercise all necessary and reasonable steps to ensure that participation is equal to or exceeds the contract goal.

If the percentage of the contract that is proposed for DBEs is 1% or greater, the Contractor shall agree to meet or exceed the contract goal on the last bid sheet of the proposal.

All Bidders shall submit to the Office of Civil Rights Form OCR-481, signed by the Prime Contractor and the DBE Subcontractors, no later than the 3rd business day after opening of the bids.

Form OCR-481 is available on the MDOT website at www.mdot.ms.gov under the Civil Rights tab, or by calling 601-359-7466.

The OCR-481 Form must contain the following information:

The name and address of each certified DBE Contractor / Supplier;

The Reference Number, percent of work to be completed by the DBE subcontractor and the dollar amount of each item. If a portion of an item is subcontracted, a breakdown of that item including quantities and unit price must be attached, detailing what part of the item the DBE firm is to perform and who will perform the remainder of the item.

If the DBE Commitment shown on the last bid sheet of the proposal, does not equal or exceed the contract goal, the bidder must submit, to MDOT Contract Administration Division prior to bid opening, information to satisfy the Department that adequate good faith efforts have been made to meet the contract goal.

Failure of the lowest bidder to furnish acceptable proof of good faith efforts, submitted to MDOT Contract Administration Division prior to bid opening, shall be just cause for rejection of the proposal. Award may then be made to the next lowest responsive bidder or the project may be re-advertised.

GOOD FAITH EFFORTS

The following factors are illustrative of matters the Department will consider in judging whether or not the bidder has made adequate good faith effort to satisfy the contract goal.

- (1) Whether the bidder attended the pre-bid meeting that was scheduled by the Department to inform DBEs of subcontracting opportunities;
- (2) Whether the bidder advertised in general circulation, trade association, and minority-focus media concerning the subcontracting opportunities;
- (3) Whether the bidder provided written notice to a reasonable number of specific DBEs that their interest in the contract is being solicited;
- (4) Whether the bidder followed up initial solicitations of interest by contacting DBEs to determine with certainty whether they were interested;
- (5) Whether the bidder selected portions of the work to be performed by DBEs in order to increase the likelihood of meeting the contract goal;
- (6) Whether the bidder provided interested DBEs with adequate information about the plans, specifications and requirements of the contract;

- (7) Whether the bidder negotiated in good faith with interested DBEs and did not reject them as unqualified without sound reasons based on a thorough investigation of their capabilities; and
- (8) Whether the bidder made efforts to assist interested DBEs in obtaining any required bonding or insurance.
- (9) Whether the bidder has written notification to certified DBE Contractors soliciting subcontracting for items of work in the contract.
- (10) Whether the bidder has a statement of why an agreement was not reached.
- (11) Proof of written notification to certified DBE Contractors by certified mail that their interest is solicited in subcontracting the work defaulted by the previous DBE or in subcontracting other items of work in the contract.

The bidder’s execution of the signature portion of the proposal shall constitute execution of the following assurance:

The bidder hereby gives assurance pursuant to the applicable requirements of "Moving Ahead for Progress in the 21st Century Act (MAP-21)" and applicable requirements of "Title 49, Code of Federal Regulations, Part 26" that the bidder has made a good faith effort to meet the contract goal for DBE participation for which this proposal is submitted.

DIRECTORY

A list of “Certified DBE Contractors” which have been certified as such by the Mississippi Department of Transportation and other Unified Certification Partners (UPC) can be found on the Mississippi Department of Transportation website at www.mdot.ms.gov. The list is in the top left corner of the current Letting Calendar under Contracts & Letting. The DBE firm must be certified at the time the project is let and approved by MDOT to count towards meeting the DBE goal.

REPLACEMENT

If a DBE Subcontractor cannot perform satisfactorily, and this causes the OCR-481 commitment to fall below the contract goal, the Contractor shall take all necessary reasonable steps to replace the DBE with another certified DBE Subcontractor or submit information to satisfy the Mississippi Department of Transportation that adequate good faith efforts have been made to replace the DBE. The good faith efforts outlined previously in this document still apply. The replacement DBE must be a DBE who was on the Department's list of "Certified DBE Contractors" when the job was let, and who is still active. All DBE replacements must be approved by the Department.

Under no circumstances shall the Prime or any Subcontractor perform the DBE's work (as shown on the OCR-481) without prior written approval from the Department. See "Sanctions" at the end of this document for penalties for performing DBE's work.

When a Contractor proposes to substitute/replace/terminate a DBE that was originally named on the OCR-481, the Contractor must obtain a release, in writing, from the named DBE explaining why the DBE Subcontractor cannot perform the work. A copy of the original DBE's release must be attached to the Contractor's written request to substitute/replace/terminate along with appropriate Subcontract Forms for the substitute/replacement/terminated Subcontractor, all of which must be submitted to the DBE Coordinator and approved, in advance, by MDOT.

PRE-BID MEETING

A pre-bid meeting will be held in the [Commission Room on the 1st Floor](#) of the [MDOT Administration Building](#) in Jackson, at 2:00 P.M. on the day preceding the date of the bid opening.

This meeting is to inform DBE firms of subcontracting and material supply opportunities. Attendance at this meeting is considered of prime importance in demonstrating good faith effort to meet the contract goal.

PARTICIPATION / DBE CREDIT

Participation shall be counted toward meeting the goal in this contract as follows:

- (1) If the Prime Contractor is a certified DBE firm, only the value of the work actually performed by the DBE Prime can be counted towards the project goal, along with any work subcontracted to a certified DBE firm.
- (2) If the Contractor is not a DBE, the work subcontracted to a certified DBE Contractor will be counted toward the goal.
- (3) The Contractor may count toward the goal a portion of the total dollar value of a contract with a joint venture eligible under the standards of this provision equal to the percentage of the DBE partner in the joint venture.
- (4) Expenditures to DBEs that perform a commercially useful function may be counted toward the goal. A business is considered to perform a commercially useful function when it is responsible for the execution of a distinct element of the work and carries out its responsibilities by actually performing, managing, and supervising the work involved.
- (5) The Contractor may count 100% of the expenditures for materials and supplies obtained from certified DBE suppliers and manufacturers that produce goods from raw materials or substantially alters them for resale provided the suppliers and manufacturers assume the actual and contractual responsibility for the provision of the materials and supplies. The Contractor may count sixty percent (60%) of the expenditures to suppliers that are not

manufacturers, provided the supplier performs a commercially useful function in the supply process. Within 30 days after receipt of the materials, the Contractor shall furnish to the DBE Coordinator invoices from the certified supplier to verify the DBE goal.

- (6) Any work that a certified DBE firm subcontracts or sub-subcontracts to a non-DBE firm will not count towards the DBE goal.
- (7) Only the dollars actually paid to the DBE firm may be counted towards the DBE goal. The participation of a DBE Firm cannot be counted towards the Prime Contractor's DBE goal until the amount being counted towards the goal has been paid to the DBE.

AWARD

Award of this contract to the low bidder will be contingent upon the following conditions:

- (1) Concurrence from Federal Highway Administration, when applicable.
- (2) **All Bidders** must submit to the Office of Civil Rights for approval, Form OCR-481 (DBE Commitment) no later than the 3rd business day after opening of the bids to satisfy the Department and that adequate good faith efforts have been made to meet the contract goal. For answers to questions regarding Form OCR-481, contact the MDOT Office of Civil Rights at (601) 359-7466.
- (3) Bidder must include OCR-485 information with their bid proposal listing all firms that submitted quotes for material supplies or items to be subcontracted. OCR-485 information must be **signed and** included with the bid proposal. If the OCR-485 information is not included as part of bid proposal, your bid will be deemed irregular.

Prior to the start of any work, the bidder must notify the Project Engineer, in writing, of the name of the designated "DBE Liaison Officer" for this project. This notification must be posted on the bulletin board at the project site.

DEFAULT

If the contract goal established by MDOT in this proposal is 1% or greater, it must be met to fulfill the terms of the contract. The Contractor may list DBE Subcontractors and items that exceed MDOT's contract goal, but should unforeseen problems arise that would prevent a DBE from completing its total commitment percentage, the Contractor will meet the terms of the contract as long as it meets or exceeds MDOT's Contract Goal. For additional information, refer to "Replacement" section of this Notice.

DBE REPORTS

- (1) OCR-481: Refer to "CONTRACT GOAL" section of this Notice to Bidders for information regarding this form.

- (2) OCR-482: At the conclusion of the project, before the final estimate is paid and the project is closed out, the Prime Contractor will submit to the Project Engineer for verification of quantities and further handling Form OCR-482 whereby the Contractor certifies to the amounts of payments made to all Contractors / Suppliers over the life of the contract. The Project Engineer shall submit the completed Form OCR-482 to the DBE Coordinator (Office of Civil Rights). Final acceptance of the project is dependent upon Contract Administration Division's receipt of completed Form OCR-482 which they will receive from the Office of Civil Rights.
- (3) OCR-483: The Project Engineer/Inspector will complete Form OCR-483, the Commercially Useful Function (CUF) Performance Report, in accordance with MDOT S.O.P. No. OCR-03-05-02-483. Evaluations reported on this form are used to determine whether or not the DBE firm is performing a CUF. The Prime Contractor should take corrective action when the report contains any negative evaluations. DBE credit may be disallowed and/or other sanctions imposed if it is determined the DBE firm is not performing a CUF. This form should also be completed and returned to the DBE Coordinator (Office of Civil Rights).
- (4) OCR-484: Each month, the Prime Contractor will submit to the Project Engineer OCR-484 that certifies payments to all Subcontractors and shows all firms even if the Prime Contractor has paid no monies to the firm during that estimate period (negative report). The Project Engineer will attach the form to the monthly estimate before forwarding to the Contract Administration Division for further processing. Failure of the Contractor to submit the OCR-484 will result in the estimate not being processed and paid.
- (5) OCR-485: ALL BIDDERS must submit signed form with bid proposal of all firms that submitted quotes for material supplies or items to be subcontracted. If the OCR-485 information is not included as part of bid proposal, the bid will be deemed irregular.
- (6) OCR-487: Only used by Prime Contractors that are certified DBE firms. This form is used in determining the exact percentage of DBE credit for the specified project. The low Bidder should return this form to MDOT with the OCR-481 form, or can also be returned with the Permission to Subcontract Forms (CAD-720, CAD-725 and CAD-521).

DBE Forms, can be obtained from the Office of Civil Rights Division, MDOT Administration Building, 401 North West Street, Jackson, MS, or at www.mdot.ms.gov under the Civil Rights tab.

SANCTIONS

The Department has the option to enforce any of the following penalties for failure of the Prime Contractor to fulfill the DBE goal as stated on the OCR-481 form or any violations of the DBE program guidelines:

- (1) Disallow credit towards the DBE goal

(2) Withhold progress estimate payments

(3) Deduct from the final estimate or recover an amount equal to the unmet portion of the DBE goal which may include additional monetary penalties as outlined below based on the number of offenses and the severity of the violation as determined by MDOT.

1 st Offense	10% of unmet portion of goal	or	\$5,000 lump sum payment	or	Both
2 nd Offense	20% of unmet portion of goal	or	\$10,000 lump sum payment	or	Both
3 rd Offense	40% of unmet portion of goal	or	\$20,000 lump sum payment	or	\$20,000 lump sum payment and debarment

(4) Debar the Contractor involved from bidding on MDOT federally funded projects for a period of up to 12 months after notification by certified email.

MISSISSIPPI DEPARTMENT OF TRANSPORTATION

SECTION 904 - NOTICE TO BIDDERS NO. 2782

CODE: (SP)

DATE: 8/13/2020

SUBJECT: DBE Pre-Bid Meeting

Due to the COVID-19 pandemic and the Department not allowing visitors in the Administration Building at this time, the DBE Pre-Bid Meeting referenced on Page 5 of Notice to Bidders No. 2611 will be held by **video conference only**. The meeting will be held at 2:00 P.M. on the day preceding the date of the bid opening using Zoom video conferencing software. Anyone interested in participating can download Zoom and connect to the meeting at the below link.

<https://zoom.us/j/5548736403?pwd=SDh5S2hQSE5pNG5FOEkzR3NsUnBYQT09>

Password (if prompted): 272147

For those unable to participate via Zoom, the below teleconference number may be used instead.

1-888-227-7517

Conference Code: 404496

MISSISSIPPI DEPARTMENT OF TRANSPORTATION

SECTION 904 - NOTICE TO BIDDERS NO. 2954

CODE: (SP)

DATE: 12/01/2020

SUBJECT: Reflective Sheeting for Signs

Bidders are hereby advised that the retroreflective sign sheeting used for signs on this project shall be as listed below and shall meet the requirements of Subsection 721.06.

Temporary Construction Signs

Temporary traffic control (orange) sign sheeting shall be a minimum Type IX Fluorescent Orange sheeting as shown in Special Provision 907-721.

Permanent Signs

Permanent signs, except signs on traffic signal poles/mast arms, shall be as follows:

- Brown background sheeting on guide signs shall be a minimum Type VIII sheeting,
- Green and blue background sheeting on guide signs shall be a minimum Type IX sheeting, and
- All white, yellow, red, fluorescent yellow, and fluorescent yellow/green sheeting shall be Type XI sheeting.

MISSISSIPPI DEPARTMENT OF TRANSPORTATION

SECTION 904 – NOTICE TO BIDDERS NO. 3599

CODE: (SP)

DATE: 08/11/2021

SUBJECT: Standard Drawings

Standard Drawings attached hereto shall govern appropriate items of required work.

Larger copies of Standard Drawings may be purchased from:

MDOT Plans Print Shop
MDOT Shop Complex, Building C, Room 114
2567 North West Street
P.O. Box 1850
Jackson, MS 39215-1850
Telephone: (601) 359-7460
or FAX: (601) 359-7461
or e-mail: plans@mdot.state.ms.us

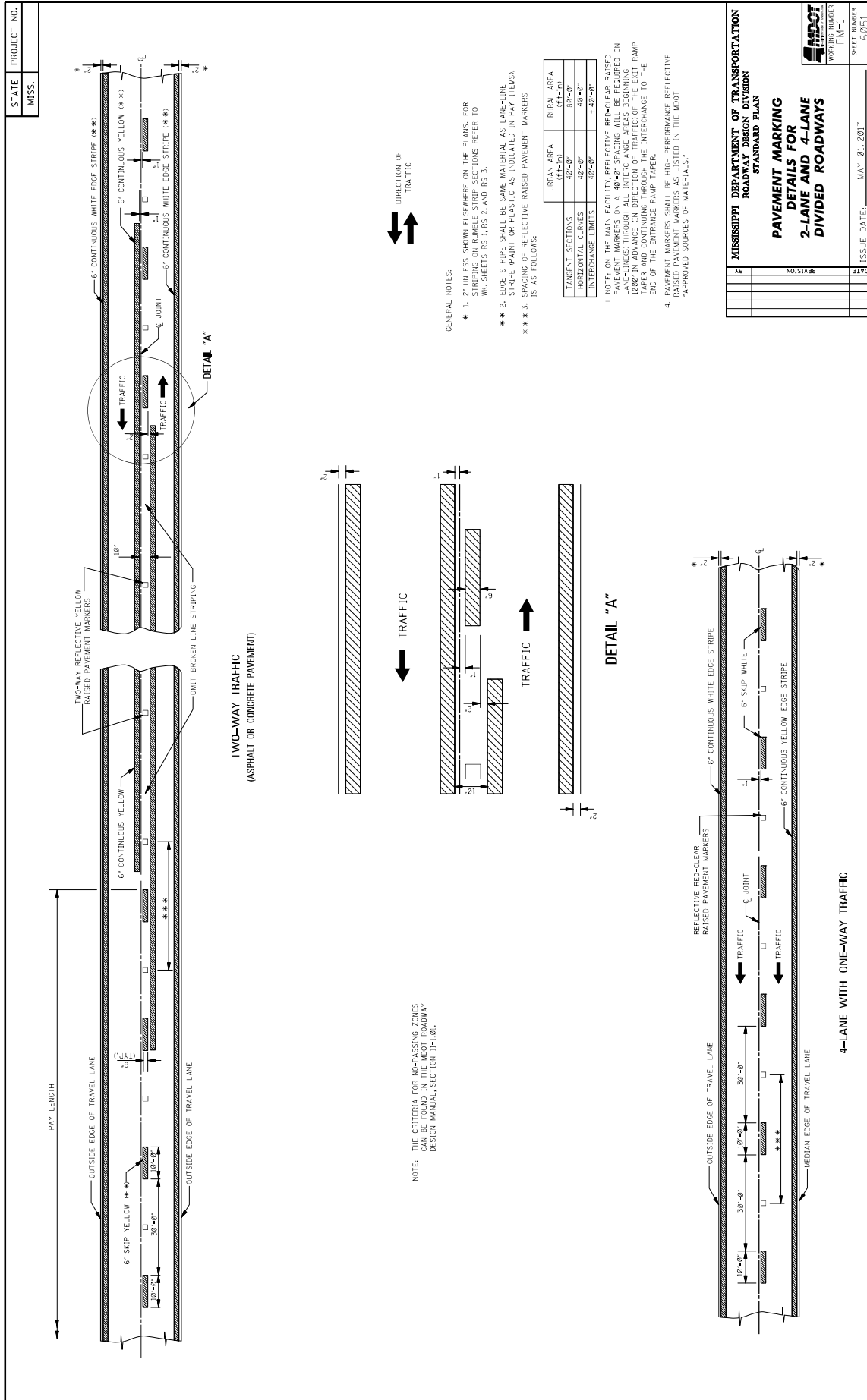

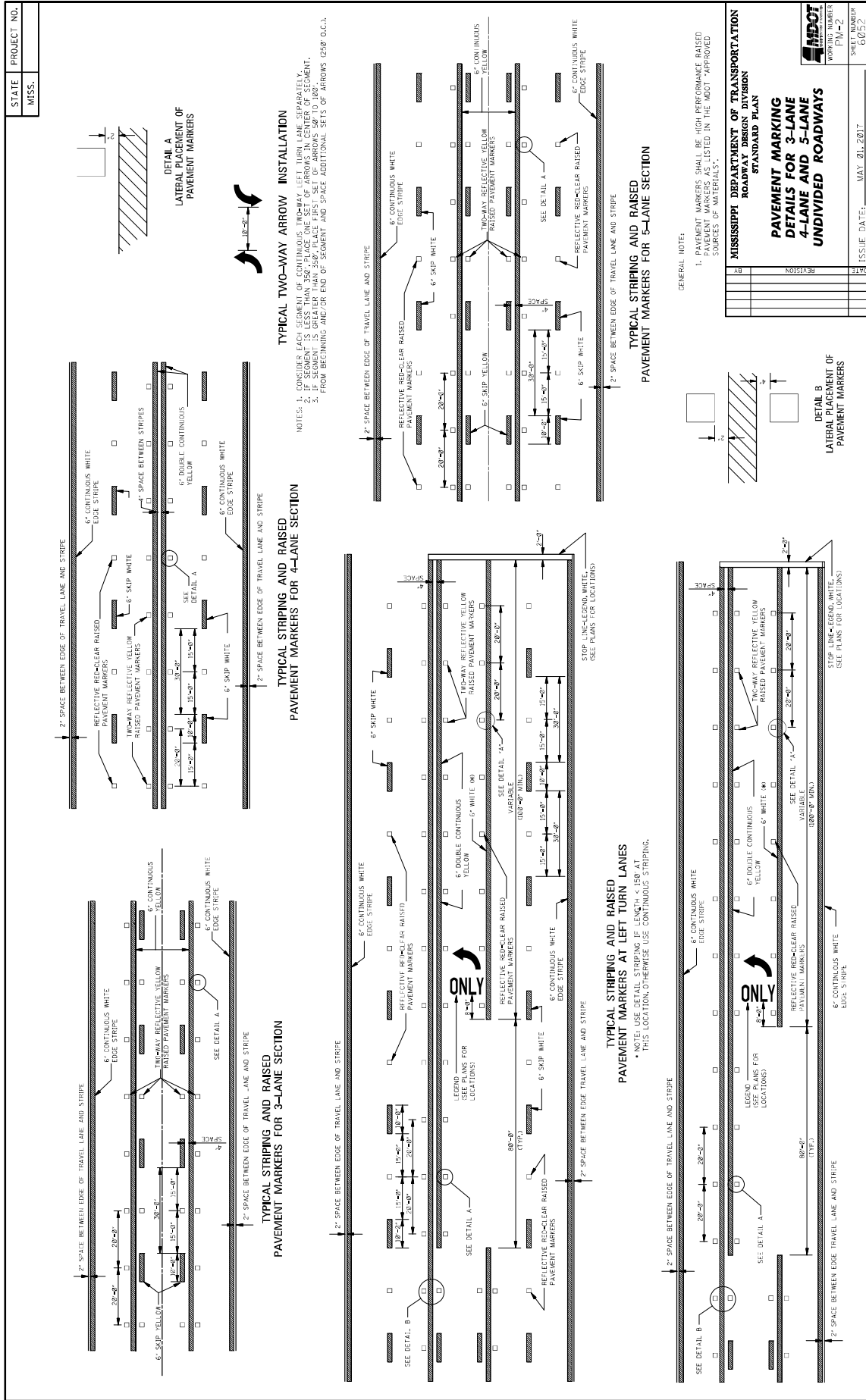

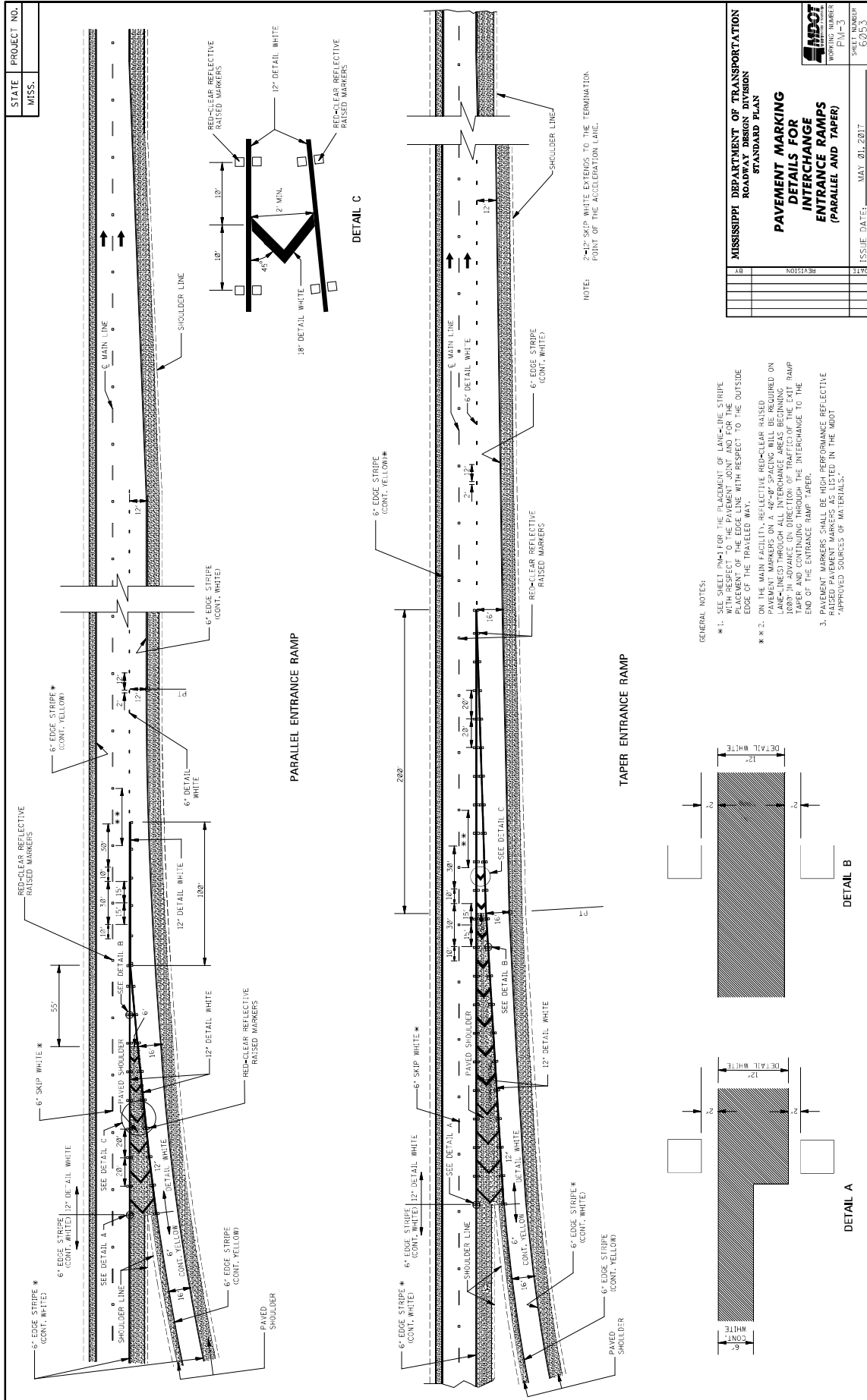

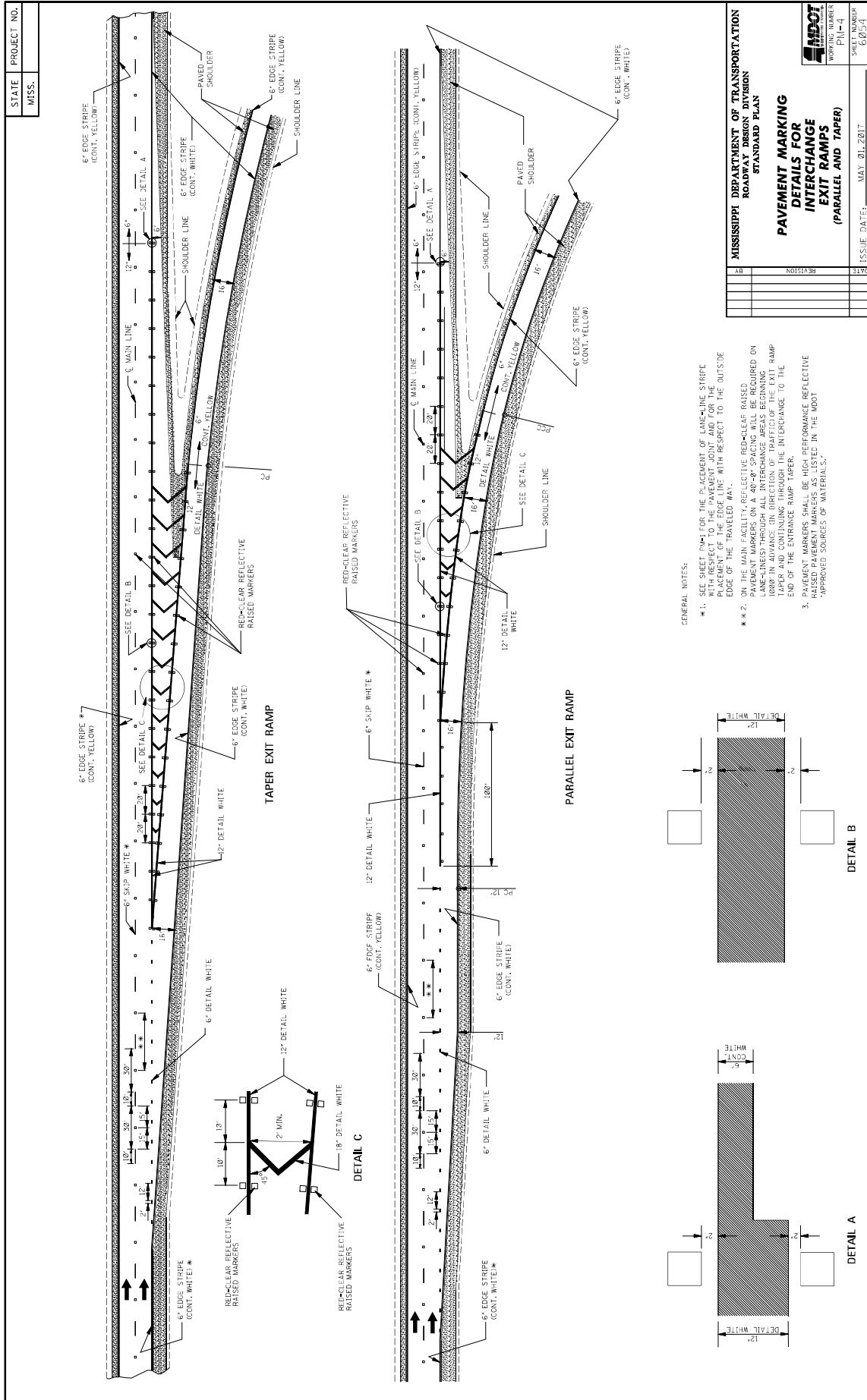

MISSISSIPPI DEPARTMENT OF TRANSPORTATION	
ROADWAY DESIGN DIVISION	
STANDARD PLAN	
PAVEMENT MARKING	
DETAILS FOR	
INTERCHANGE	
EXIT RAMP	
(PARALLEL AND TAPER)	
SHEET NUMBER	ISSUE DATE: MAY 01, 2017
PM-4	
WORKING NUMBER	
62/2/4	
DATE	REVISION

STATE MISS.	PROJECT NO.					
----------------	-------------	--	--	--	--	--

GENERAL NOTES:

- TWO HORIZONTAL GAPS (USED BY TEMPLATE CONNECTIONS) OF 1/2" OR LESS MAY EXTEND THROUGH OR BE OMITTED FROM EITHER LETTER OR SIGN.
- FOR OTHER DETAILS, SEE THE MANUAL ON UNIFORM TRAFFIC CONTROL DEVICES.
- PAY QUANTITIES FOR PAVEMENT MARKING LEGENDS ARE AS FOLLOWS:

LEGEND	AREA (ft ²)
STOP	24.6
RIGHT	28.6
LEFT	19.5
YIELD	22.2
TRAFFIC	22.2
AHEAD	32.2
YIELD	26.8
EXIT	18.5
SIGNAL	32.5
SCHOOL	35.5

MISSISSIPPI DEPARTMENT OF TRANSPORTATION
ROADWAY DESIGN DIVISION
STANDARD PLAN

PAVEMENT MARKING LEGEND DETAILS

DATE	BY	REVISION

ISSUE DATE: MAY 01, 2017
SHEET NUMBER: PM-5
PROJECT NUMBER: 60535

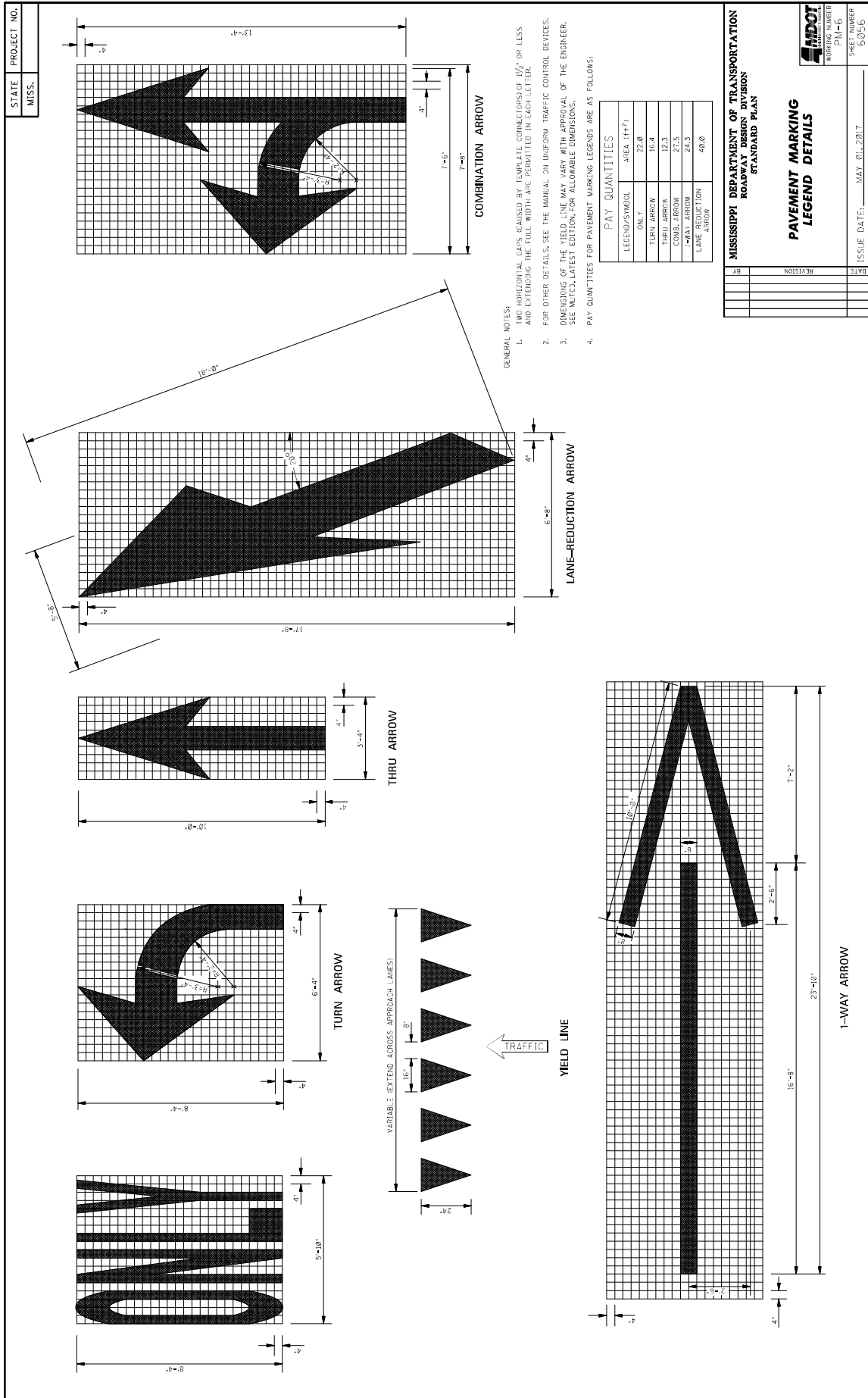

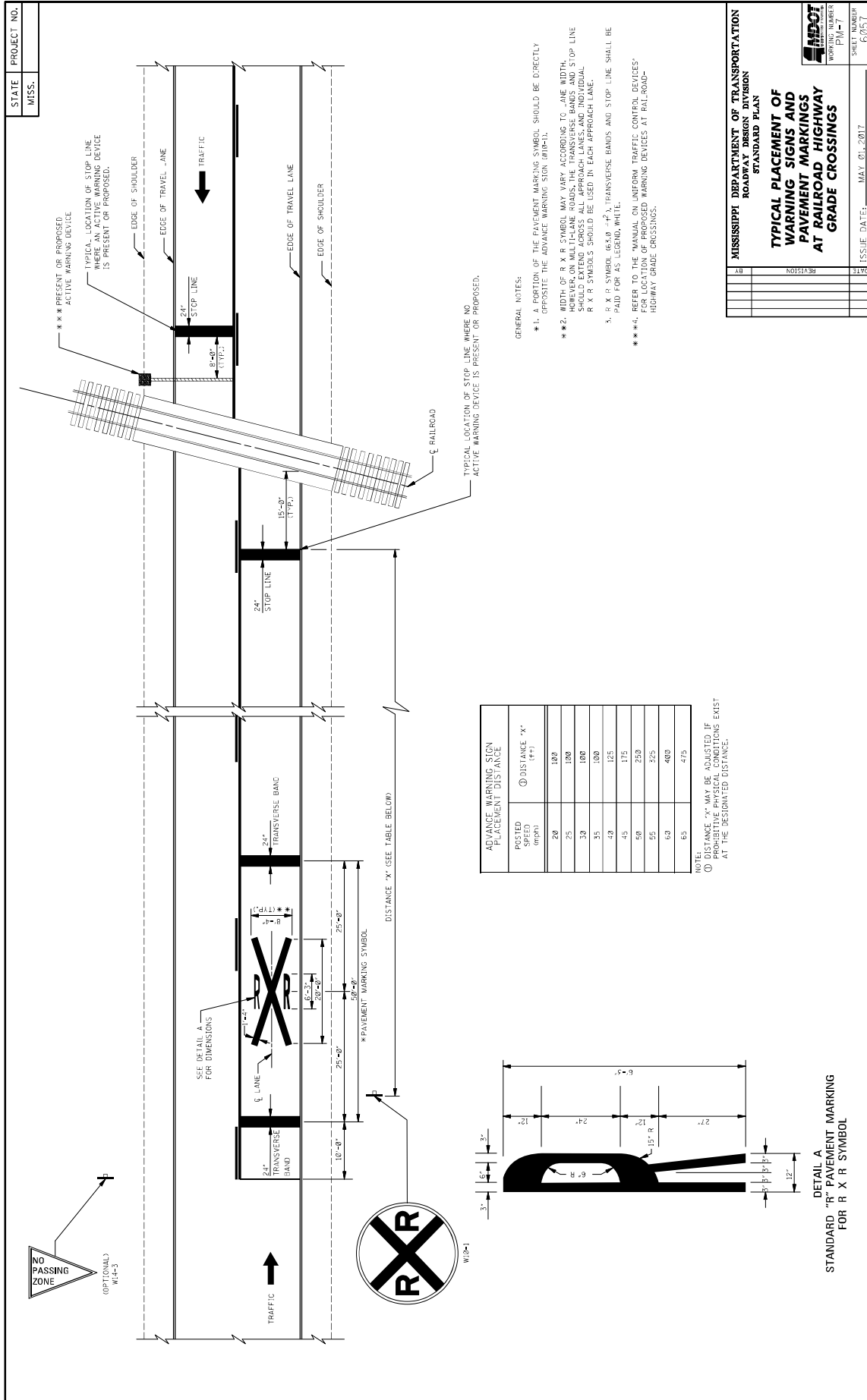

POSTED SPEED (mph)	① DISTANCE 'x' (ft)
20	100
25	100
30	100
35	100
40	125
45	175
50	250
55	325
60	400
65	475

NOTE: DISTANCE 'x' MAY BE SHORTER IF PROTECTIVE PHYSICAL CONDITIONS EXIST AT THE DESIGNATED DISTANCE.

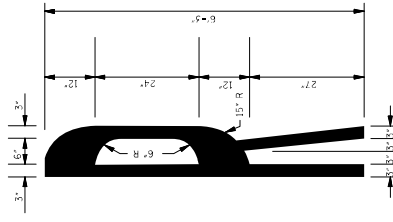

DETAIL A
STANDARD "R" PAVEMENT MARKING
FOR R X R SYMBOL

- GENERAL NOTES:
- **1. A PORTION OF THE PAVEMENT MARKING SYMBOL SHOULD BE DIRECTLY OPPOSITE THE ADVANCE WARNING SIGN (W14-3).
 - **2. WIDTH OF R X R SYMBOL MAY VARY ACCORDING TO LANE WIDTH. SYMBOL SHOULD EXTEND ACROSS ALL APPROACH LANES AND INDIVIDUAL R X R SYMBOLS SHOULD BE USED IN EACH APPROACH LANE.
 - **3. R X R SYMBOL (65.0 - 75.0) TRANSVERSE BANDS AND STOP LINE SHALL BE PAID FOR AS LEGEND WHITE.
 - **4. REFER TO THE MANUAL ON URBAN TRAFFIC CONTROL DEVICES FOR LOCATION OF PROPOSED WARNING DEVICES AT RAILROAD-HIGHWAY GRADE CROSSINGS.

STATE PROJECT NO.
MISS.

MISSISSIPPI DEPARTMENT OF TRANSPORTATION
ROADWAY DESIGN DIVISION
STANDARD PLAN

TYPICAL PLACEMENT OF WARNING SIGNS AND PAVEMENT MARKINGS AT RAILROAD HIGHWAY GRADE CROSSINGS

WORKING NUMBER: P10-1
SHEET NUMBER: 60511

ISSUE DATE: MAY 01, 2017

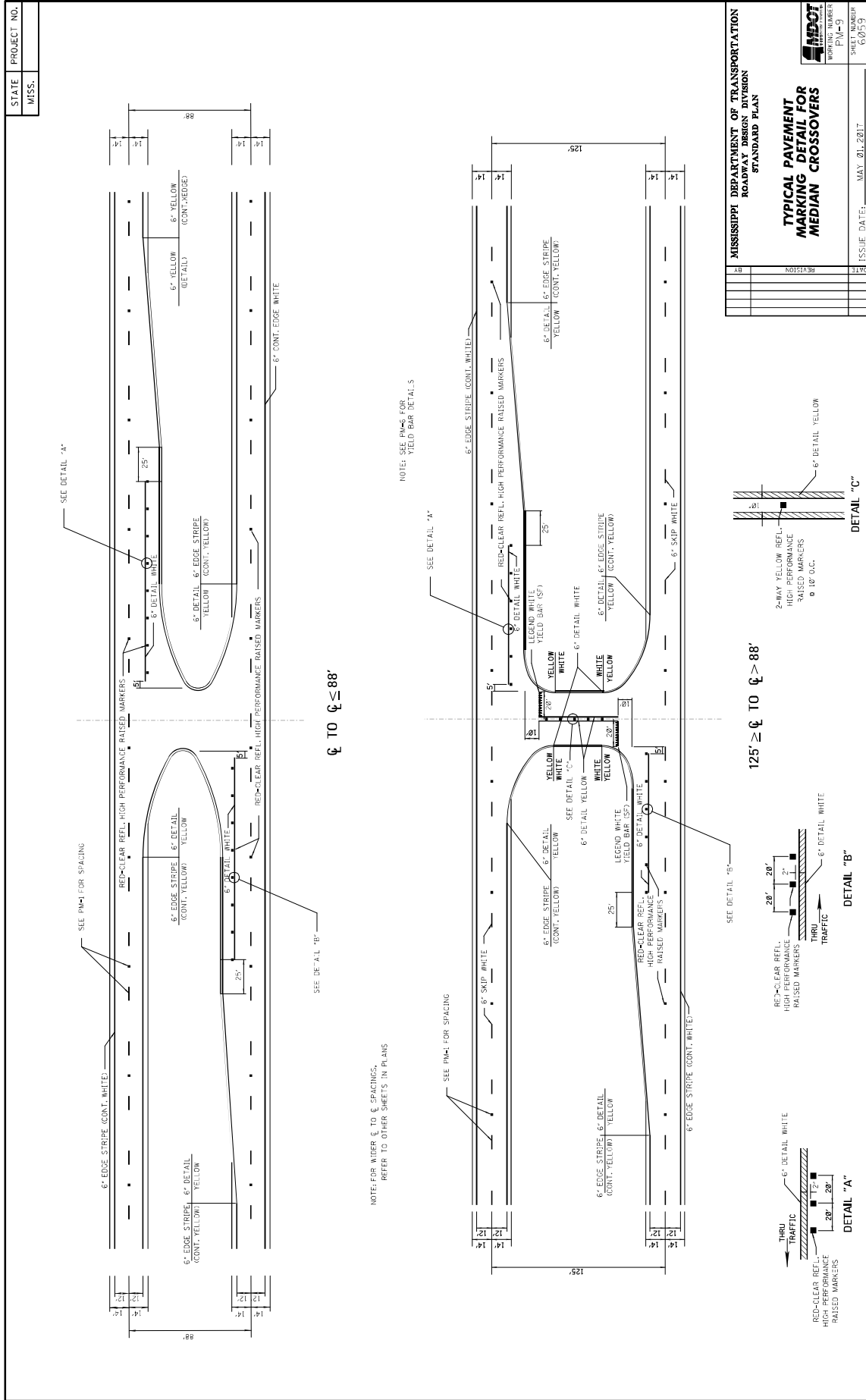

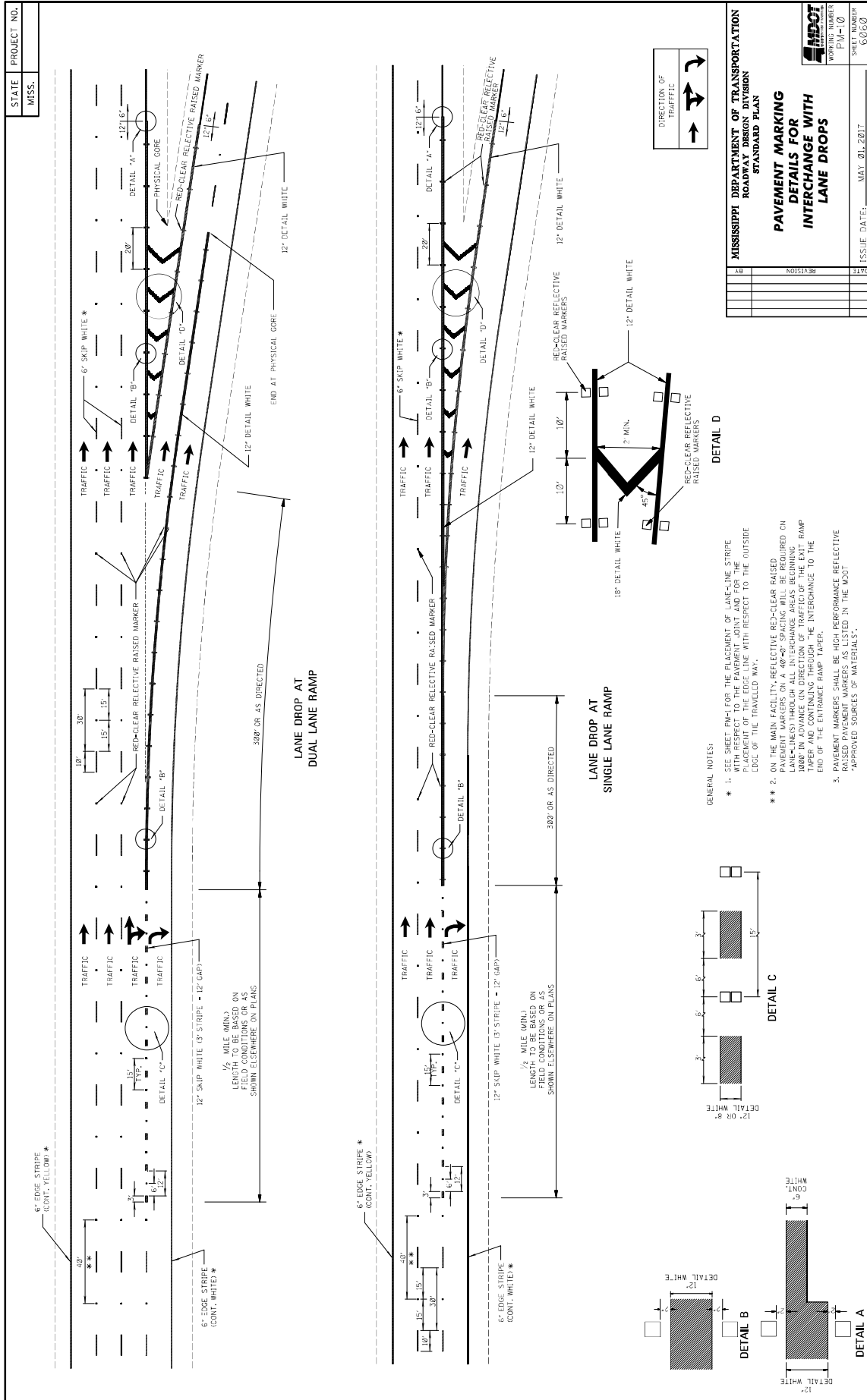

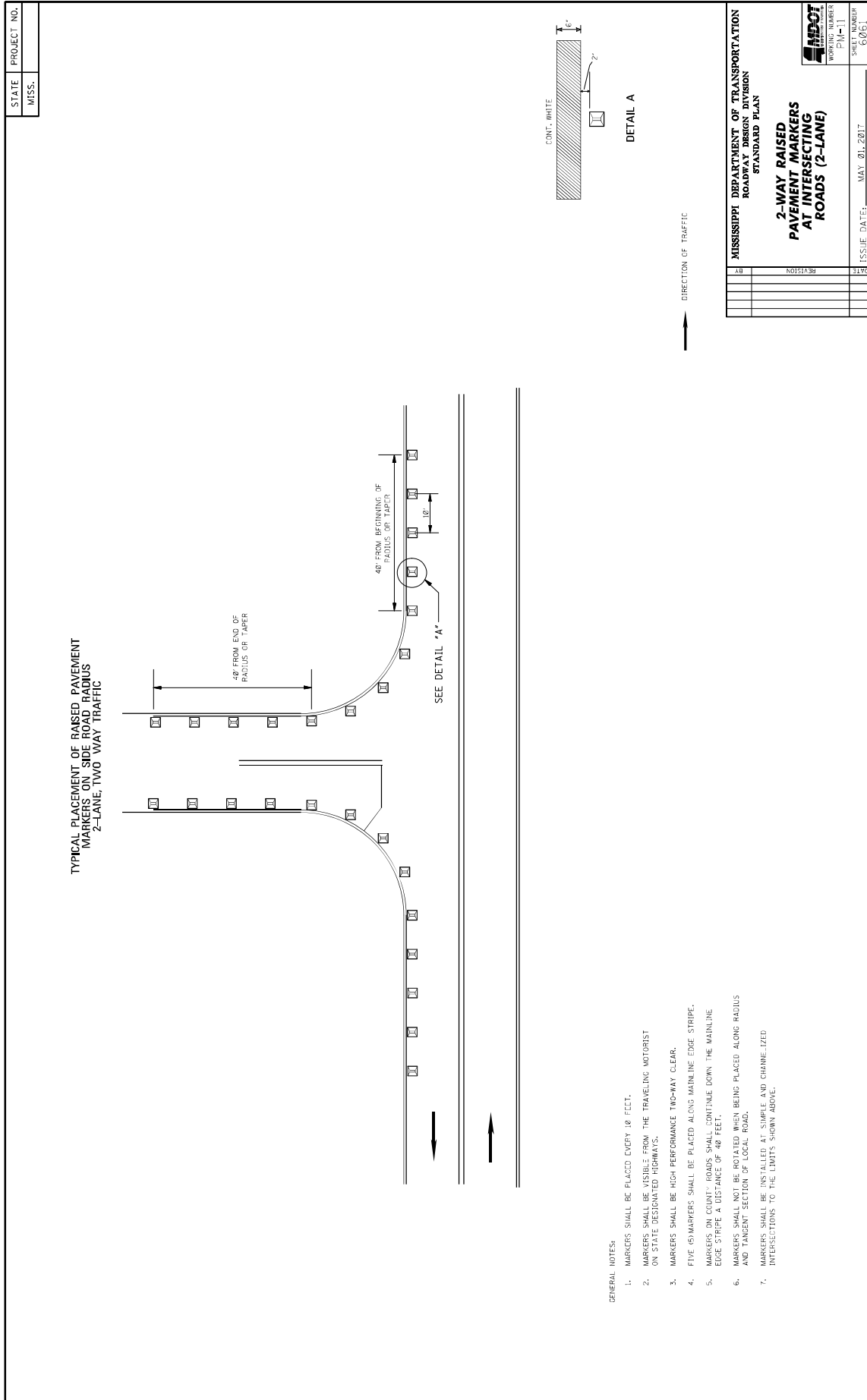

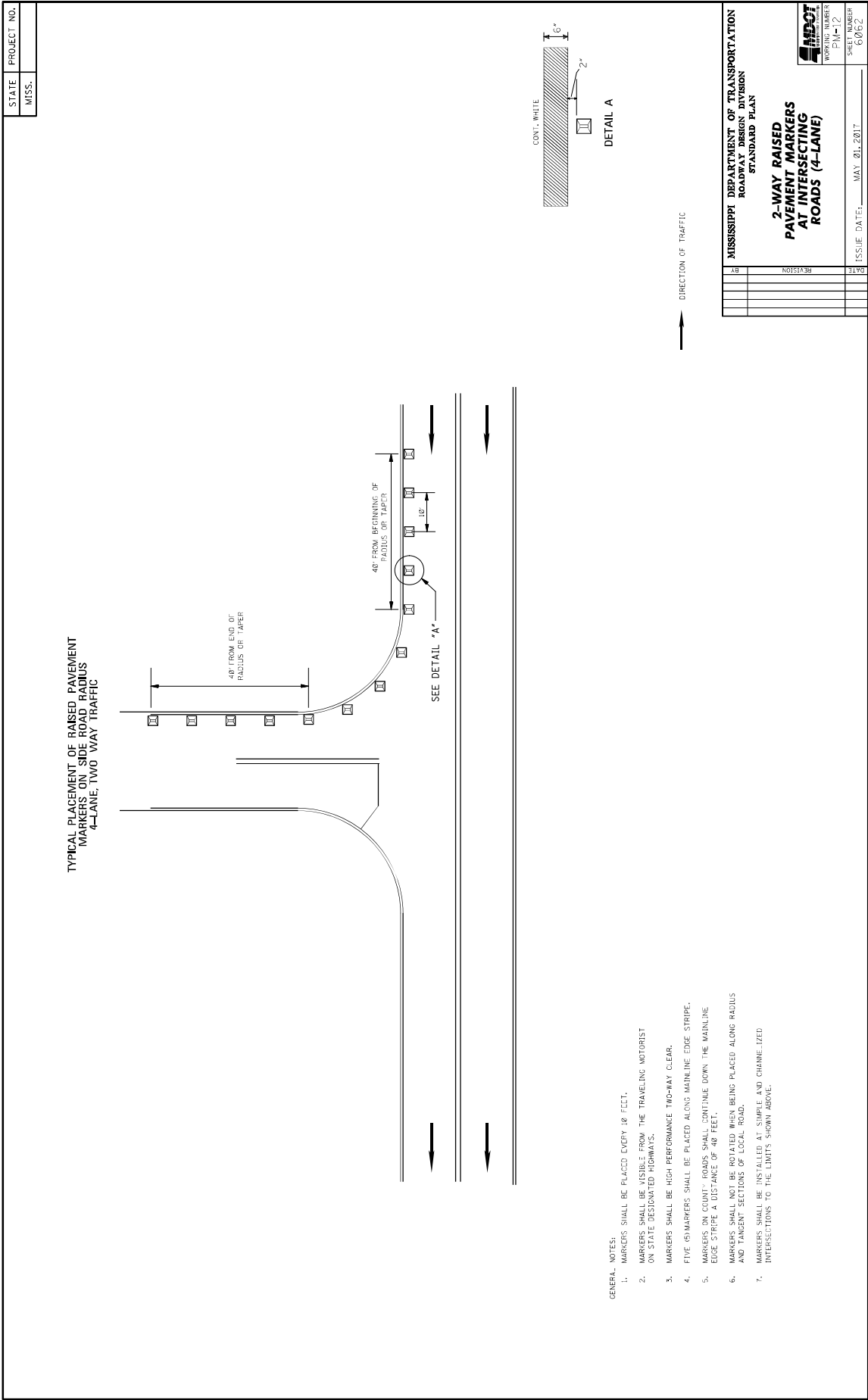

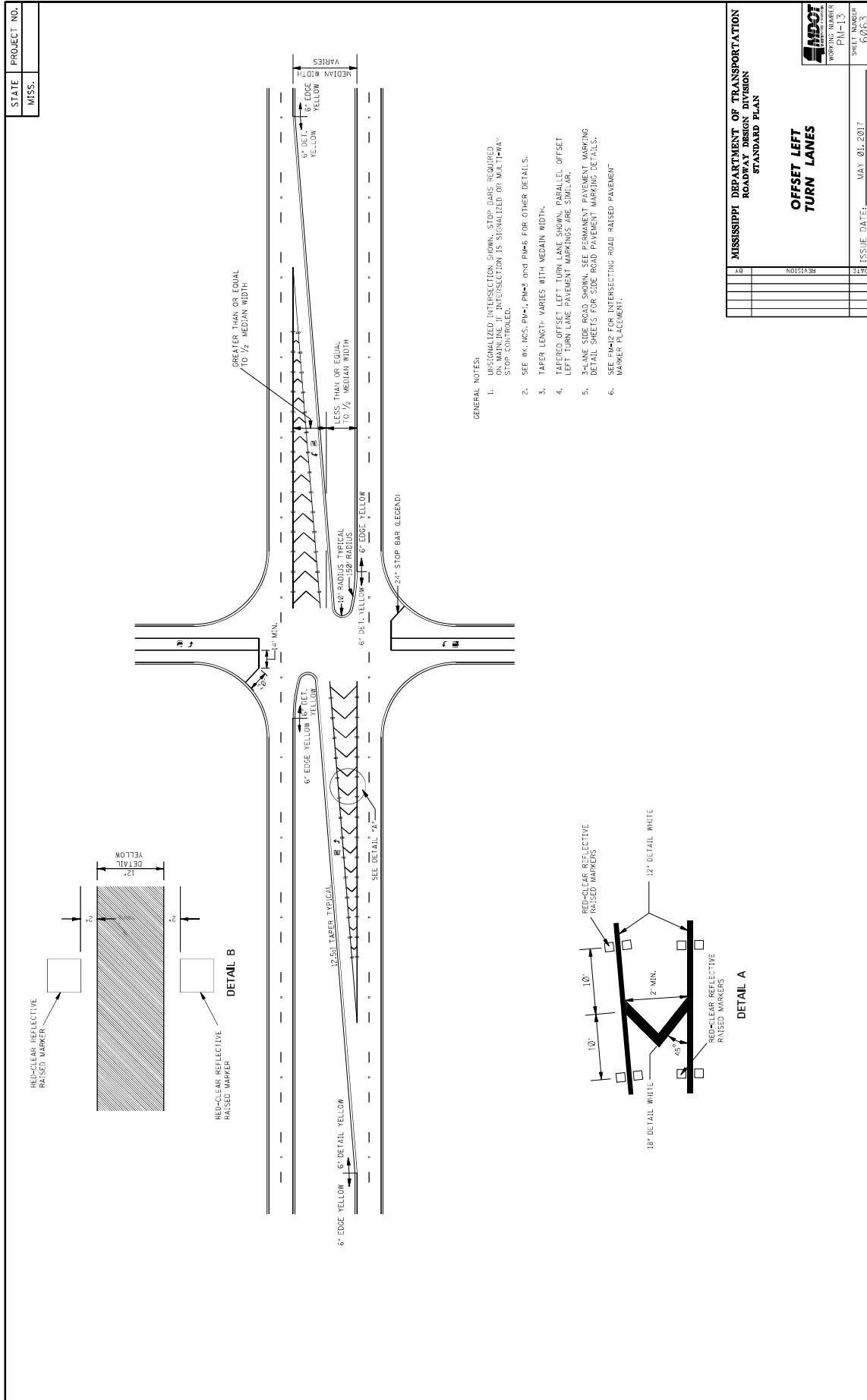

MISSISSIPPI DEPARTMENT OF TRANSPORTATION	
ROADWAY DESIGN DIVISION	
STANDARD PLAN	
OFFSET LEFT TURN LANES	
DATE	ISSUE DATE: MAY 01, 2017
BY	SHEET NUMBER 0263
REVISION	WORKING NUMBER PM-13

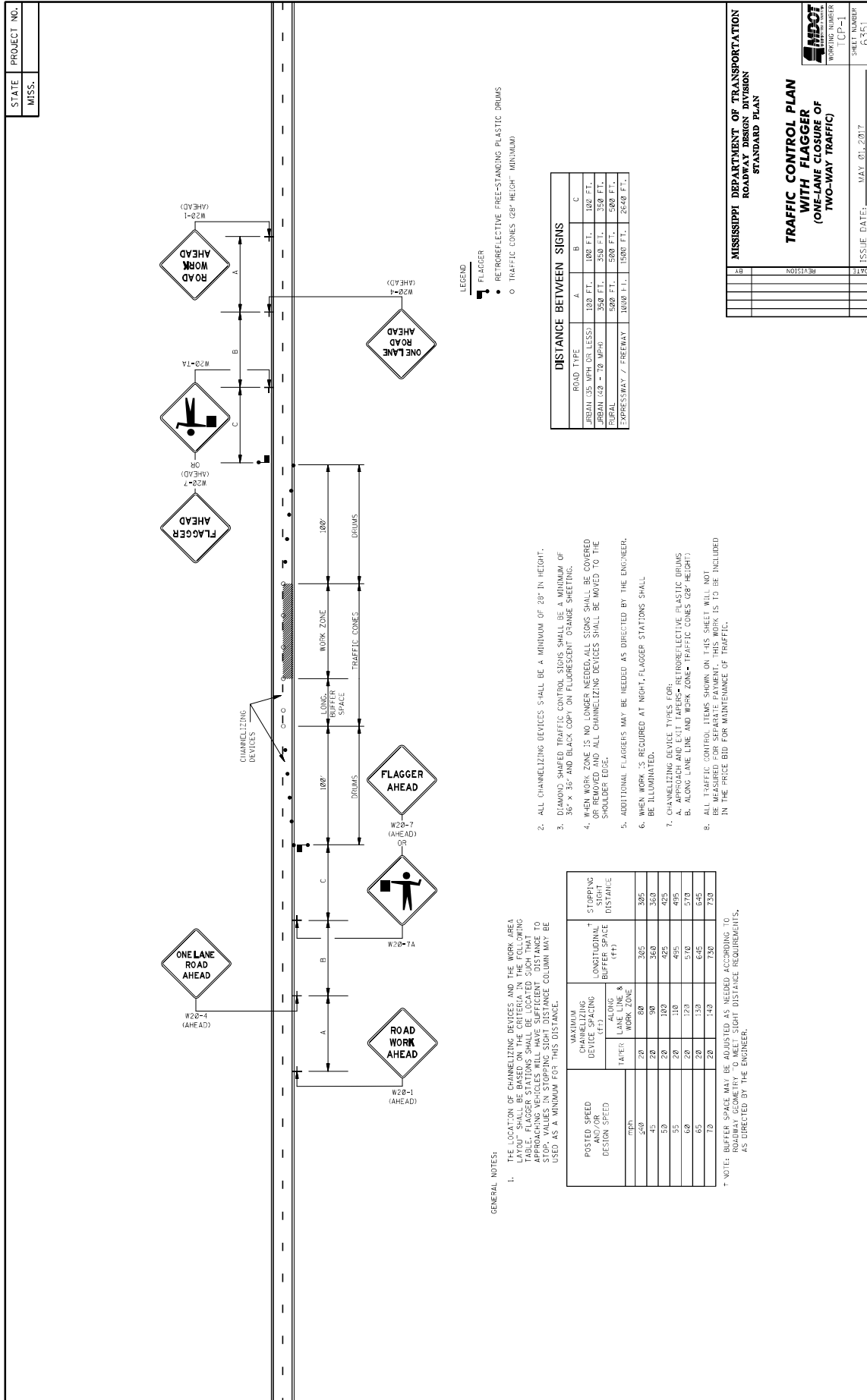

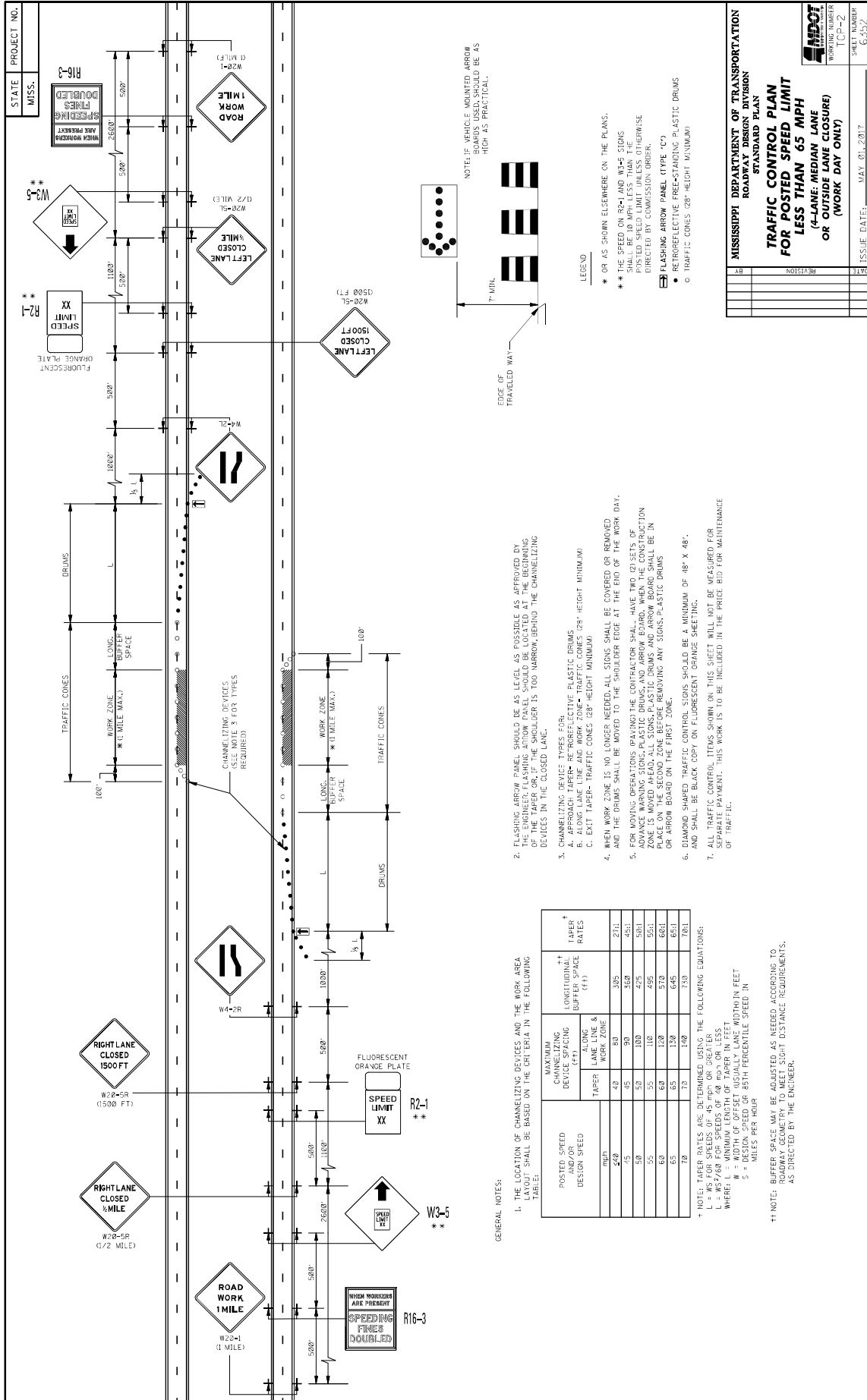

GENERAL NOTES:

1. THE LOCATION OF CHANNELIZING DEVICES AND THE WORK AREA LAYOUT SHALL BE BASED ON THE CRITERIA IN THE FOLLOWING TABLE:
- | POSTED SPEED AND/OR DESIGN SPEED | MAXIMUM CHANNELIZING DEVICE SPACING (FT) | | LONGITUDINAL BUFFER SPACE (FT) | TAPER RATES |
|----------------------------------|--|-----------|--------------------------------|-------------|
| | LANE LINE & WORK ZONE | WORK ZONE | | |
| 40 | 40 | 80 | 305 | 27:1 |
| 45 | 45 | 90 | 350 | 45:1 |
| 50 | 50 | 100 | 425 | 50:1 |
| 55 | 55 | 110 | 495 | 55:1 |
| 60 | 60 | 120 | 570 | 60:1 |
| 65 | 65 | 130 | 645 | 65:1 |
| 70 | 70 | 140 | 730 | 70:1 |
- † NOTE: TAPER RATES ARE DETERMINED USING THE FOLLOWING EQUATIONS:
 L = WS FOR SPEEDS OF 45 MPH OR GREATER
 L = WS FOR SPEEDS OF 40 MPH OR GREATER
 WHERE: L = MINIMUM LENGTH OF TAPER IN FEET
 W = WIDTH OF OFFSET (USUALLY LANE WIDTH) IN FEET
 S = DESIGN SPEED OR 85TH PERCENTILE SPEED IN MILES PER HOUR
- †† NOTE: BUFFER SPACE MAY BE ADJUSTED AS NEEDED ACCORDING TO ROADWAY GEOMETRY TO MEET SIGHT DISTANCE REQUIREMENTS, AS DIRECTED BY THE ENGINEER.

2. FLASHING ARROW PANEL SHOULD BE AS LEVEL AS POSSIBLE AS APPROVED BY THE ENGINEER. THE PANEL SHOULD BE LOCATED AT THE END OF THE WORK DAY OF THE TAPER OR AT THE SHOULDER IS TOO NARROW, BEHIND THE CHANNELIZING DEVICES IN THE CLOSED LANE.
3. CHANNELIZING DEVICES TYPES: FOR
 A. APPROACH TAPER- RETROREFLECTIVE PLASTIC DRUMS
 B. ALONG LANE LINE AND WORK ZONE- TRAFFIC CONES (28" HEIGHT MINIMUM)
 C. EXIT TAPER- TRAFFIC CONES (28" HEIGHT MINIMUM)
4. WHEN WORK ZONE IS NO LONGER NEEDED ALL SIGNS SHALL BE COVERED OR REMOVED AND THE DRUMS SHALL BE MOVED TO THE SHOULDER EDGE AT THE END OF THE WORK DAY.
5. FOR MOVING OPERATIONS (PAVING) THE CONTRACTOR SHALL HAVE TWO (2) SETS OF ADVANCE WARNING SIGNS- PLASTIC DRUMS AND ARROW BOARD. WHEN THE CONSTRUCTION ZONE IS MOVED AHEAD, ALL SIGNS- PLASTIC DRUMS AND ARROW BOARD SHALL BE IN PLACE ON THE SECOND ZONE BEFORE REMOVING ANY SIGNS- PLASTIC DRUMS OR ARROW BOARD ON THE FIRST ZONE.
6. DIAMOND SHAPED TRAFFIC CONTROL SIGNS SHOULD BE A MINIMUM OF 48" X 48" AND SHALL BE BLACK COPY ON FLUORESCENT ORANGE SHEETING.
7. ALL TRAFFIC CONTROL ITEMS SHOWN ON THIS SHEET WILL NOT BE MEASURED FOR PAYMENT. THIS WORK IS TO BE INCLUDED IN THE PRICE BID FOR MAINTENANCE OF TRAFFIC.

LEGEND

- * OR AS SHOWN ELSEWHERE ON THE PLANS.
- ** THE SPEED ON R2-1 AND W3-5 SIGNS SHALL BE 10 MPH LESS THAN THE POSTED SPEED LIMIT UNLESS OTHERWISE DIRECTED BY COMMISSION ORDER.
- ◻ FLASHING ARROW PANEL (TYPE 'C')
- RETROREFLECTIVE FREE-STANDING PLASTIC DRUMS
- TRAFFIC CONES (28" HEIGHT MINIMUM)

NOTE: IF VEHICLE MOUNTED ARROW BOARD IS USED, IT SHOULD BE AS HIGH AS PRACTICAL.

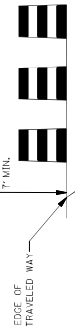

STATE PROJECT NO. MISS. R16-3

MISSISSIPPI DEPARTMENT OF TRANSPORTATION
 ROADWAY DESIGN DIVISION
 STANDARD PLAN

**TRAFFIC CONTROL PLAN
 FOR POSTED SPEED LIMIT
 LESS THAN 65 MPH
 (4-LANE, MEDIAN LANE
 OR OUTSIDE LANE CLOSURE)
 OR (WORK DAY ONLY)**

ISSUE DATE: MAY 01, 2017
 SHEET NUMBER: 6252
 WORKING NUMBER: T1P-2

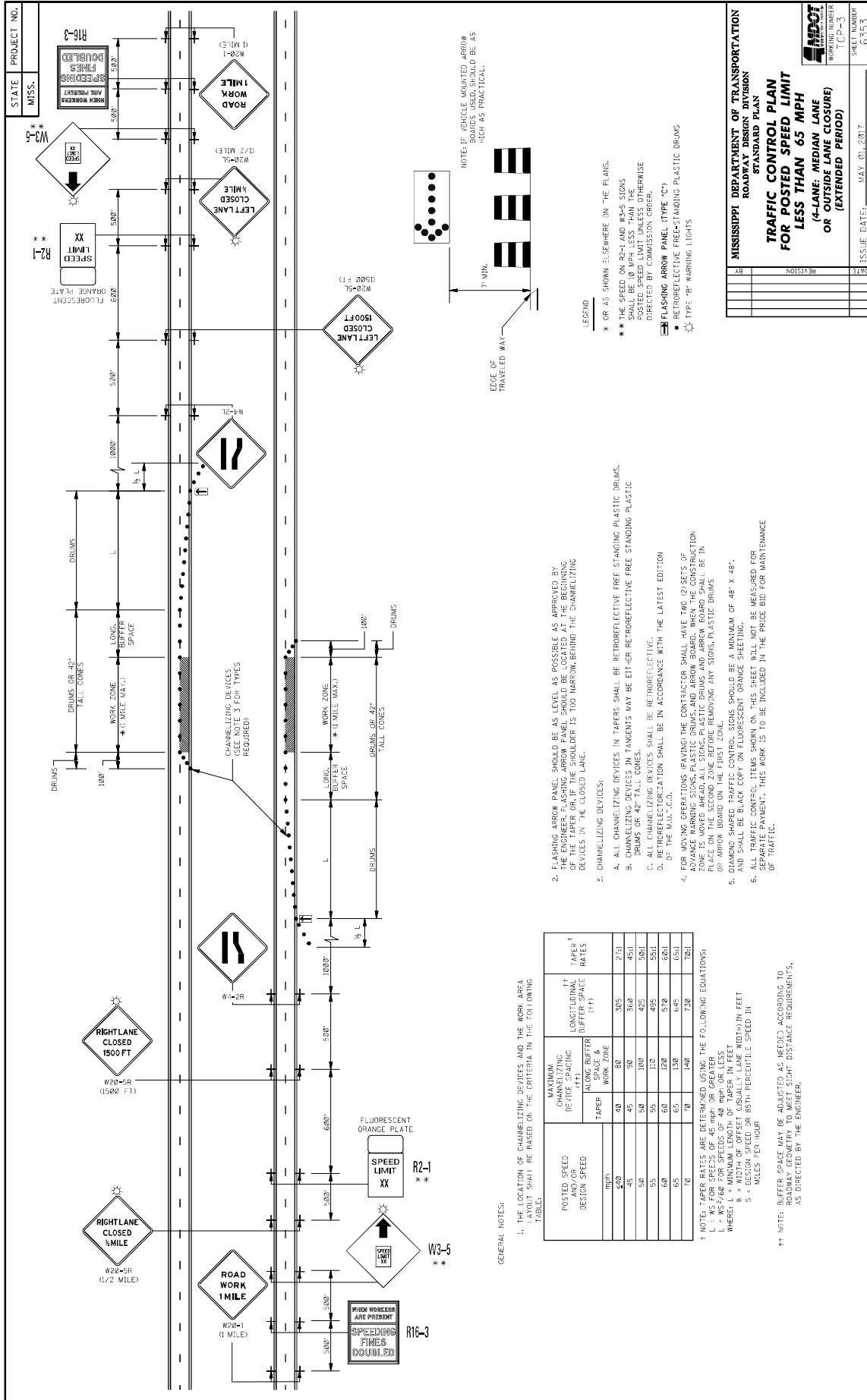

1. THE LOCATION OF CHANNELIZING DEVICES AND THE WORK AREA LAYOUT SHALL BE BASED ON THE CRITERIA IN THE FOLLOWING TABLE:

POSTED SPEED DESIGN SPEED	MAXIMUM CHANNELIZING DEVICE SPACING (FT)		LONGITUDINAL BUFFER SPACE (FT)	TAPER RATES
	ALONG BUFFER	WORK ZONE		
30	40	80	305	2:1
40	45	90	360	4:1
50	50	100	425	5:1
60	55	110	495	6:1
70	60	120	570	8:1
80	65	130	645	10:1
90	70	140	730	12:1

† NOTE: TAPER RATES ARE DETERMINED USING THE FOLLOWING EQUATIONS:
 L = AS FOR SPEEDS OF 45 MPH OR GREATER
 L = WS/60 FOR SPEEDS OF 40 MPH OR LESS
 WHERE: W = WIDTH OF OFFSET, USUALLY LANE WIDTH IN FEET
 S = DESIGN SPEED OR 85TH PERCENTILE SPEED IN MILES PER HOUR

†† NOTE: BUFFER SPACE MAY BE ADJUSTED AS NEEDED, ACCORDING TO ROADWAY GEOMETRY TO MEET SIGHT DISTANCE REQUIREMENTS, AS DIRECTED BY THE ENGINEER.

GENERAL NOTES:

- THE LOCATION OF CHANNELIZING DEVICES AND THE WORK AREA LAYOUT SHALL BE BASED ON THE CRITERIA IN THE FOLLOWING TABLE:
- FLASHING ARROW PANEL SHOULD BE AS LEVEL AS POSSIBLE AS APPROVED BY THE ENGINEER. FLASHING ARROW PANEL SHOULD BE LOCATED AT THE BEGINNING OF THE WORK ZONE. BUFFER SPACE SHOULD BE 100' MINIMUM BEHIND THE CHANNELIZING DEVICES IN THE CLOSED LANE.
- CHANNELIZING DEVICES:
 - ALL CHANNELIZING DEVICES IN TAPERS SHALL BE RETROREFLECTIVE FREE STANDING PLASTIC DRUMS.
 - DRUMS OR 42" TALL CONES.
 - ALL CHANNELIZING DEVICES SHALL BE RETROREFLECTIVE.
 - RETROREFLECTORIZATION SHALL BE IN ACCORDANCE WITH THE LATEST EDITION OF THE M.I.T.D.C.
- FOR WORKING DRUMS, TAPERS THE CONTRACTOR SHALL HAVE TWO (2) FEET OF CHANNELIZING DEVICES (DRUMS OR 42" TALL CONES) BEHIND THE CONSTRUCTION ZONE IS MOVED AHEAD. ALL SIGNS, PLASTIC DRUMS AND ARROW BOARD SHALL BE IN PLACE ON THE SECOND ZONE BEFORE REMOVING ANY SIGNS, PLASTIC DRUMS OR ARROW BOARD ON THE FIRST ZONE.
- ALL CHANNELIZING DEVICES SHALL BE A MINIMUM OF 48" X 48" AND SHALL BE BLACK COPY ON FLUORESCENT ORANGE SHEETING.
- ALL TRAFFIC CONTROL ITEMS SHOWN ON THIS SHEET WILL NOT BE MEASURED FOR SEPARATE PAYMENT. THIS WORK IS TO BE INCLUDED IN THE PRICE BID FOR MAINTENANCE OF TRAFFIC.

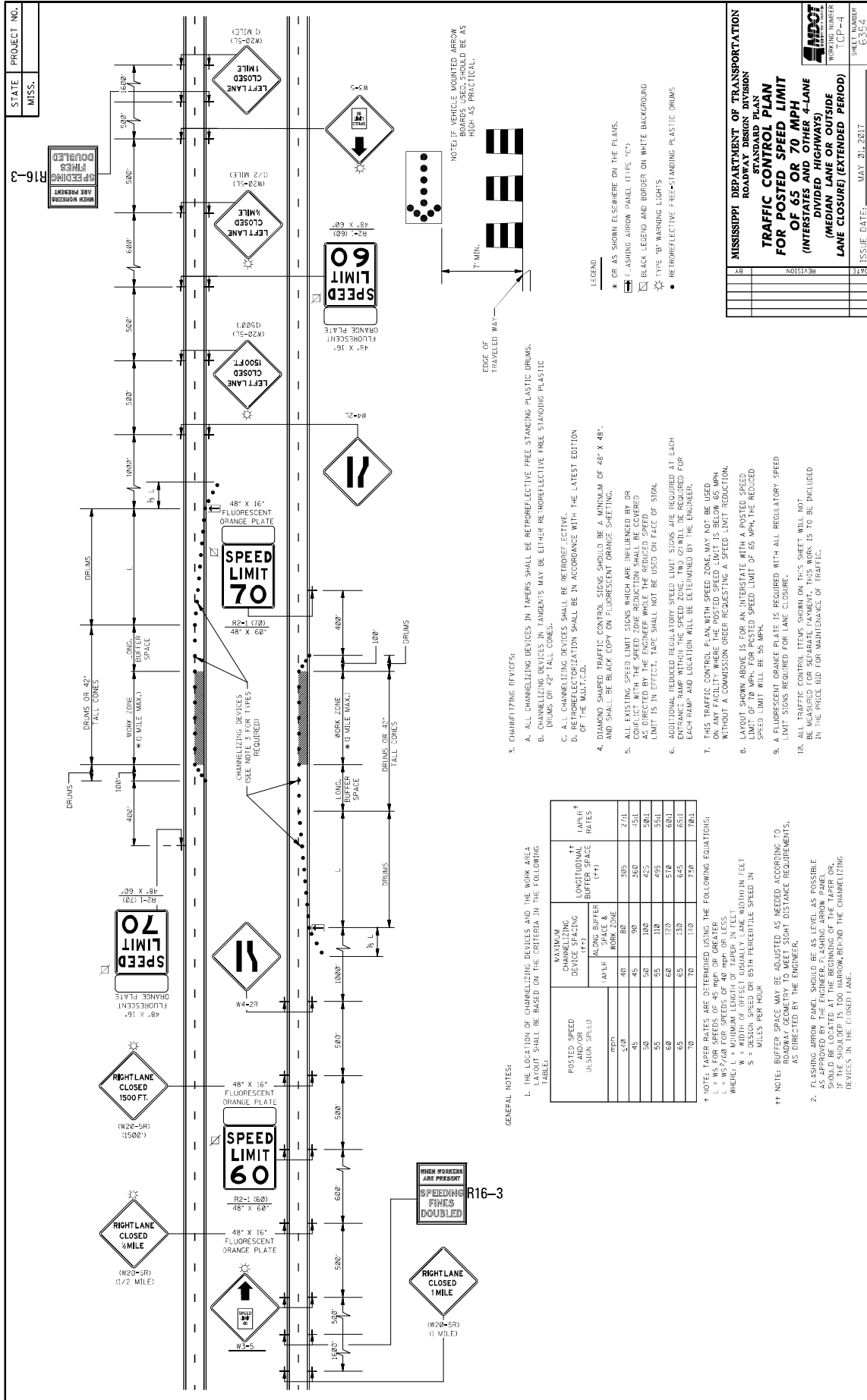

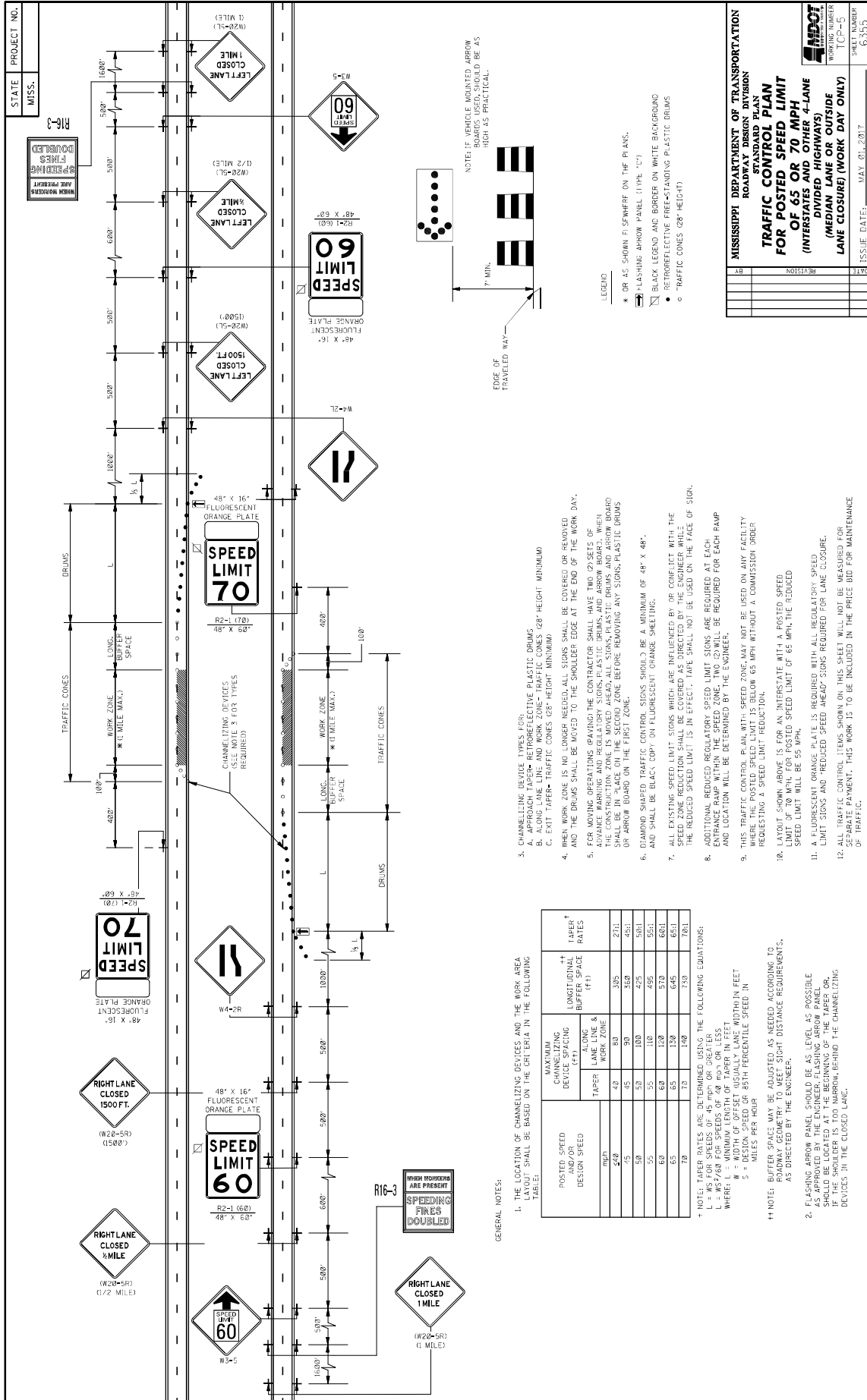

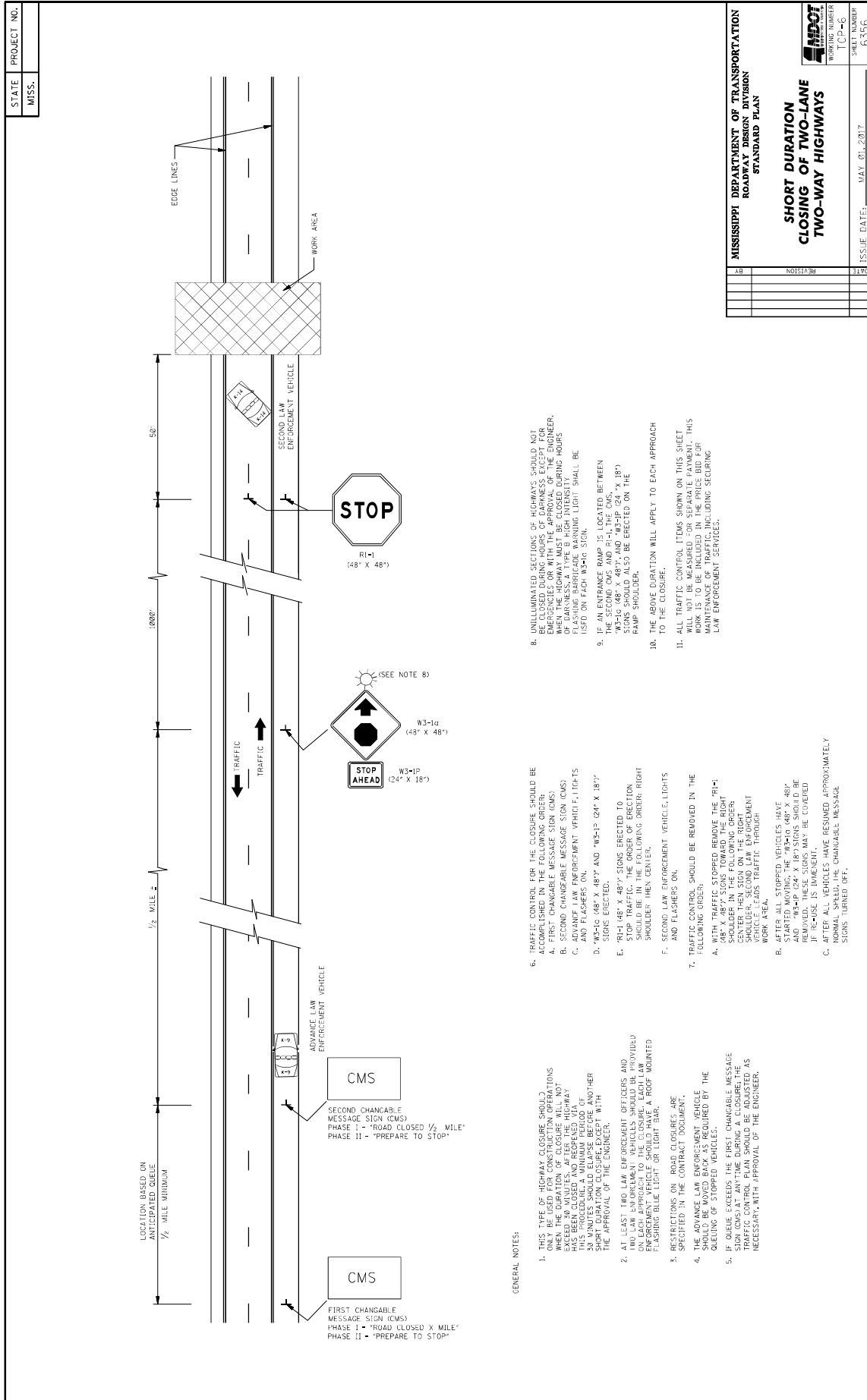

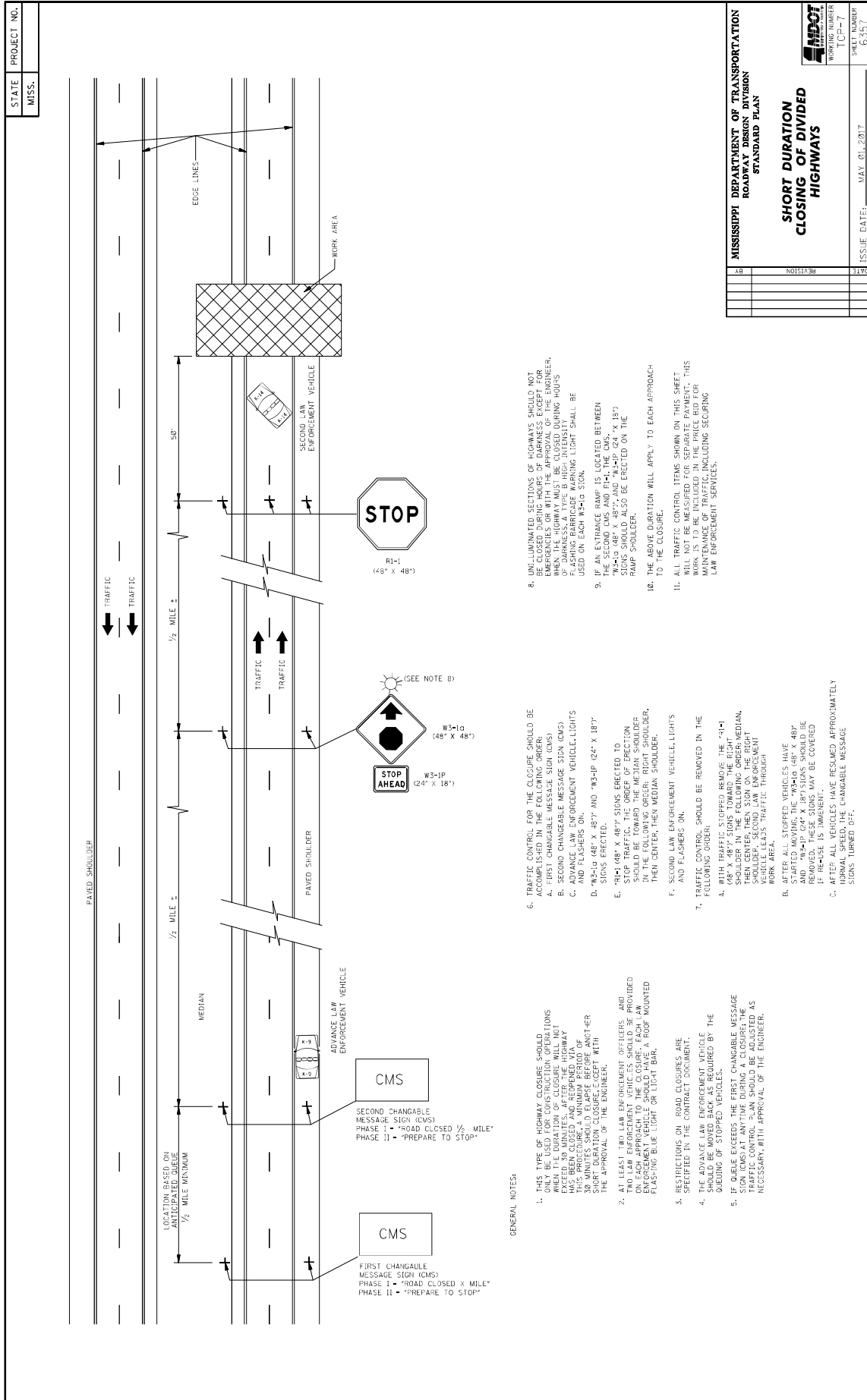

STATE PROJECT NO.
MISS.

MISSISSIPPI DEPARTMENT OF TRANSPORTATION ROADWAY DESIGN DIVISION STANDARD PLAN	
SHORT DURATION CLOSING OF DIVIDED HIGHWAYS	
AB	REVISION
3170	
ISSUE DATE: MAY 01, 2017	
SHEET NUMBER 100-7	
6357	

- GENERAL NOTES:**
- THIS TYPE OF HIGHWAY CLOSURE SHOULD BE USED ONLY WHEN THE DURATION OF CLOSURE WILL NOT EXCEED 30 MINUTES AFTER THE HIGHWAY IS CLOSED. THIS PROCEDURE A MINIMUM PERIOD OF 30 MINUTES SHOULD ELAPSE BEFORE ANY OTHER CLOSURES ARE MADE WITH THE APPROVAL OF THE ENGINEER.
 - AT LEAST TWO LAW ENFORCEMENT OFFICERS AND TWO LAW ENFORCEMENT VEHICLES SHOULD BE PROVIDED ON EACH APPROACH TO THE CLOSURE. EACH LAW ENFORCEMENT VEHICLE SHOULD BE EQUIPPED WITH A ROOF MOUNTED FLASHING BLUE LIGHT OR LIGHT BAR.
 - RESTRICTIONS ON ROAD CLOSURES ARE SPECIFIED IN THE CONTRACT DOCUMENT.
 - THE ADVANCE LAW ENFORCEMENT VEHICLE SHOULD BE MOVED BACK AS REQUIRED BY THE QUEUING OF STOPPED VEHICLES.
 - IF QUEUE EXCEEDS THE FIRST CHANGEABLE MESSAGE SIGN, THE SECOND CHANGEABLE MESSAGE SIGN SHOULD BE CHANGED TO THE MESSAGE NECESSARY WITH APPROVAL OF THE ENGINEER.
 - TRAFFIC CONTROL FOR THE CLOSURE SHOULD BE ACCOMPLISHED IN THE FOLLOWING ORDER:
 - FIRST CHANGEABLE MESSAGE SIGN (CMS)
 - SECOND CHANGEABLE MESSAGE SIGN (CMS)
 - STOP AHEAD AND FLASHERS ON
 - W3-1G (48" X 48") AND W3-1P (24" X 18") SIGNS ERECTED.
 - RI-1 (48" X 48") SIGNS ERECTED TO STOP TRAFFIC. THE ORDER OF ERECTION SHOULD BE TOWARD THE MEDIAN SHOULDER, THEN CENTER, THEN MEDIAN SHOULDER, AND FLASHERS ON.
 - SECOND LAW ENFORCEMENT VEHICLE, LIGHTS AND FLASHERS ON.
 - TRAFFIC CONTROL SHOULD BE REMOVED IN THE FOLLOWING ORDER:
 - WITH TRAFFIC STOPPED REMOVE THE RI-1 SIGN FROM THE MEDIAN SHOULDER, THEN CENTER, THEN SHOULDER IN THE FOLLOWING ORDER: MEDIAN, SHOULDER, THEN SIGN ON THE RIGHT SIDE OF THE ROAD. THE ORDER OF REMOVAL OF VEHICLE LEADS TRAFFIC THROUGH WORK AREA.
 - AFTER ALL STOPPED VEHICLES HAVE STARTED MOVING, THE W3-1G (48" X 48") AND W3-1P (24" X 18") SIGNS SHOULD BE REMOVED. THESE SIGNS MAY BE COVERED IF RELEASE IS IMMINENT.
 - AFTER ALL VEHICLES HAVE RESUMED APPROXIMATELY NORMAL FLOW, THE CHANGEABLE MESSAGE SIGNS TURNED OFF.
 - UNILLUMINATED SECTIONS OF HIGHWAYS SHOULD NOT BE CLOSED DURING HOURS OF DARKNESS EXCEPT FOR EMERGENCY REPAIRS. THE SIGNAGE FOR DARKNESS WHEN THE HIGHWAY MUST BE CLOSED DURING HOURS OF DARKNESS: A TYPE B HIGH-INTENSITY FLUORESCENT SIGN WITH AN AMBI-ORANGE LIGHT SHALL BE USED ON EACH W3-1G SIGN.
 - IF AN ENTRANCE RAMP IS LOCATED BETWEEN THE SECOND CMS AND RI-1, THE CMS "W3-1G (48" X 48") AND "W3-1P (24" X 18") SIGNS SHOULD ALSO BE ERECTED ON THE RAMP SHOULDER.
 - THE ABOVE DURATION WILL APPLY TO EACH APPROACH TO THE CLOSURE.
 - ALL TRAFFIC CONTROL ITEMS SHOWN ON THIS SHEET WILL NOT BE MEASURED FOR SEPARATE PAYMENT. THIS WORK SHALL BE INCLUDED IN THE PRICE FOR MAINTENANCE OF SERVICES INCLUDING SECURING LAW ENFORCEMENT SERVICES.

STATE	PROJECT NO.				
MISS.					

WING BARRICADES

1. WING BARRICADES ARE TYPE II BARRICADES ERECTED ON THE SHOULDER OF A ROADWAY OR RESTRICTED ROADWAY. WING BARRICADES MAY BE USED AS A MOUNTING FOR THE ADVANCE WARNING SIGNS OR FLASHERS.

2. WING BARRICADES SHOULD BE USED:

A. IN ADVANCE OF A CONSTRUCTION PROJECT EVEN WHEN NO PART OF THE ROADWAY IS ACTUALLY CLOSED.

B. IN ADVANCE OF ALL BRIDGE OR CULVERT WIDENING OPERATIONS.

PLASTIC DRUM STRIPING DETAIL

1. PLASTIC DRUMS SHALL BE ON END AND USED AS AN EXPEDIENT METHOD FOR TRAFFIC CHANNELIZATION. THE COLOR AND MARKING OF DRUMS SHALL BE CONSISTENT WITH MARKING STRIPES. THE PREFERRED COLOR OF DRUMS SHALL BE ORANGE WITH POLYESTER-RETROREFLECTIVE, HORIZONTAL, CIRCUMFERENTIAL STRIPES (2 ORANGE & 2 WHITE) 6" WIDE.

2. DRUMS SHOULD NEVER BE PLACED IN THE ROADWAY WITHOUT WARNING SIGNS.

3. WHERE PRACTICAL PLASTIC DRUMS SHOULD BE PLACED NO CLOSER THAN 3'-0" FROM THE EDGE OF TRAVELED LANE.

BARRICADE CHARACTERISTICS

	I	II	III
WIDTH OF RAIL **	8" MIN. - 12" MAX.	8" MIN. - 12" MAX.	8" MIN. - 12" MAX.
LENGTH OF RAIL **	24' MIN.	24' MIN.	48' MIN.
WIDTH OF STRIPE *	6"	6"	6"
HEIGHT	36" MIN.	36" MIN.	60" MIN.
NUMBER OF RETROREFLECTORIZED RAIL FACES	2 (ONE EACH DIRECTION)	4 (TWO EACH DIRECTION)	3 IF FACING TRAFFIC IN ONE DIRECTION 4 IF FACING TRAFFIC IN TWO DIRECTIONS

BARRICADE CLOSING A ROAD

STANDARD BARRICADES

1. THE MARKING FOR BARRICADE RAILS SHALL BE ORANGE AND WHITE (SLOPING DOWNWARD AT AN ANGLE OF 45° IN THE DIRECTION OF TRAFFIC IS TO PASS).

2. RAIL STRIPE SHALL BE 6 INCHES EXCEPT THAT 4-INCH WIDE STRIPES MAY BE USED IF RAIL LENGTHS ARE LESS THAN 36 INCHES.

3. DO NOT PLACE SANDBAGS OR OTHER DEVICES TO PROVIDE MASS ON THE BOTTOM RAIL THAT WILL BLOCK VIEW OR RAIL FACE.

4. FOR ADDITIONAL INFORMATION OR DETAILS, SEE METHOD, LATEST EDITION.

5. BARRICADES ARE CLASSIFIED BY FHWA AS CATEGORY II WHEN ONE DEVICES WHICH REQUIRE SUCCESSFULLY CRASH TESTED. A LIST OF CRASHWORTHY BARRICADES AND OTHER CATEGORY II DEVICES CAN BE FOUND ON FHWA'S WEBSITE: http://safety.fhwa.dot.gov/roadway_dept/pafety_guidance/road_hardware/cat2.cfm

CHEVRON SIGN DETAIL

1. A CHEVRON SIGN CONSISTS OF A BLACK CHEVRON TYPE MARKING ON AN ORANGE BACKGROUND AND SHALL POINT IN THE DIRECTION OF TRAFFIC FLOW.

2. THE CHEVRON SIGN SHALL BE MOUNTED ON CRASHWORTHY SUPPORT.

3. CHEVRON SIGNS MAY BE USED TO SUPPLEMENT OTHER STANDARD DEVICES WHERE ONE OR MORE LANES ARE CLOSED FOR CONSTRUCTION OR MAINTENANCE. THEY SHOULD BE PLACED APPROXIMATELY 2'-0" BEHIND THE LANE TRANSITION STRIPE.

TYPE 3 OBJECT MARKER (OM-3R)

1. TYPE 3 OBJECT MARKERS SHALL BE USED AT ALL EXPOSED BRIDGE ABUTMENTS AND AT OTHER LOCATIONS AS DETERMINED NECESSARY BY THE ENGINEER.

2. THE OM-3R IS SIMILAR EXCEPT THE STRIPES SLOPE DOWNWARD FROM THE UPPER LEFT SIDE TO THE LOWER RIGHT SIDE AND SHALL BE PLACED ON THE LEFT SIDE OF THE OBJECT.

3. THE INSIDE EDGE OF THE MARKER SHALL BE IN LINE WITH THE INNER EDGE OF THE OBSTRUCTION.

STATE MISS.	PROJECT NO.	
----------------	-------------	--

MOBILE OPERATIONS ON MULTILANE ROAD

MOBILE OPERATIONS ON MULTILANE ROAD

MOBILE OPERATIONS ON TWO-LANE ROAD

MOBILE OPERATIONS ON TWO-LANE ROAD

NOTES FOR MULTILANE LANE OPERATION:

- VEHICLES USED FOR THESE OPERATIONS SHOULD BE MADE HIGHLY VISIBLE WITH APPROPRIATE EQUIPMENT, SUCH AS FLASHING LIGHTS, ROTATING BEACONS, FLASGS, SIGNS, OR ARROW PANELS.
- SHADOW VEHICLE 2 SHOULD BE EQUIPPED WITH AN ARROW PANEL AND TRUCK MOUNTED ATTENUATOR (TMA), AN APPROPRIATE LANE CLOSURE SIGN SHOULD BE DISPLAYED ON SHADOW VEHICLE 2 SO AS NOT TO OBSCURE THE ARROW PANEL.
- SHADOW VEHICLE 1 SHOULD BE EQUIPPED WITH AN ARROW PANEL AND TRUCK MOUNTED ATTENUATOR (TMA).
- SHADOW VEHICLE 2 SHOULD TRAVEL AT A VARYING DISTANCE FROM THE WORK OPERATION SO AS TO PROVIDE ADEQUATE SIGHT DISTANCE FOR TRAFFIC APPROACHING FROM THE REAR.
- WHEN ADEQUATE SHOULDER WIDTH IS NOT AVAILABLE, SHADOW VEHICLE 2 SHOULD BE ELIMINATED.
- ON HIGH-SPEED ROADWAYS, A THIRD SHADOW VEHICLE SHOULD BE USED (i.e., VEHICLE 3 ON THE SHOULDER OF PRACTICALLY, VEHICLE 2 IN THE CLOSED LANE, AND VEHICLE 1 IN THE CLOSED LANE).
- ARROW PANELS SHALL BE AS A MINIMUM TYPE B, 60" X 36" IN ACCORDANCE WITH THE CRITERIA PRESENTED IN THE MUTCD.
- WORK SHOULD NORMALLY BE DONE DURING OFF-PEAK HOURS.
- VEHICLE-MOUNTED SIGNS SHOULD BE MOUNTED WITH THE BOTTOM OF THE SIGN LOCATED AT A MINIMUM HEIGHT OF 48" ABOVE THE PAVEMENT AND SHALL NOT BE OBSCURED BY EQUIPMENT OR SUPPLEMENTARY SIGN LEGENDS SHALL BE COVERED OR TURNED FROM VIEW WHEN WORK IS NOT IN PROGRESS.
- ALL TRAFFIC CONTROL ITEMS SHOWN ON THIS SHEET WILL NOT BE MEASURED FOR SEPARATE PAYMENT. THIS WORK IS TO BE INCLUDED IN THE PRICE BID FOR MAINTENANCE OF TRAFFIC.

NOTES FOR TWO-LANE OPERATION:

- WHERE PRACTICAL AND WHEN NEEDED, THE WORK AND SHADOW VEHICLES SHOULD PULL OVER PERIODICALLY TO ALLOW TRAFFIC TO PASS. IF THIS CAN NOT BE DONE FREQUENTLY AS AN ALTERNATIVE, A "DO NOT PASS" SIGN MAY BE PLACED ON THE REAR OF THE VEHICLE BLOCKING THE LANE.
- THE DISTANCE BETWEEN THE WORK AND SHADOW VEHICLES MAY VARY ACCORDING TO TERRAIN, PAINT DRYING TIME, AND OTHER FACTORS. SHADOW VEHICLES ARE USED TO WARN TRAFFIC OF THE OPERATION AHEAD. WHENEVER ADEQUATE SHOULD MAINTAIN THE MINIMUM DISTANCE AND PROCEED AT THE SAME SPEED AS THE WORK VEHICLE. THE SHADOW VEHICLE SHOULD SLOW DOWN IN ADVANCE OF VERTICAL OR HORIZONTAL CURVES THAT RESTRICT SIGHT DISTANCE.
- ADDITIONAL SHADOW VEHICLES TO WARN AND REDUCE THE SPEED OF ONCOMING OR OPPOSING TRAFFIC MAY BE USED. POLICE PATROL CARS MAY BE USED FOR THIS PURPOSE.
- A TRUCK-MOUNTED ATTENUATOR (TMA) SHOULD BE USED ON THE SHADOW VEHICLE AND MAY BE USED ON THE WORK VEHICLE.
- THE WORK VEHICLE SHALL BE EQUIPPED WITH BEACONS AND THE SHADOW VEHICLE SHALL BE EQUIPPED WITH BEACONS AND LIGHTS. TRUCK-MOUNTED LIGHTS MOUNTED ON THE REAR, ADJACENT TO THE SIGN, SHADOW AND WORK VEHICLES SHALL DISPLAY FLASHING OR ROTATING BEACONS BOTH FORWARD AND TO THE REAR.
- VEHICLE-MOUNTED SIGNS SHOULD BE MOUNTED WITH THE BOTTOM OF THE SIGN LOCATED AT A MINIMUM HEIGHT OF 48" ABOVE THE PAVEMENT AND SHALL NOT BE OBSCURED BY EQUIPMENT OR SUPPLEMENTARY SIGN LEGENDS SHALL BE COVERED OR TURNED FROM VIEW WHEN WORK IS NOT IN PROGRESS.
- ARROW BOARD TO BE USED IN CAUTION MODE.
- ALL TRAFFIC CONTROL ITEMS SHOWN ON THIS SHEET WILL NOT BE MEASURED FOR SEPARATE PAYMENT. THIS WORK IS TO BE INCLUDED IN THE PRICE BID FOR MAINTENANCE OF TRAFFIC.

MISSISSIPPI DEPARTMENT OF TRANSPORTATION
ROADWAY DESIGN DIVISION
STANDARD PLAN

TRAFFIC CONTROL PLAN
MOBILE OPERATIONS
MULTILANE ROADS
TWO-LANE ROADS

REV		REVISION
1		1

ISSUE DATE: MAY 01, 2017

SHEET NUMBER		PROJECT NUMBER
6359		CP-9

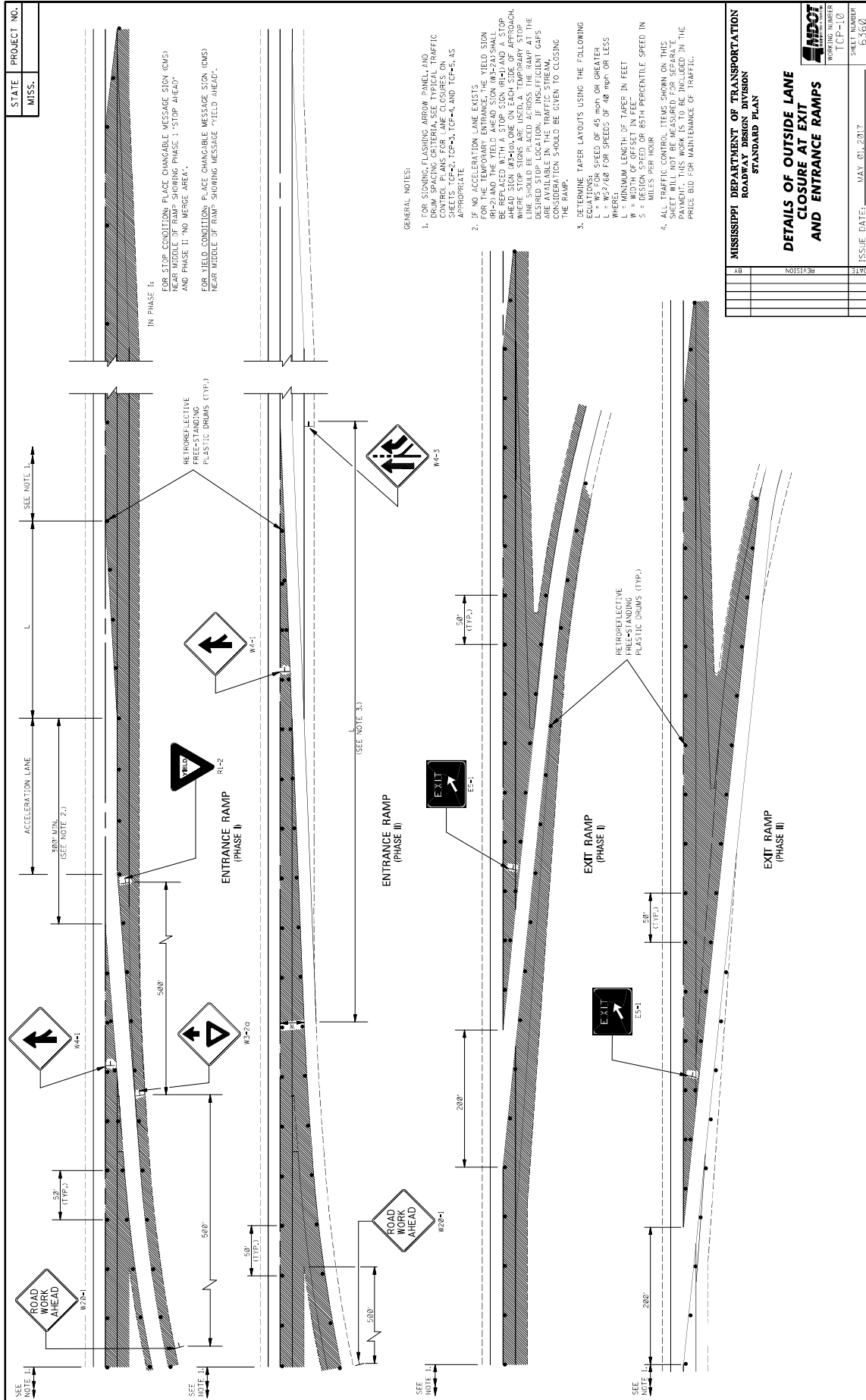

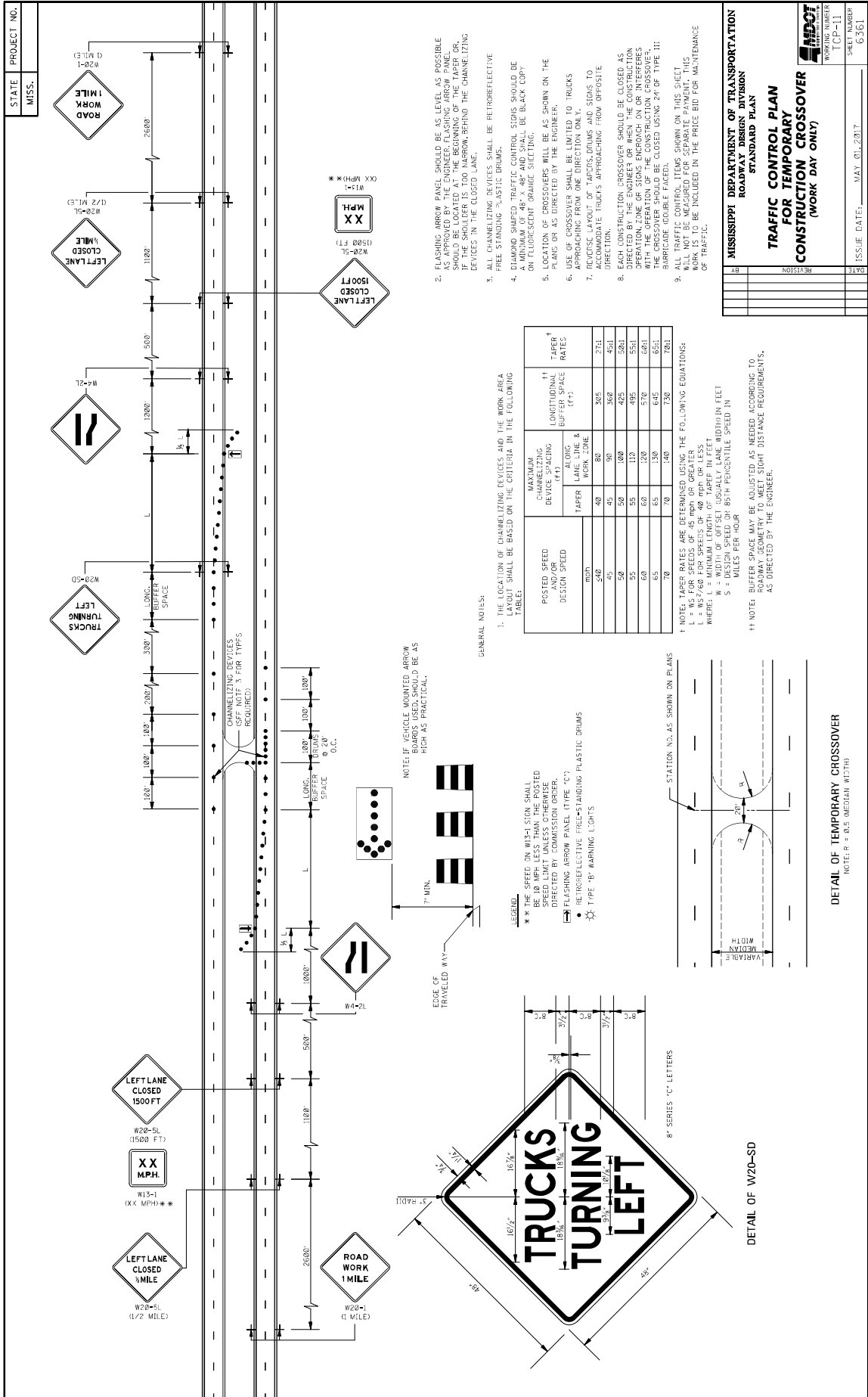

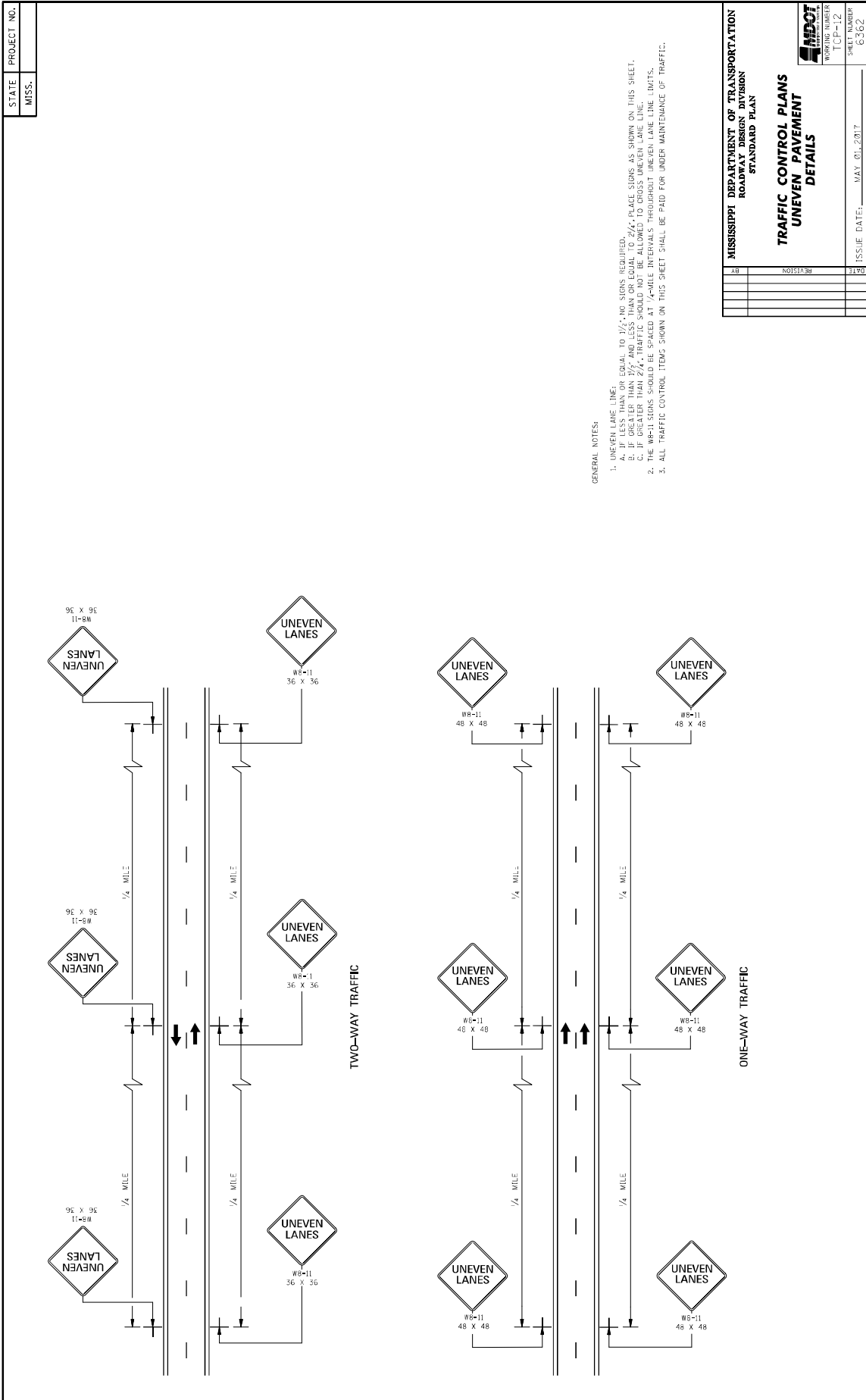

STATE	PROJECT NO.
MISS.	

MISSISSIPPI DEPARTMENT OF TRANSPORTATION ROADWAY DESIGN DIVISION STANDARD PLAN	
TRAFFIC CONTROL PLANS UNEVEN PAVEMENT DETAILS	
WORKING NUMBER	SHEET NUMBER
ICP-12	6262
ISSUE DATE:	MAY 01, 2017
REVISION	
NO.	DATE

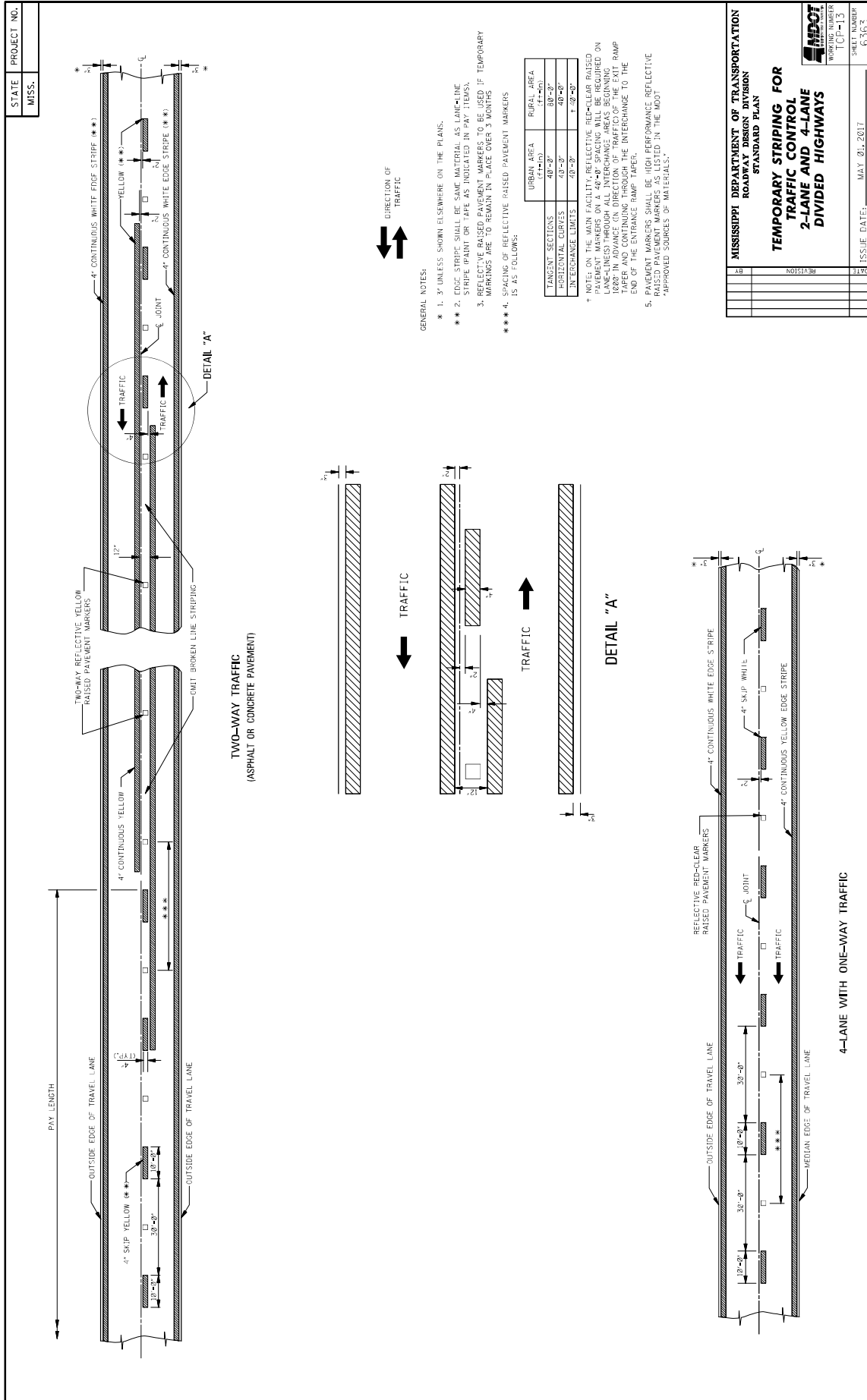

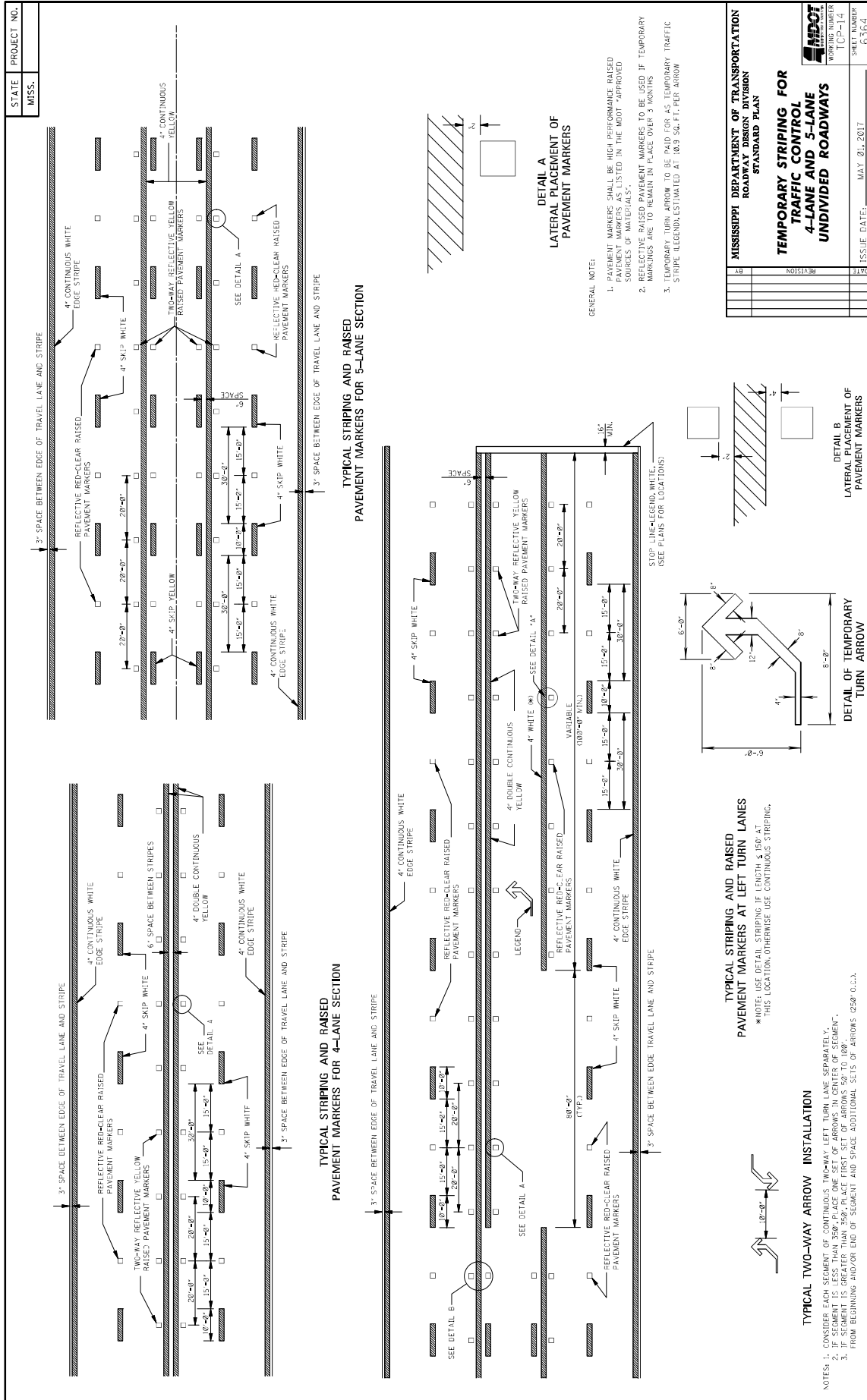

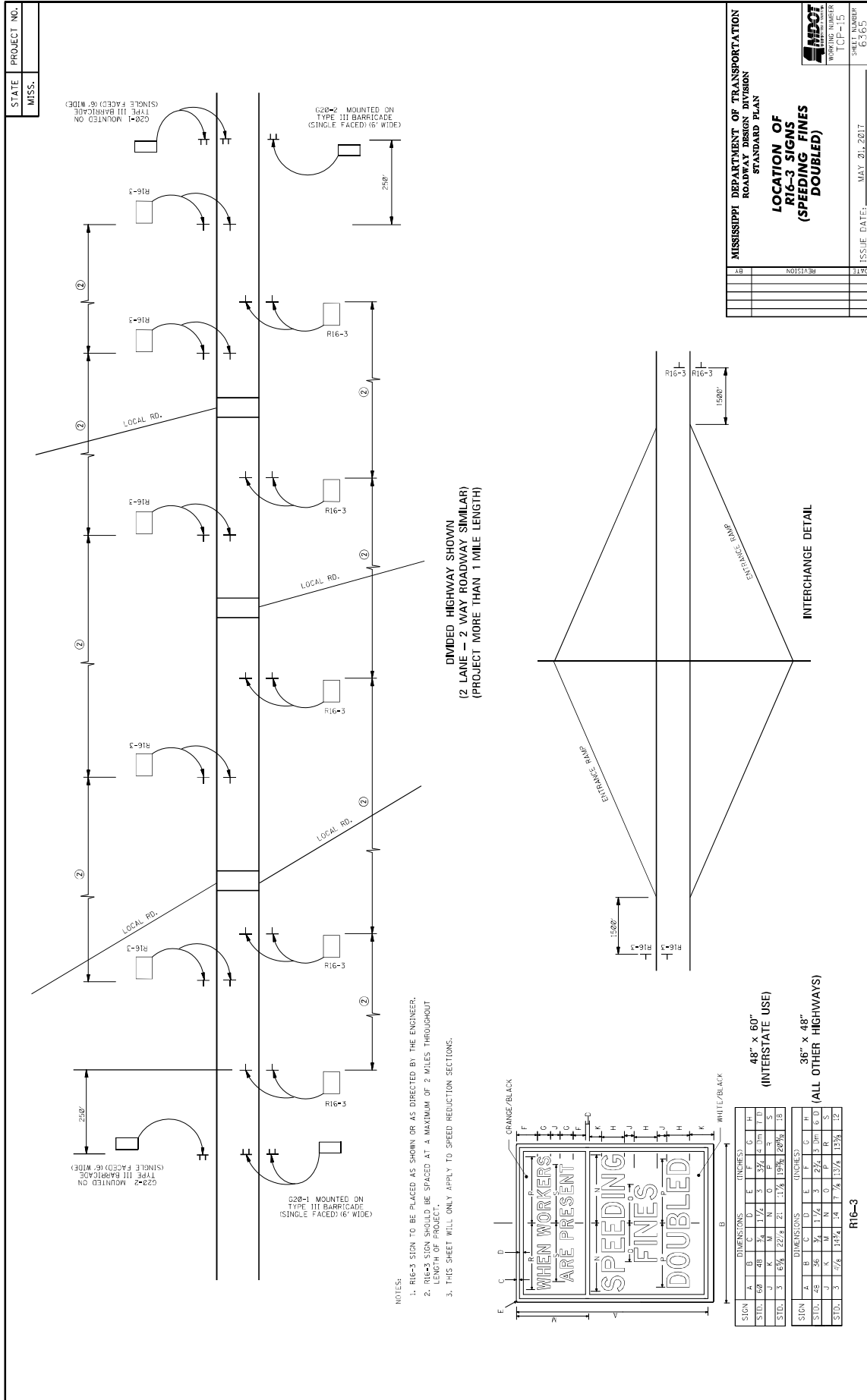

- NOTES:
1. R16-3 SIGN TO BE PLACED AS SHOWN OR AS DIRECTED BY THE ENGINEER.
 2. R16-3 SIGN SHOULD BE SPACED AT A MAXIMUM OF 2 MILES THROUGHOUT LENGTH OF PROJECT.
 3. THIS SHEET WILL ONLY APPLY TO SPEED REDUCTION SECTIONS.

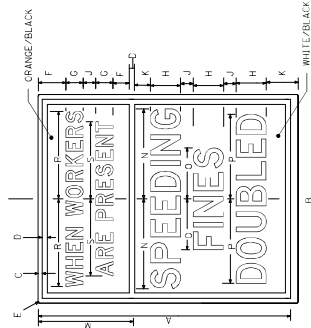

SIGN		DIMENSIONS (INCHES)																
A	B	C	D	E	F	G	H	I	J	K	L	M	N	O	P	Q	R	S
STD.	6-0	48	36	1 1/4	5	3/4	4	3/16	1/2	1 1/4	1 3/8	2 8/16	1 1/2	1 1/2	1 1/2	1 1/2	1 1/2	1 1/2
STD.	3	1 5/8	1 2/8	1/2	1 1/4	1 3/8	2 8/16	1 1/2	1 1/2	1 1/2	1 1/2	1 1/2	1 1/2	1 1/2	1 1/2	1 1/2	1 1/2	1 1/2

SIGN		DIMENSIONS (INCHES)																
A	B	C	D	E	F	G	H	I	J	K	L	M	N	O	P	Q	R	S
STD.	3	47 1/4	35 1/4	1 1/4	4 1/2	3/4	3 3/4	1/2	1 1/4	1 3/8	2 8/16	1 1/2	1 1/2	1 1/2	1 1/2	1 1/2	1 1/2	1 1/2

MISSISSIPPI DEPARTMENT OF TRANSPORTATION
ROADWAY DESIGN DIVISION
STANDARD PLAN

LOCATION OF R16-3 SIGNS (SPEEDING FINES DOUBLED)

ISSUE DATE: MAY 21, 2017

WORKING NUMBER: ICF-15

SHEET NUMBER: 6-163

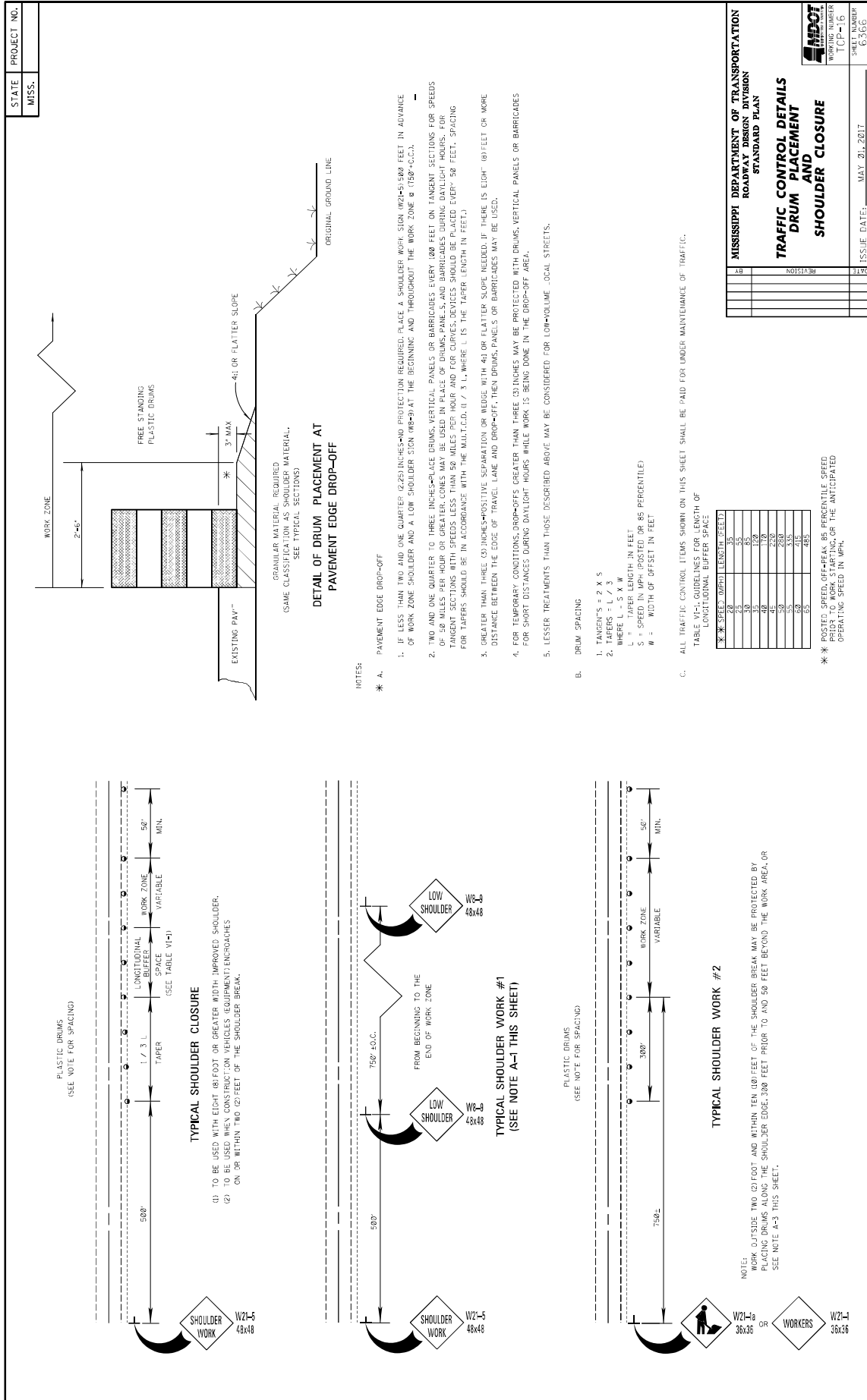

- GENERAL NOTES**
- GROUND-IN RUMBLE STRIPES SHALL BE APPLIED TO BOTH SHOULDERS OF ALL PAVED SHOULDERS ON THIS PROJECT.
 - GROUND-IN RUMBLE STRIPES SHALL BE APPLIED TO ALL EXISTING AND NEW ROADS, INCLUDING OTHER INTERSECTIONS, NORMAL SHOULDER WIDTH AS DIRECTED BY THE ENGINEER.
 - COST TO BE PAID FOR USING APPROPRIATE PAY ITEMS.
 - GROUND-IN RUMBLE STRIPES SHALL BE APPLIED TO:
 - MAINLINE
 - INTERSECTING ROADWAY IF OVERLAP OR RECONSTRUCTED BEYOND NORMAL MAINLINE R.O.W.
 - ANY ROADWAY WITH EXISTING RUMBLE STRIPES PRIOR TO CONSTRUCTION.
 - DO NOT USE WHERE TRAVEL LANE IS LESS THAN 11' WIDE.

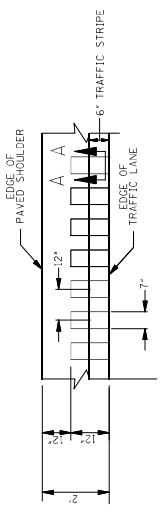

SECTION "A-A"

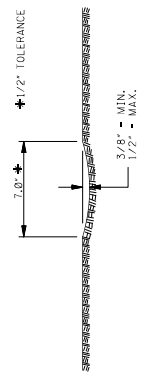

SECTION "A-A"

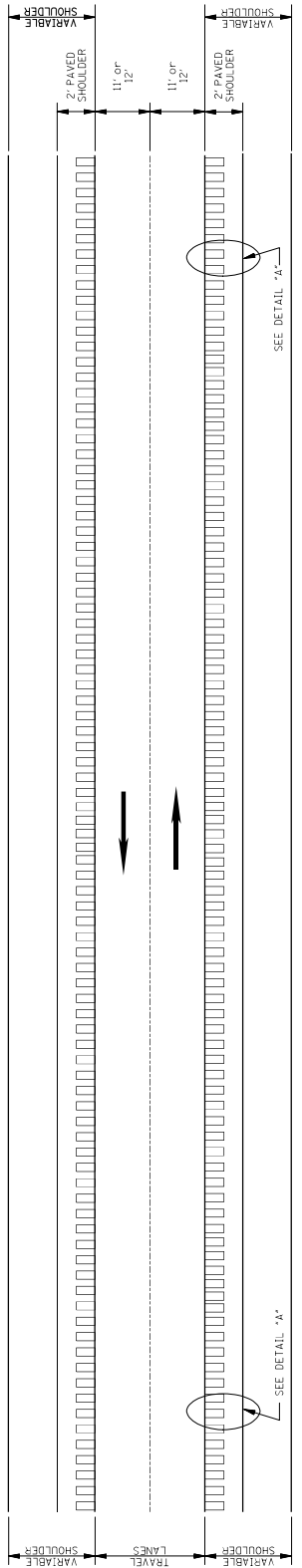

PLAN
NOT TO SCALE

MISSISSIPPI DEPARTMENT OF TRANSPORTATION ROADWAY DESIGN DIVISION STANDARD PLAN	
REVISION	DATE
05R	08/01/17
REVISION	DATE
RUMBLE STRIPES 2-LANE HIGHWAYS (ASPHALT LANES, 2-FT ASPHALT SHOULDERS)	
PROJECT NUMBER RS-1	ISSUE DATE: AUGUST 01, 2017
PROJECT NUMBER 6064	

STATE PROJECT NO.
MISS.

GENERAL NOTES

- GROUND-IN RUMBLE STRIPES SHALL BE APPLIED TO ALL PAVED SHOULDERS ON THIS PROJECT.
- GROUND-IN RUMBLE STRIPES SHALL BE APPLIED TO ALL PAVED SHOULDERS ON INTERSECTING ROADWAYS AND OTHER INTERSECTIONS IN NORMAL SHOULDER WIDTH AS DIRECTED BY THE ENGINEER.
- COST TO BE PAID FOR USING APPROPRIATE PAY ITEMS.
- GROUND-IN RUMBLE STRIPES SHALL BE APPLIED TO:
 - MAINLINE
 - INTERSECTING ROADWAY IF OVERLAP OR RECONSTRUCTED BEYOND NORMAL MAINLINE R.O.W.
 - ANY ROADWAY WITH EXISTING RUMBLE STRIPES PRIOR TO CONSTRUCTION.

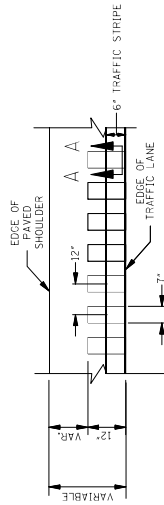
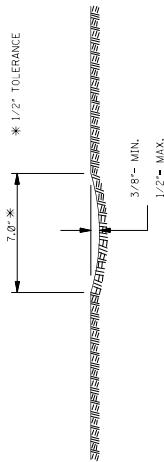

SECTION "A-A"

DETAIL "A"

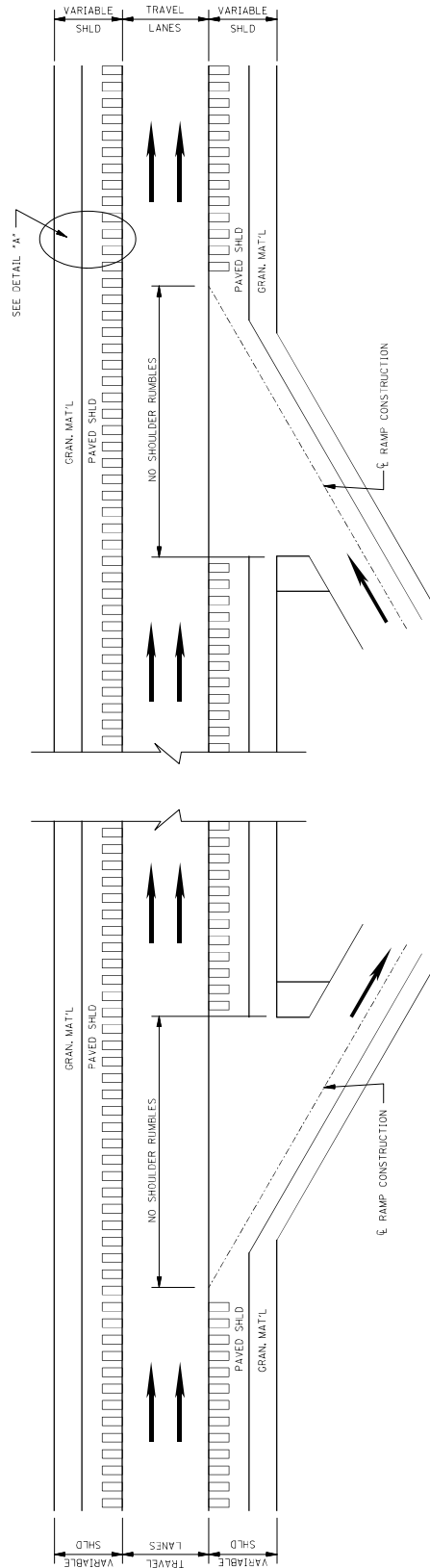

PLAN

NOT TO SCALE

DETAILS OF RUMBLE STRIPS

MISSISSIPPI DEPARTMENT OF TRANSPORTATION		RUMBLE STRIPES 4-LANE HIGHWAYS (ASPHALT LANES, 2-FT OR WIDER, ASPHALT SHOULDERS)		ISSUE NUMBER	6065
ROADWAY DESIGN DIVISION				ISSUE DATE:	AUGUST 01, 2017
STANDARD PLAN		REVISION	DATE	BY	
		05R	05R		

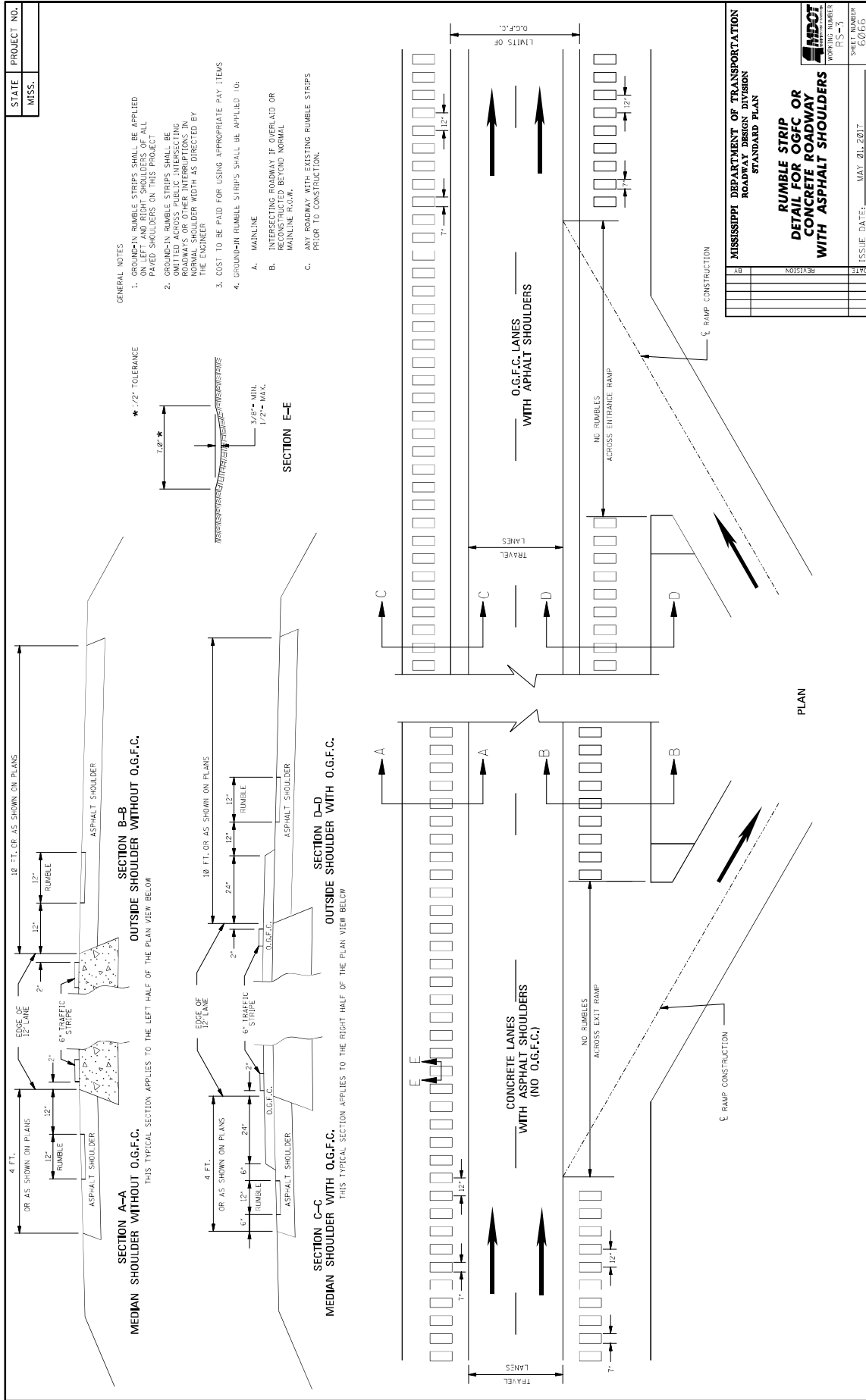

MISSISSIPPI DEPARTMENT OF TRANSPORTATION ROADWAY DESIGN DIVISION STANDARD PLAN	
RUMBLE STRIP DETAIL FOR OGFC OR CONCRETE ROADWAY WITH ASPHALT SHOULDERS	SHEET NUMBER P.S.-5 WORKING NUMBER 62/66
DATE	ISSUE DATE: MAY 01, 2017
BY	REVISION

MISSISSIPPI DEPARTMENT OF TRANSPORTATION

SECTION 904 - NOTICE TO BIDDERS NO. 3676

CODE: (SP)

DATE: 09/21/2021

SUBJECT: Asphalt Gyrotory Compactor Internal Angle Calibration

Bidders are advised that by March 1, 2022, all asphalt gyrotory compactors shall be calibrated to an internal angle of $1.16^{\circ} \pm 0.02^{\circ}$. This requirement will be reflected in updates made to MT-78, MT-80, and MT-83. This calibration requirement also extends to all QC/QA testing.

MISSISSIPPI DEPARTMENT OF TRANSPORTATION

SECTION 904 - NOTICE TO BIDDERS NO. 3744

CODE: (SP)

DATE: 11/5/2021

SUBJECT: Contract Time

PROJECT: IM-0055-02(249) / 107577301 -- Madison County

The completion of work to be performed by the Contractor for this project will not be a specified date but shall be when all allowable working days are assessed, or any extension thereto as provided in Subsection 108.06. It is anticipated that the Notice of Award will be issued no later than **February 8, 2022** and the date for Notice to Proceed / Beginning of Contract Time will be **March 10, 2022**.

Should the Contractor request a Notice to Proceed earlier than **March 10, 2022** and it is agreeable with the Department for an early Notice to Proceed, the requested date will become the new Notice to Proceed date. Regardless of whether or not an early Notice to Proceed is granted, contract time will start at the original Notice to Proceed date.

All requests for an early Notice to Proceed shall be sent to the Project Engineer who will forward it to the Contract Administration Division.

129 Working Days have been allowed for the completion of work on this project.

MISSISSIPPI DEPARTMENT OF TRANSPORTATION

SECTION 904 - NOTICE TO BIDDERS NO. 3745

DATE: 11/08/2021

SUBJECT: Specialty Items

PROJECT: IM-0055-02(249)/107577301 - MADISON

Pursuant to the provisions of Section 108, the following work items are hereby designated as "Specialty Items" for this contract. Bidders are reminded that these items must be subcontracted in order to be considered as specialty items.

CATEGORY: GUARDRAIL, GUIDERAIL

Line No	Pay Item	Description
0150	606-A002	Guard Post, Type II Modified
0160	606-B003	Guard Rail, Class A, Type 1, 'W' Beam, Metal Post
0170	606-B011	Guard Rail, Class A, Type 1, Thrie Beam, Metal Post
0180	606-B013	Guard Rail, Class A, Type 1, Thrie Beam, Transition Section
0190	606-D005	Guard Rail, Bridge End Section, Type A
0200	606-D020	Guard Rail, Bridge End Section, Type H, Metal Post
0210	606-E005	Guard Rail, Terminal End Section, Flared
0220	606-E007	Guard Rail, Terminal End Section, Non-Flared

CATEGORY: MISCELLANEOUS/ SPECIALTY WORK ITEMS

Line No	Pay Item	Description
0130	423-A001	Rumble Strips, Ground In

CATEGORY: PAVEMENT STRIPING AND MARKING

Line No	Pay Item	Description
0320	626-A001	6" Thermoplastic Double Drop Traffic Stripe, Skip White
0330	626-C002	6" Thermoplastic Double Drop Edge Stripe, Continuous White
0340	626-E001	6" Thermoplastic Double Drop Traffic Stripe, Continuous Yellow
0350	626-G004	Thermoplastic Double Drop Detail Stripe, White
0360	626-G005	Thermoplastic Double Drop Detail Stripe, Yellow
0370	627-K001	Red-Clear Reflective High Performance Raised Markers

CATEGORY: TRAFFIC CONTROL - PERMANENT

Line No	Pay Item	Description
0380	630-F006	Delineators, Guard Rail, White
0390	630-F007	Delineators, Guard Rail, Yellow
0400	630-G004	Type 3 Object Markers, OM-3R or OM-3L

CATEGORY: TRAFFIC CONTROL - TEMPORARY

Line No	Pay Item	Description
0240	619-A1001	Temporary Traffic Stripe, Continuous White

CATEGORY: TRAFFIC CONTROL - TEMPORARY

Line No	Pay Item	Description
0250	619-A2001	Temporary Traffic Stripe, Continuous Yellow
0260	619-A3001	Temporary Traffic Stripe, Skip White
0270	619-A5001	Temporary Traffic Stripe, Detail
0280	619-D1001	Standard Roadside Construction Signs, Less than 10 Square Feet
0290	619-D2001	Standard Roadside Construction Signs, 10 Square Feet or More
0300	619-G4005	Barricades, Type III, Single Faced

MISSISSIPPI DEPARTMENT OF TRANSPORTATION

SECTION 904 - NOTICE TO BIDDERS NO. 3746

CODE: (SP)

DATE: 6/23/2021

SUBJECT: Scope of Work

PROJECT: IM-0055-02(249) / 107577301 -- Madison County

The contract documents do not include an official set of construction plans but may, by reference, include some Standard Drawings when so specified in a Notice to Bidders entitled, "Standard Drawings".

A general description of the work required on the project is for milling, inlaying, and overlaying approximately 7.2 miles of existing asphalt pavement, spot milling and filling any cracked or oxidized locations, repairing shoulder, placing rumble strip, and replacing guard rail on Interstate 55 in Madison County beginning approximately 2 miles north of SR 22 (BOP Station 0+00) and ending at the Yazoo County Line (EOP Station 378+12) in Madison County. A list of milling locations will be provided by the project office.

Details of specific work are mentioned in the following sections:

Station 175+56 to 251+12 (North Bound)

Prior to the overlay operation, work in this area shall consist of milling the top 1½" and variable of existing mainline and inside shoulder and inlaying both lanes and inside shoulders with 1½" of 9.5-mm, HT, Polymer Modified asphalt in order to increase structural integrity. Where the cross slope is not equal to 2%, the thickness of the milling/inlaying efforts shall be adjusted to correct the cross slope. The cross slope on mainline tangent sections is to be 2%.

Project Wide Work Station 0+00 (BOP) to 378+12 (EOP) (North & South Bound)

Prior to beginning the overlaying operations, any failed areas in the existing pavement shall be removed to subgrade depth and repaired with 12.5-mm, HT, Leveling asphalt. Payment for removal and disposal of failed areas will be made using the appropriate pay items. Other repairs may be necessary as field conditions require and as directed by the Engineer.

Any location on the mainline severely cracked or oxidized shall be spot milled and filled at a depth of 1½" with 9.5-mm, HT, Polymer Modified asphalt. A list of milling locations can be found in the attached table. Other spot mill and fill locations may be necessary as field conditions require and as directed by the Engineer.

After failures/spot mill and fill locations have been repaired, all travel lanes and inside shoulders (approximately 7.2 miles) shall be overlaid with 1½" of 9.5-mm, SMA, asphalt, as per the attached typical sections, and the outside shoulders overlaid with 1½" of 9.5-mm, ST asphalt.

Following the overlay with SMA, all travel lanes shall be overlaid with 1" of OGFC extending the OGFC overlay one foot (1') outside the travel lanes. The correct tie-in procedures, when paving with OGFC, for bridges and paved ramps can be found in the following attachments.

At the SR 16 interchange, the mainline of SR 16 will not be milled/paved. Entrance and exit ramps and paved ramp shoulders will receive the following: mill 1½" then overlay ramps with 1½" of 9.5-mm, HT, Polymer Modified asphalt, and overlay shoulders with 1½" of 9.5-mm, ST, asphalt.

General Notes: These general notes are applicable to all sites.

Milling

Milling/paving will not begin until an **approved** asphalt mix design has been received, nor until such time that, in the opinion of the Engineer, weather conditions have been consistently suitable enough to allow placement of the asphalt pavement after the milling operations.

The Reclaimed Asphalt Pavement (RAP) material removed by the milling operation shall become the property of the Contractor.

Where milling is required, the Contractor shall provide outlets in the existing shoulders at sufficient intervals to prevent pooling or standing water on the milled surface, the cost of which shall be absorbed in other items bid.

Milling and paving operations shall be performed such that a -2% slope from centerline is provided in normal crown roadway sections. Super elevation through curves shall be maintained as it currently exists or improved as directed. Where slope correction is required correction will be made by milling, paving, or combination thereof as directed by the Engineer. Milling correction: Mill outside edge of pavement to a depth of 1½" on a 2% slope towards the centerline. Paving Correction: Mill outside edge of pavement to a depth of 1½" and 2¼" and variable on centerline and 1½" on outside edge. Combination Method: Combination of both methods as directed by the Engineer to achieve the desired slope. In super elevated areas where correct SE exist milling will transition to thickness through curves. Where correct SE does not exist milling will transition at curves to correct SE as directed by the Engineer.

Traffic will be allowed to travel on the milled surface for five (5) days. Traffic will be allowed to run on all milled local roads for 30 days unless otherwise stated. This allowance is for the Contractor's convenience and thus, the Contractor is responsible for any pavement failures or damage sustained during this period. Approved mix designs must be on hand prior to milling. Milling operations will not commence until such time that, in the opinion of the Engineer, weather conditions have been consistently suitable enough to allow the placement of the asphalt pavement after the milling operations. If required, overnight lane closures will be permitted **after** the Contractor has submitted a traffic control plan and it has been approved. All items necessary for an overnight lane closure shall be absorbed into other items bid.

Milling shall consist of a depth of 1½" and variable on travel lanes within the designated station limits, or as directed by the Engineer, with intent to correct tangent area cross slopes to 2%. Milling shall be performed in accordance with the attached drawings on tie-ins, bridge ends, etc.

Milled tie-ins will be required at all ramps. Traffic will be allowed to run on all milled tie-ins. Temporary pavement joints (paper joints) shall be at least three (3) paper-widths long shall be used at all milled tie-ins and shall be adequately maintained.

Milling operations shall be performed in accordance with the Contract documents and the MDOT Standard Specifications for Road and Bridge Construction. Variable width and length transitions may be required for ties at ramps, local roads, project limits.

Paving

Prior to beginning the overlaying operations, any failed areas in the existing pavement shall be removed to subgrade depth and repaired with 12.5-mm, HT, Leveling asphalt. Payment for removal and disposal of failed areas will be made using the appropriate pay items. Other repairs may be necessary as field conditions require and as directed by the Engineer. Payment for removal of failed areas shall be made under pay item 202-B: Removal of Asphalt Pavement, Failed Areas. If deemed necessary by the Engineer, the subgrade below the asphalt may need to be removed. Payment for the removal of subgrade below the asphalt, variable depth, will be paid for under pay item 203-G: Excess Excavation, FM, AH. All other items necessary for failed area removal and repair will be absorbed.

If traditional excavation methods are used, the removal area shall first be saw cut full depth including concrete, where applicable, to create a neat line and prevent damage to the adjacent pavement structure. Payment for saw cuts will be made using the appropriate items. If milling techniques are used, the area will not require saw cuts but care should be exercised to create a neat removal line and to prevent damaged to the adjacent pavement structure. If saw cuts are used in conjunction with milling, payment will be made using the appropriate pay items. Payment will not be made for saw cuts that are not performed.

Prior to overlay operations and subsequent to the repair of failed areas, spot milling and leveling shall be performed in the areas listed in the attached tables and at other areas as directed by the Engineer. Spot milling at a depth of 1½” shall be performed in the areas to remove cracked/oxidized asphalt. Subsequent to spot milling leveling shall be performed to correct the longitudinal and transverse profile of the roadway. Work shall be conducted and coordinated in a manner to prevent a longitudinal joint of more than 2¼” where traffic is expected to cross. Adjacent lanes and shoulders shall be brought up to grade as required to prevent drop-offs and as specified in Subsection 618.03.3. Payment for milling, leveling, and granular shoulder work will be made using the appropriate pay items. “Uneven Lanes” signs shall be used as required and as shown on the MDOT Standard Drawings.

Prior to beginning the overlay operation, the northbound lanes and inside shoulder from station 175+56 to 251+12 shall be milled 1½” and variable. Both lanes and the inside shoulder shall then be inlaid with 1½” of 9.5-mm, HT, Polymer Modified asphalt in order to increase structural integrity. For all polymer mixes, PG-76-22 shall be used as the asphalt binder. The cross slope on mainline tangent sections is to be 2%. If the cross slope in the tangent sections is not 2%, the cross slope shall be restored to 2% by a combination of milling and paving. The mainline cross slope in curves shall be at the appropriate super elevation slope. If the super elevated cross slope is not correct, it shall be corrected by a combination of milling and paving. The Department will determine the slopes and areas for correction. The inside paved shoulder will be milled 1½” and

overlaid with 1½" of 9.5-mm, HT, Polymer Modified asphalt. In order to prevent a drop-off of no more than 1" from the finish OGFC and paved shoulder, the mainline lanes shall be paved 14' wide at the required normal crown slope (or S.E. as necessary) and the shoulder slope adjusted. The longitudinal joint between the two main travel lanes when paving with 9.5-mm, SMA asphalt shall be sealed with joint sealant. Payment for sealing the longitudinal joint shall be paid for under pay item 403-S: Joint Sealant.

Granular Shoulder Material

The existing shoulders shall be raised to match the new pavement elevation by placing variable depth Granular Material (Class 5, Group C) on the existing shoulders. Placement of the granular material on the finished asphalt course shall not be permitted. The material shall be bladed, rolled, and compacted to a finished slope of four percent (4%). Placement of this material shall be performed to provide a uniform and compacted shoulder with a minimum depth and width of material placed. Shoulders with adequate shoulder material in place shall be bladed to a slope of four percent (4%). The cost of blading will be an absorbed item and is not to be included in the price of pay items bid.

Contractor shall on a daily basis, pull shoulder material up to edge of asphalt to maintain 2" or less drop off.

Any unpaved shoulders should be constructed with Class 5, Group 'C' granular material.

Temporary and Permanent Pavement Markings

Temporary traffic stripe will be required immediately after the required overlay/milling and prior to opening area to traffic. Temporary stripe is to be placed in the same location and configuration as the permanent stripe.

If temporary stripe is offset, the Contractor shall conduct operations in a manner to insure the final temporary stripe is placed at the required location of the permanent stripe. If removal of temporary offset stripe is required in order to achieve the correct location and alignment of permanent stripe, the cost of removal will be absorbed in other items bid. Placing double temporary centerline will not be allowed.

Temporary striping shall conform to finished stripe specifications for alignment, neatness, and straightness.

All permanent striping will be thermoplastic double-drop. Edge lines shall be placed to accommodate the lane widths shown on the applicable typical sections unless prevented by field conditions. Thermoplastic pavement marking thickness shall be a minimum of 90 mils for center lines, edge lines, lane lines, gore areas, turnouts, and county roads. All other thermoplastic pavement markings shall be a minimum of 120 mils. All stripe thickness shall be as stated unless otherwise specified in Subsection 626.03.1.2.

The use of short strips of traffic tape will not be allowed unless approved by the Engineer.

Permanent pavement markers shall be placed in accordance with the attached drawings and Standard Drawings.

Rumble strips shall be placed throughout the project according to standard specifications and per attached drawing. Payment for Rumble Strips shall be made under pay item 423-A: Rumble Strips, Ground in.

Guardrail

All existing guard rail shall be removed and replaced at bridge nos. 119.7A (0+00), 119.7B (0+00), 120.8A (59+42), 120.8B (56+98), 126.8A (377+17), 126.8B (373+06), 126.9A (380+17), 126.9B (380+17) and as shown on the attached tables to meet the new MASH height requirement from the finished surface of asphalt pavement. **This includes the northbound direction of bridge 119.7B and the southbound direction of bridge 126.9A where no paving operation will occur.** Payment for removal of this shall be paid under pay item 202-B: Removal of Guard Rail, Including Rail, Posts & Terminal Ends, and shall consist of the removal of bridge end section, w-beam, terminal end section, posts, and all other appurtenances.

All rail components removed shall be delivered to the Canton Maintenance Headquarters located at 150 Canton One Dive, Canton MS. A 24-hour notice is required before delivery. Any removed metal post, concrete anchors, hardware, and wooden posts shall be disposed of by the Contractor at no additional cost to the state.

All guardrail removed shall be replaced the same day and prior to reopening the adjacent lane of traffic. The new guard rail shall be placed in the same location as the existing railing and height shall meet the approved departmental standards (Currently 25" to center from the finished surface of asphalt pavement). Voids created by the removal of posts, concrete anchors, footings, etc. shall be backfilled and tamped in accordance with Section 203 of the Standard Specifications.

Asphalt shall be extended under the guard rail and two feet (2') behind the guard rail posts as per the attached detail. The area to be paved shall be free of dirt, debris, etc. in order to accommodate 1½" and variable of 9.5-mm, ST, asphalt. The guardrail pad shall be placed prior to the placement of the new guardrail. Guardrail posts shall not be completely surrounded by pavement (asphalt or concrete). The area surrounding the posts shall be treated as shown on the attached drawing. The work required to treat the guardrail post area will not be measured for separate payment and should be absorbed in the cost of other items bid.

Guardrail lengths are based on terminal end length of 37.5'. If terminal of length other than this is used, an adjustment in w-beam length is required.

Delineators will be required on all new guardrails within the project, as per attached tables and standard drawings. The cost of removing existing guardrail and all accessories shall be included in the price of pay item 202-B: Removal of Guardrail.

Permanent Signs

Object markers at bridge approaches and other locations shall be replaced as shown in the attached table. Removal of object markers shall be absorbed in the cost of other items bid. The Contractor shall use new bolts, screws, washers, nuts, etc. of the required sizes in the installation of signs. Post lengths for all signs shall be verified in the field by the Contractor prior to

fabrication. Installation dates shall be clearly written in bold black markings on the back bottom half off all signs with a permanent marking stick that is waterproof, fade resistant, and marks on wet or dry surfaces.

Traffic Control

The Contractor shall erect and maintain construction signing and provide all signs and traffic control devices necessary to safely maintain traffic around and through the work areas in accordance with the Traffic Control Plan and the MUTCD. The cost is to be included in the price bid for pay item 618-A: Maintenance of Traffic. Fluorescent orange sheeting shall be used on all construction and traffic control signs except those designated in the plans to be black legend and border on white background. Standard roadside construction signs and barricades will be paid for using the appropriate pay items.

Roadside construction signs, barrels, etc. shall be placed in accordance with the attached drawings or as directed by the Engineer. W20-1 signs shall be placed on all public road approaches/ramps as shown or as directed.

The Contractor shall on a daily basis, remove all debris and equipment from within the roadway and a 30-foot clear zone which, in the opinion of the Engineer, is a hazard to the traveling public. This activity shall begin with the beginning of work or the beginning of the contract time, whichever comes first. No direct payment will be made for the debris removal; the cost is to be included in the prices of items bid. Failure of the Contractor to remove the debris as prescribed herein shall be just cause for withholding the monthly progress estimate payment or suspending active operations until the debris is satisfactorily removed by the Contractor.

Potholes that may exist shall be patched in a timely manner from the date of Notice to Proceed until the date of the Final Maintenance Release. Cracks of significant depth or depressions in the existing surface which, in the opinion of the Engineer, may cause reflection cracking shall be filled with asphalt pavement immediately prior to overlay operations. Patching of potholes shall be considered an absorbed item.

Temporary asphalt joints (aka paper joints) shall be employed at all locations requiring traffic to traverse an uneven, transverse, pavement joint. Paper joints shall be a minimum of nine feet (three paper widths) in length and for the full width of the milled/paved surface. Paper joints required for differences in height 1" or greater. Paper joints shall be adequately maintained.

Miscellaneous Notes

It shall be the responsibility of the Contractor to protect existing structures such as pipes, inlets, aprons, bridges, etc. from damage which might occur during construction. The Contractor shall replace or repair, as directed by the Engineer, any structures damaged by the Contractor during the life of the contract. No payment will be made for replacement or repair of damaged items.

Any signs that are in conflict with construction of this project shall be removed and relocated by the Contractor as directed by the Engineer; the cost of which is to be absorbed in other items bid.

Incidental work such as removing vegetation, shaping and compacting shoulders, removing and resetting signs, removing excess asphalt material, project clean-up, and other items of incidental

work necessary to complete the project will not be measured for separate payment and will be considered included in the prices of items bid.

Existing raised pavement markers are to be removed prior to beginning the overlay operation. No measurement for removal will be made for separate payment; the cost of which is to be included in the prices for other items bid. Permanent pavement markers are to be placed in accordance with the attached drawings and Standard Drawings. Temporary raised pavement markers are to be placed if the open graded friction course is not going to be placed within three months of the stone matrix asphalt completion.

Prior to the final inspection, bridges, islands, and areas with curb shall be swept/cleaned. Care should be taken to prevent milled asphalt, asphalt debris, vegetative/granular debris, etc. from entering drainage structures or clogging other drainage ways. Disposal of material will not be measured for separate payments.

Throughout the life of the project and until the partial or full maintenance release, all dead or dying trees within the ROW as identified by the Project Engineer shall be cut and removed from the mowing areas. The initial pass of tree cutting/removal shall be prior to the milling/overlay portion of the project. If additional trees are discovered after the overlay has been completed, the Contractor shall cut the trees as directed by the Engineer and shall take precautions to prevent damage to the roadway, stripe, guardrails, and other structures. If the tree is located in the non-mowing area the stump shall not be left more than one foot (1') above the ground line. The cut tree (trunk, top, and limbs) may be pushed into the adjacent wooded area of the ROW. If the tree is located in an open area of the ROW and would cause an unsightly view, it is to be removed from the ROW or moved into a wooded area on the project designated by the Engineer. The stumps of such trees shall be cut off flush with the ground line. No separate payment will be made for transporting or removing trees. The Contractor shall coordinate the activities with local utilities if any trees pose danger to utility lines. Appropriate traffic control shall be used for all tree cutting and disposal operations. Current locations of dead trees are listed in the attached table. Payment for the removal of dead/dying trees will be paid for under pay item 202-B: Removal of Trees.

Guard posts shall be removed and replaced in the location(s) listed in the attached table. Other locations may be necessary as field conditions require and as directed by the Engineer. Removal of existing guard posts will be paid for by pay item 202-B: Removal of Guard Post. The cost of removing existing guard posts and all accessories shall be included in the price of pay item 202-B: Removal of Guard Post. The cost of steel cable, concrete anchors, clamps, and reinforcement bars shall be included in pay item 606-A: Guard Post, Type II Modified.

1-55 OVERLAY PROJECT FROM 2 MILES NORTH OF SR 22 TO YAZOO COUNTY LINE MADISON COUNTY 107577/301000

EOP 378+12



BOP 0+00

107577/301000 TYPICAL SECTION MADISON COUNTY 0+00 TO 378+12 I-55 MAINLINE

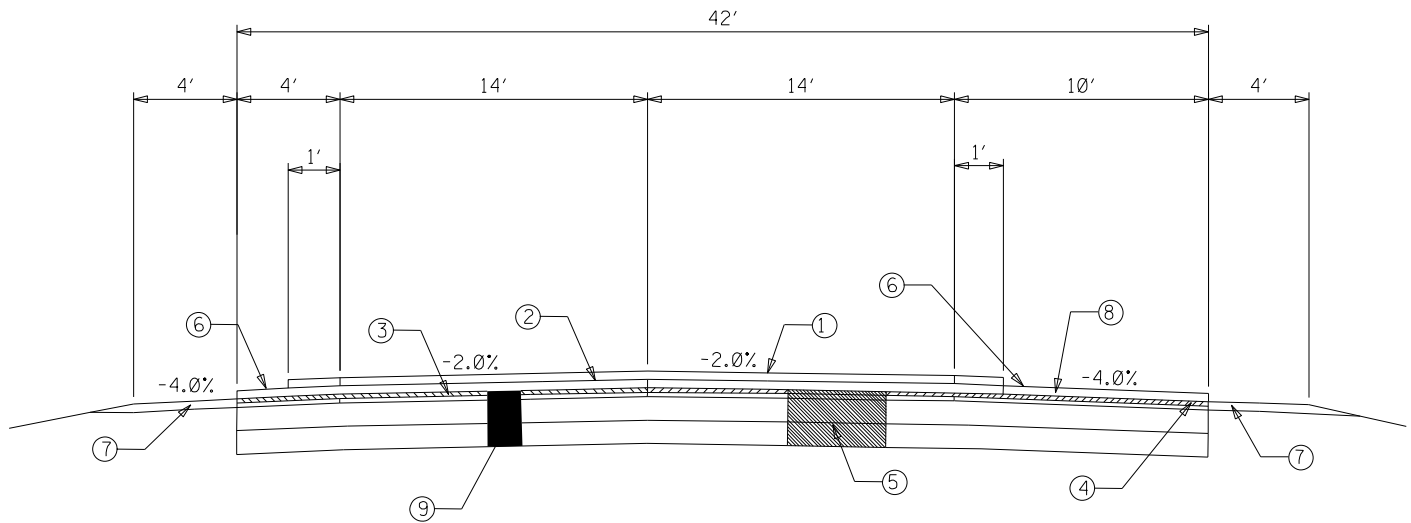

TYPICAL REPRESENTS DIRECTION OF TRAFFIC FLOW
NORTH BOUND SHOWN SOUTH BOUND SHALL BE SIMILAR

- ① 1.00" OPEN GRADE FRICTION COURSE
- ② 1 1/2" FINE MILLING AND REPLACE WITH 1 1/2" SMA 9.5mm ASPHALT PAVEMENT
- ③ SPOT MILL/FILL ANY LOCATIONS DEEMED NECESSARY WITH 1 1/2" HMA, HT 9.5mm (Polymer Modified)
- ④ OVERLAY BOTH LANES AND INSIDE SHOULDER WITH 1 LIFT @ 1 1/2" OF SMA 9.5mm ASPHALT PAVEMENT
- ⑤ REPAIR ANY FAILED AREAS TO FULL DEPTH WITH 12.5mm HT, LEVELING ASPHALT PAVEMENT
- ⑥ RUMBLE STRIPS WILL BE REQUIRED AS PER SPECIAL DESIGN SHEET RS-3.
- ⑦ GRANULAR MATERIAL (CLASS 5 GROUP C)
- ⑧ OVERLAY OUTSIDE SHOULDERS WITH 1 LIFT @ 1 1/2" OF ST 9.5mm ASPHALT PAVEMENT
- ⑨ Existing Pavement Structure (12" ~~85~~ 16") HMA

107577/301000 TYPICAL SECTION RAMPS @ SR 16 INTERCHANGE MADISON COUNTY

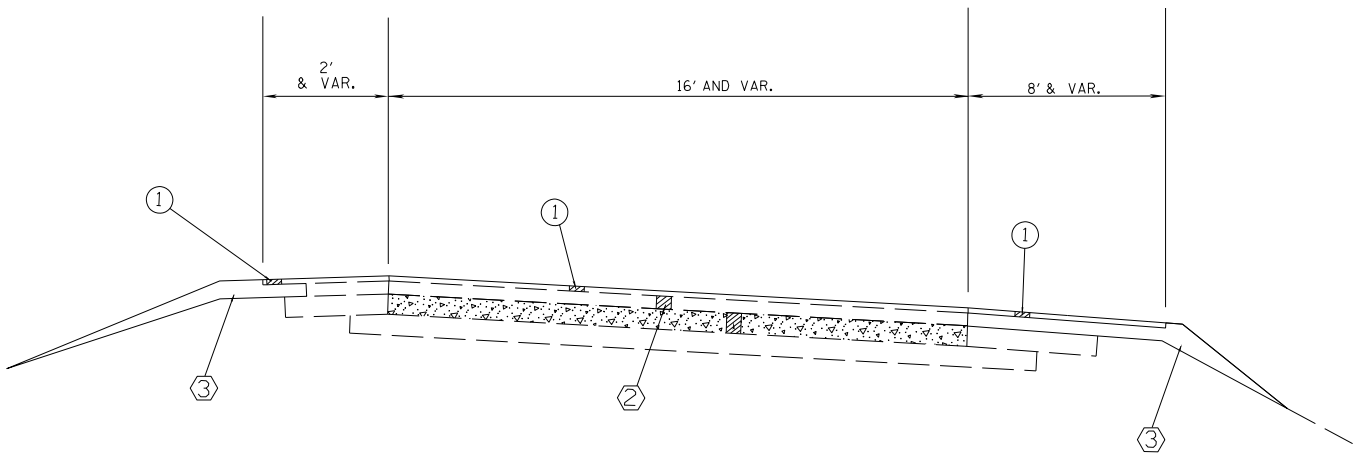

TYPICAL SECTION
INTERCHANGE RAMPS

- ① Mill 1 1/2", then overlay shoulders & mainline with 1 1/2" HMA, HT 9.5mm (Polymer Modified)
- ② Repair any failed areas with full depth HMA, 12mm, HT Leveling Asphalt Pavement
- ③ Granular Material (Class 5 Group C)

Removal of Trees

107577/301000					
Station	NB Location	QTY (EA)	Station	SB Location	QTY (EA)
13+56.00	RT	1	375+39.00	RT	1
19+15.00	RT	1	363+38.00	RT	1
20+38.00	RT	1	358+26.00	RT	1
26+07.00	RT	1	357+42.00	RT	1
31+55.00	RT	1	356+01.00	RT	1
33+22.00	RT	1	336+08.00	RT	1
33+98.00	RT	1	335+05.00	RT	1
63+99.00	RT	1	324+70.00	RT	1
69+01.00	RT	1	295+12.00	LT	1
69+92.00	RT	1	295+10.00	LT	1
72+78.00	RT	1	283+27.00	RT	1
74+87.00	RT	1	278+92.00	LT	1
81+55.00	RT	1	273+63.00	RT	1
89+24.00	RT	1	260+48.00	LT	1
90+14.00	RT	1	245+59.00	LT	1
106+10.00	RT	1	239+03.00	LT	1
113+12.00	RT	1	194+49.00	RT	1
159+31.00	RT	1	165+76.00	RT	1
212+37.00	RT	1	36+11.00	RT	1
217+00.00	RT	1	35+09.00	RT	1
217+05.00	RT	1	33+43.00	RT	1
229+82.00	RT	1	15+85.00	RT	1
231+24.00	RT	1	14+70.00	RT	1
234+10.00	RT	1	12+86.00	RT	1
235+28.00	RT	1	10+39.00	RT	1
244+63.00	LT	1	10+29.00	RT	1
245+25.00	RT	1	7+21.00	RT	1
248+30.00	RT	1			
252+76.00	LT	1			
252+80.00	LT	1			
261+19.00	LT	1			
265+18.00	LT	1			
282+42.00	LT	1			
286+99.00	RT	1			
289+97.00	RT	1			
302+51.00	LT	1			
337+46.00	RT	1			
364+36.00	RT	1			
364+72.00	RT	1			
Total		39	Total		27
<u>Grand Total</u>					66
10% for Contingencies					73

I-55 NB Spot Mill and Fill Areas				
Location	Lane	Length	Width	Area (SY)
0+00-3+00	RT/LT/SH	300	28	933.333
7+50-10+50	RT/LT/SH	300	28	933.333
18+00-24+50	RT/LT/SH	650	28	2022.222
24+50-31+00	RT	650	12	866.667
55+80-57+30	RT/LT/SH	150	28	466.667
58+90-60+40	RT/LT/SH	150	28	466.667
260+00-264+00	RT/LT/SH	400	12	533.333
329+00-331+00	RT	200	28	622.222
350+00-358+00	RT/LT/SH	800	28	2488.889
369+81-371+31	RT/LT/SH	150	28	466.667
373+75-378+12	RT/LT/SH	437	28	1359.556
	Total	4187	Total	11159.556
I-55 SB Spot Mill and Fill Areas				
Location	Lane	Length	Width	Area (SY)
376+58-372+29	RT/LT/SH	429	28	1334.667
369+83-368+33	RT/LT/SH	150	28	466.667
366+00-330+00	RT	3600	12	4800.000
318+00-290+00	RT/LT/SH	2800	28	8711.111
266+50-254+50	RT/LT/SH	1200	28	3733.333
250+00-204+00	RT	4600	12	6133.333
61+10-59+60	RT/LT/SH	150	28	466.667
57+20-55+70	RT/LT/SH	150	28	466.667
21+00-16+00	RT/LT/SH	500	28	1555.556
4+50-0+00	RT/LT/SH	450	28	1400.000
	Total	14029	Total	29068.000

107577/301000 in Madison County		
Guard Post Items for Median		
	202-B135	606-A002
Location	Removal of Guard Post	Guard Post, Type II Modified *
235+00	2	6
Totals (EA)	2	6
* Cost of Steel Cable, Concrete Anchors, Clamps, and Reinforcement Bars to be absorbed in Guard Post Pay Items.		

107577/301000
 CONSTRUCTION SIGNING DETAIL
 I-55 OVERLAY
 MADISON COUNTY

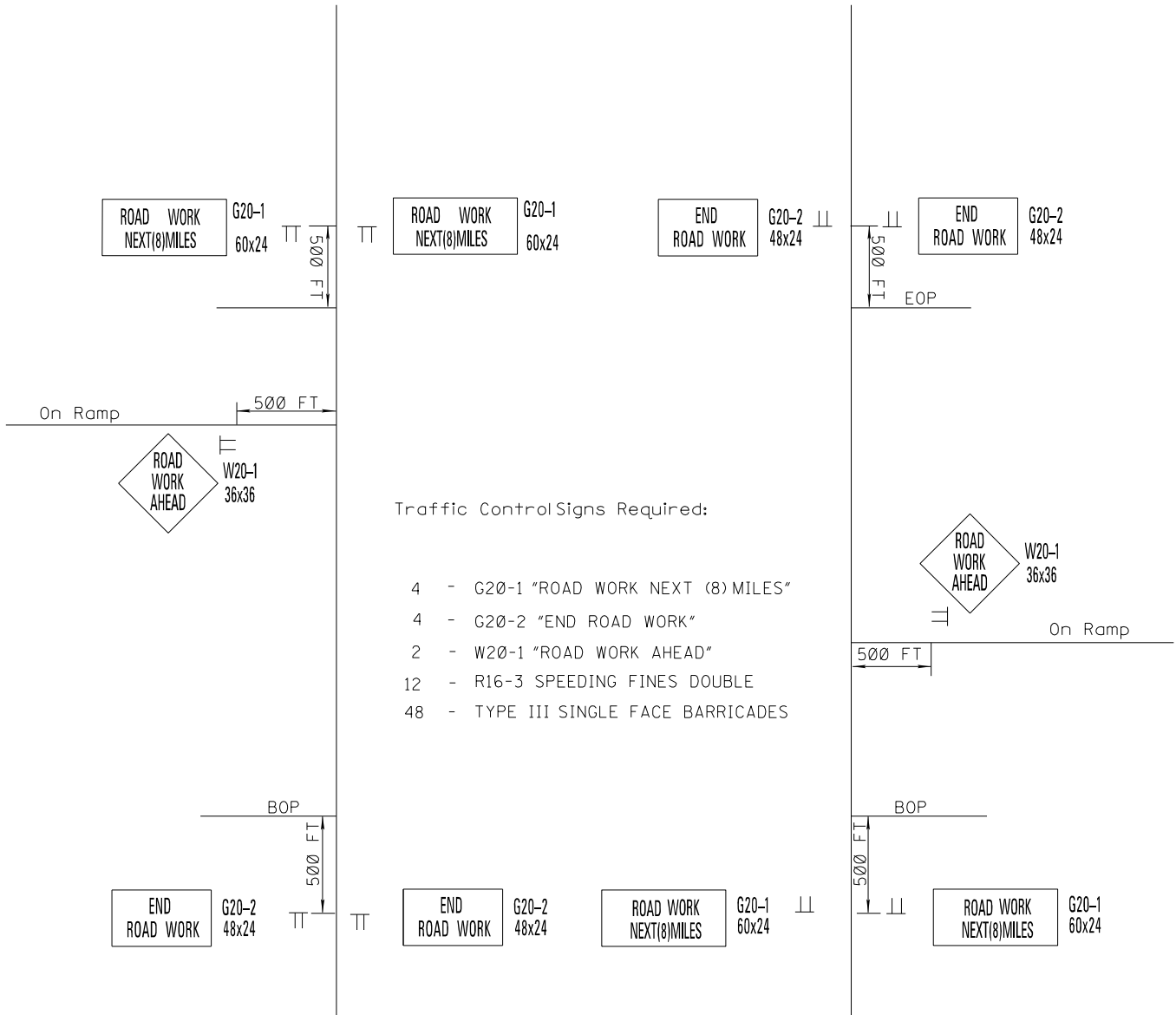

NOTES: One (1) W20-1 "ROAD WORK AHEAD" Sign is Required at each on ramp, Entering the Project.

G20-1 and G20-2 signs mounted on Type III Single Faced Barricade.

SPEEDING FINES DOUBLE SIGNS TO BE PLACED EVERY 2 MILES THROUGHOUT PROJECT.

FWS CON.

OGFC PAVING LIMITS AND MILLING REQUIREMENTS AT RAMPS AND BRIDGES

STATE	PROJECT NO.
MISS.	

INSET A

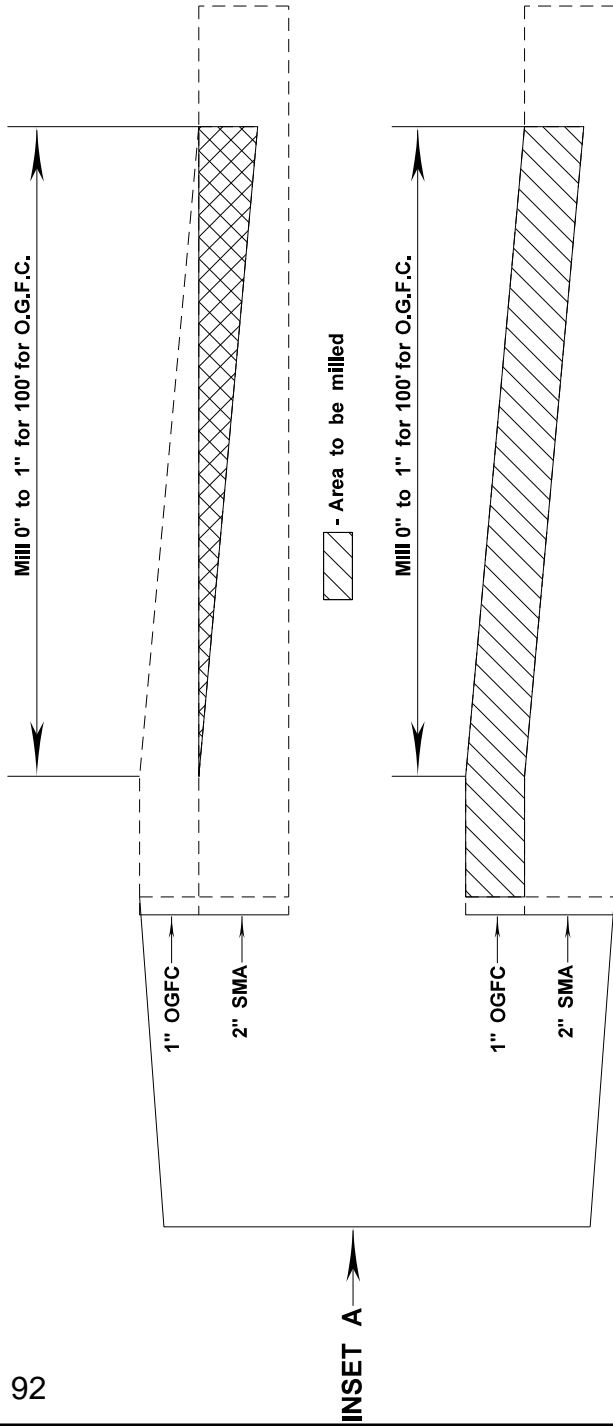
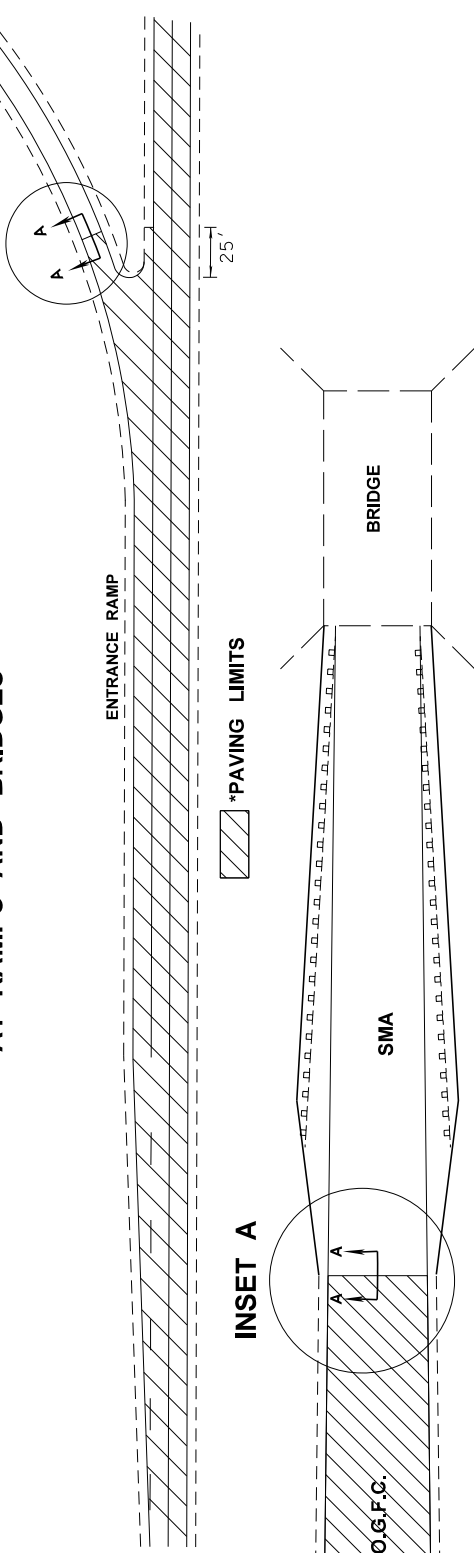

92

Note:
Weep holes shall be required through the shoulder to prevent water from ponding on the milled areas as directed by Engineer.

(NOT TO SCALE)

MISSISSIPPI DEPARTMENT OF TRANSPORTATION

PAVING LIMITS ON RAMPS AND BRIDGES

COUNTY: _____ PROJ. NUM.: _____
 FILENAME: DETAIL_PLR-I.DGN SHEET NUMBER _____
 DESIGN TEAM _____ DATE _____

REVISION	DATE	BY



I-55
MADISON COUNTY
107577/301000

Typical Section of Additional Shoulder Paving
Required at Guardrail Locations

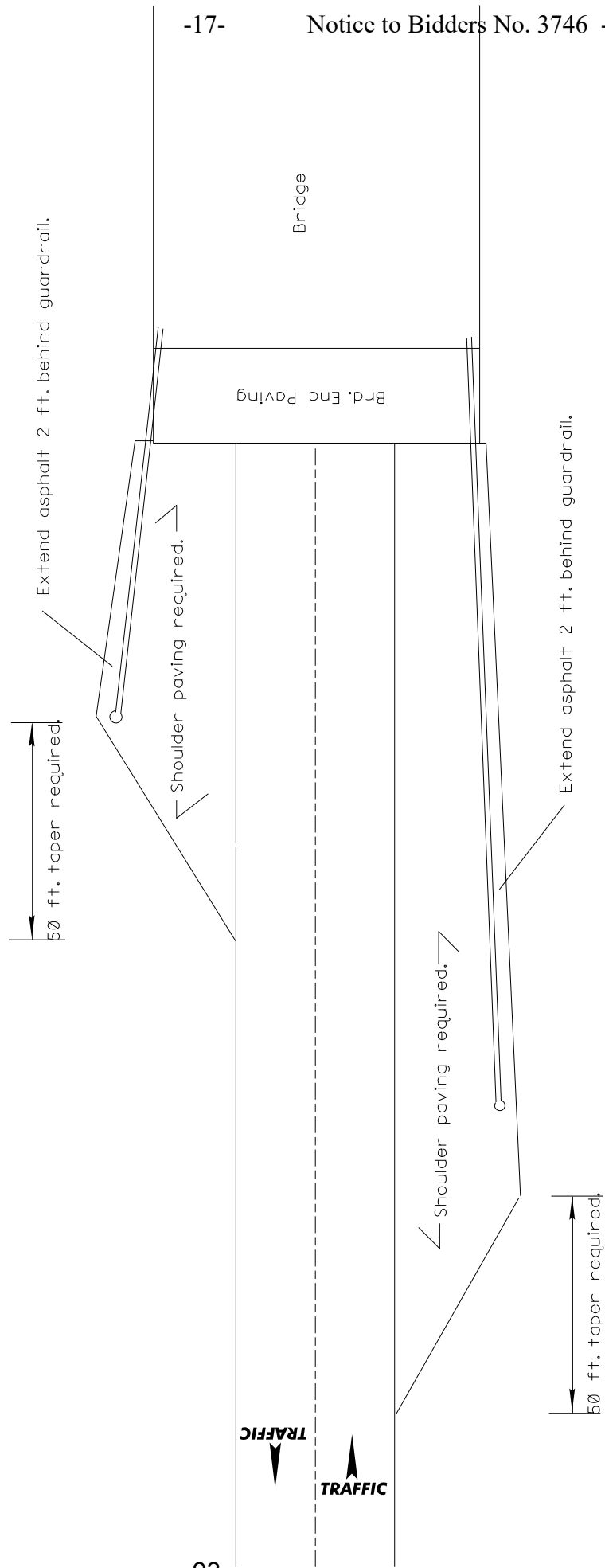

Bridge End Paving Detail

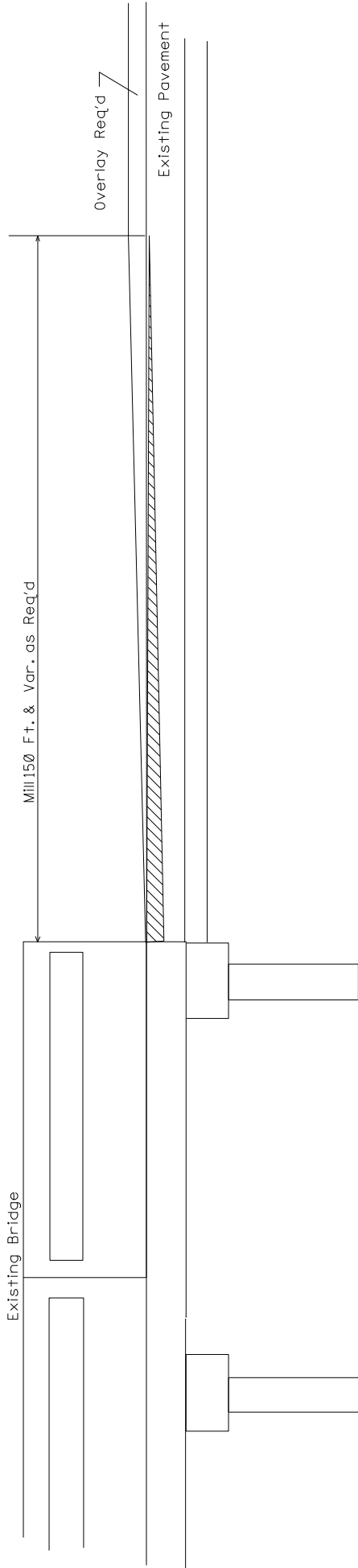

B.O.P & E.O.P. Paving Detail

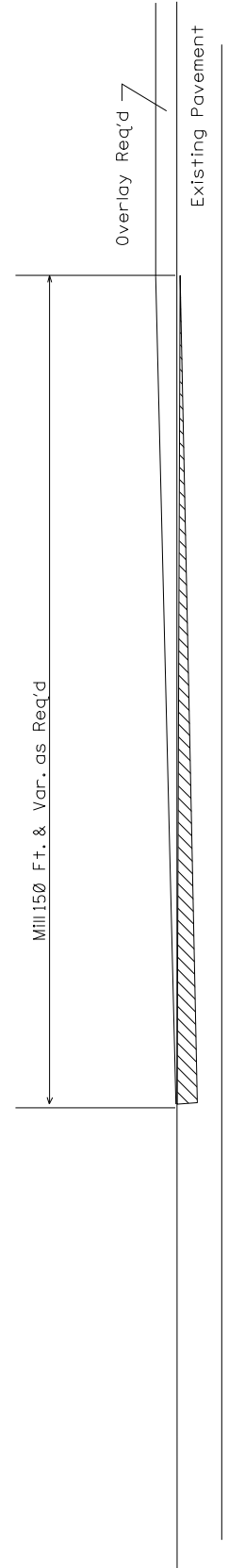

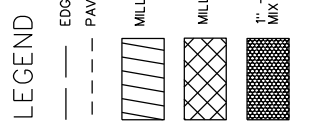
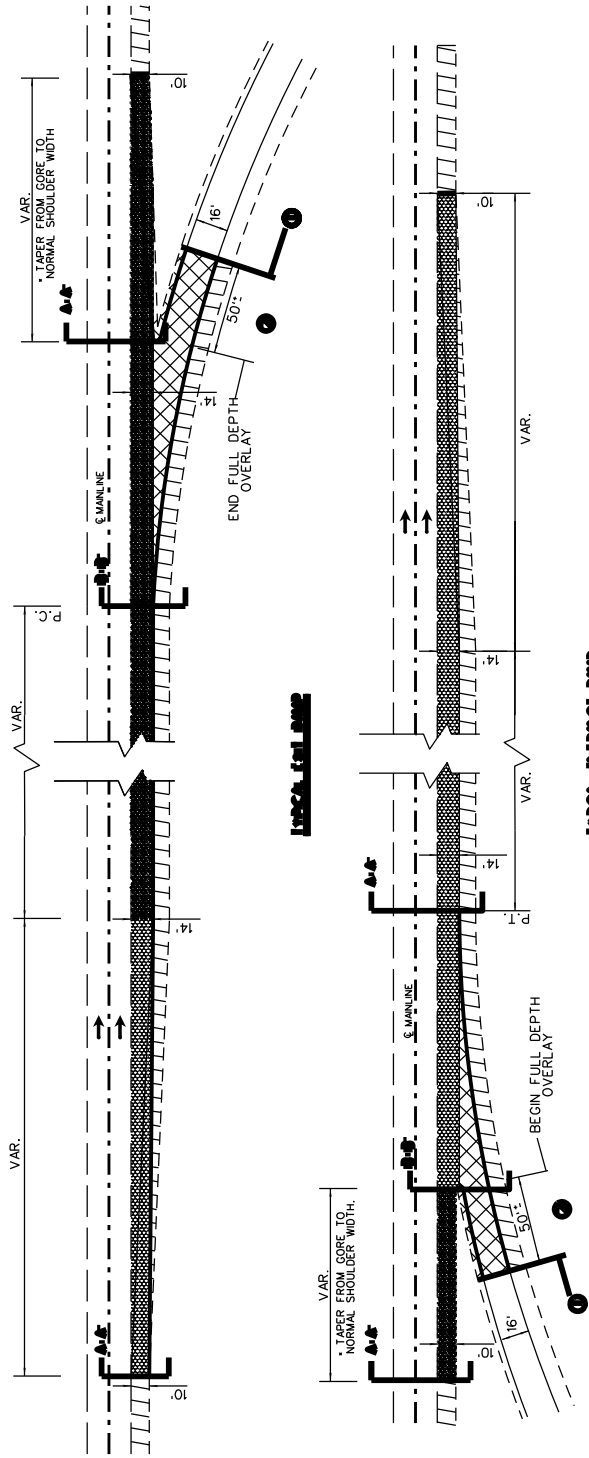

PAVING DETAILS

- ① MILL AND OVERLAY OR OVERLAY AS PER APPLICABLE TYPICAL SECTIONS
- ② MILL AND INLAY AS PER APPLICABLE TYPICAL SECTIONS
- ③ MAINLINE ASPHALT OVERLAY AS PER APPLICABLE TYPICAL SECTION
- ④ 1" - OGFC MIX REOD (101")
- ⑤ PER TYPICAL SECTION
- ⑥ PER TYPICAL SECTION

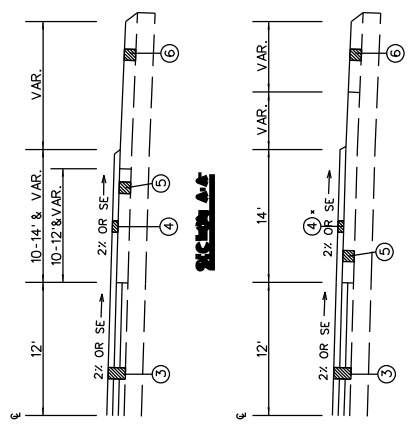

* COMPACT OUTER 2' OF OGFC TO 1/2" THICKNESS

MISSISSIPPI DEPARTMENT OF TRANSPORTATION
TYPICAL SECTION
OGFC PAVING DETAILS
AT INTERCHANGE RAMP

PROJECT NUMBER
COUNTY
FLYING SAUCER
DATE

107577/301000 EMERGENCY CROSSOVER DETAIL I-55 MADISON COUNTY

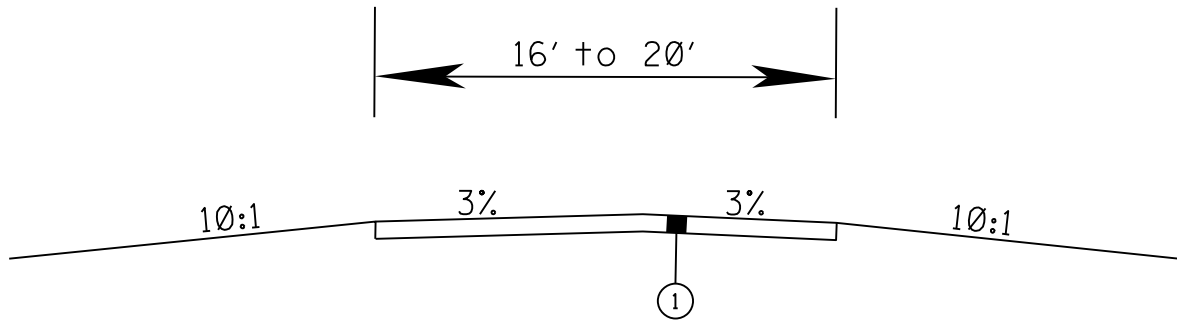

① PAVED SURFACE - THICKNESS AND TYPE TO BE DETERMINED BY THE DISTRICT.

107577/301000 EMERGENCY CROSSOVER DETAIL I-55 MADISON COUNTY

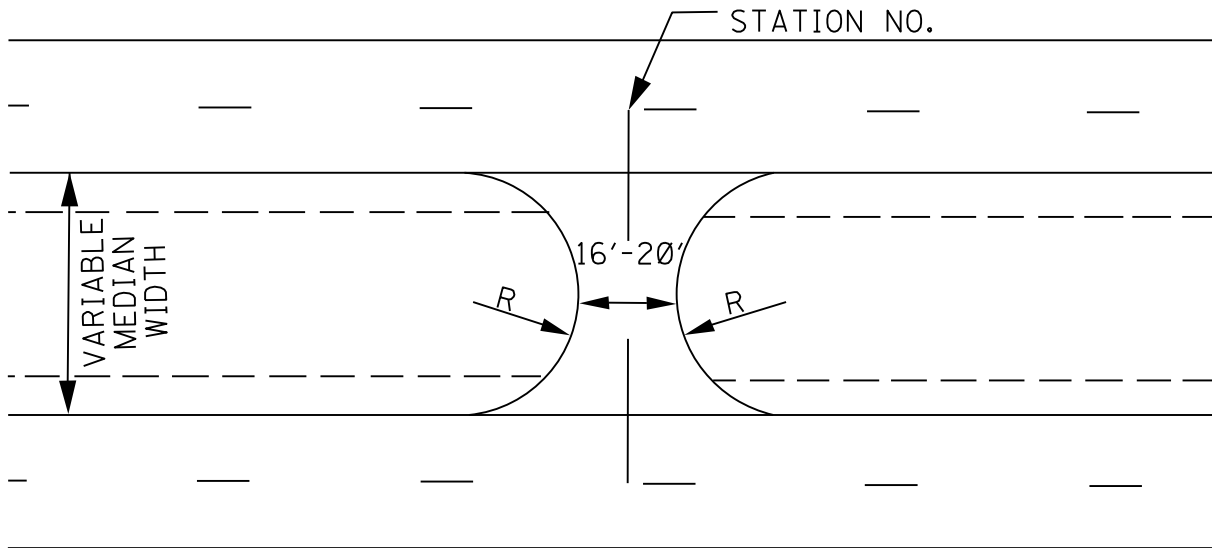

DETAIL OF INTERSTATE EMERGENCY CROSSOVER
NOTE: R VARIES (20'-32')

- GENERAL NOTES**
- GROUND-IN RUMBLE STRIPS SHALL BE APPLIED TO ALL PAVED SHOULDERS ON THIS PROJECT.
 - GROUND-IN RUMBLE STRIPS SHALL BE APPLIED TO ALL PAVED SHOULDERS ON THIS PROJECT.
 - COST TO BE PAID FOR USING APPROPRIATE PAY ITEMS
 - GROUND-IN RUMBLE STRIPS SHALL BE APPLIED TO:
 - MAINLINE
 - INTERSECTING ROADWAY IF OVERLAID OR RECONSTRUCTED BEYOND NORMAL MAINLINE R.O.M.
 - ANY ROADWAY WITH EXISTING RUMBLE STRIPS PRIOR TO CONSTRUCTION.

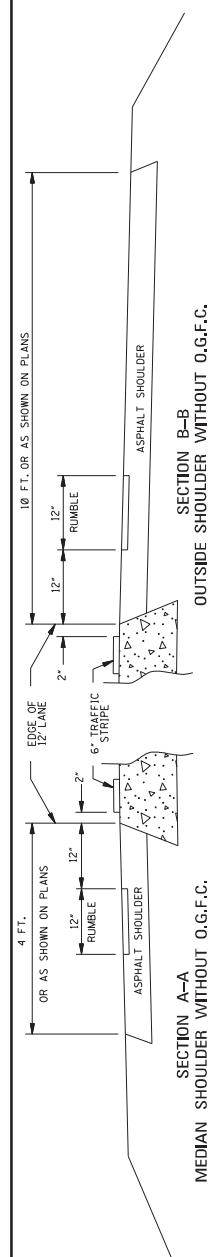
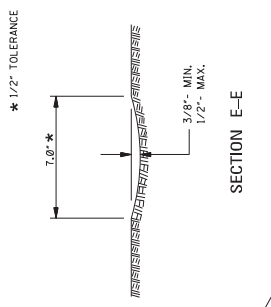

SECTION A-A
MEDIAN SHOULDER WITHOUT O.G.F.C.

THIS TYPICAL SECTION APPLIES TO THE LEFT HALF OF THE PLAN VIEW BELOW

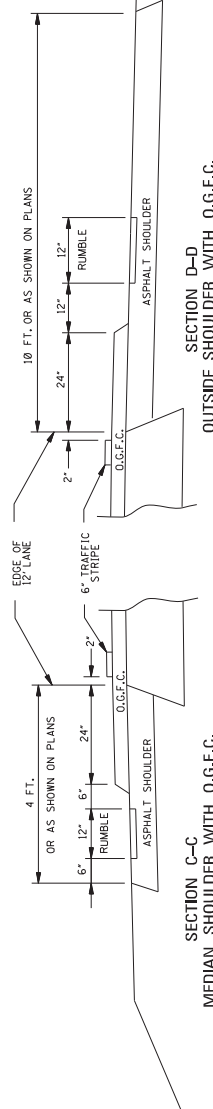

SECTION B-B
OUTSIDE SHOULDER WITHOUT O.G.F.C.

THIS TYPICAL SECTION APPLIES TO THE LEFT HALF OF THE PLAN VIEW BELOW

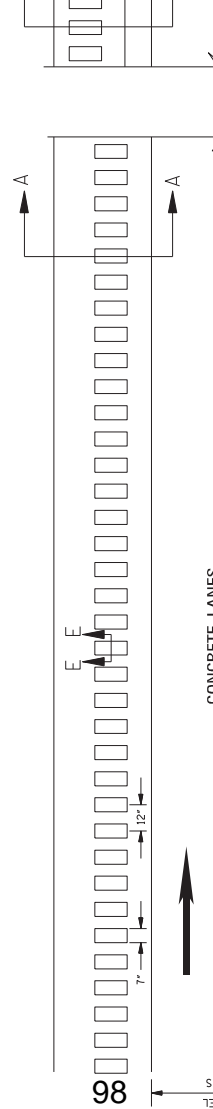

SECTION C-C
MEDIAN SHOULDER WITH O.G.F.C.

THIS TYPICAL SECTION APPLIES TO THE RIGHT HALF OF THE PLAN VIEW BELOW

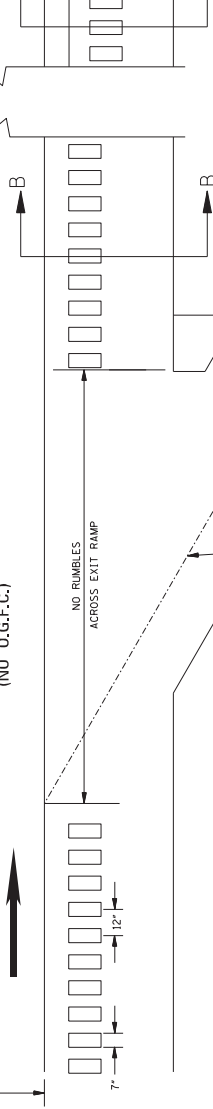

SECTION D-D
OUTSIDE SHOULDER WITH O.G.F.C.

THIS TYPICAL SECTION APPLIES TO THE RIGHT HALF OF THE PLAN VIEW BELOW

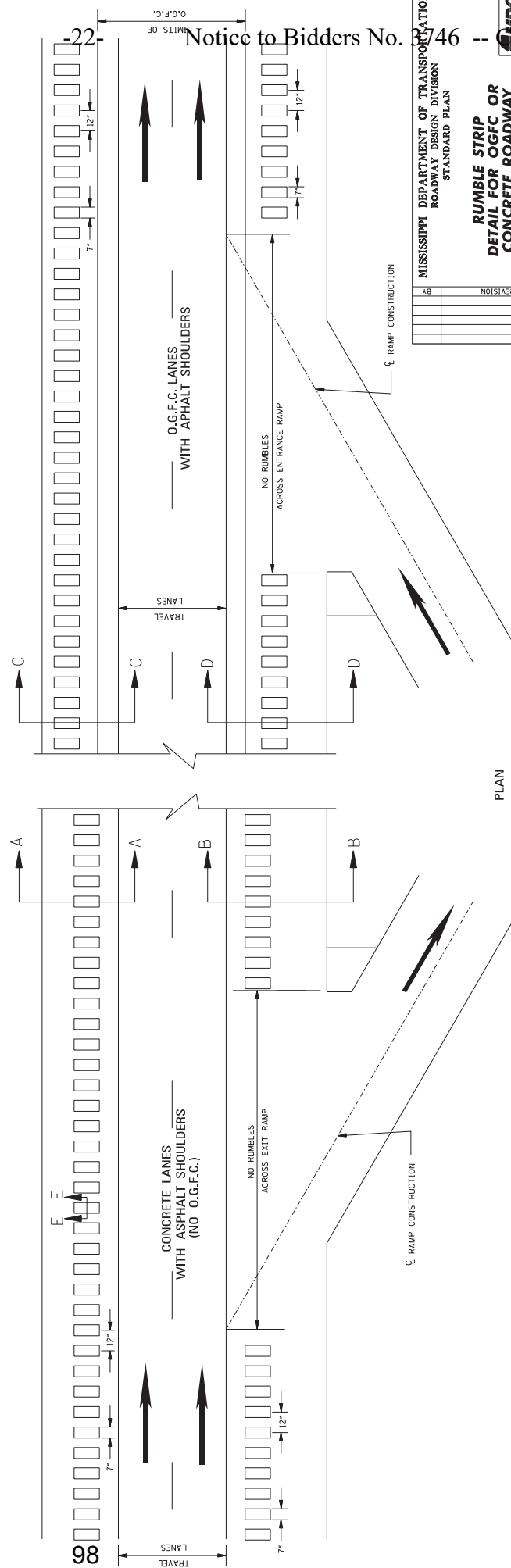

PLAN

MISSISSIPPI DEPARTMENT OF TRANSPORTATION
ROADWAY DESIGN DIVISION
STANDARD PLAN

**RUMBLE STRIP OR
DETAIL FOR OGFC OR
CONCRETE ROADWAY
WITH ASPHALT SHOULDERS**

ISSUE DATE: AUGUST 01, 2017

DATE	REVISION

PROJECT NUMBER: 6066

STATE	PROJECT NO.
MISS.	

- GENERAL NOTES**
1. ALL RUMBLE STRIPES SHALL BE GROUND-IN. RUMBLE STRIPES SHALL BE OMITTED ACROSS PRINCIPAL INTERSECTING ROADWAYS OR OTHER INTERRUPTIONS IN NORMAL SHOULDER WIDTH AS DIRECTED BY THE ENGINEER
 2. GROUND-IN RUMBLE STRIPES SHALL BE APPLIED TO MAINLINE ONLY.

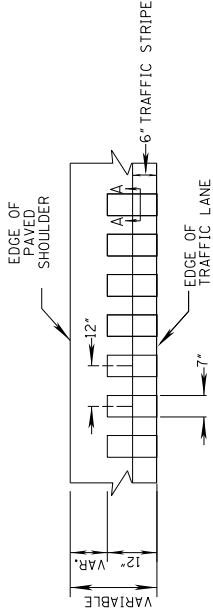

DETAIL "A"

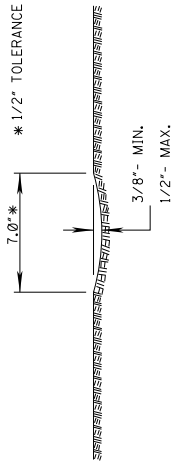

SECTION "A-A"

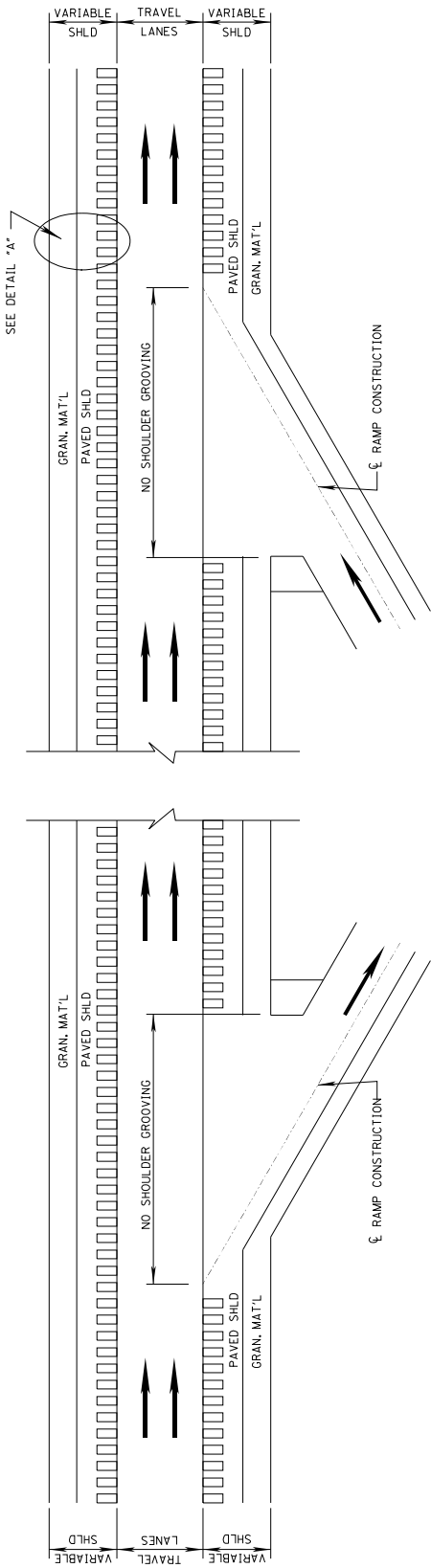

PLAN

NOT TO SCALE
DETAILS OF
RUMBLE STRIPS

MISSISSIPPI DEPARTMENT OF TRANSPORTATION	
RUMBLE STRIPES	
4-LANE HIGHWAYS	
(ASPH. LANES, 2-FT ASPH. SHLD)	
PROJECT NO:	16-2
COUNTY:	
FILE NAME:	
DESIGN TEAM:	
CHECKED:	DATE: 05/01/14
NO. OF NUMBER	
SHEET NUMBER	

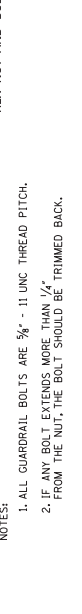
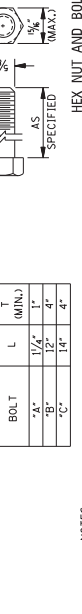
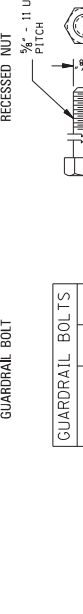
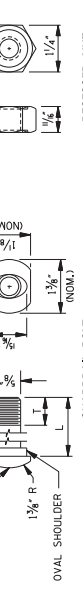
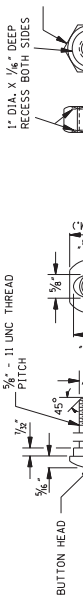
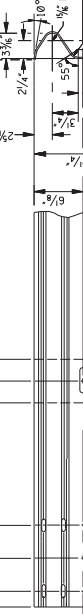
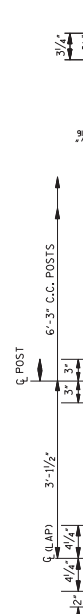
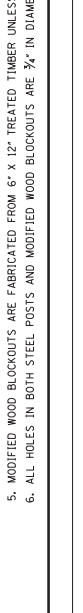
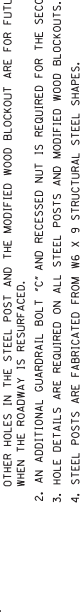
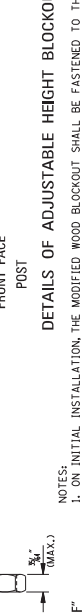
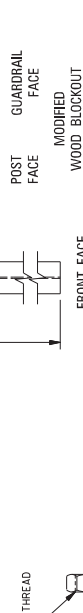
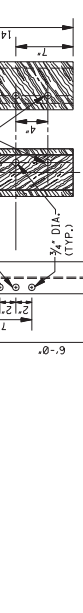
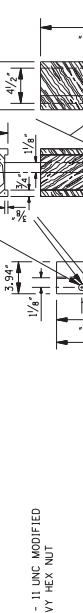
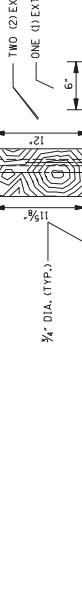
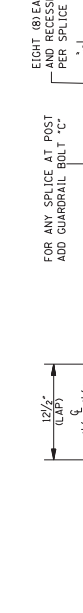
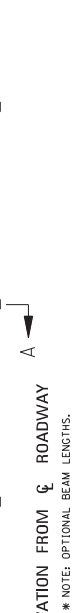
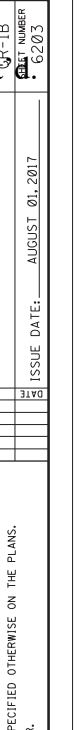
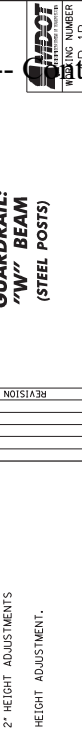
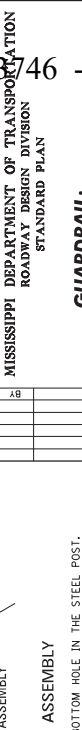
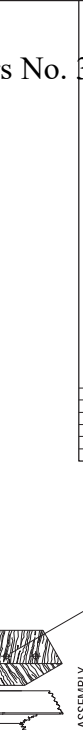
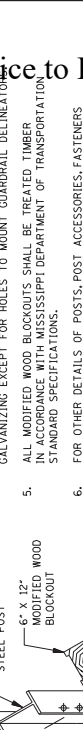
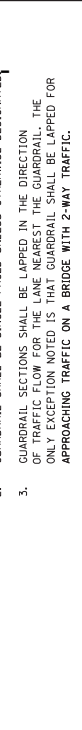
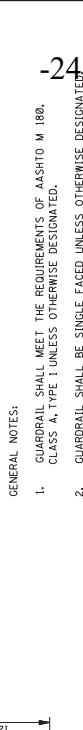
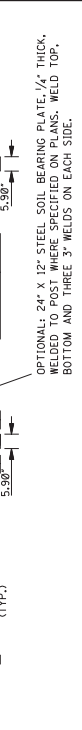
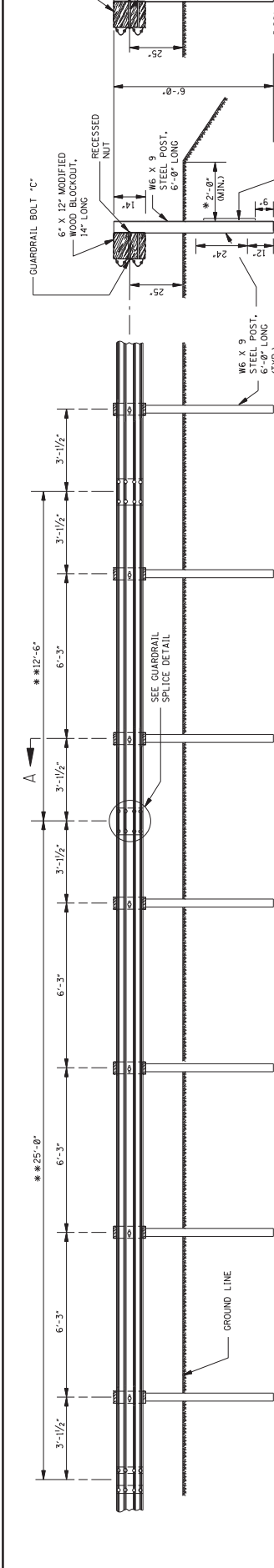

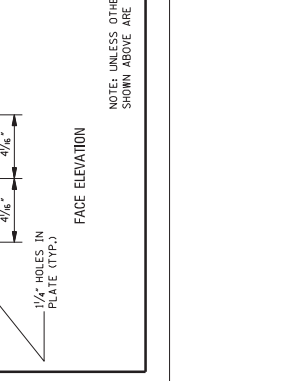
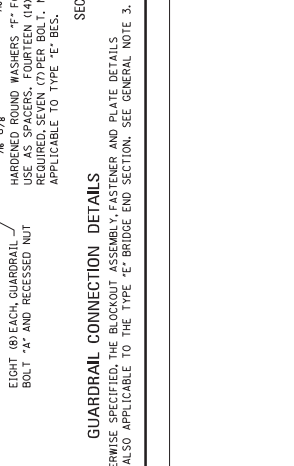
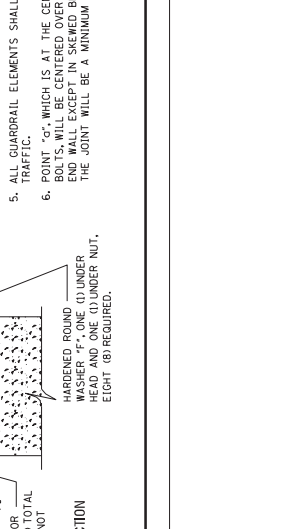
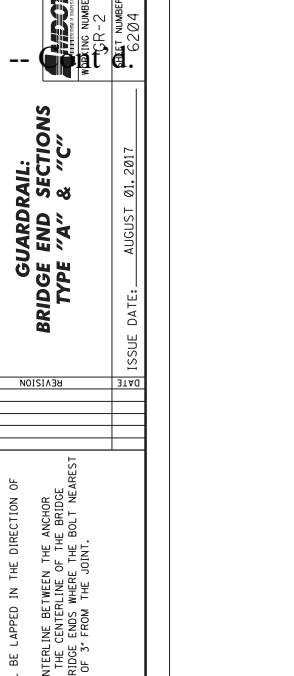
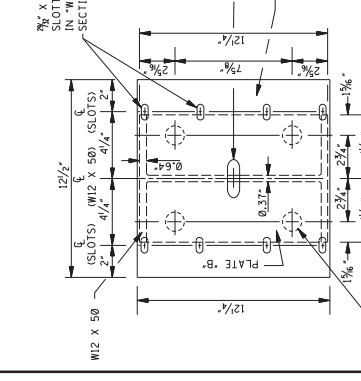
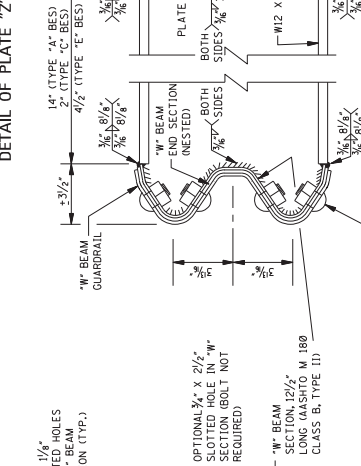
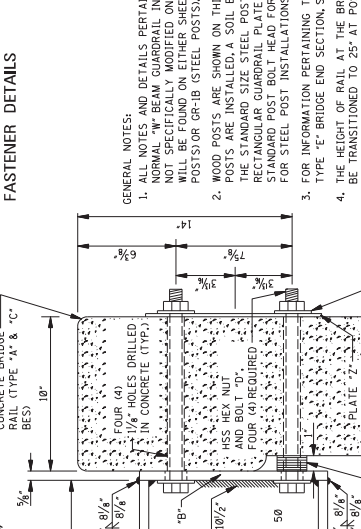
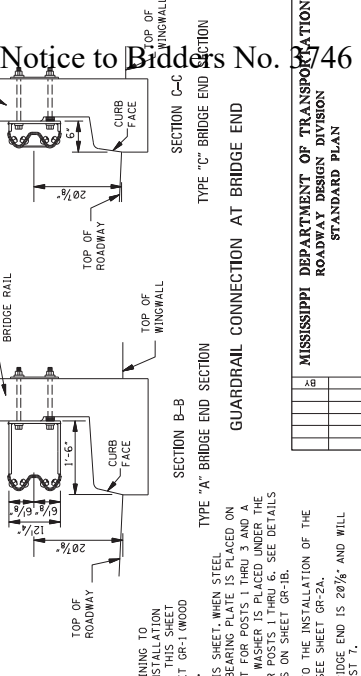
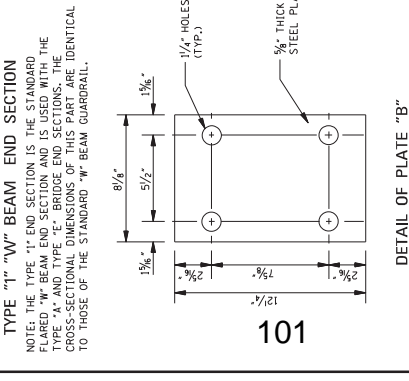
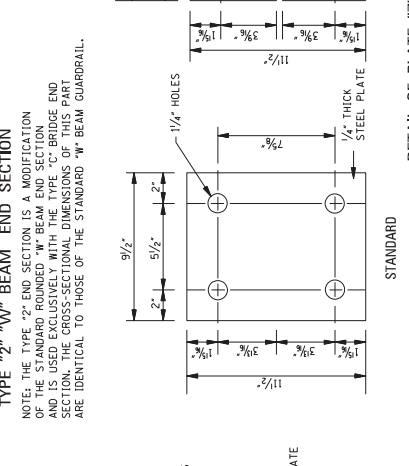
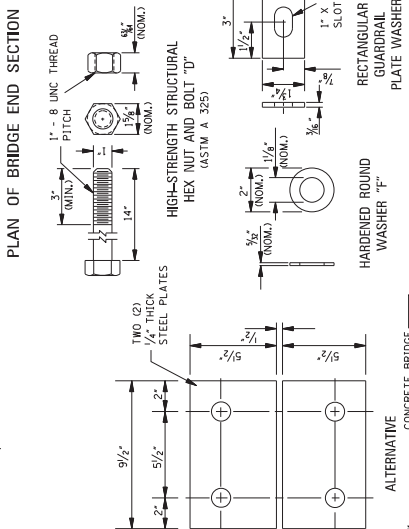
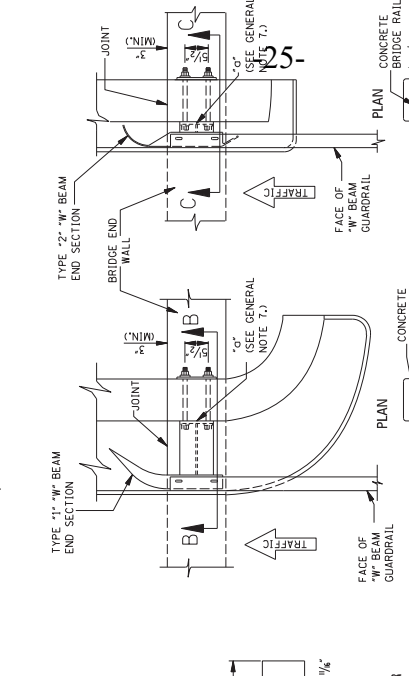
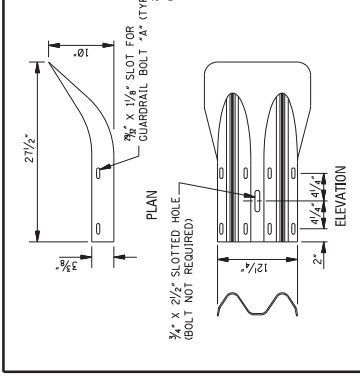
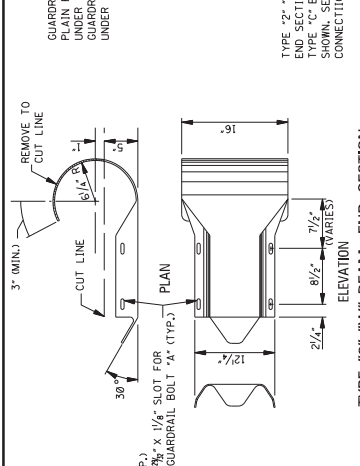
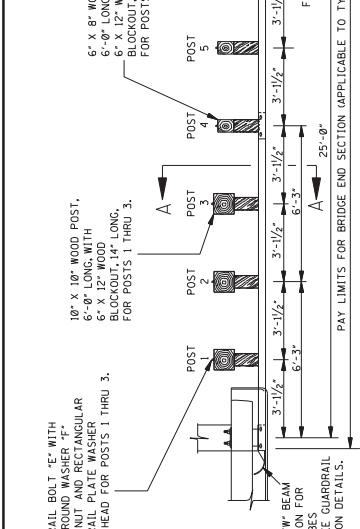
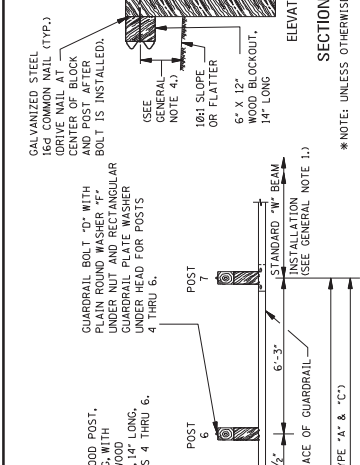

STATE PROJECT NO. MISS.

GUARDRAIL BOLT "E" WITH PLAIN ROUND WASHER "F" UNDER NUT AND RECTANGULAR GUARDRAIL PLATE WASHER "G" UNDER HEAD FOR POSTS 1 THRU 3.

GUARDRAIL BOLT "E" WITH PLAIN ROUND WASHER "F" UNDER NUT AND RECTANGULAR GUARDRAIL PLATE WASHER "G" UNDER HEAD FOR POSTS 4 THRU 6.

10" X 10" WOOD POST, 6'-0" LONG, WITH 6" X 12" WOOD BLOCKOUT, 14" LONG, FOR POSTS 1 THRU 3.

6" X 8" WOOD POST, 6'-0" LONG, WITH 6" X 12" WOOD BLOCKOUT, 14" LONG, FOR POSTS 4 THRU 6.

STANDARD "W" BEAM END SECTION FOR TYPE "C-C" BEES SHOWING GUARDRAIL CONNECTION DETAILS.

TYPE "2" "W" BEAM END SECTION

TYPE "1" "W" BEAM END SECTION

TYPE "2" "W" BEAM END SECTION

TYPE "1" "W" BEAM END SECTION

PLAN OF BRIDGE END SECTION

FASTENER DETAILS

DETAIL OF PLATE "B"

DETAIL OF PLATE "Z"

GUARDRAIL CONNECTION DETAILS

GENERAL NOTES:

- ALL NOTES AND DETAILS PERTAINING TO NORMAL "W" BEAM GUARDRAIL INSTALLATION NOT SPECIFICALLY MODIFIED ON THIS SHEET WILL BE FOUND ON EITHER SHEET GR-1 (WOOD POSTS) OR GR-2 (STEEL POSTS).
- WOOD POSTS ARE SHOWN ON THIS SHEET. WHEN STEEL POSTS ARE INSTALLED, A SOIL BEARING PLATE IS PLACED ON THE STANDARD SIZE STEEL POST FOR POSTS 1 THRU 3 AND A RECTANGULAR GUARDRAIL PLATE WASHER IS PLACED UNDER THE GUARDRAIL BOLT. SEE DETAILS FOR STEEL POST INSTALLATIONS ON SHEET GR-2B.
- FOR INFORMATION PERTAINING TO THE INSTALLATION OF THE TYPE "E" BRIDGE END SECTION, SEE SHEET GR-2A.
- THE HEIGHT OF RAIL AT THE BRIDGE END IS 28" AND WILL BE TRANSITIONED TO 25" AT POST 1.
- ALL GUARDRAIL ELEMENTS SHALL BE LAPPED IN THE DIRECTION OF TRAFFIC.
- POINT "G", WHICH IS AT THE CENTERLINE BETWEEN THE ANCHOR BOLTS, WILL BE CENTERED OVER THE CENTERLINE OF THE BRIDGE END. THE WELDED JOINT BETWEEN THE ANCHOR BOLTS NEAREST THE JOINT WILL BE A MINIMUM OF 3' FROM THE JOINT.

MISSISSIPPI DEPARTMENT OF TRANSPORTATION
ROADWAY DESIGN DIVISION
STANDARD PLAN

GUARDRAIL:
BRIDGE END SECTIONS
TYPE "A" & "C"

REVISION

DATE

ISSUE DATE: AUGUST 01, 2017

PROJECT NUMBER: 6204

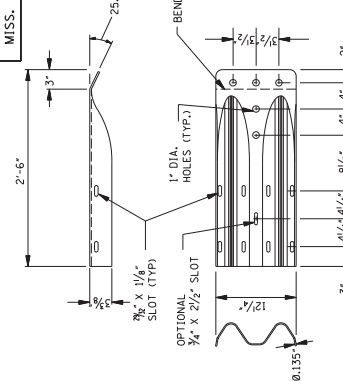

1. THE "W" BEAM TERMINAL CONNECTOR SHALL BE AASHTO M 180 CORRUGATED SHEET STEEL, CLASS B, TYPE 1.
2. SPLICE-BOLT SLOTS MAY ALSO BE ORIENTED AT 50° (ON THE FLAT) INSTEAD OF 0° AS SHOWN.

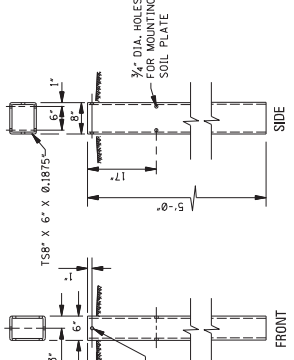
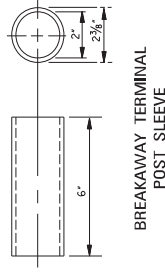
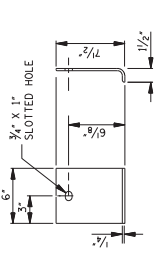

NOTE: TERMINAL POST SHALL BE ABLE TO SLIDE INTO THE TOP OF THIS SECTION SO THE ACTUAL INSIDE DIMENSIONS OF THIS GALVANIZED TUBE CANNOT BE LESS THAN 1/2" X 5/2".

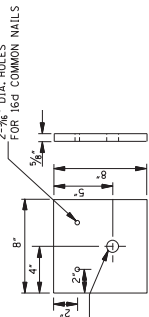

BEARING PLATE

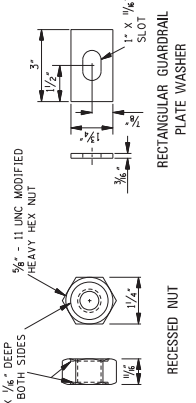

RECTANGULAR GUARDRAIL PLATE WASHER

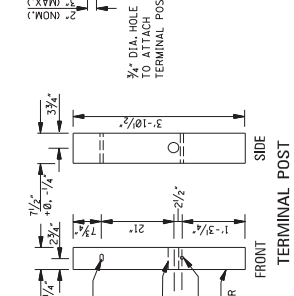

TERMINAL POST FOR FOUNDATION TUBE INSTALLATION

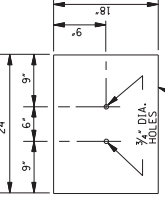

SOIL PLATE

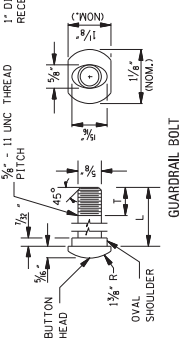

GUARDRAIL BOLT

BOLT	L	T (MIN.)
"A"	17 1/2"	4"
"B"	12"	4"
"C"	14"	4"
"D"	22"	4"
"E"	33"	4"
"F"	2"	1 3/4"
	10"	4"
	23"	4"

NOTES:
1. ALL GUARDRAIL BOLTS ARE 3/8" - 11 UNC THREAD PITCH.
2. IF ANY DIMENSIONS EXTENDS MORE THAN 1/2" FROM THE BOLT, THE BOLT SHOULD BE TRIMMED BACK.

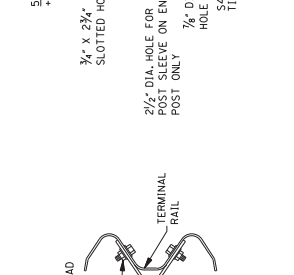

ANCHOR PLATE ASSEMBLY DETAILS

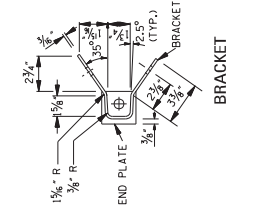

END PLATE

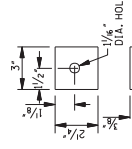

BRACKET

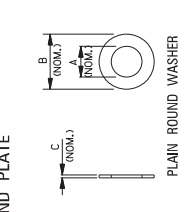

PLAIN ROUND WASHER

WASHER (NOM.)	A (NOM.)	B (NOM.)	C (NOM.)
"F"	1 1/4"	1 3/4"	3/4"
"H"	1 1/4"	2"	3/4"

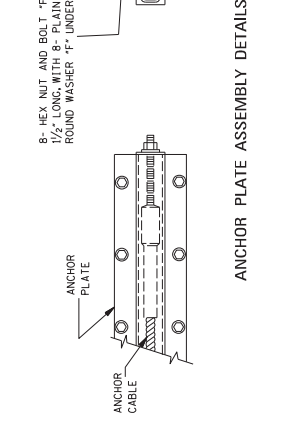

ANCHOR PLATE

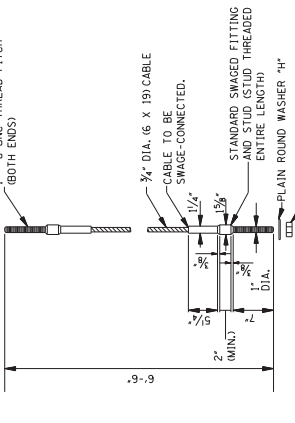

CABLE ANCHOR ASSEMBLY

MISSISSIPPI DEPARTMENT OF TRANSPORTATION

SECTION 904 - NOTICE TO BIDDERS NO. 3747

CODE: (SP)

DATE: 11/08/2021

SUBJECT: Temporary Construction Signs

PROJECT: IM-0055-02(249) / 107577301 -- Madison County

Bidders are hereby advised of the following regarding the Temporary Construction Signs required:

Should the Bidders elect to install Temporary Construction Signs by first driving short u-channel sections and then bolting the longer, correct height u-channel sections to them, the Bidders are advised that these short sections shall be a minimum of five (5) feet from the ground level when driven and the splice must consist of a minimum of eighteen (18) inches of overlap with a total of four (4) bolts. Bidders are also advised that it is mandatory that these short sections be removed at the completion of the project.

MISSISSIPPI DEPARTMENT OF TRANSPORTATION

SECTION 904 - NOTICE TO BIDDERS NO. 3748

CODE: (SP)

DATE: 11/08/2021

SUBJECT: Underground Utilities

PROJECT: IM-0055-02(249) / 107577301 -- Madison County

Bidders are hereby advised that utility lines owned and maintained by MDOT may be present within the project limits. These utilities are not located by Mississippi 811. It shall be the Contractor's responsibility to coordinate with MDOT to have the utility lines located and marked prior to beginning work. The Contractor shall give a minimum of three (3) working days of advance notice for locate requests. The contacts for MDOT utility lines are as follows:

Underground Power Lines:

Michael Lee – 601-683-3341 – mlee@mdot.ms.gov

Vince Herrington – 601-683-3341 – vherrington@mdot.ms.gov

Underground Communication Lines:

Kerby McFarland – 601-359-7450 – kmcfarland@mdot.ms.gov

Steven Newell – 601-359-7450 – snewell@mdot.ms.gov

Henry Lewis – 601-359-1454 – hlewis@mdot.ms.gov

Underground Signal Lines:

Amrik Singh – 601-359-1454 – asingh@mdot.ms.gov

Kenneth Welch – 601-359-1454 – kwelch@mdot.ms.gov

Superseded General Decision Number: MS20200137

State: Mississippi

Construction Type: Highway

County: Madison County in Mississippi.

HIGHWAY CONSTRUCTION PROJECTS

Note: Under Executive Order (EO) 13658, an hourly minimum wage of \$10.95 for calendar year 2021 applies to all contracts subject to the Davis-Bacon Act for which the contract is awarded (and any solicitation was issued) on or after January 1, 2015. If this contract is covered by the EO, the contractor must pay all workers in any classification listed on this wage determination at least \$10.95 per hour (or the applicable wage rate listed on this wage determination, if it is higher) for all hours spent performing on the contract in calendar year 2021. If this contract is covered by the EO and a classification considered necessary for performance of work on the contract does not appear on this wage determination, the contractor must pay workers in that classification at least the wage rate determined through the conformance process set forth in 29 CFR 5.5(a)(1)(ii) (or the EO minimum wage rate, if it is higher than the conformed wage rate). The EO minimum wage rate will be adjusted annually. Please note that this EO applies to the above-mentioned types of contracts entered into by the federal government that are subject to the Davis-Bacon Act itself, but it does not apply to contracts subject only to the Davis-Bacon Related Acts, including those set forth at 29 CFR 5.1(a)(2)-(60). Additional information on contractor requirements and worker protections under the EO is available at www.dol.gov/whd/govcontracts.

Modification Number	Publication Date
0	01/01/2021
1	10/22/2021

* ELEC0480-010 07/01/2021

	Rates	Fringes
TRAFFIC SIGNALIZATION		
Electrician.....	\$ 26.35	10.39

SUMS2010-060 08/04/2014		

	Rates	Fringes
CARPENTER (Form Work Only).....	\$ 12.32	0.00
CEMENT MASON/CONCRETE FINISHER...	\$ 12.85	0.39
ELECTRICIAN.....	\$ 24.04	5.87
HIGHWAY/PARKING LOT STRIPING:		
Truck Driver (Line Striping		
Truck).....	\$ 10.86	0.00
INSTALLER - GUARDRAIL.....	\$ 12.07	0.00

INSTALLER - SIGN.....	\$ 11.54	0.00
IRONWORKER, REINFORCING.....	\$ 15.52	0.00
LABORER: Common or General, Including Asphalt Raking, Shoveling, Spreading; and Grade Checking.....	\$ 10.38	0.00
LABORER: Flagger.....	\$ 9.91	0.00
LABORER: Luteman.....	\$ 12.88	0.00
LABORER: Mason Tender - Cement/Concrete.....	\$ 11.27	0.00
LABORER: Pipelayer.....	\$ 13.44	0.00
LABORER: Laborer-Cones/ Barricades/Barrels - Setter/Mover/Sweeper.....	\$ 10.26	0.00
OPERATOR: Asphalt Spreader.....	\$ 14.71	0.00
OPERATOR: Backhoe/Excavator/Trackhoe.....	\$ 14.37	0.00
OPERATOR: Bobcat/Skid Steer/Skid Loader.....	\$ 11.64	0.00
OPERATOR: Broom/Sweeper.....	\$ 10.48	0.00
OPERATOR: Bulldozer.....	\$ 13.88	0.00
OPERATOR: Concrete Saw.....	\$ 15.50	0.00
OPERATOR: Crane.....	\$ 15.00	0.00
OPERATOR: Distributor.....	\$ 10.95	0.00
OPERATOR: Grader/Blade.....	\$ 14.28	0.00
OPERATOR: Grinding/Grooving Machine.....	\$ 15.90	0.00
OPERATOR: Loader.....	\$ 13.28	0.00
OPERATOR: Mechanic.....	\$ 13.00	0.00
OPERATOR: Milling Machine.....	\$ 14.68	0.00
OPERATOR: Mixer.....	\$ 14.25	0.00
OPERATOR: Oiler.....	\$ 12.35	0.00
OPERATOR: Paver (Asphalt, Aggregate, and Concrete).....	\$ 11.74	0.00
OPERATOR: Roller (All Types)....	\$ 10.85	0.00
OPERATOR: Scraper.....	\$ 12.25	0.00
OPERATOR: Tractor.....	\$ 10.56	0.00

TRUCK DRIVER: Flatbed Truck.....	\$ 14.06	0.00
TRUCK DRIVER: Lowboy Truck.....	\$ 12.08	0.00
TRUCK DRIVER: Mechanic.....	\$ 13.00	0.00
TRUCK DRIVER: Water Truck.....	\$ 10.00	0.00
TRUCK DRIVER: Dump Truck (All Types).....	\$ 11.02	0.00
TRUCK DRIVER: Semi/Trailer Truck.....	\$ 12.50	0.00

WELDERS - Receive rate prescribed for craft performing operation to which welding is incidental.

=====

Note: Executive Order (EO) 13706, Establishing Paid Sick Leave for Federal Contractors applies to all contracts subject to the Davis-Bacon Act for which the contract is awarded (and any solicitation was issued) on or after January 1, 2017. If this contract is covered by the EO, the contractor must provide employees with 1 hour of paid sick leave for every 30 hours they work, up to 56 hours of paid sick leave each year. Employees must be permitted to use paid sick leave for their own illness, injury or other health-related needs, including preventive care; to assist a family member (or person who is like family to the employee) who is ill, injured, or has other health-related needs, including preventive care; or for reasons resulting from, or to assist a family member (or person who is like family to the employee) who is a victim of, domestic violence, sexual assault, or stalking. Additional information on contractor requirements and worker protections under the EO is available at www.dol.gov/whd/govcontracts.

Unlisted classifications needed for work not included within the scope of the classifications listed may be added after award only as provided in the labor standards contract clauses (29CFR 5.5 (a) (1) (ii)).

The body of each wage determination lists the classification and wage rates that have been found to be prevailing for the cited type(s) of construction in the area covered by the wage determination. The classifications are listed in alphabetical order of ""identifiers"" that indicate whether the particular rate is a union rate (current union negotiated rate for local), a survey rate (weighted average rate) or a union average rate (weighted union average rate).

Union Rate Identifiers

A four letter classification abbreviation identifier enclosed in dotted lines beginning with characters other than ""SU"" or ""UAVG"" denotes that the union classification and rate were prevailing for that classification in the survey. Example: PLUM0198-005 07/01/2014. PLUM is an abbreviation identifier of the union which prevailed in the survey for this classification, which in this example would be Plumbers. 0198

indicates the local union number or district council number where applicable, i.e., Plumbers Local 0198. The next number, 005 in the example, is an internal number used in processing the wage determination. 07/01/2014 is the effective date of the most current negotiated rate, which in this example is July 1, 2014.

Union prevailing wage rates are updated to reflect all rate changes in the collective bargaining agreement (CBA) governing this classification and rate.

Survey Rate Identifiers

Classifications listed under the "SU" identifier indicate that no one rate prevailed for this classification in the survey and the published rate is derived by computing a weighted average rate based on all the rates reported in the survey for that classification. As this weighted average rate includes all rates reported in the survey, it may include both union and non-union rates. Example: SULA2012-007 5/13/2014. SU indicates the rates are survey rates based on a weighted average calculation of rates and are not majority rates. LA indicates the State of Louisiana. 2012 is the year of survey on which these classifications and rates are based. The next number, 007 in the example, is an internal number used in producing the wage determination. 5/13/2014 indicates the survey completion date for the classifications and rates under that identifier.

Survey wage rates are not updated and remain in effect until a new survey is conducted.

Union Average Rate Identifiers

Classification(s) listed under the UAVG identifier indicate that no single majority rate prevailed for those classifications; however, 100% of the data reported for the classifications was union data. EXAMPLE: UAVG-OH-0010 08/29/2014. UAVG indicates that the rate is a weighted union average rate. OH indicates the state. The next number, 0010 in the example, is an internal number used in producing the wage determination. 08/29/2014 indicates the survey completion date for the classifications and rates under that identifier.

A UAVG rate will be updated once a year, usually in January of each year, to reflect a weighted average of the current negotiated/CBA rate of the union locals from which the rate is based.

WAGE DETERMINATION APPEALS PROCESS

1.) Has there been an initial decision in the matter? This can be:

- * an existing published wage determination
- * a survey underlying a wage determination
- * a Wage and Hour Division letter setting forth a position on a wage determination matter
- * a conformance (additional classification and rate) ruling

On survey related matters, initial contact, including requests for summaries of surveys, should be with the Wage and Hour

Regional Office for the area in which the survey was conducted because those Regional Offices have responsibility for the Davis-Bacon survey program. If the response from this initial contact is not satisfactory, then the process described in 2.) and 3.) should be followed.

With regard to any other matter not yet ripe for the formal process described here, initial contact should be with the Branch of Construction Wage Determinations. Write to:

Branch of Construction Wage Determinations
Wage and Hour Division
U.S. Department of Labor
200 Constitution Avenue, N.W.
Washington, DC 20210

2.) If the answer to the question in 1.) is yes, then an interested party (those affected by the action) can request review and reconsideration from the Wage and Hour Administrator (See 29 CFR Part 1.8 and 29 CFR Part 7). Write to:

Wage and Hour Administrator
U.S. Department of Labor
200 Constitution Avenue, N.W.
Washington, DC 20210

The request should be accompanied by a full statement of the interested party's position and by any information (wage payment data, project description, area practice material, etc.) that the requestor considers relevant to the issue.

3.) If the decision of the Administrator is not favorable, an interested party may appeal directly to the Administrative Review Board (formerly the Wage Appeals Board). Write to:

Administrative Review Board
U.S. Department of Labor
200 Constitution Avenue, N.W.
Washington, DC 20210

4.) All decisions by the Administrative Review Board are final.

=====

END OF GENERAL DECISION"

SUPPLEMENT TO FORM FHWA-1273

DATE: 12/17/2018

SUBJECT: **Federal Contract Provisions for Subcontracts and Cargo Preference Act**

Federal Contract Provisions for Subcontracts

All subcontracts shall be in writing and contain all pertinent provisions and requirements of the prime contract.

Each “Request for Permission to Subcontract” (Mississippi Department of Transportation Form CAD-720) shall include a copy of the subcontract. The federal contract provisions (FHWA-1273, SUPPLEMENT TO FORM FHWA-1273, NOTICE OF REQUIREMENT FOR AFFIRMATIVE ACTION TO ENSURE EQUAL EMPLOYMENT OPPORTUNITY (EXECUTIVE ORDER 11246), DAVIS-BACON AND RELATED ACT PROVISIONS (WAGE RATES)) must be physically incorporated as part of the subcontract. A completed Mississippi Department of Transportation Form CAD-521 and Form CAD-725 must be attached to the CAD-720.

Cargo Preference Act

The Contractor is hereby advised of the requirements set forth in the following Attachment (Title 46 - Shipping) as it pertains to the implementation of Cargo Preference Act (CPA) requirements in the Federal-aid Highway Program.

By signing this contract, the Contractor agrees to conform to the requirements of the CPA.

Attachment

Title 46- Shipping

Volume: 8

Date: 2014-10-01

Original Date: 2014-10-01

Title: Section 381.7 - Federal Grant, Guaranty, Loan and Advance at Funds Agreements.

Context: Title 46- Shipping. CHAPTER II- MARITIME ADMINISTRATION, DEPARTMENT OF TRANSPORTATION. SUBCHAPTER J - MISCELLANEOUS. PART 381 - CARGO PREFERENCE-U.S.-FLAG VESSELS.

§ 381.7 Federal Grant, Guaranty, Loan and Advance of Funds Agreements.

In order to insure a fair and reasonable participation by privately owned United States-flag commercial vessels in transporting cargoes which are subject to the Cargo Preference Act of 1954 and which are generated by U.S. Government Grant, Guaranty, Loan and/or Advance of Funds Programs, the head of each affected department or agency shall require appropriate clauses to be inserted in those Grant, Guaranty, Loan and/or Advance of Funds Agreements and all third party contracts executed between the borrower/grantee and other parties, where the possibility exists for ocean transportation of items procured, contracted for or otherwise obtained by or on behalf of the grantee, borrower, or any of their contractors or subcontractors. The clauses required by this part shall provide that at least 50 percent of the freight revenue and tonnage of cargo generated by the U.S. Government Grant, Guaranty, Loan or Advance of Funds be transported on privately owned United States-flag commercial vessels. These clauses shall also require that all parties provide to the Maritime Administration the necessary shipment information as set forth in § 381.3. A copy of the appropriate clauses required by this part shall be submitted by each affected agency or department to the Secretary, Maritime Administration, for approval no later than 30 days after the effective date of this part. The following are suggested acceptable clauses with respect to the use of United States-flag vessels to be incorporated in the Grant, Guaranty, Loan and/or Advance of Funds Agreements as well as contracts and subcontracts resulting therefrom:

(a) *Agreement Clauses.* "Use of United States-flag vessels:

"(1) Pursuant to Pub. L 664 (43 U.S.C. 1241(b)) at least 50 percent of any equipment, materials or commodities procured, contracted for or otherwise obtained with funds granted, guaranteed, loaned, or advanced by the U.S. Government under this agreement, and which may be transported by ocean vessel, shall be transported on privately owned United States-flag commercial vessels, if available.

"(2) Within 20 days following the date of loading for shipments originating within the United States or within 30 working days following the date of loading for shipments originating outside the United States, a legible copy of a rated, 'on-board' commercial ocean bill-of-lading in English for each shipment of cargo described in paragraph (a)(1) of this section shall be furnished to both the Contracting Officer (through the prime contractor in the case of subcontractor bills-of-lading) and to the Division of National Cargo, Office of Market Development, Maritime Administration, Washington, DC 20590."

(b) *Contractor and Subcontractor Clauses.* "Use of United States-flag vessels: The contractor agrees --

"(1) To utilize privately owned United States-flag commercial vessels to ship at least 50 percent of the gross tonnage (computed separately for dry bulk carriers, dry cargo liners, and tankers) involved, whenever shipping any equipment, material, or commodities pursuant to this contract, to the extent such vessels are available at fair and reasonable rates for United States-flag commercial vessels.

"(2) To furnish within 20 days following the date of loading for shipments originating within the United

States or within 30 working days following the date of loading for shipments originating outside the United States, a legible copy of a rated, 'on-board' commercial ocean bill-of-lading in English for each shipment of cargo described in paragraph (b) (1) of this section to both the Contracting Officer (through the prime contractor in the case of subcontractor bills-of-lading) and to the Division of National Cargo, Office of Market Development, Maritime Administration, Washington, DC 20590.

"(3) To insert the substance of the provisions of this clause in all subcontracts issued pursuant to this contract."

(Reorganization Plans No.21 of 1950(64 Stat. 1273) and No. 7 of 1961 (75 Stat. 840) as amended by Pub. L 91.469 (84 Stat 1036) and Department of Commerce Organization Order 10-8 (38 FR 19707, July 23, 1973)) (42 FR 57126, Nov. 1, 1977]

**REQUIRED CONTRACT PROVISIONS
FEDERAL-AID CONSTRUCTION CONTRACTS**

- I. General
- II. Nondiscrimination
- III. Nonsegregated Facilities
- IV. Davis-Bacon and Related Act Provisions
- V. Contract Work Hours and Safety Standards Act Provisions
- VI. Subletting or Assigning the Contract
- VII. Safety: Accident Prevention
- VIII. False Statements Concerning Highway Projects
- IX. Implementation of Clean Air Act and Federal Water Pollution Control Act
- X. Compliance with Governmentwide Suspension and Debarment Requirements
- XI. Certification Regarding Use of Contract Funds for Lobbying

ATTACHMENTS

A. Employment and Materials Preference for Appalachian Development Highway System or Appalachian Local Access Road Contracts (included in Appalachian contracts only)

I. GENERAL

1. Form FHWA-1273 must be physically incorporated in each construction contract funded under Title 23 (excluding emergency contracts solely intended for debris removal). The contractor (or subcontractor) must insert this form in each subcontract and further require its inclusion in all lower tier subcontracts (excluding purchase orders, rental agreements and other agreements for supplies or services).

The applicable requirements of Form FHWA-1273 are incorporated by reference for work done under any purchase order, rental agreement or agreement for other services. The prime contractor shall be responsible for compliance by any subcontractor, lower-tier subcontractor or service provider.

Form FHWA-1273 must be included in all Federal-aid design-build contracts, in all subcontracts and in lower tier subcontracts (excluding subcontracts for design services, purchase orders, rental agreements and other agreements for supplies or services). The design-builder shall be responsible for compliance by any subcontractor, lower-tier subcontractor or service provider.

Contracting agencies may reference Form FHWA-1273 in bid proposal or request for proposal documents, however, the Form FHWA-1273 must be physically incorporated (not referenced) in all contracts, subcontracts and lower-tier subcontracts (excluding purchase orders, rental agreements and other agreements for supplies or services related to a construction contract).

2. Subject to the applicability criteria noted in the following sections, these contract provisions shall apply to all work performed on the contract by the contractor's own organization and with the assistance of workers under the contractor's immediate superintendence and to all work performed on the contract by piecework, station work, or by subcontract.

3. A breach of any of the stipulations contained in these Required Contract Provisions may be sufficient grounds for withholding of progress payments, withholding of final payment, termination of the contract, suspension / debarment or any other action determined to be appropriate by the contracting agency and FHWA.

4. Selection of Labor: During the performance of this contract, the contractor shall not use convict labor for any purpose within the limits of a construction project on a Federal-aid highway unless it is labor performed by convicts who are on parole, supervised release, or probation. The term Federal-aid highway does not include roadways functionally classified as local roads or rural minor collectors.

II. NONDISCRIMINATION

The provisions of this section related to 23 CFR Part 230 are applicable to all Federal-aid construction contracts and to all related construction subcontracts of \$10,000 or more. The provisions of 23 CFR Part 230 are not applicable to material supply, engineering, or architectural service contracts.

In addition, the contractor and all subcontractors must comply with the following policies: Executive Order 11246, 41 CFR 60, 29 CFR 1625-1627, Title 23 USC Section 140, the Rehabilitation Act of 1973, as amended (29 USC 794), Title VI of the Civil Rights Act of 1964, as amended, and related regulations including 49 CFR Parts 21, 26 and 27; and 23 CFR Parts 200, 230, and 633.

The contractor and all subcontractors must comply with: the requirements of the Equal Opportunity Clause in 41 CFR 60-1.4(b) and, for all construction contracts exceeding \$10,000, the Standard Federal Equal Employment Opportunity Construction Contract Specifications in 41 CFR 60-4.3.

Note: The U.S. Department of Labor has exclusive authority to determine compliance with Executive Order 11246 and the policies of the Secretary of Labor including 41 CFR 60, and 29 CFR 1625-1627. The contracting agency and the FHWA have the authority and the responsibility to ensure compliance with Title 23 USC Section 140, the Rehabilitation Act of 1973, as amended (29 USC 794), and Title VI of the Civil Rights Act of 1964, as amended, and related regulations including 49 CFR Parts 21, 26 and 27; and 23 CFR Parts 200, 230, and 633.

The following provision is adopted from 23 CFR 230, Appendix A, with appropriate revisions to conform to the U.S. Department of Labor (US DOL) and FHWA requirements.

1. Equal Employment Opportunity: Equal employment opportunity (EEO) requirements not to discriminate and to take affirmative action to assure equal opportunity as set forth under laws, executive orders, rules, regulations (28 CFR 35, 29 CFR 1630, 29 CFR 1625-1627, 41 CFR 60 and 49 CFR 27) and orders of the Secretary of Labor as modified by the provisions prescribed herein, and imposed pursuant to 23 U.S.C. 140 shall constitute the EEO and specific affirmative action standards for the contractor's project activities under

this contract. The provisions of the Americans with Disabilities Act of 1990 (42 U.S.C. 12101 et seq.) set forth under 28 CFR 35 and 29 CFR 1630 are incorporated by reference in this contract. In the execution of this contract, the contractor agrees to comply with the following minimum specific requirement activities of EEO:

a. The contractor will work with the contracting agency and the Federal Government to ensure that it has made every good faith effort to provide equal opportunity with respect to all of its terms and conditions of employment and in their review of activities under the contract.

b. The contractor will accept as its operating policy the following statement:

"It is the policy of this Company to assure that applicants are employed, and that employees are treated during employment, without regard to their race, religion, sex, color, national origin, age or disability. Such action shall include: employment, upgrading, demotion, or transfer; recruitment or recruitment advertising; layoff or termination; rates of pay or other forms of compensation; and selection for training, including apprenticeship, pre-apprenticeship, and/or on-the-job training."

2. EEO Officer: The contractor will designate and make known to the contracting officers an EEO Officer who will have the responsibility for and must be capable of effectively administering and promoting an active EEO program and who must be assigned adequate authority and responsibility to do so.

3. Dissemination of Policy: All members of the contractor's staff who are authorized to hire, supervise, promote, and discharge employees, or who recommend such action, or who are substantially involved in such action, will be made fully cognizant of, and will implement, the contractor's EEO policy and contractual responsibilities to provide EEO in each grade and classification of employment. To ensure that the above agreement will be met, the following actions will be taken as a minimum:

a. Periodic meetings of supervisory and personnel office employees will be conducted before the start of work and then not less often than once every six months, at which time the contractor's EEO policy and its implementation will be reviewed and explained. The meetings will be conducted by the EEO Officer.

b. All new supervisory or personnel office employees will be given a thorough indoctrination by the EEO Officer, covering all major aspects of the contractor's EEO obligations within thirty days following their reporting for duty with the contractor.

c. All personnel who are engaged in direct recruitment for the project will be instructed by the EEO Officer in the contractor's procedures for locating and hiring minorities and women.

d. Notices and posters setting forth the contractor's EEO policy will be placed in areas readily accessible to employees, applicants for employment and potential employees.

e. The contractor's EEO policy and the procedures to implement such policy will be brought to the attention of employees by means of meetings, employee handbooks, or other appropriate means.

4. Recruitment: When advertising for employees, the contractor will include in all advertisements for employees the notation: "An Equal Opportunity Employer." All such advertisements will be placed in publications having a large circulation among minorities and women in the area from which the project work force would normally be derived.

a. The contractor will, unless precluded by a valid bargaining agreement, conduct systematic and direct recruitment through public and private employee referral sources likely to yield qualified minorities and women. To meet this requirement, the contractor will identify sources of potential minority group employees, and establish with such identified sources procedures whereby minority and women applicants may be referred to the contractor for employment consideration.

b. In the event the contractor has a valid bargaining agreement providing for exclusive hiring hall referrals, the contractor is expected to observe the provisions of that agreement to the extent that the system meets the contractor's compliance with EEO contract provisions. Where implementation of such an agreement has the effect of discriminating against minorities or women, or obligates the contractor to do the same, such implementation violates Federal nondiscrimination provisions.

c. The contractor will encourage its present employees to refer minorities and women as applicants for employment. Information and procedures with regard to referring such applicants will be discussed with employees.

5. Personnel Actions: Wages, working conditions, and employee benefits shall be established and administered, and personnel actions of every type, including hiring, upgrading, promotion, transfer, demotion, layoff, and termination, shall be taken without regard to race, color, religion, sex, national origin, age or disability. The following procedures shall be followed:

a. The contractor will conduct periodic inspections of project sites to insure that working conditions and employee facilities do not indicate discriminatory treatment of project site personnel.

b. The contractor will periodically evaluate the spread of wages paid within each classification to determine any evidence of discriminatory wage practices.

c. The contractor will periodically review selected personnel actions in depth to determine whether there is evidence of discrimination. Where evidence is found, the contractor will promptly take corrective action. If the review indicates that the discrimination may extend beyond the actions reviewed, such corrective action shall include all affected persons.

d. The contractor will promptly investigate all complaints of alleged discrimination made to the contractor in connection with its obligations under this contract, will attempt to resolve such complaints, and will take appropriate corrective action within a reasonable time. If the investigation indicates that the discrimination may affect persons other than the complainant, such corrective action shall include such other persons. Upon completion of each investigation, the contractor will inform every complainant of all of their avenues of appeal.

6. Training and Promotion:

a. The contractor will assist in locating, qualifying, and increasing the skills of minorities and women who are

applicants for employment or current employees. Such efforts should be aimed at developing full journey level status employees in the type of trade or job classification involved.

b. Consistent with the contractor's work force requirements and as permissible under Federal and State regulations, the contractor shall make full use of training programs, i.e., apprenticeship, and on-the-job training programs for the geographical area of contract performance. In the event a special provision for training is provided under this contract, this subparagraph will be superseded as indicated in the special provision. The contracting agency may reserve training positions for persons who receive welfare assistance in accordance with 23 U.S.C. 140(a).

c. The contractor will advise employees and applicants for employment of available training programs and entrance requirements for each.

d. The contractor will periodically review the training and promotion potential of employees who are minorities and women and will encourage eligible employees to apply for such training and promotion.

7. Unions: If the contractor relies in whole or in part upon unions as a source of employees, the contractor will use good faith efforts to obtain the cooperation of such unions to increase opportunities for minorities and women. Actions by the contractor, either directly or through a contractor's association acting as agent, will include the procedures set forth below:

a. The contractor will use good faith efforts to develop, in cooperation with the unions, joint training programs aimed toward qualifying more minorities and women for membership in the unions and increasing the skills of minorities and women so that they may qualify for higher paying employment.

b. The contractor will use good faith efforts to incorporate an EEO clause into each union agreement to the end that such union will be contractually bound to refer applicants without regard to their race, color, religion, sex, national origin, age or disability.

c. The contractor is to obtain information as to the referral practices and policies of the labor union except that to the extent such information is within the exclusive possession of the labor union and such labor union refuses to furnish such information to the contractor, the contractor shall so certify to the contracting agency and shall set forth what efforts have been made to obtain such information.

d. In the event the union is unable to provide the contractor with a reasonable flow of referrals within the time limit set forth in the collective bargaining agreement, the contractor will, through independent recruitment efforts, fill the employment vacancies without regard to race, color, religion, sex, national origin, age or disability; making full efforts to obtain qualified and/or qualifiable minorities and women. The failure of a union to provide sufficient referrals (even though it is obligated to provide exclusive referrals under the terms of a collective bargaining agreement) does not relieve the contractor from the requirements of this paragraph. In the event the union referral practice prevents the contractor from meeting the obligations pursuant to Executive Order 11246, as amended, and these special provisions, such contractor shall immediately notify the contracting agency.

8. Reasonable Accommodation for Applicants / Employees with Disabilities: The contractor must be familiar

with the requirements for and comply with the Americans with Disabilities Act and all rules and regulations established there under. Employers must provide reasonable accommodation in all employment activities unless to do so would cause an undue hardship.

9. Selection of Subcontractors, Procurement of Materials and Leasing of Equipment: The contractor shall not discriminate on the grounds of race, color, religion, sex, national origin, age or disability in the selection and retention of subcontractors, including procurement of materials and leases of equipment. The contractor shall take all necessary and reasonable steps to ensure nondiscrimination in the administration of this contract.

a. The contractor shall notify all potential subcontractors and suppliers and lessors of their EEO obligations under this contract.

b. The contractor will use good faith efforts to ensure subcontractor compliance with their EEO obligations.

10. Assurance Required by 49 CFR 26.13(b):

a. The requirements of 49 CFR Part 26 and the State DOT's U.S. DOT-approved DBE program are incorporated by reference.

b. The contractor or subcontractor shall not discriminate on the basis of race, color, national origin, or sex in the performance of this contract. The contractor shall carry out applicable requirements of 49 CFR Part 26 in the award and administration of DOT-assisted contracts. Failure by the contractor to carry out these requirements is a material breach of this contract, which may result in the termination of this contract or such other remedy as the contracting agency deems appropriate.

11. Records and Reports: The contractor shall keep such records as necessary to document compliance with the EEO requirements. Such records shall be retained for a period of three years following the date of the final payment to the contractor for all contract work and shall be available at reasonable times and places for inspection by authorized representatives of the contracting agency and the FHWA.

a. The records kept by the contractor shall document the following:

(1) The number and work hours of minority and non-minority group members and women employed in each work classification on the project;

(2) The progress and efforts being made in cooperation with unions, when applicable, to increase employment opportunities for minorities and women; and

(3) The progress and efforts being made in locating, hiring, training, qualifying, and upgrading minorities and women;

b. The contractors and subcontractors will submit an annual report to the contracting agency each July for the duration of the project, indicating the number of minority, women, and non-minority group employees currently engaged in each work classification required by the contract work. This information is to be reported on [Form FHWA-1391](#). The staffing data should represent the project work force on board in all or any part of the last payroll period preceding the end of July. If on-the-job training is being required by special provision, the contractor

will be required to collect and report training data. The employment data should reflect the work force on board during all or any part of the last payroll period preceding the end of July.

III. NONSEGREGATED FACILITIES

This provision is applicable to all Federal-aid construction contracts and to all related construction subcontracts of \$10,000 or more.

The contractor must ensure that facilities provided for employees are provided in such a manner that segregation on the basis of race, color, religion, sex, or national origin cannot result. The contractor may neither require such segregated use by written or oral policies nor tolerate such use by employee custom. The contractor's obligation extends further to ensure that its employees are not assigned to perform their services at any location, under the contractor's control, where the facilities are segregated. The term "facilities" includes waiting rooms, work areas, restaurants and other eating areas, time clocks, restrooms, washrooms, locker rooms, and other storage or dressing areas, parking lots, drinking fountains, recreation or entertainment areas, transportation, and housing provided for employees. The contractor shall provide separate or single-user restrooms and necessary dressing or sleeping areas to assure privacy between sexes.

IV. DAVIS-BACON AND RELATED ACT PROVISIONS

This section is applicable to all Federal-aid construction projects exceeding \$2,000 and to all related subcontracts and lower-tier subcontracts (regardless of subcontract size). The requirements apply to all projects located within the right-of-way of a roadway that is functionally classified as Federal-aid highway. This excludes roadways functionally classified as local roads or rural minor collectors, which are exempt. Contracting agencies may elect to apply these requirements to other projects.

The following provisions are from the U.S. Department of Labor regulations in 29 CFR 5.5 "Contract provisions and related matters" with minor revisions to conform to the FHWA-1273 format and FHWA program requirements.

1. Minimum wages

a. All laborers and mechanics employed or working upon the site of the work, will be paid unconditionally and not less often than once a week, and without subsequent deduction or rebate on any account (except such payroll deductions as are permitted by regulations issued by the Secretary of Labor under the Copeland Act (29 CFR part 3)), the full amount of wages and bona fide fringe benefits (or cash equivalents thereof) due at time of payment computed at rates not less than those contained in the wage determination of the Secretary of Labor which is attached hereto and made a part hereof, regardless of any contractual relationship which may be alleged to exist between the contractor and such laborers and mechanics.

Contributions made or costs reasonably anticipated for bona fide fringe benefits under section 1(b)(2) of the Davis-Bacon Act on behalf of laborers or mechanics are considered wages

paid to such laborers or mechanics, subject to the provisions of paragraph 1.d. of this section; also, regular contributions made or costs incurred for more than a weekly period (but not less often than quarterly) under plans, funds, or programs which cover the particular weekly period, are deemed to be constructively made or incurred during such weekly period. Such laborers and mechanics shall be paid the appropriate wage rate and fringe benefits on the wage determination for the classification of work actually performed, without regard to skill, except as provided in 29 CFR 5.5(a)(4). Laborers or mechanics performing work in more than one classification may be compensated at the rate specified for each classification for the time actually worked therein: Provided, That the employer's payroll records accurately set forth the time spent in each classification in which work is performed. The wage determination (including any additional classification and wage rates conformed under paragraph 1.b. of this section) and the Davis-Bacon poster (WH-1321) shall be posted at all times by the contractor and its subcontractors at the site of the work in a prominent and accessible place where it can be easily seen by the workers.

b. (1) The contracting officer shall require that any class of laborers or mechanics, including helpers, which is not listed in the wage determination and which is to be employed under the contract shall be classified in conformance with the wage determination. The contracting officer shall approve an additional classification and wage rate and fringe benefits therefore only when the following criteria have been met:

(i) The work to be performed by the classification requested is not performed by a classification in the wage determination; and

(ii) The classification is utilized in the area by the construction industry; and

(iii) The proposed wage rate, including any bona fide fringe benefits, bears a reasonable relationship to the wage rates contained in the wage determination.

(2) If the contractor and the laborers and mechanics to be employed in the classification (if known), or their representatives, and the contracting officer agree on the classification and wage rate (including the amount designated for fringe benefits where appropriate), a report of the action taken shall be sent by the contracting officer to the Administrator of the Wage and Hour Division, Employment Standards Administration, U.S. Department of Labor, Washington, DC 20210. The Administrator, or an authorized representative, will approve, modify, or disapprove every additional classification action within 30 days of receipt and so advise the contracting officer or will notify the contracting officer within the 30-day period that additional time is necessary.

(3) In the event the contractor, the laborers or mechanics to be employed in the classification or their representatives, and the contracting officer do not agree on the proposed classification and wage rate (including the amount designated for fringe benefits, where appropriate), the contracting officer shall refer the questions, including the views of all interested parties and the recommendation of the contracting officer, to the Wage and Hour Administrator for determination. The Wage and Hour Administrator, or an authorized representative, will issue a determination within 30 days of receipt and so advise

the contracting officer or will notify the contracting officer within the 30-day period that additional time is necessary.

(4) The wage rate (including fringe benefits where appropriate) determined pursuant to paragraphs 1.b.(2) or 1.b.(3) of this section, shall be paid to all workers performing work in the classification under this contract from the first day on which work is performed in the classification.

c. Whenever the minimum wage rate prescribed in the contract for a class of laborers or mechanics includes a fringe benefit which is not expressed as an hourly rate, the contractor shall either pay the benefit as stated in the wage determination or shall pay another bona fide fringe benefit or an hourly cash equivalent thereof.

d. If the contractor does not make payments to a trustee or other third person, the contractor may consider as part of the wages of any laborer or mechanic the amount of any costs reasonably anticipated in providing bona fide fringe benefits under a plan or program, Provided, That the Secretary of Labor has found, upon the written request of the contractor, that the applicable standards of the Davis-Bacon Act have been met. The Secretary of Labor may require the contractor to set aside in a separate account assets for the meeting of obligations under the plan or program.

2. Withholding

The contracting agency shall upon its own action or upon written request of an authorized representative of the Department of Labor, withhold or cause to be withheld from the contractor under this contract, or any other Federal contract with the same prime contractor, or any other federally-assisted contract subject to Davis-Bacon prevailing wage requirements, which is held by the same prime contractor, so much of the accrued payments or advances as may be considered necessary to pay laborers and mechanics, including apprentices, trainees, and helpers, employed by the contractor or any subcontractor the full amount of wages required by the contract. In the event of failure to pay any laborer or mechanic, including any apprentice, trainee, or helper, employed or working on the site of the work, all or part of the wages required by the contract, the contracting agency may, after written notice to the contractor, take such action as may be necessary to cause the suspension of any further payment, advance, or guarantee of funds until such violations have ceased.

3. Payrolls and basic records

a. Payrolls and basic records relating thereto shall be maintained by the contractor during the course of the work and preserved for a period of three years thereafter for all laborers and mechanics working at the site of the work. Such records shall contain the name, address, and social security number of each such worker, his or her correct classification, hourly rates of wages paid (including rates of contributions or costs anticipated for bona fide fringe benefits or cash equivalents thereof of the types described in section 1(b)(2)(B) of the Davis-Bacon Act), daily and weekly number of hours worked, deductions made and actual wages paid. Whenever the Secretary of Labor has found under 29 CFR 5.5(a)(1)(iv) that the wages of any laborer or mechanic include the amount of any costs reasonably anticipated in providing benefits under a plan or program described in section 1(b)(2)(B) of the Davis-

Bacon Act, the contractor shall maintain records which show that the commitment to provide such benefits is enforceable, that the plan or program is financially responsible, and that the plan or program has been communicated in writing to the laborers or mechanics affected, and records which show the costs anticipated or the actual cost incurred in providing such benefits. Contractors employing apprentices or trainees under approved programs shall maintain written evidence of the registration of apprenticeship programs and certification of trainee programs, the registration of the apprentices and trainees, and the ratios and wage rates prescribed in the applicable programs.

b. (1) The contractor shall submit weekly for each week in which any contract work is performed a copy of all payrolls to the contracting agency. The payrolls submitted shall set out accurately and completely all of the information required to be maintained under 29 CFR 5.5(a)(3)(i), except that full social security numbers and home addresses shall not be included on weekly transmittals. Instead the payrolls shall only need to include an individually identifying number for each employee (e.g. , the last four digits of the employee's social security number). The required weekly payroll information may be submitted in any form desired. Optional Form WH-347 is available for this purpose from the Wage and Hour Division Web site at <http://www.dol.gov/esa/whd/forms/wh347instr.htm> or its successor site. The prime contractor is responsible for the submission of copies of payrolls by all subcontractors. Contractors and subcontractors shall maintain the full social security number and current address of each covered worker, and shall provide them upon request to the contracting agency for transmission to the State DOT, the FHWA or the Wage and Hour Division of the Department of Labor for purposes of an investigation or audit of compliance with prevailing wage requirements. It is not a violation of this section for a prime contractor to require a subcontractor to provide addresses and social security numbers to the prime contractor for its own records, without weekly submission to the contracting agency..

(2) Each payroll submitted shall be accompanied by a "Statement of Compliance," signed by the contractor or subcontractor or his or her agent who pays or supervises the payment of the persons employed under the contract and shall certify the following:

(i) That the payroll for the payroll period contains the information required to be provided under §5.5 (a)(3)(ii) of Regulations, 29 CFR part 5, the appropriate information is being maintained under §5.5 (a)(3)(i) of Regulations, 29 CFR part 5, and that such information is correct and complete;

(ii) That each laborer or mechanic (including each helper, apprentice, and trainee) employed on the contract during the payroll period has been paid the full weekly wages earned, without rebate, either directly or indirectly, and that no deductions have been made either directly or indirectly from the full wages earned, other than permissible deductions as set forth in Regulations, 29 CFR part 3;

(iii) That each laborer or mechanic has been paid not less than the applicable wage rates and fringe benefits or cash equivalents for the classification of work performed, as specified in the applicable wage determination incorporated into the contract.

(3) The weekly submission of a properly executed certification set forth on the reverse side of Optional Form WH-347 shall satisfy the requirement for submission of the "Statement of Compliance" required by paragraph 3.b.(2) of this section.

(4) The falsification of any of the above certifications may subject the contractor or subcontractor to civil or criminal prosecution under section 1001 of title 18 and section 231 of title 31 of the United States Code.

c. The contractor or subcontractor shall make the records required under paragraph 3.a. of this section available for inspection, copying, or transcription by authorized representatives of the contracting agency, the State DOT, the FHWA, or the Department of Labor, and shall permit such representatives to interview employees during working hours on the job. If the contractor or subcontractor fails to submit the required records or to make them available, the FHWA may, after written notice to the contractor, the contracting agency or the State DOT, take such action as may be necessary to cause the suspension of any further payment, advance, or guarantee of funds. Furthermore, failure to submit the required records upon request or to make such records available may be grounds for debarment action pursuant to 29 CFR 5.12.

4. Apprentices and trainees

a. Apprentices (programs of the USDOL).

Apprentices will be permitted to work at less than the predetermined rate for the work they performed when they are employed pursuant to and individually registered in a bona fide apprenticeship program registered with the U.S. Department of Labor, Employment and Training Administration, Office of Apprenticeship Training, Employer and Labor Services, or with a State Apprenticeship Agency recognized by the Office, or if a person is employed in his or her first 90 days of probationary employment as an apprentice in such an apprenticeship program, who is not individually registered in the program, but who has been certified by the Office of Apprenticeship Training, Employer and Labor Services or a State Apprenticeship Agency (where appropriate) to be eligible for probationary employment as an apprentice.

The allowable ratio of apprentices to journeymen on the job site in any craft classification shall not be greater than the ratio permitted to the contractor as to the entire work force under the registered program. Any worker listed on a payroll at an apprentice wage rate, who is not registered or otherwise employed as stated above, shall be paid not less than the applicable wage rate on the wage determination for the classification of work actually performed. In addition, any apprentice performing work on the job site in excess of the ratio permitted under the registered program shall be paid not less than the applicable wage rate on the wage determination for the work actually performed. Where a contractor is performing construction on a project in a locality other than that in which its program is registered, the ratios and wage rates (expressed in percentages of the journeyman's hourly rate) specified in the contractor's or subcontractor's registered program shall be observed.

Every apprentice must be paid at not less than the rate specified in the registered program for the apprentice's level of progress, expressed as a percentage of the journeymen hourly

rate specified in the applicable wage determination. Apprentices shall be paid fringe benefits in accordance with the provisions of the apprenticeship program. If the apprenticeship program does not specify fringe benefits, apprentices must be paid the full amount of fringe benefits listed on the wage determination for the applicable classification. If the Administrator determines that a different practice prevails for the applicable apprentice classification, fringes shall be paid in accordance with that determination.

In the event the Office of Apprenticeship Training, Employer and Labor Services, or a State Apprenticeship Agency recognized by the Office, withdraws approval of an apprenticeship program, the contractor will no longer be permitted to utilize apprentices at less than the applicable predetermined rate for the work performed until an acceptable program is approved.

b. Trainees (programs of the USDOL).

Except as provided in 29 CFR 5.16, trainees will not be permitted to work at less than the predetermined rate for the work performed unless they are employed pursuant to and individually registered in a program which has received prior approval, evidenced by formal certification by the U.S. Department of Labor, Employment and Training Administration.

The ratio of trainees to journeymen on the job site shall not be greater than permitted under the plan approved by the Employment and Training Administration.

Every trainee must be paid at not less than the rate specified in the approved program for the trainee's level of progress, expressed as a percentage of the journeyman hourly rate specified in the applicable wage determination. Trainees shall be paid fringe benefits in accordance with the provisions of the trainee program. If the trainee program does not mention fringe benefits, trainees shall be paid the full amount of fringe benefits listed on the wage determination unless the Administrator of the Wage and Hour Division determines that there is an apprenticeship program associated with the corresponding journeyman wage rate on the wage determination which provides for less than full fringe benefits for apprentices. Any employee listed on the payroll at a trainee rate who is not registered and participating in a training plan approved by the Employment and Training Administration shall be paid not less than the applicable wage rate on the wage determination for the classification of work actually performed. In addition, any trainee performing work on the job site in excess of the ratio permitted under the registered program shall be paid not less than the applicable wage rate on the wage determination for the work actually performed.

In the event the Employment and Training Administration withdraws approval of a training program, the contractor will no longer be permitted to utilize trainees at less than the applicable predetermined rate for the work performed until an acceptable program is approved.

c. Equal employment opportunity. The utilization of apprentices, trainees and journeymen under this part shall be in conformity with the equal employment opportunity requirements of Executive Order 11246, as amended, and 29 CFR part 30.

d. Apprentices and Trainees (programs of the U.S. DOT).

Apprentices and trainees working under apprenticeship and skill training programs which have been certified by the Secretary of Transportation as promoting EEO in connection with Federal-aid highway construction programs are not subject to the requirements of paragraph 4 of this Section IV. The straight time hourly wage rates for apprentices and trainees under such programs will be established by the particular programs. The ratio of apprentices and trainees to journeymen shall not be greater than permitted by the terms of the particular program.

5. Compliance with Copeland Act requirements. The contractor shall comply with the requirements of 29 CFR part 3, which are incorporated by reference in this contract.

6. Subcontracts. The contractor or subcontractor shall insert Form FHWA-1273 in any subcontracts and also require the subcontractors to include Form FHWA-1273 in any lower tier subcontracts. The prime contractor shall be responsible for the compliance by any subcontractor or lower tier subcontractor with all the contract clauses in 29 CFR 5.5.

7. Contract termination: debarment. A breach of the contract clauses in 29 CFR 5.5 may be grounds for termination of the contract, and for debarment as a contractor and a subcontractor as provided in 29 CFR 5.12.

8. Compliance with Davis-Bacon and Related Act requirements. All rulings and interpretations of the Davis-Bacon and Related Acts contained in 29 CFR parts 1, 3, and 5 are herein incorporated by reference in this contract.

9. Disputes concerning labor standards. Disputes arising out of the labor standards provisions of this contract shall not be subject to the general disputes clause of this contract. Such disputes shall be resolved in accordance with the procedures of the Department of Labor set forth in 29 CFR parts 5, 6, and 7. Disputes within the meaning of this clause include disputes between the contractor (or any of its subcontractors) and the contracting agency, the U.S. Department of Labor, or the employees or their representatives.

10. Certification of eligibility.

a. By entering into this contract, the contractor certifies that neither it (nor he or she) nor any person or firm who has an interest in the contractor's firm is a person or firm ineligible to be awarded Government contracts by virtue of section 3(a) of the Davis-Bacon Act or 29 CFR 5.12(a)(1).

b. No part of this contract shall be subcontracted to any person or firm ineligible for award of a Government contract by virtue of section 3(a) of the Davis-Bacon Act or 29 CFR 5.12(a)(1).

c. The penalty for making false statements is prescribed in the U.S. Criminal Code, 18 U.S.C. 1001.

V. CONTRACT WORK HOURS AND SAFETY STANDARDS ACT

The following clauses apply to any Federal-aid construction contract in an amount in excess of \$100,000 and subject to the overtime provisions of the Contract Work Hours and Safety Standards Act. These clauses shall be inserted in addition to the clauses required by 29 CFR 5.5(a) or 29 CFR 4.6. As used in this paragraph, the terms laborers and mechanics include watchmen and guards.

1. Overtime requirements. No contractor or subcontractor contracting for any part of the contract work which may require or involve the employment of laborers or mechanics shall require or permit any such laborer or mechanic in any workweek in which he or she is employed on such work to work in excess of forty hours in such workweek unless such laborer or mechanic receives compensation at a rate not less than one and one-half times the basic rate of pay for all hours worked in excess of forty hours in such workweek.

2. Violation; liability for unpaid wages; liquidated damages. In the event of any violation of the clause set forth in paragraph (1.) of this section, the contractor and any subcontractor responsible therefor shall be liable for the unpaid wages. In addition, such contractor and subcontractor shall be liable to the United States (in the case of work done under contract for the District of Columbia or a territory, to such District or to such territory), for liquidated damages. Such liquidated damages shall be computed with respect to each individual laborer or mechanic, including watchmen and guards, employed in violation of the clause set forth in paragraph (1.) of this section, in the sum of \$10 for each calendar day on which such individual was required or permitted to work in excess of the standard workweek of forty hours without payment of the overtime wages required by the clause set forth in paragraph (1.) of this section.

3. Withholding for unpaid wages and liquidated damages. The FHWA or the contacting agency shall upon its own action or upon written request of an authorized representative of the Department of Labor withhold or cause to be withheld, from any moneys payable on account of work performed by the contractor or subcontractor under any such contract or any other Federal contract with the same prime contractor, or any other federally-assisted contract subject to the Contract Work Hours and Safety Standards Act, which is held by the same prime contractor, such sums as may be determined to be necessary to satisfy any liabilities of such contractor or subcontractor for unpaid wages and liquidated damages as provided in the clause set forth in paragraph (2.) of this section.

4. Subcontracts. The contractor or subcontractor shall insert in any subcontracts the clauses set forth in paragraph (1.) through (4.) of this section and also a clause requiring the subcontractors to include these clauses in any lower tier subcontracts. The prime contractor shall be responsible for compliance by any subcontractor or lower tier subcontractor with the clauses set forth in paragraphs (1.) through (4.) of this section.

VI. SUBLETTING OR ASSIGNING THE CONTRACT

This provision is applicable to all Federal-aid construction contracts on the National Highway System.

1. The contractor shall perform with its own organization contract work amounting to not less than 30 percent (or a greater percentage if specified elsewhere in the contract) of the total original contract price, excluding any specialty items designated by the contracting agency. Specialty items may be performed by subcontract and the amount of any such specialty items performed may be deducted from the total original contract price before computing the amount of work required to be performed by the contractor's own organization (23 CFR 635.116).

a. The term "perform work with its own organization" refers to workers employed or leased by the prime contractor, and equipment owned or rented by the prime contractor, with or without operators. Such term does not include employees or equipment of a subcontractor or lower tier subcontractor, agents of the prime contractor, or any other assignees. The term may include payments for the costs of hiring leased employees from an employee leasing firm meeting all relevant Federal and State regulatory requirements. Leased employees may only be included in this term if the prime contractor meets all of the following conditions:

(1) the prime contractor maintains control over the supervision of the day-to-day activities of the leased employees;

(2) the prime contractor remains responsible for the quality of the work of the leased employees;

(3) the prime contractor retains all power to accept or exclude individual employees from work on the project; and

(4) the prime contractor remains ultimately responsible for the payment of predetermined minimum wages, the submission of payrolls, statements of compliance and all other Federal regulatory requirements.

b. "Specialty Items" shall be construed to be limited to work that requires highly specialized knowledge, abilities, or equipment not ordinarily available in the type of contracting organizations qualified and expected to bid or propose on the contract as a whole and in general are to be limited to minor components of the overall contract.

2. The contract amount upon which the requirements set forth in paragraph (1) of Section VI is computed includes the cost of material and manufactured products which are to be purchased or produced by the contractor under the contract provisions.

3. The contractor shall furnish (a) a competent superintendent or supervisor who is employed by the firm, has full authority to direct performance of the work in accordance with the contract requirements, and is in charge of all construction operations (regardless of who performs the work) and (b) such other of its own organizational resources (supervision, management, and engineering services) as the contracting officer determines is necessary to assure the performance of the contract.

4. No portion of the contract shall be sublet, assigned or otherwise disposed of except with the written consent of the contracting officer, or authorized representative, and such consent when given shall not be construed to relieve the contractor of any responsibility for the fulfillment of the contract. Written consent will be given only after the

contracting agency has assured that each subcontract is evidenced in writing and that it contains all pertinent provisions and requirements of the prime contract.

5. The 30% self-performance requirement of paragraph (1) is not applicable to design-build contracts; however, contracting agencies may establish their own self-performance requirements.

VII. SAFETY: ACCIDENT PREVENTION

This provision is applicable to all Federal-aid construction contracts and to all related subcontracts.

1. In the performance of this contract the contractor shall comply with all applicable Federal, State, and local laws governing safety, health, and sanitation (23 CFR 635). The contractor shall provide all safeguards, safety devices and protective equipment and take any other needed actions as it determines, or as the contracting officer may determine, to be reasonably necessary to protect the life and health of employees on the job and the safety of the public and to protect property in connection with the performance of the work covered by the contract.

2. It is a condition of this contract, and shall be made a condition of each subcontract, which the contractor enters into pursuant to this contract, that the contractor and any subcontractor shall not permit any employee, in performance of the contract, to work in surroundings or under conditions which are unsanitary, hazardous or dangerous to his/her health or safety, as determined under construction safety and health standards (29 CFR 1926) promulgated by the Secretary of Labor, in accordance with Section 107 of the Contract Work Hours and Safety Standards Act (40 U.S.C. 3704).

3. Pursuant to 29 CFR 1926.3, it is a condition of this contract that the Secretary of Labor or authorized representative thereof, shall have right of entry to any site of contract performance to inspect or investigate the matter of compliance with the construction safety and health standards and to carry out the duties of the Secretary under Section 107 of the Contract Work Hours and Safety Standards Act (40 U.S.C.3704).

VIII. FALSE STATEMENTS CONCERNING HIGHWAY PROJECTS

This provision is applicable to all Federal-aid construction contracts and to all related subcontracts.

In order to assure high quality and durable construction in conformity with approved plans and specifications and a high degree of reliability on statements and representations made by engineers, contractors, suppliers, and workers on Federal-aid highway projects, it is essential that all persons concerned with the project perform their functions as carefully, thoroughly, and honestly as possible. Willful falsification, distortion, or misrepresentation with respect to any facts related to the project is a violation of Federal law. To prevent any misunderstanding regarding the seriousness of these and similar acts, Form FHWA-1022 shall be posted on each Federal-aid highway project (23 CFR 635) in one or more places where it is readily available to all persons concerned with the project:

18 U.S.C. 1020 reads as follows:

"Whoever, being an officer, agent, or employee of the United States, or of any State or Territory, or whoever, whether a person, association, firm, or corporation, knowingly makes any false statement, false representation, or false report as to the character, quality, quantity, or cost of the material used or to be used, or the quantity or quality of the work performed or to be performed, or the cost thereof in connection with the submission of plans, maps, specifications, contracts, or costs of construction on any highway or related project submitted for approval to the Secretary of Transportation; or

Whoever knowingly makes any false statement, false representation, false report or false claim with respect to the character, quality, quantity, or cost of any work performed or to be performed, or materials furnished or to be furnished, in connection with the construction of any highway or related project approved by the Secretary of Transportation; or

Whoever knowingly makes any false statement or false representation as to material fact in any statement, certificate, or report submitted pursuant to provisions of the Federal-aid Roads Act approved July 1, 1916, (39 Stat. 355), as amended and supplemented;

Shall be fined under this title or imprisoned not more than 5 years or both."

IX. IMPLEMENTATION OF CLEAN AIR ACT AND FEDERAL WATER POLLUTION CONTROL ACT

This provision is applicable to all Federal-aid construction contracts and to all related subcontracts.

By submission of this bid/proposal or the execution of this contract, or subcontract, as appropriate, the bidder, proposer, Federal-aid construction contractor, or subcontractor, as appropriate, will be deemed to have stipulated as follows:

1. That any person who is or will be utilized in the performance of this contract is not prohibited from receiving an award due to a violation of Section 508 of the Clean Water Act or Section 306 of the Clean Air Act.

2. That the contractor agrees to include or cause to be included the requirements of paragraph (1) of this Section X in every subcontract, and further agrees to take such action as the contracting agency may direct as a means of enforcing such requirements.

X. CERTIFICATION REGARDING DEBARMENT, SUSPENSION, INELIGIBILITY AND VOLUNTARY EXCLUSION

This provision is applicable to all Federal-aid construction contracts, design-build contracts, subcontracts, lower-tier subcontracts, purchase orders, lease agreements, consultant contracts or any other covered transaction requiring FHWA approval or that is estimated to cost \$25,000 or more – as defined in 2 CFR Parts 180 and 1200.

1. Instructions for Certification – First Tier Participants:

a. By signing and submitting this proposal, the prospective first tier participant is providing the certification set out below.

b. The inability of a person to provide the certification set out below will not necessarily result in denial of participation in this

covered transaction. The prospective first tier participant shall submit an explanation of why it cannot provide the certification set out below. The certification or explanation will be considered in connection with the department or agency's determination whether to enter into this transaction. However, failure of the prospective first tier participant to furnish a certification or an explanation shall disqualify such a person from participation in this transaction.

c. The certification in this clause is a material representation of fact upon which reliance was placed when the contracting agency determined to enter into this transaction. If it is later determined that the prospective participant knowingly rendered an erroneous certification, in addition to other remedies available to the Federal Government, the contracting agency may terminate this transaction for cause of default.

d. The prospective first tier participant shall provide immediate written notice to the contracting agency to whom this proposal is submitted if any time the prospective first tier participant learns that its certification was erroneous when submitted or has become erroneous by reason of changed circumstances.

e. The terms "covered transaction," "debarred," "suspended," "ineligible," "participant," "person," "principal," and "voluntarily excluded," as used in this clause, are defined in 2 CFR Parts 180 and 1200. "First Tier Covered Transactions" refers to any covered transaction between a grantee or subgrantee of Federal funds and a participant (such as the prime or general contractor). "Lower Tier Covered Transactions" refers to any covered transaction under a First Tier Covered Transaction (such as subcontracts). "First Tier Participant" refers to the participant who has entered into a covered transaction with a grantee or subgrantee of Federal funds (such as the prime or general contractor). "Lower Tier Participant" refers any participant who has entered into a covered transaction with a First Tier Participant or other Lower Tier Participants (such as subcontractors and suppliers).

f. The prospective first tier participant agrees by submitting this proposal that, should the proposed covered transaction be entered into, it shall not knowingly enter into any lower tier covered transaction with a person who is debarred, suspended, declared ineligible, or voluntarily excluded from participation in this covered transaction, unless authorized by the department or agency entering into this transaction.

g. The prospective first tier participant further agrees by submitting this proposal that it will include the clause titled "Certification Regarding Debarment, Suspension, Ineligibility and Voluntary Exclusion-Lower Tier Covered Transactions," provided by the department or contracting agency, entering into this covered transaction, without modification, in all lower tier covered transactions and in all solicitations for lower tier covered transactions exceeding the \$25,000 threshold.

h. A participant in a covered transaction may rely upon a certification of a prospective participant in a lower tier covered transaction that is not debarred, suspended, ineligible, or voluntarily excluded from the covered transaction, unless it knows that the certification is erroneous. A participant is responsible for ensuring that its principals are not suspended, debarred, or otherwise ineligible to participate in covered transactions. To verify the eligibility of its principals, as well as the eligibility of any lower tier prospective participants, each participant may, but is not required to, check the Excluded Parties List System website (<https://www.epls.gov/>), which is compiled by the General Services Administration.

i. Nothing contained in the foregoing shall be construed to require the establishment of a system of records in order to render in good faith the certification required by this clause. The knowledge and information of the prospective participant is not required to exceed that which is normally possessed by a prudent person in the ordinary course of business dealings.

j. Except for transactions authorized under paragraph (f) of these instructions, if a participant in a covered transaction knowingly enters into a lower tier covered transaction with a person who is suspended, debarred, ineligible, or voluntarily excluded from participation in this transaction, in addition to other remedies available to the Federal Government, the department or agency may terminate this transaction for cause or default.

* * * * *

2. Certification Regarding Debarment, Suspension, Ineligibility and Voluntary Exclusion – First Tier Participants:

a. The prospective first tier participant certifies to the best of its knowledge and belief, that it and its principals:

(1) Are not presently debarred, suspended, proposed for debarment, declared ineligible, or voluntarily excluded from participating in covered transactions by any Federal department or agency;

(2) Have not within a three-year period preceding this proposal been convicted of or had a civil judgment rendered against them for commission of fraud or a criminal offense in connection with obtaining, attempting to obtain, or performing a public (Federal, State or local) transaction or contract under a public transaction; violation of Federal or State antitrust statutes or commission of embezzlement, theft, forgery, bribery, falsification or destruction of records, making false statements, or receiving stolen property;

(3) Are not presently indicted for or otherwise criminally or civilly charged by a governmental entity (Federal, State or local) with commission of any of the offenses enumerated in paragraph (a)(2) of this certification; and

(4) Have not within a three-year period preceding this application/proposal had one or more public transactions (Federal, State or local) terminated for cause or default.

b. Where the prospective participant is unable to certify to any of the statements in this certification, such prospective participant shall attach an explanation to this proposal.

2. Instructions for Certification - Lower Tier Participants:

(Applicable to all subcontracts, purchase orders and other lower tier transactions requiring prior FHWA approval or estimated to cost \$25,000 or more - 2 CFR Parts 180 and 1200)

a. By signing and submitting this proposal, the prospective lower tier is providing the certification set out below.

b. The certification in this clause is a material representation of fact upon which reliance was placed when this transaction was entered into. If it is later determined that the prospective lower tier participant knowingly rendered an erroneous certification, in addition to other remedies available to the Federal Government, the department, or agency with which

this transaction originated may pursue available remedies, including suspension and/or debarment.

c. The prospective lower tier participant shall provide immediate written notice to the person to which this proposal is submitted if at any time the prospective lower tier participant learns that its certification was erroneous by reason of changed circumstances.

d. The terms "covered transaction," "debarred," "suspended," "ineligible," "participant," "person," "principal," and "voluntarily excluded," as used in this clause, are defined in 2 CFR Parts 180 and 1200. You may contact the person to which this proposal is submitted for assistance in obtaining a copy of those regulations. "First Tier Covered Transactions" refers to any covered transaction between a grantee or subgrantee of Federal funds and a participant (such as the prime or general contract). "Lower Tier Covered Transactions" refers to any covered transaction under a First Tier Covered Transaction (such as subcontracts). "First Tier Participant" refers to the participant who has entered into a covered transaction with a grantee or subgrantee of Federal funds (such as the prime or general contractor). "Lower Tier Participant" refers any participant who has entered into a covered transaction with a First Tier Participant or other Lower Tier Participants (such as subcontractors and suppliers).

e. The prospective lower tier participant agrees by submitting this proposal that, should the proposed covered transaction be entered into, it shall not knowingly enter into any lower tier covered transaction with a person who is debarred, suspended, declared ineligible, or voluntarily excluded from participation in this covered transaction, unless authorized by the department or agency with which this transaction originated.

f. The prospective lower tier participant further agrees by submitting this proposal that it will include this clause titled "Certification Regarding Debarment, Suspension, Ineligibility and Voluntary Exclusion-Lower Tier Covered Transaction," without modification, in all lower tier covered transactions and in all solicitations for lower tier covered transactions exceeding the \$25,000 threshold.

g. A participant in a covered transaction may rely upon a certification of a prospective participant in a lower tier covered transaction that is not debarred, suspended, ineligible, or voluntarily excluded from the covered transaction, unless it knows that the certification is erroneous. A participant is responsible for ensuring that its principals are not suspended, debarred, or otherwise ineligible to participate in covered transactions. To verify the eligibility of its principals, as well as the eligibility of any lower tier prospective participants, each participant may, but is not required to, check the Excluded Parties List System website (<https://www.epls.gov/>), which is compiled by the General Services Administration.

h. Nothing contained in the foregoing shall be construed to require establishment of a system of records in order to render in good faith the certification required by this clause. The knowledge and information of participant is not required to exceed that which is normally possessed by a prudent person in the ordinary course of business dealings.

i. Except for transactions authorized under paragraph e of these instructions, if a participant in a covered transaction knowingly enters into a lower tier covered transaction with a person who is suspended, debarred, ineligible, or voluntarily excluded from participation in this transaction, in addition to other remedies available to the Federal Government, the

department or agency with which this transaction originated may pursue available remedies, including suspension and/or debarment.

* * * * *

Certification Regarding Debarment, Suspension, Ineligibility and Voluntary Exclusion--Lower Tier Participants:

1. The prospective lower tier participant certifies, by submission of this proposal, that neither it nor its principals is presently debarred, suspended, proposed for debarment, declared ineligible, or voluntarily excluded from participating in covered transactions by any Federal department or agency.

2. Where the prospective lower tier participant is unable to certify to any of the statements in this certification, such prospective participant shall attach an explanation to this proposal.

* * * * *

XI. CERTIFICATION REGARDING USE OF CONTRACT FUNDS FOR LOBBYING

This provision is applicable to all Federal-aid construction contracts and to all related subcontracts which exceed \$100,000 (49 CFR 20).

1. The prospective participant certifies, by signing and submitting this bid or proposal, to the best of his or her knowledge and belief, that:

a. No Federal appropriated funds have been paid or will be paid, by or on behalf of the undersigned, to any person for influencing or attempting to influence an officer or employee of any Federal agency, a Member of Congress, an officer or employee of Congress, or an employee of a Member of Congress in connection with the awarding of any Federal contract, the making of any Federal grant, the making of any Federal loan, the entering into of any cooperative agreement, and the extension, continuation, renewal, amendment, or modification of any Federal contract, grant, loan, or cooperative agreement.

b. If any funds other than Federal appropriated funds have been paid or will be paid to any person for influencing or attempting to influence an officer or employee of any Federal agency, a Member of Congress, an officer or employee of Congress, or an employee of a Member of Congress in connection with this Federal contract, grant, loan, or cooperative agreement, the undersigned shall complete and submit Standard Form-LLL, "Disclosure Form to Report Lobbying," in accordance with its instructions.

2. This certification is a material representation of fact upon which reliance was placed when this transaction was made or entered into. Submission of this certification is a prerequisite for making or entering into this transaction imposed by 31 U.S.C. 1352. Any person who fails to file the required certification shall be subject to a civil penalty of not less than \$10,000 and not more than \$100,000 for each such failure.

3. The prospective participant also agrees by submitting its bid or proposal that the participant shall require that the language of this certification be included in all lower tier subcontracts, which exceed \$100,000 and that all such recipients shall certify and disclose accordingly.

**NOTICE OF REQUIREMENTS FOR AFFIRMATIVE
ACTION TO ENSURE EQUAL EMPLOYMENT
OPPORTUNITY (EXECUTIVE ORDER 11246)**

1. The Offeror’s or Bidder’s attention is called to the “Equal Opportunity Clause” and the “Standard Federal Equal Employment Opportunity Construction Contract Specifications” set forth herein.

2. The goal for female participation, expressed in percentage terms for the Contractor’s aggregate workforce in each trade on all construction work, is 6.9%.

Until further notice	Goals for minority participation for each trade (percent)
----------------------	---

SHSA Cities:	
Pascagoula - Moss Point -----	16.9
Biloxi - Gulfport -----	19.2
Jackson -----	30.3

SMSA Counties:	
Desoto -----	32.3
Hancock, Harrison, Stone-----	19.2
Hinds, Rankin -----	30.3
Jackson -----	16.9

Non-SMSA Counties:	
George, Greene-----	26.4

Alcorn, Benton, Bolivar, Calhoun, Carroll, Chickasaw, Clay, Coahoma, Grenada, Itawamba, Lafayette, Lee, Leflore, Marshall, Monroe, Montgomery, Panola, Pontotoc, Prentiss, Quitman, Sunflower, Tallahatchie, Tate, Tippah, Tishomingo, Tunica, Union, Washington, Webster, Yalobusha -----	26.5
--	------

Attala, Choctaw, Claiborne, Clarke, Copiah, Covington, Franklin, Holmes, Humphreys, Issaquena, Jasper, Jefferson, Jefferson Davis, Jones Kemper, Lauderdale, Lawrence, Leake, Lincoln, Lowndes, Madison, Neshoba, Newton, Noxubee, Oktibbeha, Scott, Sharkey, Simpson, Smith, Warren, Wayne, Winston, Yazoo-----	32.0
--	------

Forrest, Lamar, Marion, Pearl River, Perry, Pike, Walthall-----	27.7
---	------

Adams, Amite, Wilkinson -----	30.4
-------------------------------	------

These goals are applicable to all the Contractor’s construction work (whether or not it is Federal or federally assisted) performed in the covered area. If the contractor performs construction work in a geographical area located outside of the covered area, it shall apply the goals established for such geographical area where the work is actually performed. With regard to this second area, the contractor also is subject to the goals for both its federally involved and nonfederally involved construction.

The Contractor’s compliance with the Executive Order and the regulations in 41 CFR Part 60-4 shall be based on its implementation of the Equal Opportunity clause, specific affirmative action obligations required by the specifications set forth in 41 CFR 60-4.3(a), and its efforts to meet the goals. The hours of minority and female employment and training must be substantially uniform throughout the length of the contract, and in each trade, and the Contractor shall make a good faith effort to employ minorities and women evenly on each of its projects. The transfer of minority or female employees or trainees from Contractor to Contractor or from project to project for the sole purpose of meeting the Contractor’s goals shall be a violation of the contract, the Executive Order and the regulations in 41 CFR Part 60-4.2(d). Compliance with the goals will be measured against the total work hours performed.

3. The Contractor shall provide written notification to the Director of the Office of Federal Contract Compliance Programs within 10 working days of award of any construction subcontract in excess of \$10,000 at any tier for construction work under the contract resulting from this solicitation. The notification shall list the name, address and telephone number of the subcontractor, employer identification number of the subcontractor, estimated dollar amount of the subcontract; estimated starting and completion dates of the subcontract; and the geographical area in which the subcontract is to be performed.

4. As used in this Notice, and in the contract resulting from this solicitation, the “covered area” is to the county and city (if any), stated in the advertisement.

5. The notification required in Paragraph 3 shall be addressed to the following:

Contract Compliance Officer
Mississippi Department of Transportation
P.O. Box 1850
Jackson, Mississippi 39215-1850

(12/04/2018)

MISSISSIPPI DEPARTMENT OF TRANSPORTATION

SPECIAL PROVISION NO. 907-102-2

CODE: (IS)

DATE: 11/22/2017

SUBJECT: **Bidding Requirements and Conditions**

Section 102, Bidding Requirements and Conditions, of the 2017 Edition of the Mississippi Standard Specifications for Road and Bridge Construction is hereby amended as follows.

907-102.01--Prequalification of Bidders. Delete the last sentence of the third paragraph of Subsection 102.01 on page 13, and substitute the following.

The Bidder's Certificate of Responsibility number must be on file with the Department's Contract Administration Division prior to request for permission to bid.

907-102.02--Contents of Proposal Forms. Delete the fourth paragraph in Subsection 102.02 on page 13, and substitute the following.

Prospective bidders must complete an online request for permission to be eligible to bid a project. Upon approval, the bidder will be authorized to submit a bid electronically using Bid Express at <http://bidx.com>.

MISSISSIPPI DEPARTMENT OF TRANSPORTATION

SPECIAL PROVISION NO. 907-105-1

CODE: (SP)

DATE: 05/07/2021

SUBJECT: Authority of the Engineer

Section 105, Control of Work, of the 2017 Edition of the Mississippi Standard Specifications for Road and Bridge Construction is hereby amended as follows.

907-105.1--Authority of the Engineer. Delete the first sentence of the second paragraph of Subsection 105.01 on page 31, and substitute the following.

The Engineer has the right to suspend the work wholly or in part and to withhold payments because of the Contractor's failure to correct conditions unsafe for workmen or the general public, for failure to carry out provisions of the Contract, or for failure to carry out orders.

MISSISSIPPI DEPARTMENT OF TRANSPORTATION

SPECIAL PROVISION NO. 907-108-4

CODE: (SP)

DATE: 10/07/2020

SUBJECT: Subletting of Contract

Section 108, Prosecution and Progress, of the 2017 Edition of the Mississippi Standard Specifications for Road and Bridge Construction is hereby amended as follows.

907-108.01--Subletting of Contract.

907-108.01.1--General. Delete the third sentence of the tenth paragraph of Subsection 108.01.1 on the bottom of page 72.

MISSISSIPPI DEPARTMENT OF TRANSPORTATION

SPECIAL PROVISION NO. 907-109-3

CODE: (IS)

DATE: 02/23/2021

SUBJECT: Measurement and Payment

Section 109, Measurement and Payment, of the 2017 Edition of the Mississippi Standard Specifications for Road and Bridge Construction is hereby amended as follows.

907-109.01--Measurement of Quantities. Delete the sixth full paragraph of Subsection 109.01 on page 88, and substitute the following.

If appropriate based on the specific circumstances of the project, the Contractor may request that material specified to be measured by the cubic yard or ton be converted to the other measure. The Contractor must submit this request to the Engineer. The Engineer will provide an approval or denial in writing. The decision is in the sole discretion of the Engineer. If approved, factors for this conversion will be determined by the District Materials Engineer and agreed to by the Contractor. The conversion of the materials along with the conversion factor will be incorporated into the Contract by supplemental agreement. The supplemental agreement must be executed before such method of measurement is used.

907-109.04--Extra Work.

907-109.04.1--Supplemental Agreement. Delete the second paragraph of Subsection 109.04.1 on page 90.

907-109.06--Partial Payment.

907-109.06.2--Advancement on Materials. Delete the next to last paragraph of Subsection 109.06.2 on page 95, and substitute the following.

Materials for which an advanced payment has been allowed must be paid for by the Contractor within 30 days of the estimate on which the advanced payment was first allowed and proof of said payment must be verified by the supplier. If proof of payment is not furnished within the allowable 30 days, the advanced payment will be deducted on subsequent current estimates until such time that proof of payment is furnished.

MISSISSIPPI DEPARTMENT OF TRANSPORTATION

SPECIAL PROVISION NO. 907-402-5

CODE: (SP)

DATE: 09/21/2021

SUBJECT: Open Graded Friction Course (OGFC)

Section 907-402, Open Graded Friction Course (OGFC), of the 2017 Edition of the Mississippi Standard Specifications for Road and Bridge Construction is hereby amended as follows.

907-402.02--Materials.

907-402.02.5--Contractor's Quality Management Program.

Delete Subsection 402.02.5.9 on page 271, and substitute the following.

907-402.02.5.9--Trial Section. At the beginning of placement for the lift, the Contractor shall construct a trial section of a maximum of 250 tons of mix, for the purpose of establishing and evaluating consistent mixture and compaction properties. At the discretion of the Engineer, the requirement of a trial section may be waived if the Contractor has successfully produced and placed the asphalt mixture within the previous 365 calendar days. The Contractor shall determine the production point at which the mix shall be sampled during trial section construction. This sample does not have to be selected by the formal random selection procedures used during actual production, but should be representative of the mix produced.

The Contractor (QC) and the Department (QA) will conduct tests for mixture quality. A trial section is considered to be successful if the QC test results are within the Warning Limits (the testing indicates a pay factor of 1.0) and the QC tests compare to the QA tests within the allowable differences set forth in Subsection 402.02.6.2. If the criteria for a successful trial section are not achieved, additional trial sections shall be constructed until the criteria are achieved, at which time full production can begin. In the event a successful trial section is not accomplished by the completion of the second trial section, the Contractor shall construct additional trial sections at an offsite location. The Engineer reserves the right to have any trial section removed and replaced at no additional cost to the State, if the pay factor for any characteristic for a trial section is less than 0.75.

For actual payment purposes, a pay factor of 1.00 will be used for the first and second trial sections allowed to remain in place. Any required offsite trial sections will be constructed at no additional cost to the State.

907-402.02.7--Acceptance Procedure for OGFC Pavement Smoothness. Delete the paragraph in Subsection 402.02.7 on page 274, and substitute the following.

907-402.02.7.1--High Speed Inertial Profiling System. The high speed inertial profiling system shall meet the applicable requirements of Subsection 401.02.6.9. Additionally, each laser shall have minimum footprint of three (3) inches oriented in the transverse direction of travel.

907-402.02.7.2--Smoothness Tolerances. When the contract requires multiple lifts of asphalt and the top lift is OGFC, the smoothness tolerance shall meet the requirements of Subsection 907-402.02.7.2.1. When the contract only requires an OGFC lift, the smoothness tolerance shall meet the requirements of Subsection 907-402.02.7.2.2.

907-402.02.7.2.1--Multiple Lifts with OGFC. Smoothness tolerances for these surfaces shall meet the minimum requirements of the long continuous interval for Category A projects as defined in Subsection 403.03.2.1. Short continuous interval smoothness tolerances shall be applied to the final lift of asphalt preceding placement of OGFC and meet the requirements for Category A projects as defined in Subsection 403.03.2.1. A unit price increase will be added when the MRI for the final surface lift is less than or equal to forty five inches per mile (45.0 inches / mile) on the long continuous interval report. The final riding surface will be considered for incentive pay based on the following guidelines for the long continuous interval MRI.

Mean Roughness Index (inches/mile)	Contract Price Adjustment Percent of Asphalt Unit Bid Price
Less than 30.0	108
30.1 to 35.0	106
35.1 to 40.0	104
40.1 to 45.0	102
45.1 to 60.0	100

In addition to the above pay factors, the final riding surface will be subject to a disincentive when the Long Continuous Interval MRI exceeds the allowable tolerance based on the following guidelines.

Mean Roughness Index (inches / mile)	Contract Price Adjustment Percent of Asphalt Unit Bid Price
Above 20.0 Over	REMOVE AND REPLACE
15.1 to 20.0 Over	80
10.1 to 15.0 Over	85
5.1 to 10.0 Over	90
0.1 to 5.0 Over	95
Required Surface MRI (60 inches / mile)	100

All transverse joints in or abutting the OGFC shall meet a tolerance of 1/8" or less when checked using a 10-foot straight edge, unless directed by the Engineer.

907-402.02.7.2.1.1--Surface Correction. In the event surface correction is needed it shall be accomplished by removal and replacement in accordance with Subsection 403.03.4. All such corrections shall be at no additional cost to the State.

907-402.02.7.2.2--Single Lift of OGFC.

When the contract requires the OGFC to be placed on a milled surface, the final OGFC surface shall be measured by a long continuous (528-foot) surface MRI and have a value of no more than 60 inches per mile.

Mean Roughness Index (inches / mile)	Contract Price Adjustment Percent of Asphalt Unit Bid Price
Above 80.0	70
75.1 to 80.0	80
70.1 to 75.0	85
65.1 to 70.0	90
60.1 to 65.0	95
Required Surface MRI (60 inches / mile)	100

The final riding surface for the OGFC will not be subject to any smoothness requirements other than all transverse joints in or abutting the OGFC shall meet a tolerance of 1/8" or less when checked using a 10-foot straight edge, unless directed by the Engineer.

907-402.05--Basis of Payment. Delete the list of the pay items on page 281, and substitute the following.

907-402-A: Open Graded Friction Course, $\frac{*}{\text{Mixture}}$ - per ton

907-402-B: Bituminous Tack Coat - per gallon

* 9.5-mm mixture or 12.5-mm mixture

MISSISSIPPI DEPARTMENT OF TRANSPORTATION

SPECIAL PROVISION NO. 907-405-1

CODE: (SP)

DATE: 09/21/2021

SUBJECT: Stone Matrix Asphalt

Section 907-405, Stone Matrix Asphalt, of the 2017 Edition of the Mississippi Standard Specifications for Road and Bridge Construction is hereby amended as follows.

907-405.02--Materials.

907-405.02.5--Contractor's Quality Management Program.

Delete Subsection 405.02.5.9 on page 300, and substitute the following.

907-405.02.5.9--Trial Section. At the beginning of placement for each lift, the Contractor shall construct a trial section of a maximum of 400 tons of mixture, for the purpose of establishing and evaluating consistent mixture properties and the compactability of the mixture. At the discretion of the Engineer, the requirement of a trial section may be waived if the Contractor has successfully produced and placed the asphalt mixture within the previous 365 calendar days. The Contractor shall determine the production point at which the mixture shall be sampled during trial section construction. This sample does not have to be selected by the formal random selection procedures used during actual production, but should be representative of the mixture produced.

Density tests shall be performed according to the procedures in Chapter 7 of MDOT's Field Manual for Asphalt Mixtures (First Production Day) with the exception that two (2) lots shall be tested and the core densities be averaged. The Contractor (QC) and the Department (QA) will conduct tests for mixture quality. A trial section is considered to be successful if the QC test results are within the Warning Limits (the testing indicates a pay factor of 1.0) and the QC tests compare to the QA tests within the allowable differences set forth in Subsection 401.02.6.2. If the criteria for a successful trial section are not achieved, additional trial sections of at least 200 tons but not more than 400 tons shall be constructed until the criteria are achieved, at which time full production can begin. In the event a successful trial section is not accomplished by the completion of the second trial section, the Contractor shall construct additional trial sections at an offsite location. The Engineer reserves the right to have any trial section removed and replaced at no additional cost to the State, if the pay factor for any characteristic for a trial section is less than 0.75.

For actual payment purposes, a pay factor of 1.00 will be used for all first and second trial sections allowed to remain in place. Any required offsite trial sections will be constructed at no additional cost to the State.

907-405.05--Basis of Payment. Add the "907" prefix to the pay item listed on page 305.

MISSISSIPPI DEPARTMENT OF TRANSPORTATION

SPECIAL PROVISION NO. 907-701-3

CODE: (SP)

DATE: 05/04/2021

SUBJECT: Hydraulic Cement

Section 701, Hydraulic Cement, of the 2017 Edition of the Mississippi Standard Specifications for Road and Bridge Construction is hereby amended as follows.

907-701.01--General. In the first sentence of the second paragraph of Subsection 701.01 on page 718, change “mills” to “plants.”

In the second sentence of the sixth paragraph of Subsection 701.01 on pages 718 and 719, change “shall” to “will.”

907-701.02--Portland Cement.

907-701.02.1-General.

907-701.02.1.2--Alkali Content. Delete the sentence in Subsection 701.02.1.2 on page 719, and substitute the following.

When used in portland cement concrete, the total alkali contribution from all cement types in this Subsection shall not exceed 4.0 lb. per cubic yard of concrete calculated as follows:

$$\text{lb alkali per cu Yd} = \frac{(\text{lb cement per cu Yd}) \times (\% \text{Na}_2\text{O equivalent in cement})}{100}$$

In the above calculation, the maximum cement alkali content reported on the cement mill certificate shall be used. An example calculation can be found in the Department’s *Concrete Field Manual*.

907-701.02.2--Replacement by Other Cementitious Materials. Delete the paragraph in Subsection 701.02.2 on page 719, and substitute the following.

The maximum replacement of cement by weight is 25% for fly ash or 50% for ground granulated blast furnace slag (GGBFS). Replacement contents below 20% for fly ash or 45% for GGBFS may be used, but will not be given any special considerations, such as the maximum acceptance temperature for portland cement concrete containing pozzolans in Subsection 804.02.13.1.5. Special considerations shall only apply for replacement of cement by fly ash or GGBFS.

Delete Subsection 701.02.2.1 on pages 719 and 720, and substitute the following.

907-701.02.2.1--Portland Cement Concrete Exposed to Soluble Sulfate Conditions or Seawater.

When portland cement concrete is exposed to moderate or severe soluble sulfate conditions, or to seawater, cement types and replacement of cement by Class F fly ash or GGBFS shall be as follows in Table 1. Class C fly ash shall not be used as a replacement for cement in any of the sulfate exposure conditions listed in Table 1.

Table 1- Cementitious Materials for Soluble Sulfate Conditions or Seawater

Sulfate Exposure	Water-soluble sulfate (SO ₄) in soil, % by mass	Sulfate (SO ₄) in water, ppm	Cementitious material required
Moderate and Seawater	0.10 - 0.20	150 - 1,500	Type I cement with one of the following replacements of cement by weight: 24.5 - 25.0% Class F fly ash, or 49.5 - 50.0% GGBFS or Type II ^{**} cement
Severe	0.20 - 2.00	1,500 - 10,000	Type I cement with a replacement by weight of 49.5 - 50.0% GGBFS, or Type II [*] cement with one of the following replacements of cement by weight: 24.5 - 25.0% Class F fly ash, or 49.5 - 50.0% GGBFS

* Type III cement conforming to AASHTO M85 with a maximum 8% tricalcium aluminate (C₃A) may be used in lieu of Type II cement as allowed in Subsection 701.02.1; this cement is given the designation “Type III(MS).”

** Class F fly ash or GGBFS may be added as a replacement for cement as allowed in Subsection 907-701.02.2.

Delete Subsection 701.02.2.2 on page 720, and substitute the following.

907-701.02.2.2--Portland Cement for Soil Stabilization Exposed to Soluble Sulfate Conditions or Seawater. When portland cement for use in soil stabilization is exposed to moderate or severe soluble sulfate conditions, or to seawater, cement types and replacement of cement by Class F fly ash or GGBFS shall meet the requirements of Subsection 701.02.2.1.

907-701.04--Blended Hydraulic Cement.

907-701.04.1--General. Delete Subsection 701.04.1.1 on page 720, and substitute the following.

907-701.04.1.1--Types of Blended Hydraulic Cement. Blended hydraulic cements (blended cements) shall be of the following types and conform to AASHTO M 240:

- Type IL – Portland-limestone cement
- Type IP – Portland-pozzolan cement
- Type IS – Portland blast-furnace slag cement

Blended cement Types IL, IP, and IS meeting the “MS” sulfate resistance requirement listed in AASHTO M 240, Table 3 shall have the “(MS)” suffix added to the type designation.

907-701.04.1.2--Alkali Content. Delete the sentence in Subsection 701.04.1.2 on page 720, and substitute the following.

All blended cement types shall be made with clinker that would result in cement meeting the requirements of Subsection 701.02.1.2 when used in the production of AASHTO M 85, Type I or Type II cement.

The blended cement manufacturer shall include the percent equivalent alkalis as Na₂O on their cement mill reports.

When calculating the total alkali contribution with blended cements, use the equivalent alkali content of the base portland cement. An example calculation for cases where blended cements are used can be found in the Department’s *Concrete Field Manual*.

907-701.04.2--Replacement by Other Cementitious Materials. Delete the paragraph in Subsection 701.04.2 on page 720, and substitute the following.

The maximum replacement of blended cement Type IL by weight is 35% for fly ash or 50% for GGBFS. Replacement contents below 20% for fly ash or 45% for GGBFS may be used, but will not be given any special considerations, such as the maximum acceptance temperature for blended cement concrete containing pozzolans in Subsection 804.02.13.1.5. Special considerations shall only apply for replacement of blended cement by fly ash or GGBFS.

No additional cementitious materials, such as portland cement, blended cement, fly ash, GGBFS, or others, shall be added to or as a replacement for blended cement Types IP and IS.

Delete Subsection 701.04.2.1 on pages 720 and 721, and substitute the following.

907-701.04.2.1--Blended Cement Concrete Exposed to Soluble Sulfate Conditions or Seawater. When blended cement concrete is exposed to moderate or severe soluble sulfate conditions, or to seawater, cement types and replacement of cement by Class F fly ash or GGBFS shall be as follows in Table 2. Class C fly ash shall not be used as a replacement for cement in any of the sulfate exposure conditions listed in Table 2.

Table 2- Cementitious Materials for Soluble Sulfate Conditions or Seawater

Sulfate Exposure	Water-soluble sulfate (SO ₄) in soil, % by mass	Sulfate (SO ₄) in water, ppm	Cementitious material required
Moderate and Seawater	0.10 - 0.20	150 - 1,500	Type IL (MS) * cement, Type IL cement with one of the following replacements of cement by weight: 24.5 - 35.0% Class F fly ash, or 49.5 - 50.0% GGBFS, Type IP (MS) cement, or Type IS (MS) cement
Severe	0.20 - 2.00	1,500 - 10,000	Type IL cement with a replacement of cement by weight of 49.5 - 50.0% GGBFS, or Type IL (MS) cement with one of following replacements of cement by weight: 24.5 - 35.0% Class F fly ash, or 49.5 - 50.0% GGBFS

* Class F fly ash or GGBFS may be added as a replacement for cement as allowed in Subsection 907-701.04.2.

Delete Subsection 701.04.2.2 on page 721, and substitute the following.

907-701.04.2.2--Blended Cement for Soil Stabilization Exposed to Soluble Sulfate Conditions or Seawater. When blended cement for use in soil stabilization is exposed to moderate or severe soluble sulfate conditions, or to seawater, cement types and replacement of cement by Class F fly ash or GGBFS shall meet the requirements of Subsection 701.04.2.1.

Delete Subsection 701.04.3 on page 721.

MISSISSIPPI DEPARTMENT OF TRANSPORTATION

SPECIAL PROVISION NO. 907-702-4

CODE: (IS)

DATE: 09/11/2018

SUBJECT: Bituminous Materials

Section 702, Bituminous Materials, of the 2017 Edition of the Mississippi Standard Specifications for Road and Bridge Construction is hereby amended as follows.

907-702.04--Sampling. Delete the sentence in Subsection 702.04 on page 722, and substitute the following.

Sampling of bituminous materials shall be as set out in AASHTO R 66.

907-702.07--Emulsified Asphalt. Delete the last sentence in Subsection 702.07 on page 724, and substitute the following.

Asphalt for fog seal shall conform to the requirements of Subsection 907-702.12, Table V.

907-702.12--Tables. Delete Table V in Subsection 702.12 on page 729, and substitute the following.

**TABLE V
SPECIFICATION FOR FOG SEAL**

Test Requirements	LD-7		CHPF-1		Test Method
	Min.	Max.	Min.	Max.	
Viscosity, Saybolt Furol, @ 25°C, Sec.	10	100	-	100	AASHTO T 72
Storage Stability Test, 24 hr, %	-	1	-	1	AASHTO T 59
Settlement, 5 day, %	-	5	-	-	AASHTO T 59
Oil Distillate, %	-	1	-	-	AASHTO T 59
Sieve Test, % *	-	0.3	-	0.1	AASHTO T 59
Residue by Distillation, %	40	-	40	-	AASHTO T 59
Test on Residue from Distillation					
Penetration @ 25°C, 100g, 5 sec	-	20	40	90	AASHTO T 49
Softening Point, °C	65	-	-	-	ASTM D 36
Solubility in trichloroethylene, %	97.5	-	-	-	AASHTO T 44
Elastic Recovery @ 25°C, %	-	-	40	-	AASHTO T 301
Original DSR @ 82° (G*/Sinδ, 10 rad/sec)	1	-	-	-	AASHTO T 111

* The Sieve Test result is tested for reporting purposes only and may be waived if no application problems are present in the field.

MISSISSIPPI DEPARTMENT OF TRANSPORTATION

SPECIAL PROVISION NO. 907-703-1

CODE: (IS)

DATE: 06/13/2018

SUBJECT: Gradation

Section 703, Aggregates, of the 2017 Edition of the Mississippi Standard Specifications for Road and Bridge Construction is hereby amended as follows.

907-703.03--Course Aggregates for Hydraulic Cement Concrete.

907-703.03.2--Detail Requirements.

907-703.03.2.4--Gradation. In the table in Subsection 703.03.2.4 on page 734, add 100 for the percent passing by weight on the 1½-inch sieve for Size No. 67 aggregates.

MISSISSIPPI DEPARTMENT OF TRANSPORTATION

SPECIAL PROVISION NO. 907-705-1

CODE: (IS)

DATE: 06/13/2018

SUBJECT: Stone Riprap

Section 705, Stone Blanket Protection and Filter Blanket Materials, of the 2017 Edition of the Mississippi Standard Specifications for Road and Bridge Construction is hereby amended as follows.

907-705.04--Stone Riprap. Delete the last sentence of the first paragraph of Subsection 705.04 on page 750, and substitute the following.

Quality requirements for rock to be furnished under these specifications will come from a pre-approved source and be visually approved prior to use.

MISSISSIPPI DEPARTMENT OF TRANSPORTATION

SPECIAL PROVISION NO. 907-707-3

CODE: (SP)

DATE: 10/27/2021

SUBJECT: Joint Materials

Section 707, Joint Materials, of the 2017 Edition of the Mississippi Standard Specifications for Road and Bridge Construction is hereby amended as follows.

907-707.02--Joint Filler.

907-707.02.2--Preformed Sponge, Rubber, Cork and Closed-Cell Polypropylene Foam Joint Fillers for concrete Paving and Structural Constructions. Delete the two paragraphs of Subsection 707.02.2 on page 755, and substitute the following.

Preformed joint filler shall conform to AASHTO M 153 for sponge, rubber, and cork and tested according to ASTM D545. The type required will be indicated on the plans.

Closed-cell polypropylene foam shall conform to the requirements in ASTM D8139 and tested in accordance with ASTM D545.

907-707.02.3--Wood. Delete paragraph (b) of Subsection 707.02.3 on page 755, and substitute the following:

- (b) Dimensions shall be as shown on the plans. Dimensions shown on the plans are “dressed” sizes in accordance with Table 3 of the American Softwood Lumber Standard, SP-20. At the discretion of the Engineer, a 3/4-inch dressed board may be used in lieu of a 1-inch dressed board. A tolerance of plus or minus 1/16 inch thickness and plus or minus 1/8 inch width will be permitted. For slip-form paving a tolerance of minus 1/4 inch on each end in length will be permitted.

907-707.06--Flexible Plastic Gasket for Joining Conduit. Delete the third paragraph of Subsection 707.06 on page 756, and substitute the following.

The Department may require the performance test described in ASTM C 990.

MISSISSIPPI DEPARTMENT OF TRANSPORTATION

SPECIAL PROVISION NO. 907-711-2

CODE: (IS)

DATE: 09/11/2018

SUBJECT: Plain Steel Wire

Section 711, Reinforcement and Wire Rope, of the 2017 Edition of the Mississippi Standard Specifications for Road and Bridge Construction is hereby amended as follows.

907-711.02--Deformed and Plain Carbon-Steel Bars for Concrete Reinforcing.

907-711.02.3--Steel Welded and Non-Welded Wire Reinforcement, Plain and Deformed, for Concrete.

907-711.02.3.1--Plain Steel Wire. Delete the sentence in Subsection 711.02.3.1 on pages 780 and 781, and substitute the following.

Plain steel wire and plain steel welded wire shall conform to the requirements of AASHTO M 336.

MISSISSIPPI DEPARTMENT OF TRANSPORTATION

SPECIAL PROVISION NO. 907-714-3

CODE: (SP)

DATE: 08/31/2021

SUBJECT: Miscellaneous Materials

Section 714, Miscellaneous Materials, of the 2017 Edition of the Mississippi Standard Specifications for Road and Bridge Construction is hereby amended as follows.

907-714.01--Water.

907-714.01.1--General. Delete the last sentence of the second paragraph in Subsection 714.01.1 on page 794.

907-714.01.2--Water for Use in Concrete. Delete Subsection 714.01.2 on page 794, and substitute the following:

Water from municipal sources is permitted be used as mixing water in concrete, mortar, and grout without Department testing. Water from non-municipal water sources used in mixing of concrete, mortar, and grout which does not meet the requirements in Subsection 714.01.1 shall be tested for conformance as required in AASHTO M157, Table 1 and Table 2.

907-714.01.3--Water for Use in Chemically Stabilized Based. Delete the first sentence of first paragraph in Subsection 714.01.3 on page 794, and substitute the following:

Water used in the construction of bases that contain cement, lime, or other chemical additive shall be as set out in Subsection 714.01.1. Water from municipal sources is permitted to be used without testing for conformance to the requirements below. If water is not from a municipal source, it shall not contain impurities in excess of the following limits:

Delete Subsection 714.01.6 on page 795, and substitute the following.

907-714.01.6--Blank.

907-714.05--Fly Ash.

907-714.05.1--General. Delete the first sentence of the fifth paragraph in Subsection 714.05.1 on page 797.

907-714.13--Geotextiles.

907-714.13.11--Tables. Delete Table 1 in Subsection 714.13.11 on page 813, and substitute the following.

Table 1 - Geotextiles

Type Designation	I ¹	II ¹	III	IV	V	VI		VII		VIII	IX	Test Method
	Sediment Control	Drainage	Paving	Separation & Drainage	Separation, Stabilization & Reinforcement	Non-Woven	Woven	Non-Woven	Woven	High Strength		
Grab Strength (lb)	50	90	110	90	200	180	280	180	450	280	280	ASTM D 4632
Elongation (%)	---	50% max @ 45 lb	20% min	50% min @ break	50% min	50% min	50% max	50% min	50% max	50% min	50% min	ASTM D 4632
Seam Strength (lb)	---	---	70	---	180	160	240	160	400	240	240	ASTM D 4632
Puncture Strength (lb)	---	---	40	---	80	75	110	75	180	115	115	ASTM D 6241
Trapezoidal Tear (lb)	---	---	40	---	80	70	100	70	150	100	100	ASTM D 4533
Asphalt Retention (gal/yd ²)	---	---	---	0.2	---	---	---	---	---	---	---	ASTM D 6140
Permittivity (sec ⁻¹) min	0.05	0.05	0.5	---	0.2	0.2	0.2	0.2	0.2	0.2	0.2	ASTM D 4491
AOS Woven (mm) max	0.60	0.60	0.6	---	0.6	0.43	0.43	---	0.43	---	---	ASTM D 4751
AOS Non-Woven (mm) max	0.84	0.84	0.43	---	0.43	0.43	---	0.43	---	0.43	---	---
Tensile Strength after UV (% Retained)	70% @ 500 hr	70% @ 500 hr	50% @ 500 hr	---	50% @ 500 hr	50% @ 500 hr	50% @ 500 hr	50% @ 500 hr	50% @ 500 hr	50% @ 500 hr	50% @ 500 hr	ASTM D 4355
Melting Point °(F)	---	---	---	325	---	---	---	---	---	---	---	ASTM D 276
Minimum Ultimate Tensile Strength ³ (lb/in)	---	---	---	---	---	---	---	---	---	---	660	ASTM D 4595

Notes: 1 - All property values, with the exception of apparent opening size (AOS), represent minimum average roll values in the weakest principal direction. Values for AOS represent the maximum average roll values, 2 - Values not identified in this table should meet manufacturer certification for the use and application, 3 - Machine direction

Delete Subsection 714.15 on pages 816 and 817 and substitute the following.

907-714.15--Geogrids.

907-714.15.1--General. A geogrid is defined as a geosynthetic formed by a regular network of connected elements with apertures greater than 0.25 inch to allow interlocking with surrounding soil, rock, and other surrounding materials to function primarily as reinforcement.

Geogrid shall be manufactured from an expanded strain hardened monolithic polymer sheet composed of one or more synthetic polymers and shall be mildew resistant and inert to biological degradation and naturally encountered chemicals, alkalis and acids. The geogrid shall contain stabilizers and/or inhibitors, or a resistance finish or covering to make it resistant to deterioration from direct sunlight, ultraviolet rays, and heat.

Geogrid manufacturers shall participate in and be in compliance with the American Association of State Highway Transportation Officials (AASHTO) National Transportation Product Evaluation Program's (NTPEP) Geosynthetics audit program. Geogrid shall meet the requirements of Table II for the application and type shown on the plans and shall be selected from the Department's Approved Lists.

907-714.15.1.1--Geogrid for Retaining Walls and Reinforced Soil Slopes. Geogrid for retaining walls and reinforced soil slopes shall be creep tested in accordance with AASHTO R69 and meet Long Term Design Load, Minimum Ultimate Tensile Strength, and open area criteria listed in Table II. Manufacturers shall perform at least one long-term creep test for no less than 10,000 hours in accordance to ASTM D 5262 for each polymer or composition of polymers from which the geogrid is produced. The long-term design load that shall be reported for design use, shall be that load at which no more than 10% strain occurs over a 100-year design life of the geogrid, as calculated in accordance with AASHTO R69. Long-term design loads shall be reported unfactored, and the AASHTO strength reduction factors (Durability and Installation, and safety factors) will be considered by the Department's Geotechnical Branch on a site specific design basis.

907-714.15.1.2--Geogrid for Subgrade Stabilization. Geogrid for subgrade stabilization shall meet Minimum Ultimate Tensile Strength and open area criteria listed in Table II.

907-714.15.2--Marking, Shipment, and Storage. Each roll or container of geogrid shall be visibly labeled with the name of the manufacturer, trade name of the product, lot number, and quantity of material. In addition, each roll or container shall be clearly tagged to show the type designation that corresponds to that required by the plans. During shipment and storage the geogrid shall be protected from direct sunlight, and temperatures above 120°F or below 0°F. The geogrid shall either be wrapped and maintained in a heavy duty protective covering or stored in a safe enclosed area to protect from damage during prolonged storage.

907-714.15.3--Manufacturer Certification. The Contractor shall furnish the Engineer three copies of the manufacturer's certified test reports indicating that the geogrid furnished conforms to the requirements of the specifications and is of the same composition as the originally approved

by the Department.

907-714.15.4--Acceptance Sampling and Testing. Final acceptance of each shipment will be based upon results of tests performed by the Department on verification samples submitted from the project, as compared to the manufacturer's certified test reports. The Engineer will select one roll or container at random from each shipment for sampling. As sample extending full width of the randomly selected roll or container and being at least five (5) square yards in area will be obtained and submitted by the Engineer. All material samples shall be provided at no cost to the State.

**TABLE II
GEOGRIDS**

Physical Properties	Type Designation						Test Method
	I	II	III	IV	V	VI	
Long Term Design Load ¹ , pounds per foot, Machine Direction	250	500	750	1500	2500	3500	AASHTO R69, ASTM D5262
Minimum Ultimate Tensile Strength ² , pounds per foot, Machine Direction	500	1000	1500	3000	5000	7000	ASTM D6637
Open Area, percent	70	70	50	50	50	50	Direct Measurement

¹ Minimum design criteria requirement.

² Minimum Average Roll Value (MARV).

MISSISSIPPI DEPARTMENT OF TRANSPORTATION

SPECIAL PROVISION NO. 907-720-2

CODE: (IS)

DATE: 09/11/2018

SUBJECT: Acceptance Procedure for Glass Beads

Section 720, Pavement Marking Materials, of the 2017 Edition of the Mississippi Standard Specifications for Road and Bridge Construction is hereby amended as follows.

907-720.01--Glass Beads.

907-720.01.4--Acceptance Procedures. Delete the last sentence of the paragraph in Subsection 720.01.4 on page 841, and substitute the following.

Acceptance sampling and testing of glass beads will be in accordance with the Department's Materials Division Inspection, Testing, and Certification Manual, Section 2.9.2 -- Glass Beads.

MISSISSIPPI DEPARTMENT OF TRANSPORTATION

SPECIAL PROVISION NO. 907-721-2

CODE: (IS)

DATE: 01/08/2020

SUBJECT: Materials for Signing

Section 721, Materials for Signing, of the 2017 Edition of the Mississippi Standard Specifications for Road and Bridge Construction is hereby amended as follows.

907-721.06--Reflective Sheeting.

907-721.06.2--Performance Requirements. Delete Table 4 and Table 5 in Subsection 721.06.2 on pages 860 & 861, and substitute the following.

**MINIMUM COEFFICIENTS OF RETROREFLECTION
Candela per foot candle per square foot (cd/ft²)
Per ASTM Designation D4956**

**TABLE 4
Type IX Sheeting**

Observation Angle	Entrance Angle	White	Yellow	Green	Red	Blue	Fluorescent Yellow/Green	Fluorescent Yellow	Fluorescent Orange
0.2°	-4.0°	380	285	38	76	17	300	230	115
0.2°	+30.0°	215	162	22	43	10	170	130	65
0.5°	-4.0°	240	180	24	48	11	190	145	72
0.5°	+30.0°	135	100	14	27	6.0	110	81	41
1.0°	-4.0°	80	60	8.0	16	3.6	64	48	24
1.0°	+30.0°	45	34	4.5	9.0	2.0	36	27	14

**TABLE 5
Type XI Sheeting**

Observation Angle	Entrance Angle	White	Yellow	Green	Red	Blue	Brown	Fluorescent Yellow/Green	Fluorescent Yellow	Fluorescent Orange
0.2°	-4.0°	580	435	58	87	26	17	460	350	175
0.2°	+30.0°	220	165	22	33	10	7.0	180	130	66
0.5°	-4.0°	420	315	42	63	19	13	340	250	125
0.5°	+30.0°	150	110	15	23	7.0	5.0	120	90	45
1.0°	-4.0°	120	90	12	18	5.0	4.0	96	72	36
1.0°	+30.0°	45	34	5.0	7.0	2.0	1.0	36	27	14

SECTION 905 - PROPOSAL

Date _____

Mississippi Transportation Commission
Jackson, Mississippi

Sirs: The following proposal is made on behalf of _____
_____ of _____

for constructing the following designated project(s) within the time(s) hereinafter specified.

The plans are composed of drawings and blue prints on file in the offices of the Mississippi Department of Transportation, Jackson, Mississippi.

The Specifications are the current Standard Specifications of the Mississippi Department of Transportation approved by the Federal Highway Administration, except where superseded or amended by the plans, Special Provisions and Notice(s) to Bidders attached hereto and made a part thereof.

I (We) certify that I (we) possess a copy of said Standard and any Supplemental Specifications.

Evidence of my (our) authority to submit the Proposal is hereby furnished. The proposal is made without collusion on the part of any person, firm or corporation. I (We) certify that I (we) have carefully examined the Plans, the Specifications, including the Special Provisions and Notice(s) to Bidders, herein, and have personally examined the site of the work. On the basis of the Specifications, Special Provisions, Notice(s) to Bidders, and Plans, I (we) propose to furnish all necessary machinery, tools, apparatus and other means of construction and do all the work and furnish all the materials in the manner specified. I (We) understand that the quantities mentioned herein are approximate only and are subject to either increase or decrease, and hereby propose to perform any increased or decreased quantities of work at the unit prices bid, in accordance with the above.

I (We) acknowledge that this proposal will be found irregular and/or non-responsive unless a certified check, cashier's check, or Proposal Guaranty Bond in the amount as required in the Advertisement (or, by law) is submitted electronically with the proposal or is delivered to the Contract Administration Engineer prior to the bid opening time specified in the advertisement.

INSTRUCTION TO BIDDERS: Alternate and Optional Items on Bid Schedule.

1. Two or more items entered opposite a single unit quantity WITHOUT DEFINITE DESIGNATION AS "ALTERNATE ITEMS" are considered as "OPTIONAL ITEMS". Bidders may or may not indicate on bids the Optional Item proposed to be furnished or performed WITHOUT PREJUDICE IN REGARD TO IRREGULARITY OF BIDS.
2. Items classified on the bid schedule as "ALTERNATE ITEMS" and/or "ALTERNATE TYPES OF CONSTRUCTION" must be preselected and indicated on bids. However, "Alternate Types of Construction" may include Optional Items to be treated as set out in Paragraph 1, above.
3. Optional items not preselected and indicated on the bid schedule MUST be designated in accordance with Subsection 102.06 prior to or at the time of execution of the contract.
4. Optional and Alternate items designated must be used throughout the project.

I (We) further propose to perform all "force account or extra work" that may be required of me (us) on the basis provided in the Specifications and to give such work my (our) personal attention in order to see that it is economically performed.

I (We) further propose to execute the attached contract agreement (Section 902) as soon as the work is awarded to me (us), and to begin and complete the work within the time limit(s) provided for in the Specifications and Advertisement. I (We) also propose to execute the attached contract bond (Section 903) in an amount not less than one hundred (100) percent of the total of my (our) part, but also to guarantee the excellence of both workmanship and materials until the work is finally accepted.

I (We) shall submit electronically with our proposal or deliver prior to the bid opening time a certified check, cashier's check or bid bond for **five percent (5%) of total bid** and hereby agree that in case of my (our) failure to execute the contract and furnish bond within Ten (10) days after notice of award, the amount of this check (bid bond) will be forfeited to the State of Mississippi as liquidated damages arising out of my (our) failure to execute the contract as proposed. It is understood that in case I am (we are) not awarded the work, the check will be returned as provided in the Specifications.

SECTION 905 -- PROPOSAL (CONTINUED)

I (We) hereby certify by digital signature and electronic submission via Bid Express of the Section 905 proposal below, that all certifications, disclosures and affidavits incorporated herein are deemed to be duly executed in the aggregate, fully enforceable and binding upon delivery of the bid proposal. I (We) further acknowledge that this certification shall not extend to the bid bond or alternate security which must be separately executed for the benefit of the Commission. This signature does not cure deficiencies in any required certifications, disclosures and/or affidavits. I (We) also acknowledge the right of the Commission to require full and final execution on any certification, disclosure or affidavit contained in the proposal at the Commission's election upon award. Failure to so execute at the Commission's request within the time allowed in the Standard Specifications for execution of all contract documents will result in forfeiture of the bid bond or alternate security.

Respectfully Submitted,

DATE _____

Contractor

BY _____
Signature

TITLE _____

ADDRESS _____

CITY, STATE, ZIP _____

PHONE _____

FAX _____

E-MAIL _____

(To be filled in if a corporation)

Our corporation is chartered under the Laws of the State of _____ and the names, titles and business addresses of the executives are as follows:

President Address

Secretary Address

Treasurer Address

The following is my (our) itemized proposal.

Mill & Overlay approximately 7 miles on I-55 from approximately 2 miles north of SR 22 to the Yazoo County Line, known as Federal Aid Project No. IM-0055-02(249) / 107577301 in Madison County.

Line no.	Item Code	Adj Code	Quantity	Units	Description[Fixed Unit Price]
Roadway Items					
0010	202-B009		100	Square Yard	Removal of Asphalt Pavement, Failed Areas
0020	202-B135		2	Each	Removal of Guard Post
0030	202-B136		4,444	Linear Feet	Removal of Guard Rail
0040	202-B244		73	Each	Removal of Trees
0050	203-G001	(E)	100	Cubic Yard	Excess Excavation, FM, AH
0060	304-B003	(GT)	10,522	Ton	Granular Material, Class 5, Group C
0070	403-A015	(BA1)	7,228	Ton	9.5-mm, ST, Asphalt Pavement
0080	403-B001	(BA1)	100	Ton	12.5-mm, HT, Asphalt Pavement, Leveling
0090	403-D007	(BA1)	4,448	Ton	9.5-mm, HT, Asphalt Pavement, Polymer Modified
0100	403-S001		15	Mile	Joint Sealant
0110	406-D001		91,078	Square Yard	Fine Milling of Bituminous Pavement, All Depths
0120	407-A001	(A2)	29,013	Gallon	Asphalt for Tack Coat
0130	423-A001		26	Mile	Rumble Strips, Ground In
0140	503-C010		100	Linear Feet	Saw Cut, Full Depth
0150	606-A002		6	Each	Guard Post, Type II Modified
0160	606-B003		3,131	Linear Feet	Guard Rail, Class A, Type 1, 'W' Beam, Metal Post
0170	606-B011		60	Linear Feet	Guard Rail, Class A, Type 1, Thrie Beam, Metal Post
0180	606-B013		4	Linear Feet	Guard Rail, Class A, Type 1, Thrie Beam, Transition Section
0190	606-D005		8	Each	Guard Rail, Bridge End Section, Type A
0200	606-D020		8	Each	Guard Rail, Bridge End Section, Type H, Metal Post
0210	606-E005		6	Each	Guard Rail, Terminal End Section, Flared
0220	606-E007		16	Each	Guard Rail, Terminal End Section, Non-Flared
0230	618-A001		1	Lump Sum	Maintenance of Traffic
0240	619-A1001		41	Mile	Temporary Traffic Stripe, Continuous White
0250	619-A2001		37	Mile	Temporary Traffic Stripe, Continuous Yellow
0260	619-A3001		42	Mile	Temporary Traffic Stripe, Skip White
0270	619-A5001		13,374	Linear Feet	Temporary Traffic Stripe, Detail
0280	619-D1001		32	Square Feet	Standard Roadside Construction Signs, Less than 10 Square Feet
0290	619-D2001		216	Square Feet	Standard Roadside Construction Signs, 10 Square Feet or More
0300	619-G4005		48	Linear Feet	Barricades, Type III, Single Faced
0310	620-A001		1	Lump Sum	Mobilization
0320	626-A001		16	Mile	6" Thermoplastic Double Drop Traffic Stripe, Skip White
0330	626-C002		16	Mile	6" Thermoplastic Double Drop Edge Stripe, Continuous White
0340	626-E001		16	Mile	6" Thermoplastic Double Drop Traffic Stripe, Continuous Yellow
0350	626-G004		7,864	Linear Feet	Thermoplastic Double Drop Detail Stripe, White

Line no.	Item Code	Adj Code	Quantity	Units	Description	Fixed Unit Price
0360	626-G005		5,510	Linear Feet	Thermoplastic Double Drop Detail Stripe, Yellow	
0370	627-K001		1,040	Each	Red-Clear Reflective High Performance Raised Markers	
0380	630-F006		82	Each	Delineators, Guard Rail, White	
0390	630-F007		68	Each	Delineators, Guard Rail, Yellow	
0400	630-G004		2	Each	Type 3 Object Markers, OM-3R or OM-3L	
0410	907-402-A002	(BA1)	12,484	Ton	Open Graded Friction Course, 9.5-mm Mixture	
0420	907-402-B001	(A3)	22,698	Gallon	Bituminous Tack Coat	
0430	907-405-A001	(BA1)	20,239	Ton	Stone Matrix Asphalt, 9.5 mm Mixture	

SECTION 905 - COMBINATION BID PROPOSAL (Continued)

CONDITIONS FOR COMBINATION BID

If a bidder elects to submit a combined bid for two or more of the contracts listed for this month's letting, the bidder must complete and execute these sheets of the proposal in each of the individual proposals to constitute a combination bid. In addition to this requirement, each individual contract shall be completed, executed and submitted in the usual specified manner.

Failure to execute this Combination Bid Proposal in each of the contracts combined will be just cause for each proposal to be received and evaluated as a separate bid.

It is understood that the Mississippi Transportation Commission not only reserves the right to reject any and all proposals, but also the right to award contracts upon the basis of lowest separate bids or combination bids most advantageous to the State.

It is further understood and agreed that the Combination Bid Proposal is for comparison of bids only and that each contract shall operate in every respect as a separate contract in accordance with its proposal and contract documents.

I (We) agree to complete each contract on or before its specified completion date.

COMBINATION BID PROPOSAL

This proposal is tendered as one part of a Combination Bid Proposal utilizing option ___* of Subsection 102.11 on the following contracts:

* Option to be shown as either (a), (b), or (c).

	<u>Project No.</u>	<u>County</u>	<u>Project No.</u>	<u>County</u>
1.	_____	_____	6.	_____
2.	_____	_____	7.	_____
3.	_____	_____	8.	_____
4.	_____	_____	9.	_____
5.	_____	_____	10.	_____

(a) If Combination A has been selected, your Combination Bid is complete.

(b) If Combination B has been selected, then complete the following page.

SECTION 905 - COMBINATION BID PROPOSAL (Continued)

Project Number	Pay Item Number	Unit	Unit Price Reduction	Total Item Reduction	Total Contract Reduction
1.					
2.					
3.					
4.					
5.					
6.					
7.					
8.					

For Informational Purposes Only

SECTION 905 - COMBINATION BID PROPOSAL (Continued)

Project Number	Pay Item Number	Unit	Unit Price Reduction	Total Item Reduction	Total Contract Reduction
9.					
10.					

(c) If Combination C has been selected, then initial and complete ONE of the following.

_____ I (We) desire to be awarded work not to exceed a total monetary value of \$ _____.

_____ I (We) desire to be awarded work not to exceed _____ number of contracts.



**Certification with regard to the Performance of Previous
Contracts or Subcontracts subject to the Equal Opportunity
Clause and the filing of Required Reports**

The Bidder hereby certifies that he has _____, has not _____, participated in a previous contract or subcontract subject to the Equal Opportunity Clause, as required by Executive Orders 10925, 11114, or 11246, and that he has _____, has not _____, filed with the Joint Reporting Committee, the Director of the Office of Federal Contract Compliance, a Federal Government contracting or administering agency, or the former President's Committee on Equal Employment Opportunity, all reports due under the applicable filing requirements.

(COMPANY)

DATE: _____

NOTE: The above certification is required by the Equal Employment Opportunity Regulations of the Secretary of Labor (41 CFR 60-1.7 (b) (1)), and must be submitted by bidders and proposed subcontractors only in connection with contracts and subcontracts which are subject to the Equal Opportunity Clause. Contracts and Subcontracts which are exempt from the Equal Opportunity Clause are set forth in 41 CFR 60-1.5. (Generally only contracts or subcontracts of \$10,000 or under are exempt.)

Currently, Standard Form 100 (EEO-1) is the only report required by the Executive Orders or their implementing regulations.

Proposed prime Contractors and Subcontractors who have participated in a previous contract or subcontract subject to the Executive orders and have not filed the required reports should note that 41 CFR 60-1.7 (b) (1) prevents the award of contracts and subcontracts unless such Contractors submit a report covering the delinquent period or such other period specified by the Federal Highway Administration or by the Director, Office of Federal Contract Compliance, U. S. Department of Labor.

MISSISSIPPI DEPARTMENT OF TRANSPORTATION
CERTIFICATION

I, _____,
(Name of person signing bid)

individually, and in my capacity as _____ of
(Title of person signing bid)

_____ do hereby certify under
(Name of Firm, partnership, or Corporation)

penalty of perjury under the laws of the United States and the State of Mississippi that _____

_____, Bidder
(Name of Firm, Partnership, or Corporation)

on Project No. **IM-0055-02(249)/ 107577301000**

in **Madison** _____ County(ies), Mississippi, has not either

directly or indirectly entered into any agreement, participated in any collusion; or otherwise taken any action in restraint of free competitive bidding in connection with this contract; nor have any of its corporate officers or principal owners.

Except as noted hereafter, it is further certified that said legal entity and its corporate officers, principal owners, managers, auditors and others in a position of administering federal funds:

- a) Are not presently debarred, suspended, proposed for debarment, declared ineligible, or voluntarily excluded from covered transactions by any Federal department or agency;
- b) Have not within a three-year period preceding this proposal been convicted of or had a civil judgment rendered against them for commission of fraud or a criminal offense in connection with obtaining, attempting to obtain, or performing a public (Federal, State or local) transaction or contract under a public transaction; violation of Federal or State antitrust statutes or commission of embezzlement, theft, forgery, bribery, falsification or destruction of records, making false statements, or receiving stolen property;
- c) Are not presently indicted for or otherwise criminally or civilly charged by a governmental entity (Federal, State or local) with commission of any of the offenses enumerated in (b) above; and
- d) Have not within a three-year period preceding this application/ proposal had one or more public transactions (Federal, State or local) terminated for cause or default.

Do exceptions exist and are made a part thereof? Yes / No

Any exceptions shall address to whom it applies, initiating agency and dates of such action.

Note: Exceptions will not necessarily result in denial of award but will be considered in determining bidder responsibility. Providing false information may result in criminal prosecution or administrative sanctions.

The bidder further certifies that the certification requirements contained in Section XI of Form FHWA 1273, will be or have been included in all subcontracts, material supply agreements, purchase orders, etc. except those procurement contracts for goods or services that are expected to be less than the Federal procurement small purchase threshold fixed at 10 U.S.C. 2304(g) and 41 U.S.C. 253(g) (currently \$25,000) which are excluded from the certification requirements.

The bidder further certifies, to the best of his or her knowledge and belief, that:

1) No Federal appropriated funds have been paid or will be paid to any person for influencing or attempting to influence an officer or employee of any Federal agency, a Member of Congress, an officer or employee of Congress, or an employee of a Member of Congress in connection with the awarding of any Federal contract, the making of any Federal grant, the making of any Federal loan, the entering into of any cooperative agreement, and the extension, continuation, renewal, amendment, or modification of any Federal contract, grant, loan, or cooperative agreement.

2) If any funds other than Federal appropriated funds have been paid or will be paid to any person for influencing or attempting to influence an officer or employee of any Federal agency, a Member of Congress, an officer or employee of Congress, or an employee of a Member of Congress in connection with this contract, Standard Form-LLL, Disclosure Form to Report Lobbying, in accordance with its instructions will be completed and submitted.

The certification contained in (1) and (2) above is a material representation of fact upon which reliance is placed and a prerequisite imposed by Section 1352, Title 31, U.S. Code prior to entering into this contract. Failure to comply shall be subject to a civil penalty of not less than \$10,000 and not more than \$100,000. The bidder shall include the language of the certification in all subcontracts exceeding \$100,000 and all subcontractors shall certify and disclose accordingly.

All of the foregoing is true and correct.

Executed on _____

Signature

MISSISSIPPI DEPARTMENT OF TRANSPORTATION

SAM.GOV Registration and DUNS Number

Bidders are advised that the Prime Contractor must maintain current registration in the **System for Award Management** (<http://www.sam.gov>) at all times during the project. A Dun and Bradstreet Data Universal Numbering System (DUNS) Number (<http://www.dnb.com>) is one of the requirements for registration in the System for Award Management.

Bidders are advised that prior to the award of this contract, they **MUST** be registered in the System for Award Management.

I (We) acknowledge that this contract cannot be awarded if I (We) are not registered in the System for Award Management prior to the award of this contract. _____ (Yes / No)

I (We) have a DUNS Number . _____ (Yes / No)

DUNS Number: _____

Company Name: _____

Company e-mail address: _____

(6/2015F)

For Informational Purposes Only

SECTION 902

CONTRACT FOR IM-0055-02(249)/ 107577301000

LOCATED IN THE COUNTY(IES) OF Madison

STATE OF MISSISSIPPI,
COUNTY OF HINDS

This contract entered into by and between the Mississippi Transportation Commission on one hand, and the undersigned contractor, on the other witnesseth;

That, in consideration of the payment by the Mississippi Transportation Commission of the prices set out in the proposal hereto attached, to the undersigned contractor, such payment to be made in the manner and at the time of times specified in the specifications and the special provisions, if any, the undersigned contractor hereby agrees to accept the prices stated in the proposal in full compensation for the furnishing of all materials and equipment and the executing of all the work contemplated in this contract.

It is understood and agreed that the advertising according to law, the Advertisement, the instructions to bidders, the proposal for the contract, the specifications, the revisions of the specifications, the special provisions, and also the plans for the work herein contemplated, said plans showing more particularly the details of the work to be done, shall be held to be, and are hereby made a part of this contract by specific reference thereto and with like effect as if each and all of said instruments had been set out fully herein in words and figures.

It is further agreed that for the same consideration the undersigned contractor shall be responsible for all loss or damage arising out of the nature of the work aforesaid; or from the action of the elements and unforeseen obstructions or difficulties which may be encountered in the prosecution of the same and for all risks of every description connected with the work, exceptions being those specifically set out in the contract; and for faithfully completing the whole work in good and workmanlike manner according to the approved Plans, Specifications, Special Provisions, Notice(s) to Bidders and requirements of the Mississippi Department of Transportation.

It is further agreed that the work shall be done under the direct supervision and to the complete satisfaction of the Executive Director of the Mississippi Department of Transportation, or his authorized representatives, and when Federal Funds are involved subject to inspection at all times and approval by the Federal Highway Administration, or its agents as the case may be, or the agents of any other Agency whose funds are involved in accordance with those Acts of the Legislature of the State of Mississippi approved by the Governor and such rules and regulations issued pursuant thereto by the Mississippi Transportation Commission and the authorized Federal Agencies.

The Contractor agrees that all labor as outlined in the Special Provisions may be secured from list furnished by

It is agreed and understood that each and every provision of law and clause required by law to be inserted in this contract shall be deemed to be inserted herein and this contract shall be read and enforced as though it were included herein, and, if through mere mistake or otherwise any such provision is not inserted, then upon the application of either party hereto, the contract shall forthwith be physically amended to make such insertion.

The Contractor agrees that he has read each and every clause of this Contract, and fully understands the meaning of same and that he will comply with all the terms, covenants and agreements therein set forth.

Witness our signatures this the ___ day of _____, _____.

Contractor(s)

By _____

MISSISSIPPI TRANSPORTATION COMMISSION

Title _____

By _____

Signed and sealed in the presence of:
(names and addresses of witnesses)

Executive Director

Secretary to the Commission

Award authorized by the Mississippi Transportation Commission in session on the ___ day of _____, _____, Minute Book No. _____, Page No. _____.

Revised 8/06/2003

SECTION 903
PERFORMANCE AND PAYMENT BOND

CONTRACT BOND FOR: IM-0055-02(249)/107577301000

LOCATED IN THE COUNTY(IES) OF: Madison

STATE OF MISSISSIPPI,
COUNTY OF HINDS

Know all men by these presents: that we, _____
(Contractor)
_____ Principal, a _____

residing at _____ in the State of _____

and _____

(Surety)
residing at _____ in the State of _____,

authorized to do business in the State of Mississippi, under the laws thereof, as surety, effective as of the contract date shown below, are held and firmly bound unto the State of Mississippi in the sum of _____

_____ Dollars, lawful money of the United States of America, to be paid to it for which payment well and truly to be made, we bind ourselves, our heirs, administrators, successors, or assigns jointly and severally by these presents.

The conditions of this bond are such, that whereas the said _____

_____ principal, has (have) entered into a contract with the Mississippi Transportation Commission, bearing the date of _____ day of _____ A.D. _____ hereto annexed, for the construction of certain projects(s) in the State of Mississippi as mentioned in said contract in accordance with the Contract Documents therefor, on file in the offices of the Mississippi Department of Transportation, Jackson, Mississippi.

Now therefore, if the above bounden _____ in all things shall stand to and abide by and well and truly observe, do keep and perform all and singular the terms, covenants, conditions, guarantees and agreements in said contract, contained on his (their) part to be observed, done, kept and performed and each of them, at the time and in the manner and form and furnish all of the material and equipment specified in said contract in strict accordance with the terms of said contract which said plans, specifications and special provisions are included in and form a part of said contract and shall maintain the said work contemplated until its final completion and acceptance as specified in Subsection 109.11 of the approved specifications, and save harmless said Mississippi Transportation Commission from any loss or damage arising out of or occasioned by the negligence, wrongful or criminal act, overcharge, fraud, or any other loss or damage whatsoever, on the part of said principal (s), his (their) agents, servants, or employees in the performance of said work or in any manner connected therewith, and shall be liable and responsible in a civil action instituted by the State at the instance of the Mississippi Transportation Commission or any officer of the State authorized in such cases, for double any amount in money or property, the State may lose or be overcharged or otherwise defrauded of, by reason of wrongful or criminal act, if any, of the Contractor(s), his (their) agents or employees, and shall promptly pay the said agents, servants and employees and all persons furnishing labor, material, equipment or supplies therefor, including premiums incurred, for Surety Bonds, Liability Insurance, and Workmen's Compensation Insurance; with the additional obligation that such Contractor shall promptly make payment of all taxes, licenses, assessments, contributions, damages,

any liquidated damages which may arise prior to any termination of said principal's contract, any liquidated damages which may arise after termination of the said principal's contract due to default on the part of said principal, penalties and interest thereon, when and as the same may be due this state, or any county, municipality, board, department, commission or political subdivision: in the course of the performance of said work and in accordance with Sections 31-5-51 et seq. Mississippi Code of 1972, and other State statutes applicable thereto, and shall carry out to the letter and to the satisfaction of the Executive Director of the Mississippi Department of Transportation, all, each and every one of the stipulations, obligations, conditions, covenants and agreements and terms of said contract in accordance with the terms thereof and all of the expense and cost and attorney's fee that may be incurred in the enforcement of the performance of said contract, or in the enforcement of the conditions and obligations of this bond, then this obligation shall be null and void, otherwise to be and remain in full force and virtue.

_____	_____
(Contractors) Principal	Surety
By _____	By _____
	(Signature) Attorney in Fact
	Address _____

Title _____	_____
(Contractor's Seal)	(Printed) MS Agent

	(Signature) MS Agent
	Address _____

	(Surety Seal)

	Mississippi Insurance ID Number



BID BOND

KNOW ALL MEN BY THESE PRESENTS, that we _____
Contractor

Address

City, State ZIP

As principal, hereinafter called the Principal, and _____
Surety

a corporation duly organized under the laws of the state of _____

as Surety, hereinafter called the Surety, are held and firmly bound unto State of Mississippi, Jackson, Mississippi

As Obligee, hereinafter called Obligee, in the sum of **Five Per Cent (5%) of Amount Bid**

Dollars(\$ _____)

for the payment of which sum will and truly to be made, the said Principal and said Surety, bind ourselves, our heirs, executors, administrators, successors and assigns, jointly and severally, firmly by these presents.

WHEREAS, the Principal has submitted a bid for **Mill & Overlay approximately 7 miles on I-55 from approximately 2 miles north of SR 22 to the Yazoo County Line, known as Federal Aid Project No. IM-0055-02 (249) / 107577301 in Madison County.**

NOW THEREFORE, the condition of this obligation is such that if the aforesaid Principal shall be awarded the contract, the said Principal will, within the time required, enter into a formal contract and give a good and sufficient bond to secure the performance of the terms and conditions of the contract, then this obligation to be void; otherwise the Principal and Surety will pay unto the Obligee the difference in money between the amount of the bid of the said Principal and the amount for which the Obligee legally contracts with another party to perform the work if the latter amount be in excess of the former, but in no event shall liability hereunder exceed the penal sum hereof.

Signed and sealed this _____ day of _____, 20__

(Principal)

(Seal)

(Witness) (Name) By: _____ (Title)

(Surety) (Seal)

(Witness) (Attorney-in-Fact) By: _____

(MS Agent)

Mississippi Insurance ID Number

MISSISSIPPI DEPARTMENT OF TRANSPORTATION
OFFICE OF CIVIL RIGHTS
JACKSON, MISSISSIPPI

LIST OF FIRMS SUBMITTING QUOTES

I/we received quotes from the following firms on:

Letting Date: **January 25, 2022**

Project No: **IM-0055-02(249)/ 107577301000**

County: **Madison**

Disadvantaged Business Enterprise (DBE) Regulations as stated in 49 CFR 26.11 require the Mississippi Department of Transportation (MDOT) to create and maintain a comprehensive list of all firms quoting/bidding subcontracts on prime contracts and quoting/bidding subcontracts on federally-funded transportation projects. For every firm, we require the following information:

Firm Name: _____
Contact Name/Title: _____
Firm Mailing Address: _____
Phone Number: _____
_____ DBE Firm _____ Non-DBE Firm

Firm Name: _____
Contact Name/Title: _____
Firm Mailing Address: _____
Phone Number: _____
_____ DBE Firm _____ Non-DBE Firm

Firm Name: _____
Contact Name/Title: _____
Firm Mailing Address: _____
Phone Number: _____
_____ DBE Firm _____ Non-DBE Firm

Firm Name: _____
Contact Name/Title: _____
Firm Mailing Address: _____
Phone Number: _____
_____ DBE Firm _____ Non-DBE Firm

Firm Name: _____
Contact Name/Title: _____
Firm Mailing Address: _____
Phone Number: _____
_____ DBE Firm _____ Non-DBE Firm

SUBMITTED BY (Signature)

FIRM NAME

