

MDOT Use Only

Checked \_\_\_\_\_

Loaded \_\_\_\_\_

Keyed \_\_\_\_\_

12 -



SM No. CSTP9999030181

# PROPOSAL AND CONTRACT DOCUMENTS

## FOR THE CONSTRUCTION OF

12

Bridge Joint Repair on various routes throughout Holmes & Yazoo Counties, known as Federal Aid Project Nos. STP-9999-03(018) / 107913301 & STP-9999-03(018) / 107913302 in Holmes & Yazoo Counties.

Project Completion: 121 Working Days

**(STATE DELEGATED)**

### NOTICE

**BIDDERS MUST COMPLETE AN ONLINE REQUEST  
FOR PERMISSION TO BID THIS PROJECT.**

Electronic addendum updates will be posted on [www.gomdot.com](http://www.gomdot.com)

## **SECTION 900**

### **OF THE CURRENT**

### **2017 STANDARD SPECIFICATIONS**

### **FOR ROAD AND BRIDGE CONSTRUCTION**

**JACKSON, MISSISSIPPI**

**MISSISSIPPI DEPARTMENT OF TRANSPORTATION  
TABLE OF CONTENTS**

**PROJECT: STP-9999-03(018)/107913301 - Holmes  
STP-9999-03(018)/107913302 - Yazoo**

Section 901 - Advertisement

Section 904 - Notice to Bidders

#1	Governing Specification
#2	Status of ROW, w/ Attachments
#7	Disadvantaged Business Enterprise In Federal-Aid Highway Construction, w/ Supplement
#9	Federal Bridge Formula
#296	Reduced Speed Limit Signs
#401	Standard Drawings
#445	Mississippi Agent and Qualified Nonresident Agent
#516	Errata and Modifications to the 2017 Standard Specifications
#977	DUNS Requirement For Federal Funded Projects
#1206	MASH Compliant Devices
#1225	Early Notice to Proceed
#1226	Material Storage Under Bridges
#1241	Fuel and Material Adjustments
#1532	Contract Time
#1533	Scope of Work
906	Required Federal Contract Provisions -- FHWA 1273, w/Supplements

Section 907 - Special Provisions

907-102-2	Bidding Requirements and Conditions
907-103-2	Award and Execution of Contract
907-701-1	Hydraulic Cement
907-702-4	Bituminous Materials
907-703-1	Gradation
907-705-1	Stone Riprap
907-711-2	Plain Steel Wire
907-720-2	Acceptance Procedure for Glass Beads
907-808-1	Joint Repair
907-823-5	Preformed Joint Seal

Section 905 - Proposal, Proposal Bid Items, Combination Bid Proposal

Certification of Performance - Prior Federal-Aid Contracts  
Certification Regarding Non-Collusion, Debarment and Suspension  
SAM.GOV Registration and DUNS Number

Section 902 - Contract Form

Section 903 - Contract Bond Forms

Form -- OCR-485

Progress Schedule

**PROJECT: STP-9999-03(018)/107913301 - Holmes**  
**STP-9999-03(018)/107913302 - Yazoo**

(REVISIONS TO THE ABOVE WILL BE INDICATED ON THE SECOND SHEET  
OF SECTION 905 AS ADDENDA)

05/01/2019 10:52 AM

# MISSISSIPPI DEPARTMENT OF TRANSPORTATION

## SECTION 901 - ADVERTISEMENT

Electronic bids will be received by the Mississippi Transportation Commission at 10:00 o'clock A.M., Wednesday, May 29, 2019, from the Bid Express Service and shortly thereafter publicly read on the Sixth Floor For:

Bridge Joint Repair on various routes throughout Holmes & Yazoo Counties, known as Federal Aid Project Nos. STP-9999-03(018) / 107913301 & STP-9999-03(018) / 107913302 in Holmes & Yazoo Counties.

The attention of bidders is directed to the Contract Provisions governing selection and employment of labor. Minimum wage rates have been predetermined by the Secretary of Labor and are subject to Public Law 87-581, Work Hours Act of 1962, as set forth in the Contract Provisions.

The Mississippi Department of Transportation hereby notifies all bidders that it will affirmatively insure that in any contract entered into pursuant to this advertisement, disadvantaged business enterprises will be afforded full opportunity to submit bids in response to this invitation and will not be discriminated against on the grounds of race, color, sex, age, disability, religion or national origin in consideration for an award.

**The award of this contract will be contingent upon the Contractor satisfying the DBE requirements.**

The specifications are on file in the offices of the Mississippi Department of Transportation.

Contractors may request permission to bid online at <http://shopmdot.ms.gov> at no cost. Upon approval, Contractors shall be eligible to submit a bid using Bid Express at <http://bidx.com>. Specimen proposals may be viewed and downloaded online at no cost at <http://mdot.ms.gov> or purchased online at <http://shopmdot.ms.gov> at a cost of Ten Dollars (\$10.00) per proposal plus a small convenience fee. Cash or checks will not be accepted as payment.

Bid bond, signed or countersigned by a Mississippi Agent or Qualified Nonresident Agent, with Power of Attorney attached, a Cashier's check or Certified Check for five (5%) percent of bid, payable to STATE OF MISSISSIPPI, must accompany each proposal.

The attention of bidders is directed to the provisions of Subsection 102.07 pertaining to irregular proposals and rejection of bids.

MELINDA L. MCGRATH  
EXECUTIVE DIRECTOR



# MISSISSIPPI DEPARTMENT OF TRANSPORTATION

**SECTION 904 - NOTICE TO BIDDERS NO. 1**

**CODE: (IS)**

**DATE: 03/01/2017**

**SUBJECT: Governing Specifications**

The current (2017) Edition of the Standard Specifications for Road and Bridge Construction adopted by the Mississippi Transportation Commission is made a part hereof fully and completely as if it were attached hereto, except where superseded by special provisions, or amended by revisions of the Specifications contained within this proposal. Copies of the specification book may be purchased from the MDOT Construction Division, or online at [shopmdot/default.aspx?StoreIndex=1](http://shopmdot/default.aspx?StoreIndex=1).

A reference in any contract document to controlling requirements in another portion of the contract documents shall be understood to apply equally to any revision or amendment thereof included in the contract.

In the event the plans or proposal contain references to the 2004 Edition of the Standard Specifications for Road and Bridge Construction, it is to be understood that such references shall mean the comparable provisions of the 2017 Edition of the Standard Specifications.

## MISSISSIPPI DEPARTMENT OF TRANSPORTATION

**SECTION 904 - NOTICE TO BIDDERS NO. 2**

**CODE: (IS)**

**DATE: 03/01/2017**

**SUBJECT: Status of Right-of-Way**

Although it is desirable to have acquired all rights-of-way and completed all railroad agreements, utility adjustments and work to be performed by others prior to receiving bids, sometimes it is not considered to be in the public interest to wait until each and every such clearance has been obtained. The bidder is hereby advised of possible unacquired rights-of-way, relocations, railroad agreements and utilities adjustments which have not been completed.

The status of right-of-way acquisition, utility adjustments, encroachments, potentially contaminated sites, railroad facilities, improvements, and asbestos contamination are set forth in the following attachments.

In the event right of entry is not available to ALL parcels of right-of-way and/or all work that is to be accomplished by others on the date set forth in the contract for the Notice to Proceed is not complete, the Department will issue a restricted Notice to Proceed.

**STATUS OF RIGHT-OF-WAY**

STP-9999-03(018)

107913/301000

STP-9999-03(018)

107913/302000

Holmes & Yazoo County

All rights of way and legal rights of entry have been acquired **except:**

**None.**

ASBESTOS CONTAMINATION STATUS OF BUILDINGS  
TO BE REMOVED BY THE CONTRACTOR  
STP-9999-03(018)  
107913-301000, 302000  
Holmes & Yazoo Counties  
April 2, 2019

Reference is made to notices to bidders entitled "Asbestos National Emission Standards for Hazardous Air Pollutants (NESHAP)" and "Removal of Obstructions".

The following pertinent information is furnished concerning asbestos containing materials (ACMs), if any, found in buildings to be removed by the Contractor.

There is no Right of Way required for this project. There are no buildings to be removed by the contractor.

STATUS OF POTENTIALLY CONTAMINATED SITES  
STP-9999-03(018)  
107913-301000, 302000  
Holmes & Yazoo Counties  
April 2, 2019

THERE IS NO RIGHT OF WAY REQUIRED FOR THIS PROJECT. NO INITIAL SITE ASSESSMENT WILL BE PERFORMED. IF CONTAMINATION ON EXISTING RIGHT OF WAY IS DISCOVERED, IT WILL BE HANDLED BY THE DEPARTMENT.

# MISSISSIPPI DEPARTMENT OF TRANSPORTATION

## *Inter-Departmental Memorandum*

<b>To:</b>	Right of Way Division Trudi Loflin	<b>Date:</b>	April 2 <sup>nd</sup> , 2019
<b>From:</b>	Pre-Construction Engineer District 3 Jarrett Taylor	<b>Project No:</b>	107913/301000 STP-9999-03(018)  107913/302000 STP-9999-03(018)
		<b>County:</b>	Holmes & Yazoo

### DISTRICT STATUS REPORT

1. **STATUS OF RIGHT OF WAY:** All work to be done within existing ROW.
2. **RIGHT OF WAY CLEARANCE:** There are no encroachments.
3. **STATUS OF AFFECTED RAILROAD OPERATING FACILITIES:** None affected.
4. **STATUS OF REQUIRED UTILITY RELOCATIONS:** No utility conflicts.
5. **STATUS OF CONSTRUCTION AGREEMENT:** None required.

JT:jt

pc: Charlie Milner (District Three)  
 Leroy Crisco (Construction Division)  
 Katherine Lamey (Construction Division)  
 Vicki Shows (Right of Way)  
 File

Improvements to be included in Notice to Bidders to be removed by the Construction Contractor  
FMS Construction Project No: 107913-301000, 302000  
External ROW No: STP-9999-03(018)

Parcel No:  
Station No:  
Property Owner:  
Description/Pictures:

**NA**

## MISSISSIPPI DEPARTMENT OF TRANSPORTATION

### SUPPLEMENT TO NOTICE TO BIDDERS NO. 7

**DATE:** 01/17/2017

The goal is 0 percent for the Disadvantaged Business Enterprise. The low bidder is required to submit Form OCR-481 for all DBEs. Bidders are advised to check the bid tabulation link for this project on the MDOT website at:

<http://sp.gomdot.com/Contract%20Administration/BidSystems/Pages/letting%20calendar.aspx>

Bid tabulations are usually posted by 3:00 pm on Letting Day.



# MISSISSIPPI DEPARTMENT OF TRANSPORTATION

**SECTION 904 - NOTICE TO BIDDERS NO. 7**

**CODE: (IS)**

**DATE: 03/01/2017**

**SUBJECT: Disadvantaged Business Enterprises In Federal-Aid Highway Construction**

This contract is subject to the "Moving Ahead for Progress in the 21<sup>st</sup> Century Act (MAP-21)" and applicable requirements of "Part 26, Title 49, Code of Federal Regulations". Portions of the Act are set forth in this Notice as applicable to compliance by the Contractor and all of the Act, and the MDOT DBE Program, is incorporated by reference herein.

The Department has developed a Disadvantaged Business Enterprise Program that is applicable to this contract and is made a part thereof by reference.

Copies of the program may be obtained from:

Office of Civil Rights  
Mississippi Department of Transportation  
P. O. Box 1850  
Jackson, Mississippi 39215-1850

## **POLICY**

It is the policy of the Mississippi Department of Transportation to provide a level playing field, to foster equal opportunity in all federally assisted contracts, to improve the flexibility of the DBE Program, to reduce the burdens on small businesses, and to achieve that amount of participation that would be obtained in a non-discriminatory market place. In doing so, it is the policy of MDOT that there will be no discrimination in the award and performance of federally assisted contracts on the basis of race, color, sex, age, religion, national origin, or any handicap.

## **ASSURANCES THAT CONTRACTORS MUST TAKE**

MDOT will require that each contract which MDOT signs with a sub-recipient or a Contractor, and each subcontract the Prime Contractor signs with a Subcontractor, includes the following assurances:

“The Contractor, sub-recipient or Subcontractor shall not discriminate on the basis of race, color, national origin, or sex in the performance of this contract. The Contractor shall carry out applicable requirements of 49 CFR 26 in the award and administration of federally assisted contracts. Failure by the Contractor to carry out these requirements is a material breach of this contract, which may result in the termination of this contract or such other remedy as MDOT deems appropriate.”

## **DEFINITIONS**

For purposes of this provision the following definitions will apply:

"Disadvantaged Business" means a small business concern: (a) which is at least 51 percent owned by one or more socially and economically disadvantaged individual(s) or in the case of any publicly owned business, at least 51 percent of the stock of which is owned by one or more socially and economically disadvantaged individual(s); and (b) whose management and daily business operations are controlled by one or more of the socially and economically disadvantaged individual(s) who own it. It is important to note that the business owners themselves must control the operations of the business. Absentee ownership or title ownership by an individual who does not take an active role in controlling the business is not consistent with eligibility as a DBE under CFR 49 Part 26.71.

### **CONTRACTOR'S OBLIGATION**

The Contractor and all Subcontractors shall take all necessary and reasonable steps to ensure that DBE firms can compete for and participate in the performance of a portion of the work in this contract and shall not discriminate on the basis of race, color, national origin, religion or sex. Failure on the part of the Contractor to carry out the DBE requirements of this contract constitutes a breach of contract and after proper notification the Department may terminate the contract or take other appropriate action as determined by the Department.

When a contract requires a zero percent (0%) DBE goal, the Contractor still has the responsibility to take all necessary and reasonable steps to ensure that DBE firms can compete for and participate in the performance of the work in the contract. In this case, all work performed by a certified DBE firm is considered to be a "race neutral" measure and the Department will receive DBE credit towards the overall State goals when the DBE firm is paid for their work. If the Prime Contractor is a certified DBE firm, the Department can receive DBE credit only for the work performed by the Prime Contractor's work force or any work subcontracted to another DBE firm. Work performance by a non-DBE Subcontractor is not eligible for DBE credit.

### **CONTRACT GOAL**

The goal for participation by DBEs is established for this contract in the attached Supplement. The Contractor shall exercise all necessary and reasonable steps to ensure that participation is equal to or exceeds the contract goal.

If the percentage of the contract that is proposed for DBEs is 1% or greater, the Contractor shall agree to meet or exceed the contract goal on the last bid sheet of the proposal.

The apparent lowest responsive bidder shall submit to the Office of Civil Rights Form OCR-481, signed by the Prime Contractor and the DBE Subcontractors, no later than the 3<sup>rd</sup> business day after opening of the bids.

Form OCR-481 is available on the MDOT website at GoMDOT.com, then Divisions, Civil Rights, Forms, DBE, MDOT Projects, or by calling 601-359-7466.

The OCR-481 Form must contain the following information:

The name and address of each certified DBE Contractor / Supplier;

The Reference Number, percent of work and the dollar amount of each item. If a portion of an item is subcontracted, a breakdown of that item including quantities and unit price must be attached, detailing what part of the item the DBE firm is to perform and who will perform the remainder of the item.

If the DBE Commitment shown on the last bid sheet of the proposal, does not equal or exceed the contract goal, the bidder must submit, to MDOT Contract Administration Division prior to bid opening, information to satisfy the Department that adequate good faith efforts have been made to meet the contract goal.

Failure of the lowest bidder to furnish acceptable proof of good faith efforts, submitted to MDOT Contract Administration Division prior to bid opening, shall be just cause for rejection of the proposal. Award may then be made to the next lowest responsive bidder or the work may be re-advertised.

The following factors are illustrative of matters the Department will consider in judging whether or not the bidder has made adequate good faith effort to satisfy the contract goal.

- (1) Whether the bidder attended the pre-bid meeting that was scheduled by the Department to inform DBEs of subcontracting opportunities;
- (2) Whether the bidder advertised in general circulation, trade association, and minority-focus media concerning the subcontracting opportunities;
- (3) Whether the bidder provided written notice to a reasonable number of specific DBEs that their interest in the contract is being solicited;
- (4) Whether the bidder followed up initial solicitations of interest by contacting DBEs to determine with certainty whether they were interested;
- (5) Whether the bidder selected portions of the work to be performed by DBEs in order to increase the likelihood of meeting the contract goal;
- (6) Whether the bidder provided interested DBEs with adequate information about the plans, specifications and requirements of the contract;
- (7) Whether the bidder negotiated in good faith with interested DBEs and did not reject them as unqualified without sound reasons based on a thorough investigation of their capabilities; and
- (8) Whether the bidder made efforts to assist interested DBEs in obtaining any required bonding or insurance.
- (9) Whether the bidder has written notification to certified DBE Contractors soliciting subcontracting for items of work in the contract.
- (10) Whether the bidder has a statement of why an agreement was not reached.

The bidder’s execution of the signature portion of the proposal shall constitute execution of the following assurance:

The bidder hereby gives assurance pursuant to the applicable requirements of "Moving Ahead for Progress in the 21<sup>st</sup> Century Act (MAP-21)" and applicable requirements of "Part 26, Title 49, Code of Federal Regulations" that the bidder has made a good faith effort to meet the contract goal for DBE participation for which this proposal is submitted.

### **DIRECTORY**

A list of “Certified DBE Contractors” which have been certified as such by the Mississippi Department of Transportation and other Unified Certification Partners (UPC) can be found on the Mississippi Department of Transportation website at [www.gomdot.com](http://www.gomdot.com). The list is in the top left corner of the current Letting Calendar under Contracts & Letting. The DBE firm must be certified at the time the project is let and approved by MDOT to count towards meeting the DBE goal.

### **REPLACEMENT**

If a DBE Subcontractor cannot perform satisfactorily, and this causes the OCR-481 commitment to fall below the contract goal, the Contractor shall take all necessary reasonable steps to replace the DBE with another certified DBE Subcontractor or submit information to satisfy the Mississippi Department of Transportation that adequate good faith efforts have been made to replace the DBE. The replacement DBE must be a DBE who was on the Department's list of "Certified DBE Contractors" when the job was let, and who is still active. All DBE replacements must be approved by the Department.

Under no circumstances shall the Prime or any Subcontractor perform the DBE's work (as shown on the OCR-481) without prior written approval from the Department. See "Sanctions" at the end of this document for penalties for performing DBE's work.

When a Contractor proposes to substitute/replace/terminate a DBE that was originally named on the OCR-481, the Contractor must obtain a release, in writing, from the named DBE explaining why the DBE Subcontractor cannot perform the work. A copy of the original DBE's release must be attached to the Contractor's written request to substitute/replace/terminate along with appropriate Subcontract Forms for the substitute/replacement/terminated Subcontractor, all of which must be submitted to the DBE Coordinator and approved, in advance, by MDOT.

### **GOOD FAITH EFFORTS**

To demonstrate good faith efforts to replace any DBE that is unable to perform successfully, the Contractor must document steps taken to subcontract with another certified DBE Contractor. Such documentation shall include no less than the following:

- (1) Proof of written notification to certified DBE Contractors by certified mail that their interest is solicited in subcontracting the work defaulted by the previous DBE or in subcontracting other items of work in the contract.

- (2) If the Prime Contractor is a certified DBE firm, only the value of the work actually performed by the DBE Prime can be counted towards the project goal, along with any work subcontracted to a certified DBE firm.
- (3) If the Contractor is not a DBE, the work subcontracted to a certified DBE Contractor will be counted toward the goal.
- (4) The Contractor may count toward the goal a portion of the total dollar value of a contract with a joint venture eligible under the standards of this provision equal to the percentage of the DBE partner in the joint venture.
- (5) Expenditures to DBEs that perform a commercially useful function may be counted toward the goal. A business is considered to perform a commercially useful function when it is responsible for the execution of a distinct element of the work and carries out its responsibilities by actually performing, managing, and supervising the work involved.
- (6) The Contractor may count 100% of the expenditures for materials and supplies obtained from certified DBE suppliers and manufacturers that produce goods from raw materials or substantially alters them for resale provided the suppliers and manufacturers assume the actual and contractual responsibility for the provision of the materials and supplies. The Contractor may count sixty percent (60%) of the expenditures to suppliers that are not manufacturers, provided the supplier performs a commercially useful function in the supply process. Within 30 days after receipt of the materials, the Contractor shall furnish to the DBE Coordinator invoices from the certified supplier to verify the DBE goal.
- (7) Any work that a certified DBE firm subcontracts or sub-subcontracts to a non-DBE firm will not count towards the DBE goal.
- (8) Only the dollars actually paid to the DBE firm may be counted towards the DBE goal.

Failure of the Contractor to demonstrate good faith efforts to replace a DBE Subcontractor that cannot perform as intended with another DBE Subcontractor, when required, shall be a breach of contract and may be just cause to be disqualified from further bidding for a period of up to 12 months after notification by certified mail.

### **PRE-BID MEETING**

A pre-bid meeting will be held in Amphitheater 1 & 2 of the Hilton Jackson located at I-55 and County Line Road, Jackson, Mississippi at 2:00 P.M. on the day preceding the date of the bid opening.

This meeting is to inform DBE firms of subcontracting and material supply opportunities. Attendance at this meeting is considered of prime importance in demonstrating good faith effort to meet the contract goal.

### **PARTICIPATION / DBE CREDIT**

Participation shall be counted toward meeting the goal in this contract as follows:

- (1) If the Prime Contractor is a certified DBE firm, only the value of the work actually performed by the DBE Prime can be counted towards the project goal, along with any work subcontracted to a certified DBE firm.
- (2) If the Contractor is not a DBE, the work subcontracted to a certified DBE Contractor will be counted toward the goal.
- (3) The Contractor may count toward the goal a portion of the total dollar value of a contract with a joint venture eligible under the standards of this provision equal to the percentage of the DBE partner in the joint venture.
- (4) Expenditures to DBEs that perform a commercially useful function may be counted toward the goal. A business is considered to perform a commercially useful function when it is responsible for the execution of a distinct element of the work and carries out its responsibilities by actually performing, managing, and supervising the work involved.
- (5) The Contractor may count 100% of the expenditures for materials and supplies obtained from certified DBE suppliers and manufacturers that produce goods from raw materials or substantially alters them for resale provided the suppliers and manufacturers assume the actual and contractual responsibility for the provision of the materials and supplies. The Contractor may count sixty percent (60%) of the expenditures to suppliers that are not manufacturers, provided the supplier performs a commercially useful function in the supply process. Within 30 days after receipt of the materials, the Contractor shall furnish to the DBE Coordinator invoices from the certified supplier to verify the DBE goal.
- (6) Any work that a certified DBE firm subcontracts or sub-subcontracts to a non-DBE firm will not count towards the DBE goal.
- (7) Only the dollars actually paid to the DBE firm may be counted towards the DBE goal. The participation of a DBE Firm cannot be counted towards the Prime Contractor’s DBE goal until the amount being counted towards the goal has been paid to the DBE.

**AWARD**

Award of this contract to the low bidder will be contingent upon the following conditions:

- (1) Concurrence from Federal Highway Administration, when applicable.
- (2) Bidder must submit to the Office of Civil Rights for approval, Form OCR-481 (DBE Commitment) no later than the 3<sup>rd</sup> business day after opening of the bids to satisfy the Department and that adequate good faith efforts have been made to meet the contract goal. For answers to questions regarding Form OCR-481, contact the MDOT Office of Civil Rights at (601) 359-7466.
- (3) Bidder must include OCR-485 information with their bid proposal listing all firms that submitted quotes for material supplies or items to be subcontracted. OCR-485 information

must be included with the bid proposal. If the OCR-485 information is not included as part of bid proposal, your bid will be deemed irregular.

Prior to the start of any work, the bidder must notify the Project Engineer, in writing, of the name of the designated "DBE Liaison Officer" for this project. This notification must be posted on the bulletin board at the project site.

### **DEFAULT**

If the contract goal established by MDOT in this proposal is 1% or greater, it must be met to fulfill the terms of the contract. The Contractor may list DBE Subcontractors and items that exceed MDOT's contract goal, but should unforeseen problems arise that would prevent a DBE from completing its total commitment percentage, the Contractor will meet the terms of the contract as long as it meets or exceeds MDOT's Contract Goal. For additional information, refer to "Replacement" section of this Notice.

### **DBE REPORTS**

- (1) OCR-481: Refer to "CONTRACT GOAL" section of this Notice to Bidders for information regarding this form.
- (2) OCR-482: OCR-482: At the conclusion of the project, before the final estimate is paid and the project is closed out, the Prime Contractor will submit to the Project Engineer for verification of quantities and further handling Form OCR-482 whereby the Contractor certifies to the amounts of payments made to all Contractors / Suppliers over the life of the contract. The Project Engineer shall submit the completed Form OCR-482 to the DBE Coordinator (Office of Civil Rights). Final acceptance of the project is dependent upon Contract Administration Division's receipt of completed Form OCR-482 which they will receive from the Office of Civil Rights.
- (3) OCR-483: The Project Engineer/Inspector will complete Form OCR-483, the Commercially Useful Function (CUF) Performance Report, in accordance with MDOT S.O.P. No. OCR-03-09-01-483. Evaluations reported on this form are used to determine whether or not the DBE firm is performing a CUF. The Prime Contractor should take corrective action when the report contains any negative evaluations. DBE credit may be disallowed and/or other sanctions imposed if it is determined the DBE firm is not performing a CUF. This form should also be completed and returned to the DBE Coordinator (Office of Civil Rights).
- (4) OCR-484: Each month, the Prime Contractor will submit to the Project Engineer OCR-484 that certifies payments to all Subcontractors and shows all firms even if the Prime Contractor has paid no monies to the firm during that estimate period (negative report). The Project Engineer will attach the form to the monthly estimate before forwarding to the Contract Administration Division for further processing. Failure of the Contractor to submit the OCR-484 will result in the estimate not being processed and paid.

- (5) OCR-485: ALL BIDDERS must submit signed form with bid proposal of all firms that submitted quotes for material supplies or items to be subcontracted. If the OCR-485 information is not included as part of bid proposal, the bid will be deemed irregular.
- (6) OCR-487: Only used by Prime Contractors that are certified DBE firms. This form is used in determining the exact percentage of DBE credit for the specified project. It should be returned to MDOT with the OCR-481 form, or can also be returned with the Permission to Subcontract Forms (CAD-720, CAD-725 and CAD-521).

DBE Forms, can be obtained from the Office of Civil Rights Division, MDOT Administration Building, 401 North West Street, Jackson, MS, or at [www.gomdot.com](http://www.gomdot.com) under Divisions, Civil Rights, and Forms.

**SANCTIONS**

The Department has the option to enforce any of the following penalties for failure of the Prime Contractor to fulfill the DBE goal as stated on the OCR-481 form or any violations of the DBE program guidelines:

- (1) Disallow credit towards the DBE goal
- (2) Withhold progress estimate payments
- (3) Deduct from the final estimate or recover an amount equal to the unmet portion of the DBE goal which may include additional monetary penalties as outlined below based on the number of offenses and the severity of the violation as determined by MDOT.

1 <sup>st</sup> Offense	10% of unmet portion of goal	or	\$5,000 lump sum payment	or	Both
2 <sup>nd</sup> Offense	20% of unmet portion of goal	or	\$10,000 lump sum payment	or	Both
3 <sup>rd</sup> Offense	40% of unmet portion of goal	or	\$20,000 lump sum payment	or	\$20,000 lump sum payment and debarment

- (4) Debar the Contractor involved from bidding on MDOT federally funded projects.



**MISSISSIPPI DEPARTMENT OF TRANSPORTATION**

**SECTION 904 - NOTICE TO BIDDERS NO. 9**

**CODE: (IS)**

**DATE: 03/01/2017**

**SUBJECT: Federal Bridge Formula**

Bidders are hereby advised that the latest revision of Federal Highway Administration Publication No. FHWA-HOP-06-105, **BRIDGE FORMULA WEIGHTS**, dated August 2006, is made a part of this contract when applicable.

Prior to the preconstruction conference, the Contractor shall advise the Engineer, in writing, what materials, if any, will be delivered to the jobsite via Interstate route(s).

Copies of the **BRIDGE FORMULA WEIGHTS** publication may be obtained by contacting:

Federal Highway Administration  
400 7<sup>th</sup> Street, SW  
Washington, DC 20590  
(202) 366-2212

or

[http://www.ops.fhwa.dot.gov/Freight/publications/brdg\\_frm\\_wgths/bridge\\_formula\\_all\\_rev.pdf](http://www.ops.fhwa.dot.gov/Freight/publications/brdg_frm_wgths/bridge_formula_all_rev.pdf)

An on line **BRIDGE FORMULA WEIGHTS CALCULATOR** is available at

[http://ops.fhwa.dot.gov/freight/sw/brdgcalc/calc\\_page.htm](http://ops.fhwa.dot.gov/freight/sw/brdgcalc/calc_page.htm)

**MISSISSIPPI DEPARTMENT OF TRANSPORTATION**

**SECTION 904 - NOTICE TO BIDDERS NO. 296**

**CODE: (SP)**

**DATE: 07/25/2017**

**SUBJECT: Reduced Speed Limit Signs**

Bidders are advised that when the plans or contract documents require the speed limit on a project to be reduced, the Contractor shall begin work within 48 hours of installing the reduced speed limit signs. Should the Contractor not start work or have no plans to start work within 48 hours of installing the signs, the reduced speed limit signs shall be covered and existing speed limit signs uncovered.

**MISSISSIPPI DEPARTMENT OF TRANSPORTATION**

**SECTION 904 – NOTICE TO BIDDERS NO. 401**

**CODE: (SP)**

**DATE: 09/12/2017**

**SUBJECT: Standard Drawings**

Standard Drawings attached hereto shall govern appropriate items of required work.

Larger copies of Standard Drawings may be purchased from:

MDOT Plans Print Shop  
MDOT Shop Complex, Building C, Room 114  
2567 North West Street  
P.O. Box 1850  
Jackson, MS 39215-1850  
Telephone: (601) 359-7460  
or FAX: (601) 359-7461  
or e-mail: [plans@mdot.state.ms.us](mailto:plans@mdot.state.ms.us)

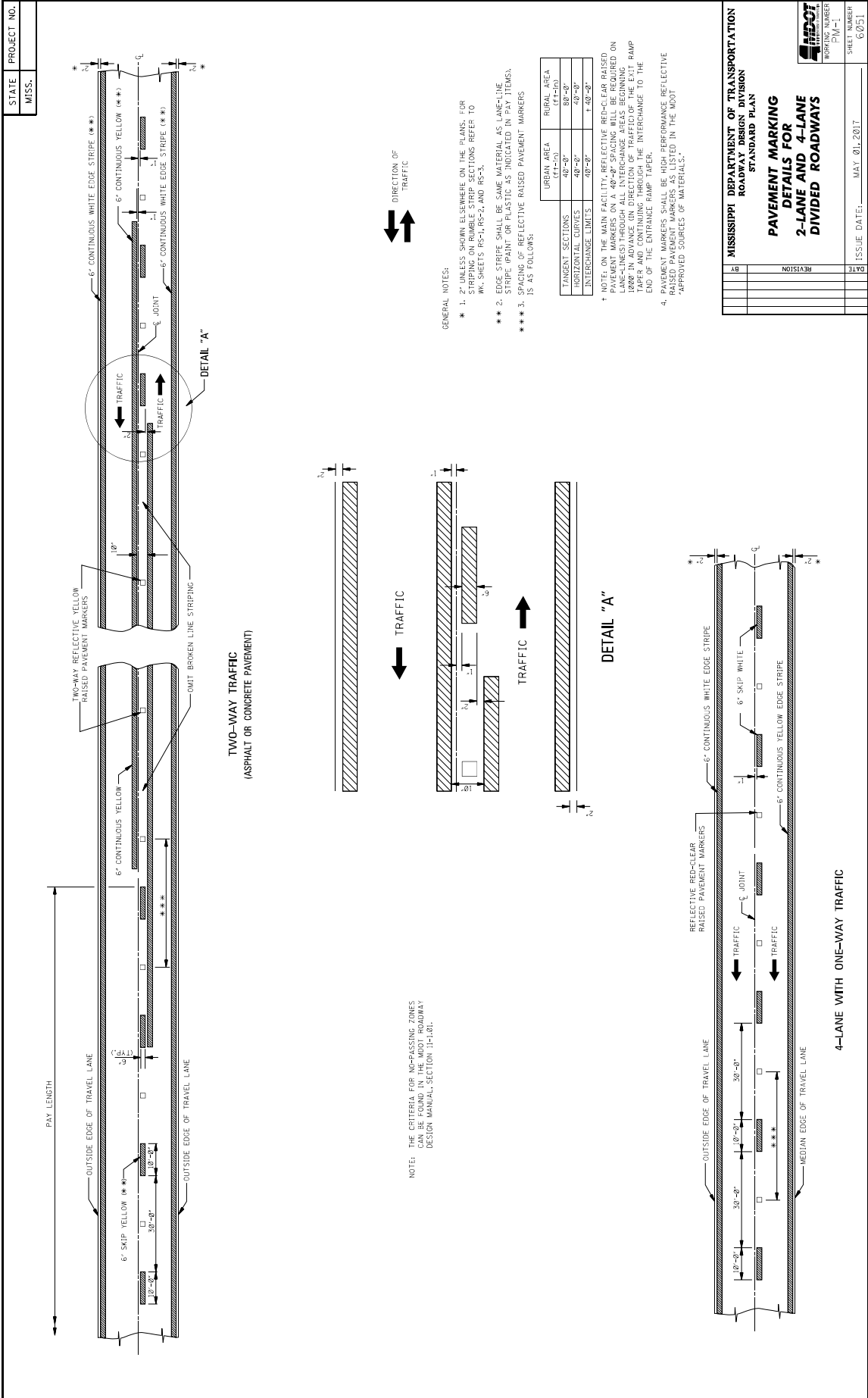

STATE MISS.	PROJECT NO.	
----------------	-------------	--

**TYPICAL STRIPING AND RAISED PAVEMENT MARKERS FOR 3-LANE SECTION**

**TYPICAL STRIPING AND RAISED PAVEMENT MARKERS FOR 4-LANE SECTION**

**NOTES:**

1. CONSIDER EACH SEGMENT OF CONTINUOUS TWO-WAY LEFT TURN LANE SEPARATELY. IF SEGMENT IS GREATER THAN 300 FEET, USE TWO ROWS OF PAVERS SET TO 180 FEET FROM BEGINNING AND/OR END OF SEGMENT AND SPACE ADDITIONAL SETS OF ARROWS (25'0" O.C.).

**TYPICAL TWO-WAY ARROW INSTALLATION**

DETAIL A  
LATERAL PLACEMENT OF PAVEMENT MARKERS

**TYPICAL STRIPING AND RAISED PAVEMENT MARKERS AT LEFT TURN LANES**

\* NOTE: USE DETAIL STRIPING IF LENGTH < 150' AT THIS LOCATION, OTHERWISE USE CONTINUOUS STRIPING.

**TYPICAL STRIPING AND RAISED PAVEMENT MARKERS AT LEFT TURN LANES**

**TYPICAL STRIPING AND RAISED PAVEMENT MARKERS FOR 3-LANE SECTION**

**TYPICAL STRIPING AND RAISED PAVEMENT MARKERS FOR 3-LANE SECTION**

**TYPICAL STRIPING AND RAISED PAVEMENT MARKERS FOR 4-LANE SECTION**

**TYPICAL STRIPING AND RAISED PAVEMENT MARKERS FOR 4-LANE SECTION**

**TYPICAL STRIPING AND RAISED PAVEMENT MARKERS FOR 3-LANE SECTION**

**TYPICAL STRIPING AND RAISED PAVEMENT MARKERS FOR 3-LANE SECTION**

**TYPICAL STRIPING AND RAISED PAVEMENT MARKERS FOR 4-LANE SECTION**

**TYPICAL STRIPING AND RAISED PAVEMENT MARKERS FOR 4-LANE SECTION**

**GENERAL NOTE:**

1. PAVEMENT MARKERS SHALL BE HIGH PERFORMANCE RAISED PAVEMENT MARKERS AS LISTED IN THE MOST APPROVED SOURCE OF MATERIALS.

**MISSISSIPPI DEPARTMENT OF TRANSPORTATION  
ROADWAY DESIGN DIVISION  
STANDARD PLAN**

**PAVEMENT MARKING  
DETAILS FOR 3-LANE  
4-LANE AND 3-LANE  
UNDIVIDED ROADWAYS**

DETAIL B  
LATERAL PLACEMENT OF PAVEMENT MARKERS

REV	REVISION	DATE

ISSUE DATE: MAY 21, 2017  
SHEET NUMBER: PM-2  
SHEET TOTAL: 60/52



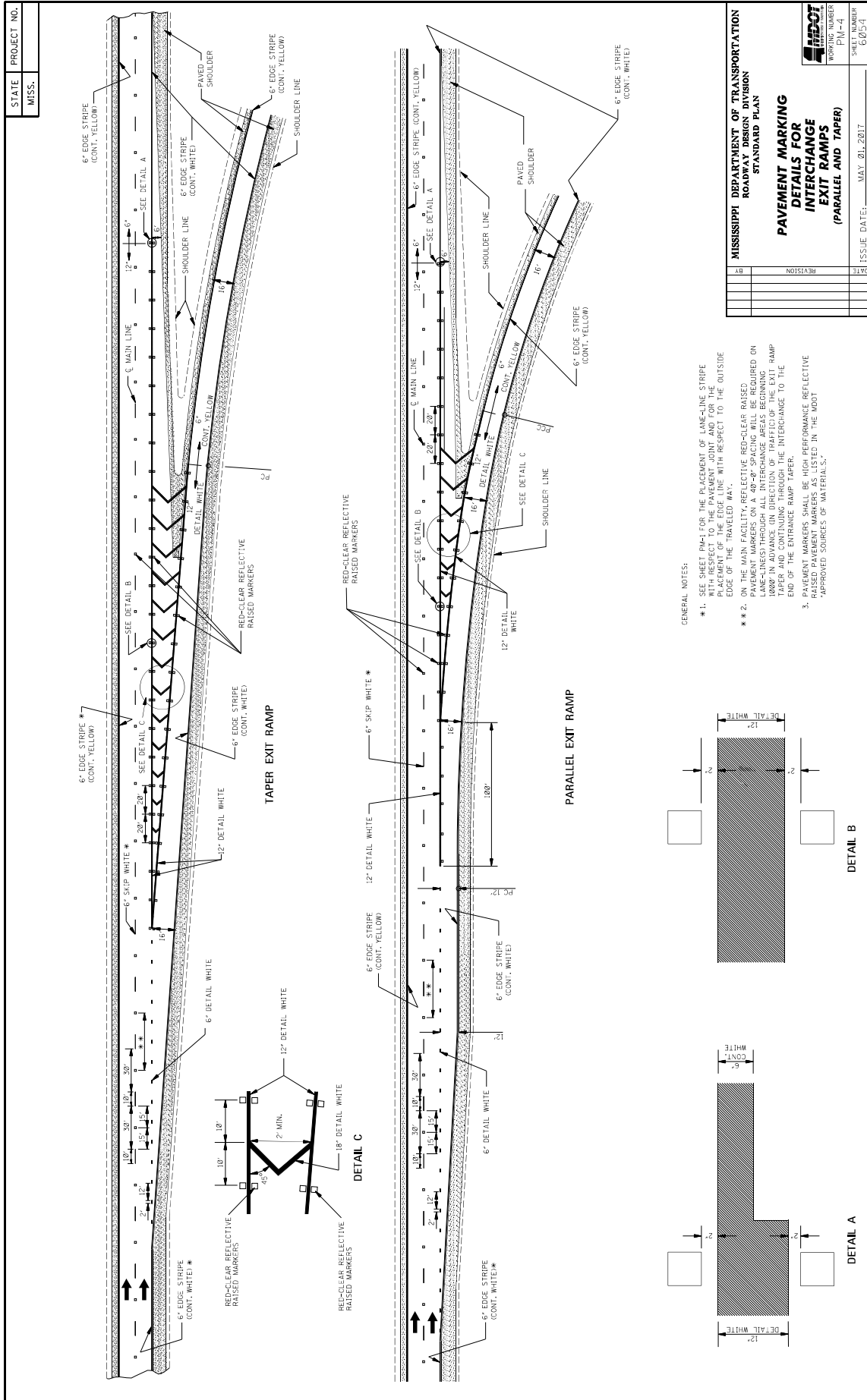

STATE PROJECT NO.		MISS.	
<b>MISSISSIPPI DEPARTMENT OF TRANSPORTATION</b> ROADWAY DESIGN DIVISION STANDARD PLAN			
<b>PAVEMENT MARKING</b> <b>DETAILS FOR</b> <b>INTERCHANGE</b> <b>EXIT RAMP</b> <b>(PARALLEL AND TAPER)</b>			
SHEET NUMBER		PM-4	
WORKING NUMBER		6025-1	
ISSUE DATE:		MAY 01, 2017	
DATE	REVISION		

- GENERAL NOTES:
- \*\* 1. SEE SHEET PM-1 FOR THE PLACEMENT OF LANE-LINE STRIPE WITH RESPECT TO THE PAVEMENT JOINT AND FOR THE PLACEMENT OF PAVED SHOULDER WITH RESPECT TO THE OUTSIDE EDGE OF MAIN CASTER REFLECTIVE BEAD-ON-GLASS RASSES.
  - \*\* 2. PAVEMENT MARKERS ON A 40'-0" SPACING WILL BE REQUIRED ON LANE-LINES THROUGH ALL INTERCHANGE AREAS BEGINNING 1000' IN ADVANCE (IN DIRECTION OF TRAFFIC) OF THE EXIT RAMP TAPER AND CONTINUING THROUGH THE INTERCHANGE TO THE END OF THE ENTRANCE RAMP TAPER.
  - 3. RAISED PAVEMENT MARKERS BE HIGH PERFORMANCE REFLECTIVE 'APPROVED SOURCES OF MATERIALS.'

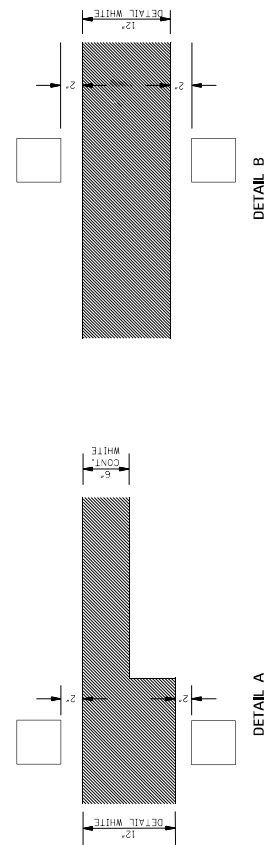

STATE MISS.	PROJECT NO.	
----------------	-------------	--

  

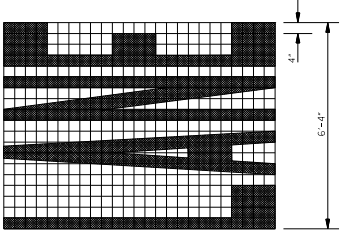

8'-4" x 6'-4" x 4"

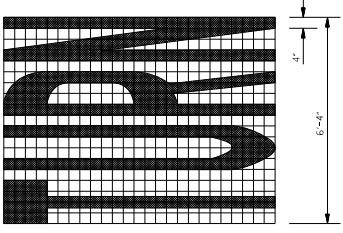

8'-4" x 6'-4" x 4"

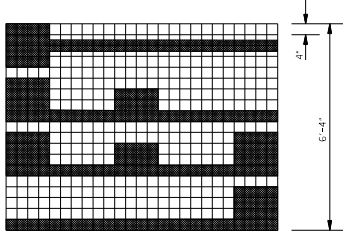

8'-4" x 6'-4" x 4"

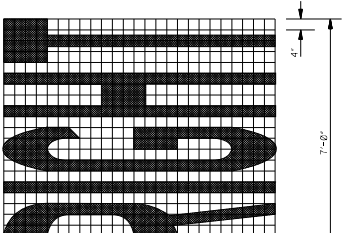

8'-4" x 7'-0" x 4"

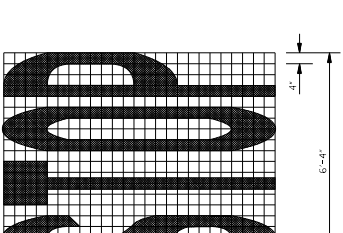

8'-4" x 8'-0" x 4"

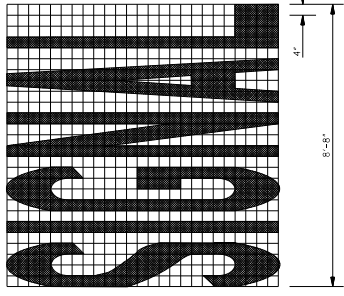

8'-4" x 8'-8" x 4"

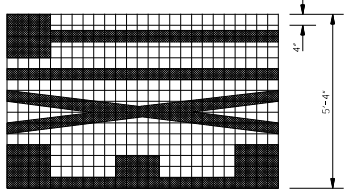

8'-4" x 5'-4" x 4"

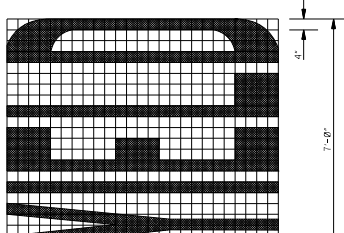

8'-4" x 7'-0" x 4"

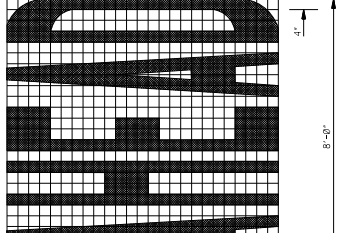

8'-4" x 9'-8" x 4"

**GENERAL NOTES:**

- TWO HORIZONTAL GAPS (CAUSED BY TEMPLATE CONNECTIONS) OF 1/2" LESS THAN THE STRETCHING LETTERS SHALL BE SHOWN IN THE STRETCHING LETTERS.
- FOR OTHER DETAILS, SEE THE MANUAL ON UNIFORM TRAFFIC CONTROL DEVICES.
- PAY QUANTITIES FOR PAVEMENT MARKING LEGENDS ARE AS FOLLOWS:

LEGEND	AREA (FT <sup>2</sup> )
STOP	24.6
RIGHT	28.6
LEFT	19.5
TRUCK	27.3
TRUCK	27.3
AHEAD	32.3
YIELD	26.8
EXIT	18.5
SIGNAL	32.5
SCHOOL	35.5

MISSISSIPPI DEPARTMENT OF TRANSPORTATION  
ROADWAY DESIGN DIVISION  
STANDARD PLAN

**PAVEMENT MARKING  
LEGEND DETAILS**

ISSUE DATE: MAY 01, 2017

WORKING NUMBER: PM-5  
SHEET NUMBER: 60355



STATE MISS.	PROJECT NO.	
----------------	-------------	--

**THRU ARROW**

**TURN ARROW**

**LANE-REDUCTION ARROW**

**COMBINATION ARROW**

**YIELD LINE**

**1-WAY ARROW**

**GENERAL NOTES:**

- TWO HORIZONTAL GAPS (CAUSED BY TEMPLATE CONNECTORS OF 1/16" OR LESS AND EXTENDING THE FULL WIDTH) ARE PERMITTED IN EACH LETTER.
- FOR OTHER DETAILS, SEE THE MANUAL ON UNIFORM TRAFFIC CONTROL DEVICES.
- DIMENSIONS OF THE YIELD LINE MAY VARY WITH APPROVAL OF THE ENGINEER. SEE MUTCD, LATEST EDITION, FOR ALLOWABLE DIMENSIONS.
- PAY QUANTITIES FOR PAVEMENT MARKING LEGENDS ARE AS FOLLOWS:

PAY QUANTITIES	
LEGEND/SYMBOL	AREA (FT <sup>2</sup> )
ONLY	22.0
TURN ARROW	16.4
THRU ARROW	12.3
COMB. ARROW	27.5
1-WAY ARROW	24.3
LANE REDUCTION ARROW	40.0

**MISSISSIPPI DEPARTMENT OF TRANSPORTATION**  
ROADWAY DESIGN DIVISION  
STANDARD PLAN

**PAVEMENT MARKING  
LEGEND DETAILS**

  

DATE	BY	REVISION	DATE	BY	REVISION	DATE	BY	REVISION

ISSUE DATE: MAY 01, 2017

SHEET NUMBER: 60/56

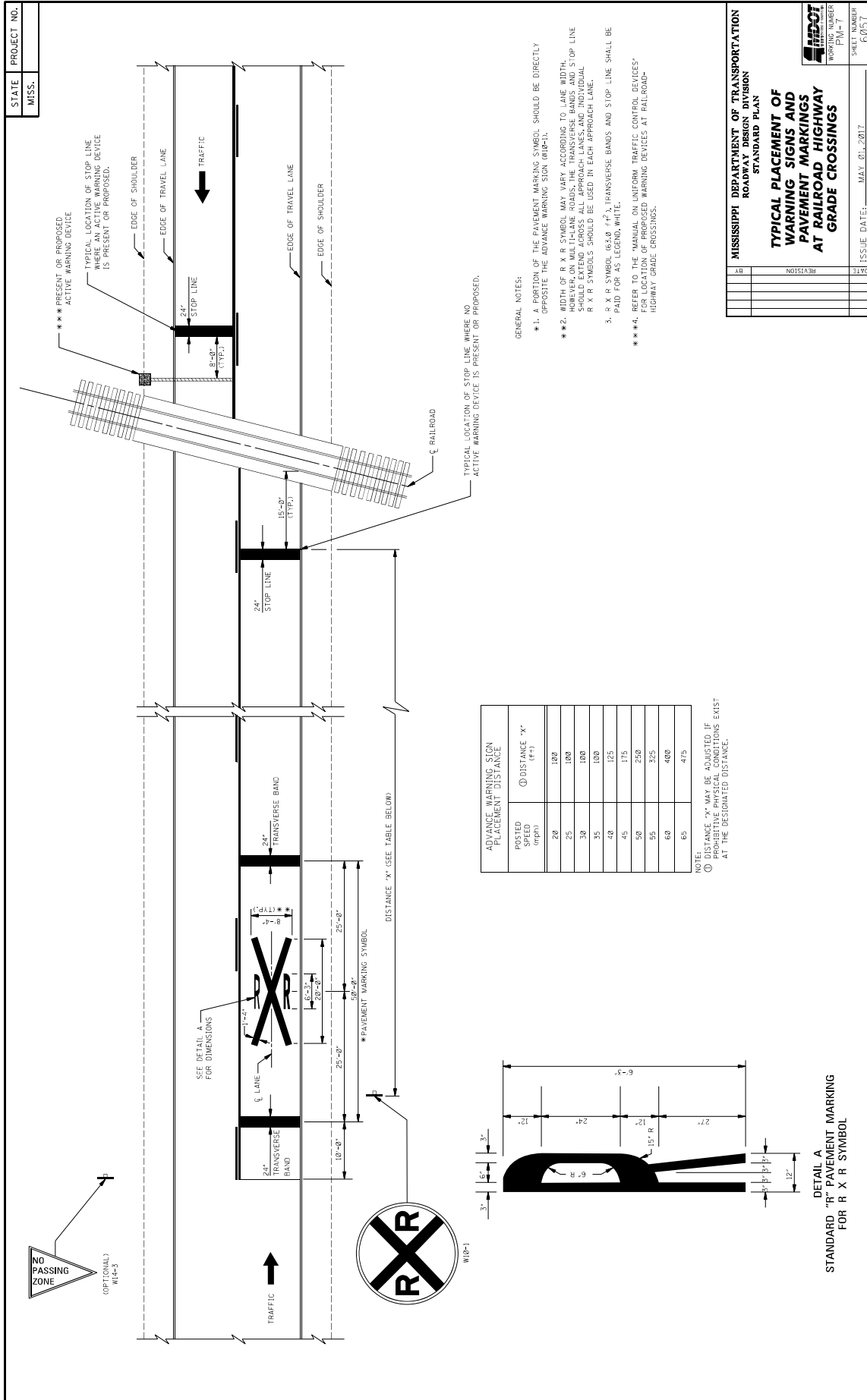

- GENERAL NOTES:
- \*\* 1. A PORTION OF THE PAVEMENT MARKING SYMBOL SHOULD BE DIRECTLY OPPOSITE THE ADVANCE WARNING SIGN (W10-1).
  - \*\* 2. WIDTH OF R X R SYMBOL MAY VARY ACCORDING TO LANE WIDTH. SYMBOL SHOULD EXTEND ACROSS ALL APPROACH LANES, AND INDIVIDUAL R X R SYMBOLS SHOULD BE USED IN EACH APPROACH LANE.
  - 3. R X R SYMBOL (63.0 x 47.1) TRANSVERSE BANDS AND STOP LINE SHALL BE PAID FOR AS LEGEND WHITE.
  - \*\* 4. REFER TO THE MANUAL ON UNIFORM TRAFFIC CONTROL DEVICES FOR LOCATION OF PROPOSED WARNING DEVICES AT RAILROAD-HIGHWAY GRADE CROSSINGS.

POSTED SPEED (mph)	ADVANCE WARNING SIGN PLACEMENT DISTANCE (ft)
20	1000
25	1000
30	1000
35	1000
40	125
45	175
50	250
55	325
60	400
65	475

NOTE: DISTANCE 'X' MAY BE SHORTER IF PROTECTIVE PHYSICAL CONDITIONS EXIST AT THE DESIGNATED DISTANCE.

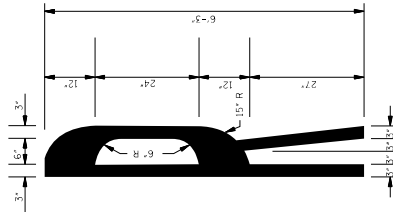

MISSISSIPPI DEPARTMENT OF TRANSPORTATION  
ROADWAY DESIGN DIVISION  
STANDARD PLAN

**TYPICAL PLACEMENT OF WARNING SIGNS AND PAVEMENT MARKINGS AT RAILROAD-HIGHWAY GRADE CROSSINGS**

WORKING NUMBER: P10-1

SHEET NUMBER: 6031

ISSUE DATE: MAY 01, 2017

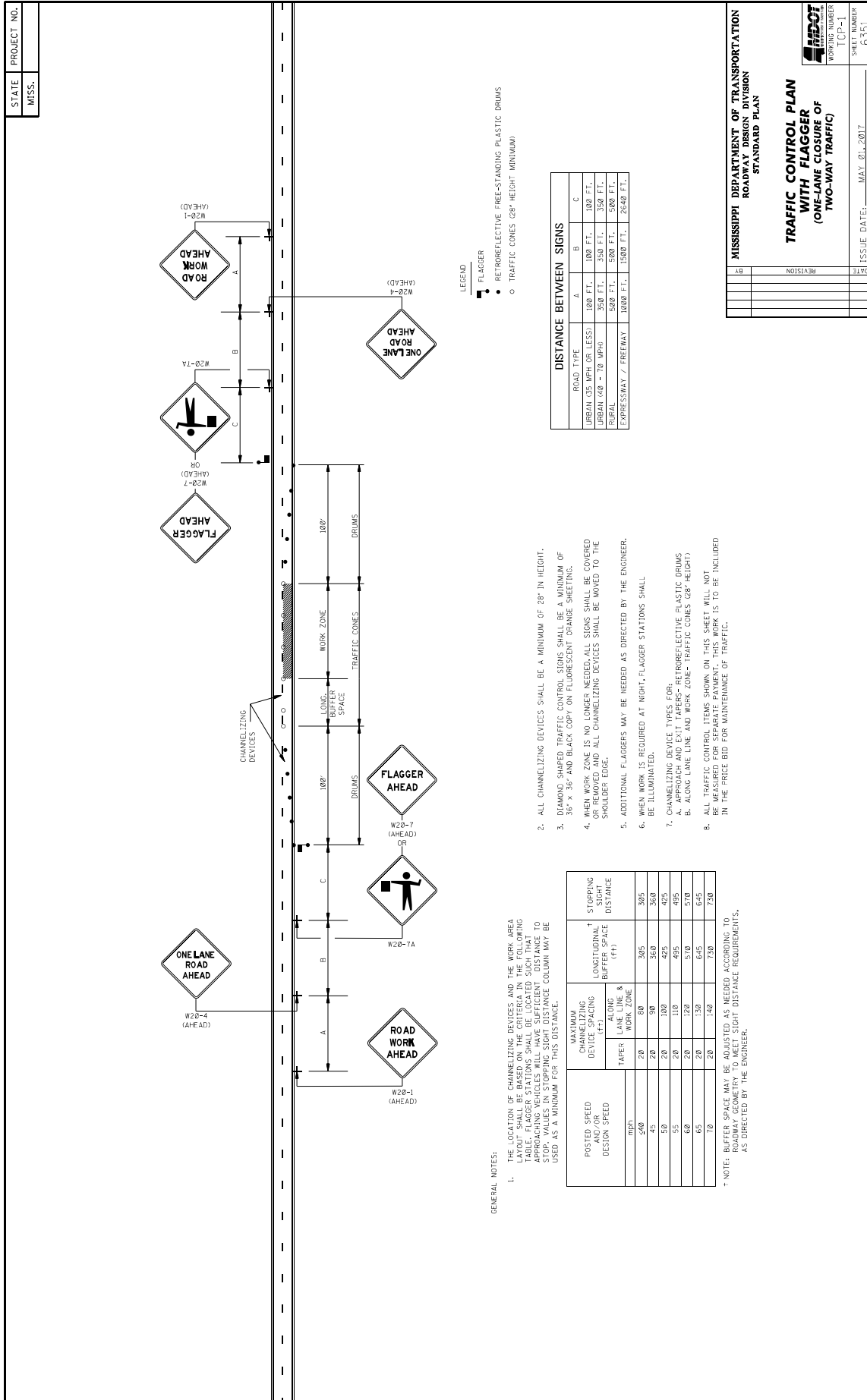

GENERAL NOTES:

- THE LOCATION OF CHANNELIZING DEVICES AND THE WORK AREA LAYOUT SHALL BE BASED ON THE CRITERIA IN THE FOLLOWING TABLE. FLAGGER STATIONS SHALL BE LOCATED SUCH THAT THE STOPPING DISTANCE OF TRAFFIC BEHIND THE FLAGGER TO STOP VALUES IN STOPPING SIGHT DISTANCE COLUMN MAY BE USED AS A MINIMUM FOR THIS DISTANCE.

POSTED SPEED DESIGN SPEED mph	MAXIMUM CHANNELIZING DEVICE SPACING (FT)	STOPPING SIGHT DISTANCE (FT)	
		PLUS BUFFER SPACE (FT)	MINUS BUFFER SPACE (FT)
50	20	80	305
45	20	90	360
50	20	100	425
55	20	110	495
60	20	120	570
65	20	130	645
70	20	140	730

\* NOTE: BUFFER SPACE MAY BE ADJUSTED AS NEEDED ACCORDING TO ROADWAY GEOMETRY TO MEET SIGHT DISTANCE REQUIREMENTS, AS DIRECTED BY THE ENGINEER.

- ALL CHANNELIZING DEVICES SHALL BE A MINIMUM OF 28" IN HEIGHT.
- DIAMOND SHADED TRAFFIC CONTROL SIGNS SHALL BE A MINIMUM OF 36" X 36" AND BLACK COPY ON FLUORESCENT ORANGE SHEETING.
- WHEN WORK ZONE IS NO LONGER NEEDED, ALL SIGNS SHALL BE COVERED OR REMOVED. ALL CHANNELIZING DEVICES SHALL BE MOVED TO THE SHOULDER EDGE.
- ADDITIONAL FLAGGERS MAY BE NEEDED AS DIRECTED BY THE ENGINEER, BE ILLUMINATED.
- CHANNELIZING DEVICE TYRES FOR:
  - APPROACH AND EXIT TAPERS- RETROREFLECTIVE PLASTIC DRUMS
  - ALONG LANE LINE AND WORK ZONE- TRAFFIC CONES (28" HEIGHT)
- ALL TRAFFIC CONTROL ITEMS SHOWN ON THIS SHEET WILL NOT BE MEASURED FOR SEPARATE PAYMENT. THIS WORK IS TO BE INCLUDED IN THE PRICE BID FOR MAINTENANCE OF TRAFFIC.

**DISTANCE BETWEEN SIGNS**

ROAD TYPE	A	B	C
URBAN (35 MPH OR LESS)	100 FT.	100 FT.	100 FT.
URBAN (40 - 70 MPH)	250 FT.	250 FT.	350 FT.
RURAL	500 FT.	500 FT.	500 FT.
EXPRESSWAY / FREEWAY	1000 FT.	1500 FT.	2040 FT.

- LEGEND
- FLAGGER
  - RETROREFLECTIVE FREE-STANDING PLASTIC DRUMS
  - TRAFFIC CONES (28" HEIGHT MINIMUM)

STATE PROJECT NO.  
MISS.

MISSISSIPPI DEPARTMENT OF TRANSPORTATION  
ROADWAY DESIGN DIVISION  
STANDARD PLAN

**TRAFFIC CONTROL PLAN  
WITH FLAGGER  
(ONE-LANE CLOSURE OF  
TWO-WAY TRAFFIC)**

WORKING NUMBER [CP-1]  
SHEET NUMBER 6351  
ISSUE DATE: MAY 01, 2017

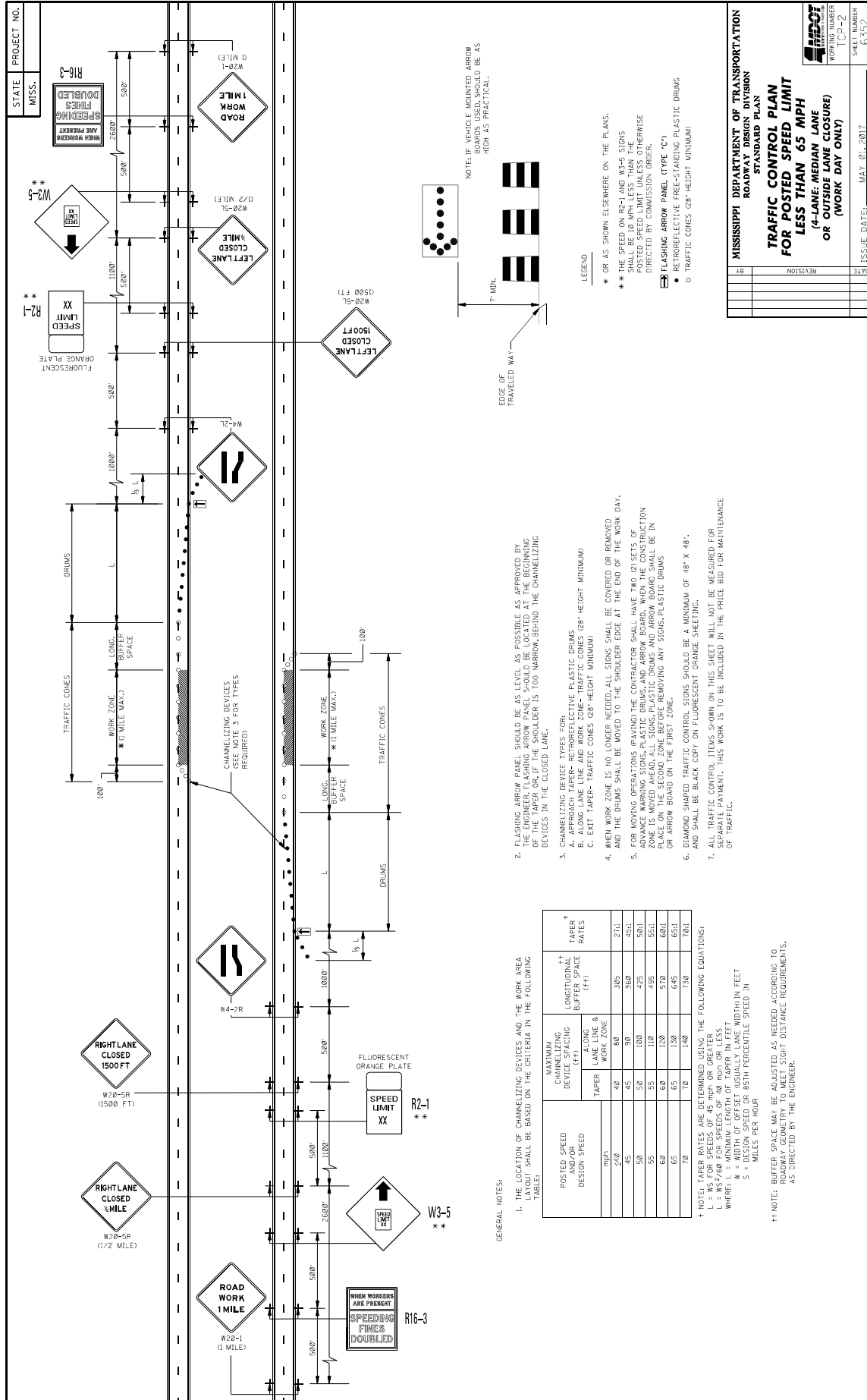

STATE PROJECT NO. MISS. R16-3

MISSISSIPPI DEPARTMENT OF TRANSPORTATION ROADWAY DESIGN DIVISION STANDARD PLAN	
<b>TRAFFIC CONTROL PLAN FOR POSTED SPEED LIMIT LESS THAN 65 MPH (4-LANE; MEDIAN LANE OR OUTSIDE LANE CLOSURE) OR (WORK DAY ONLY)</b>	
WORKING NUMBER	1CP-2
SHEET NUMBER	6352
ISSUE DATE:	MAY 01, 2017
DATE	REVISION

- GENERAL NOTES:
1. THE LOCATION OF CHANNELIZING DEVICES AND THE WORK AREA LAYOUT SHALL BE BASED ON THE CRITERIA IN THE FOLLOWING TABLE:
  2. FLASHING ARROW PANEL SHOULD BE AS LEVEL AS POSSIBLE AS APPROVED BY THE STATE ENGINEER. THE PANEL SHOULD BE PLACED AT THE END OF THE TAPER OR IF THE SHOULDER IS TOO NARROW, BEHIND THE CHANNELIZING DEVICES IN THE CLOSED LANE.
  3. CHANNELIZING DEVICES TYPES FOR:
    - A. APPROACH TAPER- RETROREFLECTIVE PLASTIC DRUMS
    - B. ALONG LANE LINE AND WORK ZONE- TRAFFIC CONES (28" HEIGHT MINIMUM)
    - C. EXIT TAPER- TRAFFIC CONES (28" HEIGHT MINIMUM)
  4. WHEN WORK ZONE IS NO LONGER NEEDED, ALL SIGNS SHALL BE COVERED OR REMOVED.
  5. FOR MOVING OPERATIONS (PAVING) THE CONTRACTOR SHALL HAVE TWO (2) SETS OF ADVANCE WARNING SIGNS, PLASTIC DRUMS, AND ARROW BOARD. WHEN THE CONSTRUCTION ZONE IS MOVED AHEAD, ALL SIGNS, PLASTIC DRUMS AND ARROW BOARD SHALL BE IN PLACE ON THE SECOND ZONE BEFORE REMOVING ANY SIGNS, PLASTIC DRUMS OR ARROW BOARD ON THE FIRST ZONE.
  6. DIAMOND SHAPED TRAFFIC CONTROL SIGNS SHOULD BE A MINIMUM OF 48" X 48" AND SHALL BE BLACK COPY ON FLOURESCENT ORANGE SHEETING.
  7. ALL TRAFFIC CONTROL ITEMS SHOWN ON THIS SHEET WILL NOT BE MEASURED FOR PAYMENT. THIS WORK IS TO BE INCLUDED IN THE PRICE BID FOR MAINTENANCE OF TRAFFIC.

POSTED SPEED AND/OR DESIGN SPEED	MAXIMUM CHANNELIZING DEVICE SPACING (FT)		LONGITUDINAL BUFFER SPACE (FT)	TAPER RATES
	LANE LINE & WORK ZONE	EXIT TAPER		
45	40	80	305	27:1
50	45	90	360	45:1
55	50	100	425	50:1
60	55	110	495	55:1
65	60	120	570	60:1
70	65	130	645	65:1
75	70	140	730	70:1

† NOTE: TAPER RATES ARE DETERMINED USING THE FOLLOWING EQUATIONS:  
 L = WS FOR SPEEDS OF 45 MPH OR GREATER  
 L = WS FOR SPEEDS OF 50 MPH OR GREATER  
 WHERE: L = MINIMUM LENGTH OF TAPER IN FEET  
 W = WIDTH OF OFFSET (USUALLY LANE WIDTH IN FEET)  
 S = DESIGN SPEED OR 85TH PERCENTILE SPEED IN MILES PER HOUR

†† NOTE: BUFFER SPACE MAY BE ADJUSTED AS NEEDED ACCORDING TO ROADWAY GEOMETRY TO MEET SIGHT DISTANCE REQUIREMENTS, AS DIRECTED BY THE ENGINEER.

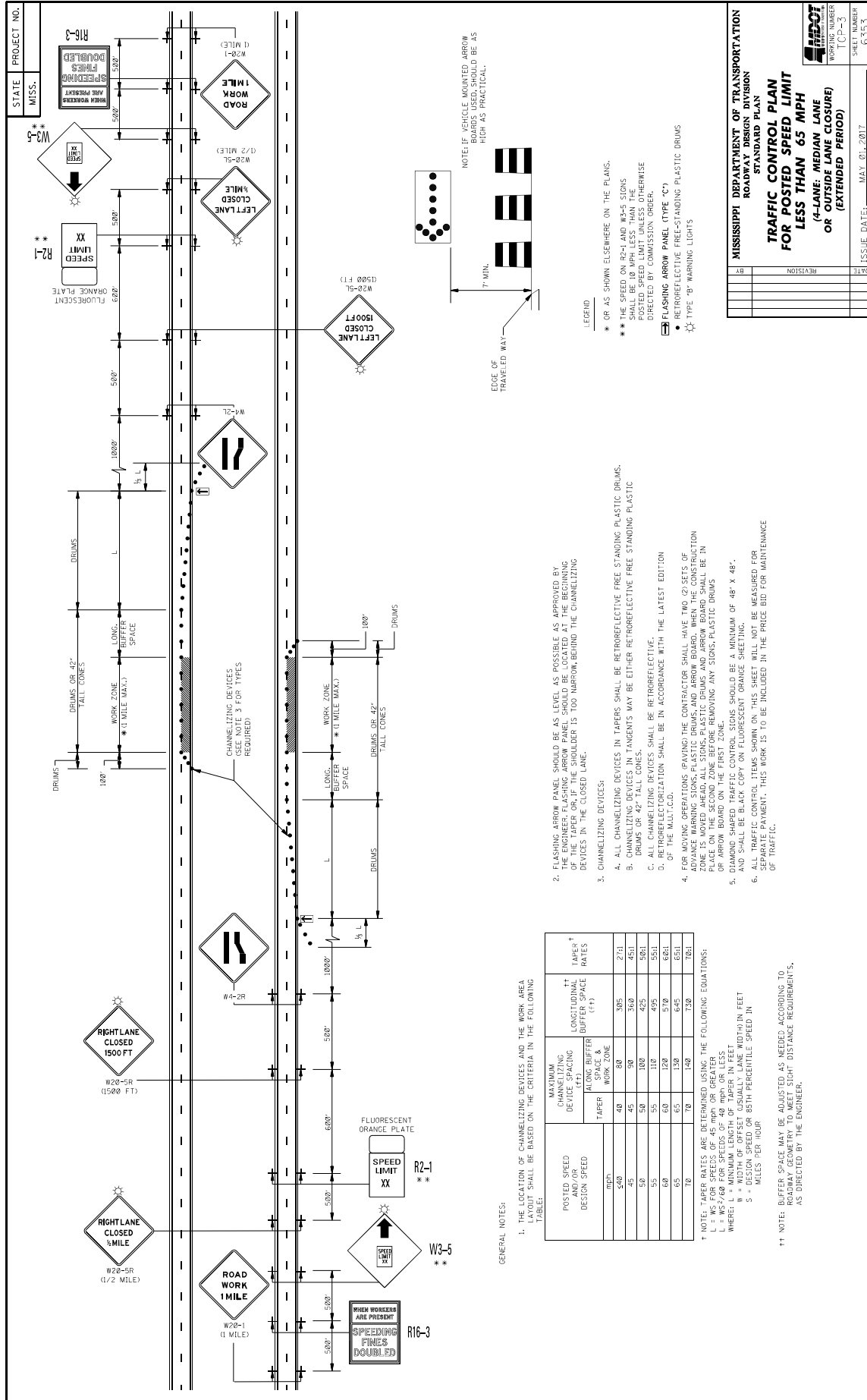

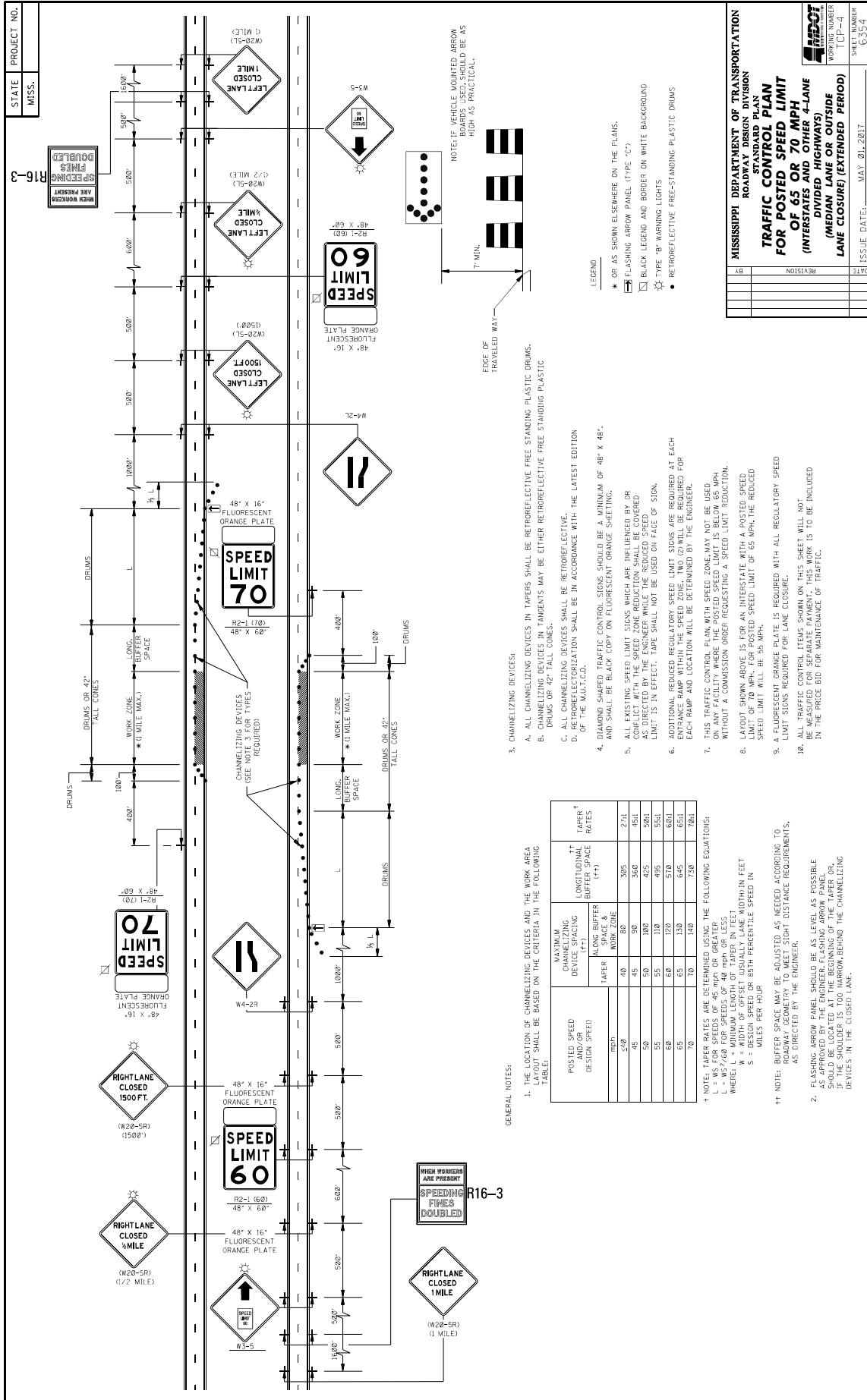

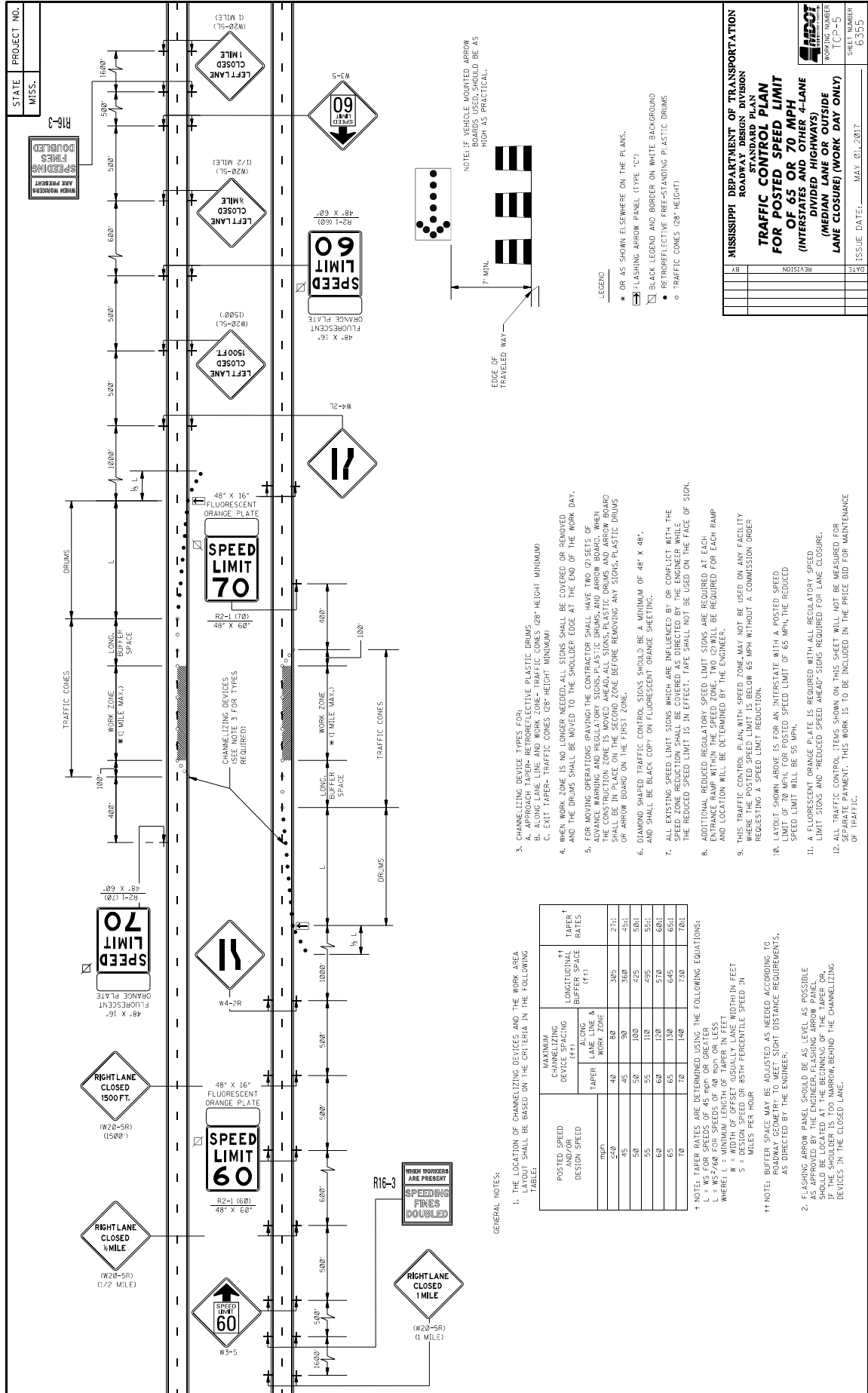

STATE PROJECT NO. MISS. R16-3

MISSISSIPPI DEPARTMENT OF TRANSPORTATION  
ROADWAY DESIGN DIVISION  
TRAFFIC CONTROL PLAN  
FOR POSTED SPEED LIMIT  
OF 65 OR 70 MPH  
(INTERSTATES AND OTHER 4-LANE  
DIVIDED HIGHWAYS)  
(MEDIAN LANE OR OUTSIDE  
LANE CLOSURE) (WORK DAY ONLY)

ISSUE DATE: MAY 01, 2017

DATE	REVISION

WORKING NUMBER: T1P-5  
SHEET NUMBER: 6355

1. THE LOCATION OF CHANNELIZING DEVICES AND THE WORK AREA LAYOUT SHALL BE BASED ON THE CRITERIA IN THE FOLLOWING TABLE:

POSTED SPEED AND/OR DESIGN SPEED (mph)	MAXIMUM CHANNELIZING DEVICE SPACING (FT)		LONGITUDINAL BUFFER SPACE (FT)	TAPER <sup>†</sup> RATES
	LANE LINE & WORK ZONE	WORK ZONE		
45	40	80	305	27:1
50	45	90	360	45:1
55	50	100	425	50:1
60	55	110	495	55:1
65	60	120	570	60:1
70	65	130	645	65:1
75	70	140	730	70:1

† NOTE: TAPER RATES ARE DETERMINED USING THE FOLLOWING EQUATIONS:  
L = WS FOR SPEEDS OF 45 MPH OR GREATER  
L = WS FOR SPEEDS OF 30 MPH OR GREATER  
WHERE: L = MINIMUM LENGTH OF TAPER IN FEET  
W = WIDTH OF OFFSET (USUALLY LANE WIDTH) IN FEET  
S = DESIGN SPEED OR 85TH PERCENTILE SPEED IN MILES PER HOUR

†† NOTE: BUFFER SPACE MAY BE ADJUSTED AS NEEDED ACCORDING TO LOCAL LIGHT DISTANCE REQUIREMENTS, AS DIRECTED BY THE ENGINEER.

GENERAL NOTES:

- THE LOCATION OF CHANNELIZING DEVICES AND THE WORK AREA LAYOUT SHALL BE BASED ON THE CRITERIA IN THE FOLLOWING TABLE:
- FLASHING ARROW PANEL SHOULD BE AS LEVEL AS POSSIBLE AND BE LOCATED AT THE BEGINNING OF THE TAPER OR IF THE SHOULDER IS TOO NARROW BEHIND THE CHANNELIZING DEVICES IN THE CLOSED LANE.
- CHANNELIZING DEVICE TYPES FOR:  
A. APPROACH TAPER- RETROREFLECTIVE PLASTIC DRUMS  
B. ALONG LANE LINE AND WORK ZONE- TRAFFIC CONES (28" HEIGHT MINIMUM)  
C. EXIT TAPER- TRAFFIC CONES (28" HEIGHT MINIMUM)  
4. WHEN WORK ZONE IS NO LONGER NEEDED, ALL SIGNS SHALL BE COVERED OR REMOVED AND THE DRUMS SHALL BE MOVED TO THE SHOULDER EDGE AT THE END OF THE WORK DAY.  
5. FOR MOVING OPERATIONS (PAVING) THE CONTRACTOR SHALL HAVE TWO (2) SETS OF ADVANCE WARNING AND REGULATORY SIGNS, PLASTIC DRUMS, AND ARROW BOARD. WHEN THE WORK ZONE IS MOVED, THE ADVANCE WARNING AND REGULATORY SIGNS, PLASTIC DRUMS, AND ARROW BOARD SHALL BE IN PLACE ON THE SECOND ZONE BEFORE REMOVING ANY SIGNS, PLASTIC DRUMS OR ARROW BOARD ON THE FIRST ZONE.  
6. DIAMOND SHAPED TRAFFIC CONTROL SIGNS SHOULD BE A MINIMUM OF 48" X 48", AND SHALL BE BLACK COPY ON FLOURESCENT ORANGE SHEETING.  
7. ALL EXISTING SPEED LIMIT SIGNS WHICH ARE IN CONFLICT WITH THE SPEED ZONE REDUCTION SHALL BE COVERED AS DIRECTED BY THE ENGINEER WHILE THE REDUCED SPEED LIMIT IS IN EFFECT. TAPE SHALL NOT BE USED ON THE FACE OF SIGN.  
8. ADDITIONAL REVISED REGULATORY SPEED LIMIT SIGNS ARE REQUIRED AT EACH ENTRANCE RAMP WITHIN THE SPEED ZONE. TWO (2) WILL BE REQUIRED FOR EACH RAMP AND LOCATION WILL BE DETERMINED BY THE ENGINEER.  
9. THIS TRAFFIC CONTROL PLAN WITH SPEED ZONE MAY NOT BE USED ON ANY FACILITY REQUESTING A SPEED LIMIT REDUCTION.  
10. LAYOUT SHOWN ABOVE IS FOR AN INTERSTATE WITH A POSTED SPEED LIMIT OF 70 MPH FOR POSTED SPEED LIMIT OF 65 MPH, THE REDUCED SPEED LIMIT WILL BE 55 MPH.  
11. A FLOURESCENT ORANGE PLATE IS REQUIRED WITH ALL REGULATORY SPEED LIMIT SIGNS AND "REDUCED SPEED AHEAD" SIGNS REQUIRED FOR LANE CLOSURE.  
12. ALL TRAFFIC CONTROL ITEMS SHOWN ON THIS SHEET WILL NOT BE MEASURED FOR SEPARATE PAYMENT. THIS WORK IS TO BE INCLUDED IN THE PRICE BID FOR MAINTENANCE OF TRAFFIC.

STATE PROJECT NO.  
MISS.

WORKING NUMBER  
ICP-6  
6350

SHEET NUMBER  
1

ISSUE DATE: MAY 01, 2017

**WING BARRICADES**

- WING BARRICADES ARE TYPE III BARRICADES ERECTED ON THE SHOULDER OF ROADWAYS OR RESTRICTED ROADWAY. WING BARRICADES MAY BE USED AS A MOUNTING FOR THE ADVANCE WARNING SIGNS OR FLASHERS.
- WING BARRICADES SHOULD BE USED:
  - IN ADVANCE OF A CONSTRUCTION PROJECT EVEN WHEN NO PART OF THE ROADWAY IS ACTUALLY CLOSED.
  - IN ADVANCE OF ALL BRIDGE OR CULVERT WIDENING OPERATIONS.

**BARRICADE CLOSING A ROAD**

**BARRICADE CHARACTERISTICS**

	I	II	III
WIDTH OF RAIL **	8" MIN. - 12" MAX.	8" MIN. - 12" MAX.	8" MIN. - 12" MAX.
LENGTH OF RAIL **	24" MIN.	24" MIN.	48" MIN.
WIDTH OF STRIPE *	6"	6"	6"
HEIGHT	36" MIN.	36" MIN.	60" MIN.
NUMBER OF RETROREFLECTORIZED RAIL FACES	2 (ONE EACH DIRECTION)	4 (TWO EACH DIRECTION)	3 IF FACING TRAFFIC IN ONE DIRECTION 6 IF FACING TRAFFIC IN TWO DIRECTIONS

\* 1. FOR RAILS LESS THAN 36" LONG, 4" WIDE STRIPES MAY BE USED.  
 \*\* 2. BARRICADES INTENDED FOR USE ON EXPRESSWAYS, FREEWAYS AND OTHER HIGH SPEED ROADWAYS, SHALL HAVE A MINIMUM OF 270 IN<sup>2</sup> OF REFLECTIVE AREA FACING TRAFFIC.

**STANDARD BARRICADES**

- THE MARKING FOR BARRICADE RAILS SHALL BE ORANGE AND WHITE (SLOPING DOWNWARD AT AN ANGLE OF 45° IN THE DIRECTION TRAFFIC IS TO PASS).
- RAIL STRIPE SHALL BE 6 INCHES, EXCEPT THAT 4-INCH WIDE STRIPES MAY BE USED IF RAIL LENGTHS ARE LESS THAN 36 INCHES.
- DO NOT PLACE SANDBAGS OR OTHER DEVICES TO PROVIDE MASS ON THE BOTTOM RAIL THAT WILL BLOCK VIEW OR RAIL FACE.
- FOR ADDITIONAL INFORMATION OR DETAILS, SEE MUTCD, LATEST EDITION.
- BARRICADES ARE CLASSIFIED BY FHWA AS CATEGORY II WORK ZONE DEVICES WHICH REQUIRE SUCCESSFUL CRASH TESTING. A LIST OF CRASHWORTHY BARRICADES AND OTHER CATEGORY II DEVICES CAN BE FOUND ON FHWA'S WEBSITE: [http://safety.fhwa.dot.gov/roadway\\_dept/policy\\_guidance/road\\_hardware/cat2.cfm](http://safety.fhwa.dot.gov/roadway_dept/policy_guidance/road_hardware/cat2.cfm)

**CHEVRON SIGN DETAIL**

- A CHEVRON SIGN CONSISTS OF A BLACK CHEVRON TYPE MARKING ON AN ORANGE BACKGROUND AND SHALL POINT IN THE DIRECTION OF TRAFFIC FLOW.
- THE CHEVRON SIGN SHALL BE MOUNTED ON CRASHWORTHY SUPPORT.
- CHEVRON SIGNS MAY BE USED TO SUPPLEMENT OTHER STANDARD DEVICES WHERE ONE OR MORE LANES ARE CLOSED FOR CONSTRUCTION OR MAINTENANCE. THEY SHOULD BE PLACED APPROXIMATELY 2'-0" BEHIND THE LANE TRANSITION STRIPE.

**PLASTIC DRUM STRIPING DETAIL**

- PLASTIC DRUMS SHALL BE ON END AND USED AS AN EXPEDITED METHOD FOR TRAFFIC CHANNELIZATION. THE COLOR AND MARKING OF DRUMS SHALL BE CONSISTENT WITH THE MARKING STRIPES OR STRIPES. THE PREDOMINANT COLOR OF DRUMS SHALL BE ORANGE WITH FOUR RETROREFLECTIVE, HORIZONTAL, CIRCUMFERENTIAL STRIPES (2 ORANGE & 2 WHITE) 6" WIDE.
- DRUMS SHOULD NEVER BE PLACED IN THE ROADWAY WITHOUT WARNING SIGNS.
- WHERE PRACTICAL PLASTIC DRUMS SHOULD BE PLACED NO CLOSER THAN 3'-0" FROM THE EDGE OF TRAVELED LANE.

**TYPE 3 OBJECT MARKER (OM-3R)**

- TYPE 3 OBJECT MARKERS SHALL BE USED AT ALL EXPOSED BRIDGE ABUTMENTS AND AT OTHER LOCATIONS AS DEEMED NECESSARY BY THE ENGINEER.
- THE OM-3R IS SHOWN. THE OM-3L IS SIMILAR EXCEPT THE STRIPES SLOPE DOWNWARD FROM THE UPPER LEFT SIDE TO THE LOWER RIGHT SIDE AND SHALL BE PLACED ON THE LEFT SIDE OF THE OBJECT.
- THE INSIDE EDGE OF THE MARKER SHALL BE IN LINE WITH THE INNER EDGE OF THE OBSTRUCTION.



STATE MISS.	PROJECT NO.	
----------------	-------------	--

### MOBILE OPERATIONS ON MULTILANE ROAD

### MOBILE OPERATIONS ON TWO-LANE ROAD

**NOTES FOR MULTILANE LANE OPERATION:**

1. VEHICLES USED FOR THESE OPERATIONS SHOULD BE MADE HIGHLY VISIBLE WITH APPROPRIATE EQUIPMENT, SUCH AS FLASHING LIGHTS, ROTATING BEACONS, FLASCS, SIGNS, OR ARROW PANELS.
2. SHADOW VEHICLE 2 SHOULD BE EQUIPPED WITH AN ARROW PANEL AND TRUCK MOUNTED ATTENUATOR (TMA), AN APPROPRIATE LANE CLOSURE SIGN SHOULD BE LEGIBLY DISPLAYED ON SHADOW VEHICLE 2 SO AS NOT TO OBSCURE THE ARROW PANEL.
3. SHADOW VEHICLE 1 SHOULD BE EQUIPPED WITH AN ARROW PANEL AND TRUCK-MOUNTED ATTENUATOR (TMA).
4. SHADOW VEHICLE 2 SHOULD TRAVEL AT A VARYING DISTANCE FROM THE WORK OPERATION SO AS TO PROVIDE ADEQUATE SIGHT DISTANCE FOR TRAFFIC APPROACHING FROM THE REAR.
5. WHEN ADEQUATE SHOULDER WIDTH IS NOT AVAILABLE, SHADOW VEHICLE 2 SHOULD BE ELIMINATED.
6. ON HIGH-SPEED ROADWAYS, A THIRD SHADOW VEHICLE SHOULD BE USED (I.E., VEHICLE 3 ON THE SHOULDER OF PRACTICALLY, VEHICLE 2 IN THE CLOSED LANE, AND VEHICLE 1 IN THE CLOSED LANE).
7. ARROW PANELS SHALL BE AS A MINIMUM TYPE B, 60" X 30" IN ACCORDANCE WITH THE CRITERIA PRESENTED IN THE MUTCO.
8. WORK SHOULD NORMALLY BE DONE DURING OFF-PEAK HOURS.
9. VEHICLE-MOUNTED SIGNS SHOULD BE MOUNTED WITH THE BOTTOM OF THE SIGN LOCATED AT A MINIMUM HEIGHT OF 48" ABOVE THE PAVEMENT AND SHALL NOT BE OBSCURED BY EQUIPMENT OR SUPPLIES. SIGN LEGENDS SHALL BE COVERED OR TURNED FROM VIEW WHEN WORK IS NOT IN PROGRESS.
10. ALL TRAFFIC CONTROL ITEMS SHOWN ON THIS SHEET WILL NOT BE MEASURED FOR SEPARATE PAYMENT. THIS WORK IS TO BE INCLUDED IN THE PRICE BID FOR MAINTENANCE OF TRAFFIC.

**NOTES FOR TWO-LANE OPERATION:**

1. WHERE PRACTICAL AND WHEN NEEDED, THE WORK AND SHADOW VEHICLES SHOULD PULL OVER PERIODICALLY TO ALLOW TRAFFIC TO PASS. IF THIS CAN NOT BE DONE FREQUENTLY AS AN ALTERNATIVE, A "DO NOT PASS" SIGN MAY BE PLACED ON THE REAR OF THE VEHICLE BLOCKING THE LANE.
2. THE DISTANCE BETWEEN THE WORK AND SHADOW VEHICLES MAY VARY ACCORDING TO TERRAIN, PAINT DRYING TIME, AND OTHER FACTORS. SHADOW VEHICLES ARE USED TO WARN TRAFFIC OF THE OPERATION AHEAD. WHENEVER ADEQUATE DISTANCE CANNOT BE MAINTAINED, THE SHADOW VEHICLE SHOULD BE USED TO MAINTAIN THE MINIMUM DISTANCE AND PROCEED AT THE SAME SPEED AS THE WORK VEHICLE. THE SHADOW VEHICLE SHOULD SLOW DOWN IN ADVANCE OF VERTICAL OR HORIZONTAL CURVES THAT RESTRICT SIGHT DISTANCE.
3. ADDITIONAL SHADOW VEHICLES TO WARN AND REDUCE THE SPEED OF ONCOMING OR OPPOSING TRAFFIC MAY BE USED. POLICE PATROL CARS MAY BE USED FOR THIS PURPOSE.
4. A. TRUCK-MOUNTED ATTENUATOR (TMA) SHOULD BE USED ON THE SHADOW VEHICLE AND MAY BE USED ON THE WORK VEHICLE.
5. THE WORK VEHICLE SHALL BE EQUIPPED WITH BEACONS, AND THE SHADOW VEHICLE SHALL BE EQUIPPED WITH BEACONS. HIGH-BEAM LIGHTS AND WORK LIGHTS MOUNTED ON THE REAR, ADJACENT TO THE SIGN, SHADOW AND WORK VEHICLES SHALL DISPLAY FLASHING OR ROTATING BEACONS BOTH FORWARD AND TO THE REAR.
6. VEHICLE-MOUNTED SIGNS SHOULD BE MOUNTED WITH THE BOTTOM OF THE SIGN LOCATED AT A MINIMUM HEIGHT OF 48" ABOVE THE PAVEMENT AND SHALL NOT BE OBSCURED BY EQUIPMENT OR SUPPLIES. SIGN LEGENDS SHALL BE COVERED OR TURNED FROM VIEW WHEN WORK IS NOT IN PROGRESS.
7. ARROW BOARD TO BE USED IN CAUTION MODE.
8. ALL TRAFFIC CONTROL ITEMS SHOWN ON THIS SHEET WILL NOT BE MEASURED FOR SEPARATE PAYMENT. THIS WORK IS TO BE INCLUDED IN THE PRICE BID FOR MAINTENANCE OF TRAFFIC.

REVISION	DATE	BY

**MISSISSIPPI DEPARTMENT OF TRANSPORTATION**  
**ROADWAY DESIGN DIVISION**  
**STANDARD PLAN**

**TRAFFIC CONTROL PLAN**  
**MOBILE OPERATIONS**  
**MULTILANE ROADS**  
**TWO-LANE ROADS**

WORKING NUMBER  
TCP-9

SHEET NUMBER  
6359

ISSUE DATE: MAY 01, 2017



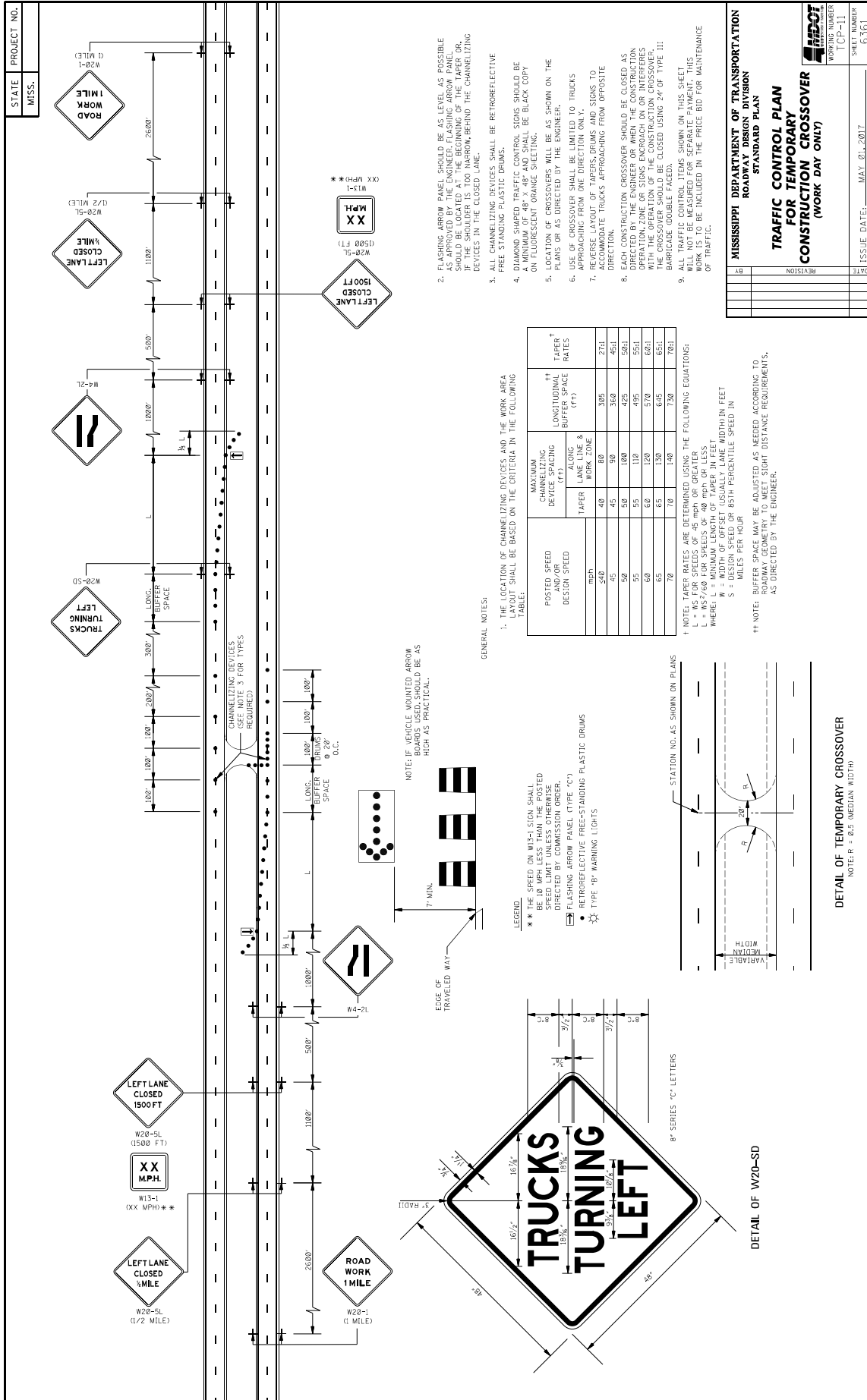

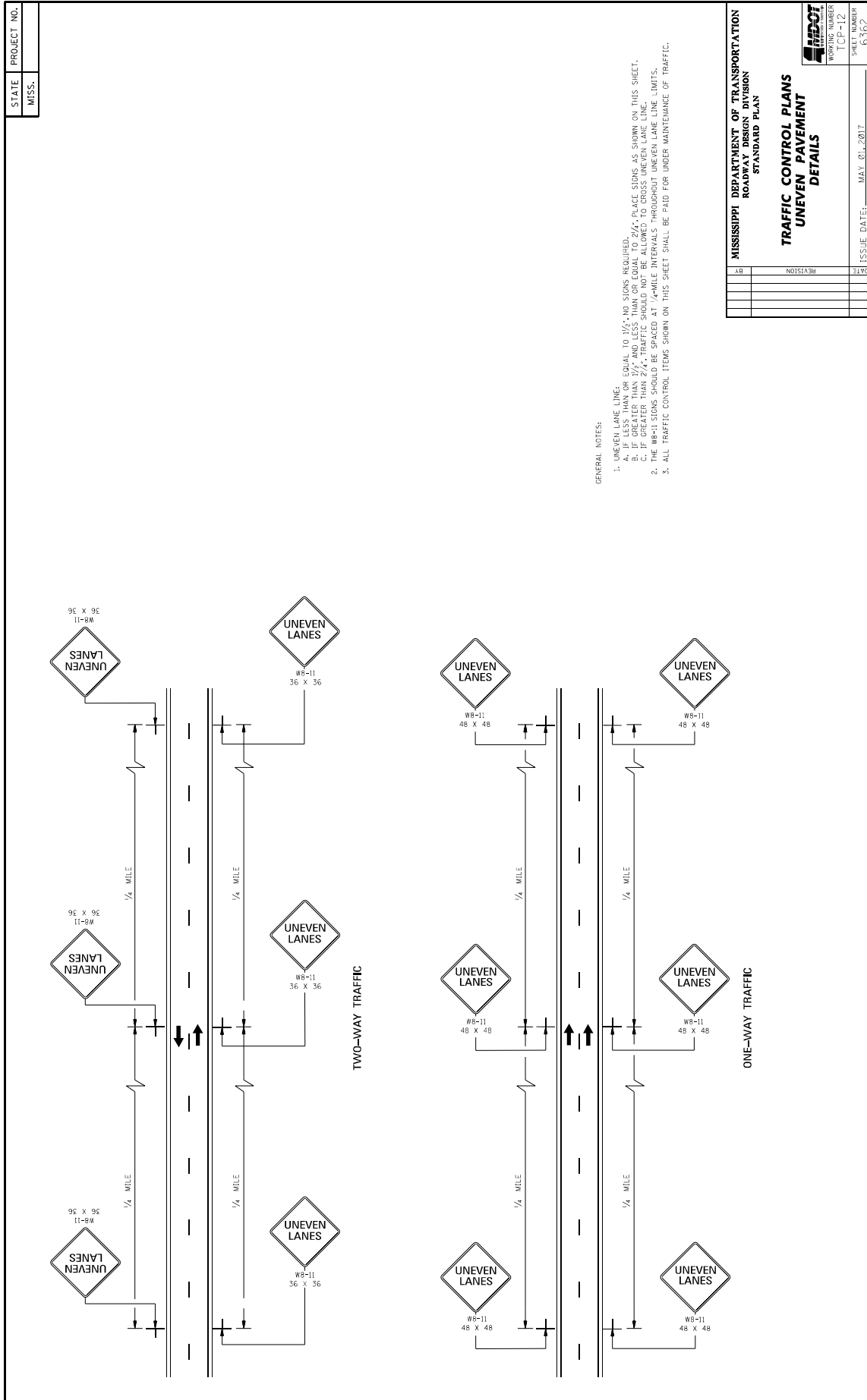

GENERAL NOTES:

- UNEVEN LANE LINE.
  - IF LESS THAN OR EQUAL TO 1/4 MILE, NO SIGNS REQUIRED.
  - IF MORE THAN 1/4 MILE AND LESS THAN 1/2 MILE, PLACE SIGNS AS SHOWN ON THIS SHEET.
  - IF MORE THAN 1/2 MILE, PLACE SIGNS AS SHOWN ON THIS SHEET.
  - IF GREATER THAN 1/4 MILE, TRAFFIC SHOULD NOT BE ALLOWED TO CROSS UNEVEN LANE LINE.
- THE WB-11 SIGNS SHOULD BE SPACED AT 1/4-MILE INTERVALS THROUGHOUT UNEVEN LANE LINE LIMITS.
- ALL TRAFFIC CONTROL ITEMS SHOWN ON THIS SHEET SHALL BE PAID FOR UNDER MAINTENANCE OF TRAFFIC.

STATE	PROJECT NO.
MISS.	

MISSISSIPPI DEPARTMENT OF TRANSPORTATION ROADWAY DESIGN DIVISION STANDARD PLAN	
<b>TRAFFIC CONTROL PLANS UNEVEN PAVEMENT DETAILS</b>	
WORKING NUMBER	SHEET NUMBER
ICP-12	6362
ISSUE DATE:	MAY 01, 2017
DATE	REVISION

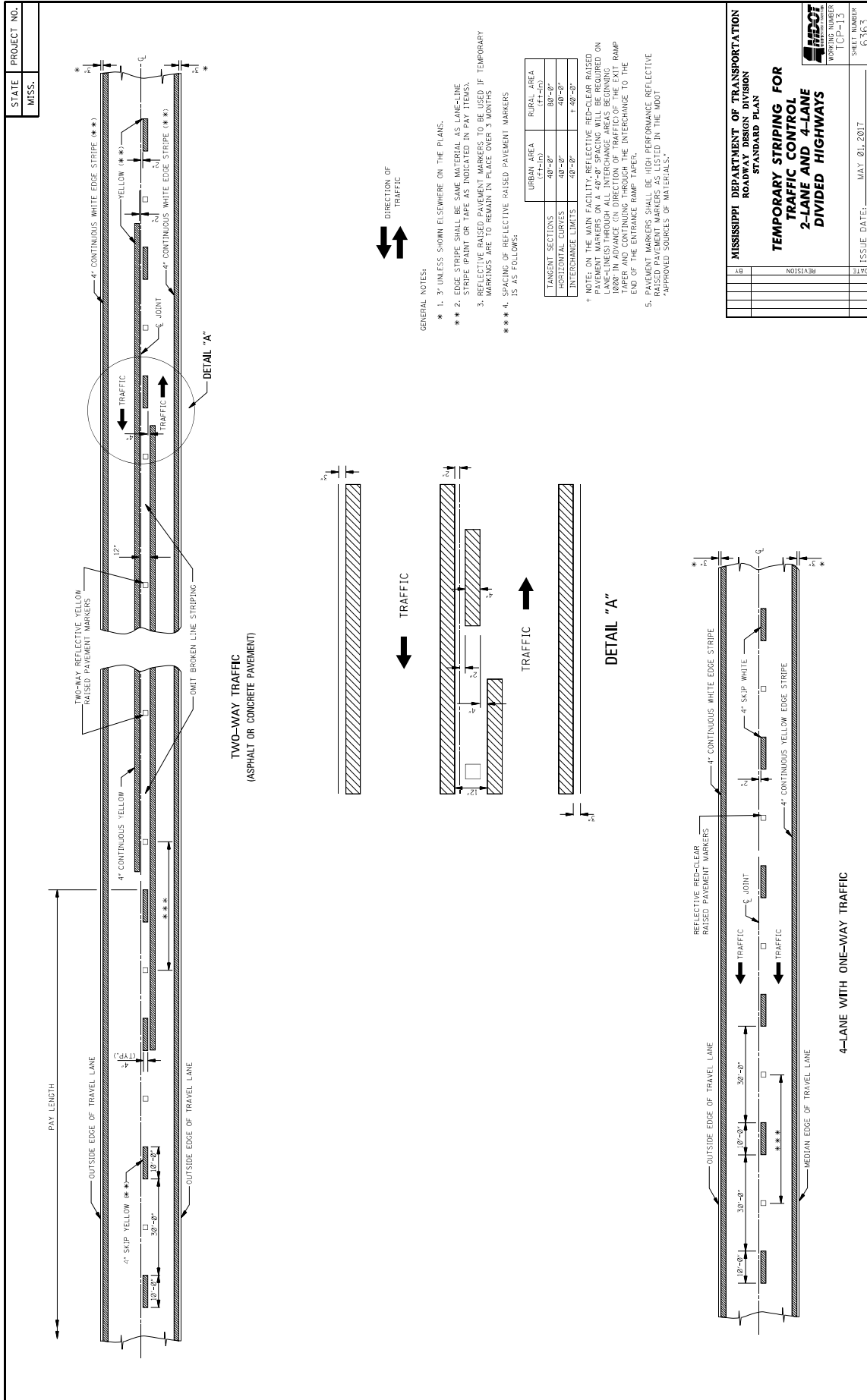

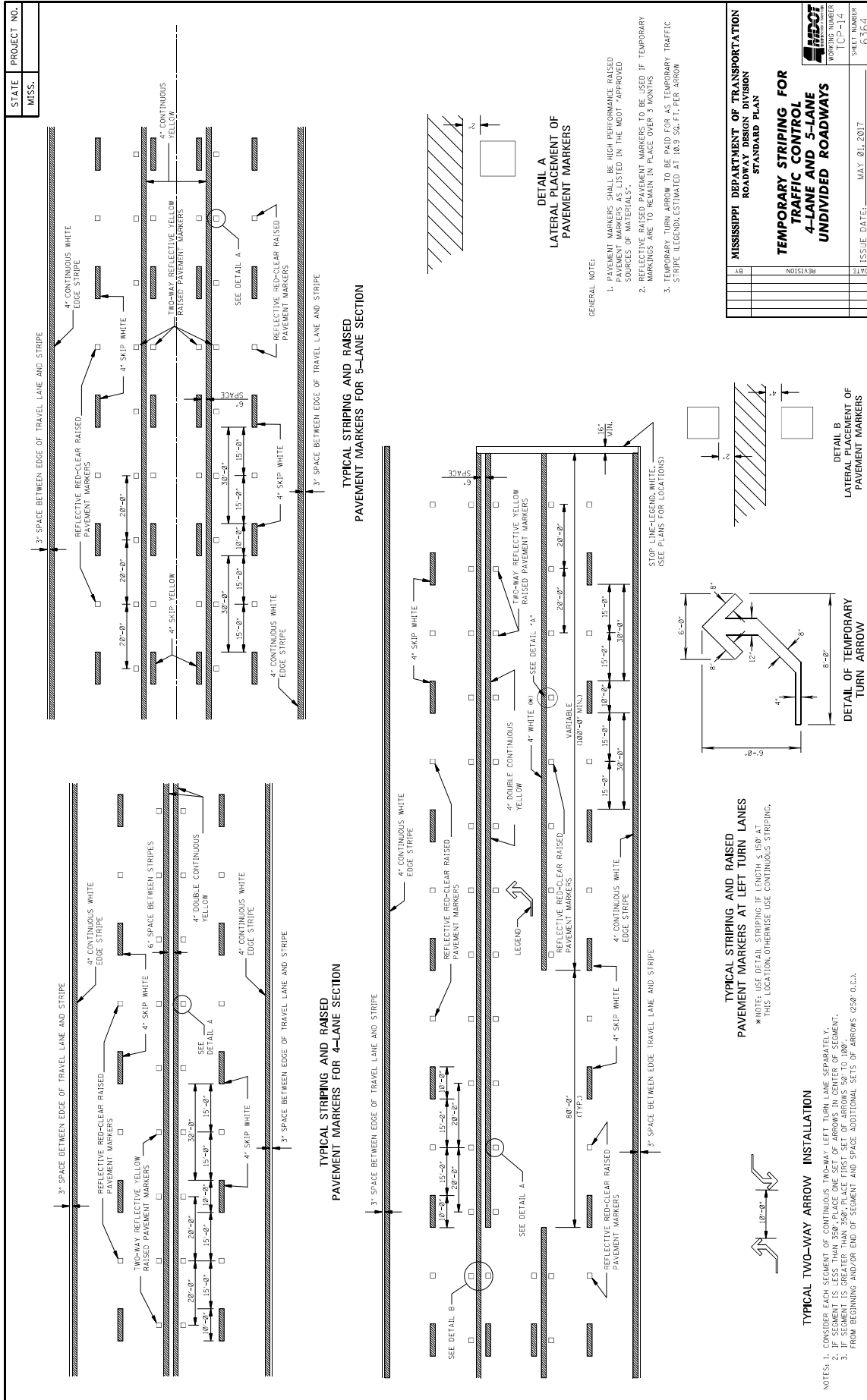

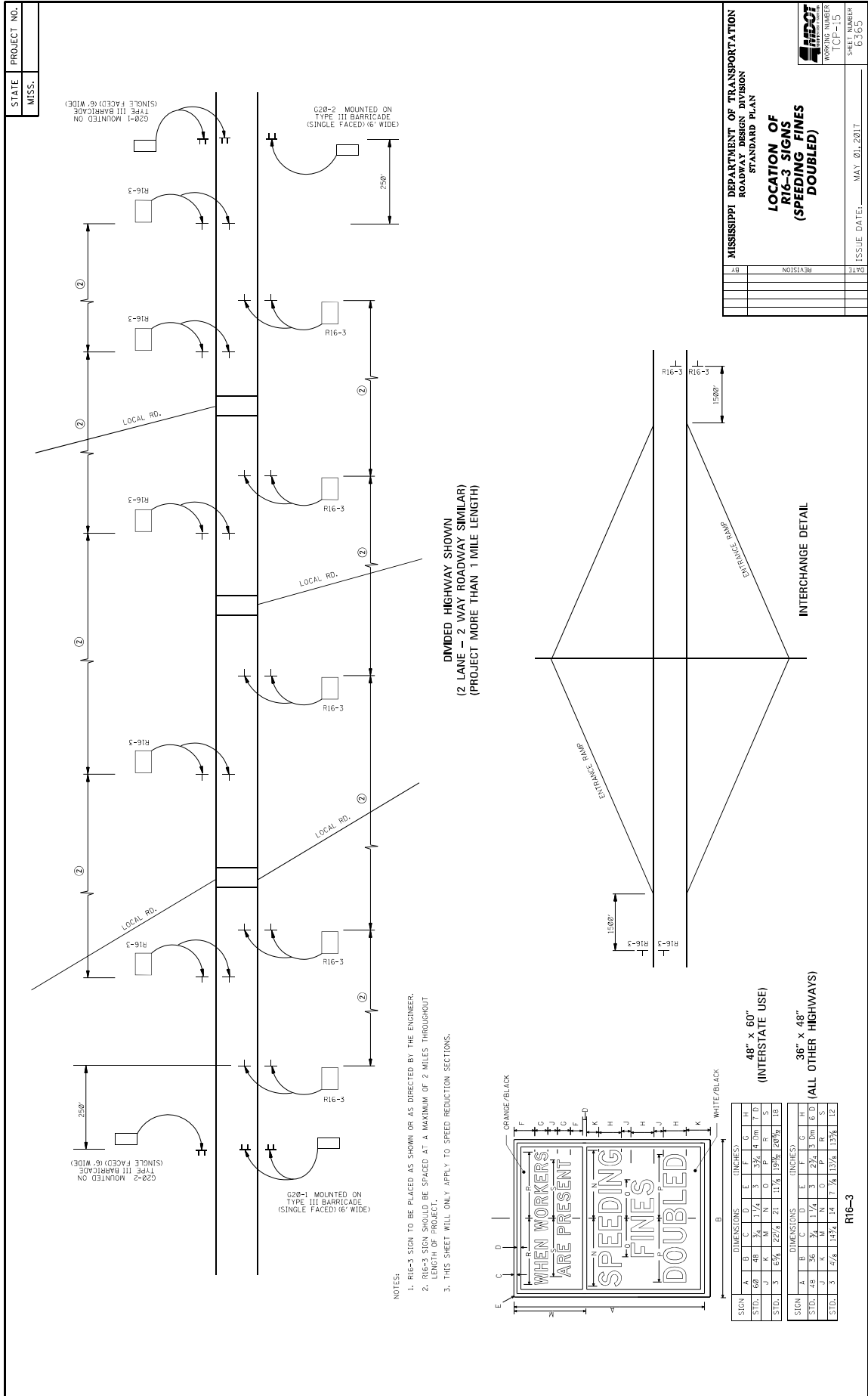

- NOTES:
1. R16-3 SIGN TO BE PLACED AS SHOWN OR AS DIRECTED BY THE ENGINEER.
  2. R16-3 SIGN SHOULD BE SPACED AT A MAXIMUM OF 2 MILES THROUGHOUT LENGTH OF PROJECT.
  3. THIS SHEET WILL ONLY APPLY TO SPEED REDUCTION SECTIONS.

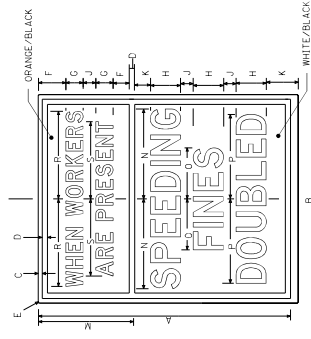

SIGN		DIMENSIONS (INCHES)											
A	B	C	D	E	F	G	H	I	J	K	L	M	N
STD.	6-0	48	36	1-1/4	5-1/4	4	11-1/4	5	1-1/4	1-1/4	1-1/4	1-1/4	1-1/4
MIN.	3	18	12	1/2	2	2	5	2	1/2	1/2	1/2	1/2	1/2
MAX.	3	48	36	1-1/4	5-1/4	4	11-1/4	5	1-1/4	1-1/4	1-1/4	1-1/4	1-1/4

SIGN		DIMENSIONS (INCHES)											
A	B	C	D	E	F	G	H	I	J	K	L	M	N
STD.	3	48	36	1-1/4	5-1/4	4	11-1/4	5	1-1/4	1-1/4	1-1/4	1-1/4	1-1/4
MIN.	3	18	12	1/2	2	2	5	2	1/2	1/2	1/2	1/2	1/2
MAX.	3	48	36	1-1/4	5-1/4	4	11-1/4	5	1-1/4	1-1/4	1-1/4	1-1/4	1-1/4

MISSISSIPPI DEPARTMENT OF TRANSPORTATION  
ROADWAY DESIGN DIVISION  
STANDARD PLAN

**LOCATION OF  
R16-3 SIGNS  
(SPEEDING FINES  
DOUBLED)**

DATE	BY	REVISION

ISSUE DATE: MAY 20, 2017  
SHEET NUMBER: ICF-15  
PROJECT NUMBER: 63363

STATE MISS.	PROJECT NO.	
----------------	-------------	--

**DETAIL OF DRUM PLACEMENT AT PAVEMENT EDGE DROP-OFF**

GRANULAR MATERIAL REQUIRED (SAME CLASSIFICATION AS SHOULDER MATERIAL. SEE TYPICAL SECTIONS)

**NOTES:**

- \* A. PAVEMENT EDGE DROP-OFF
  1. IF LESS THAN TWO AND ONE QUARTER (2.25) INCHES-NO PROTECTION REQUIRED. PLACE A SHOULDER WORK SIGN (W21-5) 500 FEET IN ADVANCE OF WORK ZONE SHOULDER AND A LOW SHOULDER SIGN (W8-9) AT THE BEGINNING AND THROUGHOUT THE WORK ZONE B (1538'+O.C.).
  2. TWO AND ONE QUARTER TO THREE INCHES-PLACE DRUMS, VERTICAL PANELS OR BARRICADES EVERY 120 FEET ON TANGENT SECTIONS FOR SPEEDS OF 50 MILES PER HOUR OR GREATER. CONES MAY BE USED IN PLACE OF DRUMS, PANELS, AND BARRICADES DURING DAYLIGHT HOURS. FOR TANGENT SECTIONS WITH SPEEDS LESS THAN 50 MILES PER HOUR AND FOR CURVES, DEVICES SHOULD BE PLACED EVERY 50 FEET. SPACING FOR TAPERS SHOULD BE IN ACCORDANCE WITH THE MULT.I.C.O. 1 / 3 L, WHERE L IS THE TAPER LENGTH IN FEET.
  3. GREATER THAN THREE (3) INCHES-POSITIVE SEPARATION OR WEDGE WITH 4:1 OR FLATTER SLOPE NEEDED. IF THERE IS EIGHT (8) FEET OR MORE DISTANCE BETWEEN THE EDGE OF TRAVEL LANE AND DROP-OFF, THEN DRUMS, PANELS OR BARRICADES MAY BE USED.
  4. FOR TEMPORARY CONDITIONS, DROP-OFFS GREATER THAN THREE (3) INCHES MAY BE PROTECTED WITH DRUMS, VERTICAL PANELS OR BARRICADES FOR SHORT DISTANCES DURING DAYLIGHT HOURS WHILE WORK IS BEING DONE IN THE DROP-OFF AREA.
  5. LESSER TREATMENTS THAN THOSE DESCRIBED ABOVE MAY BE CONSIDERED FOR LOW-VOLUME LOCAL STREETS.
- B. DRUM SPACING
  1. TANGENTS =  $2 \times S$
  2. WHERE  $S =$  SPEED IN MPH (POSTED OR 85 PERCENTILE)
  3.  $L =$  TAPER LENGTH IN FEET
  4.  $W =$  WIDTH OF OFFSET IN FEET
- C. ALL TRAFFIC CONTROL ITEMS SHOWN ON THIS SHEET SHALL BE PAID FOR UNDER MAINTENANCE OF TRAFFIC.
 

TABLE V-1. GUIDELINES FOR LENGTH OF LONGITUDINAL BUFFER SPACE	
X = SPEED (MPH)	LENGTH (FEET)
25	35
30	45
35	55
40	65
45	75
50	85
55	95
60	105
65	115

\* \* POSTED SPEED, OFF-PEAK 85 PERCENTILE SPEED PRIOR TO WORK STARTING, OR THE ANTICIPATED OPERATING SPEED IN MPH.

PLASTIC DRUMS  
(SEE NOTE FOR SPACING)

**TYPICAL SHOULDER CLOSURE**

(1) TO BE USED WITH EIGHT (8) FOOT OR GREATER WIDTH IMPROVED SHOULDER.  
(2) TO BE USED WHEN CONSTRUCTION VEHICLES (EQUIPMENT) ENCRUSHES ON OR WITHIN TWO (2) FEET OF THE SHOULDER BREAK.

PLASTIC DRUMS  
(SEE NOTE FOR SPACING)

**TYPICAL SHOULDER WORK #1  
(SEE NOTE A-I THIS SHEET)**

PLASTIC DRUMS  
(SEE NOTE FOR SPACING)

**TYPICAL SHOULDER WORK #2**

NOTE:  
WORK OUTSIDE TWO (2) FOOT AND WITHIN TEN (10) FEET OF THE SHOULDER BREAK MAY BE PROTECTED BY PLACING DRUMS ALONG THE SHOULDER EDGE 300 FEET PRIOR TO AND 50 FEET BEYOND THE WORK AREA, OR SEE NOTE A-3 THIS SHEET.

<b>MISSISSIPPI DEPARTMENT OF TRANSPORTATION ROADWAY DESIGN DIVISION STANDARD PLAN</b>	
<b>TRAFFIC CONTROL DETAILS DRUM PLACEMENT SHOULDER CLOSURE</b>	
WORKING NUMBER TCP-16	SHEET NUMBER G506
DATE	ISSUE DATE: MAY 01, 2017



STATE	PROJECT NO.
MISS.	

- GENERAL NOTES
- GROUND-IN RUMBLE STRIPES SHALL BE APPLIED ON LEFT AND RIGHT SHOULDERS OF ALL PAVED SHOULDERS ON THIS PROJECT.
  - GROUND-IN RUMBLE STRIPES SHALL BE APPLIED TO ALL PAVED SHOULDERS ON ROADWAYS OR OTHER INTERUPTIONS IN NORMAL SHOULDER WIDTH AS DIRECTED BY THE ENGINEER.
  - COST TO BE PAID FOR USING APPROPRIATE PAY ITEMS.
  - GROUND-IN RUMBLE STRIPES SHALL BE APPLIED TO:
    - MAINLINE
    - INTERSECTING ROADWAY IF OVERLAD OR RECONSTRUCTED BEYOND NORMAL MAINLINE R.O.W.
    - ANY ROADWAY WITH EXISTING RUMBLE STRIPES PRIOR TO CONSTRUCTION.
  - DO NOT USE WHERE TRAVEL LANE IS LESS THAN 11' WIDE.

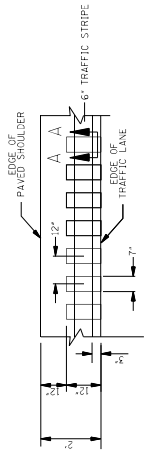

DETAIL "A"

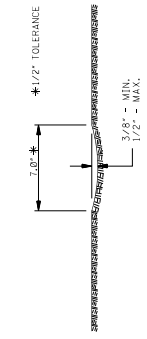

SECTION "A-A"

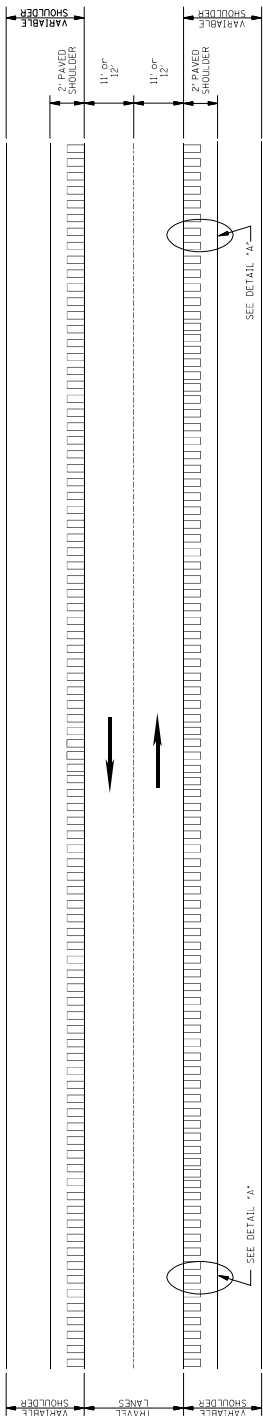

PLAN  
NOT TO SCALE

MISSISSIPPI DEPARTMENT OF TRANSPORTATION ROADWAY DESIGN DIVISION STANDARD PLAN	
<b>RUMBLE STRIPES 2-LANE HIGHWAYS (ASPHALT LANES, 2-FT ASPHALT SHOULDERS)</b>	
BY	REVISION
DATE	ISSUE DATE: MAY 21, 2017
SHEET NUMBER RS-1 6064	



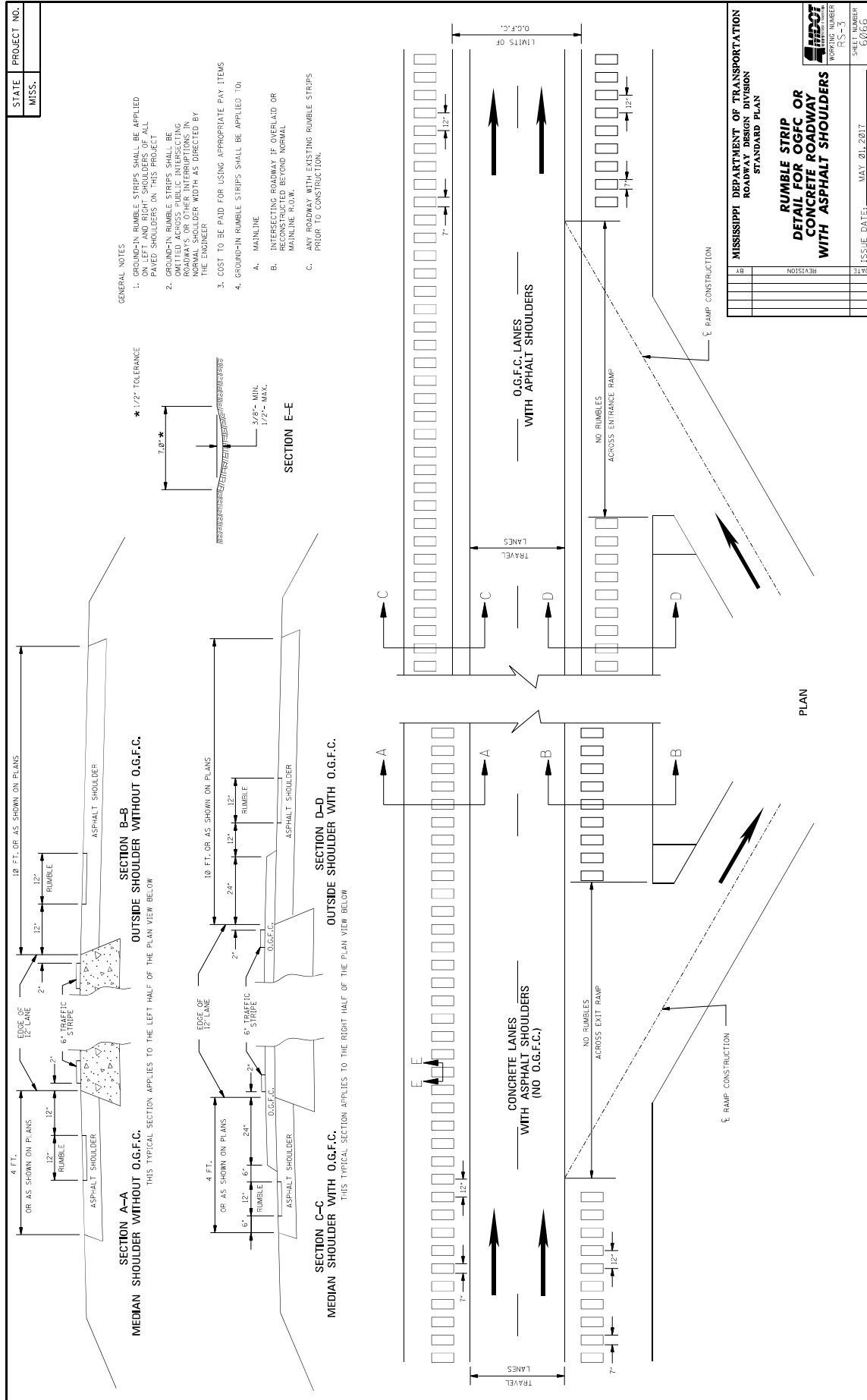

**MISSISSIPPI DEPARTMENT OF TRANSPORTATION**

**SECTION 904 - NOTICE TO BIDDERS NO. 445**

**CODE: (SP)**

**DATE: 10/10/2017**

**SUBJECT: Mississippi Agent or Qualified Nonresident Agent**

Bidders are hereby advised of the requirements of Subsections 102.08, 103.05.2, and 107.14.2.1 of the *2017 Standard Specifications for Road and Bridge Construction* as it refers to bonding agents. Proposal guaranties, bonds, and liability insurance policies must be signed by a **Mississippi Agent or Qualified Nonresident Agent.**

## MISSISSIPPI DEPARTMENT OF TRANSPORTATION

SECTION 904 - NOTICE TO BIDDERS NO. 516

CODE: (IS)

DATE: 11/28/2017

SUBJECT: Errata and Modifications to the 2017 Standard Specifications

<u>Page</u>	<u>Subsection</u>	<u>Change</u>
16	102.06	In the seventh full paragraph, change “Engineer” to “Director.”
33	105.05.1	In the sixth sentence, change “Contract Administration Engineer” to “Contract Administration Director.”
34	105.05.2.1	In subparagraph 2, change “SWPPP, ECP” to “SWPPP and the ECP”
35	105.05.2.2	In subparagraphs 2, add “ and” to the end of the sentence. In subparagraph 3, remove “, and” and add “.”.
90	109.04.2	In the last paragraph of subparagraph (a), place a period “.” at the end of the sentence.
93	109.04.2	In the last paragraph of subparagraph (g), place a period “.” at the end of the sentence. Also, in the first paragraph of subparagraph (h), place a period “.” at the end of the sentence.
97	109.07	Under ADJUSTMENT CODE, subparagraph (A1), change “HMA mixture” to “Asphalt mixtures.”
98	109.11	In the third sentence, change “Engineer” to “Director.”
219	308.04	In the last sentence of the last paragraph, change “Contractor’s decision” to “Engineer’s decision.”
300	405.02.5.9	In the first sentence of the second paragraph, change “Hot Mix Asphalt” to “Asphalt Mixtures.”
502	630.01.1	In the first paragraph, change “AASHTO” to “AASHTO’s LRFD”.
636	646.05	Change “each” to “per each” for the pay item units of payment.
640	656.02.6.2	In item 7), change “down stream” to “downstream”.
688	630.03.2	Change the subsection number from “630.03.2” to “680.03.2.”

- |     |               |   |
|-----|---------------|---|
| 725 | 702.08.3      | In the second sentence of the first paragraph, change “hot-mix” to “asphalt.”                     |
| 954 | 804.02.13.1.6 | In the definition for “M” in the % Reduction formulas, change “paragraph 7.3” to “paragraph 5.3.” |

## MISSISSIPPI DEPARTMENT OF TRANSPORTATION

SECTION 904 - NOTICE TO BIDDERS NO. 977

CODE: (IS)

DATE: 07/25/2018

SUBJECT: DUNS Requirement for Federal Funded Projects

Bidders are advised that the Prime Contractor must maintain a current registration in the System for Award Management ( <http://www.sam.gov> ) at all times during this project. A Dun and Bradstreet Data Universal Numbering System (DUNS) Number ( <http://www.dnb.com> ) is one of the requirements for registration in the System for Award Management.

Bidders are also advised that prior to the award of this contract, they MUST be registered, active, and have no active exclusions in the System for Award Management.

## MISSISSIPPI DEPARTMENT OF TRANSPORTATION

SECTION 904 - NOTICE TO BIDDERS NO. 1206

CODE: (SP)

DATE: 10/16/2018

SUBJECT: MASH Compliant Devices

Bidders are hereby advised that the Standard Specifications may require certain traffic control and permanent safety hardware devices to meet the requirements of the Manual for Assessing Safety Hardware (MASH). However, devices meeting the requirements of NCHRP Report 350 will be allowed until the mandatory effective date for MASH compliance. The following table shows the effective dates for MASH compliant devices.

Device	Effective Date for MASH Compliance
W-beam barriers, cast-in-place concrete barriers	December 31, 2017
W-beam terminals - non-flared	June 30, 2018
Crash cushions	December 31, 2018
Cable barriers, cable barrier terminals, bridge rails, transitions, all other longitudinal barriers including portable barriers installed permanently, W-beam terminals - flared, all other terminals, sign supports, all other breakaway hardware	December 31, 2019

Temporary work zone devices, including portable barriers manufactured after December 31, 2019, must have been successfully tested to the 2016 Edition of MASH. Such devices manufactured on or before this date and successfully tested to NCHRP Report 350 or the 2009 Edition of MASH may continue to be used throughout their normal service lives.



**MISSISSIPPI DEPARTMENT OF TRANSPORTATION**

**SECTION 904 - NOTICE TO BIDDERS NO. 1225**

**CODE: (SP)**

**DATE: 11/13/2018**

**SUBJECT: Early Notice to Proceed**

Bidders are advised that if an early notice to proceed is allowed by the Department and the Contractor experiences problems or delays between the early notice to proceed date and the original notice to proceed date, this shall not be justification for any monetary compensation or an extension of contract time.

## MISSISSIPPI DEPARTMENT OF TRANSPORTATION

SECTION 904 - NOTICE TO BIDDERS NO. 1226

CODE: (SP)

DATE: 11/16/2018

SUBJECT: Material Storage Under Bridges

Bidders are advised that Subsection 106.08 of the Standard Specifications allows the Contractor to store materials and equipment on portions of the right-of-way. However, the Contractor will not be allowed to store or stockpile materials under bridges without written permission from the Project Engineer. The Contractor shall submit a detailed request of all proposed materials to be stored under bridges to the Engineer a minimum of 14 calendar days prior to anticipated storage. This detail shall include, but not limited to, bridge location, material type, material quantity, and duration of storage. The Project Engineer and any other needed Division will review this information and determine whether to grant approval. The Contractor shall not store any material under any bridge without written approval from the Project Engineer.

**MISSISSIPPI DEPARTMENT OF TRANSPORTATION**

**SECTION 904 - NOTICE TO BIDDERS NO. 1241**

**CODE: (SP)**

**DATE: 11/27/2018**

**SUBJECT: Fuel and Material Adjustments**

Bidder's attention is brought to the last paragraph of Subsection 109.07 of the Standard Specifications which states that no fuel or material adjustment will be made after the completion of contract time. Any fuels consumed or materials incorporated into the work during the monthly estimate period falling wholly after the expiration of contract time will not be subject a fuel or material adjustment.

**MISSISSIPPI DEPARTMENT OF TRANSPORTATION**

**SECTION 904 - NOTICE TO BIDDERS NO. 1532**

**CODE: (SP)**

**DATE: 04/02/2019**

**SUBJECT: Contract Time**

**PROJECT: STP-9999-03(018) / 107913301 – Holmes County  
STP-9999-03(018) / 107913302 – Yazoo County**

The completion of work to be performed by the Contractor for this project will not be a specified date but shall be when all allowable working days are assessed, or any extension thereto as provided in Subsection 108.06. It is anticipated that the Notice of Award will be issued no later than June 11, 2019 and the date for Notice to Proceed / Beginning of Contract Time will be July 11, 2019.

Should the Contractor request a Notice to Proceed earlier than July 11, 2019 and it is agreeable with the Department for an early Notice to Proceed, the requested date will become the new Notice to Proceed date. Regardless of whether or not an early Notice to Proceed is granted, contract time will start at the original Notice to Proceed date.

All requests for an early Notice to Proceed shall be sent to the Project Engineer who will forward it to the Contract Administration Division.

121 Working Days have been allowed for the completion of work on this project.

## MISSISSIPPI DEPARTMENT OF TRANSPORTATION

**SECTION 904 – NOTICE TO BIDDERS NO. 1533**

**CODE: (SP)**

**DATE: 03/7/2019**

**SUBJECT: Scope of Work**

**PROJECT: STP-9999-03(018) / 107913301 – Holmes County  
STP-9999-03(018) / 107913302 – Yazoo County**

The contract documents do not include an official set of construction plans, but may, by reference, include some Standard Drawings when so specified in a Notice to Bidders entitled, “Standard Drawings.” All other references to plans in the contract documents and Standard Specification for Road and Bridge Construction are to be disregarded.

Minor changes in detail of design or construction procedure may be authorized by the Director of Structures, State Bridge Engineer provided such changes will not be cause for contract price adjustment. Work for which no pay item is provided will not be paid for directly and shall therefore be considered an absorbed item of work.

It shall be the responsibility of the Contractor to protect existing structures from damage which might occur during construction. The Contractor shall replace or repair, as directed by the Engineer, any structures damaged during the life of the contract. No payment will be made for replacement or repair of damaged items.

All details are based on the dimensions shown on the original plans for the existing structure. The Contractor shall be responsible for adjusting the elements of the new construction to ensure a proper fit with the existing structure. The Contractor shall verify all dimensions of the existing structure prior to beginning work.

During construction, care shall be exercised to ensure that no debris falls into the roadway crossing below the structure.

Work on the project shall consist of repairing joints on various bridges in Holmes and Yazoo Counties as follows:

### **Joint Repair & Sealing:**

The joint repair shall include removal of all existing joint material, joint preparation, saw cutting, installation of the preformed joint seal and other necessary work per the included standard drawings or as directed by the Engineer. All concrete approach slab joints shall be sealed. If the bridge has an asphalt approach, the joint between the asphalt and concrete shall not be disturbed. Removal of material from all joint types will not be paid directly and shall be considered an absorbed item of work under Pay Item No. 907-808-A: Joint Repair without Epoxy.

After the existing joint material has been removed, the joints shall then be saw cut as per the Joint Repair Standard Drawings. Saw cuts will be paid for under pay item no. 907-823-B: Saw Cut. The joints are then to be repaired, if necessary, with epoxy mortar or an approved equivalent. This work will be paid for under pay item no. 907-808-A: Joint Repair without Epoxy. The joint shall then be sealed by one of the three approved Manufacturers listed in Special Provision 907-823 and installed according to the Manufacturer's specifications.

**Traffic Control Plan:**

The Contractor shall erect and maintain construction signing and provide all signs and traffic handling devices necessary to safely maintain traffic around or through the work areas in accordance with the Traffic Control Plan. Payment shall be included in the price bid for pay item no. 618-A: Maintenance of Traffic. All traffic control devices on this project should comply with Part VI of the MUTCD, Latest Edition. Fluorescent orange sheeting shall be used on all construction and traffic control signs except for those designated in plans to be black legend and border on white background. The Contractor will be required to use 42-inch channelize cones with 6-inch wide reflective tape and a 16-pound base for each cone.

Bridge Joint Repair														
County	Route	ID	Structure Name	# Joints	Gutter to Gutter (ft)	Joint Width (in)	Skew Angle	Total LF	Joint Repair	Saw Cuts		Preformed Joint Seal		Bent #'s
										Type I	Type II	Type I	Type II	
Yazoo	51	16159	140.20	7	44.83	2	45	444	888	0	888	0	444	All 1 - 7
Holmes	51	16194	142.30	4	40.03	2	30	185	370	0	370	0	185	1A, 1, 6, 6A
Holmes	51	16195	143.40	4	40.03	2	0	160	320	0	320	0	160	1A, 1, 6, 6A
Holmes	51	16196	148.80	6	40.03	1.5	30	277	554	0	554	277	0	1A, 1, 3, 4, 6, 6A
Holmes	51	16187	153.60	7	39.37	1.5	0	276	552	0	552	276	0	1A, 1, 2, 3, 4, 5, 5A
Holmes	51	16188	154.80	6	39.37	1.5	0	236	472	0	472	236	0	1A, 1, 2, 3, 4, 4A
Holmes	51	15952	156.90	4	39.37	2	25	174	348	0	348	0	174	1A, 1, 7, 7A
Holmes	51	15953	159.30	6	39.37	1.5	0	236	472	0	472	236	0	1A, 1, 2, 3, 4, 4A
Holmes	51	15954	162.20	4	39.37	1.5	0	157	314	0	314	157	0	1A, 1, 7, 7A
Holmes	51	15955	162.60	6	39.37	1.5	0	236	472	0	472	236	0	1A, 1, 2, 3, 4, 5, 5A
Holmes	51	15956	162.80	4	39.37	1.5	0	157	314	0	314	157	0	1A, 1, 4, 4A
Holmes	51	16351	163.90	6	39.37	1.5	15	245	490	0	490	245	0	1A, 1, 2, 4, 5, 5A
Holmes	51	16353	166.00	4	39.37	1.5	0	157	314	0	314	157	0	1A, 1, 4, 4A
Holmes	49E	11603	240.00	4	40.03	1.5	0	160	320	0	320	160	0	1A, 1, 4, 4A
Holmes	49E	11599	232.10	4	40.03	2	0	160	320	0	320	0	160	1A, 1, 4, 4A
Holmes	49E	11608	231.80	6	40.03	2	0	240	480	0	480	0	240	1A, 1, 2, 3, 4, 4A
Holmes	49E	11609	231.30	3	40.03	2	0	120	240	0	240	0	120	1A, 1, 4
Holmes	49E	11607	230.70	4	40.03	2	0	160	320	0	320	0	160	1A, 1, 5, 5A
Holmes	49E	11606	228.30	8	43.96	2	0	352	704	0	704	0	352	1A, 1, 2, 3, 4, 5, 6, 6A
Holmes	49E	15525	222.90	6	43.96	2	0	264	528	0	528	0	264	1A, 1, 2, 3, 4, 4A
Yazoo	49W	15281	39.80	9	70.87	2	0	638	1276	0	1276	0	638	1A, 1 - 7, 7A
Yazoo	49W	15740	39.8A	9	31.5	1	0	284	568	0	568	284	0	1A, 1, 2, 7, 8, 9, 10, 11, 12
Yazoo	49W	15741	39.8B	9	31.5	1.5	0	284	568	0	568	284	0	1A, 1, 2, 8, 9, 10, 11, 12, 13
Yazoo	I-55	15233	127.1A	8	40.35	1.5	0	323	646	0	646	323	0	All 1 - 8
Yazoo	I-55	15234	127.1B	8	40.35	1.5	0	323	646	0	646	323	0	All 1 - 8
Yazoo	I-55	15238	127.7A	11	40.35	2	0	444	888	0	888	0	444	All 1 - 11
Yazoo	I-55	15239	127.7B	11	40.35	2	0	444	888	0	888	0	444	All 1 - 11
Yazoo	I-55	15240	128.2A	11	40.35	2	0	444	888	0	888	0	444	All 1 - 11
Yazoo	I-55	15241	128.2B	11	40.35	2	0	444	888	0	888	0	444	All 1 - 11
Yazoo	I-55	15227	128.4A	11	40.35	2	0	444	888	0	888	0	444	All 1 - 11
Yazoo	I-55	15228	128.4B	11	40.35	2	0	444	888	0	888	0	444	All 1 - 11
Yazoo	I-55	15229	132.2A	6	40.35	2	0	242	484	0	484	0	242	1A, 1, 2, 3, 4, 4A
Yazoo	I-55	15230	132.2B	6	40.35	2	0	242	484	0	484	0	242	1A, 1, 2, 3, 4, 4A

GENERAL HIGHWAY MAP

OF

HOLMES COUNTY (26)

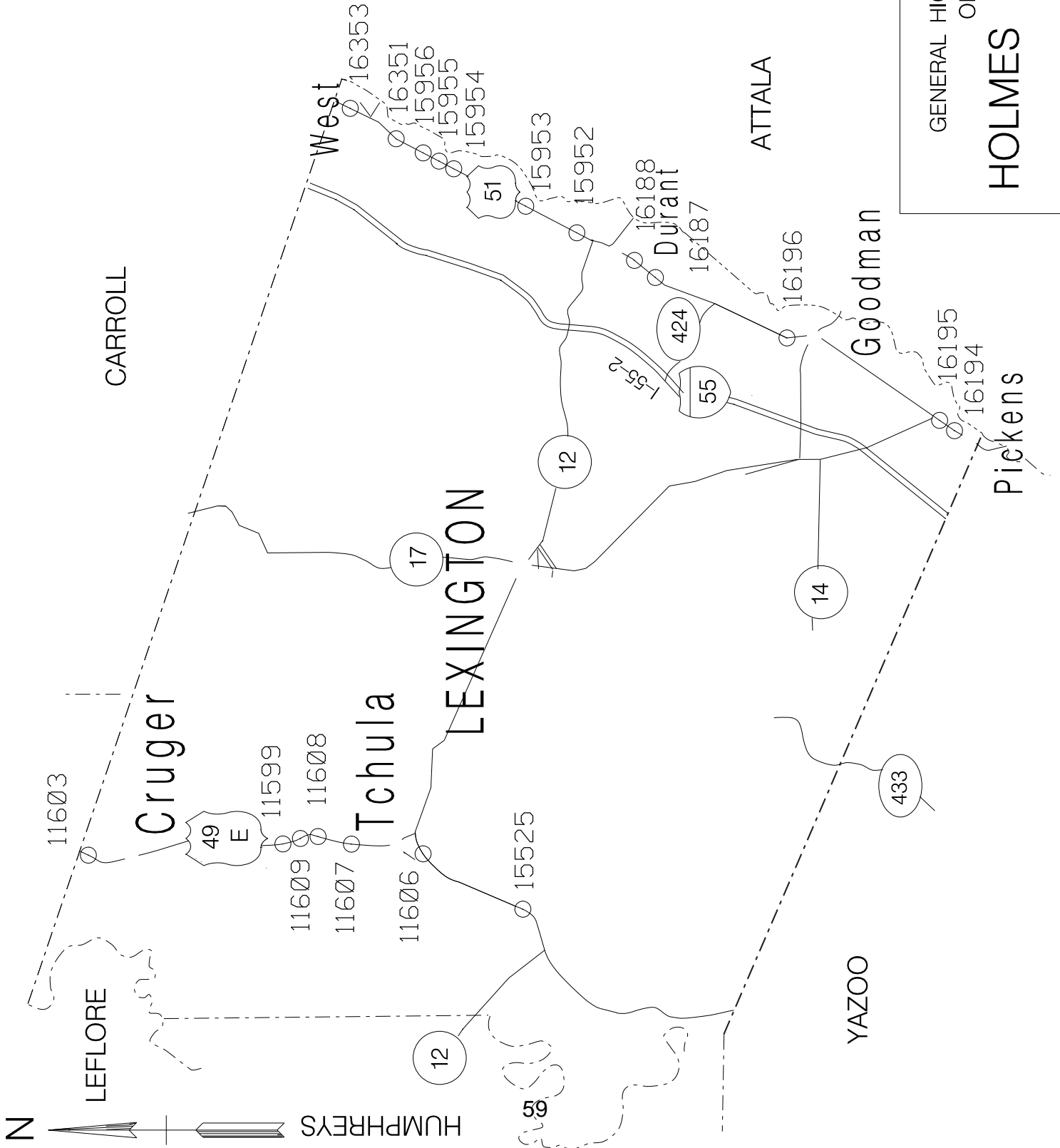



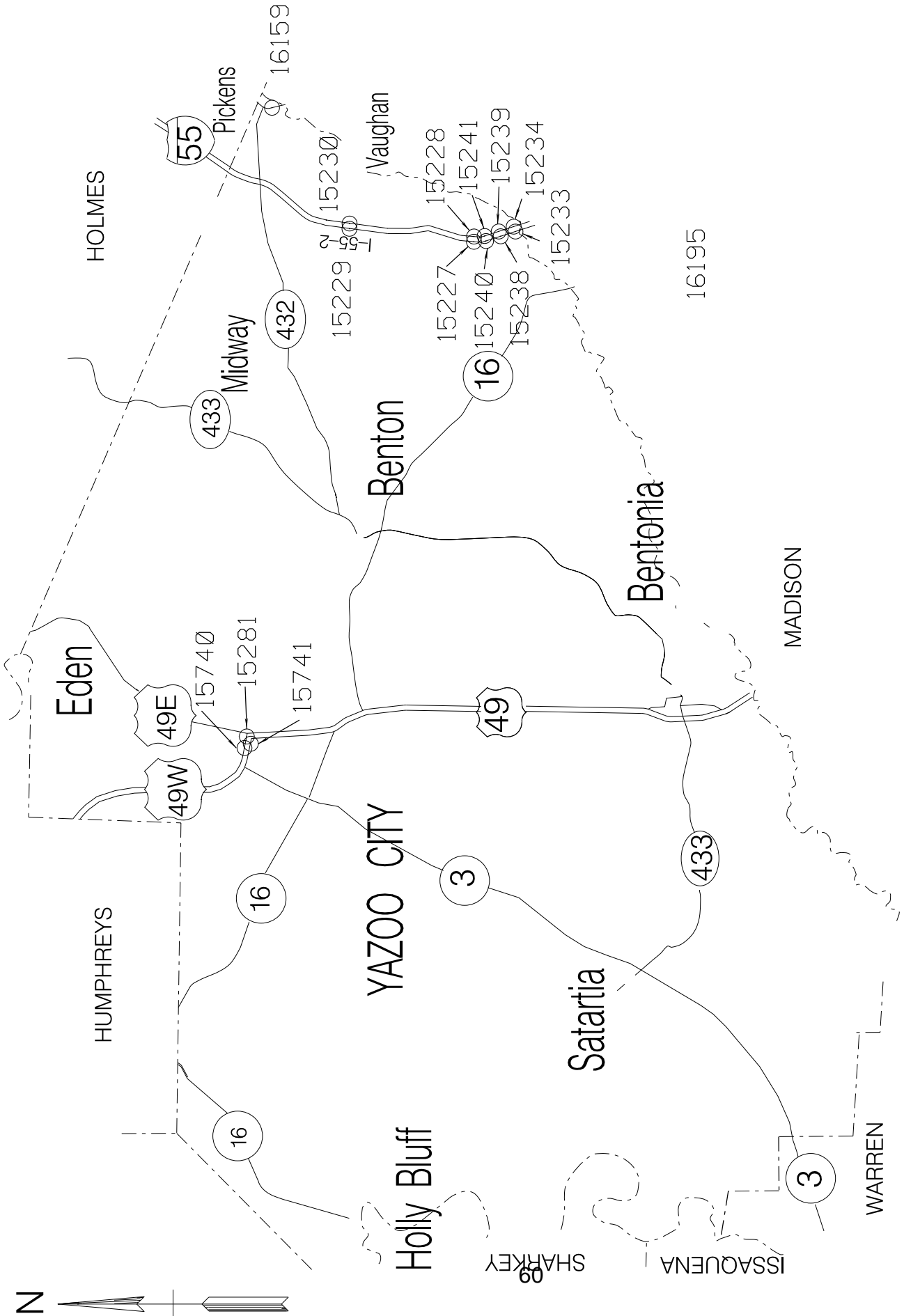

GENERAL HIGHWAY MAP  
OF  
YAZOO COUNTY (82)

General Decision Number: MS190090 01/04/2019 MS90

Superseded General Decision Number: MS20180194

State: Mississippi

Construction Type: Highway

County: Holmes County in Mississippi.

HIGHWAY CONSTRUCTION PROJECTS

Note: Under Executive Order (EO) 13658, an hourly minimum wage of \$10.60 for calendar year 2019 applies to all contracts subject to the Davis-Bacon Act for which the contract is awarded (and any solicitation was issued) on or after January 1, 2015. If this contract is covered by the EO, the contractor must pay all workers in any classification listed on this wage determination at least \$10.60 per hour (or the applicable wage rate listed on this wage determination, if it is higher) for all hours spent performing on the contract in calendar year 2019. If this contract is covered by the EO and a classification considered necessary for performance of work on the contract does not appear on this wage determination, the contractor must pay workers in that classification at least the wage rate determined through the conformance process set forth in 29 CFR 5.5(a)(1)(ii) (or the EO minimum wage rate, if it is higher than the conformed wage rate). The EO minimum wage rate will be adjusted annually. Please note that this EO applies to the above-mentioned types of contracts entered into by the federal government that are subject to the Davis-Bacon Act itself, but it does not apply to contracts subject only to the Davis-Bacon Related Acts, including those set forth at 29 CFR 5.1(a)(2)-(60). Additional information on contractor requirements and worker protections under the EO is available at [www.dol.gov/whd/govcontracts](http://www.dol.gov/whd/govcontracts).

Modification Number	Publication Date
0	01/04/2019

SUMS2010-013 08/04/2014

	Rates	Fringes
CARPENTER (Form Work Only).....	\$ 13.99	0.00
CARPENTER, Excludes Form Work....	\$ 14.03	0.00
CEMENT MASON/CONCRETE FINISHER...	\$ 15.69	0.00
ELECTRICIAN.....	\$ 21.80	7.93
HIGHWAY/PARKING LOT STRIPING:		
Truck Driver (Line Striping		
Truck).....	\$ 14.11	0.00

INSTALLER - GUARDRAIL.....	\$ 11.42	0.00
INSTALLER - SIGN.....	\$ 11.65	0.00
IRONWORKER, REINFORCING.....	\$ 16.29	0.00
LABORER: Asphalt, Includes Raker, Shoveler, Spreader and Distributor.....	\$ 10.61	0.00
LABORER: Common or General.....	\$ 10.37	0.00
LABORER: Concrete Worker.....	\$ 10.91	0.00
LABORER: Flagger.....	\$ 10.06	0.00
LABORER: Grade Checker.....	\$ 11.32	0.00
LABORER: Landscape.....	\$ 9.77	0.00
LABORER: Mason Tender - Cement/Concrete.....	\$ 11.08	0.00
LABORER: Pipelayer.....	\$ 11.34	0.00
LABORER: Laborer-Cones/ Barricades/Barrels - Setter/Mover/Sweeper.....	\$ 12.93	0.00
OPERATOR: Asphalt Spreader.....	\$ 16.03	0.00
OPERATOR: Backhoe/Excavator/Trackhoe.....	\$ 15.25	0.00
OPERATOR: Broom/Sweeper.....	\$ 10.77	0.00
OPERATOR: Bulldozer.....	\$ 14.15	0.00
OPERATOR: Concrete Saw.....	\$ 10.25	0.00
OPERATOR: Crane.....	\$ 21.25	0.00
OPERATOR: Distributor.....	\$ 11.83	0.00
OPERATOR: Drill.....	\$ 19.22	0.00
OPERATOR: Grader/Blade.....	\$ 14.44	0.00
OPERATOR: Grinding/Grooving Machine.....	\$ 15.94	0.00
OPERATOR: Loader.....	\$ 12.21	0.00
OPERATOR: Mechanic.....	\$ 17.07	0.00
OPERATOR: Milling Machine.....	\$ 18.16	0.00
OPERATOR: Oiler.....	\$ 12.33	0.48

OPERATOR: Paver (Asphalt, Aggregate, and Concrete).....	\$ 12.05	0.00
OPERATOR: Piledriver.....	\$ 15.13	0.00
OPERATOR: Roller (All Types)....	\$ 11.88	0.00
OPERATOR: Scraper.....	\$ 12.96	0.00
OPERATOR: Tractor.....	\$ 12.56	0.00
OPERATOR: Trencher.....	\$ 15.00	0.00
TRUCK DRIVER: Flatbed Truck.....	\$ 12.64	0.00
TRUCK DRIVER: Lowboy Truck.....	\$ 13.80	0.00
TRUCK DRIVER: Mechanic.....	\$ 14.08	0.00
TRUCK DRIVER: Off the Road Truck.....	\$ 12.29	0.00
TRUCK DRIVER: Water Truck.....	\$ 10.89	0.00
TRUCK DRIVER: Dump Truck (All Types).....	\$ 11.99	0.00
TRUCK DRIVER: Semi/Trailer Truck.....	\$ 15.29	0.00

-----

WELDERS - Receive rate prescribed for craft performing  
operation to which welding is incidental.

=====

Note: Executive Order (EO) 13706, Establishing Paid Sick Leave for Federal Contractors applies to all contracts subject to the Davis-Bacon Act for which the contract is awarded (and any solicitation was issued) on or after January 1, 2017. If this contract is covered by the EO, the contractor must provide employees with 1 hour of paid sick leave for every 30 hours they work, up to 56 hours of paid sick leave each year. Employees must be permitted to use paid sick leave for their own illness, injury or other health-related needs, including preventive care; to assist a family member (or person who is like family to the employee) who is ill, injured, or has other health-related needs, including preventive care; or for reasons resulting from, or to assist a family member (or person who is like family to the employee) who is a victim of, domestic violence, sexual assault, or stalking. Additional information on contractor requirements and worker protections under the EO is available at [www.dol.gov/whd/govcontracts](http://www.dol.gov/whd/govcontracts).

Unlisted classifications needed for work not included within the scope of the classifications listed may be added after award only as provided in the labor standards contract clauses (29CFR 5.5 (a) (1) (ii)).

-----

The body of each wage determination lists the classification and wage rates that have been found to be prevailing for the cited type(s) of construction in the area covered by the wage determination. The classifications are listed in alphabetical order of "identifiers" that indicate whether the particular rate is a union rate (current union negotiated rate for local), a survey rate (weighted average rate) or a union average rate (weighted union average rate).

#### Union Rate Identifiers

A four letter classification abbreviation identifier enclosed in dotted lines beginning with characters other than "SU" or "UAVG" denotes that the union classification and rate were prevailing for that classification in the survey. Example: PLUM0198-005 07/01/2014. PLUM is an abbreviation identifier of the union which prevailed in the survey for this classification, which in this example would be Plumbers. 0198 indicates the local union number or district council number where applicable, i.e., Plumbers Local 0198. The next number, 005 in the example, is an internal number used in processing the wage determination. 07/01/2014 is the effective date of the most current negotiated rate, which in this example is July 1, 2014.

Union prevailing wage rates are updated to reflect all rate changes in the collective bargaining agreement (CBA) governing this classification and rate.

#### Survey Rate Identifiers

Classifications listed under the "SU" identifier indicate that no one rate prevailed for this classification in the survey and the published rate is derived by computing a weighted average rate based on all the rates reported in the survey for that classification. As this weighted average rate includes all rates reported in the survey, it may include both union and non-union rates. Example: SULA2012-007 5/13/2014. SU indicates the rates are survey rates based on a weighted average calculation of rates and are not majority rates. LA indicates the State of Louisiana. 2012 is the year of survey on which these classifications and rates are based. The next number, 007 in the example, is an internal number used in producing the wage determination. 5/13/2014 indicates the survey completion date for the classifications and rates under that identifier.

Survey wage rates are not updated and remain in effect until a new survey is conducted.

#### Union Average Rate Identifiers

Classification(s) listed under the UAVG identifier indicate that no single majority rate prevailed for those classifications; however, 100% of the data reported for the classifications was union data. EXAMPLE: UAVG-OH-0010 08/29/2014. UAVG indicates that the rate is a weighted union average rate. OH indicates the state. The next number, 0010 in

the example, is an internal number used in producing the wage determination. 08/29/2014 indicates the survey completion date for the classifications and rates under that identifier.

A UAVG rate will be updated once a year, usually in January of each year, to reflect a weighted average of the current negotiated/CBA rate of the union locals from which the rate is based.

---

WAGE DETERMINATION APPEALS PROCESS

1.) Has there been an initial decision in the matter? This can be:

- \* an existing published wage determination
- \* a survey underlying a wage determination
- \* a Wage and Hour Division letter setting forth a position on a wage determination matter
- \* a conformance (additional classification and rate) ruling

On survey related matters, initial contact, including requests for summaries of surveys, should be with the Wage and Hour Regional Office for the area in which the survey was conducted because those Regional Offices have responsibility for the Davis-Bacon survey program. If the response from this initial contact is not satisfactory, then the process described in 2.) and 3.) should be followed.

With regard to any other matter not yet ripe for the formal process described here, initial contact should be with the Branch of Construction Wage Determinations. Write to:

Branch of Construction Wage Determinations  
Wage and Hour Division  
U.S. Department of Labor  
200 Constitution Avenue, N.W.  
Washington, DC 20210

2.) If the answer to the question in 1.) is yes, then an interested party (those affected by the action) can request review and reconsideration from the Wage and Hour Administrator (See 29 CFR Part 1.8 and 29 CFR Part 7). Write to:

Wage and Hour Administrator  
U.S. Department of Labor  
200 Constitution Avenue, N.W.  
Washington, DC 20210

The request should be accompanied by a full statement of the interested party's position and by any information (wage payment data, project description, area practice material, etc.) that the requestor considers relevant to the issue.

3.) If the decision of the Administrator is not favorable, an interested party may appeal directly to the Administrative Review Board (formerly the Wage Appeals Board). Write to:

Administrative Review Board  
U.S. Department of Labor  
200 Constitution Avenue, N.W.  
Washington, DC 20210

4.) All decisions by the Administrative Review Board are final.

=====

END OF GENERAL DECISION

General Decision Number: MS190123 01/04/2019 MS123

Superseded General Decision Number: MS20180227

State: Mississippi

Construction Type: Highway

County: Yazoo County in Mississippi.

HIGHWAY CONSTRUCTION PROJECTS

Note: Under Executive Order (EO) 13658, an hourly minimum wage of \$10.60 for calendar year 2019 applies to all contracts subject to the Davis-Bacon Act for which the contract is awarded (and any solicitation was issued) on or after January 1, 2015. If this contract is covered by the EO, the contractor must pay all workers in any classification listed on this wage determination at least \$10.60 per hour (or the applicable wage rate listed on this wage determination, if it is higher) for all hours spent performing on the contract in calendar year 2019. If this contract is covered by the EO and a classification considered necessary for performance of work on the contract does not appear on this wage determination, the contractor must pay workers in that classification at least the wage rate determined through the conformance process set forth in 29 CFR 5.5(a)(1)(ii) (or the EO minimum wage rate, if it is higher than the conformed wage rate). The EO minimum wage rate will be adjusted annually. Please note that this EO applies to the above-mentioned types of contracts entered into by the federal government that are subject to the Davis-Bacon Act itself, but it does not apply to contracts subject only to the Davis-Bacon Related Acts, including those set forth at 29 CFR 5.1(a)(2)-(60). Additional information on contractor requirements and worker protections under the EO is available at [www.dol.gov/whd/govcontracts](http://www.dol.gov/whd/govcontracts).

Modification Number	Publication Date
0	01/04/2019

SUMS2010-046 08/04/2014

	Rates	Fringes
CARPENTER (Form Work Only).....	\$ 12.26	0.12
CARPENTER, Excludes Form Work....	\$ 14.21	0.00
CEMENT MASON/CONCRETE FINISHER...	\$ 13.23	0.00
ELECTRICIAN.....	\$ 22.64	7.73
HIGHWAY/PARKING LOT STRIPING:		
Truck Driver (Line Striping		
Truck).....	\$ 12.63	0.00



INSTALLER - GUARDRAIL.....	\$ 11.42	0.00
INSTALLER - SIGN.....	\$ 11.56	0.00
IRONWORKER, REINFORCING.....	\$ 16.43	0.00
LABORER: Common or General, Including Asphalt Raking, Shoveling, Spreading and Concrete Work.....	\$ 10.92	0.00
LABORER: Flagger.....	\$ 9.83	0.00
LABORER: Grade Checker.....	\$ 10.46	0.00
LABORER: Landscape.....	\$ 9.82	0.00
LABORER: Mason Tender - Cement/Concrete.....	\$ 11.69	0.00
LABORER: Pipelayer.....	\$ 13.13	0.00
LABORER: Laborer-Cones/ Barricades/Barrels - Setter/Mover/Sweeper.....	\$ 10.53	0.00
OPERATOR: Asphalt Spreader.....	\$ 16.13	0.00
OPERATOR: Backhoe/Excavator/Trackhoe.....	\$ 13.28	0.00
OPERATOR: Broom/Sweeper.....	\$ 10.17	0.00
OPERATOR: Bulldozer.....	\$ 15.69	0.00
OPERATOR: Concrete Saw.....	\$ 13.60	0.00
OPERATOR: Crane.....	\$ 16.00	0.00
OPERATOR: Distributor.....	\$ 11.70	0.00
OPERATOR: Drill.....	\$ 19.22	0.00
OPERATOR: Grader/Blade.....	\$ 13.84	0.00
OPERATOR: Loader.....	\$ 11.73	0.00
OPERATOR: Mechanic.....	\$ 16.28	0.00
OPERATOR: Milling Machine.....	\$ 15.38	0.00
OPERATOR: Mixer.....	\$ 14.85	0.00
OPERATOR: Oiler.....	\$ 13.08	0.48
OPERATOR: Paver (Asphalt, Aggregate, and Concrete).....	\$ 13.01	0.00
OPERATOR: Piledriver.....	\$ 15.13	0.00

OPERATOR: Roller (All Types).....	\$ 12.14	0.00
OPERATOR: Scraper.....	\$ 12.63	0.00
OPERATOR: Tractor.....	\$ 9.98	0.00
OPERATOR: Trencher.....	\$ 15.00	0.00
TRUCK DRIVER: Flatbed Truck.....	\$ 13.29	0.00
TRUCK DRIVER: Lowboy Truck.....	\$ 12.49	0.00
TRUCK DRIVER: Mechanic.....	\$ 12.35	0.00
TRUCK DRIVER: Off the Road Truck.....	\$ 12.31	0.00
TRUCK DRIVER: Water Truck.....	\$ 13.15	0.00
TRUCK DRIVER: Dump Truck (All Types).....	\$ 13.58	0.00
TRUCK DRIVER: Semi/Trailer Truck.....	\$ 17.34	0.00

-----

WELDERS - Receive rate prescribed for craft performing operation to which welding is incidental.

=====

Note: Executive Order (EO) 13706, Establishing Paid Sick Leave for Federal Contractors applies to all contracts subject to the Davis-Bacon Act for which the contract is awarded (and any solicitation was issued) on or after January 1, 2017. If this contract is covered by the EO, the contractor must provide employees with 1 hour of paid sick leave for every 30 hours they work, up to 56 hours of paid sick leave each year. Employees must be permitted to use paid sick leave for their own illness, injury or other health-related needs, including preventive care; to assist a family member (or person who is like family to the employee) who is ill, injured, or has other health-related needs, including preventive care; or for reasons resulting from, or to assist a family member (or person who is like family to the employee) who is a victim of, domestic violence, sexual assault, or stalking. Additional information on contractor requirements and worker protections under the EO is available at [www.dol.gov/whd/govcontracts](http://www.dol.gov/whd/govcontracts).

Unlisted classifications needed for work not included within the scope of the classifications listed may be added after award only as provided in the labor standards contract clauses (29CFR 5.5 (a) (1) (ii)).

-----

The body of each wage determination lists the classification

and wage rates that have been found to be prevailing for the cited type(s) of construction in the area covered by the wage determination. The classifications are listed in alphabetical order of "identifiers" that indicate whether the particular rate is a union rate (current union negotiated rate for local), a survey rate (weighted average rate) or a union average rate (weighted union average rate).

#### Union Rate Identifiers

A four letter classification abbreviation identifier enclosed in dotted lines beginning with characters other than "SU" or "UAVG" denotes that the union classification and rate were prevailing for that classification in the survey. Example: PLUM0198-005 07/01/2014. PLUM is an abbreviation identifier of the union which prevailed in the survey for this classification, which in this example would be Plumbers. 0198 indicates the local union number or district council number where applicable, i.e., Plumbers Local 0198. The next number, 005 in the example, is an internal number used in processing the wage determination. 07/01/2014 is the effective date of the most current negotiated rate, which in this example is July 1, 2014.

Union prevailing wage rates are updated to reflect all rate changes in the collective bargaining agreement (CBA) governing this classification and rate.

#### Survey Rate Identifiers

Classifications listed under the "SU" identifier indicate that no one rate prevailed for this classification in the survey and the published rate is derived by computing a weighted average rate based on all the rates reported in the survey for that classification. As this weighted average rate includes all rates reported in the survey, it may include both union and non-union rates. Example: SULA2012-007 5/13/2014. SU indicates the rates are survey rates based on a weighted average calculation of rates and are not majority rates. LA indicates the State of Louisiana. 2012 is the year of survey on which these classifications and rates are based. The next number, 007 in the example, is an internal number used in producing the wage determination. 5/13/2014 indicates the survey completion date for the classifications and rates under that identifier.

Survey wage rates are not updated and remain in effect until a new survey is conducted.

#### Union Average Rate Identifiers

Classification(s) listed under the UAVG identifier indicate that no single majority rate prevailed for those classifications; however, 100% of the data reported for the classifications was union data. EXAMPLE: UAVG-OH-0010 08/29/2014. UAVG indicates that the rate is a weighted union average rate. OH indicates the state. The next number, 0010 in the example, is an internal number used in producing the wage determination. 08/29/2014 indicates the survey completion date for the classifications and rates under that identifier.

A UAVG rate will be updated once a year, usually in January of each year, to reflect a weighted average of the current negotiated/CBA rate of the union locals from which the rate is based.

---

WAGE DETERMINATION APPEALS PROCESS

1.) Has there been an initial decision in the matter? This can be:

- \* an existing published wage determination
- \* a survey underlying a wage determination
- \* a Wage and Hour Division letter setting forth a position on a wage determination matter
- \* a conformance (additional classification and rate) ruling

On survey related matters, initial contact, including requests for summaries of surveys, should be with the Wage and Hour Regional Office for the area in which the survey was conducted because those Regional Offices have responsibility for the Davis-Bacon survey program. If the response from this initial contact is not satisfactory, then the process described in 2.) and 3.) should be followed.

With regard to any other matter not yet ripe for the formal process described here, initial contact should be with the Branch of Construction Wage Determinations. Write to:

Branch of Construction Wage Determinations  
Wage and Hour Division  
U.S. Department of Labor  
200 Constitution Avenue, N.W.  
Washington, DC 20210

2.) If the answer to the question in 1.) is yes, then an interested party (those affected by the action) can request review and reconsideration from the Wage and Hour Administrator (See 29 CFR Part 1.8 and 29 CFR Part 7). Write to:

Wage and Hour Administrator  
U.S. Department of Labor  
200 Constitution Avenue, N.W.  
Washington, DC 20210

The request should be accompanied by a full statement of the interested party's position and by any information (wage payment data, project description, area practice material, etc.) that the requestor considers relevant to the issue.

3.) If the decision of the Administrator is not favorable, an interested party may appeal directly to the Administrative Review Board (formerly the Wage Appeals Board). Write to:

Administrative Review Board  
U.S. Department of Labor  
200 Constitution Avenue, N.W.

Washington, DC 20210

4.) All decisions by the Administrative Review Board are final.

=====

END OF GENERAL DECISION

**SUPPLEMENT TO FORM FHWA-1273**

**DATE:** 12/17/2018

**SUBJECT:** **Federal Contract Provisions for Subcontracts and Cargo Preference Act**

**Federal Contract Provisions for Subcontracts**

All subcontracts shall be in writing and contain all pertinent provisions and requirements of the prime contract.

Each “Request for Permission to Subcontract” (Mississippi Department of Transportation Form CAD-720) shall include a copy of the subcontract. The federal contract provisions (FHWA-1273, SUPPLEMENT TO FORM FHWA-1273, NOTICE OF REQUIREMENT FOR AFFIRMATIVE ACTION TO ENSURE EQUAL EMPLOYMENT OPPORTUNITY (EXECUTIVE ORDER 11246), DAVIS-BACON AND RELATED ACT PROVISIONS (WAGE RATES)) must be physically incorporated as part of the subcontract. A completed Mississippi Department of Transportation Form CAD-521 and Form CAD-725 must be attached to the CAD-720.

**Cargo Preference Act**

The Contractor is hereby advised of the requirements set forth in the following Attachment (Title 46 - Shipping) as it pertains to the implementation of Cargo Preference Act (CPA) requirements in the Federal-aid Highway Program.

By signing this contract, the Contractor agrees to conform to the requirements of the CPA.

## Attachment

### Title 46- Shipping

Volume: 8

Date: 2014-10-01

Original Date: 2014-10-01

Title: Section 381.7 - Federal Grant, Guaranty, Loan and Advance at Funds Agreements.

Context: Title 46- Shipping. CHAPTER II- MARITIME ADMINISTRATION, DEPARTMENT OF TRANSPORTATION. SUBCHAPTER J - MISCELLANEOUS. PART 381 - CARGO PREFERENCE-U.S.- FLAG VESSELS.

#### § 381.7 Federal Grant, Guaranty, Loan and Advance of Funds Agreements.

In order to insure a fair and reasonable participation by privately owned United States-flag commercial vessels in transporting cargoes which are subject to the Cargo Preference Act of 1954 and which are generated by U.S. Government Grant, Guaranty, Loan and/or Advance of Funds Programs, the head of each affected department or agency shall require appropriate clauses to be inserted in those Grant, Guaranty, Loan and/or Advance of Funds Agreements and all third party contracts executed between the borrower/grantee and other parties, where the possibility exists for ocean transportation of items procured, contracted for or otherwise obtained by or on behalf of the grantee, borrower, or any of their contractors or subcontractors. The clauses required by this part shall provide that at least 50 percent of the freight revenue and tonnage of cargo generated by the U.S. Government Grant, Guaranty, Loan or Advance of Funds be transported on privately owned United States-flag commercial vessels. These clauses shall also require that all parties provide to the Maritime Administration the necessary shipment information as set forth in § 381.3. A copy of the appropriate clauses required by this part shall be submitted by each affected agency or department to the Secretary, Maritime Administration, for approval no later than 30 days after the effective date of this part. The following are suggested acceptable clauses with respect to the use of United States-flag vessels to be incorporated in the Grant, Guaranty, Loan and/or Advance of Funds Agreements as well as contracts and subcontracts resulting therefrom:

(a) *Agreement Clauses.* "Use of United States-flag vessels:

"(1) Pursuant to Pub. L 664 (43 U.S.C. 1241(b)) at least 50 percent of any equipment, materials or commodities procured, contracted for or otherwise obtained with funds granted, guaranteed, loaned, or advanced by the U.S. Government under this agreement, and which may be transported by ocean vessel, shall be transported on privately owned United States-flag commercial vessels, if available.

"(2) Within 20 days following the date of loading for shipments originating within the United States or within 30 working days following the date of loading for shipments originating outside the United States, a legible copy of a rated, 'on-board' commercial ocean bill-of-lading in English for each shipment of cargo described in paragraph (a)(1) of this section shall be furnished to both the Contracting Officer (through the prime contractor in the case of subcontractor bills-of-lading) and to the Division of National Cargo, Office of Market Development, Maritime Administration, Washington, DC 20590."

(b) *Contractor and Subcontractor Clauses.* "Use of United States-flag vessels: The contractor agrees --

"(1) To utilize privately owned United States-flag commercial vessels to ship at least 50 percent of the gross tonnage (computed separately for dry bulk carriers, dry cargo liners, and tankers) involved, whenever shipping any equipment, material, or commodities pursuant to this contract, to the extent such vessels are available at fair and reasonable rates for United States-flag commercial vessels.

"(2) To furnish within 20 days following the date of loading for shipments originating within the United

States or within 30 working days following the date of loading for shipments originating outside the United States, a legible copy of a rated, 'on-board' commercial ocean bill-of-lading in English for each shipment of cargo described in paragraph (b) (1) of this section to both the Contracting Officer (through the prime contractor in the case of subcontractor bills-of-lading) and to the Division of National Cargo, Office of Market Development, Maritime Administration, Washington, DC 20590.

"(3) To insert the substance of the provisions of this clause in all subcontracts issued pursuant to this contract."

(Reorganization Plans No.21 of 1950(64 Stat. 1273) and No. 7 of 1961 (75 Stat. 840) as amended by Pub. L 91.469 (84 Stat 1036) and Department of Commerce Organization Order 10-8 (38 FR 19707, July 23, 1973)) (42 FR 57126, Nov. 1, 1977]



**REQUIRED CONTRACT PROVISIONS  
FEDERAL-AID CONSTRUCTION CONTRACTS**

---

- I. General
- II. Nondiscrimination
- III. Nonsegregated Facilities
- IV. Davis-Bacon and Related Act Provisions
- V. Contract Work Hours and Safety Standards Act Provisions
- VI. Subletting or Assigning the Contract
- VII. Safety: Accident Prevention
- VIII. False Statements Concerning Highway Projects
- IX. Implementation of Clean Air Act and Federal Water Pollution Control Act
- X. Compliance with Governmentwide Suspension and Debarment Requirements
- XI. Certification Regarding Use of Contract Funds for Lobbying

**ATTACHMENTS**

A. Employment and Materials Preference for Appalachian Development Highway System or Appalachian Local Access Road Contracts (included in Appalachian contracts only)

**I. GENERAL**

1. Form FHWA-1273 must be physically incorporated in each construction contract funded under Title 23 (excluding emergency contracts solely intended for debris removal). The contractor (or subcontractor) must insert this form in each subcontract and further require its inclusion in all lower tier subcontracts (excluding purchase orders, rental agreements and other agreements for supplies or services).

The applicable requirements of Form FHWA-1273 are incorporated by reference for work done under any purchase order, rental agreement or agreement for other services. The prime contractor shall be responsible for compliance by any subcontractor, lower-tier subcontractor or service provider.

Form FHWA-1273 must be included in all Federal-aid design-build contracts, in all subcontracts and in lower tier subcontracts (excluding subcontracts for design services, purchase orders, rental agreements and other agreements for supplies or services). The design-builder shall be responsible for compliance by any subcontractor, lower-tier subcontractor or service provider.

Contracting agencies may reference Form FHWA-1273 in bid proposal or request for proposal documents, however, the Form FHWA-1273 must be physically incorporated (not referenced) in all contracts, subcontracts and lower-tier subcontracts (excluding purchase orders, rental agreements and other agreements for supplies or services related to a construction contract).

2. Subject to the applicability criteria noted in the following sections, these contract provisions shall apply to all work performed on the contract by the contractor's own organization and with the assistance of workers under the contractor's immediate superintendence and to all work performed on the contract by piecework, station work, or by subcontract.

3. A breach of any of the stipulations contained in these Required Contract Provisions may be sufficient grounds for withholding of progress payments, withholding of final payment, termination of the contract, suspension / debarment or any other action determined to be appropriate by the contracting agency and FHWA.

4. Selection of Labor: During the performance of this contract, the contractor shall not use convict labor for any purpose within the limits of a construction project on a Federal-aid highway unless it is labor performed by convicts who are on parole, supervised release, or probation. The term Federal-aid highway does not include roadways functionally classified as local roads or rural minor collectors.

**II. NONDISCRIMINATION**

The provisions of this section related to 23 CFR Part 230 are applicable to all Federal-aid construction contracts and to all related construction subcontracts of \$10,000 or more. The provisions of 23 CFR Part 230 are not applicable to material supply, engineering, or architectural service contracts.

In addition, the contractor and all subcontractors must comply with the following policies: Executive Order 11246, 41 CFR 60, 29 CFR 1625-1627, Title 23 USC Section 140, the Rehabilitation Act of 1973, as amended (29 USC 794), Title VI of the Civil Rights Act of 1964, as amended, and related regulations including 49 CFR Parts 21, 26 and 27; and 23 CFR Parts 200, 230, and 633.

The contractor and all subcontractors must comply with: the requirements of the Equal Opportunity Clause in 41 CFR 60-1.4(b) and, for all construction contracts exceeding \$10,000, the Standard Federal Equal Employment Opportunity Construction Contract Specifications in 41 CFR 60-4.3.

Note: The U.S. Department of Labor has exclusive authority to determine compliance with Executive Order 11246 and the policies of the Secretary of Labor including 41 CFR 60, and 29 CFR 1625-1627. The contracting agency and the FHWA have the authority and the responsibility to ensure compliance with Title 23 USC Section 140, the Rehabilitation Act of 1973, as amended (29 USC 794), and Title VI of the Civil Rights Act of 1964, as amended, and related regulations including 49 CFR Parts 21, 26 and 27; and 23 CFR Parts 200, 230, and 633.

The following provision is adopted from 23 CFR 230, Appendix A, with appropriate revisions to conform to the U.S. Department of Labor (US DOL) and FHWA requirements.

**1. Equal Employment Opportunity:** Equal employment opportunity (EEO) requirements not to discriminate and to take affirmative action to assure equal opportunity as set forth under laws, executive orders, rules, regulations (28 CFR 35, 29 CFR 1630, 29 CFR 1625-1627, 41 CFR 60 and 49 CFR 27) and orders of the Secretary of Labor as modified by the provisions prescribed herein, and imposed pursuant to 23 U.S.C. 140 shall constitute the EEO and specific affirmative action standards for the contractor's project activities under

this contract. The provisions of the Americans with Disabilities Act of 1990 (42 U.S.C. 12101 et seq.) set forth under 28 CFR 35 and 29 CFR 1630 are incorporated by reference in this contract. In the execution of this contract, the contractor agrees to comply with the following minimum specific requirement activities of EEO:

a. The contractor will work with the contracting agency and the Federal Government to ensure that it has made every good faith effort to provide equal opportunity with respect to all of its terms and conditions of employment and in their review of activities under the contract.

b. The contractor will accept as its operating policy the following statement:

"It is the policy of this Company to assure that applicants are employed, and that employees are treated during employment, without regard to their race, religion, sex, color, national origin, age or disability. Such action shall include: employment, upgrading, demotion, or transfer; recruitment or recruitment advertising; layoff or termination; rates of pay or other forms of compensation; and selection for training, including apprenticeship, pre-apprenticeship, and/or on-the-job training."

**2. EEO Officer:** The contractor will designate and make known to the contracting officers an EEO Officer who will have the responsibility for and must be capable of effectively administering and promoting an active EEO program and who must be assigned adequate authority and responsibility to do so.

**3. Dissemination of Policy:** All members of the contractor's staff who are authorized to hire, supervise, promote, and discharge employees, or who recommend such action, or who are substantially involved in such action, will be made fully cognizant of, and will implement, the contractor's EEO policy and contractual responsibilities to provide EEO in each grade and classification of employment. To ensure that the above agreement will be met, the following actions will be taken as a minimum:

a. Periodic meetings of supervisory and personnel office employees will be conducted before the start of work and then not less often than once every six months, at which time the contractor's EEO policy and its implementation will be reviewed and explained. The meetings will be conducted by the EEO Officer.

b. All new supervisory or personnel office employees will be given a thorough indoctrination by the EEO Officer, covering all major aspects of the contractor's EEO obligations within thirty days following their reporting for duty with the contractor.

c. All personnel who are engaged in direct recruitment for the project will be instructed by the EEO Officer in the contractor's procedures for locating and hiring minorities and women.

d. Notices and posters setting forth the contractor's EEO policy will be placed in areas readily accessible to employees, applicants for employment and potential employees.

e. The contractor's EEO policy and the procedures to implement such policy will be brought to the attention of employees by means of meetings, employee handbooks, or other appropriate means.

**4. Recruitment:** When advertising for employees, the contractor will include in all advertisements for employees the notation: "An Equal Opportunity Employer." All such advertisements will be placed in publications having a large circulation among minorities and women in the area from which the project work force would normally be derived.

a. The contractor will, unless precluded by a valid bargaining agreement, conduct systematic and direct recruitment through public and private employee referral sources likely to yield qualified minorities and women. To meet this requirement, the contractor will identify sources of potential minority group employees, and establish with such identified sources procedures whereby minority and women applicants may be referred to the contractor for employment consideration.

b. In the event the contractor has a valid bargaining agreement providing for exclusive hiring hall referrals, the contractor is expected to observe the provisions of that agreement to the extent that the system meets the contractor's compliance with EEO contract provisions. Where implementation of such an agreement has the effect of discriminating against minorities or women, or obligates the contractor to do the same, such implementation violates Federal nondiscrimination provisions.

c. The contractor will encourage its present employees to refer minorities and women as applicants for employment. Information and procedures with regard to referring such applicants will be discussed with employees.

**5. Personnel Actions:** Wages, working conditions, and employee benefits shall be established and administered, and personnel actions of every type, including hiring, upgrading, promotion, transfer, demotion, layoff, and termination, shall be taken without regard to race, color, religion, sex, national origin, age or disability. The following procedures shall be followed:

a. The contractor will conduct periodic inspections of project sites to insure that working conditions and employee facilities do not indicate discriminatory treatment of project site personnel.

b. The contractor will periodically evaluate the spread of wages paid within each classification to determine any evidence of discriminatory wage practices.

c. The contractor will periodically review selected personnel actions in depth to determine whether there is evidence of discrimination. Where evidence is found, the contractor will promptly take corrective action. If the review indicates that the discrimination may extend beyond the actions reviewed, such corrective action shall include all affected persons.

d. The contractor will promptly investigate all complaints of alleged discrimination made to the contractor in connection with its obligations under this contract, will attempt to resolve such complaints, and will take appropriate corrective action within a reasonable time. If the investigation indicates that the discrimination may affect persons other than the complainant, such corrective action shall include such other persons. Upon completion of each investigation, the contractor will inform every complainant of all of their avenues of appeal.

**6. Training and Promotion:**

a. The contractor will assist in locating, qualifying, and increasing the skills of minorities and women who are

applicants for employment or current employees. Such efforts should be aimed at developing full journey level status employees in the type of trade or job classification involved.

b. Consistent with the contractor's work force requirements and as permissible under Federal and State regulations, the contractor shall make full use of training programs, i.e., apprenticeship, and on-the-job training programs for the geographical area of contract performance. In the event a special provision for training is provided under this contract, this subparagraph will be superseded as indicated in the special provision. The contracting agency may reserve training positions for persons who receive welfare assistance in accordance with 23 U.S.C. 140(a).

c. The contractor will advise employees and applicants for employment of available training programs and entrance requirements for each.

d. The contractor will periodically review the training and promotion potential of employees who are minorities and women and will encourage eligible employees to apply for such training and promotion.

**7. Unions:** If the contractor relies in whole or in part upon unions as a source of employees, the contractor will use good faith efforts to obtain the cooperation of such unions to increase opportunities for minorities and women. Actions by the contractor, either directly or through a contractor's association acting as agent, will include the procedures set forth below:

a. The contractor will use good faith efforts to develop, in cooperation with the unions, joint training programs aimed toward qualifying more minorities and women for membership in the unions and increasing the skills of minorities and women so that they may qualify for higher paying employment.

b. The contractor will use good faith efforts to incorporate an EEO clause into each union agreement to the end that such union will be contractually bound to refer applicants without regard to their race, color, religion, sex, national origin, age or disability.

c. The contractor is to obtain information as to the referral practices and policies of the labor union except that to the extent such information is within the exclusive possession of the labor union and such labor union refuses to furnish such information to the contractor, the contractor shall so certify to the contracting agency and shall set forth what efforts have been made to obtain such information.

d. In the event the union is unable to provide the contractor with a reasonable flow of referrals within the time limit set forth in the collective bargaining agreement, the contractor will, through independent recruitment efforts, fill the employment vacancies without regard to race, color, religion, sex, national origin, age or disability; making full efforts to obtain qualified and/or qualifiable minorities and women. The failure of a union to provide sufficient referrals (even though it is obligated to provide exclusive referrals under the terms of a collective bargaining agreement) does not relieve the contractor from the requirements of this paragraph. In the event the union referral practice prevents the contractor from meeting the obligations pursuant to Executive Order 11246, as amended, and these special provisions, such contractor shall immediately notify the contracting agency.

**8. Reasonable Accommodation for Applicants / Employees with Disabilities:** The contractor must be familiar

with the requirements for and comply with the Americans with Disabilities Act and all rules and regulations established there under. Employers must provide reasonable accommodation in all employment activities unless to do so would cause an undue hardship.

**9. Selection of Subcontractors, Procurement of Materials and Leasing of Equipment:** The contractor shall not discriminate on the grounds of race, color, religion, sex, national origin, age or disability in the selection and retention of subcontractors, including procurement of materials and leases of equipment. The contractor shall take all necessary and reasonable steps to ensure nondiscrimination in the administration of this contract.

a. The contractor shall notify all potential subcontractors and suppliers and lessors of their EEO obligations under this contract.

b. The contractor will use good faith efforts to ensure subcontractor compliance with their EEO obligations.

**10. Assurance Required by 49 CFR 26.13(b):**

a. The requirements of 49 CFR Part 26 and the State DOT's U.S. DOT-approved DBE program are incorporated by reference.

b. The contractor or subcontractor shall not discriminate on the basis of race, color, national origin, or sex in the performance of this contract. The contractor shall carry out applicable requirements of 49 CFR Part 26 in the award and administration of DOT-assisted contracts. Failure by the contractor to carry out these requirements is a material breach of this contract, which may result in the termination of this contract or such other remedy as the contracting agency deems appropriate.

**11. Records and Reports:** The contractor shall keep such records as necessary to document compliance with the EEO requirements. Such records shall be retained for a period of three years following the date of the final payment to the contractor for all contract work and shall be available at reasonable times and places for inspection by authorized representatives of the contracting agency and the FHWA.

a. The records kept by the contractor shall document the following:

(1) The number and work hours of minority and non-minority group members and women employed in each work classification on the project;

(2) The progress and efforts being made in cooperation with unions, when applicable, to increase employment opportunities for minorities and women; and

(3) The progress and efforts being made in locating, hiring, training, qualifying, and upgrading minorities and women;

b. The contractors and subcontractors will submit an annual report to the contracting agency each July for the duration of the project, indicating the number of minority, women, and non-minority group employees currently engaged in each work classification required by the contract work. This information is to be reported on [Form FHWA-1391](#). The staffing data should represent the project work force on board in all or any part of the last payroll period preceding the end of July. If on-the-job training is being required by special provision, the contractor

will be required to collect and report training data. The employment data should reflect the work force on board during all or any part of the last payroll period preceding the end of July.

### III. NONSEGREGATED FACILITIES

This provision is applicable to all Federal-aid construction contracts and to all related construction subcontracts of \$10,000 or more.

The contractor must ensure that facilities provided for employees are provided in such a manner that segregation on the basis of race, color, religion, sex, or national origin cannot result. The contractor may neither require such segregated use by written or oral policies nor tolerate such use by employee custom. The contractor's obligation extends further to ensure that its employees are not assigned to perform their services at any location, under the contractor's control, where the facilities are segregated. The term "facilities" includes waiting rooms, work areas, restaurants and other eating areas, time clocks, restrooms, washrooms, locker rooms, and other storage or dressing areas, parking lots, drinking fountains, recreation or entertainment areas, transportation, and housing provided for employees. The contractor shall provide separate or single-user restrooms and necessary dressing or sleeping areas to assure privacy between sexes.

### IV. DAVIS-BACON AND RELATED ACT PROVISIONS

This section is applicable to all Federal-aid construction projects exceeding \$2,000 and to all related subcontracts and lower-tier subcontracts (regardless of subcontract size). The requirements apply to all projects located within the right-of-way of a roadway that is functionally classified as Federal-aid highway. This excludes roadways functionally classified as local roads or rural minor collectors, which are exempt. Contracting agencies may elect to apply these requirements to other projects.

The following provisions are from the U.S. Department of Labor regulations in 29 CFR 5.5 "Contract provisions and related matters" with minor revisions to conform to the FHWA-1273 format and FHWA program requirements.

#### 1. Minimum wages

a. All laborers and mechanics employed or working upon the site of the work, will be paid unconditionally and not less often than once a week, and without subsequent deduction or rebate on any account (except such payroll deductions as are permitted by regulations issued by the Secretary of Labor under the Copeland Act (29 CFR part 3)), the full amount of wages and bona fide fringe benefits (or cash equivalents thereof) due at time of payment computed at rates not less than those contained in the wage determination of the Secretary of Labor which is attached hereto and made a part hereof, regardless of any contractual relationship which may be alleged to exist between the contractor and such laborers and mechanics.

Contributions made or costs reasonably anticipated for bona fide fringe benefits under section 1(b)(2) of the Davis-Bacon Act on behalf of laborers or mechanics are considered wages

paid to such laborers or mechanics, subject to the provisions of paragraph 1.d. of this section; also, regular contributions made or costs incurred for more than a weekly period (but not less often than quarterly) under plans, funds, or programs which cover the particular weekly period, are deemed to be constructively made or incurred during such weekly period. Such laborers and mechanics shall be paid the appropriate wage rate and fringe benefits on the wage determination for the classification of work actually performed, without regard to skill, except as provided in 29 CFR 5.5(a)(4). Laborers or mechanics performing work in more than one classification may be compensated at the rate specified for each classification for the time actually worked therein: Provided, That the employer's payroll records accurately set forth the time spent in each classification in which work is performed. The wage determination (including any additional classification and wage rates conformed under paragraph 1.b. of this section) and the Davis-Bacon poster (WH-1321) shall be posted at all times by the contractor and its subcontractors at the site of the work in a prominent and accessible place where it can be easily seen by the workers.

b. (1) The contracting officer shall require that any class of laborers or mechanics, including helpers, which is not listed in the wage determination and which is to be employed under the contract shall be classified in conformance with the wage determination. The contracting officer shall approve an additional classification and wage rate and fringe benefits therefore only when the following criteria have been met:

(i) The work to be performed by the classification requested is not performed by a classification in the wage determination; and

(ii) The classification is utilized in the area by the construction industry; and

(iii) The proposed wage rate, including any bona fide fringe benefits, bears a reasonable relationship to the wage rates contained in the wage determination.

(2) If the contractor and the laborers and mechanics to be employed in the classification (if known), or their representatives, and the contracting officer agree on the classification and wage rate (including the amount designated for fringe benefits where appropriate), a report of the action taken shall be sent by the contracting officer to the Administrator of the Wage and Hour Division, Employment Standards Administration, U.S. Department of Labor, Washington, DC 20210. The Administrator, or an authorized representative, will approve, modify, or disapprove every additional classification action within 30 days of receipt and so advise the contracting officer or will notify the contracting officer within the 30-day period that additional time is necessary.

(3) In the event the contractor, the laborers or mechanics to be employed in the classification or their representatives, and the contracting officer do not agree on the proposed classification and wage rate (including the amount designated for fringe benefits, where appropriate), the contracting officer shall refer the questions, including the views of all interested parties and the recommendation of the contracting officer, to the Wage and Hour Administrator for determination. The Wage and Hour Administrator, or an authorized representative, will issue a determination within 30 days of receipt and so advise

the contracting officer or will notify the contracting officer within the 30-day period that additional time is necessary.

(4) The wage rate (including fringe benefits where appropriate) determined pursuant to paragraphs 1.b.(2) or 1.b.(3) of this section, shall be paid to all workers performing work in the classification under this contract from the first day on which work is performed in the classification.

c. Whenever the minimum wage rate prescribed in the contract for a class of laborers or mechanics includes a fringe benefit which is not expressed as an hourly rate, the contractor shall either pay the benefit as stated in the wage determination or shall pay another bona fide fringe benefit or an hourly cash equivalent thereof.

d. If the contractor does not make payments to a trustee or other third person, the contractor may consider as part of the wages of any laborer or mechanic the amount of any costs reasonably anticipated in providing bona fide fringe benefits under a plan or program, Provided, That the Secretary of Labor has found, upon the written request of the contractor, that the applicable standards of the Davis-Bacon Act have been met. The Secretary of Labor may require the contractor to set aside in a separate account assets for the meeting of obligations under the plan or program.

## 2. Withholding

The contracting agency shall upon its own action or upon written request of an authorized representative of the Department of Labor, withhold or cause to be withheld from the contractor under this contract, or any other Federal contract with the same prime contractor, or any other federally-assisted contract subject to Davis-Bacon prevailing wage requirements, which is held by the same prime contractor, so much of the accrued payments or advances as may be considered necessary to pay laborers and mechanics, including apprentices, trainees, and helpers, employed by the contractor or any subcontractor the full amount of wages required by the contract. In the event of failure to pay any laborer or mechanic, including any apprentice, trainee, or helper, employed or working on the site of the work, all or part of the wages required by the contract, the contracting agency may, after written notice to the contractor, take such action as may be necessary to cause the suspension of any further payment, advance, or guarantee of funds until such violations have ceased.

## 3. Payrolls and basic records

a. Payrolls and basic records relating thereto shall be maintained by the contractor during the course of the work and preserved for a period of three years thereafter for all laborers and mechanics working at the site of the work. Such records shall contain the name, address, and social security number of each such worker, his or her correct classification, hourly rates of wages paid (including rates of contributions or costs anticipated for bona fide fringe benefits or cash equivalents thereof of the types described in section 1(b)(2)(B) of the Davis-Bacon Act), daily and weekly number of hours worked, deductions made and actual wages paid. Whenever the Secretary of Labor has found under 29 CFR 5.5(a)(1)(iv) that the wages of any laborer or mechanic include the amount of any costs reasonably anticipated in providing benefits under a plan or program described in section 1(b)(2)(B) of the Davis-

Bacon Act, the contractor shall maintain records which show that the commitment to provide such benefits is enforceable, that the plan or program is financially responsible, and that the plan or program has been communicated in writing to the laborers or mechanics affected, and records which show the costs anticipated or the actual cost incurred in providing such benefits. Contractors employing apprentices or trainees under approved programs shall maintain written evidence of the registration of apprenticeship programs and certification of trainee programs, the registration of the apprentices and trainees, and the ratios and wage rates prescribed in the applicable programs.

b. (1) The contractor shall submit weekly for each week in which any contract work is performed a copy of all payrolls to the contracting agency. The payrolls submitted shall set out accurately and completely all of the information required to be maintained under 29 CFR 5.5(a)(3)(i), except that full social security numbers and home addresses shall not be included on weekly transmittals. Instead the payrolls shall only need to include an individually identifying number for each employee (e.g., the last four digits of the employee's social security number). The required weekly payroll information may be submitted in any form desired. Optional Form WH-347 is available for this purpose from the Wage and Hour Division Web site at <http://www.dol.gov/esa/whd/forms/wh347instr.htm> or its successor site. The prime contractor is responsible for the submission of copies of payrolls by all subcontractors. Contractors and subcontractors shall maintain the full social security number and current address of each covered worker, and shall provide them upon request to the contracting agency for transmission to the State DOT, the FHWA or the Wage and Hour Division of the Department of Labor for purposes of an investigation or audit of compliance with prevailing wage requirements. It is not a violation of this section for a prime contractor to require a subcontractor to provide addresses and social security numbers to the prime contractor for its own records, without weekly submission to the contracting agency..

(2) Each payroll submitted shall be accompanied by a "Statement of Compliance," signed by the contractor or subcontractor or his or her agent who pays or supervises the payment of the persons employed under the contract and shall certify the following:

(i) That the payroll for the payroll period contains the information required to be provided under §5.5 (a)(3)(ii) of Regulations, 29 CFR part 5, the appropriate information is being maintained under §5.5 (a)(3)(i) of Regulations, 29 CFR part 5, and that such information is correct and complete;

(ii) That each laborer or mechanic (including each helper, apprentice, and trainee) employed on the contract during the payroll period has been paid the full weekly wages earned, without rebate, either directly or indirectly, and that no deductions have been made either directly or indirectly from the full wages earned, other than permissible deductions as set forth in Regulations, 29 CFR part 3;

(iii) That each laborer or mechanic has been paid not less than the applicable wage rates and fringe benefits or cash equivalents for the classification of work performed, as specified in the applicable wage determination incorporated into the contract.

(3) The weekly submission of a properly executed certification set forth on the reverse side of Optional Form WH-347 shall satisfy the requirement for submission of the "Statement of Compliance" required by paragraph 3.b.(2) of this section.

(4) The falsification of any of the above certifications may subject the contractor or subcontractor to civil or criminal prosecution under section 1001 of title 18 and section 231 of title 31 of the United States Code.

c. The contractor or subcontractor shall make the records required under paragraph 3.a. of this section available for inspection, copying, or transcription by authorized representatives of the contracting agency, the State DOT, the FHWA, or the Department of Labor, and shall permit such representatives to interview employees during working hours on the job. If the contractor or subcontractor fails to submit the required records or to make them available, the FHWA may, after written notice to the contractor, the contracting agency or the State DOT, take such action as may be necessary to cause the suspension of any further payment, advance, or guarantee of funds. Furthermore, failure to submit the required records upon request or to make such records available may be grounds for debarment action pursuant to 29 CFR 5.12.

#### 4. Apprentices and trainees

##### a. Apprentices (programs of the USDOL).

Apprentices will be permitted to work at less than the predetermined rate for the work they performed when they are employed pursuant to and individually registered in a bona fide apprenticeship program registered with the U.S. Department of Labor, Employment and Training Administration, Office of Apprenticeship Training, Employer and Labor Services, or with a State Apprenticeship Agency recognized by the Office, or if a person is employed in his or her first 90 days of probationary employment as an apprentice in such an apprenticeship program, who is not individually registered in the program, but who has been certified by the Office of Apprenticeship Training, Employer and Labor Services or a State Apprenticeship Agency (where appropriate) to be eligible for probationary employment as an apprentice.

The allowable ratio of apprentices to journeymen on the job site in any craft classification shall not be greater than the ratio permitted to the contractor as to the entire work force under the registered program. Any worker listed on a payroll at an apprentice wage rate, who is not registered or otherwise employed as stated above, shall be paid not less than the applicable wage rate on the wage determination for the classification of work actually performed. In addition, any apprentice performing work on the job site in excess of the ratio permitted under the registered program shall be paid not less than the applicable wage rate on the wage determination for the work actually performed. Where a contractor is performing construction on a project in a locality other than that in which its program is registered, the ratios and wage rates (expressed in percentages of the journeyman's hourly rate) specified in the contractor's or subcontractor's registered program shall be observed.

Every apprentice must be paid at not less than the rate specified in the registered program for the apprentice's level of progress, expressed as a percentage of the journeymen hourly

rate specified in the applicable wage determination. Apprentices shall be paid fringe benefits in accordance with the provisions of the apprenticeship program. If the apprenticeship program does not specify fringe benefits, apprentices must be paid the full amount of fringe benefits listed on the wage determination for the applicable classification. If the Administrator determines that a different practice prevails for the applicable apprentice classification, fringes shall be paid in accordance with that determination.

In the event the Office of Apprenticeship Training, Employer and Labor Services, or a State Apprenticeship Agency recognized by the Office, withdraws approval of an apprenticeship program, the contractor will no longer be permitted to utilize apprentices at less than the applicable predetermined rate for the work performed until an acceptable program is approved.

##### b. Trainees (programs of the USDOL).

Except as provided in 29 CFR 5.16, trainees will not be permitted to work at less than the predetermined rate for the work performed unless they are employed pursuant to and individually registered in a program which has received prior approval, evidenced by formal certification by the U.S. Department of Labor, Employment and Training Administration.

The ratio of trainees to journeymen on the job site shall not be greater than permitted under the plan approved by the Employment and Training Administration.

Every trainee must be paid at not less than the rate specified in the approved program for the trainee's level of progress, expressed as a percentage of the journeyman hourly rate specified in the applicable wage determination. Trainees shall be paid fringe benefits in accordance with the provisions of the trainee program. If the trainee program does not mention fringe benefits, trainees shall be paid the full amount of fringe benefits listed on the wage determination unless the Administrator of the Wage and Hour Division determines that there is an apprenticeship program associated with the corresponding journeyman wage rate on the wage determination which provides for less than full fringe benefits for apprentices. Any employee listed on the payroll at a trainee rate who is not registered and participating in a training plan approved by the Employment and Training Administration shall be paid not less than the applicable wage rate on the wage determination for the classification of work actually performed. In addition, any trainee performing work on the job site in excess of the ratio permitted under the registered program shall be paid not less than the applicable wage rate on the wage determination for the work actually performed.

In the event the Employment and Training Administration withdraws approval of a training program, the contractor will no longer be permitted to utilize trainees at less than the applicable predetermined rate for the work performed until an acceptable program is approved.

c. Equal employment opportunity. The utilization of apprentices, trainees and journeymen under this part shall be in conformity with the equal employment opportunity requirements of Executive Order 11246, as amended, and 29 CFR part 30.

d. Apprentices and Trainees (programs of the U.S. DOT).

Apprentices and trainees working under apprenticeship and skill training programs which have been certified by the Secretary of Transportation as promoting EEO in connection with Federal-aid highway construction programs are not subject to the requirements of paragraph 4 of this Section IV. The straight time hourly wage rates for apprentices and trainees under such programs will be established by the particular programs. The ratio of apprentices and trainees to journeymen shall not be greater than permitted by the terms of the particular program.

**5. Compliance with Copeland Act requirements.** The contractor shall comply with the requirements of 29 CFR part 3, which are incorporated by reference in this contract.

**6. Subcontracts.** The contractor or subcontractor shall insert Form FHWA-1273 in any subcontracts and also require the subcontractors to include Form FHWA-1273 in any lower tier subcontracts. The prime contractor shall be responsible for the compliance by any subcontractor or lower tier subcontractor with all the contract clauses in 29 CFR 5.5.

**7. Contract termination: debarment.** A breach of the contract clauses in 29 CFR 5.5 may be grounds for termination of the contract, and for debarment as a contractor and a subcontractor as provided in 29 CFR 5.12.

**8. Compliance with Davis-Bacon and Related Act requirements.** All rulings and interpretations of the Davis-Bacon and Related Acts contained in 29 CFR parts 1, 3, and 5 are herein incorporated by reference in this contract.

**9. Disputes concerning labor standards.** Disputes arising out of the labor standards provisions of this contract shall not be subject to the general disputes clause of this contract. Such disputes shall be resolved in accordance with the procedures of the Department of Labor set forth in 29 CFR parts 5, 6, and 7. Disputes within the meaning of this clause include disputes between the contractor (or any of its subcontractors) and the contracting agency, the U.S. Department of Labor, or the employees or their representatives.

**10. Certification of eligibility.**

a. By entering into this contract, the contractor certifies that neither it (nor he or she) nor any person or firm who has an interest in the contractor's firm is a person or firm ineligible to be awarded Government contracts by virtue of section 3(a) of the Davis-Bacon Act or 29 CFR 5.12(a)(1).

b. No part of this contract shall be subcontracted to any person or firm ineligible for award of a Government contract by virtue of section 3(a) of the Davis-Bacon Act or 29 CFR 5.12(a)(1).

c. The penalty for making false statements is prescribed in the U.S. Criminal Code, 18 U.S.C. 1001.

**V. CONTRACT WORK HOURS AND SAFETY STANDARDS ACT**

The following clauses apply to any Federal-aid construction contract in an amount in excess of \$100,000 and subject to the overtime provisions of the Contract Work Hours and Safety Standards Act. These clauses shall be inserted in addition to the clauses required by 29 CFR 5.5(a) or 29 CFR 4.6. As used in this paragraph, the terms laborers and mechanics include watchmen and guards.

**1. Overtime requirements.** No contractor or subcontractor contracting for any part of the contract work which may require or involve the employment of laborers or mechanics shall require or permit any such laborer or mechanic in any workweek in which he or she is employed on such work to work in excess of forty hours in such workweek unless such laborer or mechanic receives compensation at a rate not less than one and one-half times the basic rate of pay for all hours worked in excess of forty hours in such workweek.

**2. Violation; liability for unpaid wages; liquidated damages.** In the event of any violation of the clause set forth in paragraph (1.) of this section, the contractor and any subcontractor responsible therefor shall be liable for the unpaid wages. In addition, such contractor and subcontractor shall be liable to the United States (in the case of work done under contract for the District of Columbia or a territory, to such District or to such territory), for liquidated damages. Such liquidated damages shall be computed with respect to each individual laborer or mechanic, including watchmen and guards, employed in violation of the clause set forth in paragraph (1.) of this section, in the sum of \$10 for each calendar day on which such individual was required or permitted to work in excess of the standard workweek of forty hours without payment of the overtime wages required by the clause set forth in paragraph (1.) of this section.

**3. Withholding for unpaid wages and liquidated damages.** The FHWA or the contacting agency shall upon its own action or upon written request of an authorized representative of the Department of Labor withhold or cause to be withheld, from any moneys payable on account of work performed by the contractor or subcontractor under any such contract or any other Federal contract with the same prime contractor, or any other federally-assisted contract subject to the Contract Work Hours and Safety Standards Act, which is held by the same prime contractor, such sums as may be determined to be necessary to satisfy any liabilities of such contractor or subcontractor for unpaid wages and liquidated damages as provided in the clause set forth in paragraph (2.) of this section.

**4. Subcontracts.** The contractor or subcontractor shall insert in any subcontracts the clauses set forth in paragraph (1.) through (4.) of this section and also a clause requiring the subcontractors to include these clauses in any lower tier subcontracts. The prime contractor shall be responsible for compliance by any subcontractor or lower tier subcontractor with the clauses set forth in paragraphs (1.) through (4.) of this section.

## VI. SUBLETTING OR ASSIGNING THE CONTRACT

This provision is applicable to all Federal-aid construction contracts on the National Highway System.

1. The contractor shall perform with its own organization contract work amounting to not less than 30 percent (or a greater percentage if specified elsewhere in the contract) of the total original contract price, excluding any specialty items designated by the contracting agency. Specialty items may be performed by subcontract and the amount of any such specialty items performed may be deducted from the total original contract price before computing the amount of work required to be performed by the contractor's own organization (23 CFR 635.116).

a. The term "perform work with its own organization" refers to workers employed or leased by the prime contractor, and equipment owned or rented by the prime contractor, with or without operators. Such term does not include employees or equipment of a subcontractor or lower tier subcontractor, agents of the prime contractor, or any other assignees. The term may include payments for the costs of hiring leased employees from an employee leasing firm meeting all relevant Federal and State regulatory requirements. Leased employees may only be included in this term if the prime contractor meets all of the following conditions:

(1) the prime contractor maintains control over the supervision of the day-to-day activities of the leased employees;

(2) the prime contractor remains responsible for the quality of the work of the leased employees;

(3) the prime contractor retains all power to accept or exclude individual employees from work on the project; and

(4) the prime contractor remains ultimately responsible for the payment of predetermined minimum wages, the submission of payrolls, statements of compliance and all other Federal regulatory requirements.

b. "Specialty Items" shall be construed to be limited to work that requires highly specialized knowledge, abilities, or equipment not ordinarily available in the type of contracting organizations qualified and expected to bid or propose on the contract as a whole and in general are to be limited to minor components of the overall contract.

2. The contract amount upon which the requirements set forth in paragraph (1) of Section VI is computed includes the cost of material and manufactured products which are to be purchased or produced by the contractor under the contract provisions.

3. The contractor shall furnish (a) a competent superintendent or supervisor who is employed by the firm, has full authority to direct performance of the work in accordance with the contract requirements, and is in charge of all construction operations (regardless of who performs the work) and (b) such other of its own organizational resources (supervision, management, and engineering services) as the contracting officer determines is necessary to assure the performance of the contract.

4. No portion of the contract shall be sublet, assigned or otherwise disposed of except with the written consent of the contracting officer, or authorized representative, and such consent when given shall not be construed to relieve the contractor of any responsibility for the fulfillment of the contract. Written consent will be given only after the

contracting agency has assured that each subcontract is evidenced in writing and that it contains all pertinent provisions and requirements of the prime contract.

5. The 30% self-performance requirement of paragraph (1) is not applicable to design-build contracts; however, contracting agencies may establish their own self-performance requirements.

## VII. SAFETY: ACCIDENT PREVENTION

This provision is applicable to all Federal-aid construction contracts and to all related subcontracts.

1. In the performance of this contract the contractor shall comply with all applicable Federal, State, and local laws governing safety, health, and sanitation (23 CFR 635). The contractor shall provide all safeguards, safety devices and protective equipment and take any other needed actions as it determines, or as the contracting officer may determine, to be reasonably necessary to protect the life and health of employees on the job and the safety of the public and to protect property in connection with the performance of the work covered by the contract.

2. It is a condition of this contract, and shall be made a condition of each subcontract, which the contractor enters into pursuant to this contract, that the contractor and any subcontractor shall not permit any employee, in performance of the contract, to work in surroundings or under conditions which are unsanitary, hazardous or dangerous to his/her health or safety, as determined under construction safety and health standards (29 CFR 1926) promulgated by the Secretary of Labor, in accordance with Section 107 of the Contract Work Hours and Safety Standards Act (40 U.S.C. 3704).

3. Pursuant to 29 CFR 1926.3, it is a condition of this contract that the Secretary of Labor or authorized representative thereof, shall have right of entry to any site of contract performance to inspect or investigate the matter of compliance with the construction safety and health standards and to carry out the duties of the Secretary under Section 107 of the Contract Work Hours and Safety Standards Act (40 U.S.C.3704).

## VIII. FALSE STATEMENTS CONCERNING HIGHWAY PROJECTS

This provision is applicable to all Federal-aid construction contracts and to all related subcontracts.

In order to assure high quality and durable construction in conformity with approved plans and specifications and a high degree of reliability on statements and representations made by engineers, contractors, suppliers, and workers on Federal-aid highway projects, it is essential that all persons concerned with the project perform their functions as carefully, thoroughly, and honestly as possible. Willful falsification, distortion, or misrepresentation with respect to any facts related to the project is a violation of Federal law. To prevent any misunderstanding regarding the seriousness of these and similar acts, Form FHWA-1022 shall be posted on each Federal-aid highway project (23 CFR 635) in one or more places where it is readily available to all persons concerned with the project:

18 U.S.C. 1020 reads as follows:



"Whoever, being an officer, agent, or employee of the United States, or of any State or Territory, or whoever, whether a person, association, firm, or corporation, knowingly makes any false statement, false representation, or false report as to the character, quality, quantity, or cost of the material used or to be used, or the quantity or quality of the work performed or to be performed, or the cost thereof in connection with the submission of plans, maps, specifications, contracts, or costs of construction on any highway or related project submitted for approval to the Secretary of Transportation; or

Whoever knowingly makes any false statement, false representation, false report or false claim with respect to the character, quality, quantity, or cost of any work performed or to be performed, or materials furnished or to be furnished, in connection with the construction of any highway or related project approved by the Secretary of Transportation; or

Whoever knowingly makes any false statement or false representation as to material fact in any statement, certificate, or report submitted pursuant to provisions of the Federal-aid Roads Act approved July 1, 1916, (39 Stat. 355), as amended and supplemented;

Shall be fined under this title or imprisoned not more than 5 years or both."

#### **IX. IMPLEMENTATION OF CLEAN AIR ACT AND FEDERAL WATER POLLUTION CONTROL ACT**

This provision is applicable to all Federal-aid construction contracts and to all related subcontracts.

By submission of this bid/proposal or the execution of this contract, or subcontract, as appropriate, the bidder, proposer, Federal-aid construction contractor, or subcontractor, as appropriate, will be deemed to have stipulated as follows:

1. That any person who is or will be utilized in the performance of this contract is not prohibited from receiving an award due to a violation of Section 508 of the Clean Water Act or Section 306 of the Clean Air Act.

2. That the contractor agrees to include or cause to be included the requirements of paragraph (1) of this Section X in every subcontract, and further agrees to take such action as the contracting agency may direct as a means of enforcing such requirements.

#### **X. CERTIFICATION REGARDING DEBARMENT, SUSPENSION, INELIGIBILITY AND VOLUNTARY EXCLUSION**

This provision is applicable to all Federal-aid construction contracts, design-build contracts, subcontracts, lower-tier subcontracts, purchase orders, lease agreements, consultant contracts or any other covered transaction requiring FHWA approval or that is estimated to cost \$25,000 or more – as defined in 2 CFR Parts 180 and 1200.

##### **1. Instructions for Certification – First Tier Participants:**

a. By signing and submitting this proposal, the prospective first tier participant is providing the certification set out below.

b. The inability of a person to provide the certification set out below will not necessarily result in denial of participation in this

covered transaction. The prospective first tier participant shall submit an explanation of why it cannot provide the certification set out below. The certification or explanation will be considered in connection with the department or agency's determination whether to enter into this transaction. However, failure of the prospective first tier participant to furnish a certification or an explanation shall disqualify such a person from participation in this transaction.

c. The certification in this clause is a material representation of fact upon which reliance was placed when the contracting agency determined to enter into this transaction. If it is later determined that the prospective participant knowingly rendered an erroneous certification, in addition to other remedies available to the Federal Government, the contracting agency may terminate this transaction for cause of default.

d. The prospective first tier participant shall provide immediate written notice to the contracting agency to whom this proposal is submitted if any time the prospective first tier participant learns that its certification was erroneous when submitted or has become erroneous by reason of changed circumstances.

e. The terms "covered transaction," "debarred," "suspended," "ineligible," "participant," "person," "principal," and "voluntarily excluded," as used in this clause, are defined in 2 CFR Parts 180 and 1200. "First Tier Covered Transactions" refers to any covered transaction between a grantee or subgrantee of Federal funds and a participant (such as the prime or general contractor). "Lower Tier Covered Transactions" refers to any covered transaction under a First Tier Covered Transaction (such as subcontracts). "First Tier Participant" refers to the participant who has entered into a covered transaction with a grantee or subgrantee of Federal funds (such as the prime or general contractor). "Lower Tier Participant" refers any participant who has entered into a covered transaction with a First Tier Participant or other Lower Tier Participants (such as subcontractors and suppliers).

f. The prospective first tier participant agrees by submitting this proposal that, should the proposed covered transaction be entered into, it shall not knowingly enter into any lower tier covered transaction with a person who is debarred, suspended, declared ineligible, or voluntarily excluded from participation in this covered transaction, unless authorized by the department or agency entering into this transaction.

g. The prospective first tier participant further agrees by submitting this proposal that it will include the clause titled "Certification Regarding Debarment, Suspension, Ineligibility and Voluntary Exclusion-Lower Tier Covered Transactions," provided by the department or contracting agency, entering into this covered transaction, without modification, in all lower tier covered transactions and in all solicitations for lower tier covered transactions exceeding the \$25,000 threshold.

h. A participant in a covered transaction may rely upon a certification of a prospective participant in a lower tier covered transaction that is not debarred, suspended, ineligible, or voluntarily excluded from the covered transaction, unless it knows that the certification is erroneous. A participant is responsible for ensuring that its principals are not suspended, debarred, or otherwise ineligible to participate in covered transactions. To verify the eligibility of its principals, as well as the eligibility of any lower tier prospective participants, each participant may, but is not required to, check the Excluded Parties List System website (<https://www.epls.gov/>), which is compiled by the General Services Administration.

i. Nothing contained in the foregoing shall be construed to require the establishment of a system of records in order to render in good faith the certification required by this clause. The knowledge and information of the prospective participant is not required to exceed that which is normally possessed by a prudent person in the ordinary course of business dealings.

j. Except for transactions authorized under paragraph (f) of these instructions, if a participant in a covered transaction knowingly enters into a lower tier covered transaction with a person who is suspended, debarred, ineligible, or voluntarily excluded from participation in this transaction, in addition to other remedies available to the Federal Government, the department or agency may terminate this transaction for cause or default.

\* \* \* \* \*

## **2. Certification Regarding Debarment, Suspension, Ineligibility and Voluntary Exclusion – First Tier Participants:**

a. The prospective first tier participant certifies to the best of its knowledge and belief, that it and its principals:

(1) Are not presently debarred, suspended, proposed for debarment, declared ineligible, or voluntarily excluded from participating in covered transactions by any Federal department or agency;

(2) Have not within a three-year period preceding this proposal been convicted of or had a civil judgment rendered against them for commission of fraud or a criminal offense in connection with obtaining, attempting to obtain, or performing a public (Federal, State or local) transaction or contract under a public transaction; violation of Federal or State antitrust statutes or commission of embezzlement, theft, forgery, bribery, falsification or destruction of records, making false statements, or receiving stolen property;

(3) Are not presently indicted for or otherwise criminally or civilly charged by a governmental entity (Federal, State or local) with commission of any of the offenses enumerated in paragraph (a)(2) of this certification; and

(4) Have not within a three-year period preceding this application/proposal had one or more public transactions (Federal, State or local) terminated for cause or default.

b. Where the prospective participant is unable to certify to any of the statements in this certification, such prospective participant shall attach an explanation to this proposal.

### **2. Instructions for Certification - Lower Tier Participants:**

(Applicable to all subcontracts, purchase orders and other lower tier transactions requiring prior FHWA approval or estimated to cost \$25,000 or more - 2 CFR Parts 180 and 1200)

a. By signing and submitting this proposal, the prospective lower tier is providing the certification set out below.

b. The certification in this clause is a material representation of fact upon which reliance was placed when this transaction was entered into. If it is later determined that the prospective lower tier participant knowingly rendered an erroneous certification, in addition to other remedies available to the Federal Government, the department, or agency with which

this transaction originated may pursue available remedies, including suspension and/or debarment.

c. The prospective lower tier participant shall provide immediate written notice to the person to which this proposal is submitted if at any time the prospective lower tier participant learns that its certification was erroneous by reason of changed circumstances.

d. The terms "covered transaction," "debarred," "suspended," "ineligible," "participant," "person," "principal," and "voluntarily excluded," as used in this clause, are defined in 2 CFR Parts 180 and 1200. You may contact the person to which this proposal is submitted for assistance in obtaining a copy of those regulations. "First Tier Covered Transactions" refers to any covered transaction between a grantee or subgrantee of Federal funds and a participant (such as the prime or general contract). "Lower Tier Covered Transactions" refers to any covered transaction under a First Tier Covered Transaction (such as subcontracts). "First Tier Participant" refers to the participant who has entered into a covered transaction with a grantee or subgrantee of Federal funds (such as the prime or general contractor). "Lower Tier Participant" refers any participant who has entered into a covered transaction with a First Tier Participant or other Lower Tier Participants (such as subcontractors and suppliers).

e. The prospective lower tier participant agrees by submitting this proposal that, should the proposed covered transaction be entered into, it shall not knowingly enter into any lower tier covered transaction with a person who is debarred, suspended, declared ineligible, or voluntarily excluded from participation in this covered transaction, unless authorized by the department or agency with which this transaction originated.

f. The prospective lower tier participant further agrees by submitting this proposal that it will include this clause titled "Certification Regarding Debarment, Suspension, Ineligibility and Voluntary Exclusion-Lower Tier Covered Transaction," without modification, in all lower tier covered transactions and in all solicitations for lower tier covered transactions exceeding the \$25,000 threshold.

g. A participant in a covered transaction may rely upon a certification of a prospective participant in a lower tier covered transaction that is not debarred, suspended, ineligible, or voluntarily excluded from the covered transaction, unless it knows that the certification is erroneous. A participant is responsible for ensuring that its principals are not suspended, debarred, or otherwise ineligible to participate in covered transactions. To verify the eligibility of its principals, as well as the eligibility of any lower tier prospective participants, each participant may, but is not required to, check the Excluded Parties List System website (<https://www.epls.gov/>), which is compiled by the General Services Administration.

h. Nothing contained in the foregoing shall be construed to require establishment of a system of records in order to render in good faith the certification required by this clause. The knowledge and information of participant is not required to exceed that which is normally possessed by a prudent person in the ordinary course of business dealings.

i. Except for transactions authorized under paragraph e of these instructions, if a participant in a covered transaction knowingly enters into a lower tier covered transaction with a person who is suspended, debarred, ineligible, or voluntarily excluded from participation in this transaction, in addition to other remedies available to the Federal Government, the

department or agency with which this transaction originated may pursue available remedies, including suspension and/or debarment.

\* \* \* \* \*

**Certification Regarding Debarment, Suspension, Ineligibility and Voluntary Exclusion--Lower Tier Participants:**

1. The prospective lower tier participant certifies, by submission of this proposal, that neither it nor its principals is presently debarred, suspended, proposed for debarment, declared ineligible, or voluntarily excluded from participating in covered transactions by any Federal department or agency.

2. Where the prospective lower tier participant is unable to certify to any of the statements in this certification, such prospective participant shall attach an explanation to this proposal.

\* \* \* \* \*

**XI. CERTIFICATION REGARDING USE OF CONTRACT FUNDS FOR LOBBYING**

This provision is applicable to all Federal-aid construction contracts and to all related subcontracts which exceed \$100,000 (49 CFR 20).

1. The prospective participant certifies, by signing and submitting this bid or proposal, to the best of his or her knowledge and belief, that:

a. No Federal appropriated funds have been paid or will be paid, by or on behalf of the undersigned, to any person for influencing or attempting to influence an officer or employee of any Federal agency, a Member of Congress, an officer or employee of Congress, or an employee of a Member of Congress in connection with the awarding of any Federal contract, the making of any Federal grant, the making of any Federal loan, the entering into of any cooperative agreement, and the extension, continuation, renewal, amendment, or modification of any Federal contract, grant, loan, or cooperative agreement.

b. If any funds other than Federal appropriated funds have been paid or will be paid to any person for influencing or attempting to influence an officer or employee of any Federal agency, a Member of Congress, an officer or employee of Congress, or an employee of a Member of Congress in connection with this Federal contract, grant, loan, or cooperative agreement, the undersigned shall complete and submit Standard Form-LLL, "Disclosure Form to Report Lobbying," in accordance with its instructions.

2. This certification is a material representation of fact upon which reliance was placed when this transaction was made or entered into. Submission of this certification is a prerequisite for making or entering into this transaction imposed by 31 U.S.C. 1352. Any person who fails to file the required certification shall be subject to a civil penalty of not less than \$10,000 and not more than \$100,000 for each such failure.

3. The prospective participant also agrees by submitting its bid or proposal that the participant shall require that the language of this certification be included in all lower tier subcontracts, which exceed \$100,000 and that all such recipients shall certify and disclose accordingly.

**NOTICE OF REQUIREMENTS FOR AFFIRMATIVE  
ACTION TO ENSURE EQUAL EMPLOYMENT  
OPPORTUNITY (EXECUTIVE ORDER 11246)**

1. The Offeror’s or Bidder’s attention is called to the “Equal Opportunity Clause” and the “Standard Federal Equal Employment Opportunity Construction Contract Specifications” set forth herein.

2. The goal for female participation, expressed in percentage terms for the Contractor’s aggregate workforce in each trade on all construction work, is 6.9%.

Until further notice	Goals for minority participation for each trade (percent)
----------------------	---

SHSA Cities:	
Pascagoula - Moss Point -----	16.9
Biloxi - Gulfport -----	19.2
Jackson -----	30.3

SMSA Counties:	
Desoto -----	32.3
Hancock, Harrison, Stone-----	19.2
Hinds, Rankin -----	30.3
Jackson -----	16.9

Non-SMSA Counties:	
George, Greene-----	26.4

Alcorn, Benton, Bolivar, Calhoun, Carroll, Chickasaw, Clay, Coahoma, Grenada, Itawamba, Lafayette, Lee, Leflore, Marshall, Monroe, Montgomery, Panola, Pontotoc, Prentiss, Quitman, Sunflower, Tallahatchie, Tate, Tippah, Tishomingo, Tunica, Union, Washington, Webster, Yalobusha -----	26.5
---	------

Attala, Choctaw, Claiborne, Clarke, Copiah, Covington, Franklin, Holmes, Humphreys, Issaquena, Jasper, Jefferson, Jefferson Davis, Jones Kemper, Lauderdale, Lawrence, Leake, Lincoln, Lowndes, Madison, Neshoba, Newton, Noxubee, Oktibbeha, Scott, Sharkey, Simpson, Smith, Warren, Wayne, Winston, Yazoo-----	32.0
---	------

Forrest, Lamar, Marion, Pearl River, Perry, Pike, Walthall-----	27.7
--	------

Adams, Amite, Wilkinson -----	30.4
-------------------------------	------

These goals are applicable to all the Contractor’s construction work (whether or not it is Federal or federally assisted) performed in the covered area. If the contractor performs construction work in a geographical area located outside of the covered area, it shall apply the goals established for such geographical area where the work is actually performed. With regard to this second area, the contractor also is subject to the goals for both its federally involved and nonfederally involved construction.

The Contractor’s compliance with the Executive Order and the regulations in 41 CFR Part 60-4 shall be based on its implementation of the Equal Opportunity clause, specific affirmative action obligations required by the specifications set forth in 41 CFR 60-4.3(a), and its efforts to meet the goals. The hours of minority and female employment and training must be substantially uniform throughout the length of the contract, and in each trade, and the Contractor shall make a good faith effort to employ minorities and women evenly on each of its projects. The transfer of minority or female employees or trainees from Contractor to Contractor or from project to project for the sole purpose of meeting the Contractor’s goals shall be a violation of the contract, the Executive Order and the regulations in 41 CFR Part 60-4.2(d). Compliance with the goals will be measured against the total work hours performed.

3. The Contractor shall provide written notification to the Director of the Office of Federal Contract Compliance Programs within 10 working days of award of any construction subcontract in excess of \$10,000 at any tier for construction work under the contract resulting from this solicitation. The notification shall list the name, address and telephone number of the subcontractor, employer identification number of the subcontractor, estimated dollar amount of the subcontract; estimated starting and completion dates of the subcontract; and the geographical area in which the subcontract is to be performed.

4. As used in this Notice, and in the contract resulting from this solicitation, the “covered area” is to the county and city (if any), stated in the advertisement.

5. The notification required in Paragraph 3 shall be addressed to the following:

Contract Compliance Officer  
Mississippi Department of Transportation  
P.O. Box 1850  
Jackson, Mississippi 39215-1850

(12/04/2018)

## MISSISSIPPI DEPARTMENT OF TRANSPORTATION

SPECIAL PROVISION NO. 907-102-2

CODE: (IS)

DATE: 11/22/2017

SUBJECT: **Bidding Requirements and Conditions**

Section 102, Bidding Requirements and Conditions, of the 2017 Edition of the Mississippi Standard Specifications for Road and Bridge Construction is hereby amended as follows.

**907-102.01--Prequalification of Bidders.** Delete the last sentence of the third paragraph of Subsection 102.01 on page 13, and substitute the following.

The Bidder's Certificate of Responsibility number must be on file with the Department's Contract Administration Division prior to request for permission to bid.

**907-102.02--Contents of Proposal Forms.** Delete the fourth paragraph in Subsection 102.02 on page 13, and substitute the following.

Prospective bidders must complete an online request for permission to be eligible to bid a project. Upon approval, the bidder will be authorized to submit a bid electronically using Bid Express at <http://bidx.com>.

## MISSISSIPPI DEPARTMENT OF TRANSPORTATION

SPECIAL PROVISION NO. 907-103-2

CODE: (SP)

DATE: 06/22/2017

SUBJECT: Award and Execution of Contract

Section 103, Award and Execution of Contract, of the 2017 Edition of the Mississippi Standard Specifications for Road and Bridge Construction is hereby amended as follows.

**907-103.01--Consideration of Proposal.** Delete the second and third paragraphs of Subsection 103.01 on page 19, and substitute the following.

**907-103.01.1--For Projects Constructed Without Federal Funds.** Resident Contractors actually domiciled in Mississippi are to be granted preference over nonresidents in awarding of Contracts financed 100% with State funds.

In consideration of proposals that are equal to or in excess of \$50,000 and financed 100% with State funds, a nonresident bidder domiciled in a state having laws granting preference to local Contractors will be considered for such contracts on the same basis as the nonresident bidder's state awards contracts to Mississippi Contractors bidding under similar circumstances. When a nonresident Contractor submits a bid equal to or in excess of \$50,000 on a contract financed 100% with State funds, a copy of the current laws from the state of domicile and an explanation thereof pertaining to treatment of nonresident Contractors shall be attached. If no preferential treatment is provided for Contractors in the state of domicile and contracts are awarded to the lowest responsible bidder, a statement to this effect shall be attached. Should the attachment not accompany the bid when submitted, the Contractor shall have 10 days following the opening of the bids to furnish the required information to the Contract Administration Director for attachment to the bid. Failure to provide the attachment within 10 days will result in the nonresident Contractor's bid being rejected and not considered for award. As used herein, the term "resident Contractor" includes a nonresident person, firm or corporation that has been qualified to do business in this State and has maintained a permanent full-time office in the State of Mississippi for two years prior to the submission of the bid, and the subsidiaries and affiliates of such a person, firm or corporation.

## MISSISSIPPI DEPARTMENT OF TRANSPORTATION

SPECIAL PROVISION NO. 907-701-1

CODE: (SP)

DATE: 10/23/2018

SUBJECT: Hydraulic Cement

Section 701, Hydraulic Cement, of the 2017 Edition of the Mississippi Standard Specifications for Road and Bridge Construction is hereby amended as follows.

**907-701.01--General.** In the first sentence of the third paragraph of Subsection 701.01 on page 718, change “mills” to “plants.”

In the second sentence of the seventh paragraph of Subsection 701.01 on pages 718 and 719, change “shall” to “will.”

**907-701.02--Portland Cement.**

**907-701.02.1-General.**

**907-701.02.1.2--Alkali Content.** Delete the sentence in Subsection 701.02.1.2 on page 719, and substitute the following.

The Equivalent alkali content for all cement types in this Subsection shall not exceed 0.60%.

**907-701.02.2--Replacement by Other Cementitious Materials.** Delete the paragraph in Subsection 701.02.2 on page 719, and substitute the following.

The maximum replacement of cement by weight is 25% for fly ash or 50% for ground granulated blast furnace slag (GGBFS). Replacement contents below 20% for fly ash or 45% for GGBFS may be used, but will not be given any special considerations, such as the maximum acceptance temperature for portland cement concrete containing pozzolans in Subsection 804.02.13.1.5. Special considerations shall only apply for replacement of cement by fly ash or GGBFS.

Delete Subsection 701.02.2.1 on pages 719 and 720, and substitute the following.

**907-701.02.2.1--Portland Cement Concrete Exposed to Soluble Sulfate Conditions or Seawater.**

When portland cement concrete is exposed to moderate or severe soluble sulfate conditions, or to seawater, cement types and replacement of cement by Class F fly ash or GGBFS shall be as follows in Table 1. Class C fly ash shall not be used as a replacement for cement in any of the sulfate exposure conditions listed in Table 1.

**Table 1- Cementitious Materials for Soluble Sulfate Conditions or Seawater**

Sulfate Exposure	Water-soluble sulfate (SO <sub>4</sub> ) in soil, % by mass	Sulfate (SO <sub>4</sub> ) in water, ppm	Cementitious material required
Moderate and Seawater	0.10 - 0.20	150 - 1,500	Type I cement with one of the following replacements of cement by weight: 24.5 - 25.0% Class F fly ash, or 49.5 - 50.0% GGBFS or Type II <sup>*,**</sup> cement
Severe	0.20 - 2.00	1,500 - 10,000	Type I cement with a replacement by weight of 49.5 - 50.0% GGBFS, or Type II <sup>*</sup> cement with one of the following replacements of cement by weight: 24.5 - 25.0% Class F fly ash, or 49.5 - 50.0% GGBFS

\* Type III cement conforming to AASHTO M85 with a maximum 8% tricalcium aluminate (C<sub>3</sub>A) may be used in lieu of Type II cement as allowed in Subsection 701.02.1; this cement is given the designation “Type III(MS).”

\*\* Class F fly ash or GGBFS may be added as a replacement for cement as allowed in Subsection 907-701.02.2.

Delete Subsection 701.02.2.2 on page 720, and substitute the following.

**907-701.02.2.2--Portland Cement for Soil Stabilization Exposed to Soluble Sulfate Conditions or Seawater.** When portland cement for use in soil stabilization is exposed to moderate or severe soluble sulfate conditions, or to seawater, cement types and replacement of cement by Class F fly ash or GGBFS shall meet the requirements of Subsection 701.02.2.1.

**907-701.04--Blended Hydraulic Cement.**

**907-701.04.1--General.** Delete Subsection 701.04.1.1 on page 720, and substitute the following.

**907-701.04.1.1--Types of Blended Hydraulic Cement.** Blended hydraulic cements (blended cements) shall be of the following types and conform to AASHTO M 240:

- Type IL – Portland-limestone cement
- Type IP – Portland-pozzolan cement
- Type IS – Portland blast-furnace slag cement

Blended cement Types IL, IP, and IS meeting the “MS” sulfate resistance requirement listed in AASHTO M 240, Table 3 shall have the “(MS)” suffix added to the type designation.

**907-701.04.1.2--Alkali Content.** Delete the sentence in Subsection 701.04.1.2 on page 720, and substitute the following.



All blended cement types shall be made with clinker that would result in cement meeting the requirements of Subsection 701.02.1.2 when used in the production of AASHTO M 85, Type I or Type II cement.

**907-701.04.2--Replacement by Other Cementitious Materials.** Delete the paragraph in Subsection 701.04.2 on page 720, and substitute the following.

The maximum replacement of blended cement Type IL by weight is 35% for fly ash or 50% for GGBFS. Replacement contents below 20% for fly ash or 45% for GGBFS may be used, but will not be given any special considerations, such as the maximum acceptance temperature for blended cement concrete containing pozzolans in Subsection 804.02.13.1.5. Special considerations shall only apply for replacement of blended cement by fly ash or GGBFS.

No additional cementitious materials, such as portland cement, blended cement, fly ash, GGBFS, or others, shall be added to or as a replacement for blended cement Types IP and IS.

Delete Subsection 701.04.2.1 on pages 720 and 721, and substitute the following.

**907-701.04.2.1--Blended Cement Concrete Exposed to Soluble Sulfate Conditions or Seawater.** When blended cement concrete is exposed to moderate or severe soluble sulfate conditions, or to seawater, cement types and replacement of cement by Class F fly ash or GGBFS shall be as follows in Table 2. Class C fly ash shall not be used as a replacement for cement in any of the sulfate exposure conditions listed in Table 2.

**Table 2- Cementitious Materials for Soluble Sulfate Conditions or Seawater**

Sulfate Exposure	Water-soluble sulfate (SO <sub>4</sub> ) in soil, % by mass	Sulfate (SO <sub>4</sub> ) in water, ppm	Cementitious material required
Moderate and Seawater	0.10 - 0.20	150 - 1,500	Type IL (MS)* cement, Type IL cement with one of the following replacements of cement by weight: 24.5 - 35.0% Class F fly ash, or 49.5 - 50.0% GGBFS, Type IP (MS) cement, or Type IS (MS) cement
Severe	0.20 - 2.00	1,500 - 10,000	Type IL cement with a replacement of cement by weight of 49.5 - 50.0% GGBFS, or Type IL (MS) cement with one of following replacements of cement by weight: 24.5 - 35.0% Class F fly ash, or 49.5 - 50.0% GGBFS

- \* Class F fly ash or GGBFS may be added as a replacement for cement as allowed in Subsection 907-701.04.2.

Delete Subsection 701.04.2.2 on page 721, and substitute the following.

**907-701.04.2.2--Blended Cement for Soil Stabilization Exposed to Soluble Sulfate Conditions or Seawater.** When blended cement for use in soil stabilization is exposed to moderate or severe soluble sulfate conditions, or to seawater, cement types and replacement of cement by Class F fly ash or GGBFS shall meet the requirements of Subsection 701.04.2.1.

Delete Subsection 701.04.3 on page 721.

# MISSISSIPPI DEPARTMENT OF TRANSPORTATION

**SPECIAL PROVISION NO. 907-702-4**

**CODE: (IS)**

**DATE: 09/11/2018**

**SUBJECT: Bituminous Materials**

Section 702, Bituminous Materials, of the 2017 Edition of the Mississippi Standard Specifications for Road and Bridge Construction is hereby amended as follows.

**907-702.04--Sampling.** Delete the sentence in Subsection 702.04 on page 722, and substitute the following.

Sampling of bituminous materials shall be as set out in AASHTO R 66.

**907-702.07--Emulsified Asphalt.** Delete the last sentence in Subsection 702.07 on page 724, and substitute the following.

Asphalt for fog seal shall conform to the requirements of Subsection 907-702.12, Table V.

**907-702.12--Tables.** Delete Table V in Subsection 702.12 on page 729, and substitute the following.

**TABLE V  
SPECIFICATION FOR FOG SEAL**

Test Requirements	LD-7		CHPF-1		Test Method
	Min.	Max.	Min.	Max.	
Viscosity, Saybolt Furol, @ 25°C, Sec.	10	100	-	100	AASHTO T 72
Storage Stability Test, 24 hr, %	-	1	-	1	AASHTO T 59
Settlement, 5 day, %	-	5	-	-	AASHTO T 59
Oil Distillate, %	-	1	-	-	AASHTO T 59
Sieve Test, % *	-	0.3	-	0.1	AASHTO T 59
Residue by Distillation, %	40	-	40	-	AASHTO T 59
<b>Test on Residue from Distillation</b>					
Penetration @ 25°C, 100g, 5 sec	-	20	40	90	AASHTO T 49
Softening Point, °C	65	-	-	-	ASTM D 36
Solubility in trichloroethylene, %	97.5	-	-	-	AASHTO T 44
Elastic Recovery @ 25°C, %	-	-	40	-	AASHTO T 301
Original DSR @ 82° (G*/Sinδ, 10 rad/sec)	1	-	-	-	AASHTO T 111

\* The Sieve Test result is tested for reporting purposes only and may be waived if no application problems are present in the field.

**MISSISSIPPI DEPARTMENT OF TRANSPORTATION**

**SPECIAL PROVISION NO. 907-703-1**

**CODE: (IS)**

**DATE: 06/13/2018**

**SUBJECT: Gradation**

Section 703, Aggregates, of the 2017 Edition of the Mississippi Standard Specifications for Road and Bridge Construction is hereby amended as follows.

**907-703.03--Course Aggregates for Hydraulic Cement Concrete.**

**907-703.03.2--Detail Requirements.**

**907-703.03.2.4--Gradation.** In the table in Subsection 703.03.2.4 on page 734, add 100 for the percent passing by weight on the 1½-inch sieve for Size No. 67 aggregates.

**MISSISSIPPI DEPARTMENT OF TRANSPORTATION**

**SPECIAL PROVISION NO. 907-705-1**

**CODE: (IS)**

**DATE: 06/13/2018**

**SUBJECT: Stone Riprap**

Section 705, Stone Blanket Protection and Filter Blanket Materials, of the 2017 Edition of the Mississippi Standard Specifications for Road and Bridge Construction is hereby amended as follows.

**907-705.04--Stone Riprap.** Delete the last sentence of the first paragraph of Subsection 705.04 on page 750, and substitute the following.

Quality requirements for rock to be furnished under these specifications will come from a pre-approved source and be visually approved prior to use.

**MISSISSIPPI DEPARTMENT OF TRANSPORTATION**

**SPECIAL PROVISION NO. 907-711-2**

**CODE: (IS)**

**DATE: 09/11/2018**

**SUBJECT: Plain Steel Wire**

Section 711, Reinforcement and Wire Rope, of the 2017 Edition of the Mississippi Standard Specifications for Road and Bridge Construction is hereby amended as follows.

**907-711.02--Deformed and Plain Carbon-Steel Bars for Concrete Reinforcing.**

**907-711.02.3--Steel Welded and Non-Welded Wire Reinforcement, Plain and Deformed, for Concrete.**

**907-711.02.3.1--Plain Steel Wire.** Delete the sentence in Subsection 711.02.3.1 on pages 780 and 781, and substitute the following.

Plain steel wire and plain steel welded wire shall conform to the requirements of AASHTO M 336.

**MISSISSIPPI DEPARTMENT OF TRANSPORTATION**

**SPECIAL PROVISION NO. 907-720-2**

**CODE: (IS)**

**DATE: 09/11/2018**

**SUBJECT: Acceptance Procedure for Glass Beads**

Section 720, Pavement Marking Materials, of the 2017 Edition of the Mississippi Standard Specifications for Road and Bridge Construction is hereby amended as follows.

**907-720.01--Glass Beads.**

**907-720.01.4--Acceptance Procedures.** Delete the last sentence of the paragraph in Subsection 720.01.4 on page 841, and substitute the following.

Acceptance sampling and testing of glass beads will be in accordance with the Department's Materials Division Inspection, Testing, and Certification Manual, Section 2.9.2 -- Glass Beads.

**MISSISSIPPI DEPARTMENT OF TRANSPORTATION**

**SPECIAL PROVISION NO. 907-808-1**

**CODE: (SP)**

**DATE: 11/01/2018**

**SUBJECT: Joint Repair**

Section 808, Joint Repair, of the 2017 Edition of the Mississippi Standard Specifications for Road and Bridge Construction is hereby amended as follows.

**907-808.04--Method of Measurement.** Delete the paragraph in Subsection 808.04 on page 1009, and substitute the following.

When a pay item is included in the plans, joint repair will be measured by the linear foot and mortar mix will be measured by the gallon. The volume of measurement for the epoxy/sand mortar mix will be determined from the summation of the volumes of the epoxy components and the volume of sand will not be measured for payment.

**907-808.05--Basis of Payment.** Delete the paragraph in Subsection 808.05 on page 1009, and substitute the following.

When a pay item is included in the plans, joint repair, measured as prescribed above, will be paid for at the contract unit price per linear foot, which price shall be full compensation for furnishing and placing all materials, labor, tools, equipment, and all incidentals necessary to complete the work.

When a pay item is included in the plans, mortar mix, measured as prescribed above, will be paid for at the contract unit price per gallon, which price shall be full compensation for furnishing all materials including sand and forming materials, and all incidentals necessary to complete the work. No payment will be made for the sand used in the epoxy mortar mix.

The price bid for each item of work shall include the cost of continuous maintenance of traffic and protective services as required by the Department's Traffic Control Plan. This shall include all required individual traffic control devices.

Payment will be made under:

907-808-A: Joint Repair - per linear foot

907-808-B: Mortar Mix - per gallon



# MISSISSIPPI DEPARTMENT OF TRANSPORTATION

SPECIAL PROVISIONS NO. 907-823-5

CODE: (SP)

DATE: 01/22/2019

SUBJECT: **Preformed Joint Seal**

Section 907-823, Preformed Joint Seal, is hereby added to and becomes a part of the 2017 Edition of the Mississippi Standard Specifications for Road and Bridge Construction as follows.

## **SECTION 907-823--PREFORMED JOINT SEAL**

**907-823.01--Description.** This work consists of furnishing and installing preformed joint seals in accordance with these specifications and the details shown in the Plans or drawings provided.

**907-823.02--Materials.** The Contractor shall furnish a manufacturer's certification stating that the material used meets the requirements of this specification.

The preformed joint seal shall be one of the following, or an approved equal. The size of the seal, Type I or Type II, shall be determined based on the size of the joint opening, as detailed in the Plans or drawings provided. It is the Contractor's responsibility to ensure that the size selected is appropriate for the width of the joint. Type I shall be used for joint openings less than two inches (2"). Type II shall be used for joint openings greater than two inches (2"), with the maximum joint opening being two and one-half inches (2½"). In cases where the joint opening is greater than two and one-half inches (2½"), another type of expansion material shall be required as directed by the Director of Structures, State Bridge Engineer.

1. Silicoflex Joint Sealing System  
Manufactured by R.J. Watson, Inc. in Alden, NY  
[www.rjwatson.com](http://www.rjwatson.com)
2. Wabo@SPS Joint System  
Manufactured by Watson Bowman Acme Corporation in Amherst, NY  
[www.wbacorp.com](http://www.wbacorp.com)
3. Silspec SSS Silicone Strip Seal  
Manufactured by SSI Commercial & Highway Construction Materials in Tulsa, OK  
[www.ssicm.com](http://www.ssicm.com)

**907-823.03--Construction Methods.** Preformed joint seals shall be installed in accordance with the manufacturer's recommendations. The material shall seal the deck surface, gutters, and curbs to prevent moisture or other contaminants from leaking through the joints. The joint seal shall be installed in such a manner that the top surface of the material is within the minimum and maximum depths below the roadway or bridge surface recommended by the manufacturer.

Saw cutting for the joint repair shall be accomplished by sawing at the locations and depth shown

on the joint repair detail sheets in the plans or in the contract documents. Saw cuts shall be as near vertical as possible at the saw line of the repair area. The saw cut depth shall be equivalent to the installation depth required by the manufacturer's specifications, and the type specified shall be the same as the type specified for preformed joint seal.

**907-823.04--Method of Measurement.** Preformed joint seal of the type specified will be measured in linear feet along the length of the centerline joint.

Saw cuts of the type specified will be measured by the linear foot along the length of the bridge deck on each side of the centerline joint.

**907-823.05--Basis of Payment.** Preformed joint seal, measured as prescribed above, will be paid for at the contract unit price per linear foot, which shall be full compensation for furnishing all labor, equipment, tools, materials, and incidentals necessary to complete the work.

Saw cuts, measured as prescribed above, will be paid for at the contract unit price per linear foot, which shall be full compensation for furnishing all labor, equipment, tools, materials, and incidentals necessary to complete the work.

Payment will be made under:

907-823-A: Preformed Joint Seal, Type \_\_\_\_ - per linear foot

907-823-B: Saw Cut, Type \_\_\_\_\_ - per linear foot

**NOTES ON ASSOCIATED ITEMS OF WORK:**

**907-808-4002 JOINT REPAIR WITH EPOXY**

**Description:**

Shall Include The Work Necessary To Repair Joints In Preparation For The Placement Of New Expansion Material. Shall Also Be Included Under This Item Of Work Removal Of Existing Silicone Sealed, Compression, And AC Sealed Joint Materials Will Not Be Paid For Directly And Shall Be Considered As Incorporated Under This Item Of Work. All Other Requirements Shall Be As Applicable To The Miscellaneous Provisions Of Section 808 Of The Specifications And Any Other Sections Specified Therein.

**Basis Of Payment:**

The Accepted Quantities Will Be Paid For In Linear Feet At The Contract Unit Price Along The Length Of The Bridge Deck On Each Side Of The Centerline Joint.

**907-808-4002 JOINT REPAIR WITHOUT EPOXY**

**Description:**

Shall Include The Work Necessary To Repair Joints In Preparation For The Placement Of New Expansion Material, Including The Removal Of Existing Silicone Sealed, Compression, And AC Sealed Joint Materials Will Not Be Paid For Directly And Shall Be Considered As Incorporated Under This Item Of Work. All Other Requirements Shall Be As Applicable To The Miscellaneous Provisions Of Section 808 Of The Specifications And Any Other Sections Specified Therein.

**Basis Of Payment:**

The Accepted Quantities Will Be Paid For In Linear Feet At The Contract Unit Price Along The Length Of The Bridge Deck On Each Side Of The Centerline Joint.

**907-823-8001 SAW CUT, TYPE I & 907-823-8002 SAW CUT, TYPE II**

**Description:**

The Saw Cut Depth Shall Be Equivalent To The Installation Depth Required By The Manufacturer's Specifications. The Saw Cut Type Shall Be The Same As The Performed Joint Seal Selected.

**Basis Of Payment:**

The Accepted Quantities Will Be Paid For In Linear Feet At The Contract Unit Price Along The Length Of The Bridge Deck On Each Side Of The Centerline Joint. The Contractor Shall Be Responsible To Ensure That The Proper Depth Is Selected Based On The Manufacturer's Recommendations.

**907-823-4001 PREFORMED JOINT SEAL, TYPE I**

**Description:**

Shall Include The Manufacturer's Required Joint Preparation Including Cleaning Both Sides Of The Joint And Blowing The Joint Free Of Debris. The Seal Shall Be Applied And Placement Of The Preformed Joint Seal.

**Basis Of Payment:**

The Accepted Quantities Will Be Paid For In Linear Feet At The Contract Unit Price Along The Length Of The Centerline Joint.

**EPDOXY MORTAR AND POLYMER CONCRETE NOTES:**

Either Epoxy Mortar Or Polymer Concrete May Be Used. Guidelines For Selection Of Materials Can Be Found In Section 808 Of The Specifications.

**GENERAL NOTES:**

1. Specifications, Massachusetts Standard Specifications For Road And Bridge Construction, 2017.
2. No Change Of Plans Will Be Permitted Except By Written Approval Of The Director Of Structures, State Bridge Engineer. Any Change Of Plans Must Be Approved In Writing. Changes May Be Authorized By The Bridge Engineer Provided Such Changes Will Not Be Cause For Contract Price Adjustment. Work For Which No Pay Item Is Provided In The Proposal Will Be Considered As Work For Which It Is Specifically And Shall Therefore Be Considered An Assessed Item Of Work.

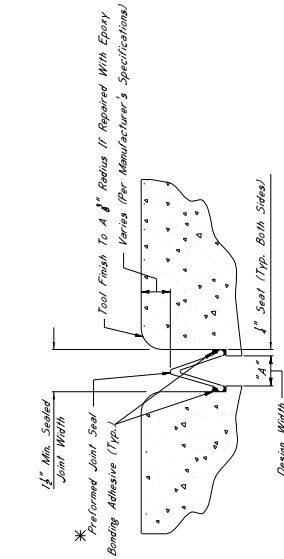

**TYPICAL SECTION AT SAWCUT & SEALED JOINT**

Showing Sealed Joint After Sawcut

**\*NOTES:**

1. The Preformed Joint Seal Shall Be One Of The Following, Installed According To The Manufacturer's Specifications:

- A. SilicoFlex Joint Sealing System Manufactured By R.J. Watson, Inc. In Alden, NY [www.rjwatson.com](http://www.rjwatson.com)
- B. Mega SPS Joint System Manufactured By SSI Commercial & Highway Construction Materials [www.ssi.com](http://www.ssi.com)
- C. SiloSeal SSS Silicone Strip Seal Manufactured By SSI Commercial & Highway Construction Materials [www.ssi.com](http://www.ssi.com)

2. For Estimating Purposes, The R.J. Watson SilicoFlex Joint Sealing System Was Selected. However, Should Another Supplier Be Chosen, It Is The Contractor's Responsibility To Obtain The Manufacturer's Specifications, Installation Details, And Other Information From The Manufacturer. The Contractor Shall Be Responsible To Ensure That The Contractor Is Properly Trained In Installation Of The Joint Material.

3. Joints Shall Be Sealed At Their Design Widths, Dimension "A", Which Is Defined As The Actual Width Of The Joint Opening. This Width Does Not Account For The Sealant. The Sealant Shall Be Applied To The Joint After The Sealant Is Applied. For Design Widths Greater Than Or Equal To 2" Sealant Type "B" Shall Be Used. For Design Widths Greater Than Or Equal To 2" Sealant Type "C" Shall Be Used. The Contractor Shall Be Responsible To Ensure That The Contractor Is Properly Trained In Installation Of The Joint Material. It Is The Contractor's Responsibility To Ensure That The Size Selected Is Appropriate For The Width Of The Joint.

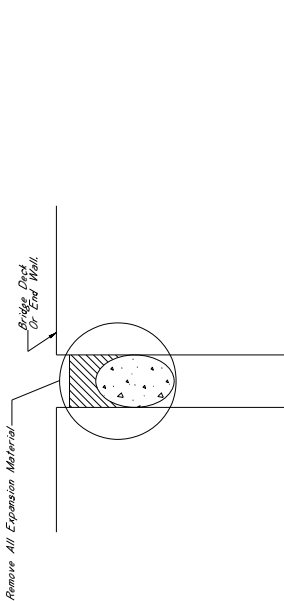

**TYPICAL SECTION AT EXISTING JOINT**

Showing Existing Expansion Materials To Be Removed And Replaced With Preformed Joint Seal

**TYPICAL SECTION AT JOINT AFTER REMOVAL OF EXISTING SEAL AND SAWCUT**

Showing Limits Of Joint Preparation For Application Of New Joint Seal Materials And Sawcut

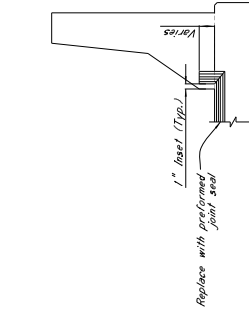
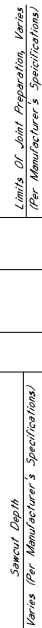

**TYPICAL SECTION AT JOINT REPAIR**

Showing Area Where Repairs Are Made After Sawcut With Epoxy Mortar Or Approved Equivalent

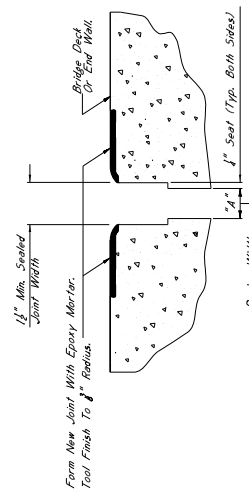

**TYPICAL SECTION AT SAWCUT & JOINT REPAIR**

Showing Area Where Repairs Are Made After Sawcut With Epoxy Mortar Or Approved Equivalent

**\*NOTES:**  
For Jersey Slab Barriers, The Minimum Required Vertical Joint Seal Dimension Within The Barrier Is 3".  
For Jersey Slab Barriers, The Minimum Required Vertical Joint Seal Dimension Within The Barrier Is 6".

**ELEVATION AT END OF SPAN**

**NOTES ON ASSOCIATED ITEMS OF WORK:**

**907-808-4002 JOINT REPAIR WITH EPOXY**

**Description:** Shall include the work necessary to repair joints in preparation for the placement of new expansion material, as designated in the detail drawings provided. Epoxy mortar shall also be included under this item of work. Removal of existing silicone sealant, compression and SC spacer joint materials will not be paid for directly and shall be considered as absorbed under this item of work. All other requirements shall be in accordance with the applicable provisions of Section 808 of the specifications and any other sections specified therein.

**Basis Of Payment:** The accepted quantities will be paid for in linear feet at the contract unit price along the length of the bridge deck on each side of the centerline joint.

**907-808-4002 JOINT REPAIR WITHOUT EPOXY**

**Description:** Shall include the work necessary to repair joints in preparation for the placement of new expansion material, as designated in the detail drawings provided. Removal of existing silicone sealant, compression and SC spacer joint materials will not be paid for directly and shall be considered as absorbed under this item of work. All other requirements shall be in accordance with the applicable provisions of Section 808 of the specifications and any other sections specified therein.

**Basis Of Payment:** The accepted quantities will be paid for in linear feet at the contract unit price along the length of the bridge deck on each side of the centerline joint.

**907-823-8001 SAW CUT, TYPE I & 907-823-8002 SAW CUT, TYPE II**

**Description:** The saw cut depth shall be equivalent to the installation depth required by the manufacturer's specifications. The saw cut type shall be the same as the preformed joint seal selected.

**Basis Of Payment:** The accepted quantities will be paid for in linear feet at the contract unit price along the length of the bridge deck on each side of the centerline joint. It is the contractor's responsibility to ensure that the proper depth is selected based on the manufacturer's recommendations.

**907-823-4001 PREFORMED JOINT SEAL, TYPE I**

**Description:** Shall include the manufacturer's required joint preparation including sandblasting, both sides of the joint and blowing the preformed joint seal.

**Basis Of Payment:** The accepted quantities will be paid for in linear feet at the contract unit price along the length of the centerline joint.

**EPOXY MORTAR AND POLYMER CONCRETE NOTES:**

Filler For Mortar Or Polymer Concrete May Be Used, Guidelines For Selection Of Materials Can Be Found In Section 808 of the Specifications.

**GENERAL NOTES:**

1. Specifications, Mississippi Standard Specifications For Road And Bridge Construction, 2017.
2. Approval Of The Director Of Structures, State Bridge Engineer, Minor Changes To Detail Of Design Or Construction Procedure May Be Authorized By The Bridge Engineer Provided Such Changes Do Not Affect The Structural Integrity Of The Work. Work For Which No Pay Item Is Provided In The Proposal Will Not Be Paid For Directly And Shall Therefore Be Considered An Absorbed Item Of Work.

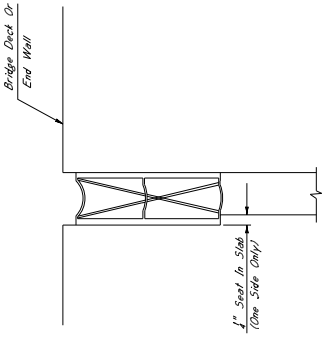

**TYPICAL SECTION AT EXISTING JOINT**  
Showing Existing Expansion Device To Be Removed And Replaced With Preformed Joint Seal

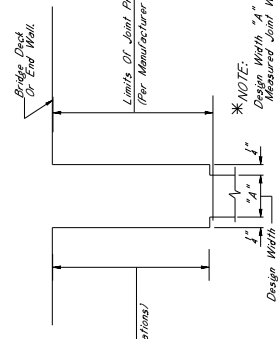

**TYPICAL SECTION AT JOINT AFTER REMOVAL OF EXISTING SEAL AND SAWCUT**  
Showing Limits Of Joint Preparation For Application Of New Joint Seal Materials And Sawcut

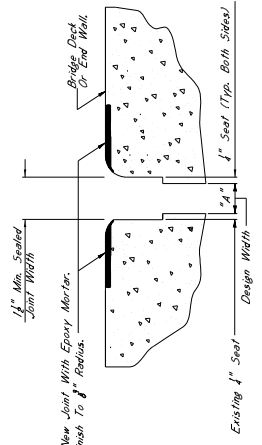

**TYPICAL SECTION AT SAWCUT & JOINT REPAIR**  
Showing Limits Of Joint Preparation For Application Of Approved Epoxy Mortar Or Approved Equivalent

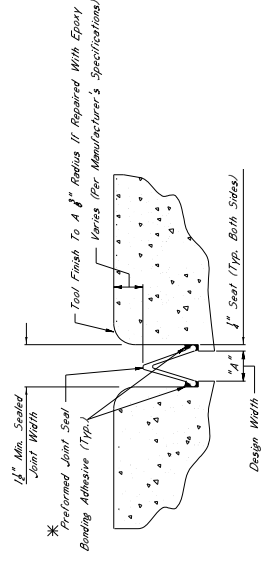

**TYPICAL SECTION AT SAWCUT & SEALED JOINT**  
Showing Sealed Joint After Sawcut And Repair With Epoxy Mortar

**\*NOTES:**  
1. The Preformed Joint Seal Shall Be One Of The Following, Installed According To The Manufacturer's Specifications:  
A. Silicone Joint Sealing System  
www.jointseal.com  
www.jointseal.com  
B. Mids SPS Joint Sealing System  
Manufactured By: Welton Bowman Acme Corporation In Amherst, NY  
www.wbcorp.com  
C. Silicone SSS Silicone Strip Seal  
Manufactured By: SSI Commercial & Highway Construction Materials  
www.ssi.com

2. For Existing Purposes, The R.J. Welton Silicone Joint Sealing System Was Used For Design Widths Greater Than Or Equal To 2" With The Design Edge Width Of Expansion Material Shall Be As Prescribed In The Joint Sealing System To Ensure That The Contractor Is Properly Schooled In Installation Of The Joint Material.  
3. Joints Shall Be Sealed At Their Design Widths, Dimension "A", Which Is Defined As The Actual Width Both Sides Of The Joint. An Access For Sealant Shall Be Used For Design Widths Less Than 2". Preformed Joint Seal, Type II, Shall Be Used For Design Widths Greater Than Or Equal To 2" With The Design Edge Width Of Expansion Material Shall Be As Prescribed In The Joint Sealing System To Ensure That The Contractor Is Properly Schooled In Installation Of The Joint Material.

**\*NOTE:**  
Design Width "A" Is Defined As The Actual Measured Joint Width.

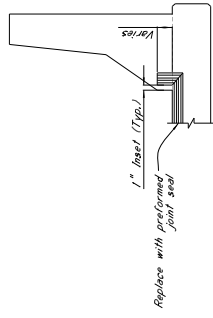

**ELEVATION AT END OF SPAN**

**NOTES ON ASSOCIATED ITEMS OF WORK:**

**907-808-A022 JOINT REPAIR WITH EPOXY**

**Description:** Seal includes the work necessary to repair joints in preparation for the placement of new expansion material. Seal also be included under this item of work. Removal of Existing Seal and Epoxy Mortar shall be considered as absorbed under this item of work. All other requirements shall be in accordance with the applicable provisions of Section 808 of the Specifications and any other sections specified therein.

**Basis of Payment:** The Accepted Quantities Will Be Paid For in Linear Feet At The Contract Unit Price Along The Length Of The Bridge Deck On Each Side Of The Centerline Joint.

**907-808-A023 JOINT REPAIR WITHOUT EPOXY**

**Description:** Seal includes the work necessary to repair joints in preparation for the placement of new expansion material. As designed in the detail drawings provided. Epoxy Mortar of Existing Silicone Sealed, Compression and AC Sealed Joint shall be removed and replaced with epoxy mortar. Epoxy mortar shall be in accordance with this item of work. All other requirements shall be in accordance with the applicable provisions of Section 808 of the Specifications and any other sections specified therein.

**Basis of Payment:** The Accepted Quantities Will Be Paid For in Linear Feet At The Contract Unit Price Along The Length Of The Bridge Deck On Each Side Of The Centerline Joint.

**907-823-B001 SAW CUT, TYPE I & 907-823-B002 SAW CUT, TYPE II**

**Description:** The Saw Cut Depth Shall Be Equivalent To The Installation Depth Required By The Manufacturer's Specifications. The Saw Cut Type Shall Be The Same As The Preformed Joint Seal Selected.

**Basis of Payment:** The Accepted Quantities Will Be Paid For in Linear Feet At The Contract Unit Price Along The Length Of The Bridge Deck On Each Side Of The Centerline Joint. It Is The Contractor's Responsibility To Ensure That The Proper Depth Is Selected Based On The Manufacturer's Recommendations.

**907-823-A001 PREFORMED JOINT SEAL, TYPE I**

**Description:** Seal includes the manufacturer's required joint preparation including sandblasting both sides of the joint and blowing the joint free of debris with compressed air and placement of the new preformed joint seal.

**Basis of Payment:** The Accepted Quantities Will Be Paid For in Linear Feet At The Contract Unit Price Along The Length Of The Centerline Joint.

**EPOXY MORTAR AND POLYMER CONCRETE NOTES:**

Either Epoxy Mortar Or Polymer Concrete May Be Used. Guidelines For Selection Of Materials Can Be Found In Section 808 of The Specifications.

**GENERAL NOTES:**

1. Specifications: Mississippi Standard Specifications For Road And Bridge Construction, 2017.
2. Approval Of The Director Of Structures, State Bridge Engineer, Minor Changes To Detail Of Design Or Construction Procedure May Be Authorized By The Bridge Engineer Provided Such Changes Will Not Affect The Safety, Strength, Or Durability Of The Work For Which No Pay Item Is Provided. The Proposal Will Not Be Paid For Directly And Shall Therefore Be Considered An Absorbed Item of Work.

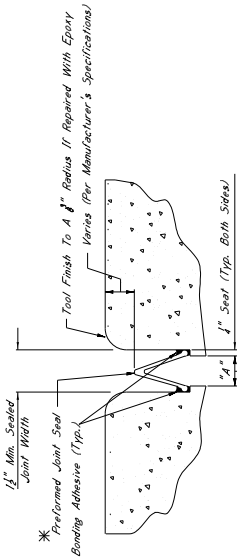

**TYPICAL SECTION AT SAWCUT & SEALED JOINT**

Showing Sealed Joint After Sawcut And Repair With Epoxy Mortar

**\* NOTES:**

1. The Preformed Joint Seal Shall Be One Of The Following, Installed According To The Manufacturer's Specifications:
  - A. Silcoflex Joint Sealing System [www.walston.com](http://www.walston.com)
  - B. Wako SPS Joint Sealing System [www.wacoep.com](http://www.wacoep.com)
  - C. Silseal 555 Silicone Strip Seal Manufactured By 551 Commercial & Highway Construction Materials [www.551ccm.com](http://www.551ccm.com)
2. For Estimating Purposes, The R.J. Walston Silcoflex Joint Sealing System May Be Used For Design Purposes. The Manufacturer's Recommendations Are Followed For Joint Preparation, Installation Details, And Weights, Adhesive, Sealing Times, And Material Quantities. The Contractor Shall Be Responsible For Obtaining The Manufacturer's Representative Shall Be Present At The Time Joint Sealing Begins To Ensure That The Contractor Is Properly Trained In Installation Of The Joint Material.
3. Joints Shall Be Sealed At Their Design Widths, Dimension "A", Which Is Defined As Seal Width On Both Sides Of The Joint. The Contractor Shall Be Responsible For Ensuring That The Seal Widths Are Less Than 2". Preformed Joint Seal Type II Shall Be Used For Design Purposes. The Contractor Shall Be Responsible For Obtaining The Manufacturer's Representative Shall Be Present At The Time Joint Sealing Begins To Ensure That The Contractor Is Properly Trained In Installation Of The Joint Material. It Is The Contractor's Responsibility To Ensure That The Size Selected Is Appropriate For The Width Of The Joint.

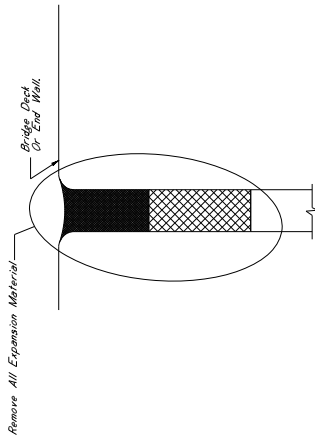

**TYPICAL SECTION AT EXISTING JOINT**

Showing Existing Expansion Material To Be Removed And Replaced With Preformed Joint Seal

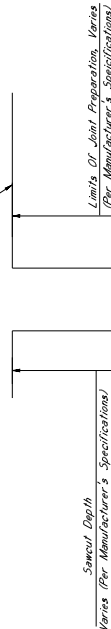

**TYPICAL SECTION AT JOINT AFTER REMOVAL OF EXISTING SEAL AND SAWCUT**

Showing Limits Of Joint Preparation For Application Of New Joint Seal Materials And Sawcut

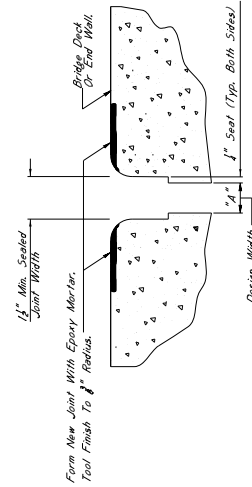

**TYPICAL SECTION AT SAWCUT & JOINT REPAIR**

Showing Area Where Repairs Are Made After Sawcut With Epoxy Mortar Or Approved Equivalent

**\* NOTES:**

- For Jersey Slope Barricade, The Minimum Required Vertical Joint Seal Dimension Within The Barricade Is 3" For Box And Beam Barricade, The Minimum Required Vertical Joint Seal Dimension Within The Barricade Is 6".

**ELEVATION AT END OF SPAN**

**\* 1" SAWCUT NOTES:**  
 All 1" Sawcuts Shall Be Considered An Absorbed Item of Work. The Contractor Shall Verify Depth of Reinforcing Steel Before Making Any Sawcuts. The Depth of The Reinforcing Steel Shall Be Repaired To The Satisfaction Of The Engineer At No Cost To The State.

**\* CONCRETE REMOVAL BLOCKOUT NOTES**  
 Removal Of The Concrete Blockout Area Shall Be Considered An Absorbed Item Of Work Under Pay Item 202-B169. The Contractor Shall Use Hand Tools To Cut A Length Than 30" LB. To Complete This Work.

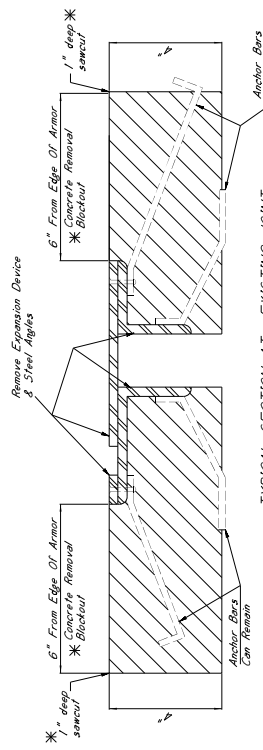

**TYPICAL SECTION AT EXISTING JOINT**  
 Showing Existing Expansion Device To Be Removed And Replaced With Performed Joint Seal

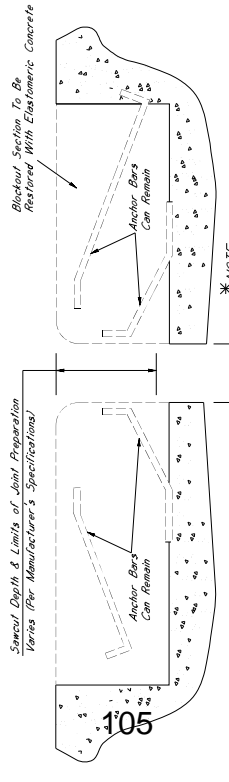

**TYPICAL SECTION AT JOINT AFTER REMOVAL OF EXISTING SEAL**  
 Showing Limits Of Joint Preparation For Application Of New Joint Seal Materials

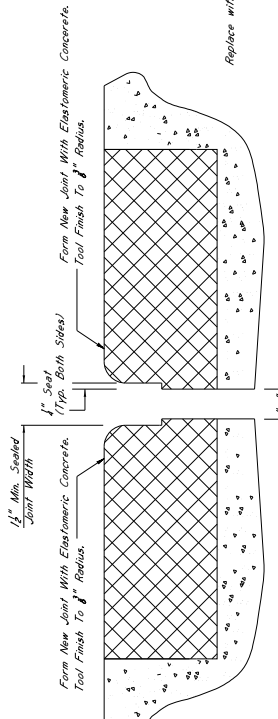

**TYPICAL SECTION AT SAWCUT & JOINT REPAIR**  
 Showing Area Where Repairs Are Made After Sawcut With Elastomeric Concrete

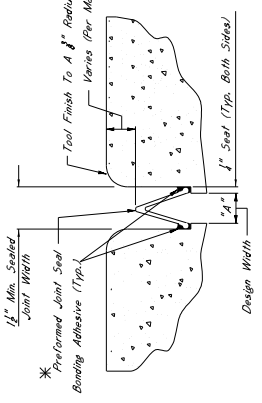

**TYPICAL SECTION AT SAWCUT & SEALED JOINT**  
 Showing Sealed Joint After Sawcut And Repair With Elastomeric Concrete

**\* NOTES:**  
 1. The Performed Joint Seal Shall Be One Of The Following, Installed According To The Manufacturer's Specifications:  
 A. Silcrete Joint Sealing System Manufactured By R.J. Watson, Inc. In Alden, NY  
 www.rjwatson.com  
 B. Welo Joint System Manufactured By Watson Bowman Acme Corporation In Amherst, NY  
 www.wbcorp.com  
 C. Silcrete 555 Silicone Strip Seal Manufactured By 551 Commercial & Highway Construction Materials www.551.com

2. For Estimating Purposes, The R.J. Watson Silicone Joint Sealing System Was Selected. It Is The Contractor's Responsibility To Ensure That The Manufacturer's Recommendations Are Followed For All Applications. All Applications, Details, and Methods, Applicable, Sealing Times, And Other Information Available From The Manufacturer Shall Be Present At The Time Joint Sealing Begins. A Manufacturer Representative Shall Be Present At The Installation Of The Joint To Ensure That The Contractor Is Properly Trained In Installation Of The Joint Material.  
 3. Joints Shall Be Sealed To Their Design Width. Dimension "A", Which Is Defined As Seal Applied On Both Sides Of The Joint, Performed Joint Seal, Type I, Shall Be Used For Design Purposes. For Estimating Purposes, The Minimum Seal Width Shall Be 1 1/2". In Cases Where Design Widths Are Greater Than 2", Another Type Of Expansion Material Shall Be Required As Directed By The Director Of Structures. The Contractor Shall Be Responsible For The Selection Of Seal Material To Ensure That The Seal Is Appropriate For The Width Of The Joint.

**\* NOTES:**  
 For Anchor, Signs, Barriers, The Minimum Required Vertical Joint Seal Dimension With The Expansion Device For Post And Beam Barriers, The Minimum Required Vertical Joint Seal Dimension Within The Barrier is 6".

**ELEVATION AT END OF SPAN**

**NOTES ON ASSOCIATED ITEMS OF WORK:**  
 202-B169 REMOVAL OF EXISTING JOINT MATERIAL

**Description:** Shall Include The Removal Of Material Associated With Armor, Sliding Plates and Mappings Provided. Removal As Designated In The Detail Drawings Provided. Removal Of The Concrete Blockout Area Shall Be Absorbed Under This Item Of Work. Other Joint Types Shall Not Be Included Under This Item Of Work Unless Otherwise Directed By The Engineer.

**Basis Of Payment:** Removal Of Armor And Sliding Plate Joint Material Will Be Paid For In Cubic Yards At The Rate Specified Along The Length Of The Centerline Joint, While Removal Of Negative Joint Material Will Only Be Paid For As The Length Along The Centerline Of The Joint.

**907-823-8001 SAW CUT, TYPE I & 907-823-8002 SAW CUT, TYPE II**

**Description:** This Saw Cut Depth Shall Be Established To The Installation Depth Required By The Manufacturer's Specifications. The Saw Cut Type Shall Be The Same As The Performed Joint Seal Selected.

**Basis Of Payment:** The Accepted Quantities Will Be Paid For In Linear Feet At The Rate Specified Along The Length Of The Bridge Deck On Each Side Of The Centerline Joint.

**907-823-8001 REFORMED JOINT SEAL, TYPE I**  
**907-823-8002 REFORMED JOINT SEAL, TYPE II**

**Description:** Shall Include The Manufacturer's Required Joint Preparation For The Performed Joint Seal. The Joint Preparation Shall Be Done With Compressed Air And Placement Of The New Performed Joint Seal.

**Basis Of Payment:** The Accepted Quantities Will Be Paid For In Linear Feet At The Rate Specified Along The Length Of The Centerline Joint.

**ELASTOMERIC CONCRETE NOTES**  
**907-824-9007 BRIDGE REPAIR ELASTOMERIC CONCRETE**

**Description:** Elastomeric Concrete Shall Be One Of The Following Products, Installed According To The Manufacturer's Specifications:

- A. Poly-Ton Elastomeric Concrete  
 www.polyton.com
  - B. WeloCrete II  
 www.wbcorp.com
  - C. Ductcrete Elastomeric Concrete  
 www.ductcrete.com
- Basis Of Payment:** The Accepted Quantities Will Be Paid For In Cubic Yards At The Contract Unit Price.

**GENERAL NOTES:**

1. Specifications: Mississippi Standard Specifications For Road And Bridge Construction, 2017.
2. No Change Of Items Will Be Permitted Except By Written Order. Minor Changes To Detail Of Design Or Construction Procedure May Be Authorized By The Bridge Engineer Provided Such Changes Will Not Be Cause For Contract Price Adjustment. Proposal Will Be Paid For Directly And Shall Therefore Be Considered An Absorbed Item of Work.

**NOTES ON ASSOCIATED ITEMS OF WORK:**

**202-8169 REMOVAL OF EXISTING JOINT MATERIAL**

**Description:** Shall include the removal of material associated with armor, sliding plate, and neoprene expansion joints, as designated in the detail drawings provided. Removal of material shall include the removal of neoprene joints, armor, or metal. Other joint types shall not be included under this item of work unless otherwise directed by the Engineer.

**Basis of Payment:** Removal of armor and sliding plate joint material will be paid for in linear feet at the contract unit price along the length of the bridge deck on each side of the centerline joint. Removal of neoprene joints, armor, or metal will be paid for as the length along the centerline of the joint.

**907-823-8001 SAW CUT, TYPE I & 907-823-8002 SAW CUT, TYPE II**

**Description:** The saw cut depth shall be equivalent to the installation depth required by the manufacturer's specifications. The saw cut type shall be the same as the preformed joint seal selected.

**Basis of Payment:** The accepted quantities will be paid for in linear feet at the contract unit price along the length of the bridge deck on each side of the centerline joint.

**907-823-4001 PREFORMED JOINT SEAL, TYPE I**

**Description:** Shall include the manufacturer's required joint preparation including sandblasting both sides of the joint and blowing the joint free of debris with compressed air and placement of the new preformed joint seal.

**Basis of Payment:** The accepted quantities will be paid for in linear feet at the contract unit price along the length of the centerline joint.

- 7 -

**ELASTOMERIC CONCRETE REPAIR**

**Description:** Elastomeric concrete shall be one of the following products installed according to the manufacturer's specifications:

- A. Poly-Ton Elastomeric Concrete, Manufactured by R.L. Watson, Inc. in Alden, NY www.rwatson.com
- B. Wika-Silcote II, Manufactured by Wilson Bowman Acme Corporation in Amherst, NY www.wbcorp.com
- C. Polysk Elastomeric Concrete, Manufactured by The U.S. Brem Company in North Baltimore, OH www.sbr.com

**Basis of Payment:** The accepted quantities will be paid for in cubic yards at the contract unit price.

**GENERAL NOTES:**

1. Specifications: Mississippi Standard Specifications For Road And Bridge Construction, 2017.
2. No Change Of Plans Will Be Permitted Except By Written Approval Of The Engineer.
3. Minor Changes To Detail Or Design Or Construction Procedure May Be Authorized By The Bridge Engineer Provided Such Changes Will Not Be Cause For Contract Price Adjustment. Proposed Changes To Detail Or Design Or Construction Procedure Will Not Be Paid For Directly And Shall Therefore Be Considered An Absorbed Item Of Work.

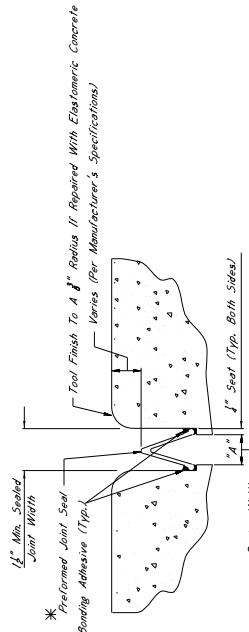

**TYPICAL SECTION AT SAWCUT & SEALED JOINT**

Showing Sealed Joint Area, Sawcut, and Repair With Elastomeric Concrete

**\*NOTES:**

1. The preformed joint seal shall be one of the following, installed according to the manufacturer's specifications:
  - A. Silcote II Joint Sealing System, Manufactured by R.L. Watson, Inc. in Alden, NY www.rwatson.com
  - B. Wika SPS Joint Sealing System, Manufactured by Wilson Bowman Acme Corporation in Amherst, NY www.wbcorp.com
  - C. Silseco 555 Silicone Strip Seal, Manufactured by SSI Commercial & Highway Construction Materials www.ssi.com
2. For estimating purposes, the R.L. Watson Silcote II Joint Sealing System was selected. However, should another supplier be chosen, it is the contractor's responsibility to ensure proper joint preparation, installation depths and widths, adhesive setting times, and any other variances between the specifications provided by the manufacturer. The contractor shall ensure that the contractor is properly schooled in installation of the joint material.
3. Joints shall be sealed at their design widths, dimension "A", which is defined as the actual width of the joint opening. This width does not account for the sealant. The sealant shall be applied to the joint opening. The sealant shall be used for design widths less than 2 inches. For design widths greater than or equal to 2 inches, the maximum design width of expansion material shall be required as determined by the contractor of structures. State Bridge Engineer. It is the contractor's responsibility to ensure that the size selected is appropriate for the width of the joint.

**\* CONCRETE REMOVAL BLOCKOUT NOTES**

Removal of the concrete blockout area shall be considered an absorbed item of work. The contractor shall be responsible for providing the contractor shall use a hammer no larger than 30 lbs to complete this work.

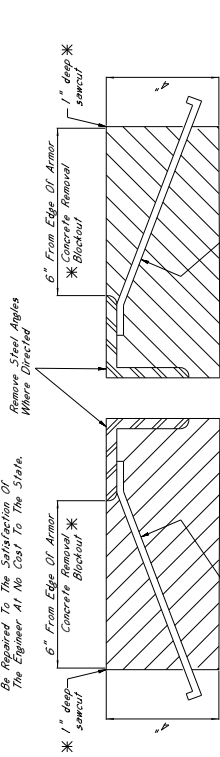

**TYPICAL SECTION AT EXISTING JOINT**

Showing Existing Existing Area, Sawcut, and Repair With Elastomeric Concrete

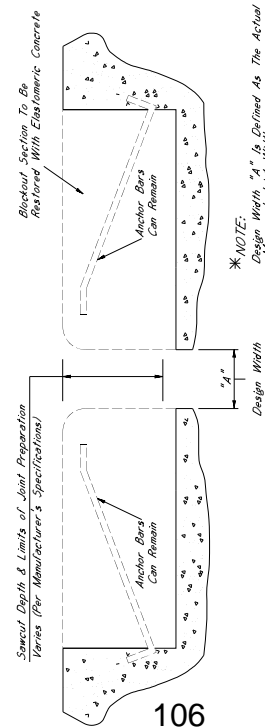

**\*NOTE:** Dimension "A" is defined as the actual measured joint width.

**TYPICAL SECTION AT JOINT AFTER REMOVAL OF EXISTING SEAL**

Showing Limits of Joint Preparation For Application of New Joint Seal Materials

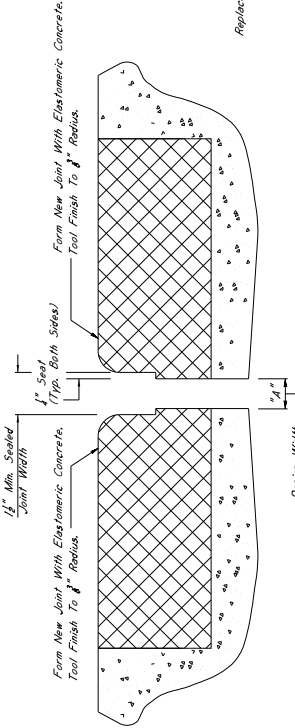

**TYPICAL SECTION AT SAWCUT & JOINT REPAIR**

Showing Area Where Repairs Are Made After Sawcut With Elastomeric Concrete

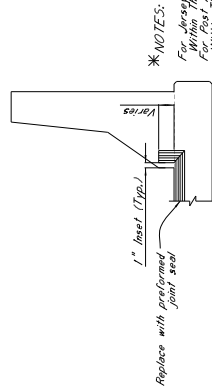

**\*NOTES:** For Jersey Sign Barrings, The Minimum Required Vertical Joint Seal Dimension Within The Span Barrings, The Minimum Required Vertical Joint Seal Dimension Within The Barrier is 6".

**\* 1" SAWCUT NOTES:**  
 All 1" Sawcuts Shall Be Considered An Absorbed Item of Work. The Contractor Shall Verify Depth of Reinforcing Steel, and Slicing Depth of Armor. The Depth of the Sawcut Shall Be No More Than 1/2" From Edge of Reinforcing Steel. Any Damage To Reinforcing Steel Shall Be Repaired To The Satisfaction Of The Engineer At No Cost To The State.

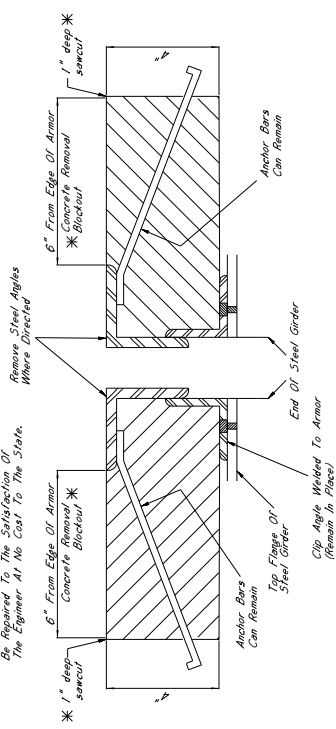

**TYPICAL SECTION AT EXISTING JOINT**  
 Showing Existing Existing Joint Seal To Be Removed And Replaced With Preformed Joint Seal

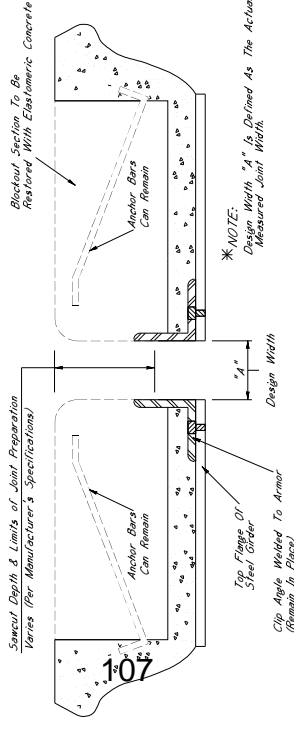

**TYPICAL SECTION AT JOINT AFTER REMOVAL OF EXISTING SEAL**  
 Showing Limits Of Joint Preparation For Application Of New Joint Seal Materials

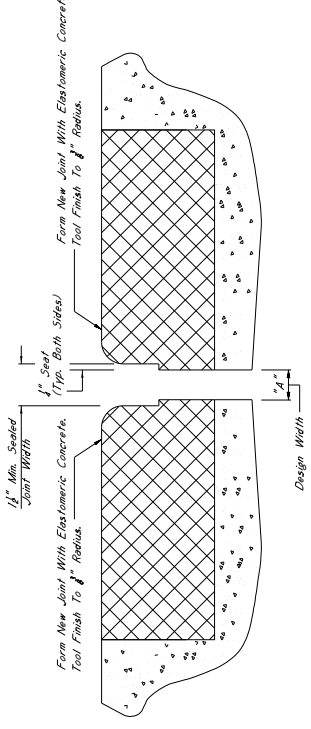

**TYPICAL SECTION AT SAWCUT & JOINT REPAIR**  
 Showing Area Where Repairs Are Made After Sawcut With Elastomeric Concrete

**\* CONCRETE REMOVAL BLOCKOUT NOTES**  
 Removal Of The Concrete Blockout Area Shall Be Considered An Absorbed Item Of Work Under Item 202-8169. The Contractor Shall Remove All Material To A Depth Of 30" To Complete This Work.

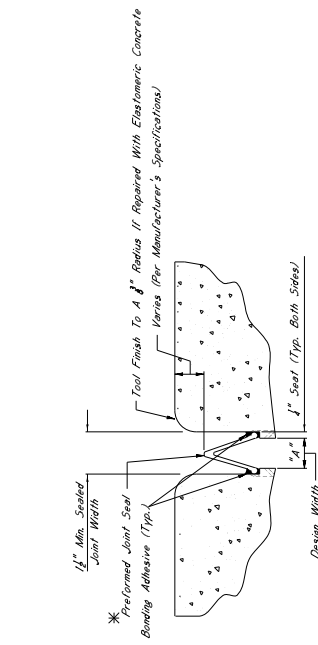

**TYPICAL SECTION AT SAWCUT & SEALED JOINT**  
 Showing Sealed Joint After Sawcut And Repair With Elastomeric Concrete

**\* NOTES:**

- The Preformed Joint Seal Shall Be One Of The Following, Installed According To The Manufacturer's Specifications:
  - Silicoflex Joint Sealing System Manufactured By R.J. Watson, Inc. In Allen, NY [www.rjwatson.com](http://www.rjwatson.com)
  - Wale SP3 Joint System Manufactured By Watson Bowman Acme Corporation In Amherst, NY [www.watsonb.com](http://www.watsonb.com)
  - Slipcrete SSS Silicone Slip Seal Manufactured By SSI Commercial & Highway Construction Materials [www.ssi.com](http://www.ssi.com)
- For Estimating Purposes, The R.J. Watson Silicone Joint Sealing System Was Selected. However, Should Another Supplier Be Chosen, It Is The Contractor's Responsibility To Ensure That The Manufacturer's Recommendations Are Followed. Any Other Variance Between The Specifications Provided By The Manufacturer, A Manufacturer Representative, Shall Be Present At The Time Joint Sealing Begins. Material Approved For Use Shall Be Properly Sealed In Installation Of The Joint.
- Joints Shall Be Sealed At Their Design Widths, Dimension "A", Which Is Defined As The Actual Width Of The Joint Opening. This Width Does Not Account For The Seal Required On Both Sides Of The Joint. Preformed Joint Seal, Type 1, Shall Be Installed On Both Sides Of The Joint. The Seal Shall Be Installed With The Seal Face For Design Widths Greater Than Or Equal To 2" With The Maximum Design Width Being 2 1/2". In Cases Where Design Widths Are Greater Than 2 1/2", Another Type Of Seal Shall Be Selected. The Contractor Shall Be Responsible For The Selection Of The Seal Material Selected Is Appropriate For The Width Of The Joint.

**\* NOTES:**

For Any Steps, Barings, The Minimum Required Vertical Joint Seal Dimension For Foot And Beam Barriers, The Minimum Required Vertical Joint Seal Dimension Within The Barrier Is 6".

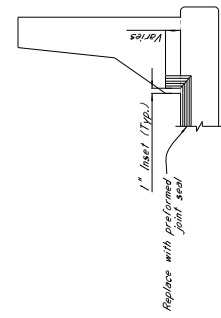

**ELEVATION AT END OF SPAN**

**NOTES ON ASSOCIATED ITEMS OF WORK:**

- 202-8169 REMOVAL OF EXISTING JOINT MATERIAL**  
 Description: Shall Include The Removal Of Material Associated With Armor, Slicing Bars, And Measure Expansion Joints, As Indicated On The Plans. The Contractor Shall Remove All Item Of Work. Other Joint Types, Shall Not Be Included Under This Item Of Work Unless Otherwise Directed By The Engineer.
- Basis Of Payment:** Removal of Armor And Slicing Bars Joint Material Will Be Paid For In Linear Feet At The Contract Unit Price Along The Length While The Bridge Deck On Each Side Of The Material Will Only Be Paid For As The Length Along The Centerline Of The Joint.
- 907-823-8001 SAW CUT, TYPE I & 907-823-8002 SAW CUT, TYPE II**  
 Description: The Saw Cut Depth Shall Be Equivalent To The Installation Depth Required By The Manufacturer's Specifications. The Saw Cut Type Shall Be The Same As The Preformed Joint Seal Selected.
- Basis Of Payment:** The Accepted Quantities Will Be Paid For In Linear Feet At The Contract Unit Price Along The Length Of The Bridge Deck On Each Side Of The Centerline Joint.
- 907-823-4001 PREFORMED JOINT SEAL, TYPE I**  
**907-823-4002 PREFORMED JOINT SEAL, TYPE II**  
 Description: Shall Include The Manufacturer's Required Joint Preparation Including Sandblasting Both Sides Of The Joint And Blowing The Joint Of Debris With Compressed Air And Placement Of The New Preformed Joint Seal
- Basis Of Payment:** The Accepted Quantities Will Be Paid For In Linear Feet At The Contract Unit Price Along The Length Of The Centerline Joint.

**ELASTOMERIC CONCRETE NOTES**

- 907-824-8007 BRIDGE REPAIR, ELASTOMERIC CONCRETE**  
 Description: Elastomeric Concrete Shall Be One Of The Following Products, Installed According To The Manufacturer's Specifications:
- Poly-Ton Elastomeric Concrete Manufactured By R.L. Watson, Inc. In Allen, NY [www.rjwatson.com](http://www.rjwatson.com)
  - WaleCrete II Manufactured By Watson Bowman Acme Corporation In Amherst, NY [www.watsonb.com](http://www.watsonb.com)
  - Delcrete Elastomeric Concrete Manufactured By The U.S. Brown Company In North Baltimore, OH [www.usbrown.com](http://www.usbrown.com)
- Basis Of Payment:** The Accepted Quantities Will Be Paid For In Cubic Yards At The Contract Unit Price.

**GENERAL NOTES:**

- Specifications, Manufacturer Standard Specifications For Road And Bridge Construction, 2017.
- No Change Of Plans Will Be Permitted Except By Written Approval Of The Director Of Structures, State Bridge Engineer. Any Change To The Specifications, Plans, Or Details, Shall Be Authorized By The Bridge Engineer Provided Such Changes Will Not Be Cause For Contract Price Adjustment. Work For Which No Pay Item Is Provided In The Proposal Will Be Considered An Absorbed Item of Work.



**\* 1" SAWCUT NOTES:**

All 1" sawcuts shall be considered in Absorbed Item 202-9169. The Contractor Shall Verify Depth Of Reinforcing Steel Before Making Any Sawcuts. The Depth Of The Sawcut Shall Be No More Than 1/2" From Edge Of Armor. Any Damage To Reinforcing Steel Shall Be Repaired To The Satisfaction Of The Engineer At No Cost To The State.

**\* CONCRETE REMOVAL BLOCKOUT NOTES**

All concrete removal blockouts shall be considered in Absorbed Item 202-9169. The Contractor Shall Use A Hammer No Larger Than 30 Lbs To Complete This Work.

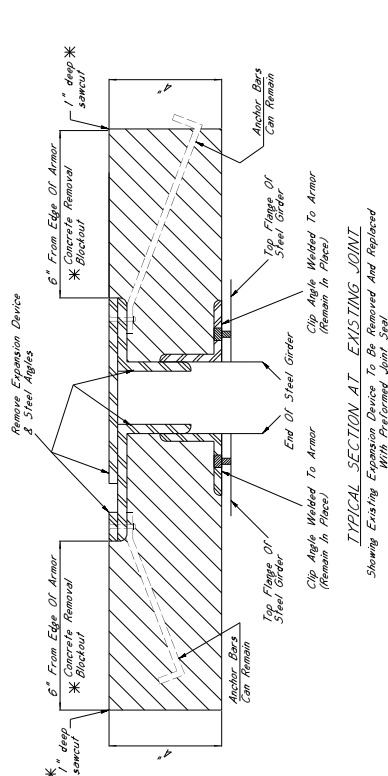

**TYPICAL SECTION AT EXISTING JOINT**

Showing Existing Expansion Device To Be Removed And Replaced With Preformed Joint Seal

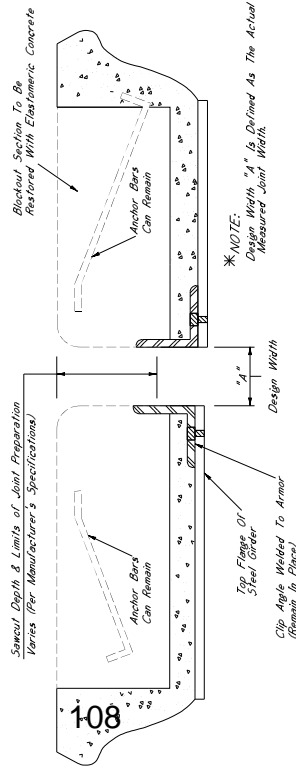

**TYPICAL SECTION AT JOINT AFTER REMOVAL OF EXISTING SEAL**

Showing Limits Of Joint Preparation For Application Of New Joint Seal Materials

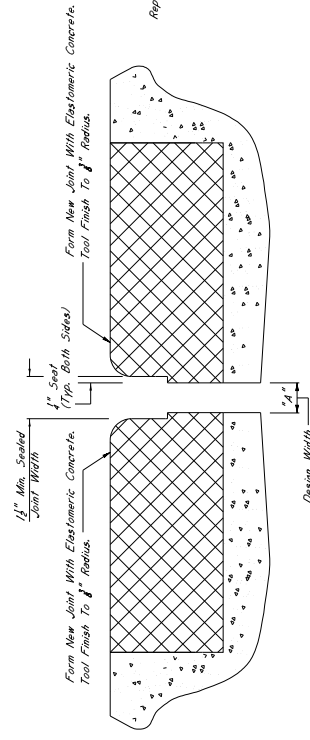

**TYPICAL SECTION AT SAWCUT & JOINT REPAIR**

Showing Area Where Repairs Are Made After Sawcut With Elastomeric Concrete

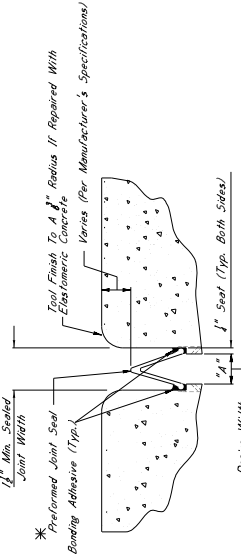

**TYPICAL SECTION AT SAWCUT & SEALED JOINT**

Showing Sealed Joint After Sawcut And Repair With Elastomeric Concrete

**\* NOTES:**

- The Preformed Joint Seal Shall Be One Of The Following, Installed According To The Manufacturer's Specifications:
  - Silicoflex Joint Sealing System Manufactured By R.J. Watson, Inc. In Alden, NY [www.rjwatson.com](http://www.rjwatson.com)
  - Weldo SPS Joint System Manufactured By Watson Bowman Acme Corporation In Amherst, NY [www.wbcorp.com](http://www.wbcorp.com)
  - Silgoc 555 Silsbom Strip Seal Manufactured By SSI Commercial & Highway Construction Materials [www.ssiinc.com](http://www.ssiinc.com)
- For Estimating Purposes, The R.J. Watson Silicoflex Joint Sealing System Was Used For Design Widths Less Than 2". Preformed Joint Seal Type 111 Shall Be Used For Joint Preparation, Installation, Depth, And Widths, Adhesive, Sealing Times, And Material Properties. The Manufacturer's Recommendations Are Followed. A Manufacturer Representative Shall Be Present At The Time Joint Sealing Begins To Ensure That The Contractor Is Properly Schooled In Installation Of The Joint Material.
- Joints Shall Be Sealed At Their Design Widths, Dimension "A", Which Is Defined As Seal Prepared On Both Sides Of The Joint. The Preformed Joint Seal Type 111 Shall Be Used For Design Widths Less Than 2". Preformed Joint Seal Type 111 Shall Be Used For Design Widths Greater Than 2". Design Widths Are Greater Than Design Widths. Expansion Material Shall Be Required As Directed By The Director Of Structures. Sealing Time Estimating For The Width Of The Joint.

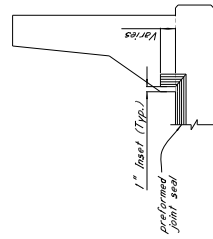

**ELEVATION AT END OF SPAN**

**\* NOTES:**

For Jersey Slope Barriers The Minimum Required Vertical Joint Seal Dimension For Post And Beam Barriers, The Minimum Required Vertical Joint Seal Dimension Within The Barrier Is 6".

**NOTES ON ASSOCIATED ITEMS OF WORK:**

**202-9169 REMOVAL OF EXISTING JOINT MATERIAL**

Shall Include The Removal Of Material Associated With Armor, Sliding Plate, And Neoprene Expansion Joints, As Designated In The Detail Drawings Provided. Removal Of Material From The Joint Shall Be Done In A Manner That Allows Other Joint Types Not To Be Damaged Under This Item Of Work Unless Otherwise Directed By The Engineer.

**Basis Of Payment:**

Removal Of Armor And Sliding Plate Joint Material Will Be Paid For In Linear Feet At The Contract Unit Price Along The Length Of The Bridge Deck On Each Side Of The Material To Be Removed. The Engineer Will Determine The Material To Be Removed. Payment For As The Length Along The Centerline Of The Joint.

**907-823-8001 SAW CUT, TYPE I & 907-823-8002 SAW CUT, TYPE II**

The Saw Cut Depth Shall Be Equivalent To The Installation Depth Required By The Manufacturer's Specifications. The Saw Cut Type Shall Be The Same As The Preformed Joint Seal Selected.

**Basis Of Payment:**

The Accepted Quantities Will Be Paid For In Linear Feet At The Contract Unit Price Along The Length Of The Bridge Deck On Each Side Of The Centerline Joint.

**907-823-4001 PREFORMED JOINT SEAL, TYPE I**

Shall Include The Manufacturer's Required Joint Preparation Including Sandblasting Both Sides Of The Joint And Blowing The Joint Free Of Debris With Compressed Air And Placement Of The New Preformed Joint Seal

**Basis Of Payment:**

The Accepted Quantities Will Be Paid For In Linear Feet At The Contract Unit Price Along The Length Of The Centerline Joint.

**ELASTOMERIC CONCRETE NOTES**

907-824-0007 BRIDGE REPAIR, ELASTOMERIC CONCRETE

Installed According To The Manufacturer's Specifications:

- Poly-Ton Elastomeric Concrete Manufactured By R.J. Watson, Inc. In Alden, NY [www.rjwatson.com](http://www.rjwatson.com)
- WeldoCrete II Manufactured By Watson Bowman Acme Corporation In Amherst, NY [www.wbcorp.com](http://www.wbcorp.com)
- Delcrete Elastomeric Concrete Manufactured By The D.S. Brown Company In North Ballwin, OH [www.dsbrown.com](http://www.dsbrown.com)

**Basis Of Payment:**

The Accepted Quantities Will Be Paid For In Cubic Yards At The Contract Unit Price.

**GENERAL NOTES:**

- Specifications: Mississippi Standard Specifications For Road And Bridge Construction, 2017 Edition, Section 202.01, And Chapter 202.02, As Amended Except By Written Approval Of The Director Of Structures, State Bridge Engineer.
- Minor Changes To Detail Of Design Or Construction Procedure May Be Authorized By The Bridge Engineer Provided Such Changes Do Not Affect The Safety Or Structural Integrity Of The Work For Which No Pay Item Is Provided In The Proposal Will Not Be Paid For Directly And Shall Therefore Be Considered An Absorbed Item Of Work.

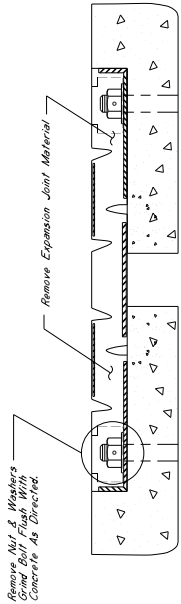

TYPICAL SECTION AT EXISTING JOINT  
Showing Existing Expansion Device To Be Removed and Replaced With Performed Joint Seal

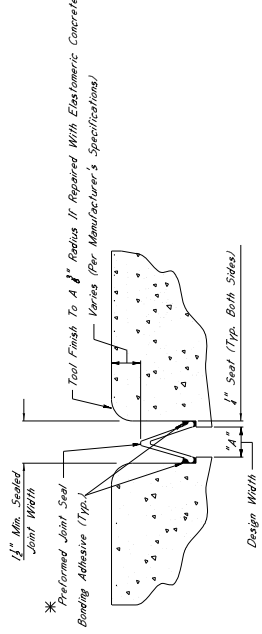

TYPICAL SECTION AT SAWCUT & SEALED JOINT  
Showing Sawcut Joint After Sawcut and Repair With Elastomeric Concrete

\*NOTES:

- The Performed Joint Seal Shall Be One Of The Following, Installed According To The Manufacturer's Specifications:
  - SilicoFlex Joint Sealing System Manufactured By R.J. Watson, Inc. In Aiken, NY [www.rjwatson.com](http://www.rjwatson.com)
  - Wells 355 Joint System Manufactured By Watson Bowman Acme Corporation In Amherst, NY [www.wbcorp.com](http://www.wbcorp.com)
  - Silgaps SSS Silicone Strip Seal Manufactured By SSI Commercial & Highway Construction Materials [www.ssi.com](http://www.ssi.com)
- For Estimating Purposes, The R.J. Watson SilicoFlex Joint Sealing System Was Selected. However, Should Another Supplier Be Chosen, It Is The Contractor's Responsibility To Obtain Approval From The Manufacturer For The Use Of Any Other Products Between The Specifications Provided By The Manufacturer, To Ensure That The Contractor Is Properly Schooled In Installation Of The Joint Material.
- Joints Shall Be Sealed At Their Design Widths, Dimension "A", Which Is Defined As The Actual Width Of The Joint Opening. This Width Does Not Account For The Joint Sealant. The Sealant Shall Be Applied To The Joint After The Concrete Has Been Placed. For Design Widths Greater Than Or Equal To 2" With The Maximum Design Width Of Expansion Material Shall Be Provided As Directed By The Director Of Structures, State Bridge Engineer. It Is The Contractor's Responsibility To Ensure That The Size Selected Is Appropriate For The Width Of The Joint.

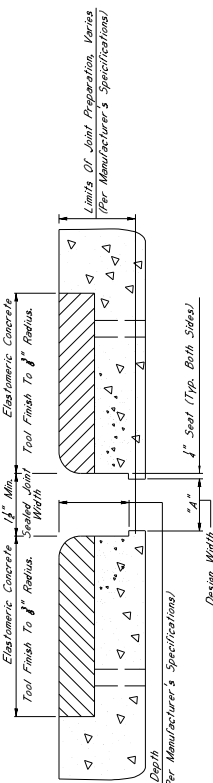

TYPICAL SECTION AT JOINT AFTER REMOVAL OF EXISTING SEAL  
Showing Limits Of Joint Preparation For Application Of New Joint Seal Materials

\*NOTE:  
Design Width "A" Is Defined As The Actual Measured Joint Width.

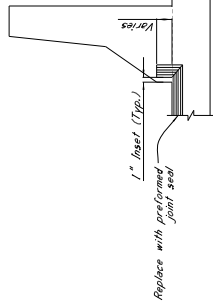

ELEVATION AT END OF SPAN

NOTES ON ASSOCIATED ITEMS OF WORK:

- 202-0169 REMOVAL OF EXISTING JOINT MATERIAL  
Description: Shall Include The Removal Of Material Associated With Armor, Sliding Plates, And Neoprene Expansion Joints, As Designated In The Detail Drawings Provided. Other Work Shall Be As Directed By The Engineer. The Removal Of Work Unless Otherwise Directed By The Engineer.  
Basis Of Payment: Removal Of Armor And Sliding Plates Joint Material Will Be Paid For In Linear Feet Along The Length Of The Bridge Deck On Each Side Of The Centerline Joint, While Removal Of Neoprene Joint Material Will Only Be Paid For As The Length Along The Centerline Of The Joint.
- 907-823-0001 SAW CUT, TYPE I & 907-823-0002 SAW CUT, TYPE II  
Description: The Saw Cut Depth Shall Be Equivalent To The Installation Depth Required By The Manufacturer Specifications. The Saw Cut Type Shall Be The Same As The Performed Joint Seal Selected.  
Basis Of Payment: The Accepted Quantities Will Be Paid For In Linear Feet At Each Side Of The Centerline Joint.
- 907-823-0001 PERFORMED JOINT SEAL, TYPE I  
907-823-0002 PERFORMED JOINT SEAL, TYPE II  
Description: Shall Include The Manufacturer's Required Joint Preparation The Joint Sealant Shall Be Applied To The Joint After The Concrete Is Free Of Debris With Compressed Air And Placement Of The New Performed Joint Seal  
Basis Of Payment: The Accepted Quantities Will Be Paid For In Linear Feet At Each Side Of The Centerline Joint.
- ELASTOMERIC CONCRETE REPAIR, ELASTOMERIC CONCRETE  
Description: Elastomeric Concrete Shall Be One Of The Following Products, Installed According To The Manufacturer's Specifications:  
A. Poly-Ton Elastomeric Concrete Manufactured By R.J. Watson, Inc. In Aiken, NY [www.rjwatson.com](http://www.rjwatson.com)  
B. WeloCrete II Manufactured By Watson Bowman Acme Corporation In Amherst, NY [www.wbcorp.com](http://www.wbcorp.com)  
C. Dycrite Elastomeric Concrete Manufactured By The D.S. Brown Company In North Baltimore, OH [www.dsbrown.com](http://www.dsbrown.com)  
Basis Of Payment: The Accepted Quantities Will Be Paid For In Cubic Yards At The Contract Unit Price.

GENERAL NOTES:

- Specifications: Mississippi Standard Specifications For Road And Bridge Construction, 2017.
- Approval: All Work Shall Be Approved In Advance By The Director Of Structures, State Bridge Engineer. Any Changes To Detail Of Design Or Construction Procedure May Be Authorized By The Bridge Engineer Provided Such Changes Do Not Affect The Safety Or Structural Integrity Of The Work. Work For Which No Particulars Are Provided In The Proposal Will Not Be Paid For Directly And Shall Therefore Be Considered An Assorted Item of Work.

**NOTES ON ASSOCIATED ITEMS OF WORK:**  
 907-824-PP008 BRIDGE REPAIR, ENDWALL REPAIR

**Description:** Shall include the Work Necessary To Remove And Replace The Damaged Concrete On The End Wall At The Damaged Section, The Specified Depth Of Endwall Shall Be Removed Along The Entire Width Of The Bridge Deck. The Associated Quantities Will Be Paid For In Linear Feet At The Contract Unit Price Along The Width Of The Bridge Deck.

**Damage Caused To Other Elements Of The Structure Or Roadway While Completing Work Of Work Shall Be Repaired By The Contractor At No Cost To The Department.**

**Prior To Placing New Concrete, All Concrete Surfaces That Will Be In Contact With The New Concrete Shall Be Painted With An Approved Epoxy Binder Designed To Bond New Concrete To Old.**

**New Concrete Shall Be High Early Strength Bridge Concrete, As Follows:**

The concrete mixture design shall be furnished by the Contractor for approval by the materials Division. Mixture design parameters are as follows:

**Required Strength:** 5000 psi  
**Maximum Slump:** 6 inches

Non-chloride based accelerator may be used if the ambient temperature is 50°F or less, but shall not be used if the ambient temperature is greater than 50°F. Synthetic structural fibers shall be used. The Contractor shall select a manufacturer from AADOT's Approved Products List, and the manufacturer's recommendations shall be followed for the dosage rate.

Curing is to be continuous until 2500 psi is attained. Traffic is to be diverted from the repair area until this value is reached. The Contractor may use the Ministry of Transportation 207 subject to the contractor's approval. However, final acceptance of the in-place concrete shall be determined using eight concrete test cylinders, which shall be cured in a container next to the concrete placement. Two cylinders are to be tested at 8, 16, and 24-hour intervals. The remaining cylinders shall be used to determine the 28-day compressive strength of the concrete.

The Removal Of Existing Expansion Material May Require Any Number Of The Pay Items Associated With The Removal Of Existing Expansion Material To Be Used On The Corresponding Joint Repair Detail Sheet For Additional Details On The Associated Items Of Work.

**GENERAL NOTES:**

1. No Change Of Plans Will Be Permitted Except By Writing. Approval Changes To Detail Of Design Construction May Be Authorized By The Bridge Engineer Provided Such Changes Will Not Be Cause For Contract Price Adjustment. Proposal Will Not Be Paid For Directly And Shall Therefore Be Considered An Absorbed Item Of Work.
2. And Bridge Construction 2017.
3. Approved By The Bridge Engineer. May Be Authorized By The Bridge Engineer Provided Such Changes Will Not Be Cause For Contract Price Adjustment. Proposal Will Not Be Paid For Directly And Shall Therefore Be Considered An Absorbed Item Of Work.

**REMOVAL OF EXISTING JOINT MATERIAL**  
 907-808-A002 JOINT REPAIR WITH EPOXY  
 907-823-B001 SAW CUT, TYPE I  
 907-823-A001 PREFORMED JOINT SEAL, TYPE I  
 907-823-A002 PREFORMED JOINT SEAL, TYPE II

**REMOVAL OF EXISTING JOINT MATERIAL**  
 907-808-A002 JOINT REPAIR WITH EPOXY  
 907-823-B001 SAW CUT, TYPE I  
 907-823-A001 PREFORMED JOINT SEAL, TYPE I  
 907-823-A002 PREFORMED JOINT SEAL, TYPE II

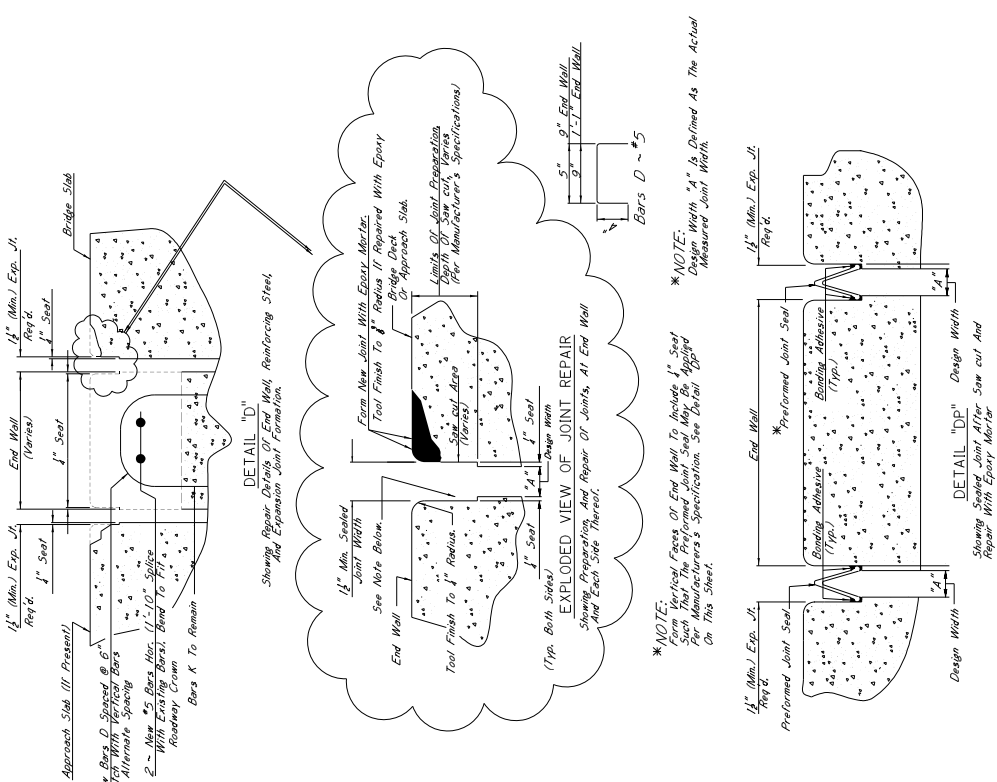

**\*NOTE:**  
 Vertical Faces Of End Wall To Be Sealed With Epoxy Adhesive For Manufacturer's Specification. See Detail Above On This Sheet.

**\*NOTE:**  
 Design Width 'A' Is Defined As The Actual Measured Joint Width.

**\*NOTE:**  
 Vertical Faces Of End Wall To Be Sealed With Epoxy Adhesive For Manufacturer's Specification. See Detail Above On This Sheet.

**\*NOTE:**  
 Design Width 'A' Is Defined As The Actual Measured Joint Width.

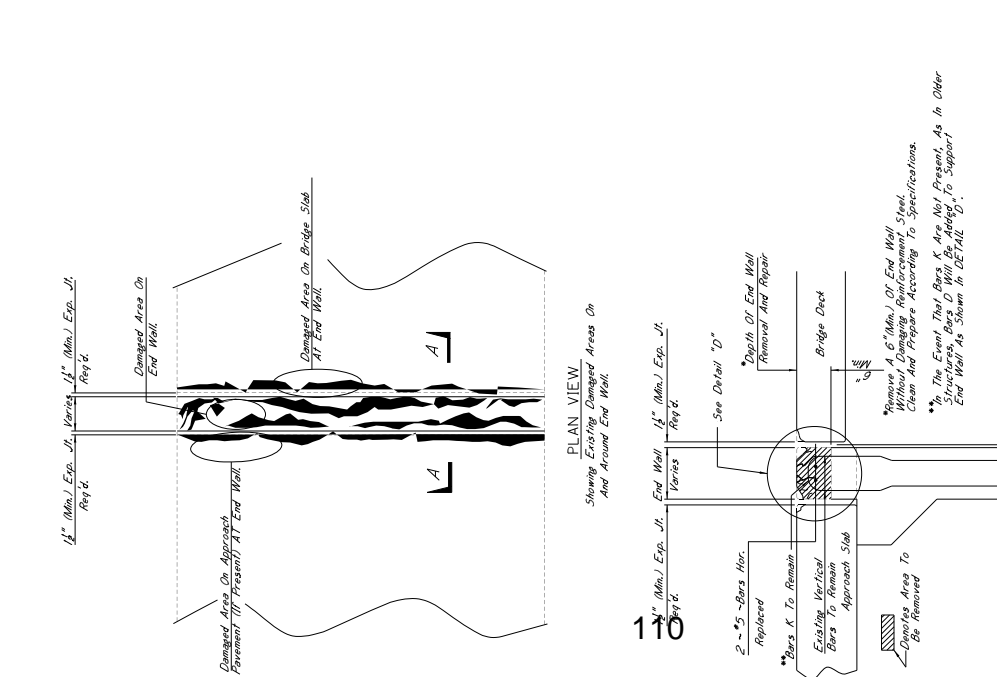

**\*NOTES:**

1. The Preformed Joint Seal Shall Be One Of The Following, Installed According To The Manufacturer's Specifications:  
 A. Silcaflex Joint Sealing System  
 B. Wicks SSS Joint Sealer  
 C. Silogac SSS Silicone Strip Seal  
 www.silcaflex.com  
 www.wicks.com  
 www.ssilcom.com
2. For Estimating Purposes, The RJ Wilson Silcaflex Joint Sealing System Was Used For Joint Preparation, Installation Details, And Widths. Adhesive Sealing Times, And A Manufacturer Representative Shall Be Present At The Time Joint Sealing Begins To Ensure That The Contractor Is Properly Trained In Installation Of The Joint Material.
3. Joints Shall Be Sealed At Their Design Widths, Dimension 'A', Which Is Defined As Seal Provided On Both Sides Of The Preformed Joint Seal. Type I Seal Shall Be Used For Design Widths Less Than 2". Preformed Joint Seal, Type II Seal, Shall Be Used For Design Widths Greater Than 2". To Ensure The Design Width Of The Joint Is Maintained, The Contractor Shall Be Responsible For Ensuring The Design Width Of Expansion Material Shall Be Maintained As Directed By The Contractor. Structures, Bars D Will Be Adequately Supported.

**\*NOTES:**

1. The Preformed Joint Seal Shall Be One Of The Following, Installed According To The Manufacturer's Specifications:  
 A. Silcaflex Joint Sealing System  
 B. Wicks SSS Joint Sealer  
 C. Silogac SSS Silicone Strip Seal  
 www.silcaflex.com  
 www.wicks.com  
 www.ssilcom.com
2. For Estimating Purposes, The RJ Wilson Silcaflex Joint Sealing System Was Used For Joint Preparation, Installation Details, And Widths. Adhesive Sealing Times, And A Manufacturer Representative Shall Be Present At The Time Joint Sealing Begins To Ensure That The Contractor Is Properly Trained In Installation Of The Joint Material.
3. Joints Shall Be Sealed At Their Design Widths, Dimension 'A', Which Is Defined As Seal Provided On Both Sides Of The Preformed Joint Seal. Type I Seal Shall Be Used For Design Widths Less Than 2". Preformed Joint Seal, Type II Seal, Shall Be Used For Design Widths Greater Than 2". To Ensure The Design Width Of The Joint Is Maintained, The Contractor Shall Be Responsible For Ensuring The Design Width Of Expansion Material Shall Be Maintained As Directed By The Contractor. Structures, Bars D Will Be Adequately Supported.

# SECTION 905 - PROPOSAL

Date \_\_\_\_\_

Mississippi Transportation Commission  
Jackson, Mississippi

Sirs: The following proposal is made on behalf of \_\_\_\_\_  
\_\_\_\_\_ of \_\_\_\_\_

for constructing the following designated project(s) within the time(s) hereinafter specified.

The plans are composed of drawings and blue prints on file in the offices of the Mississippi Department of Transportation, Jackson, Mississippi.

The Specifications are the current Standard Specifications of the Mississippi Department of Transportation approved by the Federal Highway Administration, except where superseded or amended by the plans, Special Provisions and Notice(s) to Bidders attached hereto and made a part thereof.

I (We) certify that I (we) possess a copy of said Standard and any Supplemental Specifications.

Evidence of my (our) authority to submit the Proposal is hereby furnished. The proposal is made without collusion on the part of any person, firm or corporation. I (We) certify that I (we) have carefully examined the Plans, the Specifications, including the Special Provisions and Notice(s) to Bidders, herein, and have personally examined the site of the work. On the basis of the Specifications, Special Provisions, Notice(s) to Bidders, and Plans, I (we) propose to furnish all necessary machinery, tools, apparatus and other means of construction and do all the work and furnish all the materials in the manner specified. I (We) understand that the quantities mentioned herein are approximate only and are subject to either increase or decrease, and hereby propose to perform any increased or decreased quantities of work at the unit prices bid, in accordance with the above.

I (We) acknowledge that this proposal will be found irregular and/or non-responsive unless a certified check, cashier's check, or Proposal Guaranty Bond in the amount as required in the Advertisement (or, by law) is submitted electronically with the proposal or is delivered to the Contract Administration Engineer prior to the bid opening time specified in the advertisement.

**INSTRUCTION TO BIDDERS: Alternate and Optional Items on Bid Schedule.**

1. Two or more items entered opposite a single unit quantity WITHOUT DEFINITE DESIGNATION AS "ALTERNATE ITEMS" are considered as "OPTIONAL ITEMS". Bidders may or may not indicate on bids the Optional Item proposed to be furnished or performed WITHOUT PREJUDICE IN REGARD TO IRREGULARITY OF BIDS.
2. Items classified on the bid schedule as "ALTERNATE ITEMS" and/or "ALTERNATE TYPES OF CONSTRUCTION" must be preselected and indicated on bids. However, "Alternate Types of Construction" may include Optional Items to be treated as set out in Paragraph 1, above.
3. Optional items not preselected and indicated on the bid schedule MUST be designated in accordance with Subsection 102.06 prior to or at the time of execution of the contract.
4. Optional and Alternate items designated must be used throughout the project.

I (We) further propose to perform all "force account or extra work" that may be required of me (us) on the basis provided in the Specifications and to give such work my (our) personal attention in order to see that it is economically performed.

I (We) further propose to execute the attached contract agreement (Section 902) as soon as the work is awarded to me (us), and to begin and complete the work within the time limit(s) provided for in the Specifications and Advertisement. I (We) also propose to execute the attached contract bond (Section 903) in an amount not less than one hundred (100) percent of the total of my (our) part, but also to guarantee the excellence of both workmanship and materials until the work is finally accepted.

I (We) shall submit electronically with our proposal or deliver prior to the bid opening time a certified check, cashier's check or bid bond for **five percent (5%) of total bid** and hereby agree that in case of my (our) failure to execute the contract and furnish bond within Ten (10) days after notice of award, the amount of this check (bid bond) will be forfeited to the State of Mississippi as liquidated damages arising out of my (our) failure to execute the contract as proposed. It is understood that in case I am (we are) not awarded the work, the check will be returned as provided in the Specifications.

**SECTION 905 -- PROPOSAL (CONTINUED)**

I (We) hereby certify by digital signature and electronic submission via Bid Express of the Section 905 proposal below, that all certifications, disclosures and affidavits incorporated herein are deemed to be duly executed in the aggregate, fully enforceable and binding upon delivery of the bid proposal. I (We) further acknowledge that this certification shall not extend to the bid bond or alternate security which must be separately executed for the benefit of the Commission. This signature does not cure deficiencies in any required certifications, disclosures and/or affidavits. I (We) also acknowledge the right of the Commission to require full and final execution on any certification, disclosure or affidavit contained in the proposal at the Commission's election upon award. Failure to so execute at the Commission's request within the time allowed in the Standard Specifications for execution of all contract documents will result in forfeiture of the bid bond or alternate security.

Respectfully Submitted,

DATE \_\_\_\_\_

\_\_\_\_\_  
Contractor

BY \_\_\_\_\_  
Signature

TITLE \_\_\_\_\_

ADDRESS \_\_\_\_\_

CITY, STATE, ZIP \_\_\_\_\_

PHONE \_\_\_\_\_

FAX \_\_\_\_\_

E-MAIL \_\_\_\_\_

(To be filled in if a corporation)

Our corporation is chartered under the Laws of the State of \_\_\_\_\_ and the names, titles and business addresses of the executives are as follows:

\_\_\_\_\_  
President Address

\_\_\_\_\_  
Secretary Address

\_\_\_\_\_  
Treasurer Address

The following is my (our) itemized proposal.

Bridge Joint Repair on various routes throughout Holmes & Yazoo Counties, known as Federal Aid Project Nos. STP-9999-03(018) / 107913301 & STP-9999-03(018) / 107913302 in Holmes & Yazoo Counties.

Line no.	Item Code	Adj Code	Quantity	Units	Description[Fixed Unit Price]
<b>Roadway Items</b>					
0010	618-A001		1	Lump Sum	Maintenance of Traffic
0020	618-B001		2	Square Feet	Additional Construction Signs (\$10.00)
0030	620-A001		1	Lump Sum	Mobilization
<b>Bridge Items</b>					
0040	907-808-A002	(S)	18,792	Linear Feet	Joint Repair Without Epoxy
0050	907-823-A001		3,351	Linear Feet	Preformed Joint Seal, Type I
0060	907-823-A002		6,045	Linear Feet	Preformed Joint Seal, Type II
0070	907-823-B001		6,702	Linear Feet	Saw Cut, Type I
0080	907-823-B002		12,090	Linear Feet	Saw Cut, Type II

SECTION 905 - COMBINATION BID PROPOSAL (Continued)

**CONDITIONS FOR COMBINATION BID**

If a bidder elects to submit a combined bid for two or more of the contracts listed for this month's letting, the bidder must complete and execute these sheets of the proposal in each of the individual proposals to constitute a combination bid. In addition to this requirement, each individual contract shall be completed, executed and submitted in the usual specified manner.

Failure to execute this Combination Bid Proposal in each of the contracts combined will be just cause for each proposal to be received and evaluated as a separate bid.

It is understood that the Mississippi Transportation Commission not only reserves the right to reject any and all proposals, but also the right to award contracts upon the basis of lowest separate bids or combination bids most advantageous to the State.

It is further understood and agreed that the Combination Bid Proposal is for comparison of bids only and that each contract shall operate in every respect as a separate contract in accordance with its proposal and contract documents.

I (We) agree to complete each contract on or before its specified completion date.

\*\*\*\*\*

**COMBINATION BID PROPOSAL**

This proposal is tendered as one part of a Combination Bid Proposal utilizing option \_\_\_\* of Subsection 102.11 on the following contracts:

\* Option to be shown as either (a), (b), or (c).

	<u>Project No.</u>	<u>County</u>	<u>Project No.</u>	<u>County</u>
1.	_____	_____	6.	_____
2.	_____	_____	7.	_____
3.	_____	_____	8.	_____
4.	_____	_____	9.	_____
5.	_____	_____	10.	_____

(a) If Combination A has been selected, your Combination Bid is complete.

(b) If Combination B has been selected, then complete the following page.

SECTION 905 - COMBINATION BID PROPOSAL (Continued)

Project Number	Pay Item Number	Unit	Unit Price Reduction	Total Item Reduction	Total Contract Reduction
1.					
2.					
3.					
4.					
5.					
6.					
7.					
8.					

For Informational Purposes Only



SECTION 905 - COMBINATION BID PROPOSAL (Continued)

Project Number	Pay Item Number	Unit	Unit Price Reduction	Total Item Reduction	Total Contract Reduction
9.					
10.					

(c) If Combination C has been selected, then initial and complete ONE of the following.

\_\_\_\_\_ I (We) desire to be awarded work not to exceed a total monetary value of \$ \_\_\_\_\_.

\_\_\_\_\_ I (We) desire to be awarded work not to exceed \_\_\_\_\_ number of contracts.



**Certification with regard to the Performance of Previous  
Contracts or Subcontracts subject to the Equal Opportunity  
Clause and the filing of Required Reports**

The Bidder hereby certifies that he has \_\_\_\_\_, has not \_\_\_\_\_, participated in a previous contract or subcontract subject to the Equal Opportunity Clause, as required by Executive Orders 10925, 11114, or 11246, and that he has \_\_\_\_\_, has not \_\_\_\_\_, filed with the Joint Reporting Committee, the Director of the Office of Federal Contract Compliance, a Federal Government contracting or administering agency, or the former President's Committee on Equal Employment Opportunity, all reports due under the applicable filing requirements.

\_\_\_\_\_  
(COMPANY)

DATE: \_\_\_\_\_

NOTE: The above certification is required by the Equal Employment Opportunity Regulations of the Secretary of Labor (41 CFR 60-1.7 (b) (1)), and must be submitted by bidders and proposed subcontractors only in connection with contracts and subcontracts which are subject to the Equal Opportunity Clause. Contracts and Subcontracts which are exempt from the Equal Opportunity Clause are set forth in 41 CFR 60-1.5. (Generally only contracts or subcontracts of \$10,000 or under are exempt.)

Currently, Standard Form 100 (EEO-1) is the only report required by the Executive Orders or their implementing regulations.

Proposed prime Contractors and Subcontractors who have participated in a previous contract or subcontract subject to the Executive orders and have not filed the required reports should note that 41 CFR 60-1.7 (b) (1) prevents the award of contracts and subcontracts unless such Contractors submit a report covering the delinquent period or such other period specified by the Federal Highway Administration or by the Director, Office of Federal Contract Compliance, U. S. Department of Labor.

**MISSISSIPPI DEPARTMENT OF TRANSPORTATION**  
**CERTIFICATION**

I, \_\_\_\_\_,  
(Name of person signing bid)

individually, and in my capacity as \_\_\_\_\_ of  
(Title of person signing bid)

\_\_\_\_\_ do hereby certify under  
(Name of Firm, partnership, or Corporation)

penalty of perjury under the laws of the United States and the State of Mississippi that \_\_\_\_\_

\_\_\_\_\_, Bidder  
(Name of Firm, Partnership, or Corporation)

on Project No. **STP-9999-03(018)/ 107913301000 & STP-9999-03(018)/ 107913302000**

in **Holmes & Yazoo** County(ies), Mississippi, has not either

directly or indirectly entered into any agreement, participated in any collusion; or otherwise taken any action in restraint of free competitive bidding in connection with this contract; nor have any of its corporate officers or principal owners.

Except as noted hereafter, it is further certified that said legal entity and its corporate officers, principal owners, managers, auditors and others in a position of administering federal funds:

- a) Are not presently debarred, suspended, proposed for debarment, declared ineligible, or voluntarily excluded from covered transactions by any Federal department or agency;
- b) Have not within a three-year period preceding this proposal been convicted of or had a civil judgment rendered against them for commission of fraud or a criminal offense in connection with obtaining, attempting to obtain, or performing a public (Federal, State or local) transaction or contract under a public transaction; violation of Federal or State antitrust statutes or commission of embezzlement, theft, forgery, bribery, falsification or destruction of records, making false statements, or receiving stolen property;
- c) Are not presently indicted for or otherwise criminally or civilly charged by a governmental entity (Federal, State or local) with commission of any of the offenses enumerated in (b) above; and
- d) Have not within a three-year period preceding this application/ proposal had one or more public transactions (Federal, State or local) terminated for cause or default.

Do exceptions exist and are made a part thereof? Yes / No

Any exceptions shall address to whom it applies, initiating agency and dates of such action.

Note: Exceptions will not necessarily result in denial of award but will be considered in determining bidder responsibility. Providing false information may result in criminal prosecution or administrative sanctions.

The bidder further certifies that the certification requirements contained in Section XI of Form FHWA 1273, will be or have been included in all subcontracts, material supply agreements, purchase orders, etc. except those procurement contracts for goods or services that are expected to be less than the Federal procurement small purchase threshold fixed at 10 U.S.C. 2304(g) and 41 U.S.C. 253(g) (currently \$25,000) which are excluded from the certification requirements.

The bidder further certifies, to the best of his or her knowledge and belief, that:

1) No Federal appropriated funds have been paid or will be paid to any person for influencing or attempting to influence an officer or employee of any Federal agency, a Member of Congress, an officer or employee of Congress, or an employee of a Member of Congress in connection with the awarding of any Federal contract, the making of any Federal grant, the making of any Federal loan, the entering into of any cooperative agreement, and the extension, continuation, renewal, amendment, or modification of any Federal contract, grant, loan, or cooperative agreement.

2) If any funds other than Federal appropriated funds have been paid or will be paid to any person for influencing or attempting to influence an officer or employee of any Federal agency, a Member of Congress, an officer or employee of Congress, or an employee of a Member of Congress in connection with this contract, Standard Form-LLL, Disclosure Form to Report Lobbying, in accordance with its instructions will be completed and submitted.

The certification contained in (1) and (2) above is a material representation of fact upon which reliance is placed and a prerequisite imposed by Section 1352, Title 31, U.S. Code prior to entering into this contract. Failure to comply shall be subject to a civil penalty of not less than \$10,000 and not more than \$100,000. The bidder shall include the language of the certification in all subcontracts exceeding \$100,000 and all subcontractors shall certify and disclose accordingly.

All of the foregoing is true and correct.

Executed on \_\_\_\_\_

\_\_\_\_\_  
Signature

**MISSISSIPPI DEPARTMENT OF TRANSPORTATION**

SAM.GOV Registration and DUNS Number

Bidders are advised that the Prime Contractor must maintain current registration in the **System for Award Management** (<http://www.sam.gov>) at all times during the project. A Dun and Bradstreet Data Universal Numbering System (DUNS) Number (<http://www.dnb.com>) is one of the requirements for registration in the System for Award Management.

Bidders are advised that prior to the award of this contract, they **MUST** be registered in the System for Award Management.

I (We) acknowledge that this contract cannot be awarded if I (We) are not registered in the System for Award Management prior to the award of this contract. \_\_\_\_\_ (Yes / No)

I (We) have a DUNS Number . \_\_\_\_\_ (Yes / No)

DUNS Number: \_\_\_\_\_

Company Name: \_\_\_\_\_

Company e-mail address: \_\_\_\_\_

(6/2015F)

For Informational Purposes Only

SECTION 902

CONTRACT FOR STP-9999-03(018)/ 107913301000 & STP-9999-03(018)/ 107913302000

LOCATED IN THE COUNTY(IES) OF Holmes & Yazoo

STATE OF MISSISSIPPI,  
COUNTY OF HINDS

This contract entered into by and between the Mississippi Transportation Commission on one hand, and the undersigned contractor, on the other witnesseth;

That, in consideration of the payment by the Mississippi Transportation Commission of the prices set out in the proposal hereto attached, to the undersigned contractor, such payment to be made in the manner and at the time of times specified in the specifications and the special provisions, if any, the undersigned contractor hereby agrees to accept the prices stated in the proposal in full compensation for the furnishing of all materials and equipment and the executing of all the work contemplated in this contract.

It is understood and agreed that the advertising according to law, the Advertisement, the instructions to bidders, the proposal for the contract, the specifications, the revisions of the specifications, the special provisions, and also the plans for the work herein contemplated, said plans showing more particularly the details of the work to be done, shall be held to be, and are hereby made a part of this contract by specific reference thereto and with like effect as if each and all of said instruments had been set out fully herein in words and figures.

It is further agreed that for the same consideration the undersigned contractor shall be responsible for all loss or damage arising out of the nature of the work aforesaid; or from the action of the elements and unforeseen obstructions or difficulties which may be encountered in the prosecution of the same and for all risks of every description connected with the work, exceptions being those specifically set out in the contract; and for faithfully completing the whole work in good and workmanlike manner according to the approved Plans, Specifications, Special Provisions, Notice(s) to Bidders and requirements of the Mississippi Department of Transportation.

It is further agreed that the work shall be done under the direct supervision and to the complete satisfaction of the Executive Director of the Mississippi Department of Transportation, or his authorized representatives, and when Federal Funds are involved subject to inspection at all times and approval by the Federal Highway Administration, or its agents as the case may be, or the agents of any other Agency whose funds are involved in accordance with those Acts of the Legislature of the State of Mississippi approved by the Governor and such rules and regulations issued pursuant thereto by the Mississippi Transportation Commission and the authorized Federal Agencies.

The Contractor agrees that all labor as outlined in the Special Provisions may be secured from list furnished by

It is agreed and understood that each and every provision of law and clause required by law to be inserted in this contract shall be deemed to be inserted herein and this contract shall be read and enforced as though it were included herein, and, if through mere mistake or otherwise any such provision is not inserted, then upon the application of either party hereto, the contract shall forthwith be physically amended to make such insertion.

The Contractor agrees that he has read each and every clause of this Contract, and fully understands the meaning of same and that he will comply with all the terms, covenants and agreements therein set forth.

Witness our signatures this the \_\_\_ day of \_\_\_\_\_, \_\_\_\_\_.

\_\_\_\_\_  
Contractor(s)

By \_\_\_\_\_

MISSISSIPPI TRANSPORTATION COMMISSION

Title \_\_\_\_\_

By \_\_\_\_\_

Signed and sealed in the presence of:  
(names and addresses of witnesses)

Executive Director

\_\_\_\_\_

Secretary to the Commission

Award authorized by the Mississippi Transportation Commission in session on the \_\_\_ day of \_\_\_\_\_, \_\_\_\_\_, Minute Book No. \_\_\_\_\_, Page No. \_\_\_\_\_.

Revised 8/06/2003

**SECTION 903**  
**PERFORMANCE AND PAYMENT BOND**

CONTRACT BOND FOR: STP-9999-03(018)/ 107913301000 & STP-9999-03(018)/ 107913302000

LOCATED IN THE COUNTY(IES) OF: Holmes & Yazoo

STATE OF MISSISSIPPI,  
COUNTY OF HINDS

Know all men by these presents: that we, \_\_\_\_\_  
\_\_\_\_\_  
(Contractor)

Principal, a \_\_\_\_\_

residing at \_\_\_\_\_ in the State of \_\_\_\_\_

and \_\_\_\_\_

(Surety)  
residing at \_\_\_\_\_ in the State of \_\_\_\_\_,

authorized to do business in the State of Mississippi, under the laws thereof, as surety, effective as of the contract date

shown below, are held and firmly bound unto the State of Mississippi in the sum of \_\_\_\_\_

\_\_\_\_\_ Dollars, lawful money of the United States of America, to be paid to it for which payment well and truly to be made, we bind ourselves, our heirs, administrators, successors, or assigns jointly and severally by these presents.

The conditions of this bond are such, that whereas the said \_\_\_\_\_

principal, has (have) entered into a contract with the Mississippi Transportation Commission, bearing the date of

\_\_\_\_\_ day of \_\_\_\_\_ A.D. \_\_\_\_\_ hereto annexed, for the construction of certain projects(s) in

the State of Mississippi as mentioned in said contract in accordance with the Contract Documents therefor, on file in the

offices of the Mississippi Department of Transportation, Jackson, Mississippi.

Now therefore, if the above bounden \_\_\_\_\_

in all things shall stand to and abide by and well and truly observe, do keep and perform all and singular the terms, covenants, conditions, guarantees and agreements in said contract, contained on his (their) part to be observed, done, kept and performed and each of them, at the time and in the manner and form and furnish all of the material and equipment specified in said contract in strict accordance with the terms of said contract which said plans, specifications and special provisions are included in and form a part of said contract and shall maintain the said work contemplated until its final completion and acceptance as specified in Subsection 109.11 of the approved specifications, and save harmless said Mississippi Transportation Commission from any loss or damage arising out of or occasioned by the negligence, wrongful or criminal act, overcharge, fraud, or any other loss or damage whatsoever, on the part of said principal (s), his (their) agents, servants, or employees in the performance of said work or in any manner connected therewith, and shall be liable and responsible in a civil action instituted by the State at the instance of the Mississippi Transportation Commission or any officer of the State authorized in such cases, for double any amount in money or property, the State may lose or be overcharged or otherwise defrauded of, by reason of wrongful or criminal act, if any, of the Contractor(s), his (their) agents or employees, and shall promptly pay the said agents, servants and employees and all persons furnishing labor, material, equipment or supplies therefor, including premiums incurred, for Surety Bonds, Liability Insurance, and Workmen's Compensation Insurance; with the additional obligation that such Contractor shall promptly make payment of all taxes, licenses, assessments, contributions, damages,

any liquidated damages which may arise prior to any termination of said principal's contract, any liquidated damages which may arise after termination of the said principal's contract due to default on the part of said principal, penalties and interest thereon, when and as the same may be due this state, or any county, municipality, board, department, commission or political subdivision: in the course of the performance of said work and in accordance with Sections 31-5-51 et seq. Mississippi Code of 1972, and other State statutes applicable thereto, and shall carry out to the letter and to the satisfaction of the Executive Director of the Mississippi Department of Transportation, all, each and every one of the stipulations, obligations, conditions, covenants and agreements and terms of said contract in accordance with the terms thereof and all of the expense and cost and attorney's fee that may be incurred in the enforcement of the performance of said contract, or in the enforcement of the conditions and obligations of this bond, then this obligation shall be null and void, otherwise to be and remain in full force and virtue.

_____	_____
(Contractors) Principal	Surety
By _____	By _____
	(Signature) Attorney in Fact
	Address _____
	_____
Title _____	_____
(Contractor's Seal)	(Printed) MS Agent
	_____
	(Signature) MS Agent
	Address _____
	_____
	_____
	(Surety Seal)
	_____
	Mississippi Insurance ID Number





# BID BOND

KNOW ALL MEN BY THESE PRESENTS, that we \_\_\_\_\_  
Contractor

\_\_\_\_\_  
Address

\_\_\_\_\_  
City, State ZIP

As principal, hereinafter called the Principal, and \_\_\_\_\_  
Surety

a corporation duly organized under the laws of the state of \_\_\_\_\_

as Surety, hereinafter called the Surety, are held and firmly bound unto State of Mississippi, Jackson, Mississippi

As Obligee, hereinafter called Obligee, in the sum of **Five Per Cent (5%) of Amount Bid**

Dollars(\$ \_\_\_\_\_ )

for the payment of which sum will and truly to be made, the said Principal and said Surety, bind ourselves, our heirs, executors, administrators, successors and assigns, jointly and severally, firmly by these presents.

WHEREAS, the Principal has submitted a bid for **Bridge Joint Repair on various routes throughout Holmes & Yazoo Counties, known as Federal Aid Project Nos. STP-9999-03(018) / 107913301 & STP-9999-03(018) / 107913302 in Holmes & Yazoo Counties.**

NOW THEREFORE, the condition of this obligation is such that if the aforesaid Principal shall be awarded the contract, the said Principal will, within the time required, enter into a formal contract and give a good and sufficient bond to secure the performance of the terms and conditions of the contract, then this obligation to be void; otherwise the Principal and Surety will pay unto the Obligee the difference in money between the amount of the bid of the said Principal and the amount for which the Obligee legally contracts with another party to perform the work if the latter amount be in excess of the former, but in no event shall liability hereunder exceed the penal sum hereof.

Signed and sealed this \_\_\_\_\_ day of \_\_\_\_\_, 20\_\_

\_\_\_\_\_  
(Witness)

\_\_\_\_\_  
(Principal) (Seal)

By: \_\_\_\_\_  
(Name) (Title)

\_\_\_\_\_  
(Witness)

\_\_\_\_\_  
(Surety) (Seal)

By: \_\_\_\_\_  
(Attorney-in-Fact)

\_\_\_\_\_  
(MS Agent)

\_\_\_\_\_  
Mississippi Insurance ID Number



