

MDOT Use Only

Checked \_\_\_\_\_

Loaded \_\_\_\_\_

Keyed \_\_\_\_\_

25 -



SM No. CMP5468610131

# PROPOSAL AND CONTRACT DOCUMENTS

## FOR THE CONSTRUCTION OF

25

Mill & Overlay approximately 11 miles of SR 468 from Deeb St. to US 80 in Brandon & approximately 0.4 miles of US 80 from SR 468 to Louis Wilson Rd., known as State Project No. MP-5468-61(013) / 306931301 in Rankin County.

Project Completion: 137 Working Days

**(STATE DELEGATED)**

### NOTICE

**BIDDERS MUST COMPLETE AN ONLINE REQUEST  
FOR PERMISSION TO BID THIS PROJECT.**

Electronic addendum updates will be posted on [www.gomdot.com](http://www.gomdot.com)

**SECTION 900  
OF THE CURRENT  
2017 STANDARD SPECIFICATIONS  
FOR ROAD AND BRIDGE CONSTRUCTION  
JACKSON, MISSISSIPPI**

**MISSISSIPPI DEPARTMENT OF TRANSPORTATION  
TABLE OF CONTENTS**

**PROJECT: MP-5468-61(013)/306931301 - Rankin**

Section 901 - Advertisement

Section 904 - Notice to Bidders

#1	Governing Specification, w/ Supplement
#3	Final Cleanup
#9	Federal Bridge Formula
#13	Safety Edge
#113	Tack Coat
#296	Reduced Speed Limit Signs
#445	Mississippi Agent or Qualified Nonresident Agent
#516	Errata and Modifications to the 2017 Standard Specifications
#1225	Early Notice to Proceed
#1226	Material Storage Under Bridges
#1241	Fuel and Material Adjustments
#1963	Guardrail Pads
#2206	MASH Compliant Devices
#2273	Mississippi Special Fuel Tax Law
#2278	Smoothness Tolerances
#2954	Reflective Sheeting for Signs
#3599	Standard Drawings w/Supplement
#3676	Asphalt Gyratory Compactor Internal Angle Calibration
#3875	General ITS Requirements
#4201	Contract Time
#4202	Scope of Work
#4204	Temporary Construction Signs
#4205	Underground Utilities

Section 907 - Special Provisions

907-102-2	Bidding Requirements and Conditions
907-103-2	Award and Execution of Contract
907-105-1	Authority of the Engineer
907-108-4	Subletting of Contract
907-109-3	Measurement and Payment
907-619-6	Temporary Portable Rumble Strips
907-631-1	Traffic Signal Systems - General
907-632-1	Traffic Signal Cabinet Assemblies
907-641-3	Radar Vehicle Detection
907-701-3	Hydraulic Cement
907-702-4	Bituminous Materials
907-703-1	Gradation
907-705-1	Stone Riprap
907-707-3	Joint Materials
907-711-2	Plain Steel Wire
907-712-1	Fence and Guardrail
907-714-3	Miscellaneous Materials

**PROJECT: MP-5468-61(013)/306931301 - Rankin**

907-718-1	Timber and Dimension Lumber
907-720-2	Acceptance Procedure for Glass Beads
907-721-4	Materials for Signing
907-722-1	Materials for Traffic Signal Installation

Section 905 - Proposal, Proposal Bid Items, Combination Bid Proposal  
State Board of Contractors Requirement  
State Certification Regarding Non-Collusion, Debarment and Suspensions  
Section 902 - Contract Form  
Section 903 - Contract Bond Forms

Progress Schedule

(REVISIONS TO THE ABOVE WILL BE INDICATED ON THE SECOND SHEET  
OF SECTION 905 AS ADDENDA)

04/28/2022 10:13 AM

# MISSISSIPPI DEPARTMENT OF TRANSPORTATION

## SECTION 901 - ADVERTISEMENT

Electronic bids will be received by the Mississippi Transportation Commission at 10:00 o'clock A.M., Tuesday, May 24, 2022, from the Bid Express Service and shortly thereafter publicly read on the Sixth Floor for:

Mill & Overlay approximately 11 miles of SR 468 from Deeb St. to US 80 in Brandon & approximately 0.4 miles of US 80 from SR 468 to Louis Wilson Rd., known as State Project No. MP-5468-61(013) / 306931301 in Rankin County.

The attention of bidders is directed to the predetermined minimum wage rate set by the U. S. Department of Labor under the Fair Labor Standards Act.

The Mississippi Department of Transportation hereby notifies all bidders that it will affirmatively insure that in any contract entered into pursuant to this advertisement, disadvantaged business enterprises will be afforded full opportunity to submit bids in response to this invitation and will not be discriminated against on the grounds of race, color, sex, age, disability, religion or national origin in consideration for an award.

The specifications are on file in the offices of the Mississippi Department of Transportation.

Contractors may request permission to bid online at <http://shopmdot.ms.gov> at no cost. Upon approval, Contractors shall be eligible to submit a bid using Bid Express at <http://bidx.com>. Specimen proposals may be viewed and downloaded online at no cost at <http://mdot.ms.gov> or purchased online at <http://shopmdot.ms.gov> at a cost of Ten Dollars (\$10.00) per proposal plus a small convenience fee. Cash or checks will not be accepted as payment.

Bid bond, signed or countersigned by a Mississippi Agent or Qualified Nonresident Agent, with Power of Attorney attached, a Cashier's check or Certified Check for five (5%) percent of bid, payable to STATE OF MISSISSIPPI, must accompany each proposal.

The attention of bidders is directed to the provisions of Subsection 102.07 pertaining to irregular proposals and rejection of bids.

BRAD WHITE  
EXECUTIVE DIRECTOR

**MISSISSIPPI DEPARTMENT OF TRANSPORTATION**

**SUPPLEMENT TO NOTICE TO BIDDERS NO. 1**

**DATE: 06/08/2021**

**SUBJECT: Governing Specifications**

Change the web address at the end of the first paragraph to the following.

<https://shop.mdot.ms.gov/default.aspx?StoreIndex=1>

# MISSISSIPPI DEPARTMENT OF TRANSPORTATION

**SECTION 904 - NOTICE TO BIDDERS NO. 1**

**CODE: (IS)**

**DATE: 03/01/2017**

**SUBJECT: Governing Specifications**

The current (2017) Edition of the Standard Specifications for Road and Bridge Construction adopted by the Mississippi Transportation Commission is made a part hereof fully and completely as if it were attached hereto, except where superseded by special provisions, or amended by revisions of the Specifications contained within this proposal. Copies of the specification book may be purchased from the MDOT Construction Division, or online at [shopmdot/default.aspx?StoreIndex=1](http://shopmdot/default.aspx?StoreIndex=1).

A reference in any contract document to controlling requirements in another portion of the contract documents shall be understood to apply equally to any revision or amendment thereof included in the contract.

In the event the plans or proposal contain references to the 2004 Edition of the Standard Specifications for Road and Bridge Construction, it is to be understood that such references shall mean the comparable provisions of the 2017 Edition of the Standard Specifications.

**MISSISSIPPI DEPARTMENT OF TRANSPORTATION**

**SECTION 904 - NOTICE TO BIDDERS NO. 3**

**CODE: (SP)**

**DATE: 01/17/2017**

**SUBJECT: Final Clean-Up**

Immediately prior to final inspection for release of maintenance, the Contractor shall pick up, load, transport and properly dispose of all litter from the entire highway right-of-way that is within the termini of the project.

Litter shall include, but not be limited to, solid wastes such as glass, paper products, tires, wood products, metal, synthetic materials and other miscellaneous debris.

Litter removal is considered incidental to other items of work and will not be measured for separate payment.

**MISSISSIPPI DEPARTMENT OF TRANSPORTATION**

**SECTION 904 - NOTICE TO BIDDERS NO. 9**

**CODE: (IS)**

**DATE: 03/01/2017**

**SUBJECT: Federal Bridge Formula**

Bidders are hereby advised that the latest revision of Federal Highway Administration Publication No. FHWA-HOP-06-105, **BRIDGE FORMULA WEIGHTS**, dated August 2006, is made a part of this contract when applicable.

Prior to the preconstruction conference, the Contractor shall advise the Engineer, in writing, what materials, if any, will be delivered to the jobsite via Interstate route(s).

Copies of the **BRIDGE FORMULA WEIGHTS** publication may be obtained by contacting:

Federal Highway Administration  
400 7<sup>th</sup> Street, SW  
Washington, DC 20590  
(202) 366-2212

or

[http://www.ops.fhwa.dot.gov/Freight/publications/brdg\\_frm\\_wgths/bridge\\_formula\\_all\\_rev.pdf](http://www.ops.fhwa.dot.gov/Freight/publications/brdg_frm_wgths/bridge_formula_all_rev.pdf)

An on line **BRIDGE FORMULA WEIGHTS CALCULATOR** is available at

[http://ops.fhwa.dot.gov/freight/sw/brdgcalc/calc\\_page.htm](http://ops.fhwa.dot.gov/freight/sw/brdgcalc/calc_page.htm)



**MISSISSIPPI DEPARTMENT OF TRANSPORTATION**

**SECTION 904 - NOTICE TO BIDDERS NO. 13**

**CODE: (IS)**

**DATE: 03/01/2017**

**SUBJECT: Safety Edge**

Bidders are hereby advised that the Shoulder Wedge (Safety Edge) specified in Section 401, Asphalt Pavements, shall only apply to the top two (2) lifts of asphalt. Open Graded Friction Courses (OGFC) are not to be considered a lift as it pertains to safety edge. Attached is a drawing showing the safety edge. Note that the shoulder dimensions in the bottom two drawings will be less than three feet (3').



**MISSISSIPPI DEPARTMENT OF TRANSPORTATION**

**SECTION 904 - NOTICE TO BIDDERS NO. 113**

**CODE: (SP)**

**DATE: 04/18/2017**

**SUBJECT: Tack Coat**

Bidders are advised that in addition to the products listed on the Department's APL as referenced in Subsection 401.03.1.2 on page 256, the Contractor may use one of the following as a tack coat.

- CSS-1
- CSS-1h
- SS-1
- SS-1h

**MISSISSIPPI DEPARTMENT OF TRANSPORTATION**

**SECTION 904 - NOTICE TO BIDDERS NO. 296**

**CODE: (SP)**

**DATE: 07/25/2017**

**SUBJECT: Reduced Speed Limit Signs**

Bidders are advised that when the plans or contract documents require the speed limit on a project to be reduced, the Contractor shall begin work within 48 hours of installing the reduced speed limit signs. Should the Contractor not start work or have no plans to start work within 48 hours of installing the signs, the reduced speed limit signs shall be covered and existing speed limit signs uncovered.

**MISSISSIPPI DEPARTMENT OF TRANSPORTATION**

**SECTION 904 - NOTICE TO BIDDERS NO. 445**

**CODE: (SP)**

**DATE: 10/10/2017**

**SUBJECT: Mississippi Agent or Qualified Nonresident Agent**

Bidders are hereby advised of the requirements of Subsections 102.08, 103.05.2, and 107.14.2.1 of the *2017 Standard Specifications for Road and Bridge Construction* as it refers to bonding agents. Proposal guaranties, bonds, and liability insurance policies must be signed by a **Mississippi Agent or Qualified Nonresident Agent.**

## MISSISSIPPI DEPARTMENT OF TRANSPORTATION

SECTION 904 - NOTICE TO BIDDERS NO. 516

CODE: (IS)

DATE: 11/28/2017

SUBJECT: Errata and Modifications to the 2017 Standard Specifications

<u>Page</u>	<u>Subsection</u>	<u>Change</u>
16	102.06	In the seventh full paragraph, change “Engineer” to “Director.”
33	105.05.1	In the sixth sentence, change “Contract Administration Engineer” to “Contract Administration Director.”
34	105.05.2.1	In subparagraph 2, change “SWPPP, ECP” to “SWPPP and the ECP”
35	105.05.2.2	In subparagraphs 2, add “ and” to the end of the sentence. In subparagraph 3, remove “, and” and add “.”.
90	109.04.2	In the last paragraph of subparagraph (a), place a period “.” at the end of the sentence.
93	109.04.2	In the last paragraph of subparagraph (g), place a period “.” at the end of the sentence. Also, in the first paragraph of subparagraph (h), place a period “.” at the end of the sentence.
97	109.07	Under ADJUSTMENT CODE, subparagraph (A1), change “HMA mixture” to “Asphalt mixtures.”
98	109.11	In the third sentence, change “Engineer” to “Director.”
219	308.04	In the last sentence of the last paragraph, change “Contractor’s decision” to “Engineer’s decision.”
300	405.02.5.9	In the first sentence of the second paragraph, change “Hot Mix Asphalt” to “Asphalt Mixtures.”
502	630.01.1	In the first paragraph, change “AASHTO” to “AASHTO’s LRFD”.
636	646.05	Change “each” to “per each” for the pay item units of payment.
640	656.02.6.2	In item 7), change “down stream” to “downstream”.
688	630.03.2	Change the subsection number from “630.03.2” to “680.03.2.”

- |     |               |   |
|-----|---------------|---|
| 725 | 702.08.3      | In the second sentence of the first paragraph, change “hot-mix” to “asphalt.”                     |
| 954 | 804.02.13.1.6 | In the definition for “M” in the % Reduction formulas, change “paragraph 7.3” to “paragraph 5.3.” |

**MISSISSIPPI DEPARTMENT OF TRANSPORTATION**

**SECTION 904 - NOTICE TO BIDDERS NO. 1225**

**CODE: (SP)**

**DATE: 11/13/2018**

**SUBJECT: Early Notice to Proceed**

Bidders are advised that if an early notice to proceed is allowed by the Department and the Contractor experiences problems or delays between the early notice to proceed date and the original notice to proceed date, this shall not be justification for any monetary compensation or an extension of contract time.



**MISSISSIPPI DEPARTMENT OF TRANSPORTATION**

**SECTION 904 - NOTICE TO BIDDERS NO. 1226**

**CODE: (IS)**

**DATE: 11/16/2018**

**SUBJECT: Material Storage Under Bridges**

Bidders are advised that Subsection 106.08 of the Standard Specifications allows the Contractor to store materials and equipment on portions of the right-of-way. However, the Contractor will not be allowed to store or stockpile materials under bridges without written permission from the Project Engineer. The Contractor shall submit a detailed request of all proposed materials to be stored under bridges to the Engineer a minimum of 14 calendar days prior to anticipated storage. This detail shall include, but not limited to, bridge location, material type, material quantity, and duration of storage. The Project Engineer and any other needed Division will review this information and determine whether to grant approval. The Contractor shall not store any material under any bridge without written approval from the Project Engineer.

**MISSISSIPPI DEPARTMENT OF TRANSPORTATION**

**SECTION 904 - NOTICE TO BIDDERS NO. 1241**

**CODE: (IS)**

**DATE: 11/27/2018**

**SUBJECT: Fuel and Material Adjustments**

Bidder's attention is brought to the last paragraph of Subsection 109.07 of the Standard Specifications which states that no fuel or material adjustment will be made after the completion of contract time. Any fuels consumed or materials incorporated into the work during the monthly estimate period falling wholly after the expiration of contract time will not be subject a fuel or material adjustment.

**MISSISSIPPI DEPARTMENT OF TRANSPORTATION**

**SECTION 904 - NOTICE TO BIDDERS NO. 1963**

**CODE: (SP)**

**DATE: 9/23/2019**

**SUBJECT: Guardrail Pads**

Bidders are hereby advised that prior to construction of the guardrail pads, the Contractor shall coordinate with the guardrail Subcontractor to determine the guardrail pad dimensions necessary to meet MASH compliance.

## MISSISSIPPI DEPARTMENT OF TRANSPORTATION

**SECTION 904 - NOTICE TO BIDDERS NO. 2206**

**CODE: (IS)**

**DATE: 01/14/2020**

**SUBJECT: MASH Compliant Devices**

Bidders are hereby advised that compliance associated with the requirements of meeting either the National Cooperative Highway Research Program (NCHRP) Report 350 or the Manual for Assessing Safety Hardware (MASH) for installations of certain traffic control devices and permanent safety hardware devices (guardrails, guardrail terminals, permanent portable barriers, cast-in-place barriers, all other permanent longitudinal barriers, crash cushions, cable barriers, cable barrier terminals, bridge rails, bridge rail transitions, all other terminals, sign supports, and all other breakaway hardware) as listed throughout the Standard Specifications and/or the Standard Drawings, or both, is now replaced with the requirements of meeting the 2016 version of MASH after December 31, 2019. This change applies to new permanent installations and to full replacements of existing installations.

At the preconstruction conference or prior to starting any work on the project, the Contractor shall submit a letter stating that the traffic control devices and permanent safety hardware devices as outlined within the paragraph above that are to be used on the project are certified to meet MASH 2016.

When a MASH 2016-compliant device does not exist for the new permanent installations and/or full replacement installations of permanent safety hardware devices, as listed above, a MASH 2009-compliant or a NCHRP 350-compliant device may be proposed by the Contractor for the project. A written request for such instances must be submitted by the Contractor either at the preconstruction conference or prior to starting any work on the project. The Contractor shall submit the following items to the Project Engineer: (1) a detailed list of the proposed devices and locations thereof; and (2) certification letters indicating that the proposed devices are compliant with either MASH 2009 or NCHRP 350.

When a MASH 2016-compliant device does not exist for the temporary work zone traffic control devices (Category 1, Category 2, and Category 3 devices), a MASH 2009-compliant or a NCHRP 350-compliant device may be proposed by the Contractor for the project. Temporary work zone traffic control devices (Category 1, Category 2, and Category 3 devices) that are MASH 2009-compliant or NCHRP 350-compliant that have been in use prior to December 31, 2019, and that have a remaining service life may be proposed for use throughout their normal service life on the project by the Contractor. For either of these scenarios for temporary work zone traffic control devices, a written request must be submitted by the Contractor either at the preconstruction conference or prior to starting any work on the project. The Contractor shall submit the following items to the Project Engineer: (1) a detailed list of the proposed devices and locations thereof; and (2) certification letters indicating that the proposed devices are compliant with either MASH 2009 or NCHRP 350.

Work will only be allowed to proceed after the Department has granted written concurrence(s) with the proposed request(s) as listed above.

**MISSISSIPPI DEPARTMENT OF TRANSPORTATION**

**SECTION 904 - NOTICE TO BIDDERS NO. 2273**

**CODE: (SP)**

**DATE: 02/12/2020**

**SUBJECT: Mississippi Special Fuel Tax Law**

Bidder's attention is brought to the second paragraph of Subsection 107.02 of the Standard Specifications which states that all Contractors and Subcontractors must comply with all requirements contained in the Mississippi Special Fuel Tax Law, Section 27-55-501, *et seq.* Attached are two Fact Sheets provided by the Mississippi Department of Revenue (MDOR) with additional information.

## Gasoline and Dyed Diesel Used for Non-Highway Purposes

*Mississippi provides a reduced rate for gasoline and dyed diesel used for non-highway purposes. The reduced rates are 6.44 cents per gallon and 5.75 cents per gallon of gasoline or dyed diesel. These fuels are generally taxed at 18 cents per gallon if for on road use.*

### Gasoline Used for Non-Highway Purposes

You may be entitled to a refund of 11.56 cents per gallon (making this an equivalent to a tax rate of 6.44 cents per gallon) if you desire to purchase gasoline to be used off road. The gasoline must be used for agricultural, maritime, industrial, manufacturing, domestic or non-highway purposes only.

Examples of non-highway include gasoline used in boats, golf carts, machinery used for manufacturing or farm equipment used exclusively in plowing, planting or harvesting farm products.

### Refund Gasoline User

The refund is based on the amount of gallons used. Before a refund is issued, you are required to...

1. Obtain a refund gasoline user's permit and a certificate for refund booklet from the Department of Revenue;
2. Have a storage tank marked "REFUND GASOLINE"; and,
3. Purchase the gasoline from someone who holds a refund gasoline dealer's permit.

No refund will be allowed for gasoline used in motor vehicles owned or operated by a government entity or used in Mississippi government contracts.

### Refund Gasoline Dealer

You must obtain a refund gasoline dealer's permit from the Department of Revenue before selling refund gasoline. At no time should the gasoline be delivered to a tank that is not properly marked. The gasoline must be dyed a distinctive mahogany color at the time of delivery.

The Department of Revenue may waive the dye requirement if the dye may cause damage to the equipment. The refund gasoline user is required to obtain the waiver from the Department of Revenue.

### Dyed Diesel Used for Non-Highway Purposes

Unlike gasoline, you are not required to apply for a refund if you desire to purchase dyed diesel to be used off road. Mississippi provides a reduced rate of 5.75 cents per gallon on dyed diesel used off road. Diesel used on road is subjected to 18 cents per gallon. Dyed diesel used in motor vehicles owned or operated by a government entity or used in Mississippi government contracts will be subjected to 18 cents per gallon.

### Dyed Diesel Used on the Highway

Any person who purchases, receives, acquires or uses dyed diesel for highway use will be liable to pay 18 cents per gallon and subject to a penalty in the amount of \$1000.

### Identifying Dyed Diesel

Storage facilities for dyed diesel must be plainly marked "NONHIGHWAY DIESEL FUEL" or "NONHIGHWAY KEROSENE". Retailers are also required to mark all pumps or dispensing equipment.



## Special Fuel Used on Government Contracts

### State and Local Government Contracts

Special fuel purchased, acquired or used in performing contracts with the State of Mississippi, counties, municipalities or any political subdivision is taxed at a rate of 18 cents per gallon. Special fuel includes but is not limited to the following:

- Dyed diesel fuel;
- Kerosene;
- Undyed diesel fuel; and,
- Fuel oil.

State and local government contracts include construction, reconstruction and maintenance or repairs of projects such as roads, bridges, water systems, sewer systems, buildings, drainage canals and recreational facilities. The Department of Revenue may require contractors to remit the excise tax directly to the state in lieu of paying the tax to a distributor.

### Special Fuel Direct Pay Permit

Contractors that remit the excise tax to the state will be issued a Special Fuel Direct Pay Permit. This permit relieves the distributor from collecting the tax and requires the contractor to file a monthly special fuel return. The distributor should include the contractor’s permit number on all invoices that are related to tax-free sales.

The contractor is required to furnish a surety or cash bond guaranteeing the payment of the excise tax prior to receiving the Special Fuel Direct Pay Permit. The Department of Revenue may accept a contractors tax bond if the bond covers the excise tax levied on special fuel.

### Special Fuel Distributors

If the contractor does not have a Special Fuel Direct Pay Permit, distributors are required to collect the 18 cents excise tax and remit the tax to the Department of Revenue. The additional 12.25 cents levied on special fuel (excluding undyed diesel) should be reported on schedules 5F and 5G of the special fuel return.

### Environmental Protection Fee

Special fuel distributors are required to collect the environmental protection fee even if the contractor has a Special Fuel Direct Pay Permit. The fee is levied at 4/10<sup>ths</sup> of a cent per gallon. The fee is suspended or reinstated when the trust fund has exceeded or fallen below the obligatory balance.

### Penalties

Any person who knowingly and willfully purchases untaxed fuel for use in equipment utilized on a road or highway construction site in this state is guilty of a misdemeanor and, upon conviction, shall be fined not less than \$1,000 or more than \$100,000, or imprisoned in the county jail for not more than one year, or both.



**MISSISSIPPI DEPARTMENT OF TRANSPORTATION**

**SECTION 904- NOTICE TO BIDDERS NO. 2278**

**CODE: (SP)**

**DATE: 03/04/2020**

**SUBJECT: Smoothness Tolerances**

Bidders are hereby advised that the smoothness tolerances for this project shall meet the requirements of a Category C project according to Subsection 403.03.2.1. Bidders are responsible for the collection of a preliminary smoothness profile prior to any work being performed.



## MISSISSIPPI DEPARTMENT OF TRANSPORTATION

SECTION 904 - NOTICE TO BIDDERS NO. 2954

CODE: (IS)

DATE: 12/01/2020

SUBJECT: Reflective Sheeting for Signs

Bidders are hereby advised that the retroreflective sign sheeting used for signs on this project shall be as listed below and shall meet the requirements of Subsection 721.06.

### Temporary Construction Signs

Temporary traffic control (orange) sign sheeting shall be a minimum Type IX Fluorescent Orange sheeting as shown in Special Provision 907-721.

### Permanent Signs

Permanent signs, except signs on traffic signal poles/mast arms, shall be as follows:

- Brown background sheeting on guide signs shall be a minimum Type VIII sheeting,
- Green and blue background sheeting on guide signs shall be a minimum Type IX sheeting, and
- All white, yellow, red, fluorescent yellow, and fluorescent yellow/green sheeting shall be Type XI sheeting.

**MISSISSIPPI DEPARTMENT OF TRANSPORTATION**

| **SUPPLEMENT TO NOTICE TO BIDDERS NO. 3599**

| **DATE: 08/11/2021**

| After the last drawing on page 33, add the following.

















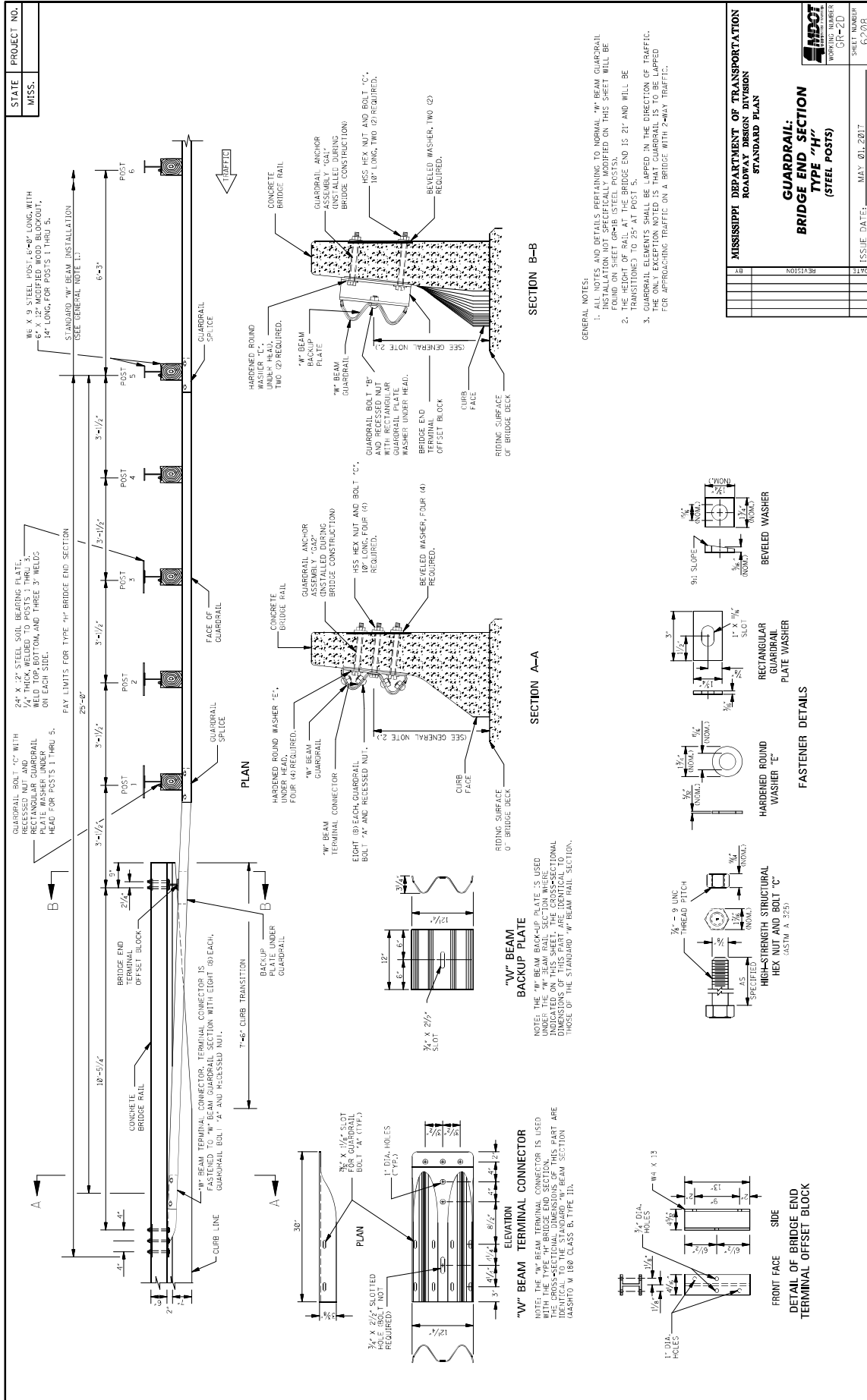



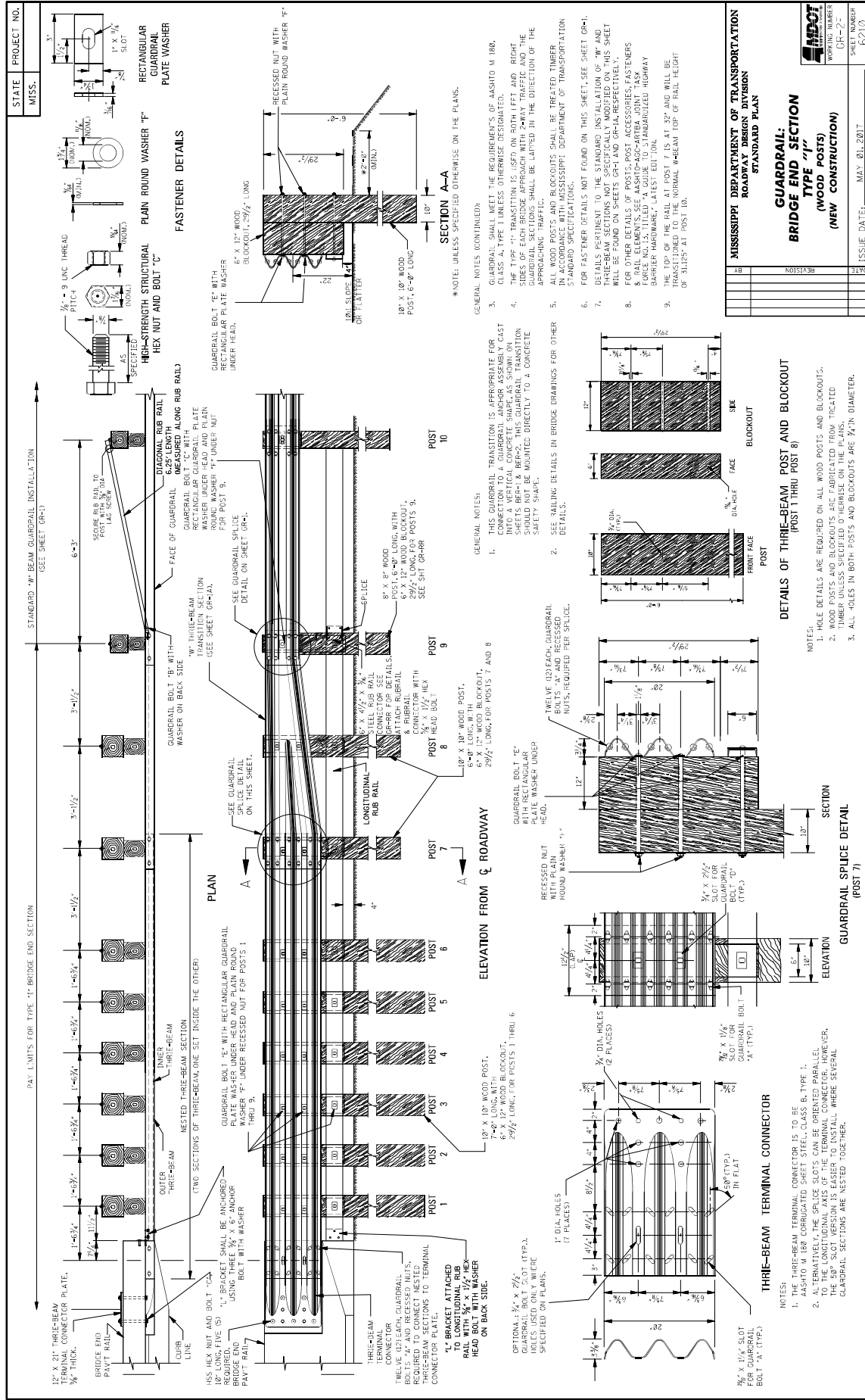

STATE	PROJECT NO.
MISS.	

MISSISSIPPI DEPARTMENT OF TRANSPORTATION ROADWAY DESIGN DIVISION STANDARD PLAN	
<b>GUARDRAIL: BRIDGE END SECTION TYPE "1" (WOOD POSTS) (NEW CONSTRUCTION)</b>	
DATE	ISSUE DATE: MAY 01, 2017
REVISION	WORKING NUMBER CH-2
	SHEET NUMBER 6210

GENERAL NOTES (CONTINUED):

- GUARDRAIL SHALL MEET THE REQUIREMENTS OF AASHTO M 188, CLASS A, TYPE I UNLESS OTHERWISE DESIGNATED.
- WOOD POSTS AND BLOCKOUTS ARE FABRICATED FROM TREATED TIMBER UNLESS SPECIFIED OTHERWISE ON THE PLANS.
- THE TOP OF THE RAIL AT POST 7 IS AT 32" AND WILL BE TRANSMITTED TO THE NORMAL W-BEAM TOP OF RAIL HEIGHT OF 31.25" AT POST 10.
- FOR FASTENER DETAILS NOT FOUND ON THIS SHEET, SEE SHEET GP-1.
- FOR OTHER DETAILS OF POSTS, POST ACCESSORIES, FASTENERS & RAIL ELEMENTS, SEE AASHTO-AOC-ARTBA JOINT TASK FORCE REPORT, "DESIGN AND CONSTRUCTION OF UNGRADE HIGHWAY BARRIER HARDWARE," LATEST EDITION.
- ALL WOOD POSTS AND BLOCKOUTS SHALL BE TREATED TIMBER TO MEET THE REQUIREMENTS OF MISSISSIPPI DEPARTMENT OF TRANSPORTATION STANDARD SPECIFICATIONS.
- FOR FASTENER DETAILS NOT FOUND ON THIS SHEET, SEE SHEET GP-1.
- FOR OTHER DETAILS OF POSTS, POST ACCESSORIES, FASTENERS & RAIL ELEMENTS, SEE AASHTO-AOC-ARTBA JOINT TASK FORCE REPORT, "DESIGN AND CONSTRUCTION OF UNGRADE HIGHWAY BARRIER HARDWARE," LATEST EDITION.
- THE TOP OF THE RAIL AT POST 7 IS AT 32" AND WILL BE TRANSMITTED TO THE NORMAL W-BEAM TOP OF RAIL HEIGHT OF 31.25" AT POST 10.

GENERAL NOTES:

- THIS GUARDRAIL TRANSITION IS APPROPRIATE FOR USE ON BRIDGE ENDS AND SHALL BE CAST INTO A VERTICAL CONCRETE SHAPE AS SHOWN ON SHEETS BR-1 & BR-2. THIS GUARDRAIL TRANSITION SHALL NOT BE MOUNTED DIRECTLY TO A CONCRETE SUPPORT SHAPE.
- SEE RAILING DETAILS IN BRIDGE DRAWINGS FOR OTHER DETAILS.

OPTIONAL: 3/4" x 2 1/2" (TYP.) HOLES (SEE ONLY W/LEC SPECIFIED ON PLANS).

THREE-BEAM TERMINAL CONNECTOR

NOTES:

- THE THREE-BEAM TERMINAL CONNECTOR IS TO BE TYPE 1, AASHTO M 188 CORRUGATED SHEET STEEL, CLASS B, TYPE 1.
- TO THE LONGITUDINAL AXIS OF THE TERMINAL CONNECTOR, HOWEVER, THE 58" SLOT VERSION IS EASIER TO INSTALL, WHERE SEVERAL GUARDRAIL SECTIONS ARE NESTED TOGETHER.

THREE-BEAM TERMINAL CONNECTOR

NOTES:

- THE THREE-BEAM TERMINAL CONNECTOR IS TO BE TYPE 1, AASHTO M 188 CORRUGATED SHEET STEEL, CLASS B, TYPE 1.
- TO THE LONGITUDINAL AXIS OF THE TERMINAL CONNECTOR, HOWEVER, THE 58" SLOT VERSION IS EASIER TO INSTALL, WHERE SEVERAL GUARDRAIL SECTIONS ARE NESTED TOGETHER.



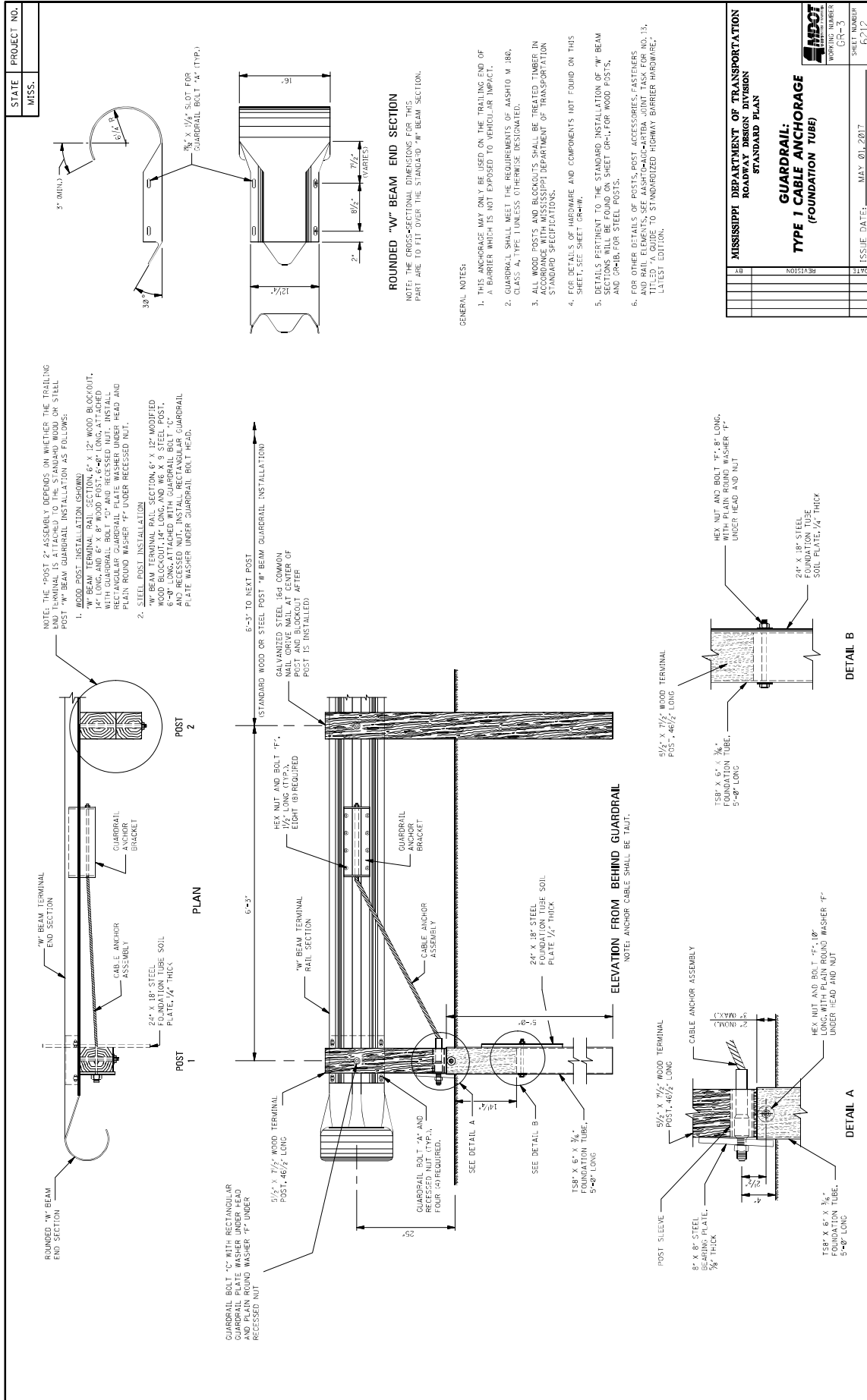

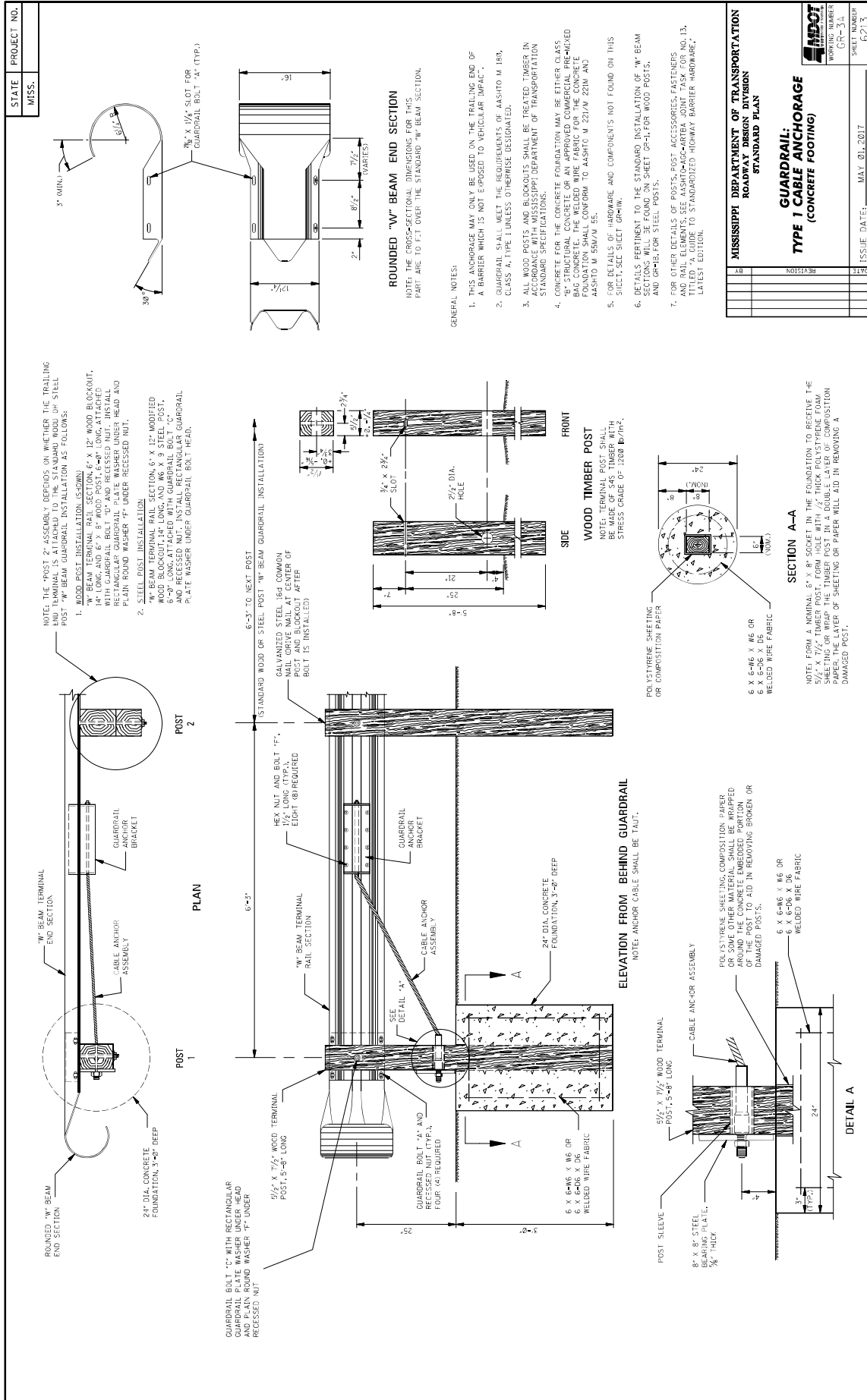

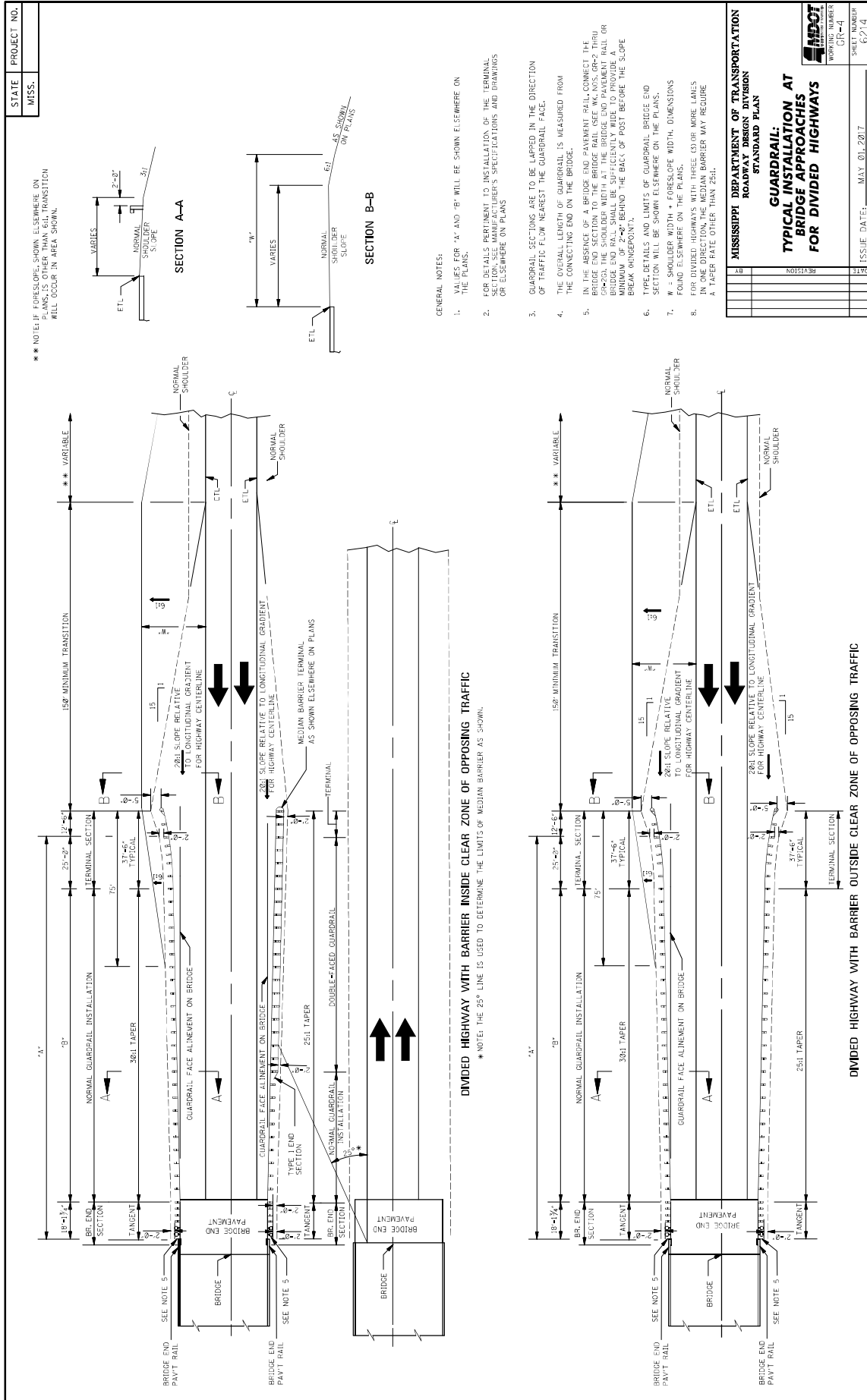



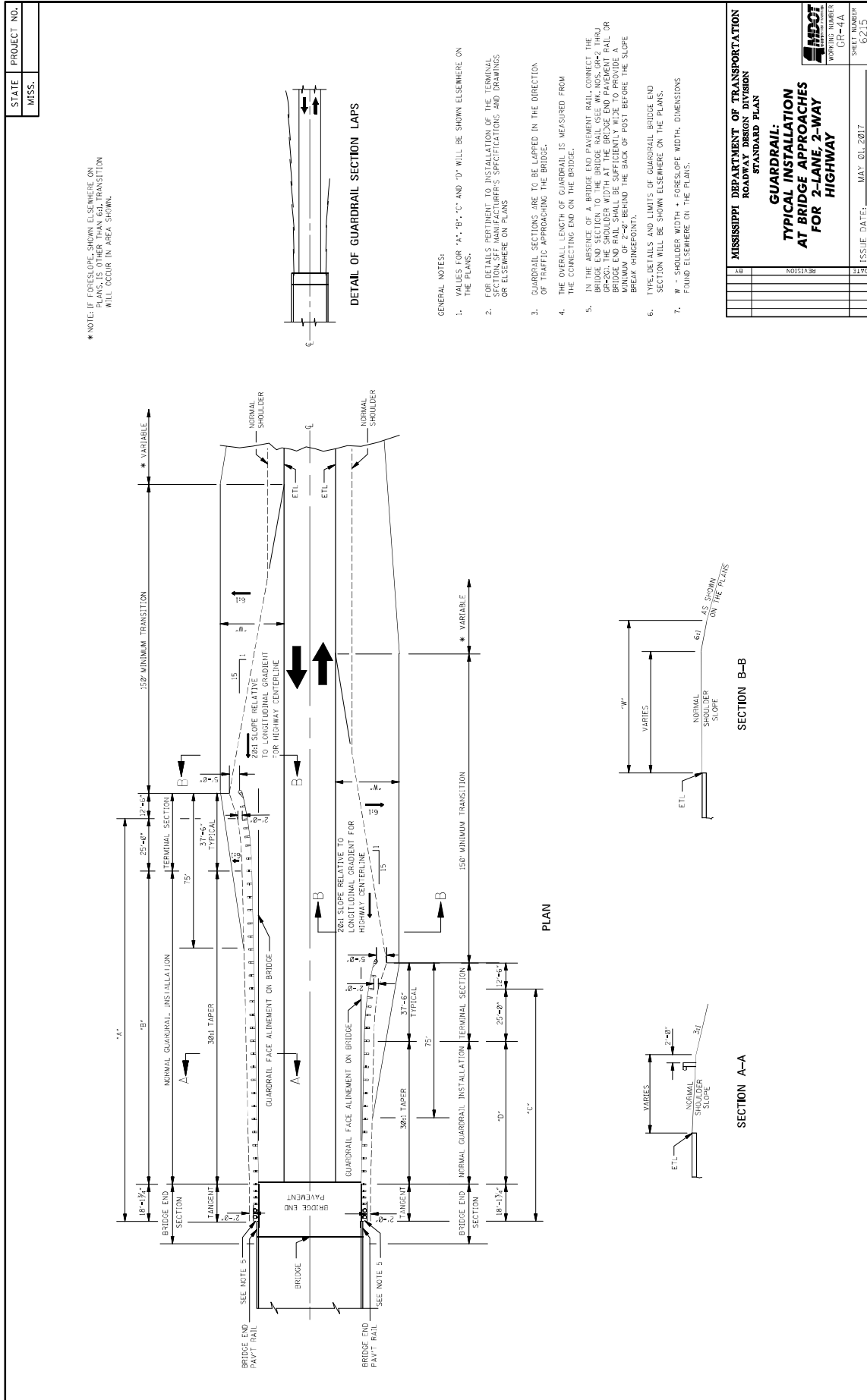

<b>MISSISSIPPI DEPARTMENT OF TRANSPORTATION</b>	
<b>ROADWAY DESIGN DIVISION</b>	
<b>STANDARD PLAN</b>	
<b>GUARDRAIL: TYPICAL INSTALLATION AT BRIDGE APPROACHES FOR 2-LANE, 2-WAY HIGHWAY</b>	
WORKING NUMBER CR-41A	SHEET NUMBER 0215
ISSUE DATE: MAY 01, 2017	

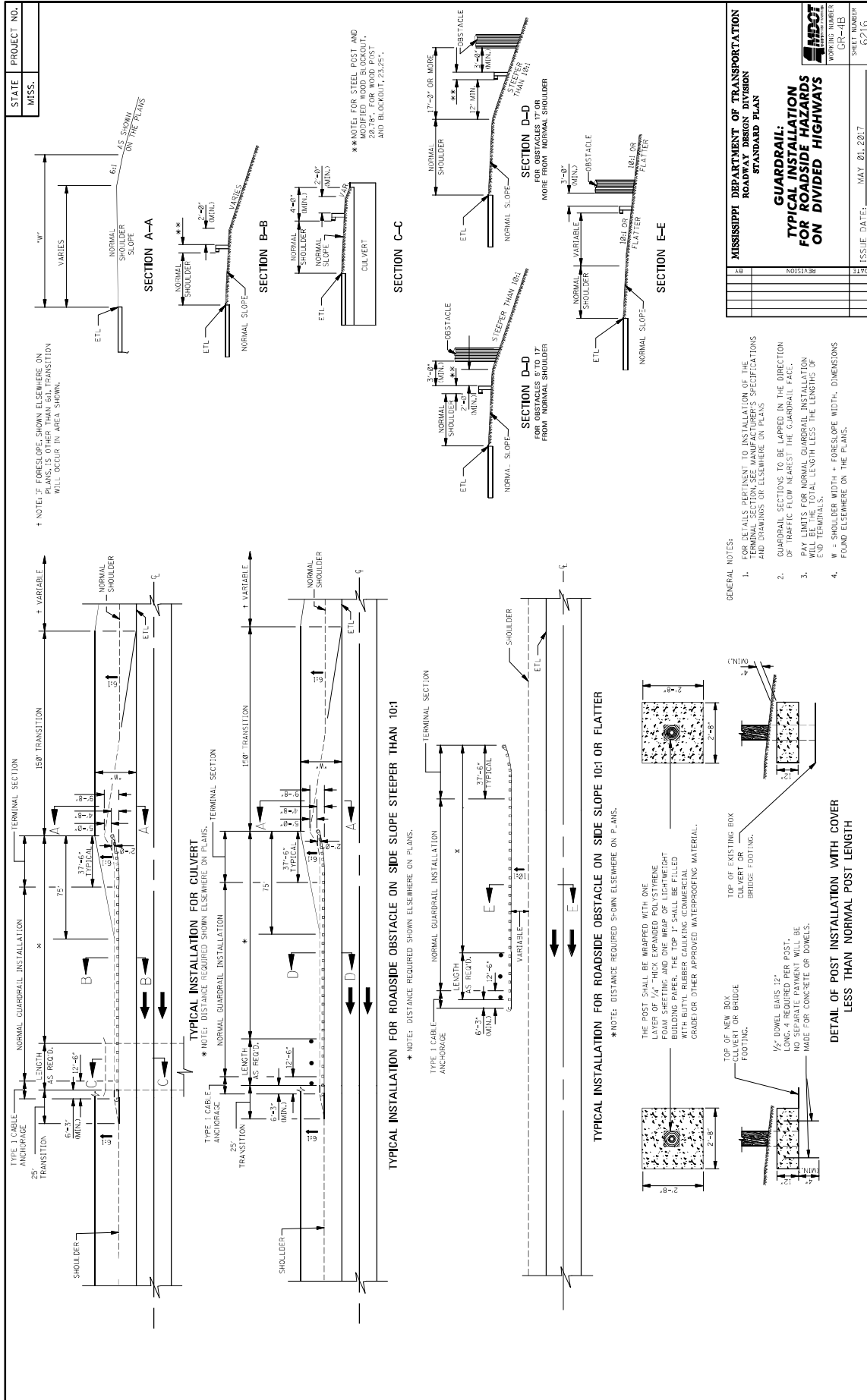

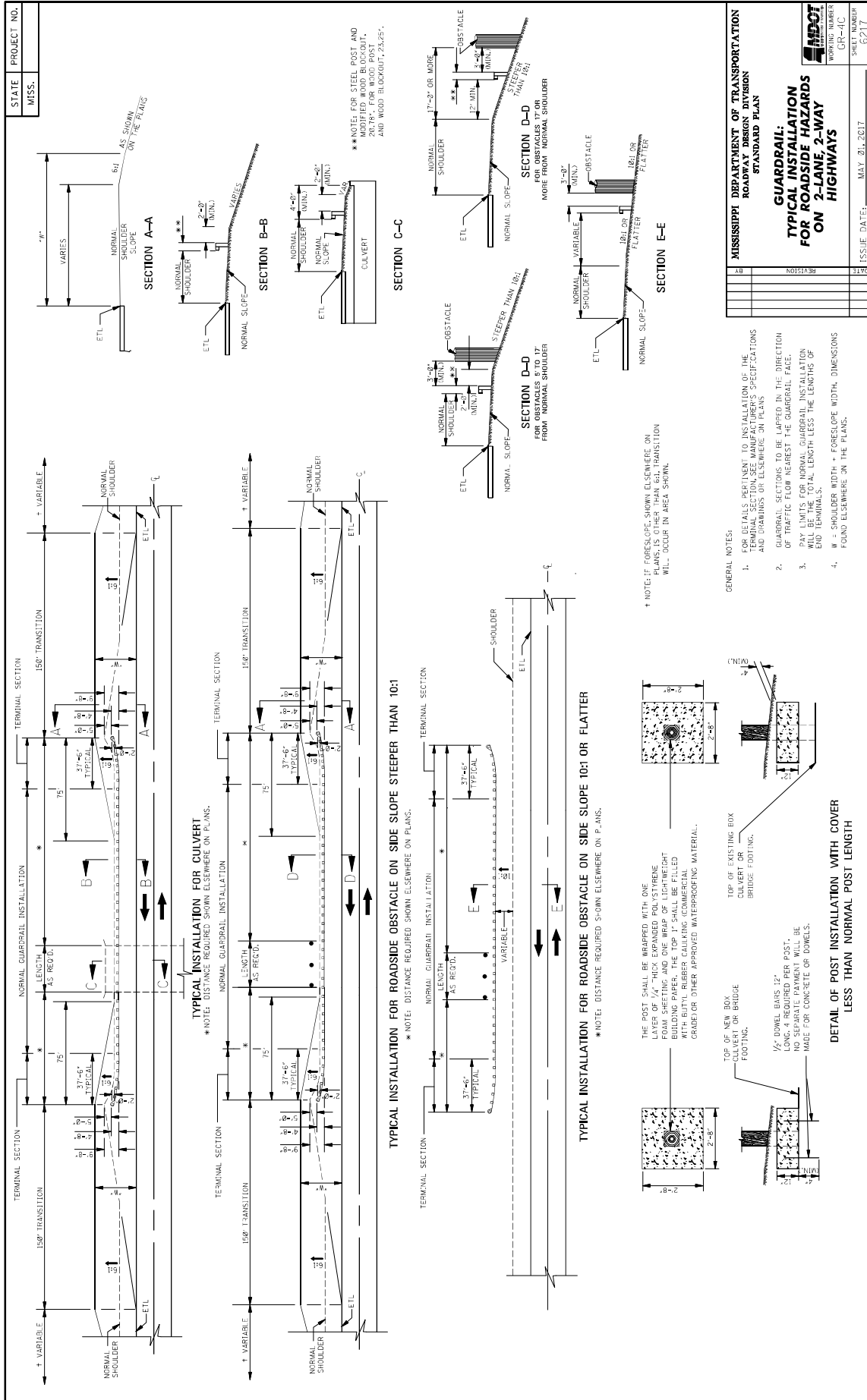

MISSISSIPPI DEPARTMENT OF TRANSPORTATION ROADWAY DESIGN DIVISION STANDARD PLAN	
<b>GUARDRAIL: TYPICAL INSTALLATION FOR ROADSIDE HAZARDS ON 2-LANE, 2-WAY HIGHWAYS</b>	
ISSUE DATE: MAY 20, 2017	SHEET NUMBER G217

STATE MISS.	PROJECT NO.		
----------------	-------------	--	--

  

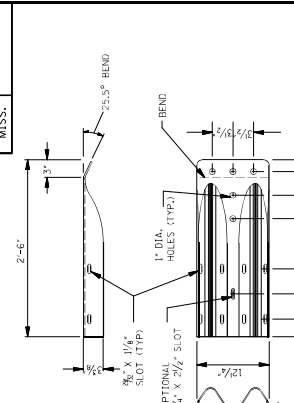

**"W" BEAM TERMINAL CONNECTOR PLATE**  
NOTES:  
1. THE "W" BEAM TERMINAL CONNECTOR IS TO BE AASHTO M 189 CORRUGATED SHEET STEEL, CLASS B, TYPE 1.  
2. SPACER-BOLT SLOTS MAY ALSO BE ORIENTED AT 50° FROM THE PLATE INSTEAD OF 8° AS SHOWN.

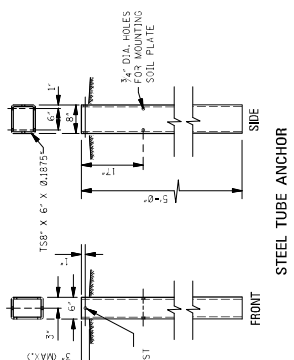

**STEEL TUBE ANCHOR**  
NOTE: TERMINAL POST SHOULD BE ABLE TO SLIDE INTO TUBE. THE ACTUAL INSIDE DIMENSIONS OF THIS GALVANIZED TUBE CANNOT BE LESS THAN 7/8" X 5/8".

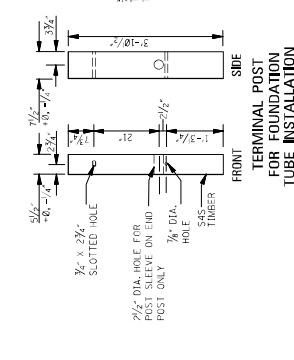

**SOIL PLATE**  
NOTE: 2 REQUIRED

  

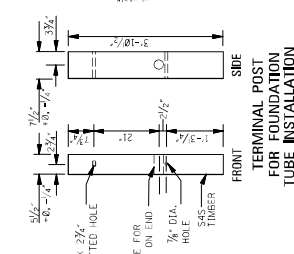

**TERMINAL POST FOR FOUNDATION TUBE INSTALLATION**  
NOTE: TERMINAL POST SHALL BE MADE OF S4S TIMBER WITH 2 STRESS GRADE OF 2000 KSI/IN<sup>2</sup>.

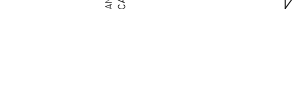

**BEARING PLATE**



**RECTANGULAR GUARDRAIL PLATE WASHER**

  

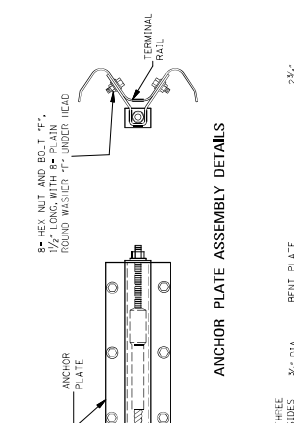

**ANCHOR PLATE ASSEMBLY DETAILS**

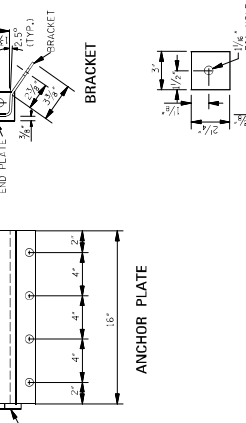

**ANCHOR PLATE**

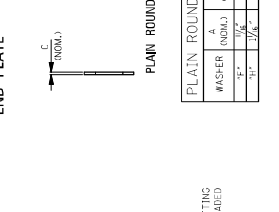

**END PLATE**

  

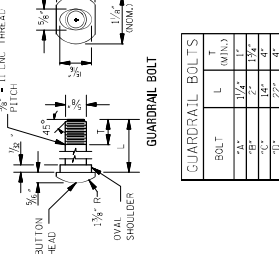

**GUARDRAIL BOLT**

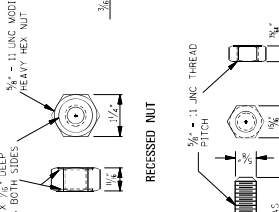

**RECESSED NUT**

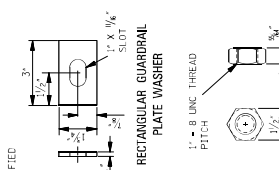

**HEX NUT AND BOLT "F"**

  

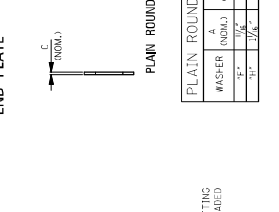

**PLAIN ROUND WASHER**

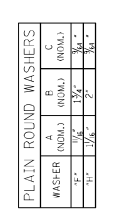

BOLT	L (MIN)	T (MIN)	C (NOM)
1/2"	1 1/2"	3/16"	3/16"
5/8"	1 3/4"	1/4"	1/4"
3/4"	2"	1/4"	1/4"
7/8"	2 1/4"	1/4"	1/4"
1"	2 3/4"	1/4"	1/4"

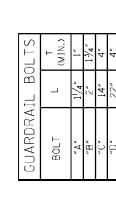

BOLT	L (MIN)	T (MIN)	C (NOM)
1/2"	1 1/2"	3/16"	3/16"
5/8"	1 3/4"	1/4"	1/4"
3/4"	2"	1/4"	1/4"
7/8"	2 1/4"	1/4"	1/4"
1"	2 3/4"	1/4"	1/4"

  

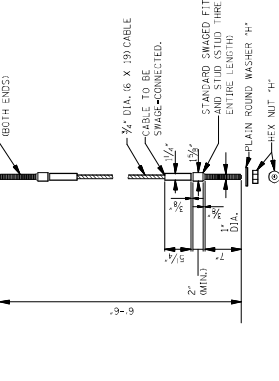

**CABLE ANCHOR ASSEMBLY**

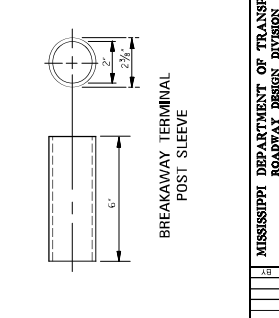

**SHELF ANGLE BRACKET**

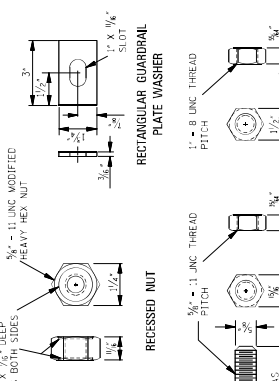

**BREAKAWAY TERMINAL POST SLEEVE**

**FASTENER DETAILS**

NOTES:  
1. ALL GUARDRAIL BOLTS ARE 3/8" - 11 UNC  
HEAVY HEX NUTS.  
2. IF ANY BOLT EXTENDS MORE THAN 1/4" FROM THE NUT, THE BOLT SHOULD BE TRIMMED BACK.

DATE \_\_\_\_\_

REVISION \_\_\_\_\_

ISSUE DATE: MAY 21, 2017

MISSISSIPPI DEPARTMENT OF TRANSPORTATION  
ROADWAY DESIGN DIVISION  
STANDARD PLAN

**GUARDRAIL:**  
**MISCELLANEOUS HARDWARE**



WORKING NUMBER  
GT-HH

SHEET NUMBER  
0221



STATE MISS.	PROJECT NO.		
----------------	-------------	--	--

**DISTANCE REFERENCE SIGN MOUNTING ON OUTSIDE SHOULDER ALONG MAIN FACILITY**

NOTE: SIGN MOUNTING ON LEFT LANE SHOULDER SHALL BE 90° OPPOSITE THE RIGHT LANE STATION. SIGN MOUNTING ON RIGHT LANE SHOULDER SHALL BE LOCATED WITHIN 50 FEET OF ITS TRUE LOCATION. IT SHALL BE OMITTED ENTIRELY.

SINGLE OR DOUBLE AS REQUIRED

**DETAIL OF SINGLE WHITE OR SINGLE YELLOW DELINEATOR**

**DETAIL OF DOUBLE WHITE OR DOUBLE YELLOW DELINEATOR**

**REAR VIEW OF DELINEATOR ASSEMBLY**

NOTE: DELINEATORS ARE TO BE FASTENED TO U-SECTION POSTS WITH 1/4" DIA. HUCK FASTENERS OR CHERRY RIVETS OF THE COLLAR TYPE OR OTHER APPROVED EQUAL.

**DETAIL OF TYPE 3 OBJECT MARKER OR DISTANCE REFERENCE SIGN ASSEMBLY**

**REAR VIEW OF TYPE 3 OBJECT MARKER OR DISTANCE REFERENCE SIGN ASSEMBLY**

NOTE: DELINEATORS AND TYPE 3 OBJECT MARKER SHALL BE REFLECTIVE SHEETING ON 0.200" THICK ALUMINUM SHEET OR 14 GAGE GALVANIZED SHEET STEEL. DELINEATOR, TYPE 3 OBJECT MARKER AND DISTANCE REFERENCE SIGN POSTS SHALL BE GALVANIZED STEEL. THE POSTS ARE TO BE FABRICATED BEFORE THE METAL IS GALVANIZED.

WEIGHT WITHOUT GROUND PLATES:

- A. DELINEATOR POST 7'-0" = 2.0 lb/ft + 10.25 lb/ft
- B. TYPE 3 OBJECT MARKER POSTS 3'-0" = 2.5 lb/ft TO 3.0 lb/ft
- C. DISTANCE REFERENCE SIGN POSTS 12'-0" = 11.4 lb/ft + 11.4 lb/ft
- D. 12'-0" = 3.0 lb/ft TO 3.5 lb/ft

NOTE: TYPE OF DELINEATORS AND TYPE 3 OBJECT MARKERS SHALL INCLUDE COST OF POST. DISTANCE REFERENCE SIGN POST WILL BE PAID PER FOOT. RADIUS IN BENDS OF POST CROSS SECTION NOT TO EXCEED 3% FOR HOT ROLLED SECTION.

GROUND PLATE NOT REQUIRED ON U-SECTION POST.

**DELINEATOR MOUNTING ON OUTSIDE SHOULDER ALONG MAIN FACILITY OR RAMP**

**DELINEATOR MOUNTING ON INTERCHANGE LOOPS WITH UNMOUNTABLE CURB ON INSIDE**

**DELINEATOR MOUNTING ON OUTSIDE SHOULDER WITH MOUNTABLE CURB ALONG MAIN FACILITY OR RAMP**

**DETAIL OF TYPE 3 OBJECT MARKER INSTALLATION**

**GENERAL NOTES:**

1. DELINEATORS AND TYPE 3 OBJECT MARKER SHALL BE REFLECTIVE SHEETING ON 0.200" THICK ALUMINUM SHEET OR 14 GAGE GALVANIZED SHEET STEEL.
2. DELINEATOR, TYPE 3 OBJECT MARKER AND DISTANCE REFERENCE SIGN POSTS SHALL BE GALVANIZED STEEL. THE POSTS ARE TO BE FABRICATED BEFORE THE METAL IS GALVANIZED.
3. WEIGHT WITHOUT GROUND PLATES:
  - A. DELINEATOR POST 7'-0" = 2.0 lb/ft + 10.25 lb/ft
  - B. TYPE 3 OBJECT MARKER POSTS 3'-0" = 2.5 lb/ft TO 3.0 lb/ft
  - C. DISTANCE REFERENCE SIGN POSTS 12'-0" = 11.4 lb/ft + 11.4 lb/ft
  - D. 12'-0" = 3.0 lb/ft TO 3.5 lb/ft
4. UNIT PRICE OF DELINEATORS AND TYPE 3 OBJECT MARKERS SHALL INCLUDE COST OF POST. DISTANCE REFERENCE SIGN POST WILL BE PAID PER FOOT.
5. RADIUS IN BENDS OF POST CROSS SECTION NOT TO EXCEED 3% FOR HOT ROLLED SECTION.
6. GROUND PLATE NOT REQUIRED ON U-SECTION POST.

**MOUNTING DETAIL**

DELINEATORS, OBJECT MARKERS OR DISTANCE REFERENCE SIGNS MOUNTED TO THIS FACE AS SHOWN.

DIRECTION OF TRAFFIC

**MISSISSIPPI DEPARTMENT OF TRANSPORTATION**  
ROADWAY DESIGN DIVISION  
STANDARD PLAN

**TYPICAL INSTALLATION AND DETAILS OF DELINEATORS AND DISTANCE REFERENCE SIGNS**

WORKING NUMBER: SN-5  
SHEET NUMBER: 62J-4

ISSUE DATE: MAY 01, 2017

DATE	REVISION	BY

**MISSISSIPPI DEPARTMENT OF TRANSPORTATION**

**SECTION 904 – NOTICE TO BIDDERS NO. 3599**

**CODE: (SP)**

**DATE: 08/11/2021**

**SUBJECT: Standard Drawings**

Standard Drawings attached hereto shall govern appropriate items of required work.

Larger copies of Standard Drawings may be purchased from:

MDOT Plans Print Shop  
MDOT Shop Complex, Building C, Room 114  
2567 North West Street  
P.O. Box 1850  
Jackson, MS 39215-1850  
Telephone: (601) 359-7460  
or FAX: (601) 359-7461  
or e-mail: [plans@mdot.state.ms.us](mailto:plans@mdot.state.ms.us)

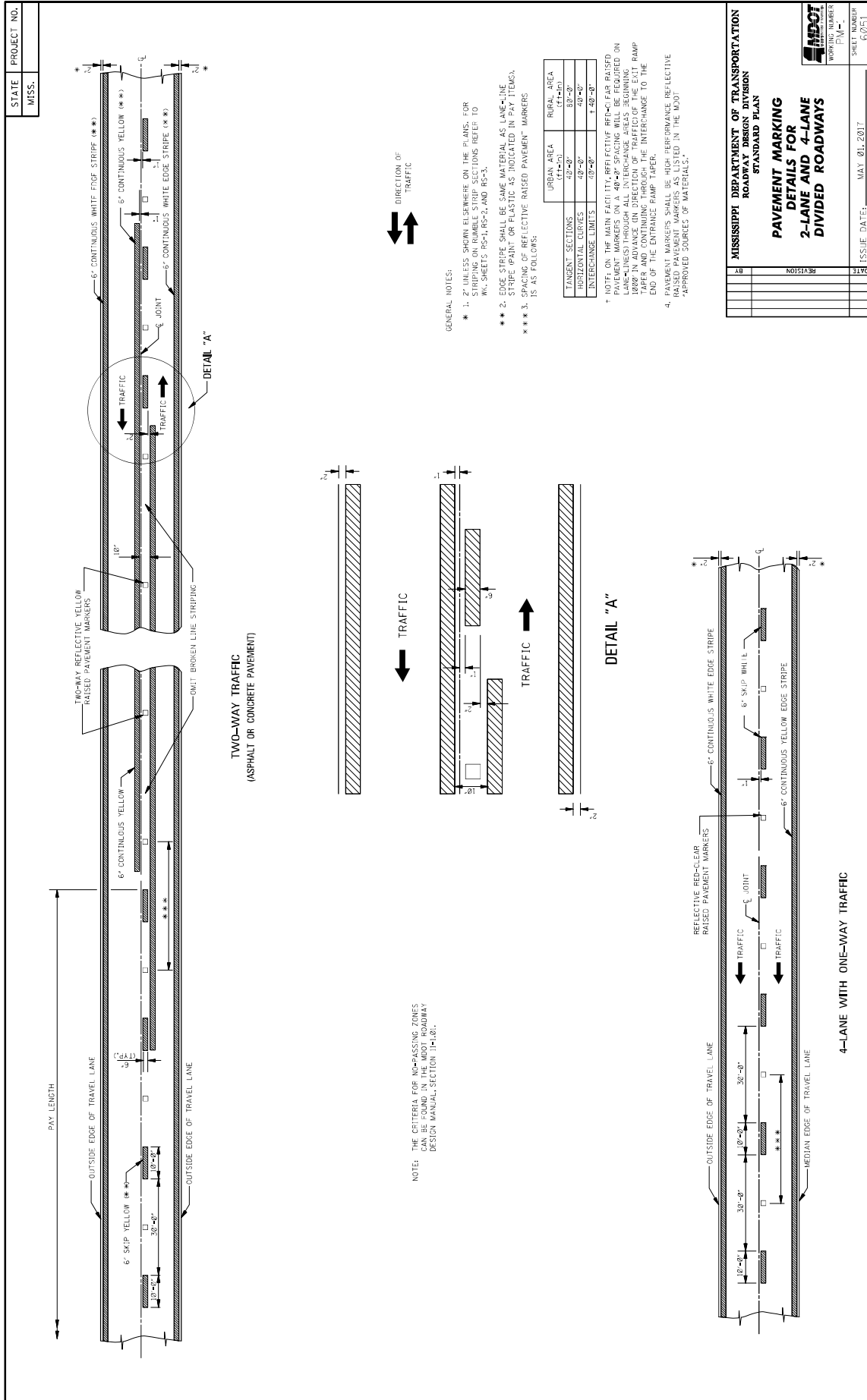

<b>MISSISSIPPI DEPARTMENT OF TRANSPORTATION</b>	
<b>ROADWAY DESIGN DIVISION</b>	
<b>STANDARD PLAN</b>	
<b>PAVEMENT MARKING</b>	
<b>2-LANE AND 4-LANE</b>	
<b>DIVIDED ROADWAYS</b>	
DATE	ISSUE DATE: MAY 01, 2017
BY	SHEET NUMBER 6001
REVISION	WORKING NUMBER P.M.-





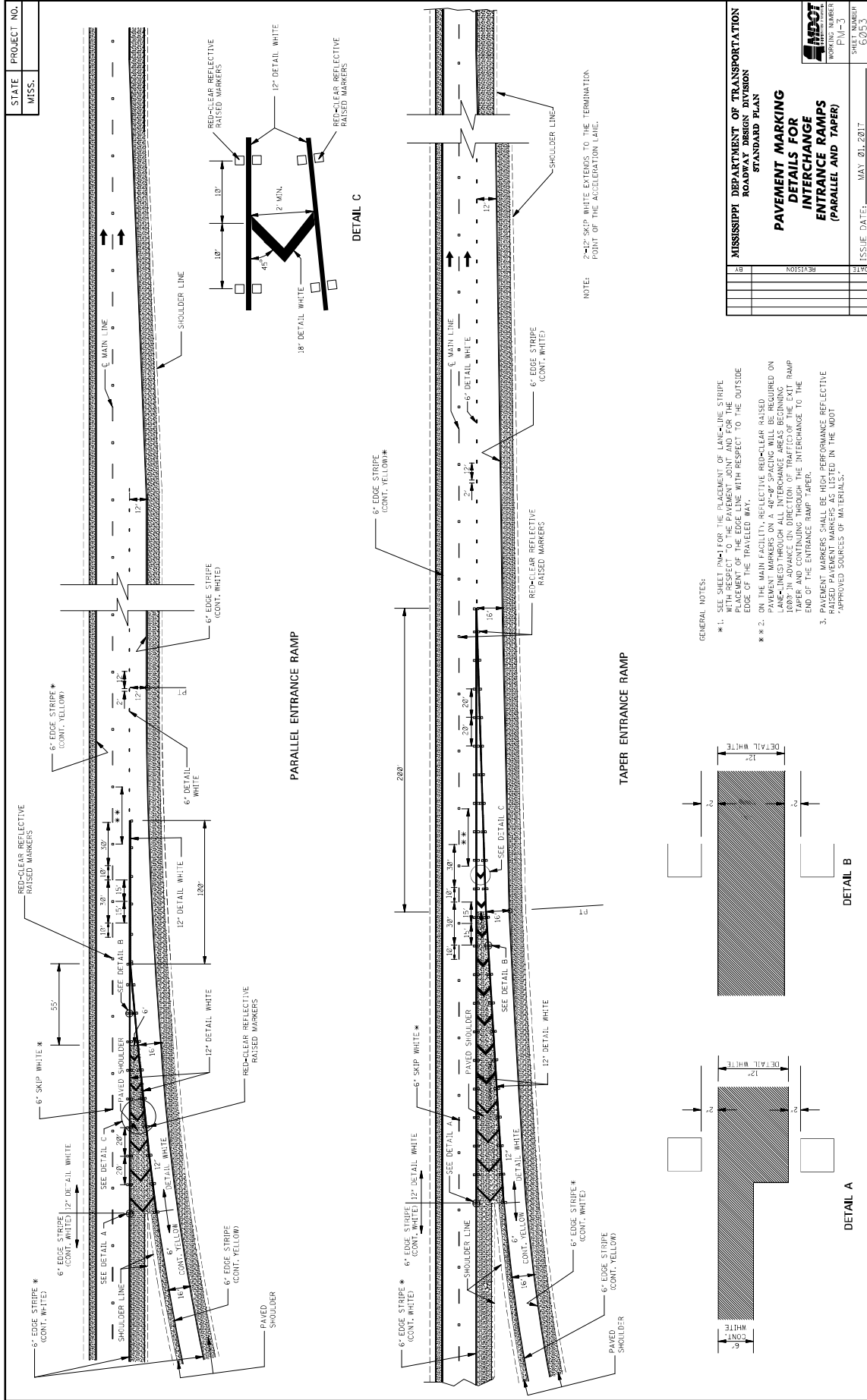

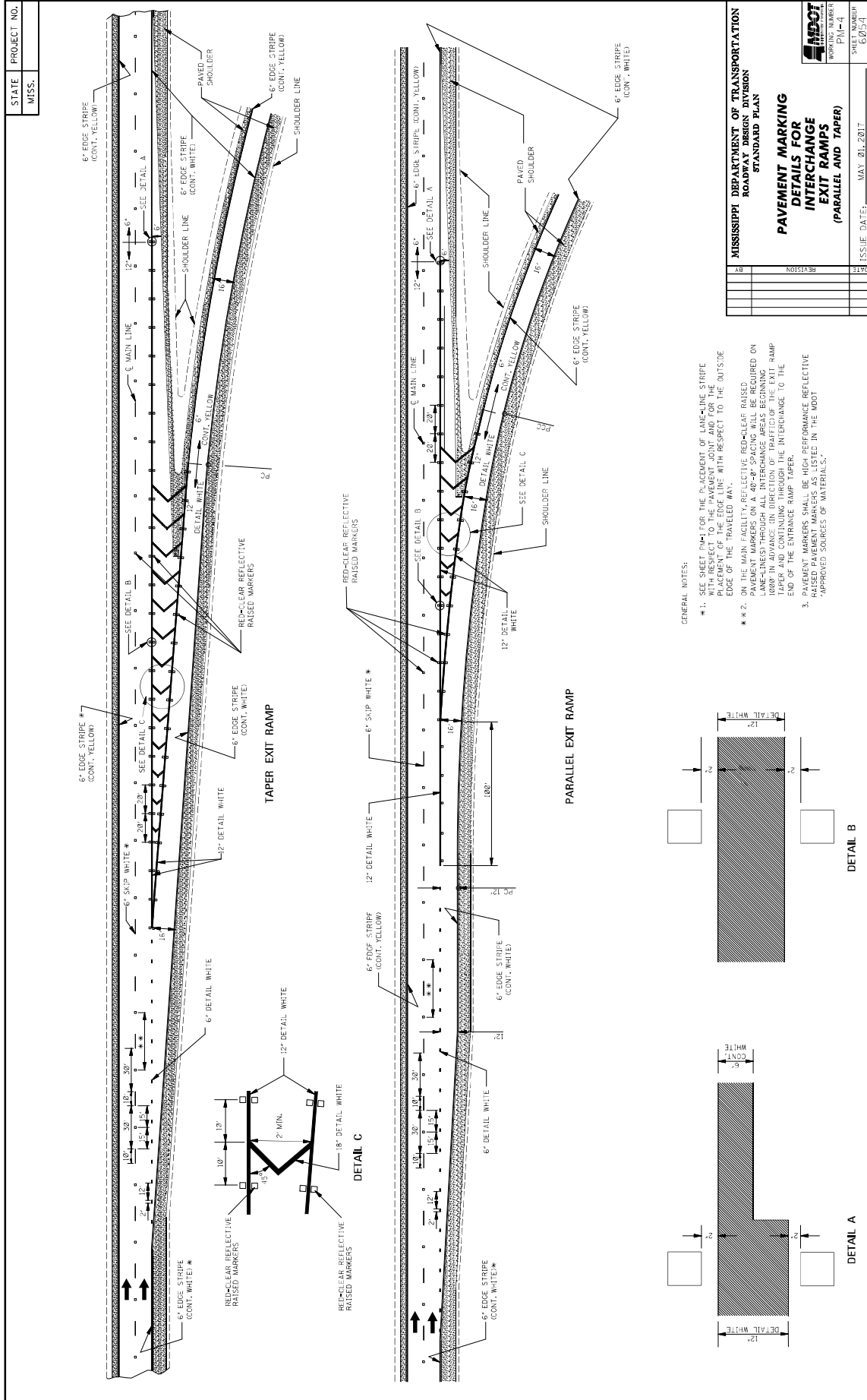

STATE MISS.	PROJECT NO.										
----------------	-------------	--	--	--	--	--	--	--	--	--	--

  

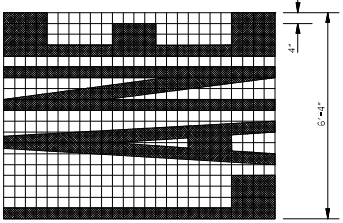

8'-4" x 6'-4" x 4"

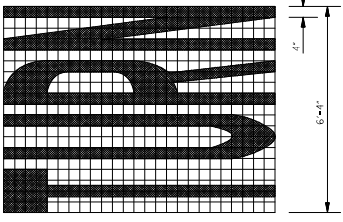

8'-4" x 6'-4" x 4"

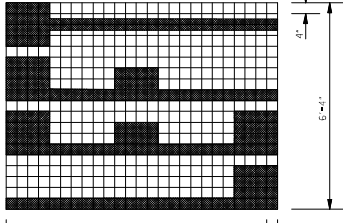

8'-4" x 6'-4" x 4"

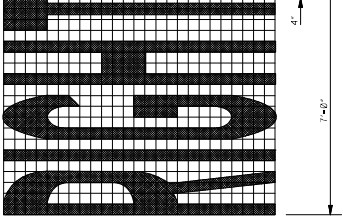

8'-4" x 7'-0" x 4"

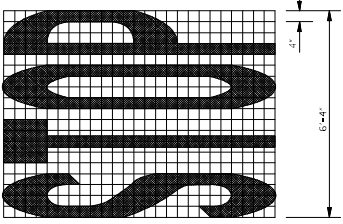

8'-4" x 6'-4" x 4"

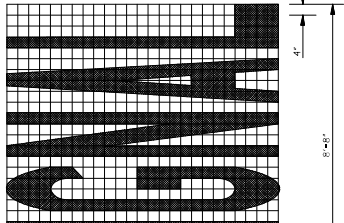

8'-4" x 6'-0" x 4"

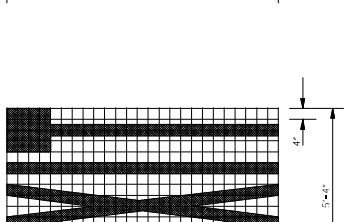

8'-4" x 5'-4" x 4"

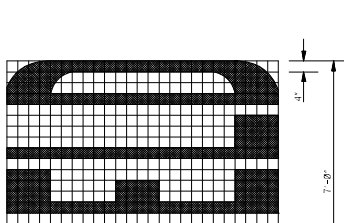

8'-4" x 7'-0" x 4"

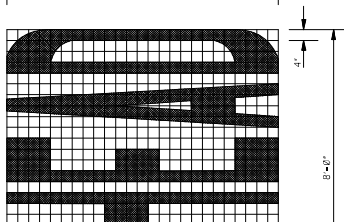

8'-4" x 8'-0" x 4"

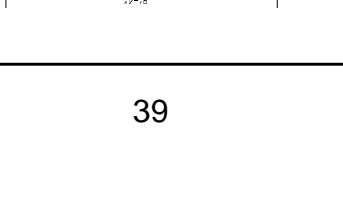

8'-4" x 9'-8" x 4"

**GENERAL NOTES:**

- TWO HORIZONTAL GAPS (USED BY TEMPLATE CONNECTIONS) OF 1/2" SHALL EXTEND THROUGH LETTERS OR BE OMITTED ENTIRELY.
- FOR OTHER DETAILS, SEE THE MANUAL ON UNIFORM TRAFFIC CONTROL DEVICES.
- PAY QUANTITIES FOR PAVEMENT MARKING LEGENDS ARE AS FOLLOWS:

**MISSISSIPPI DEPARTMENT OF TRANSPORTATION**  
ROADWAY DESIGN DIVISION  
STANDARD PLAN

**PAVEMENT MARKING LEGEND DETAILS**

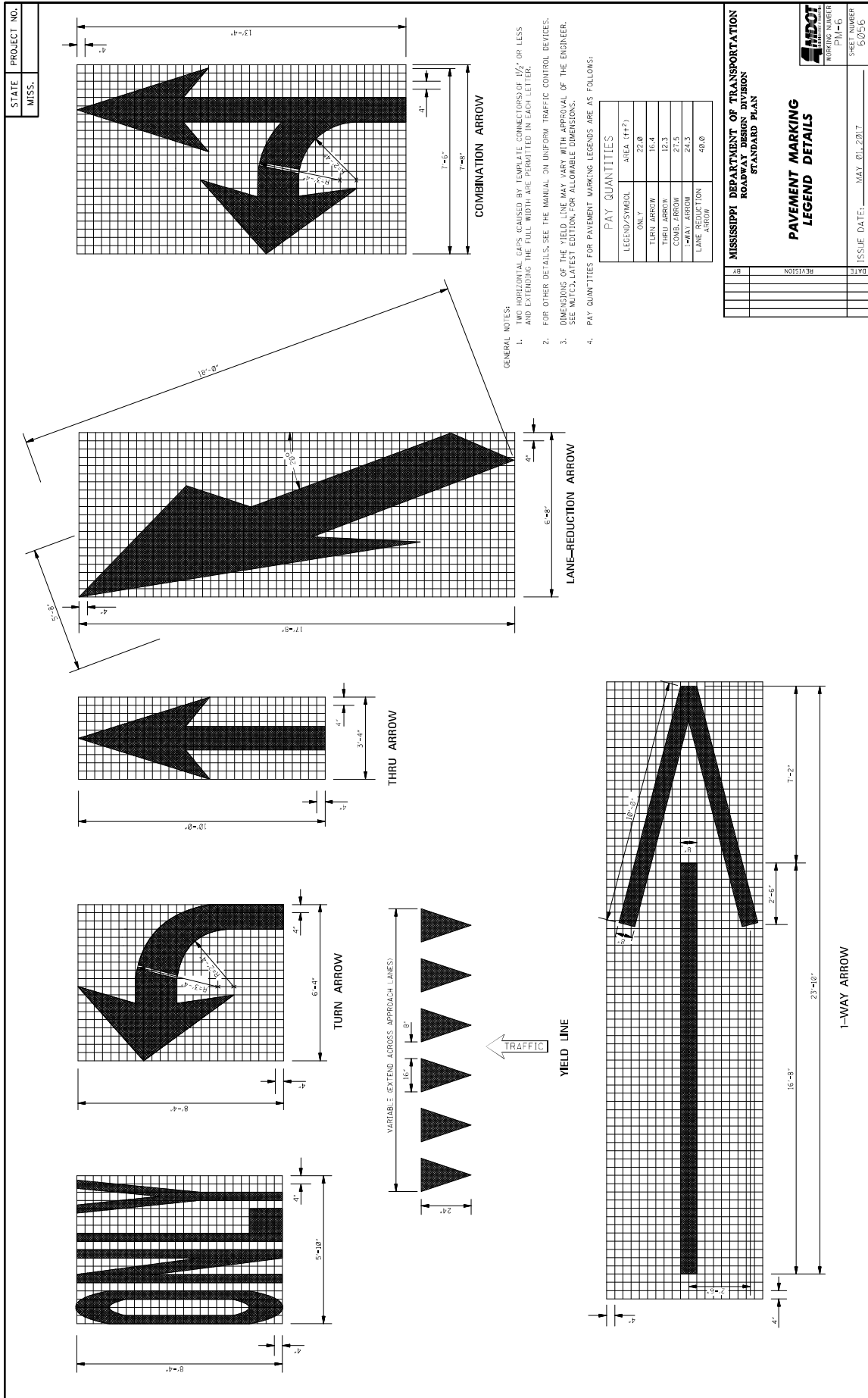

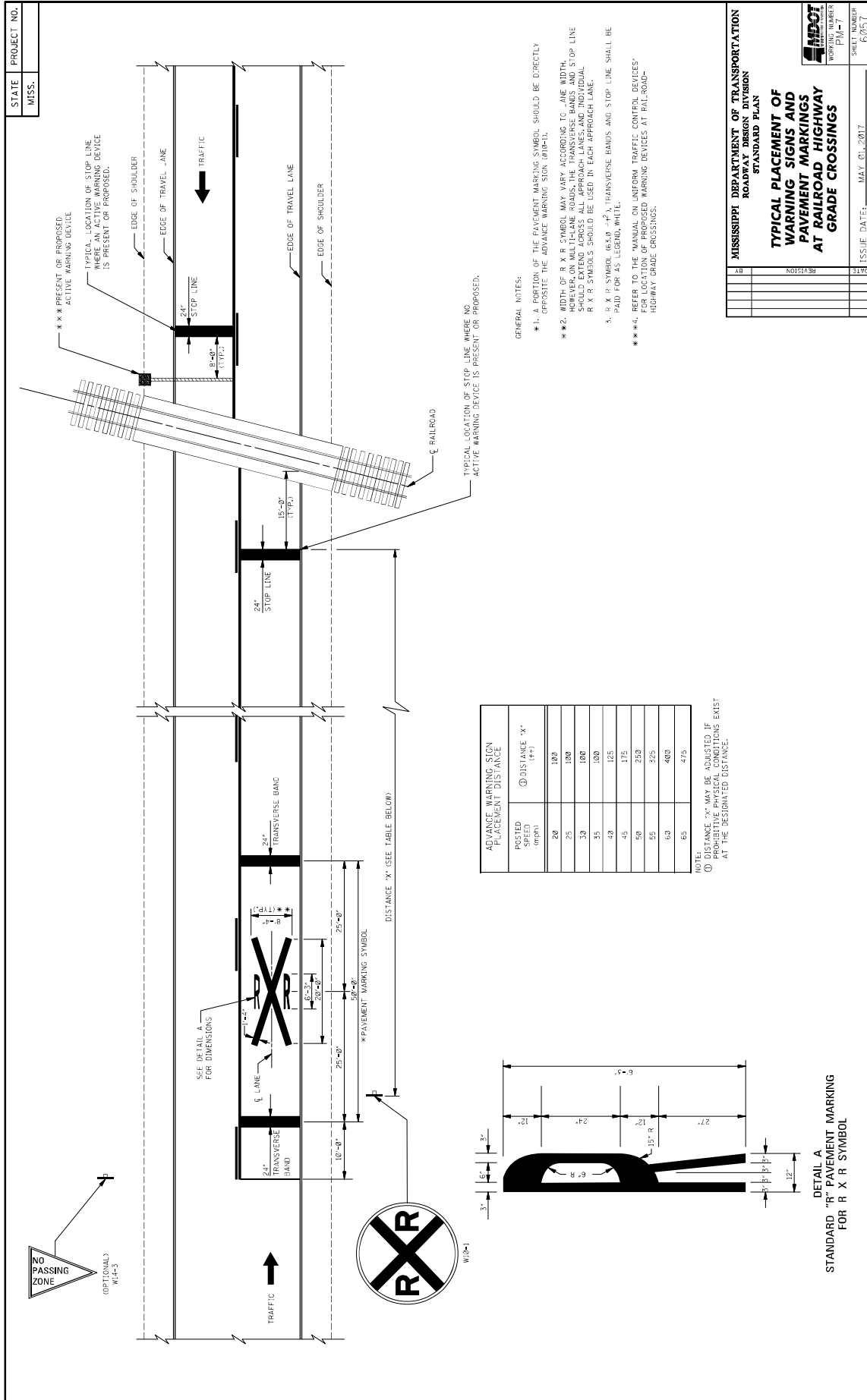

POSTED SPEED (mph)	① DISTANCE 'X' (ft)
20	100
25	100
30	100
35	100
40	125
45	175
50	250
55	325
60	400
65	475

NOTE: DISTANCE 'X' MAY BE ADJUSTED IF PROHIBITIVE PHYSICAL CONDITIONS EXIST AT THE DESIGNATED DISTANCE.

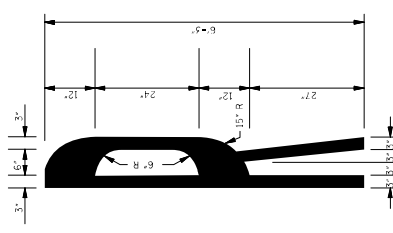

DETAIL A  
STANDARD "R" PAVEMENT MARKING  
FOR R X R SYMBOL

- GENERAL NOTES:
- \*\*1. A PORTION OF THE PAVEMENT MARKING SYMBOL SHOULD BE DIRECTLY OPPOSITE THE ADVANCE WARNING SIGN (W14-1).
  - \*\*2. WIDTH OF R X R SYMBOL MAY VARY ACCORDING TO LANE WIDTH. SYMBOL SHOULD EXTEND ACROSS ALL APPROACH LANES AND INDIVIDUAL R X R SYMBOLS SHOULD BE USED IN EACH APPROACH LANE.
  - \*\*3. R X R SYMBOL (65.8 - 71.1) TRANSVERSE BANDS AND STOP LINE SHALL BE PAID FOR AS LEGEND WHITE.
  - \*\*4. REFER TO THE MANUAL ON UNIFORM TRAFFIC CONTROL DEVICES FOR LOCATION OF PROPOSED WARNING DEVICES AT RAILROAD-HIGHWAY GRADE CROSSINGS.

STATE PROJECT NO.  
MISS.

MISSISSIPPI DEPARTMENT OF TRANSPORTATION  
ROADWAY DESIGN DIVISION  
STANDARD PLAN

**TYPICAL PLACEMENT OF WARNING SIGNS AND PAVEMENT MARKINGS AT RAILROAD HIGHWAY GRADE CROSSINGS**

MDOT  
WORKING NUMBER  
P10-7

SHEET NUMBER  
60511

ISSUE DATE: MAY 01, 2017



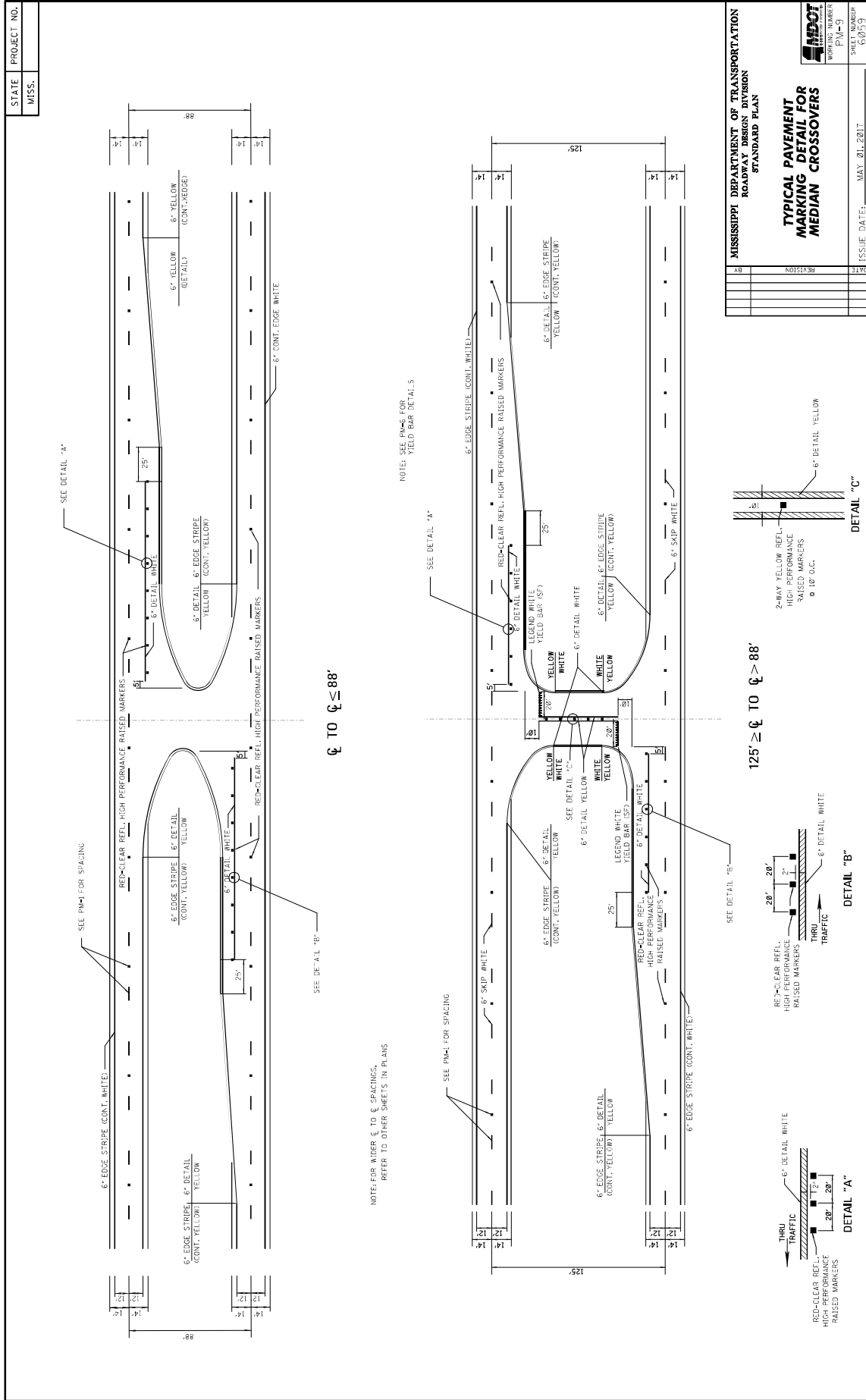



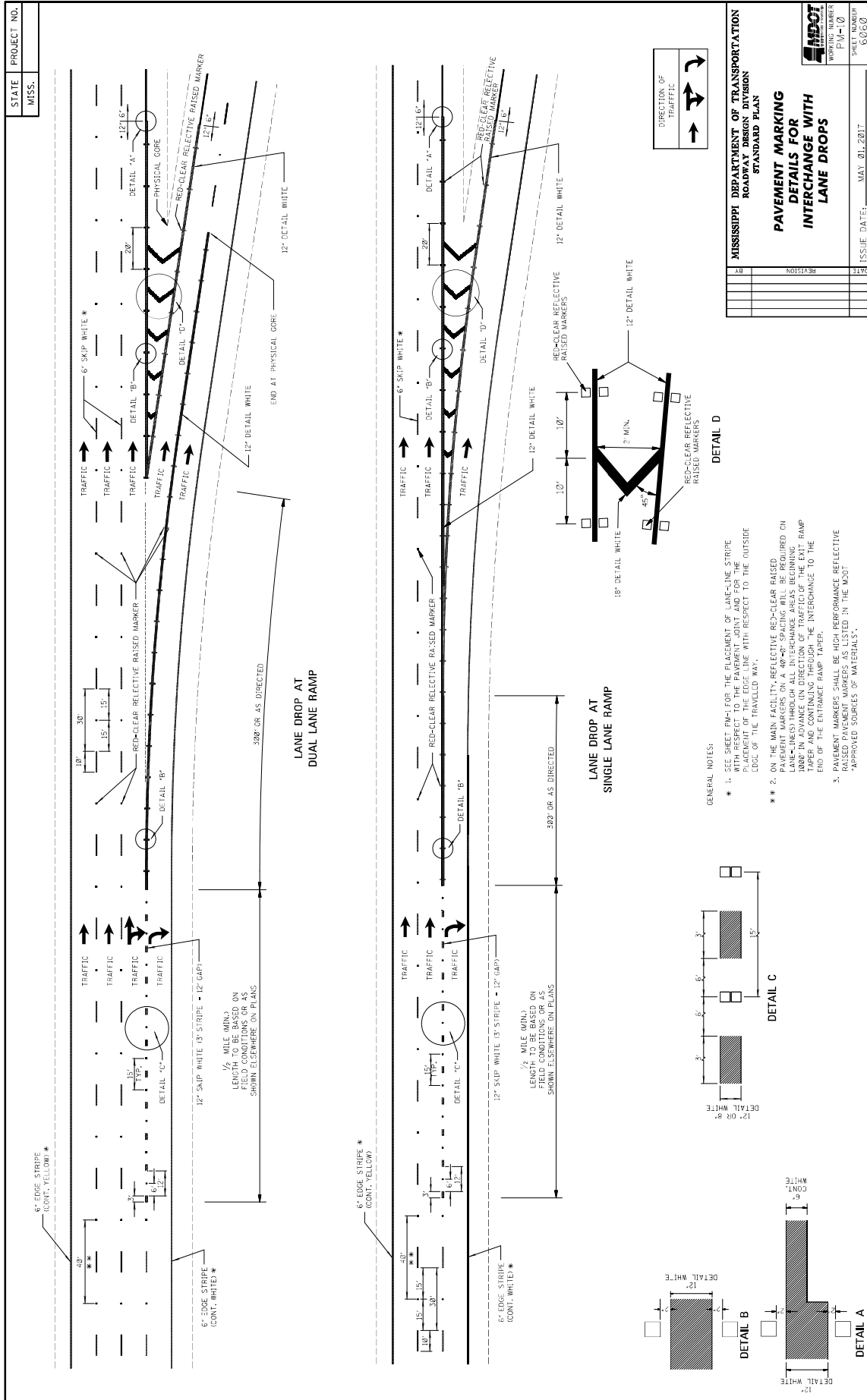

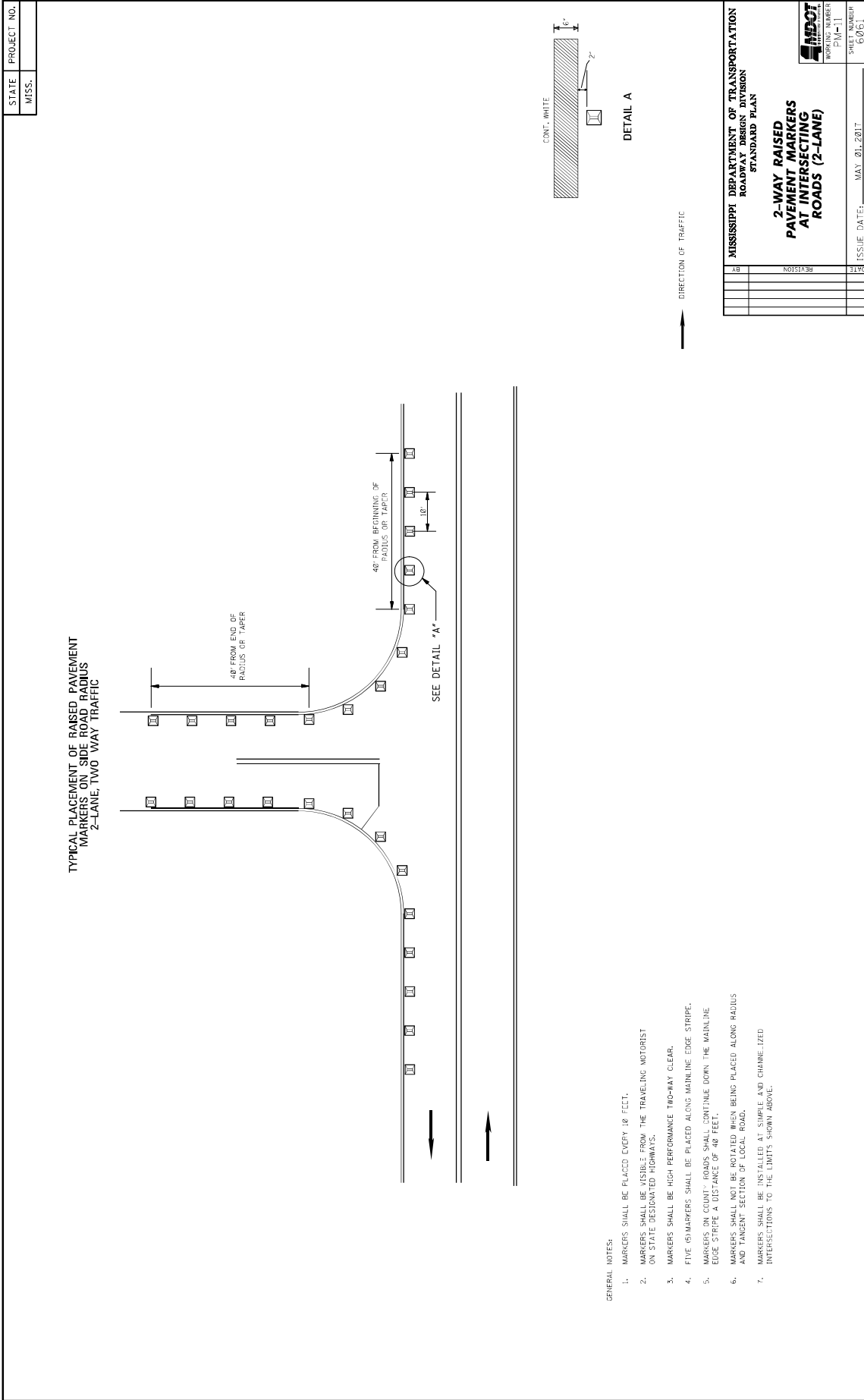

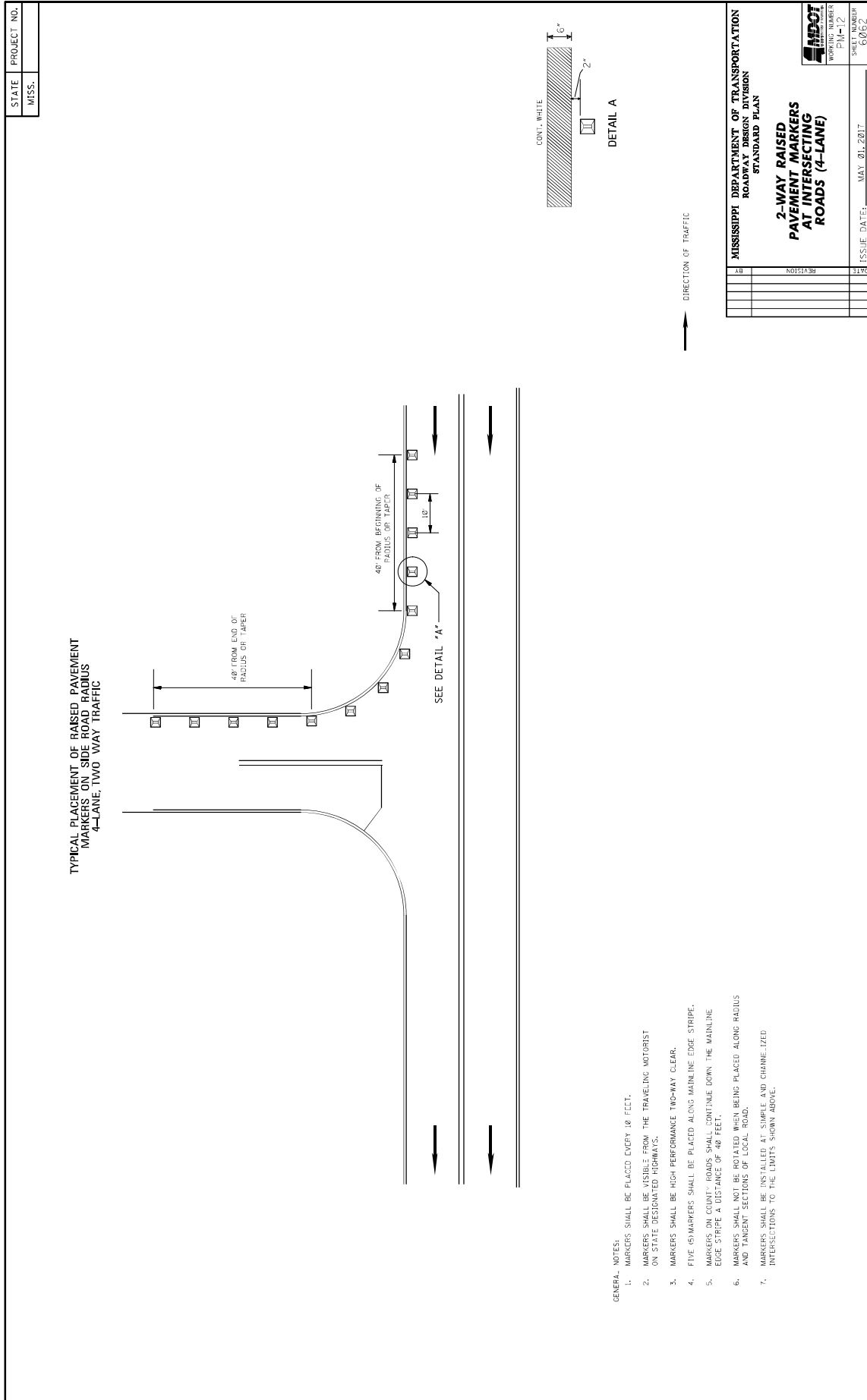

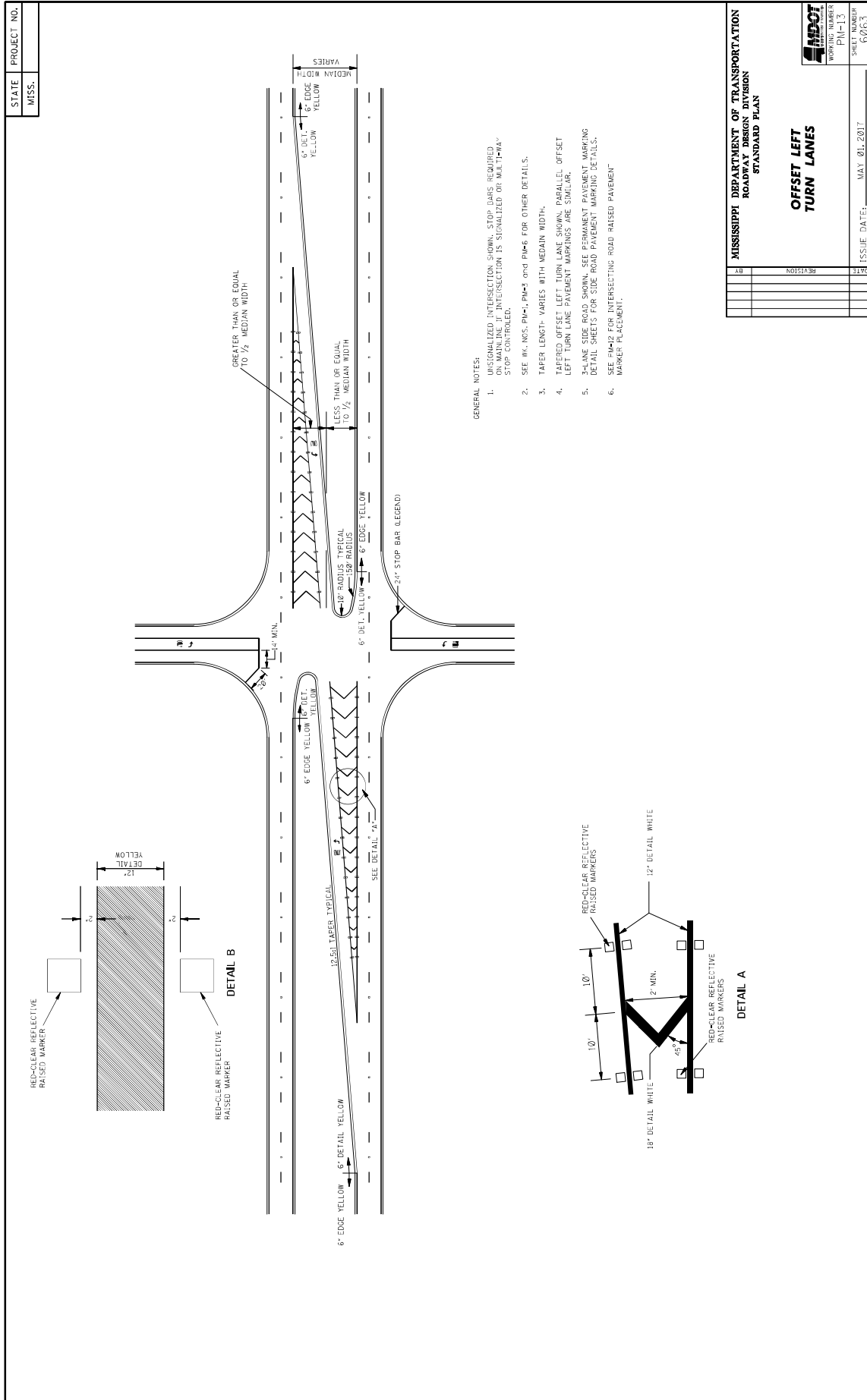

<b>MISSISSIPPI DEPARTMENT OF TRANSPORTATION</b>	
<b>ROADWAY DESIGN DIVISION</b>	
<b>STANDARD PLAN</b>	
<b>OFFSET LEFT TURN LANES</b>	
DATE	ISSUE DATE: MAY 01, 2017
BY	SHEET NUMBER
REVISION	PROJECT NUMBER

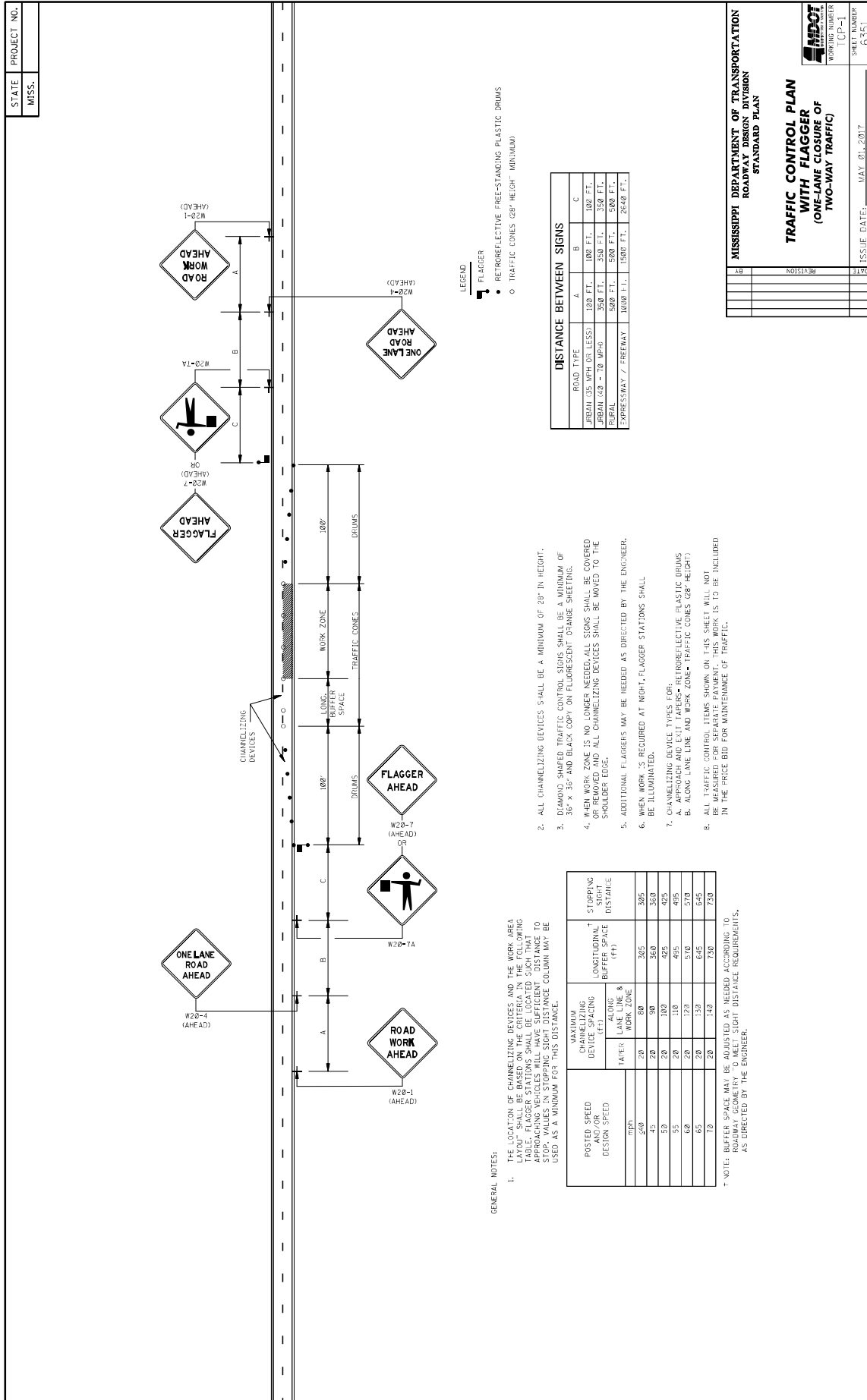

STATE PROJECT NO.  
MISS.

MISSISSIPPI DEPARTMENT OF TRANSPORTATION  
ROADWAY DESIGN DIVISION  
STANDARD PLAN

**TRAFFIC CONTROL PLAN  
WITH FLAGGER  
(ONE-LANE CLOSURE OF  
TWO-WAY TRAFFIC)**

ISSUE DATE: MAY 01, 2017

WORKING NUMBER [CP-1]  
SHEET NUMBER 6351

ROAD TYPE	A	B	C
URBAN (35 MPH OR LESS)	100 FT.	100 FT.	100 FT.
URBAN (40 - 70 MPH)	250 FT.	250 FT.	350 FT.
RURAL	500 FT.	500 FT.	500 FT.
EXPRESSWAY / FREEWAY	1000 FT.	1500 FT.	2500 FT.

LEGEND

- FLAGGER
- RETROREFLECTIVE PREF-STANDING PLASTIC DRUMS
- TRAFFIC CONES (28" HEIGHT MINIMUM)

1. THE LOCATION OF CHANNELIZING DEVICES AND THE WORK AREA LAYOUT SHALL BE BASED ON THE CRITERIA IN THE FOLLOWING TABLE. FLAGGER STATIONS SHALL BE LOCATED SUCH THAT THE FLAGGER IS ALWAYS IN THE VIEW OF TRAFFIC. STOPPING DISTANCE VALUES IN STOPPING SIGHT DISTANCE COLUMN MAY BE USED AS A MINIMUM FOR THIS DISTANCE.
2. ALL CHANNELIZING DEVICES SHALL BE A MINIMUM OF 20" IN HEIGHT.
3. DIAMOND SHAPED TRAFFIC CONTROL SIGNS SHALL BE A MINIMUM OF 36" X 36" AND BLACK COPY ON FLUORESCENT ORANGE SHEETING.
4. WHEN WORK ZONE IS NO LONGER NEEDED, ALL SIGNS SHALL BE COVERED OR REMOVED. ALL CHANNELIZING DEVICES SHALL BE MOVED TO THE SHOULDER EDGE.
5. ADDITIONAL FLAGGERS MAY BE NEEDED AT NIGHT. FLAGGER STATIONS SHALL BE ILLUMINATED.
6. WHEN WORK IS REQUIRED AT NIGHT, FLAGGER STATIONS SHALL BE ILLUMINATED.
7. CHANNELIZING DEVICE TYPES FOR:
  - A. APPROACH AND EXIT TAPERS= RETROREFLECTIVE PLASTIC DRUMS
  - B. ALONG-LANE LINE AND WORK ZONE= TRAFFIC CONES (28" HEIGHT)
8. ALL TRAFFIC CONTROL ITEMS SHOWN ON THIS SHEET WILL NOT BE MEASURED FOR SEPARATE PAYMENT. THIS WORK IS TO BE INCLUDED IN THE PRICE BID FOR MAINTENANCE OF TRAFFIC.

POSTED SPEED DESIGN SPEED	MAXIMUM CHANNELIZING DEVICE SPACING (FT)		STOPPING SIGHT DISTANCE (FT)
	LANE LINE & WORK ZONE	CONDITIONAL BUFFER SPACE	
50	20	80	305
45	20	90	320
50	20	100	425
55	20	110	495
60	20	120	570
65	20	130	645
70	20	140	730

NOTE: BUFFER SPACE MAY BE ADJUSTED AS NEEDED ACCORDING TO ROADWAY GEOMETRY TO MEET SIGHT DISTANCE REQUIREMENTS, AS DIRECTED BY THE ENGINEER.

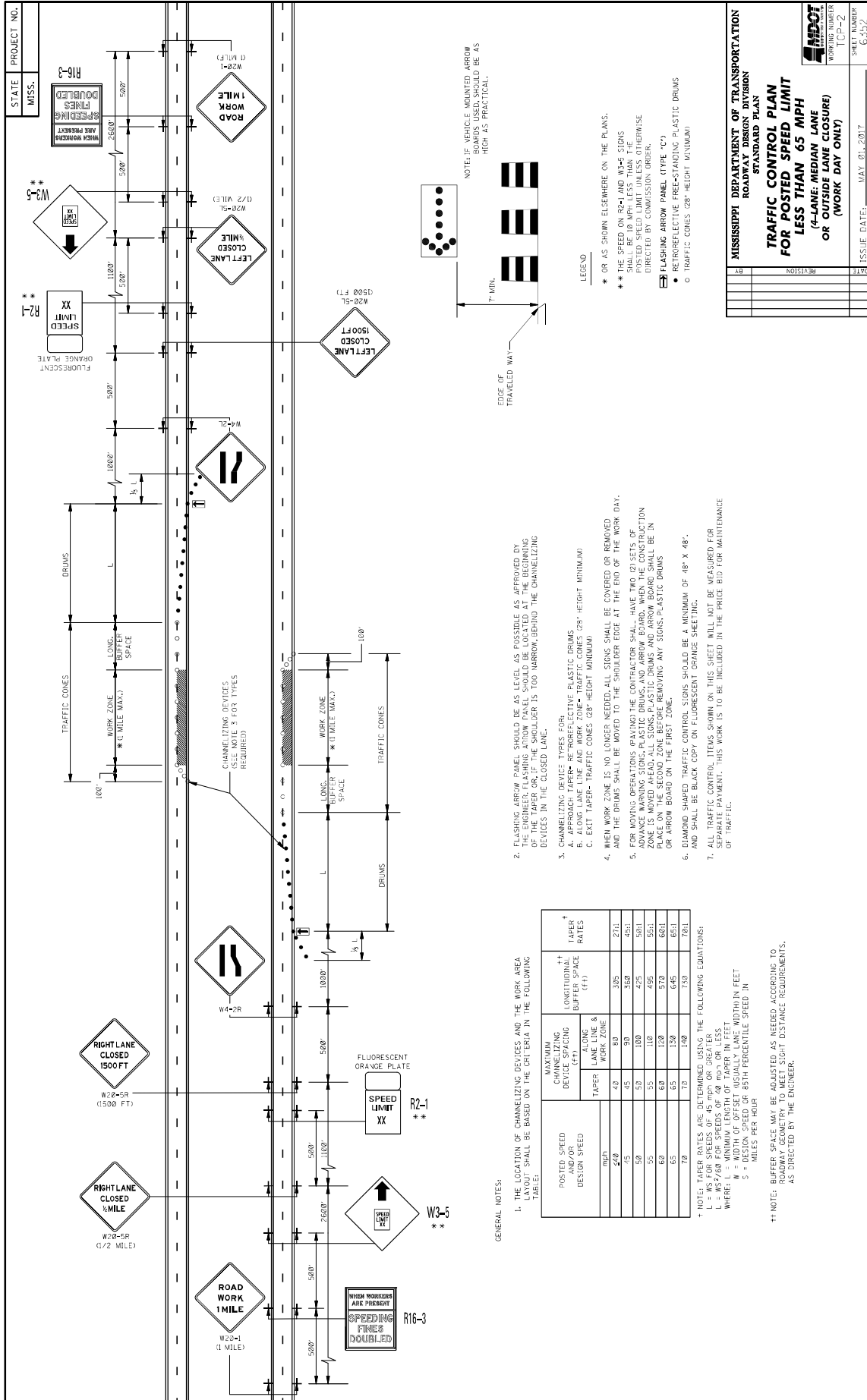

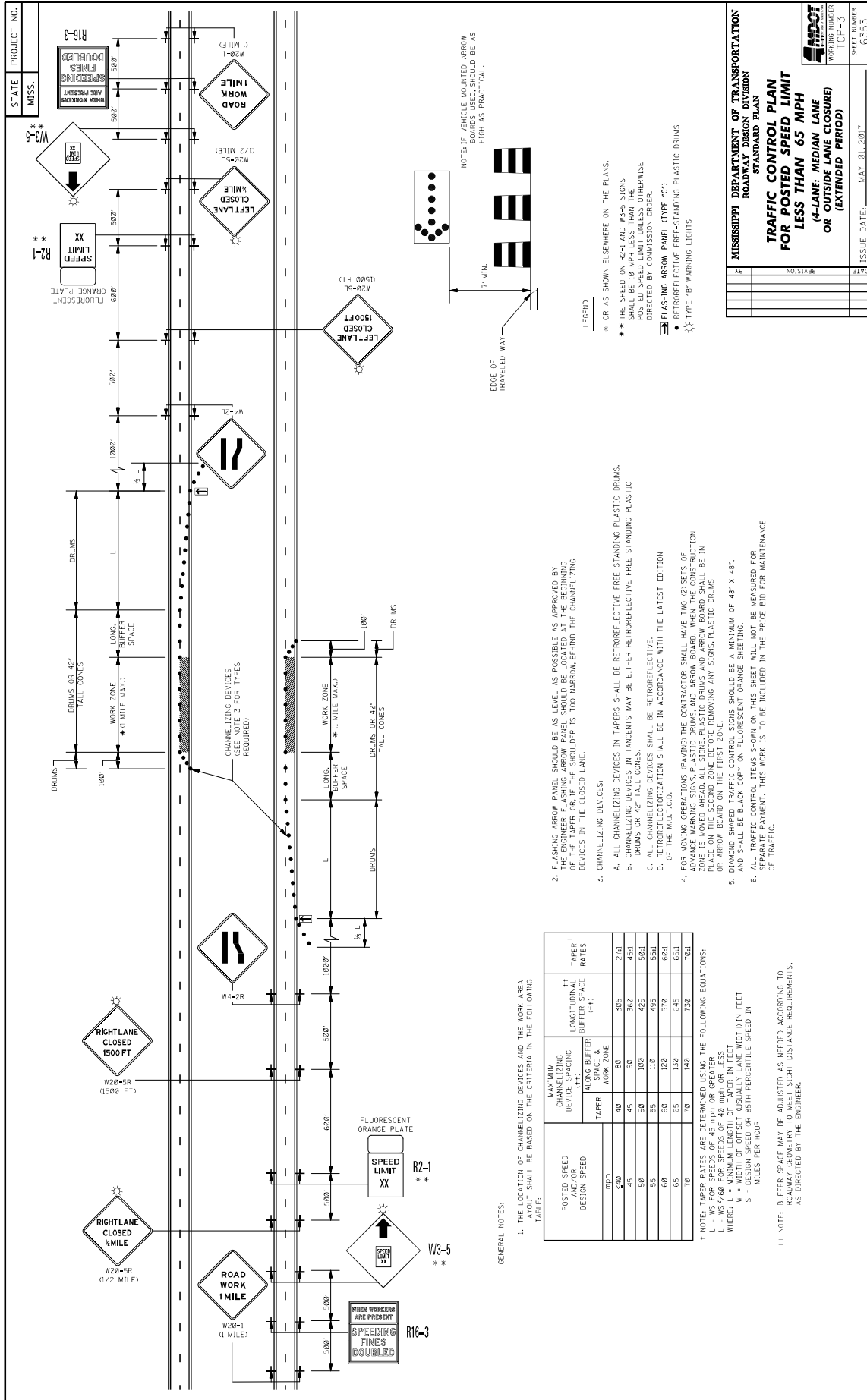

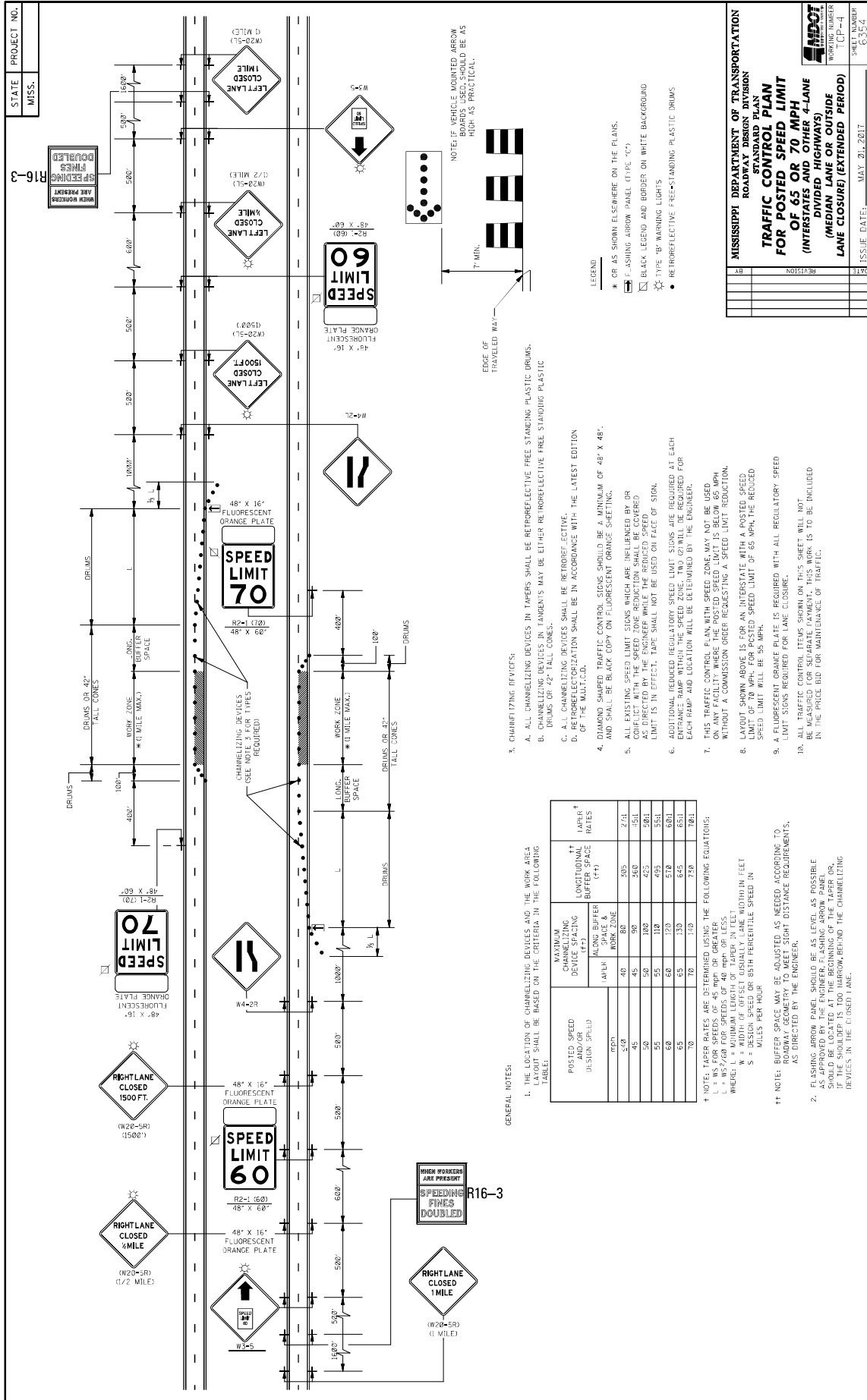



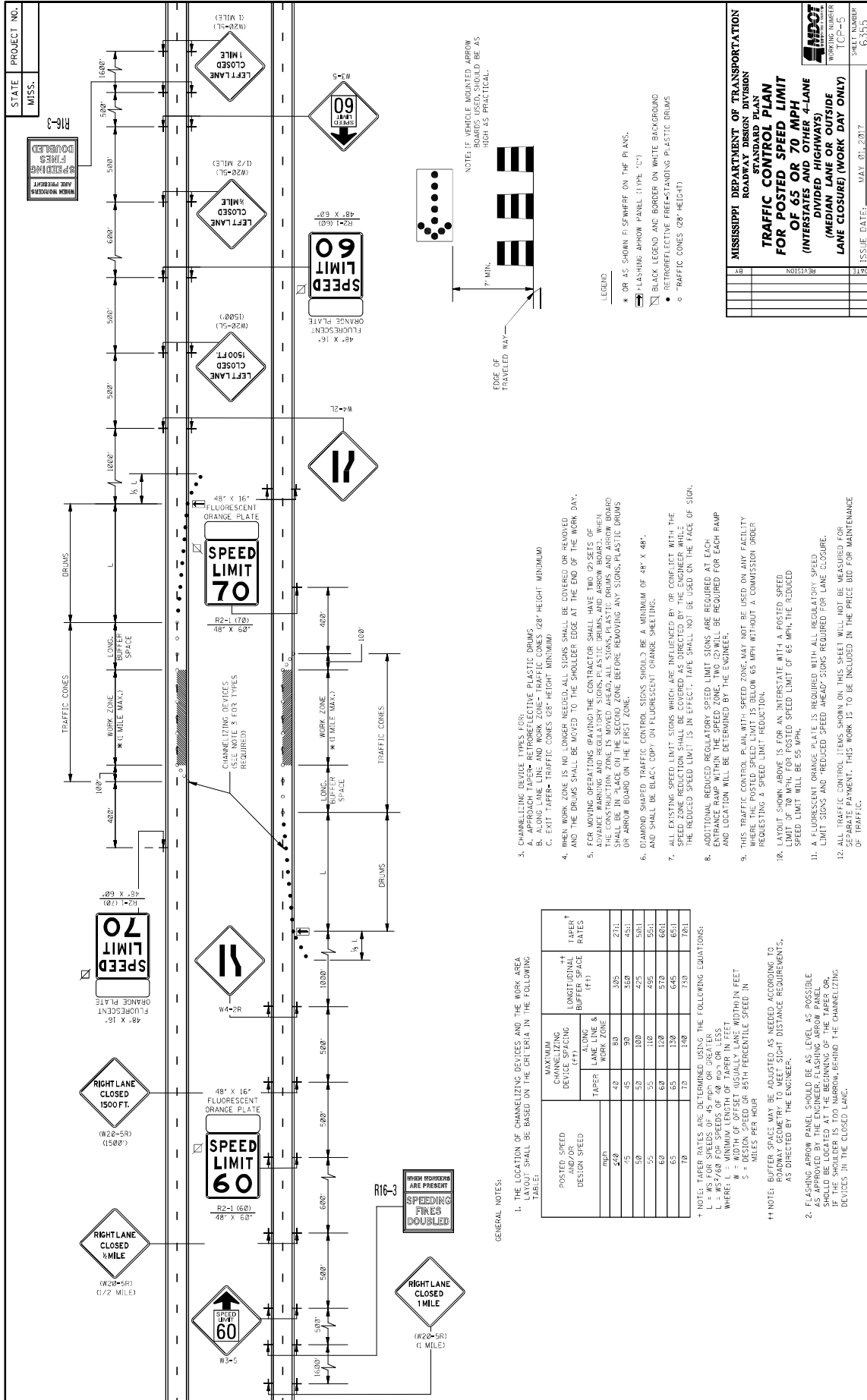

STATE PROJECT NO.  
MISS.

MISSISSIPPI DEPARTMENT OF TRANSPORTATION  
ROADWAY DESIGN DIVISION  
STANDARD PLAN  
**HIGHWAY SIGN AND BARRICADE DETAILS FOR CONSTRUCTION PROJECTS**

WORKING NUMBER: TSP-5  
SHEET NUMBER: 03300  
ISSUE DATE: MAY 20, 2017

**WING BARRICADES**

1. WING BARRICADES ARE TYPE II BARRICADES ERRECTED ON THE SHOULDER OF A ROADWAY OR RESTRICTED ROADWAY. WING BARRICADES MAY BE USED AS A MOUNTING FOR THE ADVANCE WARNING SIGNS OR FLASHERS.

2. WING BARRICADES SHOULD BE USED:

A. IN ADVANCE OF A CONSTRUCTION PROJECT EVEN WHEN NO PART OF THE ROADWAY IS ACTUALLY CLOSED.

B. IN ADVANCE OF ALL BRIDGE OR CULVERT WIDENING OPERATIONS.

**PLASTIC DRUM STRIPPING DETAIL**

1. PLASTIC DRUMS SHALL BE ON END AND USED AS AN EXPEDIENT METHOD FOR TRAFFIC CHANNELIZATION. THE COLOR AND MARKING OF DRUMS SHALL BE CONSISTENT WITH THE MARKING STRIPES. THE PREDOMINANT COLOR OF DRUMS WITH MARKING STRIPES SHALL BE RETROREFLECTIVE. HORIZONTAL, CIRCUMFERENTIAL STRIPES (2 ORANGE & 2 WHITE) 6" WIDE.

2. DRUMS SHOULD NEVER BE PLACED IN THE ROADWAY WITHOUT WARNING SIGNS.

3. WHERE PRACTICAL PLASTIC DRUMS SHOULD BE PLACED NO CLOSER THAN 3'-0" FROM THE EDGE OF TRAVELED LANE.

**BARRICADE CLOSING A ROAD**

	I	II	III
WIDTH OF RAIL **	8" MIN. - 12" MAX.	8" MIN. - 12" MAX.	8" MIN. - 12" MAX.
LENGTH OF RAIL **	24' MIN.	24' MIN.	48' MIN.
WIDTH OF STRIPE *	6"	6"	6"
HEIGHT	36" MIN.	36" MIN.	60" MIN.
NUMBER OF RETROREFLECTORIZED RAIL FACES	2 (ONE EACH DIRECTION)	4 (TWO EACH DIRECTION)	3 IF FACING TRAFFIC IN ONE DIRECTION AND 4 IN TWO DIRECTIONS

**BARRICADE CHARACTERISTICS**

\* 1. FOR RAILS LESS THAN 36" LONG, 4" WIDE STRIPES MAY BE USED.

\*\* 2. BARRICADES INTENDED FOR USE ON EXPRESSWAYS, FREEWAYS AND OTHER HIGH SPEED ROADWAYS SHALL HAVE A MINIMUM OF 270 IN<sup>2</sup> OF REFLECTIVE AREA FACING TRAFFIC.

**STANDARD BARRICADES**

1. THE MARKING FOR BARRICADE RAILS SHALL BE ORANGE AND WHITE (SLOPING DOWNWARD AT AN ANGLE OF 45° IN THE DIRECTION OF TRAFFIC IS TO PASS).

2. RAIL STRIPE SHALL BE 6 INCHES, EXCEPT THAT 4-INCH WIDE STRIPES MAY BE USED IF RAIL LENGTHS ARE LESS THAN 36 INCHES.

3. DO NOT PLACE SANDBAGS OR OTHER DEVICES TO PROVIDE MASS ON THE BOTTOM RAIL THAT WILL BLOCK VIEW OR RAIL FACE.

4. FOR ADDITIONAL INFORMATION OR DETAILS, SEE MUTCD, LATEST EDITION.

5. BARRICADES ARE CLASSIFIED BY FHWA AS CATEGORY II WHEN ZONE DEVICES WHICH REQUIRE SUCCESSFULLY CRASH TESTED. A LIST OF CRASHWORTHY BARRICADES AND OTHER CATEGORY II DEVICES CAN BE FOUND ON FHWA'S WEBSITE: [http://safety.fhwa.dot.gov/roadway\\_dept/pafety\\_guidance/road\\_hardware/cat2.cfm](http://safety.fhwa.dot.gov/roadway_dept/pafety_guidance/road_hardware/cat2.cfm)

**CHEVRON SIGN DETAIL**

1. A CHEVRON SIGN CONSISTS OF A BLACK CHEVRON TYPE MARKING ON AN ORANGE BACKGROUND AND SHALL POINT IN THE DIRECTION OF TRAFFIC FLOW.

2. THE CHEVRON SIGN SHALL BE MOUNTED ON CRASHWORTHY SUPPORT.

3. CHEVRON SIGNS MAY BE USED TO SUPPLEMENT OTHER STANDARD DEVICES WHERE ONE OR MORE LANES ARE CLOSED FOR CONSTRUCTION OR MAINTENANCE. THEY SHOULD BE PLACED APPROXIMATELY 2'-0" BEHIND THE LANE TRANSITION STRIPE.

**TYPE 3 OBJECT MARKER (OM-3R)**

1. TYPE 3 OBJECT MARKERS SHALL BE USED AT ALL EXPOSED BRIDGE ABUTMENTS AND AT OTHER LOCATIONS AS DETERMINED NECESSARY BY THE ENGINEER.

2. THE OM-3R IS SIMILAR EXCEPT THE STRIPES SLOPE DOWNWARD FROM THE UPPER LEFT SIDE TO THE LOWER RIGHT SIDE AND SHALL BE PLACED ON THE LEFT SIDE OF THE OBJECT.

3. THE INSIDE EDGE OF THE MARKER SHALL BE IN LINE WITH THE INNER EDGE OF THE OBSTRUCTION.

STATE MISS.	PROJECT NO.	
----------------	-------------	--

### MOBILE OPERATIONS ON MULTILANE ROAD

**MOBILE OPERATIONS ON MULTILANE ROAD**

### MOBILE OPERATIONS ON TWO-LANE ROAD

**MOBILE OPERATIONS ON TWO-LANE ROAD**

**NOTES FOR MULTILANE LANE OPERATION:**

- VEHICLES USED FOR THESE OPERATIONS SHOULD BE MADE HIGHLY VISIBLE WITH APPROPRIATE EQUIPMENT, SUCH AS FLASHING LIGHTS, ROTATING BEACONS, FLASERS, SIGNS, OR ARROW PANELS.
- SHADOW VEHICLE 2 SHOULD BE EQUIPPED WITH AN ARROW PANEL AND TRUCK MOUNTED ATTENUATOR (TMA), AN APPROPRIATE LANE CLOSURE SIGN SHOULD BE PLACED IN FRONT OF SHADOW VEHICLE 2 SO AS NOT TO OBSCURE THE ARROW PANEL.
- SHADOW VEHICLE 1 SHOULD BE EQUIPPED WITH AN ARROW PANEL AND TRUCK MOUNTED ATTENUATOR (TMA).
- SHADOW VEHICLE 2 SHOULD TRAVEL AT A VARYING DISTANCE FROM THE WORK OPERATION SO AS TO PROVIDE ADEQUATE SIGHT DISTANCE FOR TRAFFIC APPROACHING FROM THE REAR.
- WHEN ADEQUATE SHOULDER WIDTH IS NOT AVAILABLE, SHADOW VEHICLE 2 SHOULD BE ELIMINATED.
- ON HIGH-SPEED ROADWAYS, A THIRD SHADOW VEHICLE SHOULD BE USED (i.e., VEHICLE 3 ON THE SHOULDER OF PRACTICALLY, VEHICLE 2 IN THE CLOSED LANE, AND VEHICLE 1 IN THE CLOSED LANE).
- ARROW PANELS SHALL BE AS A MINIMUM TYPE B, 60" X 30" IN ACCORDANCE WITH THE CRITERIA PRESENTED IN THE MUTCD.
- WORK SHOULD NORMALLY BE DONE DURING OFF-PEAK HOURS.
- VEHICLE-MOUNTED SIGNS SHOULD BE MOUNTED WITH THE BOTTOM OF THE SIGN LOCATED AT A MINIMUM HEIGHT OF 48" ABOVE THE PAVEMENT AND SHALL NOT BE OBTURED BY EQUIPMENT OR SUPPLIES. SIGN LEGENDS SHALL BE COVERED OR TURNED FROM VIEW WHEN WORK IS NOT IN PROGRESS.
- ALL TRAFFIC CONTROL ITEMS SHOWN ON THIS SHEET WILL NOT BE MEASURED FOR SEPARATE PAYMENT. THIS WORK IS TO BE INCLUDED IN THE PRICE BID FOR MAINTENANCE OF TRAFFIC.

**NOTES FOR TWO-LANE OPERATION:**

- WHERE PRACTICAL AND WHEN NEEDED, THE WORK AND SHADOW VEHICLES SHOULD PULL OVER PERIODICALLY TO ALLOW TRAFFIC TO PASS. IF THIS CAN NOT BE DONE FREQUENTLY AS AN ALTERNATIVE, A "DO NOT PASS" SIGN MAY BE PLACED ON THE REAR OF THE VEHICLE BLOCKING THE LANE.
- THE DISTANCE BETWEEN THE WORK AND SHADOW VEHICLES MAY VARY ACCORDING TO TERRAIN, PAINT DRYING TIME, AND OTHER FACTORS. SHADOW VEHICLES ARE USED TO WARN TRAFFIC OF THE OPERATION AHEAD. WHENEVER ADEQUATE SIGHT DISTANCE IS NOT AVAILABLE, SHADOW VEHICLES SHOULD BE USED. SHADOW VEHICLES SHOULD MAINTAIN THE MINIMUM DISTANCE AND PROCEED AT THE SAME SPEED AS THE WORK VEHICLE. THE SHADOW VEHICLE SHOULD SLOW DOWN IN ADVANCE OF VERTICAL OR HORIZONTAL CURVES THAT RESTRICT SIGHT DISTANCE.
- ADDITIONAL SHADOW VEHICLES TO WARN AND REDUCE THE SPEED OF ONCOMING OR OPPOSING TRAFFIC MAY BE USED. POLICE PATROL CARS MAY BE USED FOR THIS PURPOSE.
- A TRUCK-MOUNTED ATTENUATOR (TMA) SHOULD BE USED ON THE SHADOW VEHICLE AND MAY BE USED ON THE WORK VEHICLE.
- THE WORK VEHICLE SHALL BE EQUIPPED WITH BEACONS AND THE SHADOW VEHICLE SHALL BE EQUIPPED WITH BEACONS AND LIGHTS. TRUCK-MOUNTED LIGHTS MOUNTED ON THE REAR, ADJACENT TO THE SIGN, SHADOW AND WORK VEHICLES SHALL DISPLAY FLASHING OR ROTATING BEACONS BOTH FORWARD AND TO THE REAR.
- VEHICLE-MOUNTED SIGNS SHOULD BE MOUNTED WITH THE BOTTOM OF THE SIGN LOCATED AT A MINIMUM HEIGHT OF 48" ABOVE THE PAVEMENT AND SHALL NOT BE OBTURED BY EQUIPMENT OR SUPPLIES. SIGN LEGENDS SHALL BE COVERED OR TURNED FROM VIEW WHEN WORK IS NOT IN PROGRESS.
- ARROW BOARD TO BE USED IN CAUTION MODE.
- ALL TRAFFIC CONTROL ITEMS SHOWN ON THIS SHEET WILL NOT BE MEASURED FOR SEPARATE PAYMENT. THIS WORK IS TO BE INCLUDED IN THE PRICE BID FOR MAINTENANCE OF TRAFFIC.

  

**MISSISSIPPI DEPARTMENT OF TRANSPORTATION**  
ROADWAY DESIGN DIVISION  
STANDARD PLAN

**TRAFFIC CONTROL PLAN**  
**MOBILE OPERATIONS**  
**MULTILANE ROADS**  
**TWO-LANE ROADS**

REV	REVISION	
1		SHEET NUMBER TCP-9
2		SHEET NUMBER 6359

ISSUE DATE: MAY 01, 2017

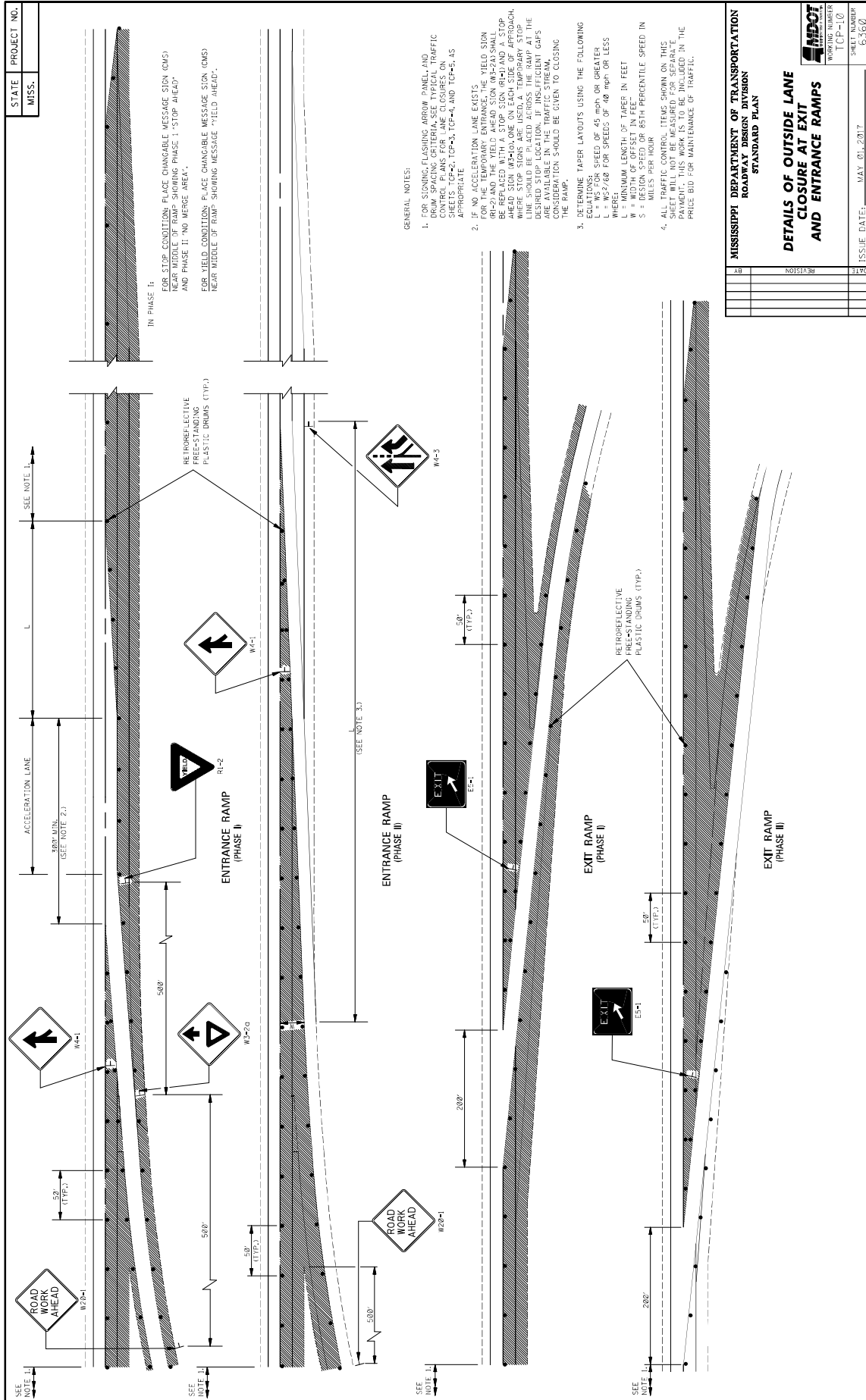

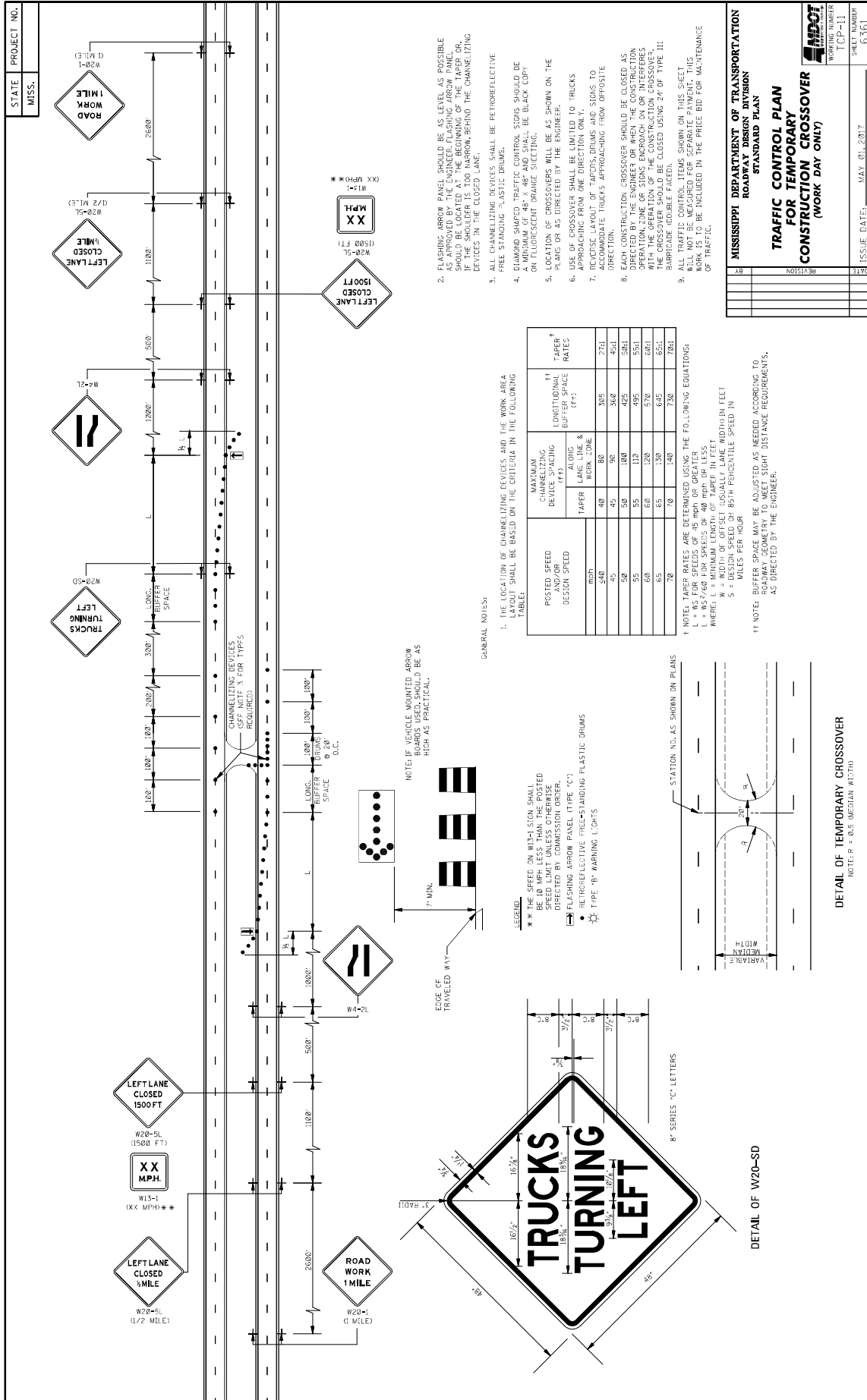

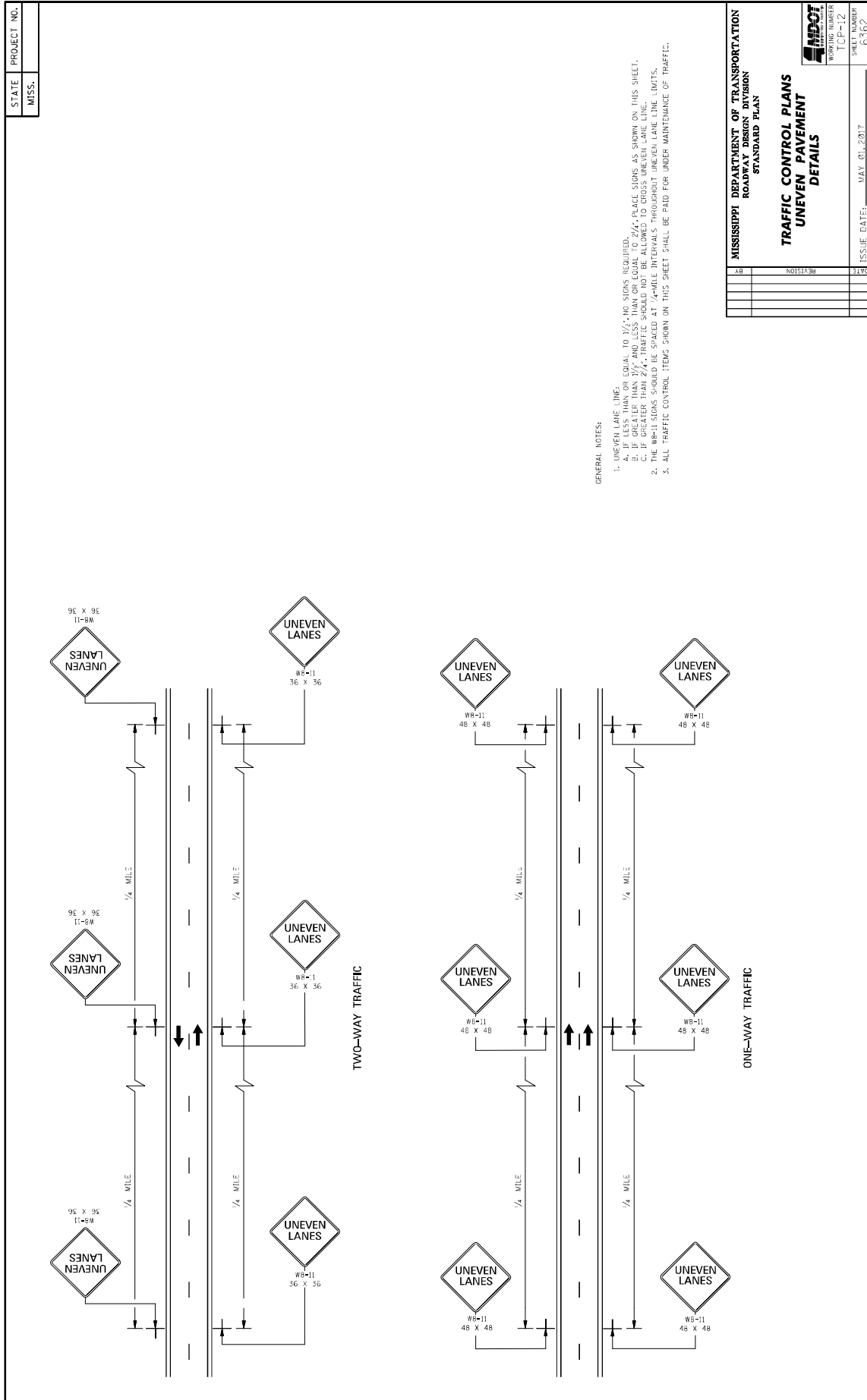

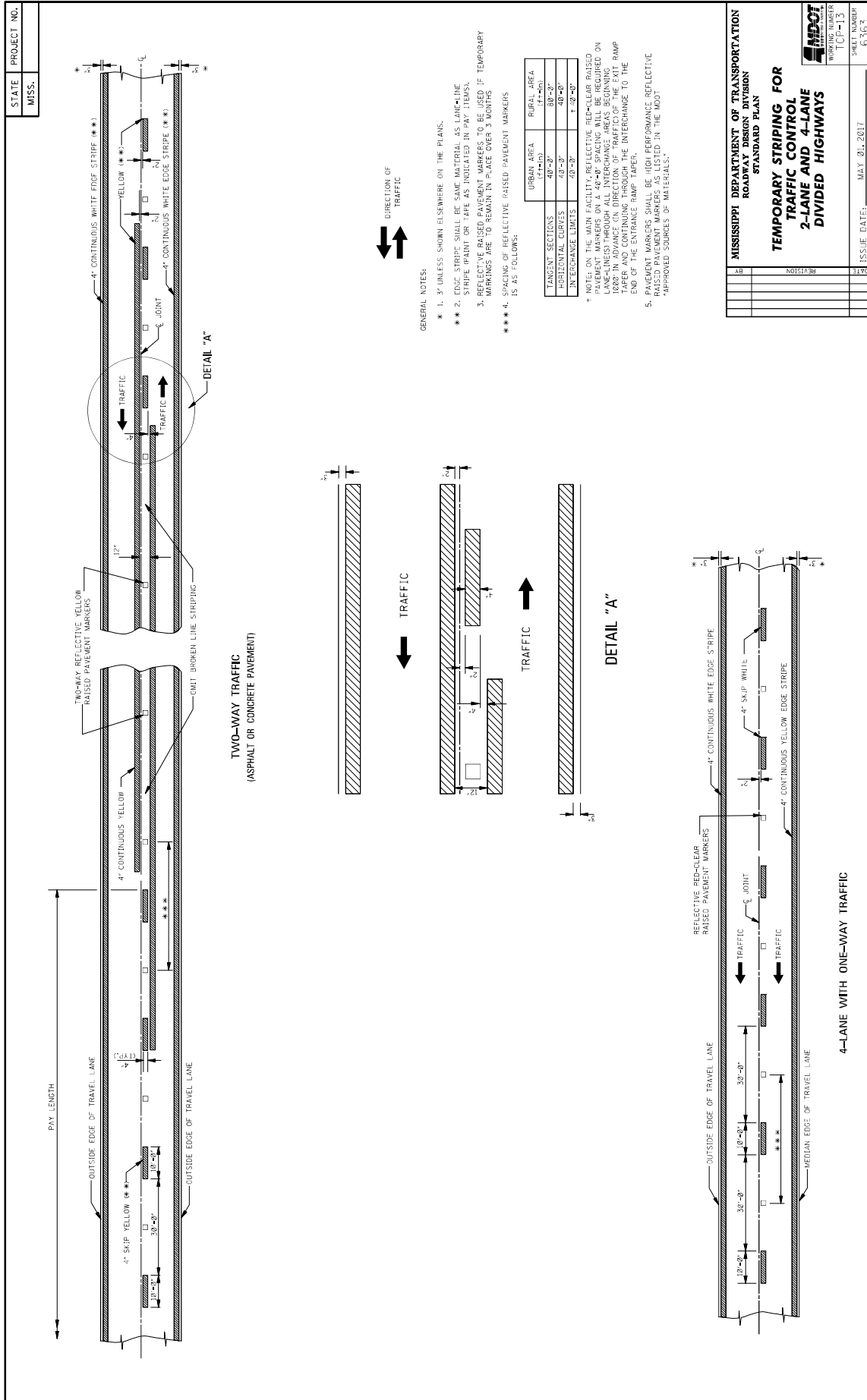

<b>MISSISSIPPI DEPARTMENT OF TRANSPORTATION</b>	
<b>ROADWAY DESIGN DIVISION</b>	
<b>STANDARD PLAN</b>	
<b>TEMPORARY STRIPING FOR</b>	
<b>2-LANE AND 4-LANE</b>	
<b>DIVIDED HIGHWAYS</b>	
WORKING NUMBER [CP-13]	SHEET NUMBER 6363
REVISION	ISSUE DATE: MAY 01, 2017

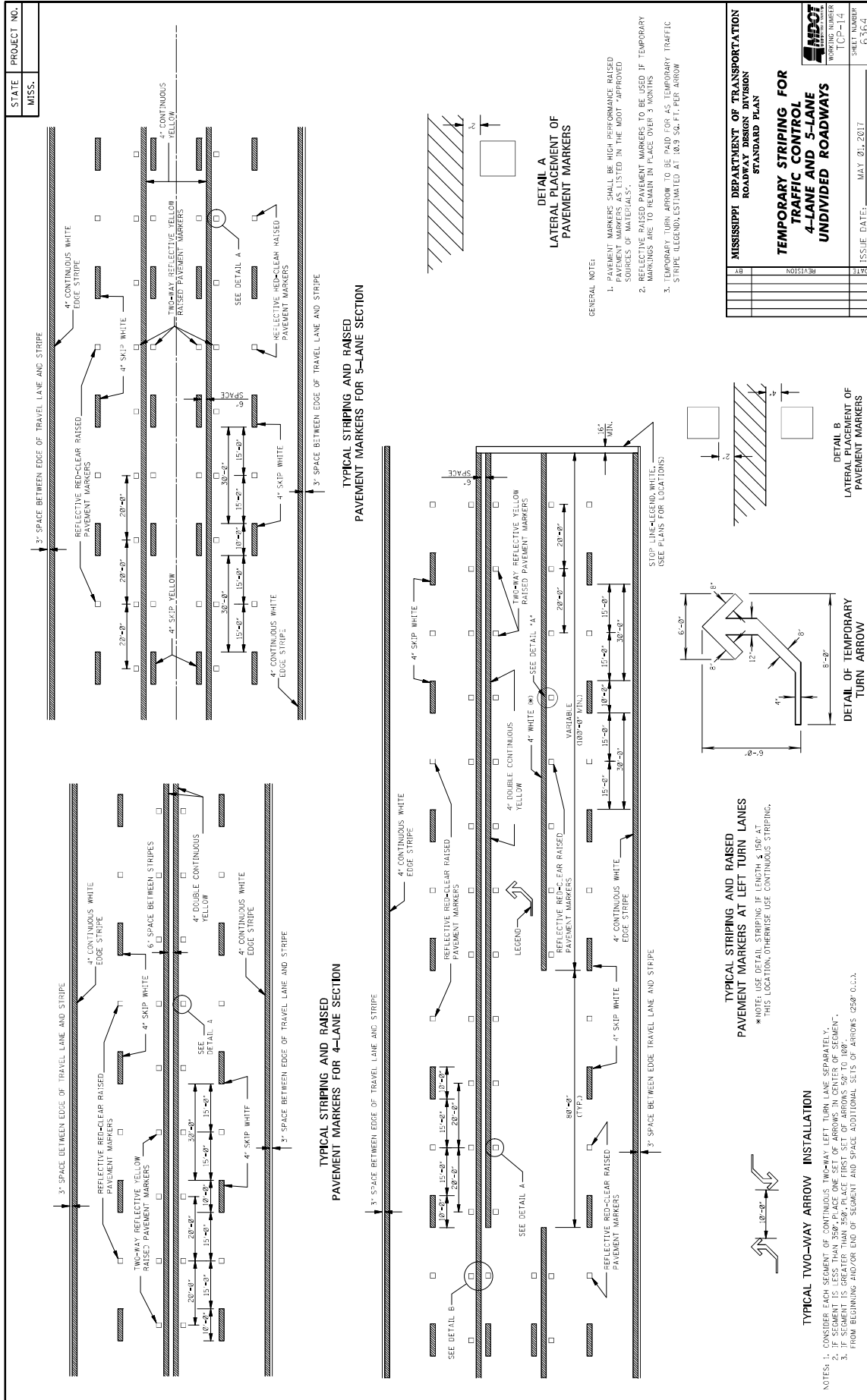



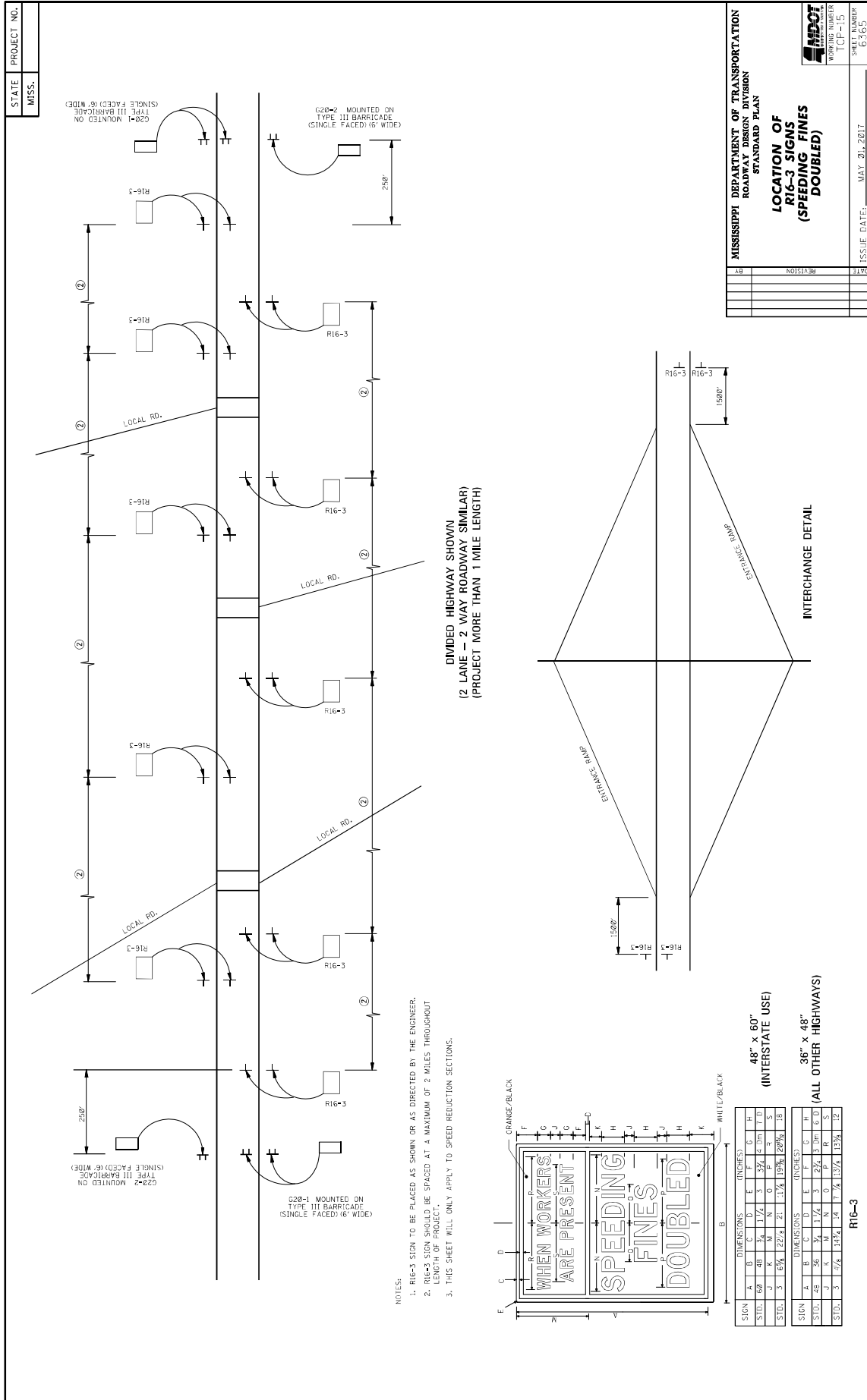

STATE PROJECT NO. MISS.	
<b>MISSISSIPPI DEPARTMENT OF TRANSPORTATION ROADWAY DESIGN DIVISION STANDARD PLAN LOCATION OF R16-3 SIGNS (SPEEDING FINES DOUBLED)</b>	
WORKING NUMBER ICP-15	SHEET NUMBER 6-163
ISSUE DATE: MAY 21, 2017	
REVISION	DATE

- NOTES:**
1. R16-3 SIGN TO BE PLACED AS SHOWN OR AS DIRECTED BY THE ENGINEER.
  2. R16-3 SIGN SHOULD BE SPACED AT A MAXIMUM OF 2 MILES THROUGHOUT LENGTH OF PROJECT.
  3. THIS SHEET WILL ONLY APPLY TO SPEED REDUCTION SECTIONS.

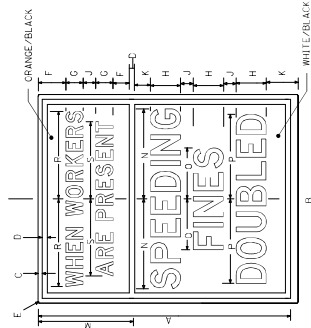

SIGN	DIMENSIONS (INCHES)							
48" x 60" (INTERSTATE USE)	A	B	C	D	E	F	G	H
	5:00	4:8	3/4	1 1/4	5	3/4	4	10 1/2
	J	K	N	O	P	Q	R	S
	3	18 3/4	22 1/2	21	1 1/4	13 3/4	28 3/4	10
	DIMENSIONS (INCHES)							
36" x 48" (ALL OTHER HIGHWAYS)	A	B	C	D	E	F	G	H
	3:00	2:8	1/2	1	3/4	3	2 1/4	8 1/2
	J	K	N	O	P	Q	R	S
	3	17 1/4	21 1/4	20	1 1/4	13 1/4	27 1/4	10

**R16-3**

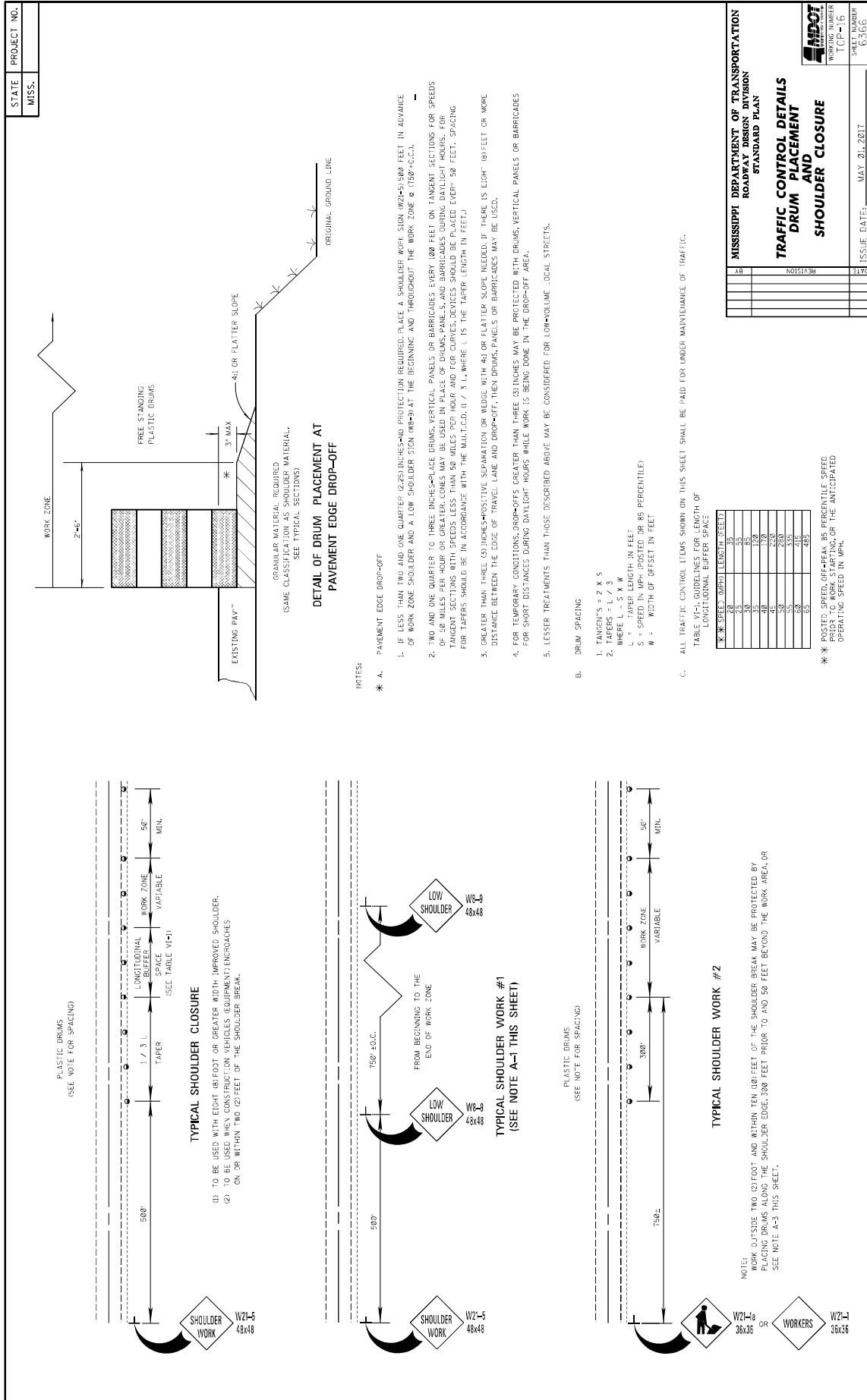

GENERAL NOTES

1. GROUND-IN RUMBLE STRIPES SHALL BE APPLIED TO PAVED SHOULDERS OF ALL PAVED SHOULDERS ON THIS PROJECT.
2. GROUND-IN RUMBLE STRIPES SHALL BE APPLIED TO ALL INTERSECTIONS, ROADWAYS, AND OTHER INTERSECTIONS IN NORMAL SHOULDER WIDTH AS DIRECTED BY THE ENGINEER.
3. COST TO BE PAID FOR USING APPROPRIATE PAY ITEMS.
4. GROUND-IN RUMBLE STRIPES SHALL BE APPLIED TO:
  - A. MAINLINE
  - B. INTERSECTING ROADWAY IF OVERLAP OR RECONSTRUCTED BEYOND NORMAL MAINLINE R.O.W.
  - C. ANY ROADWAY WITH EXISTING RUMBLE STRIPES PRIOR TO CONSTRUCTION.
5. DO NOT USE WHERE TRAVEL LANE IS LESS THAN 11' WIDE.

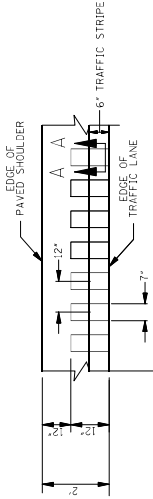

DETAIL "A"

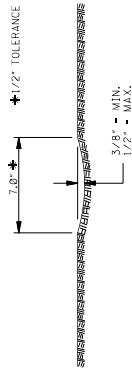

SECTION "A-A"

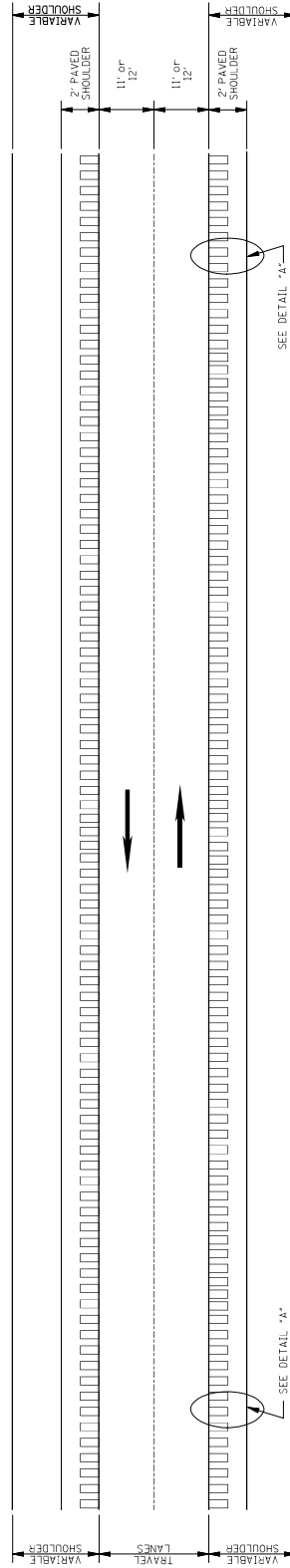

PLAN  
NOT TO SCALE

MISSISSIPPI DEPARTMENT OF TRANSPORTATION ROADWAY DESIGN DIVISION STANDARD PLAN	
DATE	ISSUE DATE: AUGUST 01, 2017
REVISION	
508	
REVISION	
509	
REVISION	
510	
REVISION	
511	
REVISION	
512	
REVISION	
513	
REVISION	
514	
REVISION	
515	
REVISION	
516	
REVISION	
517	
REVISION	
518	
REVISION	
519	
REVISION	
520	
REVISION	
521	
REVISION	
522	
REVISION	
523	
REVISION	
524	
REVISION	
525	
REVISION	
526	
REVISION	
527	
REVISION	
528	
REVISION	
529	
REVISION	
530	
REVISION	
531	
REVISION	
532	
REVISION	
533	
REVISION	
534	
REVISION	
535	
REVISION	
536	
REVISION	
537	
REVISION	
538	
REVISION	
539	
REVISION	
540	
REVISION	
541	
REVISION	
542	
REVISION	
543	
REVISION	
544	
REVISION	
545	
REVISION	
546	
REVISION	
547	
REVISION	
548	
REVISION	
549	
REVISION	
550	
REVISION	
551	
REVISION	
552	
REVISION	
553	
REVISION	
554	
REVISION	
555	
REVISION	
556	
REVISION	
557	
REVISION	
558	
REVISION	
559	
REVISION	
560	
REVISION	
561	
REVISION	
562	
REVISION	
563	
REVISION	
564	
REVISION	
565	
REVISION	
566	
REVISION	
567	
REVISION	
568	
REVISION	
569	
REVISION	
570	
REVISION	
571	
REVISION	
572	
REVISION	
573	
REVISION	
574	
REVISION	
575	
REVISION	
576	
REVISION	
577	
REVISION	
578	
REVISION	
579	
REVISION	
580	
REVISION	
581	
REVISION	
582	
REVISION	
583	
REVISION	
584	
REVISION	
585	
REVISION	
586	
REVISION	
587	
REVISION	
588	
REVISION	
589	
REVISION	
590	
REVISION	
591	
REVISION	
592	
REVISION	
593	
REVISION	
594	
REVISION	
595	
REVISION	
596	
REVISION	
597	
REVISION	
598	
REVISION	
599	
REVISION	
600	
REVISION	
601	
REVISION	
602	
REVISION	
603	
REVISION	
604	
REVISION	
605	
REVISION	
606	
REVISION	
607	
REVISION	
608	
REVISION	
609	
REVISION	
610	
REVISION	
611	
REVISION	
612	
REVISION	
613	
REVISION	
614	
REVISION	
615	
REVISION	
616	
REVISION	
617	
REVISION	
618	
REVISION	
619	
REVISION	
620	
REVISION	
621	
REVISION	
622	
REVISION	
623	
REVISION	
624	
REVISION	
625	
REVISION	
626	
REVISION	
627	
REVISION	
628	
REVISION	
629	
REVISION	
630	
REVISION	
631	
REVISION	
632	
REVISION	
633	
REVISION	
634	
REVISION	
635	
REVISION	
636	
REVISION	
637	
REVISION	
638	
REVISION	
639	
REVISION	
640	
REVISION	
641	
REVISION	
642	
REVISION	
643	
REVISION	
644	
REVISION	
645	
REVISION	
646	
REVISION	
647	
REVISION	
648	
REVISION	
649	
REVISION	
650	
REVISION	
651	
REVISION	
652	
REVISION	
653	
REVISION	
654	
REVISION	
655	
REVISION	
656	
REVISION	
657	
REVISION	
658	
REVISION	
659	
REVISION	
660	
REVISION	
661	
REVISION	
662	
REVISION	
663	
REVISION	
664	
REVISION	
665	
REVISION	
666	
REVISION	
667	
REVISION	
668	
REVISION	
669	
REVISION	
670	
REVISION	
671	
REVISION	
672	
REVISION	
673	
REVISION	
674	
REVISION	
675	
REVISION	
676	
REVISION	
677	
REVISION	
678	
REVISION	
679	
REVISION	
680	
REVISION	
681	
REVISION	
682	
REVISION	
683	
REVISION	
684	
REVISION	
685	
REVISION	
686	
REVISION	
687	
REVISION	
688	
REVISION	
689	
REVISION	
690	
REVISION	
691	
REVISION	
692	
REVISION	
693	
REVISION	
694	
REVISION	
695	
REVISION	
696	
REVISION	
697	
REVISION	
698	
REVISION	
699	
REVISION	
700	
REVISION	

**RUMBLE STRIPES  
2-LANE HIGHWAYS  
(ASPHALT LANES,  
2-FT ASPHALT SHOULDERS)**



ISSUE DATE: AUGUST 01, 2017

GENERAL NOTES

1. GROUND-IN RUMBLE STRIPES SHALL BE APPLIED TO ALL PAVED SHOULDERS AND ALL PAVED SHOULDERS ON THIS PROJECT.
2. GROUND-IN RUMBLE STRIPES SHALL BE APPLIED TO ALL INTERSECTIONS, ROADWAYS, AND OTHER INTERSECTIONS IN NORMAL SHOULDER WIDTH AS DIRECTED BY THE ENGINEER.
3. COST TO BE PAID FOR USING APPROPRIATE PAY ITEMS.
4. GROUND-IN RUMBLE STRIPES SHALL BE APPLIED TO:
  - A. MAINLINE
  - B. INTERSECTING ROADWAY IF OVERLAP OR RECONSTRUCTED BEYOND NORMAL MAINLINE R.O.W.
  - C. ANY ROADWAY WITH EXISTING RUMBLE STRIPES PRIOR TO CONSTRUCTION.

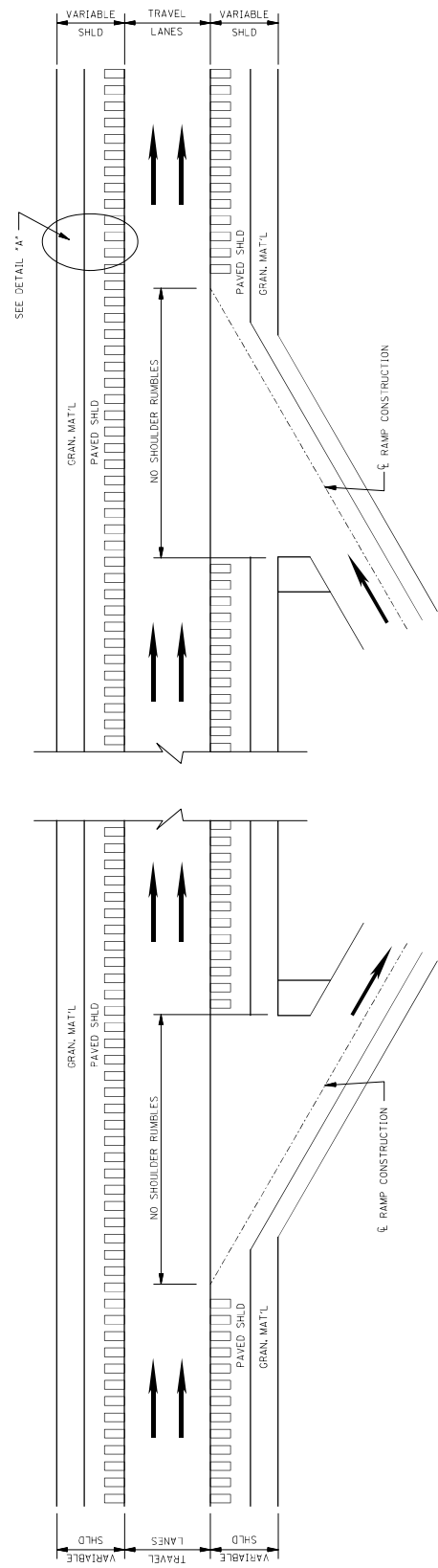
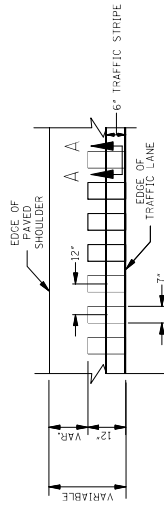
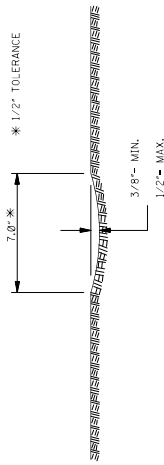

MISSISSIPPI DEPARTMENT OF TRANSPORTATION  
ROADWAY DESIGN DIVISION  
STANDARD PLAN

**RUMBLE STRIPES  
4-LANE HIGHWAYS  
(ASPHALT LANES,  
2-FT OR WIDER,  
ASPHALT SHOULDERS)**

ISSUE NUMBER: 6065  
ISSUE DATE: AUGUST 01, 2017

DATE	REVISION	LOCATION
05/08	05/08	

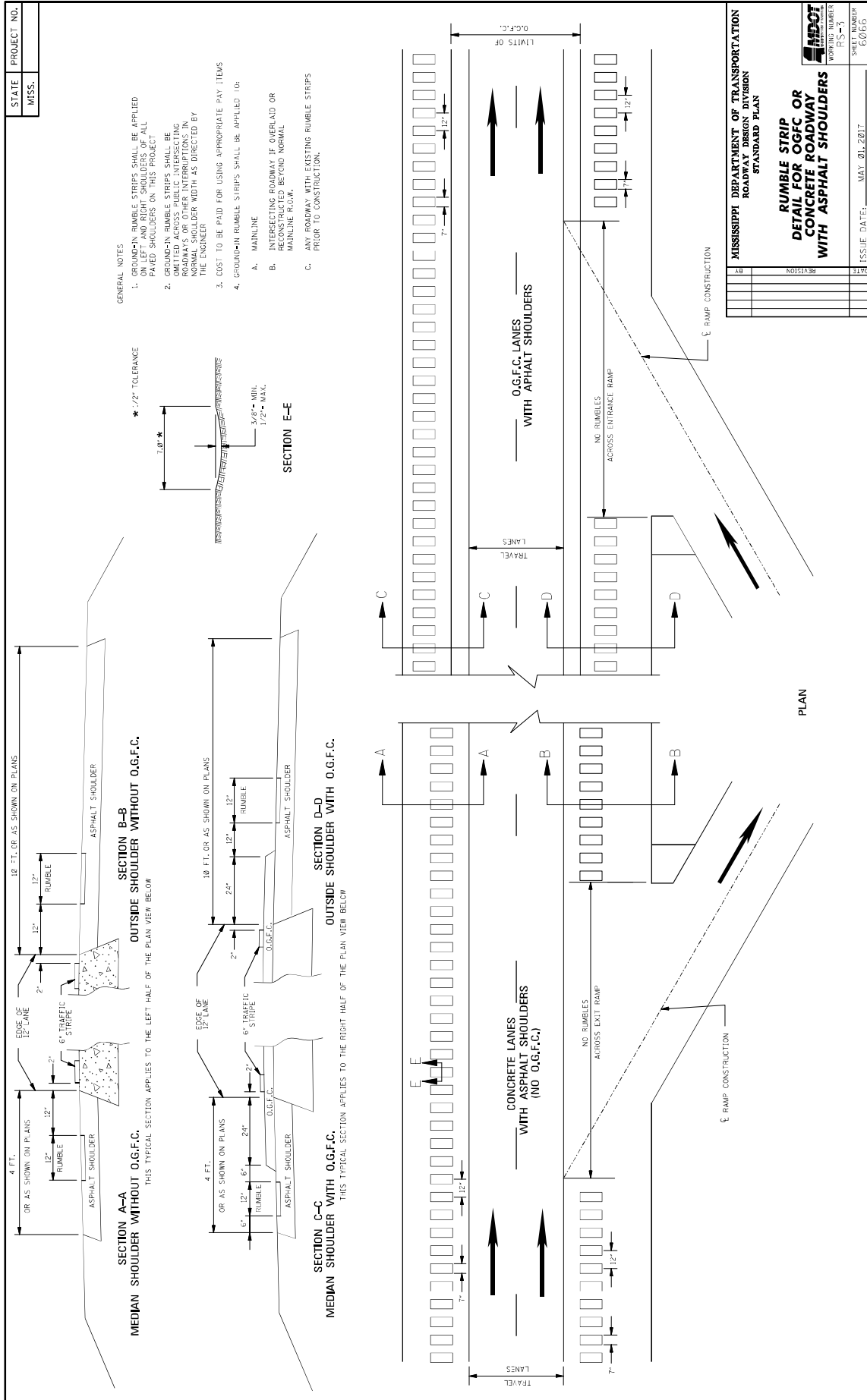

**MISSISSIPPI DEPARTMENT OF TRANSPORTATION**

**SECTION 904 - NOTICE TO BIDDERS NO. 3676**

**CODE: (SP)**

**DATE: 09/21/2021**

**SUBJECT: Asphalt Gyrotory Compactor Internal Angle Calibration**

Bidders are advised that by March 1, 2022, all asphalt gyrotory compactors shall be calibrated to an internal angle of  $1.16^{\circ} \pm 0.02^{\circ}$ . This requirement will be reflected in updates made to MT-78, MT-80, and MT-83. This calibration requirement also extends to all QC/QA testing.

## MISSISSIPPI DEPARTMENT OF TRANSPORTATION

SECTION 904 - NOTICE TO BIDDERS NO. 3875

CODE: (IS)

DATE: 12/15/2021

SUBJECT: ITS General Requirements

For this Notice to Bidders, the “Engineer” shall mean the Project Engineer and/or their designee(s) throughout the rest of this NTB, unless stated otherwise.

### Submittals

All submittals covered under this section shall be made electronically to the Project Engineer and to the ITS Engineer, shall clearly state the project name and project number, and should be in as few separate submittals as possible.

All products selected for use on this project shall be in compliance with 2 CFR 200.216, in addition to all other contract requirements as outlined throughout the specifications, special provisions and plans. No telecommunication and video surveillance equipment or services shall be manufactured by the following companies: Huawei Technologies Company, ZTE Corporation, Hytera Communications Corporation, Hangzhou Hikvision Digital Technology Company, Dahua Technology Company, and any subsidiary or affiliate of these entities.

Product Data. Manufacturers’ product data including specifications/cut-sheets, design guides, installation manuals, operating manuals, and maintenance/service manuals shall be submitted by the Contractor for each component of the ITS system, including but not limited to cabinets, controllers, sensors, conduit, pull boxes, hardware, and all other parts of the system selected for installation.

The complete information for the original product data submittal shall be contained in as few submittals as possible and be in an organized fashion.

The product data submittal shall be accompanied by a specification checklist. At a minimum, this checklist shall clearly state the following:

- 1) The project name and project number
- 2) The date of the submittal
- 3) The pay item number and description
- 4) The part and/or model number, matching the cut-sheet
- 5) The manufacturer
- 6) A Certification Statement that the referenced product is not manufactured by any of the following: Huawei Technologies Company, ZTE Corporation, Hytera Communications Corporation, Hangzhou Hikvision Digital Technology Company, Dahua Technology Company, and any subsidiary or affiliate of these entities. (as per 2 CFR 200.216)
- 7) Every material requirement as stated in in this Notice to Bidders and as outlined elsewhere within this contract.

- 8) A statement of whether the product complies with the requirements set forth in the specifications, special provisions, plans and NTB. If product is not compliant, an explanation of non-compliance shall be provided.

All subsections of a particular section may be omitted if the section heading is included, is indicated to be not applicable, and that it is evident that all subsections being omitted are also not applicable.

It shall be the responsibility of the Contractor to guarantee the accuracy of the checklist.

Other Submittals. The following submittals shall be required:

- 1) Shop Drawings
- 2) Cabinet wiring diagrams with system labeling schedule.
- 3) Site wiring/connection drawings.
- 4) Rack diagrams showing rack mounted equipment.
- 5) All documentation as described in the Project Testing Plan Requirements section below.
- 6) Project Record Drawings:
  - a. The purpose of Project Record Drawings is to provide factual information regarding all aspects of the Work, to enable future service, modifications, and additions to the Work.
  - b. Project Record Drawings are an important element of this Work. Contractor shall accurately maintain Project Record Drawings throughout the course of this project.
  - c. Project Record Drawings shall include documentation of all Work, including the conduit locations, pull box locations, equipment locations, foundation details, setup parameters and wiring and block diagrams.
  - d. Project Record Drawings shall accurately show the physical placement of the following:
    - i. Cabinets, sensors, pull boxes, and other materials installed at each site.
    - ii. Conduit runs and splicing information.
  - e. Project Record Drawings shall show the physical placement of each system component installed during the project at each site. Where the plan details do not depict actual field conditions, the Contractor shall amend the construction plan as required.
- 7) Upon completion of Work, and prior to Final Acceptance, the Contractor shall prepare and submit the final record set of Project Record Drawings. This set shall reflect the installed Work.
- 8) Closeout Submittals - A set of Project Record Drawings shall be provided to the Project Engineer and ITS Engineer for any items that changed or were not previously submitted, including:
  - a. Project Record Drawings
  - b. Product Data
  - c. Installation Manuals
  - d. Operating Manuals
  - e. Maintenance/Service Manuals

As-Built Plans. The Contractor shall provide GPS locations of all pull boxes, splices,



termination equipment cabinets, ITS field locations and all pole locations. The Contractor shall record and submit the sequential footage markers from the fiber optic trunk and drop cables for each GPS location. The Contractor shall provide scanned PDF files of all plan sheets with pen and ink markups. The Contractor shall provide a site location inventory of ITS devices to include manufacturer model, serial numbers, MAC addresses, and IP addresses (as applicable) for all installed devices. All documentation will be due to the Department a minimum of thirty (30) calendar days after the installation.

**Additional Quality Assurance Measures**

The project shall be constructed in such a manner as to comply with environmental regulations and erosion control as specified in the plans and elsewhere in MDOT standard specifications.

At the completion of the Work, the site shall be cleaned, restored, grassed and otherwise stabilized to a condition consistent with conditions before work began. This work shall be paid for under other items of work.

All disturbed signs, guardrail, markers, fencing, and other roadway appurtenances shall be restored. Disturbed roadway appurtenances that require complete removal and replacement will be identified within the contract and will have separate pay items and quantities set forth for such work.

The Contractor shall clean-up debris caused by Contractor's activities on a daily basis as the work progresses. This work shall be paid for under other items of work.

All work-related accidents shall be reported immediately to the Project Engineer or his/her representative.

Maintenance and Technical Support. The supplier must provide and have a parts support system capable of providing parts for the length of the warranty period.

**Project Testing Plan Requirements**

The Contractor shall conduct a Project Testing Plan as required below in addition to all other project testing and acceptance procedures required elsewhere in the specifications and Plans. Some specifications contain details regarding the testing for individual device types or attributes, but this section outlines the overall testing plans for the entire project as a whole. The Project Testing Plan shall include a series of tests on all project materials occurring at various stages in the project. All costs associated with the Project Testing Plan shall be absorbed in contract pay items; no separate payment will be made for any testing.

General Requirements. The Contractor is responsible for planning, coordinating, conducting and documenting all aspects of the Project Testing Plan as detailed below and providing all required equipment for the tests. The Engineer reserves the right to attend and observe all tests.

Each test shall be an individual and separate event for each type of test and for each type of equipment as defined elsewhere within this NTB. The Contractor shall follow the testing sequence as described in this NTB and shall perform the required tests on all applicable

devices and infrastructure.

Test procedures shall be submitted and approved for each test as part of the project submittals programs. Test procedures shall include every action necessary to fully demonstrate that the material under test is clearly and definitively in full compliance with all project requirements. Test procedure actions shall cross-reference to the specifications or Plans requirement that is the subject of the test action. Test procedure actions shall cross-reference the applicable sections of the final approved Project Submittal Compliance Form and the submittal materials for the subject of the test action. Test procedures shall contain test setup and block/wiring diagrams showing all materials being tested and all test and measurement equipment, with calibration documentation, and shall contain documentation regarding the equipment configurations and programming. Test procedures shall include checkoff blanks for each project requirement included in that test and shall include forms for the documentation of all measured test results.

No testing shall be scheduled until approval of all project submittals for all materials covered under a given test and approval of the test procedures for the given test has been granted.

Unless otherwise required herein, the Contractor shall request in writing the Engineer's approval for each test occurrence a minimum of 14 days prior to the requested test date. Test requests shall include the test to be performed and the material to be tested. The Engineer reserves the right to reschedule tests if needed.

For any series of tests on different installations of a given material (e.g., different sections of cable), the Contractor shall request in writing the Engineer's approval for the first test occurrence of the series a minimum of 14 days prior to the requested test date, regardless of the notification requirements for subsequent test occurrences.

The Contractor shall provide all ancillary equipment, materials, diagnostic and test software, and computers as required in the approved test procedures.

All test results shall be documented in writing by the Contractor in accordance with the test procedure and submitted to the Engineer within seven (7) days of the completion of the test. Any given test session is considered incomplete until the Engineer has approved the documentation for that test session.

The Contractor shall provide test results documentation in electronic format and printed format (3 copies). Electronic formats shall be provided in both PDF and Microsoft Excel or other approved application. Printed copies shall be bound and organized by test, equipment type, and individual unit.

- Two sets are for the Traffic Engineering ITS Department
- One set is for the Engineer

All test results shall be provided in English units of measure.

All test results deemed by the Engineer to be unsatisfactorily completed shall be repeated by the Contractor, following all test requirements as defined elsewhere in this NTB and contract specifications. This shall include a request in writing for the Engineer's approval for the repeated test a minimum of 14 days prior to the requested test date, unless this requirement is waived by the Engineer. In the written request for each test occurrence that is a repeat of a previous test, the Contractor shall summarize the diagnosis and correction of each aspect of the previous test that was deemed unsatisfactory. Any revisions to the test procedures for a repeated test occurrence shall meet all requirements for the original test procedures, including review and approval by the Engineer.

The satisfactory completion of any test shall not relieve the Contractor of his responsibility to provide a completely acceptable and operating system that meets all requirements of this project.

It is possible for the Contractor to schedule multiple test dates and revise the actual test being performed on a particular day if; 1) the Engineer approves of the change, 2) all test scheduling requirements above have still been met for the actual test to be performed on the date, and 3) there is not an unreasonable change of location, time, duration, or requirement of the Engineer.

Factory Acceptance Test (FAT). FATs shall be conducted at the Manufacturer or Contractor's facility or at a facility acceptable to all parties prior to shipping from the factory. The goal of the FAT is to verify that the equipment meets the requirements of the specifications. All equipment to be utilized for this project shall be subject to tests that demonstrate the suitability of the design and manufacturing procedures and compliance with the contract requirements, unless an exception for a specific equipment item is granted by the Engineer. The tests shall be performed on production units identified to be delivered under this Contract. As a minimum, a FAT is required for each of the following project materials:

- Dynamic Message Signs

The FAT testing procedures and results for specifically identified materials shall demonstrate that all testing requirements as outlined within the contract (standard specifications, plans, special provisions, and notice to bidders) are met, including, but not limited to: functional/system performance requirements, electrical requirements, data transmission/communication requirements, safety/password requirements, environmental requirements, and interface requirements with other components of the project system.

The Engineer reserves the right to waive FATs which are deemed to be unnecessary and reserves the right to witness all FATs that are determined to be critical to the project. At the Engineer's discretion, the Engineer may be in attendance at the FAT for any units tested. The FAT for the first three (3) units shall be conducted during the same time period and shall be completed before additional units are produced.

The Engineer shall be notified a minimum of 45 calendar days in advance of such tests. Salary and travel expenses of the Engineer and his/her representatives will be the responsibility of the Department. In case of equipment or other failures that make a retest necessary, travel expenses associated with retests for the Engineer and his/her representatives shall be the responsibility of

the Contractor. The travel expenses shall include all costs associated with having a two-person Engineer review team on site, including but not limited to airfare, automobile rental, lodging, and per diem. These costs, excluding airfare, shall not exceed \$500.00 per representative, per day. These costs shall be deducted from the payments due or charged to the withholding account of the Contractor when the project is terminated.

The vendor must complete the FAT on all remaining units on their own and submit documentation to the Engineer that the FATs were completed. The Engineer reserves the right to randomly attend those FAT tests.

No equipment for which a FAT is required shall be shipped to the project site without successful completion of factory acceptance testing as approved by the Engineer and the Engineer's approval to ship.

Bench Test Components (BTC). The Contractor shall perform a complete BTC on the lesser of the full contract quantity of units of equipment and materials or the number of units required as specified in this subsection below. The quantity listed in the subsection below is a "minimum" quantity and the Engineer reserves the right to require testing of additional quantities if the initial testing is not deemed adequate. The Contractor shall provide the testing location and facility, which shall be in Mississippi and within a 25-mile radius of the project limits. The test location must be approved by the Engineer as part of the BTC test procedure submittal.

The BTC shall demonstrate that all equipment and materials are in full compliance with all project requirements and works "out of the box" by visual inspection, setup and operation "on the bench", functional testing of the component including manufacturer's recommended startup diagnostics, and testing prior to any field installation of that equipment or material. Test results documentation shall be provided for each equipment item and material in the full contract quantity; test results documentation shall include the manufacturer's serial number and the project location ID for each item.

As a minimum, a BTC is required for each of the following project materials for quantities as shown.

- Closed Circuit Television Equipment, 4 PTZ units & 6 fixed units
- Dynamic Message Sign, 2 complete units of each type
- Travel Time Signs, 2 complete units
- Network Switches Type A, 4 units
- Network Switches Type B & F, 2 units each
- Network Switches, Type C, D, & E, 1 unit each
- ITS Radar Vehicle Detection Sensors, 6 units
- Highway Advisory Radios, 2 units
- Radio Interconnect System, 4 units of each type
- Bluetooth Detection System, 6 units
- DSRC devices, 6 units
- Roadway Weather Information System, 2 complete units
- Traveler Information Video Kiosk, 2 complete units

- Smart Work Zone System
  - Portable CCTV station, 2 complete units
  - Non-Intrusive Vehicle Detection Devices / Portable Traffic Sensors, 4 complete units
  - Highway Advisory Radio, 2 complete units
  - Portable Changeable Message Signs, 2 complete units
  - Portable Traffic Signal, 2 complete units
- Off-the-shelf and Vendor Software, all necessary
- Equipment Cabinet (Type A), 2 cabinets
- Equipment Cabinet (Type B), 4 cabinets
- Equipment Cabinet (Type C), 2 cabinets

Pre-Installation Tests (PIT). The Contractor shall perform Pre-Installation Tests (PIT) on all device quantities that are not included in the BTC. The Contractor shall provide the testing location and facility, which shall be within a 25-mile radius of the project limits or as approved by the Engineer. The test location must be approved by the Engineer as part of the PIT test procedure submittal. The PIT shall be a shortened version of the BTC to ensure the equipment will power up, operate, and was not damaged during shipment. The Engineer reserves the right to attend any PIT as desired; however, the contractor shall submit documentation of the PITs whether the Engineer is present or not. In addition to these requirements, see the DMS, TTS, and Fiber Optic Cable Special Provisions for more details.

Stand Alone Site Tests (SAT). The Contractor shall perform a complete SAT on all equipment and materials associated with the field device site, including but not limited to electrical service, conduit, pull boxes, communication links infrastructure (fiber, leased copper, wireless), cable, poles, camera lowering devices, device communication cables, cabinet apparatus, etc. The goal of the SAT is to verify that the equipment has been properly installed and commissioned according to the manufacturer requirements. A SAT shall be conducted at every field device site including communications hubs. A SAT shall be conducted for a fully installed and completed control center in the TMC as described in the TMC modification NTB. A SAT shall be conducted for all fiber optic infrastructure.

The SAT shall demonstrate that all equipment and materials are in full compliance with all project requirements, are fully functional as installed, and are in their final configuration. As part of this demonstration, SATs shall include but are not limited to the following:

- A visual inspection of the cabinet and all construction elements at the site to ensure they are compliant with the Specifications and have no physical damage or deformities.
- The inspection of the cabinet at each site shall include the functional test of all cabinet equipment, including circuit breaker, receptacles, fan and thermostat, lights, and door switches.
- Verify that manufacturer documentation for each device is present.
- A measurement of the DC power supply shall be made at the cabinet when it is operating under full load.
- Verify that all equipment has proper power, surge protector, and grounding connections.
- Inspect the integrity of all cable connections and terminations and verify that the cables are

connected and terminated as specified in the Plans.

The SATs for each site type shall include but are not limited to the following:

- *CCTV Stand Alone Site Test*: Shall be conducted at the CCTV Cabinet and shall demonstrate the complete operation of the CCTV, Network Switch, and the link(s) to any devices that are connected to the Power Supply in the CCTV Cabinet. The SAT shall include a 5-minute recording of each PTZ and Fixed camera showing the field of view and video quality. Two copies of the recording shall be provided to the Engineer on USB flash drives. The recording will start at the preset default position(s) and will demonstrate the full zoom capabilities of the cameras, as well as the full range of the pan and tilt functions of PTZ cameras. This recording shall be in a format playable with Windows Media Player or pre-approved by the Engineer.
- *ITS Communications HUT Stand Alone Site Test*: Shall be conducted at the HUT and shall demonstrate the complete operation of all equipment inside the HUT including Network Switches. This also includes visual inspection of the Site elements associated with the HUT.
- *ITS Termination Cabinet Stand Alone Site Test*: Shall be conducted at the termination cabinet and shall demonstrate the complete operation of all equipment inside the cabinet including Network Switches. This also includes visual inspection of the Site elements associated with the termination cabinet.
- *Radio Interconnect System Stand Alone Site Test*: Shall be conducted from the cabinets at both ends of the communications link (even if one end consists of existing equipment) and shall demonstrate that the radios, the antennas, the entire link, the Network Switch, and the transmission of video and/or data are fully operational. See Radio Interconnect Special Provision for more details.
- *Highway Advisory Radio Site Test*: Shall be conducted at the HAR cabinet, antenna, and advisory signs and shall demonstrate complete operation of recordings, transmissions, and remote flashing beacon unit(s). See HAR Special Provision for more details.
- *Fiber Optic Cable Stand Alone Site Test*: Shall be conducted at each Cabinet and at each HUB and shall include both power meter tests and OTDR tests. See Fiber Optic Special Provision for more details.
- *Conduit Detection Wire Stand Alone Site Test*: Shall be conducted at each pull box and shall demonstrate that a continuous run of conduit detection wire was installed between pull boxes, vaults, cabinets, and structures as required.
- *ITS Radar Vehicle Detection Stand Alone Site Test*: Shall be conducted at the IRVD Cabinet and shall demonstrate the complete operation, proper configuration, and verification of detection for each lane of traffic or zone of the IRVD unit(s).
- *BDS Stand Alone Site Test*: Shall be conducted at the Device Cabinet and shall demonstrate the complete operation and proper configuration of the unit(s), verify network connection to the BDS through ping and telnet sessions from a remote PC, and confirm that the system is fully functional by detecting Bluetooth devices at a sample rate approved by the Engineer.
- *RWIS Stand Alone Site Test*: Shall be conducted at the RWIS Cabinet and shall demonstrate the complete operation and proper configuration of the RWIS and shall verify that the remote flashing beacon unit(s) on the warning signs are activated properly as

specified and will de-activate automatically without renewal at preset intervals.

- *SWZ Stand Alone Site Test:* Shall be conducted at each device at its initial location and shall demonstrate the complete operation and proper configuration of the device as described in the Smart Work Zone Special Provision and NTB. At any subsequent locations, at a minimum, a document verifying that the device is configured for the new location shall be submitted to the Engineer.
- *Kiosk Stand Alone Site Test:* Shall be conducted at the device, verify all required video layouts and displays, demonstrate all required software features, and demonstrate the complete operation of the device and Network Switch. Refer to the Traveler Information Video Kiosk specification for more details.

*DMS & TTS Stand Alone Site Test:* Shall be conducted at the Device Cabinet, verify that all pixels are operational, verify that the sign can be controlled locally through both the serial and Ethernet ports, and demonstrate the complete operation of the device and Network Switch. The signs shall be delivered with and tested using default fonts and sizes that are provided by the MDOT ATMS drivers.

The Contractor shall request in writing the Engineer's approval for each test occurrence a minimum of 14 days prior to the requested test date. The Contractor shall arrange, at no additional expense to the State, the attendance of a qualified technical representative of the equipment manufacturer to attend each test until a minimum of two (2) sites of that type are approved.

Sub-System Test (SST). The Contractor shall perform an SST on each DMS and TTS to verify and document that all remote TTS and DMS functions and alarms are operational from the TMC.

An SST is required for at least ten percent (10%) of each of the following devices being placed for the project, taken by a random sampling: BDS, Network Switch, IRVD, HAR, Radio, CCTV, Video Vehicle Detection, and RWIS including beacons. The SST will require the Contractor to demonstrate and document that all functions and alarms are operational from the TMC.

An SST is required for each Traveler Information Kiosk in the project and will require the Contractor to demonstrate and document the features demonstrated in the Kiosk SAT using remote access from the TMC.

An SST is required for each Smart Work Zone device in the project and will require the Contractor to demonstrate and document the connection between the device and the central data/video collection site. Once a Smart Work Zone device has been verified to be properly configured, working, and communicating at its current location, the device can be utilized without further testing. The Conditional System Acceptance Test, Burn-in period, Final Inspection, or Final System Acceptance is not required for a device being solely utilized as part of the temporary Smart Work Zone System. Devices moved to a new location do require verification that they are still working as intended in the new location.

The Contractor shall coordinate the SST to be performed with the Project Engineer or designee present. The Contractor shall provide an SST plan to the Project Engineer for review and approval a minimum of two weeks in advance of tests being performed.

Conditional System Acceptance Test. The Contractor shall perform a complete conditional system acceptance test on all equipment and materials in the project. The Contractor shall not request the conditional system acceptance test until the SATs have been satisfactorily completed, all as-built documentation has been submitted and approved, and all other project work has been completed to the satisfaction of the Engineer. Prior to a Conditional System Acceptance Test, the Contractor shall provide advance notice of and written test results documenting that the Contractor has performed a dry-run of the conditional system acceptance test. The Engineer reserves the right to attend a dry-run test session.

The Contractor shall coordinate the CSAT with the Engineer. The Contractor shall provide a CSAT plan to the Engineer and be approved a minimum of fourteen (14) calendar days in advance of tests being performed. The CSAT plan shall be inclusive of steps and procedures to be performed and scheduled times to perform test procedures.

The Contractor shall test all project systems simultaneously from the State TMC in a manner equivalent to the normal day-to-day operation of the system. The Conditional System Acceptance Test shall demonstrate that all equipment and materials in the network are in full compliance with all project requirements and fully functional as installed and in final configuration, communicating with and being controlled through the control center at the State TMC. If pre-processing systems (e.g., edge computing) or post-processing systems (e.g., video image processing and analytics, detection in one device triggering an alarm or event in another device, etc.) are present, these shall be tested, verified, and documented as working as intended during the CSAT. Edge computing is where data-handling activities, such as analysis and event-triggering, takes place near the physical location that the data is collected.

The Engineer reserves the right to require, at no additional expense to the State, the attendance of a qualified technical representative of the equipment and/or software manufacturers to attend any given Conditional System Acceptance Test.

Upon completion and full approval of the Conditional System Acceptance Test for all equipment in all phases, Conditional System Acceptance will be given and the Burn-in Period will begin.

Burn-In Period. Following the Engineer's written notice of successful completion of the Conditional System Acceptance Test, the entire newly installed system must operate successfully for a **thirty (30) day** burn-in period. The Contractor shall be responsible for the full maintenance of the newly installed equipment during the burn-in period. This maintenance includes all troubleshooting and repairs as well as providing preventive maintenance that meets the equipment manufacturer's recommendations. However, no separate payment will be made during the burn-in period. Successful completion of the burn-in period will occur at the end of **thirty (30) complete days** of operation without a system failure attributable to hardware, software or communications components. Each system failure during the burn-in period will require an additional **thirty (30) days** of successful operation prior to being eligible for Final Acceptance (i.e., if the initial burn-in period is **thirty (30) days** and there are two (2) system failures during this time, the burn-in period would be increased to **ninety (90) days**).



Burn-In General Requirements:

- Determination of a system failure shall be at the sole discretion of the Engineer.
- System failure is defined as a condition under which the system is unable to function as a whole or in significant part to provide the services as designed. While a single component failure will not constitute a system failure, chronic failure of that component or component type may be sufficient to be considered a system failure. Chronic failure of a component or component type is defined as three (3) or more failures for the same component during the burn-in period.
- Components are defined as contract items or major material elements in a contract item. For electrical and electronic contract items, components are defined as the complete assembly of materials that makes up the contract item.
- Specifically exempted as system failures are failures caused by accident, acts of God, or other external forces that are beyond the control of the Contractor. However, failure of the contractor to respond to the repair request for that failure within 24 hours may be considered a system failure.
- The Department will advise the Contractor in writing when it considers that a system failure has occurred or chronic failure exists.
- If multiple system and/or chronic failures continue to occur throughout the burn-in period due to a single component type, the Contractor may be required to replace all units of that component type with a different model or manufacturer.
- The Contractor shall document all failures and subsequent diagnosis and repair. The repair documentation shall include as a minimum:
  - Description of the problem
  - Troubleshooting and diagnosis steps
  - Repairs made
  - List of all equipment and materials changed including serial numbers.
  - Update of the equipment inventory where needed.
  - The Contractor shall provide the repair documentation to the Engineer within two (2) days of completing the repair; failure to provide acceptable documentation as required shall be reason to not approve the repair as complete. The Engineer will provide acceptance or rejection of the repair and documentation within seven (7) days of receiving the repair documentation.
  - The Engineer reserves the right to require, at no additional expense to the State, the presence of a qualified technical representative of the equipment and/or software manufacturers as related to the diagnosis and/or repair of any system failure.
- During the burn-in period, the Contractor shall perform incidental work such as touching up, cleaning of exposed surfaces, leveling and repair of sites, sodding/grassing and other maintenance work as may be deemed necessary by the Engineer to ensure the effectiveness and neat appearance of the work sites.
- During the burn-in period, the Engineer shall maintain a “burn-in period punch list” that contains required Contractor actions but that the Engineer does not define as a system failure. Each burn-in period punch list action item shall be completed by the Contractor to the Engineer’s satisfaction within seven (7) days of Contractor notification of the action item.
- During the burn-in period, the Contractor is required to meet the following response times

once notified there is a problem. A response is defined as being on-site to begin diagnosing the problem.

- Monday thru Friday: The Contractor shall respond no later than 9:00 a.m. the following morning after being notified.
- Weekends: If the Contractor is notified on Friday afternoon or during the weekend, the Contractor shall respond by 9:00 a.m. on Monday morning.
- During the burn-in period, the Contractor shall provide all labor, materials, equipment and replacement parts to completely maintain, troubleshoot and repair all items installed under this contract. No separate payment will be made for any labor, materials, equipment, or replacement parts needed during the burn-in period.
- The overall burn-in period will be considered complete upon the successful completion of the burn-in time periods, the Engineer's acceptance of all repairs and repair documentation, completion of all burn-in period punch list actions, and a final inspection as described below.

Contract time will not cease during the burn-in period(s). Contract time for the burn-in period was considered when determining the original contract time.

Final Inspection. Upon successful completion of the burn-in period, the entire project shall be eligible for Final Inspection. The Final Inspection will be conducted provided the burn-in period has demonstrated the entire system is operating successfully. The Final Inspection shall include but is not limited to:

1. monitoring of all system functions at the State TMC to demonstrate the overall system is operational
2. a field visit to each site to ensure all field components are in their correct final configuration
3. verification that all burn-in punch list items have been completed
4. verification that all final cleanup requirements have been completed
5. approval of final as-built documentation

Prior to conducting the Final Inspection, the burn-in period shall demonstrate that all requirements defined in the specifications have been met, including, but not limited to: functional/system performance requirements, electrical requirements, data transmission/communication requirements, safety/password requirements, environmental requirements, and interface requirements with other components of the system.

The Contractor shall request in writing the Engineer's approval to start the Final Inspection a minimum of 14 days prior to the requested start date. The Engineer reserves the right to reschedule the start date if needed. The start date for the Final Inspection cannot be prior to the successful completion of the overall burn-in period.

An unsuccessful or incomplete Final Inspection shall require a new Final Inspection after the Contractor has made the necessary corrections. Up to 14 days shall be allowed for the Engineer to conduct a Final Inspection. The presence of the MDOT ITS Engineer or his/her designee is required during the final inspection.

The Engineer reserves the right to require, at no additional expense to the State, the attendance of a qualified technical representative of the equipment and/or software manufacturers to attend a portion of a Final Inspection.

The Contractor shall be responsible for the full maintenance of all project equipment and materials during the entire time period from the successful completion of the burn-in period until Final System Acceptance is granted.

Final System Acceptance. Upon successful completion of the Final Inspection and all other items of work on the project, the Engineer will grant Final System Acceptance in accordance with Subsection 105.20 of the Standard Specifications.

Beneficial Use of Dynamic Message Signs During Construction. Each DMS shall be roadside controllable (by sign vendor software) within 30 days of attachment to structures (visible to motorists). The Contractor's construction schedule shall clearly identify when installation of the signs over the roadway shall occur, and when roadside control shall be established for each sign. The Contractor shall not install a DMS over the roadway until all ancillary and infrastructure elements, including cabinets, controllers, conduits, cabling, etc. necessary to operate the sign are in place and functional. Once roadside controllable, the Contractor shall display emergency, special event, construction, safety or traveler information messages approved by MDOT, only when requested by MDOT, at no additional cost to MDOT. Normal diagnostic messaging for the purpose of installation and testing shall be determined by the Contractor but shall not be allowed to the extent that excessive power consumption or distraction to motorists occurs as determined by the Engineer. Any beneficial use of the signs to MDOT and the public prior to Final Acceptance does not constitute MDOT acceptance or waive any Contractor testing requirements. The cost that may be incurred by the Contractor to display messages as described above during this construction contract shall be considered incidental and included in the cost of other items.

### **Warranties**

The following components of the Project shall be warranted against manufacturing defects and workmanship for a period of at least one (1) year:

- Radio interconnect system components as listed under SP 907-662-2
- Layer 2, Type A; Layer 3, Type C, Type C4, Type E1, and Type E2 Network Switches; and Network Terminal Server & Network Cellular Modem as listed under SP 907-663-5
- Communication Node Hut & Hut Modifications under SP 907-664-4
- Video Communication Equipment components under SP 907-665-1
- Bluetooth Detection System components under SP 907-666-3
- Roadway Weather Information System & Warning Signs with Flashing Beacon under SP 907-670-3
- Kiosk Monitoring Camera under SP 907-671-1
- Travel Time Sign under SP 907-674-1
- ITS Radar Vehicle Detector under SP 907-641-2
- On Street Video Equipment under SP 907-650-4;
- Highway Advisory System components under SP 907-655-2;
- Dynamic Message Signs under SP 907-656-1.

The following components of the Project shall be warranted against manufacturing defects and workmanship for a period as listed below for each respective item from the date of Final Maintenance Release.

- *Fiber Optic Cable*: Ten (10) year warranty on materials and workmanship
- *Traveler Information Video Kiosk*: Two (2) year extended warranty on materials/hardware
- *TMC Modification*: Two (2) year warranty on hardware and one (1) year warranty on software
- *Type C1, C2, & C3 Network Switches*: Five (5) year warranty on hardware
- *Type D, E, & F Network Switches*: Five (5) year warranty on hardware

The Contractor shall supply the warranties in writing with the Final Maintenance Release date documented on them. These warranties shall cover complete replacement at no charge for the equipment. The Contractor will be responsible for all labor, shipping, insurance and other charges until Final System Acceptance. Equipment covered by the manufacturers' warranties shall have the registration of that component placed in the Department's name prior to Final Inspection. The Contractor is responsible for ensuring that the vendors or manufacturers supplying the components and providing the equipment warranties recognize MDOT as the original purchaser and owner/end user of the components from new.

During the warranty period, the supplier shall repair or replace with new material of equal or greater kind and quality and meeting all of the applicable specifications herein, at no additional cost to the State, any product containing a warranty defect, provided the product is returned postage-paid by the Department to the supplier's factory or authorized warranty site. Products repaired or replaced under warranty by the supplier shall be returned prepaid by the supplier. During the warranty period, technical support shall be available from the Contractor via telephone within four (4) hours of the time a call is made by the Department. If it is deemed necessary by the Engineer, technical support shall be available from factory certified personnel of the supplier via telephone within eight (8) hours of the time of the initial call made by the Department. During the warranty period, updates, patches, performance improvements, and corrections to all software and firmware used during the project shall be made available to the Department by the supplier at no additional cost.

**Training**

After the Stand Alone Site Tests have been conducted but prior to Conditional System Acceptance, the Contractor shall provide separate training sessions for each subsystem training pay item included in the project. The training sessions may require multiple classes as noted below) and shall accommodate from six (6) to twelve (12) personnel per class. Additional sessions for additional personnel may be required if the make and model of the subject component is not currently in the MDOT system.

The training must include formal classroom and "hands-on" operations training with a complete demonstration of the configuration, operation, and capabilities of each component in the system. The training should also consist of a hands-on demonstration of all software configuration and functionality where applicable. Each training day shall include a mixture of classroom style

training in equipment operations, hands-on operator training using the same models of equipment furnished for the project, and question and answer sessions.

During the burn-in period, the Contractor shall also provide two (2) identical non-consecutive training sessions on the maintenance of the overall system. The training shall be provided for at least ten (10) personnel with individual copies of all training materials provided to each participant. The training must include both classroom style training and hands-on training in the field of the maintenance and troubleshooting procedures required for each component. Additional sessions for additional personnel may be required if the make and model of certain components are not currently in the MDOT system.

Prior to scheduling the training, the Contractor shall submit resume and references of the training instructor(s) to the Engineer for approval. The qualifications of the trainers must meet, at a minimum, the recommended qualifications of the equipment manufacturer with a minimum of four years of experience in training personnel. If qualified personnel are not on the Contractor's staff, a representative of the manufacturer shall provide the training.

The training shall be provided at an agreed upon location. If training requires travel on the part of training instructors, then the cost of travel shall be included.

The Contractor shall provide individual copies of documentation, training, and maintenance materials for each participant. These materials shall include detailed specifications and information pertaining to each device in the system. The documentation shall include details of the technical and operational aspects of the completed system. This shall include operational and maintenance manuals, system diagrams, cabling diagrams and mounting/positioning details. The Contractor shall supply emergency contact information and necessary procedures for obtaining vital replacement parts within a designated, agreed upon time frame.

The Contractor shall submit a detailed Training Plan including course agendas, detailed description of functions to be demonstrated, and a general schedule to the Engineer for approval within 90 days of Contract Notice-to-Proceed. The exact date of the training shall be submitted to the Engineer for approval at least four (4) weeks ahead of the date.

### **Grounding**

The Contractor shall provide a grounding and lightning protection system to protect from electrical power surges caused by lightning or disruptions in the power supply system. Ground rods, ground conductor, lightning collectors and appurtenances shall be as detailed on the plans and as required by these specifications.

General. All non-current carrying metal parts of the site shall be grounded according to NEC specifications. In addition, all non-current carrying metal parts shall have a voltage potential of zero relative to reference ground. This reference ground shall be achieved via the equipment-grounding conductor.

Support cable, metallic cable sheaths, conduit, metal poles, pedestals, and communication building shall be made mechanically and electrically secure and grounded. Bonding and grounding jumpers

shall be properly sized according to the NEC and in no case shall they be smaller than a #6 AWG copper wire. Ground pole-mounted accessories to the pole. Equipment on wood poles shall be grounded.

Permanently ground the poles by bonding the No. 6 AWG solid copper wire to a separate ground rod.

Metal raceways, metal enclosures of electrical devices, lighting fixtures, panelboards, and other non-current carrying metallic parts of equipment shall be securely grounded.

Ground rods shall be installed according to plan details. A length of copper conductor shall be attached to the ground rod, utilizing the specified grounding methods, and connected to the grounding system. Do not ground to a permanent water system instead of the driven ground rod. Ensure that grounding devices conform to the requirements of the NEC and NEMA.

Cabinet Grounding. A single-point grounding system shall be constructed.

All grounds for the cabinet shall be installed on the side of the building that utilities, communication cables, and fiber enter. All earth grounds shall be connected to this point, including the grounding system for Surge Protection Devices (SPD). All connections to SPDs shall be made according to the manufacturer's recommendations.

A single ground bus bar shall be mounted on the side of the cabinet wall adjacent to the power panel for the connection of AC neutral wires and chassis ground wires.

The Contractor shall ensure that communication cables, AC power, emergency generator, and equipment frames are connected by the shortest practical route to the grounding system. The lead lengths from each device to the SPD shall be protected. Electrical continuity of all connections shall be verified. All non-conducting surface coatings shall be removed before each connection is made. Ground conductors shall be downward coursing, vertical, and as short and straight as possible. Sharp bends and multiple bends shall be avoided in grounding conductors.

**Surge Suppressor**

Surge protection device (SPD) shall be provided to protect electronics from lightning, transient voltage surges, and induced current. All SPDs shall be installed at the top and bottom of each pole to provide reliable lightning protection. SPDs shall be installed on all power, data, video and any other conductive circuit.

SPD for 120 Volt or 120/240 Volt Power. A SPD shall be installed at the utility disconnect to the cabinet. The SPD at the utility disconnect shall include L-N, L-G, and N-G protection. The SPD shall meet the requirements of UL 1449, Third Edition and be listed by a NRTL.

A SPD shall be provided where the supply circuit enters the cabinet. The SPD shall be located on the load side of the main disconnect and ahead of any and all electronic devices and connected in parallel with the AC supply. The SPD in the cabinet shall include L-N, L-G, and N-G protection. The SPD shall meet the requirements of UL 1449, Third Edition and be listed by a NRTL.

The SPD shall have a visual indication system that monitors the weakest link in each mode and shows normal operation or failure status and also provides one set of normally open (NO)/normally closed (NC) Form C contacts for remote alarm monitoring. The enclosure for a SPD shall have a NEMA 4 rating

SPDs for Low-Voltage Power, Control, Data and Signal Systems. A specialized SPD shall be installed on all conductive circuits including, but not limited to, data communication cables, coaxial video cables, and low-voltage power cables. These devices shall comply with recommendations from the device manufacturer.

SPD at Point of Use. A SPD shall be installed at the point the ITS devices receive 120 volt power and connected in series with the circuits. SPDs shall be selected and installed according to recommendation from the device manufacturer. The units shall be rated at 15 or 20 amps load and configured with receptacles. These units shall have internal fuse protection and provide common mode (L+N-G) protection.

SPDs shall meet the requirements of UL 497B or UL 497C, as applicable, and are listed by a NRTL.

### **Solar Power Systems**

The Contractor shall provide a solar power system meeting the following requirements:

1. The supplier shall provide documentation specifying approximate daily power generation, power consumption, storage capacity, and charge rates representing an optimal power source to the satisfaction and approval of the Project Engineer.
2. Shall include a solar controller with automatic battery temperature compensation and automatic charging circuitry to prevent overcharging.
3. The battery back-up system chargers shall meet all specified requirements while operating between -40 °C to +74 °C (-40 °F to +165 °F), and 95% relative humidity.
4. Shall include metering for voltage and charging current.
5. Solar panels shall be Jet Propulsion Laboratory Block-5 tested and approved.
6. Solar panels shall be compliant with IEC 61215 and IEEE 1262.
7. Solar panels shall be break-resistant and sealed.
8. Battery shall be maintenance-free, sealed, gel-cell.
9. The Contractor shall test the battery for faulty irregularities and provide documentation to the Project Engineer stating the battery's voltage, and resistance. The battery voltage and resistance shall meet the manufacturer's specifications.

The Solar Power Systems for each site type shall include but are not limited to the following:

- *HAR Flashing Beacons:*
  1. A performance design study shall be conducted and submitted for approval for the proposed solar power system. The solar power system shall be designed on the performance design study.
  2. The solar system shall, at a minimum, operate the flashing beacons continuously at

- full power for at least three (3) days with no sunlight. This must be accomplished without an auxiliary generator or AC power connection.
3. Solar panels shall have a power rating of 80-watts.
  4. The Solar power system shall include a separate aluminum NEMA 3R enclosure to house the battery. This enclosure shall be designed to provide protection from rain, sleet, snow and corrosion.
    - a. The enclosure shall be constructed from 0.125" thick aluminum alloy type 5052- H32.
    - b. The enclosure shall be lockable.
    - c. The enclosure door shall include a EDPM rubber or equivalent closed-cell gasket
- *Type A BDS:*
    1. All solar panels shall be in accordance with UL1703, or equivalent.
    2. The solar cell shall have a minimum power capacity of 30 watts.
    3. The battery shall provide sufficient power for all BDS component operation for a minimum of 168 hours (7 days).
    4. Should solar power be specified with the Type A BDS, the NEMA 4 enclosure shall be sized appropriately for the solar power components.

Performance Design Study. A performance design study shall be conducted where required before the installation of a Solar Power System. The performance design study shall include, but is not limited to:

1. The daily Solar Insulation data averaged on a monthly basis.
2. The correct Tilt Angle for the solar array.
3. The daily Array Output, in Amp-Hours, averaged on a monthly basis.
4. The total Daily Load requirement, in Amp Hours, averaged on a monthly basis.
5. A monthly Loss of Load Probability (LOLP) of the designed power supply.
6. The number of Battery Reserve Days, averaged on a monthly basis.
7. The monthly Average Battery State of Charge.
8. The statistical Interval to Loss of Load, in years.



## MISSISSIPPI DEPARTMENT OF TRANSPORTATION

SECTION 904 - NOTICE TO BIDDERS NO. 4201

CODE: (SP)

DATE: 4/21/2022

SUBJECT: Contract Time

PROJECT: MP-5468-61(013) / 306931301 – Rankin County

The completion of work to be performed by the Contractor for this project will not be a specified date but shall be when all allowable working days are assessed, or any extension thereto as provided in Subsection 108.06. It is anticipated that the Notice of Award will be issued no later than **June 14, 2022** and the date for Notice to Proceed / Beginning of Contract Time will be **July 14, 2022**.

Should the Contractor request a Notice to Proceed earlier than **July 14, 2022** and it is agreeable with the Department for an early Notice to Proceed, the requested date will become the new Notice to Proceed date. Regardless of whether or not an early Notice to Proceed is granted, contract time will start at the original Notice to Proceed date.

All requests for an early Notice to Proceed shall be sent to the Project Engineer who will forward it to the Contract Administration Division.

**137** Working Days have been allowed for the completion of work on this project.

# MISSISSIPPI DEPARTMENT OF TRANSPORTATION

**SECTION 904 - NOTICE TO BIDDERS NO. 4202**

**CODE: (SP)**

**DATE: 04/12/022**

**SUBJECT: Scope of Work**

**PROJECT: MP-5468-61(013) / 306931301 -- Rankin County**

The contract documents do not include an official set of construction plans but may, by reference, include some Standard Drawings when so specified in a Notice to Bidders entitled, "Standard Drawings".

A general description of the work required on the project is as follows:

Mill & overlay approximately 10.8 miles of SR 468 in Rankin County beginning near Deeb St. (BOP Station 163+40) and ending just south of US 80 (EOP Station 41+50). Additionally mill & overlay approximately 0.4 miles of US 80 thru downtown Brandon. Details of specific work are mentioned in the following sections.

## **Sections of Mill and Overlay (See Project Map):**

**Section 1 - Station 163+40 (BOP) to Station 0+00, Deeb Street to Whitfield hospital (Station numbers run West)**

**Section 2 - Station 0+00 to Station 366+00, Whitfield hospital to College Street (Station numbers run East)**

Work in sections 1 and 2 shall consist of milling 1½" and inlaying with 2" of 12.5-mm, MT asphalt. Intersecting roads shall be milled 1½" and paved with 2" and variable of 12.5-mm, MT asphalt. The railroad crossing near Greenfield Road shall be omitted. Milling should be full depth 2" at bridge approach slabs to avoid a thin lift of asphalt. Failed areas listed in the provided table shall be repaired full depth using 12.5-mm, MT, Leveling asphalt. Traffic will be allowed to run on milled surfaces no more than five (5) consecutive days. Guardrails shall be replaced per the enclosed General Notes and Guardrail table.

**Section 3 - Station 0+00 to Station 41+50, College Street to EOP South of US 80 (Station numbers run North)**

**Section 4 - Station 100+00 to Station 119+31, US 80 in Downtown Brandon (Station numbers run East)**

Work in sections 3 and 4 shall consist of milling 2" and inlaying with 2" of 12.5-mm MT asphalt. Intersecting roads shall be milled 1½" inches and paved with 2" and variable of 12.5-mm MT asphalt. Traffic will be allowed to run on milled surfaces no more than three (3) consecutive days.

**GENERAL NOTES:**

**Milling**

Milling/paving shall not begin until an approved asphalt mix design has been received, nor until such time that, in the opinion of the Engineer, weather conditions have been consistently suitable enough to allow placement of the asphalt pavement after the milling operations.

The reclaimed asphalt pavement (RAP) material removed by the milling operation shall become the property of the Contractor.

Milling and paving operations shall be performed such that a -2% slope from centerline is provided in normal crown roadway sections. Superelevation through curves shall be maintained as it currently exists or improved as directed. Where slope correction is required, correction will be made by milling, paving, or combination thereof as directed by the Engineer. Milling correction: Mill outside edge of pavement to a depth of 1½” on a 2% slope towards the centerline. Paving Correction: Mill to depth of 1½” on existing slope and pave 2¼” and variable on centerline and 1½” on outside edge. Combination Method: Combination of both methods as directed by the Engineer to achieve the desired slope. In super elevated areas where correct SE exist milling will transition to thickness through curves. Where correct SE does not exist milling will transition at curves to correct SE as directed by the engineer.

Milling operations shall be performed in accordance with the Contract documents and the Standard Specifications. Variable width and length transitions may be required for ties at ramps, local roads, and project limits.

Milling of driveway pads shall be conducted in a manner to prevent gouging or otherwise affecting the roadway pavement structure and slope. Milling of driveway pads shall not be done in simultaneous path with mainline milling.

Traffic will be allowed to travel on the milled surface for 5 or 3 days depending on location. Traffic will be allowed to run on all milled local roads for five (5) days unless otherwise stated. The Contractor will be assessed a penalty of \$5,000 per calendar day until the milled surfaces are covered with the next lift of asphalt. Approved mix designs must be on hand prior to milling. Night time lane closures will NOT be allowed.

**Paving**

Prior to mainline milling and paving operations, failed areas provided in the table shall be repaired full depth (see typical section).

Failed areas in the existing pavement shall be removed and backfilled with 12.5-mm, MT, Leveling asphalt per the attached typical sections and details (see full depth repair table). Asphalt shall be placed in multiple lifts with a maximum lift thickness of three inches (3”). Any granular/chemically treated/stone/etc. base or subgrade material deemed unsuitable by the Engineer shall be removed as directed and backfilled with 12.5-mm, MT, Leveling asphalt. Payment for the excavation of the granular base and subgrade will be made under pay item 203-G: Excess Excavation. Pavement repairs shall be completed as a continuous operation in order to

minimize traffic impacts. Lane closures shall remain in place until the failed area has been completely repaired. Lane closures shall not be left unattended. Night time lane closures will NOT be allowed.

If traditional excavation methods are used, the removal area shall first be saw cut full depth, including concrete where applicable, to create a neat line and prevent damage to the adjacent pavement structure. Payment for saw cuts will be made using the appropriate items. If milling techniques are used, the area will not require saw cuts, care should be exercised to create a neat removal line and to prevent damaged to the adjacent pavement structure. If saw cuts are used in conjunction with milling, payment will be made using the appropriate pay items. Payment will not be made for saw cuts that are not performed.

Publicly maintained roads and streets shall be paved to the existing right-of-way with paving transitioning from 2” on the mainline to 1½” at local road tie-ins (See attached intersection drawing).

Privately owned entrances shall be paved to the shoulder line per the included typical drawing unless otherwise directed. Pad dimensions shall match the existing lengths and widths unless otherwise directed. Pads shall be shaped horizontally and vertically to prevent excessive drop-offs. Any new driveway pads deemed necessary by the Engineer shall be placed according to specifications.

**Granular Shoulder Material**

Where applicable, the existing shoulders shall be raised to match the new pavement elevation by placing variable depth granular material. The shoulders shall be graded and pulled up daily to eliminate drop-offs in excess of 2”. Placement of the granular material on the finished asphalt course shall not be permitted. The existing shoulder shall be scarified to allow incorporation of the new shoulder material. The material shall be bladed, rolled, and compacted to a finished slope of four percent (4%) in normal crown sections. Placement of this material shall be performed to provide a uniform and compacted shoulder with a minimum depth and width of material placed.

Shoulders with adequate shoulder material in place shall be bladed to a slope of four percent (4%) in normal crown sections. The cost of blading will be an absorbed item and is to be included in the price of other items bid. Crushed concrete will not be allowed if crushed stone is used for shoulder material.

Granular material shall be provided around driveway pads as directed to prevent shoulder drop-offs and shall be placed in a timely manner. Drop-offs exceeding 2½” shall be corrected within two (2) calendar days of the placement of the pad.

Any material excavated from the existing shoulder during pavement widening operations or as a result of shoulder blading shall be used on the existing shoulder to match the new pavement elevation, any surplus material shall be spread along the edge of the shoulders, fore slopes, or other adjacent areas as directed by the Engineer and will be an absorbed item. Material which cannot be suitably placed in adjacent areas and deemed to be excess excavation by the Engineer shall be

removed from the project site. Payment for removal of excess material will be made under pay item 203-G: Excess Excavation.

**Temporary and Permanent Pavement Markings**

Temporary traffic stripe shall be required immediately after the milling and/or required overlay and prior to opening area to traffic. Temporary stripe shall be placed in the same location and configuration as the permanent stripe except that it may be offset as required for milling and paving operations.

If temporary stripe is offset, the Contractor shall conduct operations in a manner to insure the final temporary stripe is placed at the required location of the permanent stripe.

Temporary striping shall conform to finished stripe specifications for alignment, neatness, and straightness.

The use of short strips of traffic tape will not be allowed unless approved by the Engineer

All permanent striping will be double drop thermoplastic, 90-mil thickness unless otherwise specified in Subsection 626.03.1.2. Edge lines shall be placed to accommodate the lane widths shown on the attached applicable typical sections unless prevented by field conditions.

**Guardrail**

Guardrails at the locations shown on the attached table shall be replaced. Removal of guardrail shall consist of removal of bridge end section, w-beam/their beam, terminal end section, posts, and all other appurtenances. All guardrail removed shall be replaced the same day and prior to reopening the adjacent lane of traffic. Voids created by the removal of posts, concrete anchors, footings, etc. shall be backfilled and compacted in accordance with Section 203 of the Standard Specifications.

Asphalt shall be extended under the guard rail and two feet (2') behind guard rail post as per the attached detail. The area to be paved shall be bladed to accommodate 3" of 12.5-mm, MT asphalt. The elevation of the finished surface of the asphalt pavement shall provide for the required MASH guardrail height (see Standard Drawings). The excavated material shall be retained and used to raise the existing shoulder to match the new pavement elevation. The cost of blading will be an absorbed item and shall be included in the price of other pay items bid. Material which cannot be placed and blended in adjacent areas and deemed to be excess excavation by the Engineer shall be removed under pay item 203-G: Excess Excavation.

The asphalt guardrail pad shall be removed or milled and repaved prior to the placement of the new guardrail. Removal of the guardrail pad shall be paid for using the milling pay item.

Guardrail lengths are based on terminal end length of 37.5'. If terminal of length other than this is used, an adjustment in w-beam length is required.

All existing guardrail will be retained by the Department. The Contractor shall coordinate the delivery of the retained guardrail with MDOT maintenance personnel and the removed guardrail shall be delivered to the MDOT Whitfield Maintenance Yard at 3769 Highway 468 in Pearl, MS.

**Permanent Signs**

Permanent signs as listed on the attached tables shall be replaced. Unless otherwise listed in the attached tables, existing posts, anchors, angles/bars, and other components shall be reused. The Contractor shall use new bolts, screws, washers, nuts, etc. of the required sizes in the installation of signs. If required as part of the sign replacement activities, all post, pipe, and I-beam lengths in these plans are estimated. Post lengths for all signs shall be verified in the field by the Contractor prior to fabrication. Installation dates shall be clearly written in bold black markings on the back bottom half off all signs with a permanent marking stick that is waterproof, fade resistant, and marks on wet or dry surfaces. If existing sign posts or footings are to be replaced, the existing posts and footings shall be removed and the area backfilled and compacted in accordance with Section 203 of the Standard Specifications. Removal of sign, post, and footing and backfilling will be paid using the removal of sign pay item.

Object markers at bridge approaches and other locations are to be replaced as shown in the attached table. Removal of object markers shall be absorbed in the cost of other items bid

**Traffic Signals**

Vehicle loop detectors at desired locations shall be replaced with radar detection sensors. Radar units shall be installed per manufacturer’s recommendations. Existing EPAC Controllers shall be replaced with new controllers and existing EPAC controllers shall be salvaged and delivered to MDOT Signal Shop (601-359-1493). It is the responsibility of the Contractor to coordinate delivery of existing EPAC controllers with MDOT personnel to MDOT signal shop. Contractor shall also be responsible for transferring existing controller data to the new controllers. Contractor may remove existing detection loop cable, if necessary. Cable quantities may be adjusted based on radar locations per manufacturer recommendations. Removal of vehicle loop detection cable shall be absorbed into other items bid.

**In order to prevent long term disruptions of normal signal timing operations, the signal work must be completed prior to milling/paving activities in the applicable areas.** Concurrent milling/paving and signal replacement operations will be allowed provided the established signal operations are not affected.

**Traffic Control**

The Contractor shall erect and maintain construction signing and provide all signs and traffic control devices necessary to safely maintain traffic around and through the work areas in accordance with the Traffic Control Plan and the MUTCD. The cost is to be included in the price bid for pay item 618-A: Maintenance of Traffic. Fluorescent orange sheeting shall be used on all construction and traffic control signs except those designated in the plans to be black legend and border on white background.

Standard roadside construction signs, barricades, etc. shall be placed in accordance with the attached tables, drawings, and as directed by the Engineer. W20-1 signs shall be placed on all

public road approaches as shown or as directed. Payment for standard roadside construction signs, barricades, etc. will be made using the appropriate pay items.

The Contractor shall on a daily basis, remove all debris from within the roadway and a 30-foot clear zone which, in the opinion of the Engineer, is a hazard to the traveling public. This activity shall begin with the beginning of work or the beginning of the contract time, whichever comes first. No direct payment will be made for the debris removal; the cost is to be included in the prices of items bid. Failure of the Contractor to remove the debris as prescribed herein shall be just cause for withholding the monthly progress estimate payment or suspending active operations until the debris is satisfactorily removed by the Contractor.

Temporary asphalt joints (aka paper joints) shall be employed at all locations requiring traffic to traverse an uneven, transverse, pavement joint. Paper joints shall be a minimum of nine feet (9') in length and for the full width of the milled/paved surface. Paper joints shall be adequately maintained.

Potholes that may exist or occur in the existing pavement shall be patched in a timely manner as required. Patching of potholes shall be considered an absorbed item.

**Miscellaneous Notes**

It shall be the responsibility of the Contractor to protect existing structures such as pipes, inlets, aprons, bridges, etc. from damage which might occur during construction. The Contractor shall replace or repair, as directed by the engineer, any structures damaged during the life of the Contract. No payment will be made for replacement or repair of damaged items.

Any signs that are in conflict with construction of this project shall be removed and relocated by the Contractor as directed by the Engineer; the cost of which is to be absorbed in other items bid.

Removal of existing raised pavement markers shall be included in the prices for other items bid.

Incidental work such as removing vegetation, shaping and compacting shoulders, removing and resetting signs and/or mailboxes, removing excess asphalt material, project clean-up, and other items of incidental work necessary to complete the project will not be measured for separate payment and will be considered included in the prices of items bid.

Header curb shall be removed and replaced in the vicinity of Allens Grocery and a slotted curb shall replace the ground mounted delineators on College Street at the Highway 80 intersection (See table for quantities and station numbers).

Prior to the final inspection, bridges, islands, and areas with curb shall be swept/cleaned. Care should be taken to prevent milled asphalt, asphalt debris, vegetative/granular debris, etc. from entering drainage structures or clogging other drainage ways. Disposal of material will not be measured for separate payments.

Inset J

**RANKIN COUNTY**  
306931/30100  
HIGHWAY 468 &  
HIGHWAY 80

**EOP**  
STA.# 366+00

**EOP**  
STA.# 44+00

**EOP**  
STA.# 119+81

**BOP**  
STA.# 100+00

**BOP**  
STA.# 0+00

**BOP**  
STA.# 0+00

**EOP**  
STA.# 163+40

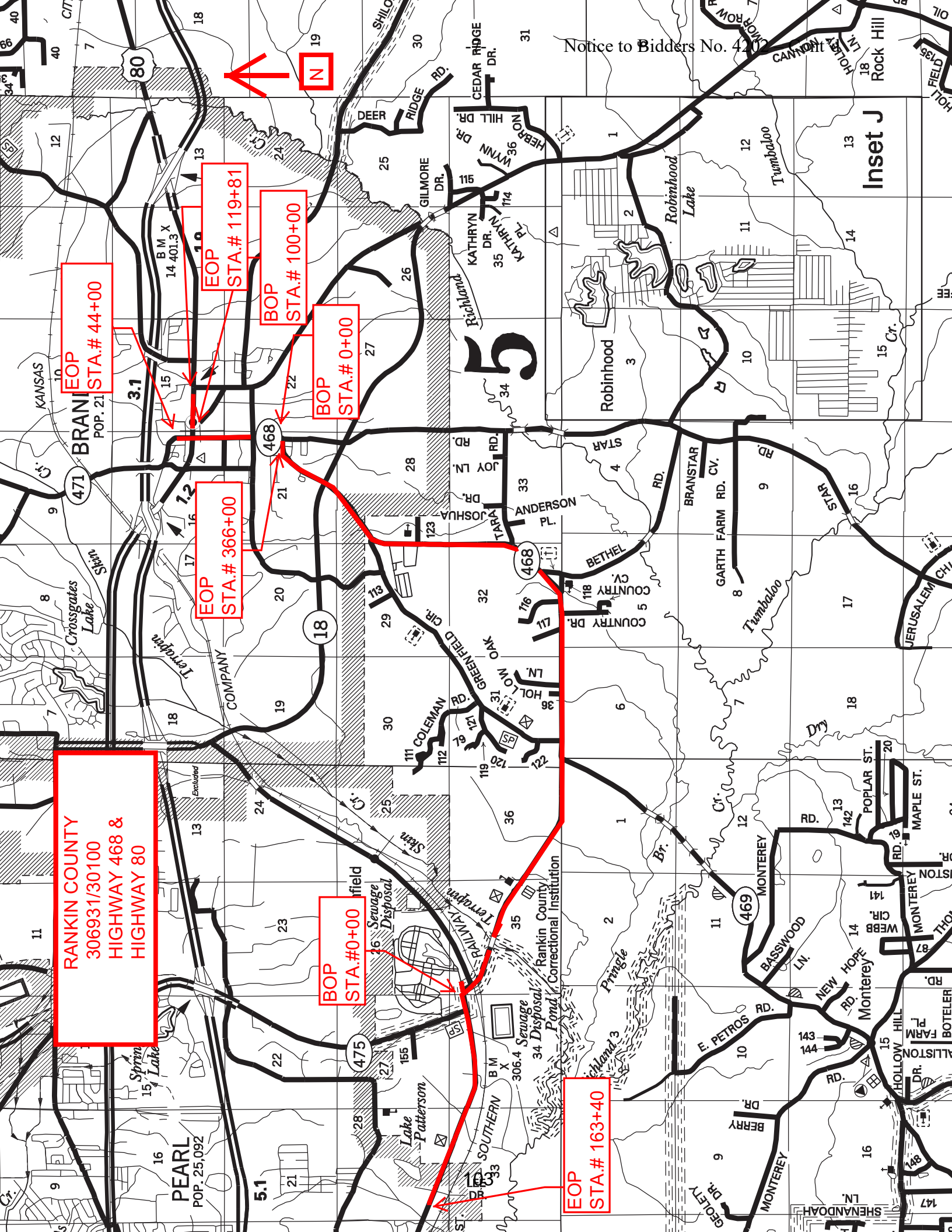



RANKIN COUNTY  
306931/301000  
HIGHWAY 468

**HWY 468 STATION NUMBERS  
STA. 00+00 - STA. 163+40  
SECTION 1**

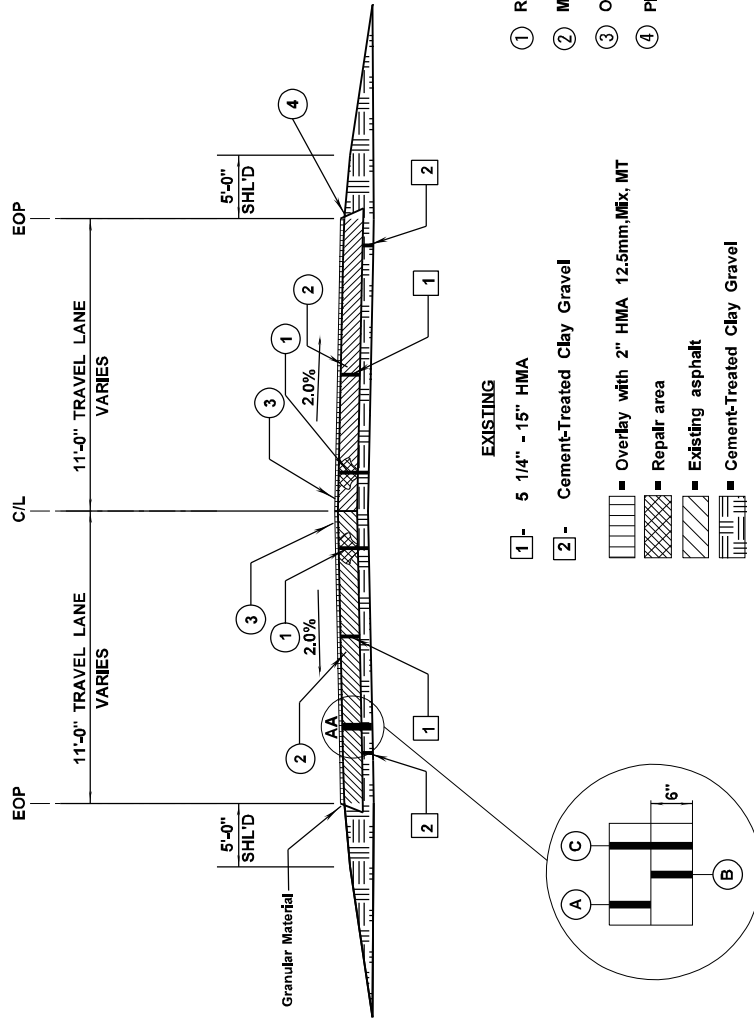

- (AA) BASE FAILURE REPAIR (ALL LOCATIONS)
- (A) EXISTING PAVEMENT TO BE REMOVED
- (B) UNDERCUT EXISTING MATERIAL AS DIRECTED
- (C) REPLACE FULL DEPTH WITH HMA 12.5-MM MT. ASPHALT PAVEMENT (LEVELING)

RANKIN COUNTY  
306931/301000  
HIGHWAY 468

**WHITFIELD RD STATION NUMBERS  
STA. 00+00 - STA. 340+00  
SECTION 2**

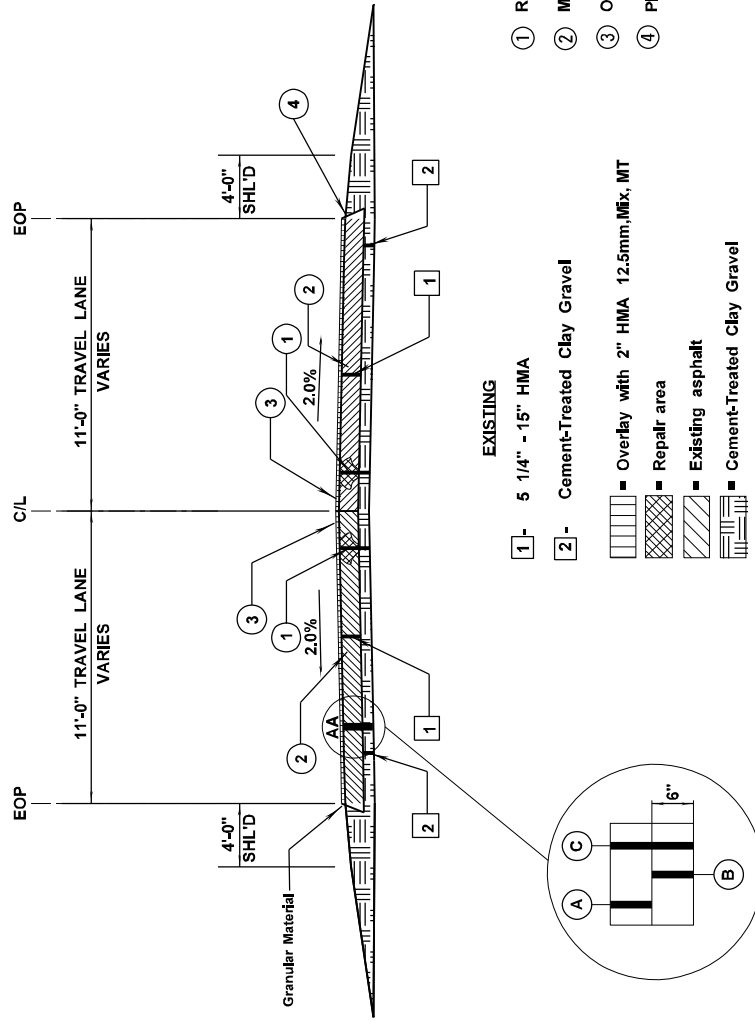

**PROPOSED**

- ① Repair failed areas with HMA 12.5mm, Mix MT Leveling full depth.
- ② MII existing asphalt 1 1/2" and variable.
- ③ Overlay with 2" and variable of HMA 12.5mm Mix, MT.
- ④ Place 2" and Variable Granular Material on shoulder as directed by the Engineer

**EXISTING**

- 1- 5 1/4" - 15" HMA
- 2- Cement-Treated Clay Gravel
- Overlay with 2" HMA 12.5mm, Mix, MT
- Repair area
- Existing asphalt
- Cement-Treated Clay Gravel

- ⓐ BASE FAILURE REPAIR (ALL LOCATIONS)
- Ⓐ EXISTING PAVEMENT TO BE REMOVED
- Ⓑ UNDERCUT EXISTING MATERIAL AS DIRECTED
- Ⓒ REPLACE FULL DEPTH WITH HMA 12.5-MM MT. ASPHALT PAVEMENT (LEVELING)

RANKIN COUNTY  
306931/301000  
HIGHWAY 468

**S COLLEGE ST STATION NUMBERS**  
**STA. 0+00 - STA. 44+00**  
**SECTION 3**

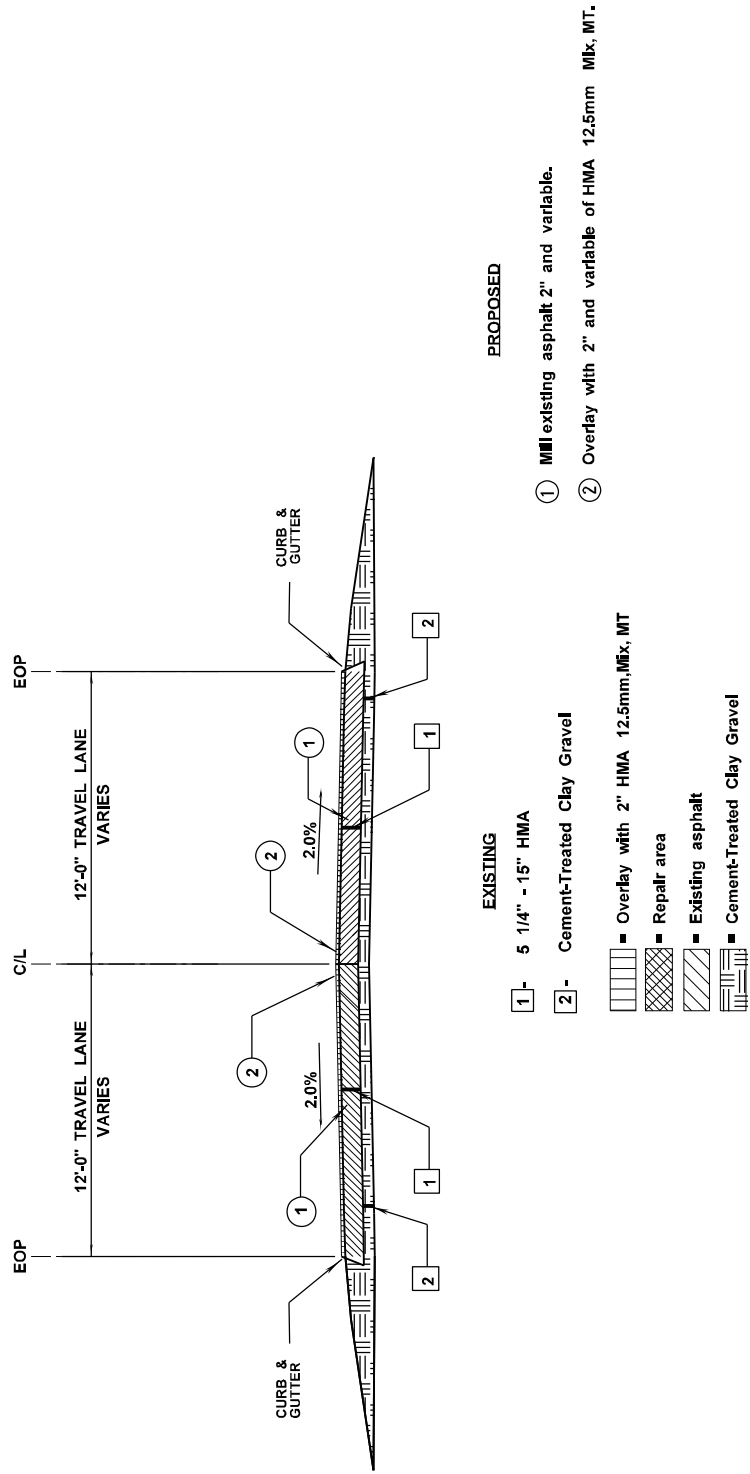

RANKIN COUNTY  
306931/301000  
HIGHWAY 80

**HWY 80/E. GOVERNMENT ST TYPICAL SECTION  
SECTION 4**

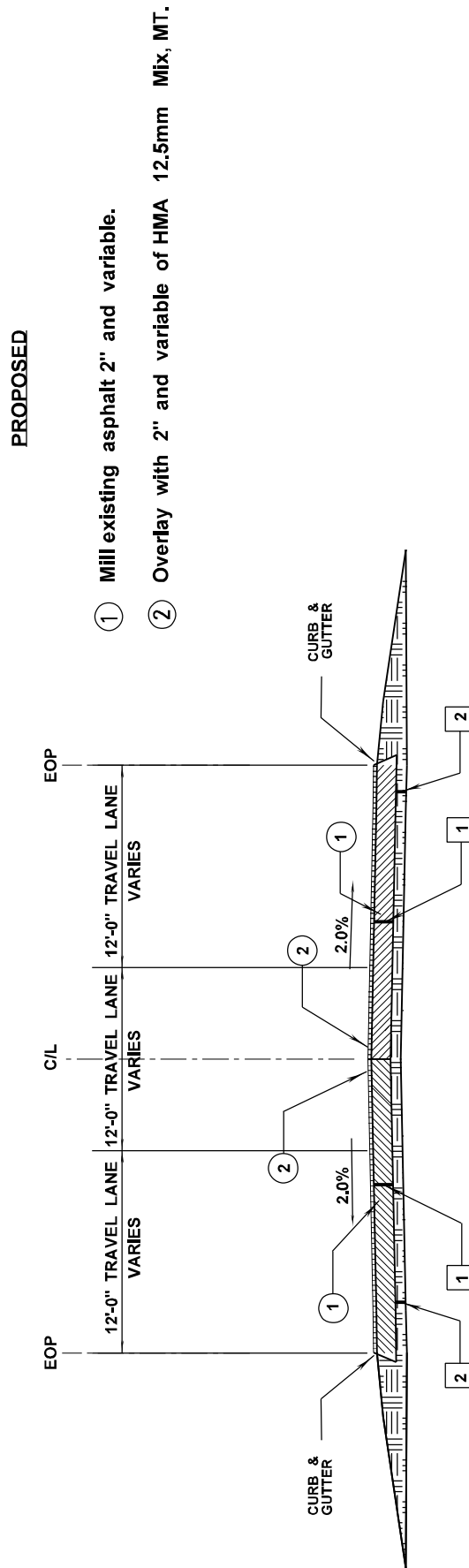

**PROPOSED**

- ① Mill existing asphalt 2" and variable.
- ② Overlay with 2" and variable of HMA 12.5mm Mix, MT.

**EXISTING**

- 1 - 5 1/4" - 15" HMA
- 2 - Cement-Treated Clay Gravel
- ▨ Overlay with 2" HMA 12.5mm, Mix, MT
- ▩ Repair area
- ▧ Existing asphalt
- ▧ Cement-Treated Clay Gravel

12- CONSTRUCTION SIGNING DETAIL Notice to Bidders No. 4202 – Cont'd  
 HWY 468  
 RANKIN COUNTY  
 SECTION FROM DEEB ST. TO  
 WHITFIELD

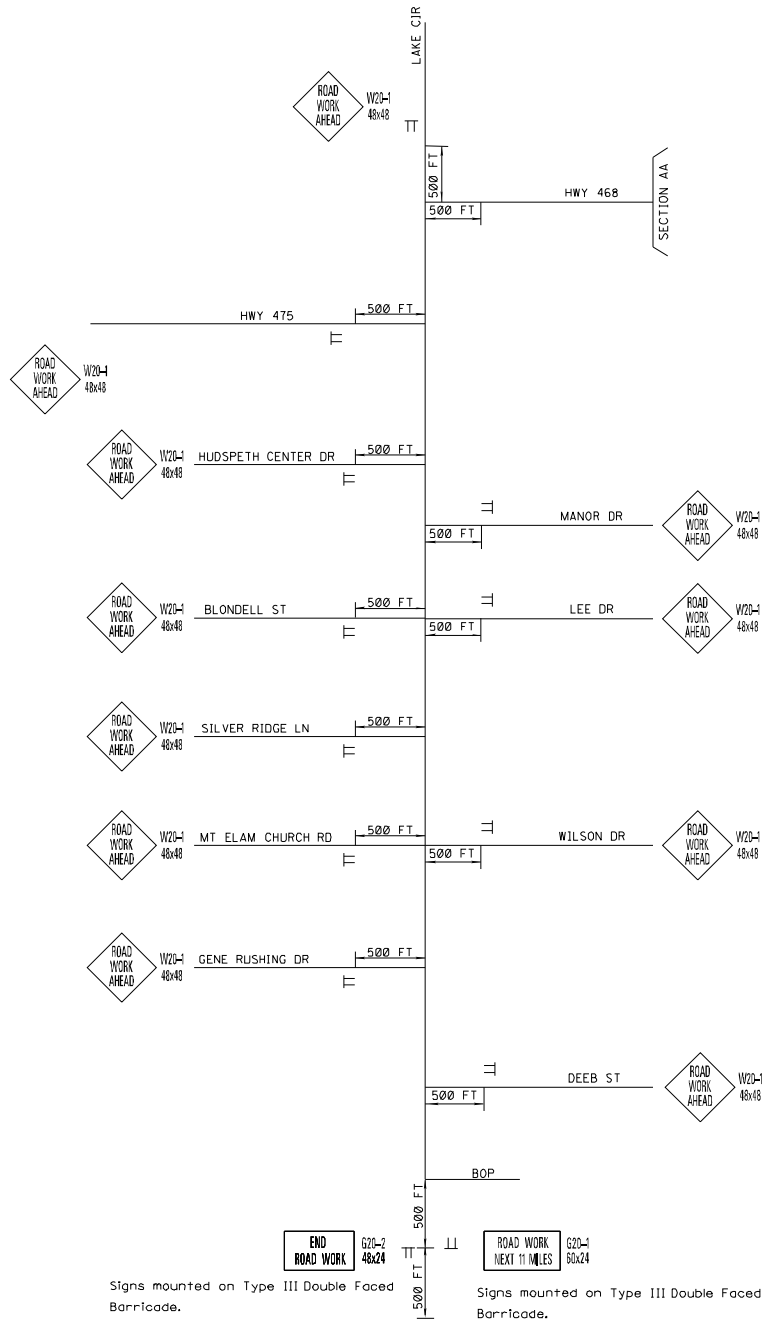

ESTIMATED

- Traffic Control Signs Required:
- 1 - G20-2 "END ROAD WORK"
  - 11 - W20-1 "ROAD WORK AHEAD"
  - 11 - R4-1 "DO NOT PASS"
  - 6 - R4-2 "PASS WITH CARE"
  - 5 - W14-3 "NO PASSING ZONE"
  - 2 - TYPE III DBL. FACE BARRICADES
  - 1 - G20-1

NOTES: One (1) W20-1 "ROAD WORK AHEAD" Sign is Required at each Local Road, Street or Highway Entering the Project.  
 R4-1 "DO NOT PASS", R4-2 "PASS WITH CARE" AND W14-3 "NO PASSING ZONE" signs are required in accordance with Subsection 618.03.3 and as specified in the MUTCD. If No Passing zones are 1000 ft or more, install additional "DO NOT PASS" signs on maximum spacing of 750 ft. Payment for these signs will be under the appropriate pay item numbers in the summary of quantities

-13- Notice to Bidders No. 4202 – Cont'd  
 CONSTRUCTION SIGNING DETAIL  
 HWY 468 (WHITFIELD RD)  
 RANKIN COUNTY  
 SECTION FROM WHITFIELD TO  
 STA. 225+00

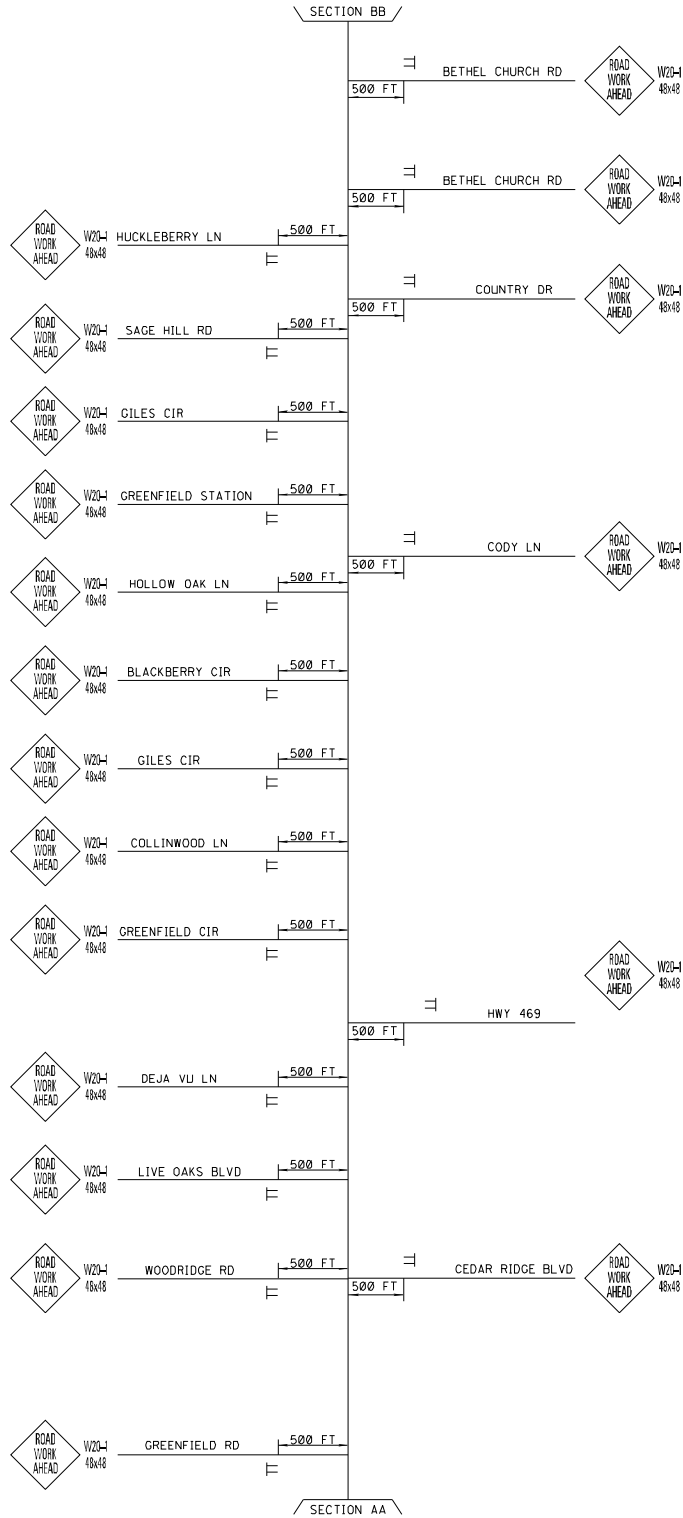

ESTIMATED

- Traffic Control Signs Required:
- 19 - W20-1 "ROAD WORK AHEAD"
  - 43 - R4-1 "DO NOT PASS"
  - 7 - R4-2 "PASS WITH CARE"
  - 8 - W14-3 "NO PASSING ZONE"

NOTES: One (1) W20-1 "ROAD WORK AHEAD" Sign is Required at each Local Road, Street or Highway Entering the Project.  
 R4-1 "DO NOT PASS", R4-2 "PASS WITH CARE" AND W14-3 "NO PASSING ZONE" signs are required in accordance with Subsection 618.03.3 and as specified in the MUTCD, if No Passing zones are 1000 ft or more, install additional NOT PASS" signs on maximum spacing of 750 ft. Payment for these signs will be under the appropriate pay item numbers in the summary of quantities

-14- Notice to Bidders No. 4202 – Cont'd  
 CONSTRUCTION SIGNING DETAIL  
 HWY 468 (WHITFIELD RD)  
 RANKIN COUNTY  
 SECTION FROM STA. 225+00 TO  
 COLLEGE ST.

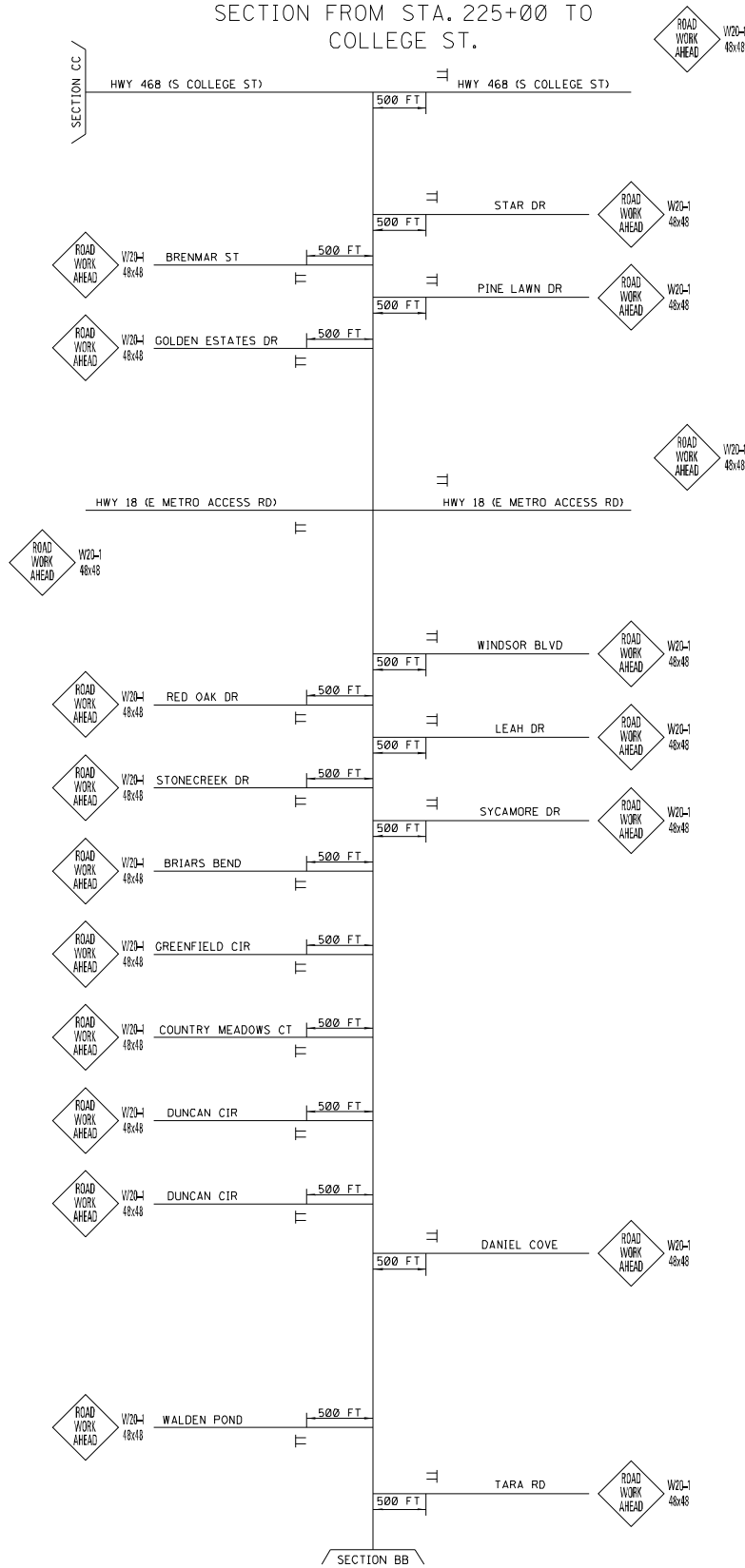

- ESTIMATED
- Traffic Control Signs Required:
- 20 - W20-1 "ROAD WORK AHEAD"
  - 30 - R4-1 "DO NOT PASS"
  - 6 - R4-2 "PASS WITH CARE"
  - 8 - W14-3 "NO PASSING ZONE"

NOTES: One (1) W20-1 "ROAD WORK AHEAD" Sign is Required at each Local Road, Street or Highway Entering the Project. R4-1 "DO NOT PASS", R4-2 "PASS WITH CARE" AND W14-3 "NO PASSING ZONE" signs are required in accordance with Subsection 618.03.3 and as specified in the MUTCD. If No Passing zones are 1000 ft or more, install additional

110 "DO NOT PASS" signs on maximum spacing of 750 ft. Payment for these signs will be under the appropriate pay item numbers in the summary of quantities

15- Notice to Bidders No. 4202 – Cont'd  
 CONSTRUCTION SIGNING DETAIL  
 HWY 468 (S COLLEGE ST)  
 RANKIN COUNTY  
 COLLEGE ST. SECTION  
 (DOWNTOWN BRANDON)

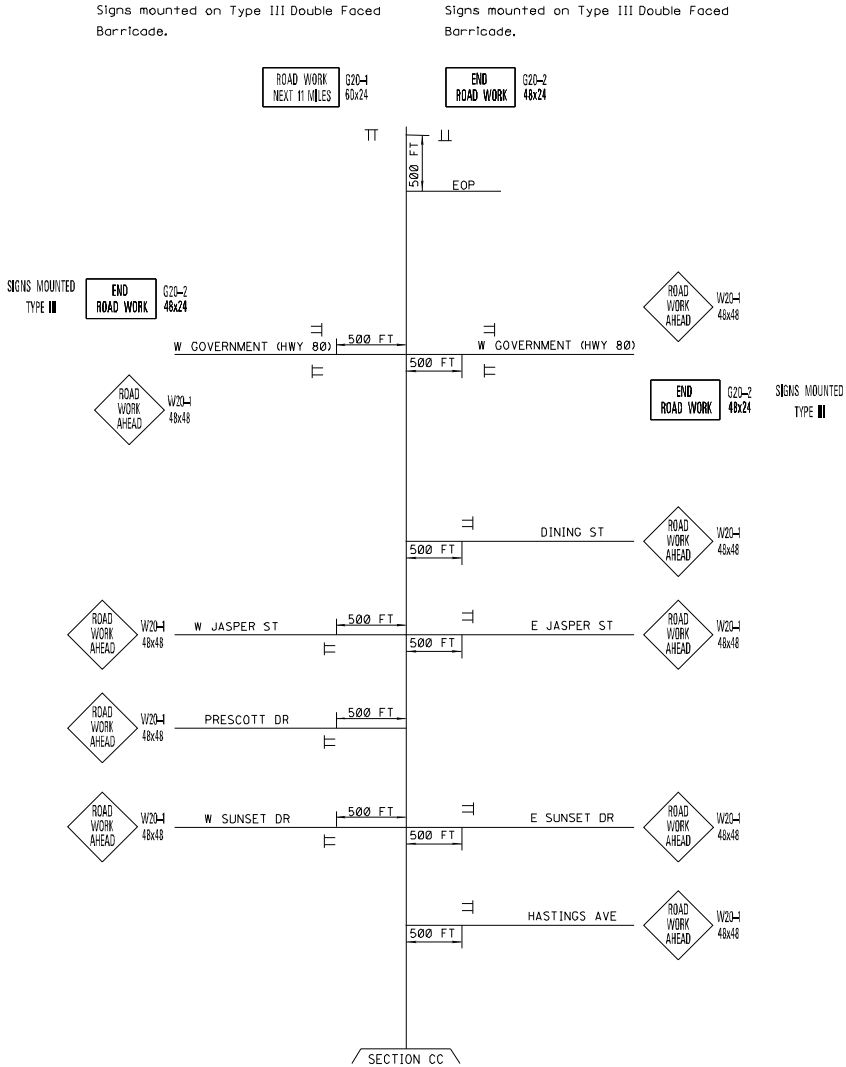

ESTIMATED

- Traffic Control Signs Required:
- 3 - G20-2 "END ROAD WORK"
  - 9 - W20-1 "ROAD WORK AHEAD"
  - 14 - R4-1 "DO NOT PASS"
  - 1 - W14-3 "NO PASSING ZONE"
  - 6 - TYPE III DBL. FACE BARRICADES
  - 1 - G20-1

NOTES: One (1) W20-1 "ROAD WORK AHEAD" Sign is Required at each Local Road, Street or Highway Entering the Project.  
 R4-1 "DO NOT PASS", R4-2 "PASS WITH CARE" AND W14-3 "NO PASSING ZONE" signs are required in accordance with Subsection 618.03.3 and as specified in the MUTCD. If No Passing zones are 1000 ft or more, install additional "DO NOT PASS" signs on maximum spacing of 750 ft.  
 Payment for these signs will be under the appropriate pay item numbers in the summary of quantities



16- Notice to Bidders No. 4202 – Cont'd  
 CONSTRUCTION SIGNING DETAIL  
 HWY 80  
 RANKIN COUNTY  
 SECTION FROM FELICITY ST. TO  
 LOUIS WILSON DR

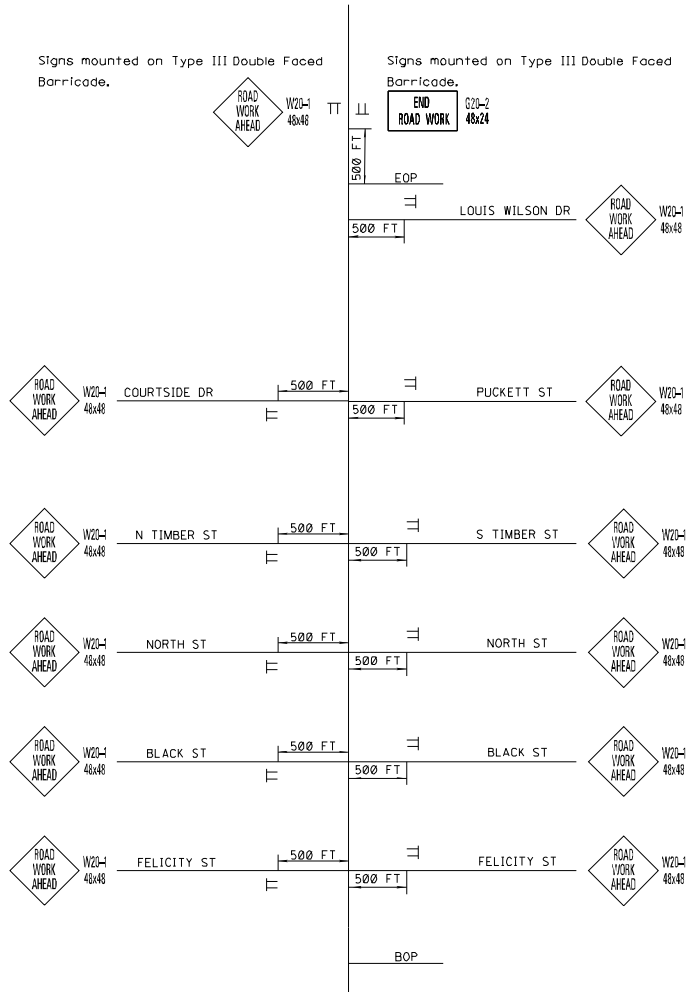

ESTIMATED

- Traffic Control Signs Required:
- 1 - G20-2 "END ROAD WORK"
  - 12 - W20-1 "ROAD WORK AHEAD"
  - 6 - R4-1 "DO NOT PASS"
  - 0 - R4-2 "PASS WITH CARE"
  - 2 - W14-3 "NO PASSING ZONE"
  - 2 - TYPE III DBL. FACE BARRICADES

NOTES: One (1) W20-1 "ROAD WORK AHEAD" Sign is Required at each Local Road,

Street or Highway Entering the Project.  
 R4-1 "DO NOT PASS", R4-2 "PASS WITH CARE"  
 AND W14-3 "NO PASSING ZONE" signs  
 are required in accordance with Subsection  
 618.03.3 and as specified  
 in the MUTCD. If No Passing zones are 1000  
 ft or more, install additional  
 "DO NOT PASS" signs on maximum spacing of 750 ft.  
 Payment for these signs will be under the  
 appropriate pay item numbers in the summary of  
 quantities

MP-5468-61(013) 306931/301000

Rankin County

Full Depth Repair										
Section	STA	to	STA	Lane	Length	Width	Saw Cuts (ft)	Asphalt Removal (SY)	Estimated Excess (CY)	Estimated Asphalt Leveling (Tons)
1*	0+10		2+10	TURN LANE TO SECTION 2	200	12	234	266.67	140.00	264.00
1*	0+00		0+40	RT CENTER AND RT,RT	40	24	88	106.67	56.00	105.60
1*	7+80		9+05	LT,LT	125	12	149	166.67	87.50	165.00
1*	7+80		8+70	LT,RT	90	12	204	120.00	63.00	118.80
1*	7+80		8+37	RT CENTER AND RT,RT	57	24	105	152.00	79.80	150.48
1*	60+30		60+80	BOTH	50	24	48	133.33	70.00	132.00
2**	0+22		1+56	CENTER AND LT	134	24	316	357.33	187.60	353.76
2**	2+00		3+40	CENTER	140	12	304	186.67	98.00	184.80
2**	342+85		345+00	BOTH	215	24	48	573.33	301.00	567.60
							<b>Totals</b>	<b>2063</b>	<b>1083</b>	<b>2292</b>

Note: Failed areas may be adjusted at the discretion of the Engineer.

Note: Additional leveling is required on College Street from Station 40+08 to E.O.P. Additional quantity (250 TONS) is reflected in estimated asphalt leveling total.

\*Section 1 - Station 163+40 (BOP) to Station 0+00 Deeb St. to Whitfield hospital (Station numbers run West)

\*\*Section 2 - Station 0+00 to Station 366+00 Whitfield hospital to College St. (Station numbers run East)

**MP-5468-61(013) 306931/301000  
Rankin County**

<b>CURB QUANTITIES</b>					
<b>Section</b>	<b>Station</b>	<b>Curb Removal (LF)</b>	<b>Estimated Excess (CY)</b>	<b>New Curb (LF)</b>	<b>Description:</b>
2*	145+75	13	1	34	HEADER CURB
*Section 2 - Station 0+00 to Station 366+00 Whitfield hospital to College St. (Station numbers run East)					

<b>STANDARD ROADWAY SIGNS QUANTITIES</b>					
<b>Section</b>	<b>Station</b>	<b>Type III Object Markers, OM-3R or OM-3L, Post Mounted (EA)</b>	<b>Standard Roadside Sign, Sheet Aluminum, 0.125" Thickness (SF)</b>	<b>Steel U-Section Posts, 3.0lb/ft (LF)</b>	<b>Description:</b>
1*	36+00	0	16	14	W1-2R
1*	See Note	13	0	0	
*Section 1 - Station 163+40 (BOP) to Station 0+00 Deeb St. to Whitfield hospital (Station numbers run West)					
Note: To be directed by Engineer.					

<b>SPECIAL DESIGN CURB QUANTITIES</b>				
<b>Section</b>	<b>Station</b>	<b>Removal of Delineators, All Types (EA)</b>	<b>Concrete Curb, Special Design (LF)</b>	<b>Description:</b>
3*	39+35 to 41+15	43	171	Type 2 Anchored Slotted Curb
*Section 3 - Station 0+00 to Station 41+50 College St. to EOP South of US 80 (Station numbers run North)				

MP-5468-61(013) 306931/301000  
Rankin County

STATION	GUARDRAIL QUANTITIES										REMOVAL ITEMS					
	GUARDRAIL		TERMINAL END SECTION				BRIDGE END SECTION				DELINEATORS			Type 3 OBJECT MARKERS		GUARDRAIL REMARKS
	(W-BEAM)	TRANS. SECT.	THREE BEAM	FLARED TERMINAL END SECT.	T AGENT TERMINAL END SECT.	CABLE ANCHOR TYPE 1	TYPE "I"	TYPE "C"	TYPE "F"	SPEC. DESIGN BRIDGE END CONNECTOR	WHITE	YELLOW	(EA)	(EA)	(LF)	
27+03	(LF)	(LF)	(LF)	(EA)	(EA)	(EA)	(EA)	(EA)	(EA)	(EA)	(EA)	(EA)	(EA)	(EA)	(LF)	
	50	0	0	1	0	0	1	0	0	0	4	0	0	1	107	LEFT
27+03		0	0	1	0	0	1	0	0	0	7	0	0	1	219	RIGHT
29+26		50	0	1	0	0	1	0	0	0	4	0	0	1	107	RIGHT
29+26		162.5	0	1	0	0	1	0	0	0	7	0	0	1	219	LEFT
<b>TOTAL =</b>	<b>425</b>	<b>0</b>	<b>0</b>	<b>4</b>	<b>0</b>	<b>0</b>	<b>4</b>	<b>0</b>	<b>0</b>	<b>0</b>	<b>22</b>	<b>0</b>	<b>0</b>	<b>4</b>	<b>652</b>	
	L.F.	EA.	L.F.	EA.	EA.	EA.	EA.	EA.	EA.	EA.	EA.	EA.	EA.	EA.	L.F.	

**NOTES:**  
 \* REMOVAL OF ALL GUARDRAIL (BRIDGE END SECTIONS, W-BEAM, TYPE-I CABLE ANCHORAGE, TERMINAL END SECTIONS, ETC.) WILL BE PAID UNDER PAY ITEM 202-B158 REMOVAL OF GUARD RAIL.  
 \* REMOVAL OF GUARDRAIL DELINEATORS ARE CONSIDERED INCIDENTAL TO THE REMOVAL OF GUARDRAIL AND WILL NOT BE MEASURED AS A SEPARATE PAY ITEM.  
 \* ALL GUARDRAIL (METAL RAIL AND METAL POSTS ONLY) WILL BE RETAINED BY MDOT. WOODEN POSTS, ALL BLOCKOUTS, CONCRETE ANCHORS, ETC. WILL BE THE PROPERTY OF THE CONTRACTOR.  
 \* TOTAL GUARDRAIL LENGTH IS BASED ON A TERMINAL END SECTION 37.5' LONG. IF A TERMINAL END SECTION OF A DIFFERENT LENGTH IS USED, THE LENGTH OF THE W-BEAM MAY HAVE TO BE ADJUSTED.

MP-5468-61(013) 306931/301000

Rankin County

TRAFFIC SIGNAL RADAR DETECTION CHART

Intersection	Detection Zone Location	Phase #	Detection Zone Size	STOPBAR Radar Units	Advance Radar Unit	Radar Cable (ft)	Existing Controller Type	Existing Pole Configuration
MS 468 at MS 18	WB Left Turn Lane	1	6'X50'	1		210	Existing M34 Controller (New Controller Required)	MAST ARM POLES
	WB Thru Lanes	6	405' from STOPBAR		1	240		
	EB Left Turn Lane	5	6'X50'	1		95		
	EB Thru Lanes	2	405' from STOPBAR		1	120		
	NB Left Turn/Thru Lanes	3	6'X50'	1		210	Existing M34 Controller (New Controller Required)	MAST ARM POLES
	SB Left Turn/Thru Lanes	4	6'X50'	1		95		
	WB Left Turn Lane	1	6'X50'	1		165		
	WB Thru Lanes	6	6'X50'					
US 80 at College St	EB Left Turn Lane	5	6'X50'	1		55	Existing M34 Controller (New Controller Required)	MAST ARM POLES
	EB Thru Lanes	2	6'X50'					
	SB Left Turn Lane	7	6'X50'	1		55		
	SB Thru Lane	4	6'X50'					
	NB Left Turn Lane	3	6'X50'	1		165		
	NB Thru LaNE	8	6'X50'					
	WB Left Turn Lane	1	6'X50'	1		120		
	WB Thru Lanes	6	405' from STOPBAR		1	120		
MS 468 at Woodridge Road	EB Left Turn Lane	5	6'X50'	1		100	Existing M34 Controller (New Controller Required)	Woodpole Spanwire
	EB Thru Lanes	2	405' from STOPBAR		1	40		
	NB Left Turn/Thru Lanes	3	6'X50'	1		40		
	SB Left Turn/Thru Lanes	4	6'X50'	1		100		
	Totals			12	4	1930	3	

Notes:

\* Replace existing EPAC Controllers with new controllers. Existing EPAC controllers to be salvaged to MDOT Signal Shop (601-359-1454).

\* Contractor shall be responsible for transferring existing controller data to the new controllers.

\* Radar units shall be mounted per manufacturer recommendations.

\* Contractor may remove existing detection loop cable, if necessary.

\* Cable quantities may be adjusted based on radar locations per manufacturer recommendations

**RANKIN COUNTY - HWY 468  
TYPICAL MILLING PLAN FOR  
CHANNELIZED INTERSECTIONS**

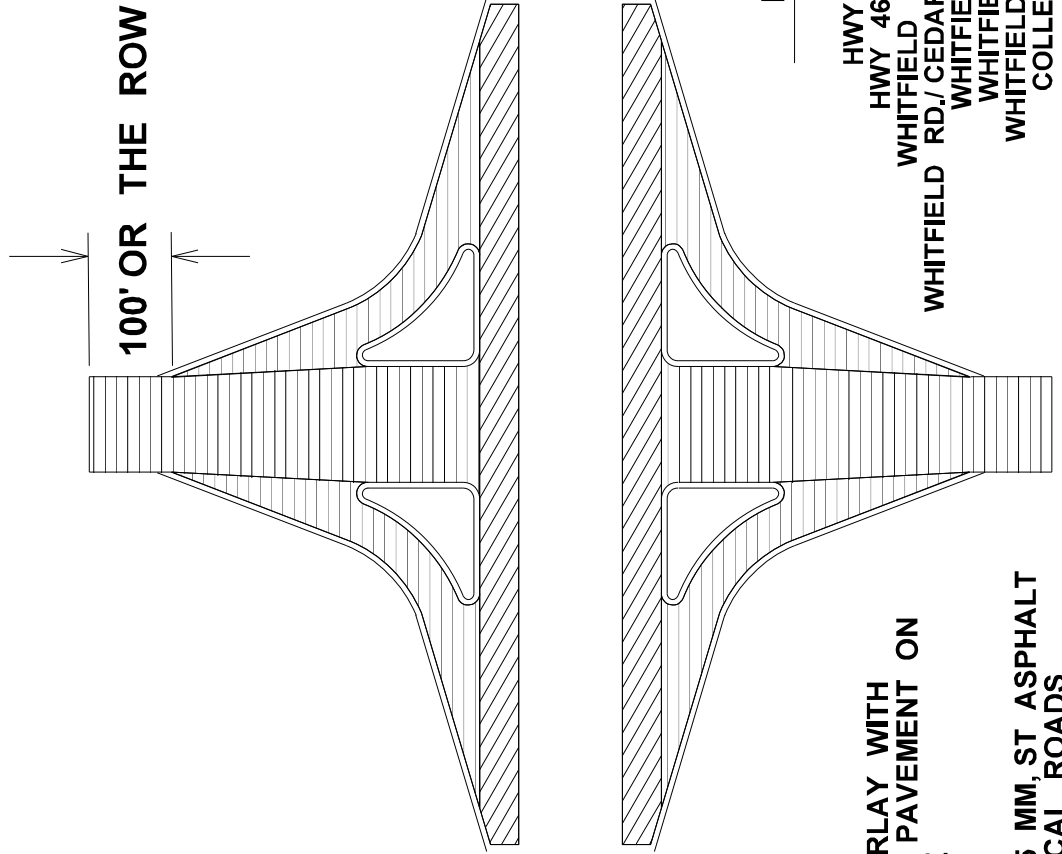

- HWY 468/HWY 475
- HWY 468/WHITFIELD RD.
- WHITFIELD RD./GREENFIELD RD.
- WHITFIELD RD./CEDAR RIDGE R. & WOODRIDGE DR.
- WHITFIELD RD./HWY 469
- WHITFIELD RD./HWY 18
- WHITFIELD RD./COLLEGE ST.
- COLLEGE ST./HWY 80

**Mill 1 1/2" AND OVERLAY WITH  
2" 12.5MM, MT, ASPHALT PAVEMENT ON  
MAINLINE**

**TRANSITION TO 1 1/2" 12.5 MM, ST ASPHALT  
PAVEMENT ON LOCAL ROADS**

**RANKIN COUNTY**  
**MP-5468-61(013) / 306931/301000**  
**SR 468**

**FULL DEPTH PAVEMENT REPAIR DETAIL**

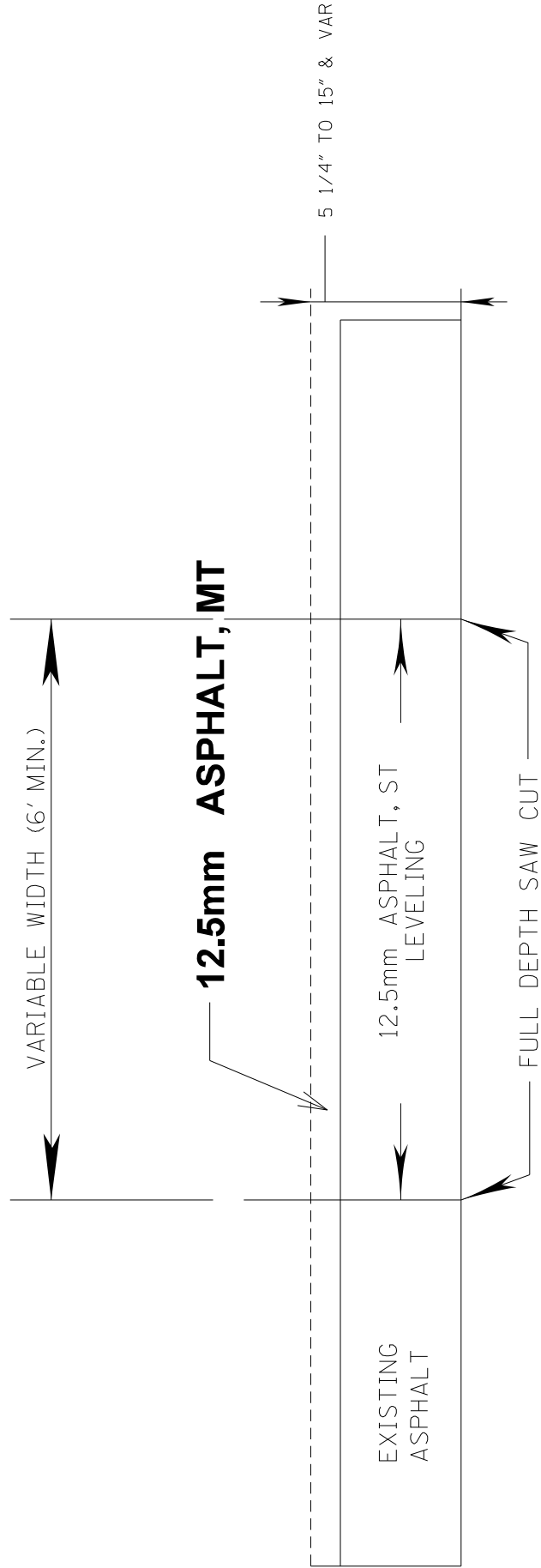

**RANKIN COUNTY  
MP-5468-61(013) 306931/301000**

**TYPICAL DETAIL OF ADDITIONAL SHOULDER PAVING  
REQUIRED AT GUARDRAIL LOCATIONS**

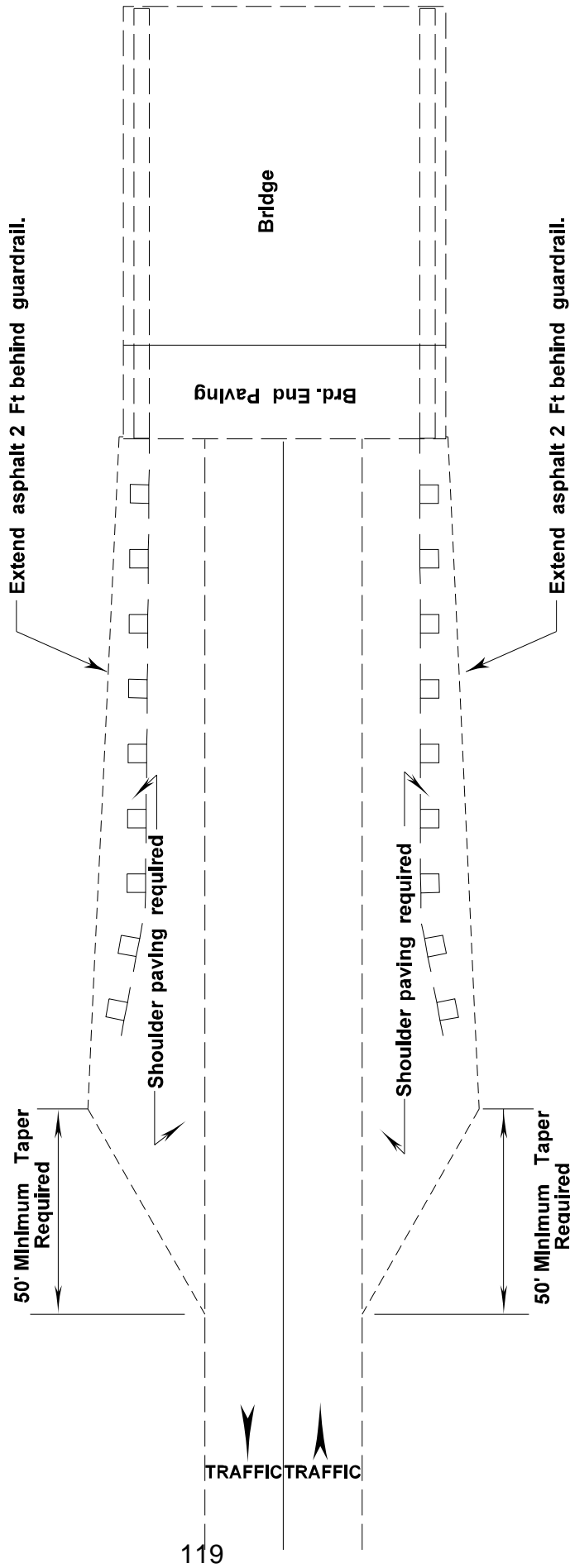

\*Asphalt Thickness  
See scope of work for additional details



S.R. 468 - RANKIN COUNTY  
COUNTY ROAD PAVING/STRIPING  
DETAIL

STRIPE DETAIL

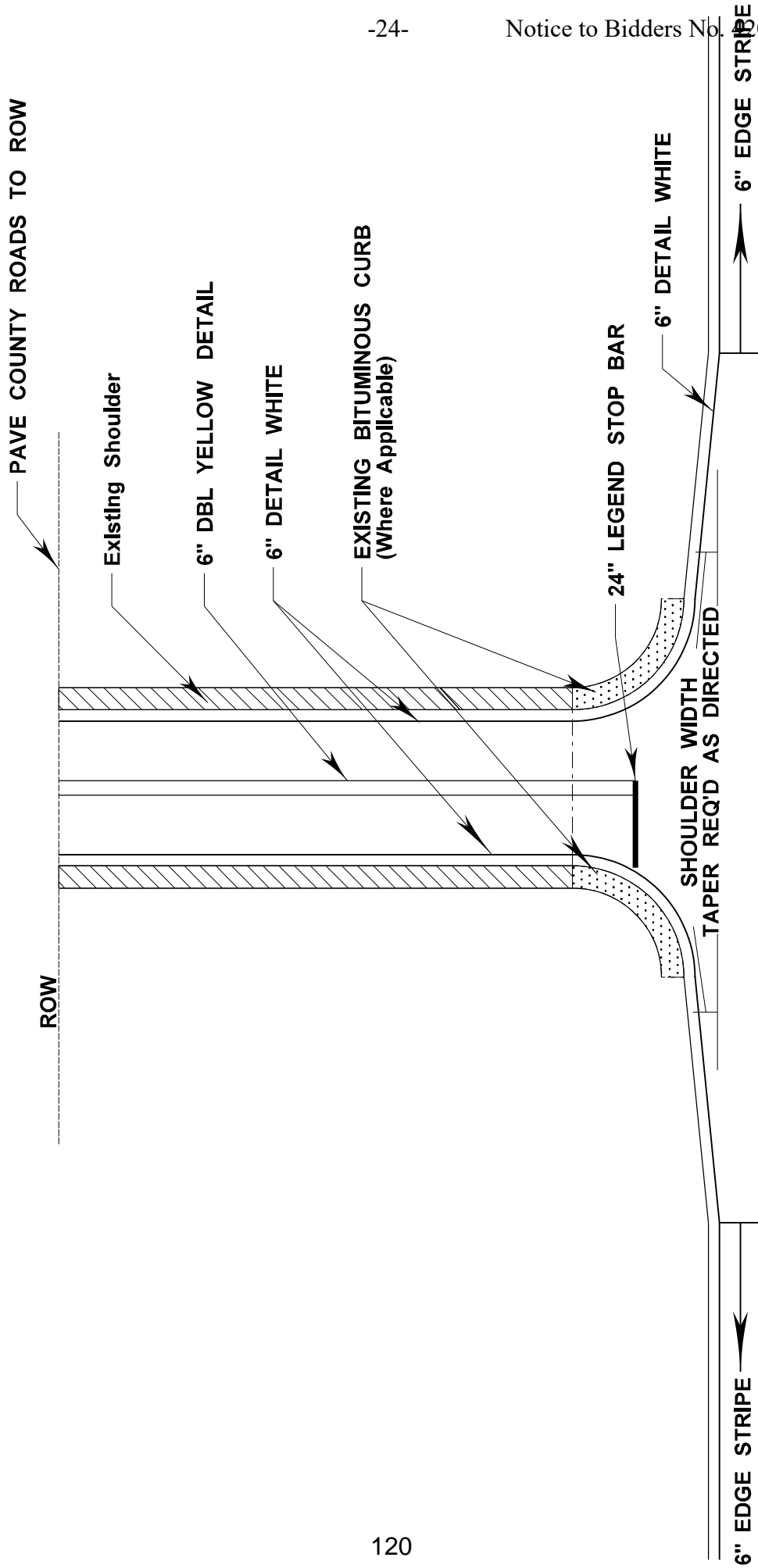

TYPICAL RAMP/PAD DETAIL

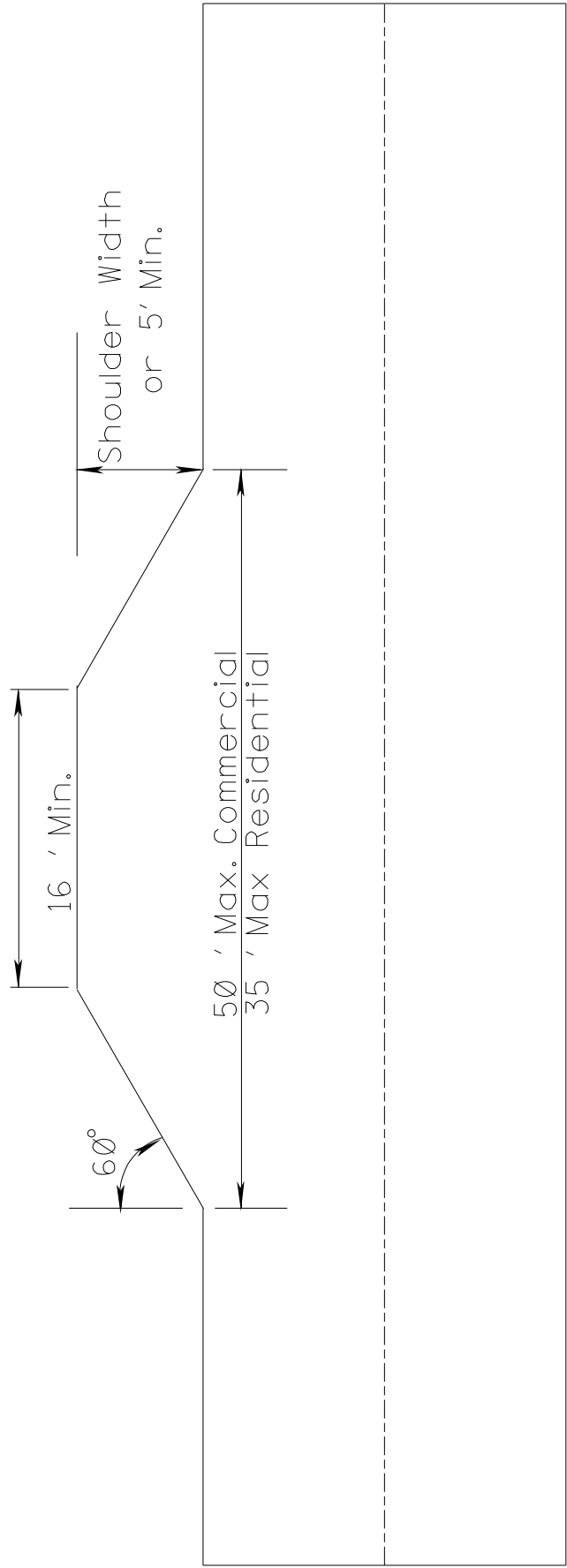

FMS CON-306931301000

STATE	PROJECT NO.
MISS.	MP-5468-61(013)

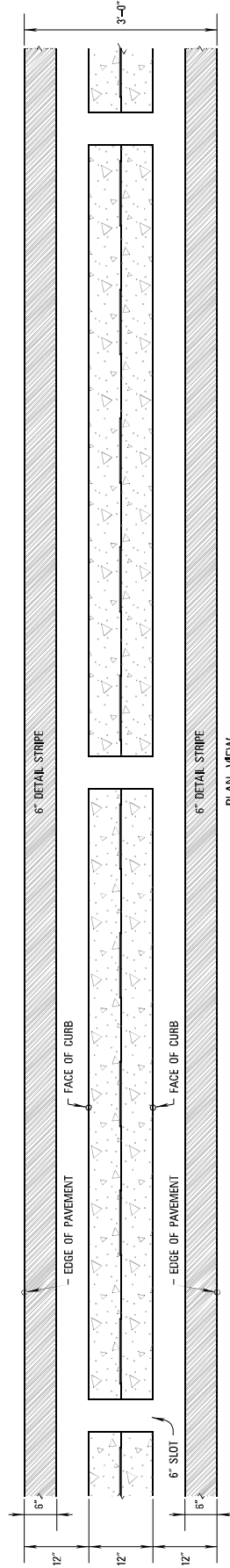

PLAN VIEW  
SPECIAL DESIGN TYPE 2' ANCHORED SLOTTED CURB

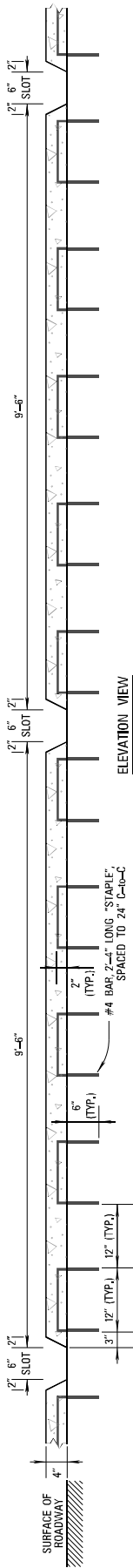

ELEVATION VIEW  
SPECIAL DESIGN TYPE 2' ANCHORED SLOTTED CURB

- NOTES:
- DRAINAGE OPENINGS ("SLOTS") SHALL BE PLACED AT LEAST EVERY 10' OF CURB LENGTH (CENTER-TO-CENTER). SLOTS SHALL BE MIN. 6" LONG.
  - LENGTH OF RECD. DRAINAGE OPENINGS WILL BE INCLUDED IN THE CURB PAY ITEM AND WILL NOT BE MEASURED SEPARATELY.
  - DRAINAGE OPENINGS SHALL BE CENTERED BETWEEN 'STAPLE' PROVIDING A MINIMUM OF 2" CONCRETE COVER.

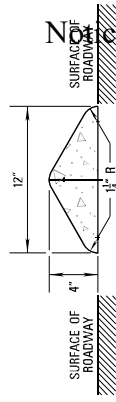

HOLE FOR "STAPLE" SHALL BE DRILLED INTO THE PAVEMENT  $\frac{1}{8}$ " LARGER THAN DIAMETER OF THE BAR

EPOXY RESIN SHALL BE USED TO ANCHOR "STAPLE" IN THE PAVEMENT.

SECTION VIEW DETAIL  
SPECIAL DESIGN TYPE 2' ANCHORED SLOTTED CURB

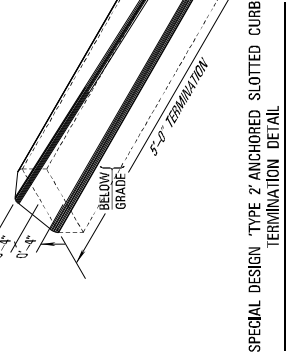

SPECIAL DESIGN TYPE 2' ANCHORED SLOTTED CURB  
TERMINATION DETAIL

N.T.S

MISSISSIPPI DEPARTMENT OF TRANSPORTATION	
SPECIAL DESIGN	
'TYPE 2' ANCHORED SLOTTED CURB DETAILS	
PROJECT NO. MP-5468-61(013)	
HINDS COUNTY	
FILE NAME:	DESIGN TEAM
DATE	CHECKED
BY	REVISION



TYPICAL FOR RAISED PAVEMENT MARKERS  
PLACED ON SIDE ROAD RADIUS

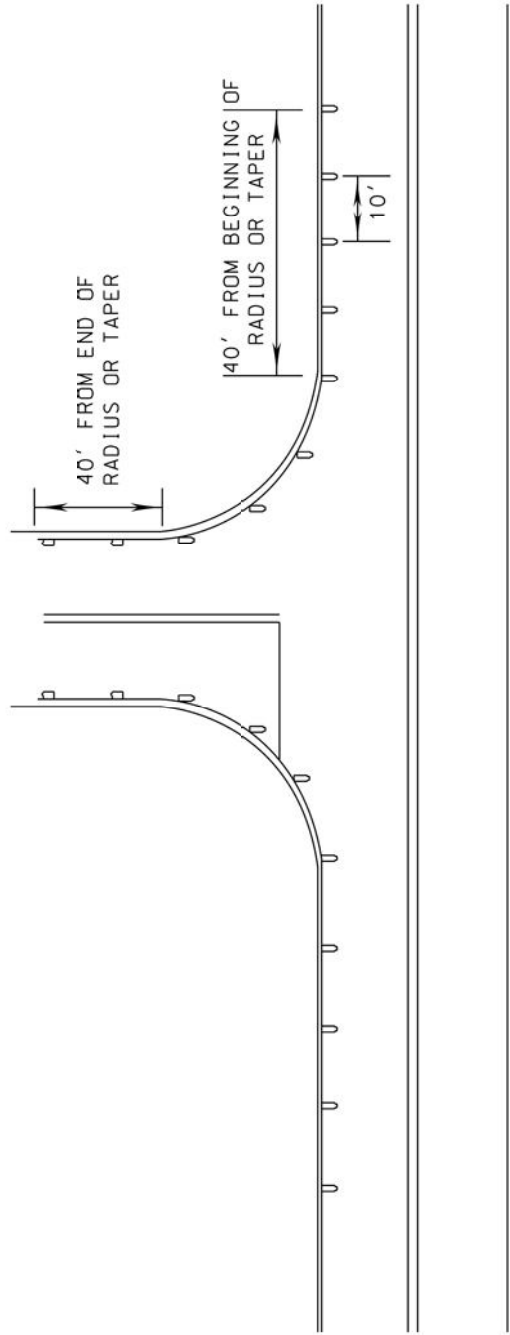

NOTE 1. MARKERS SHALL BE PLACED EVERY 10 FEET.

NOTE 2. MARKERS SHALL BE VISIBLE FROM THE TRAVELING MOTORIST ON STATE DESIGNATED HIGHWAYS.

NOTE 3. MARKERS SHALL BE HIGH PERFORMANCE TWO WAY CLEAR.

NOTE 4. FIVE (5) MARKERS SHALL BE PLACED ALONG MAINLINE EDGE STRIPE.

NOTE 5. MARKERS FOR COUNTY ROADS SHALL CONTINUE DOWN THE EDGE STRIPE A DISTANCE OF 40 FEET.

**MISSISSIPPI DEPARTMENT OF TRANSPORTATION**

**SECTION 904 - NOTICE TO BIDDERS NO. 4204**

**CODE: (SP)**

**DATE: 04/13/2022**

**SUBJECT: Temporary Construction Signs**

**PROJECT: MP-5468-61(013) / 306931301 -- Rankin County**

Bidders are hereby advised of the following regarding the Temporary Construction Signs required:

Should the Bidders elect to install Temporary Construction Signs by first driving short u-channel sections and then bolting the longer, correct height u-channel sections to them, the Bidders are advised that these short sections shall be a minimum of five (5) feet from the ground level when driven and the splice must consist of a minimum of eighteen (18) inches of overlap with a total of four (4) bolts. Bidders are also advised that it is mandatory that these short sections be removed at the completion of the project.

**MISSISSIPPI DEPARTMENT OF TRANSPORTATION**

**SECTION 904 - NOTICE TO BIDDERS NO. 4205**

**CODE: (SP)**

**DATE: 04/13/2022**

**SUBJECT: Underground Utilities**

**PROJECT: MP-5468-61(013) / 306931301 -- Rankin County**

Bidders are hereby advised that utility lines owned and maintained by MDOT may be present within the project limits. These utilities are not located by Mississippi 811. It shall be the Contractor's responsibility to coordinate with MDOT to have the utility lines located and marked prior to beginning work. The Contractor shall give a minimum of three (3) working days of advance notice for locate requests. The contacts for MDOT utility lines are as follows:

**Underground Power Lines:**

Michael Lee – 601-683-3341 – [mlee@mdot.ms.gov](mailto:mlee@mdot.ms.gov)

Vince Herrington – 601-683-3341 – [vherrington@mdot.ms.gov](mailto:vherrington@mdot.ms.gov)

**Underground Communication Lines:**

Kerby McFarland – 601-359-7450 – [kmcfarland@mdot.ms.gov](mailto:kmcfarland@mdot.ms.gov)

Steven Newell – 601-359-7450 – [snewell@mdot.ms.gov](mailto:snewell@mdot.ms.gov)

Henry Lewis – 601-359-1454 – [hlewis@mdot.ms.gov](mailto:hlewis@mdot.ms.gov)

**Underground Signal Lines:**

Amrik Singh – 601-359-1454 – [asingh@mdot.ms.gov](mailto:asingh@mdot.ms.gov)

Kenneth Welch – 601-359-1454 – [kwelch@mdot.ms.gov](mailto:kwelch@mdot.ms.gov)

## MISSISSIPPI DEPARTMENT OF TRANSPORTATION

SPECIAL PROVISION NO. 907-102-2

CODE: (IS)

DATE: 11/22/2017

SUBJECT: **Bidding Requirements and Conditions**

Section 102, Bidding Requirements and Conditions, of the 2017 Edition of the Mississippi Standard Specifications for Road and Bridge Construction is hereby amended as follows.

**907-102.01--Prequalification of Bidders.** Delete the last sentence of the third paragraph of Subsection 102.01 on page 13, and substitute the following.

The Bidder's Certificate of Responsibility number must be on file with the Department's Contract Administration Division prior to request for permission to bid.

**907-102.02--Contents of Proposal Forms.** Delete the fourth paragraph in Subsection 102.02 on page 13, and substitute the following.

Prospective bidders must complete an online request for permission to be eligible to bid a project. Upon approval, the bidder will be authorized to submit a bid electronically using Bid Express at <http://bidx.com>.

## MISSISSIPPI DEPARTMENT OF TRANSPORTATION

SPECIAL PROVISION NO. 907-103-2

CODE: (SP)

DATE: 06/22/2017

SUBJECT: Award and Execution of Contract

Section 103, Award and Execution of Contract, of the 2017 Edition of the Mississippi Standard Specifications for Road and Bridge Construction is hereby amended as follows.

**907-103.01--Consideration of Proposal.** Delete the second and third paragraphs of Subsection 103.01 on page 19, and substitute the following.

**907-103.01.1--For Projects Constructed Without Federal Funds.** Resident Contractors actually domiciled in Mississippi are to be granted preference over nonresidents in awarding of Contracts financed 100% with State funds.

In consideration of proposals that are equal to or in excess of \$50,000 and financed 100% with State funds, a nonresident bidder domiciled in a state having laws granting preference to local Contractors will be considered for such contracts on the same basis as the nonresident bidder's state awards contracts to Mississippi Contractors bidding under similar circumstances. When a nonresident Contractor submits a bid equal to or in excess of \$50,000 on a contract financed 100% with State funds, a copy of the current laws from the state of domicile and an explanation thereof pertaining to treatment of nonresident Contractors shall be attached. If no preferential treatment is provided for Contractors in the state of domicile and contracts are awarded to the lowest responsible bidder, a statement to this effect shall be attached. Should the attachment not accompany the bid when submitted, the Contractor shall have 10 days following the opening of the bids to furnish the required information to the Contract Administration Director for attachment to the bid. Failure to provide the attachment within 10 days will result in the nonresident Contractor's bid being rejected and not considered for award. As used herein, the term "resident Contractor" includes a nonresident person, firm or corporation that has been qualified to do business in this State and has maintained a permanent full-time office in the State of Mississippi for two years prior to the submission of the bid, and the subsidiaries and affiliates of such a person, firm or corporation.



**MISSISSIPPI DEPARTMENT OF TRANSPORTATION**

**SPECIAL PROVISION NO. 907-105-1**

**CODE: (SP)**

**DATE: 05/07/2021**

**SUBJECT: Authority of the Engineer**

Section 105, Control of Work, of the 2017 Edition of the Mississippi Standard Specifications for Road and Bridge Construction is hereby amended as follows.

**907-105.1--Authority of the Engineer.** Delete the first sentence of the second paragraph of Subsection 105.01 on page 31, and substitute the following.

The Engineer has the right to suspend the work wholly or in part and to withhold payments because of the Contractor's failure to correct conditions unsafe for workmen or the general public, for failure to carry out provisions of the Contract, or for failure to carry out orders.

**MISSISSIPPI DEPARTMENT OF TRANSPORTATION**

**SPECIAL PROVISION NO. 907-108-4**

**CODE: (SP)**

**DATE: 10/07/2020**

**SUBJECT: Subletting of Contract**

Section 108, Prosecution and Progress, of the 2017 Edition of the Mississippi Standard Specifications for Road and Bridge Construction is hereby amended as follows.

**907-108.01--Subletting of Contract.**

**907-108.01.1--General.** Delete the third sentence of the tenth paragraph of Subsection 108.01.1 on the bottom of page 72.

## MISSISSIPPI DEPARTMENT OF TRANSPORTATION

SPECIAL PROVISION NO. 907-109-3

CODE: (IS)

DATE: 02/23/2021

SUBJECT: Measurement and Payment

Section 109, Measurement and Payment, of the 2017 Edition of the Mississippi Standard Specifications for Road and Bridge Construction is hereby amended as follows.

**907-109.01--Measurement of Quantities.** Delete the sixth full paragraph of Subsection 109.01 on page 88, and substitute the following.

If appropriate based on the specific circumstances of the project, the Contractor may request that material specified to be measured by the cubic yard or ton be converted to the other measure. The Contractor must submit this request to the Engineer. The Engineer will provide an approval or denial in writing. The decision is in the sole discretion of the Engineer. If approved, factors for this conversion will be determined by the District Materials Engineer and agreed to by the Contractor. The conversion of the materials along with the conversion factor will be incorporated into the Contract by supplemental agreement. The supplemental agreement must be executed before such method of measurement is used.

**907-109.04--Extra Work.**

**907-109.04.1--Supplemental Agreement.** Delete the second paragraph of Subsection 109.04.1 on page 90.

**907-109.06--Partial Payment.**

**907-109.06.2--Advancement on Materials.** Delete the next to last paragraph of Subsection 109.06.2 on page 95, and substitute the following.

Materials for which an advanced payment has been allowed must be paid for by the Contractor within 30 days of the estimate on which the advanced payment was first allowed and proof of said payment must be verified by the supplier. If proof of payment is not furnished within the allowable 30 days, the advanced payment will be deducted on subsequent current estimates until such time that proof of payment is furnished.

## MISSISSIPPI DEPARTMENT OF TRANSPORTATION

SPECIAL PROVISION NO. 907-619-6

CODE: (SP)

DATE: 03/21/2018

SUBJECT: Temporary Portable Rumble Strips

Section 619, Traffic Control for Construction Zones, of the 2017 Edition of the Mississippi Standard Specifications for Road and Bridge Construction is hereby amended as follows.

**907-619.02--Materials.** After Subsection 619.02.15 on page 472, add the following.

**907-619.02.16--Temporary Portable Rumble Strips.** Temporary portable rumble strips shall be RoadQuake manufactured by PSS and meet the following requirements:

- capable of being installed without adhesives or bolts,
- have a minimum weight of 100 pounds,
- have a minimum overall length of 11 feet,
- have a minimum width of 12 inches, and
- have a maximum height of 3/4 inch.

Temporary portable rumble strips shall be installed in accordance with the attached details, or as directed by the Engineer.

**907-619.03--Construction Requirements.** After Subsection 619.03.11 on page 476, add the following.

**907-619.03.16--Temporary Portable Rumble Strips.** Temporary portable rumble strips shall be placed at locations shown on the traffic control plans, attached drawing, or as directed by the Engineer. The rumble strips shall be removed when lane closures are removed, relocated when lane closures are relocated, or as directed by the Engineer.

Prior to placement of the rumble strips, the roadway shall be cleaned to be free of dust, sand, and other materials that may cause slippage. The minimum roadway temperature at the time of installation shall be in accordance with manufacturer recommendations.

A minimum of three (3) temporary portable rumble strips shall be arranged in an array. The spacing of temporary portable rumble strips in each array shall be on 15-foot centers. One array of three (3) strips shall be used in each lane. The rumble strips shall be regularly monitored and maintained to ensure they stay in place under traffic.

**907-619.04--Method of Measurement.** At the end of Subsection 619.04 on page 478, add the following.

Temporary Portable Rumble Strips will be measured for payment by the linear foot only when a pay item for temporary portable rumble strips is included in the contract. Otherwise, temporary portable rumble strips will be included in the cost of pay item 618-A, Maintenance of Traffic. The quantity of temporary portable rumble strips will be the length of rumble strips approved by the Engineer to be in-place on the project at any one time.

**907-619.05--Basis of Payment.** After the fifth paragraph of Subsection 619.05 on page 478, add the following.

Temporary Portable Rumble Strips measured as prescribed above, will be paid for at the contract unit price per linear foot, which price shall be full compensation for cleaning the roadway surface, installing the rumble strips, maintenance and repair of the strips, cleaning and resetting of the strips, removal and replacement, and for all labor, equipment, tools, and incidentals necessary to complete the work.

After the last pay item listed on page 480, add the following.

907-619-B: Temporary Portable Rumble Strips - per linear foot

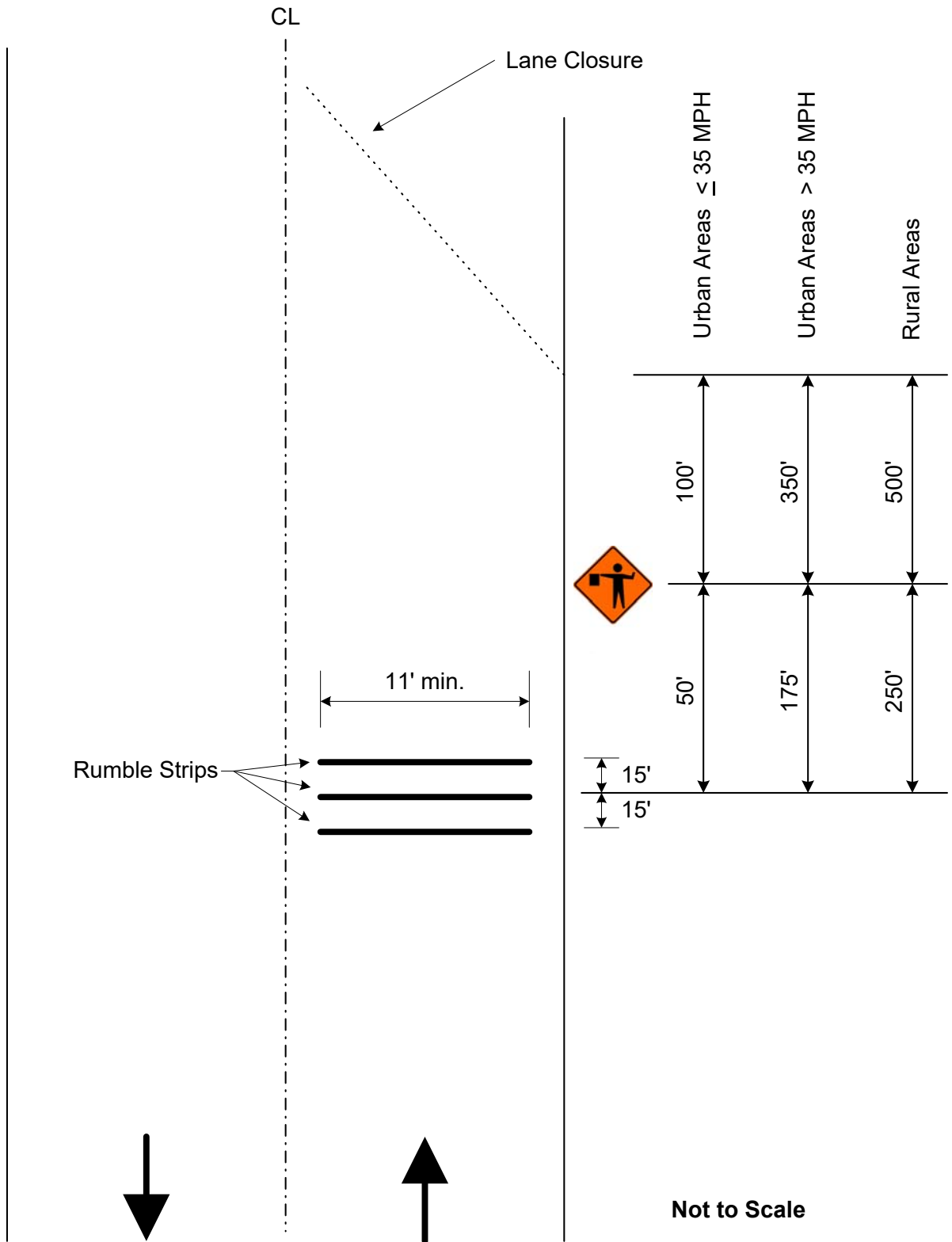

**Detail of Temporary Portable Rumble Strips**

# MISSISSIPPI DEPARTMENT OF TRANSPORTATION

SPECIAL PROVISION NO. 907-631-1

CODE: (IS)

DATE: 11/15/2017

SUBJECT: Traffic Signal Systems - General

Section 631, Traffic Signal Systems - General, of the 2017 Edition of the Mississippi Standard Specifications for Road and Bridge Construction is hereby amended as follows.

## **907-631.02--Materials.**

**907-631.02.4--Operations.** Delete the second paragraph in Subsection 631.02.4 on page 513 and substitute the following.

The Contractor shall conduct the work at all times in such a manner as to ensure the least possible inconvenience to the traveling public, and to property owners on the streets, alleys, and other public places where the construction will take place.

**907-631.02.5--Electrical Service.** Delete the first paragraph in Subsection 631.02.5 on page 515 and substitute the following.

It shall be the Contractor's responsibility to make the necessary arrangements with the local power company to provide the electrical service for any new installation. The Contractor shall pay for, at no cost to the Department, all deposits, hook-up charges, or other service fees required by the power company for the establishment of new service. The cost of all such fees shall be considered incidental and absorbed within existing pay items. The Department or the local agency will be responsible for payment of the monthly service bill for the new power service installation. It shall be the responsibility of the Contractor to swap the electrical service account over to the Department or local agency.

## **907-631.03--Construction Requirements.**

**907-631.03.2--Electrical Service Equipment.** Delete the paragraphs of Subsection 631.03.2 on pages 515 and 516, and substitute the following.

The power supply assembly shall consist of all equipment mounted in a Power Service Pedestal as described in Subsection 722.13 or as otherwise shown in the plans. The configuration and installation of the equipment mounted on the assembly shall meet the safety requirements and approval of the utility company or municipality furnishing power for operation.

When required, service poles shall be provided by the Contractor and consist of wood poles with required pole line hardware, conduit, ground rods, guy wires and anchors and all other accessories and appurtenances mounted on the pole, except those items furnished by the utility company or

municipality, or as specified separately in the contract or plans. Costs of service poles shall be included in other items bids.

Main disconnect switches shall be separately housed on the power supply assembly. Circuit breaker cabinets and meters shall not be installed on the street or walk side of the pole or pedestal.

**907-631.03.3--Performance Tests.** Delete the second sentence of Subsection 631.03.3 on page 516.



# MISSISSIPPI DEPARTMENT OF TRANSPORTATION

SPECIAL PROVISION NO. 907-632-1

CODE: (IS)

DATE: 11/15/2017

SUBJECT: Traffic Signal Cabinet Assemblies

Section 632, Traffic Signal Cabinet Assemblies, of the 2017 Edition of the Mississippi Standard Specifications for Road and Bridge Construction is hereby amended as follows.

Delete Section 632 on pages 517 thru 538, and substitute the following.

## **SECTION 907-632 - TRAFFIC SIGNAL CABINET ASSEMBLIES**

**907-632.01--Description.** This work consists of furnishing, assembling, configuring and installing all component materials and software required to form completed traffic signal controller assemblies, closed loop master controller assemblies and signal system installation of the types specified, in conformity with these specifications, to ensure fully operational traffic signal installations as shown on the plans.

### **907-632.02--Materials.**

**907-632.02.1--Cabinet Assembly.** Cabinet Assemblies shall meet the NEMA 3R requirements and be constructed principally of 0.125-inch thick, 5052-H32 aluminum. The aluminum shall have a mill finish per NEMA TS 2 7.7.3. Intermittent welds may be used for construction and any unwelded cabinet seams shall be sealed with clear RTV silicone. All external fasteners shall be stainless steel and no holes will be allowed in top of cabinet.

The door handles shall be stainless steel or cast aluminum. Door hinges shall be of the continuous type with a stainless steel hinge pin. Rivets are not be used to attach the hinge. The main door stop rod shall be constructed using stainless steel. The door stop mechanism shall be adjustable and capable of being securely latched in multiple opened positions including 90 degrees and a maximum of 120 degrees. The brackets attaching the stop rod to the door and cabinet shall be aluminum and welded in place. The main door cylinder lock shall be a #2 key type lock. Two (2) traffic industry standard No. 2 keys shall be provided with each cabinet and shall be made using heavy duty key blanks.

Extruded aluminum channels permanently attached to the right and left cabinet sides shall be provided for attaching adjustable shelving and mounting of other component panels. The cabinet shall have two (2) shelves installed. Both shelves shall be provided with the front edge pre-drilled with 0.25-inch holes located twelve (12) inches apart.

### **907-632.02.2--Physical Features.**

**907-632.02.2.1--Pull Out Drawer.** A pull out drawer shall be installed and centered under the

bottom shelf. The drawer shall be made of 0.080-inch thick, 5052-H32 aluminum and come out on full extension drawer slides. The pull out drawer shall provide an approximate 16-inch x 14-inch working area and have the ability to bear a constant 25 pound burden. There shall be a compartment for document storage. The lid shall be hinged at the rear, to gain access to the storage area. The drawer will be used to store documents as well as support a notebook computer. The drawer slides shall be of the full extension ball bearing type. Dimensions of the drawer shall be large enough to support a notebook computer and a drawer of sufficient size to hold at least two (2) copies of the cabinet drawings and other related cabinet documentation. The surface of the lid shall have a non-slip surface.

**907-632.02.2.2--Cabinet Lighting.** Cabinets shall be provided with a minimum of two (2) white light LED modules. One (1) lighting module shall be installed along the front top section of the cabinet and the second lighting module shall be installed underneath the bottom cabinet shelf in such a location as to provide direct lighting of the load bay area of the cabinet but must not interfere with the cabinet drawer operation.

Both LED lighting modules shall be controlled by a NEMA rated, commercial quality, pushbutton door switch. The cabinet lighting shall turn on when the cabinet main door is opened and shall turn off when the main door is closed or an ON/OFF NEMA rated, commercial quality, toggle switch mounted on the inside cabinet door service panel shall be provided to turn both LED lighting modules on or off.

**907-632.02.2.3--Police Panel Switches.** Police panel switches shall be provided with all controller cabinets. All switches shall be hard wired and labeled as to their function.

**NORMAL-FLASH:** When this switch is in the FLASH position, all signal indications shall transfer to the flashing mode. AC power shall be removed from the load switches when the signal indications transfer to the flashing mode.

The controller unit shall operate in accordance with appropriate specifications during the flashing mode. When the switch is placed in the NORMAL position, transfer from the flash mode to normal operation shall be made in accordance with uniform code flash requirements.

**SIGNAL ON-OFF:** AC power shall be removed from the signal heads and the intersection will become dark when this switch is in the OFF position.

**MANUAL CONTROL ON-OFF:** When this switch is in the ON position, a logic ground shall be applied to the manual control enable input of the controller unit.

**INTERVAL ADVANCE INPUT JACK:** A manual jack shall be installed on the police panel. The jack shall inter-mate with a 3-circuit, ¼-inch diameter phone plug. The tip and ring (middle) circuits of the jack shall be connected to the logic ground and the interval advance inputs of the controller unit. When the manual hand cord is plugged into the jack and the pushbutton is pressed, logic ground shall be connected to the interval advance input of the controller unit.

When specified in the contract documents, an interval advance cord shall be provided. The cord

shall have a minimum length of three (3) feet. It shall have a 1/4-inch diameter, three circuit plug connected to one end and a manual pushbutton enclosed in a hand-held enclosure at the other end. A complete cycle (push-release) of the manual pushbutton shall terminate the controller unit interval which is active except the vehicular yellow and red clearance intervals. Cycling the pushbutton during the vehicular yellow or all red clearance intervals shall not terminate the timing of those intervals.

**907-632.02.2.4--Service Panel Switches.** Service panel switches shall be hard wired and clearly labeled to identify as to their functions. Service panel switches shall be mounted on the service panel located on the inside of the main cabinet door. Alternate switch locations may be described in the plans or contract documents but final switch design and location shall be approved by the Engineer prior to cabinet fabrication.

**NORMAL-FLASH:** When this switch is in the FLASH position, all signal indications shall transfer to the flashing mode. AC power shall be removed from the load switches when the signal indications transfer to the flashing mode.

The controller unit shall operate in accordance with appropriate specifications during the flashing mode. When the switch is placed in the NORMAL position transfer from the flash mode to normal operation shall be made in accordance with uniform code flash requirements.

**CONTROLLER ON-OFF:** When this switch is in the OFF position, AC power shall be removed from the controller. When this switch is returned to the ON position, the controller unit shall perform normal start up functions and resume normal operation in accordance with the applicable specification.

**STOP TIME-RUN-NORMAL:** A 3-position manual switch shall be provided which places the controller into Stop Time mode manually or through remote input.

**VEHICLE DETECTORS:** A 3-position switch shall be provided for each vehicle and pedestrian detector circuit. All switches shall be located on a panel mounted on the inside of the main cabinet door. The switch panel shall be labeled CALL SWITCH. Labeling of phase number and intended function (vehicles or pedestrian calls) shall be provided for each switch.

The vehicle detector switch functions are defined as follows:

- Locked Call            Call is continually placed into the controller unit.
- Off (center)            Vehicle detector is connected to the controller unit vehicle detector input, i.e. normal detector operation.
- Momentary Call        Call is continuous as long as the switch is manually held in this position.

**907-632.02.2.5--Police and Service Panel Locations.** The police and service panels shall be constructed of 5052-H32 0.125-inch thick aluminum.

The police panel shall be located behind the police door which is enclosed within the main door.

The police door shall be hinged and provided with a neoprene gasket seal. Access to any portion or equipment contained behind the main cabinet door shall not be accessible through any part of the police panel. The police panel shall be of appropriate dimensions to accommodate all switch or devices described within this specification, the plans or contract document. The police door shall be provided with a treasury #2 key type lock and two (2) keys for the police door lock shall be provided with each cabinet.

The service panel shall be mounted on the inside portion of the main cabinet door, adjacent to the back side of the police panel or on the left hand side of the cabinet.

**907-632.02.2.6--Cabinet Ventilation.** Cabinets shall be vented to allow dissipation of the heat generated by the equipment contained within. All cabinets shall have a thermostatically controlled exhaust fan located at the top of the cabinet that is capable of 100 cubic feet per minute air displacement. The thermostat shall be mounted on the inside top of the cabinet and shall have a nominal temperature range from 80°F to 170°F.

The intake vent shall be louvered or equivalent design to prevent rain infiltration. The vent area will be located along the bottom portion of the cabinet door. A 16-inch x 12-inch x 1-inch disposable pleated air filter shall be provided on the inside portion of the cabinet and shall fully cover the vent area.

**907-632.02.2.7--Air Filter Assembly.** Air filters shall be one piece and shall be held firmly in place against the cabinet door in order to prevent dust from bypassing the perimeter of the filter and shall fully cover the vent area. Wing nuts or thumbscrews are preferred. Air filter shall be a 16-inch x 12-inch x 1-inch disposable pleated filter.

**907-632.02.2.8--Cabinet Sizes.**

**907-632.02.2.8.1--Type I Cabinet.** A Type I cabinet, 51”H x 30”W x 18”D, may be used for both pole and base mounted cabinets that require a maximum eight (8) position load bay. Pole mounted cabinets do not require rear access.

**907-632.02.2.8.2--Type II Cabinet.** A Type II cabinet, 51”H x 36”W x 18”D, may be used for both pole and base mounted cabinets that require a maximum twelve (12) position load bay. Pole mounted cabinets do not require rear access.

**907-632.02.2.8.3--Type III Cabinet.** A Type III cabinet, 56”H x 44”W x 27”D, shall be used for base mount installations and shall require a sixteen (16) position load bay and rear access door.

**907-632.02.2.8.4--Type IV Cabinet.** A Type IV dual chamber cabinet, 56”H x 57”W x 29”D, shall be used for base mount installations and shall require a sixteen (16) position load bay, rear access door, and external generator plug. When called for in the plans, a UPS shall be housed inside this cabinet.

**907-632.02.2.8.5--Type V Cabinet.** A Type V cabinet, 77”H x 44”W x 27”D, shall be used for base mount installations and shall require a sixteen (16) position load bay and rear access door.

**907-632.02.3--Power Distribution Panel.** The power panel shall be wired to provide the necessary power to all equipment. It shall be manufactured from 0.125-inch thick, 5052- H32 aluminum. The power panel shall house the following components: Main Breaker, Auxiliary Breakers, and Terminal Block. The panel shall be of such design so as to allow a technician to easily access the main and auxiliary breakers.

A 3-position terminal block with a removable insulated cover accepting up to AWG #4 stranded wire shall be supplied for accepting only the incoming power lines. This terminal block shall be in advance of and supply only the 30-amp main breaker, 10-amp and 5-amp Auxiliary breakers, AC neutral buss and earth ground buss.

**907-632.02.3.1--Ground and Neutral Busbars.** Cabinet grounding shall meet the requirements set forth in Subsection 722.09 for grounding and ground rods. A solid copper ground busbar shall be mounted on the side of the cabinet wall adjacent to the power panel for the connection of chassis ground wires. If more than one (1) ground busbar is used in a cabinet, a minimum of an AWG #6 copper wire shall be used to bond them.

The copper ground busbar shall have a minimum of thirteen (13) connector points, each capable of securing at least one (1) AWG #6 conductor.

A solid copper neutral busbar shall be mounted on the side of the cabinet wall adjacent to the power panel for the connection of AC neutral wires.

The copper neutral busbar shall have a minimum of thirteen (13) connector points, each capable of securing at least one (1) AWG #6 conductor.

**907-632.02.3.2--Terminal Strips.** Conductors shall be terminated on terminal strips with insulated terminal lugs. When two (2) or more conductors are terminated on field wiring terminal strip screws, a terminal ring lug shall be used for termination of those conductors. The voltage and current rating of terminal strips shall be greater than the voltage and current rating of the wire which is terminated on the terminal strip.

**907-632.02.3.3--Cabinet Receptacles.** A 3-wire 115 Volt AC (15A) Ground Fault Circuit Interrupt (GFCI) duplex receptacle shall be provided in the cabinet for maintenance use. It shall be securely mounted near the bottom right side of the cabinet and easily accessible.

Two (2) 3-wire 115 Volt AC (15A) non-GFCI protected outlets shall be installed, one on each side of the cabinet. These two (2) outlets are used for communication or other auxiliary equipment.

**907-632.02.3.4--Operating Line Voltage.** All equipment shall be designed to operate from a 120 volt, 60 cycle AC supply. Operation shall be satisfactory at voltages from 105 volts to 130 volts. All operating voltages into and out of the controller shall be NEMA level DC voltages except for the controller AC power source (Connector A, Pin p – AC-Control and Pin U – AC Common).

**907-632.02.3.5--Circuit Breakers.** Circuit breakers shall meet the requirements set forth in

Subsection 722.07. A 30-amp main breaker, with a minimum of 10,000 amp interrupting capacity, shall be provided for all cabinets to supply power to the controller, MMU, signals, and rack power supply.

Two (2) auxiliary breakers shall be provided. The first breaker, 10-amp, shall supply power to the fan, light, GFCI utility receptacle and two (2) auxiliary standard receptacles. The second breaker, 5-amp, shall be installed to supply power for the Controller Unit and MMU2. The above circuit breakers line side shall be jumpered together and will be fed from an external main circuit. A third 5-amp breaker shall be required if an ITS camera panel is called for in the plans.

**907-632.02.3.6--Main Line Arrestors.** Surge protection shall be provided that meets the requirements set forth in Subsection 722.12. A main line arrestor shall be provided to reduce the effects of voltage transients on the AC power line. It shall be installed after the circuit breaker. The main line arrestor shall be sufficient to protect all equipment and devices as per the plans and the following minimum specifications.

- Multi-stage Hybrid Design
- Series induction filtering
- Thermally protected Metal Oxide Varistors (TMOV's)
- Operating Voltage: 120 VAC
- Clamping Voltage: 395 VAC
- Operating Current: 15 A
- Peak Surge Current: 50 kA/Mode, 100 kA/Phase
- Operating Frequency: 47-63Hz
- EMI Attenuation: 40 dB Typ
- SPD Technology: TMOV's w/ W-C Filter
- Modes of Protection: L-N, L-G, N-G
- Status Indication: Power On & TMOV's Functional
- Connection Type: ¼-20 Stainless Steel Stud
- Operating Temperature: -40°F to +185°F

**907-632.02.3.7--Solid State Main Line Relay (SSR).** A normally-open, 75-amp, hybrid SSR shall be provided on the power distribution panel. The relay shall include a LED indicator to verify circuit power.

**907-632.02.4--Terminal Facilities Board.** The Terminal Facility shall be a hardwired load bay for NEMA TS 2 Type 1 actuated controllers. The load bay shall include either eight (8), twelve (12) or sixteen (16) load switch positions, as specified by the plans, and shall be centered along the back of the cabinet below the bottom shelf.

All wires terminated behind the backboard, as well as any additional panels, shall be soldered. No pressure or solderless connectors shall be used, unless they are soldered to the wire and tab after connection.

**907-632.02.4.1--Load Switches and Flashers.** Solid State Load Switches, compatible with low

wattage LED signals, shall be provided for the sequence called for on the plans. The load switch sockets shall be wired for triple-signal load switches conforming to NEMA TS 1-1994 and NEMA TS 2-2003 requirements.

The flasher socket shall be wired for and provided with a Type 3, two (2) circuit Solid State Flasher conforming to NEMA TS 1-1994 and NEMA TS 2-2003 requirements. It shall be possible to flash either the amber or red indication on any load switch outputs. It shall be possible to easily change the flash indication from the front side of the panel using readily available tools such as a screwdriver. A nominal flash rate of 50 to 60 FPM shall be provided. Flash rate shall be stable when used with generators or inverters.

Support(s) shall be provided to support the Flasher and Load Switches at some point approximately half of the total length from the panel surface. Sufficient area beneath the Load Switch or Flasher shall be clear in order to allow for free flow of air across the Load Switches or Flasher. Load Switches and Flashers must be provided with LED indicator lights on the side facing the cabinet door.

**907-632.02.4.2--Flash Transfer Relay.** All flash transfer relays, as a minimum, shall meet NEMA TS 1 requirements. The number of relays that shall be supplied with each cabinet shall accommodate the number of signal phases as indicated in the project plans. The coil of the flash transfer relay must be de-energized for flash operation.

**907-632.02.5--Cabinet Wiring.** Controller cabinets shall be wired in accordance with the signal phasing plans. If phases are indicated as omitted for future use, or if phases are not shown to be used in the plans, the cabinet shall be wired for use of the phases shown as future or unused. Load Switches shall not be provided for future or unused phases.

Wiring in the cabinets shall conform to the requirements of the National Electrical Code (NEC) and all of these specifications. All conductors in the cabinet shall be stranded copper. All wiring shall be laced. All wiring shall be in accordance as specified by Section 636 and Subsection 722.03 for Electric Cable and IMSA Specification 19 and/or 20 for Signal Wiring.

Connector harnesses for controller, conflict monitor, vehicle detectors, and accessory equipment (including NEMA defined Card Rack with power supply and pre-wired optical detection slots) shall be provided and wired into the cabinet circuitry. Connecting cables for controller and conflict monitor harnesses shall be sleeved in a braided mesh. All wires shall be securely terminated on terminal strips. The lay of the interconnect cable between the components must be such that when the door is closed, it does not press against the cables or force the cables against the various components inside the cabinets.

All communication wiring shall be bundled and routed independently of all other wiring. All live conductors shall be covered with suitable insulating material. All equipment grounds shall run directly and independently to the grounding bus.

All wires shall be cut and terminated as close as possible to the proper length before assembly. Consideration of equipment location adjustments must be made when determining appropriate

wire lengths. Excessive lengths of wire or cable shall not be allowed. All line voltage conductors used in controller cabinet shall conform to the following color code:

- AC Neutral: White
- AC Hot: Black
- Safety Ground: Green

**907-632.02.5.1--Signal Terminal Arrestor Grounding Bar.** A field terminal arrestor grounding bar shall be provided along the back portion of the cabinet for the installation of signal arrestors. This bar shall be attached using an AWG #10 stranded copper to the earth ground circuitry.

**907-632.02.5.2--Signal Terminal Arrestors.** The field terminal arrestor shall be a three (3) circuit protective device intended for use on traffic control load relay outputs. The arrestor shall be furnished with three (3) leads and a grounding stud which will be used to attach the arrestor to the grounding bar. The field terminal arrestor shall meet the following minimum specifications:

- Operating Voltage: 120 VAC
- Clamping Voltage: 475 VAC
- Peak Surge Current: 10 kA
- Operating Frequency: 47 – 63 Hz
- SPD Technology: MOV's
- Connection Type: Wire Leads
- Lead Wire: 14 AWG 12" Length
- Ground Stud: 10 x 32 5/8" Length
- Operating Temperature: -40°F to +185°F

**907-632.02.6--Accessory Components.**

**907-632.02.6.1--Traffic Actuated Controller Unit.** The fully actuated controller unit shall, at a minimum, meet the requirements of both NEMA TS 1-1989 and NEMA TS 2-2003 requirements for actuated controller units. The controller shall be of the TS 2 Type 2 configuration. The controller shall be provided with the multiple communication interface devices or properties as defined below.

- 10 Base-T Ethernet with front panel RJ-45 connector
- IEEE defined MAC address
- EIA-232 port
- External Serial Fiber options for both single and multi-mode (optional as per plans)
- External FSK 1200 bps modem (optional as per plans)
- D connector with 37 pin configuration for TS 1 compatibility
- USB port for signal controller database upload/download to the controller flash
- Controller
- ECOMM Compatible

The controller unit must have an alphanumeric backlit LCD display with a minimum of sixteen



(16) lines at 40 characters per line. The controller must be air-cooled with sufficient ventilation openings and capable of operating between -30°F and 165°F. The controller unit must be provided with a time-of-day clock, automatic daylight savings time adjustment and a power supply for maintaining SRAM during a power outage. The controller unit shall be capable of being used in a Closed-Loop System and must be capable of operating in the role of master controller in a Closed Loop System. The controller unit firmware shall be fully compatible with the Department's existing Traffic Signal Management Software. The Contractor shall ensure all controller firmware versions are compatible with the existing Traffic Signal Management Software that the Regional Department staff currently utilizes prior to submitting the controller for approval. The Contractor shall notify the Department if any special controller configuration or firmware is needed prior to submitting the controller for approval based on project requirements.

Where Flashing Yellow Arrow (FYA) operations are being used, all traffic signal controller firmware shall be capable of delaying the onset of the flashing yellow arrow.

All operator entered data shall be stored and backed up on to a flash memory device provided with the controller unit at no cost. This flash memory device shall require no battery to support value storage. No internal components of circuitry shall require battery support. The database shall be able to be backed up to a USB drive via the USB drive on the controller.

Traffic Actuated Controllers shall be of the Type shown on the plans. Type 1 Controllers shall have a Linux based processor and a minimum of one (1) USB port. Type 2 Controllers shall have the same features as Type 1 Controllers with the addition of an ATC backplane.

Type 3 Controllers shall have all features of the Type 2 Controller with the addition of the ATC module. All three (3) types of actuated controllers shall have Master controller capability, and if required shall be designated with 'M' in the plans.

**907-632.02.6.2--Closed Loop Master Controller Unit.** When called for in the plans, this work also consists of furnishing, installing and configuring the equipment, software and accessories necessary to connect one (1) traffic Closed-Loop Master Controller to its corresponding central or portable PC-based Traffic Computer Facility Control System via a communications connection. The communications or network connection device will be either existing or provided by the Contractor.

**907-632.02.6.2.1--General.** The Master shall monitor intersections in the system, display status and operational state and provide traffic flow data from intersection vehicle detectors. The Master shall include all communications equipment and software necessary to provide reporting to a remote terminal as well as upload/download of all local intersection data and provide timing synchronization. Communications to local controllers from the Master and from the Master to the central-office computer facility shall be by FSK, 900 MHz Radio, Broadband Radio, Serial Fiber, Ethernet, Fiber, Cell Modem or Leased Line, as indicated in the plans. The Master shall be able to run on the same controller simultaneously operating the intersection, with the local signal control software, on any given controller unit.

**907-632.02.6.2.2--System Configuration.** The system architecture shall be designed to minimize

the effect of equipment failures on system operation and performance. The system consists of four (4) principal elements:

- Local System Intersection Controllers
- Communication (Telemetry Links)
- On-Street Master(s)
- Central-Office Computer Software

**907-632.02.6.2.3--Local System Intersection Controller.** The local system intersection controllers connected to the Master controller unit shall be capable of controlling a fully actuated two (2) to sixteen (16) phase intersection and shall meet or exceed NEMA TS 1-1989 and TS 2-2003 standards for fully actuated traffic control units. The local controller shall have internal communication capability with direct access to the data memory. The local system controller shall be capable of processing controller and detector data and provide all necessary intersection control functions. The local system intersection controller shall meet the requirements of the Traffic Actuated Controller Unit.

**907-632.02.6.2.4--Communications (Telemetry) Links.** The communications links for the "Closed-Loop" System shall perform the following functions:

- Provide the medium (radio/fiber/hardwire/etc.) for two-way communications between the On-Street Master and the local intersection controllers.
- Provide the medium for two-way communication between the On-Street Master and the central-office computer facility.
- Error checking shall be included in both mediums to assure transmission and reception of valid data.

**907-632.02.6.2.5--On-Street Master.** The On-Street Master may be located at an intersection and connected via the communication network to at least 32 local intersection controllers. The Master shall be capable of implementing Traffic Responsive Control, Time Base Control, Manual Control or Remote Control modes of operation.

Analysis of sampling sensor data from at least 64 system detectors and corresponding selection of the best Traffic Responsive timing pattern shall be provided by the On-Street Master during the Traffic Responsive mode of operation.

Automatic and continuous monitoring of system activity shall be provided by the On-Street Master to include both Master and intersection alarm conditions.

System parameter entry shall be provided via the On-Street Master including all Master and local intersection assignment and group parameters. Master parameters shall include:

- System coordination setup and pattern data entry by group
- System time base event scheduler
- System traffic responsive computational and pattern selection setup by group
- Intersection system group and detector assignments

The On-Street Master shall provide comprehensive system report generation including, as a minimum: system, intersection, detector and failure status and history reports in addition to system performance reporting.

A RS-232C interface shall be provided on the On-Street Master to allow for printing of reports or for interconnecting to a remote central site.

To enhance overall system operation and increase system management flexibility, the On- Street Master shall also support two-way dial-up communications to a central office computer for control, monitoring, data collection and for timing pattern updating purposes, all from a remote central office location. Continuous, seven (7) days/week - 24 hours/day, system monitoring shall be enhanced by the On-Street Master's capability to automatically dial-up the central office computer upon detection of user defined critical alarm conditions.

**907-632.02.6.2.6--System Functional Requirements.**

**907-632.02.6.2.6.1--Operator Interface.** In order to provide ease in programming and operation, the system shall provide a simplified user-friendly menu format at each local, master and central office facility. No special programming skills shall be required for the user to fully access and operate this control and monitoring system at any level.

All programming, both of the local intersection controllers and the On-Street Master(s) shall be via a front panel keyboard and display, driven by English Language menus. All data change entries will be automatically verified against established ranges prior to acceptance to prevent programming data errors. Data access shall be controlled by user- definable access controls.

**907-632.02.6.2.6.2--System Traffic Control.** The system shall have the capability of controlling a minimum of sixteen (16) vehicle phases and eight (8) pedestrian phases. The system shall have the capability of implementing a minimum of four (4) timing rings, fifteen (15) alternate sequences, and sixteen (16) offsets.

The system shall provide the capability of selecting any of the following operational modes on a group basis:

- Traffic Responsive
- Time Base (Time-of-Day/Day-of-Week)
- Remote (External Command)
- Manual (Operator Entry)

The system shall be capable of implementing system FLASH and system FREE operation. The system shall have the capability to command, on/off based on time, up to eight (8) independent special functions.

**907-632.02.6.2.6.3--Detectors.** The system shall have the capability of accepting and processing data from at least 632 system detectors for Traffic Responsive program selection.

**907-632.02.6.2.6.4--Pattern Selection.** In addition to providing Manual and Remote program selection capability, the Master shall provide for Traffic Responsive and Time Base modes of operation for timing pattern selection.

**907-632.02.6.2.6.4.1--Traffic Responsive Mode.** Traffic plan selection in the Traffic Responsive mode shall be user-enabled and supplied with the controller, per the plans and specifications. The pattern selection shall be based on sampling detector volume and occupancy analysis by the On-Street Master.

**907-632.02.6.2.6.4.2--Time Base Mode.** The system shall provide the capability of implementing time-of-day, day-of-week and week-of-year control for each of the two (2) groups using an internal time clock referenced to the 60-Hz AC power line frequency for its time base. The Time Base mode shall contain automatic adjustment for leap year and daylight savings time changes.

The system Time Base mode shall provide, as a minimum, 100 events each capable of requesting any of the 48 traffic control patterns along with Traffic Responsive override enable or auxiliary events consisting of enable/disable any of up to four (4) system-wide special functions and setting sample and log interval time periods.

**907-632.02.6.2.6.5--System Control Priority.** The system coordination control (program-in-effect) for each group shall be selected on a priority basis. The priority from highest to lowest shall be as follows:

- Manual Control Entry
- External Control (Remote Command)
- Time Base Control (Time-of-Day/Day-of-Week) (Traffic Responsive control will prevail whenever Traffic Responsive Override Enable is active and the selected cycle length is greater than that being commanded by Time Base)
- Traffic Responsive Control

**907-632.02.6.2.6.6--Measures of Effectiveness.** The system shall have the capability to report selected Measures of Effectiveness (MOE's) on an intersection basis. MOE calculations shall be made on all phases by the local system intersection controller and as a minimum shall include measures such as: volume, number of stops, delays and green utilization. These measures shall be calculated on the basis of the active timing plan. Alternate ways of reporting MOE'S may be approved on a case-by-case review.

**907-632.02.6.2.6.7--Uploading and Downloading.** The system shall provide, for any selected local system intersection controller, the capability of uploading and downloading any or all, new or modified local intersection parameters from the central-office computer and the Department Central Traffic Signal Management Software, and shall include, as a minimum, all: Phase Timing and Unit Data; Coordination Data, Time Base Data; Preemption Data, System Communication Parameters, System Traffic Responsive Data, and any other System Data residing at the intersection such as Detector Diagnostic Values, Report Parameters and Speed Parameters.

During either uploading or downloading operations, normal traffic control operations shall not be suspended. All data shall be continually accessible and may be displayed at the On- Street Master or the central office computer.

**907-632.02.6.2.6.8--System Monitoring and Diagnostics.** The system shall automatically and continually monitor system activity and log/report occurrences of Master and intersection alarm conditions. All alarm condition events shall include at the intersection, (Master and central-office computer) an alpha-numeric description of the event as well as the time and date of occurrence.

As a minimum, monitored master alarms conditions shall include:

- Insufficient or Improper Data
- Failed Computational Channels
- Failed System Detectors
- Intersection Communication Failure
- Failed Controllers
- Minimum of six (6) special user defined alarms for user application flexibility
- Monitored intersection alarms conditions shall include as a minimum:
  - Cycle Faults and Failures
  - Coordination Failures
  - Voltage Monitor
  - Conflict, Local and Remote Flash Conditions
  - Preempt
  - Local Free
- Minimum of six (6) special user defined alarms for additional user flexibility.

When the Master detects a critical alarm condition, as defined by the user, it shall automatically dial-up the central office computer and report the condition. On a BUSY or NO ANSWER, the system may be programmed, at user option, to alert a secondary computer.

The system shall also automatically and continually monitor, verify and attempt to correct Sync Pulse, Time Base Clock and Pattern-In-Effect. The system shall provide capabilities to perform diagnostics on system and local detectors, communications and intersection operations. When a fault has been detected, an indication shall be provided. It shall be possible to isolate the fault to the failed unit from controls and indicators available on the Master unit. Auxiliary equipment such as a data terminal or CRT shall not be required to identify the failure.

**907-632.02.6.2.6.9--Real Time Display.** The Master shall provide for any selected local system intersection controller, real-time status information on its front panel. Real-time intersection status information shall include simultaneous display of: vehicle and pedestrian signal and detector status by phase, overlap signal status and cars waiting count by phase. Real-time controller status information shall include simultaneous display of: two (2) Ring Active timers, On/Next, Call/Recall and Hold/Omit Status by phase, Coordination, Preempt and Stop Time Status.

**907-632.02.6.2.6.10--System Management.** The system, without hardware changes but with its

ability to directly modify Master and intersection parameters, shall provide the user system configuration and operational controls of the following functions: add/delete controllers and system detectors, enable Traffic Responsive mode, assign intersections to groups, assign system detectors to computational channels and channels to pattern select routines, and assign special and/or standard detectors as system detectors for use with computational channels or to track activity.

**907-632.02.6.2.6.11--System Logging and Reports.** The system shall automatically and continually process system data and log/report on occurrence of changes in intersection status, system detector status, communications status, controller status and local detector status in addition to system program changes, Traffic Responsive computations, measures of effectiveness and performance.

**907-632.02.6.2.6.12--Security.** The On-Street Master shall provide for a user-specified security code entry before any data may be altered. In order to view any parameter, security code entry shall not be required. Security access shall be automatically rescinded approximately ten (10) minutes after either access was gained or the last parameter change was entered. The Master and local controller shall have the ability via keyboard to disable security code requirements, allowing for perpetual access without requiring hardware changes.

**907-632.02.6.2.7--Design Characteristics.** The On-Street Master shall be designed to operate in either an office or field environment and shall be suitably housed in a separate enclosure or in a local intersection cabinet. The Master shall be designed to meet the following electrical and mechanical requirements:

**907-632.02.6.2.7.1--Programming and Security.** Operator programmable data entry shall be accomplished through panel keyboard(s). The Master shall prevent the alteration of keyboard set variables prior to the user having entered a specific access code through the keyboard. The Master shall maintain user-programmable variables in non-volatile memory with a battery-backed RAM to assure continued efficient system operation.

**907-632.02.6.2.7.2--Test and Repair.** To enhance maintenance and trouble-shooting activities, On-Street Masters shall include resident diagnostics as a standard. No extender- cards, special tools or PROMs shall be necessary to fully maintain these components. The Master unit design shall ensure that all printed circuit boards be readily accessible for maintenance testing purposes. All fuses, connectors and controls shall be accessible from the front of the Master unit.

**907-632.02.6.2.8--Traffic Signal System Software.** All Traffic Signal System Software shall be compatible with the latest version of the Department's existing Master and local controllers and existing Traffic Signal Management Software for the Department region.

**907-632.02.6.2.8.1--Traffic Signal Closed Loop Software.** The Traffic Signal Closed-Loop Software shall provide the ability to manage Master and local controller databases including the uploading and downloading of data parameters. The software shall provide status information and provide reporting capabilities for Master and local controller data, alarms and logs.

**907-632.02.6.2.8.2--Traffic Signal System Workstation Software.** The Traffic Signal System Workstation shall provide the ability to manage Master and local controller databases including the uploading and downloading of data parameters. The software shall provide status information and provide reporting capabilities for Master and local controller data, alarms and logs.

The Traffic Signal System Workstation Software shall also be capable of operating as a network-connected user workstation to existing centralized signal systems and their associated databases.

When disconnected from the centralized signal system, the software shall be capable of running as a standalone system similar to the Closed-Loop Software. Under this mode, the software shall provide management, report and status functions for Master and local controllers. Under Standalone Mode of operation the software shall allow for its own database(s) for data management without the need for connecting to a centralized signal system database.

**907-632.02.6.2.9--Services.** Technical services shall be provided, as required, to assist in installation and initial setup of the Closed-Loop Master System and its sub-components. Technical assistance with database migration and/or setup, as well as the development of graphics (such as master maps and local intersection depictions) and the assignment of associated attributes such as detectors, phasing, signals, etc., shall be provided as required. Additionally, training shall be provided on a basic or advanced target user level, as required.

**907-632.02.6.3--Malfunction Management Unit (MMU2).** The Malfunction Management Unit (MMU2) shall be a shelf-mountable, sixteen (16) channel, solid-state, IP addressable MMU. The MMU2 shall accomplish the detection of, and response to, improper and conflicting signals and improper operating voltages in a traffic signal controller assembly, including support for four (4) section Flashing Yellow Arrow (FYA) left turn displays. The MMU2 shall be capable of running a minimum of twelve (12) different modes of FYA operation.

The MMU2 shall meet or exceed Section 4 requirements of the NEMA Standards Publication No. TS 2-2003 including NEMA TS 2 Amendment #4-2012 and provide downward compatibility to NEMA Standards Publication No. TS 1-1989: Type 12 Operation, in addition to those specifications set forth in this document.

The MMU2 shall include a graphics based Liquid Crystal Display (LCD) to view the current monitor status and navigate the unit's menus. An RJ-45 Ethernet Port shall be provided for communications.

A built-in Diagnostic Wizard shall be provided that displays detailed diagnostic information regarding the fault being analyzed. This mode shall provide a concise view of the signal states involved in the fault, pinpoint faulty signal inputs and provide guidance on how the technician should isolate the cause of the malfunction. The Diagnostic Wizard shall be automatically invoked when the MMU2 is in the fault mode and the HELP button is pressed. It shall also be automatically invoked when the MMU2 is in the Previous Fail (PF) event log display and the HELP button is pressed.

A built-in Setup Mode shall be provided that automatically configures the Dual Indication Enable, Field Check Enable, Red Fail Enable and Minimum Yellow Plus Red Clearance Enable parameters from user input consisting only of channel assignment and class (vehicle, ped, pp-turn, FYA, etc.) responses.

The MMU2 shall be capable of operating in the Type 12 mode with SDLC communications enabled on Port 1. The Channel Status display shall operate in the Type 12 configuration and provide the Field Check function for up to four (4) Pedestrian Walk inputs.

In the interest of reliability and repair ability, printed circuit board mounted MS connectors shall not be acceptable. Internal MS harness wire shall be a minimum of nineteen (19) strand AWG 22 wire.

**907-632.02.6.4--NEMA defined Card Rack and Power Supply.** A minimum of one (1) NEMA compliant detector card rack with five (5) slot positions (first slot for power supply and four (4) available slots) shall be provided in each cabinet. The detector rack shall be installed on the bottom shelf of the cabinet. The power supply for the NEMA defined card slots shall be provided as a 175W minimum with four (4) independent regulated channels of 24 VDC each rated at 0.75 amps over the full NEMA operating temperature range of -30°F to +165°F. The output should be regulated to 24 VDC +/- 15%. Each of the four (4) outputs shall be independently fused, each with a separate LED for displaying output and fuse status for each of the four (4) outputs. Each of the four (4) outputs shall be protected against voltage transients by a minimum 1500 watt suppressor. All card racks shall be wired for the type detection shown in the plan sheets.

Card Guides shall be provided on the top and bottom of the card rack for each connector position.

**907-632.02.6.5--In-Cabinet Network.**

**907-632.02.6.5.1--Communications Arrestor.** The Controller Cabinet network shall consist of an SDLC connection between the Controller Unit and MMU2. Surge suppression for this network shall meet the requirements set forth in Subsection 722.12 and the following minimum requirements below:

- Operating Voltage: 5 VDC
- Clamping Voltage: 8 VDC
- Operating Current: 1.5 A
- Peak Surge Current: 47 A (10x1000  $\mu$ s)
- Frequency Range: 0 to 20 MHz
- Insertion Loss: < 0.1 dB at 20 MHz
- SPD Technology: SAD
- Connection Type: DB-15
- Operating Temperature: -40°F to +185°F

**907-632.02.6.6--System Communications.**

**907-632.02.6.6.1--Traffic Signal Ethernet Switch.** When specified in the plans or contract



documents, a traffic signal Ethernet switch shall be installed in the cabinet assembly. It shall meet the requirements for the type specified in Section 907-663. Ethernet patch cables of sufficient length shall be provided for all supplied Ethernet ready cabinet components. The switch and all components shall be connected and configured.

**907-632.02.6.6.2--Fiber Optic Patch Panel.** When specified in the plans or contract documents, fiber optic attenuator patch cords shall be installed in the cabinet assembly as specified in Section 907-661.

**907-632.02.6.6.3--Wireless Communications.** When specified in the plans or contract documents, wireless communication components shall be installed in the cabinet assembly and shall be as specified in Section 907-662.

**907-632.02.6.6.4--Serial Port Server or Terminal Server.** When specified in the plans or contract documents, serial port servers shall be installed in the cabinet assembly and shall be as specified in Subsection 907-663.02.2.

**907-632.02.6.6.5--GPS Clock.** This work includes furnishing a Global Positioning System (GPS) Synchronization clock that can be used to sync the internal clocks in traffic signal controllers when coordination is desired, but communication is not necessary. The GPS Clock System shall provide GPS based time and date synchronization to provide coordination of traffic controllers to a common time base. The system shall process GPS Time data using a tamper/vandal resistant GPS antenna and correct for Time Zone, Daylight Savings Time, Leap Years, and GPS Leap Seconds. The processed time information shall be sent to the traffic controller in the native format for the respective controller. A contact closure synchronization pulse with variable pulse width shall be available for a once per day update. If the GPS antenna is blocked for up to one (1) hour prior to scheduled time of synchronization, the system shall synchronize the traffic controllers with less than 0.4 seconds variance from the accuracy provided under normal operation with GPS satellites in view.

- The GPS Clock shall also meet the following minimum specifications:
- Input Voltage: 9-24 VDC
- Current Draw: 150 mA (max) at 12 VDC: 125 mA (max) at 24 VDC
- Contact Closure: 750 mA at 30 VDC
- Temperature Rating: -29.4°F to +167°F

GPS unit shall be mounted to the traffic signal controller cabinet as per the manufacturer's recommendation. Any and all holes created in the cabinet for the purpose of mounting the GPS unit shall be sealed to the satisfaction of the Engineer at no direct pay.

**907-632.02.6.6.6--Power-Over-Ethernet Arrestor.** Surge suppression that meets the requirements set forth in Subsection 722.12 shall be provided. In addition, the following minimum specifications shall be supplied for loads that require Power-Over-Ethernet with isolated shielded or non-shielded cable:

- Operating Voltage: 48 VDC
- Clamping Voltage: 68 VDC
- Operating Current: 0.75 A per Pin Continuous
- Peak Surge Current: 10 kA
- Insertion Loss: < 0.1 dB
- SPD Technology: GDT, SAD, with series PTC
- Modes of Protection: All Lines (1-8) Protected (L-L) and (L-G): Signal High- Low; High-Ground; Low-Ground
- Transmission Speeds: 10BaseT; 100BaseT; 1000BaseT
- Connection Type: RJ-45
- Operating Temperature: -40°F to +185°F

**907-632.02.7--Detector Panel.** A vehicle detector harness shall be provided to connect the detector panel to the card rack. The detector panel shall accept the connection of sixteen (16) field loop inputs and four (4) pedestrian detector inputs.

**907-632.02.7.1--Detector Input Arrestors.** Field Loop and Pedestrian input arrestors shall meet the requirements set forth in Subsection 722.12. Field loop arrestors shall have differential and common mode protection and be provided with the following minimum specifications:

- Operating Voltage: 75 VDC
- Clamping Voltage: 130 VDC
- Peak Surge Current: 250 A
- SPD Technology: Silicon Break-Over
- Operating Temperature: -40°F to +185°F

Pedestrian input arrestors shall be a four (4) circuit device provided with the following minimum specifications:

- Operating Voltage: 30 VDC
- Clamping Voltage: 36 VDC
- Operating Current: 0.15 A
- Peak Surge Current: 10 kA (8 x 20  $\mu$ s)
- Frequency Range: 0 to 20 MHz
- Insertion Loss: < 0.1 dB at 20 MHz
- SPD Technology: GDT, SAD, with Series PTC
- Connection Type: Terminal Block with compression lugs; Terminals accept up to 10 AWG
- Operating Temperature: -40°F to +185°F

**907-632.02.8--System Detectors.** The controller shall have the ability to receive input data from up to eight (8) special system detectors in addition to the normal actuated controller unit phase detectors. The user shall have the option to assign any of the phase detectors as “system detectors”.

**907-632.02.9--Preemption.** The cabinet shall be completely wired to accept and service calls from preemption phase selector modules, associated optical detector units and GPS units. Optical detector units and GPS unit cabinet components shall be as specified in Section 639. Provision for two (2) standard card modules shall be accommodated in a separate card rack for preemption. The preemption card rack shall provide a minimum of eight (8) channels.

Provisions shall also be made in the cabinet to accommodate Railroad Preemption when specified in the plans or contract documents. Railroad Preemption shall meet the requirements set forth in Section 639. While it is not necessary that a Railroad Preemption interface board be provided with the cabinet, the cabinet and back panel shall be designed so that a Railroad Preemption interface panel that uses a relay to isolate the track switch from the controller cabinet circuitry can be installed. Preempt 1 and 2, in the case of gate down preemption, shall be reserved for Railroad Preemptions; all subsequent preemptions shall be reserved for Emergency Vehicle, Fire Station, or Police Preemption.

**907-632.02.10--Uninterruptable Power Supply.** When specified in the plans or contract documents an Uninterruptable Power Supply (UPS) System shall be installed in the cabinet assembly. The UPS shall be installed in the cabinet and meet the requirements set forth in Section 633.

**907-632.02.11--Power Service Pedestal.** A Power Service Pedestal shall be provided as described in Section 631.03.2.

**907-632.03--Construction Requirements.**

**907-632.03.1--Mounting.** Traffic Signal Cabinet Assemblies shall be wall or pole mounted, base mounted on a concrete cabinet pad, or base mounted using a composite enclosure as specified below and as shown in the plans.

Power Service Pedestal shall be base mounted on a concrete cabinet pad or on a composite enclosure as specified below and as shown in the plans.

**907-632.03.1.1--Wall or Pole Mounted.** Wall or pole mount hardware shall be provided for mounting cabinets in specific installations as indicated in the design plans. Wall or pole mounted cabinets shall be manufactured with rigid tabs, rigid brackets or other acceptable configuration for attachment of the cabinet to the wall or pole support. Rigid attachment devices must allow for field alignment of cabinet to the wall or pole support.

**907-632.03.1.2--Concrete Cabinet Pad.** Concrete foundations shall be constructed of Class B concrete in specific installations as indicated in the design plans.

Cabinets for installation on a concrete base shall be manufactured with rigid tabs, rigid brackets or other acceptable configuration for attachment of the cabinet bottom to its flat support structure. Rigid attachment devices must allow for field alignment of cabinet with the support base. Concrete base construction details shall be provided in the design plan drawings.

**907-632.03.1.3--Composite Enclosure.** Cabinets for installation on a composite enclosure base shall be manufactured with rigid tabs, rigid brackets or other acceptable configuration for attachment of the cabinet bottom to its' flat support structure. Rigid attachment devices must allow for field alignment of cabinet with the composite enclosure. Composite enclosure attachment details shall be provided as shown in the plans.

**907-632.03.2--Documentation.** Documentation packages shall be delivered for each unit at the same time as the equipment to which it pertains.

A minimum of two (2) sets of complete schematic drawings and equipment documentation shall be supplied with each cabinet. The first copy shall be placed in a clear re-sealable print pouch of sufficient size to accommodate one (1) complete set of folded cabinet prints and placed in the pull-out drawer of the cabinet and the second copy shall be provided to the Department. Comprehensive controller data shall be included as part of the cabinet documentation package and shall be placed in the cabinet drawer pouch. Digital copies of all cabinet documentation shall be provided to the Department before final acceptance.

The documentation packages shall contain a schematic wiring diagram of the controller cabinet assembly and all auxiliary equipment. The schematic wiring diagram, including a symbols legend, shall show in detail all integrated circuits, transistors, resistors, capacitors, inductors as well as switches and indicators. All parts shown shall be easily identified on both in the cabinet and on the schematic diagram. Model numbers shall be used on schematic diagram when available.

A complete physical description of the signal cabinet assembly shall be provided to include at least the physical dimensions of the unit, weight, temperature ratings, voltage requirements, power requirements, material of construction, and complete performance specifications.

A complete set of operation guides, user manuals, and performance specifications shall be provided.

Detailed programming instructions, preventative maintenance requirements, and troubleshooting procedures shall also be provided for the controllers. These documents shall fully cover all programming procedures and programmable options capable of being made to the controllers and associated traffic control equipment. Instructions for modifications within the range of the capabilities of the unit such as changes in phases or sequences and programming matrix boards shall be included.

An intersection diagram shall be provided on the cabinet door showing geometric configuration, lane use assignments, controller cabinet and signal pole locations, vehicle and pedestrian signal head locations, vehicle and pedestrian detector zone locations, ring-barrier phasing diagram, and detector channel assignments. The intersection diagram shall be labeled with, at a minimum, a North Arrow, main street name(s), side street name(s), signal pole numbers, vehicle and pedestrian head type(s), detector zone designations, volume density and phase recall requirements, flash sequence. All field wires within the cabinet shall be labeled to coincide with those shown on the intersection diagram.

**907-632.04--Method of Measurement.** Traffic Signal Cabinet Assembly will be measured as a unit per each.

Remove and Replace Existing Traffic Signal Cabinet Assembly will be measured as unit per each.

Modify Existing Traffic Signal Cabinet will be measured as a unit per each.

Solid State Traffic Actuated Controller, of the type specified in the project plans, will be measured as a unit per each.

Signal Software License, of the type specified in the project plans, will be measured as a unit per each.

Malfunction Management Unit, of the type specified in the project plans, will be measured as a unit per each.

Card Rack, of the type specified in the project plans, will be measured as a unit per each.

GPS Clock, as specified in the project plans, will be measured as a unit per each.

Power Service Pedestal, as specified in the project plans, will be measured as a unit per each.

All pay items shall be inclusive of all materials, work, system integration, testing and incidentals necessary for a complete and operable unit in place and accepted. All removal, turn on, and acceptance of equipment, devices, traffic signals, and traffic signal assemblies shall follow Section 631 - Traffic Signal Systems-General prior to payment.

**907-632.05--Basis of Payment.** Traffic Signal Cabinet Assembly, measured as prescribed above, will be paid for at the contract unit price per each for each type(s) specified in the contract, which price shall be full compensation for furnishing, installing, configuring, wiring, testing, and mounting foundation construction, cabinets, relays, terminals, circuit breakers, modules, coordination and time base control programs, connectors wiring, overlap equipment, load switches, power cables, power supplies, controller mechanism and housing, MMU2, mounting material, all other materials, and all equipment, labor, tools, and incidentals necessary to complete the work.

Remove and Replace Existing Traffic Signal Cabinet Assembly, measured as prescribed above, will be paid for at the contract unit price per each for each type(s) specified in the contract, which price shall be full compensation for furnishing, installing, configuring, wiring, testing, cabinets, relays, terminals, circuit breakers, modules, coordination and time base control programs, connectors wiring, overlap equipment, load switches, power cables, power supplies, controller mechanism and housing, MMU2, mounting material, all other materials, removal, disposal, transfer, storage, and/or resetting of components that are existing, all other components included in the traffic signal cabinet, and all equipment, labor, tools, and incidentals necessary to complete the work.

Modify Existing Traffic Signal Cabinet, measured as prescribed above, will be paid for at the

contract unit price per each, which price shall be full compensation for furnishing, installing, configuring, and mounting all components, wiring, and devices; rewiring, reconfiguring, removal, disposal, transfer, storage, and/or resetting of existing components and devices, installing or changing coordination and time base control programs in the traffic signal cabinet assemblies, testing, final cleanup, all equipment, labor, tools, and incidentals necessary to complete the work.

Solid State Traffic Actuated Controller, measured as prescribed above, will be paid for at the contract unit price per each for each type(s) specified in the contract, which price shall be full compensation for all labor, equipment, tools, materials inclusive of the controller mechanism(s) and housing(s), all power cables, power supplies, wiring, factory and manufacturing inspection, attachment hardware, testing, storage, packaging, shipping, warranty, and all work, equipment, and appurtenances, and all incidentals necessary to provide a fully functional traffic controller ready for use. It shall also include all documentation including operations and maintenance manuals and other material necessary to document the operation of the traffic controller.

Signal Software Licenses, measured as prescribed above, will be paid for at the contract unit price per each for each type(s) specified in the contract, which price shall be full compensation for all labor, equipment, tools, materials inclusive of furnishing, installing and configuring the Signal Software, all power cables, power supplies, wiring, factory and manufacturing inspection, testing, storage, packaging, shipping, warranty, appurtenances, and all incidentals necessary to provide fully functional Signal Software ready for use. It shall also include all documentation including operations and maintenance manuals and other material necessary to document the operation of the Signal Software.

Malfunction Management Unit, measured as prescribed above, will be paid for at the contract unit price per each for each type(s) specified in the contract, which price shall be full compensation for all labor, equipment, tools, materials inclusive of furnishing, installing and configuring the Malfunction Management Unit (MMU2), all power cables, power supplies, wiring, attachment hardware, factory and manufacturing inspection, testing, storage, packaging, shipping, warranty, and all work, equipment, and appurtenances, and all incidentals necessary to provide a fully functional Malfunction Management Unit (MMU2) ready for use. It shall also include all documentation including operations and maintenance manuals and other material necessary to document the operation of the Malfunction Management Unit (MMU2).

Card Rack, measured as prescribed above, will be paid for at the contract unit price per each for each type(s) specified in the contract, which price shall be full compensation for all labor, equipment, tools, materials inclusive of furnishing, installing and configuring the Card Rack, all power cables, power supplies, wiring, attachment hardware, factory and manufacturing inspection, testing, storage, packaging, shipping, warranty, and all work, equipment, and appurtenances, and all incidentals necessary to provide a fully functional Card Rack ready for use. It shall also include all documentation including operations and maintenance manuals and other material necessary to document the operation of the Card Rack.

GPS Clock, measured as prescribed above, will be paid for at the contract unit price per each for each type(s) specified in the contract, which price shall be full compensation for all labor, equipment, tools, materials inclusive of furnishing, installing and configuring the Global

Positioning System (GPS) Clock(s), all power cables, power supplies, wiring, attachment hardware, factory and manufacturing inspection, testing, storage, packaging, shipping, warranty, and all incidentals necessary to provide a fully functional GPS Clock ready for use. It shall also include all documentation including operations and maintenance manuals and other material necessary to document the operation of the GPS Clock.

Power Service Pedestal, measured as prescribed above, will be paid for at the contract unit price per each for each type(s) specified in the contract, which price shall be full compensation for furnishing, installing, configuring, wiring, testing, and mounting foundation construction, cabinets, circuit breakers, connectors wiring, mounting material, all other materials, and all equipment, labor, tools, and incidentals necessary to complete the work.

Payment will be made under:

- 907-632-A: Solid State Traffic Signal Cabinet Assembly,  
Type \_\_ Cabinet, Type \_\_ Controller - per each
- 907-632-B: Remove and Replace Existing Traffic Signal Cabinet Assembly,  
Type \_\_ Cabinet, Type \_\_ Controller - per each
- 907-632-C: Modify Existing Traffic Signal Cabinet Assembly - per each
- 907-632-D: Solid State Traffic Actuated Controller, Type \_\_\_\_\_ - per each
- 907-632-E: Single-user Workstation Signal Software License - per each
- 907-632-F: Single-user Server Signal Software License - per each
- 907-632-G: Malfunction Management Unit - per each
- 907-632-H: Card Rack, \_\_\_\_ Position - per each
- 907-632-I: GPS Clock - per each
- 907-632-J: Power Service Pedestal - per each

# MISSISSIPPI DEPARTMENT OF TRANSPORTATION

SPECIAL PROVISION NO. 907-641-3

CODE: (IS)

DATE: 12/15/2021

SUBJECT: Radar Vehicle Detection

Section 641, Radar Detection Systems, of the 2017 Edition of the Mississippi Standard Specifications for Road and Bridge Construction is hereby amended as follows.

Delete the title of Section 641 on page 584 and substitute the following.

## **SECTION 907-641 - RADAR VEHICLE DETECTION**

Delete Subsection 641.01 on page 584, and substitute the following.

**907-641.01--Description.** This work shall consist of providing all labor, materials, equipment, and incidentals necessary to furnish, install, test, train and operate Radar Vehicle Detection, including Signal Radar Vehicle Detection (SRVD) and Intelligent Transportation Systems (ITS) Radar Vehicle Detection (IRVD). These systems will provide roadway monitoring capabilities via electromagnetic microwave radar signals through the air. The signals bounce off vehicles in their paths and the signal is returned to the detector. The returned signals are processed to determine traffic parameters.

**907-641.01.1--Signal Radar Vehicle Detection.** SRVD provide traffic parameters necessary to the traffic signal controller operation for vehicle detection. All Signal Radar Vehicle Detection shall be supplied from the same manufacturer per construction project.

Type 1 SRVD shall be used for basic vehicle detection at signalized intersections as described below in this specification. Type 2 SRVD shall have all of the functionality of the Type 1 SRVD with additional features described below in this specification.

Type 2 SRVD shall utilize a matrix of radar signals for two-dimensional coverage and shall track vehicles through each type of detection's specified Area of Coverage. The Type 2 SRVD shall report real-time detection of both moving and stopped vehicles.

**907-641.01.2--ITS Radar Vehicle Detection.** IRVD shall provide data, including, but not limited to speeds, volume, lane occupancy and classification.

**907-641.02--Materials.**

**907-641.02.1--Radar Design.** Delete the first sentence of the first paragraph of Subsection 641.02.1 on page 584, and substitute the following.



The IRVD and the SRVD stop bar microwave shall operate in the 24.0 to 24.25 GHz frequency band.

**907-641.02.1.1--Cabinet Interface Unit (CIU) Design.** Delete the last paragraph of Subsection 641.02.1.1 on page 585, and substitute the following.

The CIU shall operate in the harsh conditions of a signal cabinet, and comply with the applicable standards stated in the NEMA TS 2-2003 standard for shock, vibration, and temperature.

Delete Subsection 641.02.2 and 641.02.3 on pages 585 and 586, and substitute the following.

**907-641.02.2--Area of Coverage--SRVD.**

**907-641.02.2.1--Stop Bar Radar Vehicle Detection.** Type 1 SRVD stop bar radar sensor shall track vehicles through a field of view that extends out a minimum of 100 feet

The Type 1 SRVD stop bar radar sensor shall be able to detect and report presence in lanes located within a minimum 100-foot from the face of the detector. Any variance of the detectable area shall be approved by the Engineer.

The Type 1 SRVD stop bar radar sensor shall be able to detect up to four (4) lanes with eight (8) or sixteen (16) individual zones as indicated in the plans.

Type 2 SRVD stop bar radar sensor shall have all the functionality of the Type 1 SRVD stop bar sensor with the addition of the following:

- Type 2 SRVD stop bar radar sensor shall detect true presence of vehicles whether in motion or still without using Locking or Latching Algorithms.
- Type 2 SRVD stop bar radar sensor shall report presence in lanes with a minimum 90 degree arc from the face of the detector.
- Type 2 SRVD stop bar radar sensor shall be able to detect a minimum of ten (10) lanes.

**907-641.02.2.2--Advanced Radar Vehicle Detection.** The Type 1 SRVD advanced radar sensor shall be able to detect and report vehicle information such as range and speed when mounted within 50 feet of the center of the lanes of interest. Variance of this distance shall be approved by the Engineer per the application.

The Type 1 SRVD advanced radar sensor shall be forward fired and be able to detect and report vehicle information when mounted at heights above the road surface, as per manufacturer's recommendations.

The Type 1 SRVD advanced radar sensor shall be able to detect and report vehicles on the roadway up to 600 feet from the detector.

The Type 2 SRVD advanced radar sensor shall have all the functionality of the Type 1 SRVD advanced radar sensor with the following additions:

- Type 2 SRVD advanced radar sensor shall be able to detect and report heavy vehicles on the roadway up to 900 feet from the detector.
- Type 2 SRVD advanced radar sensor shall be able to detect Estimated Time of Arrival (ETA) for vehicles. The advanced radar sensors shall support user configurable upper and lower ETA filters for each zone. The sensors shall support the configuring of ETA filters in increments of 0.1 seconds.

**907-641.02.3--Area of Coverage--IRVD.** The IRVD's field of view shall cover an area with a minimum detection range of six (6) feet from the IRVD and a maximum detection range of 250 feet from the IRVD.

Delete the title of Subsection 641.02.4 on page 586, and substitute the following.

**907-641.02.4--Detection Zones--SRVD.**

Delete the title of Subsection 641.02.4.1 on page 586, and substitute the following.

**907-641.02.4.1--Stop Bar Radar Vehicle Detection.**

After the last sentence of the second paragraph of Subsection 641.02.4.1 on page 586, add the following.

A minimum of one (1) separate detection zone per lane is required.

Delete the title of Subsection 641.02.4.2 on page 586, and substitute the following.

**907-641.02.4.2--Advanced Radar Vehicle Detection.**

Delete the third paragraph of Subsection 641.02.4.2 on page 586, add the following.

The advanced radar sensors shall provide vehicle call and extend data on up to eight (8) channels that can connect to contact closure modules compliant with NEMA TS 1, NEMA TS 2, and 170/2070 controller cabinets.

Delete the title of Subsection 641.02.5 on page 586, and substitute the following.

**907-641.02.5--Detection Zones--IRVD.**

Delete the title of Subsection 641.02.6 on page 586, and substitute the following.

**907-641.02.6--Capabilities--SRVD.**

Delete the title of Subsection 641.02.6.1 on page 587, and substitute the following.

**907-641.02.6.1--Stop Bar Radar Vehicle Detection.**

Delete the title of Subsection 641.02.6.2 on page 587, and substitute the following.

**907-641.02.6.2--Advanced Radar Vehicle Detection.**

After item 2) of Subsection 641.02.6.2 on page 587, add the following.

- 3) Maintain a detection accuracy of 95% for each detection zone set-up on the graphical user interface.

Delete the title of Subsection 641.02.7 on page 587, and substitute the following.

**907-641.02.7--Capabilities--IRVD.**

Delete the first sentence of the first paragraph of Subsection 641.02.7 on page 587, and substitute the following.

The IRVD shall detect true presence of vehicles whether in motion or still without using Locking or Latching Algorithms.

Delete item 5) in Subsection 641.02.7 on page 587, and substitute the following.

- 5) IRVD in forward-looking configuration shall monitor traffic in one lane and be capable providing the following data: Volume, occupancy, average speed and travel direction in the lane.

**907-641.02.8--Environmental Conditions and Protection.** Delete the last sentence of the first paragraph of Subsection 641.02.8 on page 588, and substitute the following.

Except as stated otherwise herein, the equipment shall meet all its specified requirements during and after subjecting to any combination of the NEMA TS 2-2003 standard and the following:

**907-641.02.10--Electrical.** Delete the first paragraph of Subsection 641.02.10 on page 588, and substitute the following.

The radar sensors shall consume less than 10 W and shall operate with a DC input between 12 VDC and 28 VDC for IRVD and 9 VDC and 32 VDC for SRVD, or POE. POE injectors shall be approved by the Engineer.

Delete the title of Subsection 641.02.11 on page 589, and substitute the following.

**907-641.02.11--Radar Design.**

**907-641.02.12--Communication Ports.** Delete the second sentence of the first paragraph of Subsection 641.02.12 on page 589, and substitute the following.

The IRVD shall be upgradable (optional) to include integral 10/100 Base-T Ethernet supporting TCP, UDP, IP, ARP, ICMP.

Delete the second sentence of the second paragraph of Subsection 641.02.12 on page 589, and substitute the following.

For SRVD, any external device needed to convert serial to IP Ethernet within the cabinet for remote communications shall be provided with the radar sensor unit at no additional cost.

Delete Subsection 641.02.13 on page 589, and substitute the following.

**907-641.02.13--Radar Detection Cabling.** All Radar Detection cable shall be paid per the unit cost of the pay item for Radar Detection Cable, as shown on the plans or details. The manufacturer is responsible for obtaining plan sets and ensuring cable lengths are properly measured and accounted for in the bid price for each sensor unit and as shown on the plans.

The cable shall have a single continuous run with no splices, unless inside a manufacturer supplied junction box. The cable shall be terminated only on the two (2) farthest ends of the cable. The cable shall meet the requirements of the manufacturer.

Delete the title of Subsection 641.02.15 on page 590, and substitute the following.

**907-641.02.15--Configuration--SRVD.**

Delete the title of Subsection 641.02.15.1 on page 590, and substitute the following.

**907-641.02.15.1--Stop Bar Radar Vehicle Detection.**

Delete the title of Subsection 641.02.15.2 on page 590, and substitute the following.

**907-641.02.15.2--Advanced Radar Vehicle Detection.**

**907-641.03--Construction Requirements.** Delete the first sentence of the first paragraph of Subsection 641.03 on page 590, and substitute the following.

Radar Detection System shall be constructed to withstand and operate in sustained winds of up to 90 mph and a 30% gust factor.

Delete the title of Subsection 641.03.1 on page 590, and substitute the following.

**907-641.03.1--SRVD Installation Requirements.**

Delete the first sentence of the third paragraph of Subsection 641.03.1 on page 590, and substitute the following.

Unused conductors in the cable shall be ground or terminated in the cabinet in accordance with the manufacturer's recommendations.

Delete the last sentence of the third paragraph of Subsection 641.03.1 on page 590, and substitute the following.

If required by the plans and installation methods, impedance termination and testing of multi drop runs shall be required per RS485 multi-drop standards.

Delete the title of Subsection 641.03.2 on page 591, and substitute the following.

**907-641.03.2--IRVD Installation Requirements.**

Delete Items 1) and 2) of Subsection 641.03.2 on page 591, and substitute the following.

- 1) The IRVD shall be mounted in side-fired or forward-looking configuration on poles as shown in the plans, using mounting brackets. The brackets shall be attached with approved 3/4-inch wide stainless steel bands.
- 2) The Contractor shall install the detector unit on a pole at the manufacturer's recommended height above the road surface so that the masking of vehicles is minimized and that all detection zones are contained within the specified elevation angle as suggested by the manufacturer.

Delete Items 4) and 5) of Subsection 641.03.2 on page 591, and substitute the following.

- 4) The IRVD mode of operation, detection zones and other calibration and set up will be performed using a MS Windows™ based software and a Notebook PC. The software shall allow verification of correct setup and diagnostics. It shall include facilities for saving verification data and collected data as well as saving and retrieving sensor setup from disk file.
- 5) Unused conductors in the ITS Radar Vehicle Detector Cable shall be grounded or terminated in the cabinet in accordance with the manufacturer's recommendations. Terminated conductors shall be individually doubled back and taped, then loosely bundled and secured.

Delete Item 7) of Subsection 641.03.2 on page 591, and substitute the following.

- 7) Any new, additional or updated drivers required for the existing ATMS software to communicate and control new IRVD installed by the Contractor shall be the responsibility of the Contractor.

Delete Subsection 641.03.3 on pages 591 and 592, and substitute the following.

**907-641.03.3--Testing.**

**907-641.03.3.1--SRVD Testing.** At the request of the Project Engineer or his/her Representative, all equipment associated with the Signal Radar Vehicle Detection System shall undergo testing to

verify conformance to requirements of the plans and these special provisions. All costs associated with testing shall be included in the overall contract price; no separate payment will be made for any testing.

At the request of the Project Engineer or his/her Representative, a SAT shall be required and shall include videos of the approach with detection zones overlaid showing detector activations.

- 1) One (1) hour videos shall be made of each approach and compared to actual detection calls.
- 2) 30-minute videos shall be made starting 15 minutes prior to sunrise and sunset for each approach and compared to actual detection calls.
- 3) All videos shall be date and time stamped.
- 4) Provide all videos to the Engineer with a summary of the results included total calls, missed calls and false calls.
- 5) All test results must meet a 95% accuracy requirement.

At the request of the Project Engineer or his/her Representative, the Contractor must demonstrate the accuracy requirements specified in Subsections 907-641.02.6.1 and 907-641.02.6.2 at selected intersections during the thirty (30) day burn in period. The intersections to be tested will be randomly selected by the Project Engineer.

**907-643.03.3.2—IRVD Testing.** All equipment associated with the IRVD site shall undergo testing to verify conformance to requirements of the plans and these special provisions. The Contractor shall conduct a Project Testing Program as required in the Notice to Bidders entitled “ITS General Requirements.” All costs associated with the Project Testing Program shall be included in the overall contract price; no separate payment will be made for any testing.

Delete Subsection 641.03.4 on page 592, and substitute the following.

**907-641.03.4--Submittals.** The submittal requirements defined in the Notice to Bidders entitled “ITS General Requirements” shall be met for IRVD sites. All costs associated with submittals shall be included in the overall contract price; no separate payment will be made for any documenting and submitting.

Delete Subsection 641.03.5 on pages 592 and 593, and substitute the following.

**907-641.03.5--Quality Assurance.** The quality assurance requirements defined in the Notice to Bidders entitled “ITS General Requirements” shall be met for IRVD sites. All costs associated with the quality assurance requirements shall be included in the overall contract price.

Delete Subsection 641.03.6 on page 593, and substitute the following.

**907-641.03.6--Warranty.** At a minimum, the warranty requirements defined in the Notice to Bidders entitled “ITS General Requirements” shall be met for IRVD equipment.

The Signal Radar Vehicle Detection equipment shall be warranted to be free of manufacturer defects in materials and workmanship for a period of one (1) year from the date of Final Acceptance. Equipment covered by the manufacturer’s warranties shall have the registration of that component placed in the Department’s name prior to Final Inspection. The Contractor shall be responsible for ensuring that the vendors and/or manufacturers supplying the components and providing the equipment warranties recognize the Department as the original purchaser and owner/end user of the component from new. During the warranty period, the supplier shall repair or replace with new or refurbished material, at no additional cost to the State, any product containing a warranty defect, provided the product is returned postage-paid by the Department to the supplier's factory or authorized warranty site. Products repaired or replaced under warranty by the supplier shall be returned prepaid by the supplier.

During the warranty period, technical support shall be available from the supplier via telephone within four hours of the time a call is made by the Department, and this support shall be available from factory certified personnel. During the warranty period, updates and corrections to control unit software shall be made available to the Department by the supplier at no additional cost.

Delete Subsection 641.03.7 on page 593, and substitute the following.

**907-641.03.7--Training.** The minimum training requirements shall be as defined in the Notice to Bidders entitled “ITS General Requirements” for IRVD equipment.

For Signal Radar Vehicle Detection equipment training, the supplier of the radar detection sensors shall, at a minimum, provide an 8-hour operations and maintenance training class with suitable documentation for up to eight (8) persons selected by the Department, if shown and quantified in the plans. The training shall be at the discretion and approved by the Engineer. The training must include both classroom style training and hands-on training in the field of the maintenance and troubleshooting procedures required for the system. The training should also consist of a hands-on demonstration of all software configuration and functionality where applicable. The operations and maintenance class shall be scheduled at a mutually acceptable time and location.

**907-641.03.8--Maintenance and Technical Support.** The supplier shall maintain an adequate inventory of parts to support maintenance and repair of the radar detection sensor(s). The manufacturer of the radar detection system must provide, and have a parts support system capable of providing parts for a period of five (5) years from the date of system acceptance. Spare parts shall be available for delivery within 30 days of placement of an acceptable order at the supplier's then current pricing and terms of sale of said spare parts.

The suppliers shall maintain an ongoing program of technical support for the Radar Detection System. This technical support shall be available via telephone or via personnel sent to the installation site upon placement of an acceptable order at the supplier's then current pricing and terms of sale of said technical support services.

**907-641.04--Method of Measurement.** Delete the paragraphs of Subsection 641.04 on page 593, and substitute the following.

The Radar Vehicle Detection Sensors, of the type specified, will be measured as a unit per each.

Radar Vehicle Detection Cable will be measured by the linear foot, measured horizontally along the conduit, messenger cable or mast arm and vertically along the pole.

Radar Vehicle Detection Training will be measured per lump sum.

**907-641.05--Basis of Payment.** Delete the paragraphs of Subsection 641.05 on pages 593 & 594, and substitute the following.

Signal Stop Bar and Signal Advanced Radar Vehicle Detection Sensor, of the type specified, measured as prescribed above, will be paid for at the contract unit price bid per each, which price shall be full compensation for furnishing all materials, all documentation and submittals, warranties, construction installation, connecting, testing, for all equipment, tools, labor, quality assurance, and all incidentals required to complete the work. Work shall include furnishing, installing, system integration, and testing of complete radar sensor system that includes the unit, cabling between the unit and the cabinet, surge protection devices, communication converters (if required), all conduit, risers and weatherhead between the radar sensors and the cabinet, interconnection wiring, power supply, connections to support structures (includes all incidental components, attachment hardware, mounting brackets, mounting arms, bolts, or any other items to mount the radar sensor as intended), and satisfactory completion of testing and training requirements and all work, equipment and appurtenances as required to effect the full operation including remote and local control of the radar site complete in place and ready to use. The price bid shall also include all system documentation including: shop drawings, operations and maintenance manuals, wiring diagrams, block diagrams and other material necessary to document the operation of the radar sensor. Cabinet Interface Units shall be provided, and installed as specified in the plans, which shall be inclusive of any testing, connections, terminations, and testing required for interfacing the radar sensors and signal controller within the signal cabinet environment.

ITS Radar Vehicle Detection Sensor, of the type specified, measured as prescribed above, will be paid for at the contract unit price bid per each, which price shall be full compensation for furnishing all materials, all documentation and submittals, warranties, construction installation, connecting, testing, for all equipment, tools, labor and incidentals required to complete the work and quality assurance. Work shall include furnishing, installing, system integration, and testing of complete radar sensor system that includes the unit, surge protection devices, communication converters (if required), all conduit, risers and weatherhead between the radar sensors and the cabinet, interconnection wiring, power supply, connections to support structures (includes all incidental components, attachment hardware, mounting brackets, mounting arms, bolts, or any other items to mount the radar sensor as intended), and satisfactory completion of testing requirements and all work, equipment and appurtenances as required to effect the full operation including remote and local control of the radar site complete in place and ready to use. The price



bid shall also include all system documentation including: shop drawings, operations and maintenance manuals, wiring diagrams, block diagrams and other material necessary to document the operation of the radar sensor. Cabinet Interface Units shall be provided, and installed as specified in the plans, which shall be inclusive of any testing, connections, terminations, and testing required for interfacing the radar sensors and signal controller within the signal cabinet environment.

Radar Vehicle Detection Cable will be paid at the contract unit price per linear foot, which price shall be full compensation for all labor, materials, equipment tools, furnishing, installing, system integration, connections, testing, and all incidentals necessary to complete the work.

Radar Vehicle Detection Training, measured as prescribed above, will be paid for as a lump sum unit price which price shall be full compensation for all training costs including coordination, materials, labor, training location costs, and all incidentals required to complete the training as described above.

Delete the pay items listed on page 594, and substitute the following.

- 907-641-A: Signal Stop Bar Radar Vehicle Detection Sensor, Type \_\_\_\_\_ - per each
- 907-641-B: Signal Advanced Radar Vehicle Detection Sensor, Type \_\_\_\_\_ - per each
- 907-641-C: ITS Radar Vehicle Detection Sensor - per each
- 907-641-D: Radar Vehicle Detection Cable - linear foot
- 907-641-E: Radar Vehicle Detection Training - lump sum

MISSISSIPPI DEPARTMENT OF TRANSPORTATION

SPECIAL PROVISION NO. 907-701-3

CODE: (IS)

DATE: 05/04/2021

SUBJECT: Hydraulic Cement

Section 701, Hydraulic Cement, of the 2017 Edition of the Mississippi Standard Specifications for Road and Bridge Construction is hereby amended as follows.

**907-701.01--General.** In the first sentence of the second paragraph of Subsection 701.01 on page 718, change “mills” to “plants.”

In the second sentence of the sixth paragraph of Subsection 701.01 on pages 718 and 719, change “shall” to “will.”

**907-701.02--Portland Cement.**

**907-701.02.1-General.**

**907-701.02.1.2--Alkali Content.** Delete the sentence in Subsection 701.02.1.2 on page 719, and substitute the following.

When used in portland cement concrete, the total alkali contribution from all cement types in this Subsection shall not exceed 4.0 lb. per cubic yard of concrete calculated as follows:

$$\text{lb alkali per cu Yd} = \frac{(\text{lb cement per cu Yd}) \times (\% \text{Na}_2\text{O equivalent in cement})}{100}$$

In the above calculation, the maximum cement alkali content reported on the cement mill certificate shall be used. An example calculation can be found in the Department’s *Concrete Field Manual*.

**907-701.02.2--Replacement by Other Cementitious Materials.** Delete the paragraph in Subsection 701.02.2 on page 719, and substitute the following.

The maximum replacement of cement by weight is 25% for fly ash or 50% for ground granulated blast furnace slag (GGBFS). Replacement contents below 20% for fly ash or 45% for GGBFS may be used, but will not be given any special considerations, such as the maximum acceptance temperature for portland cement concrete containing pozzolans in Subsection 804.02.13.1.5. Special considerations shall only apply for replacement of cement by fly ash or GGBFS.

Delete Subsection 701.02.2.1 on pages 719 and 720, and substitute the following.

**907-701.02.2.1--Portland Cement Concrete Exposed to Soluble Sulfate Conditions or Seawater.**

When portland cement concrete is exposed to moderate or severe soluble sulfate conditions, or to seawater, cement types and replacement of cement by Class F fly ash or GGBFS shall be as follows in Table 1. Class C fly ash shall not be used as a replacement for cement in any of the sulfate exposure conditions listed in Table 1.

**Table 1- Cementitious Materials for Soluble Sulfate Conditions or Seawater**

Sulfate Exposure	Water-soluble sulfate (SO <sub>4</sub> ) in soil, % by mass	Sulfate (SO <sub>4</sub> ) in water, ppm	Cementitious material required
Moderate and Seawater	0.10 - 0.20	150 - 1,500	Type I cement with one of the following replacements of cement by weight: 24.5 - 25.0% Class F fly ash, or 49.5 - 50.0% GGBFS or Type II <sup>**</sup> cement
Severe	0.20 - 2.00	1,500 - 10,000	Type I cement with a replacement by weight of 49.5 - 50.0% GGBFS, or Type II <sup>*</sup> cement with one of the following replacements of cement by weight: 24.5 - 25.0% Class F fly ash, or 49.5 - 50.0% GGBFS

\* Type III cement conforming to AASHTO M85 with a maximum 8% tricalcium aluminate (C<sub>3</sub>A) may be used in lieu of Type II cement as allowed in Subsection 701.02.1; this cement is given the designation “Type III(MS).”

\*\* Class F fly ash or GGBFS may be added as a replacement for cement as allowed in Subsection 907-701.02.2.

Delete Subsection 701.02.2.2 on page 720, and substitute the following.

**907-701.02.2.2--Portland Cement for Soil Stabilization Exposed to Soluble Sulfate Conditions or Seawater.** When portland cement for use in soil stabilization is exposed to moderate or severe soluble sulfate conditions, or to seawater, cement types and replacement of cement by Class F fly ash or GGBFS shall meet the requirements of Subsection 701.02.2.1.

**907-701.04--Blended Hydraulic Cement.**

**907-701.04.1--General.** Delete Subsection 701.04.1.1 on page 720, and substitute the following.

**907-701.04.1.1--Types of Blended Hydraulic Cement.** Blended hydraulic cements (blended cements) shall be of the following types and conform to AASHTO M 240:

- Type II – Portland-limestone cement
- Type IP – Portland-pozzolan cement
- Type IS – Portland blast-furnace slag cement

Blended cement Types II, IP, and IS meeting the “MS” sulfate resistance requirement listed in AASHTO M 240, Table 3 shall have the “(MS)” suffix added to the type designation.

**907-701.04.1.2--Alkali Content.** Delete the sentence in Subsection 701.04.1.2 on page 720, and substitute the following.

All blended cement types shall be made with clinker that would result in cement meeting the requirements of Subsection 701.02.1.2 when used in the production of AASHTO M 85, Type I or Type II cement.

The blended cement manufacturer shall include the percent equivalent alkalis as Na<sub>2</sub>O on their cement mill reports.

When calculating the total alkali contribution with blended cements, use the equivalent alkali content of the base portland cement. An example calculation for cases where blended cements are used can be found in the Department’s *Concrete Field Manual*.

**907-701.04.2--Replacement by Other Cementitious Materials.** Delete the paragraph in Subsection 701.04.2 on page 720, and substitute the following.

The maximum replacement of blended cement Type II by weight is 35% for fly ash or 50% for GGBFS. Replacement contents below 20% for fly ash or 45% for GGBFS may be used, but will not be given any special considerations, such as the maximum acceptance temperature for blended cement concrete containing pozzolans in Subsection 804.02.13.1.5. Special considerations shall only apply for replacement of blended cement by fly ash or GGBFS.

No additional cementitious materials, such as portland cement, blended cement, fly ash, GGBFS, or others, shall be added to or as a replacement for blended cement Types IP and IS.

Delete Subsection 701.04.2.1 on pages 720 and 721, and substitute the following.

**907-701.04.2.1--Blended Cement Concrete Exposed to Soluble Sulfate Conditions or Seawater.** When blended cement concrete is exposed to moderate or severe soluble sulfate conditions, or to seawater, cement types and replacement of cement by Class F fly ash or GGBFS shall be as follows in Table 2. Class C fly ash shall not be used as a replacement for cement in any of the sulfate exposure conditions listed in Table 2.

**Table 2- Cementitious Materials for Soluble Sulfate Conditions or Seawater**

Sulfate Exposure	Water-soluble sulfate (SO <sub>4</sub> ) in soil, % by mass	Sulfate (SO <sub>4</sub> ) in water, ppm	Cementitious material required
Moderate and Seawater	0.10 - 0.20	150 - 1,500	Type IL (MS) * cement, Type IL cement with one of the following replacements of cement by weight: 24.5 - 35.0% Class F fly ash, or 49.5 - 50.0% GGBFS, Type IP (MS) cement, or Type IS (MS) cement
Severe	0.20 - 2.00	1,500 - 10,000	Type IL cement with a replacement of cement by weight of 49.5 - 50.0% GGBFS, or Type IL (MS) cement with one of following replacements of cement by weight: 24.5 - 35.0% Class F fly ash, or 49.5 - 50.0% GGBFS

\* Class F fly ash or GGBFS may be added as a replacement for cement as allowed in Subsection 907-701.04.2.

Delete Subsection 701.04.2.2 on page 721, and substitute the following.

**907-701.04.2.2--Blended Cement for Soil Stabilization Exposed to Soluble Sulfate Conditions or Seawater.** When blended cement for use in soil stabilization is exposed to moderate or severe soluble sulfate conditions, or to seawater, cement types and replacement of cement by Class F fly ash or GGBFS shall meet the requirements of Subsection 701.04.2.1.

Delete Subsection 701.04.3 on page 721.

**MISSISSIPPI DEPARTMENT OF TRANSPORTATION**

**SPECIAL PROVISION NO. 907-702-4**

**CODE: (IS)**

**DATE: 09/11/2018**

**SUBJECT: Bituminous Materials**

Section 702, Bituminous Materials, of the 2017 Edition of the Mississippi Standard Specifications for Road and Bridge Construction is hereby amended as follows.

**907-702.04--Sampling.** Delete the sentence in Subsection 702.04 on page 722, and substitute the following.

Sampling of bituminous materials shall be as set out in AASHTO R 66.

**907-702.07--Emulsified Asphalt.** Delete the last sentence in Subsection 702.07 on page 724, and substitute the following.

Asphalt for fog seal shall conform to the requirements of Subsection 907-702.12, Table V.

**907-702.12--Tables.** Delete Table V in Subsection 702.12 on page 729, and substitute the following.

**TABLE V  
SPECIFICATION FOR FOG SEAL**

Test Requirements	LD-7		CHPF-1		Test Method
	Min.	Max.	Min.	Max.	
Viscosity, Saybolt Furol, @ 25°C, Sec.	10	100	-	100	AASHTO T 72
Storage Stability Test, 24 hr, %	-	1	-	1	AASHTO T 59
Settlement, 5 day, %	-	5	-	-	AASHTO T 59
Oil Distillate, %	-	1	-	-	AASHTO T 59
Sieve Test, % *	-	0.3	-	0.1	AASHTO T 59
Residue by Distillation, %	40	-	40	-	AASHTO T 59
<b>Test on Residue from Distillation</b>					
Penetration @ 25°C, 100g, 5 sec	-	20	40	90	AASHTO T 49
Softening Point, °C	65	-	-	-	ASTM D 36
Solubility in trichloroethylene, %	97.5	-	-	-	AASHTO T 44
Elastic Recovery @ 25°C, %	-	-	40	-	AASHTO T 301
Original DSR @ 82° (G*/Sinδ, 10 rad/sec)	1	-	-	-	AASHTO T 111

\* The Sieve Test result is tested for reporting purposes only and may be waived if no application problems are present in the field.

**MISSISSIPPI DEPARTMENT OF TRANSPORTATION**

**SPECIAL PROVISION NO. 907-703-1**

**CODE: (IS)**

**DATE: 06/13/2018**

**SUBJECT: Gradation**

Section 703, Aggregates, of the 2017 Edition of the Mississippi Standard Specifications for Road and Bridge Construction is hereby amended as follows.

**907-703.03--Course Aggregates for Hydraulic Cement Concrete.**

**907-703.03.2--Detail Requirements.**

**907-703.03.2.4--Gradation.** In the table in Subsection 703.03.2.4 on page 734, add 100 for the percent passing by weight on the 1½-inch sieve for Size No. 67 aggregates.

**MISSISSIPPI DEPARTMENT OF TRANSPORTATION**

**SPECIAL PROVISION NO. 907-705-1**

**CODE: (IS)**

**DATE: 06/13/2018**

**SUBJECT: Stone Riprap**

Section 705, Stone Blanket Protection and Filter Blanket Materials, of the 2017 Edition of the Mississippi Standard Specifications for Road and Bridge Construction is hereby amended as follows.

**907-705.04--Stone Riprap.** Delete the last sentence of the first paragraph of Subsection 705.04 on page 750, and substitute the following.

Quality requirements for rock to be furnished under these specifications will come from a pre-approved source and be visually approved prior to use.



## MISSISSIPPI DEPARTMENT OF TRANSPORTATION

SPECIAL PROVISION NO. 907-707-3

CODE: (IS)

DATE: 10/27/2021

SUBJECT: Joint Materials

Section 707, Joint Materials, of the 2017 Edition of the Mississippi Standard Specifications for Road and Bridge Construction is hereby amended as follows.

### 907-707.02--Joint Filler.

907-707.02.2--Preformed Sponge, Rubber, Cork and Closed-Cell Polypropylene Foam Joint Fillers for concrete Paving and Structural Constructions. Delete the two paragraphs of Subsection 707.02.2 on page 755, and substitute the following.

Preformed joint filler shall conform to AASHTO M 153 for sponge, rubber, and cork and tested according to ASTM D545. The type required will be indicated on the plans.

Closed-cell polypropylene foam shall conform to the requirements in ASTM D8139 and tested in accordance with ASTM D545.

907-707.02.3--Wood. Delete paragraph (b) of Subsection 707.02.3 on page 755, and substitute the following:

- (b) Dimensions shall be as shown on the plans. Dimensions shown on the plans are “dressed” sizes in accordance with Table 3 of the American Softwood Lumber Standard, SP-20. At the discretion of the Engineer, a 3/4-inch dressed board may be used in lieu of a 1-inch dressed board. A tolerance of plus or minus 1/16 inch thickness and plus or minus 1/8 inch width will be permitted. For slip-form paving a tolerance of minus 1/4 inch on each end in length will be permitted.

907-707.06--Flexible Plastic Gasket for Joining Conduit. Delete the third paragraph of Subsection 707.06 on page 756, and substitute the following.

The Department may require the performance test described in ASTM C 990.

**MISSISSIPPI DEPARTMENT OF TRANSPORTATION**

**SPECIAL PROVISION NO. 907-711-2**

**CODE: (IS)**

**DATE: 09/11/2018**

**SUBJECT: Plain Steel Wire**

Section 711, Reinforcement and Wire Rope, of the 2017 Edition of the Mississippi Standard Specifications for Road and Bridge Construction is hereby amended as follows.

**907-711.02--Deformed and Plain Carbon-Steel Bars for Concrete Reinforcing.**

**907-711.02.3--Steel Welded and Non-Welded Wire Reinforcement, Plain and Deformed, for Concrete.**

**907-711.02.3.1--Plain Steel Wire.** Delete the sentence in Subsection 711.02.3.1 on pages 780 and 781, and substitute the following.

Plain steel wire and plain steel welded wire shall conform to the requirements of AASHTO M 336.

# MISSISSIPPI DEPARTMENT OF TRANSPORTATION

SPECIAL PROVISION NO. 907-712-1

CODE: (SP)

DATE: 12/07/2021

SUBJECT: Fence and Guardrail

Section 712, Fence and Guardrail, of the 2017 Edition of the Mississippi Standard Specifications for Road and Bridge Construction is hereby amended as follows.

**907-712.01--General.** After the sentence in Subsection 712.01 on page 785, add the following.

All materials' inspection, testing, and certification will be performed in accordance with the requirements of the current version of the Department's *Materials Division Inspection, Testing, and Certification Manual*.

Delete Subsections 712.02 and 712.03 on page 785, and substitute the following.

**907-712.02--Barbed Wire.** Barbed wire shall conform to the requirements of AASHTO M 280. In the coastal counties of Hancock, Harrison, and Jackson, either Coating Type Z Class 3 or Coating Type A shall be furnished. In all other areas of the State, either Coating Type Z Class 1, Coating Type Z Class 3, Coating Type ZA Class 60, or Coating Type A shall be furnished.

**907-712.03--Metallic-Coated, Steel Woven Wire Fence Fabric.** Woven wire fencing (i.e., "hog wire") shall conform to the requirements of AASHTO M 279. In the coastal counties of Hancock, Harrison, and Jackson, either Coating Type Z Class 3 or Coating Type A shall be furnished. In all other areas of the State, either Coating Type Z Class 1, Coating Type Z Class 3, Coating Type ZA Class 60, or Coating Type A shall be furnished.

**907-712.04--Chain Link Fence.** Delete Subsections 712.04.1 thru 712.04.7 on pages 785 & 786, and substitute the following.

**907-712.04.1--Fabric.** In the coastal counties of Hancock, Harrison, and Jackson, either Type I Class D, Type II, Type III, or Type IV fabrics shall be furnished. In all other areas of the State, either Type I Class C, Type I Class D, Type II, Type III, or Type IV fabrics shall be furnished.

**907-712.04.2--Tie Wire.** Tie wire shall be of the same material as the fencing wire being used, shall be of good commercial quality, and shall meet the requirements of AASHTO M 181. Either Type I, Type II, Type III, or Type IV tie wire shall be furnished.

**907-712.04.3--Tension Wire.** Tension wire shall be of the same material as the fencing wire being used, shall be of good commercial quality, and shall meet the requirements of AASHTO M 181. In the coastal counties of Hancock, Harrison, and Jackson, either Type I Class 3, Type II, Type III, or Type IV tension shall be furnished. In all other areas of the State, either Type II, Type III, Type IV, or Type I Classes 1, 2, or 3 tension wires shall be furnished.

**907-712.04.4--Posts Rails, Gate Frames, and Expansion Sleeves.** Posts, rails, gate frames, and expansion sleeves shall conform to the requirements for posts in Subsection 712.05.2, unless otherwise designated in the contract.

**907-712.04.5--Miscellaneous Fittings and Hardware.** Miscellaneous fittings and hardware shall conform to the requirements of Subsection 712.16.

**907-712.05--Fence Posts and Braces.**

**907-712.05.1--Treated Timber Posts and Braces.**

**907-712.05.1.1--General.** Delete the third, fourth, fifth, and sixth paragraphs of Subsection 712.05.1.1 on page 787, and substitute the following.

All wood posts and braces shall be treated in accordance with Subsections 718.03 and 718.04.

**907-712.05.1.2--Round Posts.** Delete the last sentence of the last paragraph of Subsection 712.05.1.2 on page 788.

**907-712.05.1.3--Sawed Posts.** Delete the last sentence of the paragraph of Subsection 712.05.1.3 on page 788.

**907-712.05.1.4--Sawed Braces.** Delete the last sentence of the paragraph of Subsection 712.05.1.4 on page 788.

Delete Subsection 712.05.2 on page 788, and substitute the following.

**907-712.05.2--Metal Posts.**

**907-712.05.2.1--Round Steel Pipe.** Round steel pipe shall meet the requirements of AASHTO M 181, either Grade 1 (i.e., meeting the requirements in ASTM F 1083) or Grade 2 (i.e., meeting the requirements of ASTM F 1043).

Round steel pipe shall be sized in accordance with NPS (nominal pipe size) designations as shown on Plans, and not according to the outer or inner pipe diameter.

**907-712.05.2.2--Steel Fence Post and Assemblies, Hot-Wrought.** Steel posts with the following section shapes, Tee, channel or U, and Y-Bar shall meet the requirements of AASHTO M 281, galvanized in accordance with the requirements of AASHTO M 111, unless otherwise specified in the contract. Acceptance of these steel posts shall be by certification from the manufacturer, producer, supplier, or fabricator, as applicable.

**907-712.05.2.3--Blank.**

**907-712.05.2.4--Steel H-Beam Posts.** Steel H-Beam posts shall be produced from structural quality weldable steel having a minimum yield strength of 45,000 psi and shall be galvanized in accordance with ASTM A 123. Steel H-Beam line posts shall be 2.250 inches by 1.625 inches and shall weigh 3.43 pounds per foot. A tolerance of plus or minus 5.0 percent is allowed for

weight per foot. A tolerance of plus or minus 1.0 percent is allowed for dimensions.

**907-712.05.2.5--Aluminum-Alloy Posts and Assemblies.** Round aluminum-alloy posts shall meet the requirements of ASTM B 241, Alloy 6061, T6. Aluminum-Alloy H-Beam posts shall meet the requirements of ASTM B 221, Alloy 6061, T6.

**907-712.05.2.6--Formed Steel Section Posts.** Formed steel section posts, "C" sections, shall be formed from sheet steel conforming to ASTM A 1011, Grade 45, and shall be galvanized in accordance with ASTM A 123.

**907-712.06--Guard and Guardrail Posts.**

**907-712.06.2--Treated Wood Posts.**

**907-712.06.2.1--Square Posts.** Delete the paragraph in Subsection 712.06.2.1 on page 789, and substitute the following.

All square posts shall be inspected for conformance with Section 712.05, except that the posts may be rough and shall be within  $\pm 3/8$ " of the dimensions shown on the plans.

**907-712.06.2.2--Round Posts.** Delete the paragraph in Subsection 712.06.2.2 on page 789, and substitute the following.

All round posts shall be inspected for conformance with Section 712.05, except that the posts shall be of the shape and dimensions shown on the plans.

**907-712.06.5--Treated Wood Blocks for Use with Metal Guardrail Posts.** Delete the paragraphs of Subsection 712.06.5 on pages 789 & 790, and substitute the following.

Treated wood blocks for use with metal guardrail posts shall be within  $\pm 3/8$ " of the size and dimensions shown on the plans, except that a minus tolerance shall not be allowed for the slotted width in which the metal post must fit.

Delete Subsection 712.16 on page 791, and substitute the following.

**907-712.16--Hardware.** All ferrous metal hardware for fencing such as bolts, nuts, washers, and metal straps shall be as specified on the plans and galvanizing shall not be less than 1.0 ounce per square foot of uncoated area. Aluminum coated hardware shall be coated with aluminum meeting the requirements of AASHTO M 181 for aluminum coating and at the rate of not less than 0.4 ounces per square foot of uncoated area.

Aluminum alloy hardware shall conform to the requirements of ASTM B 221 for extruded aluminum alloy 6063, T6. The finished members shall be of uniform quality.

Aluminum-zinc coated hardware shall be coated with an aluminum-zinc alloy meeting the chemical requirements and weight of coating specified for aluminum-zinc alloy coated metal gates.

MISSISSIPPI DEPARTMENT OF TRANSPORTATION

SPECIAL PROVISION NO. 907-714-3

CODE: (SP)

DATE: 08/31/2021

SUBJECT: Miscellaneous Materials

Section 714, Miscellaneous Materials, of the 2017 Edition of the Mississippi Standard Specifications for Road and Bridge Construction is hereby amended as follows.

**907-714.01--Water.**

**907-714.01.1--General.** Delete the last sentence of the second paragraph in Subsection 714.01.1 on page 794.

**907-714.01.2--Water for Use in Concrete.** Delete Subsection 714.01.2 on page 794, and substitute the following:

Water from municipal sources is permitted be used as mixing water in concrete, mortar, and grout without Department testing. Water from non-municipal water sources used in mixing of concrete, mortar, and grout which does not meet the requirements in Subsection 714.01.1 shall be tested for conformance as required in AASHTO M157, Table 1 and Table 2.

**907-714.01.3--Water for Use in Chemically Stabilized Based.** Delete the first sentence of first paragraph in Subsection 714.01.3 on page 794, and substitute the following:

Water used in the construction of bases that contain cement, lime, or other chemical additive shall be as set out in Subsection 714.01.1. Water from municipal sources is permitted to be used without testing for conformance to the requirements below. If water is not from a municipal source, it shall not contain impurities in excess of the following limits:

Delete Subsection 714.01.6 on page 795, and substitute the following.

**907-714.01.6--Blank.**

**907-714.05--Fly Ash.**

**907-714.05.1--General.** Delete the first sentence of the fifth paragraph in Subsection 714.05.1 on page 797.

**907-714.13--Geotextiles.**

**907-714.13.11--Tables.** Delete Table 1 in Subsection 714.13.11 on page 813, and substitute the following.

**Table 1 - Geotextiles**

Type Designation	I <sup>1</sup> Sediment Control	II <sup>1</sup> Control	III Drainage	IV Paving	V Separation & Drainage		VI Separation, Stabilization & Reinforcement		VIII High Strength	IX High Strength	Test Method
					Woven	Non-Woven	Woven	Non-Woven			
Grab Strength (lb)	50	90	110	90	200	280	180	450	280	---	ASTM D 4632
Elongation (%)	---	50% max @ 45 lb	20% min	50% min @ break	50% min	50% max	50% min	50% max	50% min	---	ASTM D 4632
Seam Strength (lb)	---	---	70	---	180	240	160	400	240	---	ASTM D 4632
Puncture Strength (lb)	---	---	40	---	80	110	75	180	115	---	ASTM D 6241
Trapezoidal Tear (lb)	---	---	40	---	80	100	70	150	100	---	ASTM D 4533
Asphalt Retention (gal/yd <sup>2</sup> )	---	---	---	0.2	---	---	---	---	---	---	ASTM D 6140
Permittivity (sec <sup>-1</sup> ) min	0.05	0.05	0.5	---	0.2	0.2	0.2	0.2	0.2	---	ASTM D 4491
AOS Woven (mm) max	0.60	0.60	0.6	---	0.6	0.43	---	0.43	---	---	ASTM D 4751
AOS Non-Woven (mm) max	0.84	0.84	0.43	---	0.43	---	0.43	---	0.43	---	---
Tensile Strength after UV (% Retained)	70% @ 500 hr	70% @ 500 hr	50% @ 500 hr	---	50% @ 500 hr	50% @ 500 hr	50% @ 500 hr	50% @ 500 hr	50% @ 500 hr	---	ASTM D 4355
Melting Point °(F)	---	---	---	325	---	---	---	---	---	---	ASTM D 276
Minimum Ultimate Tensile Strength <sup>3</sup> (lb/in)	---	---	---	---	---	---	---	---	660	2000	ASTM D 4595

Notes: 1 - All property values, with the exception of apparent opening size (AOS), represent minimum average roll values in the weakest principal direction. Values for AOS represent the maximum average roll values, 2 - Values not identified in this table should meet manufacturer certification for the use and application, 3 - Machine direction

Delete Subsection 714.15 on pages 816 and 817 and substitute the following.

**907-714.15--Geogrids.**

**907-714.15.1--General.** A geogrid is defined as a geosynthetic formed by a regular network of connected elements with apertures greater than 0.25 inch to allow interlocking with surrounding soil, rock, and other surrounding materials to function primarily as reinforcement.

Geogrid shall be manufactured from an expanded strain hardened monolithic polymer sheet composed of one or more synthetic polymers and shall be mildew resistant and inert to biological degradation and naturally encountered chemicals, alkalis and acids. The geogrid shall contain stabilizers and/or inhibitors, or a resistance finish or covering to make it resistant to deterioration from direct sunlight, ultraviolet rays, and heat.

Geogrid manufacturers shall participate in and be in compliance with the American Association of State Highway Transportation Officials (AASHTO) National Transportation Product Evaluation Program's (NTPEP) Geosynthetics audit program. Geogrid shall meet the requirements of Table II for the application and type shown on the plans and shall be selected from the Department's Approved Lists.

**907-714.15.1.1--Geogrid for Retaining Walls and Reinforced Soil Slopes.** Geogrid for retaining walls and reinforced soil slopes shall be creep tested in accordance with AASHTO R69 and meet Long Term Design Load, Minimum Ultimate Tensile Strength, and open area criteria listed in Table II. Manufacturers shall perform at least one long-term creep test for no less than 10,000 hours in accordance to ASTM D 5262 for each polymer or composition of polymers from which the geogrid is produced. The long-term design load that shall be reported for design use, shall be that load at which no more than 10% strain occurs over a 100-year design life of the geogrid, as calculated in accordance with AASHTO R69. Long-term design loads shall be reported unfactored, and the AASHTO strength reduction factors (Durability and Installation, and safety factors) will be considered by the Department's Geotechnical Branch on a site specific design basis.

**907-714.15.1.2--Geogrid for Subgrade Stabilization.** Geogrid for subgrade stabilization shall meet Minimum Ultimate Tensile Strength and open area criteria listed in Table II.

**907-714.15.2--Marking, Shipment, and Storage.** Each roll or container of geogrid shall be visibly labeled with the name of the manufacturer, trade name of the product, lot number, and quantity of material. In addition, each roll or container shall be clearly tagged to show the type designation that corresponds to that required by the plans. During shipment and storage the geogrid shall be protected from direct sunlight, and temperatures above 120°F or below 0°F. The geogrid shall either be wrapped and maintained in a heavy duty protective covering or stored in a safe enclosed area to protect from damage during prolonged storage.

**907-714.15.3--Manufacturer Certification.** The Contractor shall furnish the Engineer three copies of the manufacturer's certified test reports indicating that the geogrid furnished conforms to the requirements of the specifications and is of the same composition as the originally approved



by the Department.

**907-714.15.4--Acceptance Sampling and Testing.** Final acceptance of each shipment will be based upon results of tests performed by the Department on verification samples submitted from the project, as compared to the manufacturer's certified test reports. The Engineer will select one roll or container at random from each shipment for sampling. As sample extending full width of the randomly selected roll or container and being at least five (5) square yards in area will be obtained and submitted by the Engineer. All material samples shall be provided at no cost to the State.

**TABLE II  
GEOGRIDS**

Physical Properties	Type Designation						Test Method
	I	II	III	IV	V	VI	
Long Term Design Load <sup>1</sup> , pounds per foot, Machine Direction	250	500	750	1500	2500	3500	AASHTO R69, ASTM D5262
Minimum Ultimate Tensile Strength <sup>2</sup> , pounds per foot, Machine Direction	500	1000	1500	3000	5000	7000	ASTM D6637
Open Area, percent	70	70	50	50	50	50	Direct Measurement

<sup>1</sup> Minimum design criteria requirement.  
<sup>2</sup> Minimum Average Roll Value (MARV).

## MISSISSIPPI DEPARTMENT OF TRANSPORTATION

SPECIAL PROVISION NO. 907-718-1

CODE: (SP)

DATE: 12/07/2021

SUBJECT: Timber and Dimension Lumber

Section 718, Timber and Dimension Lumber, of the 2017 Edition of the Mississippi Standard Specifications for Road and Bridge Construction is hereby amended as follows.

Delete the Subsections in Section 718 on pages 836 thru 838, and substitute the following.

**907-718.01--General.** All timber and dimension lumber shall be Southern pine and shall conform in all respects to applicable requirements of AASHTO M 168. The Department reserves the right to sample and to test all materials at any time; all inspection, testing, and certification of materials will be performed in accordance with the requirements of the current version of the Department's *Materials Division Inspection, Testing, and Certification Manual*.

Timber and dimension lumber shall be furnished in the sizes shown on the plans or as specified. Unless otherwise specified, timber and dimension lumber shall be No. 1, or better, graded according to the latest American Lumber Standards.

Only one type of preservative shall be used for the treatment of materials for any one class of construction on a project, unless otherwise specified.

Where treated timber and dimensional lumber is to be used in non-highway construction or use, such as decking, handrails in walking trails, or in any manner where general public exposure by touch is possible, the treatment requirements will be as per project plans and/or approved by the State Materials Engineer.

**907-718.02--Untreated Timber and Dimension Lumber.** Untreated timber and dimension lumber shall conform to the requirements of AASHTO M 168.

**907-718.03--Treated Timber and Dimension Lumber.** Timber and dimension lumber to be treated shall meet the requirements herein specified and shall be treated as specified. Treated timber or dimensional lumber will not be accepted for use unless it has been inspected by an authorized representative of the Department and found to be satisfactory after treatment.

**907-718.03.1--Blank.**

**907-718.03.2--Treatment.**

**907-718.03.2.1--General.** All materials shall be treated in accordance with AASHTO M 133 unless otherwise directed by the Environmental Protection Agency (EPA).

**907-718.03.2.2--Blank.**

**907-718.03.2.3--Inspection.** Treated timber and dimension lumber shall be inspected by an authorized representative of the Department before being incorporated into the work. Treatment reports shall be provided to the Department for each lot of material supplied.

**907-718.03.3--Blank.**

**907-718.03.4--Storage of Treated Material.** All material treated for stock shall be stacked as compactly as possible on a well-drained surface. Material shall be supported on sills spaced as necessary, not to exceed 10 foot intervals and shall have at least one foot of air space beneath the stacks.

All materials treated with preservatives for use in buildings and applications where painting is required shall be dried after treatment. The treated wood shall be dried in accordance with American Lumber Standards.

**907-718.04--Preservative.** Preservatives shall be as specified in AASHTO M 133 unless otherwise directed by the Environmental Protection Agency (EPA).

**MISSISSIPPI DEPARTMENT OF TRANSPORTATION**

**SPECIAL PROVISION NO. 907-720-2**

**CODE: (IS)**

**DATE: 09/11/2018**

**SUBJECT: Acceptance Procedure for Glass Beads**

Section 720, Pavement Marking Materials, of the 2017 Edition of the Mississippi Standard Specifications for Road and Bridge Construction is hereby amended as follows.

**907-720.01--Glass Beads.**

**907-720.01.4--Acceptance Procedures.** Delete the last sentence of the paragraph in Subsection 720.01.4 on page 841, and substitute the following.

Acceptance sampling and testing of glass beads will be in accordance with the Department's Materials Division Inspection, Testing, and Certification Manual, Section 2.9.2 -- Glass Beads.

**MISSISSIPPI DEPARTMENT OF TRANSPORTATION**

**SPECIAL PROVISION NO. 907-721-4**

**CODE: (SP)**

**DATE: 04/19/2022**

**SUBJECT: Materials for Signing**

Section 721, Materials for Signing, of the 2017 Edition of the Mississippi Standard Specifications for Road and Bridge Construction is hereby amended as follows.

**907-721.06--Reflective Sheeting.**

**907-721.06.2--Performance Requirements.** Delete Table 4 and Table 5 in Subsection 721.06.2 on pages 860 & 861, and substitute the following.

**MINIMUM COEFFICIENTS OF RETROREFLECTION  
Candela per foot candle per square foot (cd/ft<sup>2</sup>)  
Per ASTM Designation D4956**

**TABLE 4  
Type IX Sheeting**

Observation Angle	Entrance Angle	White	Yellow	Green	Red	Blue	Fluorescent Yellow/Green	Fluorescent Yellow	Fluorescent Orange
0.2°	-4.0°	380	285	38	76	17	300	230	115
0.2°	+30.0°	215	162	22	43	10	170	130	65
0.5°	-4.0°	240	180	24	48	11	190	145	72
0.5°	+30.0°	135	100	14	27	6.0	110	81	41
1.0°	-4.0°	80	60	8.0	16	3.6	64	48	24
1.0°	+30.0°	45	34	4.5	9.0	2.0	36	27	14

**TABLE 5  
Type XI Sheeting**

Observation Angle	Entrance Angle	White	Yellow	Green	Red	Blue	Brown	Fluorescent Yellow/Green	Fluorescent Yellow	Fluorescent Orange
0.2°	-4.0°	580	435	58	87	26	17	460	350	175
0.2°	+30.0°	220	165	22	33	10	7.0	180	130	66
0.5°	-4.0°	420	315	42	63	19	13	340	250	125
0.5°	+30.0°	150	110	15	23	7.0	5.0	120	90	45
1.0°	-4.0°	120	90	12	18	5.0	4.0	96	72	36
1.0°	+30.0°	45	34	5.0	7.0	2.0	1.0	36	27	14

After Subsection 721.10 on page 864, add the following.

**907-721.11--Digital Applied Printing.** The following addresses the requirements for digitally printed finished retroreflective traffic control signs on flat sheet aluminum and digitally printed traffic sign faces intended to be applied to a sign substrate.

**907-721.11.1--Digitally Printed Ink Systems.** Traffic signs must be produced using components, and processes that comply with the retroreflective sheeting manufacturer’s recommendations.

Digital printed ink systems used to print traffic signs must meet and comply with daytime and nighttime chromaticity (color standards) as recognized in ASTM D4956 “Standard Specification for Retroreflective Sheeting for Traffic Control.”

Digital printed ink systems must meet 70% of the initial retroreflectivity specifications of each respective reflective film color as found in ASTM D4956 “Standard Specification for Retroreflective Sheeting for Traffic Control.”

Prior to fabrication and preferably at the preconstruction meeting, the Contractor shall advise the Project Engineer in writing as to which signs on the project will be digitally printed and which ones will be screen printed. The Contractor shall submit to the Project Engineer certifications for all digitally printed signs, which will be forwarded to the State Traffic Engineer for review.

**907-721.11.2--Protective Overlay Film.** Permanent traffic signs printed with digital ink systems will be fabricated with a full sign protective overlay film designed to provide a smooth surface needed for retroreflectivity, and to protect the sign from fading and UV degradation. The overlamine shall comply with the retroreflective sheeting manufacturer’s recommendations to ensure proper adhesion and transparency and will also meet the reflective film durability as identified in Table 1.

**Table 1  
Retroreflective Film Minimum Durability Requirements**

<b>ASTM D4956 Type</b>	<b>Full Sign Replacement Term (years)</b>	<b>Sheeting Replacement Term (years)</b>
IV	7	10
VIII	7	10
IX	7	12
XI	7	12

Temporary signs used in work zones printed with black ink only will not require a protective overlay film as long as the finished sign is warranted for a minimum outdoor durability of three years by the sheeting manufacturer.

**907-721.11.3--Inspection.** During fabrication, the Contractor shall provide sufficient testing and quality control throughout fabrication to insure good workmanship. Once the material has been received, it may be subject to random testing to ensure compliance with all requirements. If any test samples do not conform to the requirements, the entire order may be returned at the vendor’s expense.

**907-721.11.4--Traffic Sign Performance Warranty Provisions.** Based on the ASTM Type of sheeting specified, traffic control signs shall be warranted for the duration shown in Table 1. The Contractor shall supply a copy of the warranty document with complete details of terms and conditions upon request of the Department.

**907-721.11.5--Certified Digital Sign Fabricator.** Sign fabricators using digital imaging methods to produce regulated traffic signs must be certified by the reflective sheeting manufacturer whose materials are used to produce the delivered signs.

Certified sign fabricators must undergo an audit process by the sheeting manufacturer to ensure they have the proper equipment, manufacturing capabilities, manufacturing application processes and the materials required to fulfill the sheeting manufacturer's warranty obligations. Sign fabricators must recertify annually with reflective sheeting manufacturers or utilize a 3<sup>rd</sup> party certifier approved by the reflective sheeting manufacturer.

The Contractor shall submit proof of Sign Fabricator Certification as issued by the retroreflective sign sheeting manufacturer to the Project Engineer upon delivery of the signs, or with the Shop Drawings.

# MISSISSIPPI DEPARTMENT OF TRANSPORTATION

SPECIAL PROVISION NO. 907-722-1

CODE: (IS)

DATE: 11/15/2017

SUBJECT: Materials for Traffic Signal Installation

Section 722, Materials for Traffic Signal Installation, of the 2017 Edition of the Mississippi Standard Specifications for Road and Bridge Construction is hereby amended as follow.

**907-722.02.3--Design Strength Requirements.** Delete Subsection 722.02.3 on pages 864 thru 866, and substitute the following.

Unless specified otherwise in the plans, poles shall meet the requirements of the AASHTO *Standard Specifications for Structural Supports for Highway Signs, Luminaires, and Traffic Signals*, as specified in the plans with all interim supplements. All components of the assemblies shall be designed to the following:

- Importance Factor: 1.0; 50 year mean recurrence interval
- Basic Wind Speed (3 second gust): As shown on the project plans
- Minimum Gust Effect Factor: 1.14
- Fatigue Category: II
- Ice Loading: As shown on the project plans
- Natural Wind Gust Pressure Loads: Included
- Truck Induced Gust Pressure Loads: Not included
- Galloping: Not included

**907-722.02.5--Mast Arms for Traffic Signal and Equipment Poles.** Delete the first four sentences of the third paragraph of Subsection 722.02.5 on page 867, and substitute the following.

Anchor base plates must meet the minimum requirements of ASTM A36 or ASTM A709 Grade 36 or ASTM A572 Grade 50 and must be welded to the shaft by either telescoped with two continuous arc welds or by back up ring using full penetration welds.. Flange plate shall telescope the large end of the arm and be welded by either two (2) continuous arc welds, one (1) being on the outside of the plate, adjacent to the shaft, and the other one (1) on the inside at the end of the tubular cross section or by back up ring using full penetration welds. The thru-bolt flange plate or tapped flange plate supporting the mast arm shall be welded to the pole near the top and supported side plate tangent to the pole and gusset plates both top and bottom. The thru-bolt or tapped flange plate must be sufficient to develop the full capacity of the connecting bolts.

**907-722.03--Electric Cable.** Delete the paragraphs for Loop Detector Wire and Loop Detector Lead-in Cable in Subsection 722.03 on page 869.

Delete the first sentence of “Communication Cable” in Subsection 722.03 on page 870, and substitute the following.



Communication cables shall be as per the manufacturer's recommendation.

**907-722.05.4--Type III or Type IV Rigid Non-Metallic Conduit.** After the last sentence of Subsection 722.05.4 on page 871, add the following.

Schedule 40 conduit shall be used unless otherwise noted in the plans.

Delete the title of Subsection 722.13.3 on page 876, and substitute the following.

**907-722.13.3--Power Service Pedestal.**

Delete the first paragraph of Subsection 722.13.3 on page 876, and substitute the following.

The pedestal shall be of NEMA Type 3R rainproof construction and shall be UL Listed as "Enclosed Industrial Control Equipment" (UL 508A). External construction shall comply with UL50 requirements and shall be unpainted aluminum.

Nominal size of the pedestal shall be 48"H x 16"W x 16"D.

Pedestal shall have a voltage rating or 120v/240v single phase with an Amperage rating of 800A.

After the first sentence of the seventh paragraph of Subsection 722.13.3 on page 876, add the following.

An outdoor rated heavy duty combination lock shall be provided to lock the customer compartment door.

**907-722.14.1.3--Optical System.** Delete the sixteenth paragraph of Subsection 722.14.1.3 on page 879, and substitute the following.

The signal module on-board circuitry shall include voltage surge protection to withstand high-repetition noise transients and low-repetition high-energy transients as stated in Section 2.1.6, NEMA Standard TS 2, 1992.

Delete the last sentence of the seventeenth paragraph of Subsection 722.14.1.3 on page 879, and substitute the following.

Load switches shall be compatible with NEMA TS 1 or later, or Model 170-1989 or later.

Delete Subsection 722.14.5 on page 882, and substitute the following.

**907-722.14.5--Blank.**

Delete Subsections 722.14.7 and 722.14.8 on page 882.

# SECTION 905 - PROPOSAL

Date \_\_\_\_\_

Mississippi Transportation Commission  
Jackson, Mississippi

Sirs: The following proposal is made on behalf of \_\_\_\_\_  
\_\_\_\_\_ of \_\_\_\_\_

for constructing the following designated project(s) within the time(s) hereinafter specified.

The plans are composed of drawings and blue prints on file in the offices of the Mississippi Department of Transportation, Jackson, Mississippi.

The Specifications are the current Standard Specifications of the Mississippi Department of Transportation approved by the Federal Highway Administration, except where superseded or amended by the plans, Special Provisions and Notice(s) to Bidders attached hereto and made a part thereof.

I (We) certify that I (we) possess a copy of said Standard and any Supplemental Specifications.

Evidence of my (our) authority to submit the Proposal is hereby furnished. The proposal is made without collusion on the part of any person, firm or corporation. I (We) certify that I (we) have carefully examined the Plans, the Specifications, including the Special Provisions and Notice(s) to Bidders, herein, and have personally examined the site of the work. On the basis of the Specifications, Special Provisions, Notice(s) to Bidders, and Plans, I (we) propose to furnish all necessary machinery, tools, apparatus and other means of construction and do all the work and furnish all the materials in the manner specified. I (We) understand that the quantities mentioned herein are approximate only and are subject to either increase or decrease, and hereby propose to perform any increased or decreased quantities of work at the unit prices bid, in accordance with the above.

I (We) acknowledge that this proposal will be found irregular and/or non-responsive unless a certified check, cashier's check, or Proposal Guaranty Bond in the amount as required in the Advertisement (or, by law) is submitted electronically with the proposal or is delivered to the Contract Administration Engineer prior to the bid opening time specified in the advertisement.

**INSTRUCTION TO BIDDERS: Alternate and Optional Items on Bid Schedule.**

1. Two or more items entered opposite a single unit quantity WITHOUT DEFINITE DESIGNATION AS "ALTERNATE ITEMS" are considered as "OPTIONAL ITEMS". Bidders may or may not indicate on bids the Optional Item proposed to be furnished or performed WITHOUT PREJUDICE IN REGARD TO IRREGULARITY OF BIDS.
2. Items classified on the bid schedule as "ALTERNATE ITEMS" and/or "ALTERNATE TYPES OF CONSTRUCTION" must be preselected and indicated on bids. However, "Alternate Types of Construction" may include Optional Items to be treated as set out in Paragraph 1, above.
3. Optional items not preselected and indicated on the bid schedule MUST be designated in accordance with Subsection 102.06 prior to or at the time of execution of the contract.
4. Optional and Alternate items designated must be used throughout the project.

I (We) further propose to perform all "force account or extra work" that may be required of me (us) on the basis provided in the Specifications and to give such work my (our) personal attention in order to see that it is economically performed.

I (We) further propose to execute the attached contract agreement (Section 902) as soon as the work is awarded to me (us), and to begin and complete the work within the time limit(s) provided for in the Specifications and Advertisement. I (We) also propose to execute the attached contract bond (Section 903) in an amount not less than one hundred (100) percent of the total of my (our) part, but also to guarantee the excellence of both workmanship and materials until the work is finally accepted.

I (We) shall submit electronically with our proposal or deliver prior to the bid opening time a certified check, cashier's check or bid bond for **five percent (5%) of total bid** and hereby agree that in case of my (our) failure to execute the contract and furnish bond within Ten (10) days after notice of award, the amount of this check (bid bond) will be forfeited to the State of Mississippi as liquidated damages arising out of my (our) failure to execute the contract as proposed. It is understood that in case I am (we are) not awarded the work, the check will be returned as provided in the Specifications.

**SECTION 905 -- PROPOSAL (CONTINUED)**

I (We) hereby certify by digital signature and electronic submission via Bid Express of the Section 905 proposal below, that all certifications, disclosures and affidavits incorporated herein are deemed to be duly executed in the aggregate, fully enforceable and binding upon delivery of the bid proposal. I (We) further acknowledge that this certification shall not extend to the bid bond or alternate security which must be separately executed for the benefit of the Commission. This signature does not cure deficiencies in any required certifications, disclosures and/or affidavits. I (We) also acknowledge the right of the Commission to require full and final execution on any certification, disclosure or affidavit contained in the proposal at the Commission's election upon award. Failure to so execute at the Commission's request within the time allowed in the Standard Specifications for execution of all contract documents will result in forfeiture of the bid bond or alternate security.

Respectfully Submitted,

DATE \_\_\_\_\_

\_\_\_\_\_  
Contractor

BY \_\_\_\_\_  
Signature

TITLE \_\_\_\_\_

ADDRESS \_\_\_\_\_

CITY, STATE, ZIP \_\_\_\_\_

PHONE \_\_\_\_\_

FAX \_\_\_\_\_

E-MAIL \_\_\_\_\_

(To be filled in if a corporation)

Our corporation is chartered under the Laws of the State of \_\_\_\_\_ and the names, titles and business addresses of the executives are as follows:

\_\_\_\_\_  
President Address

\_\_\_\_\_  
Secretary Address

\_\_\_\_\_  
Treasurer Address

The following is my (our) itemized proposal.

Mill & Overlay approximately 11 miles of SR 468 from Deeb St. to US 80 in Brandon & approximately 0.4 miles of US 80 from SR 468 to Louis Wilson Rd., known as State Project No. MP-5468-61(013) / 306931301 in Rankin County.

Line no.	Item Code	Adj Code	Quantity	Units	Description[Fixed Unit Price]
<b>Roadway Items</b>					
0010	202-B009		2,063	Square Yard	Removal of Asphalt Pavement, Failed Areas
0020	202-B051		13	Linear Feet	Removal of Concrete Curb
0030	202-B117		43	Each	Removal of Delineator, All Types
0040	202-B158		652	Linear Feet	Removal of Guard Rail, Including Rails, Posts and Terminal Ends
0050	203-G001	(E)	1,084	Cubic Yard	Excess Excavation, FM, AH
0060	304-D002	(GT)	3,690	Ton	Granular Material, Crushed Stone
0070	403-A002	(BA1)	26,449	Ton	12.5-mm, MT, Asphalt Pavement
0080	403-B002	(BA1)	2,292	Ton	12.5-mm, MT, Asphalt Pavement, Leveling
0090	406-D001		194,771	Square Yard	Fine Milling of Bituminous Pavement, All Depths
0100	407-A001	(A2)	21,429	Gallon	Asphalt for Tack Coat
0110	503-C010		1,496	Linear Feet	Saw Cut, Full Depth
0120	606-B003		425	Linear Feet	Guard Rail, Class A, Type 1, 'W' Beam, Metal Post
0130	606-D022		4	Each	Guard Rail, Bridge End Section, Type I
0140	606-E005		4	Each	Guard Rail, Terminal End Section, Flared
0150	609-B002	(S)	34	Linear Feet	Concrete Curb, Header
0160	609-B003	(S)	180	Linear Feet	Concrete Curb, Special Design
0170	618-A001		1	Lump Sum	Maintenance of Traffic
0180	619-A1001		46	Mile	Temporary Traffic Stripe, Continuous White
0190	619-A2001		26	Mile	Temporary Traffic Stripe, Continuous Yellow
0200	619-A3002		1,910	Linear Feet	Temporary Traffic Stripe, Skip White
0210	619-A4002		13	Mile	Temporary Traffic Stripe, Skip Yellow
0220	619-A5001		52,851	Linear Feet	Temporary Traffic Stripe, Detail
0230	619-A6001		2,985	Square Feet	Temporary Traffic Stripe, Legend
0240	619-A6002		16,246	Linear Feet	Temporary Traffic Stripe, Legend
0250	619-D1001		789	Square Feet	Standard Roadside Construction Signs, Less than 10 Square Feet
0260	619-D2001		1,388	Square Feet	Standard Roadside Construction Signs, 10 Square Feet or More
0270	619-G4001		48	Linear Feet	Barricades, Type III, Double Faced
0280	620-A001		1	Lump Sum	Mobilization
0290	626-A002		955	Linear Feet	6" Thermoplastic Double Drop Traffic Stripe, Skip White
0300	626-B002		23	Mile	6" Thermoplastic Double Drop Traffic Stripe, Continuous White
0310	626-D001		7	Mile	6" Thermoplastic Double Drop Traffic Stripe, Skip Yellow
0320	626-E001		13	Mile	6" Thermoplastic Double Drop Traffic Stripe, Continuous Yellow
0330	626-G004		17,380	Linear Feet	Thermoplastic Double Drop Detail Stripe, White
0340	626-G005		9,046	Linear Feet	Thermoplastic Double Drop Detail Stripe, Yellow
0350	626-H001		1,493	Square Feet	Thermoplastic Double Drop Legend, White

Line no.	Item Code	Adj Code	Quantity	Units	Description[Fixed Unit Price]
0360	626-H002		8,123	Linear Feet	Thermoplastic Double Drop Legend, White
0370	627-J001		1,769	Each	Two-Way Clear Reflective High Performance Raised Markers
0380	627-K001		651	Each	Red-Clear Reflective High Performance Raised Markers
0390	627-L001		1,990	Each	Two-Way Yellow Reflective High Performance Raised Markers
0400	627-M001		3,150	Each	One-Way Clear Reflective High Performance Raised Markers
0410	630-A003		16	Square Feet	Standard Roadside Signs, Sheet Aluminum, 0.125" Thickness
0420	630-C003		14	Linear Feet	Steel U-Section Posts, 3.0 lb/ft
0430	630-F006		22	Each	Delineators, Guard Rail, White
0440	630-G005		17	Each	Type 3 Object Markers, OM-3R or OM-3L, Post Mounted
0450	907-619-B001		66	Linear Feet	Temporary Portable Rumble Strips
0460	907-632-D001		3	Each	Solid State Traffic Actuated Controller, Type 1
0470	907-641-A002		12	Each	Signal Stop Bar Radar Vehicle Detection Sensor, Type 2
0480	907-641-B002		4	Each	Signal Advanced Radar Vehicle Detection Sensor, Type 2
0490	907-641-D001		1,930	Linear Feet	Radar Vehicle Detection Cable

SECTION 905 - COMBINATION BID PROPOSAL (Continued)

**CONDITIONS FOR COMBINATION BID**

If a bidder elects to submit a combined bid for two or more of the contracts listed for this month's letting, the bidder must complete and execute these sheets of the proposal in each of the individual proposals to constitute a combination bid. In addition to this requirement, each individual contract shall be completed, executed and submitted in the usual specified manner.

Failure to execute this Combination Bid Proposal in each of the contracts combined will be just cause for each proposal to be received and evaluated as a separate bid.

It is understood that the Mississippi Transportation Commission not only reserves the right to reject any and all proposals, but also the right to award contracts upon the basis of lowest separate bids or combination bids most advantageous to the State.

It is further understood and agreed that the Combination Bid Proposal is for comparison of bids only and that each contract shall operate in every respect as a separate contract in accordance with its proposal and contract documents.

I (We) agree to complete each contract on or before its specified completion date.

\*\*\*\*\*

**COMBINATION BID PROPOSAL**

This proposal is tendered as one part of a Combination Bid Proposal utilizing option \_\_\_\* of Subsection 102.11 on the following contracts:

\* Option to be shown as either (a), (b), or (c).

	<u>Project No.</u>	<u>County</u>	<u>Project No.</u>	<u>County</u>
1.	_____	_____	6.	_____
2.	_____	_____	7.	_____
3.	_____	_____	8.	_____
4.	_____	_____	9.	_____
5.	_____	_____	10.	_____

(a) If Combination A has been selected, your Combination Bid is complete.

(b) If Combination B has been selected, then complete the following page.

SECTION 905 - COMBINATION BID PROPOSAL (Continued)

Project Number	Pay Item Number	Unit	Unit Price Reduction	Total Item Reduction	Total Contract Reduction
1.					
2.					
3.					
4.					
5.					
6.					
7.					
8.					

For Informational Purposes Only

SECTION 905 - COMBINATION BID PROPOSAL (Continued)

Project Number	Pay Item Number	Unit	Unit Price Reduction	Total Item Reduction	Total Contract Reduction
9.					
10.					

(c) If Combination C has been selected, then initial and complete ONE of the following.

\_\_\_\_\_ I (We) desire to be awarded work not to exceed a total monetary value of \$ \_\_\_\_\_.

\_\_\_\_\_ I (We) desire to be awarded work not to exceed \_\_\_\_\_ number of contracts.





TO: EXECUTIVE DIRECTOR, MISSISSIPPI DEPARTMENT OF TRANSPORTATION  
JACKSON, MISSISSIPPI

**CERTIFICATE**

If awarded this contract, I (we) contemplate that portions of the contract will be sublet. I (we) certify that those subcontracts which are equal to or in excess of fifty thousand dollars (\$50,000.00) will be in accordance with regulations promulgated and adopted by the Mississippi State Board of Contractors on September 8, 2011.

I (we) agree that this notification of intent DOES NOT constitute APPROVAL of the subcontracts.

_____	_____
(Individual or Firm)	(Address)
_____	_____
(Individual or Firm)	(Address)
_____	_____
(Individual or Firm)	(Address)
_____	_____
(Individual or Firm)	(Address)

NOTE: Failure to complete the above DOES NOT preclude subsequent subcontracts. Subsequent subcontracts, if any, equal to or in excess of fifty thousand dollars (\$50,000.00) will be in accordance with regulations promulgated and adopted by the Mississippi State Board of Contractors on September 8, 2011.

Contractor \_\_\_\_\_

**MISSISSIPPI DEPARTMENT OF TRANSPORTATION**  
**CERTIFICATION**

I, \_\_\_\_\_,  
(Name of person signing bid)

individually, and in my capacity as \_\_\_\_\_ of  
(Title of person signing bid)

\_\_\_\_\_  
(Name of Firm, partnership, or Corporation)

do hereby certify under penalty of perjury under the laws of the United States and the State of Mississippi

that \_\_\_\_\_, Bidder  
(Name of Firm, Partnership, or Corporation)

on Project No. **MP-5468-61(013)/ 306931301000**

in **Rankin** County(ies), Mississippi, has not either directly or indirectly entered into any agreement, participated in any collusion; or otherwise taken any action in restraint of free competitive bidding in connection with this contract; nor have any of its corporate officers or principal owners.

Except as noted hereafter, it is further certified that said legal entity and its corporate officers, principal owners, managers, auditors and others in a position of administering federal funds are not currently under suspension, debarment, voluntary exclusion or determination of ineligibility; nor have a debarment pending; nor been suspended, debarred, voluntarily excluded or determined ineligible within the past three years by the Mississippi Transportation Commission, the State of Mississippi, any other State or a federal agency; nor been indicted, convicted or had a civil judgment rendered by a court of competent jurisdiction in any matter involving fraud or official misconduct within the past three years.

Do exceptions exist and are made a part thereof?            Yes / No

Any exceptions shall address to whom it applies, initiating agency and dates of such action.

Note: Exceptions will not necessarily result in denial of award but will be considered in determining bidder responsibility. Providing false information may result in criminal prosecution or administrative sanctions.

All of the foregoing is true and correct.

(1/2016 S)

SECTION 902

CONTRACT FOR MP-5468-61(013)/ 306931301000

LOCATED IN THE COUNTY(IES) OF Rankin

STATE OF MISSISSIPPI,  
COUNTY OF HINDS

This contract entered into by and between the Mississippi Transportation Commission on one hand, and the undersigned contractor, on the other witnesseth;

That, in consideration of the payment by the Mississippi Transportation Commission of the prices set out in the proposal hereto attached, to the undersigned contractor, such payment to be made in the manner and at the time of times specified in the specifications and the special provisions, if any, the undersigned contractor hereby agrees to accept the prices stated in the proposal in full compensation for the furnishing of all materials and equipment and the executing of all the work contemplated in this contract.

It is understood and agreed that the advertising according to law, the Advertisement, the instructions to bidders, the proposal for the contract, the specifications, the revisions of the specifications, the special provisions, and also the plans for the work herein contemplated, said plans showing more particularly the details of the work to be done, shall be held to be, and are hereby made a part of this contract by specific reference thereto and with like effect as if each and all of said instruments had been set out fully herein in words and figures.

It is further agreed that for the same consideration the undersigned contractor shall be responsible for all loss or damage arising out of the nature of the work aforesaid; or from the action of the elements and unforeseen obstructions or difficulties which may be encountered in the prosecution of the same and for all risks of every description connected with the work, exceptions being those specifically set out in the contract; and for faithfully completing the whole work in good and workmanlike manner according to the approved Plans, Specifications, Special Provisions, Notice(s) to Bidders and requirements of the Mississippi Department of Transportation.

It is further agreed that the work shall be done under the direct supervision and to the complete satisfaction of the Executive Director of the Mississippi Department of Transportation, or his authorized representatives, and when Federal Funds are involved subject to inspection at all times and approval by the Federal Highway Administration, or its agents as the case may be, or the agents of any other Agency whose funds are involved in accordance with those Acts of the Legislature of the State of Mississippi approved by the Governor and such rules and regulations issued pursuant thereto by the Mississippi Transportation Commission and the authorized Federal Agencies.

The Contractor agrees that all labor as outlined in the Special Provisions may be secured from list furnished by

It is agreed and understood that each and every provision of law and clause required by law to be inserted in this contract shall be deemed to be inserted herein and this contract shall be read and enforced as though it were included herein, and, if through mere mistake or otherwise any such provision is not inserted, then upon the application of either party hereto, the contract shall forthwith be physically amended to make such insertion.

The Contractor agrees that he has read each and every clause of this Contract, and fully understands the meaning of same and that he will comply with all the terms, covenants and agreements therein set forth.

Witness our signatures this the \_\_\_ day of \_\_\_\_\_, \_\_\_\_\_.

\_\_\_\_\_  
Contractor(s)

By \_\_\_\_\_

MISSISSIPPI TRANSPORTATION COMMISSION

Title \_\_\_\_\_

By \_\_\_\_\_

Signed and sealed in the presence of:  
(names and addresses of witnesses)

Executive Director

\_\_\_\_\_

Secretary to the Commission

Award authorized by the Mississippi Transportation Commission in session on the \_\_\_ day of \_\_\_\_\_, \_\_\_\_\_, Minute Book No. \_\_\_\_\_, Page No. \_\_\_\_\_.

Revised 8/06/2003

**SECTION 903**  
**PERFORMANCE AND PAYMENT BOND**

CONTRACT BOND FOR: MP-5468-61(013)/306931301000

LOCATED IN THE COUNTY(IES) OF: Rankin

STATE OF MISSISSIPPI,  
COUNTY OF HINDS

Know all men by these presents: that we, \_\_\_\_\_  
(Contractor)  
\_\_\_\_\_ Principal, a \_\_\_\_\_

residing at \_\_\_\_\_ in the State of \_\_\_\_\_

and \_\_\_\_\_

(Surety)  
residing at \_\_\_\_\_ in the State of \_\_\_\_\_,

authorized to do business in the State of Mississippi, under the laws thereof, as surety, effective as of the contract date shown below, are held and firmly bound unto the State of Mississippi in the sum of \_\_\_\_\_

\_\_\_\_\_ Dollars, lawful money of the United States of America, to be paid to it for which payment well and truly to be made, we bind ourselves, our heirs, administrators, successors, or assigns jointly and severally by these presents.

The conditions of this bond are such, that whereas the said \_\_\_\_\_

\_\_\_\_\_ principal, has (have) entered into a contract with the Mississippi Transportation Commission, bearing the date of \_\_\_\_\_ day of \_\_\_\_\_ A.D. \_\_\_\_\_ hereto annexed, for the construction of certain projects(s) in the State of Mississippi as mentioned in said contract in accordance with the Contract Documents therefor, on file in the offices of the Mississippi Department of Transportation, Jackson, Mississippi.

Now therefore, if the above bounden \_\_\_\_\_ in all things shall stand to and abide by and well and truly observe, do keep and perform all and singular the terms, covenants, conditions, guarantees and agreements in said contract, contained on his (their) part to be observed, done, kept and performed and each of them, at the time and in the manner and form and furnish all of the material and equipment specified in said contract in strict accordance with the terms of said contract which said plans, specifications and special provisions are included in and form a part of said contract and shall maintain the said work contemplated until its final completion and acceptance as specified in Subsection 109.11 of the approved specifications, and save harmless said Mississippi Transportation Commission from any loss or damage arising out of or occasioned by the negligence, wrongful or criminal act, overcharge, fraud, or any other loss or damage whatsoever, on the part of said principal (s), his (their) agents, servants, or employees in the performance of said work or in any manner connected therewith, and shall be liable and responsible in a civil action instituted by the State at the instance of the Mississippi Transportation Commission or any officer of the State authorized in such cases, for double any amount in money or property, the State may lose or be overcharged or otherwise defrauded of, by reason of wrongful or criminal act, if any, of the Contractor(s), his (their) agents or employees, and shall promptly pay the said agents, servants and employees and all persons furnishing labor, material, equipment or supplies therefor, including premiums incurred, for Surety Bonds, Liability Insurance, and Workmen's Compensation Insurance; with the additional obligation that such Contractor shall promptly make payment of all taxes, licenses, assessments, contributions, damages,

any liquidated damages which may arise prior to any termination of said principal's contract, any liquidated damages which may arise after termination of the said principal's contract due to default on the part of said principal, penalties and interest thereon, when and as the same may be due this state, or any county, municipality, board, department, commission or political subdivision: in the course of the performance of said work and in accordance with Sections 31-5-51 et seq. Mississippi Code of 1972, and other State statutes applicable thereto, and shall carry out to the letter and to the satisfaction of the Executive Director of the Mississippi Department of Transportation, all, each and every one of the stipulations, obligations, conditions, covenants and agreements and terms of said contract in accordance with the terms thereof and all of the expense and cost and attorney's fee that may be incurred in the enforcement of the performance of said contract, or in the enforcement of the conditions and obligations of this bond, then this obligation shall be null and void, otherwise to be and remain in full force and virtue.

_____	_____
(Contractors) Principal	Surety
By _____	By _____
	(Signature) Attorney in Fact
	Address _____
	_____
Title _____	_____
(Contractor's Seal)	(Printed) MS Agent
	_____
	(Signature) MS Agent
	Address _____
	_____
	_____
	(Surety Seal)
	_____
	Mississippi Insurance ID Number



# BID BOND

KNOW ALL MEN BY THESE PRESENTS, that we \_\_\_\_\_  
Contractor

\_\_\_\_\_  
Address

\_\_\_\_\_  
City, State ZIP

As principal, hereinafter called the Principal, and \_\_\_\_\_  
Surety

a corporation duly organized under the laws of the state of \_\_\_\_\_

as Surety, hereinafter called the Surety, are held and firmly bound unto State of Mississippi, Jackson, Mississippi

As Obligee, hereinafter called Obligee, in the sum of **Five Per Cent (5%) of Amount Bid**

Dollars(\$ \_\_\_\_\_ )

for the payment of which sum will and truly to be made, the said Principal and said Surety, bind ourselves, our heirs, executors, administrators, successors and assigns, jointly and severally, firmly by these presents.

WHEREAS, the Principal has submitted a bid for **Mill & Overlay approximately 11 miles of SR 468 from Deeb St. to US 80 in Brandon & approximately 0.4 miles of US 80 from SR 468 to Louis Wilson Rd., known as State Project No. MP-5468-61(013) / 306931301 in Rankin County.**

NOW THEREFORE, the condition of this obligation is such that if the aforesaid Principal shall be awarded the contract, the said Principal will, within the time required, enter into a formal contract and give a good and sufficient bond to secure the performance of the terms and conditions of the contract, then this obligation to be void; otherwise the Principal and Surety will pay unto the Obligee the difference in money between the amount of the bid of the said Principal and the amount for which the Obligee legally contracts with another party to perform the work if the latter amount be in excess of the former, but in no event shall liability hereunder exceed the penal sum hereof.

Signed and sealed this \_\_\_\_\_ day of \_\_\_\_\_, 20\_\_

\_\_\_\_\_  
(Principal) (Seal)

\_\_\_\_\_  
(Witness) (Name) By: \_\_\_\_\_ (Title)

\_\_\_\_\_  
(Surety) (Seal)

\_\_\_\_\_  
(Witness) (Attorney-in-Fact) By: \_\_\_\_\_

\_\_\_\_\_  
(MS Agent)

\_\_\_\_\_  
Mississippi Insurance ID Number

