

MDOT Use Only

Checked _____

Loaded _____

Keyed _____

02 -



SM No. CNHPP0008030591

PROPOSAL AND CONTRACT DOCUMENTS

FOR THE CONSTRUCTION OF

02

Mill & Overlay approximately 9 miles of US 49 from the Simpson County Line to south of Florence, known as Federal Aid Project No. NHPP-0008-03(059) / 108245301 in Rankin County.

Project Completion: 04/04/2025

(STATE DELEGATED)

NOTICE

**BIDDERS MUST COMPLETE AN ONLINE REQUEST
FOR PERMISSION TO BID THIS PROJECT.**

Electronic addendum updates will be posted on www.gomdot.com

SECTION 900
OF THE CURRENT
2017 STANDARD SPECIFICATIONS
FOR ROAD AND BRIDGE CONSTRUCTION
JACKSON, MISSISSIPPI

**MISSISSIPPI DEPARTMENT OF TRANSPORTATION
TABLE OF CONTENTS**

PROJECT: NHPP-0008-03(059)/108245301 - Rankin

Section 901 - Advertisement

Section 904 - Notice to Bidders

#1	Governing Specification, w/ Supplement
#2	Status of ROW, w/ Attachments
#3	Final Cleanup
#9	Federal Bridge Formula
#13	Safety Edge
#113	Tack Coat
#296	Reduced Speed Limit Signs
#445	Mississippi Agent or Qualified Nonresident Agent
#446	Traffic on Milled Surface in Urban Areas
#516	Errata and Modifications to the 2017 Standard Specifications
#1226	Material Storage Under Bridges
#1241	Fuel and Material Adjustments
#1963	Guardrail Pads
#2206	MASH Compliant Devices
#2273	Mississippi Special Fuel Tax Law
#2611	Disadvantaged Business Enterprise In Federal-Aid Highway Construction, w/ Supplement
#2782	DBE Pre-Bid Meeting
#2954	Reflective Sheeting for Signs
#3599	Standard Drawings w/Supplement
#3676	Asphalt Gyratory Compactor Internal Angle Calibration
#4113	Unique Entity ID Requirement For Federal Funded Projects
#4702	App for Traffic Control Report
#5248	Contract Time
#5249	Scope of Work
#5250	Specialty Items
#5251	Temporary Construction Signs
#5252	Underground Utilities
#5253	Lane Closure Restrictions
#5260	Additional Construction Requirements

906	Required Federal Contract Provisions -- FHWA 1273, w/Supplements
-----	--

Section 907 - Special Provisions

907-101-1	Definitions and Terms
907-102-2	Bidding Requirements and Conditions
907-105-2	Control of Work
907-106-1	Control of Materials
907-108-4	Subletting of Contract
907-109-4	Measurement and Payment
907-403-2	Asphalt for Pothole Patching
907-413-2	Cleaning and Sealing Joints and Cracks

PROJECT: NHPP-0008-03(059)/108245301 - Rankin

907-512-1	Pressure Grouting Concrete Pavement
907-700-1	Materials and Tests
907-701-3	Hydraulic Cement
907-702-4	Bituminous Materials
907-703-2	Gradation
907-705-1	Stone Riprap
907-707-3	Joint Materials
907-711-2	Plain Steel Wire
907-712-1	Fence and Guardrail
907-714-3	Miscellaneous Materials
907-718-1	Timber and Dimension Lumber
907-720-2	Acceptance Procedure for Glass Beads
907-721-4	Materials for Signing
906-8	Training Special Provisions

Section 905 - Proposal, Proposal Bid Items, Combination Bid Proposal
Certification of Performance - Prior Federal-Aid Contracts
Certification Regarding Non-Collusion, Debarment and Suspension
SAM.GOV Registration and Unique Entity ID
Section 902 - Contract Form
Section 903 - Contract Bond Forms
Form -- OCR-485

(REVISIONS TO THE ABOVE WILL BE INDICATED ON THE SECOND SHEET
OF SECTION 905 AS ADDENDA)

07/26/2023 04:04 PM

MISSISSIPPI DEPARTMENT OF TRANSPORTATION

SECTION 901 - ADVERTISEMENT

Electronic bids will be received by the Mississippi Transportation Commission at 10:00 o'clock A.M., Tuesday, August 22, 2023, from the Bid Express Service and shortly thereafter publicly read on the Sixth Floor For:

Mill & Overlay approximately 9 miles of US 49 from the Simpson County Line to south of Florence, known as Federal Aid Project No. NHPP-0008-03(059) / 108245301 in Rankin County.

The attention of bidders is directed to the Contract Provisions governing selection and employment of labor. Minimum wage rates have been predetermined by the Secretary of Labor and are subject to Public Law 87-581, Work Hours Act of 1962, as set forth in the Contract Provisions.

The Mississippi Department of Transportation hereby notifies all bidders that it will affirmatively insure that in any contract entered into pursuant to this advertisement, disadvantaged business enterprises will be afforded full opportunity to submit bids in response to this invitation and will not be discriminated against on the grounds of race, color, sex, age, disability, religion or national origin in consideration for an award.

The award of this contract will be contingent upon the Contractor satisfying the DBE requirements.

The specifications are on file in the offices of the Mississippi Department of Transportation.

Contractors may request permission to bid online at <http://shop.mdot.ms.gov> at no cost. Upon approval, Contractors shall be eligible to submit a bid using Bid Express at <http://bidx.com>. Specimen proposals may be viewed and downloaded online at no cost at <http://mdot.ms.gov> or purchased online at <http://shop.mdot.ms.gov> at a cost of Ten Dollars (\$10.00) per proposal plus a small convenience fee. Cash or checks will not be accepted as payment.

Bid bond, signed or countersigned by a Mississippi Agent or Qualified Nonresident Agent, with Power of Attorney attached, a Cashier's check or Certified Check for five (5%) percent of bid, payable to STATE OF MISSISSIPPI, must accompany each proposal.

The attention of bidders is directed to the provisions of Subsection 102.07 pertaining to irregular proposals and rejection of bids.

BRAD WHITE
EXECUTIVE DIRECTOR

MISSISSIPPI DEPARTMENT OF TRANSPORTATION

SUPPLEMENT TO NOTICE TO BIDDERS NO. 1

DATE: 06/08/2021

SUBJECT: Governing Specifications

Change the web address at the end of the first paragraph to the following.

<https://shop.mdot.ms.gov/default.aspx?StoreIndex=1>

MISSISSIPPI DEPARTMENT OF TRANSPORTATION

SECTION 904 - NOTICE TO BIDDERS NO. 1

CODE: (IS)

DATE: 03/01/2017

SUBJECT: Governing Specifications

The current (2017) Edition of the Standard Specifications for Road and Bridge Construction adopted by the Mississippi Transportation Commission is made a part hereof fully and completely as if it were attached hereto, except where superseded by special provisions, or amended by revisions of the Specifications contained within this proposal. Copies of the specification book may be purchased from the MDOT Construction Division, or online at shopmdot/default.aspx?StoreIndex=1.

A reference in any contract document to controlling requirements in another portion of the contract documents shall be understood to apply equally to any revision or amendment thereof included in the contract.

In the event the plans or proposal contain references to the 2004 Edition of the Standard Specifications for Road and Bridge Construction, it is to be understood that such references shall mean the comparable provisions of the 2017 Edition of the Standard Specifications.

MISSISSIPPI DEPARTMENT OF TRANSPORTATION

SECTION 904 - NOTICE TO BIDDERS NO. 2

CODE: (IS)

DATE: 03/01/2017

SUBJECT: Status of Right-of-Way

Although it is desirable to have acquired all rights-of-way and completed all railroad agreements, utility adjustments and work to be performed by others prior to receiving bids, sometimes it is not considered to be in the public interest to wait until each and every such clearance has been obtained. The bidder is hereby advised of possible unacquired rights-of-way, relocations, railroad agreements and utilities adjustments which have not been completed.

The status of right-of-way acquisition, utility adjustments, encroachments, potentially contaminated sites, railroad facilities, improvements, and asbestos contamination are set forth in the following attachments.

In the event right of entry is not available to ALL parcels of right-of-way and/or all work that is to be accomplished by others on the date set forth in the contract for the Notice to Proceed is not complete, the Department will issue a restricted Notice to Proceed.

STATUS OF RIGHT-OF-WAY
NHPP-0008-03(059)
108245/301000
Rankin County

All rights of way and legal rights of entry have been acquired except:

None.

MISSISSIPPI DEPARTMENT OF TRANSPORTATION

Inter-Departmental Memorandum

TO: Trudi Loflin
ROW Division

DATE: June 1, 2023

FROM: Adam L. McDaniel *ALM*
District Five

SUBJECT OR PROJECT NO: NHPP-0008-03(059)/108245-301000
ROW Documentation

INFORMATION COPY TO:

COUNTY: Rankin

Project File
Construction Division

District Status Report

1. STATUS OF RIGHT OF WAY: No new ROW required.
2. RIGHT OF WAY CLEARANCE: There are no visible encroachments that conflict with construction.
3. STATUS OF AFFECTED RAILROAD OPERATING FACILITIES: No railroads affected.
4. STATUS OF REQUIRED UTILITY RELOCATIONS: There are no known utility conflicts. Permits showing the approximate location of utilities within or along the ROW are on file with the Department. The Department cannot and does not warrant that this information is complete and accurate. The Contractor is advised to contact MS 811 and MDOT to have utility lines marked prior to subsurface work. The Contractor must coordinate directly with the involved utility owners to have underground utility lines field located in advance of construction.
5. STATUS OF CONSTRUCTION AGREEMENT: None required

ALM:alm

STATUS OF POTENTIALLY CONTAMINATED SITES

NHPP-0008-03(059)

108245-301000

Rankin County

June 5, 2023

THERE IS NO RIGHT OF WAY REQUIRED FOR THIS PROJECT. NO INITIAL SITE ASSESSMENT WILL BE PERFORMED. IF CONTAMINATION ON EXISTING RIGHT OF WAY IS DISCOVERED, IT WILL BE HANDLED BY THE DEPARTMENT.

ASBESTOS CONTAMINATION STATUS OF BUILDINGS
TO BE REMOVED BY THE CONTRACTOR

NHPP-0008-03(059)
108245-301000
Rankin County
June 5, 2023

Reference is made to notices to bidders entitled "Asbestos National Emission Standards for Hazardous Air Pollutants (NESHAP)" and "Removal of Obstructions".

The following pertinent information is furnished concerning asbestos containing materials (ACMs), if any, found in buildings to be removed by the Contractor.

There is no Right of Way required for this project. There are no buildings to be removed by the contractor.

Improvements to be included in Notice to Bidders to be removed by the Construction Contractor
FMS Construction Project No: 108245-301000
External ROW No: NHPP-0008-03(059)

Parcel No:
Station No:
Property Owner:
Description/Pictures:

MISSISSIPPI DEPARTMENT OF TRANSPORTATION

SECTION 904 - NOTICE TO BIDDERS NO. 3

CODE: (SP)

DATE: 01/17/2017

SUBJECT: Final Clean-Up

Immediately prior to final inspection for release of maintenance, the Contractor shall pick up, load, transport and properly dispose of all litter from the entire highway right-of-way that is within the termini of the project.

Litter shall include, but not be limited to, solid wastes such as glass, paper products, tires, wood products, metal, synthetic materials and other miscellaneous debris.

Litter removal is considered incidental to other items of work and will not be measured for separate payment.

MISSISSIPPI DEPARTMENT OF TRANSPORTATION

SECTION 904 - NOTICE TO BIDDERS NO. 9

CODE: (IS)

DATE: 03/01/2017

SUBJECT: Federal Bridge Formula

Bidders are hereby advised that the latest revision of Federal Highway Administration Publication No. FHWA-HOP-06-105, **BRIDGE FORMULA WEIGHTS**, dated August 2006, is made a part of this contract when applicable.

Prior to the preconstruction conference, the Contractor shall advise the Engineer, in writing, what materials, if any, will be delivered to the jobsite via Interstate route(s).

Copies of the **BRIDGE FORMULA WEIGHTS** publication may be obtained by contacting:

Federal Highway Administration
400 7th Street, SW
Washington, DC 20590
(202) 366-2212

or

http://www.ops.fhwa.dot.gov/Freight/publications/brdg_frm_wgths/bridge_formula_all_rev.pdf

An on line **BRIDGE FORMULA WEIGHTS CALCULATOR** is available at

http://ops.fhwa.dot.gov/freight/sw/brdgcalc/calc_page.htm

MISSISSIPPI DEPARTMENT OF TRANSPORTATION

SECTION 904 - NOTICE TO BIDDERS NO. 13

CODE: (IS)

DATE: 03/01/2017

SUBJECT: Safety Edge

Bidders are hereby advised that the Shoulder Wedge (Safety Edge) specified in Section 401, Asphalt Pavements, shall only apply to the top two (2) lifts of asphalt. Open Graded Friction Courses (OGFC) are not to be considered a lift as it pertains to safety edge. Attached is a drawing showing the safety edge. Note that the shoulder dimensions in the bottom two drawings will be less than three feet (3').

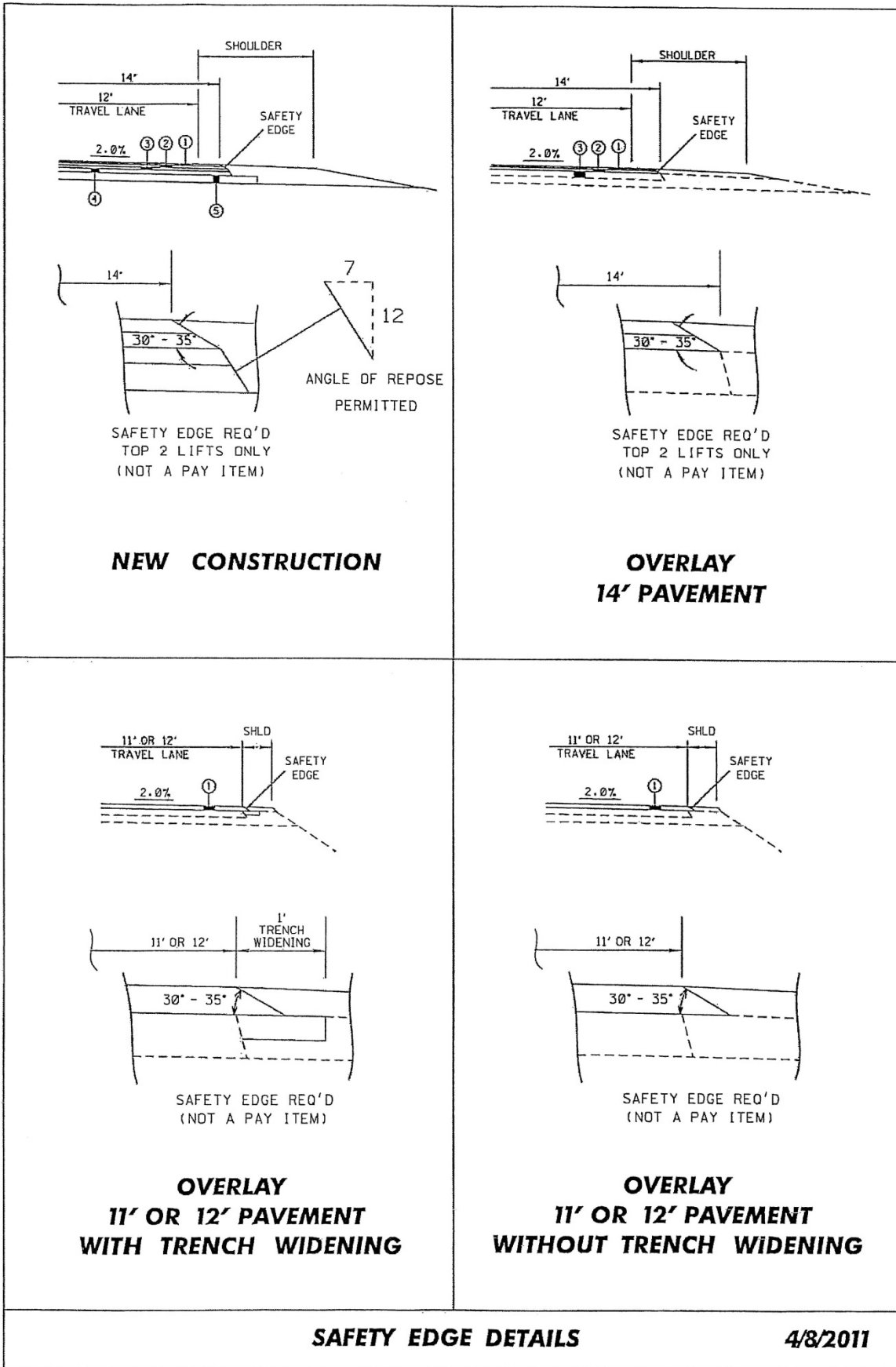

MISSISSIPPI DEPARTMENT OF TRANSPORTATION

SECTION 904 - NOTICE TO BIDDERS NO. 113

CODE: (SP)

DATE: 04/18/2017

SUBJECT: Tack Coat

Bidders are advised that in addition to the products listed on the Department's APL as referenced in Subsection 401.03.1.2 on page 256, the Contractor may use one of the following as a tack coat.

- CSS-1
- CSS-1h
- SS-1
- SS-1h

MISSISSIPPI DEPARTMENT OF TRANSPORTATION

SECTION 904 - NOTICE TO BIDDERS NO. 296

CODE: (SP)

DATE: 07/25/2017

SUBJECT: Reduced Speed Limit Signs

Bidders are advised that when the plans or contract documents require the speed limit on a project to be reduced, the Contractor shall begin work within 48 hours of installing the reduced speed limit signs. Should the Contractor not start work or have no plans to start work within 48 hours of installing the signs, the reduced speed limit signs shall be covered and existing speed limit signs uncovered.

MISSISSIPPI DEPARTMENT OF TRANSPORTATION

SECTION 904 - NOTICE TO BIDDERS NO. 445

CODE: (SP)

DATE: 10/10/2017

SUBJECT: Mississippi Agent or Qualified Nonresident Agent

Bidders are hereby advised of the requirements of Subsections 102.08, 103.05.2, and 107.14.2.1 of the *2017 Standard Specifications for Road and Bridge Construction* as it refers to bonding agents. Proposal guaranties, bonds, and liability insurance policies must be signed by a **Mississippi Agent or Qualified Nonresident Agent.**

MISSISSIPPI DEPARTMENT OF TRANSPORTATION

SECTION 904 - NOTICE TO BIDDERS NO. 446

CODE: (SP)

DATE: 10/18/2017

SUBJECT: Traffic on Milled Surface in Urban Areas

Bidders are hereby advised that when the main lanes of a roadway are fine milled, traffic will be allowed to run on a milled surfaces for up to five (5) calendar days. The Contractor will be assessed a penalty of **\$5,000 per calendar day** afterwards until the milled surfaces are covered with the next lift of asphalt. It shall be the Contractor's responsibility to ensure that the milling operations do not commence until such time as forecasted weather conditions are suitable enough to allow the placement of the asphalt pavement after the milling operations.

MISSISSIPPI DEPARTMENT OF TRANSPORTATION

SECTION 904 - NOTICE TO BIDDERS NO. 516

CODE: (IS)

DATE: 11/28/2017

SUBJECT: Errata and Modifications to the 2017 Standard Specifications

<u>Page</u>	<u>Subsection</u>	<u>Change</u>
16	102.06	In the seventh full paragraph, change “Engineer” to “Director.”
33	105.05.1	In the sixth sentence, change “Contract Administration Engineer” to “Contract Administration Director.”
34	105.05.2.1	In subparagraph 2, change “SWPPP, ECP” to “SWPPP and the ECP”
35	105.05.2.2	In subparagraphs 2, add “ and” to the end of the sentence. In subparagraph 3, remove “, and” and add “.”.
90	109.04.2	In the last paragraph of subparagraph (a), place a period “.” at the end of the sentence.
93	109.04.2	In the last paragraph of subparagraph (g), place a period “.” at the end of the sentence. Also, in the first paragraph of subparagraph (h), place a period “.” at the end of the sentence.
97	109.07	Under ADJUSTMENT CODE, subparagraph (A1), change “HMA mixture” to “Asphalt mixtures.”
98	109.11	In the third sentence, change “Engineer” to “Director.”
219	308.04	In the last sentence of the last paragraph, change “Contractor’s decision” to “Engineer’s decision.”
300	405.02.5.9	In the first sentence of the second paragraph, change “Hot Mix Asphalt” to “Asphalt Mixtures.”
502	630.01.1	In the first paragraph, change “AASHTO” to “AASHTO’s LRFD”.
636	646.05	Change “each” to “per each” for the pay item units of payment.
640	656.02.6.2	In item 7), change “down stream” to “downstream”.
688	630.03.2	Change the subsection number from “630.03.2” to “680.03.2.”

- | | | |
|-----|---------------|---|
| 725 | 702.08.3 | In the second sentence of the first paragraph, change “hot-mix” to “asphalt.” |
| 954 | 804.02.13.1.6 | In the definition for “M” in the % Reduction formulas, change “paragraph 7.3” to “paragraph 5.3.” |

MISSISSIPPI DEPARTMENT OF TRANSPORTATION

SECTION 904 - NOTICE TO BIDDERS NO. 1226

CODE: (IS)

DATE: 11/16/2018

SUBJECT: Material Storage Under Bridges

Bidders are advised that Subsection 106.08 of the Standard Specifications allows the Contractor to store materials and equipment on portions of the right-of-way. However, the Contractor will not be allowed to store or stockpile materials under bridges without written permission from the Project Engineer. The Contractor shall submit a detailed request of all proposed materials to be stored under bridges to the Engineer a minimum of 14 calendar days prior to anticipated storage. This detail shall include, but not limited to, bridge location, material type, material quantity, and duration of storage. The Project Engineer and any other needed Division will review this information and determine whether to grant approval. The Contractor shall not store any material under any bridge without written approval from the Project Engineer.

MISSISSIPPI DEPARTMENT OF TRANSPORTATION

SECTION 904 - NOTICE TO BIDDERS NO. 1241

CODE: (IS)

DATE: 11/27/2018

SUBJECT: Fuel and Material Adjustments

Bidder's attention is brought to the last paragraph of Subsection 109.07 of the Standard Specifications which states that no fuel or material adjustment will be made after the completion of contract time. Any fuels consumed or materials incorporated into the work during the monthly estimate period falling wholly after the expiration of contract time will not be subject a fuel or material adjustment.

MISSISSIPPI DEPARTMENT OF TRANSPORTATION

SECTION 904 - NOTICE TO BIDDERS NO. 1963

CODE: (SP)

DATE: 9/23/2019

SUBJECT: Guardrail Pads

Bidders are hereby advised that prior to construction of the guardrail pads, the Contractor shall coordinate with the guardrail Subcontractor to determine the guardrail pad dimensions necessary to meet MASH compliance.

MISSISSIPPI DEPARTMENT OF TRANSPORTATION

SECTION 904 - NOTICE TO BIDDERS NO. 2206

CODE: (IS)

DATE: 01/14/2020

SUBJECT: MASH Compliant Devices

Bidders are hereby advised that compliance associated with the requirements of meeting either the National Cooperative Highway Research Program (NCHRP) Report 350 or the Manual for Assessing Safety Hardware (MASH) for installations of certain traffic control devices and permanent safety hardware devices (guardrails, guardrail terminals, permanent portable barriers, cast-in-place barriers, all other permanent longitudinal barriers, crash cushions, cable barriers, cable barrier terminals, bridge rails, bridge rail transitions, all other terminals, sign supports, and all other breakaway hardware) as listed throughout the Standard Specifications and/or the Standard Drawings, or both, is now replaced with the requirements of meeting the 2016 version of MASH after December 31, 2019. This change applies to new permanent installations and to full replacements of existing installations.

At the preconstruction conference or prior to starting any work on the project, the Contractor shall submit a letter stating that the traffic control devices and permanent safety hardware devices as outlined within the paragraph above that are to be used on the project are certified to meet MASH 2016.

When a MASH 2016-compliant device does not exist for the new permanent installations and/or full replacement installations of permanent safety hardware devices, as listed above, a MASH 2009-compliant or a NCHRP 350-compliant device may be proposed by the Contractor for the project. A written request for such instances must be submitted by the Contractor either at the preconstruction conference or prior to starting any work on the project. The Contractor shall submit the following items to the Project Engineer: (1) a detailed list of the proposed devices and locations thereof; and (2) certification letters indicating that the proposed devices are compliant with either MASH 2009 or NCHRP 350.

When a MASH 2016-compliant device does not exist for the temporary work zone traffic control devices (Category 1, Category 2, and Category 3 devices), a MASH 2009-compliant or a NCHRP 350-compliant device may be proposed by the Contractor for the project. Temporary work zone traffic control devices (Category 1, Category 2, and Category 3 devices) that are MASH 2009-compliant or NCHRP 350-compliant that have been in use prior to December 31, 2019, and that have a remaining service life may be proposed for use throughout their normal service life on the project by the Contractor. For either of these scenarios for temporary work zone traffic control devices, a written request must be submitted by the Contractor either at the preconstruction conference or prior to starting any work on the project. The Contractor shall submit the following items to the Project Engineer: (1) a detailed list of the proposed devices and locations thereof; and (2) certification letters indicating that the proposed devices are compliant with either MASH 2009 or NCHRP 350.

Work will only be allowed to proceed after the Department has granted written concurrence(s) with the proposed request(s) as listed above.

MISSISSIPPI DEPARTMENT OF TRANSPORTATION

SECTION 904 - NOTICE TO BIDDERS NO. 2273

CODE: (SP)

DATE: 02/12/2020

SUBJECT: Mississippi Special Fuel Tax Law

Bidder's attention is brought to the second paragraph of Subsection 107.02 of the Standard Specifications which states that all Contractors and Subcontractors must comply with all requirements contained in the Mississippi Special Fuel Tax Law, Section 27-55-501, *et seq.* Attached are two Fact Sheets provided by the Mississippi Department of Revenue (MDOR) with additional information.

Gasoline and Dyed Diesel Used for Non-Highway Purposes

Mississippi provides a reduced rate for gasoline and dyed diesel used for non-highway purposes. The reduced rates are 6.44 cents per gallon and 5.75 cents per gallon of gasoline or dyed diesel. These fuels are generally taxed at 18 cents per gallon if for on road use.

Gasoline Used for Non-Highway Purposes

You may be entitled to a refund of 11.56 cents per gallon (making this an equivalent to a tax rate of 6.44 cents per gallon) if you desire to purchase gasoline to be used off road. The gasoline must be used for agricultural, maritime, industrial, manufacturing, domestic or non-highway purposes only.

Examples of non-highway include gasoline used in boats, golf carts, machinery used for manufacturing or farm equipment used exclusively in plowing, planting or harvesting farm products.

Refund Gasoline User

The refund is based on the amount of gallons used. Before a refund is issued, you are required to...

1. Obtain a refund gasoline user's permit and a certificate for refund booklet from the Department of Revenue;
2. Have a storage tank marked "REFUND GASOLINE"; and,
3. Purchase the gasoline from someone who holds a refund gasoline dealer's permit.

No refund will be allowed for gasoline used in motor vehicles owned or operated by a government entity or used in Mississippi government contracts.

Refund Gasoline Dealer

You must obtain a refund gasoline dealer's permit from the Department of Revenue before selling refund gasoline. At no time should the gasoline be delivered to a tank that is not properly marked. The gasoline must be dyed a distinctive mahogany color at the time of delivery.

The Department of Revenue may waive the dye requirement if the dye may cause damage to the equipment. The refund gasoline user is required to obtain the waiver from the Department of Revenue.

Dyed Diesel Used for Non-Highway Purposes

Unlike gasoline, you are not required to apply for a refund if you desire to purchase dyed diesel to be used off road. Mississippi provides a reduced rate of 5.75 cents per gallon on dyed diesel used off road. Diesel used on road is subjected to 18 cents per gallon. Dyed diesel used in motor vehicles owned or operated by a government entity or used in Mississippi government contracts will be subjected to 18 cents per gallon.

Dyed Diesel Used on the Highway

Any person who purchases, receives, acquires or uses dyed diesel for highway use will be liable to pay 18 cents per gallon and subject to a penalty in the amount of \$1000.

Identifying Dyed Diesel

Storage facilities for dyed diesel must be plainly marked "NONHIGHWAY DIESEL FUEL" or "NONHIGHWAY KEROSENE". Retailers are also required to mark all pumps or dispensing equipment.



Special Fuel Used on Government Contracts

State and Local Government Contracts

Special fuel purchased, acquired or used in performing contracts with the State of Mississippi, counties, municipalities or any political subdivision is taxed at a rate of 18 cents per gallon. Special fuel includes but is not limited to the following:

- Dyed diesel fuel;
- Kerosene;
- Undyed diesel fuel; and,
- Fuel oil.

State and local government contracts include construction, reconstruction and maintenance or repairs of projects such as roads, bridges, water systems, sewer systems, buildings, drainage canals and recreational facilities. The Department of Revenue may require contractors to remit the excise tax directly to the state in lieu of paying the tax to a distributor.

Special Fuel Direct Pay Permit

Contractors that remit the excise tax to the state will be issued a Special Fuel Direct Pay Permit. This permit relieves the distributor from collecting the tax and requires the contractor to file a monthly special fuel return. The distributor should include the contractor’s permit number on all invoices that are related to tax-free sales.

The contractor is required to furnish a surety or cash bond guaranteeing the payment of the excise tax prior to receiving the Special Fuel Direct Pay Permit. The Department of Revenue may accept a contractors tax bond if the bond covers the excise tax levied on special fuel.

Special Fuel Distributors

If the contractor does not have a Special Fuel Direct Pay Permit, distributors are required to collect the 18 cents excise tax and remit the tax to the Department of Revenue. The additional 12.25 cents levied on special fuel (excluding undyed diesel) should be reported on schedules 5F and 5G of the special fuel return.

Environmental Protection Fee

Special fuel distributors are required to collect the environmental protection fee even if the contractor has a Special Fuel Direct Pay Permit. The fee is levied at 4/10^{ths} of a cent per gallon. The fee is suspended or reinstated when the trust fund has exceeded or fallen below the obligatory balance.

Penalties

Any person who knowingly and willfully purchases untaxed fuel for use in equipment utilized on a road or highway construction site in this state is guilty of a misdemeanor and, upon conviction, shall be fined not less than \$1,000 or more than \$100,000, or imprisoned in the county jail for not more than one year, or both.



MISSISSIPPI DEPARTMENT OF TRANSPORTATION

SUPPLEMENT TO NOTICE TO BIDDERS NO. 2611

DATE: **05/02/2020**

The goal is 7 percent for the Disadvantaged Business Enterprise. All Bidders are required to submit Form OCR-481 for all DBEs. Bidders are advised to check the bid tabulation link for this project on the MDOT website at:

https://mdot.ms.gov/portal/current_letting

Bid tabulations are usually posted by 3:00 pm on Letting Day.

MISSISSIPPI DEPARTMENT OF TRANSPORTATION

SECTION 904 - NOTICE TO BIDDERS NO. 2611

CODE: (IS)

DATE: 05/21/2020

SUBJECT: Disadvantaged Business Enterprises In Federal-Aid Highway Construction

This contract is subject to the "Moving Ahead for Progress in the 21st Century Act (MAP-21)" and applicable requirements of "Title 49, Code of Federal Regulations, Part 26." Portions of the Act are set forth in this Notice as applicable to compliance by the Contractor and all of the Act, and the MDOT DBE Program, is incorporated by reference herein.

The Department has developed a Disadvantaged Business Enterprise Program that is applicable to this contract and is made a part thereof by reference.

Copies of the program may be obtained from:

Office of Civil Rights
Mississippi Department of Transportation
P. O. Box 1850
Jackson, Mississippi 39215-1850

POLICY

It is the policy of the Mississippi Department of Transportation to provide a level playing field, to foster equal opportunity in all federally assisted contracts, to improve the flexibility of the DBE Program, to reduce the burdens on small businesses, and to achieve that amount of participation that would be obtained in a non-discriminatory market place. In doing so, it is the policy of MDOT that there will be no discrimination in the award and performance of federally assisted contracts on the basis of race, color, sex, or national origin.

ASSURANCES THAT CONTRACTORS MUST TAKE

MDOT will require that each contract which MDOT signs with a sub-recipient or a Contractor, and each subcontract the Prime Contractor signs with a Subcontractor, includes the following assurances:

“The Contractor, sub-recipient or Subcontractor shall not discriminate on the basis of race, color, sex, or national origin in the performance of this contract. The Contractor shall carry out applicable requirements of 49 CFR 26 in the award and administration of federally assisted contracts. Failure by the Contractor to carry out these requirements is a material breach of this contract, which may result in the termination of this contract or such other remedy as MDOT deems appropriate.”

DEFINITIONS

For purposes of this provision the following definitions will apply:

"Disadvantaged Business" means a small business concern: (a) which is at least 51 percent owned by one or more socially and economically disadvantaged individual(s) or in the case of any publicly owned business, at least 51 percent of the stock of which is owned by one or more socially and economically disadvantaged individual(s); and (b) whose management and daily business operations are controlled by one or more of the socially and economically disadvantaged individual(s) who own it. It is important to note that the business owners themselves must control the operations of the business. Absentee ownership or title ownership by an individual who does not take an active role in controlling the business is not consistent with eligibility as a DBE under 49 CFR Part 26.71.

CONTRACTOR'S OBLIGATION

The Contractor and all Subcontractors shall take all necessary and reasonable steps to ensure that DBE firms can compete for and participate in the performance of a portion of the work in this contract and shall not discriminate on the basis of race, color, sex, or national origin. Failure on the part of the Contractor to carry out the DBE requirements of this contract constitutes a breach of contract and after proper notification the Department may terminate the contract or take other appropriate action as determined by the Department.

When a contract has a zero percent (0%) DBE goal, the Contractor still has the responsibility to take all necessary and reasonable steps to ensure that DBE firms can compete for and participate in the performance of the work in the contract. In this case, all work performed by a certified DBE firm is considered to be a "race neutral" measure and the Department will receive DBE credit towards the overall State goals when the DBE firm is paid for their work. If the Prime Contractor is a certified DBE firm, the Department can receive DBE credit only for the work performed by the Prime Contractor's work force or any work subcontracted to another DBE firm. Work performance by a non-DBE Subcontractor is not eligible for DBE credit.

CONTRACT GOAL

The goal for participation by DBEs is established for this contract in the attached Supplement. The Contractor shall exercise all necessary and reasonable steps to ensure that participation is equal to or exceeds the contract goal.

If the percentage of the contract that is proposed for DBEs is 1% or greater, the Contractor shall agree to meet or exceed the contract goal on the last bid sheet of the proposal.

All Bidders shall submit to the Office of Civil Rights Form OCR-481, signed by the Prime Contractor and the DBE Subcontractors, no later than the 3rd business day after opening of the bids.

Form OCR-481 is available on the MDOT website at www.mdot.ms.gov under the Civil Rights tab, or by calling 601-359-7466.

The OCR-481 Form must contain the following information:

The name and address of each certified DBE Contractor / Supplier;

The Reference Number, percent of work to be completed by the DBE subcontractor and the dollar amount of each item. If a portion of an item is subcontracted, a breakdown of that item including quantities and unit price must be attached, detailing what part of the item the DBE firm is to perform and who will perform the remainder of the item.

If the DBE Commitment shown on the last bid sheet of the proposal, does not equal or exceed the contract goal, the bidder must submit, to MDOT Contract Administration Division prior to bid opening, information to satisfy the Department that adequate good faith efforts have been made to meet the contract goal.

Failure of the lowest bidder to furnish acceptable proof of good faith efforts, submitted to MDOT Contract Administration Division prior to bid opening, shall be just cause for rejection of the proposal. Award may then be made to the next lowest responsive bidder or the project may be re-advertised.

GOOD FAITH EFFORTS

The following factors are illustrative of matters the Department will consider in judging whether or not the bidder has made adequate good faith effort to satisfy the contract goal.

- (1) Whether the bidder attended the pre-bid meeting that was scheduled by the Department to inform DBEs of subcontracting opportunities;
- (2) Whether the bidder advertised in general circulation, trade association, and minority-focus media concerning the subcontracting opportunities;
- (3) Whether the bidder provided written notice to a reasonable number of specific DBEs that their interest in the contract is being solicited;
- (4) Whether the bidder followed up initial solicitations of interest by contacting DBEs to determine with certainty whether they were interested;
- (5) Whether the bidder selected portions of the work to be performed by DBEs in order to increase the likelihood of meeting the contract goal;
- (6) Whether the bidder provided interested DBEs with adequate information about the plans, specifications and requirements of the contract;

- (7) Whether the bidder negotiated in good faith with interested DBEs and did not reject them as unqualified without sound reasons based on a thorough investigation of their capabilities; and
- (8) Whether the bidder made efforts to assist interested DBEs in obtaining any required bonding or insurance.
- (9) Whether the bidder has written notification to certified DBE Contractors soliciting subcontracting for items of work in the contract.
- (10) Whether the bidder has a statement of why an agreement was not reached.
- (11) Proof of written notification to certified DBE Contractors by certified mail that their interest is solicited in subcontracting the work defaulted by the previous DBE or in subcontracting other items of work in the contract.

The bidder’s execution of the signature portion of the proposal shall constitute execution of the following assurance:

The bidder hereby gives assurance pursuant to the applicable requirements of "Moving Ahead for Progress in the 21st Century Act (MAP-21)" and applicable requirements of "Title 49, Code of Federal Regulations, Part 26" that the bidder has made a good faith effort to meet the contract goal for DBE participation for which this proposal is submitted.

DIRECTORY

A list of “Certified DBE Contractors” which have been certified as such by the Mississippi Department of Transportation and other Unified Certification Partners (UPC) can be found on the Mississippi Department of Transportation website at www.mdot.ms.gov. The list is in the top left corner of the current Letting Calendar under Contracts & Letting. The DBE firm must be certified at the time the project is let and approved by MDOT to count towards meeting the DBE goal.

REPLACEMENT

If a DBE Subcontractor cannot perform satisfactorily, and this causes the OCR-481 commitment to fall below the contract goal, the Contractor shall take all necessary reasonable steps to replace the DBE with another certified DBE Subcontractor or submit information to satisfy the Mississippi Department of Transportation that adequate good faith efforts have been made to replace the DBE. The good faith efforts outlined previously in this document still apply. The replacement DBE must be a DBE who was on the Department's list of "Certified DBE Contractors" when the job was let, and who is still active. All DBE replacements must be approved by the Department.

Under no circumstances shall the Prime or any Subcontractor perform the DBE's work (as shown on the OCR-481) without prior written approval from the Department. See "Sanctions" at the end of this document for penalties for performing DBE's work.

When a Contractor proposes to substitute/replace/terminate a DBE that was originally named on the OCR-481, the Contractor must obtain a release, in writing, from the named DBE explaining why the DBE Subcontractor cannot perform the work. A copy of the original DBE's release must be attached to the Contractor's written request to substitute/replace/terminate along with appropriate Subcontract Forms for the substitute/replacement/terminated Subcontractor, all of which must be submitted to the DBE Coordinator and approved, in advance, by MDOT.

PRE-BID MEETING

A pre-bid meeting will be held in the [Commission Room on the 1st Floor](#) of the [MDOT Administration Building](#) in Jackson, at 2:00 P.M. on the day preceding the date of the bid opening.

This meeting is to inform DBE firms of subcontracting and material supply opportunities. Attendance at this meeting is considered of prime importance in demonstrating good faith effort to meet the contract goal.

PARTICIPATION / DBE CREDIT

Participation shall be counted toward meeting the goal in this contract as follows:

- (1) If the Prime Contractor is a certified DBE firm, only the value of the work actually performed by the DBE Prime can be counted towards the project goal, along with any work subcontracted to a certified DBE firm.
- (2) If the Contractor is not a DBE, the work subcontracted to a certified DBE Contractor will be counted toward the goal.
- (3) The Contractor may count toward the goal a portion of the total dollar value of a contract with a joint venture eligible under the standards of this provision equal to the percentage of the DBE partner in the joint venture.
- (4) Expenditures to DBEs that perform a commercially useful function may be counted toward the goal. A business is considered to perform a commercially useful function when it is responsible for the execution of a distinct element of the work and carries out its responsibilities by actually performing, managing, and supervising the work involved.
- (5) The Contractor may count 100% of the expenditures for materials and supplies obtained from certified DBE suppliers and manufacturers that produce goods from raw materials or substantially alters them for resale provided the suppliers and manufacturers assume the actual and contractual responsibility for the provision of the materials and supplies. The Contractor may count sixty percent (60%) of the expenditures to suppliers that are not

manufacturers, provided the supplier performs a commercially useful function in the supply process. Within 30 days after receipt of the materials, the Contractor shall furnish to the DBE Coordinator invoices from the certified supplier to verify the DBE goal.

- (6) Any work that a certified DBE firm subcontracts or sub-subcontracts to a non-DBE firm will not count towards the DBE goal.
- (7) Only the dollars actually paid to the DBE firm may be counted towards the DBE goal. The participation of a DBE Firm cannot be counted towards the Prime Contractor's DBE goal until the amount being counted towards the goal has been paid to the DBE.

AWARD

Award of this contract to the low bidder will be contingent upon the following conditions:

- (1) Concurrence from Federal Highway Administration, when applicable.
- (2) **All Bidders** must submit to the Office of Civil Rights for approval, Form OCR-481 (DBE Commitment) no later than the 3rd business day after opening of the bids to satisfy the Department and that adequate good faith efforts have been made to meet the contract goal. For answers to questions regarding Form OCR-481, contact the MDOT Office of Civil Rights at (601) 359-7466.
- (3) Bidder must include OCR-485 information with their bid proposal listing all firms that submitted quotes for material supplies or items to be subcontracted. OCR-485 information must be **signed and** included with the bid proposal. If the OCR-485 information is not included as part of bid proposal, your bid will be deemed irregular.

Prior to the start of any work, the bidder must notify the Project Engineer, in writing, of the name of the designated "DBE Liaison Officer" for this project. This notification must be posted on the bulletin board at the project site.

DEFAULT

If the contract goal established by MDOT in this proposal is 1% or greater, it must be met to fulfill the terms of the contract. The Contractor may list DBE Subcontractors and items that exceed MDOT's contract goal, but should unforeseen problems arise that would prevent a DBE from completing its total commitment percentage, the Contractor will meet the terms of the contract as long as it meets or exceeds MDOT's Contract Goal. For additional information, refer to "Replacement" section of this Notice.

DBE REPORTS

- (1) OCR-481: Refer to "CONTRACT GOAL" section of this Notice to Bidders for information regarding this form.

- (2) OCR-482: At the conclusion of the project, before the final estimate is paid and the project is closed out, the Prime Contractor will submit to the Project Engineer for verification of quantities and further handling Form OCR-482 whereby the Contractor certifies to the amounts of payments made to all Contractors / Suppliers over the life of the contract. The Project Engineer shall submit the completed Form OCR-482 to the DBE Coordinator (Office of Civil Rights). Final acceptance of the project is dependent upon Contract Administration Division's receipt of completed Form OCR-482 which they will receive from the Office of Civil Rights.
- (3) OCR-483: The Project Engineer/Inspector will complete Form OCR-483, the Commercially Useful Function (CUF) Performance Report, in accordance with MDOT S.O.P. No. OCR-03-05-02-483. Evaluations reported on this form are used to determine whether or not the DBE firm is performing a CUF. The Prime Contractor should take corrective action when the report contains any negative evaluations. DBE credit may be disallowed and/or other sanctions imposed if it is determined the DBE firm is not performing a CUF. This form should also be completed and returned to the DBE Coordinator (Office of Civil Rights).
- (4) OCR-484: Each month, the Prime Contractor will submit to the Project Engineer OCR-484 that certifies payments to all Subcontractors and shows all firms even if the Prime Contractor has paid no monies to the firm during that estimate period (negative report). The Project Engineer will attach the form to the monthly estimate before forwarding to the Contract Administration Division for further processing. Failure of the Contractor to submit the OCR-484 will result in the estimate not being processed and paid.
- (5) OCR-485: ALL BIDDERS must submit signed form with bid proposal of all firms that submitted quotes for material supplies or items to be subcontracted. If the OCR-485 information is not included as part of bid proposal, the bid will be deemed irregular.
- (6) OCR-487: Only used by Prime Contractors that are certified DBE firms. This form is used in determining the exact percentage of DBE credit for the specified project. The low Bidder should return this form to MDOT with the OCR-481 form, or can also be returned with the Permission to Subcontract Forms (CAD-720, CAD-725 and CAD-521).

DBE Forms, can be obtained from the Office of Civil Rights Division, MDOT Administration Building, 401 North West Street, Jackson, MS, or at www.mdot.ms.gov under the Civil Rights tab.

SANCTIONS

The Department has the option to enforce any of the following penalties for failure of the Prime Contractor to fulfill the DBE goal as stated on the OCR-481 form or any violations of the DBE program guidelines:

- (1) Disallow credit towards the DBE goal

(2) Withhold progress estimate payments

(3) Deduct from the final estimate or recover an amount equal to the unmet portion of the DBE goal which may include additional monetary penalties as outlined below based on the number of offenses and the severity of the violation as determined by MDOT.

1 st Offense	10% of unmet portion of goal	or	\$5,000 lump sum payment	or	Both
2 nd Offense	20% of unmet portion of goal	or	\$10,000 lump sum payment	or	Both
3 rd Offense	40% of unmet portion of goal	or	\$20,000 lump sum payment	or	\$20,000 lump sum payment and debarment

(4) Debar the Contractor involved from bidding on MDOT federally funded projects for a period of up to 12 months after notification by certified email.

MISSISSIPPI DEPARTMENT OF TRANSPORTATION

SECTION 904 - NOTICE TO BIDDERS NO. 2782

CODE: (SP)

DATE: 8/13/2020

SUBJECT: DBE Pre-Bid Meeting

Due to the COVID-19 pandemic and the Department not allowing visitors in the Administration Building at this time, the DBE Pre-Bid Meeting referenced on Page 5 of Notice to Bidders No. 2611 will be held by **video conference only**. The meeting will be held at 2:00 P.M. on the day preceding the date of the bid opening using Zoom video conferencing software. Anyone interested in participating can download Zoom and connect to the meeting at the below link.

<https://zoom.us/j/5548736403?pwd=SDh5S2hQSE5pNG5FOEkzR3NsUnBYQT09>

Password (if prompted): 272147

For those unable to participate via Zoom, the below teleconference number may be used instead.

1-888-227-7517

Conference Code: 404496

MISSISSIPPI DEPARTMENT OF TRANSPORTATION

SECTION 904 - NOTICE TO BIDDERS NO. 2954

CODE: (IS)

DATE: 12/01/2020

SUBJECT: Reflective Sheeting for Signs

Bidders are hereby advised that the retroreflective sign sheeting used for signs on this project shall be as listed below and shall meet the requirements of Subsection 721.06.

Temporary Construction Signs

Temporary traffic control (orange) sign sheeting shall be a minimum Type IX Fluorescent Orange sheeting as shown in Special Provision 907-721.

Permanent Signs

Permanent signs, except signs on traffic signal poles/mast arms, shall be as follows:

- Brown background sheeting on guide signs shall be a minimum Type VIII sheeting,
- Green and blue background sheeting on guide signs shall be a minimum Type IX sheeting, and
- All white, yellow, red, fluorescent yellow, and fluorescent yellow/green sheeting shall be Type XI sheeting.

MISSISSIPPI DEPARTMENT OF TRANSPORTATION

| **SUPPLEMENT TO NOTICE TO BIDDERS NO. 3599**

| **DATE: 08/11/2021**

| After the last drawing on page 33, add the following.

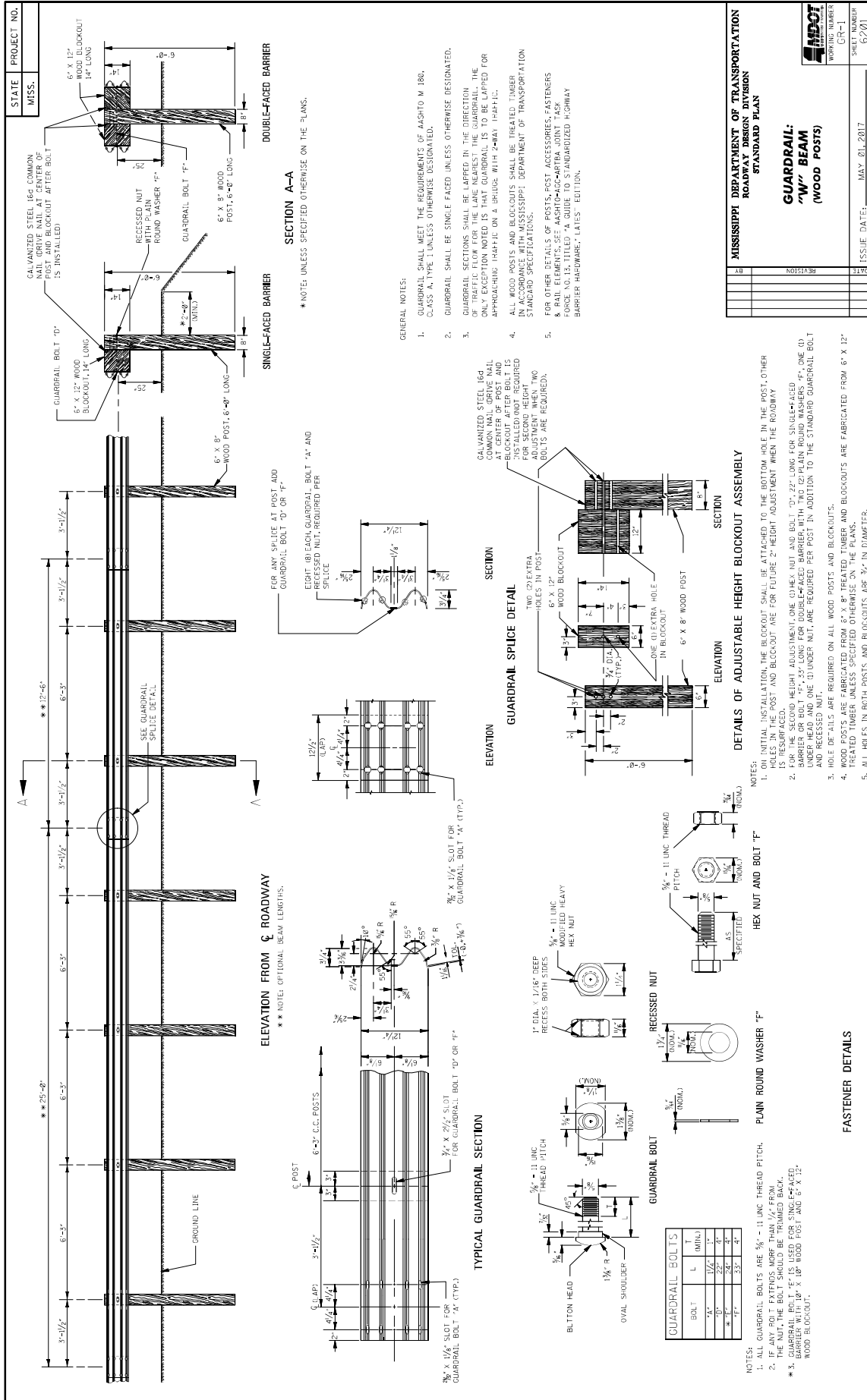

STATE PROJECT NO.
MISS.

SECTION A-A

DOUBLE-FACED BARRIER

SINGLE-FACED BARRIER

SECTION A-A

DOUBLE-FACED BARRIER

SECTION A-A

DOUBLE-FACED BARRIER

GENERAL NOTES:

1. GUARDRAIL SHALL MEET THE REQUIREMENTS OF AASHTO M 180, CLASS A, TYPE 1 UNLESS OTHERWISE DESIGNATED.
2. GUARDRAIL SHALL BE SINGLE FACED UNLESS OTHERWISE DESIGNATED.
3. GUARDRAIL SECTIONS SHALL BE LAPPED IN THE DIRECTION OF TRAVEL. THE ONLY EXCEPTION NOTED IS THAT GUARDRAIL IS TO BE LAPPED FOR APPROACHING HIGH-RISE ON A BRIDGE WITH 2-WAY 14'-14" H.H.C.
4. ALL WOOD POSTS AND BLOCKOUTS SHALL BE TREATED TIMBER IN ACCORDANCE WITH MISSISSIPPI DEPARTMENT OF TRANSPORTATION STANDARD SPECIFICATIONS.
5. FOR OTHER DETAILS OF BOLTS, POST ACCESSORIES, FASTENERS & RAIL ELEMENTS, SEE AASHTO-R20-ARTERIAL JOINT TASK FORCE NO. 13, TITLED "A GUIDE TO STANDARDIZED HIGHWAY BARRIER HARDWARE," LATEST EDITION.

MISSISSIPPI DEPARTMENT OF TRANSPORTATION
ROADWAY DESIGN DIVISION
STANDARD PLAN

**GUARDRAIL:
"W" BEAM
(WOOD POSTS)**

ISSUE DATE: MAY 01, 2017

DATE	REVISION

WORKING NUMBER	CR-1
SHEET NUMBER	02/01

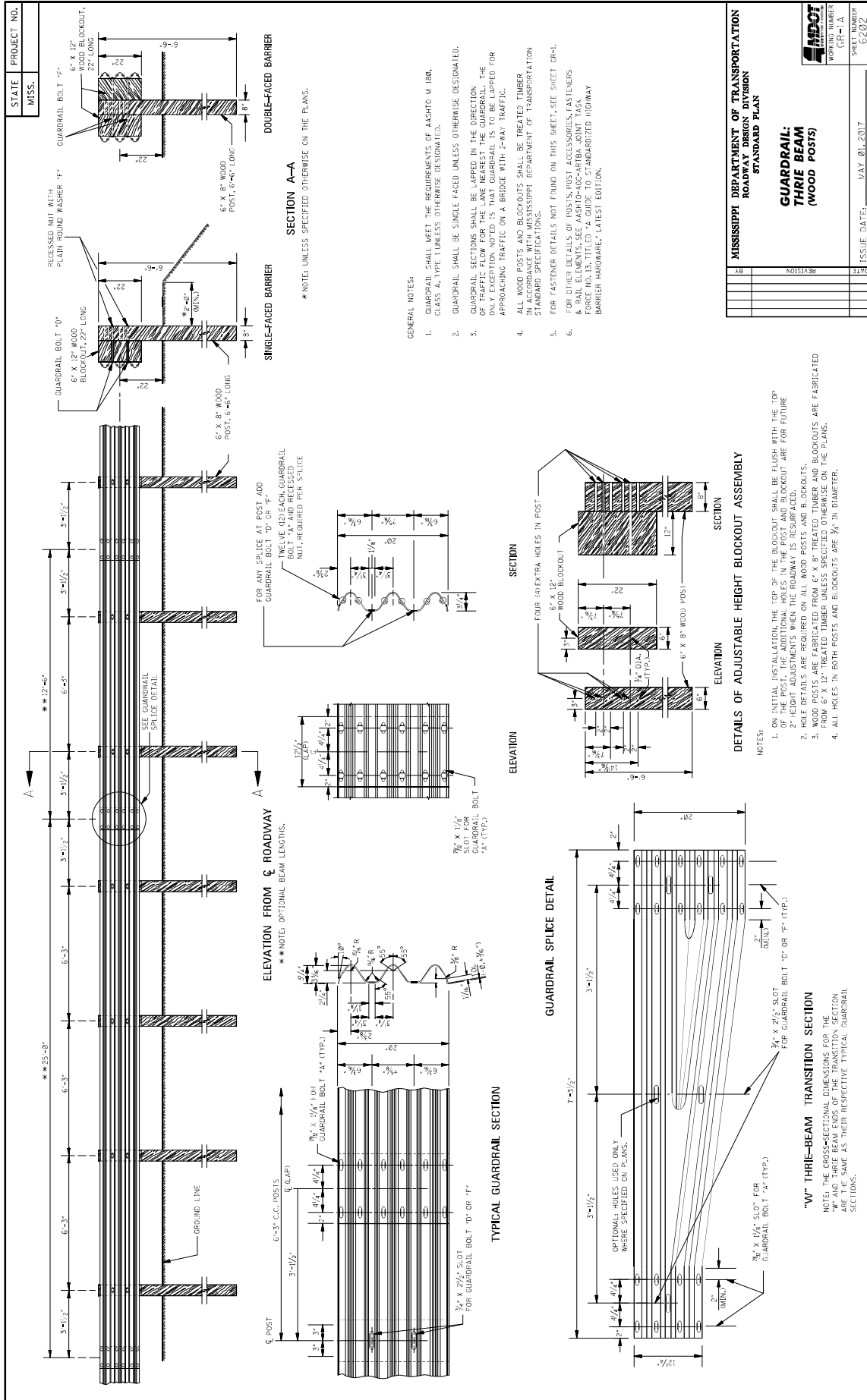

MISSISSIPPI DEPARTMENT OF TRANSPORTATION ROADWAY DESIGN DIVISION STANDARD PLAN	
GUARDRAIL: THRIE BEAM (WOOD POSTS)	
SHEET NUMBER GP-1A	ISSUE DATE: MAY 01, 2017

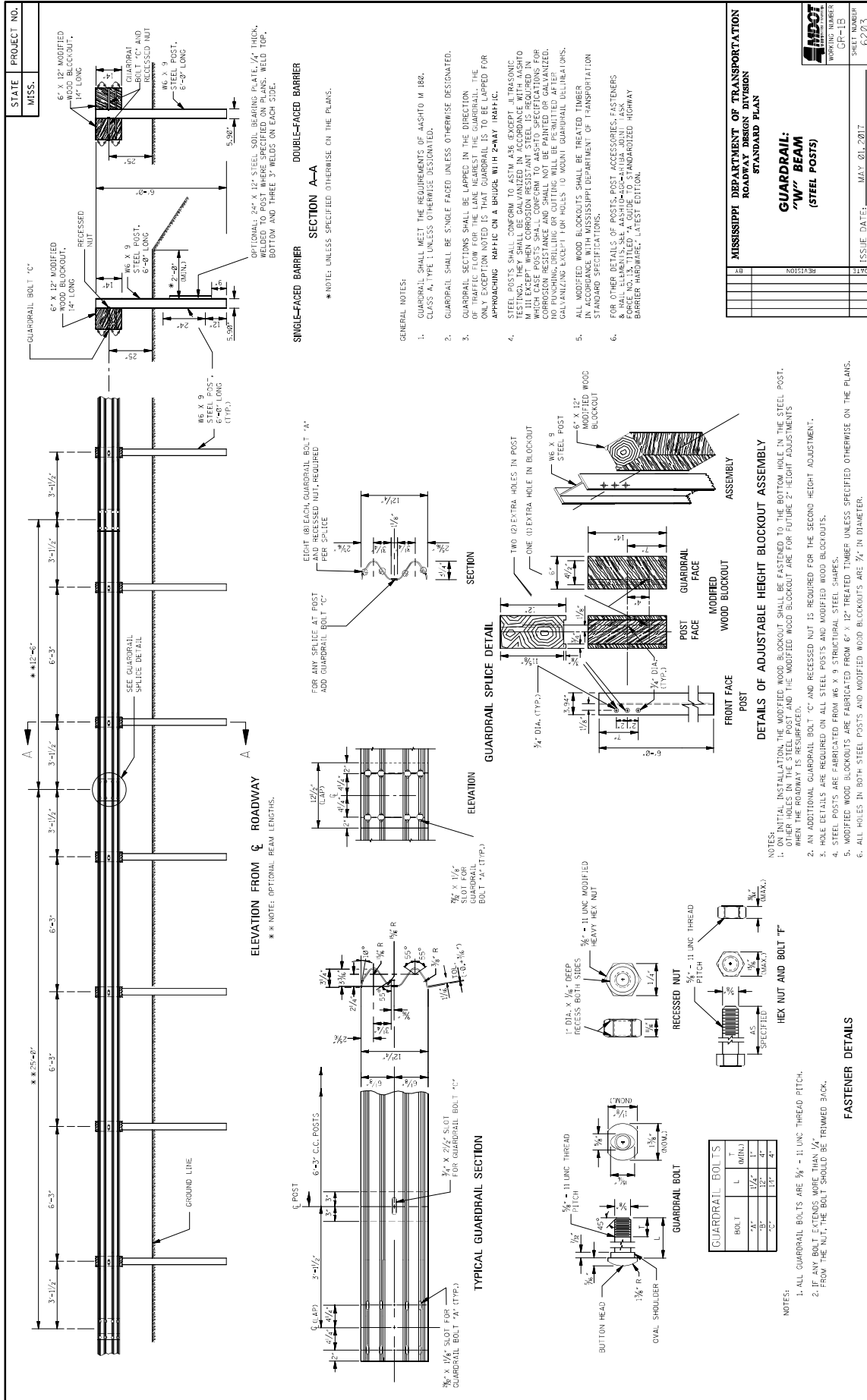

MISSISSIPPI DEPARTMENT OF TRANSPORTATION
ROADWAY DESIGN DIVISION
STANDARD PLAN

GUARDRAIL:
"W" BEAM
(STEEL POSTS)

WORKING NUMBER
GT-15

SHEET NUMBER
6283

ISSUE DATE: MAY 01, 2011

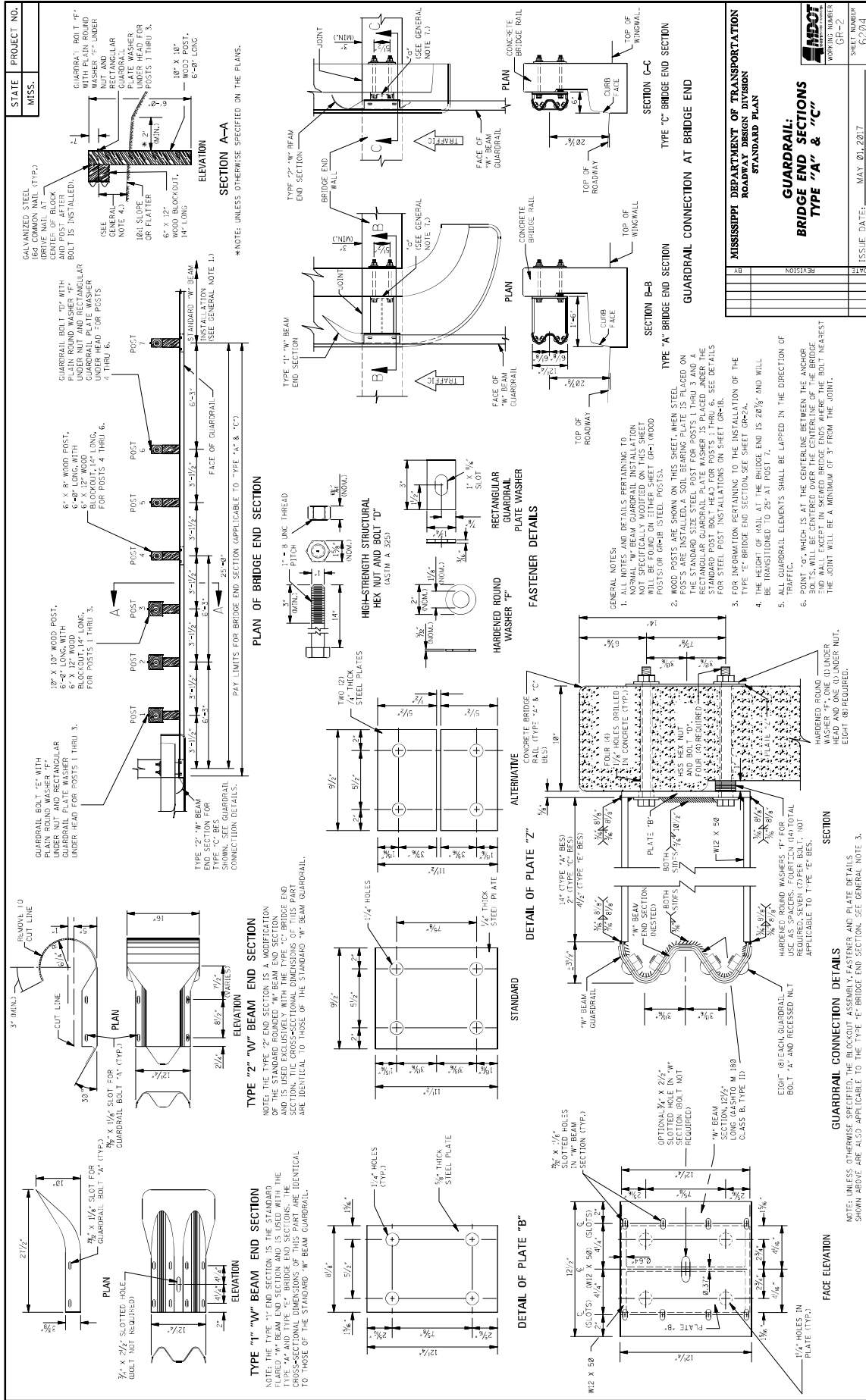

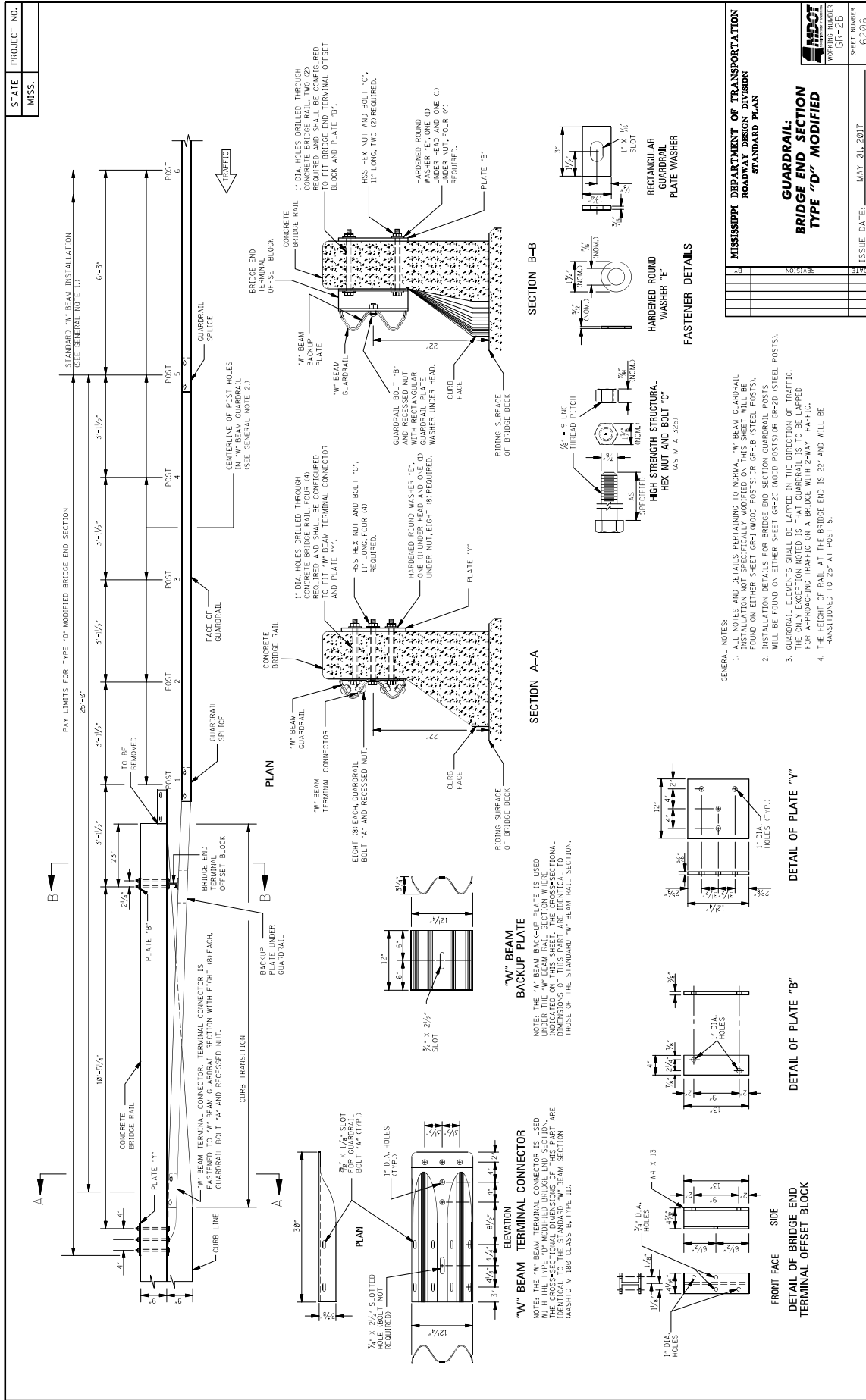

STATE PROJECT NO.
MISS.

MISSISSIPPI DEPARTMENT OF TRANSPORTATION ROADWAY DESIGN DIVISION STANDARD PLAN	
DATE	REVISION

**GUARDRAIL:
BRIDGE END SECTION
TYPE "D" MODIFIED**

ISSUE DATE: MAY 01, 2017
SHEET NUMBER: 02-206
WORKING NUMBER: 01-2B

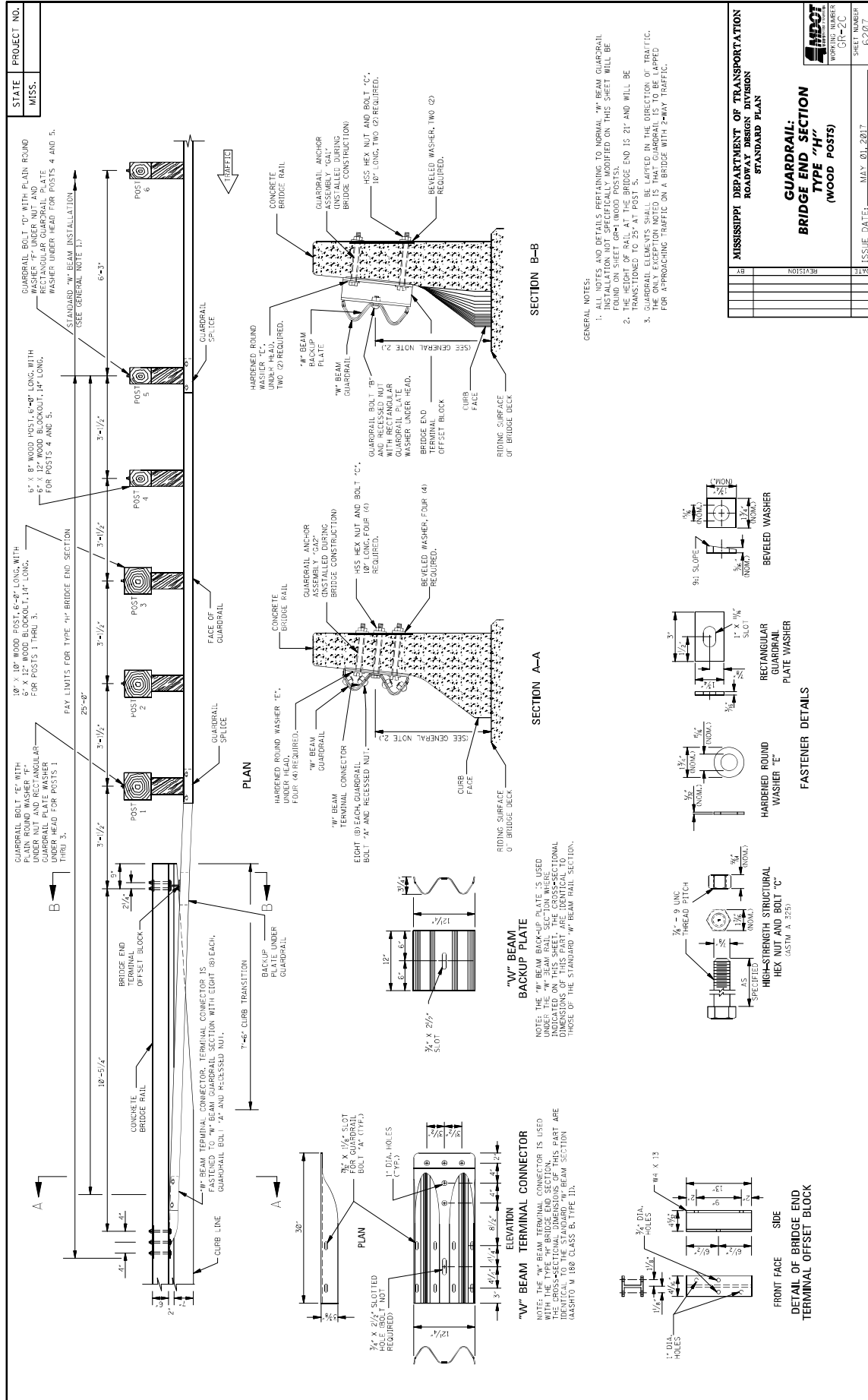

STATE	PROJECT NO.
MISS.	

MISSISSIPPI DEPARTMENT OF TRANSPORTATION ROADWAY DESIGN DIVISION STANDARD PLAN	
GUARDRAIL: BRIDGE END SECTION TYPE "H" (WOOD POSTS)	
DATE	ISSUE DATE: MAY 01, 2017
SHEET NUMBER	GT-ZC 02/01

- GENERAL NOTES:
1. ALL DIMENSIONS AND DETAILS PERTAINING TO NORMAL "W" BEAM GUARDRAIL INSTALLATION NOT SPECIFICALLY MODIFIED ON THIS SHEET WILL BE FOUND ON SHEET GP-1 (WOOD POSTS).
 2. THE HEIGHT OF RAIL AT THE BRIDGE END IS 21' AND WILL BE TRANSITIONED TO 25' POSITIVE SLOPE.
 3. GUARDRAIL END SHALL BE PROVIDED IN THE DIRECTION OF TRAFFIC. THE ONLY EXCEPTION NOTED IS THAT GUARDRAIL IS TO BE APPLIED FOR APPROACHING TRAFFIC ON A BRIDGE WITH 2-WAY TRAFFIC.

NOTE: THE "W" BEAM BACKUP PLATE IS USED UNDER THE "W" BEAM RAIL SECTION WHERE INDICATED ON THIS SHEET. THE CROSS-SECTIONAL DIMENSIONS OF THIS PART ARE THOSE OF THE STANDARD "W" BEAM RAIL SECTION.

NOTE: THE "W" BEAM TERMINAL CONNECTOR IS USED WITH THE TYPE "H" BRIDGE END SECTION OF THE GUARDRAIL. THE CROSS-SECTIONAL DIMENSIONS OF THIS PART ARE THOSE OF THE STANDARD "W" BEAM RAIL SECTION.

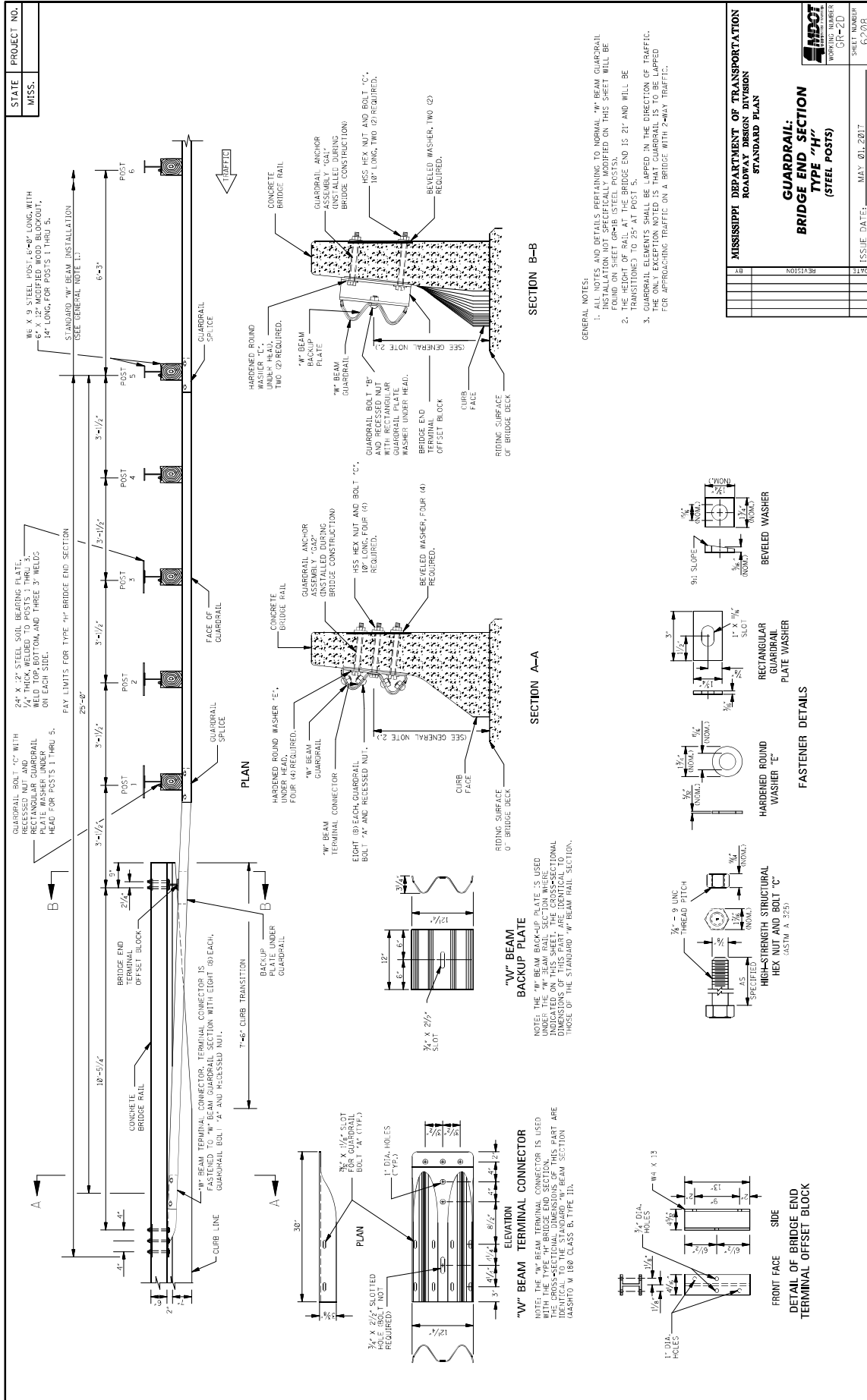

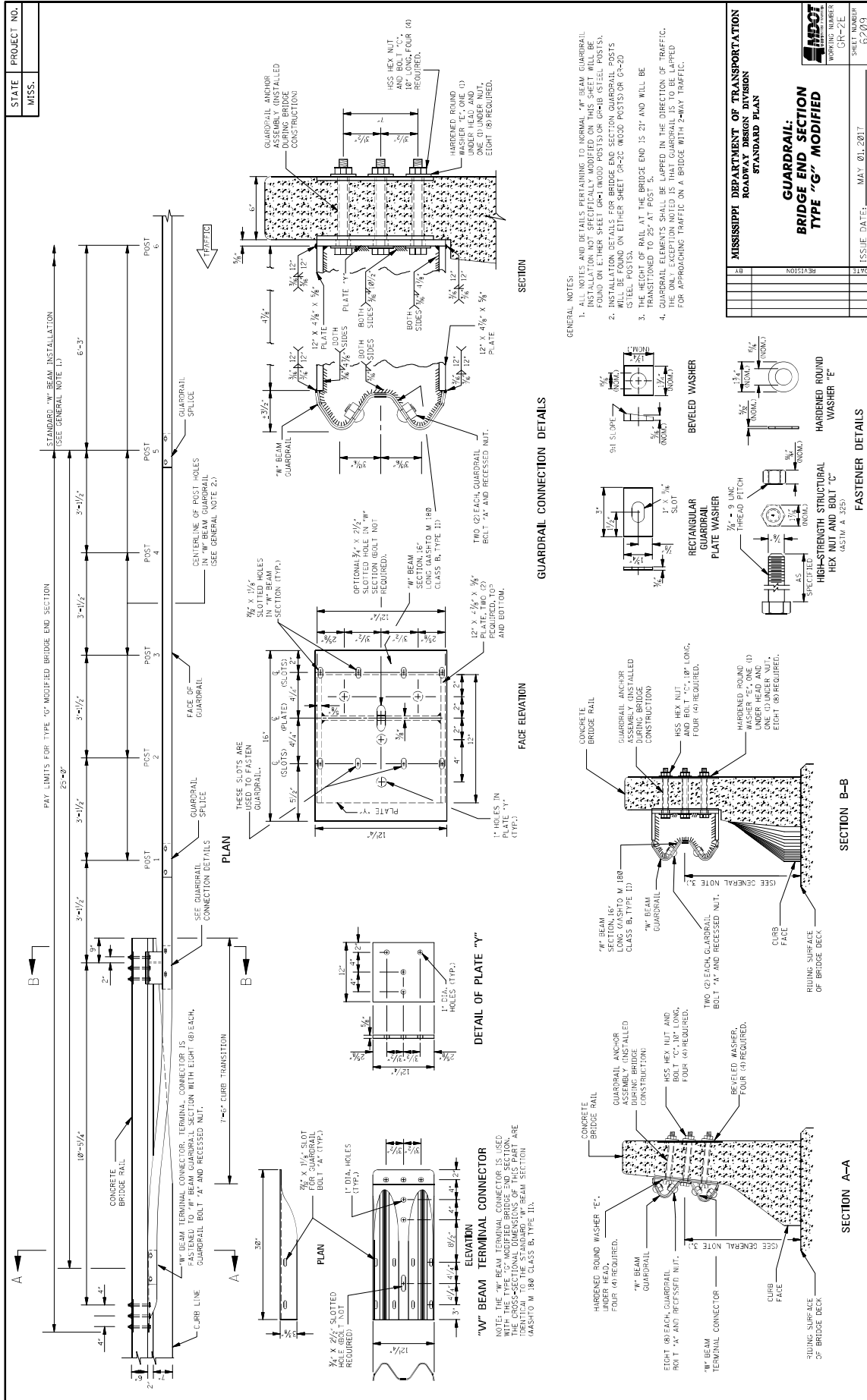

STATE MISS. PROJECT NO.

STANDARD W-BEAM GUARDRAIL INSTALLATION

FASTENER DETAILS

PLAIN ROUND WASHER "F"

RECTANGULAR GUARDRAIL PLATE WASHER

HIGH-STRENGTH STRUCTURAL HEX NUT AND BOLT "C"

RECESSED NUT WITH PLAIN ROUND WASHER "F"

SECTION A-A

GENERAL NOTES (CONTINUED):

- GUARDRAIL SHALL MEET THE REQUIREMENTS OF AASHTO M 188, CLASS A, TYPE I UNLESS OTHERWISE DESIGNATED.
- W-BEAM GUARDRAIL SHALL BE FABRICATED FROM TREATED SHEETS BER-1 & BER-2. THIS GUARDRAIL TRANSMISSION SHEET SHALL NOT BE MOUNTED DIRECTLY TO A CONCRETE SHELVEWAY.
- SEE RAILING DETAILS IN BRIDGE DRAWINGS FOR OTHER DETAILS.
- FOR FASTENER DETAILS NOT FOUND ON THIS SHEET, SEE SHEET GP-1.
- FOR OTHER DETAILS OF GUARDRAIL TRANSMISSION SHEETS, SEE SHEET GP-1.
- FOR OTHER DETAILS OF W-BEAM GUARDRAIL TRANSMISSION SHEETS, SEE SHEETS GP-1 AND GP-1A, RESPECTIVELY.
- FOR OTHER DETAILS OF POSTS, POST ACCESSORIES, FASTENERS & RAIL ELEMENTS, SEE AASHTO-AAC-ARTBA JOINT TASK GROUP REPORT (JTG/HEP) 10, "DESIGN OF UNIMPROVED HIGHWAY BARRIER HARDWARE", LATEST EDITION.
- THE TOP OF THE RAIL AT POST 7 IS AT 32' AND WILL BE TRANSMITTED TO THE NORMAL W-BEAM TOP OF RAIL HEIGHT OF 31.25' AT POST 10.

GENERAL NOTES:

- THIS GUARDRAIL TRANSMISSION IS APPROPRIATE FOR USE WITH W-BEAM GUARDRAIL TRANSMISSION SHEETS BER-1 & BER-2. THIS GUARDRAIL TRANSMISSION SHEET SHALL NOT BE MOUNTED DIRECTLY TO A CONCRETE SHELVEWAY.
- SEE RAILING DETAILS IN BRIDGE DRAWINGS FOR OTHER DETAILS.

DETAILS OF THREE-BEAM POST AND BLOCKOUT (POST 1 THRU POST 8)

NOTES:

- HOLE DETAILS ARE REQUIRED ON ALL WOOD POSTS AND BLOCKOUTS.
- WOOD POSTS AND BLOCKOUTS ARE FABRICATED FROM TREATED TIMBER UNLESS SPECIFIED OTHERWISE ON THE PLANS.
- ALL HOLES IN BOTH POSTS AND BLOCKOUTS ARE 7/8" IN DIAMETER.

SECTION

GUARDRAIL SPLICE DETAIL (POST 7)

ELEVATION FROM C ROADWAY

THREE-BEAM TERMINAL CONNECTOR

NOTES:

- THE THREE-BEAM TERMINAL CONNECTOR IS TO BE TYPE 1, AASHTO M 188 CORRUGATED SHEET STEEL, CLASS B, TYPE 1.
- TO THE LONGITUDINAL AXIS OF THE TERMINAL CONNECTOR. HOWEVER, THE 58" SLOT VERSION IS EASIER TO INSTALL WHERE SEVERAL GUARDRAIL SECTIONS ARE NESTED TOGETHER.

OPTIONAL: 5/8" x 2 1/2" (TYP.), HOLES USED ONLY WHERE SPECIFIED ON PLANS.

1" DIA. HOLES (7 PLACES)

2 3/4" DIA. HOLES (12 PLACES)

3/4" x 1 1/2" BOLT (TYP.)

3/8" x 1 1/2" BOLT (TYP.)

3/8" x 1 1/2" BOLT (TYP.)

50

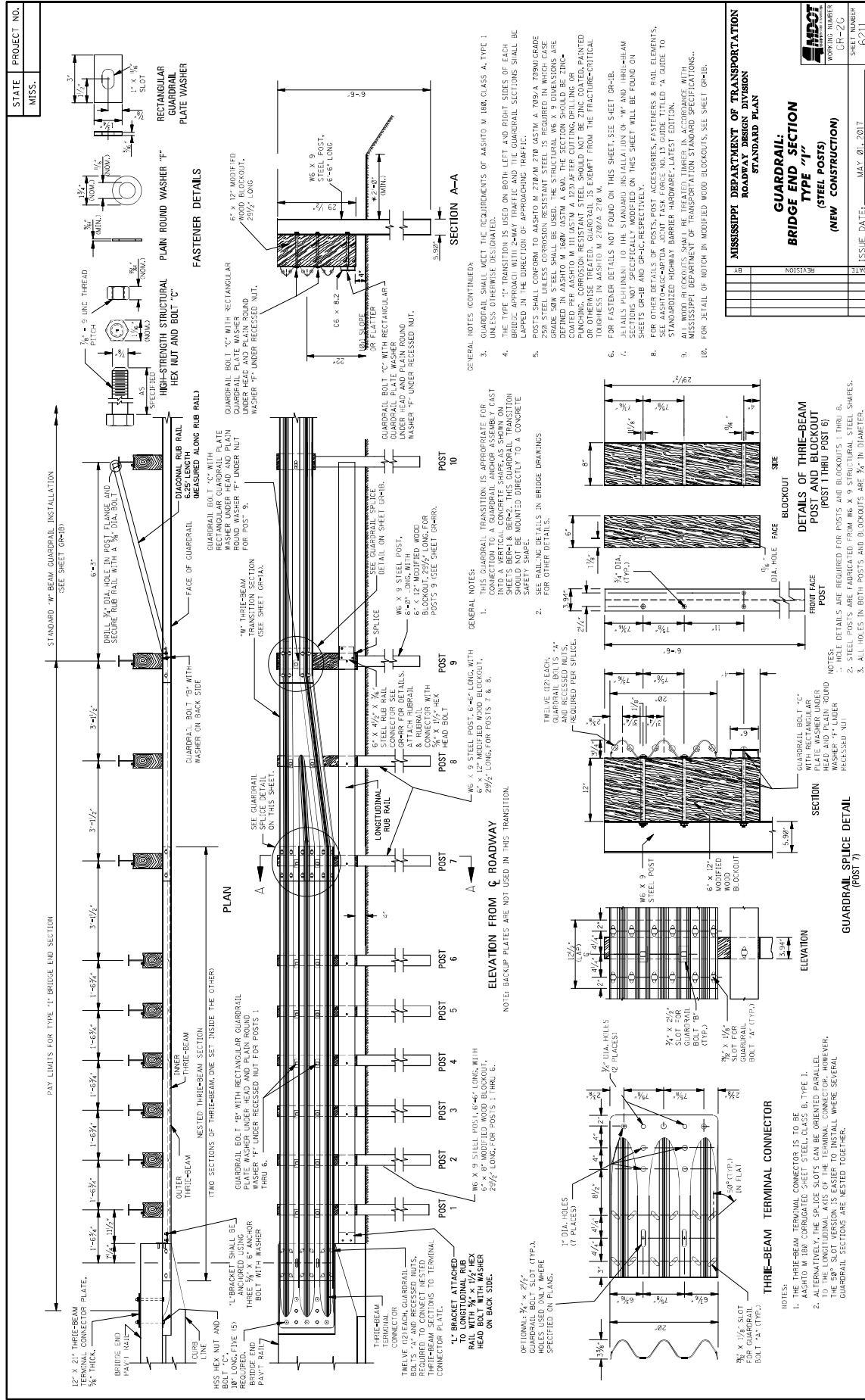

STATE	PROJECT NO.
MISS.	

REVISION	DATE

MISSISSIPPI DEPARTMENT OF TRANSPORTATION ROADWAY DESIGN DIVISION STANDARD PLAN	
GUARDRAIL: BRIDGE END SECTION TYPE "1" (STEEL POSTS) (NEW CONSTRUCTION)	
ISSUE DATE:	MAY 01, 2017
SHEET NUMBER	6211
WORKING NUMBER	CR-20

GENERAL NOTES:

- GUARDRAIL SHALL MEET THE REQUIREMENTS OF AASHTO M 188, CLASS A, TYPE 1 UNLESS OTHERWISE DESIGNATED.
- THE TYPE "1" TRANSITION IS USED ON BOTH LEFT AND RIGHT SIDES OF EACH BRIDGE APPROACH WITH 2-WAY TRAFFIC AND THE GUARDRAIL SECTIONS SHALL BE BRIDGE APPROACH GUARDRAIL.
- POSTS SHALL CONFORM TO AASHTO M 270/A, 270/A.1, 270/A.2, 270/A.3, 270/A.4, 270/A.5, 270/A.6, 270/A.7, 270/A.8, 270/A.9, 270/A.10, 270/A.11, 270/A.12, 270/A.13, 270/A.14, 270/A.15, 270/A.16, 270/A.17, 270/A.18, 270/A.19, 270/A.20, 270/A.21, 270/A.22, 270/A.23, 270/A.24, 270/A.25, 270/A.26, 270/A.27, 270/A.28, 270/A.29, 270/A.30, 270/A.31, 270/A.32, 270/A.33, 270/A.34, 270/A.35, 270/A.36, 270/A.37, 270/A.38, 270/A.39, 270/A.40, 270/A.41, 270/A.42, 270/A.43, 270/A.44, 270/A.45, 270/A.46, 270/A.47, 270/A.48, 270/A.49, 270/A.50, 270/A.51, 270/A.52, 270/A.53, 270/A.54, 270/A.55, 270/A.56, 270/A.57, 270/A.58, 270/A.59, 270/A.60, 270/A.61, 270/A.62, 270/A.63, 270/A.64, 270/A.65, 270/A.66, 270/A.67, 270/A.68, 270/A.69, 270/A.70, 270/A.71, 270/A.72, 270/A.73, 270/A.74, 270/A.75, 270/A.76, 270/A.77, 270/A.78, 270/A.79, 270/A.80, 270/A.81, 270/A.82, 270/A.83, 270/A.84, 270/A.85, 270/A.86, 270/A.87, 270/A.88, 270/A.89, 270/A.90, 270/A.91, 270/A.92, 270/A.93, 270/A.94, 270/A.95, 270/A.96, 270/A.97, 270/A.98, 270/A.99, 270/A.100.
- 2505 STEEL UNLESS CORROSION RESISTANT STEEL IS REQUIRED IN WHICH CASE GRADE 508 STEEL SHALL BE USED. THE STRUCTURAL W6 X 9 DIMENSIONS ARE DEFINED IN AASHTO M 188/A, 188/A.1, 188/A.2, 188/A.3, 188/A.4, 188/A.5, 188/A.6, 188/A.7, 188/A.8, 188/A.9, 188/A.10, 188/A.11, 188/A.12, 188/A.13, 188/A.14, 188/A.15, 188/A.16, 188/A.17, 188/A.18, 188/A.19, 188/A.20, 188/A.21, 188/A.22, 188/A.23, 188/A.24, 188/A.25, 188/A.26, 188/A.27, 188/A.28, 188/A.29, 188/A.30, 188/A.31, 188/A.32, 188/A.33, 188/A.34, 188/A.35, 188/A.36, 188/A.37, 188/A.38, 188/A.39, 188/A.40, 188/A.41, 188/A.42, 188/A.43, 188/A.44, 188/A.45, 188/A.46, 188/A.47, 188/A.48, 188/A.49, 188/A.50, 188/A.51, 188/A.52, 188/A.53, 188/A.54, 188/A.55, 188/A.56, 188/A.57, 188/A.58, 188/A.59, 188/A.60, 188/A.61, 188/A.62, 188/A.63, 188/A.64, 188/A.65, 188/A.66, 188/A.67, 188/A.68, 188/A.69, 188/A.70, 188/A.71, 188/A.72, 188/A.73, 188/A.74, 188/A.75, 188/A.76, 188/A.77, 188/A.78, 188/A.79, 188/A.80, 188/A.81, 188/A.82, 188/A.83, 188/A.84, 188/A.85, 188/A.86, 188/A.87, 188/A.88, 188/A.89, 188/A.90, 188/A.91, 188/A.92, 188/A.93, 188/A.94, 188/A.95, 188/A.96, 188/A.97, 188/A.98, 188/A.99, 188/A.100.
- FOR FASTENER DETAILS NOT FOUND ON THIS SHEET, SEE SHEET GR-18.
- DETAILS PERTAINING TO THE STANDARD INDUSTRY OF "W" AND "H" I-BEAM SHEETS GR-18 AND GR-19, RESPECTIVELY.
- FOR OTHER DETAILS OF POSTS, POST ACCESSORIES, FASTENERS & RAIL ELEMENTS, SEE AASHTO M 188/A, 188/A.1, 188/A.2, 188/A.3, 188/A.4, 188/A.5, 188/A.6, 188/A.7, 188/A.8, 188/A.9, 188/A.10, 188/A.11, 188/A.12, 188/A.13, 188/A.14, 188/A.15, 188/A.16, 188/A.17, 188/A.18, 188/A.19, 188/A.20, 188/A.21, 188/A.22, 188/A.23, 188/A.24, 188/A.25, 188/A.26, 188/A.27, 188/A.28, 188/A.29, 188/A.30, 188/A.31, 188/A.32, 188/A.33, 188/A.34, 188/A.35, 188/A.36, 188/A.37, 188/A.38, 188/A.39, 188/A.40, 188/A.41, 188/A.42, 188/A.43, 188/A.44, 188/A.45, 188/A.46, 188/A.47, 188/A.48, 188/A.49, 188/A.50, 188/A.51, 188/A.52, 188/A.53, 188/A.54, 188/A.55, 188/A.56, 188/A.57, 188/A.58, 188/A.59, 188/A.60, 188/A.61, 188/A.62, 188/A.63, 188/A.64, 188/A.65, 188/A.66, 188/A.67, 188/A.68, 188/A.69, 188/A.70, 188/A.71, 188/A.72, 188/A.73, 188/A.74, 188/A.75, 188/A.76, 188/A.77, 188/A.78, 188/A.79, 188/A.80, 188/A.81, 188/A.82, 188/A.83, 188/A.84, 188/A.85, 188/A.86, 188/A.87, 188/A.88, 188/A.89, 188/A.90, 188/A.91, 188/A.92, 188/A.93, 188/A.94, 188/A.95, 188/A.96, 188/A.97, 188/A.98, 188/A.99, 188/A.100.
- FOR DETAIL OF NOTCH IN MODIFIED WOOD BLOCKOUTS, SEE SHEET GR-18.

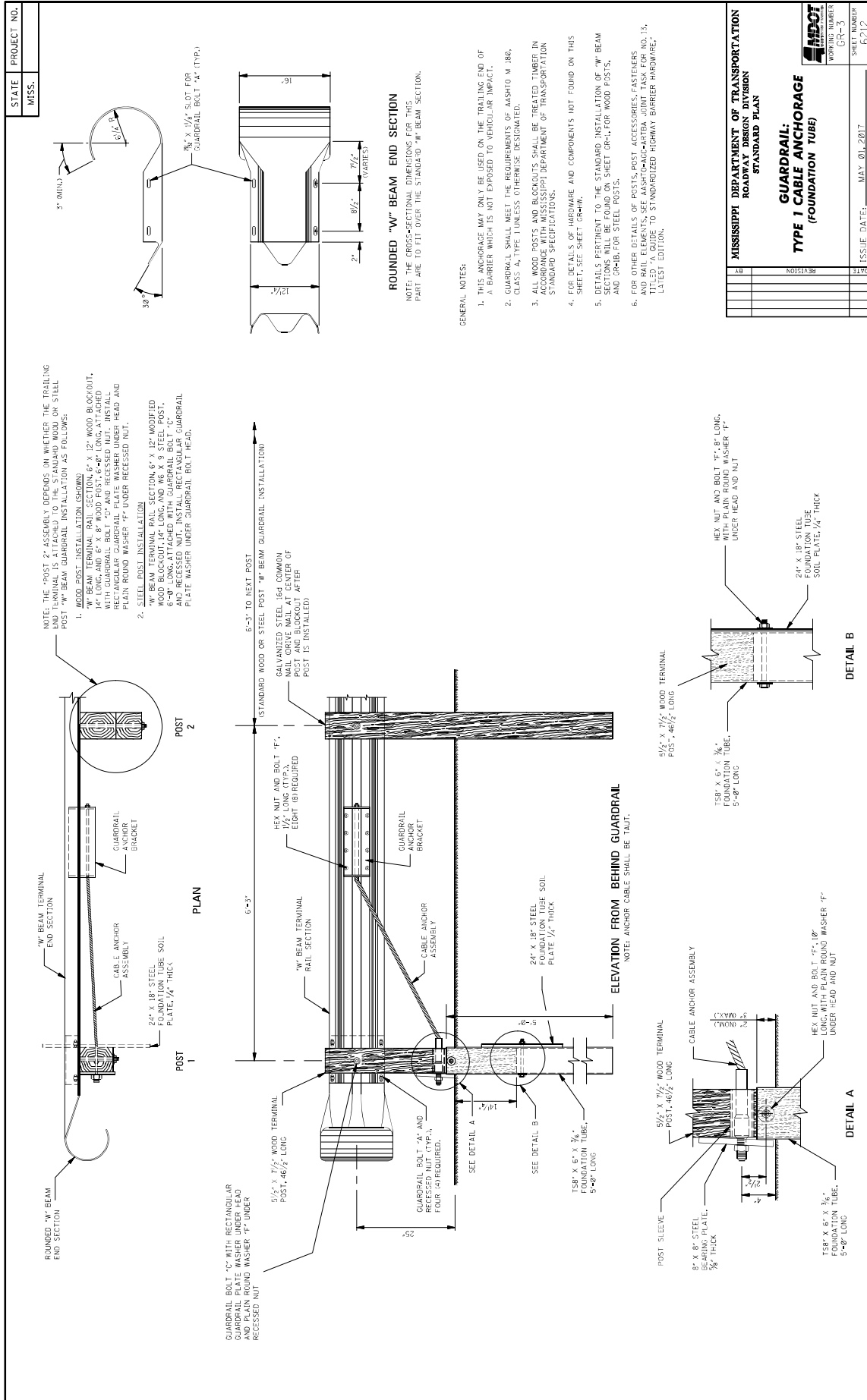

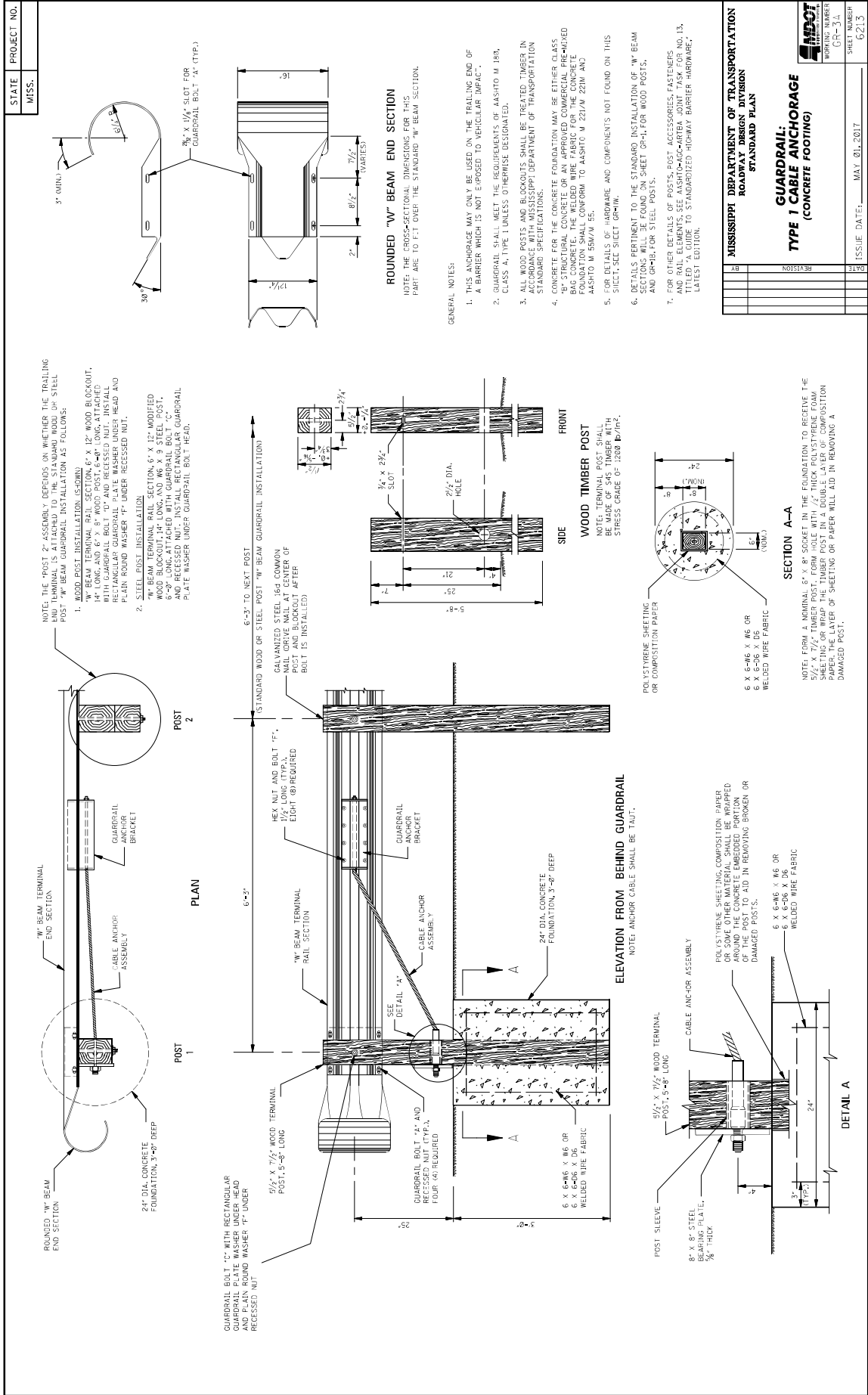

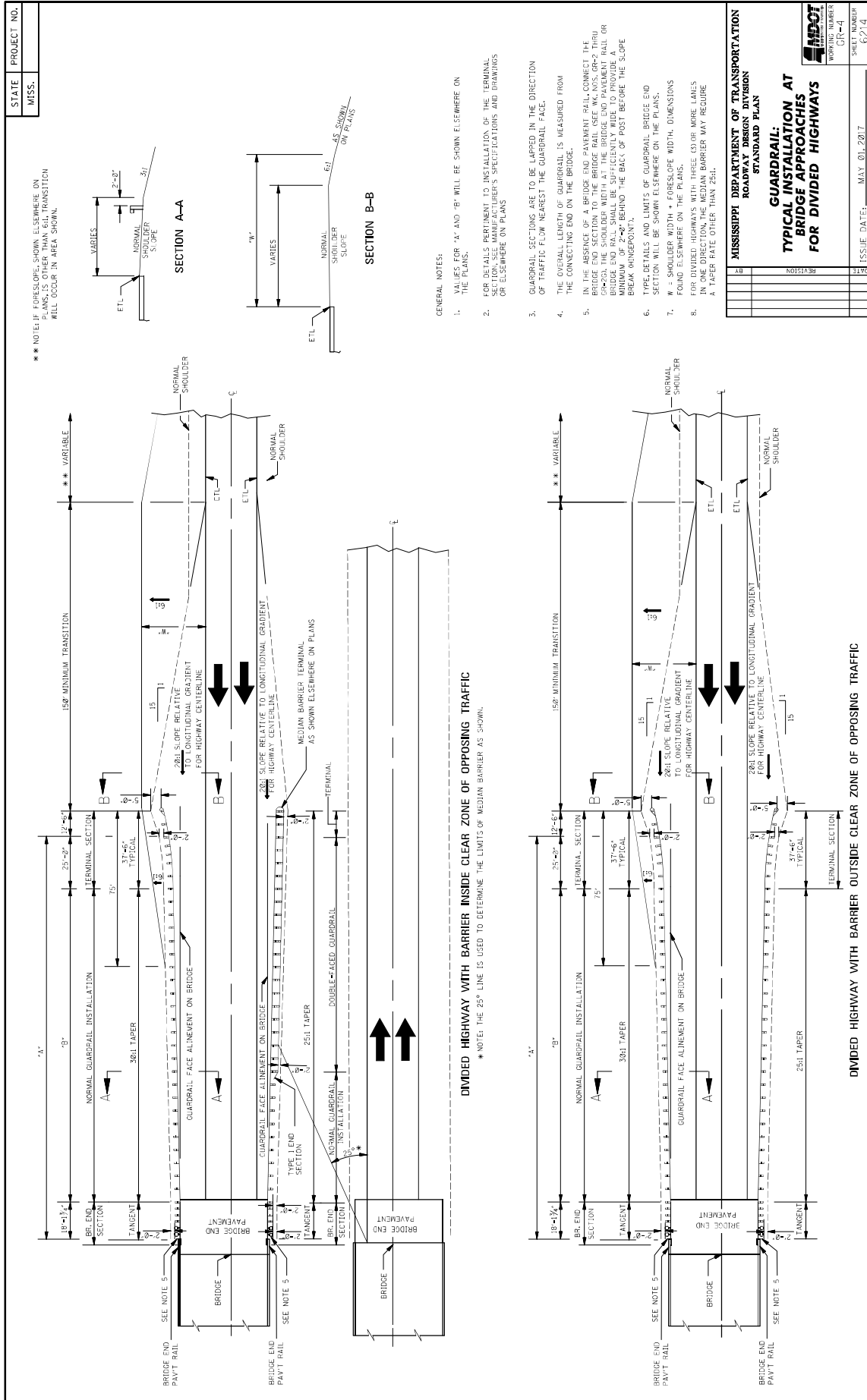

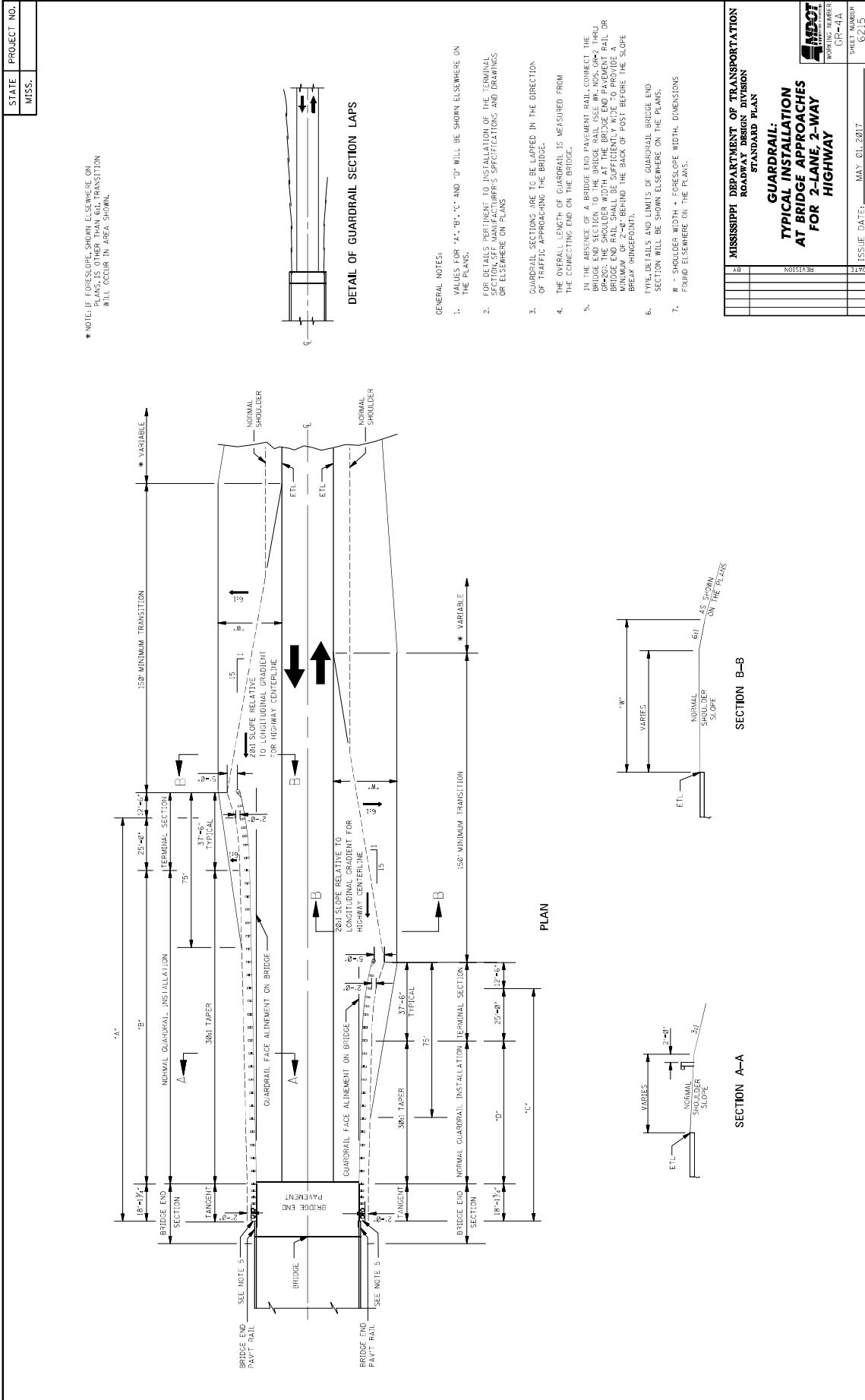

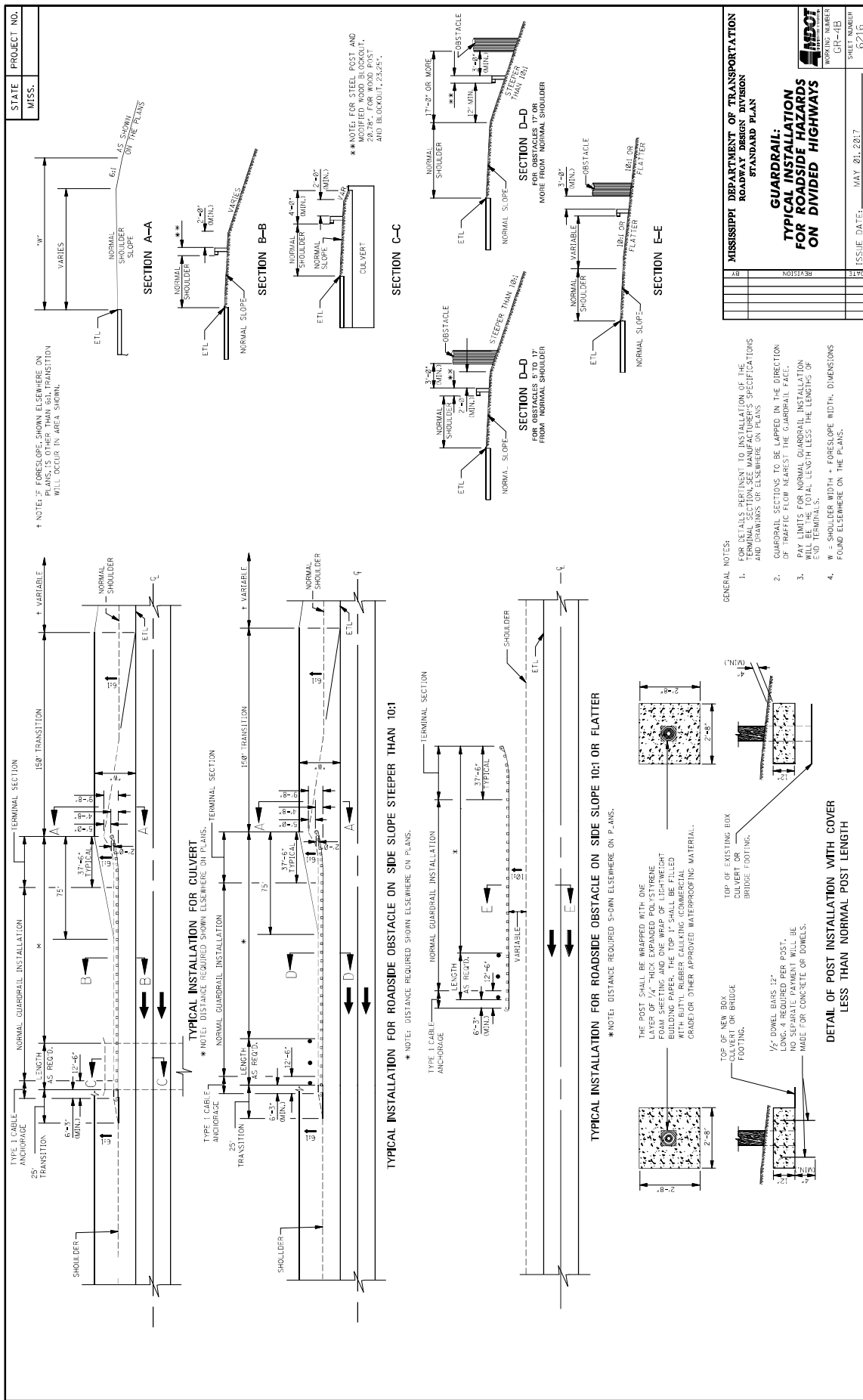

MISSISSIPPI DEPARTMENT OF TRANSPORTATION ROADWAY DESIGN DIVISION STANDARD PLAN	GUARDRAIL: TYPICAL INSTALLATION FOR ROADSIDE HAZARDS ON DIVIDED HIGHWAYS
WORKING NUMBER CH-1B	SHEET NUMBER 621G
ISSUE DATE: MAY 01, 2017	

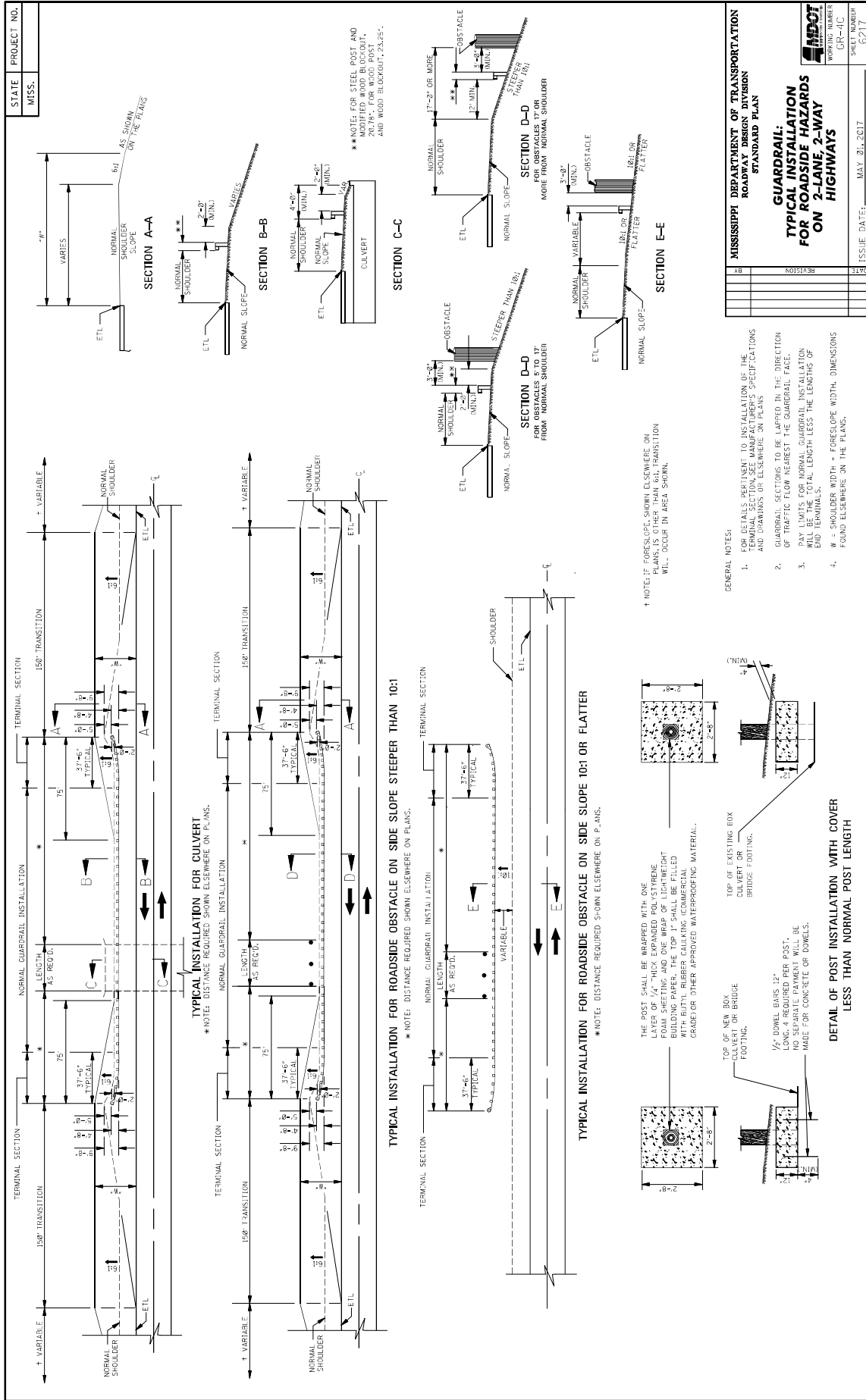

STATE	PROJECT NO.				
MISS.					

W-BEAM TERMINAL CONNECTOR PLATE

NOTES:
1. THE "W" BEAM TERMINAL CONNECTOR IS TO BE A435 TO M 180 CORRUATED SHEET STEEL, CLASS 50, TYPE 1.
2. SPACER-BOLT SLOTS MAY ALSO BE ORIENTED AT 50° FROM THE PLATE, INSTEAD OF 8° AS SHOWN.

STEEL TUBE ANCHOR

NOTE: TERMINAL POST SHOULD BE ABLE TO FIT INSIDE TUBE. ACTUAL INSIDE DIMENSIONS OF THIS GALVANIZED TUBE CANNOT BE LESS THAN 7/8" X 5/8".

TERMINAL POST FOR FOUNDATION TUBE INSTALLATION

NOTE: TERMINAL POST SHALL BE MADE OF S&S TIMBER WITH 2 STRESS GRADE OF 2000 lbf/in².

ANCHOR PLATE ASSEMBLY DETAILS

ANCHOR PLATE

WELD END PLATE TO BRACKET

BEARING PLATE

SOIL PLATE

NOTE: 2 REQUIRED

SHIELD ANGLE BRACKET

BREAKAWAY TERMINAL POST SLEEVE

RECTANGULAR GUARDRAIL PLATE WASHER

HEX NUT AND BOLT "H"

RECESSED NUT

GUARDRAIL BOLT

HEX NUT AND BOLT "T"

PLAIN ROUND WASHER

WASHER	A (INCH)	B (INCH)	C (INCH)
1/4"	1/4"	1/4"	1/4"
3/8"	3/8"	3/8"	3/8"
1/2"	1/2"	1/2"	1/2"
5/8"	5/8"	5/8"	5/8"
3/4"	3/4"	3/4"	3/4"
7/8"	7/8"	7/8"	7/8"

BOLT	L (INCH)	T (MIN) (INCH)
1/4"	1/2"	1/4"
3/8"	3/4"	3/8"
1/2"	1 1/4"	1/2"
5/8"	1 3/4"	5/8"
3/4"	2 1/4"	3/4"
7/8"	2 3/4"	7/8"

CABLE ANCHOR ASSEMBLY

NOTES:

- ALL GUARDRAIL BOLTS ARE 3/8" - 11 UNC
- IF ANY BOLT EXTENDS MORE THAN 1/4" FROM THE NUT, THE BOLT SHOULD BE TRIMMED BACK.

	<p>WORKING NUMBER GT-HH</p> <p>SHEET NUMBER 0221</p>
MISSISSIPPI DEPARTMENT OF TRANSPORTATION ROADWAY DESIGN DIVISION STANDARD PLAN	
GUARDRAIL: MISCELLANEOUS HARDWARE	
DATE	REVISION
ISSUE DATE:	MAY 01, 2017

FASTENER DETAILS

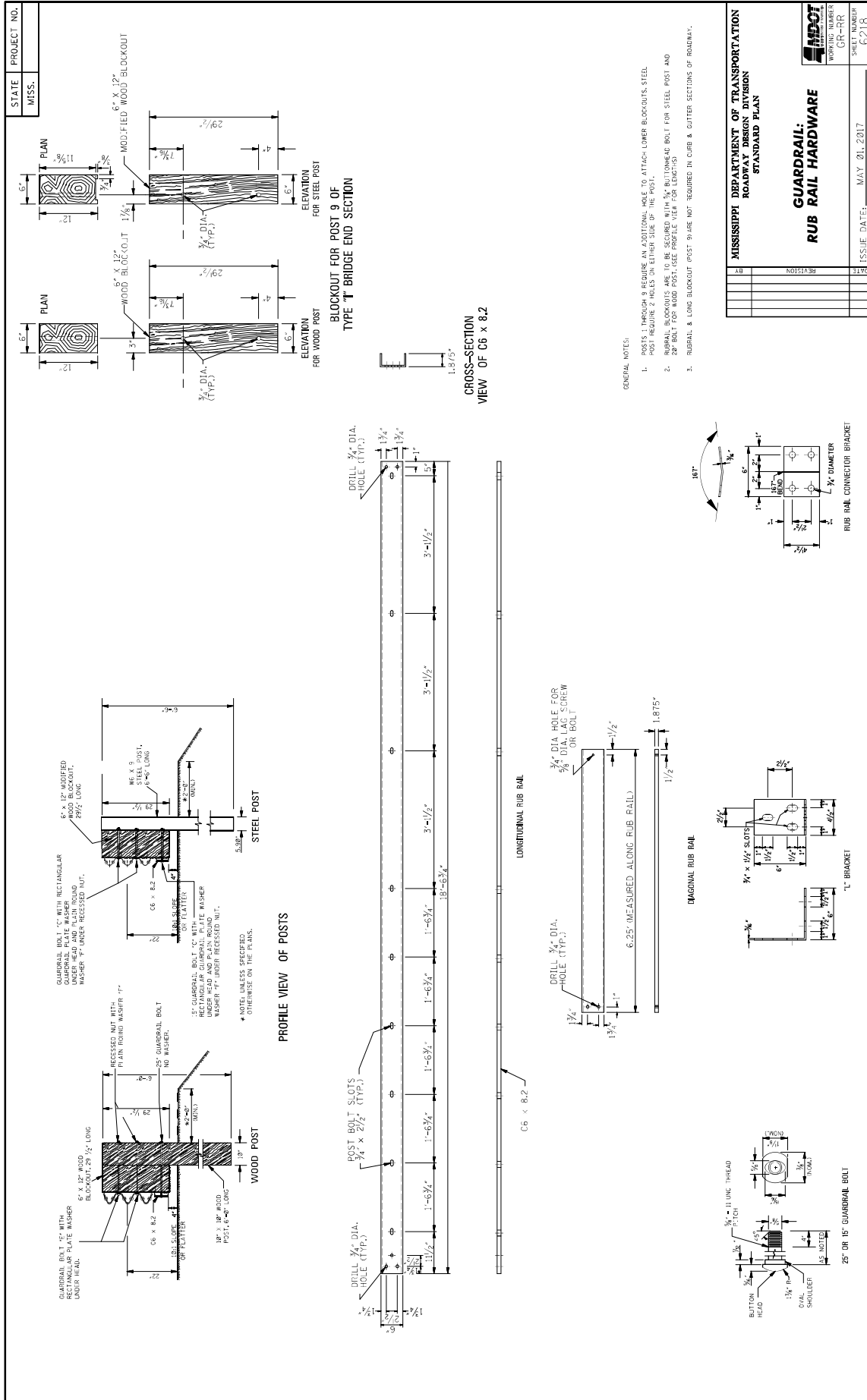

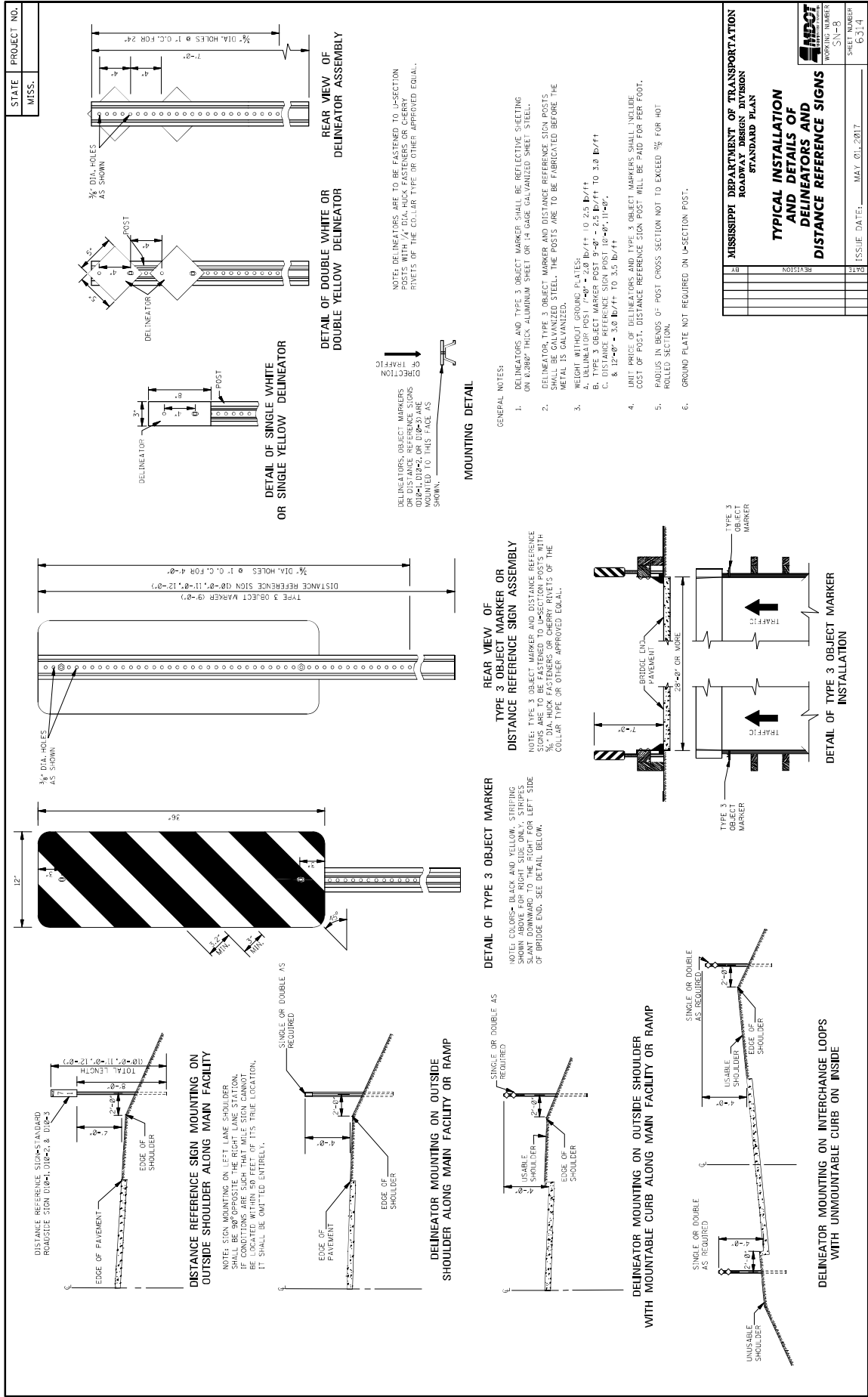

MISSISSIPPI DEPARTMENT OF TRANSPORTATION

SECTION 904 – NOTICE TO BIDDERS NO. 3599

CODE: (SP)

DATE: 08/11/2021

SUBJECT: Standard Drawings

Standard Drawings attached hereto shall govern appropriate items of required work.

Larger copies of Standard Drawings may be purchased from:

MDOT Plans Print Shop
MDOT Shop Complex, Building C, Room 114
2567 North West Street
P.O. Box 1850
Jackson, MS 39215-1850
Telephone: (601) 359-7460
or FAX: (601) 359-7461
or e-mail: plans@mdot.state.ms.us

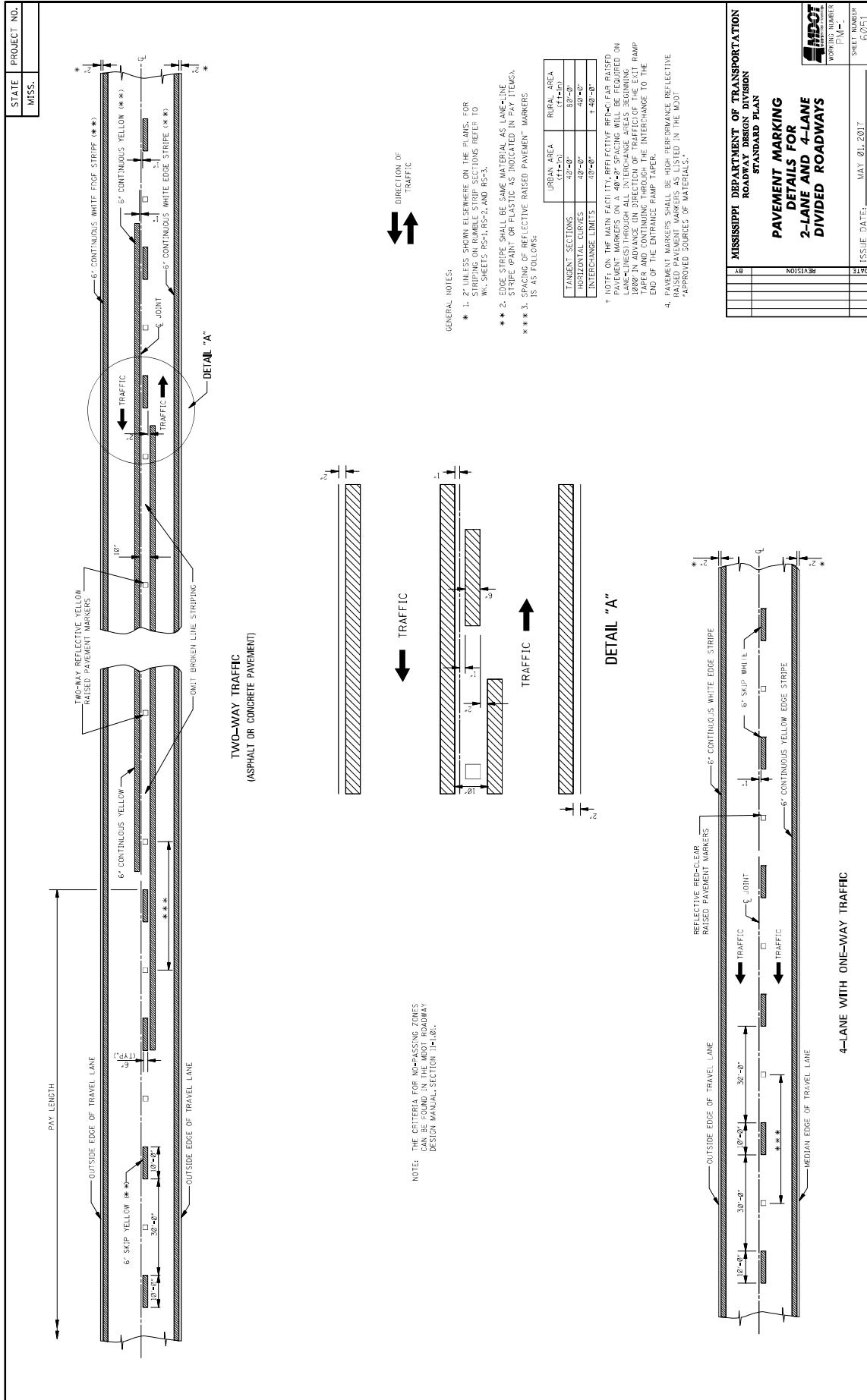

MISSISSIPPI DEPARTMENT OF TRANSPORTATION	
ROADWAY DESIGN DIVISION	
STANDARD PLAN	
PAVEMENT MARKING	
2-LANE AND 4-LANE	
DIVIDED ROADWAYS	
DATE	ISSUE DATE: MAY 01, 2017
BY	SHEET NUMBER 6001
REVISION	WORKING NUMBER P.M.-

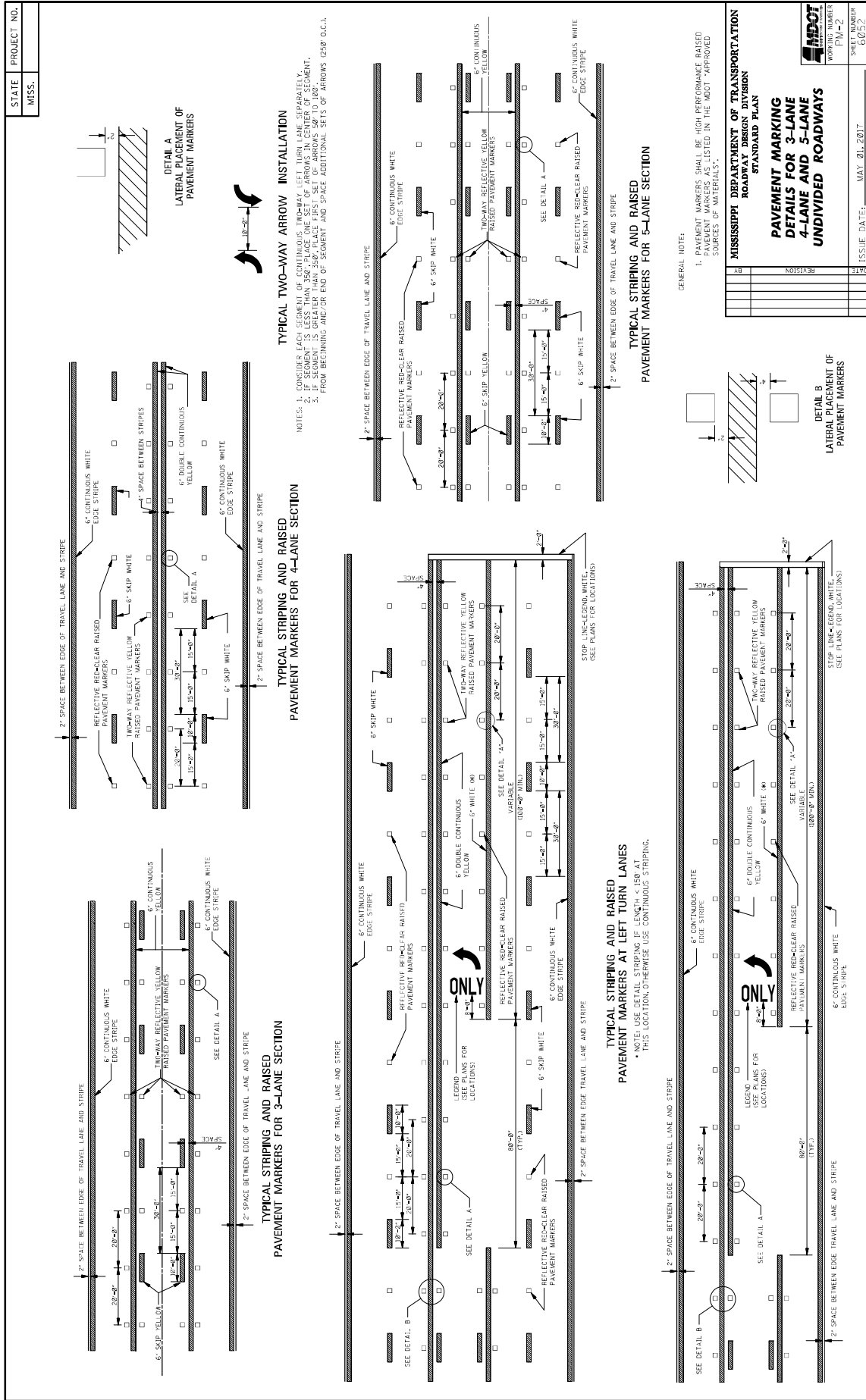

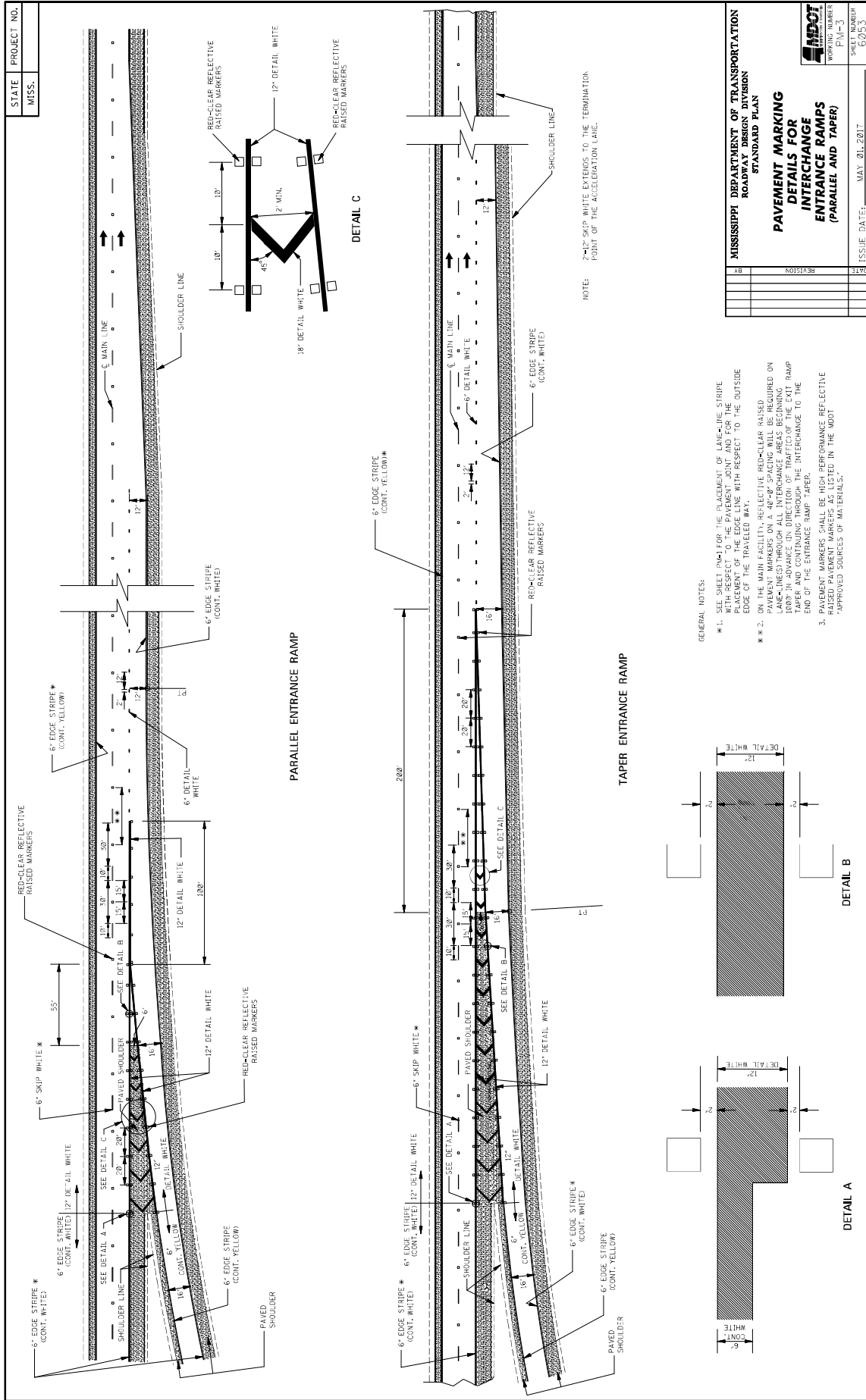

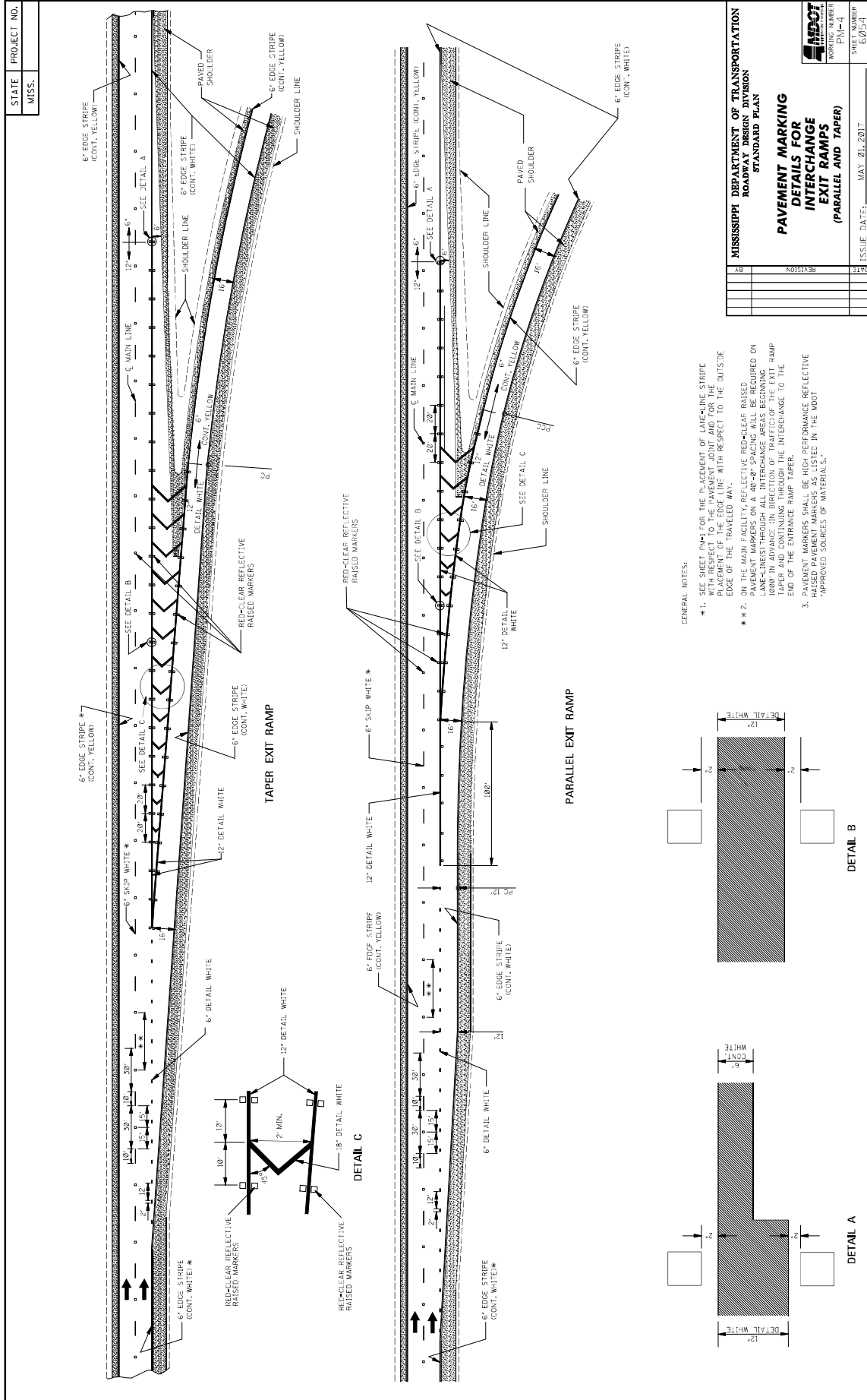

STATE MISS.	PROJECT NO.		
----------------	-------------	--	--

STOP

RIGHT

LEFT

TRAFFIC

AHEAD

SCHOOL

EXIT

YIELD

SIGNAL

GENERAL NOTES:

- TWO HORIZONTAL GAPS (USED BY TEMPLATE CONNECTIONS) OF 1/2" SHALL EXTEND THROUGH ALL WIDTH OF LETTERS.
- FOR OTHER DETAILS, SEE THE MANUAL ON UNIFORM TRAFFIC CONTROL DEVICES.
- PAY QUANTITIES FOR PAVEMENT MARKING LEGENDS ARE AS FOLLOWS:

LEGEND	AREA (ft ²)
STOP	24.6
RIGHT	28.6
LEFT	19.5
TRAFFIC	27.2
AHEAD	32.4
YIELD	26.8
EXIT	18.5
SIGNAL	32.5
SCHOOL	35.2

MISSISSIPPI DEPARTMENT OF TRANSPORTATION
ROADWAY DESIGN DIVISION
STANDARD PLAN

**PAVEMENT MARKING
LEGEND DETAILS**

DATE	REVISION	BY

ISSUE DATE: MAY 01, 2017
SHEET NUMBER: PM-5
PROJECT NUMBER: 60535

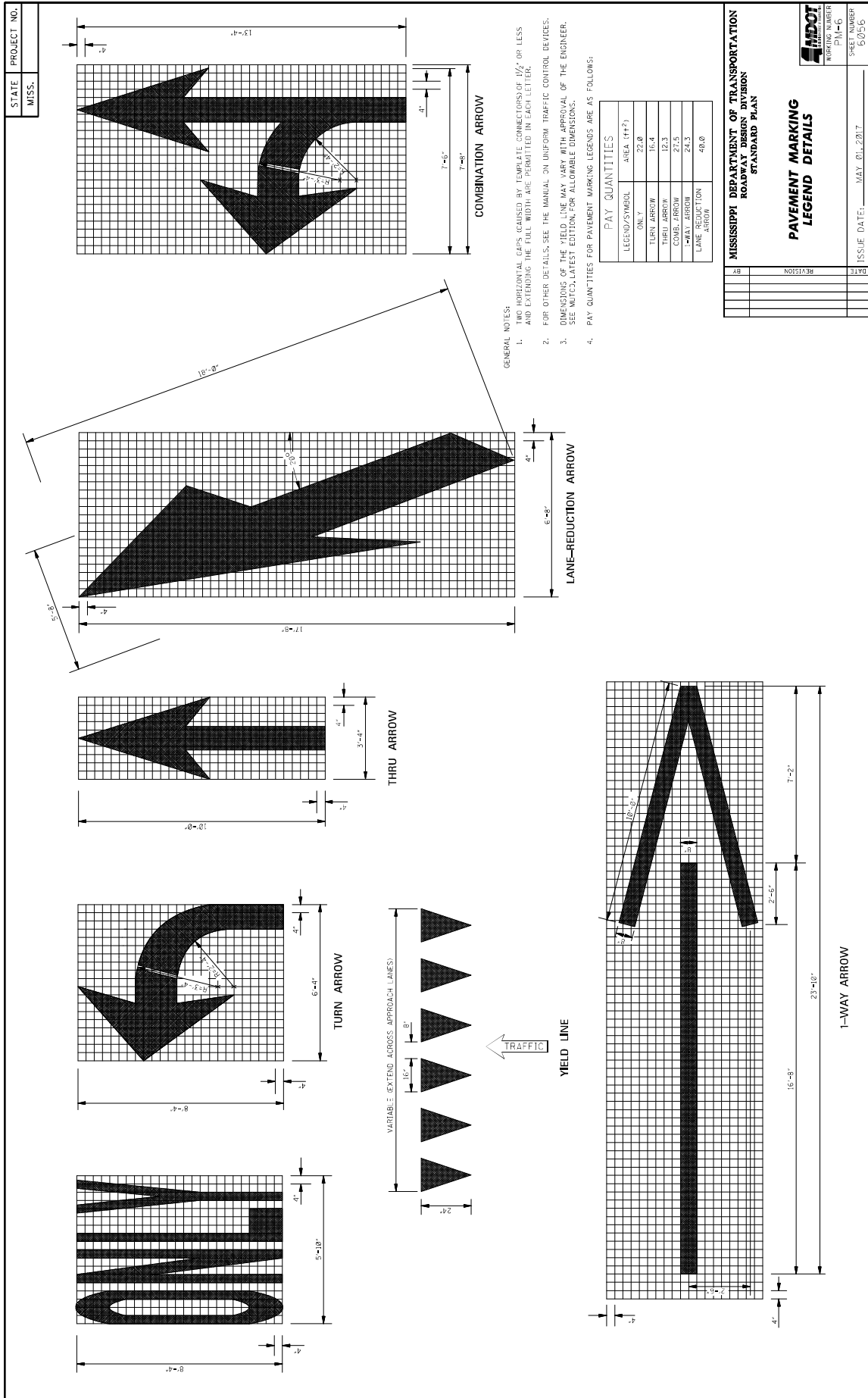

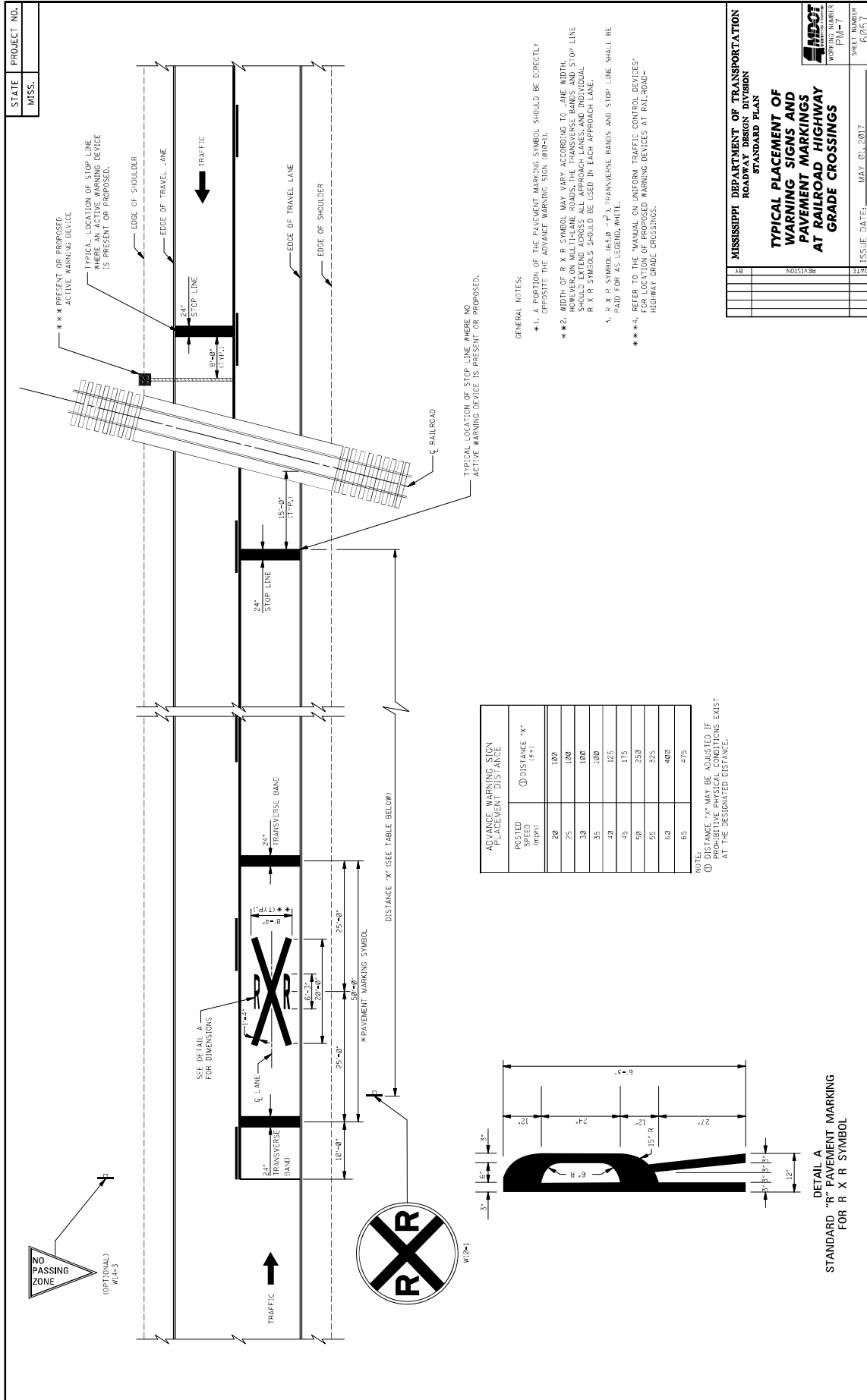

POSTED SPEED (mph)	ADVANCE WARNING SIGN PLACEMENT DISTANCE (X)
20	100
25	100
30	100
35	100
40	125
45	175
50	250
55	325
60	400
65	475

NOTE: DISTANCE 'X' MAY BE SHORTENED IF PROHIBITIVE PHYSICAL CONDITIONS EXIST AT THE DESIGNATED DISTANCE.

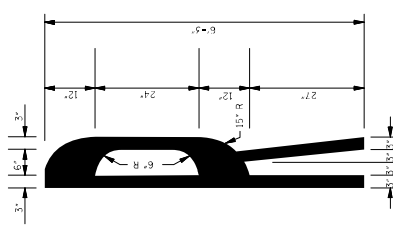

DETAIL A
STANDARD "R" PAVEMENT MARKING
FOR R X R SYMBOL

STATE PROJECT NO.
MISS.

MISSISSIPPI DEPARTMENT OF TRANSPORTATION
ROADWAY DESIGN DIVISION
STANDARD PLAN

TYPICAL PLACEMENT OF WARNING SIGNS AND PAVEMENT MARKINGS AT RAILROAD HIGHWAY GRADE CROSSINGS

MDOT
WORKING NUMBER
P10-17

SHEET NUMBER
60511

ISSUE DATE: MAY 01, 2017

- GENERAL NOTES:
- *1. A PORTION OF THE PAVEMENT MARKING SYMBOL SHOULD BE DIRECTLY OPPOSITE THE ADVANCE WARNING SIGN (W10-1).
 - **2. WIDTH OF R X R SYMBOL MAY VARY ACCORDING TO LANE WIDTH. SYMBOLS SHOULD EXTEND ACROSS ALL APPROACH LANES AND INDIVIDUAL R X R SYMBOLS SHOULD BE USED IN EACH APPROACH LANE.
 - 3. R X R SYMBOL (65 X 8 - 1/2") TRANSVERSE BANDS AND STOP LINE SHALL BE PAID FOR AS LEGEND WHITE.
 - ***4. REFER TO THE MANUAL ON UNIFORM TRAFFIC CONTROL DEVICES FOR LOCATION OF PROPOSED WARNING DEVICES AT RAILROAD-HIGHWAY GRADE CROSSINGS.

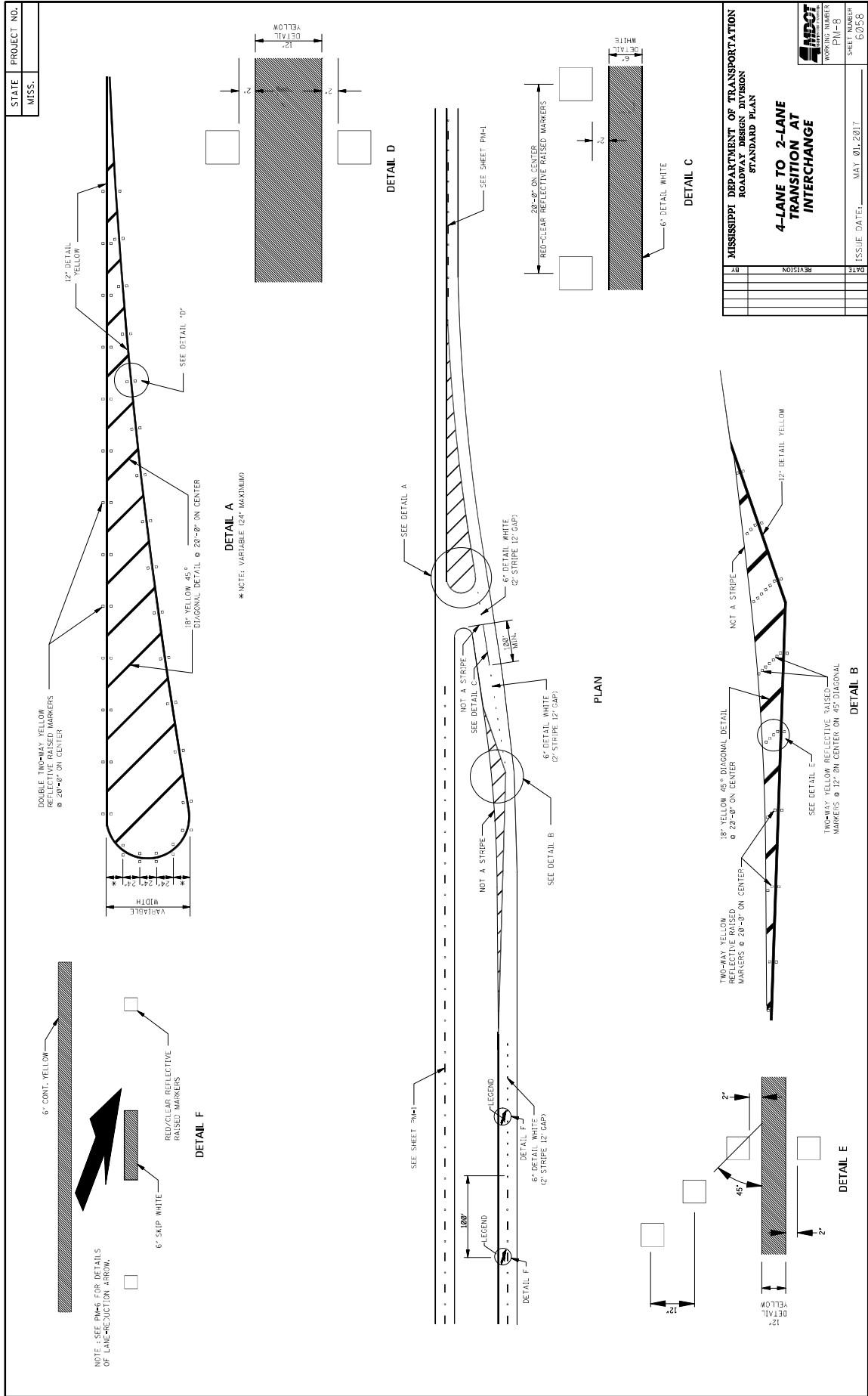

MISSISSIPPI DEPARTMENT OF TRANSPORTATION ROADWAY DESIGN DIVISION STANDARD PLAN	
4-LANE TO 2-LANE TRANSITION AT INTERCHANGE	
SHEET NUMBER PM-1-B	SHEET NUMBER 60256
DATE	ISSUE DATE: MAY 01, 2017
BY	REVISION

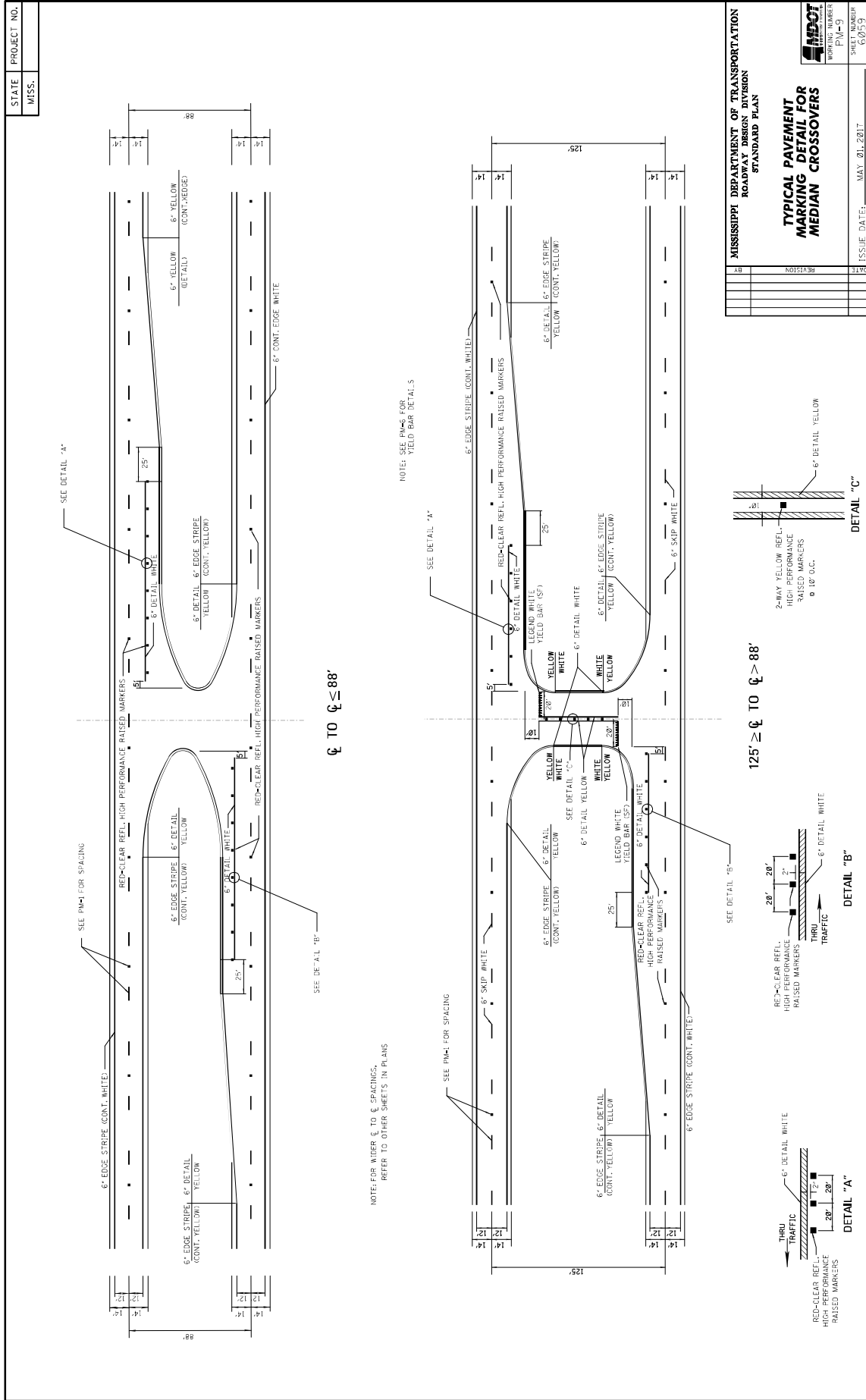

STATE	PROJECT NO.
MISS.	

MISSISSIPPI DEPARTMENT OF TRANSPORTATION ROADWAY DESIGN DIVISION STANDARD PLAN	
NO 151A3B	3170
TYPICAL PAVEMENT MARKING DETAIL FOR MEDIAN CROSSEVERS	
WORKING NUMBER PM-3	SHEET NUMBER 06239
ISSUE DATE: MAY 01, 2017	

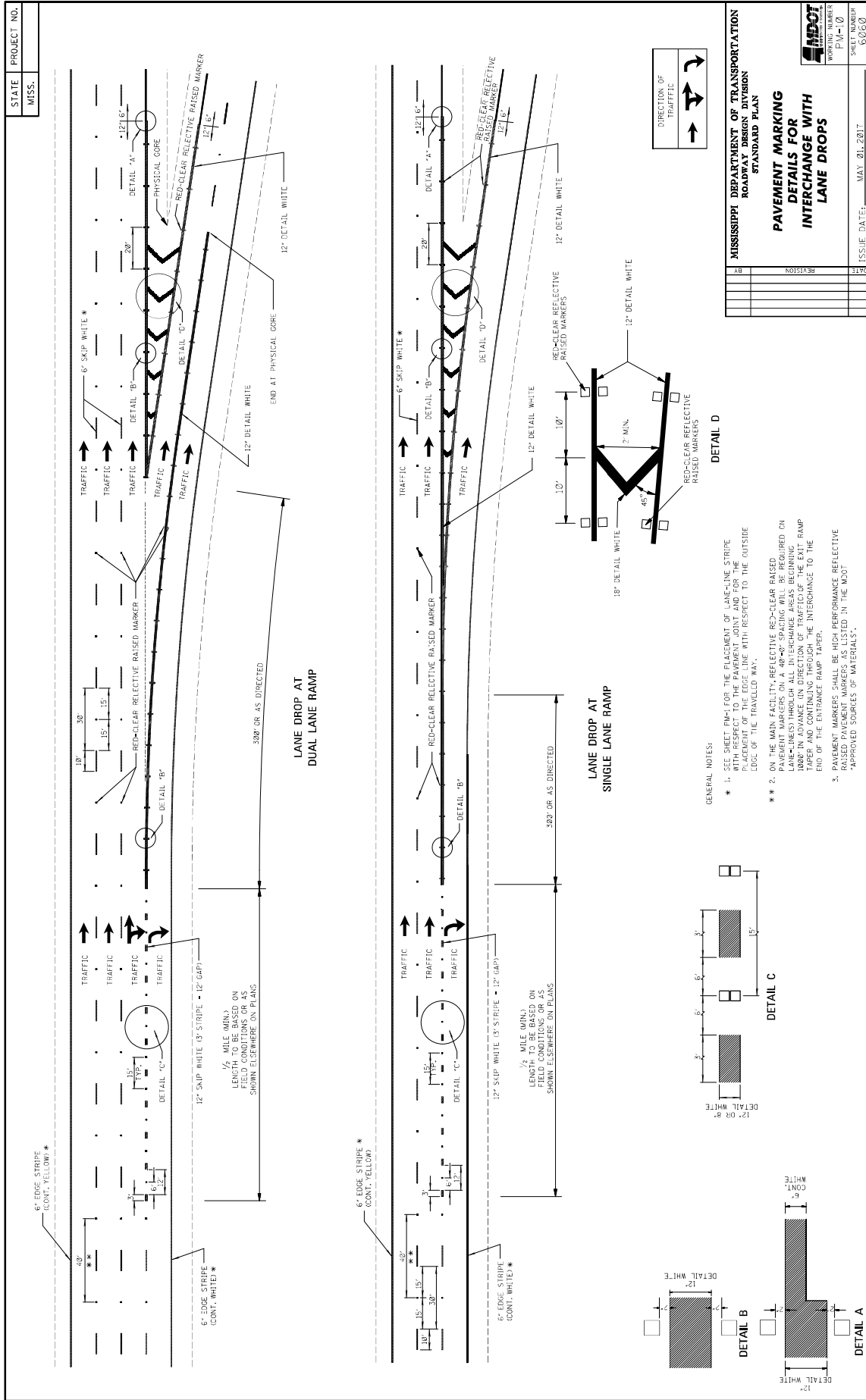

STATE MISS.	PROJECT NO.		
----------------	-------------	--	--

TYPICAL PLACEMENT OF RAISED PAVEMENT MARKERS ON SIDE ROAD RADIUS 2-LANE, TWO WAY TRAFFIC

DETAIL A

DIRECTION OF TRAFFIC →

GENERAL NOTES:

1. MARKERS SHALL BE FLACCO EVERY 18' FEET.
2. MARKERS SHALL BE VISIBLE FROM THE TRAVELING MOTORIST ON STATE DESIGNATED HIGHWAYS.
3. MARKERS SHALL BE HIGH PERFORMANCE TWO-WAY CLEAR.
4. FIVE (5) MARKERS SHALL BE PLACED ALONG MAINLINE EDGE STRIPE.
5. MARKERS IN COUNTY ROADS SHALL CONTINUE DOWN THE MAINLINE EDGE STRIPE A DISTANCE OF 48 FEET.
6. MARKERS SHALL NOT BE ROTATED WHEN BEING PLACED ALONG RADIUS AND TANGENT SECTION OF LOCAL ROAD.
7. MARKERS SHALL BE INSTALLED AT SIMPLE AND CHANNELIZED INTERSECTIONS TO THE LIMITS SHOWN ABOVE.

MISSISSIPPI DEPARTMENT OF TRANSPORTATION	
ROADWAY DESIGN DIVISION	
STANDARD PLAN	
2-WAY RAISED PAVEMENT MARKERS AT INTERSECTING ROADS (2-LANE)	
DATE	ISSUE DATE: MAY 21, 2017
BY	
REVISION	

WORKING NUMBER P-111
SHEET NUMBER 69/61

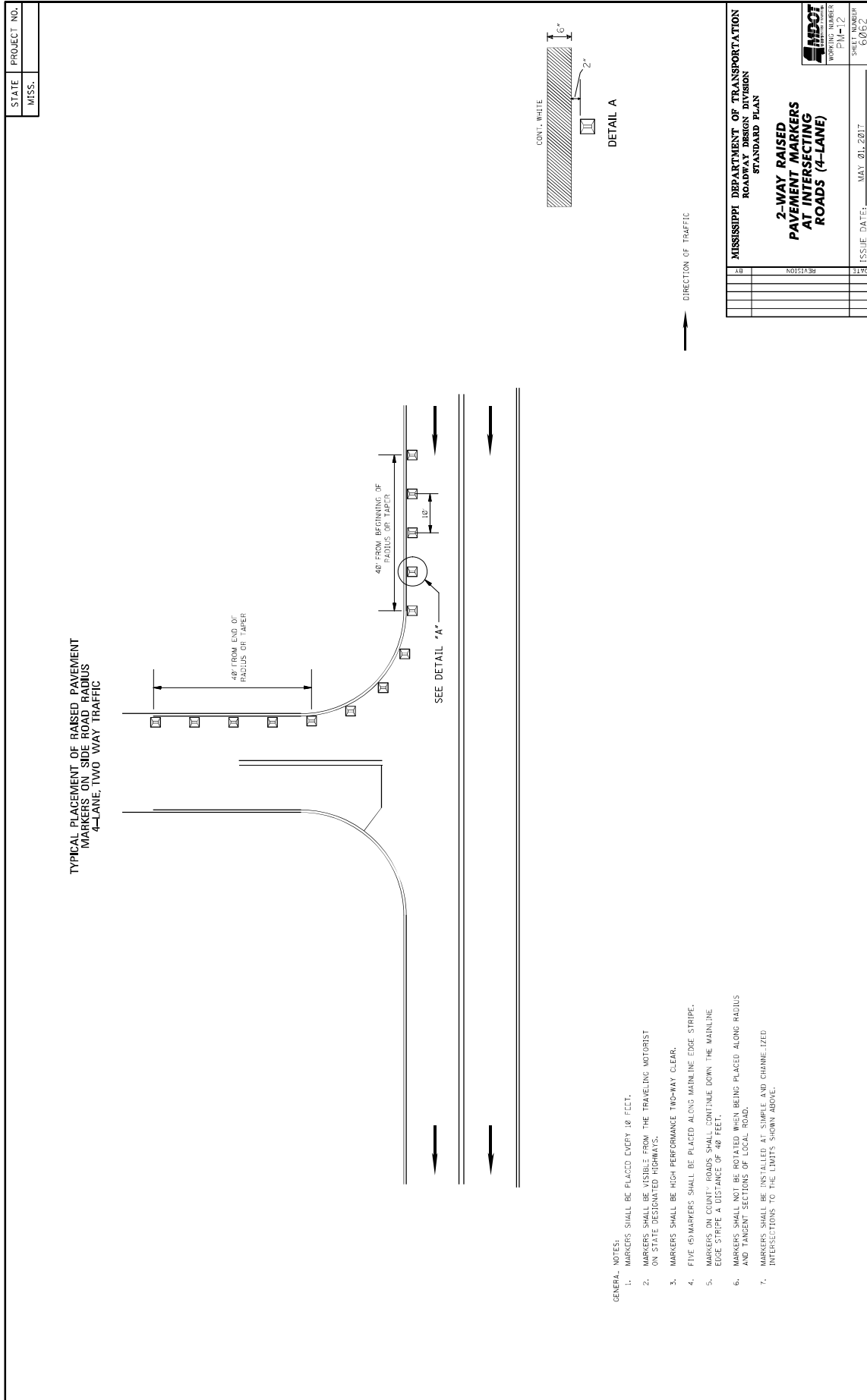

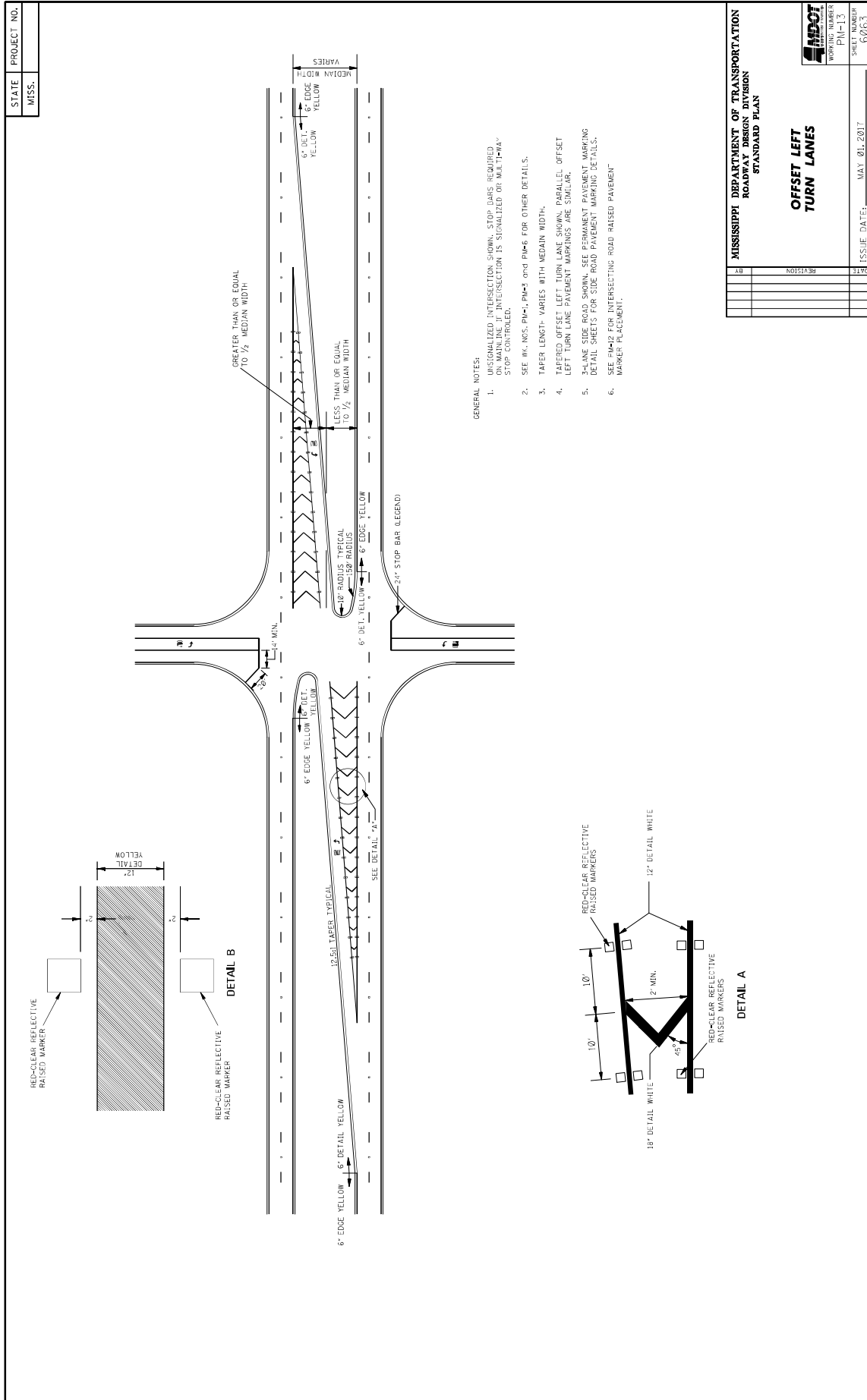

MISSISSIPPI DEPARTMENT OF TRANSPORTATION	
ROADWAY DESIGN DIVISION	
STANDARD PLAN	
OFFSET LEFT TURN LANES	
DATE	ISSUE DATE: MAY 01, 2017
BY	SHEET NUMBER 0263
REVISION	WORKING NUMBER PM-13

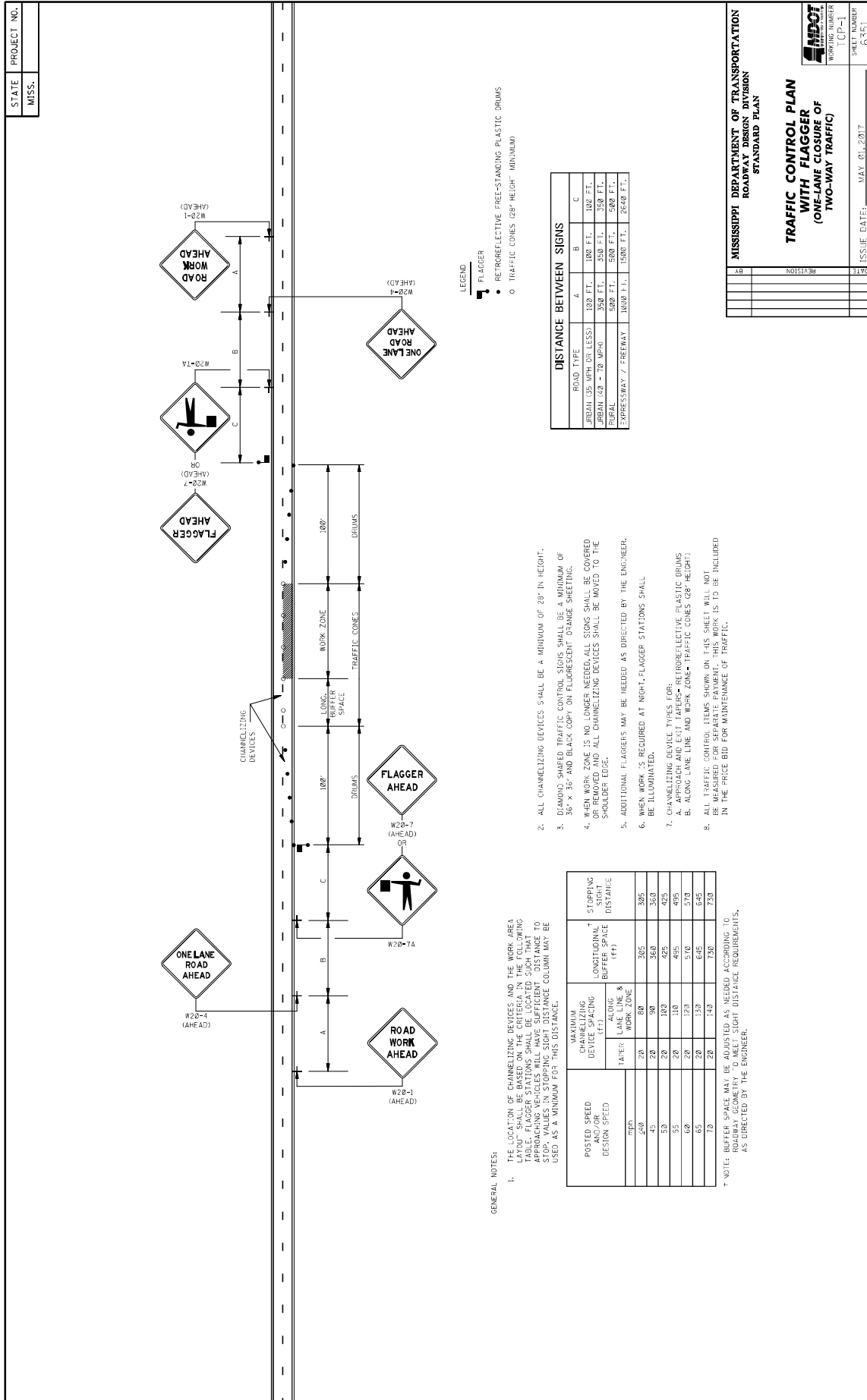

MISSISSIPPI DEPARTMENT OF TRANSPORTATION
ROADWAY DESIGN DIVISION
STANDARD PLAN

TRAFFIC CONTROL PLAN
WITH FLAGGER
(ONE-LANE CLOSURE OF TWO-WAY TRAFFIC)

ISSUE DATE: MAY 01, 2017

WORKING NUMBER [CP-1]
SHEET NUMBER 6351

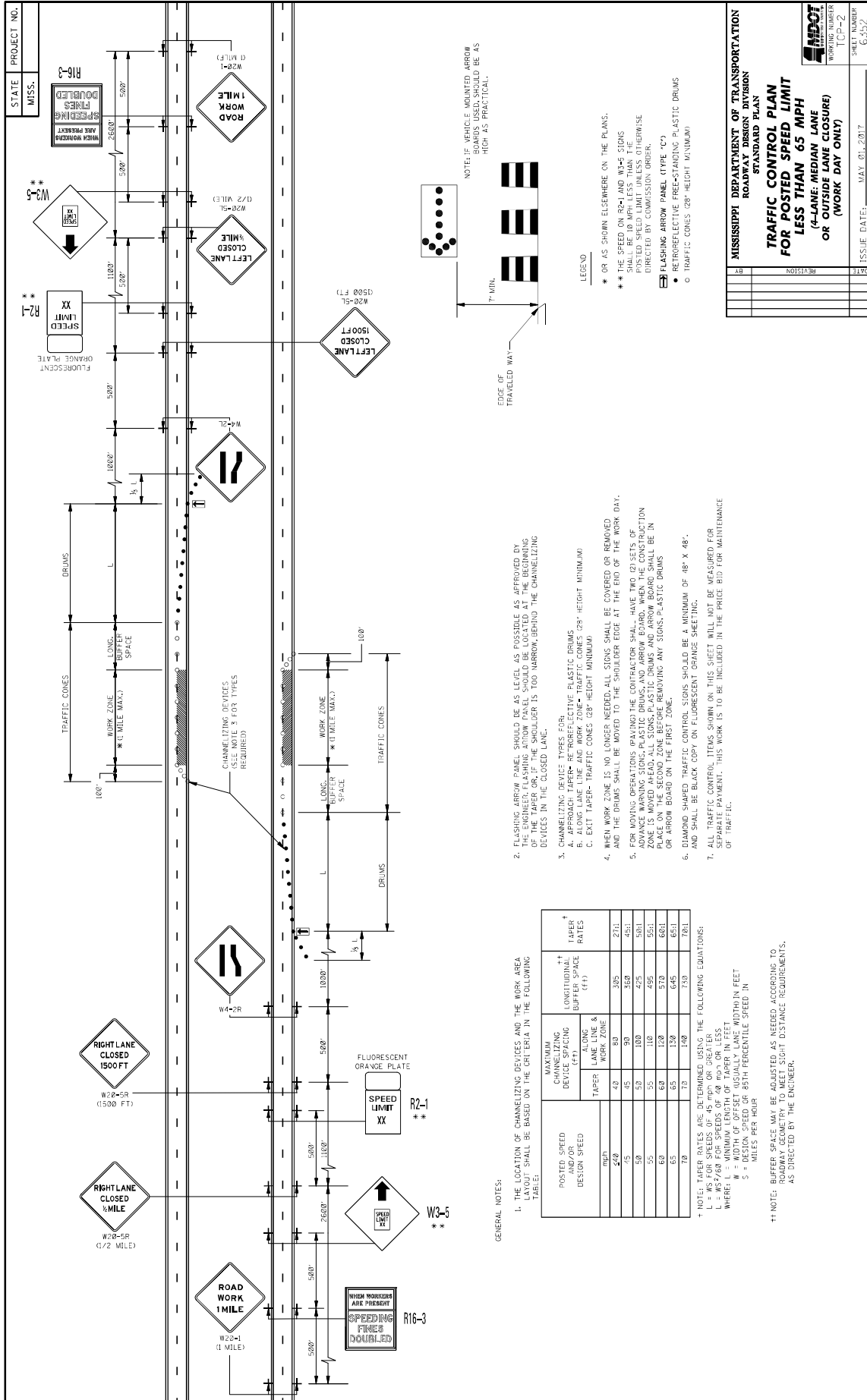

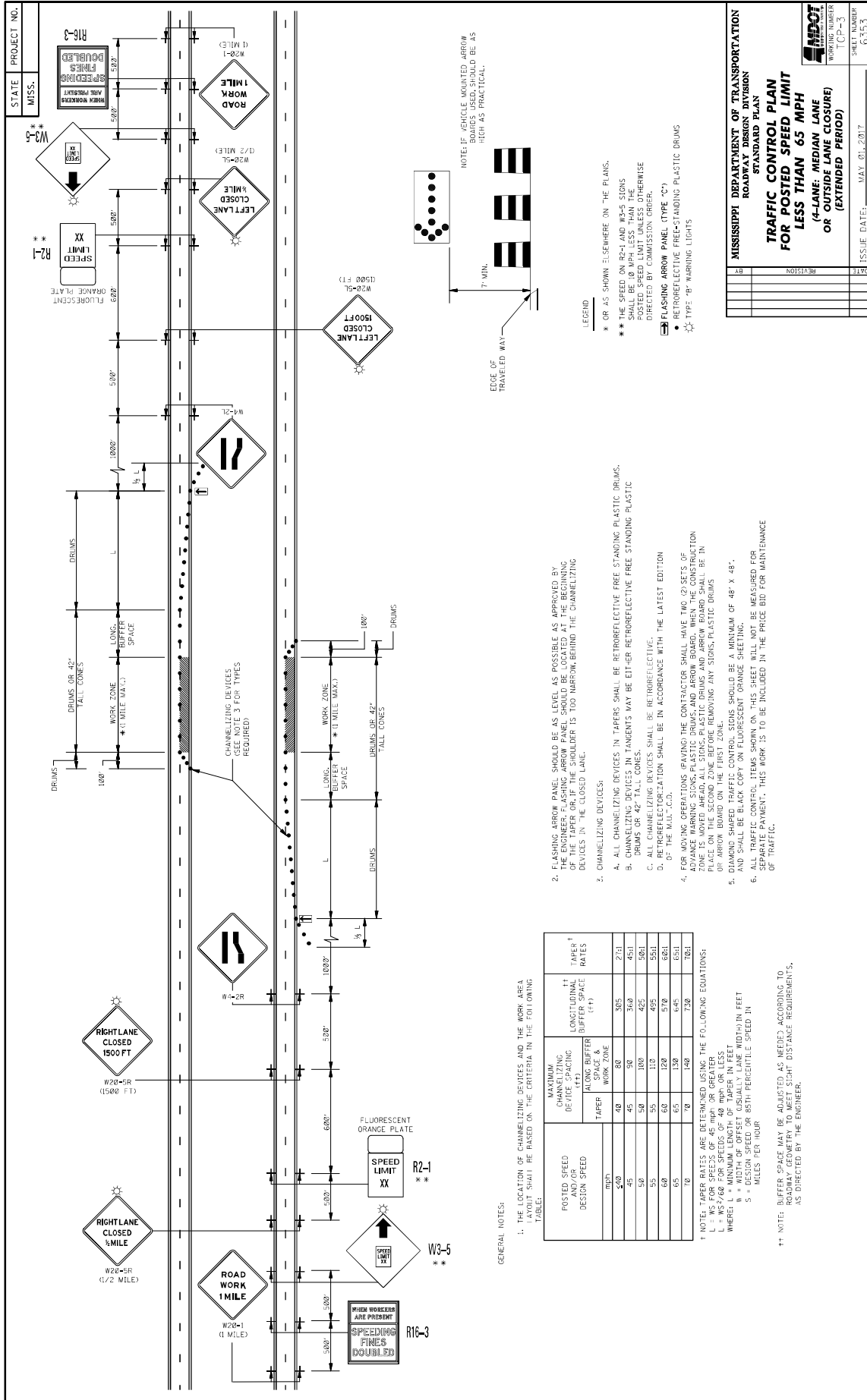

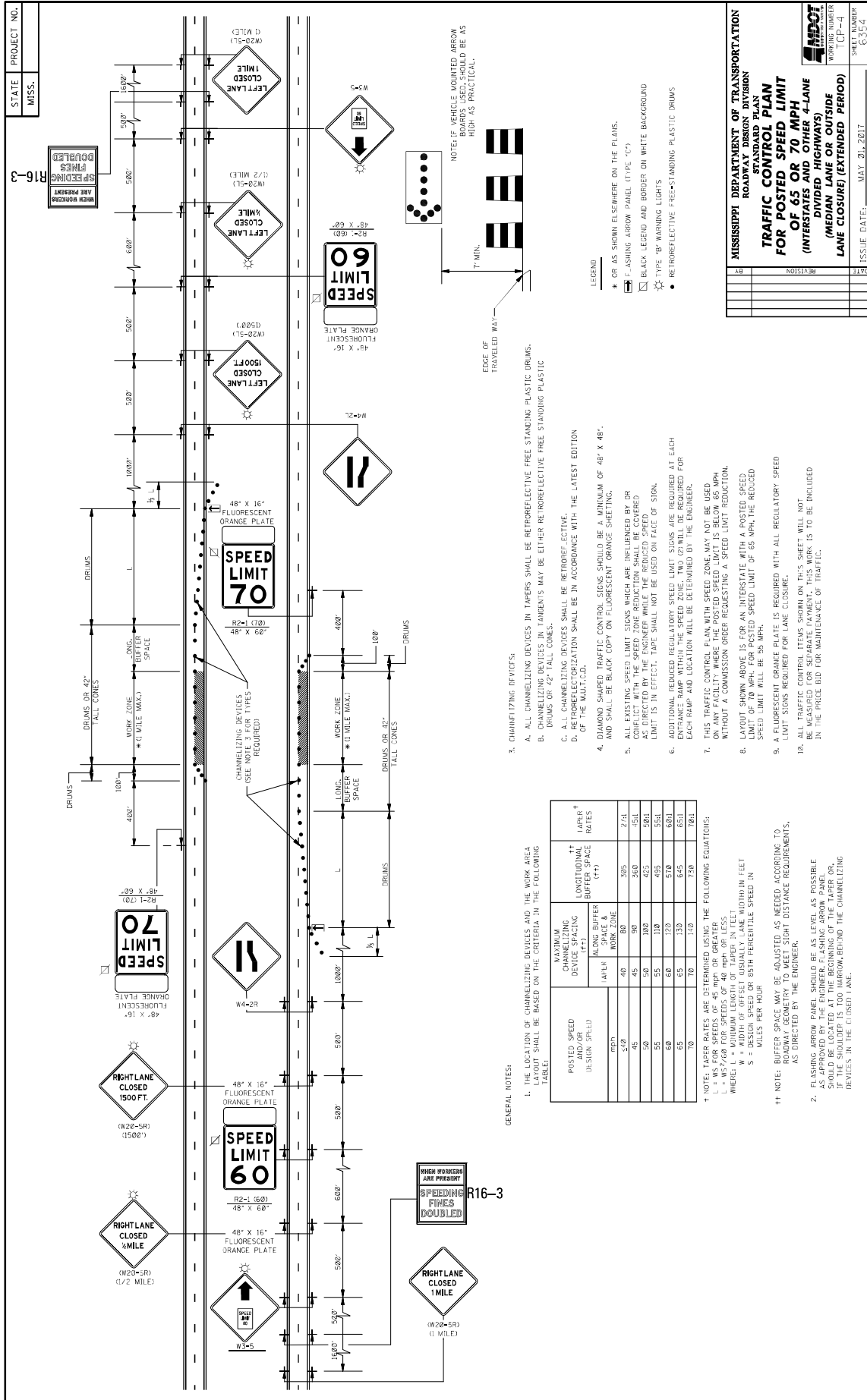

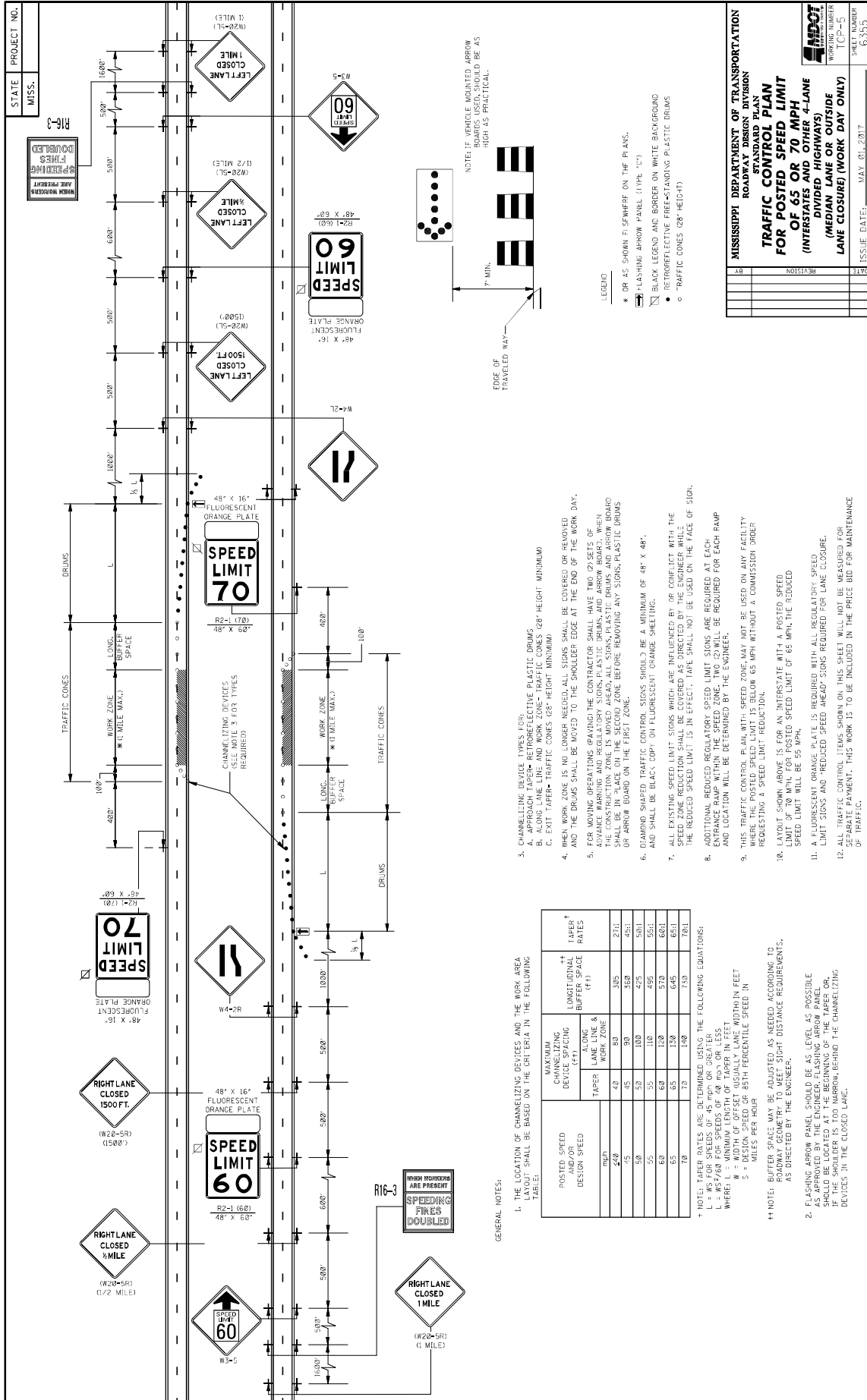

STATE PROJECT NO.
MISS.

WORKING NUMBER
ICP-5

SHEET NUMBER
03500

WING BARRICADES

1. WING BARRICADES ARE TYPE II BARRICADES ERECTED ON THE SHOULDER OF A ROADWAY OR RESTRICTED ROADWAY. WING BARRICADES MAY BE USED AS A MOUNTING FOR THE ADVANCE WARNING SIGNS OR FLASHERS.

2. WING BARRICADES SHOULD BE USED:

- IN ADVANCE OF A CONSTRUCTION PROJECT EVEN WHEN NO PART OF THE ROADWAY IS ACTUALLY CLOSED.
- IN ADVANCE OF ALL BRIDGE OR CULVERT WIDENING OPERATIONS.

BARRICADE CHARACTERISTICS

	I	II	III
WIDTH OF RAIL **	8" MIN. - 12" MAX.	8" MIN. - 12" MAX.	8" MIN. - 12" MAX.
LENGTH OF RAIL **	24" MIN.	24" MIN.	48" MIN.
WIDTH OF STRIPE *	6"	6"	6"
HEIGHT	36" MIN.	36" MIN.	60" MIN.
NUMBER OF RETROREFLECTORIZED RAIL FACES	2 (ONE EACH DIRECTION)	4 (TWO EACH DIRECTION)	3 IF FACING TRAFFIC IN ONE DIRECTION 4 IF FACING TRAFFIC IN TWO DIRECTIONS

STANDARD BARRICADES

- THE MARKING FOR BARRICADE RAILS SHALL BE ORANGE AND WHITE (SLOPING DOWNWARD AT AN ANGLE OF 45° IN THE DIRECTION OF TRAFFIC IS TO PASS).
- RAIL STRIPE SHALL BE 6 INCHES EXCEPT THAT 4-INCH WIDE STRIPES MAY BE USED IF RAIL LENGTHS ARE LESS THAN 36 INCHES.
- DO NOT PLACE SANDBAGS OR OTHER DEVICES TO PROVIDE MASS ON THE BOTTOM RAIL THAT WILL BLOCK VIEW OR RAIL FACE.
- FOR ADDITIONAL INFORMATION OR DETAILS, SEE METHOD, LATEST EDITION.
- BARRICADES ARE CLASSIFIED BY FHWA AS CATEGORY II WHEN DEVICES WHICH REQUIRE SUCCESSFULLY CRASH TESTED. A LIST OF CRASHWORTHY BARRICADES AND OTHER CATEGORY II DEVICES CAN BE FOUND ON FHWA'S WEBSITE: http://safety.fhwa.dot.gov/roadway_dept/pafety_guidance/road_hardware/cat2.cfm

CHEVRON SIGN DETAIL

- A CHEVRON SIGN CONSISTS OF A BLACK CHEVRON TYPE MARKING ON AN ORANGE BACKGROUND AND SHALL POINT IN THE DIRECTION OF TRAFFIC FLOW.
- THE CHEVRON SIGN SHALL BE MOUNTED ON CRASHWORTHY SUPPORT.
- CHEVRON SIGNS MAY BE USED TO SUPPLEMENT OTHER STANDARD DEVICES WHERE ONE OR MORE LANES ARE CLOSED FOR CONSTRUCTION OR MAINTENANCE. THEY SHOULD BE PLACED APPROXIMATELY 2' 40" BEHIND THE LANE TRANSITION STRIPE.

TYPE 3 OBJECT MARKER (OM-3R)

- TYPE 3 OBJECT MARKERS SHALL BE USED AT ALL EXPOSED BRIDGE ABUTMENTS AND AT OTHER LOCATIONS AS DEEMED NECESSARY BY THE ENGINEER.
- THE OM-3R IS SIMILAR EXCEPT THE STRIPES SLOPE DOWNWARD FROM THE UPPER LEFT SIDE TO THE LOWER RIGHT SIDE AND SHALL BE PLACED ON THE LEFT SIDE OF THE OBJECT.
- THE INSIDE EDGE OF THE MARKER SHALL BE IN LINE WITH THE INNER EDGE OF THE OBSTRUCTION.

PLASTIC DRUM STRIPING DETAIL

- PLASTIC DRUMS SHALL BE ON END AND USED AS AN EXPEDIENT METHOD FOR TRAFFIC CHANNELIZATION. THE COLOR AND MARKING OF DRUMS SHALL BE CONSISTENT WITH MARKING STRIPING. THE PREFERRED COLOR OF DRUMS WITH MARKING STRIPING IS ORANGE. THE STRIPING SHALL BE RETROREFLECTIVE STRIPES (2 ORANGE & 2 WHITE) 6" WIDE.
- DRUMS SHOULD NEVER BE PLACED IN THE ROADWAY WITHOUT WARNING SIGNS.
- WHERE PRACTICAL PLASTIC DRUMS SHOULD BE PLACED NO CLOSER THAN 3'-0" FROM THE EDGE OF TRAVELED LANE.

MISSISSIPPI DEPARTMENT OF TRANSPORTATION
ROADWAY DESIGN DIVISION
STANDARD PLAN

HIGHWAY SIGN AND BARRICADE DETAILS FOR CONSTRUCTION PROJECTS

DATE	ISSUE DATE: MAY 20, 2017
REVISION	

STATE MISS.	PROJECT NO.	
----------------	-------------	--

MOBILE OPERATIONS ON MULTILANE ROAD

MOBILE OPERATIONS ON MULTILANE ROAD

MOBILE OPERATIONS ON TWO-LANE ROAD

MOBILE OPERATIONS ON TWO-LANE ROAD

NOTES FOR MULTILANE LANE OPERATION:

- VEHICLES USED FOR THESE OPERATIONS SHOULD BE MADE HIGHLY VISIBLE WITH APPROPRIATE EQUIPMENT, SUCH AS FLASHING LIGHTS, ROTATING BEACONS, FLASGS, SIGNS, OR ARROW PANELS.
- SHADOW VEHICLE 2 SHOULD BE EQUIPPED WITH AN ARROW PANEL AND TRUCK MOUNTED ATTENUATOR (TMA), AN APPROPRIATE LANE CLOSURE SIGN SHOULD BE PLACED ON SHADOW VEHICLE 2 SO AS NOT TO OBSCURE THE ARROW PANEL.
- SHADOW VEHICLE 1 SHOULD BE EQUIPPED WITH AN ARROW PANEL AND TRUCK MOUNTED ATTENUATOR (TMA).
- SHADOW VEHICLE 2 SHOULD TRAVEL AT A VARYING DISTANCE FROM THE WORK OPERATION SO AS TO PROVIDE ADEQUATE SIGHT DISTANCE FOR TRAFFIC APPROACHING FROM THE REAR.
- WHEN ADEQUATE SHOULDER WIDTH IS NOT AVAILABLE, SHADOW VEHICLE 2 SHOULD BE ELIMINATED.
- ON HIGH-SPEED ROADWAYS, A THIRD SHADOW VEHICLE SHOULD BE USED (i.e., VEHICLE 3 ON THE SHOULDER OF PRACTICALLY, VEHICLE 2 IN THE CLOSED LANE, AND VEHICLE 1 IN THE CLOSED LANE).
- ARROW PANELS SHALL BE AS A MINIMUM TYPE B, 60" X 30" IN ACCORDANCE WITH THE CRITERIA PRESENTED IN THE MUTCD.
- WORK SHOULD NORMALLY BE DONE DURING OFF-PEAK HOURS.
- VEHICLE-MOUNTED SIGNS SHOULD BE MOUNTED WITH THE BOTTOM OF THE SIGN LOCATED AT A MINIMUM HEIGHT OF 48" ABOVE THE PAVEMENT AND SHALL NOT BE OBTURED BY EQUIPMENT OR SUPPLIES. SIGN LEGENDS SHALL BE COVERED OR TURNED FROM VIEW WHEN WORK IS NOT IN PROGRESS.
- ALL TRAFFIC CONTROL ITEMS SHOWN ON THIS SHEET WILL NOT BE MEASURED FOR SEPARATE PAYMENT. THIS WORK IS TO BE INCLUDED IN THE PRICE BID FOR MAINTENANCE OF TRAFFIC.

NOTES FOR TWO-LANE OPERATION:

- WHERE PRACTICAL AND WHEN NEEDED, THE WORK AND SHADOW VEHICLES SHOULD PULL OVER PERIODICALLY TO ALLOW TRAFFIC TO PASS. IF THIS CAN NOT BE DONE FREQUENTLY AS AN ALTERNATIVE, A "DO NOT PASS" SIGN MAY BE PLACED ON THE REAR OF THE VEHICLE BLOCKING THE LANE.
- THE DISTANCE BETWEEN THE WORK AND SHADOW VEHICLES MAY VARY ACCORDING TO TERRAIN, PAINT DRYING TIME, AND OTHER FACTORS. SHADOW VEHICLES ARE USED TO WARN TRAFFIC OF THE OPERATION AHEAD. WHENEVER ADEQUATE SHOULD MAINTAIN THE MINIMUM DISTANCE AND PROCEED AT THE SAME SPEED AS THE WORK VEHICLE. THE SHADOW VEHICLE SHOULD SLOW DOWN IN ADVANCE OF VERTICAL OR HORIZONTAL CURVES THAT RESTRICT SIGHT DISTANCE.
- ADDITIONAL SHADOW VEHICLES TO WARN AND REDUCE THE SPEED OF ONCOMING OR OPPOSING TRAFFIC MAY BE USED. POLICE PATROL CARS MAY BE USED FOR THIS PURPOSE.
- A TRUCK-MOUNTED ATTENUATOR (TMA) SHOULD BE USED ON THE SHADOW VEHICLE AND MAY BE USED ON THE WORK VEHICLE.
- THE WORK VEHICLE SHALL BE EQUIPPED WITH BEACONS AND THE SHADOW VEHICLE SHALL BE EQUIPPED WITH BEACONS. TRUCK-MOUNTED ATTENUATOR LIGHTS MOUNTED ON THE REAR, ADJACENT TO THE SIGN, SHADOW AND WORK VEHICLES SHALL DISPLAY FLASHING OR ROTATING BEACONS BOTH FORWARD AND TO THE REAR.
- VEHICLE-MOUNTED SIGNS SHOULD BE MOUNTED WITH THE BOTTOM OF THE SIGN LOCATED AT A MINIMUM HEIGHT OF 48" ABOVE THE PAVEMENT AND SHALL NOT BE OBTURED BY EQUIPMENT OR SUPPLIES. SIGN LEGENDS SHALL BE COVERED OR TURNED FROM VIEW WHEN WORK IS NOT IN PROGRESS.
- ARROW BOARD TO BE USED IN CAUTION MODE.
- ALL TRAFFIC CONTROL ITEMS SHOWN ON THIS SHEET WILL NOT BE MEASURED FOR SEPARATE PAYMENT. THIS WORK IS TO BE INCLUDED IN THE PRICE BID FOR MAINTENANCE OF TRAFFIC.

MISSISSIPPI DEPARTMENT OF TRANSPORTATION
ROADWAY DESIGN DIVISION
STANDARD PLAN

TRAFFIC CONTROL PLAN
MOBILE OPERATIONS
MULTILANE ROADS
TWO-LANE ROADS

REVISION									
1									

ISSUE DATE: MAY 01, 2017

SHEET NUMBER									
WORKING NUMBER	TOP-9	1	1	1	1	1	1	1	1
SHEET NUMBER	6359	1	1	1	1	1	1	1	1

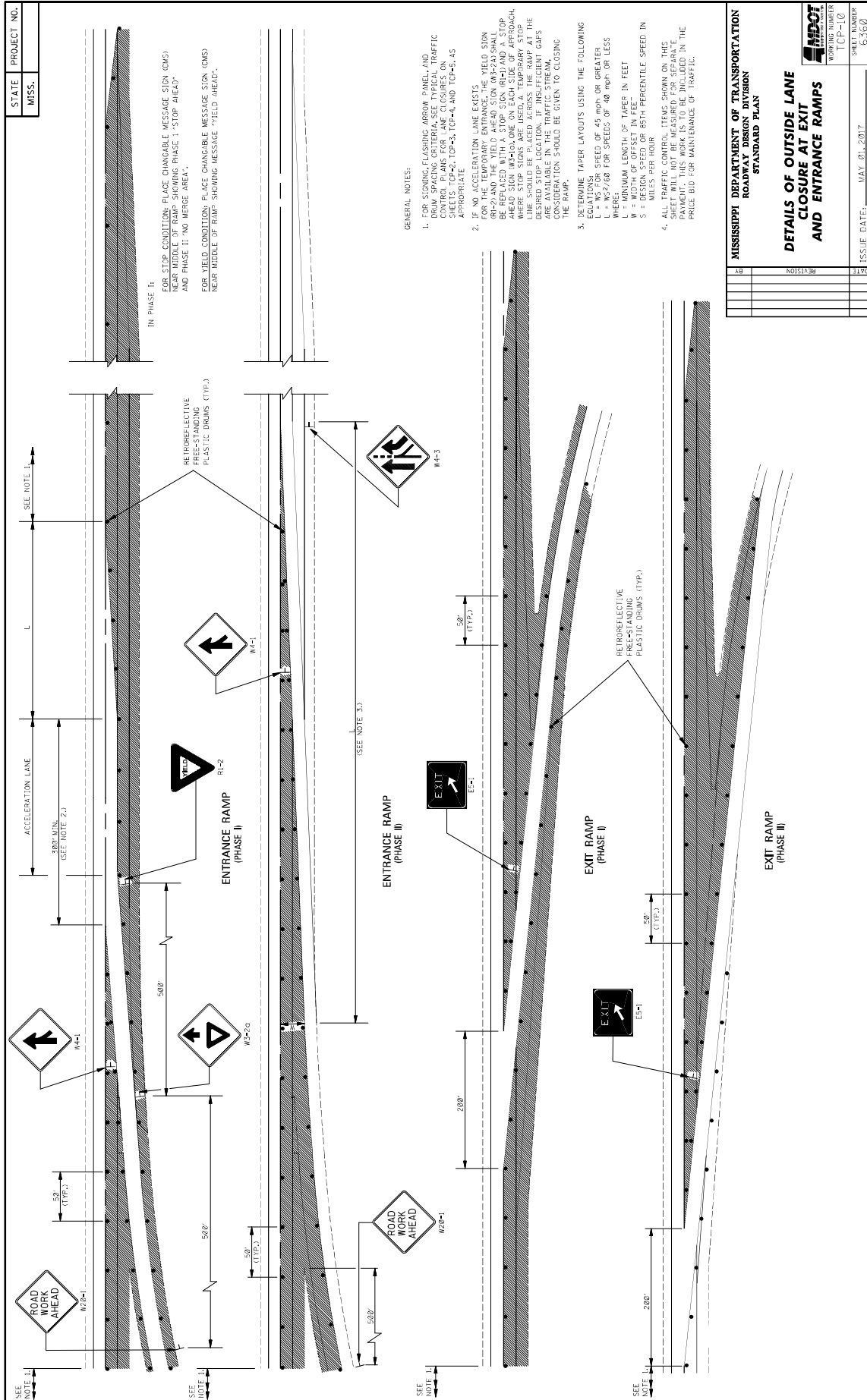

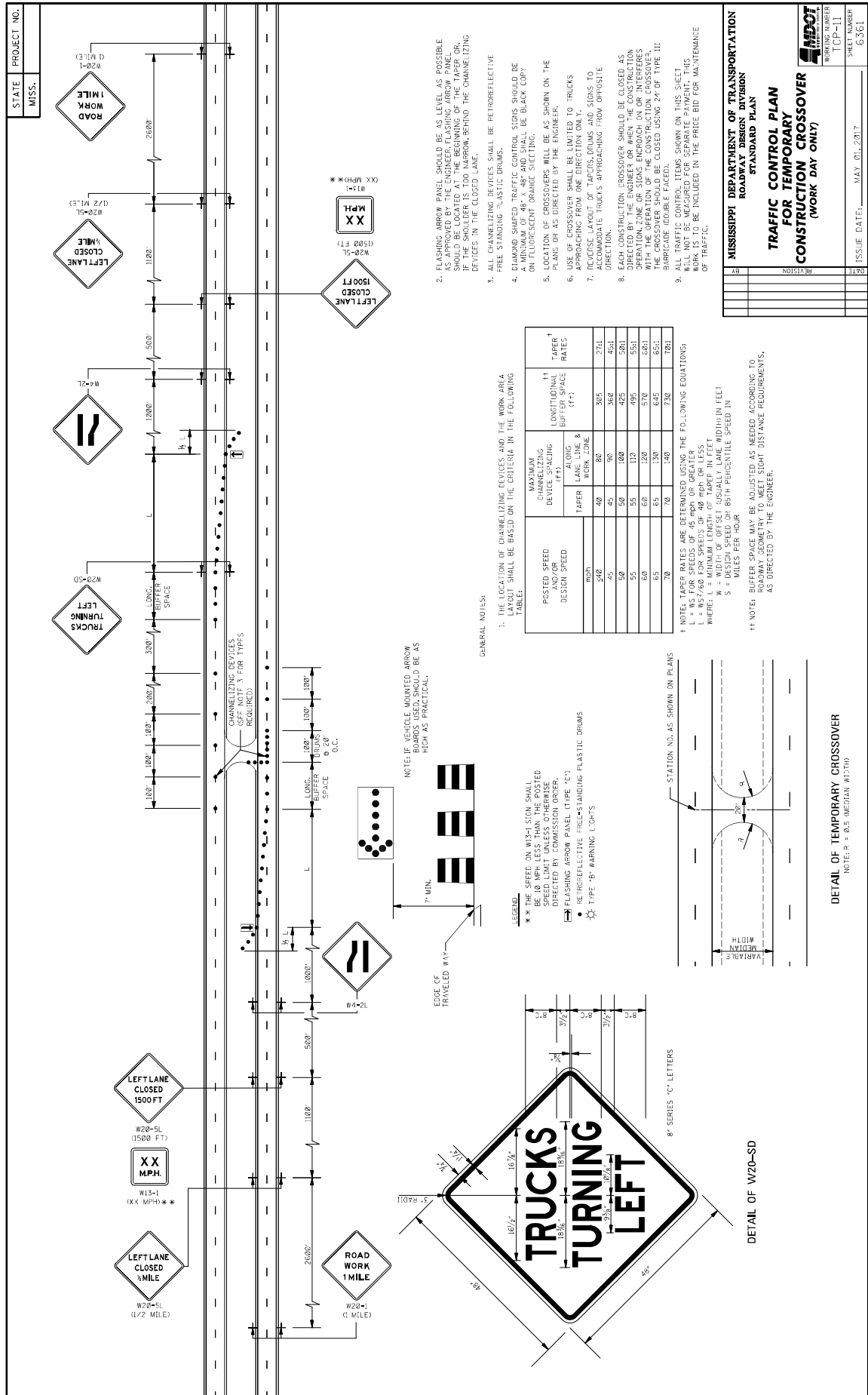

1. THE LOCATION OF CHANNELIZING DEVICES AND THE WORK AREA LIMIT SHALL BE BASED ON THE CRITERIA IN THE FOLLOWING TABLE:
2. FLASHING ARROW PANELS SHOULD BE AS LEVEL AS POSSIBLE AS APPROVED BY THE ENGINEER. FLASHING ARROW PANELS SHOULD BE LOCATED AT THE BEGINNING OF THE TAPER OR, IF THE SHOULDER IS TOO NARROW, BEHIND THE CHANNELIZING DEVICES IN THE CLOSED LANE.
3. ALL CHANNELIZING DEVICES SHALL BE RETROREFLECTIVE FREE STANDING PLASTIC DUMPS.
4. DIAMOND SHAPED TRAFFIC CONTROL SIGNS SHOULD BE BLACK COPY ON FLUORESCENT ORANGE SUCTING.
5. LOCATION OF CROSSOVERS WILL BE AS SHOWN ON THE PLANS OR AS DIRECTED BY THE ENGINEER.
6. USE OF CROSSOVERS SHALL BE LIMITED TO TRUCKS APPROACHING FROM ONE DIRECTION ONLY.
7. REVERSE LAYOUT OF TAPERS, DUMPS AND SIGNS TO ACCOMMODATE TRUCKS APPROACHING FROM OPPOSITE DIRECTION.
8. EACH CONSTRUCTION CROSSOVER SHOULD BE CLOSED AS SOON AS POSSIBLE AFTER THE WORK AREA IS OPEN TO TRAFFIC WITH THE OPERATION OF THE CONSTRUCTION CROSSOVER. THE CROSSOVER SHOULD BE CLOSED USING 24" OF TYPE III RETROREFLECTIVE FREE-STANDING PLASTIC DUMPS.
9. ALL TRAFFIC CONTROL ITEMS SHOWN ON THIS SHEET WILL NOT BE MEASURED FOR SEPARATE PAYMENT. THIS WORK IS TO BE INCLUDED IN THE PRICE BID FOR MAINTENANCE OF TRAFFIC.

POSTED SPEED DESIGN SPEED	MAXIMUM CHANNELIZING DEVICE SPACING (FT)	LONGITUDINAL BUFFER SPACE (FT)	TAPER RATES	
				MIN. TAPER RATES
50	40	80	30%	20%
55	45	90	36%	24%
60	50	100	42%	28%
65	55	110	48%	32%
70	60	120	54%	36%
75	65	130	60%	40%
80	70	140	66%	44%

NOTE: TAPER RATES ARE DETERMINED USING THE FOLLOWING EQUATIONS:
 $L = W \times S$
 WHERE: L = MINIMUM LENGTH OF TAPER IN FEET
 W = WIDTH OF OFFSET USUALLY LANE WIDTH IN FEET
 S = 65TH PERCENTILE SPEED IN MILES PER HOUR

NOTE: BUFFER SPACE MAY BE ADJUSTED AS NEEDED ACCORDING TO ROADWAY GEOMETRY TO MEET SIGHT DISTANCE REQUIREMENTS, AS DIRECTED BY THE ENGINEER.

GENERAL NOTES:

1. THE LOCATION OF CHANNELIZING DEVICES AND THE WORK AREA LIMIT SHALL BE BASED ON THE CRITERIA IN THE FOLLOWING TABLE:



NOTE: IF VEHICLE MOUNTED ARROW BOARDS USED, SHOULD BE AS HIGH AS PRACTICAL.

LEGEND

- X X THE SPEED ON W13-1 SIGN SHALL BE 10 MPH LESS THAN THE POSTED SPEED AS SHOWN ON PLANS AND/OR AS DIRECTED BY COMMISSION ORDER
- FLASHING ARROW PANEL (TYPE "C")
- RETROREFLECTIVE FREE-STANDING PLASTIC DUMPS
- TYPE "B" WARNING LIGHTS

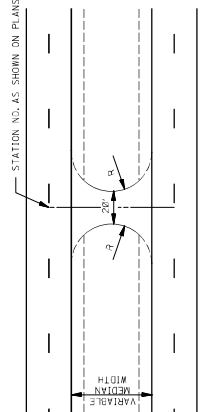

DETAIL OF W20-SD

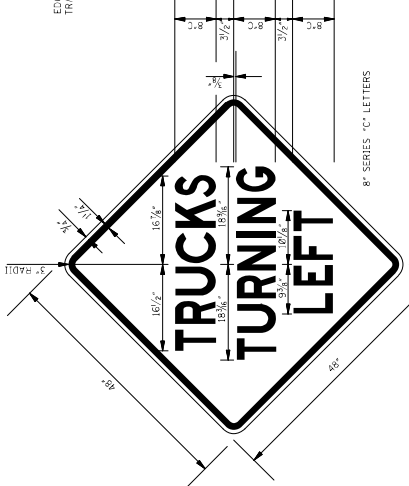

8" SERIES "C" LETTERS

STATE PROJECT NO.
MISS.

MISSISSIPPI DEPARTMENT OF TRANSPORTATION
 ROADWAY DESIGN DIVISION
 STANDARD PLAN
**TRAFFIC CONTROL PLAN
 FOR TEMPORARY
 CONSTRUCTION CROSSOVER
 (WORK DAY ONLY)**

WORKING NUMBER: TCP-11
 SHEET NUMBER: 6361
 ISSUE DATE: MAY 01, 2017

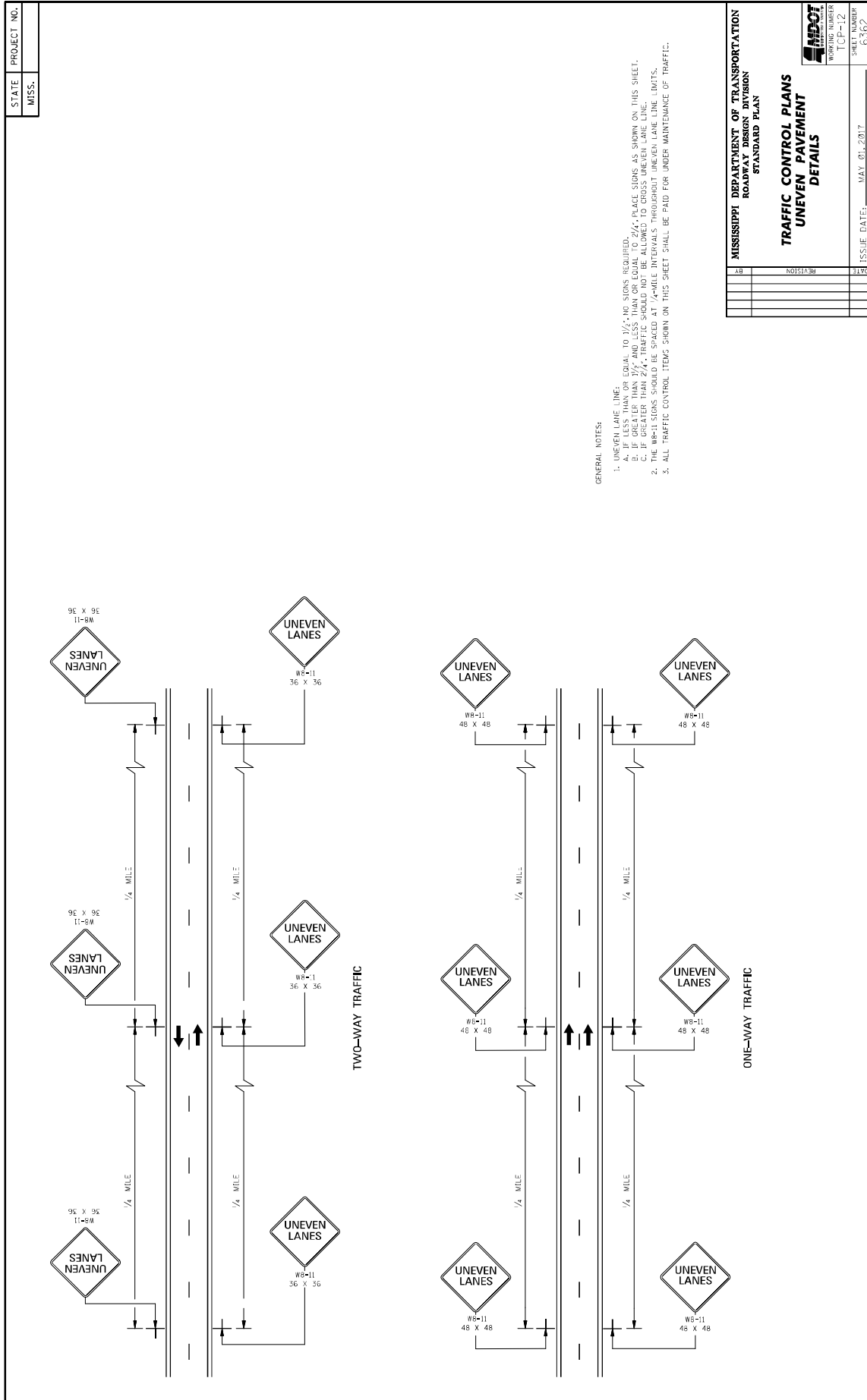

MISSISSIPPI DEPARTMENT OF TRANSPORTATION
ROADWAY DESIGN DIVISION
STANDARD PLAN

TRAFFIC CONTROL PLANS
UNEVEN PAVEMENT
DETAILS

WORKING NUMBER	ICP-12
SHEET NUMBER	6262
ISSUE DATE:	MAY 01, 2017

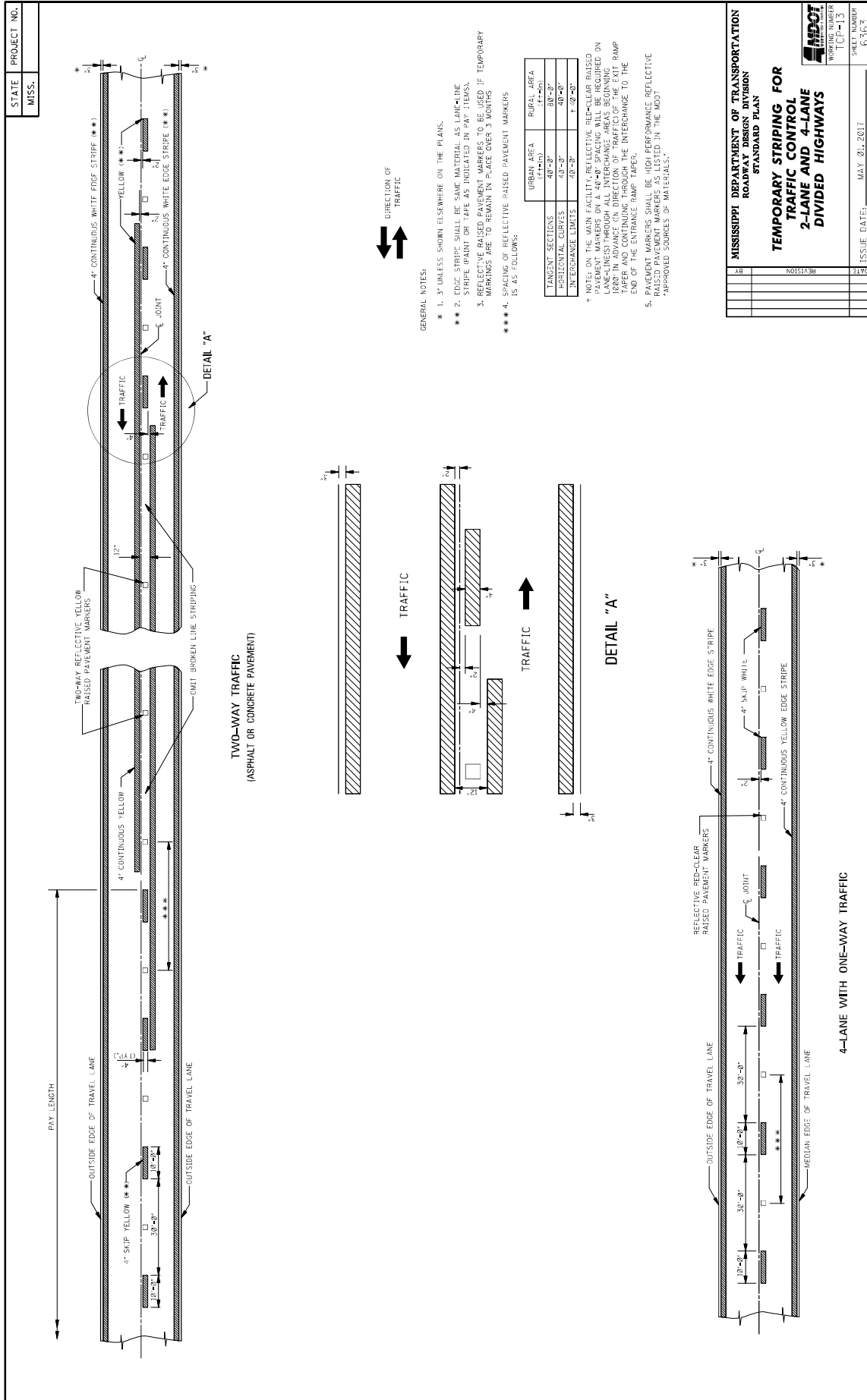

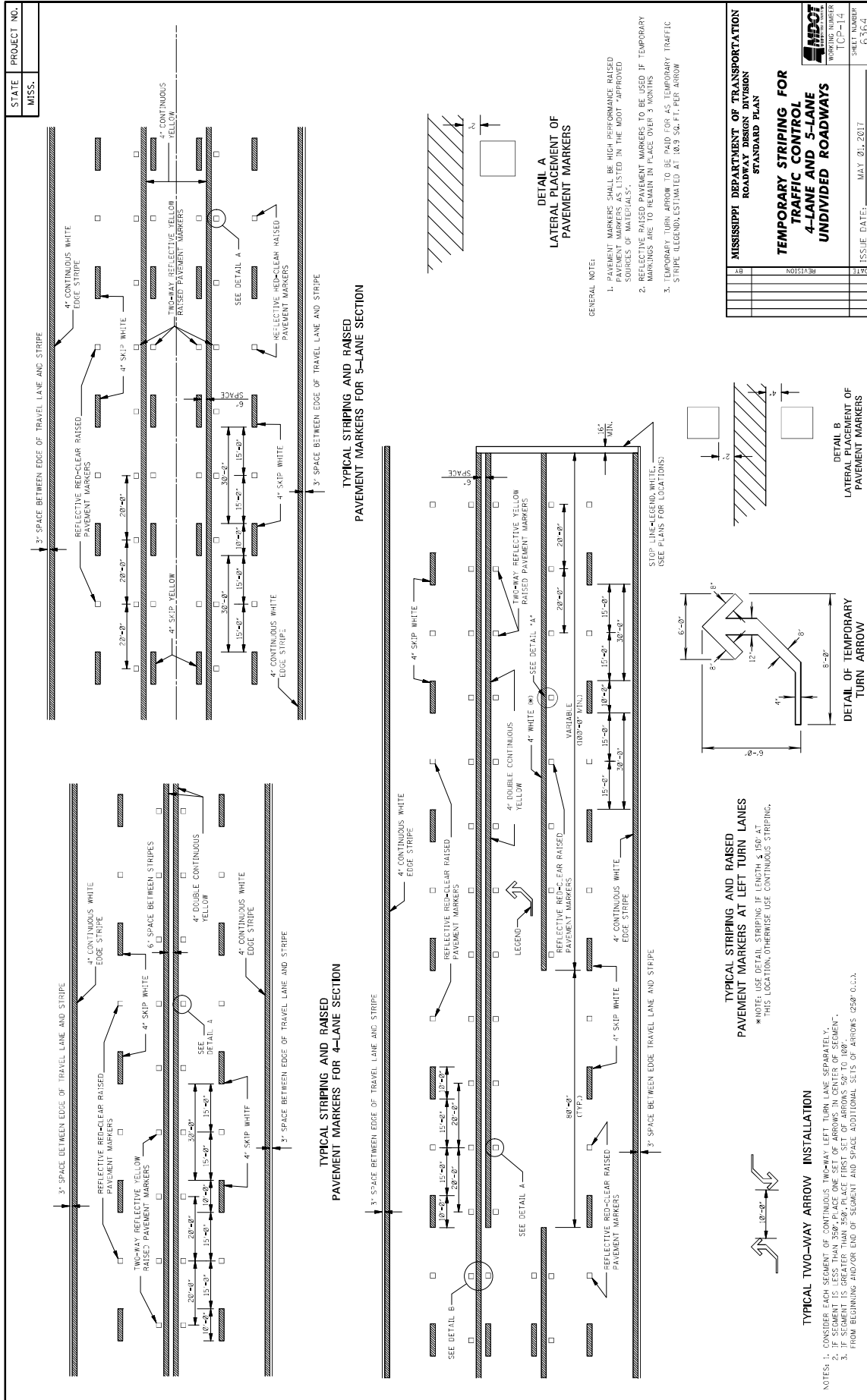

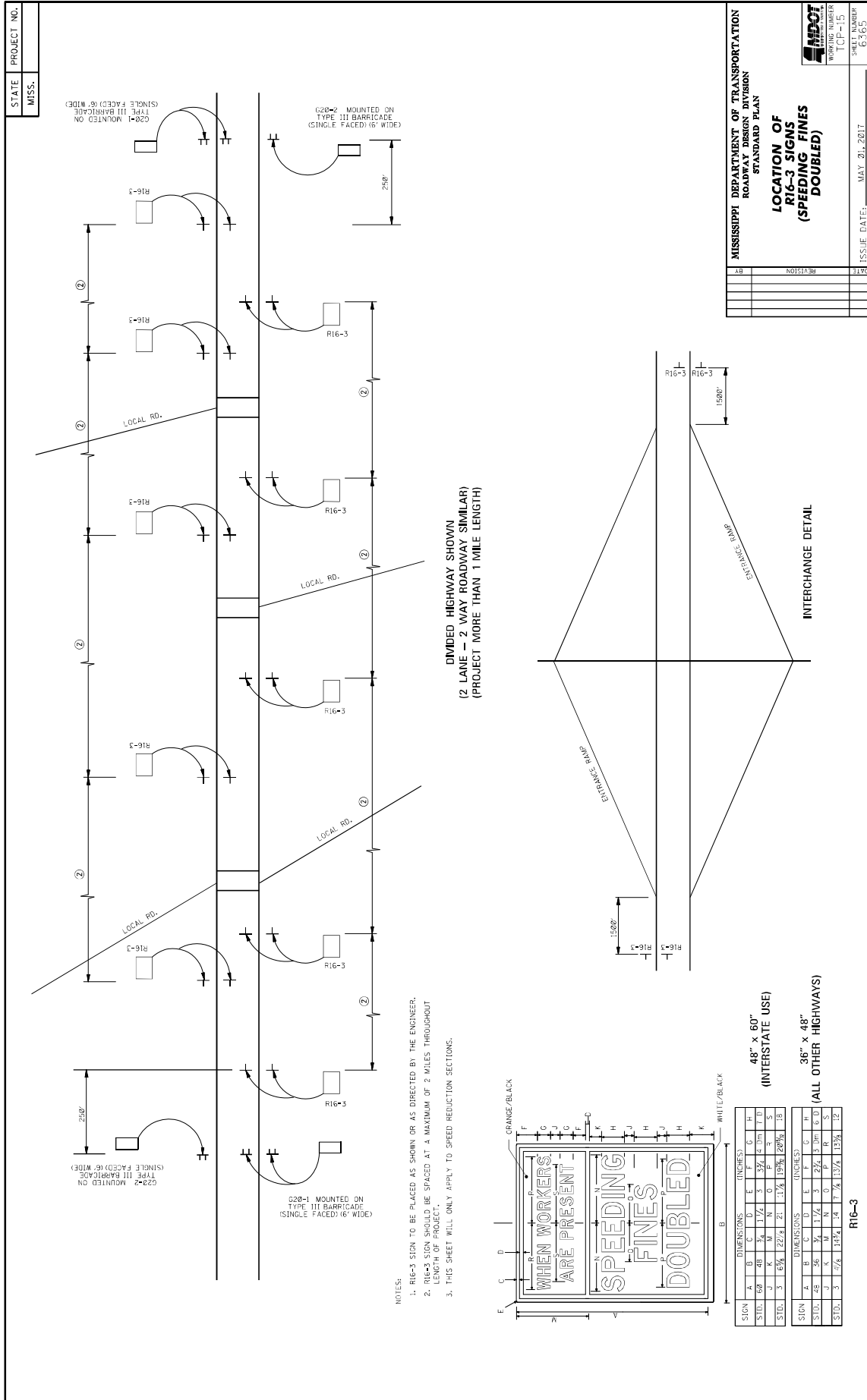

- NOTES:
1. R16-3 SIGN TO BE PLACED AS SHOWN OR AS DIRECTED BY THE ENGINEER.
 2. R16-3 SIGN SHOULD BE SPACED AT A MAXIMUM OF 2 MILES THROUGHOUT LENGTH OF PROJECT.
 3. THIS SHEET WILL ONLY APPLY TO SPEED REDUCTION SECTIONS.

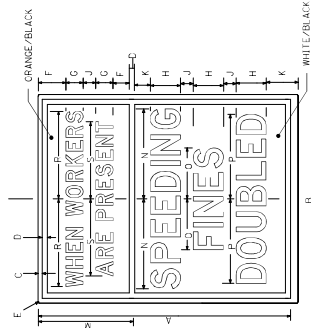

DIMENSIONS (INCHES)	
SIGN	A B C D E F G H
STD.	6-00 48 3/4 1 1/4 5 3/4 4 0 1/4 1 1/4
SIGN	J K L M N O P
STD.	3 1 5/8 2 2 1/2 2 1 1 1/4 1 3/8 2 8/16 1 1/2
DIMENSIONS (INCHES)	
SIGN	A B C D E F G H
STD.	3 3/4 1 1/4 1 1/4 1 1/4 1 1/4 1 1/4 1 1/4
SIGN	I J K L M N O P
STD.	3 3/4 1 1/4 1 1/4 1 1/4 1 1/4 1 1/4 1 1/4

48" x 60"
(INTERSTATE USE)

36" x 48"
(ALL OTHER HIGHWAYS)

R16-3

STATE PROJECT NO.
MISS.

MISSISSIPPI DEPARTMENT OF TRANSPORTATION
ROADWAY DESIGN DIVISION
STANDARD PLAN

LOCATION OF R16-3 SIGNS (SPEEDING FINES DOUBLED)

ISSUE DATE: MAY 21, 2017

WORKING NUMBER ICF-15

SHEET NUMBER 6-163

DATE	REVISION

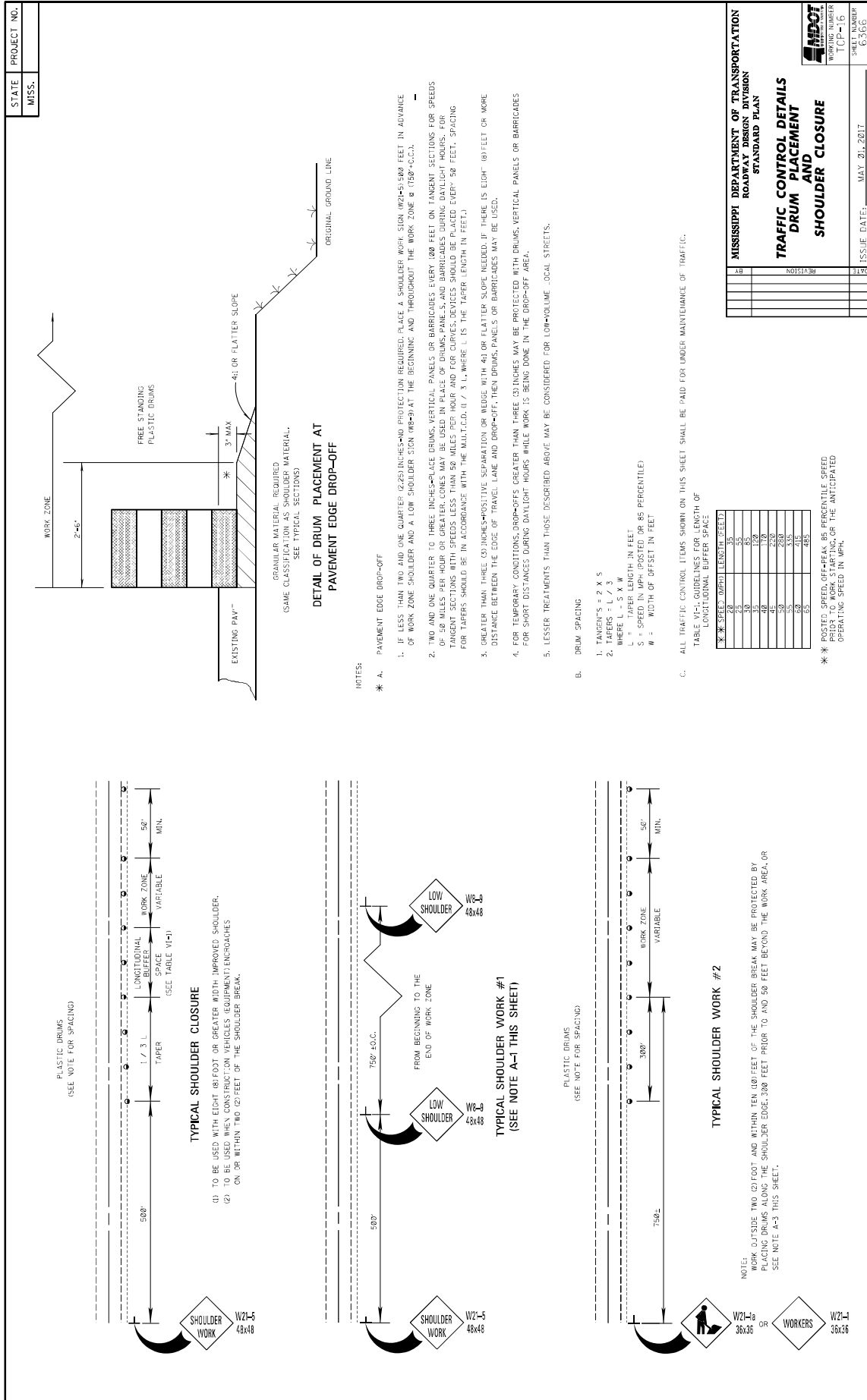

GENERAL NOTES

1. GROUND-IN RUMBLE STRIPES SHALL BE APPLIED TO LEFT SHOULDER OF ALL PAVED SHOULDERS ON THIS PROJECT.
2. GROUND-IN RUMBLE STRIPES SHALL BE APPLIED TO RIGHT SHOULDER OF ALL OVERLAID ROADWAYS AND OTHER INTERSECTIONS IN NORMAL SHOULDER WIDTH AS DIRECTED BY THE ENGINEER.
3. COST TO BE PAID FOR USING APPROPRIATE PAY ITEMS
4. GROUND-IN RUMBLE STRIPES SHALL BE APPLIED TO:
 - A. MAINLINE
 - B. INTERSECTING ROADWAY IF OVERLAID OR RECONSTRUCTED BEYOND NORMAL MAINLINE R.O.W.
 - C. ANY ROADWAY WITH EXISTING RUMBLE STRIPES PRIOR TO CONSTRUCTION.
5. DO NOT USE WHERE TRAVEL LANE IS LESS THAN 11' WIDE.

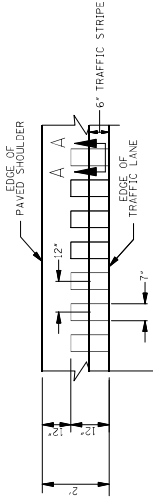

DETAIL "A"

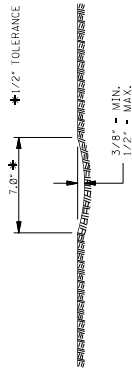

SECTION "A-A"

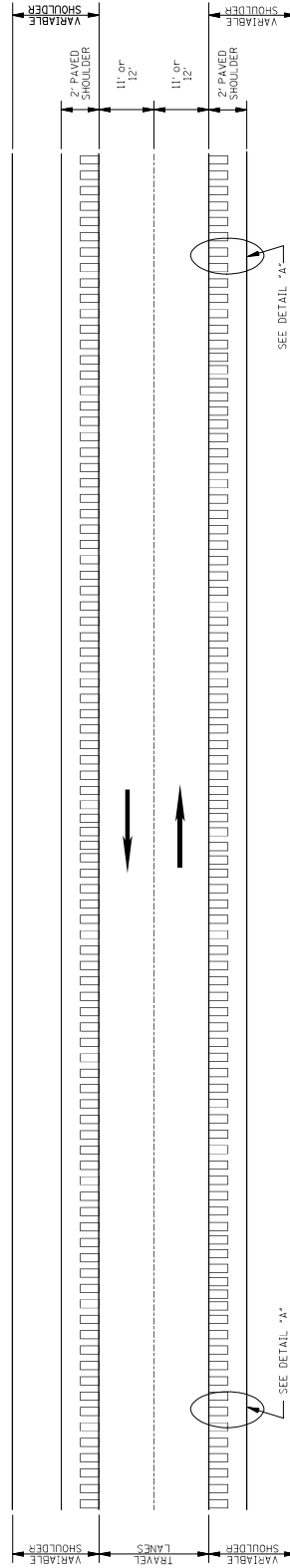

PLAN
NOT TO SCALE

MISSISSIPPI DEPARTMENT OF TRANSPORTATION		DRAWING NUMBER	
ROADWAY DESIGN DIVISION		RS-1	
STANDARD PLAN		PROJECT NUMBER	
DATE	REVISION	ISSUE DATE:	AUGUST 01, 2017
05/8	05/8		

**RUMBLE STRIPES
2-LANE HIGHWAYS
(ASPHALT LANES,
2-FT ASPHALT SHOULDERS)**

GENERAL NOTES

1. GROUND-IN RUMBLE STRIPES SHALL BE APPLIED TO ALL PAVED SHOULDERS ON THIS PROJECT.
2. GROUND-IN RUMBLE STRIPES SHALL BE APPLIED TO ALL PAVED SHOULDERS ON INTERSECTING ROADWAYS AND OTHER INTERSECTIONS IN NORMAL SHOULDER WIDTH AS DIRECTED BY THE ENGINEER.
3. COST TO BE PAID FOR USING APPROPRIATE PAY ITEMS.
4. GROUND-IN RUMBLE STRIPES SHALL BE APPLIED TO:
 - A. MAINLINE
 - B. INTERSECTING ROADWAY IF OVERLAP OR RECONSTRUCTED BEYOND NORMAL MAINLINE R.O.W.
 - C. ANY ROADWAY WITH EXISTING RUMBLE STRIPES PRIOR TO CONSTRUCTION.

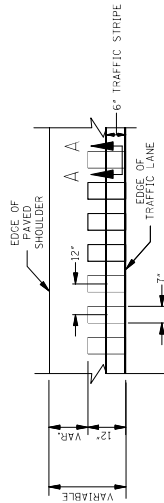
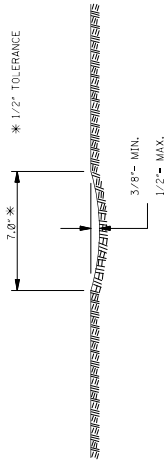

SECTION "A-A"

DETAIL "A"

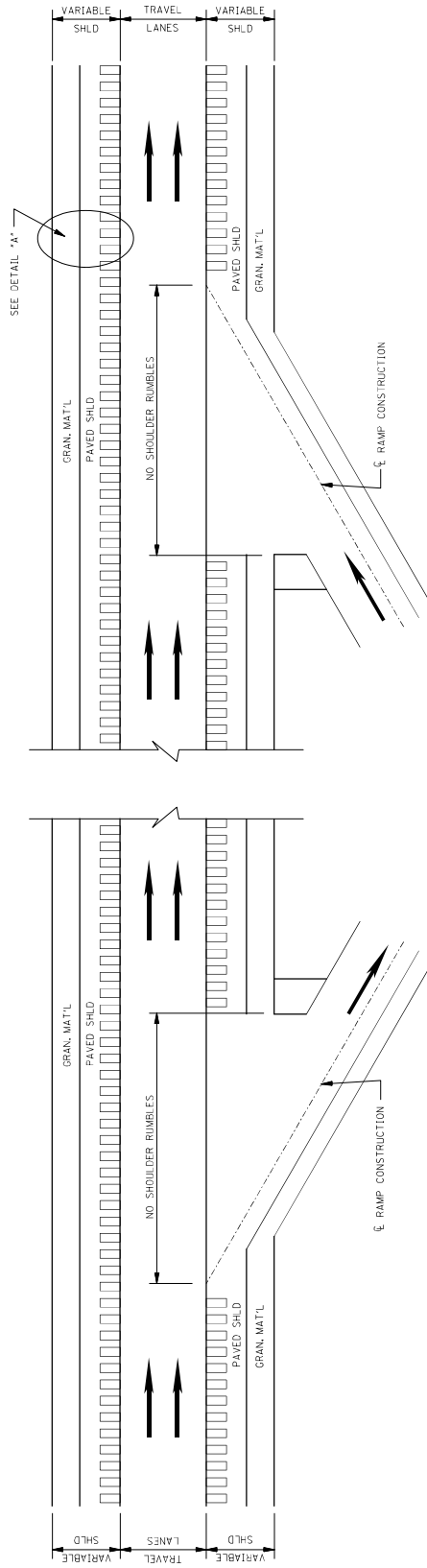

PLAN
NOT TO SCALE

DETAILS OF
RUMBLE STRIPS

MISSISSIPPI DEPARTMENT OF TRANSPORTATION		ISSUE DATE: AUGUST 01, 2017
ROADWAY DESIGN DIVISION		ISSUE NUMBER 6065
STANDARD PLAN		
RUMBLE STRIPES 4-LANE HIGHWAYS (ASPHALT LANES, 2-FT OR WIDER, ASPHALT SHOULDERS)		
DATE	REVISION	REVISION NUMBER
	05R	SS-2

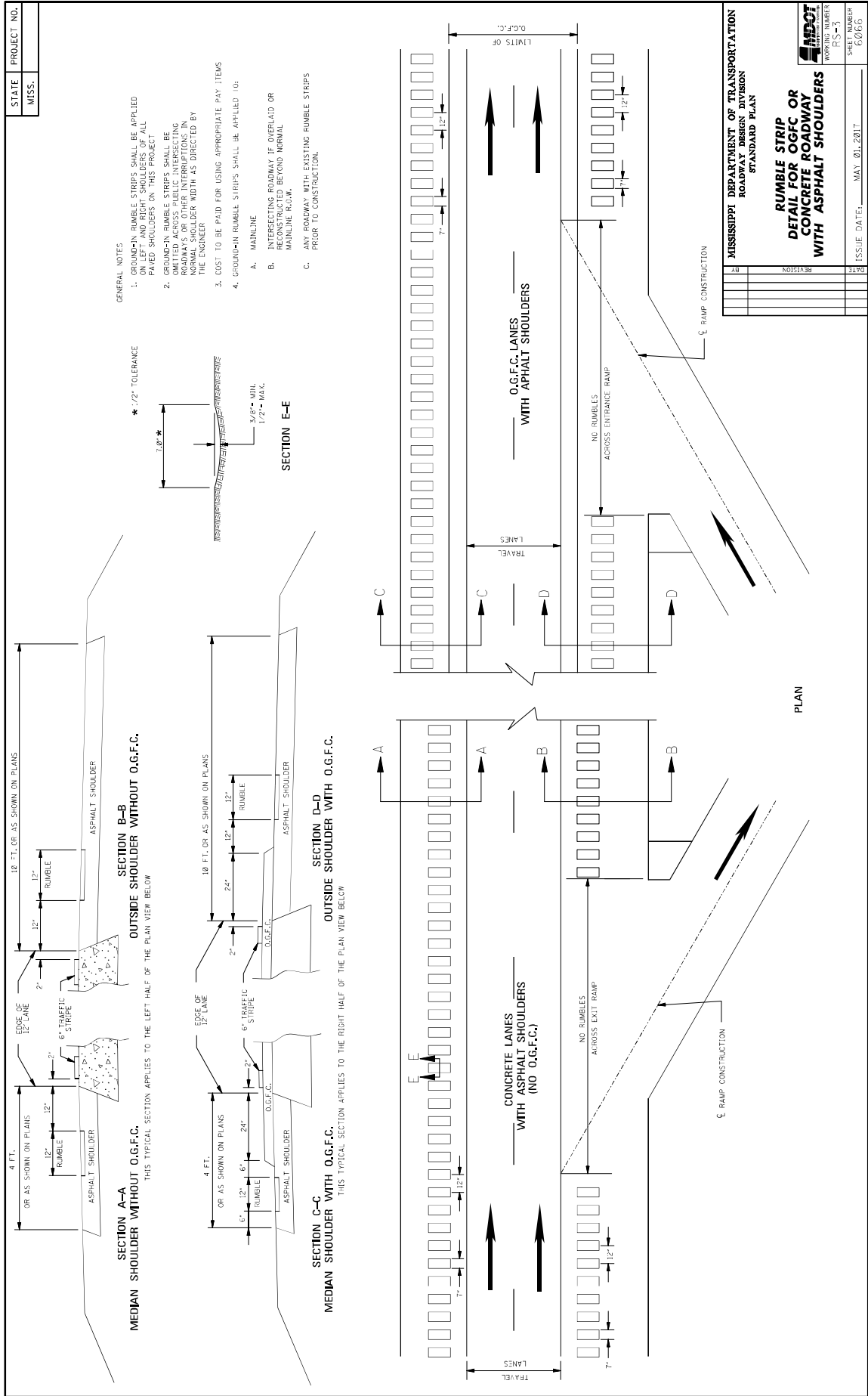

MISSISSIPPI DEPARTMENT OF TRANSPORTATION

SECTION 904 - NOTICE TO BIDDERS NO. 3676

CODE: (SP)

DATE: 09/21/2021

SUBJECT: Asphalt Gyrotory Compactor Internal Angle Calibration

Bidders are advised that by March 1, 2022, all asphalt gyrotory compactors shall be calibrated to an internal angle of $1.16^{\circ} \pm 0.02^{\circ}$. This requirement will be reflected in updates made to MT-78, MT-80, and MT-83. This calibration requirement also extends to all QC/QA testing.

MISSISSIPPI DEPARTMENT OF TRANSPORTATION

SECTION 904 - NOTICE TO BIDDERS NO. 4113

CODE: (SP)

DATE: 03/23/2022

SUBJECT: Unique Entity ID (SAM) Requirement for Federal Funded Projects

Bidders are advised that the Prime Contractor must register and maintain a current registration in the System for Award Management (<http://sam.gov>) at all times during this project. Upon registration, the Contractor will be assigned a SAM Unique Entity ID.

Bidders are also advised that prior to the award of this contract, they MUST be registered, active, and have no active exclusions in the System for Award Management.

MISSISSIPPI DEPARTMENT OF TRANSPORTATION

SECTION 904 - NOTICE TO BIDDERS NO. 4702

CODE: (SP)

DATE: 11/22/2022

SUBJECT: App for Traffic Control Reports

Bidders are advised that the Department has created a smart phone App for completing and submitting traffic control reports (Form CSD-762) required on this project. The Contractor who monitors traffic control activities and completes traffic control reports will be required to download and use this App when completing and submitting traffic control reports. The reports will then be readily available to all persons who need access to the forms. The App is free and is available for downloading at the following location.

<https://extacctmgmt.mdot.state.ms.us/>

MISSISSIPPI DEPARTMENT OF TRANSPORTATION

SECTION 904 - NOTICE TO BIDDERS NO. 5248

CODE: (SP)

DATE: 07/18/2023

SUBJECT: Contract Time

PROJECT: NHPP-0008-03(059) 108245301 – Rankin County

The calendar date for completion of work to be performed by the Contractor for this project shall be **April 4, 2025** which date or extended date as provided in Subsection 108.06 shall be the end of contract time. It is anticipated that the Notice of Award will be issued no later than **September 12, 2023** and the effective date of the Notice to Proceed / Beginning of Contract Time will be simultaneous with the execution of the contract.

MISSISSIPPI DEPARTMENT OF TRANSPORTATION

SECTION 904 - NOTICE TO BIDDERS NO. 5249

CODE:(SP)

DATE: 07/25/2023

SUBJECT: Scope of Work

PROJECT: NHPP-0008-03(059) 108245301 – Rankin County

The contract documents do not include an official set of construction plans but may, by reference, include some Standard Drawings when so specified in a Notice to Bidders entitled, “Standard Drawings”.

A general description of the work required on the project is as follows:

Mill/overlay and concrete rehabilitation of approximately 9.2 miles of existing pavement on US 49 beginning at the Simpson County line (BOP Station 10+00) and ending south of Florence (EOP Station 545+00). A section northbound and southbound from Station 288+70 to 337+43 will be omitted due to a future project. Details of specific work are mentioned in the following sections.

US 49 Northbound

From Station 10+00 (BOP) to Station 288+70

From Station 337+43 to Station 482+20

Work in this section shall consist of milling/overlaying with 2” and variable of 12.5-mm, HT Polymer Modified asphalt on mainline, 12.5-mm, HT asphalt on the outside shoulder, full depth repairs of CRCP, and pressure grouting. See attached tables for additional details. All guardrail not meeting current MDOT standards shall be replaced. Traffic will be allowed to run on the milled surfaces no more than five (5) consecutive days.

From Station 482+20 to Station 545+00 (EOP)

Work in this section shall consist of milling/overlaying with 2” and variable of 12.5-mm, HT Polymer Modified asphalt on mainline, 12.5-mm, HT asphalt on the outside shoulder, full depth repairs of JRCP, pressure grouting, and sawing and sealing of joints. See attached tables for additional details on full depth repairs. All guardrail not meeting current MDOT standards shall be replaced. Traffic will be allowed to run on the milled surfaces no more than five (5) consecutive days.

US 49 Southbound

From Station 10+00 (BOP) to Station 288+70

From Station 477+32 to Station 545+00 (EOP)

Work in this section shall consist of milling/overlaying with 2” and variable of 12.5-mm, HT Polymer Modified asphalt on mainline, 12.5-mm, HT asphalt on the outside shoulder, full depth repairs of CRCP, pressure grouting, and ditch repair. See attached tables for additional details.

All guardrail not meeting current MDOT standards shall be replaced. Traffic will be allowed to run on the milled surfaces no more than five (5) consecutive days.

From Station 337+43 to Station 477+32

Work in this section shall consist of milling/overlaying with 2” and variable of 12.5-mm, HT Polymer Modified asphalt on mainline, 12.5-mm, HT asphalt on the outside shoulder, full depth repairs of JRCP, pressure grouting, and sawing and sealing of joints. See attached tables for additional details on full depth repairs. All guardrail not meeting current MDOT standards shall be replaced. Traffic will be allowed to run on the milled surfaces no more than five (5) consecutive days.

Star Road Turn Lanes

The turn lanes on Star Road shall be widened according to the attached detail drawings. Excess excavation shall be used to remove existing material to a depth of 13”. The new pavement structure shall consist of 6” of crushed stone (day-lighted) and 7” of 12.5-mm, HT, Leveling asphalt placed in 3 lifts (2@2.5” and 1@2”). Type V Geotextile shall be placed under all areas requiring stone. This work shall be completed before milling and paving operations begin. Care shall be taken to limit the drop off to no greater than 2” if work cannot be completed in one day. Any work necessary to grade the ditches and/or restabilize any disturbed areas shall be absorbed under other items bid.

49 South to Eagle Post Road Turn Lane

Existing asphalt shall be removed to a depth of 14”. The new pavement structure shall consist of 6” of crushed stone (day-lighted) and 8” of 12.5-mm HT, Leveling asphalt placed in 3 lifts (2@3” and 1@2”). Type V Geotextile shall be placed under all areas requiring stone. This work shall be completed before milling and paving operations begin. Care shall be taken to limit the drop off to no greater than 2” if work cannot be completed in one day. Any work necessary to grade the ditches and/or restabilize any disturbed areas shall be absorbed under other items bid.

GENERAL NOTES:

MILLING

Milling/paving will not begin until an **approved** asphalt mix design has been received, nor until such time that, in the opinion of the Engineer, weather conditions have been consistently suitable enough to allow placement of the asphalt pavement after the milling operations.

The reclaimed asphalt pavement (RAP) material removed by the milling operation shall become the property of the Contractor.

Where milling is required, the Contractor shall provide outlets in the existing shoulders at sufficient intervals to prevent pooling or standing water on the milled surface, the cost of which shall be absorbed in other items bid.

Milling and paving operations shall be performed such that a -2% slope from centerline is provided in normal crown roadway sections. Super-Elevation through curves shall be maintained as it currently exists or improved as directed. Where slope correction is required correction will be

made by milling, paving, or combination thereof as directed by the Engineer. Milling correction: Mill outside edge of pavement to a depth of 1½” on a 2% slope towards the centerline. Paving Correction: Mill to depth of 1½” on existing slope and 2¼” and variable on centerline and 1½” on outside edge. Combination Method: Combination of both methods as directed by the Engineer to achieve the desired slope. In super elevated areas where correct SE exist milling will transition to thickness through curves. Where correct SE does not exist milling will transition at curves to correct SE as directed by the Engineer.

Milling operations shall be performed in accordance with the Contract documents and the MDOT Standard Specifications. Variable width and length transitions may be required for tie-ins at ramps, local roads, project limits.

Milling of driveway pads shall be conducted in a manner to prevent gouging or otherwise affecting the roadway pavement structure and slope. Milling of driveway pads shall not be done in simultaneous path with main line milling.

Traffic will be allowed to travel on the milled surface for five (5) consecutive days. Traffic will be allowed to run on all milled local roads (and crossovers) for 30 days unless otherwise stated. The Contractor will be assessed a penalty of **\$5,000 per calendar day** afterwards until the milled surfaces are covered with the next lift of asphalt. This allowance is for the Contractor’s convenience, and thus, the Contractor is responsible for any pavement failures or damage sustained during this period. Milling and paving of paved shoulders shall conform to Subsection 406.03.2 of the Standard Specifications.

PAVING

Prior to mainline milling and paving operations, failed areas in the existing concrete pavement shall be removed and repaired. JRCPC concrete failed areas shall be repaired as per the attached details. The load transfer assemblies, redwood filler board, and joint sealing shall not be paid for directly, and shall be considered included under pay item 503-A: 6” and Variable Reinforced Concrete Pavement, Broom Finish. CRCPC concrete failed areas shall be repaired as per the attached details and be paid under 8” and Variable Continuously Reinforced Concrete Pavement, Broom. The concrete pavement failures shall be removed by saw cutting and excavating the failed material. Any failures in the cement treated base shall be removed and replaced with Class “C” concrete. Payment will be made under pay item 503-D: Concrete for Base Repair. A list of the failed areas is shown in the attached tables. Pavement repairs shall be completed as a continuous operation in order to minimize traffic impacts. 12.5-mm HT, Leveling asphalt shall be placed to grade over the concrete repair, prior to opening traffic. Payment will be made under 403-B. Lane closures shall remain in place until the failed area has been completely repaired and lane closures shall not be left unattended.

A table showing locations of underlying problems with the concrete pavement has been included. The following sequence of operations will be used to correct the underlying concrete pavement problems: Fill voids under the concrete pavement, joints at the centerline of the concrete pavement, and joints at the edge of pavement between the concrete pavement and the soil cement-treated shoulder by pressure grouting. After pressure grouting, mill and replace the asphalt over the joint to a maximum depth of six inches (6”) per attached detail. After milling and prior to

replacement, if there is any remaining depth of asphalt over the joint, repair any failed asphalt by removing all loose/broken pieces. Replacement of milled area and any repair areas are to be made with 12.5-mm HT, Leveling asphalt back to existing finish grade.

The surface lift for failed area repair or concrete punchout repair shall have a maximum deviation of 3/8” as determined by a 10-foot straight edge. Any location that deviates more than this tolerance, as determined by the Engineer, shall be corrected at no additional cost to the State.

Per Subsection 401.02.3.2, the asphalt mix design shall be submitted to the Engineer at least 10 working days prior to its proposed use.

If traditional excavation methods are used, the removal area shall first be saw cut full depth including concrete, where applicable, to create a neat line and prevent damage to the adjacent pavement structure. Payment for saw cuts will be made using the appropriate items. If milling techniques are used, the area will not require saw cuts but care should be exercised to create a neat removal line and to prevent damaged to the adjacent pavement structure. If saw cuts are used in conjunction with milling, payment will be made using the appropriate pay items. Payment will not be made for saw cuts that are not performed.

Publicly maintained roads and streets should be paved to the existing right-of-way and in accordance with the attached drawings.

Privately owned entrances shall be paved to the shoulder line per the included typical drawing unless otherwise directed. Pad dimensions shall match the existing lengths and widths unless otherwise directed. Pads shall be shaped horizontally and vertically to prevent excessive drop-offs. Any new driveway pads deemed necessary by the Engineer shall be placed according to specifications.

GRANULAR SHOULDER MATERIAL

Where applicable, the existing shoulders are to be raised to match the new pavement elevation by placing variable depth granular material. The shoulders shall be graded and pulled up on a daily basis to eliminate drop-offs in excess of 2¼”. Placement of the granular material on the finished asphalt course shall not be permitted. The existing shoulder shall be scarified to allow incorporation of the new shoulder material. The material shall be bladed, rolled, and compacted to a finished slope of four percent (4%) in normal crown sections. Placement of this material shall be performed to provide a uniform and compacted shoulder with a minimum depth and width of material placed. Shoulders with adequate shoulder material in place shall be bladed to a slope of four percent (4%) in normal crown sections. The cost of blading will be an absorbed item and is to be included in the price of other items bid.

Granular material (Class 5 Group C) shall be provided around driveway pads as directed to prevent shoulder drop-offs and shall be placed in a timely manner. Drop-offs exceeding 2¼” shall be corrected within two (2) calendar days of the placement of the pad.

Any material excavated from the existing shoulder during pavement widening operations or as a result of shoulder blading shall be used on the existing shoulder to match the new pavement

elevation and any surplus material shall be spread along the edge of the shoulders, fore slopes, or other adjacent areas as directed by the Engineer and will be an absorbed item. Material which cannot be suitably placed in adjacent areas and deemed to be excess excavation by the Engineer shall be removed from the project site. Payment for removal of excess material will be made using pay item 203-G: Excess Excavation. Asphalt or rip rap placed as fill material on the shoulders shall be removed; the cost of which shall be absorbed in other items bid.

TEMPORARY AND PERMANENT PAVEMENT MARKINGS

Temporary traffic stripe will be required immediately after the milling and/or required overlay and prior to opening area to traffic. Temporary stripe shall be placed in the same location and configuration as the permanent stripe except that it may be offset as required for milling and paving operations. If temporary stripe is offset, the Contractor shall conduct operations in a manner to insure the final temporary stripe is placed at the required location of the permanent stripe. If removal of temporary offset stripe is required in order to achieve the correct location and alignment of permanent stripe, the cost of removal will be absorbed in other items bid. Placing double temporary centerline will not be allowed.

Temporary striping shall conform to finished stripe specifications for alignment, neatness, and straightness.

The use of short strips of traffic tape will not be allowed unless approved by the Engineer.

All permanent striping will be double drop thermoplastic, 90-mil thickness unless otherwise specified in Subsection 626.03.1.2. Edge lines will be placed to accommodate the lane widths shown on the attached applicable typical sections unless prevented by field conditions.

Rumble strip will be placed throughout the project limits in accordance with the attached details and MDOT Standard Drawings.

Payment for edge stripe on local roads shall be made under pay item 626-G: Thermoplastic Double Drop Detail Stripe, White when the length of said stripe is less than 150 feet when measured from the end of the radius. If the measured length is greater than 150 feet, then payment shall be made under pay item 626-B: 6" Thermoplastic Double Drop Traffic Stripe, Continuous White.

Payment for centerline stripe on local roads shall be made under pay item 626-G: Thermoplastic Double Drop Detail Stripe, Yellow when the length of said stripe is less than 150 feet when measured from the stop bar. If the measured length is greater than 150 feet, then payment shall be made under pay item 626-E: 6" Thermoplastic Double Drop Traffic Stripe, Continuous Yellow. Centerline stripe shall be omitted on local roads whose width is less than 20 feet.

The face of all existing undisturbed curbs shall be painted with at least two coats of white traffic paint with glass beads being required in the top coat. The cost associated with the painting of new or existing curb shall be included in other items bid.

The face of all existing, painted, concrete islands shall be painted with at least two coats of white traffic paint with glass beads being required in the top coat. The cost associated with the painting of new or existing curb shall be included in other items bid.

Pavement section marking tape on this project shall be located prior to overlaying and placed back in the same location after paving operations have ceased. The section marking shall be 8-inch high performance cold plastic detail stripe and shall be four feet (4') in length. The marking shall be centered across the centerline stripe. The cost of this item shall be absorbed in other items bid.

GUARDRAIL

Guardrails shall be replaced at the locations shown on the attached table. Removal of guardrail shall consist of removal of bridge end section, w-beam/thrie beam, terminal end section, posts, and all other appurtenances. All guardrail removed shall be replaced the same day and prior to reopening the adjacent lane of traffic. Voids created by the removal of posts, concrete anchors, footings, etc. shall be backfilled and compacted in accordance with Section 203 of the Standard Specifications.

Asphalt shall be extended under the guard rail and two feet (2') behind guard rail post as per the attached detail. The area to be paved shall be bladed to accommodate 3'' of 12.5-mm HT asphalt. The elevation of the finished surface of the asphalt pavement shall provide for the required MASH guardrail height (see Standard Drawings). The excavated material shall be retained and used to raise the existing shoulder to match the new pavement elevation. The cost of blading will be an absorbed item and should be included in the price of other pay items bid. Material which cannot be placed and blended in adjacent areas and deemed to be excess excavation by the Engineer shall be removed under pay item 203-G: Excess Excavation.

The asphalt guardrail pad shall be removed or milled and repaved prior to the placement of the new guardrail. Removal of the guardrail pad shall be paid for using the milling pay item. Asphalt shall be extended under the guard rail and two feet (2') behind guard rail post as per the attached detail. The area to be paved shall be bladed to accommodate 3'' of 12.5-mm HT asphalt. The elevation of the finished surface of the asphalt pavement shall provide for the required MASH guardrail height (see Standard Drawings).

Guardrail lengths are based on terminal end length of 37.5'. If terminal of length other than this is used, an adjustment in w-beam length is required.

All dimensions and spacings for bridge rail connectors shall be verified in the field by the Contractor prior to fabrication.

PERMANENT SIGNS

If specified, permanent signs as listed on the attached tables shall be replaced. Unless otherwise listed in the attached tables, existing posts, anchors, angles/bars, and other components are to be reused. The Contractor shall use new bolts, screws, washers, nuts, etc. of the required sizes in the installation of signs. If required as part of the sign replacement activities, all post and I-beam lengths in these plans are estimated. Post lengths for all signs shall be verified in the field by the Contractor prior to fabrication. Installation dates shall be clearly written in bold black markings

on the back bottom half off all signs with a permanent marking stick that is waterproof, fade resistant, and marks on wet or dry surfaces. If existing sign posts or footings are to be replaced, the existing posts and footings are to be removed and the area backfilled and compacted in accordance with Section 203 of the Standard Specifications. Removal of sign, post, and footing and backfilling will be paid using the removal of sign pay item.

Object markers at bridge approaches and other locations are to be replaced as shown in the attached table. Removal of object markers shall be absorbed in the cost of other items bid.

TRAFFIC CONTROL

The Contractor shall erect and maintain construction signing and provide all signs and traffic control devices necessary to safely maintain traffic around and through the work areas in accordance with the Traffic Control Plan and the MUTCD. The cost shall be included in the price bid for pay item 618-A: Maintenance of Traffic. Fluorescent orange sheeting shall be used on all construction and traffic control signs except those designated in the plans to be black legend and border on white background.

Standard roadside construction signs, barricades, etc. shall be placed in accordance with the attached tables, drawings, and as directed by the Engineer. W20-1 signs shall be placed on all public road approaches as shown or as directed. Payment for standard roadside construction signs, barricades, etc. will be made using the appropriate pay items.

The Contractor shall on a daily basis, remove all debris from within the roadway and a 30-foot clear zone which, in the opinion of the Engineer, is a hazard to the traveling public. This activity shall begin with the beginning of work or the beginning of the contract time, whichever comes first. No direct payment will be made for the debris removal; the cost shall be included in the prices of items bid. Failure of the Contractor to remove the debris as prescribed herein shall be just cause for withholding the monthly progress estimate payment or suspending active operations until the debris is satisfactorily removed by the Contractor.

Temporary asphalt joints (aka paper joints) shall be employed at all locations requiring traffic to traverse an uneven, transverse, pavement joint. Paper joints shall be a minimum of nine feet (9’) in length and for the full width of the milled/paved surface. Paper joints shall be adequately maintained.

MISCELLANEOUS NOTES

It shall be the responsibility of the Contractor to protect existing structures such as pipes, inlets, aprons, bridges, etc. from damage which might occur during construction. The Contractor shall replace or repair, as directed by the Engineer, any structures damaged by the Contractor during the life of the contract. No payment will be made for replacement or repair of damaged items.

Any signs that are in conflict with construction of this project shall be removed and relocated by the Contractor as directed by the Engineer; the cost of which shall be absorbed in other items bid.

Removal of existing raised pavement markers shall be included in the prices for other items bid.

Incidental work such as removing vegetation, shaping and compacting shoulders, removing and resetting signs and/or mailboxes, removing excess asphalt material, project clean-up, and other items of incidental work necessary to complete the project will not be measured for separate payment and will be considered included in the prices of items bid.

Erosion mat shall be paid and installed per the attached detail.

Crossover delineators shall be installed and paid for using pay item 630-F: Delineators, Flexible Post Mounted, Crossover, Type II. Said delineators shall be installed as per the attached detail.

Prior to the final inspection, bridges, islands, and areas with curb shall be swept/cleaned. Care should be taken to prevent milled asphalt, asphalt debris, vegetative/granular debris, etc. from entering drainage structures or clogging other drainage ways. Disposal of material will not be measured for separate payments.

Following the overlaying operation the transverse joints in the pavement shall be sawed and sealed within seven (7) days. The details for sawing and sealing transverse joints for this section are in the Standard Specifications. The width of the sawing and sealing operation will be from edge of pavement to edge of pavement, unless otherwise directed by the Engineer, to prevent “sympathy cracking”. It is the responsibility of the Contractor to locate and mark all existing joints that are to be sawed and sealed prior to the milling operation. The Contractor shall notify the Department when this is to take place so that they can oversee the work and determine the width that each joint will be sawed and sealed.

The pipe listed in the attached table shall have the existing debris and sediment removed by the Contractor and shall be paid for using pay item 202-B: Removal of Debris and Sand from Pipe, All Sizes. The applicable pay item shall be measured along the length of the pipe. The depth of sediment in the pipe is approximately 1-foot deep and is for estimation purposes only. The actual depth of the sediment shall be field verified by the Contractor prior to bidding the Project. The disposal of this material will not be measured for separate payment. Any tree removal or clearing for equipment access will be at the Engineer’s discretion and shall be absorbed in other items bid.

RANKIN COUNTY
US HWY 49
NHPP-0008-03(059)
108245/301000

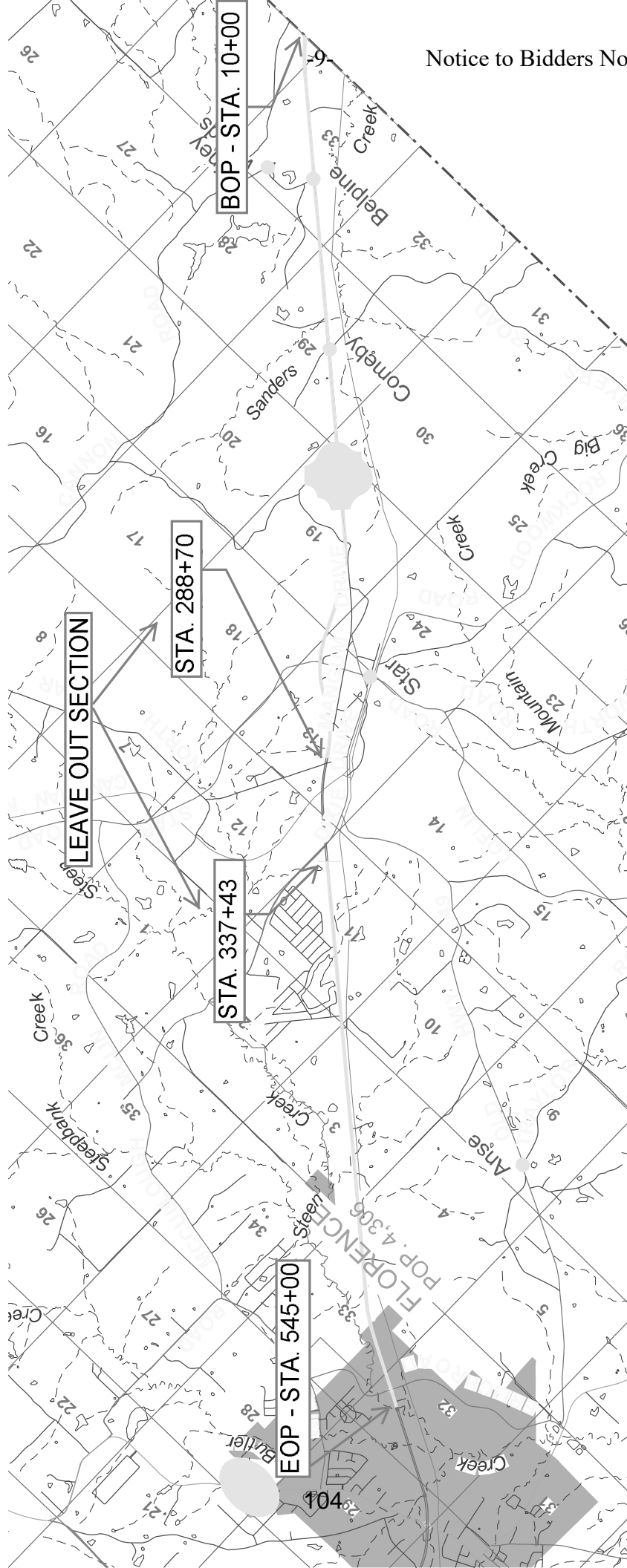

EQUATIONS:

- STA. 84+00.000 AH = 83+97.250 BK
- STA. 160+91.900 AH = 160+91.150 BK
- STA. 264+06.320 AH = 264+37.680 BK
- STA. 474+82.800 AH = 474+77.340 BK

STATE	PROJECT NO.
MISS.	NHPP-0008-03(059)

**RANKIN COUNTY
NHPP-0008-03(059)
108245/301000
HIGHWAY 49**

HIGHWAY 49 TYPICAL SECTION FOR JRCP

HIGHWAY 49 NORTHBOUND
STATION: 482+20 TO EOP

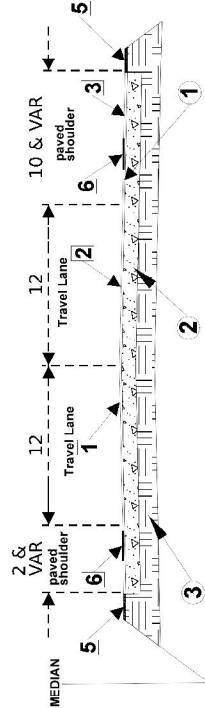

HIGHWAY 49 SOUTHBOUND
STATION: 337+43 TO 477+32

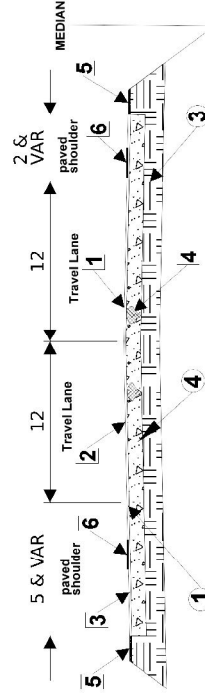

LEGEND

- [Symbol] = Overlay with 2" 12.5mm, Mix, HT Polymer Modified
- [Symbol] = Overlay outside shoulder, with 2" 12.5mm, Mix, HT, Non-Polymer Modified
- [Symbol] = Class 5 Group C
- [Symbol] = JRCP
- [Symbol] = Clay gravel
- [Symbol] = Rumble strips

- Existing:**
- ① - 4" & variable of existing asphalt
 - ② - 8" & variable of Jointed Reinforced Concrete Pavement (JRCP)
 - ③ - 6" Clay gravel
 - ④ - 6" & variable of Jointed Reinforced Concrete Pavement (JRCP)

- Proposed:**
- ① - Mill 2" of Existing Asphalt Pavement
 - ② - Overlay Mainline with 2" 12.5mm, HT, Asphalt Pavement, Polymer Modified
 - ③ - Overlay outside shoulder 2" 12.5mm, HT, Asphalt Pavement, Non-Polymer Modified
 - ④ - Repair failed area per concrete punchout typical
 - ⑤ - Place variable depth "Class 5 Group C" to bring shoulders to grade
 - ⑥ - Place rumble strip on shoulder

MISSISSIPPI DEPARTMENT OF TRANSPORTATION
DETAIL OF
JRCP SECTION

PROJECT: NHPP-0008-03(059)
COUNTY: RANKIN
SHEET NO. 1
DATE: 7/14/2022

FILENAME: 49 TYPICAL TS.DGN
DESIGN TEAM: DISTRICT 5, DCECD

STATE	PROJECT NO.
MISS.	NHP-0008-P3059

**RANKIN COUNTY
NHPP-0008-03(059)
108245/301000
HIGHWAY 49**

HIGHWAY 49 TYPICAL SECTION FOR CRCP

HIGHWAY 49 NORTHBOUND

STATION: BOP TO 288+70

STATION: 337+43 TO 482+20

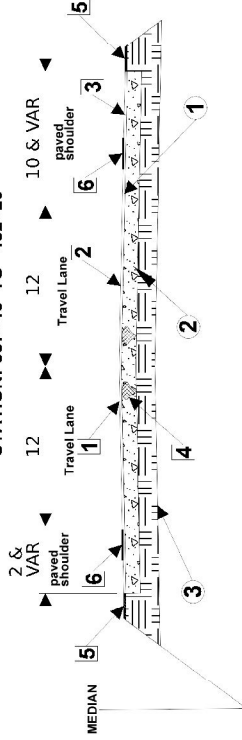

HIGHWAY 49 SOUTHBOUND

STATION: BOP TO 288+70

STATION: 477+32 TO EOP

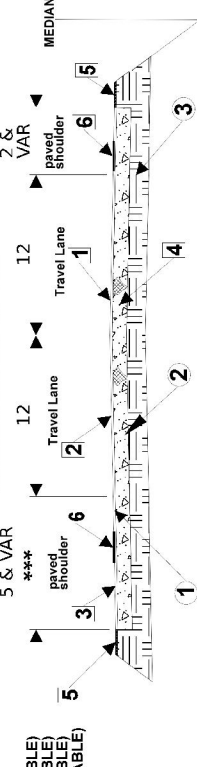

*** OUTSIDE PAVED SHOULDER WIDTH FOR SOUTHBOUND
10+00 TO 25+00 (PAVED SHOULDER WIDTH 6'-0" AND VARIABLE)
25+00 TO 205+00 (PAVED SHOULDER WIDTH 4'-0" AND VARIABLE)
210+00 TO 288+70 (PAVED SHOULDER WIDTH 8'-0" AND VARIABLE)
480+00 TO 543+55 (PAVED SHOULDER WIDTH 10'-0" AND VARIABLE)

Existing:

- ① - 4" and variable of existing asphalt
- ② - 8" & variable of Continuously Reinforced Concrete Pavement (CRCP)
- ③ - 6" of cement treated base

Proposed:

- ① - Mill 2" of Existing Asphalt Pavement
- ② - Overlay Mainline with 2" 12.5mm, HT, Asphalt Pavement, Polymer Modified
- ③ - Overlay outside shoulder 2" 12.5mm, HT, Asphalt Pavement, Non-polymer Modified
- ④ - Repair failed area per concrete punchout typical
- ⑤ - Place variable depth crushed stone to bring shoulders to grade
- ⑥ - Place rumble strip on shoulder

LEGEND

- ① = Overlay with 2" 12.5mm, Mix, HT Polymer Modified
- ② = Overlay outside shoulder with 2" 12.5mm, Mix, HT, Non-Polymer Modified
- ③ = Class 5 Group C
- ④ = CRCP
- ⑤ = Cement treated base
- ⑥ = Rumble strips

MISSISSIPPI DEPARTMENT OF TRANSPORTATION	
DETAIL OF	
CRCP SECTION	
PROJECT: NHPP-0008-03(059)	SECTION NUMBER: 15-2
COUNTY: RANKIN	FILENAME: 49 TYPICAL.TSDGN
DESIGN TEAM: DISTRICT 5, DESIGP	DATE: 1/14/2022

RANKIN COUNTY NHPP-0008-03(059) 108245/301000 HIGHWAY 49

OMITTING STATIONS: 288+70 TO 337+43



CONSTRUCTION SIGNING DETAIL

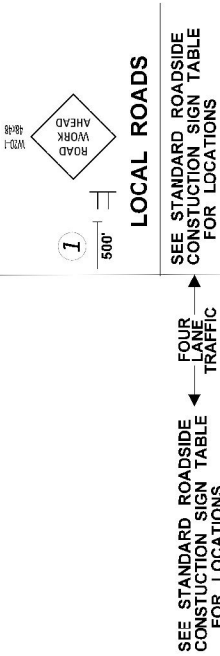

SIGN LEGEND	DESCRIPTION
1	ROAD WORK AHEAD W20-1 48x48
2	END ROAD WORK G20-2 48x24
3	SPEED LIMIT R2-1 48x60 XX
4	WHEN WORKERS ARE PRESENT R16-3 48x60 SPEEDING FINES DOUBLED

NOTE:

OMITTING STATIONS 288+70 TO 337+43, W20-1 "ROAD WORK AHEAD" SIGNS IS REQUIRED AT EACH LOCAL ROAD, STREET, OR HIGHWAY ENTERING THE PROJECT.

G20-2 "END ROAD WORK" SIGNS MOUNTED ON TYPE III SINGLE FACED BARRICADE 6 FEET WIDE.

R16-3 W3-5, R2-1 "SPEED LIMIT SPEED WARNING AND SPEEDING FINES DOUBLED" SIGNS WILL ALSO BE REQUIRED. THE R2-1 WILL REQUIRE FLUORESCENT ORANGE PLAQUE.

FIELD CONDITIONS MAY REQUIRE SOME SIGNS ON THE DETAIL TO BE ADJUSTED.

THE ABOVE SHOWN ITEMS WILL BE PAID UNDER THE APPROPRIATE PAY ITEM.

Notice to Bidders No. 24

MISSISSIPPI DEPARTMENT OF TRANSPORTATION
DETAIL OF
TRAFFIC CONTROL PLAN

PROJECT: NHPP-0008-03(059)
COUNTY: RANKIN
FILENAME: 49_TYPICAL.IS.DGN
REGION: TEAM DISTRICT 5 DESIGD 1/14/2002

TRANSPORTATION
PROJECT NUMBER
SHEET NO. 3
DATE

RANKIN COUNTY NHPP-0008-03(059) 108245/301000 HIGHWAY 49

STATE MISS. PROJECT NO. NHPP-0008-03(059)

NOTE:

OMITTING STATIONS 288+70 TO 337+34, W20-1 "ROAD WORK AHEAD" SIGNS IS REQUIRED AT EACH LOCAL ROAD STREET, OR HIGHWAY ENTERING THE PROJECT.

G20-2 "END ROAD WORK" SIGNS MOUNTED ON TYPE III SINGLE FACED BARRICADE 6 FEET WIDE.

R16-3, W3-5, R2-1 " SPEED LIMIT, SPEED WARNING, AND SPEEDING FINES DOUBLE" SIGNS WILL ALSO BE REQUIRED. THE R2-1 WILL REQUIRE FLUORESCENT ORANGE PLAQUE.

FIELD CONDITIONS MAY REQUIRE SOME SIGNS ON THE DETAIL TO BE ADJUSTED.

THE ABOVE SHOWN ITEMS WILL BE PAID UNDER THE APPROPRIATE PAY ITEM.





TRAFFIC CONTROL SIGNS REQUIRED:

- 8 - G20-2 "END ROAD WORK"
- 43 - W20-1 "ROAD WORK AHEAD XX"
- 16 - TYPE III SINGLE FACED BARRICADE
- 4 - R16-3 "WHEN WORKERS ARE PRESENT SPEEDING FINES ARE DOUBLED"
- 6 - R2-1 "SPEED LIMIT XX" SIGNS
- 4 - W3-5 " SPEED LIMIT AHEAD XX" SIGNS
- 4 - TYPE B WARNING LIGHTS

-13-

Notice to Bidders No. 24

CONSTRUCTION SIGNING DETAIL

SIGN LEGEND	DESCRIPTION
1	 W20-1 48x48 ROAD WORK AHEAD
2	 G20-2 48x24 END ROAD WORK
3	 R2-1 48x60 SPEED LIMIT XX
4	 W3-5 48x48 SPEED LIMIT AHEAD XX
5	 R16-3 48x60 WHEN WORKERS ARE PRESENT SPEEDING FINES DOUBLED

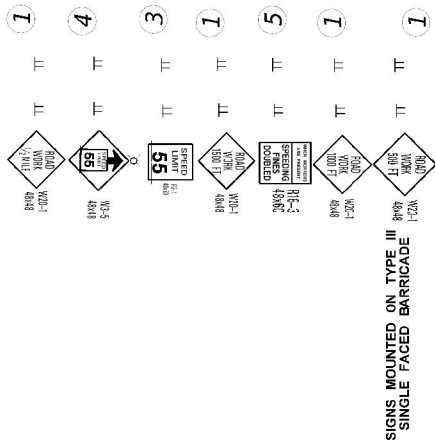

EOP STA. 545+00

SIGNS MOUNTED ON TYPE III SINGLE FACED BARRICADE

G20-2
48x24
END ROAD WORK

SEE STANDARD ROADSIDE CONSTRUCTION SIGN TABLE FOR LOCATIONS

LOCAL ROADS

SIGNS MOUNTED ON TYPE III SINGLE FACED BARRICADE

W20-1
48x48
ROAD WORK 500 FT
STA. 332+43

OMITTING STATIONS: 288+70 TO 337+43

MISSISSIPPI DEPARTMENT OF TRANSPORTATION
DETAIL OF
TRAFFIC CONTROL PLAN

PROJECT: NHPP-0008-03(059)
COUNTY: RANKIN
FILENAME: 49 TYPICAL.TSDGN
DESIGN TEAM: DISTRICT 5, DESIGP
DATE: 1/14/2022

PUNCHOUT CRCP QUANTITIES 108245/301000													
Station	Station	Location	Width (ft)	Length (ft)	503-B001 Saw Cut Longitudinal Joint, LF	503-C004 Saw Cut, 3 - inch	503-C010 Saw Cut, Full Depth, LF	202-B069 Removal of Concrete Pavement w/ Variable Depth Overlay	202-B045 Removal of Cement Treated Base, All Depths, SY	503-D001 Concrete for Base Repair, CY	503-E002 Tie Bars, NO.5 Deformed, Drilled And Epoxied or Grouted, EA	503-A001 8" and Variable Continuously Reinforced Concrete Pavement, Broom Finish, SY	403-B001 12.5-mm, HT, Asphalt Pavement, Leveling, Ton
159+56	159+64	RRL	12	8	8	24	32	11	5.5	1	5	11	2
479+92	480+00	LLL	12	8	8	24	32	11	5.5	1	5	11	2
479+92	480+00	RLL	15	8	8	30	38	13	6.5	1	5	13	2
480+23	480+31	LLL	15	8	8	30	38	13	6.5	1	5	13	2
480+23	480+31	RLL	15	8	8	30	38	13	6.5	1	5	13	2
482+25	482+33	LLL	12	8	8	24	32	11	5.5	1	5	11	2
482+25	482+33	RLL	16	8	8	32	40	14	7	1	5	14	2
484+22	484+57	LLL	12	34	34	24	58	45	22.5	1	18	45	10
484+22	484+57	RLL	21	34	34	42	76	79	39.5	1	18	79	17
TOTAL					124.00	260.00	384.00	210.00	105.00	9.00	71.00	210.00	41.00

Quantities were rounded on estimate, quantities to be used as directed by the Engineer. CRCP repairs were estimated using the PR-1B Typical CRC Pavement Repair Standard. If the Contractor elects to use PR-1A Optioinal Welding Method, then the pay item quantities will be adjusted accordingly. The load transfer device necessary for jointed concrete pavement repair is to be included in the cost of the 503-A001 pay item.

PUNCHOUT JRPC QUANTITIES 108245/301000													
Station	Station	Location	Width (ft)	Length (ft)	503-C010 Saw Cut, Full Depth, LF	503-B001 Saw Cut Longitudinal Joint, LF	202-B069 Removal of Concrete Pavement w/ Variable Depth Overlay	202-B045 Removal of Cement Treated Base, All Depths, SY	503-D001 Concrete for Base Repair, CY	503-F002 1" Smooth Dowel Bars, Drilled & Epoxied or Grouted, EA	503-E002 Tie Bars, NO.5 Deformed, Drilled And Epoxied or Grouted, EA	503-A014 6" and Variable Reinforced Concrete Pavement, Broom Finish, SY	403-B001 12.5-mm, HT, Asphalt Pavement, Leveling, Ton
369+40	369+46	LLL	12	6	30	6	8	4	1	12	4	8	1
369+40	369+46	RLL	15	6	36	6	10	5	1	15	4	10	2
403+60	403+66	LLL	12	6	30	6	8	4	1	12	4	8	1
425+80	426+20	LLL	12	40	64	40	53	26.5	1	12	21	53	6
425+80	426+20	RLL	19	40	78	40	84	42	1	19	21	84	9
428+80	429+20	LLL	12	40	64	40	53	26.5	1	12	21	53	6
441+00	441+20	LLL	12	20	44	20	27	13.5	1	12	11	27	3
441+00	441+20	RLL	15	20	50	20	33	16.5	1	15	11	33	4
444+00	444+20	LLL	12	20	44	20	27	13.5	1	12	11	27	3
444+60	445+00	LLL	12	40	64	40	53	26.5	1	12	21	53	6
461+36	461+42	RLL	15	6	36	6	10	5	1	15	4	10	2
467+00	467+40	LLL	12	40	64	40	53	26.5	1	12	21	53	9
468+49	468+55	LLL	12	6	30	6	8	4	1	12	4	8	1
468+49	468+55	RLL	15	6	36	6	10	5	1	15	4	10	1
476+75	477+15	LLL	12	40	64	40	53	26.5	1	12	21	53	6
476+75	477+15	RLL	15	40	70	40	67	33.5	1	15	21	67	7
TOTAL					804.00	376.00	557.00	278.50	16.00	214.00	204.00	557.00	67.00

Quantities were rounded on estimate, quantities to be used as directed by the Engineer. The load transfer device necessary for jointed concrete pavement repair is to be included in the cost of the 503-A001 pay item.

FAILED AREAS AND PRESSURE GROUT QUANTITIES 108245/301000									
Beginning Station	Ending Station	Direction	Lane	Length (FT)	Width (FT)	202-B009 Removal of Asphalt, Failed Areas (SY)	403-B001 12.5-mm, HT, Asphalt Pavement, Leveling, Ton	512-A001 Holes (EACH)	512-B001 Cement Pressure Grout Slurry, Type 5 (POUNDS)
78+15	78+55	NB	RT RRL	40	2	8.9	2.2	9	40
155+30	156+65	NB	RT RRL	135	2	30.0	7.4	28	135
160+00	160+30	NB	RT RRL	30	2	6.7	1.7	7	30
161+85	162+15	NB	RT RRL	30	2	6.7	1.7	7	30
163+80	164+20	NB	RT RRL	40	2	8.9	2.2	9	40
165+65	165+80	NB	RT RRL	15	2	3.3	0.8	4	15
167+30	167+50	NB	RT RRL	20	2	4.4	1.1	5	20
171+00	171+20	NB	RT RRL	20	2	4.4	1.1	5	20
186+80	187+20	NB	RT RRL	40	2	8.9	2.2	9	40
190+80	191+10	NB	RT RRL	30	2	6.7	1.7	7	30
196+40	197+00	NB	RT RRL	60	2	13.3	3.3	13	60
198+40	198+70	NB	RT RRL	30	2	6.7	1.7	7	30
209+55	210+00	NB	RT RRL	45	2	10.0	2.5	10	45
226+30	226+45	NB	RT RRL	15	2	3.3	0.8	4	15
286+30	286+80	NB	RT RRL	50	2	11.1	2.8	11	50
542+00	543+40	NB	CL RRL	140	2	31.1	7.7	29	140
Totals:						164	41	164	740

**Notes: Locations and Measurements are Approximate and may Vary With Field Conditions.
All failed areas and pressure grouting locations facing upstation direction.**

GUARD RAIL QUANTITIES 108245/301000													
STATION	GUARDRAIL		TERMINAL END		CABLE ANCHOR TYPE 1	TYPE "A"	BRIDGE END		DELINEATORS		TYPE 3 OBJECT MARKERS	GUARDRAIL REMOVAL	REMARKS
	LOCATION (LT/RT)	W-BEAM (LF)	FLARED END SECTION	NON-FLARED END SECTION			SPECIAL SECTIONS, GUARD RAIL BRIDGE END CONNECTOR	WHITE	YELLOW	GUARDRAIL REMOVAL			
545+00	L7/LT	112.5	1			1	1	1	6		1	190	
545+00	RT/LT	112.5	1			1	1	1		6	1	190	
541+10	RT/RT	200	1			1	1	1	8		1	250	
541+35	L7/RT	175	1			1	1	1		7	1	225	
493+75	RT/RT	450	1	1					10		1	500	
442+45	RT/RT	250	1	1					8		1	300	
76+00	L7/LT	350	1	1					10		2	400	
97+75	L7/LT	350	1	1					10		1	400	
123+05	L7/LT	260	1	1					10		1	310	
189+85	L7/LT	225	1	1					8		1	275	
199+05	L7/LT	350	1	1					10		1	400	Reinstall as existing condition. Remove & Reset recreational signs on object marker post. Cost absorbed.
367+05	L7/LT	30	1	1					4		2	80	
380+80	L7/LT	200	1	1					8		1	250	
447+90	L7/LT	350	1	1					8		1	400	
496+45	L7/LT	85	1	1					5		1	135	
TOTAL =		3500.00	4.00	11.00	11.00	4.00	4.00	4.00	105.00	13.00	17.00	4305.00	
		LF.	EA.	EA.	EA.	EA.	EA.	EA.	EA.	EA.	EA.	LF.	

* REMOVAL OF ALL GUARDRAIL (BRIDGE END SECTIONS, W-BEAM, TYPE-I CABLE ANCHORAGE, TERMINAL END SECTIONS, ETC.) WILL BE PAID UNDER PAY ITEM 202-B REMOVAL OF GUARD RAIL.

* REMOVAL OF GUARDRAIL DELINEATORS ARE CONSIDERED INCIDENTAL TO THE REMOVAL OF GUARDRAIL AND WILL NOT BE MEASURED AS A SEPARATE PAY ITEM.

* ALL GUARDRAIL, POSTS, BLOCKOUTS, CONCRETE ANCHORS, HARDWARE, ETC. WILL BE THE PROPERTY OF THE CONTRACTOR.

* TOTAL GUARDRAIL LENGTH IS BASED ON A TERMINAL END SECTION 37.5' LONG. IF A TERMINAL END SECTION OF A DIFFERENT LENGTH IS USED, THE LENGTH OF THE W-BEAM MAY HAVE TO BE ADJUSTED.

REMOVAL OF OBJECT MARKERS WILL NOT BE MEASURED AS A SEPARATE PAY ITEM AND SHALL BE ABSORBED IN OTHER ITEMS

TURN LANE WIDENING AND REPAIRS 108245/301000												
STATION	LENGTH, LF	WIDTH, LF	AREA, SY	202-B009 REMOVAL OF ASPHALT PAVEMENT, FAILED AREAS	503-C010 SAW CUT, FULL DEPTH, LF	202-B092 REMOVAL OF CURB, ALL TYPES	203-G002 EXCESS EXC, LVM, CY	209-A005 GEOTEXTILE TYPE V., SY	304-F002 610 CRUSHED STONE, TON	403-A001 12.5 MM, HT, TON	403-B001 12.5 MM, HT, LEVELING, TON	REMARKS
252+50	115.00	13.00	83.06		54.00	54.00	37.49	83.06	23.36	31.98		Star Rd. Widening
254+40	94.00	12.00	62.67		57.00	57.00	28.29	62.67	17.63	24.13		W. Main St. Widening
539+50	217.00	10.00	241.11	241.11	237.00			241.11	67.81		106.09	Eagle Post Rd. Failed Area
			TOTAL	241.11	348.00	111.00	65.78	386.83	108.80	56.10	106.09	

NOTES: ANY AREAS DISTURBED BY THE CONTRACTOR SHALL BE RESTABILIZED AT NO ADDITIONAL COST TO THE STATE
ADEQUATE DITCH DRAINAGE SHALL BE PROVIDED, AND ALL SITE GRADING AND INCIDENTAL GRASSING SHALL BE ABSORBED IN OTHER ITEMS BID

DITCH REPAIRS 108245/301000									
STATION	STATION	LENGTH, LF	WIDTH, LF	DEPTH, LF	203-G002 EXCESS EXC, LVM, AH (CY)	203-EX041 BORROW EXC, AH, LVM, B9-6 (CY)	229-A001 EROSION MAT (SY)	202-B114 REMOVAL OF DEBRIS AND SAND FROM PIPE, ALL SIZES (LF)	Remarks
229+80	238+08	828.00	9.00	1.00	128.80	172.50	736.00	8.00	US 49 SB LT
					128.80	172.50	736.00	8.00	
NOTES: ANY AREAS DISTURBED BY THE CONTRACTOR SHALL BE RESTABILIZED AT NO ADDITIONAL COST TO THE STATE ALL SITE GRADING, INCIDENTAL GRASSING AND SOLID SODDING IN AND AROUND REPAIRED DITCH SHALL BE ABSORBED IN OTHER ITEMS BID SEE DETAIL FOR INSTALLATION OF EROSION MAT FOR ADDITIONAL INFORMATION									

619-D2001 Standard Roadside Construction Signs, 10 Square Feet or More					
Station	Location	Description	Quantity	Unit	Remarks
51+00	RRL	W20-1 (Road Work Ahead)	16	SF	Everett Reese Rd
65+75	RRL	W20-1 (Road Work Ahead)	16	SF	Piney Woods Rd
120+70	RRL	W20-1 (Road Work Ahead)	16	SF	Cox 40 Rd
134+75	RRL	W20-1 (Road Work Ahead)	16	SF	Speights Rd
127+70	LLL	W20-1 (Road Work Ahead)	16	SF	Myers Rd
145+00	RRL	W20-1 (Road Work Ahead)	16	SF	Big Jim Ln
202+00	RRL	W20-1 (Road Work Ahead)	16	SF	Levi Cooper Rd
210+00	LLL	W20-1 (Road Work Ahead)	16	SF	Mangum Dr
254+15	RRL	W20-1 (Road Work Ahead)	16	SF	Star Rd
254+00	LLL	W20-1 (Road Work Ahead)	16	SF	W Main St
257+00	LLL	W20-1 (Road Work Ahead)	16	SF	Pecan Ln
279+50	LLL	W20-1 (Road Work Ahead)	16	SF	Wesleyanna St
293+70	LLL & RLL	W20-1 (Road Work Ahead 500 FT)	32	SF	288+70 TO 337+43 Omitted
332+43	LRL & RRL	W20-1 (Road Work Ahead 500 FT)	32	SF	288+70 TO 337+43 Omitted
366+45	RRL	W20-1 (Road Work Ahead)	16	SF	Richmond Dr
365+50	LLL	W20-1 (Road Work Ahead)	16	SF	Collins Rd
391+00	RRL	W20-1 (Road Work Ahead)	16	SF	Monmouth Rd
391+55	LLL	W20-1 (Road Work Ahead)	16	SF	Brewer Rd
434+00	LLL	W20-1 (Road Work Ahead)	16	SF	Thames Cr
451+50	LLL	W20-1 (Road Work Ahead)	16	SF	Fern Dr
468+65	LLL	W20-1 (Road Work Ahead)	16	SF	Spell Ln
485+50	LLL	W20-1 (Road Work Ahead)	16	SF	Summerlin Rd
537+00	RRL	W20-1 (Road Work Ahead)	16	SF	Eagle Post Rd
535+70	LLL	W20-1 (Road Work Ahead)	16	SF	Eagle Post Rd
541+25	LLL	W20-1 (Road Work Ahead)	16	SF	49 Pl
US 49 NB	LRL & RRL	W20-1 (Road Work Ahead 1/2 MI)	32	SF	2640' South of BOP
US 49 NB	LRL & RRL	W3-5 (Speed Zone 55 MPH)	32	SF	2000' South of BOP
US 49 NB	LRL & RRL	R2-1 (Speed Limit 55 MPH)	40	SF	1750' South of BOP
US 49 NB	LRL & RRL	W20-1 (Road Work Ahead 1500 FT)	32	SF	1500' South of BOP
US 49 NB	LRL & RRL	R16-3 (Speeding Fines Doubled)	40	SF	1250' South of BOP
US 49 NB	LRL & RRL	W20-1 (Road Work Ahead 1000 FT)	32	SF	1000' South of BOP
US 49 NB	LRL & RRL	W20-1 (Road Work Ahead 500 FT)	32	SF	500' South of BOP
US 49 SB	LLL & RLL	W20-1 (Road Work Ahead 1/2 MI)	32	SF	2640' North of EOP
US 49 SB	LLL & RLL	W3-5 (Speed Zone 55 MPH)	32	SF	2000' North of EOP
US 49 SB	LLL & RLL	R2-1 (Speed Limit 55 MPH)	40	SF	1750' North of EOP
US 49 SB	LLL & RLL	W20-1 (Road Work Ahead 1500 FT)	32	SF	1500' North of EOP
US 49 SB	LLL & RLL	R16-3 (Speeding Fines Doubled)	40	SF	1250' North of EOP
US 49 SB	LLL & RLL	W20-1 (Road Work Ahead 1000 FT)	32	SF	1000' North of EOP
US 49 SB	LLL & RLL	W20-1 (Road Work Ahead 500 FT)	32	SF	500' North of EOP
US 49 SB	LLL & RLL	R2-1 (Speed Limit 65 MPH)	40	SF	750' South of BOP

TOTAL		952	SF		
619-G7001 Warning Lights, Type "B"					
Station	Location	Description	Quantity	Unit	Remarks
US 49 NB	LRL & RRL	Mounted on W3-5	2	EA	1750' South of BOP
US 49 SB	LLL & RLL	Mounted on W3-5	2	EA	1750' North of EOP
TOTAL			4	EA	
619-D1001 Standard Roadside Construction Signs, Less than 10 Square Feet					
Station	Location	Description	Quantity	Unit	Remarks
550+00	LRL & RRL	G20-2 (End Road Work)	16	SF	500' North of EOP
337+43	LLL & RLL	G20-2 (End Road Work)	16	SF	288+70 TO 337+43 Omitted
288+70	LRL & RRL	G20-2 (End Road Work)	16	SF	288+70 TO 337+43 Omitted
5+00	LLL & RLL	G20-2 (End Road Work)	16	SF	500' South of BOP
US 49 NB	LRL & RRL	Fluorescent Orange Plaque	10	SF	1750' South of BOP. Mounted on R2-1
US 49 SB	LLL & RLL	Fluorescent Orange Plaque	10	SF	1750' North of EOP. Mounted on R2-1
US 49 SB	LLL & RLL	Fluorescent Orange Plaque	10	SF	750' South of BOP. Mounted on R2-1
TOTAL			94	SF	
619-G4005 Barricades. Type III, Single Faced					
Station	Location	Description	Quantity	Unit	Remarks
550+00	LRL & RRL	Mounted on G20-2	12	LF	500' North of EOP
337+43	LLL & RLL	Mounted on G20-2	12	LF	288+70 TO 337+43 Omitted
5+00	LRL & RRL	Mounted on W20-1 (Road Work Ahead 500 FT)	12	SF	500' South of BOP
550+00	LLL & RLL	Mounted on W20-1 (Road Work Ahead 500 FT)	12	SF	500' North of EOP
332+43	LRL & RRL	Mounted on W20-1 (Road Work Ahead 500 FT)	12	SF	288+70 TO 337+43 Omitted
293+70	LLL & RLL	Mounted on W20-1 (Road Work Ahead 500 FT)	12	SF	288+70 TO 337+43 Omitted
288+70	LRL & RRL	Mounted on G20-2	12	LF	288+70 TO 337+43 Omitted
5+00	LLL & RLL	Mounted on G20-2	12	LF	500' South of BOP
TOTAL			96	LF	

MISSISSIPPI DEPARTMENT OF TRANSPORTATION
 PRESSURE GROUTING DETAIL

PROJECT NO.: NEHP-0008-03(059)
 COUNTY: HANKIN

FILE NAME: _____
 DESIGN TEAM: _____
 SHEET NUMBER: **EG-1**
 TOTAL SHEETS: **9**

DATE: _____

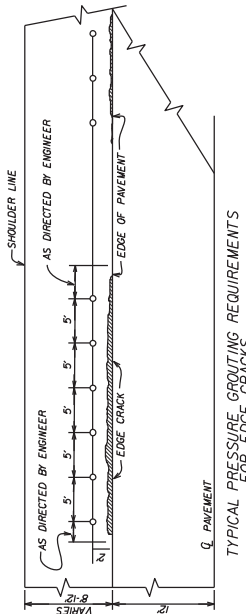
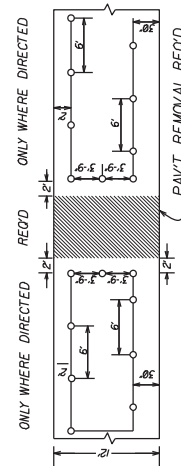
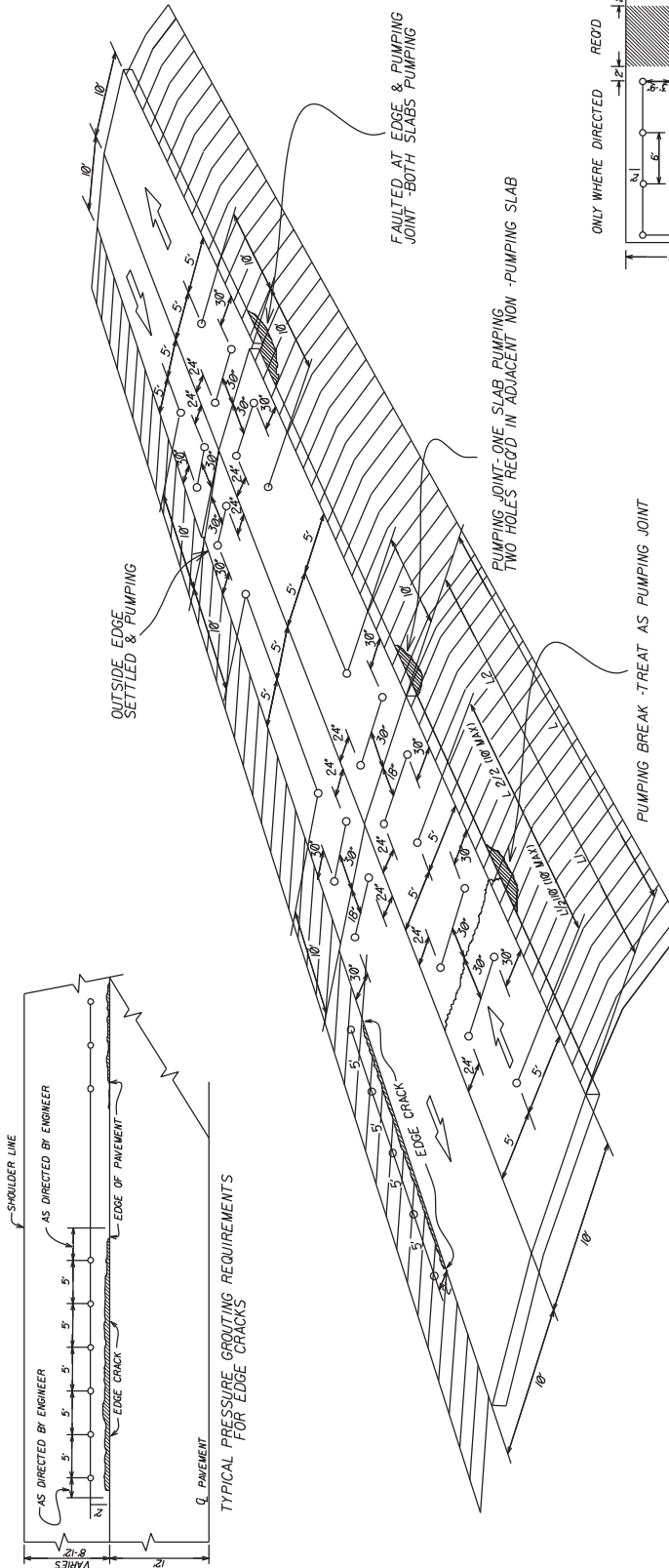

- NOTES:
1. DO NOT LOCATE HOLES WITHIN 18" OF JOINT BREAK OR PAVEMENT EDGE. ADDITIONAL HOLES MAY BE REQUIRED IF THE SLAB IS BROKEN. KNOWN CAVITY LOCATIONS SHOULD TAKE PRECEDENCE IN LOCATING HOLES.
 2. THE ABOVE HOLE LOCATIONS FOR THE CONDITIONS CITED ARE TO BE PERFORMED IN THE INITIAL GROUTING OPERATION.
 3. THE DIMENSIONS & LOCATIONS SHOWN ARE TYPICAL. THE EXACT DIMENSIONS & LOCATIONS MAY VARY DURING CONSTRUCTION AS DIRECTED BY THE ENGINEER.

STATE PROJECT NO.
MISS. HPP-0088-03(059)

MISSISSIPPI DEPARTMENT OF TRANSPORTATION	
LONGITUDINAL JOINT REPAIR	
WORKING NUMBER	101R-1
COUNTY	RANKIN
FILE NAME	
DESIGN TEAM	DECD 7/01/2021
BY	
REVISION	

LONGITUDINAL JOINT REPAIR

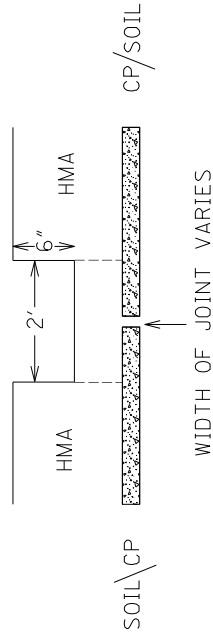

Prior to mill/overlay of the lanes, where condition of existing HMA surface course indicates underlying problems with the CP: Fill voids under the CP, joints at the centerline of the CP, and joints at the edge of pavement between the CP and soil cement treated shoulder by pressure grouting. Subsequent to pressure grouting, mill and replace HMA over the joint to a maximum depth of 6". After milling and prior to replacement, if there is any remaining depth of HMA over the joint, repair any failed HMA by removing all loose/broken pieces. Replacement of milled area and any repair area to be made with 12.5mm, HT, Asphalt Pavement, Leveling back to existing finish grade.

NOTE: REFER TO PRESSURE GROUTING DETAIL SHEET.

CONCRETE EXPANSION JOINT REPAIR DETAILS

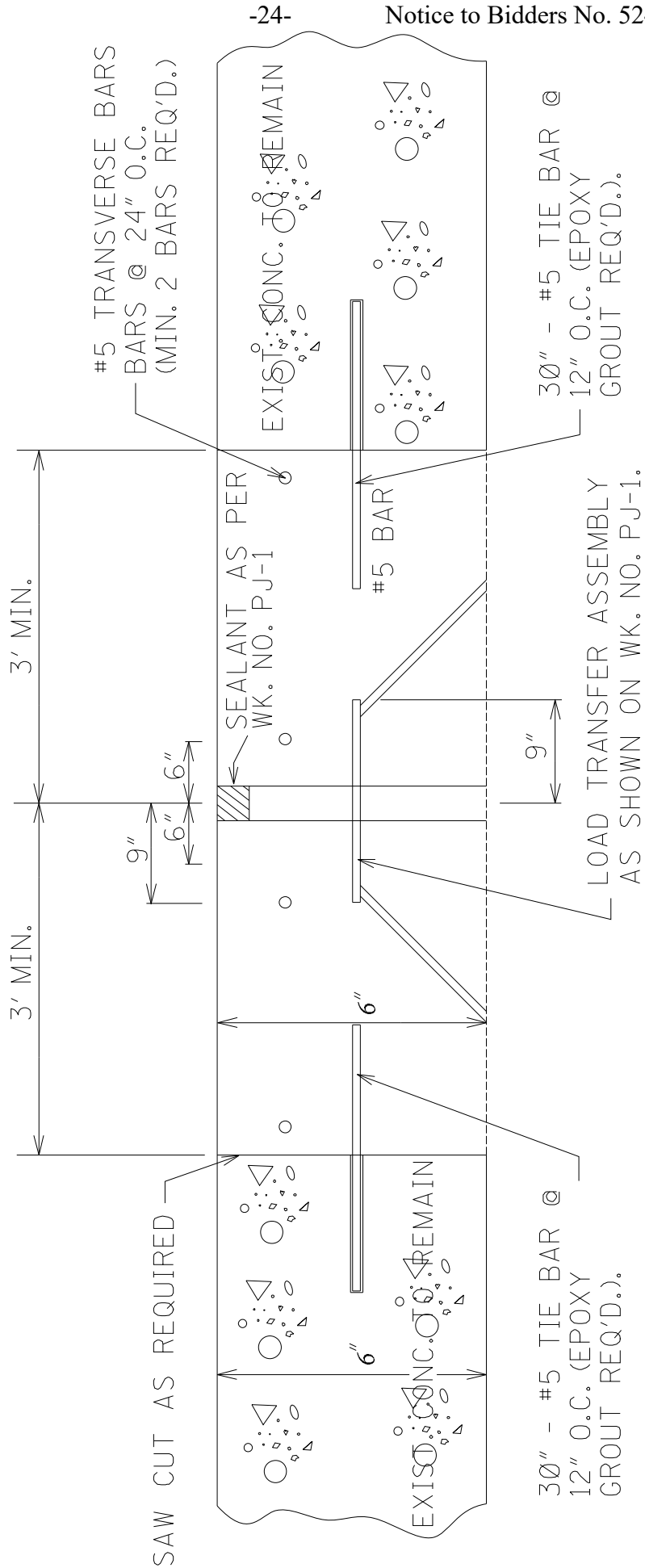

SECTIONAL VIEW OF REPLACED JOINT

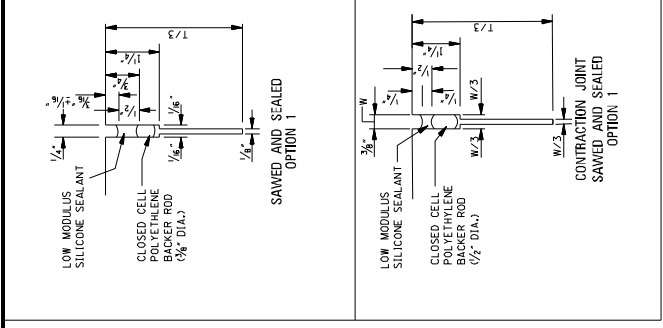
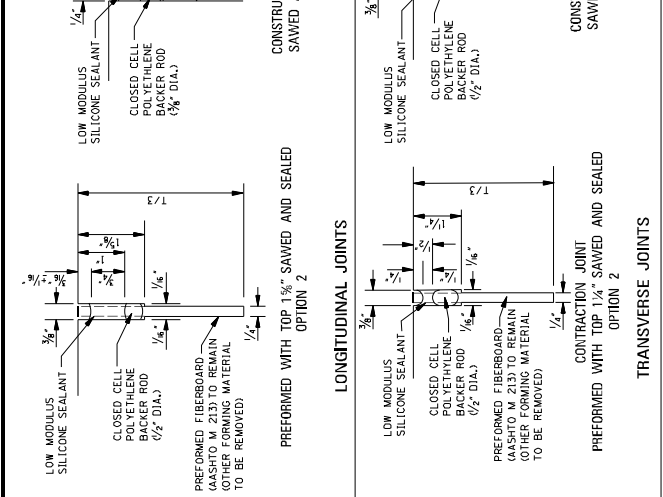

GENERAL NOTES:

- DOWEL BAR SPECIFICATIONS: AASHTO M 31 GRADE 60. TOLERANCES: THE PERMISSIBLE VARIATION IN STRAIGHTNESS SHALL BE A MAXIMUM OF 0.015" IN THE LENGTH OF THE DOWEL. THE TOLERANCES IN THE LENGTH SHALL BE +/- 0.25". THE MAXIMUM PERMISSIBLE ALIGNMENT VARIATION SHALL BE 0.25" IN THE LENGTH OF THE DOWEL IN EACH PLANE, BOTH HORIZONTALLY AND VERTICALLY. COATING: DOWELS SHALL BE SHOP PAINTED. FILL LENGTH WITH ONE OF THE FOLLOWING PAINTS AS PER SPECIFICATION: (1) FEDERAL SPECIFICATION TT-P-64B, (2) FEDERAL SPECIFICATION TT-P-30A, OR (3) STEEL STRUCTURES PAINTING COUNCIL SPECIFICATION SSPC-PAINT II.
- ASSEMBLY FRAME SPECIFICATIONS: AASHTO M 32. THE FRAME WIRES SHALL BE W3.5 OR GREATER EXCEPT THE SPREADER WIRES WHICH SHALL BE W3 OR GREATER.
- ANCHOR PINS: THE ASSEMBLY SHALL BE SECURED TO CEMENT TREATED OR ASPHALT BASE WITH RASSEL HILTI, POWERS, OR EQUIVALENT TIES MINIMUM 8" PER 12" F.T. SECTION. -- 3 ON EACH OR OTHER APPROVED TIE. THE CONTRACTOR SHALL BE RESPONSIBLE FOR SECURING THE ENTIRE ASSEMBLY IN SUCH A MANNER AS TO PREVENT DISPLACEMENT.
- FOR CONSIDERATION OF USE OF OTHER LOAD TRANSFER ASSEMBLIES, THE CONTRACTOR SHALL PROVIDE DRAWINGS TO THE ENGINEER FOR APPROVAL.
- PREFORMED FILLER IS NOT AN ALTERNATIVE FOR REDWOOD FILLER AT EXPANSION JOINTS UNLESS SPECIFICALLY REQUIRED ON THE PLANS.

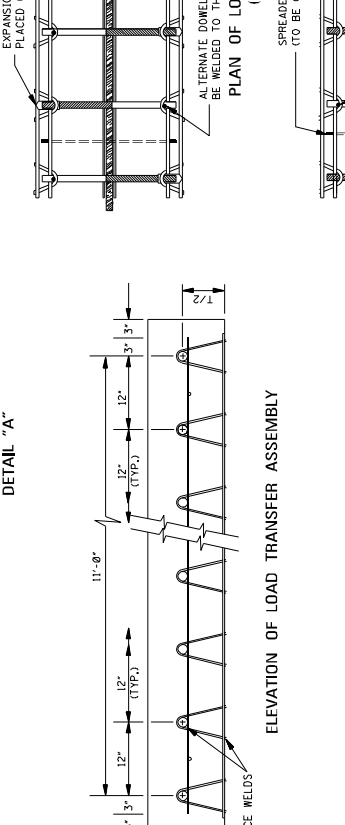
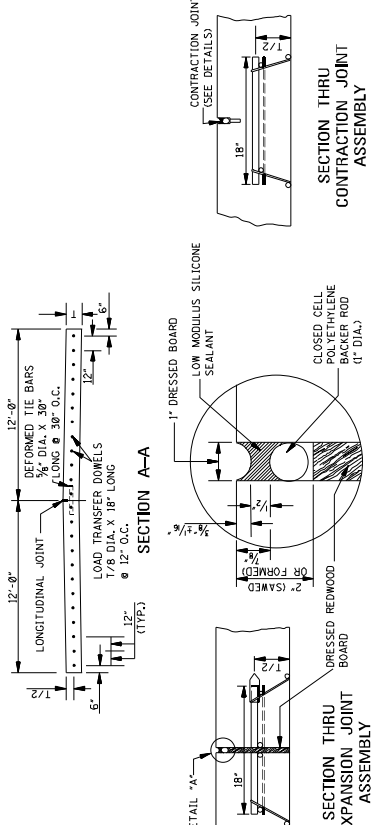
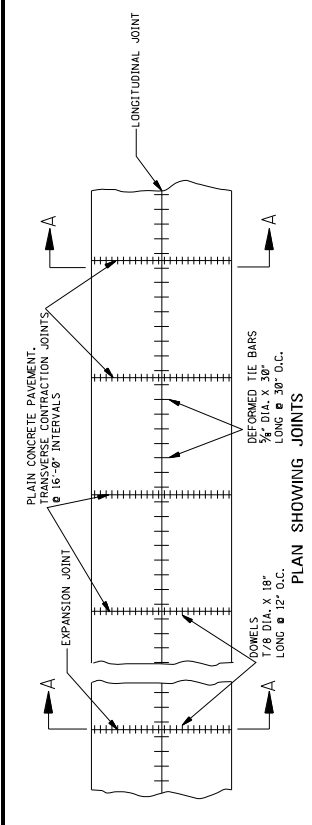

MISSISSIPPI DEPARTMENT OF TRANSPORTATION
ROADWAY DESIGN DIVISION
STANDARD PLAN

CONCRETE PAVEMENT JOINTS

BY	REVISION

DATE: _____ ISSUE DATE: AUGUST 01, 2017

PROJECT NUMBER: 249-1
SHEET NUMBER: 6004

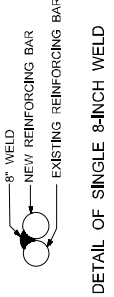
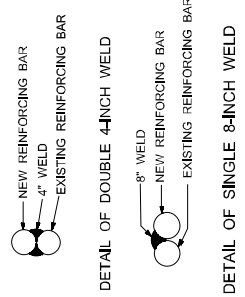
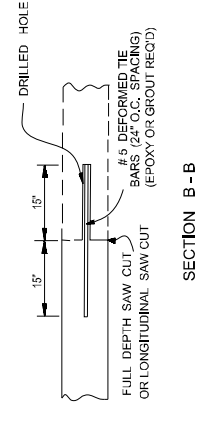
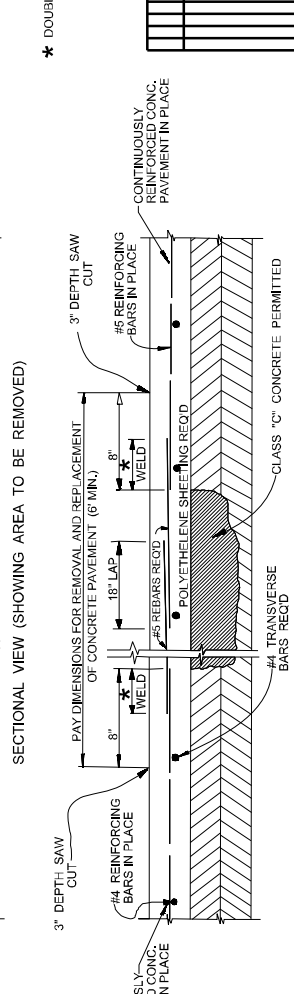
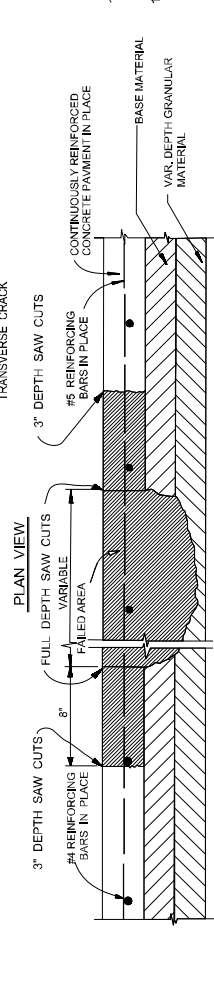
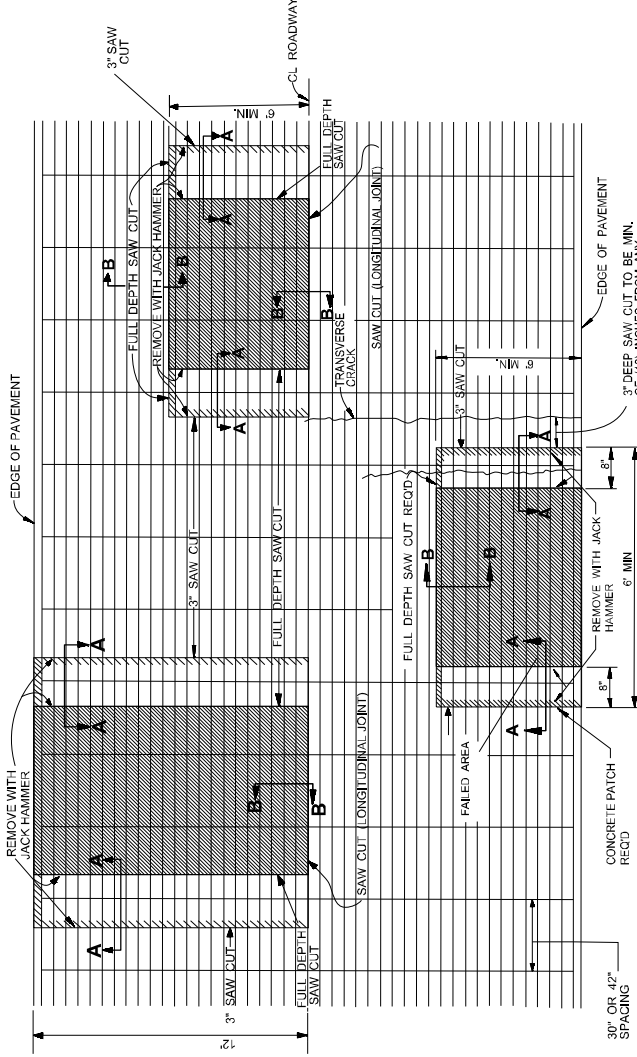
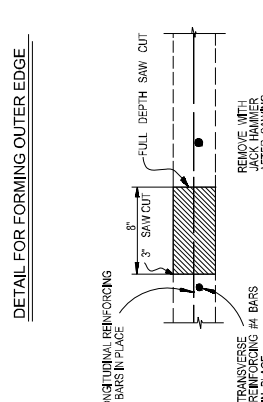
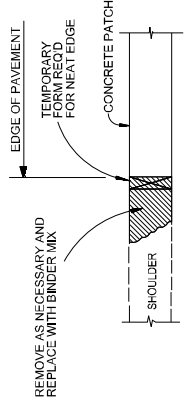

- GENERAL NOTES**
- REMOVE EXISTING MATERIALS TO DIMENSIONS DETERMINED BY THE ENGINEER.
 - REMOVAL OF ASPHALT PATCHES AND CONCRETE PAVEMENT WILL BE PAID FOR UNDER THE APPROPRIATE PAY ITEM.
 - REINFORCING BARS TO BE FIELD CUT AS DIRECTED BY THE ENGINEER. COST OF REQUIRED REINFORCING BARS TO BE INCLUDED IN THE BID PRICE OF THE CONCRETE PAVEMENT.
 - REMOVAL OF FAILED BASE (PAY AS REMOVAL OF GEMENT TREATED BASE - S.V.A.) BACKFILL WITH CLASS "C" CONCRETE (BASE REPAIR).
 - PAVEMENT EDGE ADJACENT TO SHOULDER SHALL BE FORMED.
 - SEE SHEET NO. 102 FOR DETAILS NOT SHOWN.
 - POLYETHYLENE SHEETING SHALL BE TWO (2) LAYERS OF 8 MIL THICKNESS. (ABSORBED ITEM).
 - REINFORCING BARS WILL BE SUPPORTED AS SHOWN ON SHEET NO. 102.
 - ALL SAW CUTS (3\"/>

- #5 DEFORMED TIE BARS (30 IN. LONG @ 24 IN. O.C. SPACING) WILL BE PAID FOR UNDER APPROPRIATE PAY ITEM.
- THE TRANSVERSE BARS IN THE REPAIR AREA WILL BE SPACED ON 42\"/>

Notice to Bidders No. 249 - Co

DATE	12/15/98
FILE NAME	CR-1A
DESIGN TEAM	CR-1A
CHECKED	
PROJECT NO.	
COUNTY	
NO. OF SHEETS	1
SHEET NUMBER	1

MISSISSIPPI DEPARTMENT OF TRANSPORTATION
TYPICAL CRC PAVEMENT REPAIR
(OPTIONAL WELDING METHOD)

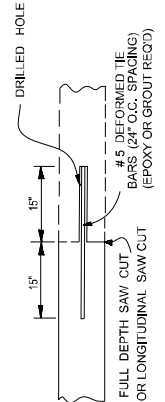
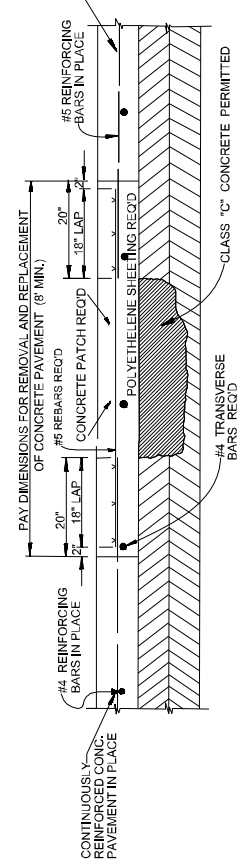
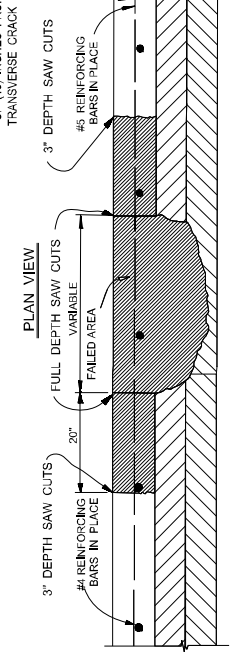
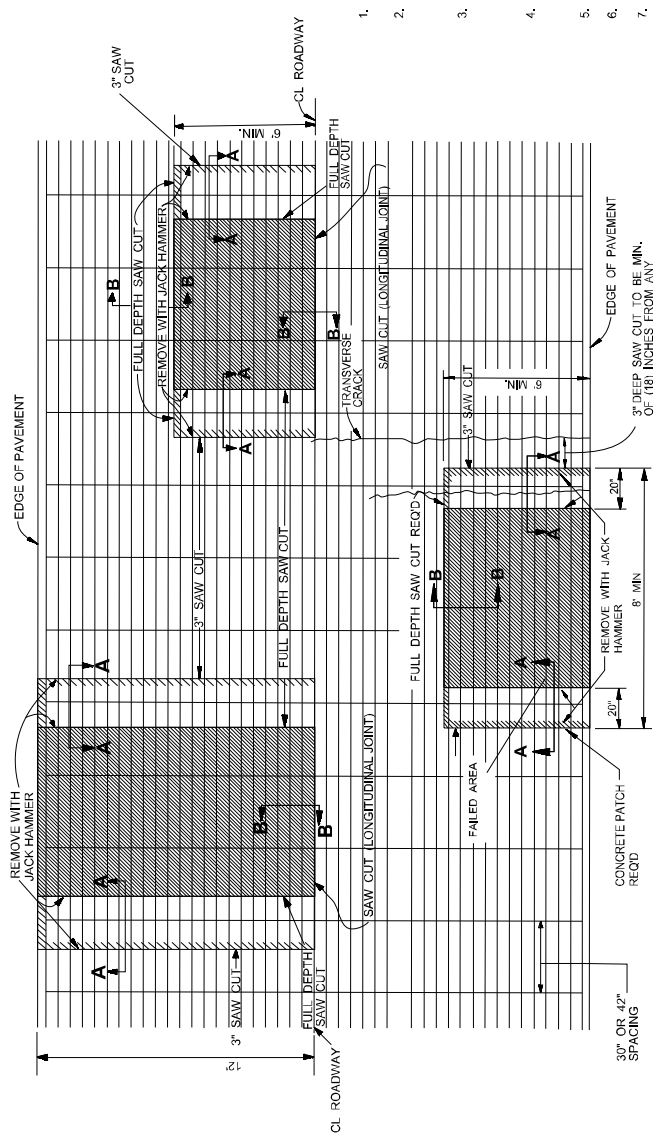
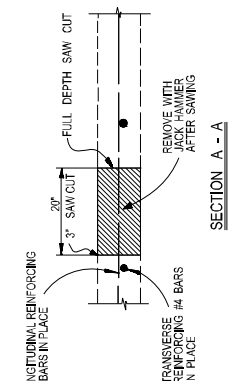
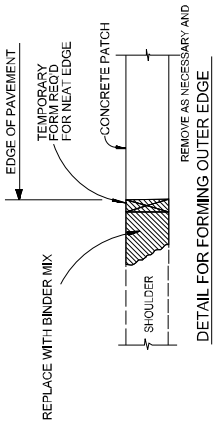

- GENERAL NOTES**
1. REMOVE EXISTING MATERIALS TO DIMENSIONS DETERMINED BY THE ENGINEER.
 2. REMOVAL OF ASPHALT PATCHES AND CONCRETE PAVEMENT WILL BE PAID FOR UNDER THE APPROPRIATE PAY ITEM.
 3. REINFORCING BARS TO BE FIELD CUT AS DIRECTED BY THE ENGINEER. COST OF REQUIRED REINFORCING BARS TO BE INCLUDED IN THE BID PRICE OF THE CONCRETE PAVEMENT.
 4. REMOVAL OF FAILED BASE (PAV AS REMOVAL OF CEMENT BASE) SHALL BE PAID FOR UNDER THE APPROPRIATE PAY ITEM (BASE REPAIR).
 5. PAVEMENT EDGE ADJACENT TO SHOULDER SHALL BE UNFORMED.
 6. SEE SHEET NO. 102 FOR DETAILS NOT SHOWN.
 7. POLYETHYLENE SHEETING SHALL BE TWO (2) LAYERS OF 8 MIL THICKNESS. (ABSORBED ITEM).
 8. REINFORCING BARS WILL BE SUPPORTED AS SHOWN ON SHEET NO. 102.
 9. ALL SAW CUTS (3\"/>

Notice to Bidders No. 5049 - Cont'd

WORKING NUMBER	PROJECT NO.:
SHEET NUMBER	COUNTY:
DESIGN TEAM	DATE
DATE	DESIGN TEAM
REVISION	DATE
BY	DATE

MISSISSIPPI DEPARTMENT OF TRANSPORTATION
 TYPICAL CRC PAVEMENT REPAIR

TYPICAL RAMP/PAD DETAIL

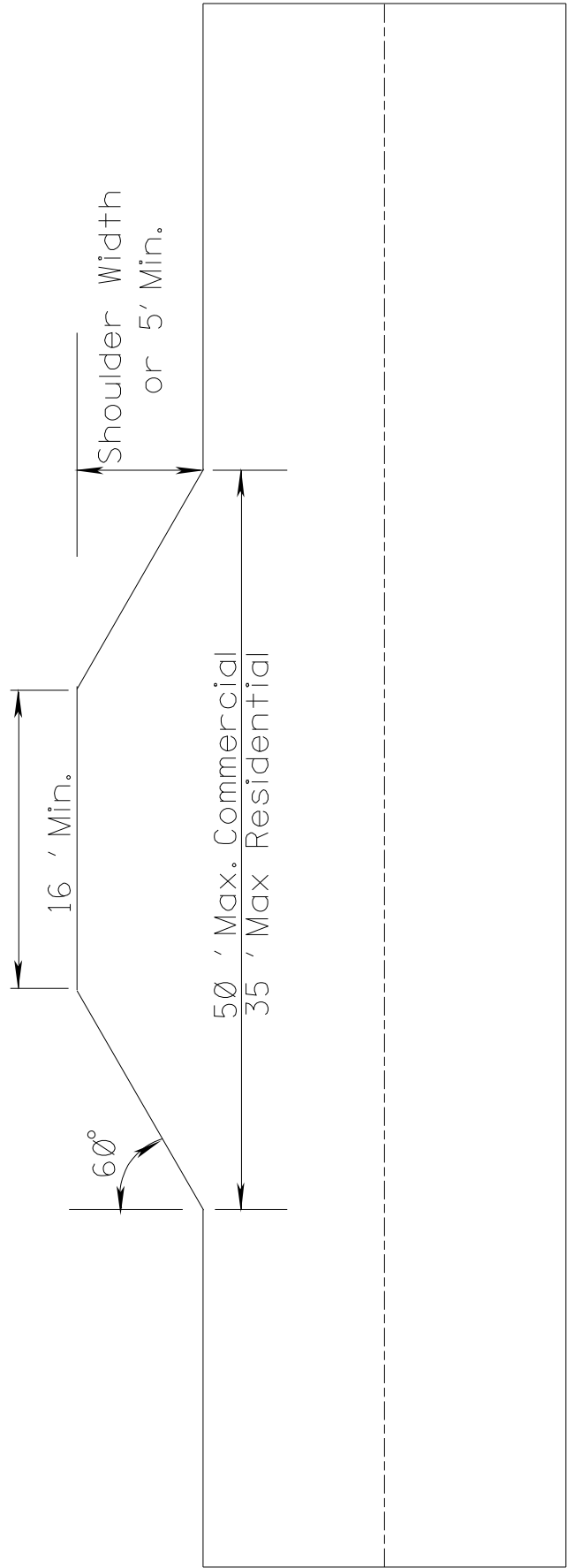

TYPICAL DETAIL OF ADDITIONAL SHOULDER PAVING
REQUIRED AT GUARDRAIL LOCATIONS

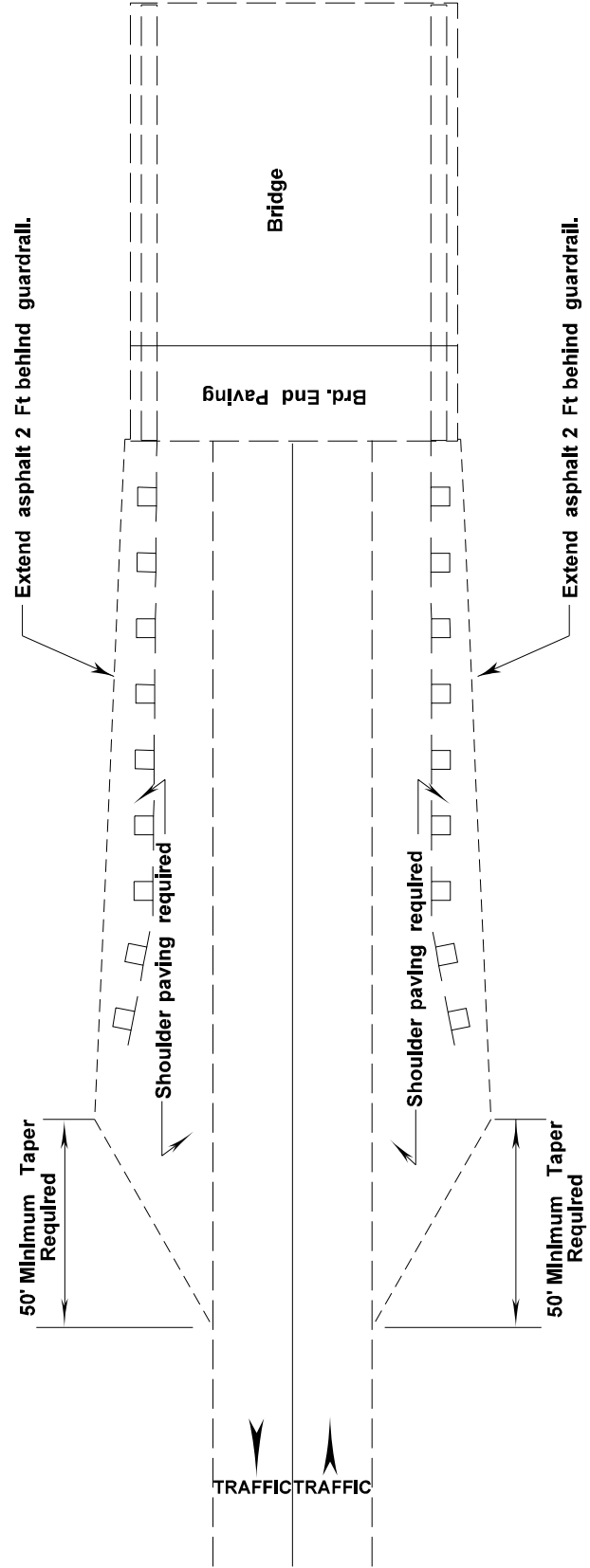

*Asphalt Thickness
See scope of work for additional details

RANKIN COUNTY - 108245/301000

SPECIAL DESIGN

BRIDGE-GUARD RAIL CONNECTOR

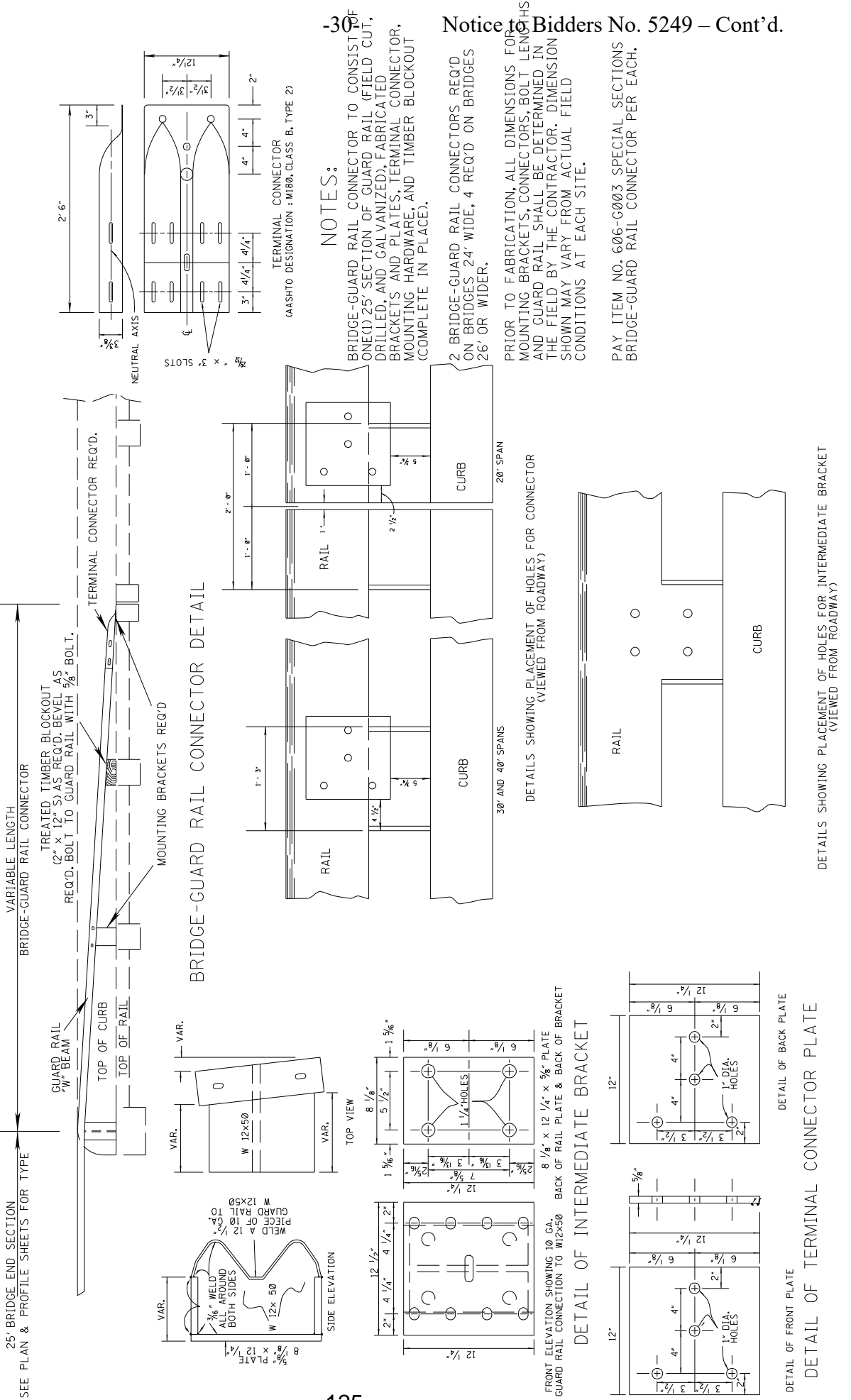

GENERAL NOTES

1. GROUND-IN RUMBLE STRIPES SHALL BE APPLIED TO ALL PAVED SHOULDERS ON THIS PROJECT.
2. GROUND-IN RUMBLE STRIPES SHALL BE APPLIED TO ALL INTERSECTIONS, ROADWAYS OR OTHER INTERUPTIONS IN NORMAL SHOULDER WIDTH AS DIRECTED BY THE ENGINEER.
3. COST TO BE PAID FOR USING APPROPRIATE PAY ITEMS.
4. GROUND-IN RUMBLE STRIPES SHALL BE APPLIED TO:
 - A. MAINLINE
 - B. INTERSECTING ROADWAY IF OVERLAID OR RECONSTRUCTED BEYOND NORMAL MAINLINE R.O.W.
 - C. ANY ROADWAY WITH EXISTING RUMBLE STRIPES PRIOR TO CONSTRUCTION.

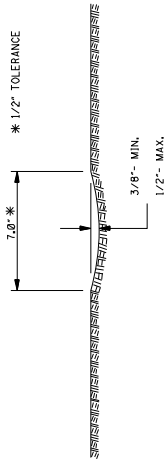

SECTION "A-A"

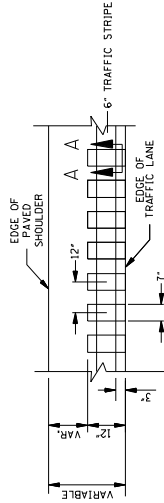

DETAIL "A"

*****NOTE: The rumble stripes will be placed 1 foot outside the pavement joint on mainline**

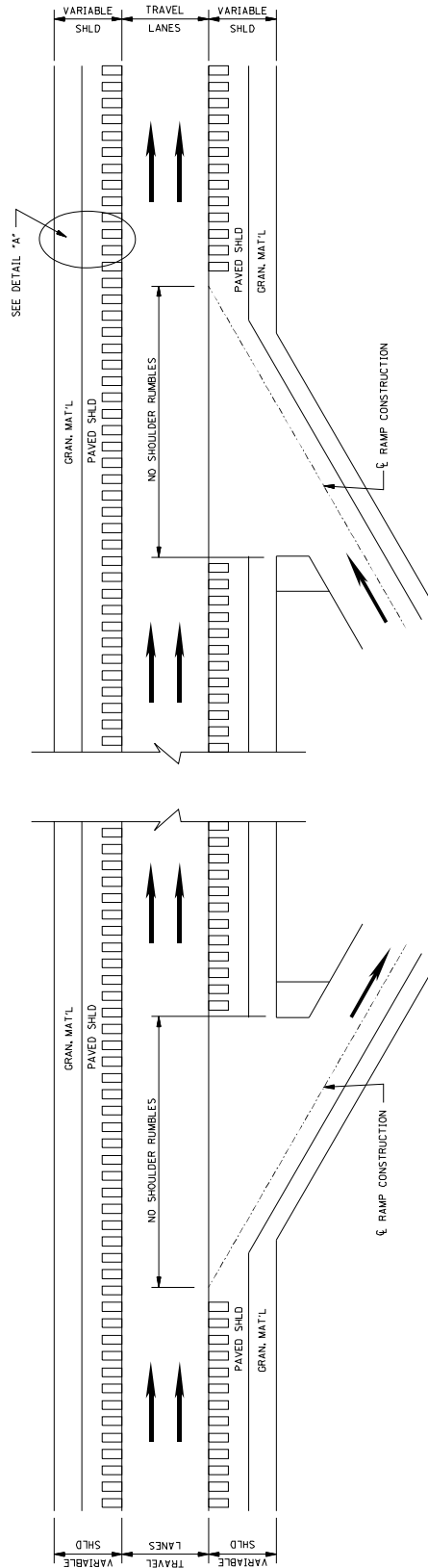

PLAN
NOT TO SCALE
DETAILS OF
RUMBLE STRIPES

MISSISSIPPI DEPARTMENT OF TRANSPORTATION ROADWAY DESIGN DIVISION STANDARD PLAN	
RUMBLE STRIPES 4-LANE HIGHWAYS (ASPHALT LANES, 2-FT OR WIDER, ASPHALT SHOULDERS)	
BY	REVISION
DATE	ISSUE DATE: AUGUST 01, 2017
MISSISSIPPI DEPARTMENT OF TRANSPORTATION ROADWAY DESIGN DIVISION STANDARD PLAN RUMBLE STRIPES 4-LANE HIGHWAYS (ASPHALT LANES, 2-FT OR WIDER, ASPHALT SHOULDERS) DRAWING NUMBER BS-2 SHEET NUMBER 6065	

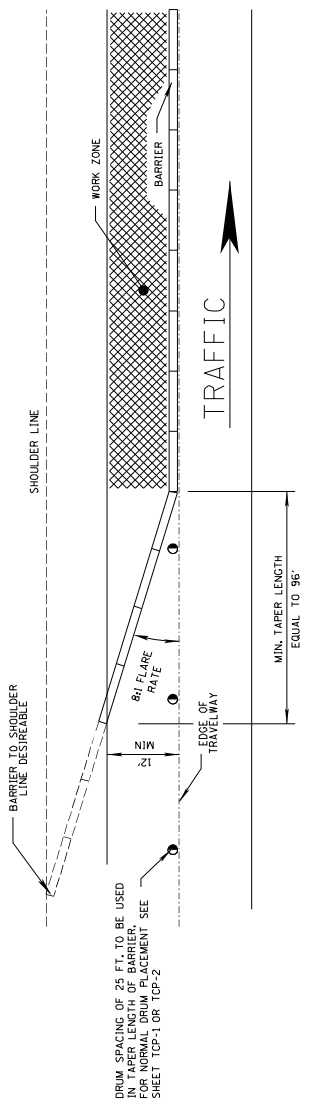

DETAIL OF POSITIVE BARRIER WITH TAPER

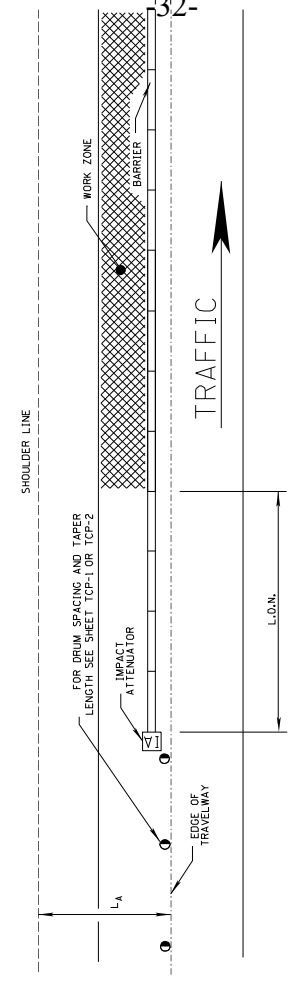

DETAIL OF POSITIVE BARRIER WITH IMPACT ATTENUATOR

NOTES:
 1. LENGTH OF NEED, L.O.N. = $\frac{L_1 L_2}{L_1 + L_2}$

WHERE: L_1 = LATERAL EXTENT OF THE AREA OF CONCERN
 L_1 = RUNOUT LENGTH
 L_2 = LATERAL OFFSET FROM EDGE OF TRAVELED WAY TO BARRIER.

2. RUNOUT LENGTH (L_2) IS TO BE DETERMINED USING THE FOLLOWING TABLE:

DESIGN SPEED (mph)	OVER 10,000 veh/day	5,000-10,000 veh/day	1,000-5,000 veh/day	UNDER 1,000 veh/day
70	360	330	290	250
60	300	250	210	200
50	230	190	160	150
40	160	130	110	100
30	110	90	80	70

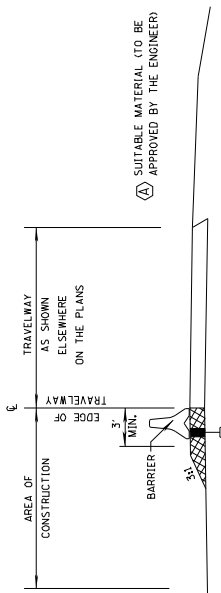

ELEVATION VIEW FOR POSITIVE BARRIER

NOTES:
 1. POSITIVE BARRIER IS REQUIRED IN THE AREA OF OPEN PUNCH OUTS THAT ARE WITHIN SIX (6) FEET OF THE TRAVELWAY WHENEVER ACTUAL REPAIR WORK IS NOT BEING PERFORMED WITHIN THE LANE CLOSURE.
 2. MATERIAL USED TO SUPPORT POSITIVE BARRIER MUST BE AT SAME ELEVATION AS PAVEMENT IN ADJACENT TRAVELWAY.
 3. DELINEATORS REQUIRED ON ALL NON-REFLECTIVE BARRIER, AS SHOWN ON WORKING NO. OMB-3.

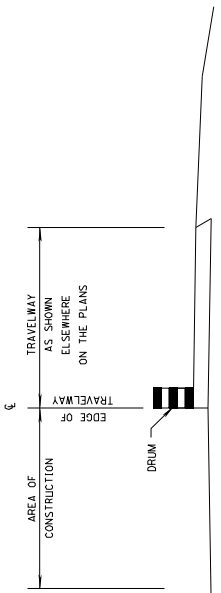

ELEVATION VIEW FOR DRUM

NOTES:
 1. WHILE WORK IS BEING PERFORMED WITHIN THE LANE CLOSURE DROP-OFFS MUST BE PROTECTED WITH DRUMS, ETC. IN EMERGENCIES EXCAVATED SECTION MAY BE BACKFILLED WITH GRANULAR MATERIAL TO AVOID OVERNIGHT DROP-OFFS.
 2. LANE CLOSURES WITH OPEN PUNCH OUT AREAS MAY NOT BE LEFT UNATTENDED WHEN DRUMS ARE BEING USED FOR LANE CLOSURE

MISSISSIPPI DEPARTMENT OF TRANSPORTATION
LANE CLOSURE DETAILS FOR GREATER THAN 3 INCH DROPOFF
 PROJECT NUMBER: NHP-0008-03(059)
 COUNTY: RANKIN
 FILE NAME: _____
 DESIGN TEAM: _____
 DATE: _____



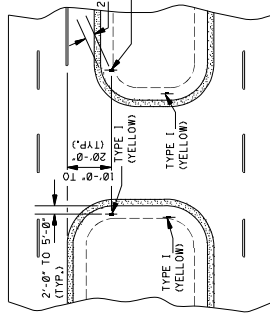

TYPICAL DELINEATION AT A CROSSOVER WITH USABLE SHOULDERS AND A MEDIAN WIDTH OVER 42'-0"

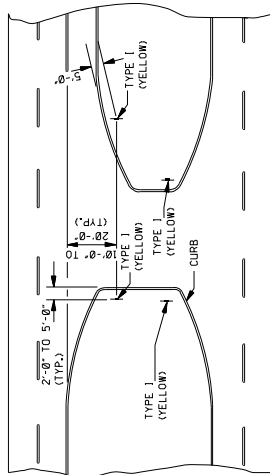

TYPICAL DELINEATION AT A CURBED CROSSOVER WITH A MEDIAN WIDTH OVER 42'-0"

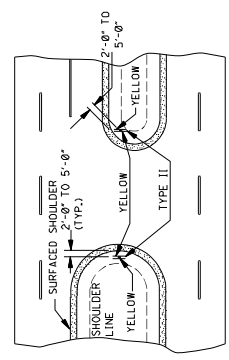

TYPICAL DELINEATION AT A CROSSOVER WITH USABLE SHOULDERS AND A MEDIAN WIDTH OF 42'-0" OR LESS

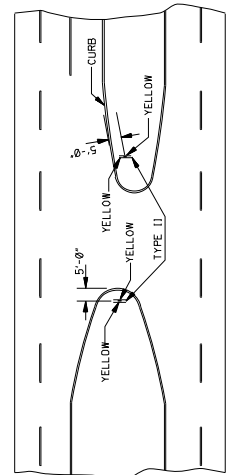

TYPICAL DELINEATION AT A CURBED CROSSOVER WITH A MEDIAN WIDTH OF 42'-0" OR LESS

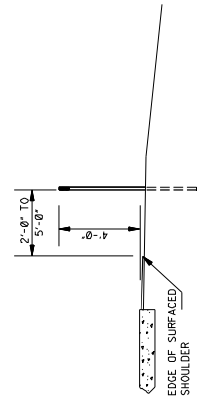

DELINEATOR MOUNTING ON CROSSOVER WITH USABLE SHOULDER

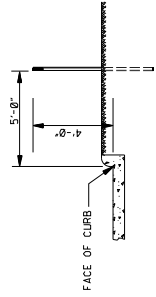

DELINEATOR MOUNTING ON CURBED CROSSOVER

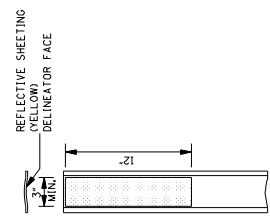

DETAIL OF TYPE I FLEXIBLE POST DELINEATOR

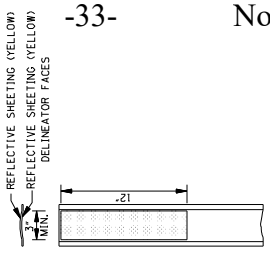

DETAIL OF TYPE II FLEXIBLE POST DELINEATOR

NOTE: CARBONITE'S CURV-FLEX DELINEATOR POSTS ARE SHOWN. OTHER FLEXIBLE POSTS THAT HAVE BEEN APPROVED FOR LISTING IN THE DEPARTMENT'S "APPROVED SOURCE OF MATERIALS" MAY BE FURNISHED.

NOTE: PLACE DELINEATORS NO MORE THAN 28'-0" FROM EDGE OF TRAVEL LANES EDGES.

- GENERAL NOTES:
1. THE UNIT PRICE OF DELINEATOR INCLUDES COST(S) OF DELINEATOR FACE(S), POST, HARDWARE AND INSTALLATION.
 2. DELINEATOR FACE WILL BE ENCAPSULATED LENS REFLECTIVE SHEETING.
 3. POST REQUIRING THE INSTALLATION OF A BASE SHALL BE INSTALLED IN ACCORDANCE WITH THE MANUFACTURER'S RECOMMENDATION.
 4. THE COLOR OF DELINEATORS SHALL BE THE COLOR OF THE ADJACENT EDGELINE PER MUTCD SECTION 3F.03.

MISSISSIPPI DEPARTMENT OF TRANSPORTATION
ROADWAY DESIGN DIVISION
STANDARD PLAN

TYPICAL CROSSOVER DELINEATION

ISSUE DATE: AUGUST 01, 2017
SHEET NUMBER 6316

DATE	REVISION

FMS. CON:	PROJECT NO.
STATE	MISS.

SOIL INSTALLATION

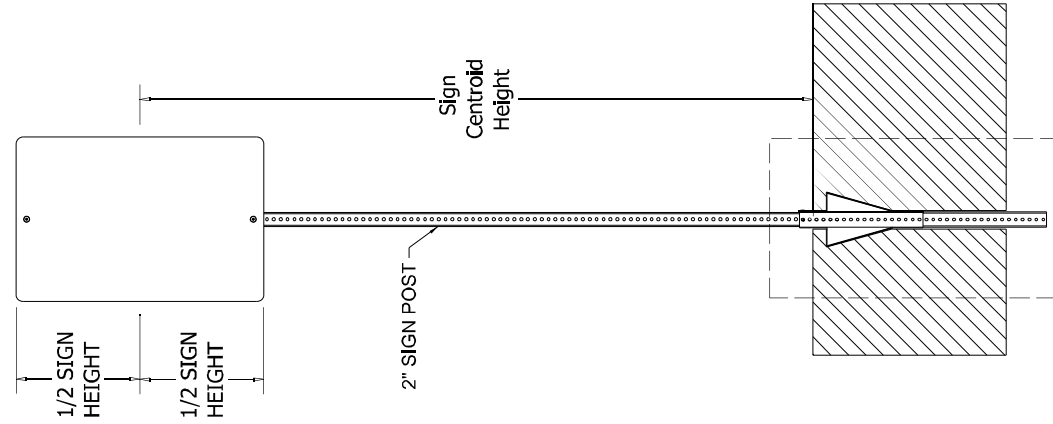

SEE OMNI SLEEVE DETAIL

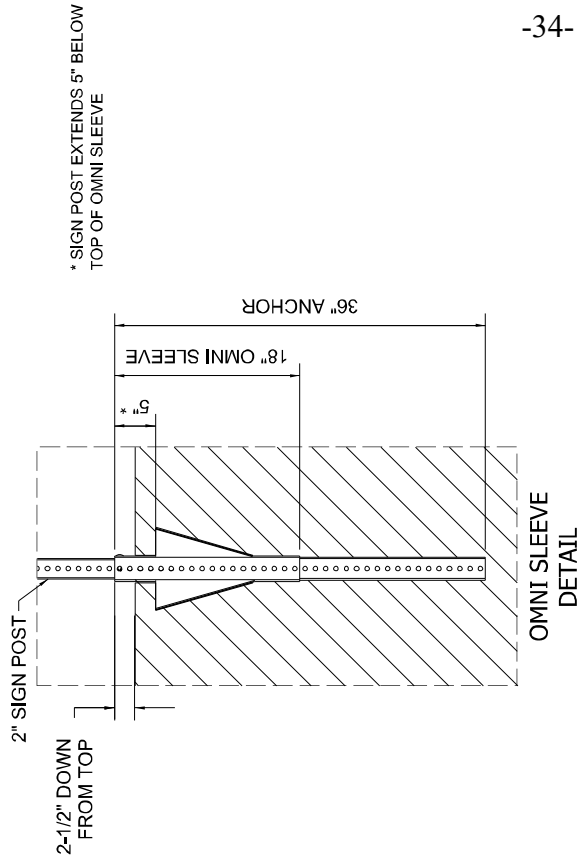

-34-

MATERIALS:
 PERFORATED SQUARE STEEL TUBE POST AND ANCHOR (PSSST): Must be ASTM A1011, Grade 50 steel with an average minimum yield strength after cold-forming must be 60,000 psi. It must be corner welded, scarfed after welding, then zinc coated after scarfing. It must be coated with a chromate conversion coating and a clear organic polymer topcoat. Its interior and exterior will be galvanized. It must have 7/16" holes spaced 1" apart along the centerline of each of its four sides.

POST must be 2" x 14ga x appropriate length.

ANCHOR must be 2-1/4" x 12ga x 36".

OMNI SLEEVE (to be absorbed) must be:
 2-1/2" x 12ga x 18" and contain four 4" x 12" x 10ga ASTM A569 steel fins welded to each of the four corner edges of the square sleeve with 4" flat end of each fin positioned 5" down from one end, and must be galvanized. A medium corner bolt must be used to secure the assembly.

Notice to Bidders No. 249 - Cont.

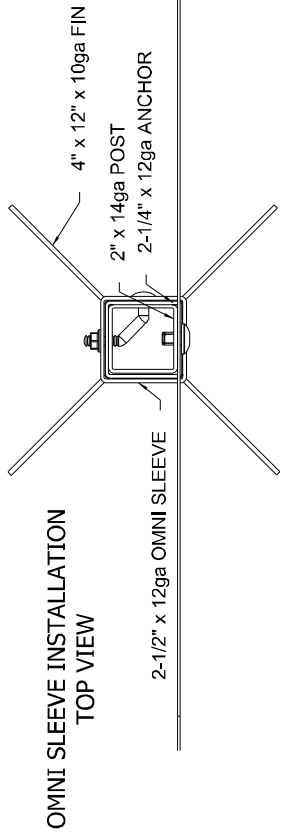

OMNI SLEEVE INSTALLATION TOP VIEW

MISSISSIPPI DEPARTMENT OF TRANSPORTATION	
SIGN SUPPORT HARDWARE	
BY	REVISION
2.0" SQUARE POST	
PROJ. NO. :	NHPP-0008-03(059)
COUNTY :	RANKIN
FILE NAME :	JSS-2.DGN
DATE :	9/2/2021
DESIGNER :	IED
CHECKED :	IED
DATE :	9/2/2021
PRICE :	\$PCG\$

MILLING AND PAVING Detail LOCAL ROADS

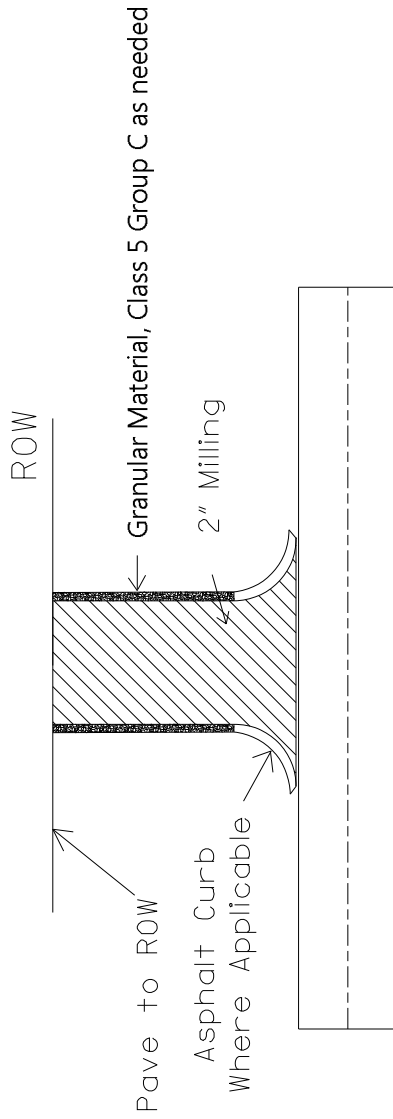

Notes:

- Mill limits of county/local roads at a depth of 2".
- Place 2" of 12.5mm, HT, Polymer Modified Asphalt to tie to mainline overlay.
- Milling/Paving area = 

STRIPE DETAIL - LOCAL ROADS

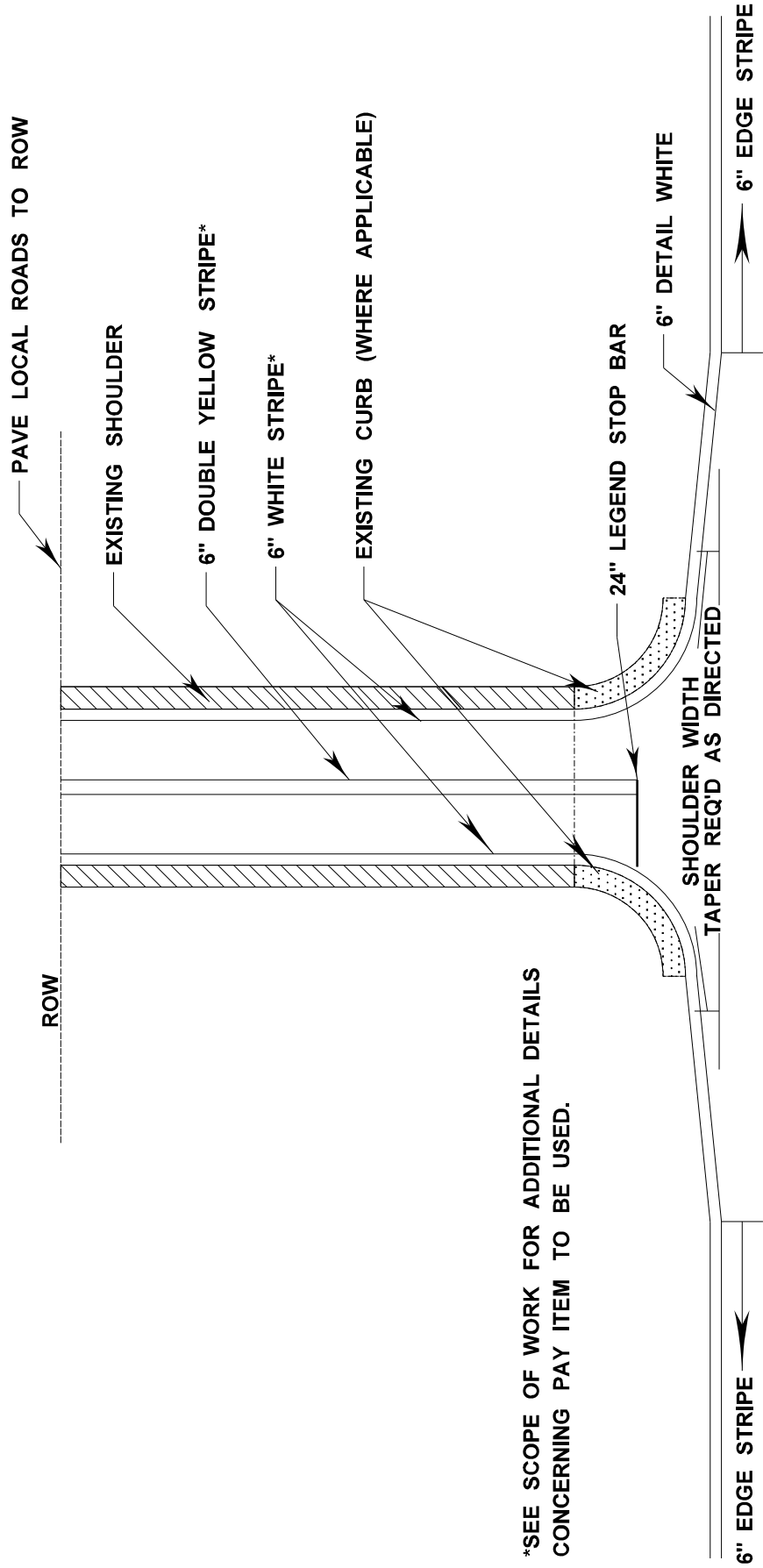

*SEE SCOPE OF WORK FOR ADDITIONAL DETAILS CONCERNING PAY ITEM TO BE USED.

NOTE: CENTERLINE STRIPE SHALL BE OMITTED ON LOCAL ROADS WHOSE WIDTH IS LESS THAN 20 FEET.

TYPICAL FOR RAISED PAVEMENT MARKERS PLACED ON SIDE ROAD RADIUS 4-LANE TRAFFIC

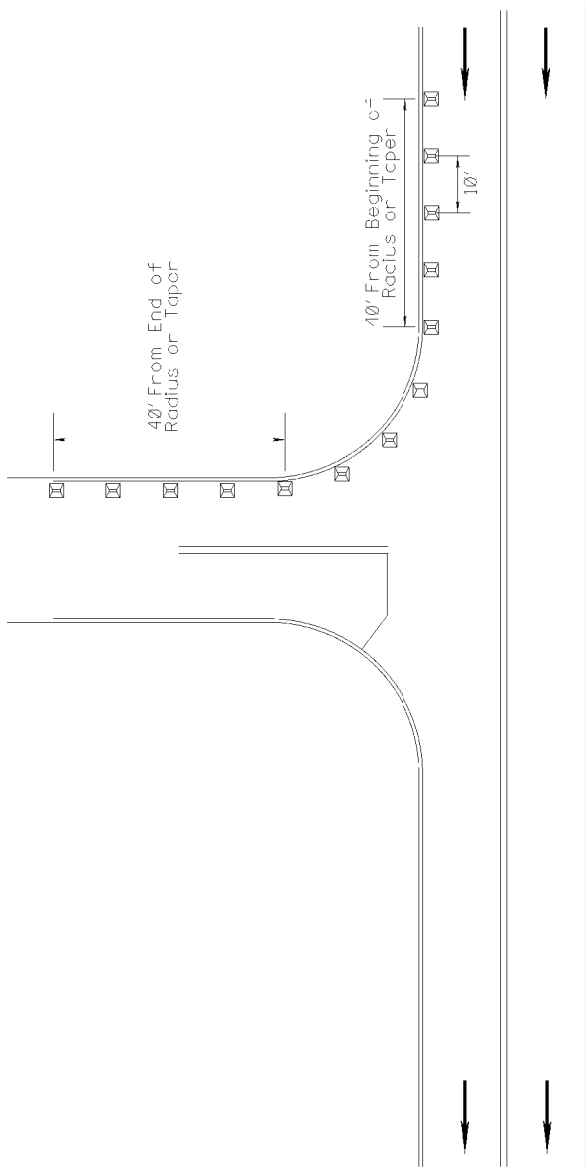

132

-37-

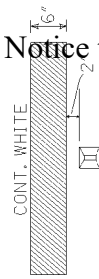

DETAIL A

NOTE 1: MARKERS SHALL BE PLACED EVERY 10 FEET.

NOTE 2: MARKERS SHALL BE VISIBLE FROM THE TRAVELING MOTORIST ON STATE DESIGNATED HIGHWAYS.

NOTE 3: MARKERS SHALL BE USED PERFORMANCE TYPE WAY CLEAR.

NOTE 4: FIVE (5) MARKERS SHALL BE PLACED ALONG MAINLINE EDGE STRIPE.

NOTE 5: MARKERS FOR COUNTY ROADS SHALL CONTINUE DOWN THE EDGE STRIPE A DISTANCE OF 40 FEET.

NOTE 6: MARKERS SHALL NOT BE ROTATED WHEN BEING PLACED ALONG RADIUS OF LOCAL ROAD.

→ DIRECTION OF TRAFFIC

Notice to Bidders No. 5249 - Cont'd.

STATE	PROJECT NO.
MISS.	

MISSISSIPPI DEPARTMENT OF TRANSPORTATION	
4- ANF	
2-WAY CLEAR RAISED PAVEMENT MARKERS OF TYPE WAY CLEAR	
WARRANT NUMBER: 03(05)03	
PROJECT NO. NHP-0008-03(05)03	
COUNTY: RANKIN	
FILENAME: SPASIDERPRM.DGN	
DESIGNER:	DATE:

-38-

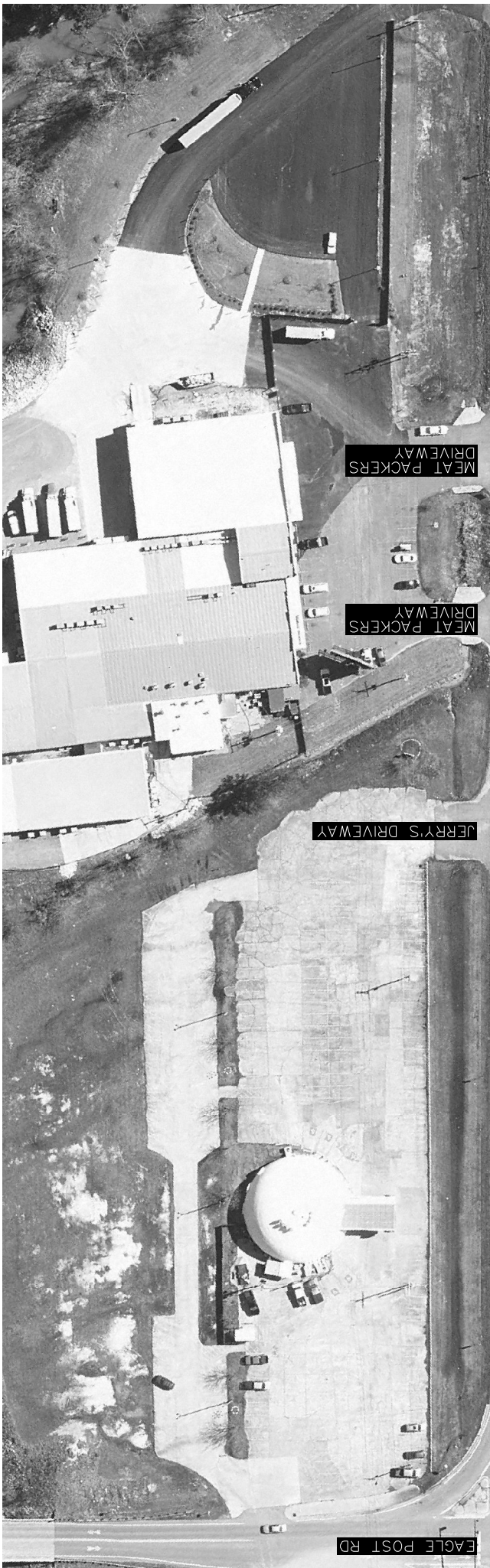

133



RIGHT TURN LANE WIDENING AT STAR RD/ W MAIN ST

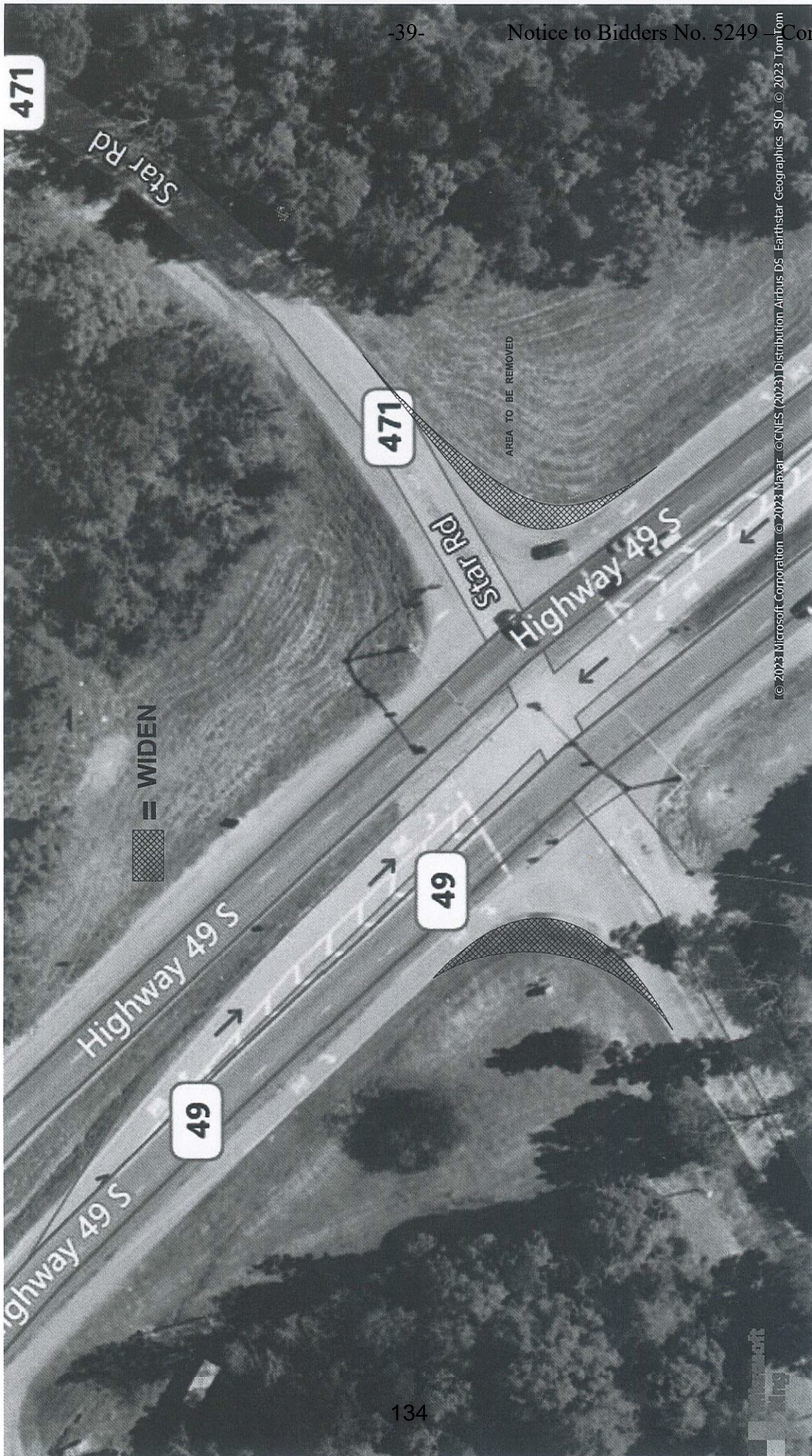

DETAIL FOR US 49 SOUTHBOUND DITCH REPAIR

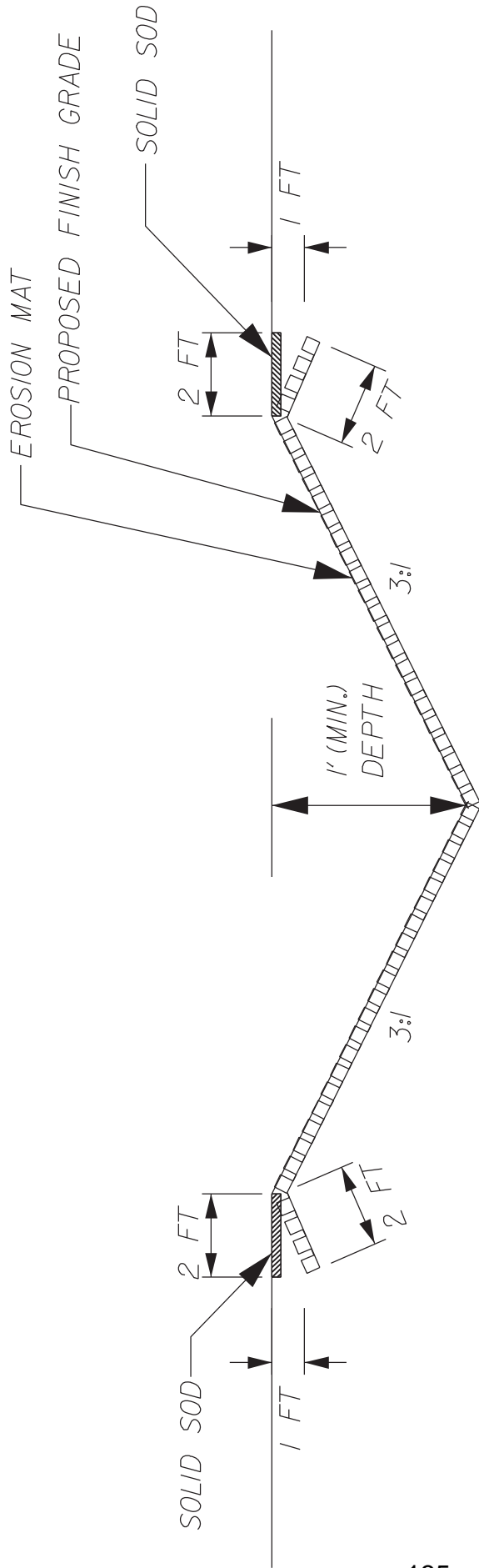

EROSION MAT LINED DITCH

NOT TO SCALE

Note: The pay area shall only be the actual area of the ditch to be lined with erosion mat. Any overlap or toe areas, as required by the manufacturer's recommendations, shall be absorbed.

MISSISSIPPI DEPARTMENT OF TRANSPORTATION

SECTION 904 - NOTICE TO BIDDERS NO. 5250

DATE: 07/20/2023

SUBJECT: Specialty Items

PROJECT: NHPP-0008-03(059)/108245301 - RANKIN

Pursuant to the provisions of Section 108, the following work items are hereby designated as "Specialty Items" for this contract. Bidders are reminded that these items must be subcontracted in order to be considered as specialty items.

CATEGORY: GUARDRAIL, GUIDERAIL

Line No	Pay Item	Description
0280	606-B003	Guard Rail, Class A, Type 1, 'W' Beam, Metal Post
0290	606-C003	Guard Rail, Cable Anchor, Type 1
0300	606-D005	Guard Rail, Bridge End Section, Type A
0310	606-E005	Guard Rail, Terminal End Section, Flared
0320	606-E007	Guard Rail, Terminal End Section, Non-Flared
0330	606-G002	Special Sections, Guard Rail Bridge End Connector

CATEGORY: MISCELLANEOUS/ SPECIALTY WORK ITEMS

Line No	Pay Item	Description
0190	423-A001	Rumble Strips, Ground In

CATEGORY: PAVEMENT STRIPING AND MARKING

Line No	Pay Item	Description
0460	626-A001	6" Thermoplastic Double Drop Traffic Stripe, Skip White
0470	626-B002	6" Thermoplastic Double Drop Traffic Stripe, Continuous White
0480	626-E001	6" Thermoplastic Double Drop Traffic Stripe, Continuous Yellow
0490	626-G004	Thermoplastic Double Drop Detail Stripe, White
0500	626-G005	Thermoplastic Double Drop Detail Stripe, Yellow
0510	626-H001	Thermoplastic Double Drop Legend, White
0520	626-H002	Thermoplastic Double Drop Legend, White
0530	627-J001	Two-Way Clear Reflective High Performance Raised Markers
0540	627-K001	Red-Clear Reflective High Performance Raised Markers
0550	627-L001	Two-Way Yellow Reflective High Performance Raised Markers

CATEGORY: TRAFFIC CONTROL - PERMANENT

Line No	Pay Item	Description
0560	630-F003	Delineators, Flexible Post Mounted, Crossover, Type II
0570	630-F006	Delineators, Guard Rail, White
0580	630-F007	Delineators, Guard Rail, Yellow
0590	630-G004	Type 3 Object Markers, OM-3R or OM-3L

CATEGORY: TRAFFIC CONTROL - TEMPORARY

Line No	Pay Item	Description
0350	619-A1001	Temporary Traffic Stripe, Continuous White
0360	619-A2001	Temporary Traffic Stripe, Continuous Yellow
0370	619-A3001	Temporary Traffic Stripe, Skip White
0380	619-A5001	Temporary Traffic Stripe, Detail
0390	619-A6001	Temporary Traffic Stripe, Legend
0400	619-A6002	Temporary Traffic Stripe, Legend
0410	619-D1001	Standard Roadside Construction Signs, Less than 10 Square Feet
0420	619-D2001	Standard Roadside Construction Signs, 10 Square Feet or More
0430	619-G4005	Barricades, Type III, Single Faced
0440	619-G7001	Warning Lights, Type "B"

MISSISSIPPI DEPARTMENT OF TRANSPORTATION

SECTION 904 - NOTICE TO BIDDERS NO. 5251

CODE: (SP)

DATE: 7/13/2023

SUBJECT: Temporary Construction Signs

PROJECT: NHPP-0008-03(059) / 108245301 – Rankin County

Bidders are hereby advised of the following regarding the Temporary Construction Signs required:

Should the Bidders elect to install Temporary Construction Signs by first driving short u-channel sections and then bolting the longer, correct height u-channel sections to them, the Bidders are advised that these short sections shall be a minimum of five (5) feet from the ground level when driven and the splice must consist of a minimum of eighteen (18) inches of overlap with a total of four (4) bolts. Bidders are also advised that it is mandatory that these short sections be removed at the completion of the project.

MISSISSIPPI DEPARTMENT OF TRANSPORTATION

SECTION 904 - NOTICE TO BIDDERS NO. 5252

CODE: (SP)

DATE: 7/13/2023

SUBJECT: Underground Utilities

PROJECT: NHPP-0008-03(059) / 108245301 – Rankin County

Bidders are hereby advised that utility lines owned and maintained by MDOT may be present within the project limits. These utilities are not located by Mississippi 811. It shall be the Contractor's responsibility to coordinate with MDOT to have the utility lines located and marked prior to beginning work. The Contractor shall give a minimum of three (3) working days of advance notice for locate requests.

Additionally, it shall be the Contractor's responsibility to maintain the utility markings or have the ability to survey the marked utilities and re-establish said utility markings as needed. The Department shall only be responsible for locating and marking the utilities once per Contract.

The contacts for MDOT utility lines are as follows:

Underground Power Lines:

Michael Lee – 601-683-3341 – mlee@mdot.ms.gov

Billy Coward – 601-683-3341 – bcoward@mdot.ms.gov

Underground Communication Lines:

Kerby McFarland – 601-359-7450 – kmcfarland@mdot.ms.gov

Steven Newell – 601-359-7450 – snewell@mdot.ms.gov

Henry Lewis – 601-359-1454 – hlewis@mdot.ms.gov

Underground Signal Lines:

Amrik Singh – 601-359-1454 – asingh@mdot.ms.gov

Kenneth Welch – 601-359-1454 – kwelch@mdot.ms.gov

MISSISSIPPI DEPARTMENT OF TRANSPORTATION

SECTION 904 - NOTICE TO BIDDERS NO. 5253

CODE: (SP)

DATE: 7/18/2023

SUBJECT: Lane Closure Restrictions

PROJECT: NHPP-0008-03(059) / 108245301 – Rankin County

Bidders are hereby advised of the following restrictions on the above captioned project.

Concrete Pavement Punchout Repair Operations

Lane closures for this work shall be allowed on weekends from 7:00 PM Friday to 6:00 AM Monday.

For Memorial Day, Easter, and Labor Day, no lane closures will be allowed during that weekend or the Friday immediately preceding that holiday. Independence Day falls on a Thursday in 2024; therefore, no lane closures shall be allowed the Wednesday through Sunday of that week. The holiday lane closure restriction applies to the entire calendar day.

Also, between the dates of November 17, 2023 and January 1, 2024, no weekend work shall be allowed

The Contractor must give the Engineer a 7 day notice prior to beginning said weekend work.

All Operations

Lane closures shall NOT be allowed during the following hours:

- US 49 Northbound
 - Monday Through Friday - 6:00 AM to 7:00 PM
 - Saturday – 11:00 AM to 7:00 PM
- US 49 Southbound
 - Monday through Friday – 9:00 AM to 7:00 PM
 - Saturday – 9:00 AM to 7:00 PM

No lane closures will be permitted on Sunday. Sunday is defined as 7 PM Saturday to 7 PM Sunday.

No lane closures will be permitted on the following holidays or the day preceding them: New Year's Day, Memorial Day, Easter, Independence Day, Labor Day, Thanksgiving Day, and Christmas Day. In the event that one of the above mentioned holidays falls during the weekend or on a Monday, no lane closures will be allowed during that weekend or the Friday immediately preceding that holiday. In addition, no lane closures will be allowed the Friday, Saturday, and Sunday following Thanksgiving. Independence Day falls on a Thursday in 2024; therefore, no

lane closures shall be allowed the Wednesday through Sunday of that week. The holiday lane closure restriction applies to the entire calendar day.

No exceptions to the above restrictions will be allowed unless specifically approved by the Project Engineer.

If the lane closure restrictions listed above are violated, the Contractor will be charged a fee of \$500.00 for each full or partial five (5) minute period until the roadway is back in compliance with the lane closure restriction requirement.

For the purposes of this contract, official time shall be the announced time available at the Jackson area telephone number (601) 355-9311.

MISSISSIPPI DEPARTMENT OF TRANSPORTATION

SECTION 904 - NOTICE TO BIDDERS NO. 5260

CODE: (SP)

DATE: 7/18/2023

SUBJECT: Additional Construction Requirements

PROJECT: NHPP-0008-03(059) / 108245301 – Rankin County

Bidders are hereby advised of the following additional construction requirements:

From the date of the Notice to Proceed until released from maintenance, potholes that exist or may develop in the pavement within the project limits are to be patched immediately upon the Contractor's discovery or notification from the Engineer. The Contractor shall inspect the project for potholes daily and after every rain event. Patching of potholes shall be paid through Pay Item No. **907-403-P002 Asphalt for Pothole Patching**. If in the opinion of the Engineer, potholes are not patched satisfactorily, and/or in a timely manner, the Engineer will, at his discretion, elect one or more of the following remedies:

- Proceed with adequate forces, equipment, and material to maintain the project. The cost of the maintenance, plus 25 percent for supervisory and administrative personnel, will be deducted from monies due the Contractor for the project.
- Suspend all other operations until corrections have been properly made; and/or
- Withhold future payment to the Contractor until corrections have been properly made.

"General Decision Number: MS20230140 02/10/2023

Superseded General Decision Number: MS20220140

State: Mississippi

Construction Type: Highway

County: Rankin County in Mississippi.

HIGHWAY CONSTRUCTION PROJECTS

Note: Contracts subject to the Davis-Bacon Act are generally required to pay at least the applicable minimum wage rate required under Executive Order 14026 or Executive Order 13658. Please note that these Executive Orders apply to covered contracts entered into by the federal government that are subject to the Davis-Bacon Act itself, but do not apply to contracts subject only to the Davis-Bacon Related Acts, including those set forth at 29 CFR 5.1(a)(2)-(60).

<p>If the contract is entered into on or after January 30, 2022, or the contract is renewed or extended (e.g., an option is exercised) on or after January 30, 2022:</p>	<ul style="list-style-type: none"> . Executive Order 14026 generally applies to the contract. . The contractor must pay all covered workers at least \$16.20 per hour (or the applicable wage rate listed on this wage determination, if it is higher) for all hours spent performing on the contract in 2023.
<p>If the contract was awarded on or between January 1, 2015 and January 29, 2022, and the contract is not renewed or extended on or after January 30, 2022:</p>	<ul style="list-style-type: none"> . Executive Order 13658 generally applies to the contract. . The contractor must pay all covered workers at least \$12.15 per hour (or the applicable wage rate listed on this wage determination, if it is higher) for all hours spent performing on that contract in 2023.

The applicable Executive Order minimum wage rate will be adjusted annually. If this contract is covered by one of the Executive Orders and a classification considered necessary for performance of work on the contract does not appear on this wage determination, the contractor must still submit a conformance request.

Additional information on contractor requirements and worker protections under the Executive Orders is available at <http://www.dol.gov/whd/govcontracts>.

Modification Number	Publication Date
0	01/06/2023
1	02/10/2023

* ELEC0480-010 01/01/2022

	Rates	Fringes
TRAFFIC SIGNALIZATION		
Electrician.....	\$ 27.35	10.40

* SUMS2010-063 08/04/2014

	Rates	Fringes
CARPENTER (Form Work Only).....	\$ 15.47 **	0.00
CEMENT MASON/CONCRETE FINISHER...	\$ 14.02 **	0.00
ELECTRICIAN.....	\$ 24.04	5.87
HIGHWAY/PARKING LOT STRIPING:		
Truck Driver (Line Striping		
Truck).....	\$ 12.04 **	0.00
INSTALLER - GUARDRAIL.....	\$ 12.07 **	0.00
INSTALLER - SIGN.....	\$ 11.92 **	0.00
IRONWORKER, REINFORCING.....	\$ 15.47 **	0.00
LABORER: Common or General,		
Including Asphalt Raking,		
Shoveling, Spreading; and		
Grade Checking.....	\$ 10.65 **	0.00
LABORER: Flagger.....	\$ 10.22 **	0.00
LABORER: Luteman.....	\$ 12.88 **	0.00
LABORER: Mason Tender -		
Cement/Concrete.....	\$ 11.27 **	0.00
LABORER: Pipelayer.....	\$ 13.44 **	0.00
LABORER: Laborer-Cones/		
Barricades/Barrels -		
Setter/Mover/Sweeper.....	\$ 11.29 **	0.00
OPERATOR: Asphalt Spreader.....	\$ 14.71 **	0.00
OPERATOR:		
Backhoe/Excavator/Trackhoe.....	\$ 15.36 **	0.00
OPERATOR: Bobcat/Skid		
Steer/Skid Loader.....	\$ 11.64 **	0.00
OPERATOR: Broom/Sweeper.....	\$ 11.57 **	0.00
OPERATOR: Bulldozer.....	\$ 15.41 **	0.00
OPERATOR: Concrete Saw.....	\$ 14.38 **	0.00
OPERATOR: Crane.....	\$ 19.22	0.00
OPERATOR: Distributor.....	\$ 10.95 **	0.00
OPERATOR: Grader/Blade.....	\$ 14.41 **	0.00

OPERATOR: Grinding/Grooving Machine.....	\$ 15.90 **	0.00
OPERATOR: Loader.....	\$ 12.57 **	0.00
OPERATOR: Mechanic.....	\$ 19.27	0.00
OPERATOR: Milling Machine.....	\$ 14.68 **	0.00
OPERATOR: Mixer.....	\$ 14.25 **	0.00
OPERATOR: Oiler.....	\$ 12.35 **	0.00
OPERATOR: Paver (Asphalt, Aggregate, and Concrete).....	\$ 12.15 **	0.00
OPERATOR: Roller (All Types)....	\$ 12.64 **	0.00
OPERATOR: Scraper.....	\$ 12.25 **	0.00
OPERATOR: Tractor.....	\$ 11.22 **	0.00
TRUCK DRIVER: Flatbed Truck.....	\$ 14.06 **	0.00
TRUCK DRIVER: Lowboy Truck.....	\$ 11.00 **	0.00
TRUCK DRIVER: Mechanic.....	\$ 13.00 **	0.00
TRUCK DRIVER: Water Truck.....	\$ 10.98 **	0.00
TRUCK DRIVER: Dump Truck (All Types).....	\$ 12.56 **	0.00
TRUCK DRIVER: Semi/Trailer Truck.....	\$ 14.60 **	0.00

WELDERS - Receive rate prescribed for craft performing operation to which welding is incidental.

=====
 ** Workers in this classification may be entitled to a higher minimum wage under Executive Order 14026 (\$16.20) or 13658 (\$12.15). Please see the Note at the top of the wage determination for more information.

Note: Executive Order (EO) 13706, Establishing Paid Sick Leave for Federal Contractors applies to all contracts subject to the Davis-Bacon Act for which the contract is awarded (and any solicitation was issued) on or after January 1, 2017. If this contract is covered by the EO, the contractor must provide employees with 1 hour of paid sick leave for every 30 hours they work, up to 56 hours of paid sick leave each year. Employees must be permitted to use paid sick leave for their own illness, injury or other health-related needs, including preventive care; to assist a family member (or person who is like family to the employee) who is ill, injured, or has other health-related needs, including preventive care; or for reasons resulting from, or to assist a family member (or person who is like family to the employee) who is a victim of, domestic violence, sexual assault, or stalking. Additional information on contractor requirements and worker protections under the EO is available at <https://www.dol.gov/agencies/whd/government-contracts>.

Unlisted classifications needed for work not included within the scope of the classifications listed may be added after award only as provided in the labor standards contract clauses (29CFR 5.5 (a) (1) (ii)).

The body of each wage determination lists the classification and wage rates that have been found to be prevailing for the cited type(s) of construction in the area covered by the wage determination. The classifications are listed in alphabetical order of ""identifiers"" that indicate whether the particular rate is a union rate (current union negotiated rate for local), a survey rate (weighted average rate) or a union average rate (weighted union average rate).

Union Rate Identifiers

A four letter classification abbreviation identifier enclosed in dotted lines beginning with characters other than ""SU"" or ""UAVG"" denotes that the union classification and rate were prevailing for that classification in the survey. Example: PLUM0198-005 07/01/2014. PLUM is an abbreviation identifier of the union which prevailed in the survey for this classification, which in this example would be Plumbers. 0198 indicates the local union number or district council number where applicable, i.e., Plumbers Local 0198. The next number, 005 in the example, is an internal number used in processing the wage determination. 07/01/2014 is the effective date of the most current negotiated rate, which in this example is July 1, 2014.

Union prevailing wage rates are updated to reflect all rate changes in the collective bargaining agreement (CBA) governing this classification and rate.

Survey Rate Identifiers

Classifications listed under the ""SU"" identifier indicate that no one rate prevailed for this classification in the survey and the published rate is derived by computing a weighted average rate based on all the rates reported in the survey for that classification. As this weighted average rate includes all rates reported in the survey, it may include both union and non-union rates. Example: SULA2012-007 5/13/2014. SU indicates the rates are survey rates based on a weighted average calculation of rates and are not majority rates. LA indicates the State of Louisiana. 2012 is the year of survey on which these classifications and rates are based. The next number, 007 in the example, is an internal number used in producing the wage determination. 5/13/2014 indicates the survey completion date for the classifications and rates under that identifier.

Survey wage rates are not updated and remain in effect until a new survey is conducted.

Union Average Rate Identifiers

Classification(s) listed under the UAVG identifier indicate that no single majority rate prevailed for those classifications; however, 100% of the data reported for the classifications was union data. EXAMPLE: UAVG-OH-0010

08/29/2014. UAVG indicates that the rate is a weighted union average rate. OH indicates the state. The next number, 0010 in the example, is an internal number used in producing the wage determination. 08/29/2014 indicates the survey completion date for the classifications and rates under that identifier.

A UAVG rate will be updated once a year, usually in January of each year, to reflect a weighted average of the current negotiated/CBA rate of the union locals from which the rate is based.

WAGE DETERMINATION APPEALS PROCESS

1.) Has there been an initial decision in the matter? This can be:

- * an existing published wage determination
- * a survey underlying a wage determination
- * a Wage and Hour Division letter setting forth a position on a wage determination matter
- * a conformance (additional classification and rate) ruling

On survey related matters, initial contact, including requests for summaries of surveys, should be with the Wage and Hour National Office because National Office has responsibility for the Davis-Bacon survey program. If the response from this initial contact is not satisfactory, then the process described in 2.) and 3.) should be followed.

With regard to any other matter not yet ripe for the formal process described here, initial contact should be with the Branch of Construction Wage Determinations. Write to:

Branch of Construction Wage Determinations
Wage and Hour Division
U.S. Department of Labor
200 Constitution Avenue, N.W.
Washington, DC 20210

2.) If the answer to the question in 1.) is yes, then an interested party (those affected by the action) can request review and reconsideration from the Wage and Hour Administrator (See 29 CFR Part 1.8 and 29 CFR Part 7). Write to:

Wage and Hour Administrator
U.S. Department of Labor
200 Constitution Avenue, N.W.
Washington, DC 20210

The request should be accompanied by a full statement of the interested party's position and by any information (wage payment data, project description, area practice material, etc.) that the requestor considers relevant to the issue.

3.) If the decision of the Administrator is not favorable, an interested party may appeal directly to the Administrative Review Board (formerly the Wage Appeals Board). Write to:

Administrative Review Board
U.S. Department of Labor
200 Constitution Avenue, N.W.

Washington, DC 20210

4.) All decisions by the Administrative Review Board are final.

=====

END OF GENERAL DECISIO"

SUPPLEMENT TO FORM FHWA-1273

DATE: 07/26/2022

SUBJECT: Federal Contract Provisions for Subcontracts

Federal Contract Provisions for Subcontracts

All subcontracts shall be in writing and contain all pertinent provisions and requirements of the prime contract.

Each “Request for Permission to Subcontract” (Mississippi Department of Transportation Form CAD-720) shall include a copy of the subcontract. The federal contract provisions (FHWA-1273, SUPPLEMENT TO FORM FHWA-1273, NOTICE OF REQUIREMENT FOR AFFIRMATIVE ACTION TO ENSURE EQUAL EMPLOYMENT OPPORTUNITY (EXECUTIVE ORDER 11246), DAVIS-BACON AND RELATED ACT PROVISIONS (WAGE RATES)) must be physically incorporated as part of the subcontract. A completed Mississippi Department of Transportation Form CAD-521 and Form CAD-725 must be attached to the CAD-720.

**REQUIRED CONTRACT PROVISIONS
FEDERAL-AID CONSTRUCTION CONTRACTS**

- I. General
- II. Nondiscrimination
- III. Non-segregated Facilities
- IV. Davis-Bacon and Related Act Provisions
- V. Contract Work Hours and Safety Standards Act Provisions
- VI. Subletting or Assigning the Contract
- VII. Safety: Accident Prevention
- VIII. False Statements Concerning Highway Projects
- IX. Implementation of Clean Air Act and Federal Water Pollution Control Act
- X. Certification Regarding Debarment, Suspension, Ineligibility and Voluntary Exclusion
- XI. Certification Regarding Use of Contract Funds for Lobbying
- XII. Use of United States-Flag Vessels:

ATTACHMENTS

A. Employment and Materials Preference for Appalachian Development Highway System or Appalachian Local Access Road Contracts (included in Appalachian contracts only)

I. GENERAL

1. Form FHWA-1273 must be physically incorporated in each construction contract funded under title 23, United States Code, as required in 23 CFR 633.102(b) (excluding emergency contracts solely intended for debris removal). The contractor (or subcontractor) must insert this form in each subcontract and further require its inclusion in all lower tier subcontracts (excluding purchase orders, rental agreements and other agreements for supplies or services). 23 CFR 633.102(e).

The applicable requirements of Form FHWA-1273 are incorporated by reference for work done under any purchase order, rental agreement or agreement for other services. The prime contractor shall be responsible for compliance by any subcontractor, lower-tier subcontractor or service provider. 23 CFR 633.102(e).

Form FHWA-1273 must be included in all Federal-aid design-build contracts, in all subcontracts and in lower tier subcontracts (excluding subcontracts for design services, purchase orders, rental agreements and other agreements for supplies or services) in accordance with 23 CFR 633.102. The design-builder shall be responsible for compliance by any subcontractor, lower-tier subcontractor or service provider.

Contracting agencies may reference Form FHWA-1273 in solicitation-for-bids or request-for-proposals documents, however, the Form FHWA-1273 must be physically incorporated (not referenced) in all contracts, subcontracts and lower-tier subcontracts (excluding purchase orders, rental agreements and other agreements for supplies or services related to a construction contract). 23 CFR 633.102(b).

2. Subject to the applicability criteria noted in the following sections, these contract provisions shall apply to all work

performed on the contract by the contractor's own organization and with the assistance of workers under the contractor's immediate superintendence and to all work performed on the contract by piecework, station work, or by subcontract. 23 CFR 633.102(d).

3. A breach of any of the stipulations contained in these Required Contract Provisions may be sufficient grounds for withholding of progress payments, withholding of final payment, termination of the contract, suspension / debarment or any other action determined to be appropriate by the contracting agency and FHWA.

4. Selection of Labor: During the performance of this contract, the contractor shall not use convict labor for any purpose within the limits of a construction project on a Federal-aid highway unless it is labor performed by convicts who are on parole, supervised release, or probation. 23 U.S.C. 114(b). The term Federal-aid highway does not include roadways functionally classified as local roads or rural minor collectors. 23 U.S.C. 101(a).

II. NONDISCRIMINATION (23 CFR 230.107(a); 23 CFR Part 230, Subpart A, Appendix A; EO 11246)

The provisions of this section related to 23 CFR Part 230, Subpart A, Appendix A are applicable to all Federal-aid construction contracts and to all related construction subcontracts of \$10,000 or more. The provisions of 23 CFR Part 230 are not applicable to material supply, engineering, or architectural service contracts.

In addition, the contractor and all subcontractors must comply with the following policies: Executive Order 11246, 41 CFR Part 60, 29 CFR Parts 1625-1627, 23 U.S.C. 140, Section 504 of the Rehabilitation Act of 1973, as amended (29 U.S.C. 794), Title VI of the Civil Rights Act of 1964, as amended (42 U.S.C. 2000d et seq.), and related regulations including 49 CFR Parts 21, 26, and 27; and 23 CFR Parts 200, 230, and 633.

The contractor and all subcontractors must comply with: the requirements of the Equal Opportunity Clause in 41 CFR 60-1.4(b) and, for all construction contracts exceeding \$10,000, the Standard Federal Equal Employment Opportunity Construction Contract Specifications in 41 CFR 60-4.3.

Note: The U.S. Department of Labor has exclusive authority to determine compliance with Executive Order 11246 and the policies of the Secretary of Labor including 41 CFR Part 60, and 29 CFR Parts 1625-1627. The contracting agency and the FHWA have the authority and the responsibility to ensure compliance with 23 U.S.C. 140, Section 504 of the Rehabilitation Act of 1973, as amended (29 U.S.C. 794), and Title VI of the Civil Rights Act of 1964, as amended (42 U.S.C. 2000d et seq.), and related regulations including 49 CFR Parts 21, 26, and 27; and 23 CFR Parts 200, 230, and 633.

The following provision is adopted from 23 CFR Part 230, Subpart A, Appendix A, with appropriate revisions to conform to the U.S. Department of Labor (US DOL) and FHWA requirements.

1. Equal Employment Opportunity: Equal Employment Opportunity (EEO) requirements not to discriminate and to take affirmative action to assure equal opportunity as set forth under laws, executive orders, rules, regulations (see 28 CFR Part 35, 29 CFR Part 1630, 29 CFR Parts 1625-1627, 41 CFR Part 60 and 49 CFR Part 27) and orders of the Secretary of Labor as modified by the provisions prescribed herein, and imposed pursuant to 23 U.S.C. 140, shall constitute the EEO and specific affirmative action standards for the contractor's project activities under this contract. The provisions of the Americans with Disabilities Act of 1990 (42 U.S.C. 12101 et seq.) set forth under 28 CFR Part 35 and 29 CFR Part 1630 are incorporated by reference in this contract. In the execution of this contract, the contractor agrees to comply with the following minimum specific requirement activities of EEO:

a. The contractor will work with the contracting agency and the Federal Government to ensure that it has made every good faith effort to provide equal opportunity with respect to all of its terms and conditions of employment and in their review of activities under the contract. 23 CFR 230.409 (g)(4) & (5).

b. The contractor will accept as its operating policy the following statement:

"It is the policy of this Company to assure that applicants are employed, and that employees are treated during employment, without regard to their race, religion, sex, sexual orientation, gender identity, color, national origin, age or disability. Such action shall include: employment, upgrading, demotion, or transfer; recruitment or recruitment advertising; layoff or termination; rates of pay or other forms of compensation; and selection for training, including apprenticeship, pre-apprenticeship, and/or on-the-job training."

2. EEO Officer: The contractor will designate and make known to the contracting officers an EEO Officer who will have the responsibility for and must be capable of effectively administering and promoting an active EEO program and who must be assigned adequate authority and responsibility to do so.

3. Dissemination of Policy: All members of the contractor's staff who are authorized to hire, supervise, promote, and discharge employees, or who recommend such action or are substantially involved in such action, will be made fully cognizant of and will implement the contractor's EEO policy and contractual responsibilities to provide EEO in each grade and classification of employment. To ensure that the above agreement will be met, the following actions will be taken as a minimum:

a. Periodic meetings of supervisory and personnel office employees will be conducted before the start of work and then not less often than once every six months, at which time the contractor's EEO policy and its implementation will be reviewed and explained. The meetings will be conducted by the EEO Officer or other knowledgeable company official.

b. All new supervisory or personnel office employees will be given a thorough indoctrination by the EEO Officer, covering all major aspects of the contractor's EEO obligations within thirty days following their reporting for duty with the contractor.

c. All personnel who are engaged in direct recruitment for the project will be instructed by the EEO Officer in the contractor's procedures for locating and hiring minorities and women.

d. Notices and posters setting forth the contractor's EEO policy will be placed in areas readily accessible to employees, applicants for employment and potential employees.

e. The contractor's EEO policy and the procedures to implement such policy will be brought to the attention of employees by means of meetings, employee handbooks, or other appropriate means.

4. Recruitment: When advertising for employees, the contractor will include in all advertisements for employees the notation: "An Equal Opportunity Employer." All such advertisements will be placed in publications having a large circulation among minorities and women in the area from which the project work force would normally be derived.

a. The contractor will, unless precluded by a valid bargaining agreement, conduct systematic and direct recruitment through public and private employee referral sources likely to yield qualified minorities and women. To meet this requirement, the contractor will identify sources of potential minority group employees and establish with such identified sources procedures whereby minority and women applicants may be referred to the contractor for employment consideration.

b. In the event the contractor has a valid bargaining agreement providing for exclusive hiring hall referrals, the contractor is expected to observe the provisions of that agreement to the extent that the system meets the contractor's compliance with EEO contract provisions. Where implementation of such an agreement has the effect of discriminating against minorities or women, or obligates the contractor to do the same, such implementation violates Federal nondiscrimination provisions.

c. The contractor will encourage its present employees to refer minorities and women as applicants for employment. Information and procedures with regard to referring such applicants will be discussed with employees.

5. Personnel Actions: Wages, working conditions, and employee benefits shall be established and administered, and personnel actions of every type, including hiring, upgrading, promotion, transfer, demotion, layoff, and termination, shall be taken without regard to race, color, religion, sex, sexual orientation, gender identity, national origin, age or disability. The following procedures shall be followed:

a. The contractor will conduct periodic inspections of project sites to ensure that working conditions and employee facilities do not indicate discriminatory treatment of project site personnel.

b. The contractor will periodically evaluate the spread of wages paid within each classification to determine any evidence of discriminatory wage practices.

c. The contractor will periodically review selected personnel actions in depth to determine whether there is evidence of discrimination. Where evidence is found, the contractor will promptly take corrective action. If the review indicates that the discrimination may extend beyond the actions reviewed, such corrective action shall include all affected persons.

d. The contractor will promptly investigate all complaints of alleged discrimination made to the contractor in connection with its obligations under this contract, will attempt to resolve such complaints, and will take appropriate corrective action

within a reasonable time. If the investigation indicates that the discrimination may affect persons other than the complainant, such corrective action shall include such other persons. Upon completion of each investigation, the contractor will inform every complainant of all of their avenues of appeal.

6. Training and Promotion:

a. The contractor will assist in locating, qualifying, and increasing the skills of minorities and women who are applicants for employment or current employees. Such efforts should be aimed at developing full journey level status employees in the type of trade or job classification involved.

b. Consistent with the contractor's work force requirements and as permissible under Federal and State regulations, the contractor shall make full use of training programs (i.e., apprenticeship and on-the-job training programs for the geographical area of contract performance). In the event a special provision for training is provided under this contract, this subparagraph will be superseded as indicated in the special provision. The contracting agency may reserve training positions for persons who receive welfare assistance in accordance with 23 U.S.C. 140(a).

c. The contractor will advise employees and applicants for employment of available training programs and entrance requirements for each.

d. The contractor will periodically review the training and promotion potential of employees who are minorities and women and will encourage eligible employees to apply for such training and promotion.

7. Unions: If the contractor relies in whole or in part upon unions as a source of employees, the contractor will use good faith efforts to obtain the cooperation of such unions to increase opportunities for minorities and women. 23 CFR 230.409. Actions by the contractor, either directly or through a contractor's association acting as agent, will include the procedures set forth below:

a. The contractor will use good faith efforts to develop, in cooperation with the unions, joint training programs aimed toward qualifying more minorities and women for membership in the unions and increasing the skills of minorities and women so that they may qualify for higher paying employment.

b. The contractor will use good faith efforts to incorporate an EEO clause into each union agreement to the end that such union will be contractually bound to refer applicants without regard to their race, color, religion, sex, sexual orientation, gender identity, national origin, age, or disability.

c. The contractor is to obtain information as to the referral practices and policies of the labor union except that to the extent such information is within the exclusive possession of the labor union and such labor union refuses to furnish such information to the contractor, the contractor shall so certify to the contracting agency and shall set forth what efforts have been made to obtain such information.

d. In the event the union is unable to provide the contractor with a reasonable flow of referrals within the time limit set forth in the collective bargaining agreement, the contractor will, through independent recruitment efforts, fill the employment vacancies without regard to race, color, religion, sex, sexual orientation, gender identity, national origin, age, or disability; making full efforts to obtain qualified and/or qualifiable minorities and women. The failure of a union to provide

sufficient referrals (even though it is obligated to provide exclusive referrals under the terms of a collective bargaining agreement) does not relieve the contractor from the requirements of this paragraph. In the event the union referral practice prevents the contractor from meeting the obligations pursuant to Executive Order 11246, as amended, and these special provisions, such contractor shall immediately notify the contracting agency.

8. Reasonable Accommodation for Applicants / Employees with Disabilities: The contractor must be familiar with the requirements for and comply with the Americans with Disabilities Act and all rules and regulations established thereunder. Employers must provide reasonable accommodation in all employment activities unless to do so would cause an undue hardship.

9. Selection of Subcontractors, Procurement of Materials and Leasing of Equipment: The contractor shall not discriminate on the grounds of race, color, religion, sex, sexual orientation, gender identity, national origin, age, or disability in the selection and retention of subcontractors, including procurement of materials and leases of equipment. The contractor shall take all necessary and reasonable steps to ensure nondiscrimination in the administration of this contract.

a. The contractor shall notify all potential subcontractors, suppliers, and lessors of their EEO obligations under this contract.

b. The contractor will use good faith efforts to ensure subcontractor compliance with their EEO obligations.

10. Assurances Required:

a. The requirements of 49 CFR Part 26 and the State DOT's FHWA-approved Disadvantaged Business Enterprise (DBE) program are incorporated by reference.

b. The contractor, subrecipient or subcontractor shall not discriminate on the basis of race, color, national origin, or sex in the performance of this contract. The contractor shall carry out applicable requirements of 49 CFR part 26 in the award and administration of DOT-assisted contracts. Failure by the contractor to carry out these requirements is a material breach of this contract, which may result in the termination of this contract or such other remedy as the recipient deems appropriate, which may include, but is not limited to:

- (1) Withholding monthly progress payments;
- (2) Assessing sanctions;
- (3) Liquidated damages; and/or
- (4) Disqualifying the contractor from future bidding as non-responsible.

c. The Title VI and nondiscrimination provisions of U.S. DOT Order 1050.2A at Appendixes A and E are incorporated by reference. 49 CFR Part 21.

11. Records and Reports: The contractor shall keep such records as necessary to document compliance with the EEO requirements. Such records shall be retained for a period of three years following the date of the final payment to the contractor for all contract work and shall be available at reasonable times and places for inspection by authorized representatives of the contracting agency and the FHWA.

a. The records kept by the contractor shall document the following:

(1) The number and work hours of minority and non-minority group members and women employed in each work classification on the project;

(2) The progress and efforts being made in cooperation with unions, when applicable, to increase employment opportunities for minorities and women; and

(3) The progress and efforts being made in locating, hiring, training, qualifying, and upgrading minorities and women.

b. The contractors and subcontractors will submit an annual report to the contracting agency each July for the duration of the project indicating the number of minority, women, and non-minority group employees currently engaged in each work classification required by the contract work. This information is to be reported on [Form FHWA-1391](#). The staffing data should represent the project work force on board in all or any part of the last payroll period preceding the end of July. If on-the-job training is being required by special provision, the contractor will be required to collect and report training data. The employment data should reflect the work force on board during all or any part of the last payroll period preceding the end of July.

III. NONSEGREGATED FACILITIES

This provision is applicable to all Federal-aid construction contracts and to all related construction subcontracts of more than \$10,000. 41 CFR 60-1.5.

As prescribed by 41 CFR 60-1.8, the contractor must ensure that facilities provided for employees are provided in such a manner that segregation on the basis of race, color, religion, sex, sexual orientation, gender identity, or national origin cannot result. The contractor may neither require such segregated use by written or oral policies nor tolerate such use by employee custom. The contractor's obligation extends further to ensure that its employees are not assigned to perform their services at any location under the contractor's control where the facilities are segregated. The term "facilities" includes waiting rooms, work areas, restaurants and other eating areas, time clocks, restrooms, washrooms, locker rooms and other storage or dressing areas, parking lots, drinking fountains, recreation or entertainment areas, transportation, and housing provided for employees. The contractor shall provide separate or single-user restrooms and necessary dressing or sleeping areas to assure privacy between sexes.

IV. DAVIS-BACON AND RELATED ACT PROVISIONS

This section is applicable to all Federal-aid construction projects exceeding \$2,000 and to all related subcontracts and lower-tier subcontracts (regardless of subcontract size), in accordance with 29 CFR 5.5. The requirements apply to all projects located within the right-of-way of a roadway that is functionally classified as Federal-aid highway. 23 U.S.C. 113. This excludes roadways functionally classified as local roads or rural minor collectors, which are exempt. 23 U.S.C. 101. Where applicable law requires that projects be treated as a project on a Federal-aid highway, the provisions of this subpart will apply regardless of the location of the project. Examples include: Surface Transportation Block Grant Program projects funded under 23 U.S.C. 133 [excluding recreational trails projects], the Nationally Significant Freight and Highway

Projects funded under 23 U.S.C. 117, and National Highway Freight Program projects funded under 23 U.S.C. 167.

The following provisions are from the U.S. Department of Labor regulations in 29 CFR 5.5 "Contract provisions and related matters" with minor revisions to conform to the FHWA-1273 format and FHWA program requirements.

1. Minimum wages (29 CFR 5.5)

a. All laborers and mechanics employed or working upon the site of the work, will be paid unconditionally and not less often than once a week, and without subsequent deduction or rebate on any account (except such payroll deductions as are permitted by regulations issued by the Secretary of Labor under the Copeland Act (29 CFR part 3)), the full amount of wages and bona fide fringe benefits (or cash equivalents thereof) due at time of payment computed at rates not less than those contained in the wage determination of the Secretary of Labor which is attached hereto and made a part hereof, regardless of any contractual relationship which may be alleged to exist between the contractor and such laborers and mechanics.

Contributions made or costs reasonably anticipated for bona fide fringe benefits under section 1(b)(2) of the Davis-Bacon Act on behalf of laborers or mechanics are considered wages paid to such laborers or mechanics, subject to the provisions of paragraph 1.d. of this section; also, regular contributions made or costs incurred for more than a weekly period (but not less often than quarterly) under plans, funds, or programs which cover the particular weekly period, are deemed to be constructively made or incurred during such weekly period. Such laborers and mechanics shall be paid the appropriate wage rate and fringe benefits on the wage determination for the classification of work actually performed, without regard to skill, except as provided in 29 CFR 5.5(a)(4). Laborers or mechanics performing work in more than one classification may be compensated at the rate specified for each classification for the time actually worked therein: Provided, That the employer's payroll records accurately set forth the time spent in each classification in which work is performed. The wage determination (including any additional classification and wage rates conformed under paragraph 1.b. of this section) and the Davis-Bacon poster (WH-1321) shall be posted at all times by the contractor and its subcontractors at the site of the work in a prominent and accessible place where it can be easily seen by the workers.

b.(1) The contracting officer shall require that any class of laborers or mechanics, including helpers, which is not listed in the wage determination and which is to be employed under the contract shall be classified in conformance with the wage determination. The contracting officer shall approve an additional classification and wage rate and fringe benefits therefore only when the following criteria have been met:

(i) The work to be performed by the classification requested is not performed by a classification in the wage determination; and

(ii) The classification is utilized in the area by the construction industry; and

(iii) The proposed wage rate, including any bona fide fringe benefits, bears a reasonable relationship to the wage rates contained in the wage determination.

(2) If the contractor and the laborers and mechanics to be employed in the classification (if known), or their representatives, and the contracting officer agree on the classification and wage rate (including the amount designated for fringe benefits where appropriate), a report of the action taken shall be sent by the contracting officer to the Administrator of the Wage and Hour Division, U.S. Department of Labor, Washington, DC 20210. The Administrator, or an authorized representative, will approve, modify, or disapprove every additional classification action within 30 days of receipt and so advise the contracting officer or will notify the contracting officer within the 30-day period that additional time is necessary.

(3) In the event the contractor, the laborers or mechanics to be employed in the classification or their representatives, and the contracting officer do not agree on the proposed classification and wage rate (including the amount designated for fringe benefits, where appropriate), the contracting officer shall refer the questions, including the views of all interested parties and the recommendation of the contracting officer, to the Administrator for determination. The Administrator, or an authorized representative, will issue a determination within 30 days of receipt and so advise the contracting officer or will notify the contracting officer within the 30-day period that additional time is necessary.

(4) The wage rate (including fringe benefits where appropriate) determined pursuant to paragraphs 1.b.(2) or 1.b.(3) of this section, shall be paid to all workers performing work in the classification under this contract from the first day on which work is performed in the classification.

c. Whenever the minimum wage rate prescribed in the contract for a class of laborers or mechanics includes a fringe benefit which is not expressed as an hourly rate, the contractor shall either pay the benefit as stated in the wage determination or shall pay another bona fide fringe benefit or an hourly cash equivalent thereof.

d. If the contractor does not make payments to a trustee or other third person, the contractor may consider as part of the wages of any laborer or mechanic the amount of any costs reasonably anticipated in providing bona fide fringe benefits under a plan or program, Provided, That the Secretary of Labor has found, upon the written request of the contractor, that the applicable standards of the Davis-Bacon Act have been met. The Secretary of Labor may require the contractor to set aside in a separate account assets for the meeting of obligations under the plan or program.

2. Withholding (29 CFR 5.5)

The contracting agency shall upon its own action or upon written request of an authorized representative of the Department of Labor, withhold or cause to be withheld from the contractor under this contract, or any other Federal contract with the same prime contractor, or any other federally-assisted contract subject to Davis-Bacon prevailing wage requirements, which is held by the same prime contractor, so much of the accrued payments or advances as may be considered necessary to pay laborers and mechanics,

including apprentices, trainees, and helpers, employed by the contractor or any subcontractor the full amount of wages required by the contract. In the event of failure to pay any laborer or mechanic, including any apprentice, trainee, or helper, employed or working on the site of the work, all or part of the wages required by the contract, the contracting agency may, after written notice to the contractor, take such action as may be necessary to cause the suspension of any further payment, advance, or guarantee of funds until such violations have ceased.

3. Payrolls and basic records (29 CFR 5.5)

a. Payrolls and basic records relating thereto shall be maintained by the contractor during the course of the work and preserved for a period of three years thereafter for all laborers and mechanics working at the site of the work. Such records shall contain the name, address, and social security number of each such worker, his or her correct classification, hourly rates of wages paid (including rates of contributions or costs anticipated for bona fide fringe benefits or cash equivalents thereof of the types described in section 1(b)(2)(B) of the Davis-Bacon Act), daily and weekly number of hours worked, deductions made and actual wages paid. Whenever the Secretary of Labor has found under 29 CFR 5.5(a)(1)(iv) that the wages of any laborer or mechanic include the amount of any costs reasonably anticipated in providing benefits under a plan or program described in section 1(b)(2)(B) of the Davis-Bacon Act, the contractor shall maintain records which show that the commitment to provide such benefits is enforceable, that the plan or program is financially responsible, and that the plan or program has been communicated in writing to the laborers or mechanics affected, and records which show the costs anticipated or the actual cost incurred in providing such benefits. Contractors employing apprentices or trainees under approved programs shall maintain written evidence of the registration of apprenticeship programs and certification of trainee programs, the registration of the apprentices and trainees, and the ratios and wage rates prescribed in the applicable programs.

b.(1) The contractor shall submit weekly for each week in which any contract work is performed a copy of all payrolls to the contracting agency. The payrolls submitted shall set out accurately and completely all of the information required to be maintained under 29 CFR 5.5(a)(3)(i), except that full social security numbers and home addresses shall not be included on weekly transmittals. Instead the payrolls shall only need to include an individually identifying number for each employee (e.g., the last four digits of the employee's social security number). The required weekly payroll information may be submitted in any form desired. Optional Form WH-347 is available for this purpose from the Wage and Hour Division Web site. The prime contractor is responsible for the submission of copies of payrolls by all subcontractors. Contractors and subcontractors shall maintain the full social security number and current address of each covered worker, and shall provide them upon request to the contracting agency for transmission to the State DOT, the FHWA or the Wage and Hour Division of the Department of Labor for purposes of an investigation or audit of compliance with prevailing wage requirements. It is not a violation of this section for a prime contractor to require a subcontractor to provide addresses and social security numbers to the prime contractor for its own records, without weekly submission to the contracting agency.

(2) Each payroll submitted shall be accompanied by a "Statement of Compliance," signed by the contractor or

subcontractor or his or her agent who pays or supervises the payment of the persons employed under the contract and shall certify the following:

(i) That the payroll for the payroll period contains the information required to be provided under 29 CFR 5.5(a)(3)(ii), the appropriate information is being maintained under 29 CFR 5.5(a)(3)(i), and that such information is correct and complete;

(ii) That each laborer or mechanic (including each helper, apprentice, and trainee) employed on the contract during the payroll period has been paid the full weekly wages earned, without rebate, either directly or indirectly, and that no deductions have been made either directly or indirectly from the full wages earned, other than permissible deductions as set forth in 29 CFR part 3;

(iii) That each laborer or mechanic has been paid not less than the applicable wage rates and fringe benefits or cash equivalents for the classification of work performed, as specified in the applicable wage determination incorporated into the contract.

(3) The weekly submission of a properly executed certification set forth on the reverse side of Optional Form WH-347 shall satisfy the requirement for submission of the "Statement of Compliance" required by paragraph 3.b.(2) of this section.

(4) The falsification of any of the above certifications may subject the contractor or subcontractor to civil or criminal prosecution under 18 U.S.C. 1001 and 31 U.S.C. 231.

c. The contractor or subcontractor shall make the records required under paragraph 3.a. of this section available for inspection, copying, or transcription by authorized representatives of the contracting agency, the State DOT, the FHWA, or the Department of Labor, and shall permit such representatives to interview employees during working hours on the job. If the contractor or subcontractor fails to submit the required records or to make them available, the FHWA may, after written notice to the contractor, the contracting agency or the State DOT, take such action as may be necessary to cause the suspension of any further payment, advance, or guarantee of funds. Furthermore, failure to submit the required records upon request or to make such records available may be grounds for debarment action pursuant to 29 CFR 5.12.

4. Apprentices and trainees (29 CFR 5.5)

a. Apprentices (programs of the USDOL).

Apprentices will be permitted to work at less than the predetermined rate for the work they performed when they are employed pursuant to and individually registered in a bona fide apprenticeship program registered with the U.S. Department of Labor, Employment and Training Administration, Office of Apprenticeship Training, Employer and Labor Services, or with a State Apprenticeship Agency recognized by the Office, or if a person is employed in his or her first 90 days of probationary employment as an apprentice in such an apprenticeship program, who is not individually registered in the program, but who has been certified by the Office of Apprenticeship Training, Employer and Labor Services or a State

Apprenticeship Agency (where appropriate) to be eligible for probationary employment as an apprentice.

The allowable ratio of apprentices to journeymen on the job site in any craft classification shall not be greater than the ratio permitted to the contractor as to the entire work force under the registered program. Any worker listed on a payroll at an apprentice wage rate, who is not registered or otherwise employed as stated above, shall be paid not less than the applicable wage rate on the wage determination for the classification of work actually performed. In addition, any apprentice performing work on the job site in excess of the ratio permitted under the registered program shall be paid not less than the applicable wage rate on the wage determination for the work actually performed. Where a contractor is performing construction on a project in a locality other than that in which its program is registered, the ratios and wage rates (expressed in percentages of the journeyman's hourly rate) specified in the contractor's or subcontractor's registered program shall be observed.

Every apprentice must be paid at not less than the rate specified in the registered program for the apprentice's level of progress, expressed as a percentage of the journeymen hourly rate specified in the applicable wage determination. Apprentices shall be paid fringe benefits in accordance with the provisions of the apprenticeship program. If the apprenticeship program does not specify fringe benefits, apprentices must be paid the full amount of fringe benefits listed on the wage determination for the applicable classification. If the Administrator determines that a different practice prevails for the applicable apprentice classification, fringes shall be paid in accordance with that determination.

In the event the Office of Apprenticeship Training, Employer and Labor Services, or a State Apprenticeship Agency recognized by the Office, withdraws approval of an apprenticeship program, the contractor will no longer be permitted to utilize apprentices at less than the applicable predetermined rate for the work performed until an acceptable program is approved.

b. Trainees (programs of the USDOL).

Except as provided in 29 CFR 5.16, trainees will not be permitted to work at less than the predetermined rate for the work performed unless they are employed pursuant to and individually registered in a program which has received prior approval, evidenced by formal certification by the U.S. Department of Labor, Employment and Training Administration.

The ratio of trainees to journeymen on the job site shall not be greater than permitted under the plan approved by the Employment and Training Administration.

Every trainee must be paid at not less than the rate specified in the approved program for the trainee's level of progress, expressed as a percentage of the journeyman hourly rate specified in the applicable wage determination. Trainees shall be paid fringe benefits in accordance with the provisions of the trainee program. If the trainee program does not mention fringe benefits, trainees shall be paid the full amount of fringe benefits listed on the wage determination unless the Administrator of the Wage and Hour Division determines that there is an apprenticeship program associated with the

corresponding journeyman wage rate on the wage determination which provides for less than full fringe benefits for apprentices. Any employee listed on the payroll at a trainee rate who is not registered and participating in a training plan approved by the Employment and Training Administration shall be paid not less than the applicable wage rate on the wage determination for the classification of work actually performed. In addition, any trainee performing work on the job site in excess of the ratio permitted under the registered program shall be paid not less than the applicable wage rate on the wage determination for the work actually performed.

In the event the Employment and Training Administration withdraws approval of a training program, the contractor will no longer be permitted to utilize trainees at less than the applicable predetermined rate for the work performed until an acceptable program is approved.

c. Equal employment opportunity. The utilization of apprentices, trainees and journeymen under this part shall be in conformity with the equal employment opportunity requirements of Executive Order 11246, as amended, and 29 CFR part 30.

d. Apprentices and Trainees (programs of the U.S. DOT).

Apprentices and trainees working under apprenticeship and skill training programs which have been certified by the Secretary of Transportation as promoting EEO in connection with Federal-aid highway construction programs are not subject to the requirements of paragraph 4 of this Section IV. 23 CFR 230.111(e)(2). The straight time hourly wage rates for apprentices and trainees under such programs will be established by the particular programs. The ratio of apprentices and trainees to journeymen shall not be greater than permitted by the terms of the particular program.

5. Compliance with Copeland Act requirements. The contractor shall comply with the requirements of 29 CFR part 3, which are incorporated by reference in this contract as provided in 29 CFR 5.5.

6. Subcontracts. The contractor or subcontractor shall insert Form FHWA-1273 in any subcontracts and also require the subcontractors to include Form FHWA-1273 in any lower tier subcontracts. The prime contractor shall be responsible for the compliance by any subcontractor or lower tier subcontractor with all the contract clauses in 29 CFR 5.5.

7. Contract termination: debarment. A breach of the contract clauses in 29 CFR 5.5 may be grounds for termination of the contract, and for debarment as a contractor and a subcontractor as provided in 29 CFR 5.12.

8. Compliance with Davis-Bacon and Related Act requirements. All rulings and interpretations of the Davis-Bacon and Related Acts contained in 29 CFR parts 1, 3, and 5 are herein incorporated by reference in this contract as provided in 29 CFR 5.5.

9. Disputes concerning labor standards. As provided in 29 CFR 5.5, disputes arising out of the labor standards provisions of this contract shall not be subject to the general disputes clause of this contract. Such disputes shall be resolved in accordance with the procedures of the Department of Labor

set forth in 29 CFR parts 5, 6, and 7. Disputes within the meaning of this clause include disputes between the contractor (or any of its subcontractors) and the contracting agency, the U.S. Department of Labor, or the employees or their representatives.

10. Certification of eligibility (29 CFR 5.5)

a. By entering into this contract, the contractor certifies that neither it (nor he or she) nor any person or firm who has an interest in the contractor's firm is a person or firm ineligible to be awarded Government contracts by virtue of section 3(a) of the Davis-Bacon Act or 29 CFR 5.12(a)(1).

b. No part of this contract shall be subcontracted to any person or firm ineligible for award of a Government contract by virtue of section 3(a) of the Davis-Bacon Act or 29 CFR 5.12(a)(1).

c. The penalty for making false statements is prescribed in the U.S. Criminal Code, 18 U.S.C. 1001.

V. CONTRACT WORK HOURS AND SAFETY STANDARDS ACT

Pursuant to 29 CFR 5.5(b), the following clauses apply to any Federal-aid construction contract in an amount in excess of \$100,000 and subject to the overtime provisions of the Contract Work Hours and Safety Standards Act. These clauses shall be inserted in addition to the clauses required by 29 CFR 5.5(a) or 29 CFR 4.6. As used in this paragraph, the terms laborers and mechanics include watchmen and guards.

1. Overtime requirements. No contractor or subcontractor contracting for any part of the contract work which may require or involve the employment of laborers or mechanics shall require or permit any such laborer or mechanic in any workweek in which he or she is employed on such work to work in excess of forty hours in such workweek unless such laborer or mechanic receives compensation at a rate not less than one and one-half times the basic rate of pay for all hours worked in excess of forty hours in such workweek. 29 CFR 5.5.

2. Violation; liability for unpaid wages; liquidated damages. In the event of any violation of the clause set forth in paragraph 1 of this section, the contractor and any subcontractor responsible therefor shall be liable for the unpaid wages. In addition, such contractor and subcontractor shall be liable to the United States (in the case of work done under contract for the District of Columbia or a territory, to such District or to such territory), for liquidated damages. Such liquidated damages shall be computed with respect to each individual laborer or mechanic, including watchmen and guards, employed in violation of the clause set forth in paragraph 1 of this section, in the sum currently provided in 29 CFR 5.5(b)(2)* for each calendar day on which such individual was required or permitted to work in excess of the standard workweek of forty hours without payment of the overtime wages required by the clause set forth in paragraph 1 of this section. 29 CFR 5.5.

* \$27 as of January 23, 2019 (See 84 FR 213-01, 218) as may be adjusted annually by the Department of Labor; pursuant to the Federal Civil Penalties Inflation Adjustment Act of 1990).

3. Withholding for unpaid wages and liquidated damages.

The FHWA or the contracting agency shall upon its own action or upon written request of an authorized representative of the Department of Labor withhold or cause to be withheld, from any moneys payable on account of work performed by the contractor or subcontractor under any such contract or any other Federal contract with the same prime contractor, or any other federally-assisted contract subject to the Contract Work Hours and Safety Standards Act, which is held by the same prime contractor, such sums as may be determined to be necessary to satisfy any liabilities of such contractor or subcontractor for unpaid wages and liquidated damages as provided in the clause set forth in paragraph 2 of this section. 29 CFR 5.5.

4. Subcontracts. The contractor or subcontractor shall insert in any subcontracts the clauses set forth in paragraphs 1 through 4 of this section and also a clause requiring the subcontractors to include these clauses in any lower tier subcontracts. The prime contractor shall be responsible for compliance by any subcontractor or lower tier subcontractor with the clauses set forth in paragraphs 1 through 4 of this section. 29 CFR 5.5.

VI. SUBLETTING OR ASSIGNING THE CONTRACT

This provision is applicable to all Federal-aid construction contracts on the National Highway System pursuant to 23 CFR 635.116.

1. The contractor shall perform with its own organization contract work amounting to not less than 30 percent (or a greater percentage if specified elsewhere in the contract) of the total original contract price, excluding any specialty items designated by the contracting agency. Specialty items may be performed by subcontract and the amount of any such specialty items performed may be deducted from the total original contract price before computing the amount of work required to be performed by the contractor's own organization (23 CFR 635.116).

a. The term "perform work with its own organization" in paragraph 1 of Section VI refers to workers employed or leased by the prime contractor, and equipment owned or rented by the prime contractor, with or without operators. Such term does not include employees or equipment of a subcontractor or lower tier subcontractor, agents of the prime contractor, or any other assignees. The term may include payments for the costs of hiring leased employees from an employee leasing firm meeting all relevant Federal and State regulatory requirements. Leased employees may only be included in this term if the prime contractor meets all of the following conditions: (based on longstanding interpretation)

- (1) the prime contractor maintains control over the supervision of the day-to-day activities of the leased employees;
- (2) the prime contractor remains responsible for the quality of the work of the leased employees;
- (3) the prime contractor retains all power to accept or exclude individual employees from work on the project; and
- (4) the prime contractor remains ultimately responsible for the payment of predetermined minimum wages, the submission of payrolls, statements of compliance and all other Federal regulatory requirements.

b. "Specialty Items" shall be construed to be limited to work that requires highly specialized knowledge, abilities, or

equipment not ordinarily available in the type of contracting organizations qualified and expected to bid or propose on the contract as a whole and in general are to be limited to minor components of the overall contract. 23 CFR 635.102.

2. Pursuant to 23 CFR 635.116(a), the contract amount upon which the requirements set forth in paragraph (1) of Section VI is computed includes the cost of material and manufactured products which are to be purchased or produced by the contractor under the contract provisions.

3. Pursuant to 23 CFR 635.116(c), the contractor shall furnish (a) a competent superintendent or supervisor who is employed by the firm, has full authority to direct performance of the work in accordance with the contract requirements, and is in charge of all construction operations (regardless of who performs the work) and (b) such other of its own organizational resources (supervision, management, and engineering services) as the contracting officer determines is necessary to assure the performance of the contract.

4. No portion of the contract shall be sublet, assigned or otherwise disposed of except with the written consent of the contracting officer, or authorized representative, and such consent when given shall not be construed to relieve the contractor of any responsibility for the fulfillment of the contract. Written consent will be given only after the contracting agency has assured that each subcontract is evidenced in writing and that it contains all pertinent provisions and requirements of the prime contract. (based on longstanding interpretation of 23 CFR 635.116).

5. The 30-percent self-performance requirement of paragraph (1) is not applicable to design-build contracts; however, contracting agencies may establish their own self-performance requirements. 23 CFR 635.116(d).

VII. SAFETY: ACCIDENT PREVENTION

This provision is applicable to all Federal-aid construction contracts and to all related subcontracts.

1. In the performance of this contract the contractor shall comply with all applicable Federal, State, and local laws governing safety, health, and sanitation (23 CFR Part 635). The contractor shall provide all safeguards, safety devices and protective equipment and take any other needed actions as it determines, or as the contracting officer may determine, to be reasonably necessary to protect the life and health of employees on the job and the safety of the public and to protect property in connection with the performance of the work covered by the contract. 23 CFR 635.108.

2. It is a condition of this contract, and shall be made a condition of each subcontract, which the contractor enters into pursuant to this contract, that the contractor and any subcontractor shall not permit any employee, in performance of the contract, to work in surroundings or under conditions which are unsanitary, hazardous or dangerous to his/her health or safety, as determined under construction safety and health standards (29 CFR Part 1926) promulgated by the Secretary of Labor, in accordance with Section 107 of the Contract Work Hours and Safety Standards Act (40 U.S.C. 3704). 29 CFR 1926.10.

3. Pursuant to 29 CFR 1926.3, it is a condition of this contract that the Secretary of Labor or authorized representative thereof, shall have right of entry to any site of contract performance to inspect or investigate the matter of compliance

with the construction safety and health standards and to carry out the duties of the Secretary under Section 107 of the Contract Work Hours and Safety Standards Act (40 U.S.C. 3704).

VIII. FALSE STATEMENTS CONCERNING HIGHWAY PROJECTS

This provision is applicable to all Federal-aid construction contracts and to all related subcontracts.

In order to assure high quality and durable construction in conformity with approved plans and specifications and a high degree of reliability on statements and representations made by engineers, contractors, suppliers, and workers on Federal-aid highway projects, it is essential that all persons concerned with the project perform their functions as carefully, thoroughly, and honestly as possible. Willful falsification, distortion, or misrepresentation with respect to any facts related to the project is a violation of Federal law. To prevent any misunderstanding regarding the seriousness of these and similar acts, Form FHWA-1022 shall be posted on each Federal-aid highway project (23 CFR Part 635) in one or more places where it is readily available to all persons concerned with the project:

18 U.S.C. 1020 reads as follows:

"Whoever, being an officer, agent, or employee of the United States, or of any State or Territory, or whoever, whether a person, association, firm, or corporation, knowingly makes any false statement, false representation, or false report as to the character, quality, quantity, or cost of the material used or to be used, or the quantity or quality of the work performed or to be performed, or the cost thereof in connection with the submission of plans, maps, specifications, contracts, or costs of construction on any highway or related project submitted for approval to the Secretary of Transportation; or

Whoever knowingly makes any false statement, false representation, false report or false claim with respect to the character, quality, quantity, or cost of any work performed or to be performed, or materials furnished or to be furnished, in connection with the construction of any highway or related project approved by the Secretary of Transportation; or

Whoever knowingly makes any false statement or false representation as to material fact in any statement, certificate, or report submitted pursuant to provisions of the Federal-aid Roads Act approved July 11, 1916, (39 Stat. 355), as amended and supplemented;

Shall be fined under this title or imprisoned not more than 5 years or both."

IX. IMPLEMENTATION OF CLEAN AIR ACT AND FEDERAL WATER POLLUTION CONTROL ACT (42 U.S.C. 7606; 2 CFR 200.88; EO 11738)

This provision is applicable to all Federal-aid construction contracts in excess of \$150,000 and to all related subcontracts. 48 CFR 2.101; 2 CFR 200.326.

By submission of this bid/proposal or the execution of this contract or subcontract, as appropriate, the bidder, proposer, Federal-aid construction contractor, subcontractor, supplier, or vendor agrees to comply with all applicable standards, orders

or regulations issued pursuant to the Clean Air Act (42 U.S.C. 7401-7671q) and the Federal Water Pollution Control Act, as amended (33 U.S.C. 1251-1387). Violations must be reported to the Federal Highway Administration and the Regional Office of the Environmental Protection Agency. 2 CFR Part 200, Appendix II.

The contractor agrees to include or cause to be included the requirements of this Section in every subcontract, and further agrees to take such action as the contracting agency may direct as a means of enforcing such requirements. 2 CFR 200.326.

X. CERTIFICATION REGARDING DEBARMENT, SUSPENSION, INELIGIBILITY AND VOLUNTARY EXCLUSION

This provision is applicable to all Federal-aid construction contracts, design-build contracts, subcontracts, lower-tier subcontracts, purchase orders, lease agreements, consultant contracts or any other covered transaction requiring FHWA approval or that is estimated to cost \$25,000 or more – as defined in 2 CFR Parts 180 and 1200. 2 CFR 180.220 and 1200.220.

1. Instructions for Certification – First Tier Participants:

a. By signing and submitting this proposal, the prospective first tier participant is providing the certification set out below.

b. The inability of a person to provide the certification set out below will not necessarily result in denial of participation in this covered transaction. The prospective first tier participant shall submit an explanation of why it cannot provide the certification set out below. The certification or explanation will be considered in connection with the department or agency's determination whether to enter into this transaction. However, failure of the prospective first tier participant to furnish a certification or an explanation shall disqualify such a person from participation in this transaction. 2 CFR 180.320.

c. The certification in this clause is a material representation of fact upon which reliance was placed when the contracting agency determined to enter into this transaction. If it is later determined that the prospective participant knowingly rendered an erroneous certification, in addition to other remedies available to the Federal Government, the contracting agency may terminate this transaction for cause of default. 2 CFR 180.325.

d. The prospective first tier participant shall provide immediate written notice to the contracting agency to whom this proposal is submitted if any time the prospective first tier participant learns that its certification was erroneous when submitted or has become erroneous by reason of changed circumstances. 2 CFR 180.345 and 180.350.

e. The terms "covered transaction," "debarred," "suspended," "ineligible," "participant," "person," "principal," and "voluntarily excluded," as used in this clause, are defined in 2 CFR Parts 180, Subpart I, 180.900-180.1020, and 1200. "First Tier Covered Transactions" refers to any covered transaction between a recipient or subrecipient of Federal funds and a participant (such as the prime or general contract). "Lower Tier Covered Transactions" refers to any covered transaction under a First Tier Covered Transaction (such as subcontracts). "First Tier Participant" refers to the participant

who has entered into a covered transaction with a recipient or subrecipient of Federal funds (such as the prime or general contractor). "Lower Tier Participant" refers any participant who has entered into a covered transaction with a First Tier Participant or other Lower Tier Participants (such as subcontractors and suppliers).

f. The prospective first tier participant agrees by submitting this proposal that, should the proposed covered transaction be entered into, it shall not knowingly enter into any lower tier covered transaction with a person who is debarred, suspended, declared ineligible, or voluntarily excluded from participation in this covered transaction, unless authorized by the department or agency entering into this transaction. 2 CFR 180.330.

g. The prospective first tier participant further agrees by submitting this proposal that it will include the clause titled "Certification Regarding Debarment, Suspension, Ineligibility and Voluntary Exclusion-Lower Tier Covered Transactions," provided by the department or contracting agency, entering into this covered transaction, without modification, in all lower tier covered transactions and in all solicitations for lower tier covered transactions exceeding the \$25,000 threshold. 2 CFR 180.220 and 180.300.

h. A participant in a covered transaction may rely upon a certification of a prospective participant in a lower tier covered transaction that is not debarred, suspended, ineligible, or voluntarily excluded from the covered transaction, unless it knows that the certification is erroneous. 2 CFR 180.300; 180.320, and 180.325. A participant is responsible for ensuring that its principals are not suspended, debarred, or otherwise ineligible to participate in covered transactions. 2 CFR 180.335. To verify the eligibility of its principals, as well as the eligibility of any lower tier prospective participants, each participant may, but is not required to, check the System for Award Management website (<https://www.sam.gov/>). 2 CFR 180.300, 180.320, and 180.325.

i. Nothing contained in the foregoing shall be construed to require the establishment of a system of records in order to render in good faith the certification required by this clause. The knowledge and information of the prospective participant is not required to exceed that which is normally possessed by a prudent person in the ordinary course of business dealings.

j. Except for transactions authorized under paragraph (f) of these instructions, if a participant in a covered transaction knowingly enters into a lower tier covered transaction with a person who is suspended, debarred, ineligible, or voluntarily excluded from participation in this transaction, in addition to other remedies available to the Federal Government, the department or agency may terminate this transaction for cause or default. 2 CFR 180.325.

2. Certification Regarding Debarment, Suspension, Ineligibility and Voluntary Exclusion – First Tier Participants:

a. The prospective first tier participant certifies to the best of its knowledge and belief, that it and its principals:

(1) Are not presently debarred, suspended, proposed for debarment, declared ineligible, or voluntarily excluded from participating in covered transactions by any Federal department or agency, 2 CFR 180.335;.

(2) Have not within a three-year period preceding this proposal been convicted of or had a civil judgment rendered against them for commission of fraud or a criminal offense in connection with obtaining, attempting to obtain, or performing a public (Federal, State, or local) transaction or contract under a public transaction; violation of Federal or State antitrust statutes or commission of embezzlement, theft, forgery, bribery, falsification or destruction of records, making false statements, or receiving stolen property, 2 CFR 180.800;

(3) Are not presently indicted for or otherwise criminally or civilly charged by a governmental entity (Federal, State or local) with commission of any of the offenses enumerated in paragraph (a)(2) of this certification, 2 CFR 180.700 and 180.800; and

(4) Have not within a three-year period preceding this application/proposal had one or more public transactions (Federal, State or local) terminated for cause or default. 2 CFR 180.335(d).

(5) Are not a corporation that has been convicted of a felony violation under any Federal law within the two-year period preceding this proposal (USDOT Order 4200.6 implementing appropriations act requirements); and

(6) Are not a corporation with any unpaid Federal tax liability that has been assessed, for which all judicial and administrative remedies have been exhausted, or have lapsed, and that is not being paid in a timely manner pursuant to an agreement with the authority responsible for collecting the tax liability (USDOT Order 4200.6 implementing appropriations act requirements).

b. Where the prospective participant is unable to certify to any of the statements in this certification, such prospective participant should attach an explanation to this proposal. 2 CFR 180.335 and 180.340.

3. Instructions for Certification - Lower Tier Participants:

(Applicable to all subcontracts, purchase orders, and other lower tier transactions requiring prior FHWA approval or estimated to cost \$25,000 or more - 2 CFR Parts 180 and 1200). 2 CFR 180.220 and 1200.220.

a. By signing and submitting this proposal, the prospective lower tier participant is providing the certification set out below.

b. The certification in this clause is a material representation of fact upon which reliance was placed when this transaction was entered into. If it is later determined that the prospective lower tier participant knowingly rendered an erroneous certification, in addition to other remedies available to the Federal Government, the department, or agency with which this transaction originated may pursue available remedies, including suspension and/or debarment.

c. The prospective lower tier participant shall provide immediate written notice to the person to which this proposal is submitted if at any time the prospective lower tier participant learns that its certification was erroneous by reason of changed circumstances. 2 CFR 180.365.

d. The terms "covered transaction," "debarred," "suspended," "ineligible," "participant," "person," "principal," and "voluntarily excluded," as used in this clause, are defined in 2 CFR Parts 180, Subpart I, 180.900 – 180.1020, and 1200. You may contact the person to which this proposal is

submitted for assistance in obtaining a copy of those regulations. "First Tier Covered Transactions" refers to any covered transaction between a recipient or subrecipient of Federal funds and a participant (such as the prime or general contractor). "Lower Tier Covered Transactions" refers to any covered transaction under a First Tier Covered Transaction (such as subcontracts). "First Tier Participant" refers to the participant who has entered into a covered transaction with a recipient or subrecipient of Federal funds (such as the prime or general contractor). "Lower Tier Participant" refers any participant who has entered into a covered transaction with a First Tier Participant or other Lower Tier Participants (such as subcontractors and suppliers).

e. The prospective lower tier participant agrees by submitting this proposal that, should the proposed covered transaction be entered into, it shall not knowingly enter into any lower tier covered transaction with a person who is debarred, suspended, declared ineligible, or voluntarily excluded from participation in this covered transaction, unless authorized by the department or agency with which this transaction originated. 2 CFR 1200.220 and 1200.332.

f. The prospective lower tier participant further agrees by submitting this proposal that it will include this clause titled "Certification Regarding Debarment, Suspension, Ineligibility and Voluntary Exclusion-Lower Tier Covered Transaction," without modification, in all lower tier covered transactions and in all solicitations for lower tier covered transactions exceeding the \$25,000 threshold. 2 CFR 180.220 and 1200.220.

g. A participant in a covered transaction may rely upon a certification of a prospective participant in a lower tier covered transaction that is not debarred, suspended, ineligible, or voluntarily excluded from the covered transaction, unless it knows that the certification is erroneous. A participant is responsible for ensuring that its principals are not suspended, debarred, or otherwise ineligible to participate in covered transactions. To verify the eligibility of its principals, as well as the eligibility of any lower tier prospective participants, each participant may, but is not required to, check the System for Award Management website (<https://www.sam.gov/>), which is compiled by the General Services Administration. 2 CFR 180.300, 180.320, 180.330, and 180.335.

h. Nothing contained in the foregoing shall be construed to require establishment of a system of records in order to render in good faith the certification required by this clause. The knowledge and information of participant is not required to exceed that which is normally possessed by a prudent person in the ordinary course of business dealings.

i. Except for transactions authorized under paragraph e of these instructions, if a participant in a covered transaction knowingly enters into a lower tier covered transaction with a person who is suspended, debarred, ineligible, or voluntarily excluded from participation in this transaction, in addition to other remedies available to the Federal Government, the department or agency with which this transaction originated may pursue available remedies, including suspension and/or debarment. 2 CFR 180.325.

Certification Regarding Debarment, Suspension, Ineligibility and Voluntary Exclusion--Lower Tier Participants:

1. The prospective lower tier participant certifies, by submission of this proposal, that neither it nor its principals:

(a) is presently debarred, suspended, proposed for debarment, declared ineligible, or voluntarily excluded from participating in covered transactions by any Federal department or agency, 2 CFR 180.355;

(b) is a corporation that has been convicted of a felony violation under any Federal law within the two-year period preceding this proposal (USDOT Order 4200.6 implementing appropriations act requirements); and

(c) is a corporation with any unpaid Federal tax liability that has been assessed, for which all judicial and administrative remedies have been exhausted, or have lapsed, and that is not being paid in a timely manner pursuant to an agreement with the authority responsible for collecting the tax liability. (USDOT Order 4200.6 implementing appropriations act requirements)

2. Where the prospective lower tier participant is unable to certify to any of the statements in this certification, such prospective participant should attach an explanation to this proposal.

XI. CERTIFICATION REGARDING USE OF CONTRACT FUNDS FOR LOBBYING

This provision is applicable to all Federal-aid construction contracts and to all related subcontracts which exceed \$100,000. 49 CFR Part 20, App. A.

1. The prospective participant certifies, by signing and submitting this bid or proposal, to the best of his or her knowledge and belief, that:

a. No Federal appropriated funds have been paid or will be paid, by or on behalf of the undersigned, to any person for influencing or attempting to influence an officer or employee of any Federal agency, a Member of Congress, an officer or employee of Congress, or an employee of a Member of Congress in connection with the awarding of any Federal contract, the making of any Federal grant, the making of any Federal loan, the entering into of any cooperative agreement, and the extension, continuation, renewal, amendment, or modification of any Federal contract, grant, loan, or cooperative agreement.

b. If any funds other than Federal appropriated funds have been paid or will be paid to any person for influencing or attempting to influence an officer or employee of any Federal agency, a Member of Congress, an officer or employee of Congress, or an employee of a Member of Congress in connection with this Federal contract, grant, loan, or cooperative agreement, the undersigned shall complete and submit Standard Form-LLL, "Disclosure Form to Report Lobbying," in accordance with its instructions.

2. This certification is a material representation of fact upon which reliance was placed when this transaction was made or entered into. Submission of this certification is a prerequisite for making or entering into this transaction imposed by 31 U.S.C. 1352. Any person who fails to file the required certification shall be subject to a civil penalty of not less than \$10,000 and not more than \$100,000 for each such failure.

3. The prospective participant also agrees by submitting its bid or proposal that the participant shall require that the language of this certification be included in all lower tier

subcontracts, which exceed \$100,000 and that all such recipients shall certify and disclose accordingly.

XII. USE OF UNITED STATES-FLAG VESSELS:

This provision is applicable to all Federal-aid construction contracts, design-build contracts, subcontracts, lower-tier subcontracts, purchase orders, lease agreements, or any other covered transaction. 46 CFR Part 381.

This requirement applies to material or equipment that is acquired for a specific Federal-aid highway project. 46 CFR 381.7. It is not applicable to goods or materials that come into inventories independent of an FHWA funded-contract.

When oceanic shipments (or shipments across the Great Lakes) are necessary for materials or equipment acquired for a specific Federal-aid construction project, the bidder, proposer, contractor, subcontractor, or vendor agrees:

1. To utilize privately owned United States-flag commercial vessels to ship at least 50 percent of the gross tonnage (computed separately for dry bulk carriers, dry cargo liners, and tankers) involved, whenever shipping any equipment, material, or commodities pursuant to this contract, to the extent such vessels are available at fair and reasonable rates for United States-flag commercial vessels. 46 CFR 381.7.

2. To furnish within 20 days following the date of loading for shipments originating within the United States or within 30 working days following the date of loading for shipments originating outside the United States, a legible copy of a rated, 'on-board' commercial ocean bill-of-lading in English for each shipment of cargo described in paragraph (b)(1) of this section to both the Contracting Officer (through the prime contractor in the case of subcontractor bills-of-lading) and to the Office of Cargo and Commercial Sealift (MAR-620), Maritime Administration, Washington, DC 20590. (MARAD requires copies of the ocean carrier's (master) bills of lading, certified onboard, dated, with rates and charges. These bills of lading may contain business sensitive information and therefore may be submitted directly to MARAD by the Ocean Transportation Intermediary on behalf of the contractor). 46 CFR 381.7.

**ATTACHMENT A - EMPLOYMENT AND MATERIALS
PREFERENCE FOR APPALACHIAN DEVELOPMENT
HIGHWAY SYSTEM OR APPALACHIAN LOCAL ACCESS
ROAD CONTRACTS (23 CFR 633, Subpart B, Appendix B)**

This provision is applicable to all Federal-aid projects funded under the Appalachian Regional Development Act of 1965.

1. During the performance of this contract, the contractor undertaking to do work which is, or reasonably may be, done as on-site work, shall give preference to qualified persons who regularly reside in the labor area as designated by the DOL wherein the contract work is situated, or the subregion, or the Appalachian counties of the State wherein the contract work is situated, except:

a. To the extent that qualified persons regularly residing in the area are not available.

b. For the reasonable needs of the contractor to employ supervisory or specially experienced personnel necessary to assure an efficient execution of the contract work.

c. For the obligation of the contractor to offer employment to present or former employees as the result of a lawful collective bargaining contract, provided that the number of nonresident persons employed under this subparagraph (1c) shall not exceed 20 percent of the total number of employees employed by the contractor on the contract work, except as provided in subparagraph (4) below.

2. The contractor shall place a job order with the State Employment Service indicating (a) the classifications of the laborers, mechanics and other employees required to perform the contract work, (b) the number of employees required in each classification, (c) the date on which the participant estimates such employees will be required, and (d) any other pertinent information required by the State Employment Service to complete the job order form. The job order may be placed with the State Employment Service in writing or by telephone. If during the course of the contract work, the information submitted by the contractor in the original job order is substantially modified, the participant shall promptly notify the State Employment Service.

3. The contractor shall give full consideration to all qualified job applicants referred to him by the State Employment Service. The contractor is not required to grant employment to any job applicants who, in his opinion, are not qualified to perform the classification of work required.

4. If, within one week following the placing of a job order by the contractor with the State Employment Service, the State Employment Service is unable to refer any qualified job applicants to the contractor, or less than the number requested, the State Employment Service will forward a certificate to the contractor indicating the unavailability of applicants. Such certificate shall be made a part of the contractor's permanent project records. Upon receipt of this certificate, the contractor may employ persons who do not normally reside in the labor area to fill positions covered by the certificate, notwithstanding the provisions of subparagraph (1c) above.

5. The provisions of 23 CFR 633.207(e) allow the contracting agency to provide a contractual preference for the use of mineral resource materials native to the Appalachian region.

6. The contractor shall include the provisions of Sections 1 through 4 of this Attachment A in every subcontract for work which is, or reasonably may be, done as on-site work.

**NOTICE OF REQUIREMENTS FOR AFFIRMATIVE
ACTION TO ENSURE EQUAL EMPLOYMENT
OPPORTUNITY (EXECUTIVE ORDER 11246)**

1. The Offeror's or Bidder's attention is called to the "Equal Opportunity Clause" and the "Standard Federal Equal Employment Opportunity Construction Contract Specifications" set forth herein.

2. The goal for female participation, expressed in percentage terms for the Contractor's aggregate workforce in each trade on all construction work, is 6.9%.

Until further notice	Goals for minority participation for each trade (percent)
----------------------	---

SHSA Cities:

Pascagoula - Moss Point -----	16.9
Biloxi - Gulfport -----	19.2
Jackson -----	30.3

SMSA Counties:

Desoto -----	32.3
Hancock, Harrison, Stone-----	19.2
Hinds, Rankin-----	30.3
Jackson -----	16.9

Non-SMSA Counties:

George, Greene-----	26.4
---------------------	------

Alcorn, Benton, Bolivar, Calhoun, Carroll, Chickasaw, Clay, Coahoma, Grenada, Itawamba, Lafayette, Lee, Leflore, Marshall, Monroe, Montgomery, Panola, Pontotoc, Prentiss, Quitman, Sunflower, Tallahatchie, Tate, Tippah, Tishomingo, Tunica, Union, Washington, Webster, Yalobusha -----	26.5
---	------

Attala, Choctaw, Claiborne, Clarke, Copiah, Covington, Franklin, Holmes, Humphreys, Issaquena, Jasper, Jefferson, Jefferson Davis, Jones Kemper, Lauderdale, Lawrence, Leake, Lincoln, Lowndes, Madison, Neshoba, Newton, Noxubee, Oktibbeha, Scott, Sharkey, Simpson, Smith, Warren, Wayne, Winston, Yazoo-----	32.0
---	------

Forrest, Lamar, Marion, Pearl River, Perry, Pike, Walthall-----	27.7
--	------

Adams, Amite, Wilkinson -----	30.4
-------------------------------	------

These goals are applicable to all the Contractor's construction work (whether or not it is Federal or federally assisted) performed in the covered area. If the contractor performs construction work in a geographical area located outside of the covered area, it shall apply the goals established for such geographical area where the work is actually performed. With regard to this second area, the contractor also is subject to the goals for both its federally involved and nonfederally involved construction.

The Contractor's compliance with the Executive Order and the regulations in 41 CFR Part 60-4 shall be based on its implementation of the Equal Opportunity clause, specific affirmative action obligations required by the specifications set forth in 41 CFR 60-4.3(a), and its efforts to meet the goals. The hours of minority and female employment and training must be substantially uniform throughout the length of the contract, and in each trade, and the Contractor shall make a good faith effort to employ minorities and women evenly on each of its projects. The transfer of minority or female employees or trainees from Contractor to Contractor or from project to project for the sole purpose of meeting the Contractor's goals shall be a violation of the contract, the Executive Order and the regulations in 41 CFR Part 60-4.2(d). Compliance with the goals will be measured against the total work hours performed.

3. The Contractor shall provide written notification to the Director of the Office of Federal Contract Compliance Programs within 10 working days of award of any construction subcontract in excess of \$10,000 at any tier for construction work under the contract resulting from this solicitation. The notification shall list the name, address and telephone number of the subcontractor, employer identification number of the subcontractor, estimated dollar amount of the subcontract; estimated starting and completion dates of the subcontract; and the geographical area in which the subcontract is to be performed.

4. As used in this Notice, and in the contract resulting from this solicitation, the "covered area" is to the county and city (if any), stated in the advertisement.

5. The notification required in Paragraph 3 shall be addressed to the following:

Contract Compliance Officer
Mississippi Department of Transportation
P.O. Box 1850
Jackson, Mississippi 39215-1850

(12/04/2018)

MISSISSIPPI DEPARTMENT OF TRANSPORTATION

SPECIAL PROVISION NO. 907-101-1

CODE: (IS)

DATE: 07/20/2023

SUBJECT: Definitions and Terms

Section 101, Definitions and Terms, of the 2017 Edition of the Mississippi Standard Specifications for Road and Bridge Construction is hereby amended as follows.

907-101.01--Abbreviations. After the abbreviation API on page 1, add the following.

APL Approved Products List

Replace the abbreviation for AWPA on page 1 with the following.

AWPA American Wood Protection Association

907-101.02--Definitions. Delete the sentence after the list of holidays in Subsection 101.02 on page 6 under **holidays, legal**, and substitute the following.

When a legal holiday falls on a Saturday or Sunday, the succeeding Monday, or as proclaimed by the Governor, will be observed as a legal holiday.

Delete the definition for Notice to Proceed in Subsection 101.02 on page 8, and substitute the following.

Notice to Proceed - Written notice to the Contractor to proceed with the contract work.

Delete the definition for “Plans” in Subsection 101.02 on page 8, and substitute the following.

plans - The approved plans, profiles, typical cross-sections, working drawings and supplemental drawings, or exact reproduction thereof, that show the location, character, dimensions, and details of the work to be done. The plans may also include electronic files, referred to on the plans as Electronic Files Identified as Plans, which may include engineering models, spreadsheets, CADD files or other electronic files used to convey design intent. When the contract does not have an official set of plans, reference to the plans shall mean the contract documents.

MISSISSIPPI DEPARTMENT OF TRANSPORTATION

SPECIAL PROVISION NO. 907-102-2

CODE: (IS)

DATE: 11/22/2017

SUBJECT: **Bidding Requirements and Conditions**

Section 102, Bidding Requirements and Conditions, of the 2017 Edition of the Mississippi Standard Specifications for Road and Bridge Construction is hereby amended as follows.

907-102.01--Prequalification of Bidders. Delete the last sentence of the third paragraph of Subsection 102.01 on page 13, and substitute the following.

The Bidder's Certificate of Responsibility number must be on file with the Department's Contract Administration Division prior to request for permission to bid.

907-102.02--Contents of Proposal Forms. Delete the fourth paragraph in Subsection 102.02 on page 13, and substitute the following.

Prospective bidders must complete an online request for permission to be eligible to bid a project. Upon approval, the bidder will be authorized to submit a bid electronically using Bid Express at <http://bidx.com>.

MISSISSIPPI DEPARTMENT OF TRANSPORTATION

SPECIAL PROVISION NO. 907-105-2

CODE: (IS)

DATE: 07/20/2023

SUBJECT: Control of Work

Section 105, Control of Work, of the 2017 Edition of the Mississippi Standard Specifications for Road and Bridge Construction is hereby amended as follows.

907-105.01--Authority of the Engineer. Delete the first sentence of the second paragraph of Subsection 105.01 on page 31, and substitute the following.

The Engineer has the right to suspend the work wholly or in part and to withhold payments because of the Contractor's failure to correct conditions unsafe for workmen or the general public, for failure to carry out provisions of the Contract, or for failure to carry out orders.

907-105.02--Plans and Working Drawings. Delete the first paragraph of Subsection 105.02 on page 31, and substitute the following.

After the contract is executed by the Executive Director, the Contractor will receive, free of charge, two bound copies of the proposal and contract documents (one executed and one blank) two full scale copies of the plans, five half-scale copies of the Plans, and Electronic Files Identified as Plans. The Contractor shall have one copy of the proposal and contract documents and one half-scale copy of the plans available at all times during work activity on the project.

MISSISSIPPI DEPARTMENT OF TRANSPORTATION

SPECIAL PROVISION NO. 907-106-1

CODE: (IS)

DATE: 10/25/2022

SUBJECT: Control of Materials

Section 106, Control of Materials, of the 2017 Edition of the Mississippi Standard Specifications for Road and Bridge Construction is hereby amended as follows.

After Subsection 106.13 on page 47, add the following.

907-106.14--Buy America Materials Sourcing Requirements for Federal-Aid Projects. The “Infrastructure Investment and Jobs Act” (the “Act”), or Bipartisan Infrastructure Law (BIL), was enacted on November 15, 2021 (See Public Law No. 117-58, Sections 70901-70953). The Buy America provisions of the Act expand the previous Buy America requirements beyond what is currently required for steel and iron products.

Any steel and iron materials per Subsection 700.01 or construction materials per Subsection 907-700.01.1, that are used for a Federal-Aid highway construction project, shall be domestically manufactured (as further described in Subsection 700.01) and compliant with current requirements of the Act, as implemented by the Office of Management and Budget (OMB) in the “Preliminary Guidance for Construction Materials” in OMB Memorandum M-22-11.

As determined by the Department within the contract prior to award, all products and/or materials will only be classified under one of the following categories: Steel and Iron, Manufactured Products, and Construction Materials. It is the Prime Contractor’s responsibility to ensure all submittals required for Buy America are submitted to the Project Engineer prior to the products and/or materials being incorporated into the work.

The following items require Buy America Certification on Federal-Aid projects:

- (a) Steel and Iron
- (b) Construction Materials

A list of items that require Buy America Certification may be viewed at www.goMDOT.com under Business Center → Engineering Standards/Guides/Manuals → Construction Materials.

Items classified as a Manufactured Product that do not include steel and iron components do not require a Buy America Certification on a Federal-Aid project. Manufactured Products are currently exempted under the 1983 waiver from FHWA. Manufactured Products are determined by the Department’s Materials Division.

To be considered a Manufactured Product, an item shall meet one of the following requirements:

- (a) The item consists of two or more of the listed construction materials that have been combined through a manufacturing process.
- (b) The item consists of at least one of the listed construction materials that has been combined through a manufacturing process with a material that is not listed as a construction material.

Buy America provisions do not apply to temporarily used items that (1) are specified to be removed at the end of the project per the contract provisions or (2) are specified to remain in place per the contract provisions and are also documented by the Department in the contract provisions to be removed in a subsequent imminent, near-term phased project.

MISSISSIPPI DEPARTMENT OF TRANSPORTATION

SPECIAL PROVISION NO. 907-108-4

CODE: (SP)

DATE: 10/07/2020

SUBJECT: Subletting of Contract

Section 108, Prosecution and Progress, of the 2017 Edition of the Mississippi Standard Specifications for Road and Bridge Construction is hereby amended as follows.

907-108.01--Subletting of Contract.

907-108.01.1--General. Delete the third sentence of the tenth paragraph of Subsection 108.01.1 on the bottom of page 72.

MISSISSIPPI DEPARTMENT OF TRANSPORTATION

SPECIAL PROVISION NO. 907-109-4

CODE: (IS)

DATE: 04/19/2021

SUBJECT: Measurement and Payment

Section 109, Measurement and Payment, of the 2017 Edition of the Mississippi Standard Specifications for Road and Bridge Construction is hereby amended as follows.

907-109.01--Measurement of Quantities. Delete the sixth full paragraph of Subsection 109.01 on page 88, and substitute the following.

If appropriate based on the specific circumstances of the project, the Contractor may request that material specified to be measured by the cubic yard or ton be converted to the other measure. The Contractor must submit this request to the Engineer. The Engineer will provide an approval or denial in writing. The decision is in the sole discretion of the Engineer. If approved, factors for this conversion will be determined by the District Materials Engineer and agreed to by the Contractor. The conversion of the materials along with the conversion factor will be incorporated into the Contract by supplemental agreement. The supplemental agreement must be executed before such method of measurement is used.

907-109.04--Extra Work.

907-109.04.1--Supplemental Agreement. Delete the second paragraph of Subsection 109.04.1 on page 90.

907-109.06--Partial Payment.

907-109.06.2--Advancement on Materials.

Delete the next to last paragraph of Subsection 109.06.2 on page 95, and substitute the following.

Materials for which an advanced payment has been allowed must be paid for by the Contractor within 30 days of the estimate on which the advanced payment was first allowed and proof of said payment must be verified by the supplier. If proof of payment is not furnished within the allowable 30 days, the advanced payment will be deducted on subsequent current estimates until such time that proof of payment is furnished.

907-109.07--Changes in Material Costs. After the fifth paragraph of Subsection 109.07 on page 96, change the web address to the following.

https://mdot.ms.gov/portal/current_letting

MISSISSIPPI DEPARTMENT OF TRANSPORTATION

SPECIAL PROVISION NO. 907-403-2

CODE: (SP)

DATE: 07/25/2023

SUBJECT: Asphalt for Pothole Patching

PROJECT: NHPP-0008-03(059) / 108245301 – Rankin County

Section 403, Asphalt Pavements, of the 2017 Edition of the Mississippi Standard Specifications for Road and Bridge Construction is hereby amended as follows:

907-403.03--Construction Requirements.

907-403.03.5--Overlays or Widening and Overlays.

907-403.03.5.4--Patching. After the last paragraph of Subsection 403.03.5.4 on page 288, add the following.

When directed by the Engineer, the Contractor shall perform pothole patching at the location(s) designated by the Engineer. Asphalt used for pothole patching shall be an approved MDOT mixture of the Contractor’s choice measured and paid for under pay item 907-403-P.

907-403.04--Method of Measurement. After the first paragraph of Subsection 403.04 on page 289, add the following.

Asphalt for pothole patching will be measured by the pound or ton. When measured by the ton, the weight of the composite mixture shall be determined in accordance with the provisions of Subsection 401.03.2.1.11. When measured by the pound, the Contractor shall weigh the truck and mixture prior to repairing pot holes and then weigh it after completion of pot hole repair to determine the quantity of asphalt used. Any other method of quantity calculation by the pound shall be approved by the Engineer.

907-403.05--Basis of Payment. After the first paragraph of Subsection 403.05 on page 290, add the following.

Asphalt for pothole patching, measured as prescribed above, will be paid for at the contract unit price per pound or ton, which price shall be full compensation for all materials, equipment, tools, labor, traffic control, and incidentals necessary to complete the work.

907-403.05.2--Pay Items. Add the following to the list of pay items page 291.

907-403-P: Asphalt for Pothole Patching

- per pound or ton

MISSISSIPPI DEPARTMENT OF TRANSPORTATION

SPECIAL PROVISION NO. 907-413-2

CODE: (SP)

DATE: 05/09/2023

SUBJECT: Cleaning and Sealing Joints and Cracks

Section 413, Cleaning and Sealing Joints and Cracks, of the 2017 Edition of the Mississippi Standard Specifications for Road and Bridge Construction is hereby amended as follows.

907-413.03--Construction Requirements.

907-413.03.3--Sawing and Sealing Transverse Joints in Asphalt Pavement.

907-413.03.3.4--Sealing. Delete the last sentence of the last paragraph of Subsection 413.03.3.4 on page 333, and substitute the following.

Poured joint sealing material shall only be placed when the air temperature is within the limits specified by the manufacturer.

907-413.05--Basis of Payment. Delete the last pay item listed on page 336, and substitute the following.

907-413-E: Sawing and Sealing Transverse Joints in Asphalt Pavement - per linear foot

MISSISSIPPI DEPARTMENT OF TRANSPORTATION

SPECIAL PROVISION NO. 907-512-1

CODE: (SP)

DATE: 08/31/2021

SUBJECT: Pressure Grouting Concrete Pavement

Section 512, Pressure Grouting Concrete Pavement, of the 2017 Edition of the Mississippi Standard Specifications for Road and Bridge Construction is hereby amended as follows.

907-512.02--Materials. In the list of materials in Subsection 512.02 on page 372, delete the cement types in the first line and substitute the following.

Cement Types I, IL, II, or III 701

907-512.05--Basis of Payment. Add the “907” prefix to the pay items listed on page 376.

MISSISSIPPI DEPARTMENT OF TRANSPORTATION

SPECIAL PROVISION NO. 907-700-1

CODE: (IS)

DATE: 10/25/2022

SUBJECT: Materials and Tests

Section 700, Materials and Tests, of the 2017 Edition of the Mississippi Standard Specifications for Road and Bridge Construction is hereby amended as follows.

After Subsection 700.01 on page 713, add the following.

907-700.01.1--Buy America Materials Sourcing Requirements for Construction Materials.

As related to the requirements in Subsection 907-106.14, Construction Materials shall include an article or material that is or consists primarily of non-ferrous metals; plastic and polymer-based products (including polyvinylchloride, composite building materials, and polymers used in fiber optic cables); glass (including optic glass); lumber; or drywall. Construction Materials which are exempt from the requirements in Subsection 907-106.14 include the following: cement or cementitious materials; aggregates such as stone, sand, or gravel; or aggregate binding agents or additives.

For Construction Materials, both the final manufacturing process and the manufacturing stage immediately preceding the final manufacturing process shall occur domestically.

907-700.01.2--Compliance Requirements. Prior to incorporation into the work, the Contractor shall furnish the Project Engineer with certificates of compliance documenting conformance to the requirements of Subsection 907-106.14.

The certificates shall be on the Supplier's/Manufacturer's letterhead, containing the following:

- Project number
- Name of manufacturer and address of manufacture location
- Material description
- Batch number / Heat number / Lot number
- Bill of lading number
- Date received
- "I certify each material listed on this certificate to be permanently incorporated in this project has been manufactured domestically."
- Signature of an authorized representative of the Supplier/Manufacturer

MISSISSIPPI DEPARTMENT OF TRANSPORTATION

SPECIAL PROVISION NO. 907-701-3

CODE: (IS)

DATE: 05/04/2021

SUBJECT: Hydraulic Cement

Section 701, Hydraulic Cement, of the 2017 Edition of the Mississippi Standard Specifications for Road and Bridge Construction is hereby amended as follows.

907-701.01--General. In the first sentence of the second paragraph of Subsection 701.01 on page 718, change “mills” to “plants.”

In the second sentence of the sixth paragraph of Subsection 701.01 on pages 718 and 719, change “shall” to “will.”

907-701.02--Portland Cement.

907-701.02.1-General.

907-701.02.1.2--Alkali Content. Delete the sentence in Subsection 701.02.1.2 on page 719, and substitute the following.

When used in portland cement concrete, the total alkali contribution from all cement types in this Subsection shall not exceed 4.0 lb. per cubic yard of concrete calculated as follows:

$$\text{lb alkali per cu Yd} = \frac{(\text{lb cement per cu Yd}) \times (\% \text{Na}_2\text{O equivalent in cement})}{100}$$

In the above calculation, the maximum cement alkali content reported on the cement mill certificate shall be used. An example calculation can be found in the Department’s *Concrete Field Manual*.

907-701.02.2--Replacement by Other Cementitious Materials. Delete the paragraph in Subsection 701.02.2 on page 719, and substitute the following.

The maximum replacement of cement by weight is 25% for fly ash or 50% for ground granulated blast furnace slag (GGBFS). Replacement contents below 20% for fly ash or 45% for GGBFS may be used, but will not be given any special considerations, such as the maximum acceptance temperature for portland cement concrete containing pozzolans in Subsection 804.02.13.1.5. Special considerations shall only apply for replacement of cement by fly ash or GGBFS.

Delete Subsection 701.02.2.1 on pages 719 and 720, and substitute the following.

907-701.02.2.1--Portland Cement Concrete Exposed to Soluble Sulfate Conditions or Seawater.

When portland cement concrete is exposed to moderate or severe soluble sulfate conditions, or to seawater, cement types and replacement of cement by Class F fly ash or GGBFS shall be as follows in Table 1. Class C fly ash shall not be used as a replacement for cement in any of the sulfate exposure conditions listed in Table 1.

Table 1- Cementitious Materials for Soluble Sulfate Conditions or Seawater

Sulfate Exposure	Water-soluble sulfate (SO ₄) in soil, % by mass	Sulfate (SO ₄) in water, ppm	Cementitious material required
Moderate and Seawater	0.10 - 0.20	150 - 1,500	Type I cement with one of the following replacements of cement by weight: 24.5 - 25.0% Class F fly ash, or 49.5 - 50.0% GGBFS or Type II ^{**} cement
Severe	0.20 - 2.00	1,500 - 10,000	Type I cement with a replacement by weight of 49.5 - 50.0% GGBFS, or Type II [*] cement with one of the following replacements of cement by weight: 24.5 - 25.0% Class F fly ash, or 49.5 - 50.0% GGBFS

* Type III cement conforming to AASHTO M85 with a maximum 8% tricalcium aluminate (C₃A) may be used in lieu of Type II cement as allowed in Subsection 701.02.1; this cement is given the designation “Type III(MS).”

** Class F fly ash or GGBFS may be added as a replacement for cement as allowed in Subsection 907-701.02.2.

Delete Subsection 701.02.2.2 on page 720, and substitute the following.

907-701.02.2.2--Portland Cement for Soil Stabilization Exposed to Soluble Sulfate Conditions or Seawater. When portland cement for use in soil stabilization is exposed to moderate or severe soluble sulfate conditions, or to seawater, cement types and replacement of cement by Class F fly ash or GGBFS shall meet the requirements of Subsection 701.02.2.1.

907-701.04--Blended Hydraulic Cement.

907-701.04.1--General. Delete Subsection 701.04.1.1 on page 720, and substitute the following.

907-701.04.1.1--Types of Blended Hydraulic Cement. Blended hydraulic cements (blended cements) shall be of the following types and conform to AASHTO M 240:

- Type II – Portland-limestone cement
- Type IP – Portland-pozzolan cement
- Type IS – Portland blast-furnace slag cement

Blended cement Types II, IP, and IS meeting the “MS” sulfate resistance requirement listed in AASHTO M 240, Table 3 shall have the “(MS)” suffix added to the type designation.

907-701.04.1.2--Alkali Content. Delete the sentence in Subsection 701.04.1.2 on page 720, and substitute the following.

All blended cement types shall be made with clinker that would result in cement meeting the requirements of Subsection 701.02.1.2 when used in the production of AASHTO M 85, Type I or Type II cement.

The blended cement manufacturer shall include the percent equivalent alkalis as Na₂O on their cement mill reports.

When calculating the total alkali contribution with blended cements, use the equivalent alkali content of the base portland cement. An example calculation for cases where blended cements are used can be found in the Department’s *Concrete Field Manual*.

907-701.04.2--Replacement by Other Cementitious Materials. Delete the paragraph in Subsection 701.04.2 on page 720, and substitute the following.

The maximum replacement of blended cement Type II by weight is 35% for fly ash or 50% for GGBFS. Replacement contents below 20% for fly ash or 45% for GGBFS may be used, but will not be given any special considerations, such as the maximum acceptance temperature for blended cement concrete containing pozzolans in Subsection 804.02.13.1.5. Special considerations shall only apply for replacement of blended cement by fly ash or GGBFS.

No additional cementitious materials, such as portland cement, blended cement, fly ash, GGBFS, or others, shall be added to or as a replacement for blended cement Types IP and IS.

Delete Subsection 701.04.2.1 on pages 720 and 721, and substitute the following.

907-701.04.2.1--Blended Cement Concrete Exposed to Soluble Sulfate Conditions or Seawater. When blended cement concrete is exposed to moderate or severe soluble sulfate conditions, or to seawater, cement types and replacement of cement by Class F fly ash or GGBFS shall be as follows in Table 2. Class C fly ash shall not be used as a replacement for cement in any of the sulfate exposure conditions listed in Table 2.

Table 2- Cementitious Materials for Soluble Sulfate Conditions or Seawater

Sulfate Exposure	Water-soluble sulfate (SO ₄) in soil, % by mass	Sulfate (SO ₄) in water, ppm	Cementitious material required
Moderate and Seawater	0.10 - 0.20	150 - 1,500	Type IL (MS) * cement, Type IL cement with one of the following replacements of cement by weight: 24.5 - 35.0% Class F fly ash, or 49.5 - 50.0% GGBFS, Type IP (MS) cement, or Type IS (MS) cement
Severe	0.20 - 2.00	1,500 - 10,000	Type IL cement with a replacement of cement by weight of 49.5 - 50.0% GGBFS, or Type IL (MS) cement with one of following replacements of cement by weight: 24.5 - 35.0% Class F fly ash, or 49.5 - 50.0% GGBFS

* Class F fly ash or GGBFS may be added as a replacement for cement as allowed in Subsection 907-701.04.2.

Delete Subsection 701.04.2.2 on page 721, and substitute the following.

907-701.04.2.2--Blended Cement for Soil Stabilization Exposed to Soluble Sulfate Conditions or Seawater. When blended cement for use in soil stabilization is exposed to moderate or severe soluble sulfate conditions, or to seawater, cement types and replacement of cement by Class F fly ash or GGBFS shall meet the requirements of Subsection 701.04.2.1.

Delete Subsection 701.04.3 on page 721.

MISSISSIPPI DEPARTMENT OF TRANSPORTATION

SPECIAL PROVISION NO. 907-702-4

CODE: (IS)

DATE: 09/11/2018

SUBJECT: Bituminous Materials

Section 702, Bituminous Materials, of the 2017 Edition of the Mississippi Standard Specifications for Road and Bridge Construction is hereby amended as follows.

907-702.04--Sampling. Delete the sentence in Subsection 702.04 on page 722, and substitute the following.

Sampling of bituminous materials shall be as set out in AASHTO R 66.

907-702.07--Emulsified Asphalt. Delete the last sentence in Subsection 702.07 on page 724, and substitute the following.

Asphalt for fog seal shall conform to the requirements of Subsection 907-702.12, Table V.

907-702.12--Tables. Delete Table V in Subsection 702.12 on page 729, and substitute the following.

**TABLE V
SPECIFICATION FOR FOG SEAL**

Test Requirements	LD-7		CHPF-1		Test Method
	Min.	Max.	Min.	Max.	
Viscosity, Saybolt Furol, @ 25°C, Sec.	10	100	-	100	AASHTO T 72
Storage Stability Test, 24 hr, %	-	1	-	1	AASHTO T 59
Settlement, 5 day, %	-	5	-	-	AASHTO T 59
Oil Distillate, %	-	1	-	-	AASHTO T 59
Sieve Test, % *	-	0.3	-	0.1	AASHTO T 59
Residue by Distillation, %	40	-	40	-	AASHTO T 59
Test on Residue from Distillation					
Penetration @ 25°C, 100g, 5 sec	-	20	40	90	AASHTO T 49
Softening Point, °C	65	-	-	-	ASTM D 36
Solubility in trichloroethylene, %	97.5	-	-	-	AASHTO T 44
Elastic Recovery @ 25°C, %	-	-	40	-	AASHTO T 301
Original DSR @ 82° (G*/Sinδ, 10 rad/sec)	1	-	-	-	AASHTO T 111

* The Sieve Test result is tested for reporting purposes only and may be waived if no application problems are present in the field.

MISSISSIPPI DEPARTMENT OF TRANSPORTATION

SPECIAL PROVISION NO. 907-703-2

CODE: (SP)

DATE: 11/29/2022

SUBJECT: Gradation

Section 703, Aggregates, of the 2017 Edition of the Mississippi Standard Specifications for Road and Bridge Construction is hereby amended as follows.

907-703.03--Coarse Aggregates for Hydraulic Cement Concrete.

907-703.03.2--Detail Requirements.

907-703.03.2.4--Gradation. In the table in Subsection 703.03.2.4 on page 734, add 100 for the percent passing by weight on the 1½-inch sieve for Size No. 67 aggregates.

Delete Note 2 under the table in Subsection 703.03.2.4 on page 734, and substitute the following.

Note ² – 100 percent shall pass the 1-inch sieve for Size 67 used in Class F and Class FX concrete.

MISSISSIPPI DEPARTMENT OF TRANSPORTATION

SPECIAL PROVISION NO. 907-705-1

CODE: (IS)

DATE: 06/13/2018

SUBJECT: Stone Riprap

Section 705, Stone Blanket Protection and Filter Blanket Materials, of the 2017 Edition of the Mississippi Standard Specifications for Road and Bridge Construction is hereby amended as follows.

907-705.04--Stone Riprap. Delete the last sentence of the first paragraph of Subsection 705.04 on page 750, and substitute the following.

Quality requirements for rock to be furnished under these specifications will come from a pre-approved source and be visually approved prior to use.

MISSISSIPPI DEPARTMENT OF TRANSPORTATION

SPECIAL PROVISION NO. 907-707-3

CODE: (IS)

DATE: 10/27/2021

SUBJECT: Joint Materials

Section 707, Joint Materials, of the 2017 Edition of the Mississippi Standard Specifications for Road and Bridge Construction is hereby amended as follows.

907-707.02--Joint Filler.

907-707.02.2--Preformed Sponge, Rubber, Cork and Closed-Cell Polypropylene Foam Joint Fillers for concrete Paving and Structural Constructions. Delete the two paragraphs of Subsection 707.02.2 on page 755, and substitute the following.

Preformed joint filler shall conform to AASHTO M 153 for sponge, rubber, and cork and tested according to ASTM D545. The type required will be indicated on the plans.

Closed-cell polypropylene foam shall conform to the requirements in ASTM D8139 and tested in accordance with ASTM D545.

907-707.02.3--Wood. Delete paragraph (b) of Subsection 707.02.3 on page 755, and substitute the following:

- (b) Dimensions shall be as shown on the plans. Dimensions shown on the plans are “dressed” sizes in accordance with Table 3 of the American Softwood Lumber Standard, SP-20. At the discretion of the Engineer, a 3/4-inch dressed board may be used in lieu of a 1-inch dressed board. A tolerance of plus or minus 1/16 inch thickness and plus or minus 1/8 inch width will be permitted. For slip-form paving a tolerance of minus 1/4 inch on each end in length will be permitted.

907-707.06--Flexible Plastic Gasket for Joining Conduit. Delete the third paragraph of Subsection 707.06 on page 756, and substitute the following.

The Department may require the performance test described in ASTM C 990.

MISSISSIPPI DEPARTMENT OF TRANSPORTATION

SPECIAL PROVISION NO. 907-711-2

CODE: (IS)

DATE: 09/11/2018

SUBJECT: Plain Steel Wire

Section 711, Reinforcement and Wire Rope, of the 2017 Edition of the Mississippi Standard Specifications for Road and Bridge Construction is hereby amended as follows.

907-711.02--Deformed and Plain Carbon-Steel Bars for Concrete Reinforcing.

907-711.02.3--Steel Welded and Non-Welded Wire Reinforcement, Plain and Deformed, for Concrete.

907-711.02.3.1--Plain Steel Wire. Delete the sentence in Subsection 711.02.3.1 on pages 780 and 781, and substitute the following.

Plain steel wire and plain steel welded wire shall conform to the requirements of AASHTO M 336.

MISSISSIPPI DEPARTMENT OF TRANSPORTATION

SPECIAL PROVISION NO. 907-712-1

CODE: (SP)

DATE: 12/07/2021

SUBJECT: Fence and Guardrail

Section 712, Fence and Guardrail, of the 2017 Edition of the Mississippi Standard Specifications for Road and Bridge Construction is hereby amended as follows.

907-712.01--General. After the sentence in Subsection 712.01 on page 785, add the following.

All materials' inspection, testing, and certification will be performed in accordance with the requirements of the current version of the Department's *Materials Division Inspection, Testing, and Certification Manual*.

Delete Subsections 712.02 and 712.03 on page 785, and substitute the following.

907-712.02--Barbed Wire. Barbed wire shall conform to the requirements of AASHTO M 280. In the coastal counties of Hancock, Harrison, and Jackson, either Coating Type Z Class 3 or Coating Type A shall be furnished. In all other areas of the State, either Coating Type Z Class 1, Coating Type Z Class 3, Coating Type ZA Class 60, or Coating Type A shall be furnished.

907-712.03--Metallic-Coated, Steel Woven Wire Fence Fabric. Woven wire fencing (i.e., "hog wire") shall conform to the requirements of AASHTO M 279. In the coastal counties of Hancock, Harrison, and Jackson, either Coating Type Z Class 3 or Coating Type A shall be furnished. In all other areas of the State, either Coating Type Z Class 1, Coating Type Z Class 3, Coating Type ZA Class 60, or Coating Type A shall be furnished.

907-712.04--Chain Link Fence. Delete Subsections 712.04.1 thru 712.04.7 on pages 785 & 786, and substitute the following.

907-712.04.1--Fabric. In the coastal counties of Hancock, Harrison, and Jackson, either Type I Class D, Type II, Type III, or Type IV fabrics shall be furnished. In all other areas of the State, either Type I Class C, Type I Class D, Type II, Type III, or Type IV fabrics shall be furnished.

907-712.04.2--Tie Wire. Tie wire shall be of the same material as the fencing wire being used, shall be of good commercial quality, and shall meet the requirements of AASHTO M 181. Either Type I, Type II, Type III, or Type IV tie wire shall be furnished.

907-712.04.3--Tension Wire. Tension wire shall be of the same material as the fencing wire being used, shall be of good commercial quality, and shall meet the requirements of AASHTO M 181. In the coastal counties of Hancock, Harrison, and Jackson, either Type I Class 3, Type II, Type III, or Type IV tension shall be furnished. In all other areas of the State, either Type II, Type III, Type IV, or Type I Classes 1, 2, or 3 tension wires shall be furnished.

907-712.04.4--Posts Rails, Gate Frames, and Expansion Sleeves. Posts, rails, gate frames, and expansion sleeves shall conform to the requirements for posts in Subsection 712.05.2, unless otherwise designated in the contract.

907-712.04.5--Miscellaneous Fittings and Hardware. Miscellaneous fittings and hardware shall conform to the requirements of Subsection 712.16.

907-712.05--Fence Posts and Braces.

907-712.05.1--Treated Timber Posts and Braces.

907-712.05.1.1--General. Delete the third, fourth, fifth, and sixth paragraphs of Subsection 712.05.1.1 on page 787, and substitute the following.

All wood posts and braces shall be treated in accordance with Subsections 718.03 and 718.04.

907-712.05.1.2--Round Posts. Delete the last sentence of the last paragraph of Subsection 712.05.1.2 on page 788.

907-712.05.1.3--Sawed Posts. Delete the last sentence of the paragraph of Subsection 712.05.1.3 on page 788.

907-712.05.1.4--Sawed Braces. Delete the last sentence of the paragraph of Subsection 712.05.1.4 on page 788.

Delete Subsection 712.05.2 on page 788, and substitute the following.

907-712.05.2--Metal Posts.

907-712.05.2.1--Round Steel Pipe. Round steel pipe shall meet the requirements of AASHTO M 181, either Grade 1 (i.e., meeting the requirements in ASTM F 1083) or Grade 2 (i.e., meeting the requirements of ASTM F 1043).

Round steel pipe shall be sized in accordance with NPS (nominal pipe size) designations as shown on Plans, and not according to the outer or inner pipe diameter.

907-712.05.2.2--Steel Fence Post and Assemblies, Hot-Wrought. Steel posts with the following section shapes, Tee, channel or U, and Y-Bar shall meet the requirements of AASHTO M 281, galvanized in accordance with the requirements of AASHTO M 111, unless otherwise specified in the contract. Acceptance of these steel posts shall be by certification from the manufacturer, producer, supplier, or fabricator, as applicable.

907-712.05.2.3--Blank.

907-712.05.2.4--Steel H-Beam Posts. Steel H-Beam posts shall be produced from structural quality weldable steel having a minimum yield strength of 45,000 psi and shall be galvanized in accordance with ASTM A 123. Steel H-Beam line posts shall be 2.250 inches by 1.625 inches and shall weigh 3.43 pounds per foot. A tolerance of plus or minus 5.0 percent is allowed for

weight per foot. A tolerance of plus or minus 1.0 percent is allowed for dimensions.

907-712.05.2.5--Aluminum-Alloy Posts and Assemblies. Round aluminum-alloy posts shall meet the requirements of ASTM B 241, Alloy 6061, T6. Aluminum-Alloy H-Beam posts shall meet the requirements of ASTM B 221, Alloy 6061, T6.

907-712.05.2.6--Formed Steel Section Posts. Formed steel section posts, "C" sections, shall be formed from sheet steel conforming to ASTM A 1011, Grade 45, and shall be galvanized in accordance with ASTM A 123.

907-712.06--Guard and Guardrail Posts.

907-712.06.2--Treated Wood Posts.

907-712.06.2.1--Square Posts. Delete the paragraph in Subsection 712.06.2.1 on page 789, and substitute the following.

All square posts shall be inspected for conformance with Section 712.05, except that the posts may be rough and shall be within $\pm 3/8$ " of the dimensions shown on the plans.

907-712.06.2.2--Round Posts. Delete the paragraph in Subsection 712.06.2.2 on page 789, and substitute the following.

All round posts shall be inspected for conformance with Section 712.05, except that the posts shall be of the shape and dimensions shown on the plans.

907-712.06.5--Treated Wood Blocks for Use with Metal Guardrail Posts. Delete the paragraphs of Subsection 712.06.5 on pages 789 & 790, and substitute the following.

Treated wood blocks for use with metal guardrail posts shall be within $\pm 3/8$ " of the size and dimensions shown on the plans, except that a minus tolerance shall not be allowed for the slotted width in which the metal post must fit.

Delete Subsection 712.16 on page 791, and substitute the following.

907-712.16--Hardware. All ferrous metal hardware for fencing such as bolts, nuts, washers, and metal straps shall be as specified on the plans and galvanizing shall not be less than 1.0 ounce per square foot of uncoated area. Aluminum coated hardware shall be coated with aluminum meeting the requirements of AASHTO M 181 for aluminum coating and at the rate of not less than 0.4 ounces per square foot of uncoated area.

Aluminum alloy hardware shall conform to the requirements of ASTM B 221 for extruded aluminum alloy 6063, T6. The finished members shall be of uniform quality.

Aluminum-zinc coated hardware shall be coated with an aluminum-zinc alloy meeting the chemical requirements and weight of coating specified for aluminum-zinc alloy coated metal gates.

MISSISSIPPI DEPARTMENT OF TRANSPORTATION

SPECIAL PROVISION NO. 907-714-3

CODE: (SP)

DATE: 08/31/2021

SUBJECT: Miscellaneous Materials

Section 714, Miscellaneous Materials, of the 2017 Edition of the Mississippi Standard Specifications for Road and Bridge Construction is hereby amended as follows.

907-714.01--Water.

907-714.01.1--General. Delete the last sentence of the second paragraph in Subsection 714.01.1 on page 794.

907-714.01.2--Water for Use in Concrete. Delete Subsection 714.01.2 on page 794, and substitute the following:

Water from municipal sources is permitted be used as mixing water in concrete, mortar, and grout without Department testing. Water from non-municipal water sources used in mixing of concrete, mortar, and grout which does not meet the requirements in Subsection 714.01.1 shall be tested for conformance as required in AASHTO M157, Table 1 and Table 2.

907-714.01.3--Water for Use in Chemically Stabilized Based. Delete the first sentence of first paragraph in Subsection 714.01.3 on page 794, and substitute the following:

Water used in the construction of bases that contain cement, lime, or other chemical additive shall be as set out in Subsection 714.01.1. Water from municipal sources is permitted to be used without testing for conformance to the requirements below. If water is not from a municipal source, it shall not contain impurities in excess of the following limits:

Delete Subsection 714.01.6 on page 795, and substitute the following.

907-714.01.6--Blank.

907-714.05--Fly Ash.

907-714.05.1--General. Delete the first sentence of the fifth paragraph in Subsection 714.05.1 on page 797.

907-714.13--Geotextiles.

907-714.13.11--Tables. Delete Table 1 in Subsection 714.13.11 on page 813, and substitute the following.

Table 1 - Geotextiles

Type Designation	I ¹ Sediment Control	II ¹ Drainage	III Drainage	IV Paving	V Separation & Drainage		VI Separation, Stabilization & Reinforcement		VIII High Strength	IX High Strength	Test Method
					Woven	Non-Woven	Woven	Non-Woven			
Grab Strength (lb)	50	90	110	90	200	280	180	450	280	280	ASTM D 4632
Elongation (%)	---	50% max @ 45 lb	20% min	50% min @ break	50% min	50% max	50% min	50% max	50% min	50% min	ASTM D 4632
Seam Strength (lb)	---	---	70	---	180	240	160	400	240	240	ASTM D 4632
Puncture Strength (lb)	---	---	40	---	80	110	75	180	115	115	ASTM D 6241
Trapezoidal Tear (lb)	---	---	40	---	80	100	70	150	100	100	ASTM D 4533
Asphalt Retention (gal/yd ²)	---	---	---	0.2	---	---	---	---	---	---	ASTM D 6140
Permittivity (sec ⁻¹) min	0.05	0.05	0.5	---	0.2	0.2	0.2	0.2	0.2	0.2	ASTM D 4491
AOS Woven (mm) max	0.60	0.60	0.6	---	0.6	0.43	---	0.43	---	---	ASTM D 4751
AOS Non-Woven (mm) max	0.84	0.84	0.43	---	0.43	---	0.43	---	0.43	---	---
Tensile Strength after UV (% Retained)	70% @ 500 hr	70% @ 500 hr	50% @ 500 hr	---	50% @ 500 hr	50% @ 500 hr	50% @ 500 hr	50% @ 500 hr	50% @ 500 hr	50% @ 500 hr	ASTM D 4355
Melting Point °(F)	---	---	---	325	---	---	---	---	---	---	ASTM D 276
Minimum Ultimate Tensile Strength ³ (lb/in)	---	---	---	---	---	---	---	---	---	660	ASTM D 4595

Notes: 1 - All property values, with the exception of apparent opening size (AOS), represent minimum average roll values in the weakest principal direction. Values for AOS represent the maximum average roll values, 2 - Values not identified in this table should meet manufacturer certification for the use and application, 3 - Machine direction

Delete Subsection 714.15 on pages 816 and 817 and substitute the following.

907-714.15--Geogrids.

907-714.15.1--General. A geogrid is defined as a geosynthetic formed by a regular network of connected elements with apertures greater than 0.25 inch to allow interlocking with surrounding soil, rock, and other surrounding materials to function primarily as reinforcement.

Geogrid shall be manufactured from an expanded strain hardened monolithic polymer sheet composed of one or more synthetic polymers and shall be mildew resistant and inert to biological degradation and naturally encountered chemicals, alkalis and acids. The geogrid shall contain stabilizers and/or inhibitors, or a resistance finish or covering to make it resistant to deterioration from direct sunlight, ultraviolet rays, and heat.

Geogrid manufacturers shall participate in and be in compliance with the American Association of State Highway Transportation Officials (AASHTO) National Transportation Product Evaluation Program's (NTPEP) Geosynthetics audit program. Geogrid shall meet the requirements of Table II for the application and type shown on the plans and shall be selected from the Department's Approved Lists.

907-714.15.1.1--Geogrid for Retaining Walls and Reinforced Soil Slopes. Geogrid for retaining walls and reinforced soil slopes shall be creep tested in accordance with AASHTO R69 and meet Long Term Design Load, Minimum Ultimate Tensile Strength, and open area criteria listed in Table II. Manufacturers shall perform at least one long-term creep test for no less than 10,000 hours in accordance to ASTM D 5262 for each polymer or composition of polymers from which the geogrid is produced. The long-term design load that shall be reported for design use, shall be that load at which no more than 10% strain occurs over a 100-year design life of the geogrid, as calculated in accordance with AASHTO R69. Long-term design loads shall be reported unfactored, and the AASHTO strength reduction factors (Durability and Installation, and safety factors) will be considered by the Department's Geotechnical Branch on a site specific design basis.

907-714.15.1.2--Geogrid for Subgrade Stabilization. Geogrid for subgrade stabilization shall meet Minimum Ultimate Tensile Strength and open area criteria listed in Table II.

907-714.15.2--Marking, Shipment, and Storage. Each roll or container of geogrid shall be visibly labeled with the name of the manufacturer, trade name of the product, lot number, and quantity of material. In addition, each roll or container shall be clearly tagged to show the type designation that corresponds to that required by the plans. During shipment and storage the geogrid shall be protected from direct sunlight, and temperatures above 120°F or below 0°F. The geogrid shall either be wrapped and maintained in a heavy duty protective covering or stored in a safe enclosed area to protect from damage during prolonged storage.

907-714.15.3--Manufacturer Certification. The Contractor shall furnish the Engineer three copies of the manufacturer's certified test reports indicating that the geogrid furnished conforms to the requirements of the specifications and is of the same composition as the originally approved

by the Department.

907-714.15.4--Acceptance Sampling and Testing. Final acceptance of each shipment will be based upon results of tests performed by the Department on verification samples submitted from the project, as compared to the manufacturer's certified test reports. The Engineer will select one roll or container at random from each shipment for sampling. As sample extending full width of the randomly selected roll or container and being at least five (5) square yards in area will be obtained and submitted by the Engineer. All material samples shall be provided at no cost to the State.

**TABLE II
GEOGRIDS**

Physical Properties	Type Designation						Test Method
	I	II	III	IV	V	VI	
Long Term Design Load ¹ , pounds per foot, Machine Direction	250	500	750	1500	2500	3500	AASHTO R69, ASTM D5262
Minimum Ultimate Tensile Strength ² , pounds per foot, Machine Direction	500	1000	1500	3000	5000	7000	ASTM D6637
Open Area, percent	70	70	50	50	50	50	Direct Measurement

¹ Minimum design criteria requirement.

² Minimum Average Roll Value (MARV).

MISSISSIPPI DEPARTMENT OF TRANSPORTATION

SPECIAL PROVISION NO. 907-718-1

CODE: (SP)

DATE: 12/07/2021

SUBJECT: Timber and Dimension Lumber

Section 718, Timber and Dimension Lumber, of the 2017 Edition of the Mississippi Standard Specifications for Road and Bridge Construction is hereby amended as follows.

Delete the Subsections in Section 718 on pages 836 thru 838, and substitute the following.

907-718.01--General. All timber and dimension lumber shall be Southern pine and shall conform in all respects to applicable requirements of AASHTO M 168. The Department reserves the right to sample and to test all materials at any time; all inspection, testing, and certification of materials will be performed in accordance with the requirements of the current version of the Department's *Materials Division Inspection, Testing, and Certification Manual*.

Timber and dimension lumber shall be furnished in the sizes shown on the plans or as specified. Unless otherwise specified, timber and dimension lumber shall be No. 1, or better, graded according to the latest American Lumber Standards.

Only one type of preservative shall be used for the treatment of materials for any one class of construction on a project, unless otherwise specified.

Where treated timber and dimensional lumber is to be used in non-highway construction or use, such as decking, handrails in walking trails, or in any manner where general public exposure by touch is possible, the treatment requirements will be as per project plans and/or approved by the State Materials Engineer.

907-718.02--Untreated Timber and Dimension Lumber. Untreated timber and dimension lumber shall conform to the requirements of AASHTO M 168.

907-718.03--Treated Timber and Dimension Lumber. Timber and dimension lumber to be treated shall meet the requirements herein specified and shall be treated as specified. Treated timber or dimensional lumber will not be accepted for use unless it has been inspected by an authorized representative of the Department and found to be satisfactory after treatment.

907-718.03.1--Blank.

907-718.03.2--Treatment.

907-718.03.2.1--General. All materials shall be treated in accordance with AASHTO M 133 unless otherwise directed by the Environmental Protection Agency (EPA).

907-718.03.2.2--Blank.

907-718.03.2.3--Inspection. Treated timber and dimension lumber shall be inspected by an authorized representative of the Department before being incorporated into the work. Treatment reports shall be provided to the Department for each lot of material supplied.

907-718.03.3--Blank.

907-718.03.4--Storage of Treated Material. All material treated for stock shall be stacked as compactly as possible on a well-drained surface. Material shall be supported on sills spaced as necessary, not to exceed 10 foot intervals and shall have at least one foot of air space beneath the stacks.

All materials treated with preservatives for use in buildings and applications where painting is required shall be dried after treatment. The treated wood shall be dried in accordance with American Lumber Standards.

907-718.04--Preservative. Preservatives shall be as specified in AASHTO M 133 unless otherwise directed by the Environmental Protection Agency (EPA).

MISSISSIPPI DEPARTMENT OF TRANSPORTATION

SPECIAL PROVISION NO. 907-720-2

CODE: (IS)

DATE: 09/11/2018

SUBJECT: Acceptance Procedure for Glass Beads

Section 720, Pavement Marking Materials, of the 2017 Edition of the Mississippi Standard Specifications for Road and Bridge Construction is hereby amended as follows.

907-720.01--Glass Beads.

907-720.01.4--Acceptance Procedures. Delete the last sentence of the paragraph in Subsection 720.01.4 on page 841, and substitute the following.

Acceptance sampling and testing of glass beads will be in accordance with the Department's Materials Division Inspection, Testing, and Certification Manual, Section 2.9.2 -- Glass Beads.

MISSISSIPPI DEPARTMENT OF TRANSPORTATION

SPECIAL PROVISION NO. 907-721-4

CODE: (IS)

DATE: 04/19/2022

SUBJECT: Materials for Signing

Section 721, Materials for Signing, of the 2017 Edition of the Mississippi Standard Specifications for Road and Bridge Construction is hereby amended as follows.

907-721.06--Reflective Sheeting.

907-721.06.2--Performance Requirements. Delete Table 4 and Table 5 in Subsection 721.06.2 on pages 860 & 861, and substitute the following.

**MINIMUM COEFFICIENTS OF RETROREFLECTION
Candela per foot candle per square foot (cd/ft²)
Per ASTM Designation D4956**

**TABLE 4
Type IX Sheeting**

Observation Angle	Entrance Angle	White	Yellow	Green	Red	Blue	Fluorescent Yellow/Green	Fluorescent Yellow	Fluorescent Orange
0.2°	-4.0°	380	285	38	76	17	300	230	115
0.2°	+30.0°	215	162	22	43	10	170	130	65
0.5°	-4.0°	240	180	24	48	11	190	145	72
0.5°	+30.0°	135	100	14	27	6.0	110	81	41
1.0°	-4.0°	80	60	8.0	16	3.6	64	48	24
1.0°	+30.0°	45	34	4.5	9.0	2.0	36	27	14

**TABLE 5
Type XI Sheeting**

Observation Angle	Entrance Angle	White	Yellow	Green	Red	Blue	Brown	Fluorescent Yellow/Green	Fluorescent Yellow	Fluorescent Orange
0.2°	-4.0°	580	435	58	87	26	17	460	350	175
0.2°	+30.0°	220	165	22	33	10	7.0	180	130	66
0.5°	-4.0°	420	315	42	63	19	13	340	250	125
0.5°	+30.0°	150	110	15	23	7.0	5.0	120	90	45
1.0°	-4.0°	120	90	12	18	5.0	4.0	96	72	36
1.0°	+30.0°	45	34	5.0	7.0	2.0	1.0	36	27	14

After Subsection 721.10 on page 864, add the following.

907-721.11--Digital Applied Printing. The following addresses the requirements for digitally printed finished retroreflective traffic control signs on flat sheet aluminum and digitally printed traffic sign faces intended to be applied to a sign substrate.

907-721.11.1--Digitally Printed Ink Systems. Traffic signs must be produced using components, and processes that comply with the retroreflective sheeting manufacturer’s recommendations.

Digital printed ink systems used to print traffic signs must meet and comply with daytime and nighttime chromaticity (color standards) as recognized in ASTM D4956 “Standard Specification for Retroreflective Sheeting for Traffic Control.”

Digital printed ink systems must meet 70% of the initial retroreflectivity specifications of each respective reflective film color as found in ASTM D4956 “Standard Specification for Retroreflective Sheeting for Traffic Control.”

Prior to fabrication and preferably at the preconstruction meeting, the Contractor shall advise the Project Engineer in writing as to which signs on the project will be digitally printed and which ones will be screen printed. The Contractor shall submit to the Project Engineer certifications for all digitally printed signs, which will be forwarded to the State Traffic Engineer for review.

907-721.11.2--Protective Overlay Film. Permanent traffic signs printed with digital ink systems will be fabricated with a full sign protective overlay film designed to provide a smooth surface needed for retroreflectivity, and to protect the sign from fading and UV degradation. The overlamine shall comply with the retroreflective sheeting manufacturer’s recommendations to ensure proper adhesion and transparency and will also meet the reflective film durability as identified in Table 1.

**Table 1
Retroreflective Film Minimum Durability Requirements**

ASTM D4956 Type	Full Sign Replacement Term (years)	Sheeting Replacement Term (years)
IV	7	10
VIII	7	10
IX	7	12
XI	7	12

Temporary signs used in work zones printed with black ink only will not require a protective overlay film as long as the finished sign is warranted for a minimum outdoor durability of three years by the sheeting manufacturer.

907-721.11.3--Inspection. During fabrication, the Contractor shall provide sufficient testing and quality control throughout fabrication to insure good workmanship. Once the material has been received, it may be subject to random testing to ensure compliance with all requirements. If any test samples do not conform to the requirements, the entire order may be returned at the vendor’s expense.

907-721.11.4--Traffic Sign Performance Warranty Provisions. Based on the ASTM Type of sheeting specified, traffic control signs shall be warranted for the duration shown in Table 1. The Contractor shall supply a copy of the warranty document with complete details of terms and conditions upon request of the Department.

907-721.11.5--Certified Digital Sign Fabricator. Sign fabricators using digital imaging methods to produce regulated traffic signs must be certified by the reflective sheeting manufacturer whose materials are used to produce the delivered signs.

Certified sign fabricators must undergo an audit process by the sheeting manufacturer to ensure they have the proper equipment, manufacturing capabilities, manufacturing application processes and the materials required to fulfill the sheeting manufacturer's warranty obligations. Sign fabricators must recertify annually with reflective sheeting manufacturers or utilize a 3rd party certifier approved by the reflective sheeting manufacturer.

The Contractor shall submit proof of Sign Fabricator Certification as issued by the retroreflective sign sheeting manufacturer to the Project Engineer upon delivery of the signs, or with the Shop Drawings.

SPECIAL PROVISION NO. 906-8

Training Special Provision

This Training Special Provision supersedes subparagraph 7b of the Special Provision entitled "Specific Equal Employment Opportunity Responsibilities," (Attachment 1), and is in implementation of 23 U.S.C. 140(a). Additional information regarding On the Job Training (OJT), Forms, and *Exhibits* are available at the following website.

<http://www.gomdot.com/Divisions/CivilRights/Resources.aspx>

As part of the Contractor's equal employment opportunity affirmative action program training shall be provided as follows:

The Contractor shall provide on-the-job training aimed at developing full journeymen in the type of trade or job classification involved.

The number of trainee hours to be trained under this special provision will be as indicated in the bid schedule of the contract.

In the event that a Contractor subcontracts a portion of the contract work, the Contractor shall determine how many, if any, of the trainee hours are to be trained by the Subcontractor, provided, however, that the Contractor shall retain the primary responsibility for meeting the training requirements imposed by this special provision. The Contractor shall also insure that this training special provision is made applicable to such subcontract. Where feasible, 25 percent of apprentices or trainees in each occupation shall be in their first year of apprenticeship or training.

The number of trainees shall be distributed among the work classifications on the basis of the Contractor's needs and the availability of journeymen in the various classifications within a reasonable area of recruitment. Prior to commencing construction, the Contractor shall submit to the State transportation agency for approval an OJT Trainee Schedule Form indicating the number of trainees to be trained in each selected classification, training program to be used and start date of training for each classification. Furthermore, the Contractor shall provide a Trainee Enrollment Form for each trainee enrolled. The Contractor will be credited for each trainee employed on the contract work who is currently enrolled or becomes enrolled in an approved program and will be reimbursed for such trainees as provided hereinafter.

Training and upgrading of minorities and women toward journeymen status is a primary objective of this Training Special Provision. Accordingly, the Contractor shall make every effort to enroll minority trainees and women (e.g., by conducting systematic and direct recruitment through public and private sources likely to yield minority and women trainees) to the extent that such persons are available within a reasonable area of recruitment. The Contractor will be responsible for demonstrating the steps that they take in pursuance thereof, prior to a determination as to whether the Contractor is in compliance with this Training Special Provision. This training commitment is not intended, and shall not be used, to discriminate against any applicant for training, whether a member of a minority group or not.

No employee shall be employed as a trainee in any classification in which he/she has successfully completed a training course leading to journeyman status or in which he/she has been employed as a journeyman. The Contractor should satisfy this requirement by including appropriate questions in the employee application or by other suitable means. Regardless of the method used the Contractor's records should document the findings in each case.

The minimum length and type of training for each classification will be as established in the training program selected by the Contractor and approved by the State highway agency and the

Federal Highway Administration. The State transportation agency and the Federal Highway Administration shall approve a program if it is reasonably calculated to meet the equal employment opportunity obligations of the Contractor and to qualify the average trainee for journeyman status in the classification concerned by the end of the training period. Furthermore, apprenticeship programs registered with the U.S. Department of Labor, Bureau of Apprenticeship and Training, or with a State apprenticeship agency recognized by the Bureau and training programs approved but not necessarily sponsored by the U.S. Department of Labor, Manpower Administration, Bureau of Apprenticeship and Training shall also be considered acceptable provided it is being administered in a manner consistent with the equal employment obligations of Federal-aid highway construction contracts. Approval or acceptance of a training program shall be obtained from the State prior to commencing work on the classification covered by the program. It is the intention of these provisions that training is to be provided in the construction crafts rather than clerk-typists or secretarial-type positions. Training is permissible in lower level management positions such as office engineers, estimators, timekeepers, etc., where the training is oriented toward construction applications. Training in the laborer classification may be permitted provided that significant and meaningful training is provided and approved by the division office.

Except as otherwise noted below, the Contractor will be reimbursed \$5.00 per hour of training given an employee on this contract in accordance with an approved training program. As approved by the engineer, reimbursement will be made for training persons in excess of the number specified herein.

No payment shall be made to the Contractor if failure to provide the required training is caused by the Contractor and evidences a lack of good faith on the part of the Contractor in meeting the requirements of this Training Special Provision. It is normally expected that a trainee will begin training on the project as soon as feasible after start of work utilizing the skill involved and remain on the project as long as training opportunities exist in the work classification or until the trainee has completed the training program. It is not required that all trainees be on board for the entire length of the contract. A Contractor's responsibility will have been fulfilled under this Training Special Provision if the Contractor has provided acceptable training to the number of trainees specified. The number trained shall be determined on the basis of the total number enrolled on the contract for a significant period.

Trainees will be paid at least 60 percent of the appropriate minimum journeyman's rate specified in the contract for the first half of the training period, 75 percent for the third quarter of the training period, and 90 percent for the last quarter of the training period, unless apprentices or trainees in an approved existing program are enrolled as trainees on this project. In that case, the appropriate rates approved by the Departments of Labor or Transportation in connection with the existing program shall apply to all trainees being trained for the same classification who are covered by this Training Special Provision.

The Contractor shall furnish the trainee a copy of the program being followed in providing the training. The Contractor shall provide each trainee with a certification showing the type and length of training satisfactorily completed.

The Contractor will provide for the maintenance of records and furnish periodic reports to include an OJT Trainee Monthly Report form and an OJT Trainee Termination Report form when appropriately documenting performance under this Training Special Provision.

Contractor's Responsibility

1. Provide On-the-Job Training aimed at developing full journeymen in the type of trade or job classification involved. Accordingly, the Contractor shall make every effort to enroll minority trainees and women (e.g., conducting systematic and direct recruitment through public and private sources likely to yield minority and women trainees) to the extent that such persons are available within a reasonable area of recruitment.
2. Contractors are expected to fulfill their obligations under the Training Special Provisions. Those obligations will be considered fulfilled if Contractors have provided acceptable training to the number of trainees specified in the OJT Plan.
3. Upon deciding to sub-contract out a portion of the contract work, determine how many, if any, of the trainees are to be trained by the sub-Contractor. The Contractor however, shall retain the primary responsibility for meeting the training requirements imposed by the special provision. Additionally, the Contractor will ensure that the Training Special Provision is made applicable to such sub-contract. Training and upgrading of minorities and women toward journeymen status is a primary objective of the Training Special Provision.
4. Prior to commencing construction (no more than 60 days from the date of the Notice to Proceed), the Contractor shall submit to the State Transportation Agency (STA) (MDOT) for approval the Trainee Schedule Form indicating the number of trainees to be trained in each selected classification and any appropriate attachments representing their training program or OJT Plan (*See Exhibit 1*) to be used. The Contractor shall also submit Trainee Enrollment Forms for each trainee to be trained (*See Exhibit 2*). Contractors should submit the above-mentioned forms as their OJT Plan to the Project Engineer who will in turn forward on to the Office of Civil Rights for Approval.
5. Designate and make known at the preconstruction conference to the Office of Civil Rights and the Project Engineer the name of the company **Equal Employment Officer (EEO Officer)/Designated Representative** who will have the responsibility for and must be capable of effectively administering and promoting an active Contractor program of equal employment opportunity and who must be assigned adequate authority and responsibility to do so. These individuals should have the authority to sign monthly trainee enrollment/time reports.
6. **Implement the EEO policy** and contractual responsibilities to provide equal employment opportunity in each grade and classification of employment. To assure that the preceding policy is adhered to, the following actions will be taken as a minimum:
 - a. Periodic meetings of supervisory and personnel office employees will be conducted before the start of work and then not less often than once every six (6) months.
 - b. Ensure that supervisors brief all employees which include trainees on company EEO Policies.
7. Utilize the following procedures to request additional training classifications not presently approved by the STA for assignment to the OJT for training.
 - a. Initially, for a “trainee” to be trained, there must be a “journeyman” on the project site to train the employee. The “trainer” can be a supervisor, foreman or another employee in the “trainee classification” who already is a “journeyman”.

- b. If a classification is not on the “Wage Determination” included in the contract, a written request for an additional classification should be submitted by the Contractor to the Project Engineer.
- c. Preferably, the request (written) should originate in the Project Office so that they will know that the Contractor has applied for the needed classification and that payrolls will not be delayed. The Project Office will ensure that they have been given the project number, Contractor, subcontractor, craft and rate and will submit to the Office of Civil Rights.

For documentation purposes it is recommended to the Contractor that the request for additional classifications should be written and addressed to the Office of Civil Rights that states in concise manner the need for the new classification in lieu of using an existing classification within the OJT Manual. In addition, the training program with required hours and job description similar to the OJT Manual.

- d. After receipt of the Request for Additional Classification, the OJT Coordinator will:
 - 1. Review for preliminary approval and submit a new Trainee Schedule Form to the Contractor for signature.
 - 2. Upon receipt of the signed form from the Project Office/Contractor, a cover letter is attached to the appropriate documentation. The cover letter and documentation are transmitted to Department of Labor (DOL) in Washington D.C. requesting concurrence of the new classification.
 - e. If an individual is hired for the requested classification during the time frame when the STA (OJT Coordinator) is awaiting approval, the individual will be paid at the proposed wage rate.
 - f. If the DOL does not agree with the proposed classification and wage rate, the DOL will make a determination on the appropriate wage rate for the classification. The Labor Compliance Officer will make a copy of the letter and attach a cover letter which cites the recommendation and rationale for the disapproval.
 - g. If the DOL approves the request, a letter will be sent to the STA (OJT Coordinator) citing approval and the accompanying wage rate. The OJT Coordinator will make a copy of the approval letter and attach a cover letter which cites the approval of the classification and wage rate. This letter is sent to the Contractor and all “paper copies” listed at the end of the cover letter.
8. Begin training as soon as possible after the start date indicated on the Trainee Schedule Form for work utilizing the skill involved. In addition, if training does not begin at the preceding time, a written explanation will be given to the Project Engineer citing the rationale and time frame when training will commence on the project. The trainee should be briefed (furnished a copy) at this juncture on the training program for which he/she has started to ensure understanding of the phases of work and wage rates within each section of the program.
9. After commencement of work at the project site, the Contractor shall implement the following **Trainee Wage Rates** according to the Davis Bacon rules.

Normally, trainees are paid a percentage of journeyman's wages (Davis Bacon rates). The following payment plan is required in the FHWA Training Special Provision;

- a. Sixty percent (60%) of the journeyman's wages for the first half of the training period;
 - b. Seventy-five percent (75%) of the journeyman's wages for the third quarter of the training period; and
 - c. Ninety percent (90%) of the journeyman's wages for the last quarter of the training period.
10. Indicate on the payroll records the trainer i.e. roller operator trainer for a given classification.
 11. Recruit a replacement for the trainee when training obligations have not been met on a project provided that there are enough work hours remaining on the project as well as time within the work phase to complete training. Contractors will document in writing all Good Faith Efforts (GFE) in accordance with FHWA Form 1273 Section II 4a- 4e Recruitment and 6a-6d Training and Promotions) (*See Exhibit 9*). The Contractor must submit documentation of GFE i.e. efforts made to hire replacements for trainees who terminated their training program to the Office of Civil Rights. The GFE will be compiled into a letter which is attached to the MDOT Monthly Training Report and submitted to the along a MDOT Termination Report (*See Exhibit 4*) that includes the names/reasons of individuals who separated from the company during the respective reporting period. The GFE will be evaluated to determine if it is sufficient or insufficient. The Project Engineer will forward documentation to the Office of Civil Rights within five (5) days of receipt.
 12. Transferring trainees from one federal-aid project to another.
 - a. Contractors are to make written requests for transferring trainees from one federal-aid project to another federal aid project and submit to the Project Engineer to be forwarded to the Office of Civil Rights for review and approval.
 - b. In addition, if trainees are approved for transfer, the gaining project must have the same training classification approved for that project. The Contractor must provide documentation i.e. written letter that the gaining project will have sufficient work time to complete training requirements.
 - c. All hours trained by employees on a project other than their originally assigned project without the proper transfer approval will not be counted towards the OJT obligation for that project. If the OJT obligation is not met, the prime Contractor will have to show good faith efforts in fulfilling this portion of the contract requirement.
 13. Utilize and submit monthly trainee reports (*See Exhibit 3*) to document training activities to the respective Project Engineer. Monthly training reports should be accurate, concise and include the following items:

- a. Report Period (month) – the date at the top of the training report reflects the month and year the trainee received the training (not the date the report was completed by the Contractor)
 - b. Project Number – project number on the certified payroll and training report should match
 - c. Contractor Name
 - d. County
 - e. Trainee Name
 - f. Job Classification/Hours Required – obtained from OJT Manual - certified payrolls and training reports should match
 - g. Hours required – obtained from OJT Manual should match the Job Classification
 - h. Date Training Started/Terminated – inserted by the Contractor
 - i. Hours trained for the month – training performed this month on federal aid projects and inserted by a respective week ending date i.e. Sunday
 - j. Hours to date – all training annotated on report for previous and current month
 - k. Hours training remaining – subtraction of total training hours to date from training hours required
 - l. Trainee wage rate – Contractor cite the appropriate wage rate for phase of training
 - m. Original signatures and dates for respective training period citing trainee, trainer, and Company EEO Officer/Designated Representative
 - n. Every applicable field on the training report is completed
14. Monthly training reports intended for submission to the MDOT Central Office should cite activities illustrated in the individual training forms received from project personnel. [Failure of the Contractor to submit monthly trainee reports may result in the estimate not being processed and paid.](#) Monthly Training Reports should be submitted to the Project Engineer within fifteen (15) days of the current month with data covering the previous month's activities. However, if monthly training reports are not submitted within this time frame, the Contractor will provide written explanation to the Project Engineer citing the reason for the delay. In addition, a copy of this documentation will be provided to the MDOT Office of Civil Rights within ten (10) days of receipt by the Project Engineer.
15. Provide the trainee with a certification (*See Exhibit 7*) showing the type and length of training satisfactorily completed.
16. Retain all EEO records, i.e. employment breakdown by race and craft on a project, recruitment and hiring of minority and females for a period of three (3) years following the completion of contract work and shall be available at reasonable times and places for inspection by authorized representatives of the STA and the FHWA.

17. Submit an annual report to the STA each July for the duration of the project, indicating the number of minority, women, and non-minority group employees currently engaged in each work classification required by the contract work. This information is to be reported on Form PR 1391 (*See Exhibit 8*). Contractors are provided an annual notice for this reporting requirement.
18. Periodically evaluate the effectiveness of their OJT Programs and trainees' progress within the training program. Based on these evaluations, forward comments / recommendations through the Project Engineer to the Office of Civil Rights for improving or correcting deficiencies in the training program.

SECTION 905 - PROPOSAL

Date _____

Mississippi Transportation Commission
Jackson, Mississippi

Sirs: The following proposal is made on behalf of _____
_____ of _____

for constructing the following designated project(s) within the time(s) hereinafter specified.

The plans are composed of drawings and blue prints on file in the offices of the Mississippi Department of Transportation, Jackson, Mississippi.

The Specifications are the current Standard Specifications of the Mississippi Department of Transportation approved by the Federal Highway Administration, except where superseded or amended by the plans, Special Provisions and Notice(s) to Bidders attached hereto and made a part thereof.

I (We) certify that I (we) possess a copy of said Standard and any Supplemental Specifications.

Evidence of my (our) authority to submit the Proposal is hereby furnished. The proposal is made without collusion on the part of any person, firm or corporation. I (We) certify that I (we) have carefully examined the Plans, the Specifications, including the Special Provisions and Notice(s) to Bidders, herein, and have personally examined the site of the work. On the basis of the Specifications, Special Provisions, Notice(s) to Bidders, and Plans, I (we) propose to furnish all necessary machinery, tools, apparatus and other means of construction and do all the work and furnish all the materials in the manner specified. I (We) understand that the quantities mentioned herein are approximate only and are subject to either increase or decrease, and hereby propose to perform any increased or decreased quantities of work at the unit prices bid, in accordance with the above.

I (We) acknowledge that this proposal will be found irregular and/or non-responsive unless a certified check, cashier's check, or Proposal Guaranty Bond in the amount as required in the Advertisement (or, by law) is submitted electronically with the proposal or is delivered to the Contract Administration Engineer prior to the bid opening time specified in the advertisement.

INSTRUCTION TO BIDDERS: Alternate and Optional Items on Bid Schedule.

1. Two or more items entered opposite a single unit quantity WITHOUT DEFINITE DESIGNATION AS "ALTERNATE ITEMS" are considered as "OPTIONAL ITEMS". Bidders may or may not indicate on bids the Optional Item proposed to be furnished or performed WITHOUT PREJUDICE IN REGARD TO IRREGULARITY OF BIDS.
2. Items classified on the bid schedule as "ALTERNATE ITEMS" and/or "ALTERNATE TYPES OF CONSTRUCTION" must be preselected and indicated on bids. However, "Alternate Types of Construction" may include Optional Items to be treated as set out in Paragraph 1, above.
3. Optional items not preselected and indicated on the bid schedule MUST be designated in accordance with Subsection 102.06 prior to or at the time of execution of the contract.
4. Optional and Alternate items designated must be used throughout the project.

I (We) further propose to perform all "force account or extra work" that may be required of me (us) on the basis provided in the Specifications and to give such work my (our) personal attention in order to see that it is economically performed.

I (We) further propose to execute the attached contract agreement (Section 902) as soon as the work is awarded to me (us), and to begin and complete the work within the time limit(s) provided for in the Specifications and Advertisement. I (We) also propose to execute the attached contract bond (Section 903) in an amount not less than one hundred (100) percent of the total of my (our) part, but also to guarantee the excellence of both workmanship and materials until the work is finally accepted.

I (We) shall submit electronically with our proposal or deliver prior to the bid opening time a certified check, cashier's check or bid bond for **five percent (5%) of total bid** and hereby agree that in case of my (our) failure to execute the contract and furnish bond within Ten (10) days after notice of award, the amount of this check (bid bond) will be forfeited to the State of Mississippi as liquidated damages arising out of my (our) failure to execute the contract as proposed. It is understood that in case I am (we are) not awarded the work, the check will be returned as provided in the Specifications.

SECTION 905 -- PROPOSAL (CONTINUED)

I (We) hereby certify by digital signature and electronic submission via Bid Express of the Section 905 proposal below, that all certifications, disclosures and affidavits incorporated herein are deemed to be duly executed in the aggregate, fully enforceable and binding upon delivery of the bid proposal. I (We) further acknowledge that this certification shall not extend to the bid bond or alternate security which must be separately executed for the benefit of the Commission. This signature does not cure deficiencies in any required certifications, disclosures and/or affidavits. I (We) also acknowledge the right of the Commission to require full and final execution on any certification, disclosure or affidavit contained in the proposal at the Commission's election upon award. Failure to so execute at the Commission's request within the time allowed in the Standard Specifications for execution of all contract documents will result in forfeiture of the bid bond or alternate security.

Respectfully Submitted,

DATE _____

Contractor

BY _____
Signature

TITLE _____

ADDRESS _____

CITY, STATE, ZIP _____

PHONE _____

FAX _____

E-MAIL _____

(To be filled in if a corporation)

Our corporation is chartered under the Laws of the State of _____ and the names, titles and business addresses of the executives are as follows:

President Address

Secretary Address

Treasurer Address

The following is my (our) itemized proposal.

Mill & Overlay approximately 9 miles of US 49 from the Simpson County Line to south of Florence, known as Federal Aid Project No. NHPP-0008-03(059) / 108245301 in Rankin County.

Line no.	Item Code	Adj Code	Quantity	Units	Description[Fixed Unit Price]
Roadway Items					
0010	202-B009		406	Square Yard	Removal of Asphalt Pavement, Failed Areas
0020	202-B045		384	Square Yard	Removal of Cement Treated Base, All Depths
0030	202-B069		767	Square Yard	Removal of Concrete Pavement w/ Variable Depth Overlay
0040	202-B092		111	Linear Feet	Removal of Curb, All Types
0050	202-B114		8	Linear Feet	Removal of Debris and Sand From Pipe, All Sizes
0060	202-B158		4,305	Linear Feet	Removal of Guard Rail, Including Rails, Posts and Terminal Ends
0070	202-B240		685	Linear Feet	Removal of Traffic Stripe
0080	203-EX040	(E)	173	Cubic Yard	Borrow Excavation, AH, LVM, Class B9
0090	203-G002	(E)	195	Cubic Yard	Excess Excavation, LVM, AH
0100	209-A005		387	Square Yard	Geotextile Stabilization, Type V, Non-Woven
0110	229-A001		736	Square Yard	Erosion Mat
0120	304-B003	(GT)	6,156	Ton	Granular Material, Class 5, Group C
0130	304-F002	(GT)	109	Ton	Size 610 Crushed Stone Base
0140	403-A001	(BA1)	15,173	Ton	12.5-mm, HT, Asphalt Pavement
0150	403-B001	(BA1)	255	Ton	12.5-mm, HT, Asphalt Pavement, Leveling
0160	403-D001	(BA1)	34,426	Ton	12.5-mm, HT, Asphalt Pavement, Polymer Modified
0170	406-D001		431,915	Square Yard	Fine Milling of Bituminous Pavement, All Depths
0180	407-A001	(A2)	42,217	Gallon	Asphalt for Tack Coat
0190	423-A001		31	Mile	Rumble Strips, Ground In
0200	503-A001	(C)	210	Square Yard	8" and Variable Continuously Reinforced Concrete Pavement, Broom Finish
0210	503-A006	(C)	557	Square Yard	6" and Variable Reinforced Concrete Pavement, Broom Finish
0220	503-B001		500	Linear Feet	Saw Cut, Longitudinal Joints
0230	503-C004		260	Linear Feet	Saw Cut, 3-inch
0240	503-C010		1,536	Linear Feet	Saw Cut, Full Depth
0250	503-D001		25	Cubic Yard	Concrete for Base Repair
0260	503-E002		275	Each	Tie Bars, No. 5 Deformed Drilled and Epoxied or Grouted
0270	503-F002		214	Each	1" Smooth Dowel Bars, Drilled & Epoxied or Grouted
0280	606-B003		3,500	Linear Feet	Guard Rail, Class A, Type 1, 'W' Beam, Metal Post
0290	606-C003		11	Each	Guard Rail, Cable Anchor, Type 1
0300	606-D005		4	Each	Guard Rail, Bridge End Section, Type A
0310	606-E005		4	Each	Guard Rail, Terminal End Section, Flared
0320	606-E007		11	Each	Guard Rail, Terminal End Section, Non-Flared
0330	606-G002		4	Each	Special Sections, Guard Rail Bridge End Connector
0340	618-A001		1	Lump Sum	Maintenance of Traffic
0350	619-A1001		38	Mile	Temporary Traffic Stripe, Continuous White

Line no.	Item Code	Adj Code	Quantity	Units	Description Fixed Unit Price
0360	619-A2001		30	Mile	Temporary Traffic Stripe, Continuous Yellow
0370	619-A3001		42	Mile	Temporary Traffic Stripe, Skip White
0380	619-A5001		47,850	Linear Feet	Temporary Traffic Stripe, Detail
0390	619-A6001		870	Square Feet	Temporary Traffic Stripe, Legend
0400	619-A6002		2,896	Linear Feet	Temporary Traffic Stripe, Legend
0410	619-D1001		94	Square Feet	Standard Roadside Construction Signs, Less than 10 Square Feet
0420	619-D2001		952	Square Feet	Standard Roadside Construction Signs, 10 Square Feet or More
0430	619-G4005		96	Linear Feet	Barricades, Type III, Single Faced
0440	619-G7001		4	Each	Warning Lights, Type "B"
0450	620-A001		1	Lump Sum	Mobilization
0460	626-A001		21	Mile	6" Thermoplastic Double Drop Traffic Stripe, Skip White
0470	626-B002		19	Mile	6" Thermoplastic Double Drop Traffic Stripe, Continuous White
0480	626-E001		15	Mile	6" Thermoplastic Double Drop Traffic Stripe, Continuous Yellow
0490	626-G004		24,305	Linear Feet	Thermoplastic Double Drop Detail Stripe, White
0500	626-G005		23,504	Linear Feet	Thermoplastic Double Drop Detail Stripe, Yellow
0510	626-H001		868	Square Feet	Thermoplastic Double Drop Legend, White
0520	626-H002		2,896	Linear Feet	Thermoplastic Double Drop Legend, White
0530	627-J001		743	Each	Two-Way Clear Reflective High Performance Raised Markers
0540	627-K001		5,871	Each	Red-Clear Reflective High Performance Raised Markers
0550	627-L001		99	Each	Two-Way Yellow Reflective High Performance Raised Markers
0560	630-F003		50	Each	Delineators, Flexible Post Mounted, Crossover, Type II
0570	630-F006		105	Each	Delineators, Guard Rail, White
0580	630-F007		13	Each	Delineators, Guard Rail, Yellow
0590	630-G004		17	Each	Type 3 Object Markers, OM-3R or OM-3L
0600	907-403-P001	(BA1)	100,000	Pounds	Asphalt for Pothole Patching
0610	907-413-E001		34,545	Linear Feet	Sawing and Sealing Transverse Joints in Asphalt Pavement
0620	907-512-A001		164	Each	Holes
0630	907-512-B001		740	Pounds	Cement Pressure Grout Slurry, Type 5
0640	907-906001		520	Hours	Trainees (\$5.00)

SECTION 905 - COMBINATION BID PROPOSAL (Continued)

CONDITIONS FOR COMBINATION BID

If a bidder elects to submit a combined bid for two or more of the contracts listed for this month's letting, the bidder must complete and execute these sheets of the proposal in each of the individual proposals to constitute a combination bid. In addition to this requirement, each individual contract shall be completed, executed and submitted in the usual specified manner.

Failure to execute this Combination Bid Proposal in each of the contracts combined will be just cause for each proposal to be received and evaluated as a separate bid.

It is understood that the Mississippi Transportation Commission not only reserves the right to reject any and all proposals, but also the right to award contracts upon the basis of lowest separate bids or combination bids most advantageous to the State.

It is further understood and agreed that the Combination Bid Proposal is for comparison of bids only and that each contract shall operate in every respect as a separate contract in accordance with its proposal and contract documents.

I (We) agree to complete each contract on or before its specified completion date.

COMBINATION BID PROPOSAL

This proposal is tendered as one part of a Combination Bid Proposal utilizing option ___* of Subsection 102.11 on the following contracts:

* Option to be shown as either (a), (b), or (c).

	<u>Project No.</u>	<u>County</u>	<u>Project No.</u>	<u>County</u>
1.	_____	_____	6.	_____
2.	_____	_____	7.	_____
3.	_____	_____	8.	_____
4.	_____	_____	9.	_____
5.	_____	_____	10.	_____

(a) If Combination A has been selected, your Combination Bid is complete.

(b) If Combination B has been selected, then complete the following page.

SECTION 905 - COMBINATION BID PROPOSAL (Continued)

Project Number	Pay Item Number	Unit	Unit Price Reduction	Total Item Reduction	Total Contract Reduction
1.					
2.					
3.					
4.					
5.					
6.					
7.					
8.					

For Informational Purposes Only

SECTION 905 - COMBINATION BID PROPOSAL (Continued)

Project Number	Pay Item Number	Unit	Unit Price Reduction	Total Item Reduction	Total Contract Reduction
9.	_____	_____	_____	_____	_____
10.	_____	_____	_____	_____	_____

(c) If Combination C has been selected, then initial and complete ONE of the following.

_____ I (We) desire to be awarded work not to exceed a total monetary value of \$ _____.

_____ I (We) desire to be awarded work not to exceed _____ number of contracts.



**Certification with regard to the Performance of Previous
Contracts or Subcontracts subject to the Equal Opportunity
Clause and the filing of Required Reports**

The Bidder hereby certifies that he has _____, has not _____, participated in a previous contract or subcontract subject to the Equal Opportunity Clause, as required by Executive Orders 10925, 11114, or 11246, and that he has _____, has not _____, filed with the Joint Reporting Committee, the Director of the Office of Federal Contract Compliance, a Federal Government contracting or administering agency, or the former President's Committee on Equal Employment Opportunity, all reports due under the applicable filing requirements.

(COMPANY)

DATE: _____

NOTE: The above certification is required by the Equal Employment Opportunity Regulations of the Secretary of Labor (41 CFR 60-1.7 (b) (1)), and must be submitted by bidders and proposed subcontractors only in connection with contracts and subcontracts which are subject to the Equal Opportunity Clause. Contracts and Subcontracts which are exempt from the Equal Opportunity Clause are set forth in 41 CFR 60-1.5. (Generally only contracts or subcontracts of \$10,000 or under are exempt.)

Currently, Standard Form 100 (EEO-1) is the only report required by the Executive Orders or their implementing regulations.

Proposed prime Contractors and Subcontractors who have participated in a previous contract or subcontract subject to the Executive orders and have not filed the required reports should note that 41 CFR 60-1.7 (b) (1) prevents the award of contracts and subcontracts unless such Contractors submit a report covering the delinquent period or such other period specified by the Federal Highway Administration or by the Director, Office of Federal Contract Compliance, U. S. Department of Labor.

MISSISSIPPI DEPARTMENT OF TRANSPORTATION
CERTIFICATION

I, _____,
(Name of person signing bid)

individually, and in my capacity as _____ of
(Title of person signing bid)

_____ do hereby certify under
(Name of Firm, partnership, or Corporation)

penalty of perjury under the laws of the United States and the State of Mississippi that _____

_____, Bidder
(Name of Firm, Partnership, or Corporation)

on Project No. **NHPP-0008-03(059)/ 108245301000**

in **Rankin** _____ County(ies), Mississippi, has not either

directly or indirectly entered into any agreement, participated in any collusion; or otherwise taken any action in restraint of free competitive bidding in connection with this contract; nor have any of its corporate officers or principal owners.

Except as noted hereafter, it is further certified that said legal entity and its corporate officers, principal owners, managers, auditors and others in a position of administering federal funds:

- a) Are not presently debarred, suspended, proposed for debarment, declared ineligible, or voluntarily excluded from covered transactions by any Federal department or agency;
- b) Have not within a three-year period preceding this proposal been convicted of or had a civil judgment rendered against them for commission of fraud or a criminal offense in connection with obtaining, attempting to obtain, or performing a public (Federal, State or local) transaction or contract under a public transaction; violation of Federal or State antitrust statutes or commission of embezzlement, theft, forgery, bribery, falsification or destruction of records, making false statements, or receiving stolen property;
- c) Are not presently indicted for or otherwise criminally or civilly charged by a governmental entity (Federal, State or local) with commission of any of the offenses enumerated in (b) above; and
- d) Have not within a three-year period preceding this application/ proposal had one or more public transactions (Federal, State or local) terminated for cause or default.

Do exceptions exist and are made a part thereof? Yes / No

Any exceptions shall address to whom it applies, initiating agency and dates of such action.

Note: Exceptions will not necessarily result in denial of award but will be considered in determining bidder responsibility. Providing false information may result in criminal prosecution or administrative sanctions.

The bidder further certifies that the certification requirements contained in Section XI of Form FHWA 1273, will be or have been included in all subcontracts, material supply agreements, purchase orders, etc. except those procurement contracts for goods or services that are expected to be less than the Federal procurement small purchase threshold fixed at 10 U.S.C. 2304(g) and 41 U.S.C. 253(g) (currently \$25,000) which are excluded from the certification requirements.

The bidder further certifies, to the best of his or her knowledge and belief, that:

1) No Federal appropriated funds have been paid or will be paid to any person for influencing or attempting to influence an officer or employee of any Federal agency, a Member of Congress, an officer or employee of Congress, or an employee of a Member of Congress in connection with the awarding of any Federal contract, the making of any Federal grant, the making of any Federal loan, the entering into of any cooperative agreement, and the extension, continuation, renewal, amendment, or modification of any Federal contract, grant, loan, or cooperative agreement.

2) If any funds other than Federal appropriated funds have been paid or will be paid to any person for influencing or attempting to influence an officer or employee of any Federal agency, a Member of Congress, an officer or employee of Congress, or an employee of a Member of Congress in connection with this contract, Standard Form-LLL, Disclosure Form to Report Lobbying, in accordance with its instructions will be completed and submitted.

The certification contained in (1) and (2) above is a material representation of fact upon which reliance is placed and a prerequisite imposed by Section 1352, Title 31, U.S. Code prior to entering into this contract. Failure to comply shall be subject to a civil penalty of not less than \$10,000 and not more than \$100,000. The bidder shall include the language of the certification in all subcontracts exceeding \$100,000 and all subcontractors shall certify and disclose accordingly.

All of the foregoing is true and correct.

Executed on _____

Signature

MISSISSIPPI DEPARTMENT OF TRANSPORTATION

SAM.GOV Registration and Unique Entity ID

Bidders are advised that the Prime Contractor must register and maintain a current registration in the **System for Award Management** (<http://sam.gov>) at all times during the project. Upon registration, the Contractor will be assigned a SAM Unique Entity ID.

Bidders are advised that prior to the award of this contract, they MUST be registered in the System for Award Management.

I (We) acknowledge that this contract cannot be awarded if I (We) are not registered in the System for Award Management prior to the award of this contract. _____ (Yes / No)

I (We) have a SAM Unique Entity ID. _____ (Yes / No)

SAM Unique Entity ID: _____

Company Name: _____

Company e-mail address: _____

SECTION 902

CONTRACT FOR NHPP-0008-03(059)/ 108245301000

LOCATED IN THE COUNTY(IES) OF Rankin

STATE OF MISSISSIPPI,
COUNTY OF HINDS

This contract entered into by and between the Mississippi Transportation Commission on one hand, and the undersigned contractor, on the other witnesseth;

That, in consideration of the payment by the Mississippi Transportation Commission of the prices set out in the proposal hereto attached, to the undersigned contractor, such payment to be made in the manner and at the time of times specified in the specifications and the special provisions, if any, the undersigned contractor hereby agrees to accept the prices stated in the proposal in full compensation for the furnishing of all materials and equipment and the executing of all the work contemplated in this contract.

It is understood and agreed that the advertising according to law, the Advertisement, the instructions to bidders, the proposal for the contract, the specifications, the revisions of the specifications, the special provisions, and also the plans for the work herein contemplated, said plans showing more particularly the details of the work to be done, shall be held to be, and are hereby made a part of this contract by specific reference thereto and with like effect as if each and all of said instruments had been set out fully herein in words and figures.

It is further agreed that for the same consideration the undersigned contractor shall be responsible for all loss or damage arising out of the nature of the work aforesaid; or from the action of the elements and unforeseen obstructions or difficulties which may be encountered in the prosecution of the same and for all risks of every description connected with the work, exceptions being those specifically set out in the contract; and for faithfully completing the whole work in good and workmanlike manner according to the approved Plans, Specifications, Special Provisions, Notice(s) to Bidders and requirements of the Mississippi Department of Transportation.

It is further agreed that the work shall be done under the direct supervision and to the complete satisfaction of the Executive Director of the Mississippi Department of Transportation, or his authorized representatives, and when Federal Funds are involved subject to inspection at all times and approval by the Federal Highway Administration, or its agents as the case may be, or the agents of any other Agency whose funds are involved in accordance with those Acts of the Legislature of the State of Mississippi approved by the Governor and such rules and regulations issued pursuant thereto by the Mississippi Transportation Commission and the authorized Federal Agencies.

The Contractor agrees that all labor as outlined in the Special Provisions may be secured from list furnished by

It is agreed and understood that each and every provision of law and clause required by law to be inserted in this contract shall be deemed to be inserted herein and this contract shall be read and enforced as though it were included herein, and, if through mere mistake or otherwise any such provision is not inserted, then upon the application of either party hereto, the contract shall forthwith be physically amended to make such insertion.

The Contractor agrees that he has read each and every clause of this Contract, and fully understands the meaning of same and that he will comply with all the terms, covenants and agreements therein set forth.

Witness our signatures this the ___ day of _____, _____.

Contractor(s)

By _____

MISSISSIPPI TRANSPORTATION COMMISSION

Title _____

By _____

Signed and sealed in the presence of:
(names and addresses of witnesses)

Executive Director

Secretary to the Commission

Award authorized by the Mississippi Transportation Commission in session on the ___ day of _____, _____, Minute Book No. _____, Page No. _____.

Revised 8/06/2003

SECTION 903
PERFORMANCE AND PAYMENT BOND

CONTRACT BOND FOR: NHPP-0008-03(059)/ 108245301000

LOCATED IN THE COUNTY(IES) OF: Rankin

STATE OF MISSISSIPPI,
COUNTY OF HINDS

Know all men by these presents: that we, _____
(Contractor)
_____ Principal, a _____

residing at _____ in the State of _____

and _____

(Surety)
residing at _____ in the State of _____,

authorized to do business in the State of Mississippi, under the laws thereof, as surety, effective as of the contract date shown below, are held and firmly bound unto the State of Mississippi in the sum of _____

_____ Dollars, lawful money of the United States of America, to be paid to it for which payment well and truly to be made, we bind ourselves, our heirs, administrators, successors, or assigns jointly and severally by these presents.

The conditions of this bond are such, that whereas the said _____

_____ principal, has (have) entered into a contract with the Mississippi Transportation Commission, bearing the date of _____ day of _____ A.D. _____ hereto annexed, for the construction of certain projects(s) in the State of Mississippi as mentioned in said contract in accordance with the Contract Documents therefor, on file in the offices of the Mississippi Department of Transportation, Jackson, Mississippi.

Now therefore, if the above bounden _____ in all things shall stand to and abide by and well and truly observe, do keep and perform all and singular the terms, covenants, conditions, guarantees and agreements in said contract, contained on his (their) part to be observed, done, kept and performed and each of them, at the time and in the manner and form and furnish all of the material and equipment specified in said contract in strict accordance with the terms of said contract which said plans, specifications and special provisions are included in and form a part of said contract and shall maintain the said work contemplated until its final completion and acceptance as specified in Subsection 109.11 of the approved specifications, and save harmless said Mississippi Transportation Commission from any loss or damage arising out of or occasioned by the negligence, wrongful or criminal act, overcharge, fraud, or any other loss or damage whatsoever, on the part of said principal (s), his (their) agents, servants, or employees in the performance of said work or in any manner connected therewith, and shall be liable and responsible in a civil action instituted by the State at the instance of the Mississippi Transportation Commission or any officer of the State authorized in such cases, for double any amount in money or property, the State may lose or be overcharged or otherwise defrauded of, by reason of wrongful or criminal act, if any, of the Contractor(s), his (their) agents or employees, and shall promptly pay the said agents, servants and employees and all persons furnishing labor, material, equipment or supplies therefor, including premiums incurred, for Surety Bonds, Liability Insurance, and Workmen's Compensation Insurance; with the additional obligation that such Contractor shall promptly make payment of all taxes, licenses, assessments, contributions, damages,

any liquidated damages which may arise prior to any termination of said principal's contract, any liquidated damages which may arise after termination of the said principal's contract due to default on the part of said principal, penalties and interest thereon, when and as the same may be due this state, or any county, municipality, board, department, commission or political subdivision: in the course of the performance of said work and in accordance with Sections 31-5-51 et seq. Mississippi Code of 1972, and other State statutes applicable thereto, and shall carry out to the letter and to the satisfaction of the Executive Director of the Mississippi Department of Transportation, all, each and every one of the stipulations, obligations, conditions, covenants and agreements and terms of said contract in accordance with the terms thereof and all of the expense and cost and attorney's fee that may be incurred in the enforcement of the performance of said contract, or in the enforcement of the conditions and obligations of this bond, then this obligation shall be null and void, otherwise to be and remain in full force and virtue.

_____	_____
(Contractors) Principal	Surety
By _____	By _____
	(Signature) Attorney in Fact
	Address _____

Title _____	_____
(Contractor's Seal)	(Printed) MS Agent

	(Signature) MS Agent
	Address _____

	(Surety Seal)

	Mississippi Insurance ID Number



BID BOND

KNOW ALL MEN BY THESE PRESENTS, that we _____
Contractor

Address

City, State ZIP

As principal, hereinafter called the Principal, and _____
Surety

a corporation duly organized under the laws of the state of _____

as Surety, hereinafter called the Surety, are held and firmly bound unto State of Mississippi, Jackson, Mississippi

As Obligee, hereinafter called Obligee, in the sum of **Five Per Cent (5%) of Amount Bid**

Dollars(\$ _____)

for the payment of which sum will and truly to be made, the said Principal and said Surety, bind ourselves, our heirs, executors, administrators, successors and assigns, jointly and severally, firmly by these presents.

WHEREAS, the Principal has submitted a bid for **Mill & Overlay approximately 9 miles of US 49 from the Simpson County Line to south of Florence, known as Federal Aid Project No. NHPP-0008-03(059) / 108245301 in Rankin County.**

NOW THEREFORE, the condition of this obligation is such that if the aforesaid Principal shall be awarded the contract, the said Principal will, within the time required, enter into a formal contract and give a good and sufficient bond to secure the performance of the terms and conditions of the contract, then this obligation to be void; otherwise the Principal and Surety will pay unto the Obligee the difference in money between the amount of the bid of the said Principal and the amount for which the Obligee legally contracts with another party to perform the work if the latter amount be in excess of the former, but in no event shall liability hereunder exceed the penal sum hereof.

Signed and sealed this _____ day of _____, 20__

(Principal)

(Seal)

(Witness) (Name) By: _____ (Title)

(Surety) (Seal)

(Witness) (Attorney-in-Fact) By: _____

(MS Agent)

Mississippi Insurance ID Number

MISSISSIPPI DEPARTMENT OF TRANSPORTATION
OFFICE OF CIVIL RIGHTS
JACKSON, MISSISSIPPI

LIST OF FIRMS SUBMITTING QUOTES

I/we received quotes from the following firms on:

Letting Date: **August 22, 2023**

Project No: **NHPP-0008-03(059)/ 108245301000**

County: **Rankin**

Disadvantaged Business Enterprise (DBE) Regulations as stated in 49 CFR 26.11 require the Mississippi Department of Transportation (MDOT) to create and maintain a comprehensive list of all firms quoting/bidding subcontracts on prime contracts and quoting/bidding subcontracts on federally-funded transportation projects. For every firm, we require the following information:

Firm Name: _____
 Contact Name/Title: _____
 Firm Mailing Address: _____
 Phone Number: _____
 _____ DBE Firm _____ Non-DBE Firm

Firm Name: _____
 Contact Name/Title: _____
 Firm Mailing Address: _____
 Phone Number: _____
 _____ DBE Firm _____ Non-DBE Firm

Firm Name: _____
 Contact Name/Title: _____
 Firm Mailing Address: _____
 Phone Number: _____
 _____ DBE Firm _____ Non-DBE Firm

Firm Name: _____
 Contact Name/Title: _____
 Firm Mailing Address: _____
 Phone Number: _____
 _____ DBE Firm _____ Non-DBE Firm

Firm Name: _____
 Contact Name/Title: _____
 Firm Mailing Address: _____
 Phone Number: _____
 _____ DBE Firm _____ Non-DBE Firm

SUBMITTED BY (Signature)

FIRM NAME