

MDOT Use Only

Checked \_\_\_\_\_

Loaded \_\_\_\_\_

Keyed \_\_\_\_\_

01 -



SM No. CSTP0018020591

# PROPOSAL AND CONTRACT DOCUMENTS

## FOR THE CONSTRUCTION OF

01

Mill & Overlay approximately 15 miles of SR 12 from US 49W to US 49E, known as Federal Aid Project No. STP-0018-02(059) / 108214301 & 302 in Humphreys & Holmes Counties.

Project Completion: 121 Working Days

**(STATE DELEGATED)**

### NOTICE

**BIDDERS MUST COMPLETE AN ONLINE REQUEST  
FOR PERMISSION TO BID THIS PROJECT.**

Electronic addendum updates will be posted on [www.gomdot.com](http://www.gomdot.com)

# SECTION 900

## OF THE CURRENT

### 2017 STANDARD SPECIFICATIONS

### FOR ROAD AND BRIDGE CONSTRUCTION

JACKSON, MISSISSIPPI

**MISSISSIPPI DEPARTMENT OF TRANSPORTATION  
TABLE OF CONTENTS**

**PROJECT: STP-0018-02(059)/108214301 - Humphreys  
STP-0018-02(059)/108214302 - Holmes**

Section 901 - Advertisement

Section 904 - Notice to Bidders

#1	Governing Specification, w/ Supplement
#2	Status of ROW, w/ Attachments
#3	Final Cleanup
#13	Safety Edge
#113	Tack Coat
#296	Reduced Speed Limit Signs
#445	Mississippi Agent or Qualified Nonresident Agent
#447	Traffic on Milled Surface in Rural Areas
#516	Errata and Modifications to the 2017 Standard Specifications
#1225	Early Notice to Proceed
#1226	Material Storage Under Bridges
#1241	Fuel and Material Adjustments
#1963	Guardrail Pads
#2206	MASH Compliant Devices
#2273	Mississippi Special Fuel Tax Law
#2278	Smoothness Tolerances
#2782	DBE Pre-Bid Meeting
#2954	Reflective Sheeting for Signs
#3599	Standard Drawings w/Supplement
#3676	Asphalt Gyratory Compactor Internal Angle Calibration
#4113	Unique Entity ID Requirement For Federal Funded Projects
#4702	App for Traffic Control Report
#5518	Contract Time
#5519	Specialty Items
#5520	Scope of Work
#5551	Federal Bridge Formula
#5605	Disadvantaged Business Enterprise In Federal-Aid Highway Construction, w/ Supplement

906	Required Federal Contract Provisions -- FHWA 1273, w/Supplements
-----	--

Section 907 - Special Provisions

907-101-1	Definitions and Terms
907-102-2	Bidding Requirements and Conditions
907-105-2	Control of Work
907-106-1	Control of Materials
907-108-4	Subletting of Contract
907-109-4	Measurement and Payment
907-420-4	Undersealing
907-618-4	Additional Signing Requirements, w/Supplement
907-619-6	Temporary Portable Rumble Strips

**PROJECT: STP-0018-02(059)/108214301 - Humphreys  
STP-0018-02(059)/108214302 - Holmes**

907-700-1	Materials and Tests
907-701-3	Hydraulic Cement
907-702-4	Bituminous Materials
907-703-2	Gradation
907-705-1	Stone Riprap
907-707-3	Joint Materials
907-711-2	Plain Steel Wire
907-712-1	Fence and Guardrail
907-714-3	Miscellaneous Materials
907-718-1	Timber and Dimension Lumber
907-720-2	Acceptance Procedure for Glass Beads
907-721-4	Materials for Signing

Section 905 - Proposal, Proposal Bid Items, Combination Bid Proposal  
Certification of Performance - Prior Federal-Aid Contracts  
Certification Regarding Non-Collusion, Debarment and Suspension  
SAM.GOV Registration and Unique Entity ID  
Section 902 - Contract Form  
Section 903 - Contract Bond Forms  
Form -- OCR-485

Progress Schedule

(REVISIONS TO THE ABOVE WILL BE INDICATED ON THE SECOND SHEET  
OF SECTION 905 AS ADDENDA)

01/30/2024 03:20 PM

# MISSISSIPPI DEPARTMENT OF TRANSPORTATION

## SECTION 901 - ADVERTISEMENT

Electronic bids will be received by the Mississippi Transportation Commission at 10:00 o'clock A.M., Tuesday, February 27, 2024, from the Bid Express Service and shortly thereafter publicly read on the Sixth Floor For:

Mill & Overlay approximately 15 miles of SR 12 from US 49W to US 49E, known as Federal Aid Project No. STP-0018-02(059) / 108214301 & 302 in Humphreys & Holmes Counties.

The attention of bidders is directed to the Contract Provisions governing selection and employment of labor. Minimum wage rates have been predetermined by the Secretary of Labor and are subject to Public Law 87-581, Work Hours Act of 1962, as set forth in the Contract Provisions.

The Mississippi Department of Transportation hereby notifies all bidders that it will affirmatively insure that in any contract entered into pursuant to this advertisement, disadvantaged business enterprises will be afforded full opportunity to submit bids in response to this invitation and will not be discriminated against on the grounds of race, color, sex, age, disability, religion or national origin in consideration for an award.

**The award of this contract will be contingent upon the Contractor satisfying the DBE requirements.**

The specifications are on file in the offices of the Mississippi Department of Transportation.

Contractors may request permission to bid online at <http://shop.mdot.ms.gov> at no cost. Upon approval, Contractors shall be eligible to submit a bid using Bid Express at <http://bidx.com>. Specimen proposals may be viewed and downloaded online at no cost at <http://mdot.ms.gov> or purchased online at <http://shop.mdot.ms.gov> at a cost of Ten Dollars (\$10.00) per proposal plus a small convenience fee. Cash or checks will not be accepted as payment.

Bid bond, signed or countersigned by a Mississippi Agent or Qualified Nonresident Agent, with Power of Attorney attached, a Cashier's check or Certified Check for five (5%) percent of bid, payable to STATE OF MISSISSIPPI, must accompany each proposal.

The attention of bidders is directed to the provisions of Subsection 102.07 pertaining to irregular proposals and rejection of bids.

BRAD WHITE  
EXECUTIVE DIRECTOR



**MISSISSIPPI DEPARTMENT OF TRANSPORTATION**

**SUPPLEMENT TO NOTICE TO BIDDERS NO. 1**

**DATE: 06/08/2021**

**SUBJECT: Governing Specifications**

Change the web address at the end of the first paragraph to the following.

<https://shop.mdot.ms.gov/default.aspx?StoreIndex=1>

# MISSISSIPPI DEPARTMENT OF TRANSPORTATION

**SECTION 904 - NOTICE TO BIDDERS NO. 1**

**CODE: (IS)**

**DATE: 03/01/2017**

**SUBJECT: Governing Specifications**

The current (2017) Edition of the Standard Specifications for Road and Bridge Construction adopted by the Mississippi Transportation Commission is made a part hereof fully and completely as if it were attached hereto, except where superseded by special provisions, or amended by revisions of the Specifications contained within this proposal. Copies of the specification book may be purchased from the MDOT Construction Division, or online at [shopmdot/default.aspx?StoreIndex=1](http://shopmdot/default.aspx?StoreIndex=1).

A reference in any contract document to controlling requirements in another portion of the contract documents shall be understood to apply equally to any revision or amendment thereof included in the contract.

In the event the plans or proposal contain references to the 2004 Edition of the Standard Specifications for Road and Bridge Construction, it is to be understood that such references shall mean the comparable provisions of the 2017 Edition of the Standard Specifications.

## MISSISSIPPI DEPARTMENT OF TRANSPORTATION

**SECTION 904 - NOTICE TO BIDDERS NO. 2**

**CODE: (IS)**

**DATE: 03/01/2017**

**SUBJECT: Status of Right-of-Way**

Although it is desirable to have acquired all rights-of-way and completed all railroad agreements, utility adjustments and work to be performed by others prior to receiving bids, sometimes it is not considered to be in the public interest to wait until each and every such clearance has been obtained. The bidder is hereby advised of possible unacquired rights-of-way, relocations, railroad agreements and utilities adjustments which have not been completed.

The status of right-of-way acquisition, utility adjustments, encroachments, potentially contaminated sites, railroad facilities, improvements, and asbestos contamination are set forth in the following attachments.

In the event right of entry is not available to ALL parcels of right-of-way and/or all work that is to be accomplished by others on the date set forth in the contract for the Notice to Proceed is not complete, the Department will issue a restricted Notice to Proceed.

**STATUS OF RIGHT-OF-WAY**  
STP-0018-02(059)  
108214/301000 & 108214/302000  
Humphreys & Holmes Counties

All rights of way and legal rights of entry have been acquired except:

**None.**

ASBESTOS ABATEMENT STATUS REPORT

STP-0018-02(059)  
108214-301000 & 108214-302000

Humphreys & Holmes Counties

December 1, 2023

Reference is made to notices to bidders entitled "Asbestos National Emission Standards for Hazardous Air Pollutants (NESHAP)" and "Removal of Obstructions".

The following pertinent information is furnished concerning asbestos-containing materials (ACMs), if any, found in buildings to be removed by the Contractor.

There is no Right of Way required for this project. There are no buildings to be removed by the contractor.

POTENTIALLY CONTAMINATED SITES STATUS REPORT

STP-0018-02(059)  
108214-301000 & 108214-302000

Humphreys & Holmes Counties

December 1, 2023

THERE IS NO RIGHT OF WAY REQUIRED FOR THIS PROJECT. NO INITIAL SITE ASSESSMENT WILL BE PERFORMED. IF CONTAMINATION ON EXISTING RIGHT OF WAY IS DISCOVERED, IT WILL BE HANDLED BY THE DEPARTMENT.

# MISSISSIPPI DEPARTMENT OF TRANSPORTATION

## *Inter-Departmental Memorandum*

**To:** Right of Way Division  
Trudi Loflin

**Date:** December 1, 2023

**From:** Pre-Construction Engineer District 3  
Adam Boggan

**Project No:** 108214/301000  
108214/302000  
STP-0018-02(059)

**County:** Humphreys & Holmes

### DISTRICT STATUS REPORT

1. **STATUS OF RIGHT OF WAY:** All work to be done within existing ROW.
2. **RIGHT OF WAY CLEARANCE:** There are no encroachments.
3. **STATUS OF AFFECTED RAILROAD OPERATING FACILITIES:** None affected.
4. **STATUS OF REQUIRED UTILITY RELOCATIONS:** No utility conflicts.
5. **STATUS OF CONSTRUCTION AGREEMENT:** None required.

AB:ab

pc: Michael Hogan (District Three)  
Wade Yeates (District Three)  
Alex Zivic (Construction Division)  
Trudi Loflin (Right of Way)  
File

**IMPROVEMENTS STATUS REPORT**

Improvements to be included in Notice to Bidders to be removed by the Construction Contractor

FMS Construction Project No: 108210-301000 & 108214-302000

FMS ROW Project No:

External ROW No: STP-0018-02(059)

Parcel No:  
Station No:  
Property Owner:  
Description/Pictures:



**MISSISSIPPI DEPARTMENT OF TRANSPORTATION**

**SECTION 904 - NOTICE TO BIDDERS NO. 3**

**CODE: (SP)**

**DATE: 01/17/2017**

**SUBJECT: Final Clean-Up**

Immediately prior to final inspection for release of maintenance, the Contractor shall pick up, load, transport and properly dispose of all litter from the entire highway right-of-way that is within the termini of the project.

Litter shall include, but not be limited to, solid wastes such a glass, paper products, tires, wood products, metal, synthetic materials and other miscellaneous debris.

Litter removal is considered incidental to other items of work and will not be measured for separate payment.

**MISSISSIPPI DEPARTMENT OF TRANSPORTATION**

**SECTION 904 - NOTICE TO BIDDERS NO. 13**

**CODE: (IS)**

**DATE: 03/01/2017**

**SUBJECT: Safety Edge**

Bidders are hereby advised that the Shoulder Wedge (Safety Edge) specified in Section 401, Asphalt Pavements, shall only apply to the top two (2) lifts of asphalt. Open Graded Friction Courses (OGFC) are not to be considered a lift as it pertains to safety edge. Attached is a drawing showing the safety edge. Note that the shoulder dimensions in the bottom two drawings will be less than three feet (3').

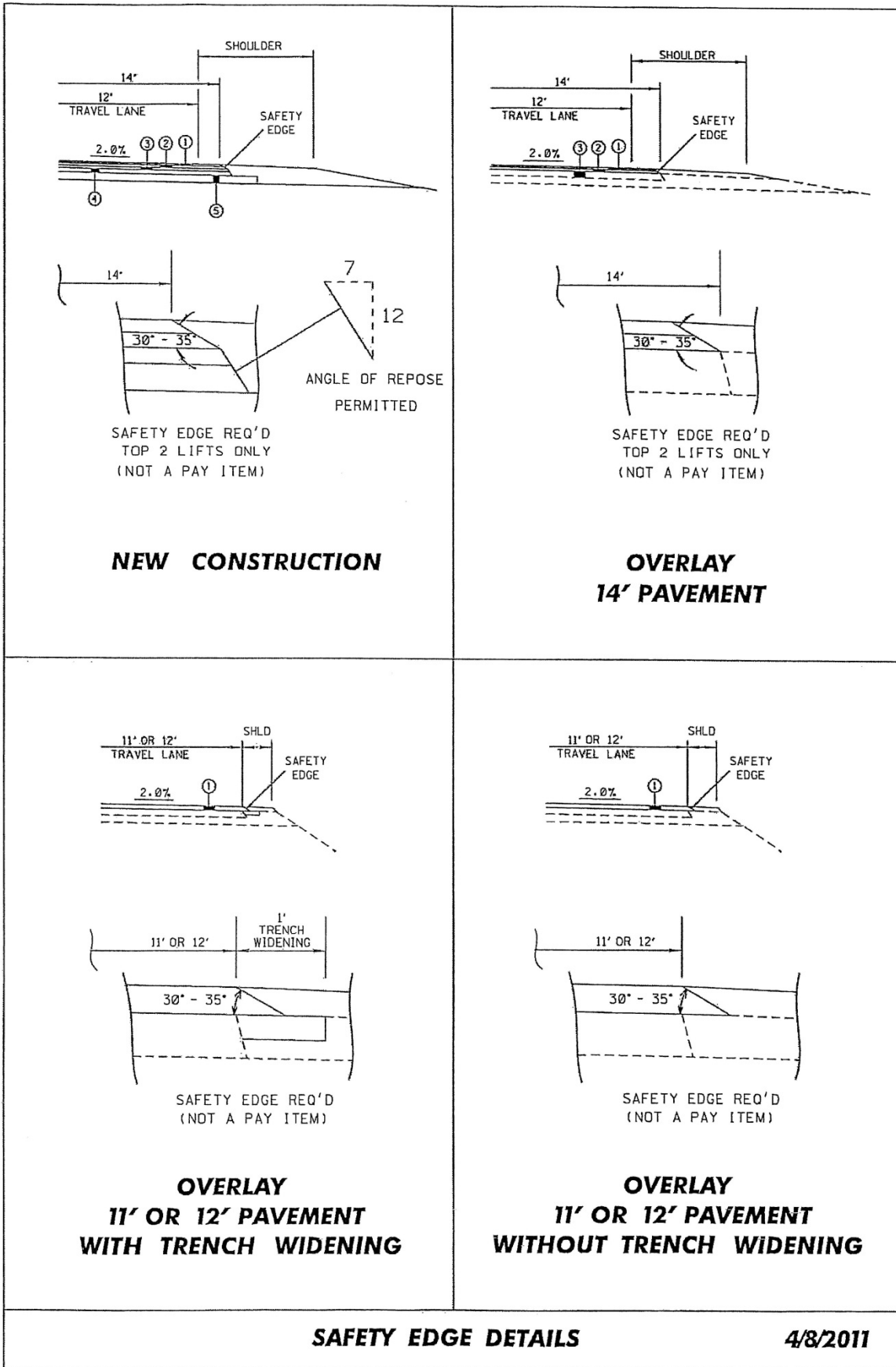

**MISSISSIPPI DEPARTMENT OF TRANSPORTATION**

**SECTION 904 - NOTICE TO BIDDERS NO. 113**

**CODE: (SP)**

**DATE: 04/18/2017**

**SUBJECT: Tack Coat**

Bidders are advised that in addition to the products listed on the Department's APL as referenced in Subsection 401.03.1.2 on page 256, the Contractor may use one of the following as a tack coat.

- CSS-1
- CSS-1h
- SS-1
- SS-1h

**MISSISSIPPI DEPARTMENT OF TRANSPORTATION**

**SECTION 904 - NOTICE TO BIDDERS NO. 296**

**CODE: (SP)**

**DATE: 07/25/2017**

**SUBJECT: Reduced Speed Limit Signs**

Bidders are advised that when the plans or contract documents require the speed limit on a project to be reduced, the Contractor shall begin work within 48 hours of installing the reduced speed limit signs. Should the Contractor not start work or have no plans to start work within 48 hours of installing the signs, the reduced speed limit signs shall be covered and existing speed limit signs uncovered.

**MISSISSIPPI DEPARTMENT OF TRANSPORTATION**

**SECTION 904 - NOTICE TO BIDDERS NO. 445**

**CODE: (SP)**

**DATE: 10/10/2017**

**SUBJECT: Mississippi Agent or Qualified Nonresident Agent**

Bidders are hereby advised of the requirements of Subsections 102.08, 103.05.2, and 107.14.2.1 of the *2017 Standard Specifications for Road and Bridge Construction* as it refers to bonding agents. Proposal guaranties, bonds, and liability insurance policies must be signed by a **Mississippi Agent or Qualified Nonresident Agent.**

**MISSISSIPPI DEPARTMENT OF TRANSPORTATION**

**SECTION 904 - NOTICE TO BIDDERS NO. 447**

**CODE: (SP)**

**DATE: 10/18/2017**

**SUBJECT: Traffic on Milled Surface in Rural Areas**

Bidders are hereby advised that when the main lanes of a roadway are fine milled, traffic will be allowed to run on a milled surfaces for up to seven (7) calendar days. The Contractor will be assessed a penalty of \$5,000 per calendar day afterwards until the milled surfaces are covered with the next lift of asphalt. It shall be the Contractor's responsibility to ensure that the milling operations do not commence until such time as forecasted weather conditions are suitable enough to allow the placement of the asphalt pavement after the milling operations.

## MISSISSIPPI DEPARTMENT OF TRANSPORTATION

SECTION 904 - NOTICE TO BIDDERS NO. 516

CODE: (IS)

DATE: 11/28/2017

SUBJECT: Errata and Modifications to the 2017 Standard Specifications

<u>Page</u>	<u>Subsection</u>	<u>Change</u>
16	102.06	In the seventh full paragraph, change “Engineer” to “Director.”
33	105.05.1	In the sixth sentence, change “Contract Administration Engineer” to “Contract Administration Director.”
34	105.05.2.1	In subparagraph 2, change “SWPPP, ECP” to “SWPPP and the ECP”
35	105.05.2.2	In subparagraphs 2, add “ and” to the end of the sentence. In subparagraph 3, remove “, and” and add “.”.
90	109.04.2	In the last paragraph of subparagraph (a), place a period “.” at the end of the sentence.
93	109.04.2	In the last paragraph of subparagraph (g), place a period “.” at the end of the sentence. Also, in the first paragraph of subparagraph (h), place a period “.” at the end of the sentence.
97	109.07	Under ADJUSTMENT CODE, subparagraph (A1), change “HMA mixture” to “Asphalt mixtures.”
98	109.11	In the third sentence, change “Engineer” to “Director.”
219	308.04	In the last sentence of the last paragraph, change “Contractor’s decision” to “Engineer’s decision.”
300	405.02.5.9	In the first sentence of the second paragraph, change “Hot Mix Asphalt” to “Asphalt Mixtures.”
502	630.01.1	In the first paragraph, change “AASHTO” to “AASHTO’s LRFD”.
636	646.05	Change “each” to “per each” for the pay item units of payment.
640	656.02.6.2	In item 7), change “down stream” to “downstream”.
688	630.03.2	Change the subsection number from “630.03.2” to “680.03.2.”



- |     |               |   |
|-----|---------------|---|
| 725 | 702.08.3      | In the second sentence of the first paragraph, change “hot-mix” to “asphalt.”                     |
| 954 | 804.02.13.1.6 | In the definition for “M” in the % Reduction formulas, change “paragraph 7.3” to “paragraph 5.3.” |

**MISSISSIPPI DEPARTMENT OF TRANSPORTATION**

**SECTION 904 - NOTICE TO BIDDERS NO. 1225**

**CODE: (SP)**

**DATE: 11/13/2018**

**SUBJECT: Early Notice to Proceed**

Bidders are advised that if an early notice to proceed is allowed by the Department and the Contractor experiences problems or delays between the early notice to proceed date and the original notice to proceed date, this shall not be justification for any monetary compensation or an extension of contract time.

## MISSISSIPPI DEPARTMENT OF TRANSPORTATION

SECTION 904 - NOTICE TO BIDDERS NO. 1226

CODE: (IS)

DATE: 11/16/2018

SUBJECT: Material Storage Under Bridges

Bidders are advised that Subsection 106.08 of the Standard Specifications allows the Contractor to store materials and equipment on portions of the right-of-way. However, the Contractor will not be allowed to store or stockpile materials under bridges without written permission from the Project Engineer. The Contractor shall submit a detailed request of all proposed materials to be stored under bridges to the Engineer a minimum of 14 calendar days prior to anticipated storage. This detail shall include, but not limited to, bridge location, material type, material quantity, and duration of storage. The Project Engineer and any other needed Division will review this information and determine whether to grant approval. The Contractor shall not store any material under any bridge without written approval from the Project Engineer.

**MISSISSIPPI DEPARTMENT OF TRANSPORTATION**

**SECTION 904 - NOTICE TO BIDDERS NO. 1241**

**CODE: (IS)**

**DATE: 11/27/2018**

**SUBJECT: Fuel and Material Adjustments**

Bidder's attention is brought to the last paragraph of Subsection 109.07 of the Standard Specifications which states that no fuel or material adjustment will be made after the completion of contract time. Any fuels consumed or materials incorporated into the work during the monthly estimate period falling wholly after the expiration of contract time will not be subject a fuel or material adjustment.

**MISSISSIPPI DEPARTMENT OF TRANSPORTATION**

**SECTION 904 - NOTICE TO BIDDERS NO. 1963**

**CODE: (SP)**

**DATE: 9/23/2019**

**SUBJECT: Guardrail Pads**

Bidders are hereby advised that prior to construction of the guardrail pads, the Contractor shall coordinate with the guardrail Subcontractor to determine the guardrail pad dimensions necessary to meet MASH compliance.

## MISSISSIPPI DEPARTMENT OF TRANSPORTATION

**SECTION 904 - NOTICE TO BIDDERS NO. 2206**

**CODE: (IS)**

**DATE: 01/14/2020**

**SUBJECT: MASH Compliant Devices**

Bidders are hereby advised that compliance associated with the requirements of meeting either the National Cooperative Highway Research Program (NCHRP) Report 350 or the Manual for Assessing Safety Hardware (MASH) for installations of certain traffic control devices and permanent safety hardware devices (guardrails, guardrail terminals, permanent portable barriers, cast-in-place barriers, all other permanent longitudinal barriers, crash cushions, cable barriers, cable barrier terminals, bridge rails, bridge rail transitions, all other terminals, sign supports, and all other breakaway hardware) as listed throughout the Standard Specifications and/or the Standard Drawings, or both, is now replaced with the requirements of meeting the 2016 version of MASH after December 31, 2019. This change applies to new permanent installations and to full replacements of existing installations.

At the preconstruction conference or prior to starting any work on the project, the Contractor shall submit a letter stating that the traffic control devices and permanent safety hardware devices as outlined within the paragraph above that are to be used on the project are certified to meet MASH 2016.

When a MASH 2016-compliant device does not exist for the new permanent installations and/or full replacement installations of permanent safety hardware devices, as listed above, a MASH 2009-compliant or a NCHRP 350-compliant device may be proposed by the Contractor for the project. A written request for such instances must be submitted by the Contractor either at the preconstruction conference or prior to starting any work on the project. The Contractor shall submit the following items to the Project Engineer: (1) a detailed list of the proposed devices and locations thereof; and (2) certification letters indicating that the proposed devices are compliant with either MASH 2009 or NCHRP 350.

When a MASH 2016-compliant device does not exist for the temporary work zone traffic control devices (Category 1, Category 2, and Category 3 devices), a MASH 2009-compliant or a NCHRP 350-compliant device may be proposed by the Contractor for the project. Temporary work zone traffic control devices (Category 1, Category 2, and Category 3 devices) that are MASH 2009-compliant or NCHRP 350-compliant that have been in use prior to December 31, 2019, and that have a remaining service life may be proposed for use throughout their normal service life on the project by the Contractor. For either of these scenarios for temporary work zone traffic control devices, a written request must be submitted by the Contractor either at the preconstruction conference or prior to starting any work on the project. The Contractor shall submit the following items to the Project Engineer: (1) a detailed list of the proposed devices and locations thereof; and (2) certification letters indicating that the proposed devices are compliant with either MASH 2009 or NCHRP 350.

Work will only be allowed to proceed after the Department has granted written concurrence(s) with the proposed request(s) as listed above.

**MISSISSIPPI DEPARTMENT OF TRANSPORTATION**

**SECTION 904 - NOTICE TO BIDDERS NO. 2273**

**CODE: (SP)**

**DATE: 02/12/2020**

**SUBJECT: Mississippi Special Fuel Tax Law**

Bidder's attention is brought to the second paragraph of Subsection 107.02 of the Standard Specifications which states that all Contractors and Subcontractors must comply with all requirements contained in the Mississippi Special Fuel Tax Law, Section 27-55-501, *et seq.* Attached are two Fact Sheets provided by the Mississippi Department of Revenue (MDOR) with additional information.

## Gasoline and Dyed Diesel Used for Non-Highway Purposes

*Mississippi provides a reduced rate for gasoline and dyed diesel used for non-highway purposes. The reduced rates are 6.44 cents per gallon and 5.75 cents per gallon of gasoline or dyed diesel. These fuels are generally taxed at 18 cents per gallon if for on road use.*

### Gasoline Used for Non-Highway Purposes

You may be entitled to a refund of 11.56 cents per gallon (making this an equivalent to a tax rate of 6.44 cents per gallon) if you desire to purchase gasoline to be used off road. The gasoline must be used for agricultural, maritime, industrial, manufacturing, domestic or non-highway purposes only.

Examples of non-highway include gasoline used in boats, golf carts, machinery used for manufacturing or farm equipment used exclusively in plowing, planting or harvesting farm products.

### Refund Gasoline User

The refund is based on the amount of gallons used. Before a refund is issued, you are required to...

1. Obtain a refund gasoline user's permit and a certificate for refund booklet from the Department of Revenue;
2. Have a storage tank marked "REFUND GASOLINE"; and,
3. Purchase the gasoline from someone who holds a refund gasoline dealer's permit.

No refund will be allowed for gasoline used in motor vehicles owned or operated by a government entity or used in Mississippi government contracts.

### Refund Gasoline Dealer

You must obtain a refund gasoline dealer's permit from the Department of Revenue before selling refund gasoline. At no time should the gasoline be delivered to a tank that is not properly marked. The gasoline must be dyed a distinctive mahogany color at the time of delivery.

The Department of Revenue may waive the dye requirement if the dye may cause damage to the equipment. The refund gasoline user is required to obtain the waiver from the Department of Revenue.

### Dyed Diesel Used for Non-Highway Purposes

Unlike gasoline, you are not required to apply for a refund if you desire to purchase dyed diesel to be used off road. Mississippi provides a reduced rate of 5.75 cents per gallon on dyed diesel used off road. Diesel used on road is subjected to 18 cents per gallon. Dyed diesel used in motor vehicles owned or operated by a government entity or used in Mississippi government contracts will be subjected to 18 cents per gallon.

### Dyed Diesel Used on the Highway

Any person who purchases, receives, acquires or uses dyed diesel for highway use will be liable to pay 18 cents per gallon and subject to a penalty in the amount of \$1000.

### Identifying Dyed Diesel

Storage facilities for dyed diesel must be plainly marked "NONHIGHWAY DIESEL FUEL" or "NONHIGHWAY KEROSENE". Retailers are also required to mark all pumps or dispensing equipment.





## Special Fuel Used on Government Contracts

### State and Local Government Contracts

Special fuel purchased, acquired or used in performing contracts with the State of Mississippi, counties, municipalities or any political subdivision is taxed at a rate of 18 cents per gallon. Special fuel includes but is not limited to the following:

- Dyed diesel fuel;
- Kerosene;
- Undyed diesel fuel; and,
- Fuel oil.

State and local government contracts include construction, reconstruction and maintenance or repairs of projects such as roads, bridges, water systems, sewer systems, buildings, drainage canals and recreational facilities. The Department of Revenue may require contractors to remit the excise tax directly to the state in lieu of paying the tax to a distributor.

### Special Fuel Direct Pay Permit

Contractors that remit the excise tax to the state will be issued a Special Fuel Direct Pay Permit. This permit relieves the distributor from collecting the tax and requires the contractor to file a monthly special fuel return. The distributor should include the contractor’s permit number on all invoices that are related to tax-free sales.

The contractor is required to furnish a surety or cash bond guaranteeing the payment of the excise tax prior to receiving the Special Fuel Direct Pay Permit. The Department of Revenue may accept a contractors tax bond if the bond covers the excise tax levied on special fuel.

### Special Fuel Distributors

If the contractor does not have a Special Fuel Direct Pay Permit, distributors are required to collect the 18 cents excise tax and remit the tax to the Department of Revenue. The additional 12.25 cents levied on special fuel (excluding undyed diesel) should be reported on schedules 5F and 5G of the special fuel return.

### Environmental Protection Fee

Special fuel distributors are required to collect the environmental protection fee even if the contractor has a Special Fuel Direct Pay Permit. The fee is levied at 4/10<sup>ths</sup> of a cent per gallon. The fee is suspended or reinstated when the trust fund has exceeded or fallen below the obligatory balance.

### Penalties

Any person who knowingly and willfully purchases untaxed fuel for use in equipment utilized on a road or highway construction site in this state is guilty of a misdemeanor and, upon conviction, shall be fined not less than \$1,000 or more than \$100,000, or imprisoned in the county jail for not more than one year, or both.



**MISSISSIPPI DEPARTMENT OF TRANSPORTATION**

**SECTION 904- NOTICE TO BIDDERS NO. 2278**

**CODE: (SP)**

**DATE: 03/04/2020**

**SUBJECT: Smoothness Tolerances**

Bidders are hereby advised that the smoothness tolerances for this project shall meet the requirements of a Category C project according to Subsection 403.03.2.1. Bidders are responsible for the collection of a preliminary smoothness profile prior to any work being performed.

## MISSISSIPPI DEPARTMENT OF TRANSPORTATION

**SECTION 904 - NOTICE TO BIDDERS NO. 2782**

**CODE: (SP)**

**DATE: 8/13/2020**

**SUBJECT: DBE Pre-Bid Meeting**

Due to the COVID-19 pandemic and the Department not allowing visitors in the Administration Building at this time, the DBE Pre-Bid Meeting referenced on Page 5 of Notice to Bidders No. 2611 will be held by **video conference only**. The meeting will be held at 2:00 P.M. on the day preceding the date of the bid opening using Zoom video conferencing software. Anyone interested in participating can download Zoom and connect to the meeting at the below link.

<https://zoom.us/j/5548736403?pwd=SDh5S2hQSE5pNG5FOEkzR3NsUnBYQT09>

Password (if prompted): 272147

For those unable to participate via Zoom, the below teleconference number may be used instead.

1-888-227-7517

Conference Code: 404496

## MISSISSIPPI DEPARTMENT OF TRANSPORTATION

SECTION 904 - NOTICE TO BIDDERS NO. 2954

CODE: (IS)

DATE: 12/01/2020

SUBJECT: Reflective Sheeting for Signs

Bidders are hereby advised that the retroreflective sign sheeting used for signs on this project shall be as listed below and shall meet the requirements of Subsection 721.06.

### Temporary Construction Signs

Temporary traffic control (orange) sign sheeting shall be a minimum Type IX Fluorescent Orange sheeting as shown in Special Provision 907-721.

### Permanent Signs

Permanent signs, except signs on traffic signal poles/mast arms, shall be as follows:

- Brown background sheeting on guide signs shall be a minimum Type VIII sheeting,
- Green and blue background sheeting on guide signs shall be a minimum Type IX sheeting, and
- All white, yellow, red, fluorescent yellow, and fluorescent yellow/green sheeting shall be Type XI sheeting.

**MISSISSIPPI DEPARTMENT OF TRANSPORTATION**

| **SUPPLEMENT TO NOTICE TO BIDDERS NO. 3599**

| **DATE: 08/11/2021**

| After the last drawing on page 33, add the following.

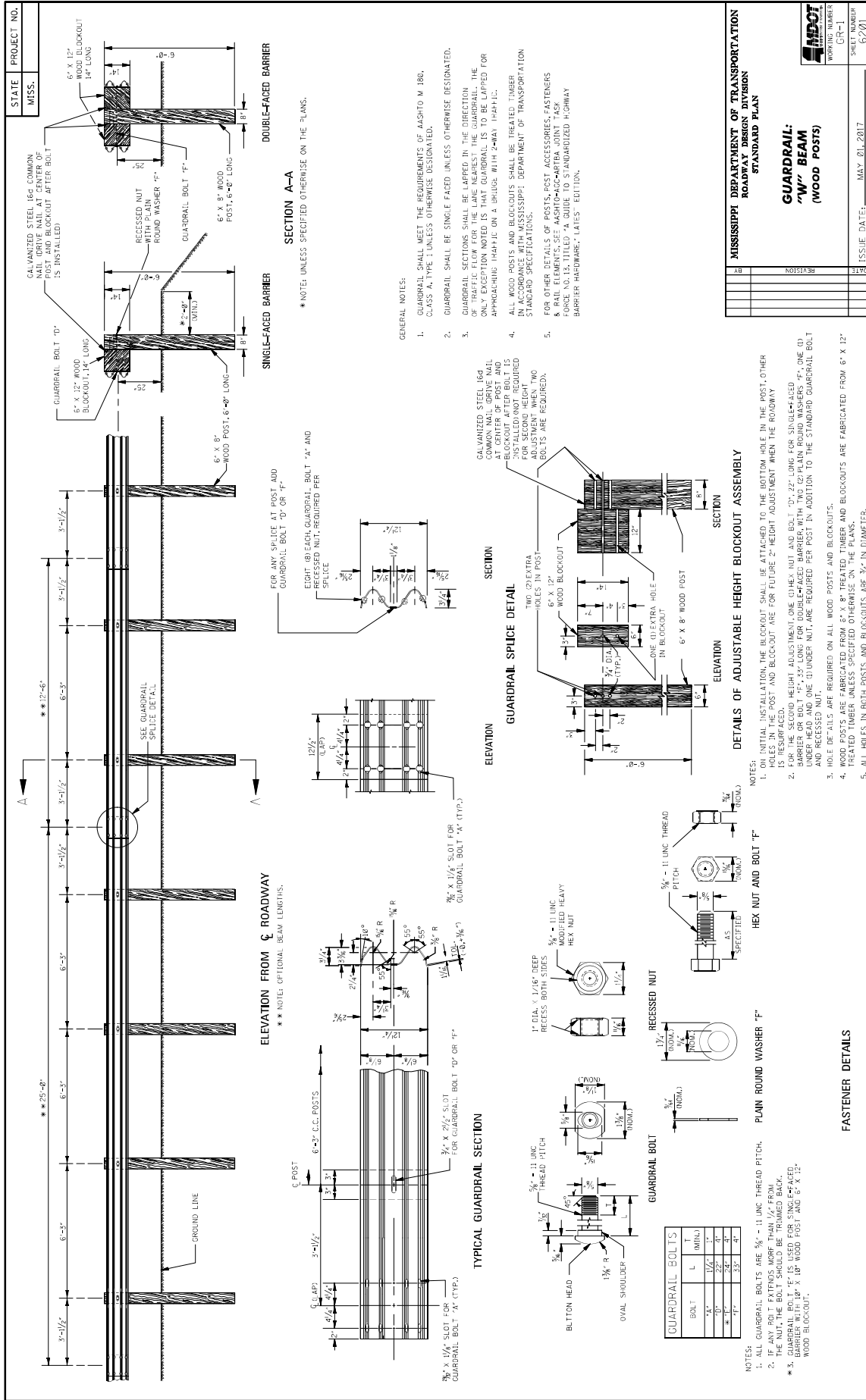

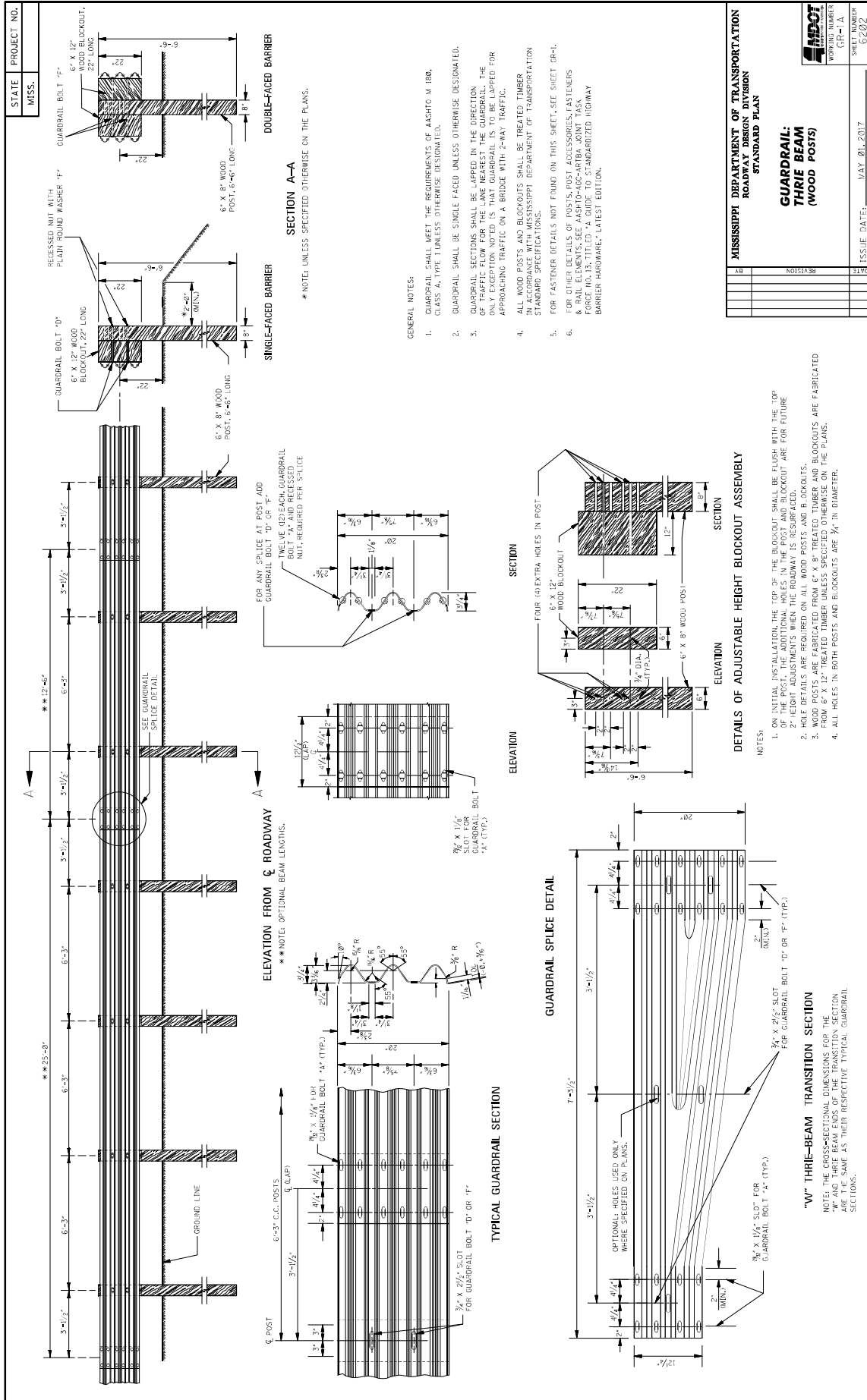

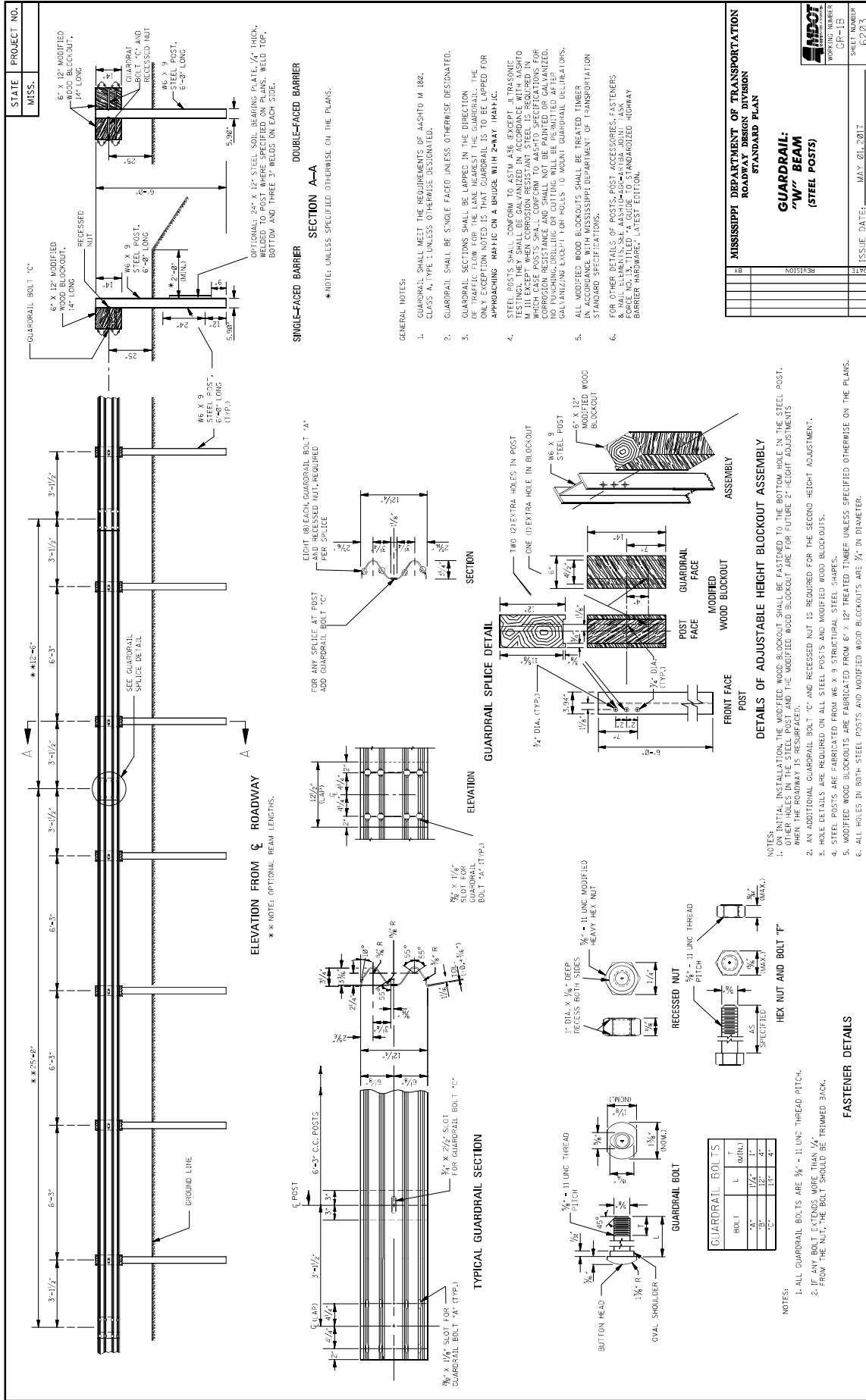

DATE	REVISION

**MISSISSIPPI DEPARTMENT OF TRANSPORTATION**  
ROADWAY DESIGN DIVISION  
STANDARD PLAN

**GUARDRAIL:**  
"W" BEAM  
(STEEL POSTS)

**ISSUE DATE:** MAY 01, 2011

**WORKING NUMBER:** GH-15

**SHEET NUMBER:** 62/83



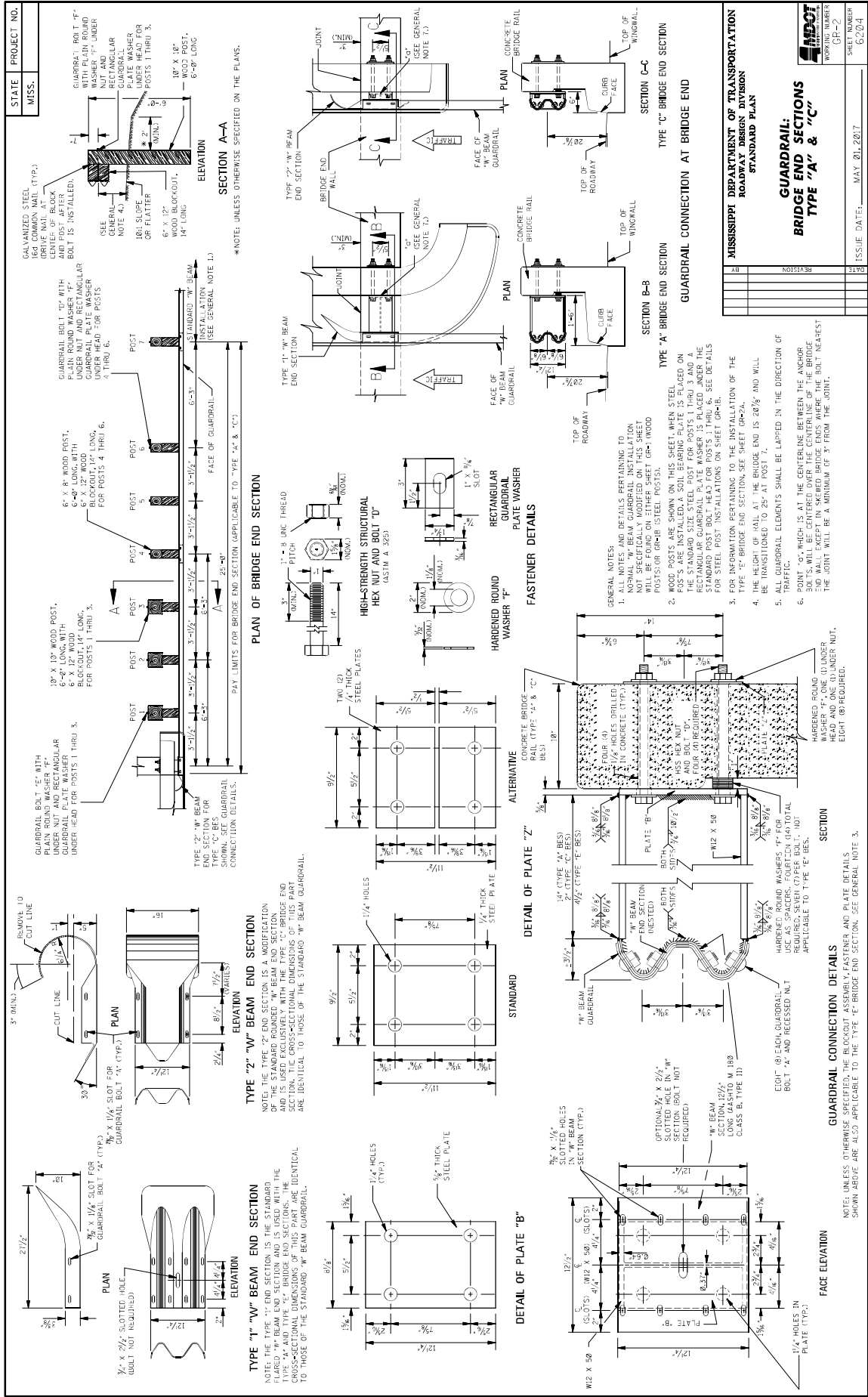

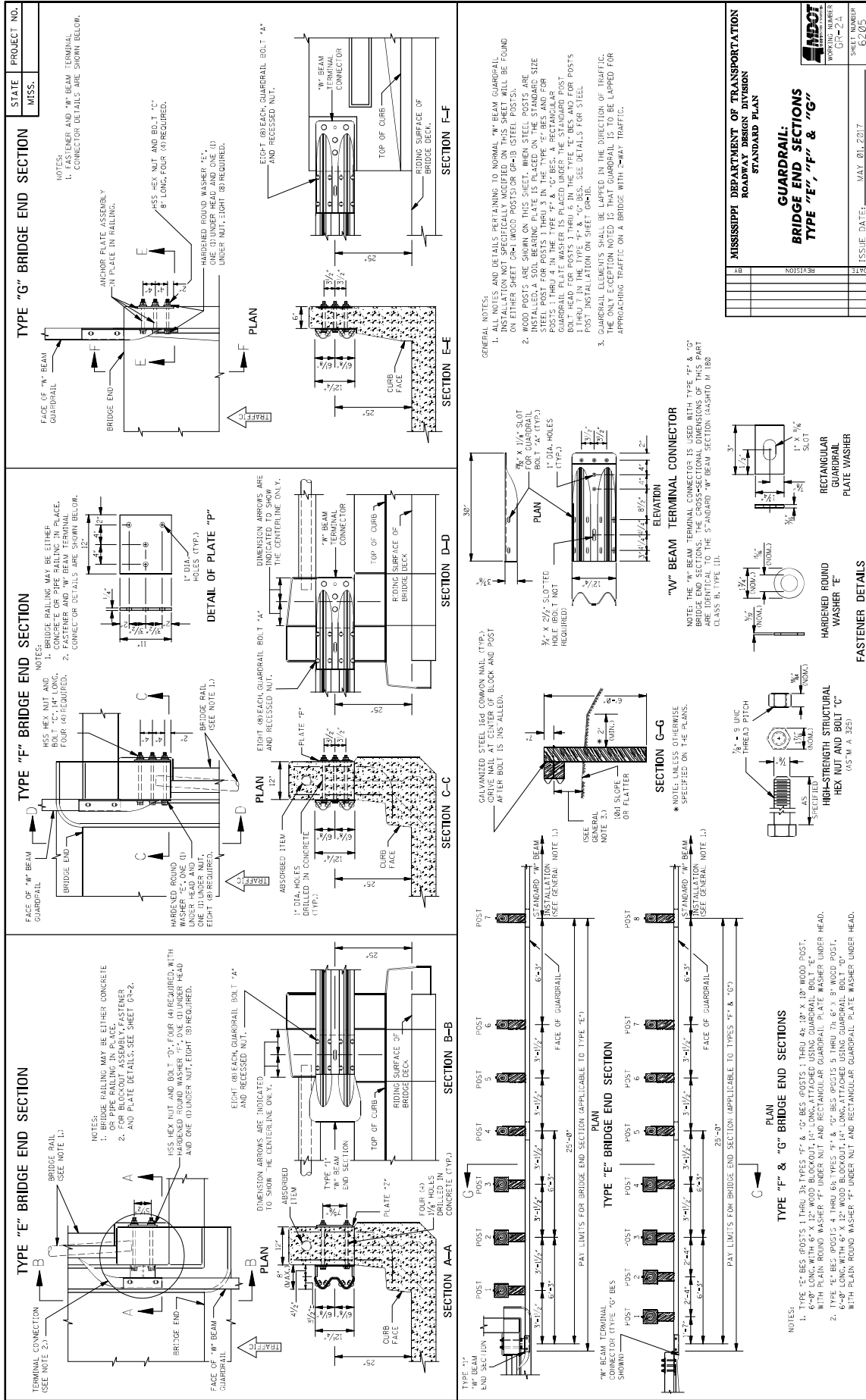



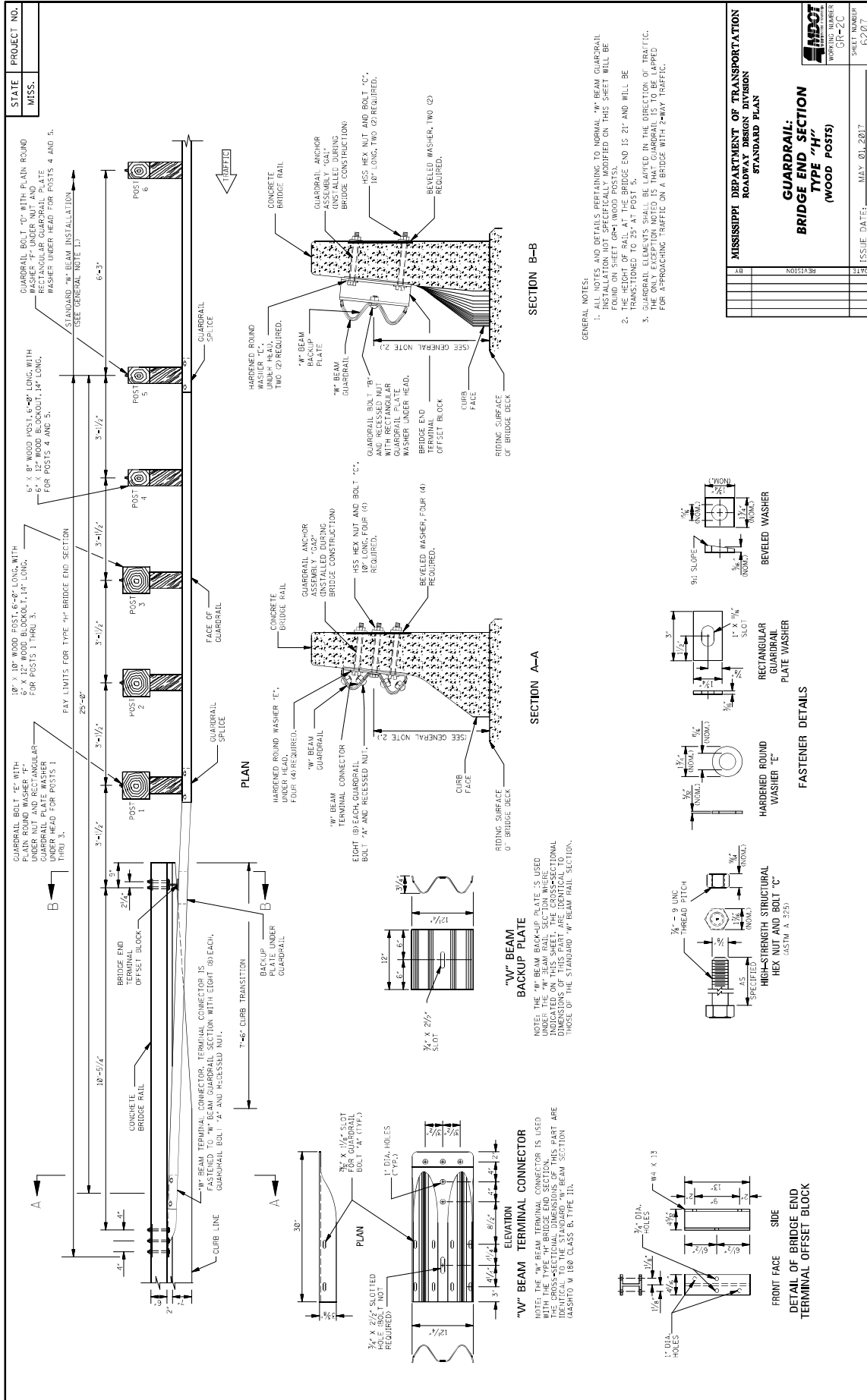

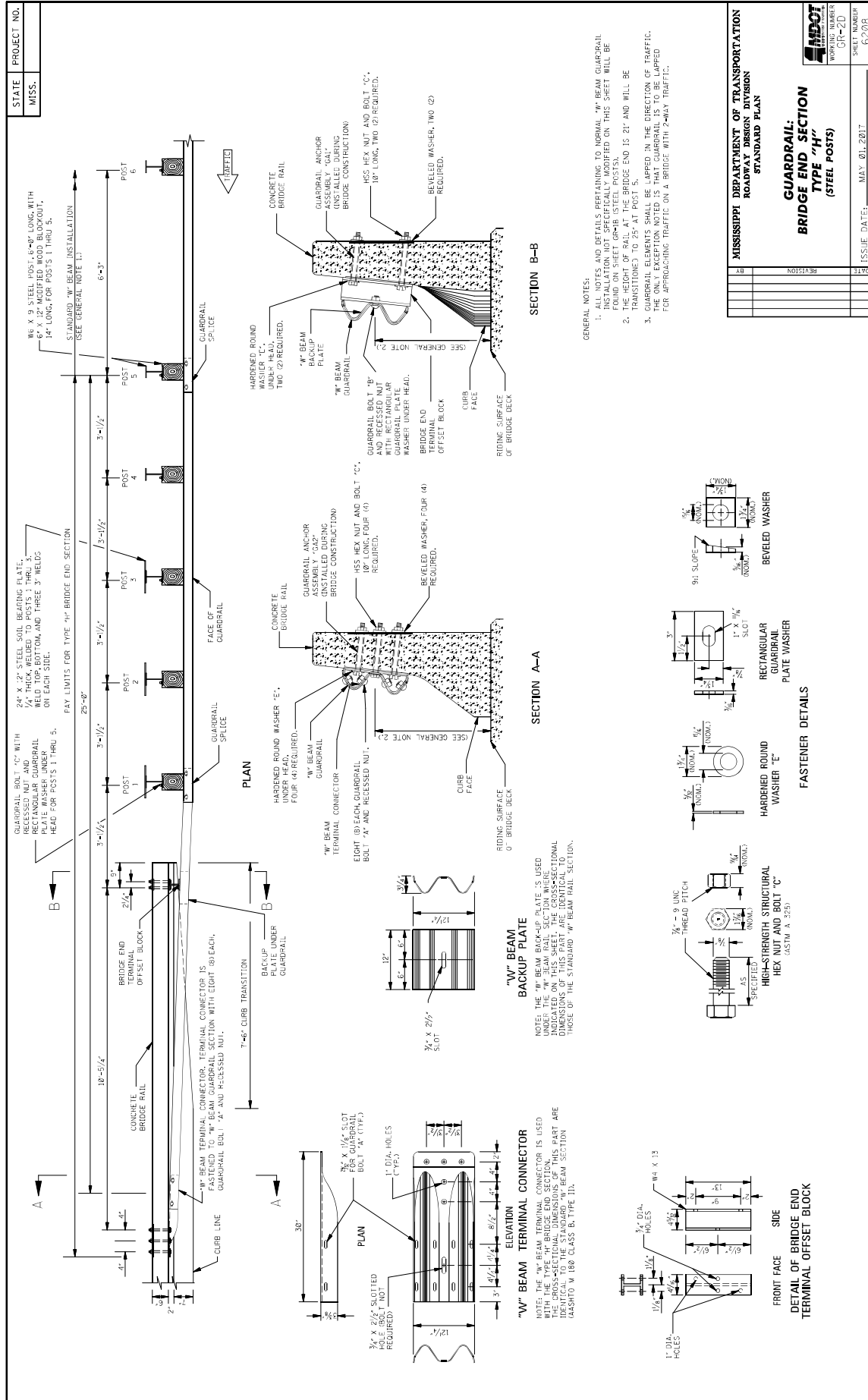

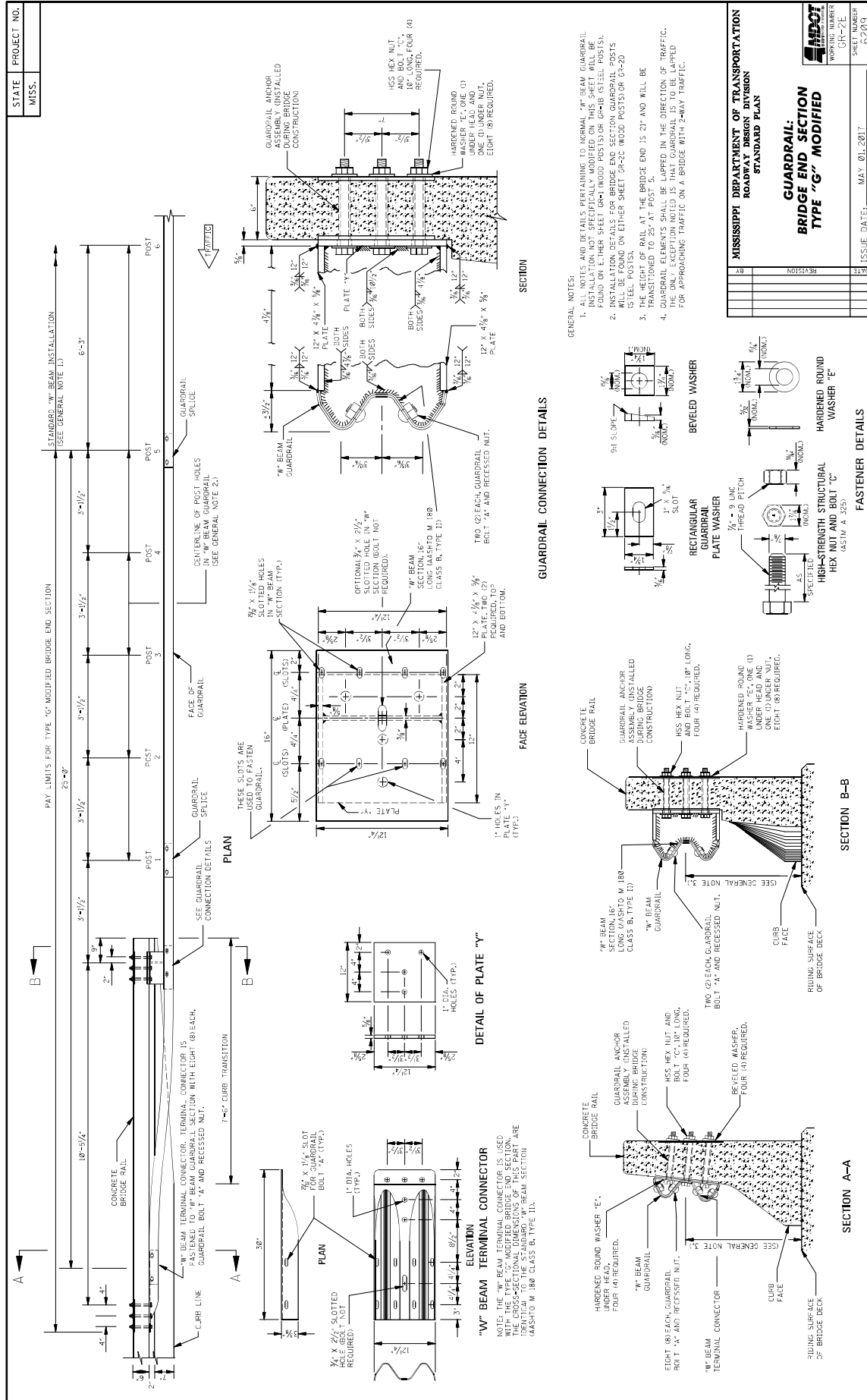

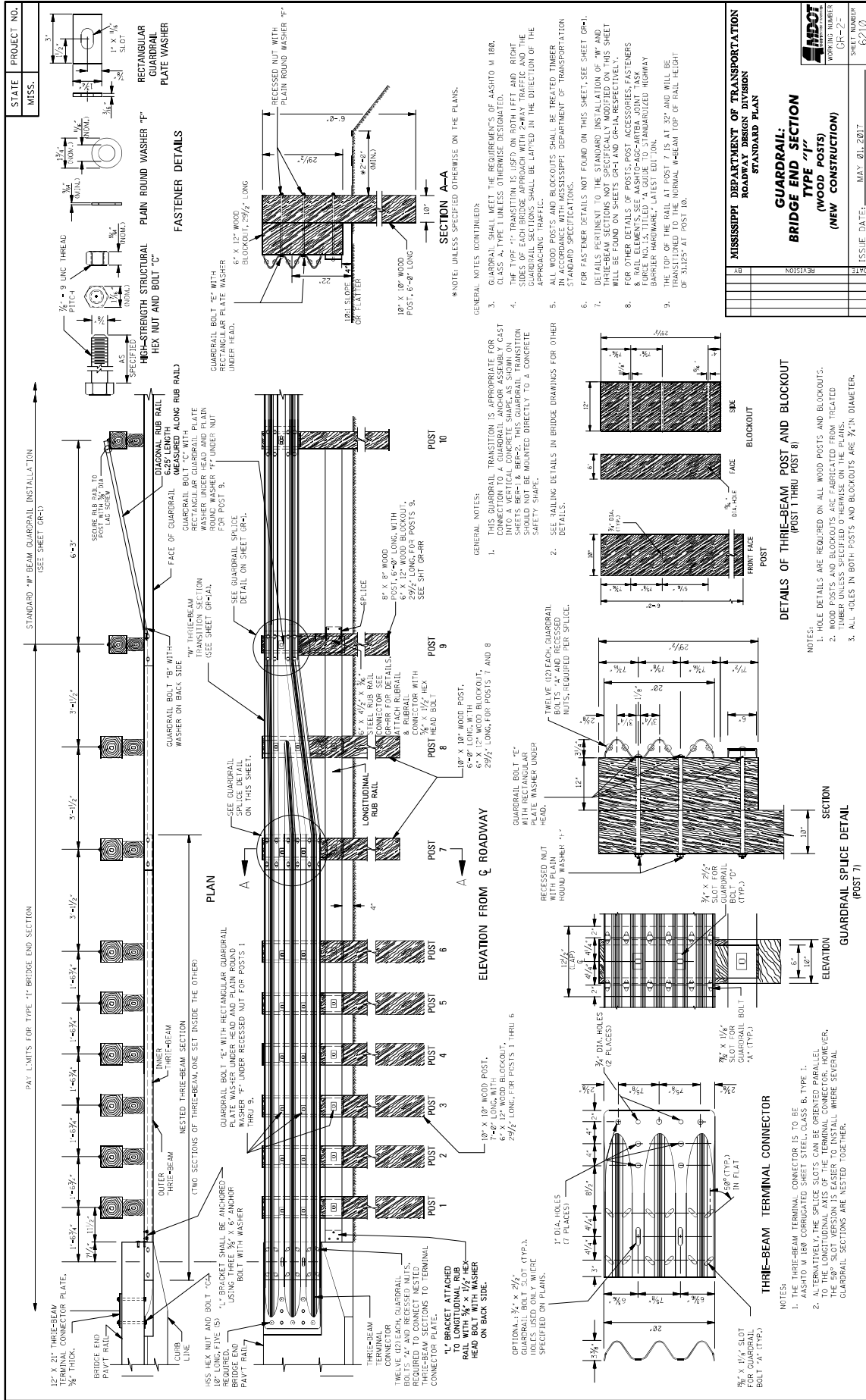





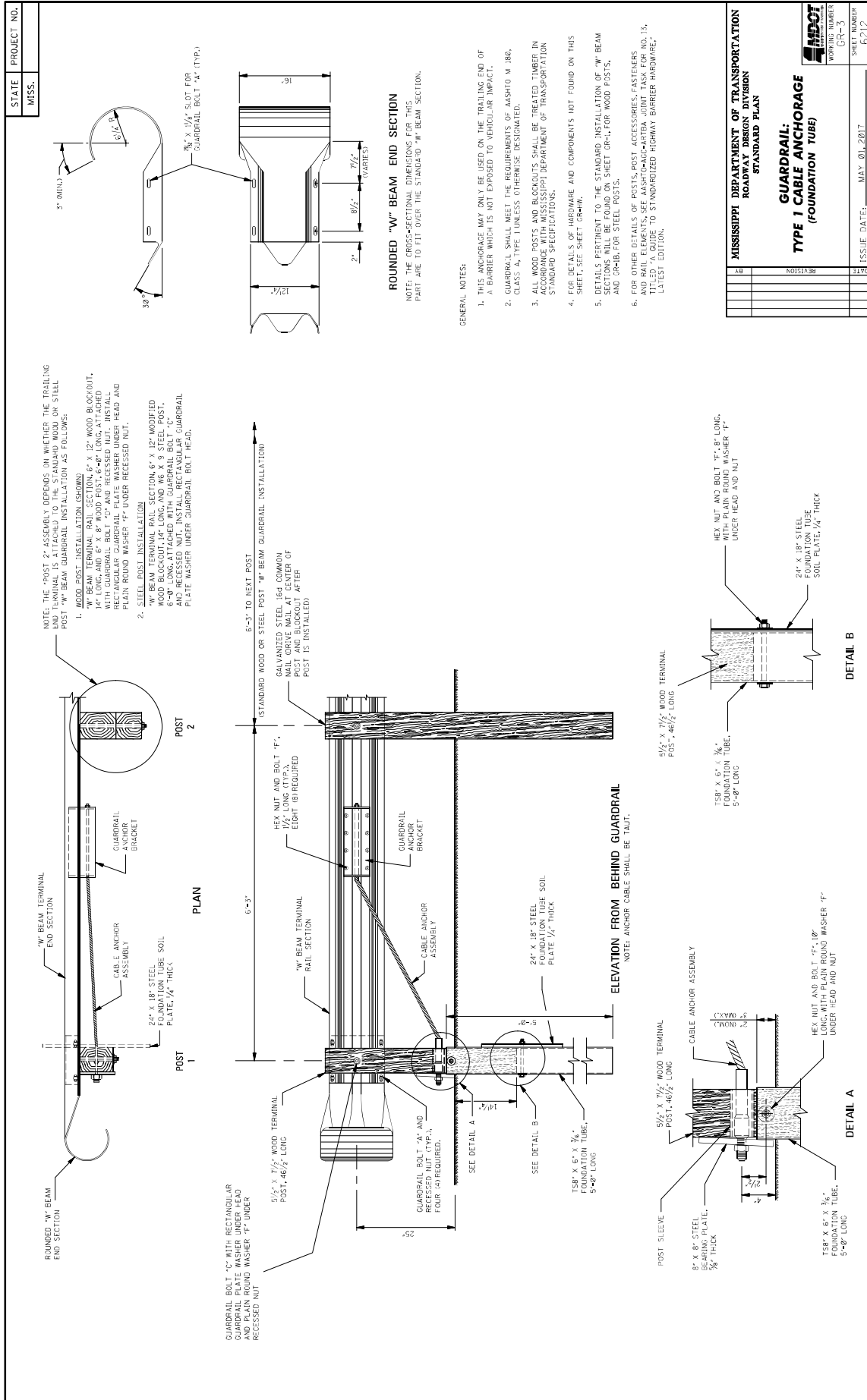

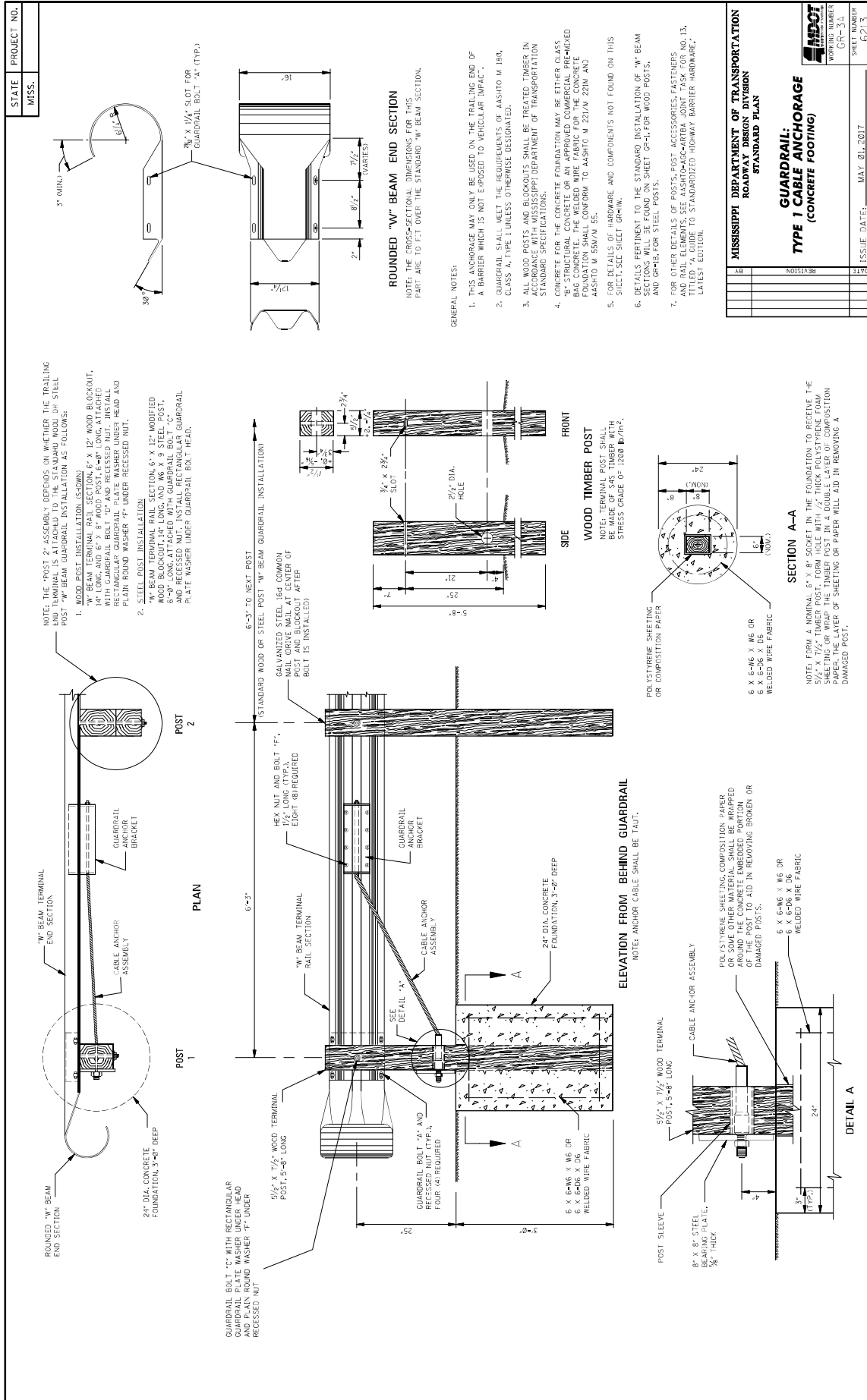

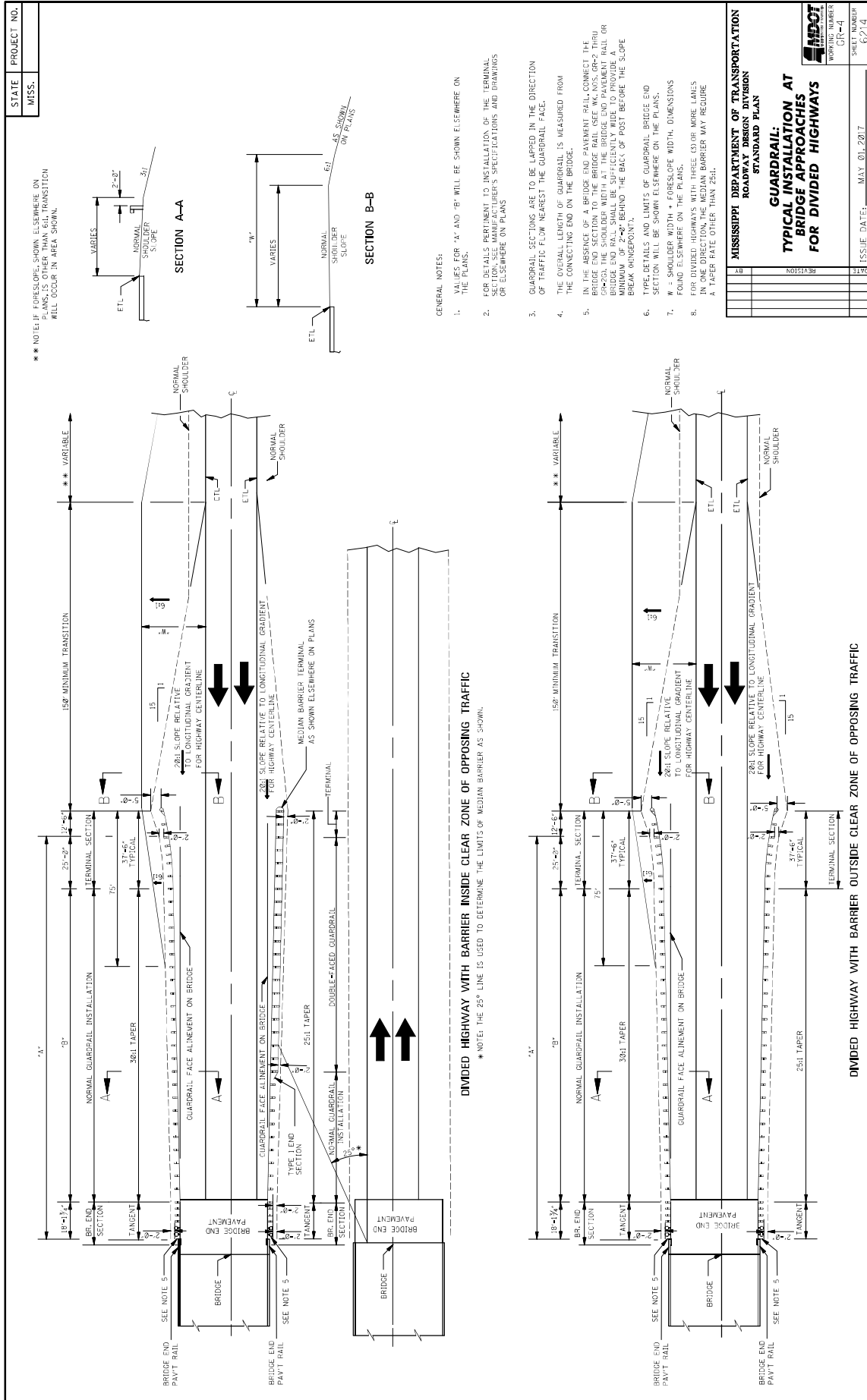

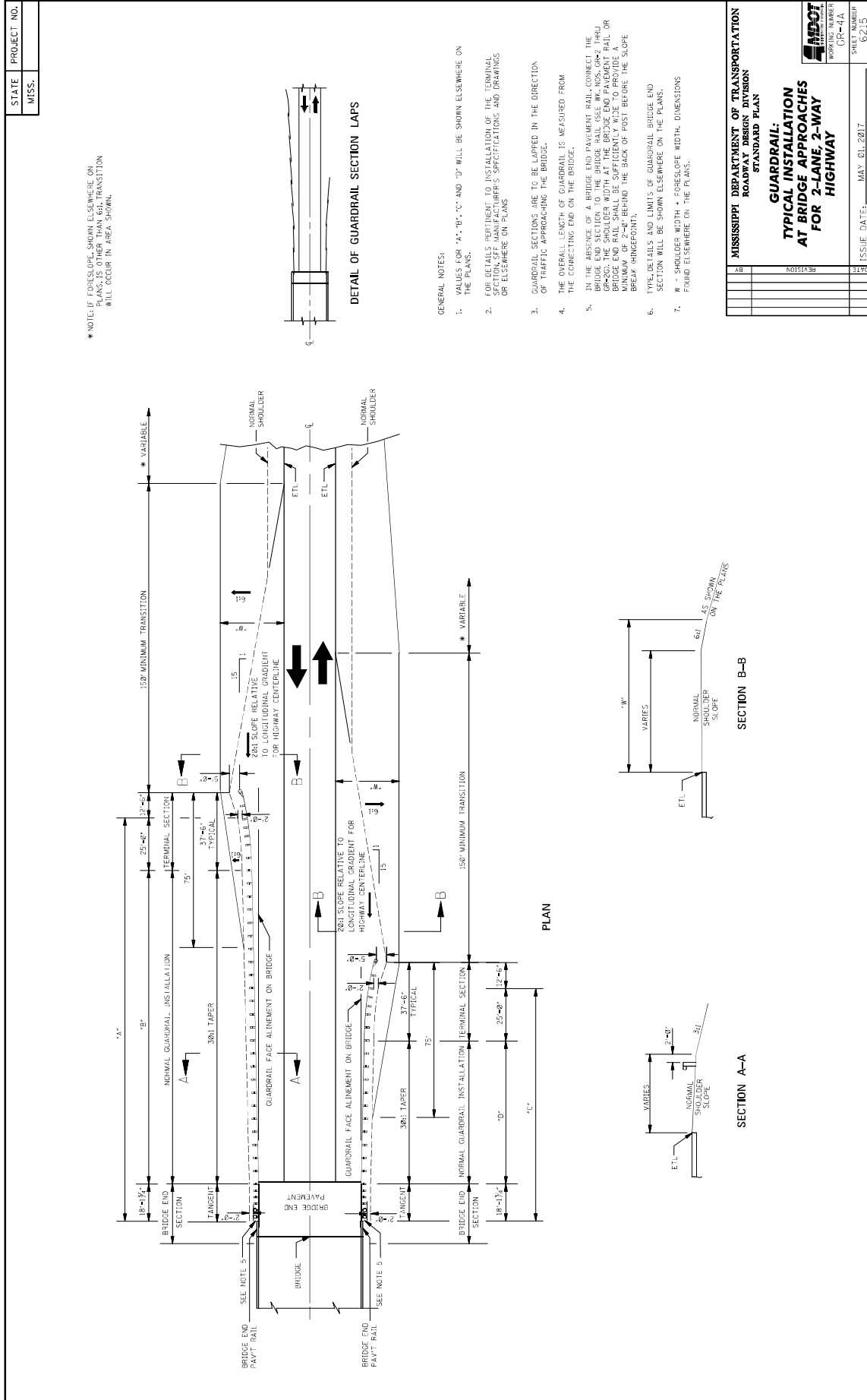

STATE MISS.	PROJECT NO.		
----------------	-------------	--	--

**SECTION A-A**

**SECTION B-B**

**SECTION C-C**

**SECTION D-D**

**SECTION D-D'**

**SECTION E-E**

**TYPICAL INSTALLATION FOR CULVERT**

**TYPICAL INSTALLATION FOR ROADSIDE OBSTACLE ON SIDE SLOPE STEEPER THAN 10:1**

**TYPICAL INSTALLATION FOR ROADSIDE OBSTACLE ON SIDE SLOPE 10:1 OR FLATTER**

**GENERAL NOTES:**

- TERMINAL SECTION: REFERENCE TO INSTALLATION OF THE TERMINAL SECTION SEE MANUFACTURER'S SPECIFICATIONS AND DRAWINGS OR ELSEWHERE ON PLANS.
- GUARDRAIL SECTIONS TO BE LAPPED IN THE DIRECTION OF TRAFFIC FLOW NEAREST THE GUARDRAIL FACE.
- MAXIMUM TOTAL LENGTH OF GUARDRAIL INSTALLATION SHALL BE THE TOTAL LENGTH LESS THE LENGTHS OF END TERMINALS.
- W = SHOULDER WIDTH + FORESLOPE WIDTH, DIMENSIONS FOUND ELSEWHERE ON THE P-ANS.

**DETAIL OF POST INSTALLATION WITH COVER LESS THAN NORMAL POST LENGTH**

THE POST SHALL BE WRAPPED WITH ONE LAYER OF 1/4" THICK EXPANDED POLYSTYRENE FOAM SHEETING AND ONE WRAP OF LIGHTWEIGHT BUILDING PAPER. THE TOP 1' SHALL BE FILLED WITH BITU. RUBBER CALKING COMMERCIAL GRADE OR OTHER APPROVED WATERPROOFING MATERIAL.

TOP OF NEW BOX  
CULVERT OR BRIDGE  
FOOTING.

TOP OF EXISTING BOX  
CULVERT OR  
BRIDGE FOOTING.

1/2" DOWEL BARS 12"  
LONG, 4 REQUIRED PER POST.  
NO SEPARATE PAYMENT WILL BE  
MADE FOR CONCRETE OR DOWELS.

**MISSISSIPPI DEPARTMENT OF TRANSPORTATION  
ROADWAY DESIGN DIVISION  
STANDARD PLAN**

**GUARDRAIL:  
TYPICAL INSTALLATION  
FOR ROADSIDE HAZARDS  
ON DIVIDED HIGHWAYS**

DATE	REVISION

ISSUE DATE: MAY 01, 2017

WORKING NUMBER: CH-115  
SHEET NUMBER: 6216

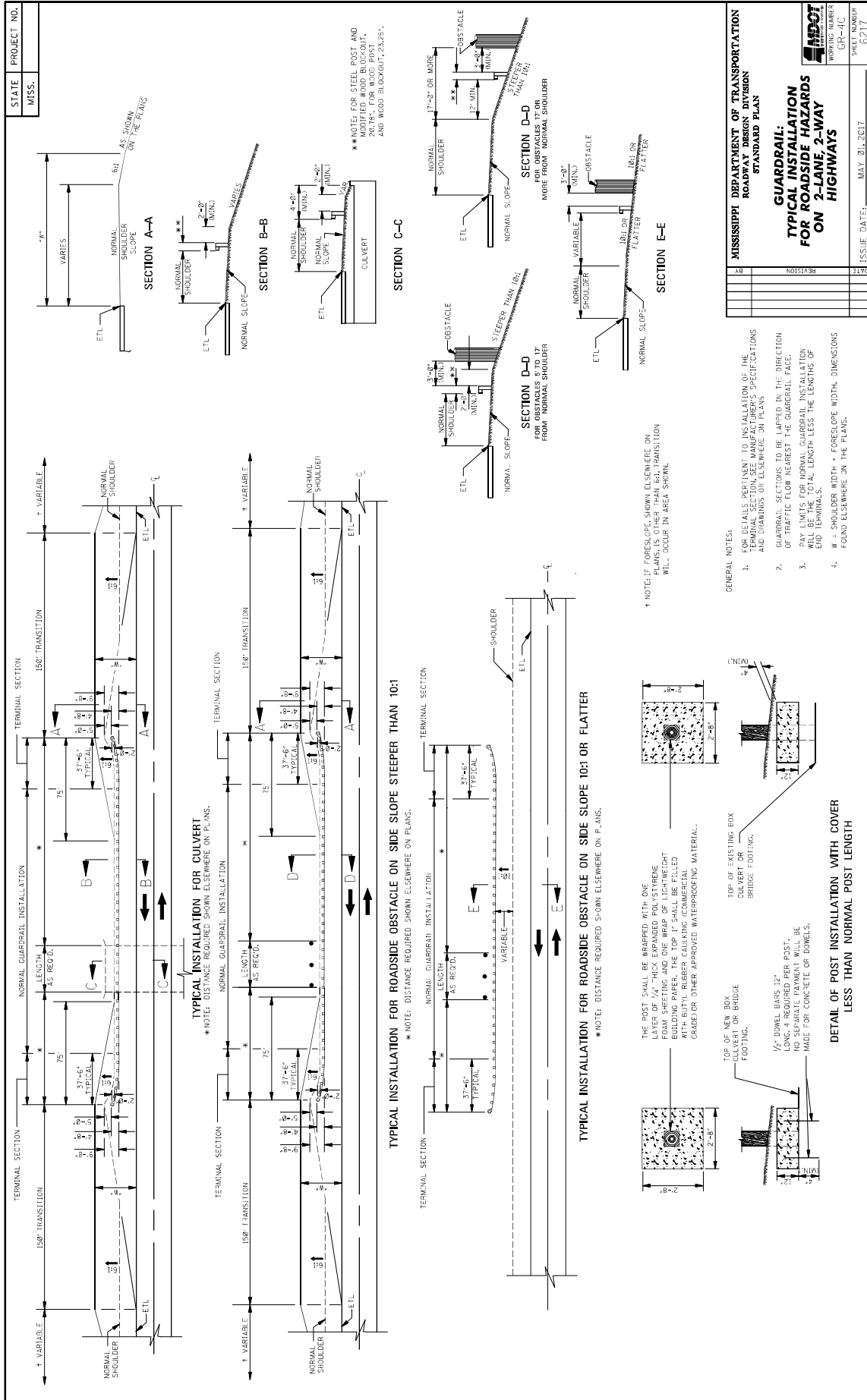

MISSISSIPPI DEPARTMENT OF TRANSPORTATION ROADWAY DESIGN DIVISION STANDARD PLAN	
<b>GUARDRAIL: TYPICAL INSTALLATION FOR ROADSIDE HAZARDS ON 2-LANE, 2-WAY HIGHWAYS</b>	
DATE	ISSUE DATE: MAY 20, 2017
REVISION	SHEET NUMBER GT-11C G217

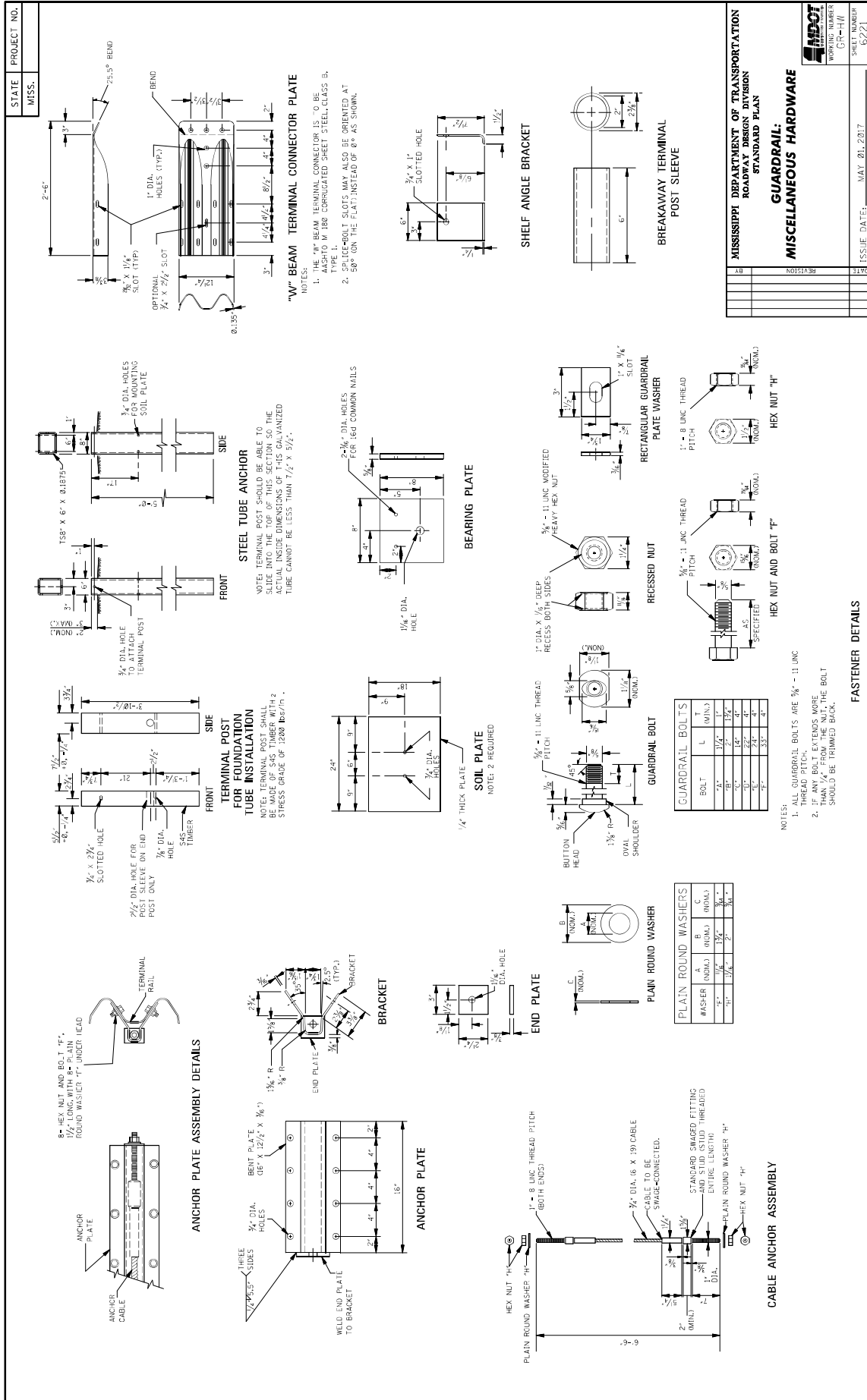

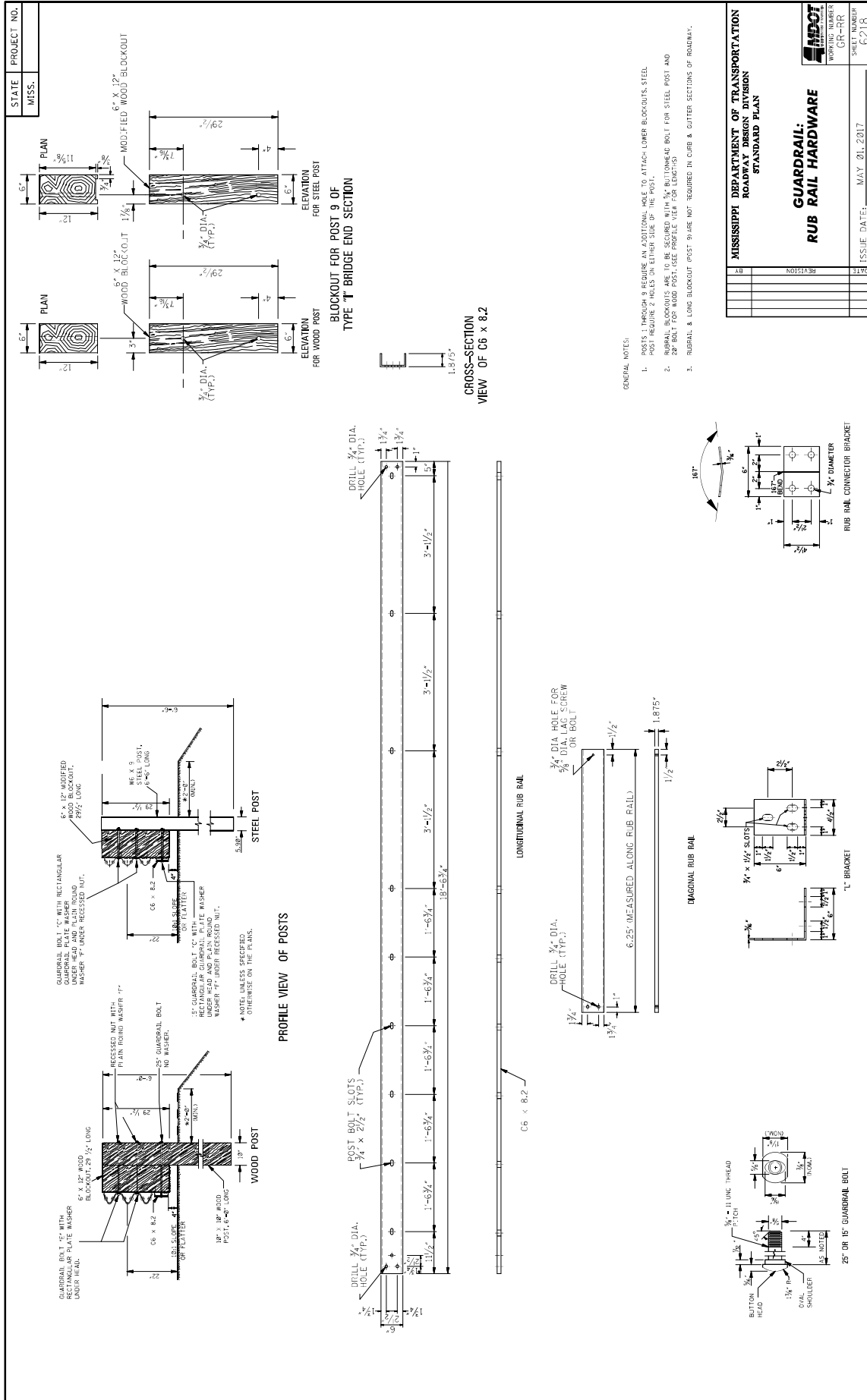



STATE MISS.	PROJECT NO.		
----------------	-------------	--	--

DISTANCE REFERENCE SIGN MOUNTING ON OUTSIDE SHOULDER ALONG MAIN FACILITY

NOTE: SIGN MOUNTING ON LEFT LANE SHOULDER SHALL BE 90° OPPOSITE THE RIGHT LANE STATION. SIGN MOUNTING ON RIGHT LANE SHOULDER SHALL BE LOCATED WITHIN 500 FEET OF ITS TRUE LOCATION. IT SHALL BE OMITTED ENTIRELY.

DELINATOR MOUNTING ON OUTSIDE SHOULDER ALONG MAIN FACILITY OR RAMP

DELINATOR MOUNTING ON OUTSIDE SHOULDER WITH MOUNTABLE CURB ALONG MAIN FACILITY OR RAMP

DELINATOR MOUNTING ON INTERCHANGE LOOPS WITH UNMOUNTABLE CURB ON INSIDE

DETAIL OF SINGLE WHITE OR SINGLE YELLOW DELINEATOR

DETAIL OF DOUBLE WHITE OR DOUBLE YELLOW DELINEATOR

REAR VIEW OF DELINEATOR ASSEMBLY

NOTE: DELINEATORS ARE TO BE FASTENED TO U-SECTION POSTS WITH 1/4\"/>

TYPE 3 OBJECT MARKER OR DISTANCE REFERENCE SIGN ASSEMBLY

NOTE: TYPE 3 OBJECT MARKER AND DISTANCE REFERENCE SIGNS ARE TO BE FASTENED TO U-SECTION POSTS WITH 3/8\"/>

DETAIL OF TYPE 3 OBJECT MARKER INSTALLATION

DETAIL OF TYPE 3 OBJECT MARKER

NOTE: COLORS= BLACK AND YELLOW. STRIPING SLANT DOWNWARD TO THE RIGHT FOR LEFT SIDE OF BRIDGE END. SEE DETAIL BELOW.

REAR VIEW OF TYPE 3 OBJECT MARKER OR DISTANCE REFERENCE SIGN ASSEMBLY

NOTE: DELINEATORS ARE TO BE FASTENED TO U-SECTION POSTS WITH 1/4\"/>

MOUNTING DETAIL

GENERAL NOTES:

1. DELINEATORS AND TYPE 3 OBJECT MARKER SHALL BE REFLECTIVE SHEETING ON 0.200\"/>
2. DELINEATOR, TYPE 3 OBJECT MARKER AND DISTANCE REFERENCE SIGN POSTS SHALL BE GALVANIZED STEEL. THE POSTS ARE TO BE FABRICATED BEFORE THE METAL IS GALVANIZED.
3. WEIGHT WITHOUT GROUND PLATES:
  - A. DELINEATOR POST 7'-0\"/>
  - B. TYPE 3 OBJECT MARKER POSTS 3'-0\"/>
  - C. DISTANCE REFERENCE SIGN POSTS 4'-0\"/>
4. UNIT PRICE OF DELINEATORS AND TYPE 3 OBJECT MARKERS SHALL INCLUDE COST OF POST. DISTANCE REFERENCE SIGN POST WILL BE PAID PER FOOT.
5. RADIUS IN BENDS OF POST CROSS SECTION NOT TO EXCEED 3% FOR HOT ROLLED SECTION.
6. GROUND PLATE NOT REQUIRED ON U-SECTION POST.

MISSISSIPPI DEPARTMENT OF TRANSPORTATION ROADWAY DESIGN DIVISION STANDARD PLAN	
TYPICAL INSTALLATION AND DETAILS OF DELINATORS AND DISTANCE REFERENCE SIGNS	SHEET NUMBER SN-5 82JL4
DATE	ISSUE DATE: MAY 01, 2017
REVISION	

**MISSISSIPPI DEPARTMENT OF TRANSPORTATION**

**SECTION 904 – NOTICE TO BIDDERS NO. 3599**

**CODE: (SP)**

**DATE: 08/11/2021**

**SUBJECT: Standard Drawings**

Standard Drawings attached hereto shall govern appropriate items of required work.

Larger copies of Standard Drawings may be purchased from:

MDOT Plans Print Shop  
MDOT Shop Complex, Building C, Room 114  
2567 North West Street  
P.O. Box 1850  
Jackson, MS 39215-1850  
Telephone: (601) 359-7460  
or FAX: (601) 359-7461  
or e-mail: [plans@mdot.state.ms.us](mailto:plans@mdot.state.ms.us)

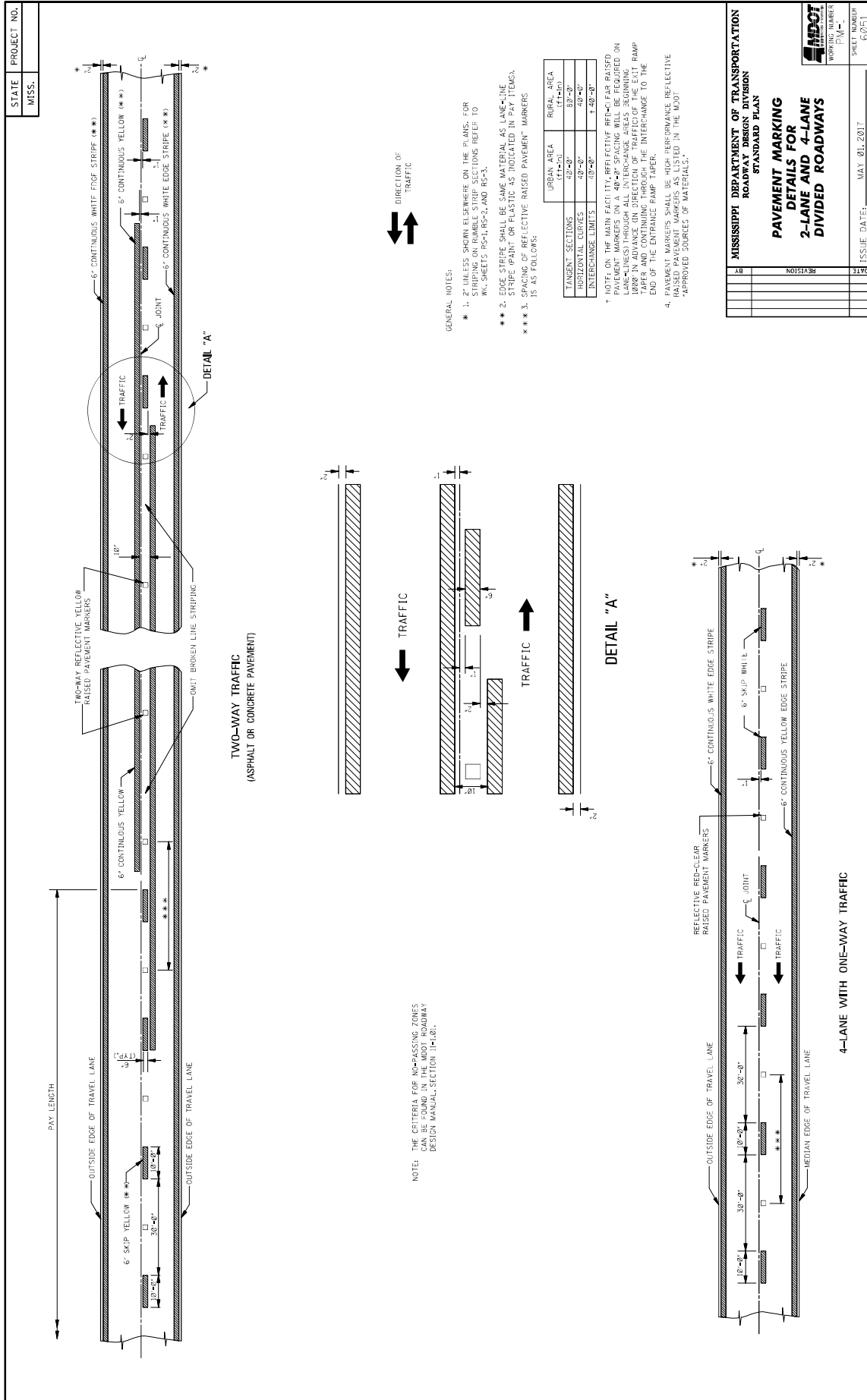

<b>MISSISSIPPI DEPARTMENT OF TRANSPORTATION</b>	
<b>ROADWAY DESIGN DIVISION</b>	
<b>STANDARD PLAN</b>	
<b>PAVEMENT MARKING</b>	
<b>2-LANE AND 4-LANE</b>	
<b>DIVIDED ROADWAYS</b>	
DATE	ISSUE DATE: MAY 01, 2017
BY	SHEET NUMBER: 6001
REVISION	WORKING NUMBER: P100-

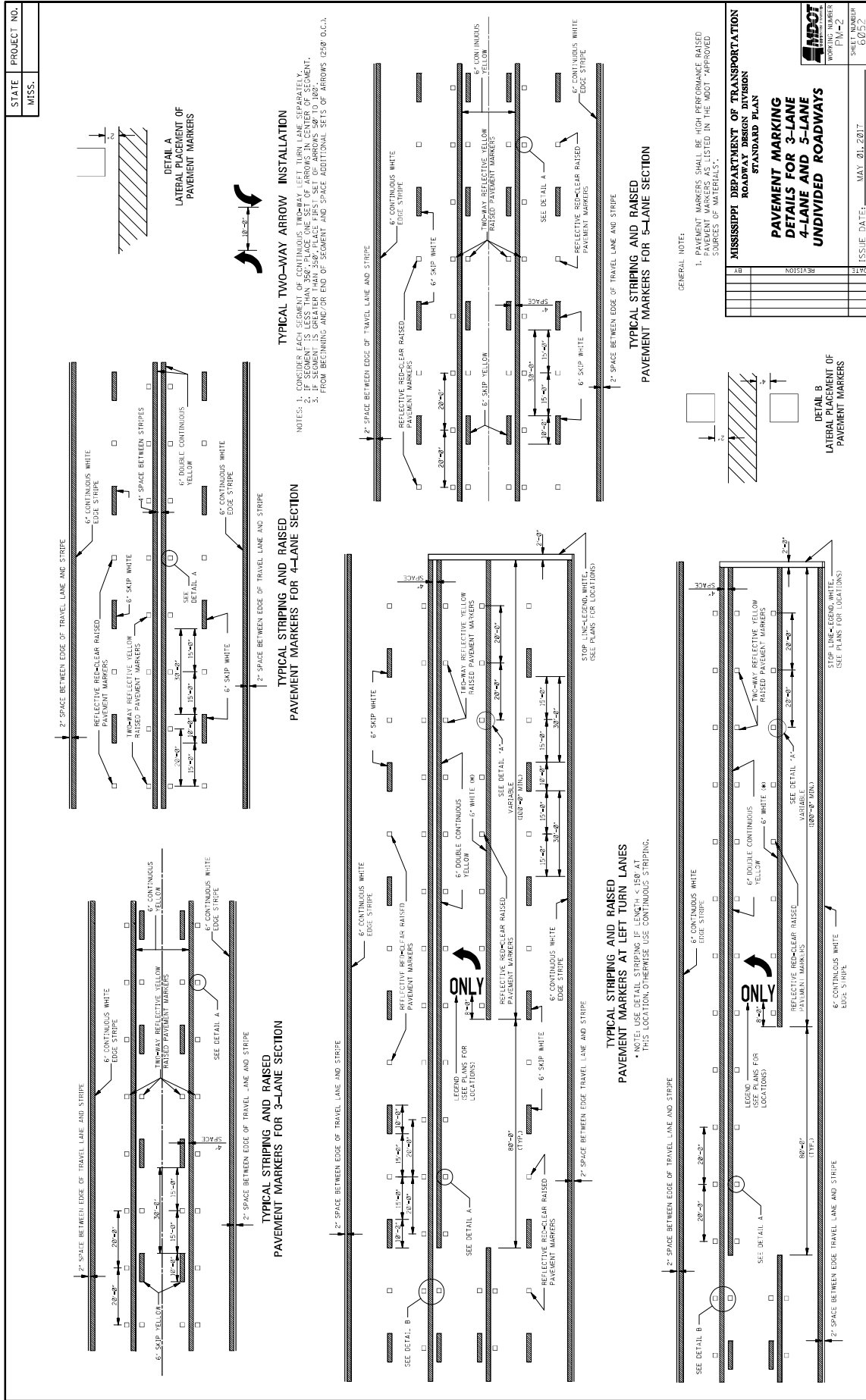

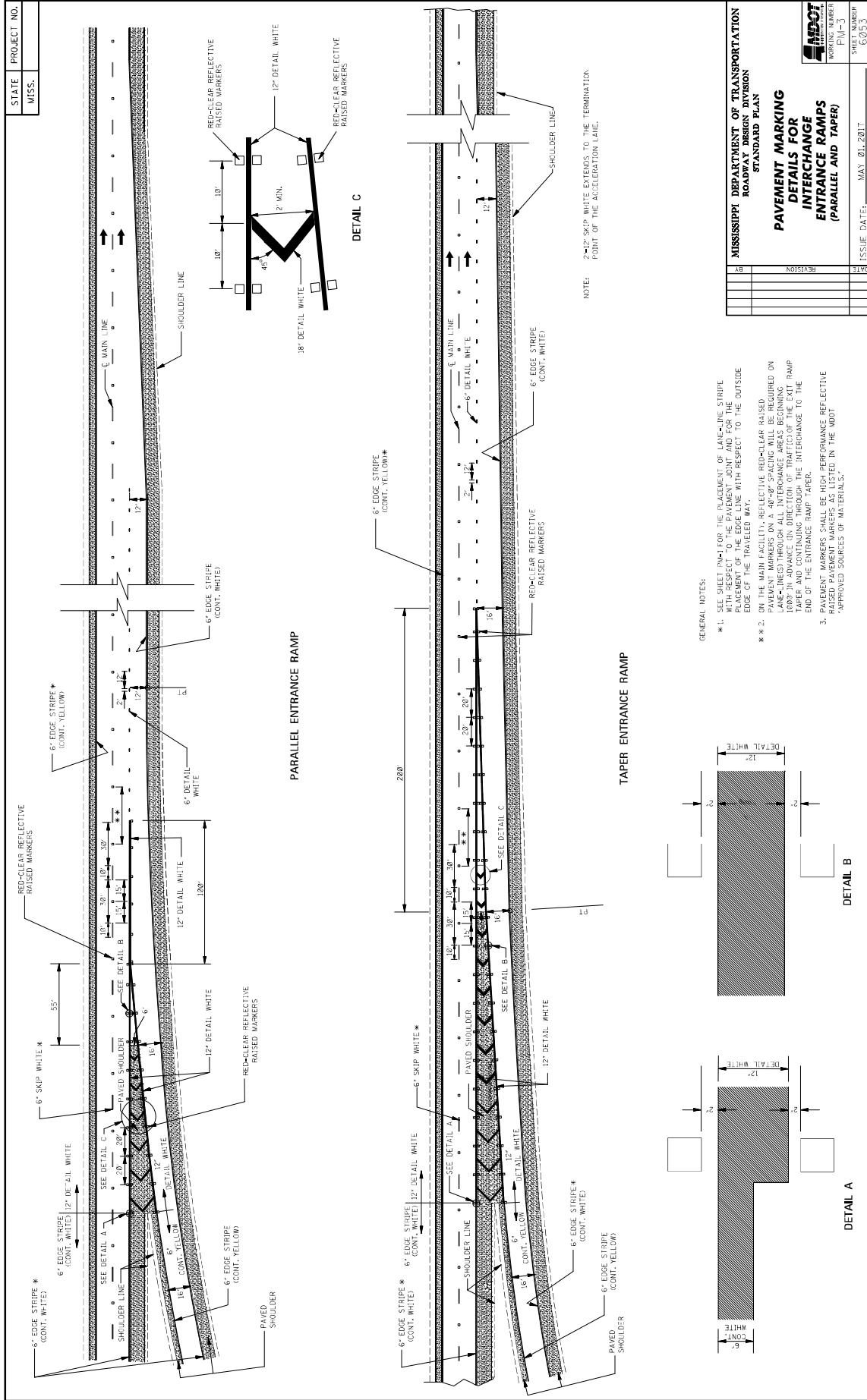

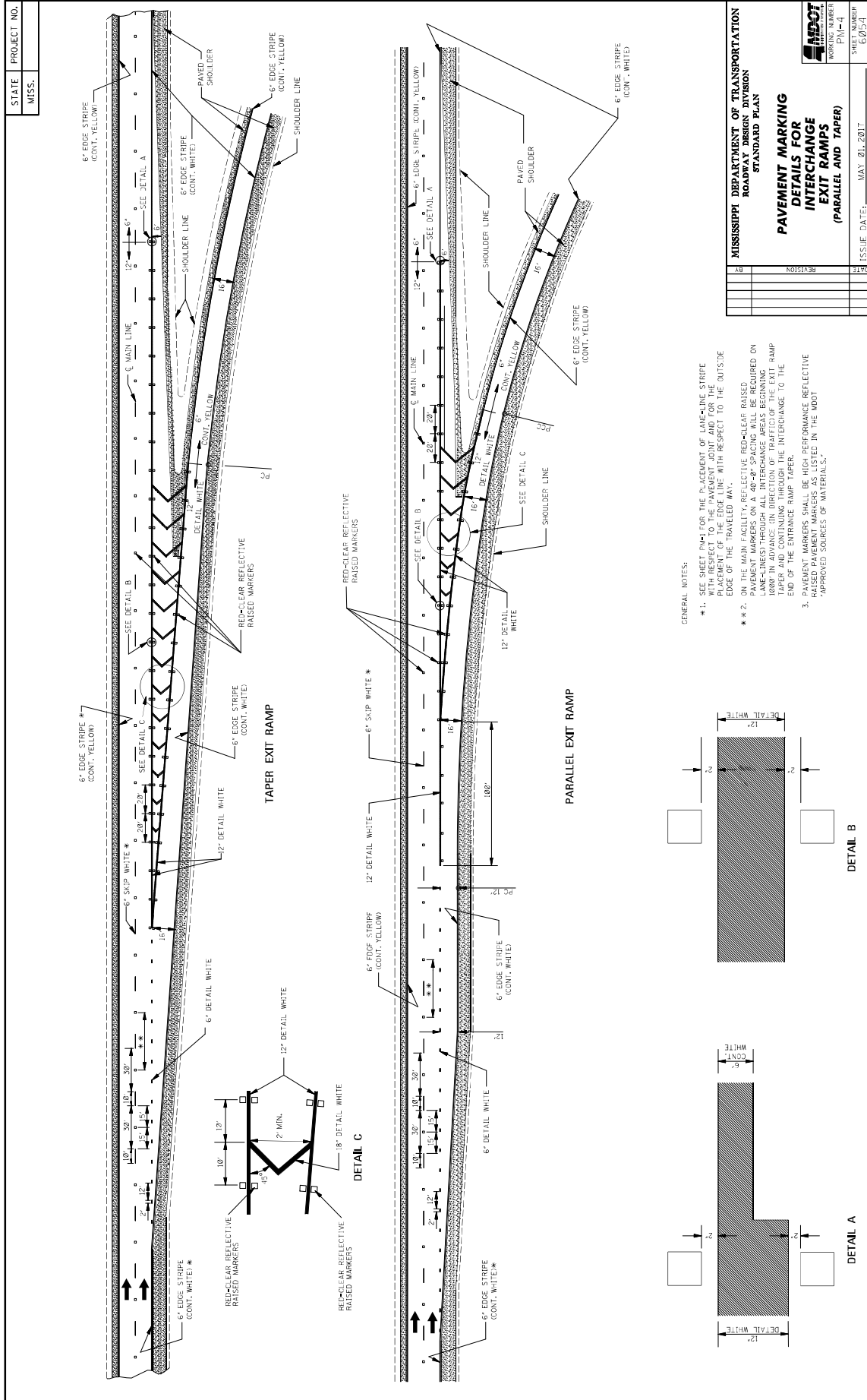

<b>MISSISSIPPI DEPARTMENT OF TRANSPORTATION</b>	
<b>ROADWAY DESIGN DIVISION</b>	
<b>STANDARD PLAN</b>	
<b>PAVEMENT MARKING</b>	
<b>INTERCHANGE</b>	
<b>EXIT RAMPS</b>	
<b>(PARALLEL AND TAPER)</b>	
SHEET NUMBER	PL-4
WORKING NUMBER	62/241
ISSUE DATE:	MAY 01, 2017
DATE	REVISION

- GENERAL NOTES:
- \* 1. SEE SHEET PM-1 FOR THE PLACEMENT OF LANE-LINE STRIPE WITH RESPECT TO THE PAVEMENT JOINT AND FOR THE PLACE OF THE 6" EDGE STRIPE WITH RESPECT TO THE OUTSIDE EDGE OF THE PAVED SHOULDER.
  - \*\* 2. THE RAISED REFLECTIVE RED-CLEAR MARKERS (PAVEMENT MARKERS ON A 40'-8" SPACING) WILL BE REQUIRED ON 1000' IN ADVANCE IN DIRECTION OF TRAFFIC OF THE EXIT RAMP TAPER AND CONTINUING THROUGH THE INTERCHANGE TO THE END OF THE ENTRANCE RAMP TAPER.
  3. RAISED PAVEMENT MARKERS BE HIGH PERFORMANCE REFLECTIVE "APPROVED SOURCES OF MATERIALS."

STATE MISS.	PROJECT NO.		
----------------	-------------	--	--

STOP

RIGHT

LEFT

TRAFFIC

AHEAD

SCHOOL

SIGNAL

EXIT

YIELD

**GENERAL NOTES:**

- TWO HORIZONTAL GAPS (USED BY TEMPLATE CONNECTIONS) OF 1/2" SHALL BE EXTENDED TO THE FULL WIDTH OF THE SIGNING LETTERS.
- FOR OTHER DETAILS, SEE THE MANUAL ON UNIFORM TRAFFIC CONTROL DEVICES.
- PAY QUANTITIES FOR PAVEMENT MARKING LEGENDS ARE AS FOLLOWS:

LEGEND	AREA (ft <sup>2</sup> )
STOP	24.6
RIGHT	28.6
LEFT	19.5
TRAFFIC	27.2
AHEAD	32.4
YIELD	26.8
EXIT	18.5
SIGNAL	32.5
SCHOOL	35.2

**MISSISSIPPI DEPARTMENT OF TRANSPORTATION**  
ROADWAY DESIGN DIVISION  
STANDARD PLAN

**PAVEMENT MARKING  
LEGEND DETAILS**

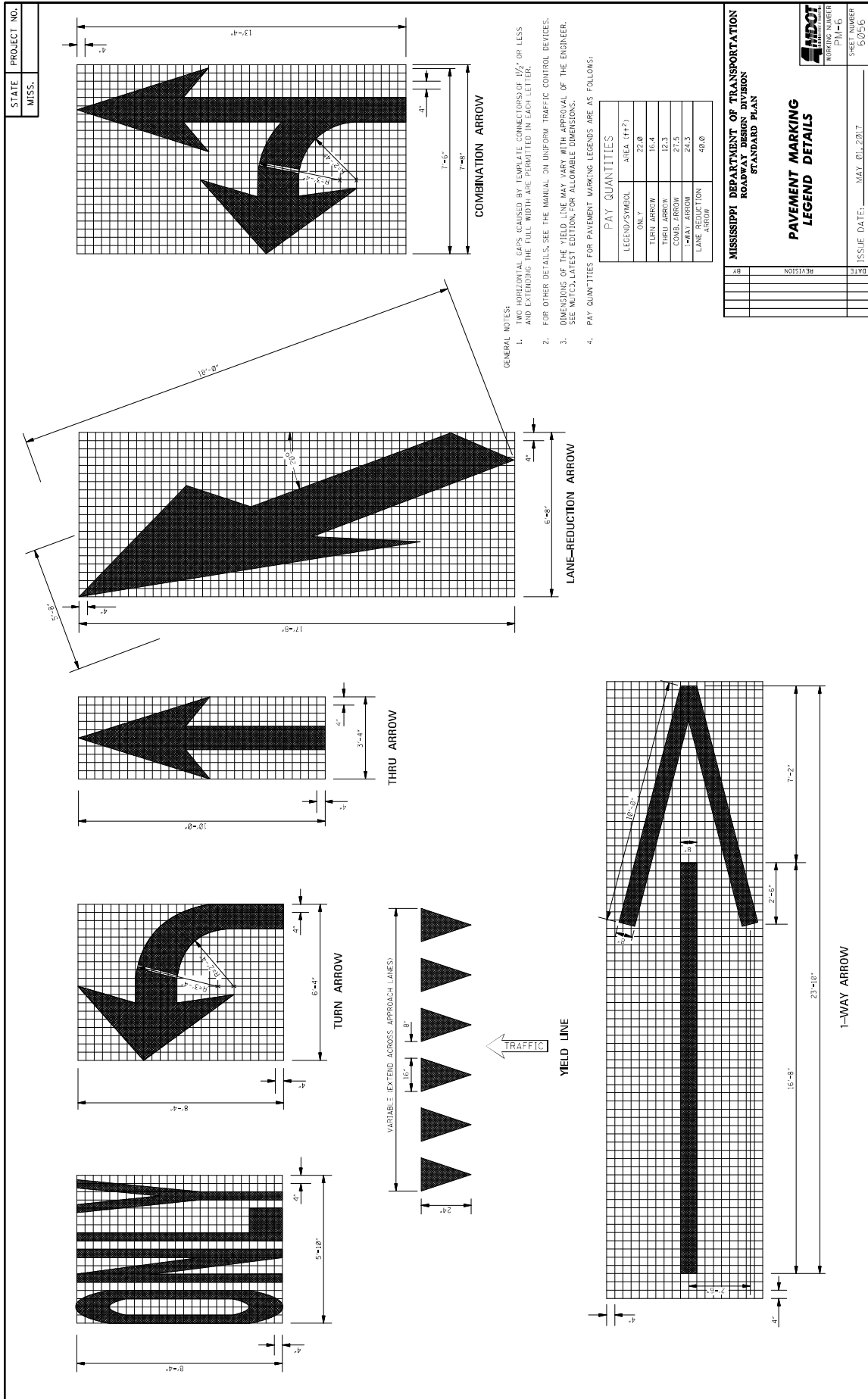



STATE MISS.	PROJECT NO.
----------------	-------------

\*\*\* PRESENT OR PROPOSED ACTIVE WARNING DEVICE  
TYPICAL LOCATION OF STOP LINE WHERE AN ACTIVE WARNING DEVICE IS PRESENT OR PROPOSED.

EDGE OF SHOULDER  
EDGE OF TRAVEL LANE  
EDGE OF TRAVEL LANE  
EDGE OF SHOULDER

STOP LINE  
STOP LINE

TRAFFIC

TRAFFIC

RAILROAD

24" STOP LINE  
24" STOP LINE

24" TRANSVERSE BAND  
24" TRANSVERSE BAND

SEE DETAIL A FOR DIMENSIONS

PAVEMENT MARKING SYMBOL

DISTANCE 'X' (SEE TABLE BELOW)

**GENERAL NOTES:**

1. A PORTION OF THE PAVEMENT MARKING SYMBOL SHOULD BE DIRECTLY OPPOSITE THE ADVANCE WARNING SIGN (WITHIN).

2. WIDTH OF 'R' X 'R' SYMBOL MAY VARY ACCORDING TO LANE WIDTH. SYMBOLS SHOULD EXTEND ACROSS ALL APPROACH LANES AND INDIVIDUAL LANE WIDTHS. 'R' X 'R' SYMBOLS SHOULD BE USED IN EACH APPROACH LANE.

3. 'R' X 'R' SYMBOL (65, 8, -7), TRANSVERSE BANDS AND STOP LINE SHALL BE PAID FOR AS LEGEND WHITE.

4. REFER TO THE MANUAL ON UNIFORM TRAFFIC CONTROL DEVICES FOR LOCATION OF PROPOSED WARNING DEVICES AT RAILROAD-HIGHWAY GRADE CROSSINGS.

POSTED SPEED (mph)	① DISTANCE 'X' (ft)
20	100
25	100
30	100
35	100
40	125
45	175
50	250
55	325
60	400
65	475

NOTE: DISTANCE 'X' MAY BE INCREASED IF PROTECTIVE PHYSICAL CONDITIONS EXIST AT THE DESIGNATED DISTANCE.

DETAIL A  
STANDARD "R" PAVEMENT MARKING  
FOR R X R SYMBOL

**MISSISSIPPI DEPARTMENT OF TRANSPORTATION**  
ROADWAY DESIGN DIVISION  
STANDARD PLAN

**TYPICAL PLACEMENT OF WARNING SIGNS AND PAVEMENT MARKINGS AT RAILROAD-HIGHWAY GRADE CROSSINGS**

WORKING NUMBER: PD-4-1 / 8051

SHEET NUMBER: 6051

ISSUE DATE: MAY 01, 2017

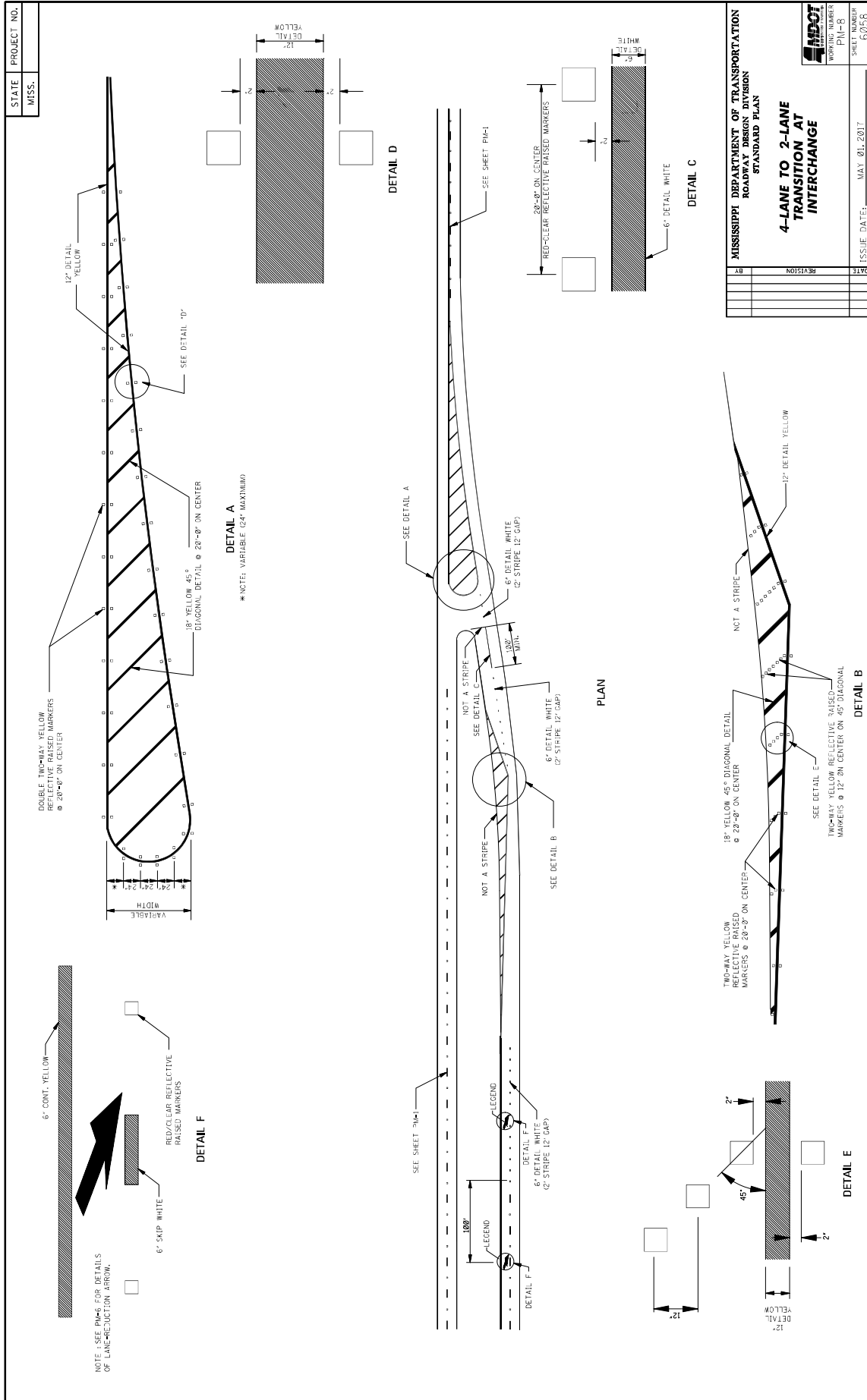

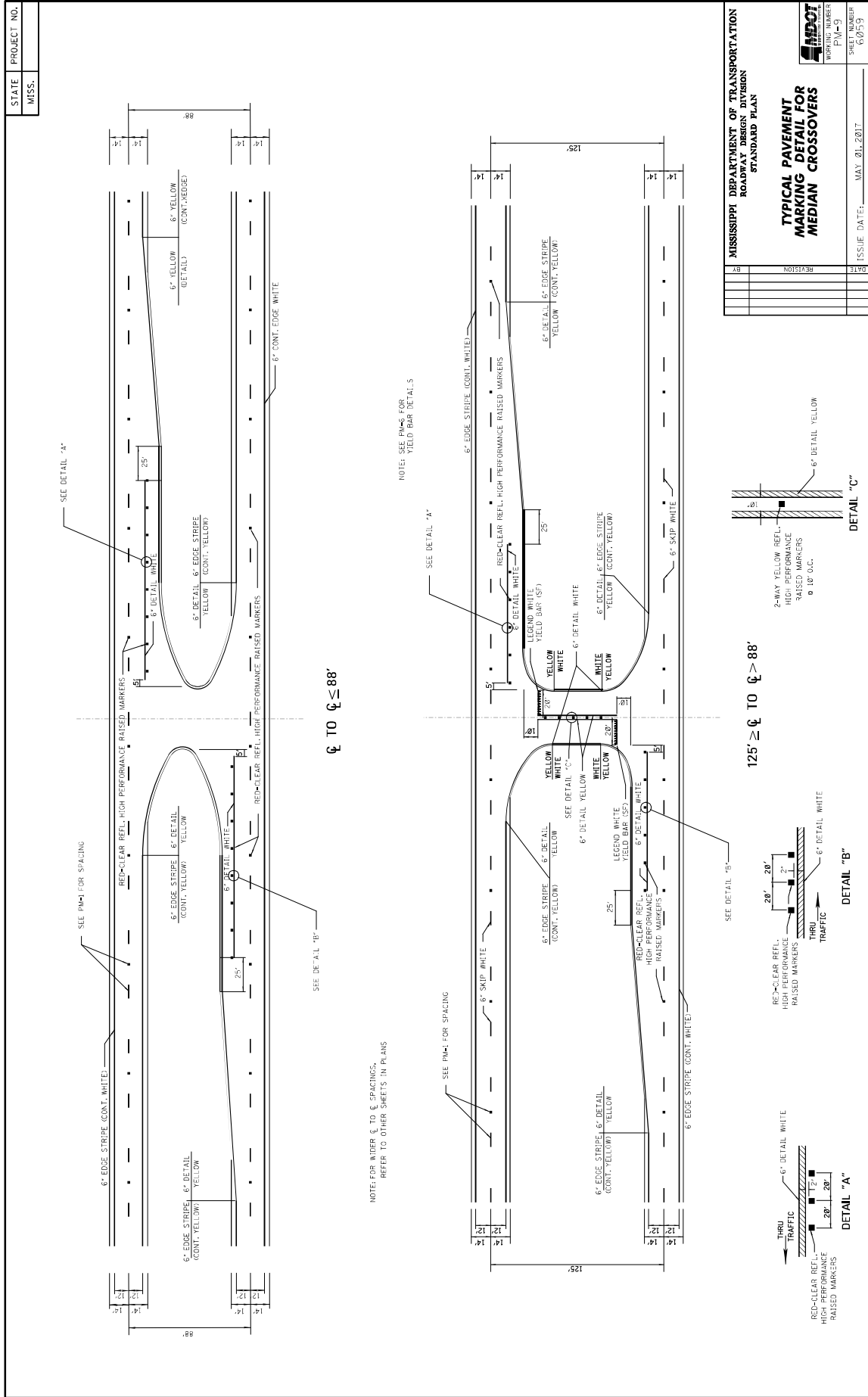

STATE	PROJECT NO.
MISS.	

MISSISSIPPI DEPARTMENT OF TRANSPORTATION	
ROADWAY DESIGN DIVISION	
STANDARD PLAN	
NO	NO 1513B
WORKING NUMBER	
P(1)-9	
SHEET NUMBER	
06/39	
ISSUE DATE	MAY 01, 2011

**TYPICAL PAVEMENT MARKING DETAIL FOR MEDIAN CROSSOVERS**



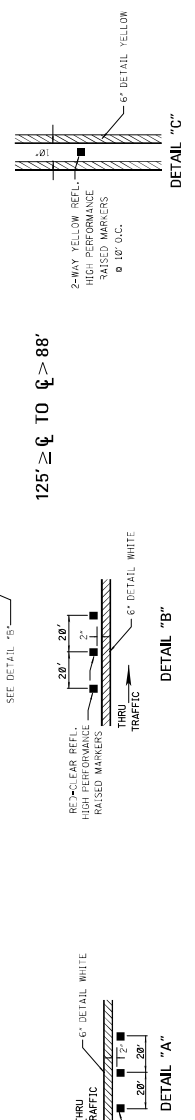

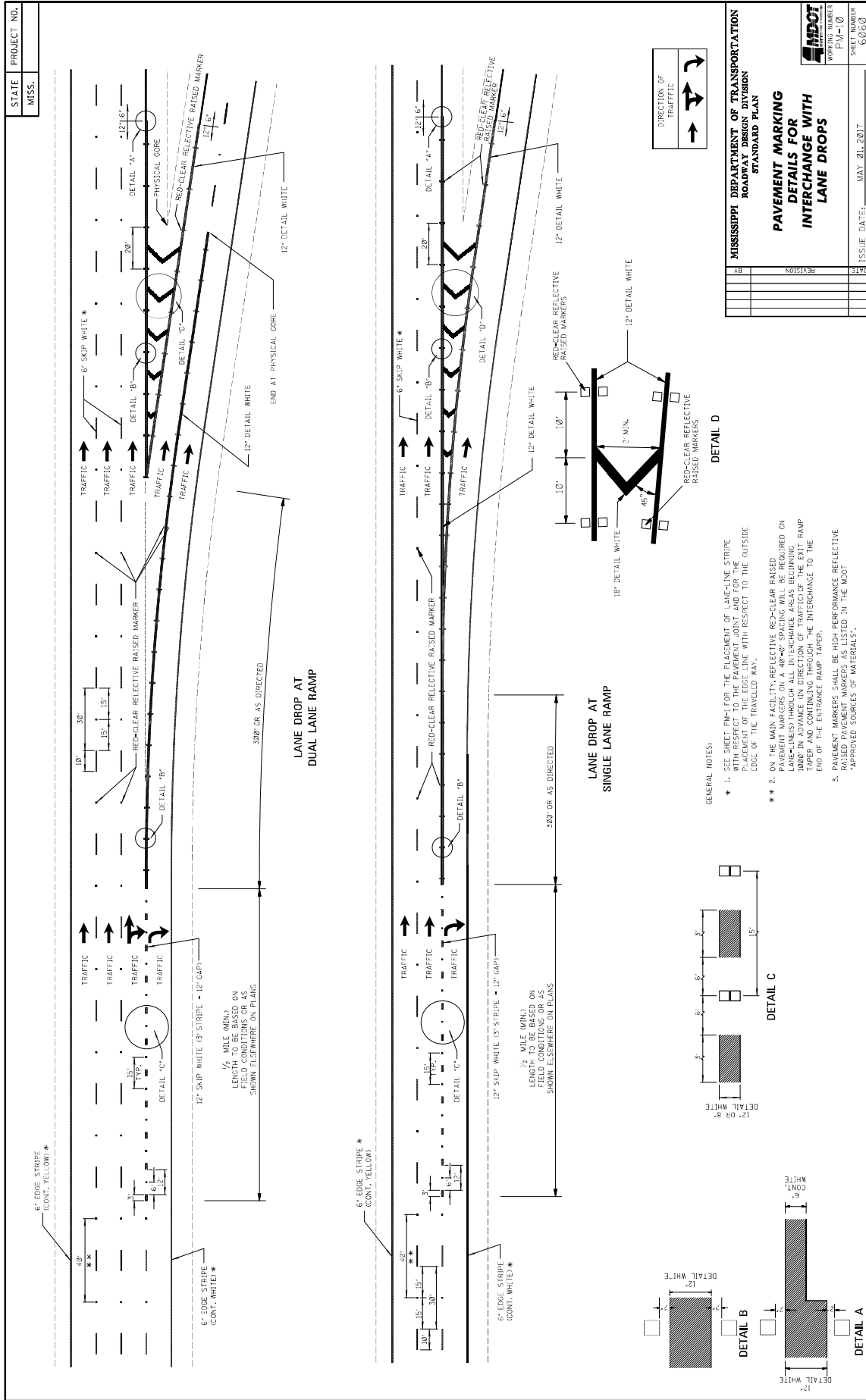
STATE	PROJECT NO.
MISS.	

TYPICAL PLACEMENT OF RAISED PAVEMENT MARKERS ON SIDE ROAD RADIUS  
2-LANE, TWO WAY TRAFFIC

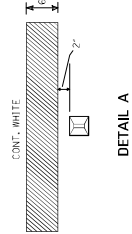
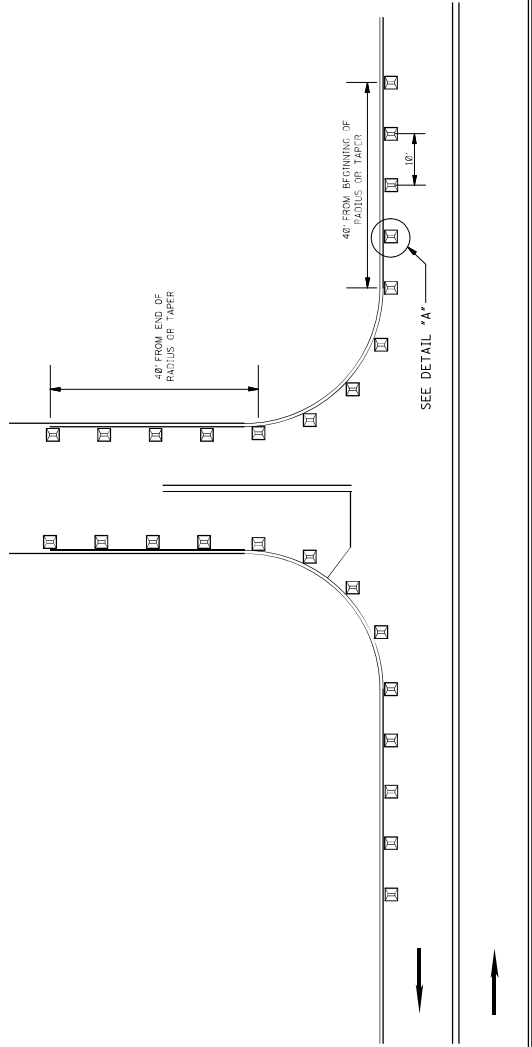

GENERAL NOTES:

1. MARKERS SHALL BE FLACCO EVERY 18' FEET.
2. MARKERS SHALL BE VISIBLE FROM THE TRAVELING MOTORIST ON STATE DESIGNATED HIGHWAYS.
3. MARKERS SHALL BE HIGH PERFORMANCE TWO-WAY CLEAR.
4. FIVE (5) MARKERS SHALL BE PLACED ALONG MAINLINE EDGE STRIPE.
5. MARKERS ON COUNTY ROADS SHALL CONTINUE DOWN THE MAINLINE EDGE STRIPE A DISTANCE OF 48 FEET.
6. MARKERS SHALL NOT BE ROTATED WHEN BEING PLACED ALONG RADIUS AND TANGENT SECTION OF LOCAL ROAD.
7. MARKERS SHALL BE INSTALLED AT SIMPLE AND CHANNELIZED INTERSECTIONS TO THE LIMITS SHOWN ABOVE.

MISSISSIPPI DEPARTMENT OF TRANSPORTATION  
ROADWAY DESIGN DIVISION  
STANDARD PLAN

**2-WAY RAISED PAVEMENT MARKERS AT INTERSECTING ROADS (2-LANE)**

ISSUE DATE: MAY 01, 2017

WORKING NUMBER: P-111  
SHEET NUMBER: 09/01

DATE	BY	REVISION

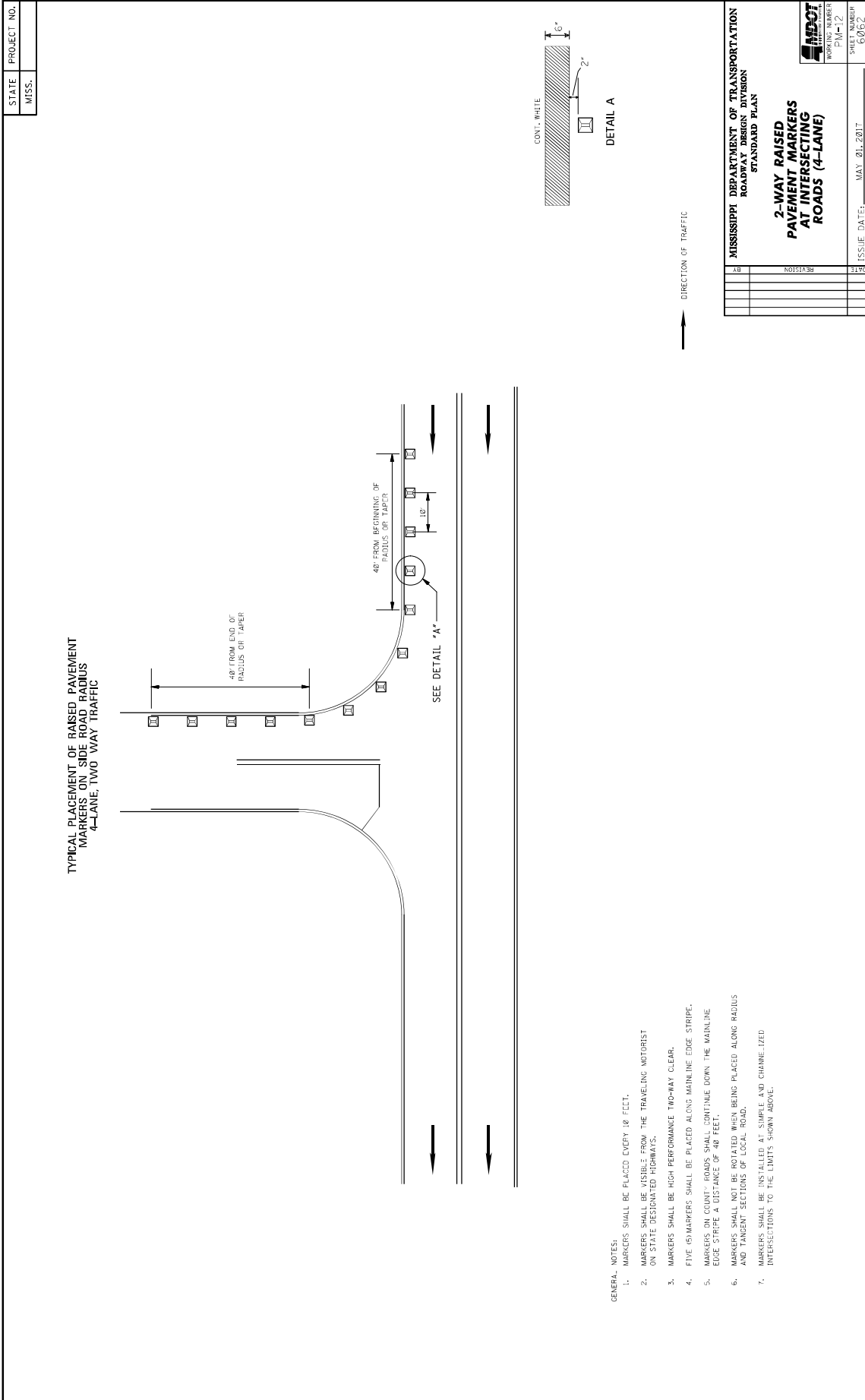

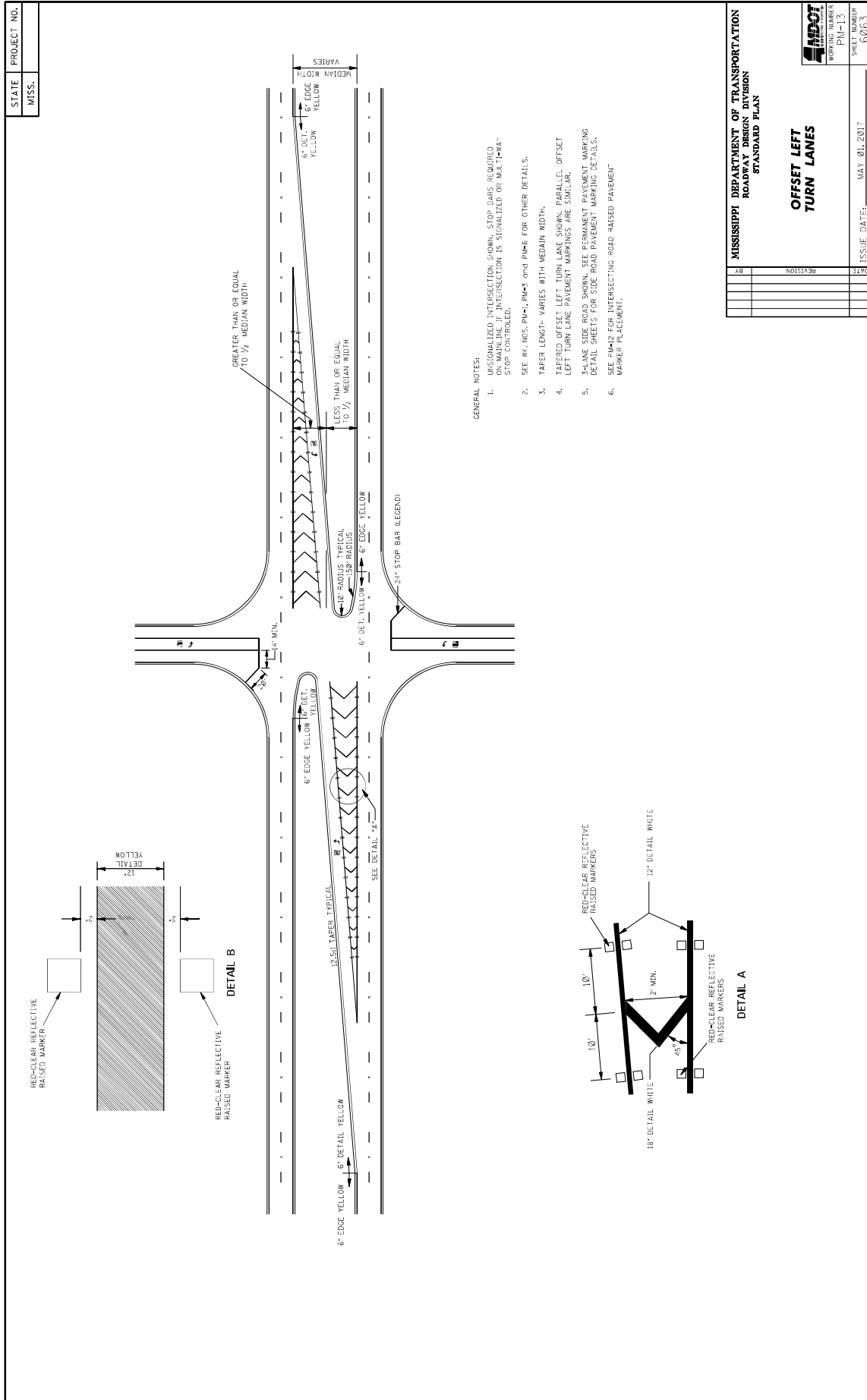

<b>MISSISSIPPI DEPARTMENT OF TRANSPORTATION</b>	
<b>ROADWAY DESIGN DIVISION</b>	
<b>STANDARD PLAN</b>	
<b>OFFSET LEFT TURN LANES</b>	
DATE	ISSUE DATE: MAY 01, 2017
BY	SHEET NUMBER 0263
REVISION	WORKING NUMBER PM-13

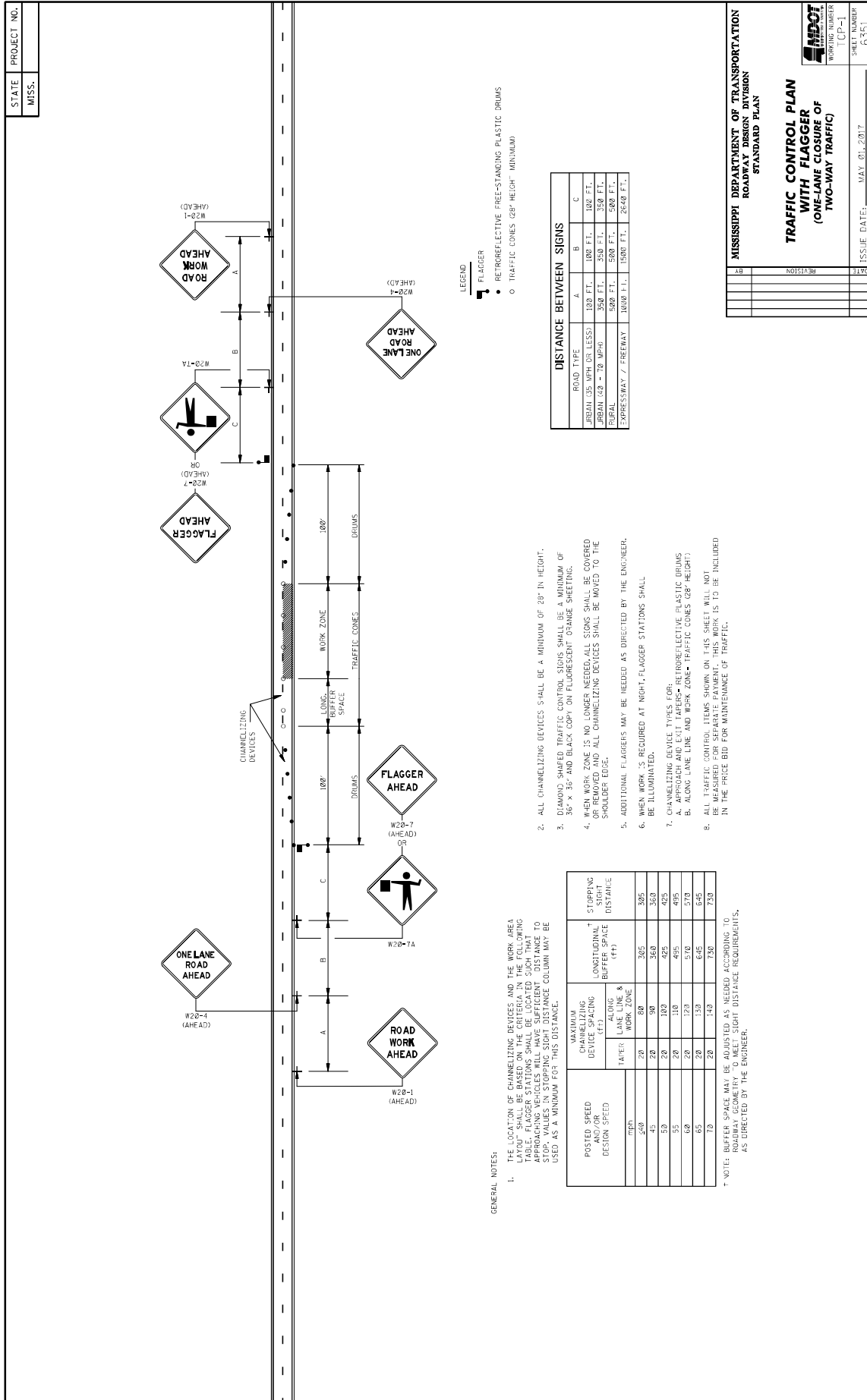



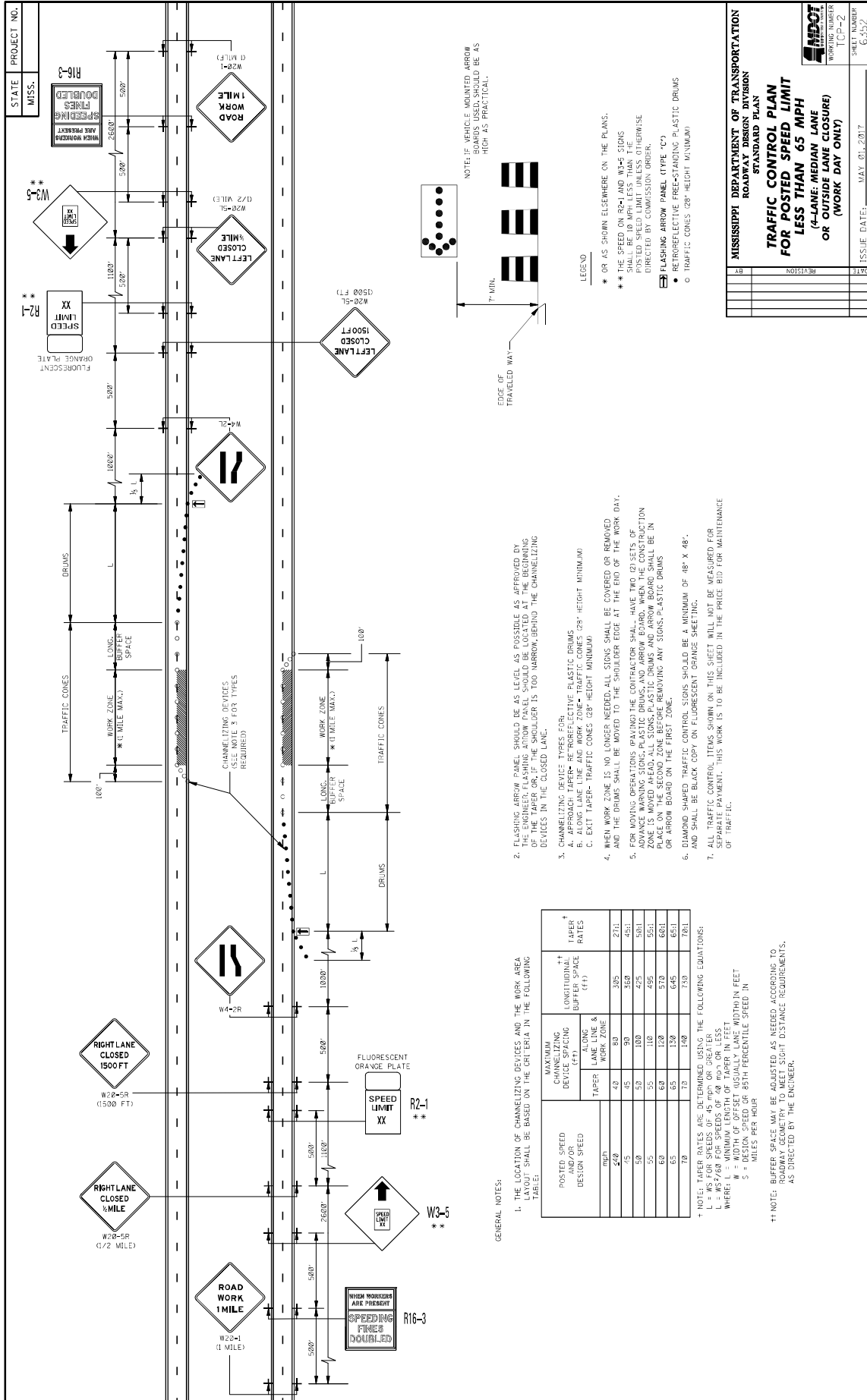

STATE PROJECT NO.  
MISS. R16-3

W20-1 (1 MILE)  
ROAD WORK 1 MILE  
W20-5L (1/2 MILE)  
LEFT LANE CLOSED 1/2 MILE  
W20-5R (1/2 MILE)  
RIGHT LANE CLOSED 1/2 MILE  
W20-11 (1500 FT)  
RIGHT LANE CLOSED 1500 FT  
W4-2R  
SPEED LIMIT XX  
R2-1  
SPEED LIMIT XX  
R16-3  
SPEEDING FINES DOUBLED  
W20-5  
SPEED LIMIT XX  
R2-1  
SPEED LIMIT XX  
R16-3  
SPEEDING FINES DOUBLED

TRAFFIC CONES  
DRUMS  
LONG. BUFFER SPACE  
WORK ZONE  
1/4 MILE MAX.  
CHANNELIZING DEVICES  
AS PER NOTE 3 FOR TYPES  
REQUIRED

100'  
500'  
1000'  
500'  
1000'  
500'  
1000'  
500'

100'  
500'  
1000'  
500'  
1000'  
500'

100'  
500'  
1000'  
500'  
1000'  
500'

100'  
500'  
1000'  
500'  
1000'  
500'

100'  
500'  
1000'  
500'  
1000'  
500'

100'  
500'  
1000'  
500'  
1000'  
500'

100'  
500'  
1000'  
500'  
1000'  
500'

100'  
500'  
1000'  
500'  
1000'  
500'

- GENERAL NOTES:
1. THE LOCATION OF CHANNELIZING DEVICES AND THE WORK AREA LAYOUT SHALL BE BASED ON THE CRT DATA IN THE FOLLOWING TABLE:

POSTED SPEED AND/OR DESIGN SPEED	MAXIMUM CHANNELIZING DEVICE SPACING (FT)		LONGITUDINAL BUFFER SPACE (FT)	TAPER RATES
	LANE LINE & WORK ZONE	WORK ZONE		
40	40	80	305	27:1
45	45	90	350	45:1
50	50	100	425	50:1
55	55	110	495	55:1
60	60	120	570	60:1
65	65	130	645	65:1
70	70	140	730	70:1

2. FLASHING ARROW PANEL SHOULD BE AS LEVEL AS POSSIBLE AS APPROVED BY THE ENGINEER. THE PANEL SHOULD BE LOCATED AT THE END OF THE WORK DAY OF THE TAPER OR, IF THE SHOULDER IS TOO NARROW, BEHIND THE CHANNELIZING DEVICES IN THE CLOSED LANE.
3. CHANNELIZING DEVICES TYPES FOR:
  - A. APPROACH TAPER- RETROREFLECTIVE PLASTIC DRUMS
  - B. ALONG LANE LINE AND WORK ZONE- TRAFFIC CONES (28" HEIGHT MINIMUM)
  - C. EXIT TAPER- TRAFFIC CONES (28" HEIGHT MINIMUM)
4. WHEN WORK ZONE IS NO LONGER NEEDED, ALL SIGNS SHALL BE COVERED OR REMOVED.
5. FOR MOVING OPERATIONS (PAVING) THE CONTRACTOR SHALL HAVE TWO (2) SETS OF ADVANCE WARNING SIGNS, PLASTIC DRUMS AND ARROW BOARD. WHEN THE CONSTRUCTION ZONE IS MOVED AHEAD, ALL SIGNS, PLASTIC DRUMS AND ARROW BOARD SHALL BE IN PLACE ON THE SECOND ZONE BEFORE REMOVING ANY SIGNS, PLASTIC DRUMS OR ARROW BOARD ON THE FIRST ZONE.
6. DIAMOND SHAPED TRAFFIC CONTROL SIGNS SHOULD BE A MINIMUM OF 48" X 48" AND SHALL BE BLACK COPY ON FLUORESCENT ORANGE SHEETING.
7. ALL TRAFFIC CONTROL ITEMS SHOWN ON THIS SHEET WILL NOT BE MEASURED FOR PAYMENT. THIS WORK IS TO BE INCLUDED IN THE PRICE BID FOR MAINTENANCE OF TRAFFIC.

- NOTE: TAPER RATES ARE DETERMINED USING THE FOLLOWING EQUATIONS:
- L = MS FOR SPEEDS OF 45 MPH OR GREATER
  - M = MINIMUM LENGTH OF TAPER IN FEET
  - W = WIDTH OF OFFSET (USUALLY LANE WIDTH) IN FEET
  - S = DESIGN SPEED OR 85TH PERCENTILE SPEED IN MILES PER HOUR
- †† NOTE: BUFFER SPACE MAY BE ADJUSTED AS NEEDED ACCORDING TO ROADWAY GEOMETRY TO MEET SIGHT DISTANCE REQUIREMENTS, AS DIRECTED BY THE ENGINEER.

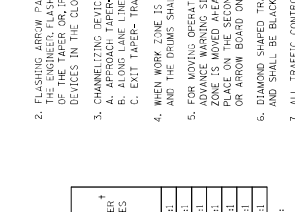

LEGEND

- \* OR AS SHOWN ELSEWHERE ON THE PLANS.
- \*\* THE SPEED ON R2-1 AND W4-5 SIGNS SHALL BE 10 MPH LESS THAN THE POSTED SPEED LIMIT UNLESS OTHERWISE DIRECTED BY COMMISSION ORDER.
- Ⓜ FLASHING ARROW PANEL (TYPE 'C')
- RETROREFLECTIVE FREE-STANDING PLASTIC DRUMS
- TRAFFIC CONES (28" HEIGHT MINIMUM)

MISSISSIPPI DEPARTMENT OF TRANSPORTATION  
ROADWAY DESIGN DIVISION  
STANDARD PLAN

**TRAFFIC CONTROL PLAN  
FOR POSTED SPEED LIMIT  
LESS THAN 65 MPH  
(4-LANE, MEDIAN LANE  
OR OUTSIDE LANE CLOSURE)  
OR (WORK DAY ONLY)**

ISSUE DATE: MAY 01, 2017

WORKING NUMBER: T1P-2  
SHEET NUMBER: 6252

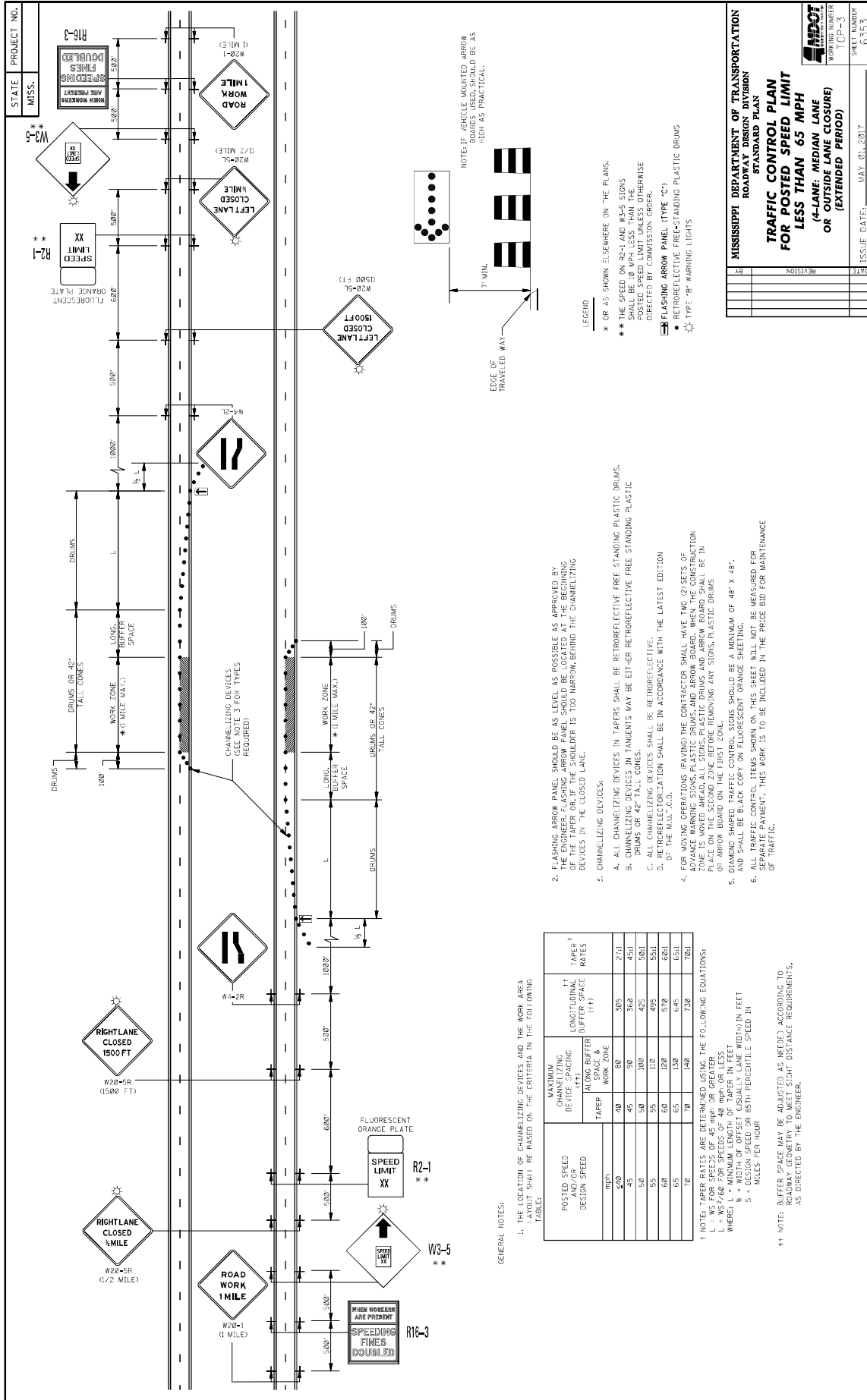

**MISSISSIPPI DEPARTMENT OF TRANSPORTATION**  
**ROADWAY DESIGN DIVISION**  
**STANDARD PLAN**  
**TRAFFIC CONTROL PLAN**  
**FOR POSTED SPEED LIMIT**  
**LESS THAN 65 MPH**  
**(4-LANE, MEDIAN LANE**  
**OR OUTSIDE LANE CLOSURE)**  
**(EXTENDED PERIOD)**

ISSUE DATE: MAY 01, 2017  
 SHEET NUMBER: TCP-3  
 6253

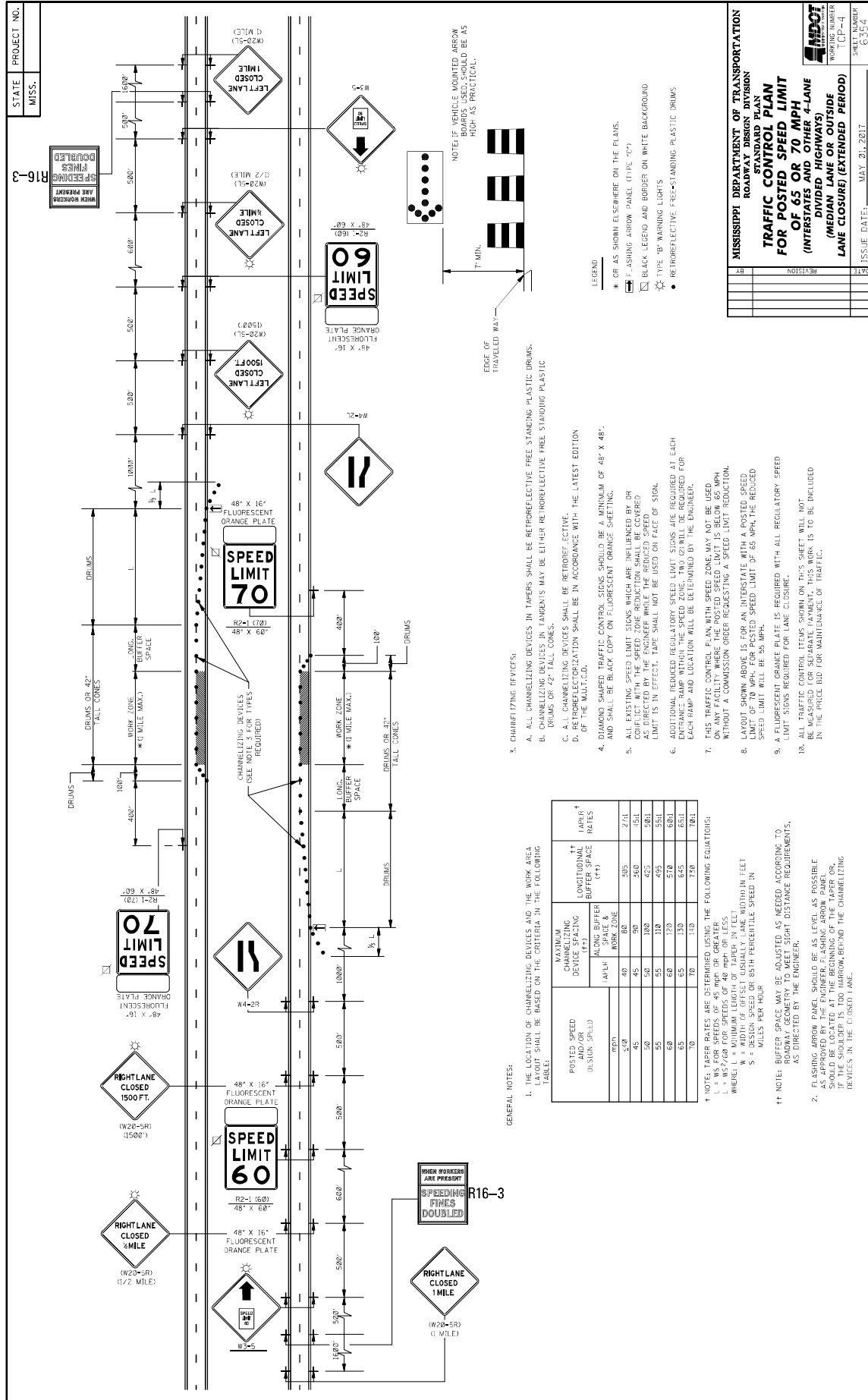

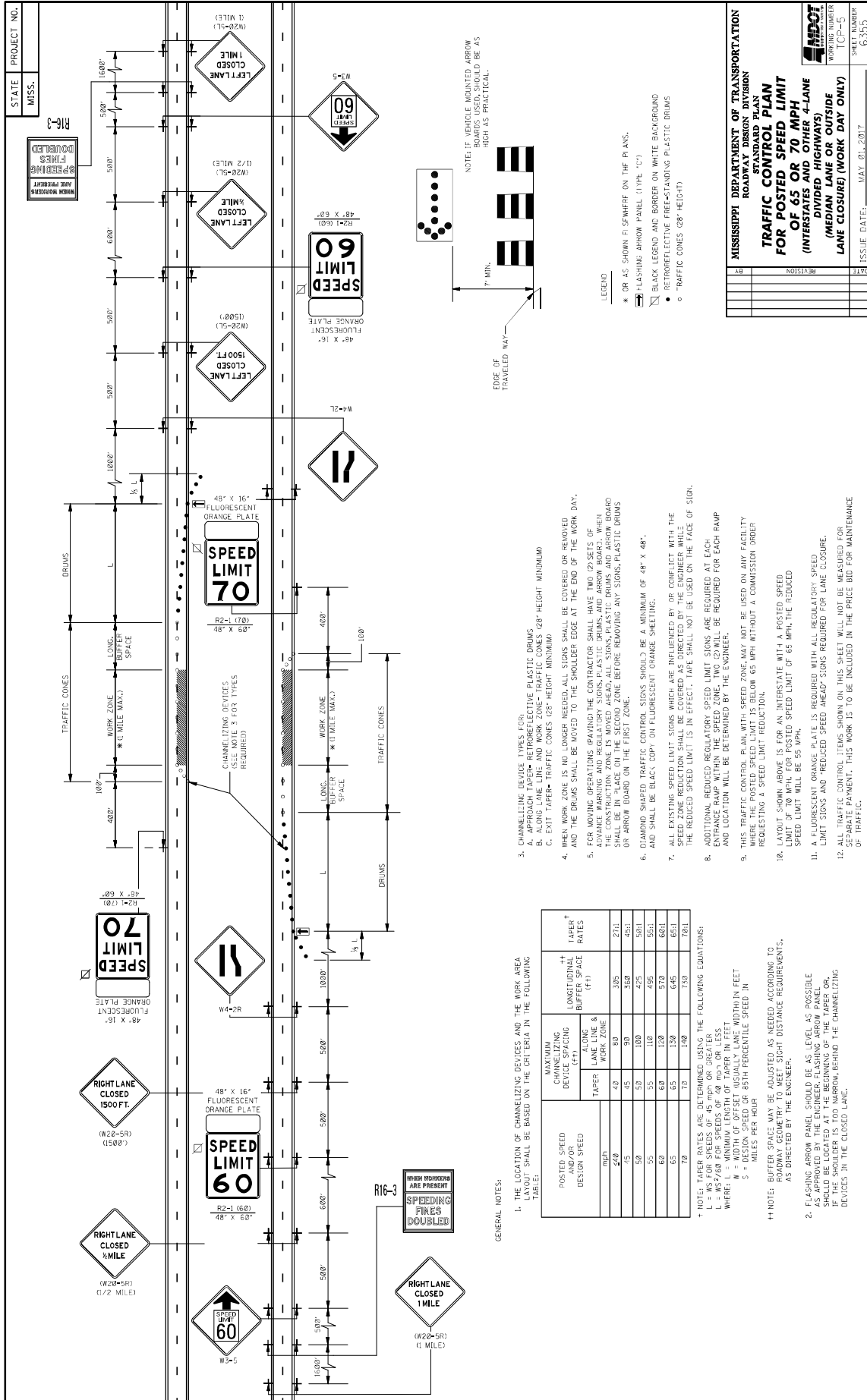

**GENERAL NOTES:**

1. THE LOCATION OF CHANNELIZING DEVICES AND THE WORK AREA LAYOUT SHALL BE BASED ON THE CRITERIA IN THE FOLLOWING TABLE:

POSTED SPEED AND/OR DESIGN SPEED (mph)	MAXIMUM CHANNELIZING DEVICE SPACING (FT)		LONGITUDINAL BUFFER SPACE (FT)	TAPER† RATES
	LANE LINE & WORK ZONE	WORK ZONE		
40	40	80	305	27:1
45	45	90	350	45:1
50	50	100	425	50:1
55	55	110	495	55:1
60	60	120	570	60:1
65	65	130	645	65:1
70	70	140	730	70:1

† NOTE: TAPER RATES ARE DETERMINED USING THE FOLLOWING EQUATIONS:  
L = MS FOR SPEEDS OF 45 MPH OR GREATER  
L = MS FOR SPEEDS OF 30 MPH OR GREATER  
WHERE: L = MINIMUM LENGTH OF TAPER IN FEET  
S = DESIGN SPEED OR 85TH PERCENTILE SPEED IN MILES PER HOUR

†† NOTE: BUFFER SPACE MAY BE ADJUSTED AS NEEDED ACCORDING TO LOCAL RIGHT OF WAY REQUIREMENTS, AS DIRECTED BY THE ENGINEER.

2. FLASHING ARROW PANEL SHOULD BE AS LEVEL AS POSSIBLE AND THE LONGEST LENGTH ALLOWED. THE PANEL SHOULD BE LOCATED AT THE BEGINNING OF THE TAPER OR IF THE SHOULDER IS TOO NARROW BEHIND THE CHANNELIZING DEVICES IN THE CLOSED LANE.

- CHANNELIZING DEVICE TYPES FOR:
  - APPROACH TAPER- RETROREFLECTIVE PLASTIC DRUMS
  - ALONG LANE LINE AND WORK ZONE- TRAFFIC CONES (28" HEIGHT- MINIMUM)
  - EXIT TAPER- TRAFFIC CONES (28" HEIGHT- MINIMUM)
- WHEN WORK ZONE IS NO LONGER NEEDED- ALL SIGNS SHALL BE COVERED OR REVOKED AND THE DRUMS SHALL BE MOVED TO THE SHOULDER EDGE AT THE END OF THE WORK DAY.
- FOR MOVING OPERATIONS (PAVING) THE CONTRACTOR SHALL HAVE TWO (2) SETS OF ADVANCE WARNING AND REGULATORY SIGNS, PLASTIC DRUMS, AND ARROW BOARDS. WHEN THE CONTRACTOR IS MOVING THE WORK ZONE, THE ADVANCE WARNING AND ARROW BOARD SHALL BE IN PLACE ON THE SECOND ZONE BEFORE REMOVING ANY SIGNS, PLASTIC DRUMS OR ARROW BOARD ON THE FIRST ZONE.
- DIAMOND SHAPED TRAFFIC CONTROL SIGNS SHOULD BE A MINIMUM OF 48" X 48".
- ALL EXISTING SPEED LIMIT SIGNS WHICH ARE INDICATED BY AN ORANGE LETTER WITH THE SPEED ZONE REDUCTION SHALL BE COVERED AS DIRECTED BY THE ENGINEER WHILE THE REDUCED SPEED LIMIT IS IN EFFECT. TAPE SHALL NOT BE USED ON THE FACE OF SIGN.
- ADDITIONAL REVOKED REGULATORY SPEED LIMIT SIGNS ARE REQUIRED AT EACH ENTRANCE RAMP WITHIN THE SPEED ZONE. TWO (2) WILL BE REQUIRED FOR EACH RAMP AND LOCATION WILL BE DETERMINED BY THE ENGINEER.
- THIS TRAFFIC CONTROL PLAN WITH SPEED ZONE MAY NOT BE USED ON ANY FACILITY REQUESTING A SPEED LIMIT REDUCTION.
- THIS TRAFFIC CONTROL PLAN WITH SPEED ZONE MAY NOT BE USED ON ANY FACILITY REQUESTING A SPEED LIMIT REDUCTION.
- LAYOUT SHOWN ABOVE IS FOR AN INTERSTATE WITH A POSTED SPEED LIMIT OF 70 MPH. FOR POSTED SPEED LIMIT OF 65 MPH, THE REDUCED SPEED LIMIT WILL BE 55 MPH.
- LIMIT SIGNS AND "REDUCED SPEED AHEAD" SIGNS REQUIRED FOR LANE CLOSURE.
- ALL TRAFFIC CONTROL ITEMS SHOWN ON THIS SHEET WILL NOT BE MEASURED FOR SEPARATE PAYMENT. THIS WORK IS TO BE INCLUDED IN THE PRICE BID FOR MAINTENANCE OF TRAFFIC.

STATE PROJECT NO.  
MISS.

WORKING NUMBER  
ICP-5

SHEET NUMBER  
03500

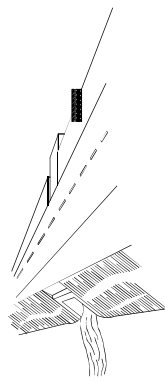
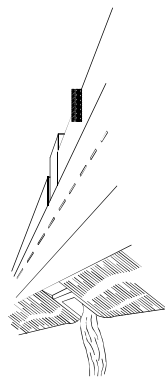
**WING BARRICADES**

1. WING BARRICADES ARE TYPE II BARRICADES ERECTED ON THE SHOULDER OF A ROADWAY OR RESTRICTED ROADWAY. WING BARRICADES MAY BE USED AS A MOUNTING FOR THE ADVANCE WARNING SIGNS OR FLASHERS.

2. WING BARRICADES SHOULD BE USED:

- IN ADVANCE OF A CONSTRUCTION PROJECT EVEN WHEN NO PART OF THE ROADWAY IS ACTUALLY CLOSED.
- IN ADVANCE OF ALL BRIDGE OR CULVERT WIDENING OPERATIONS.

**BARRICADE CLOSING A ROAD**

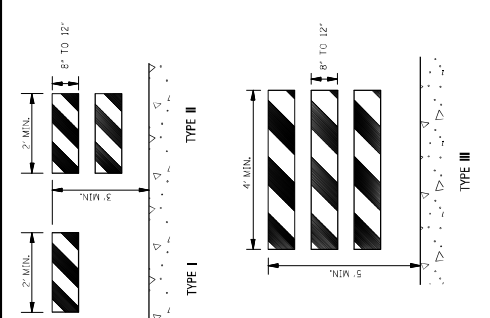

**BARRICADE CHARACTERISTICS**

	I	II	III
WIDTH OF RAIL **	8" MIN. - 12" MAX.	8" MIN. - 12" MAX.	8" MIN. - 12" MAX.
LENGTH OF RAIL **	24' MIN.	24' MIN.	48' MIN.
WIDTH OF STRIPE *	6"	6"	6"
HEIGHT	36" MIN.	36" MIN.	60" MIN.
NUMBER OF RETROREFLECTORIZED RAIL FACES	2 (ONE EACH DIRECTION)	4 (TWO EACH DIRECTION)	3 IF FACING TRAFFIC IN ONE DIRECTION 4 IF FACING TRAFFIC IN TWO DIRECTIONS

\* 1. FOR RAILS LESS THAN 36" LONG, 4" WIDE STRIPES MAY BE USED.

\*\* 2. BARRICADES INTENDED FOR USE ON EXPRESSWAYS, FREEWAYS AND OTHER HIGH SPEED ROADWAYS, SHALL HAVE A MINIMUM OF 270 IN<sup>2</sup> OF REFLECTIVE AREA FACING TRAFFIC.

**STANDARD BARRICADES**

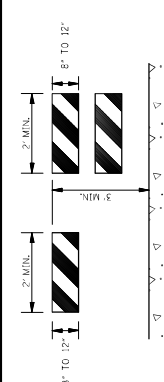
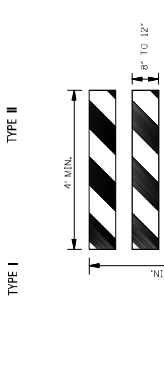
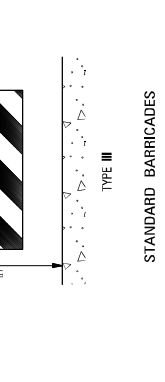
1. THE MARKING FOR BARRICADE RAILS SHALL BE ORANGE AND WHITE (SLOPING DOWNWARD AT AN ANGLE OF 45° IN THE DIRECTION OF TRAFFIC IS TO PASS).

2. RAIL STRIPE SHALL BE 6 INCHES, EXCEPT THAT 4-INCH WIDE STRIPES MAY BE USED IF RAIL LENGTHS ARE LESS THAN 36 INCHES.

3. DO NOT PLACE SANDBAGS OR OTHER DEVICES TO PROVIDE MASS ON THE BOTTOM RAIL THAT WILL BLOCK VIEW OR RAIL FACE.

4. FOR ADDITIONAL INFORMATION OR DETAILS, SEE METHOD, LATEST EDITION.

5. BARRICADES ARE CLASSIFIED BY FHWA AS CATEGORY II WHEN ZONE DEVICES WHICH REQUIRE SUCCESSFULLY CRASH TESTED. A LIST OF CRASHWORTHY BARRICADES AND OTHER CATEGORY II DEVICES CAN BE FOUND ON FHWA'S WEBSITE: [http://safety.fhwa.dot.gov/roadway\\_dept/pafety\\_guidance/road\\_hardware/cat2.cfm](http://safety.fhwa.dot.gov/roadway_dept/pafety_guidance/road_hardware/cat2.cfm)

**CHEVRON SIGN DETAIL**

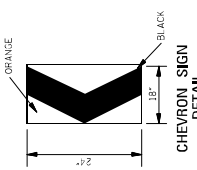

1. A CHEVRON SIGN CONSISTS OF A BLACK CHEVRON TYPE MARKING ON AN ORANGE BACKGROUND AND SHALL POINT IN THE DIRECTION OF TRAFFIC FLOW.

2. THE CHEVRON SIGN SHALL BE MOUNTED ON CRASHWORTHY SUPPORT.

3. CHEVRON SIGNS MAY BE USED TO SUPPLEMENT OTHER STANDARD DEVICES WHERE ONE OR MORE LANES ARE CLOSED FOR CONSTRUCTION OR MAINTENANCE. THEY SHOULD BE PLACED APPROXIMATELY 2' 40" BEHIND THE LANE TRANSITION STRIPE.

**PLASTIC DRUM STRIPING DETAIL**

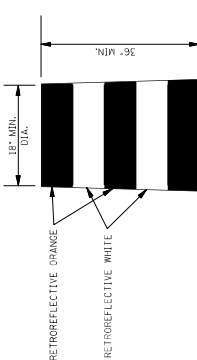

1. PLASTIC DRUMS SHALL BE ON END AND USED AS AN EXPEDIENT METHOD FOR TRAFFIC CHANNELIZATION. THE COLOR AND MARKING OF DRUMS SHALL BE CONSISTENT WITH MARKING STRIPING. THE PREFERRED COLOR OF DRUMS WITH MARKING STRIPING SHALL BE RETROREFLECTIVE. HORIZONTAL, CIRCUMFERENTIAL STRIPES (2 ORANGE & 2 WHITE) 6" WIDE.

2. DRUMS SHOULD NEVER BE PLACED IN THE ROADWAY WITHOUT WARNING SIGNS.

3. WHERE PRACTICAL PLASTIC DRUMS SHOULD BE PLACED NO CLOSER THAN 3'-0" FROM THE EDGE OF TRAVELED LANE.

**TYPE 3 OBJECT MARKER (OM-3R)**

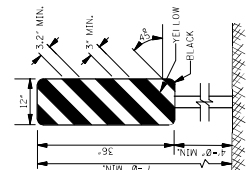

1. TYPE 3 OBJECT MARKERS SHALL BE USED AT ALL EXPOSED BRIDGE ABUTMENTS AND AT OTHER LOCATIONS AS DETERMINED NECESSARY BY THE ENGINEER.

2. THE OM-3R IS SIMILAR EXCEPT THE STRIPES SLOPE DOWNWARD FROM THE UPPER LEFT SIDE TO THE LOWER RIGHT SIDE AND SHALL BE PLACED ON THE LEFT SIDE OF THE OBJECT.

3. THE INSIDE EDGE OF THE MARKER SHALL BE IN LINE WITH THE INNER EDGE OF THE OBSTRUCTION.

**MISSISSIPPI DEPARTMENT OF TRANSPORTATION**  
ROADWAY DESIGN DIVISION  
STANDARD PLAN

**HIGHWAY SIGN AND BARRICADE DETAILS FOR CONSTRUCTION PROJECTS**

DATE	REVISION

ISSUE DATE: MAY 21, 2017

STATE MISS.	PROJECT NO.	
----------------	-------------	--

### MOBILE OPERATIONS ON MULTILANE ROAD

**MOBILE OPERATIONS ON MULTILANE ROAD**

### MOBILE OPERATIONS ON TWO-LANE ROAD

**MOBILE OPERATIONS ON TWO-LANE ROAD**

**NOTES FOR MULTILANE LANE OPERATION:**

- VEHICLES USED FOR THESE OPERATIONS SHOULD BE MADE HIGHLY VISIBLE WITH APPROPRIATE EQUIPMENT, SUCH AS FLASHING LIGHTS, ROTATING BEACONS, FLASGS, SIGNS, OR ARROW PANELS.
- SHADOW VEHICLE 2 SHOULD BE EQUIPPED WITH AN ARROW PANEL AND TRUCK MOUNTED ATTENUATOR (TMA), AN APPROPRIATE LANE CLOSURE SIGN SHOULD BE PLACED IN FRONT OF SHADOW VEHICLE 2 SO AS NOT TO OBSCURE THE ARROW PANEL.
- SHADOW VEHICLE 1 SHOULD BE EQUIPPED WITH AN ARROW PANEL AND TRUCK MOUNTED ATTENUATOR (TMA).
- SHADOW VEHICLE 2 SHOULD TRAVEL AT A VARYING DISTANCE FROM THE WORK OPERATION SO AS TO PROVIDE ADEQUATE SIGHT DISTANCE FOR TRAFFIC APPROACHING FROM THE REAR.
- WHEN ADEQUATE SHOULDER WIDTH IS NOT AVAILABLE, SHADOW VEHICLE 2 SHOULD BE ELIMINATED.
- ON HIGH-SPEED ROADWAYS, A THIRD SHADOW VEHICLE SHOULD BE USED (i.e., VEHICLE 3 ON THE SHOULDER OF PRACTICALLY, VEHICLE 2 IN THE CLOSED LANE, AND VEHICLE 1 IN THE CLOSED LANE).
- ARROW PANELS SHALL BE AS A MINIMUM TYPE B, 60" X 36" IN ACCORDANCE WITH THE CRITERIA PRESENTED IN THE MUTCD.
- WORK SHOULD NORMALLY BE DONE DURING OFF-PEAK HOURS.
- VEHICLE-MOUNTED SIGNS SHOULD BE MOUNTED WITH THE BOTTOM OF THE SIGN LOCATED AT A MINIMUM HEIGHT OF 48" ABOVE THE PAVEMENT AND SHALL NOT BE OBTURED BY EQUIPMENT OR SUPPLIES. SIGN LEGENDS SHALL BE COVERED OR TURNED FROM VIEW WHEN WORK IS NOT IN PROGRESS.
- ALL TRAFFIC CONTROL ITEMS SHOWN ON THIS SHEET WILL NOT BE MEASURED FOR SEPARATE PAYMENT. THIS WORK IS TO BE INCLUDED IN THE PRICE BID FOR MAINTENANCE OF TRAFFIC.

**NOTES FOR TWO-LANE OPERATION:**

- WHERE PRACTICAL AND WHEN NEEDED, THE WORK AND SHADOW VEHICLES SHOULD PULL OVER PERIODICALLY TO ALLOW TRAFFIC TO PASS. IF THIS CAN NOT BE DONE FREQUENTLY AS AN ALTERNATIVE, A "DO NOT PASS" SIGN MAY BE PLACED ON THE REAR OF THE VEHICLE BLOCKING THE LANE.
- THE DISTANCE BETWEEN THE WORK AND SHADOW VEHICLES MAY VARY ACCORDING TO TERRAIN, PAINT DRYING TIME, AND OTHER FACTORS. SHADOW VEHICLES ARE USED TO WARN TRAFFIC OF THE OPERATION AHEAD. WHENEVER ADEQUATE SIGHT DISTANCE IS NOT AVAILABLE, THE SHADOW VEHICLE SHOULD BE PLACED AS CLOSE AS POSSIBLE TO THE WORK VEHICLE. THE SHADOW VEHICLE SHOULD SLOW DOWN IN ADVANCE OF VERTICAL OR HORIZONTAL CURVES THAT RESTRICT SIGHT DISTANCE.
- ADDITIONAL SHADOW VEHICLES TO WARN AND REDUCE THE SPEED OF ONCOMING OR OPPOSING TRAFFIC MAY BE USED. POLICE PATROL CARS MAY BE USED FOR THIS PURPOSE.
- A TRUCK-MOUNTED ATTENUATOR (TMA) SHOULD BE USED ON THE SHADOW VEHICLE AND MAY BE USED ON THE WORK VEHICLE.
- THE WORK VEHICLE SHALL BE EQUIPPED WITH BEACONS AND THE SHADOW VEHICLE SHALL BE EQUIPPED WITH BEACONS. TRUCK-MOUNTED ATTENUATOR LIGHTS MOUNTED ON THE REAR, ADJACENT TO THE SIGN, SHADOW AND WORK VEHICLES SHALL DISPLAY FLASHING OR ROTATING BEACONS BOTH FORWARD AND TO THE REAR.
- VEHICLE-MOUNTED SIGNS SHOULD BE MOUNTED WITH THE BOTTOM OF THE SIGN LOCATED AT A MINIMUM HEIGHT OF 48" ABOVE THE PAVEMENT AND SHALL NOT BE OBTURED BY EQUIPMENT OR SUPPLIES. SIGN LEGENDS SHALL BE COVERED OR TURNED FROM VIEW WHEN WORK IS NOT IN PROGRESS.
- ARROW BOARD TO BE USED IN CAUTION MODE.
- ALL TRAFFIC CONTROL ITEMS SHOWN ON THIS SHEET WILL NOT BE MEASURED FOR SEPARATE PAYMENT. THIS WORK IS TO BE INCLUDED IN THE PRICE BID FOR MAINTENANCE OF TRAFFIC.

  

**MISSISSIPPI DEPARTMENT OF TRANSPORTATION**  
ROADWAY DESIGN DIVISION  
STANDARD PLAN

**TRAFFIC CONTROL PLAN**  
**MOBILE OPERATIONS**  
**MULTILANE ROADS**  
**TWO-LANE ROADS**

REV	REVISION	
1		
2		
3		
4		
5		
6		
7		
8		
9		
10		

ISSUE DATE: MAY 01, 2017  
SHEET NUMBER: TCP-9  
PROJECT NUMBER: 6359

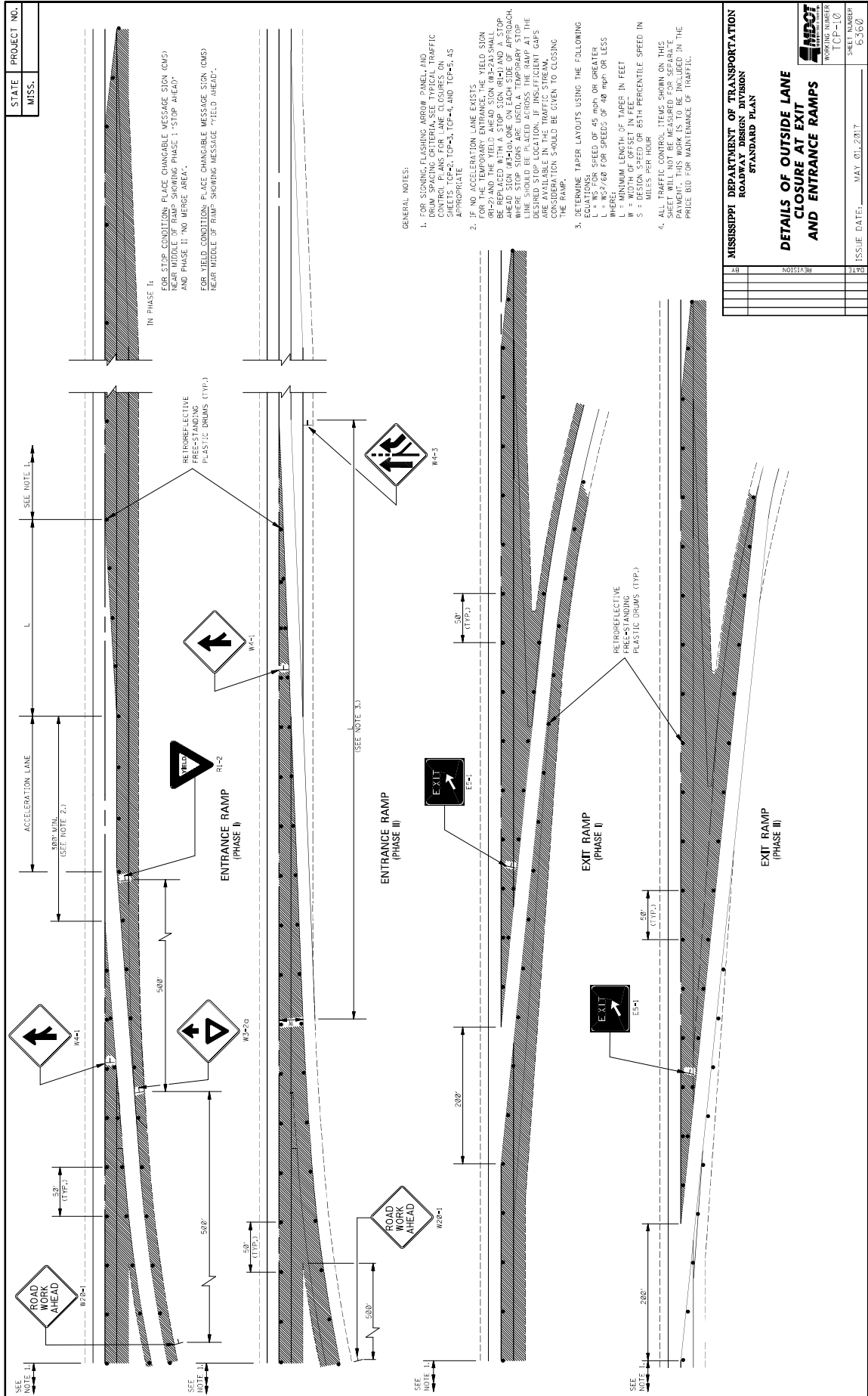

STATE PROJECT NO.  
MISS.

- GENERAL NOTES:
- FOR SIGNING FLASHING ARROW PANEL AND DRUM SPACING CRITERIA, SEE TYPICAL TRAFFIC CONTROL PLANS FOR LANE CLOSURES ON RAMP ENTRIES, T-2, T-3, T-4, T-5, T-6, T-7, T-8, T-9, T-10, T-11, T-12, T-13, T-14, T-15, T-16, T-17, T-18, T-19, T-20, T-21, T-22, T-23, T-24, T-25, T-26, T-27, T-28, T-29, T-30, T-31, T-32, T-33, T-34, T-35, T-36, T-37, T-38, T-39, T-40, T-41, T-42, T-43, T-44, T-45, T-46, T-47, T-48, T-49, T-50, T-51, T-52, T-53, T-54, T-55, T-56, T-57, T-58, T-59, T-60, T-61, T-62, T-63, T-64, T-65, T-66, T-67, T-68, T-69, T-70, T-71, T-72, T-73, T-74, T-75, T-76, T-77, T-78, T-79, T-80, T-81, T-82, T-83, T-84, T-85, T-86, T-87, T-88, T-89, T-90, T-91, T-92, T-93, T-94, T-95, T-96, T-97, T-98, T-99, T-100.
  - IF NO ACCELERATION LANE EXISTS FOR THE TEMPORARY ENTRANCE, THE YIELD SIGN (R1-2) AND THE YIELD AHEAD SIGN (R3-2a) SHALL BE REPLACED WITH A STOP SIGN (R1-1) AND A STOP AHEAD SIGN (R3-1). STOP SIGNS AND STOP AHEAD SIGNS SHOULD BE PLACED ACROSS THE RAMP AT THE DESIRED STOP LOCATION. INSUFFICIENT GAPS FOR STOPPING SHOULD BE AVOIDED. CONSIDERATION SHOULD BE GIVEN TO CLOSING THE RAMP.
  - DETERMINE TAPER LAYOUTS USING THE FOLLOWING EQUATIONS: SPEEDS OF 45 mph OR GREATER:  $L = W^2/60$  FOR SPEEDS OF 40 mph OR LESS WHERE: L = MINIMUM LENGTH OF TAPER IN FEET W = DESIGN SPEED OF 85th PERCENTILE SPEED IN MILES PER HOUR
  - ALL TRAFFIC CONTROL ITEMS SHOWN ON THIS SHEET WILL NOT BE MEASURED FOR SEPARATE PAYMENT. ITEMS SHOWN WILL BE PAID IN THE PRICE BID FOR MAINTENANCE OF TRAFFIC.

MISSISSIPPI DEPARTMENT OF TRANSPORTATION  
ROADWAY DESIGN DIVISION  
STANDARD PLAN

**DETAILS OF OUTSIDE LANE  
CLOSURE AT EXIT  
AND ENTRANCE RAMP**

ISSUE DATE: MAY 01, 2017

WORKING NUMBER: T-10  
SHEET NUMBER: 6560

DATE	REVISION

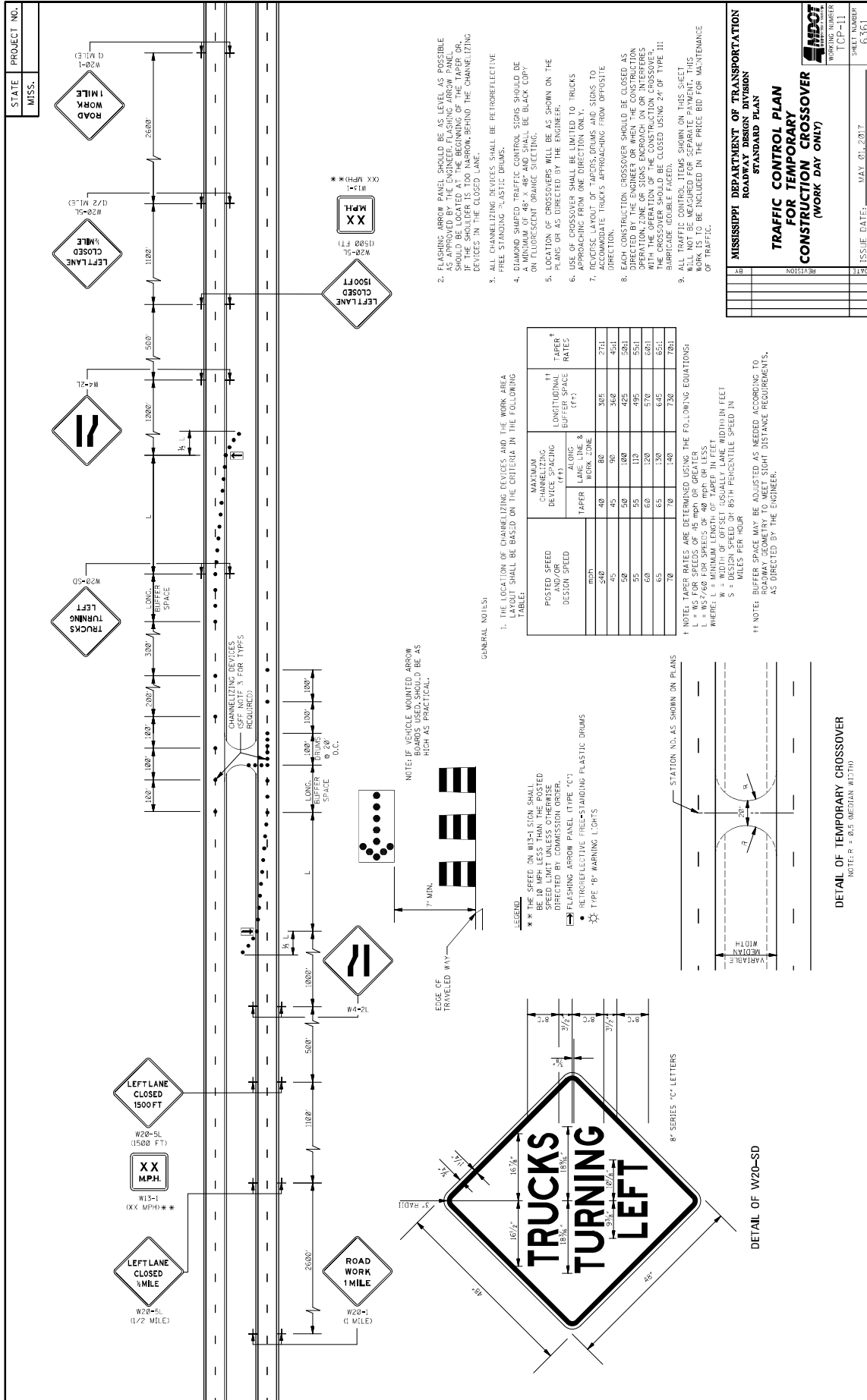

1. THE LOCATION OF CHANNELIZING DEVICES AND THE WORK AREA TAPERS SHALL BE BASED ON THE CRITERIA IN THE FOLLOWING TABLE:
2. FLASHING ARROW PANELS SHOULD BE AS LEVEL AS POSSIBLE AND APPROVED BY THE ENGINEER. FLASHING ARROW PANELS SHOULD BE LOCATED AT THE BEGINNING OF THE TAPER OR, IF THE SHOULDER IS TOO NARROW, BEHIND THE CHANNELIZING DEVICES IN THE CLOSED LANE.
3. ALL CHANNELIZING DEVICES SHALL BE RETROREFLECTIVE FREE STANDING PLASTIC DRAWS.
4. DIAMOND SHAPED TRAFFIC CONTROL SIGNS SHOULD BE BLACK COPY ON FLUORESCENT ORANGE SUCTING.
5. LOCATIONS OF CROSSOVERS WILL BE AS SHOWN ON THE PLANS OR AS DIRECTED BY THE ENGINEER.
6. USE OF CROSSOVER SHALL BE LIMITED TO TRUCKS APPROACHING FROM ONE DIRECTION ONLY.
7. REVERSE LAYOUT OF TAPERS, DRAWS AND SIGNS TO ACCOMMODATE TRUCKS APPROACHING FROM OPPOSITE DIRECTION.
8. EACH CONSTRUCTION CROSSOVER SHOULD BE CLOSED AS SOON AS POSSIBLE AND OPENED AS EARLY AS POSSIBLE WITH THE OPERATION OF THE CONSTRUCTION CROSSOVER.
9. ALL TRAFFIC CONTROL ITEMS SHOWN ON THIS SHEET WILL NOT BE MEASURED FOR SEPARATE PAYMENT, THIS WORK IS TO BE INCLUDED IN THE PRICE BID FOR MAINTENANCE OF TRAFFIC.

POSTED SPEED AND/OR DESIGN SPEED	MAXIMUM CHANNELIZING DEVICE SPACING (FT)	LONGITUDINAL BUFFER SPACE (FT)		TAPER RATES
		TYPE A	TYPE B	
40	40	80	305	27:1
45	45	90	362	45:1
50	50	100	425	50:1
55	55	110	495	55:1
60	60	120	570	60:1
65	65	130	645	65:1
70	70	140	730	70:1

NOTE: TAPER RATES ARE DETERMINED USING THE FOLLOWING EQUATIONS:  
 $L = WS^2/P$   
 $S = 65TH PERCENTILE SPEED IN MILES PER HOUR$   
 $P = MINIMUM LENGTH OF TAPER IN FEET$   
 $W = WIDTH OF OFFSET USUALLY LANE WIDTH IN FEET$   
 WHERE: L = MINIMUM LENGTH OF TAPER IN FEET  
 W = WIDTH OF OFFSET USUALLY LANE WIDTH IN FEET  
 S = 65TH PERCENTILE SPEED IN MILES PER HOUR

NOTE: BUFFER SPACE MAY BE ADJUSTED AS NEEDED ACCORDING TO ROADWAY GEOMETRY TO MEET SIGN JUSTANCE REQUIREMENTS, AS DIRECTED BY THE ENGINEER.



LEGEND:  
 \* X THE SPEED ON W4-2L SIGN SHALL BE 10 MPH LESS THAN THE POSTED SPEED AND/OR DESIGN SPEED AS DIRECTED BY COMMISSION ORDER.  
 FLASHING ARROW PANEL (TYPE 'C')  
 RETROREFLECTIVE FREE-STANDING PLASTIC DRAWS  
 TYPE 'B' WARNING LIGHTS

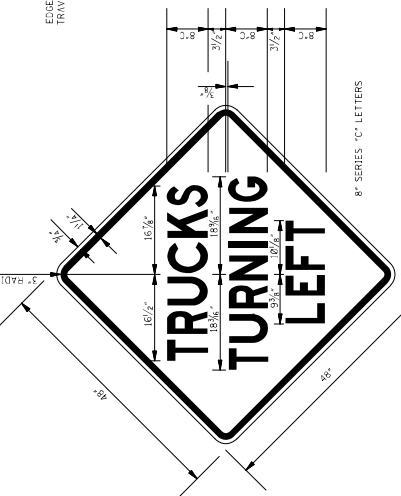

DETAIL OF W20-5D

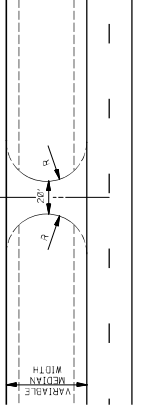

DETAIL OF TEMPORARY CROSSOVER  
 NOTE: P = 60 ft. MEDIAN W20-10'

STATE PROJECT NO. MISS.  
 MISS.

**MISSISSIPPI DEPARTMENT OF TRANSPORTATION**  
 ROADWAY DESIGN DIVISION  
 STANDARD PLAN  
**TRAFFIC CONTROL PLAN**  
**FOR TEMPORARY**  
**CONSTRUCTION CROSSOVER**  
 (WORK DAY ONLY)

WORKING NUMBER: TCP-11  
 SHEET NUMBER: 6361  
 ISSUE DATE: MAY 01, 2017



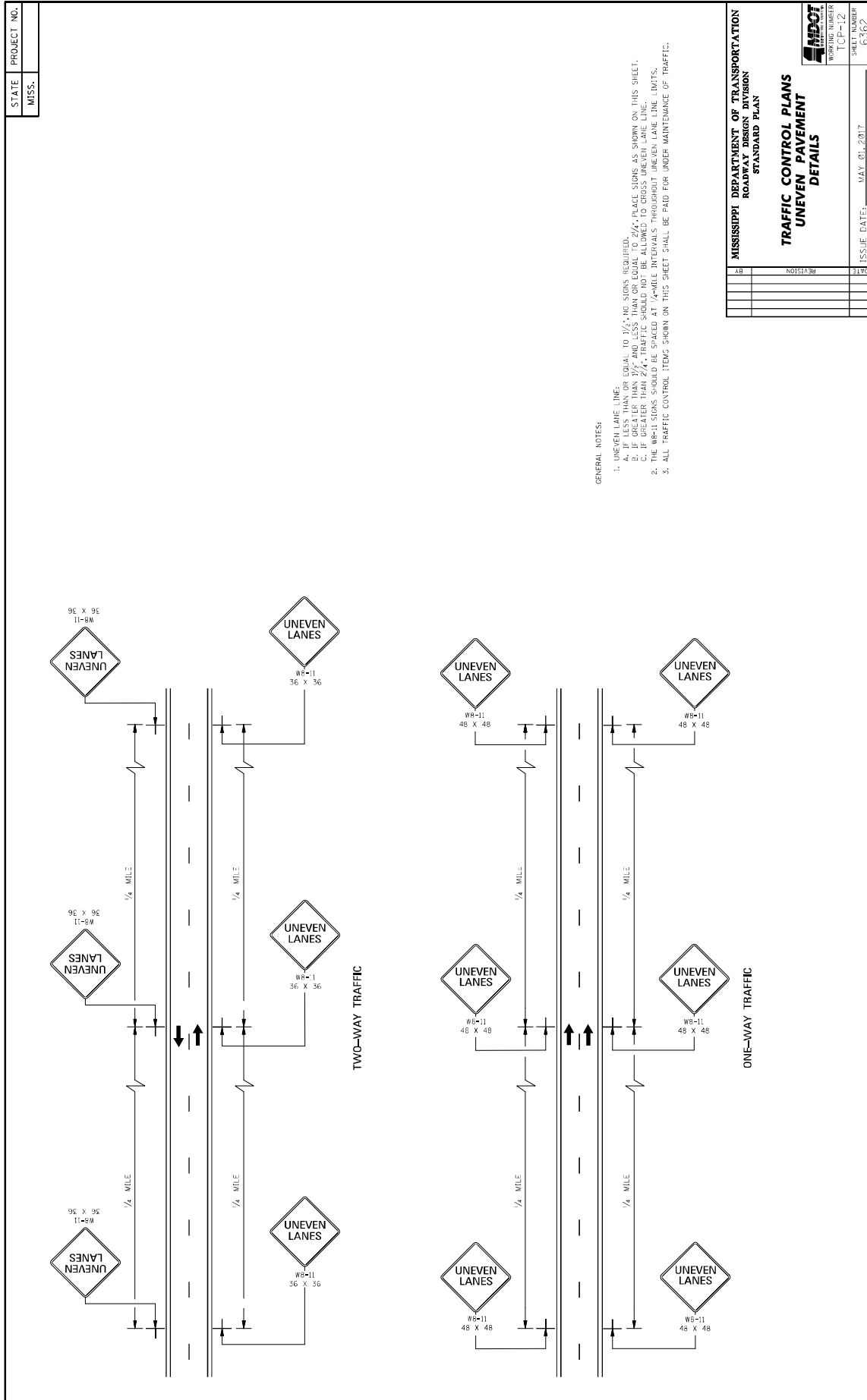

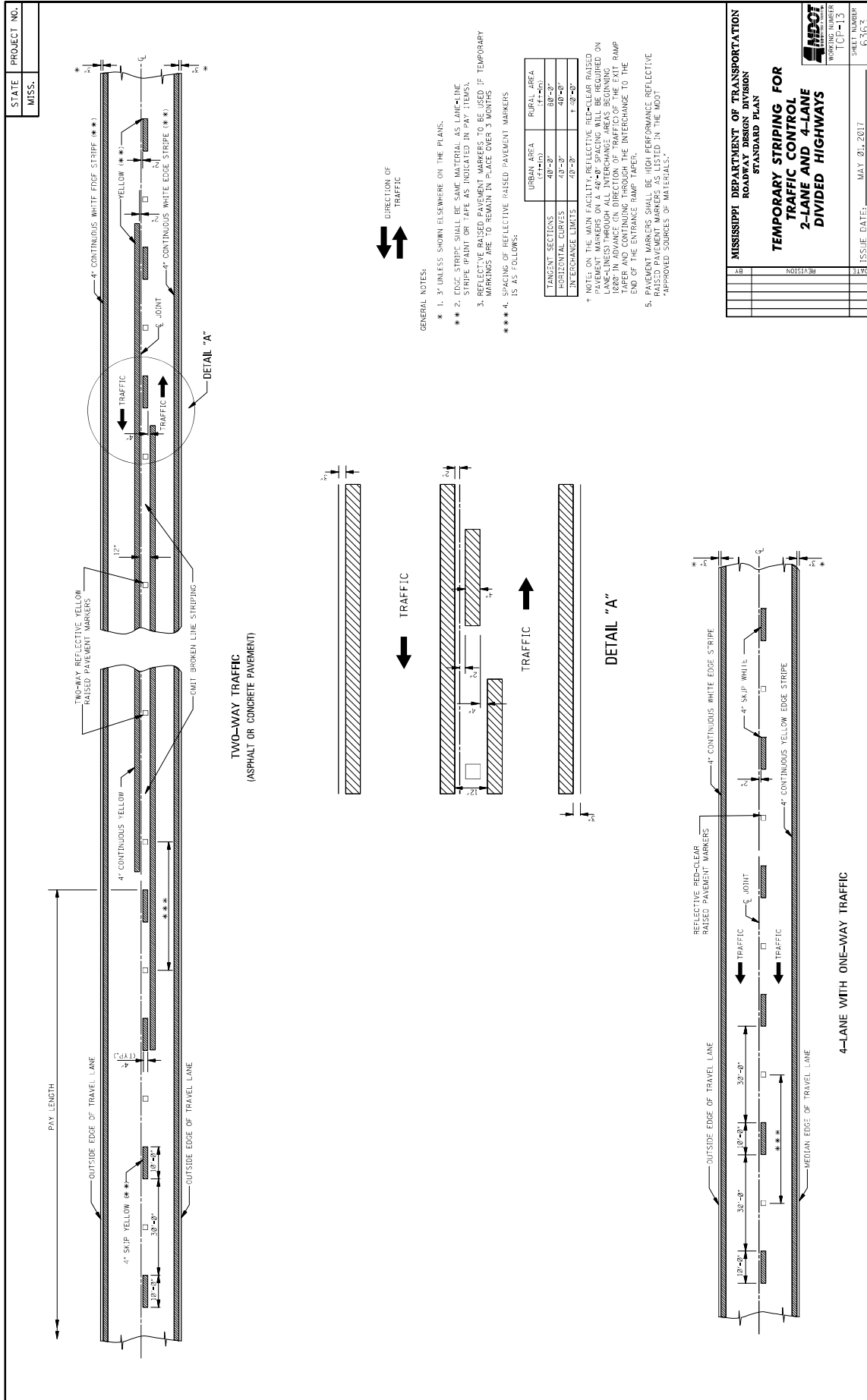

DATE	REVISION	
ISSUE DATE:	MAY 01, 2017	
SHEET NUMBER	TCP-13	
PROJECT NUMBER	6363	

**MISSISSIPPI DEPARTMENT OF TRANSPORTATION**  
**ROADWAY DESIGN DIVISION**  
**STANDARD PLAN**

**TEMPORARY STRIPING FOR**  
**2-LANE AND 4-LANE**  
**DIVIDED HIGHWAYS**

**APPROVED SOURCES OF MATERIALS:**

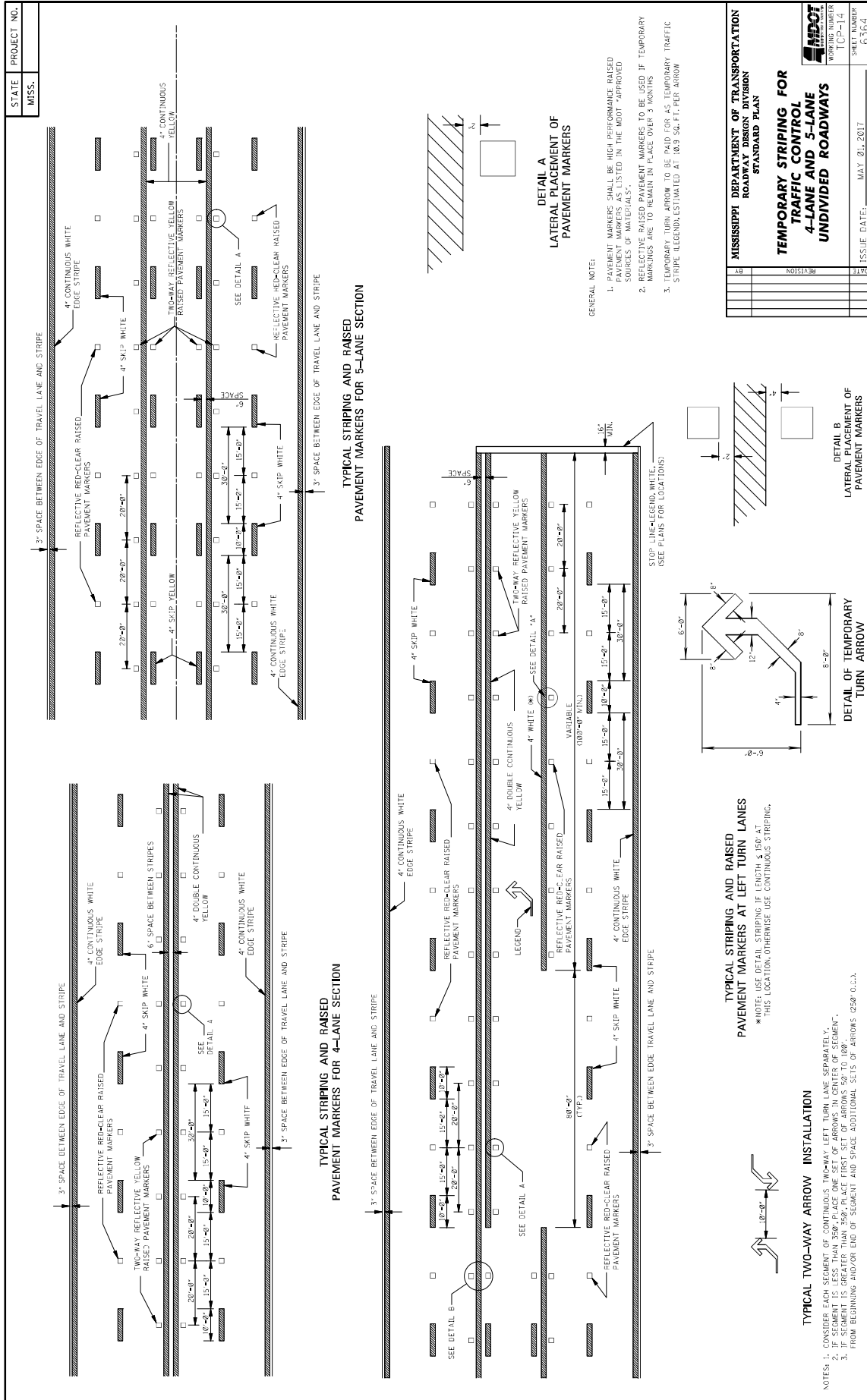

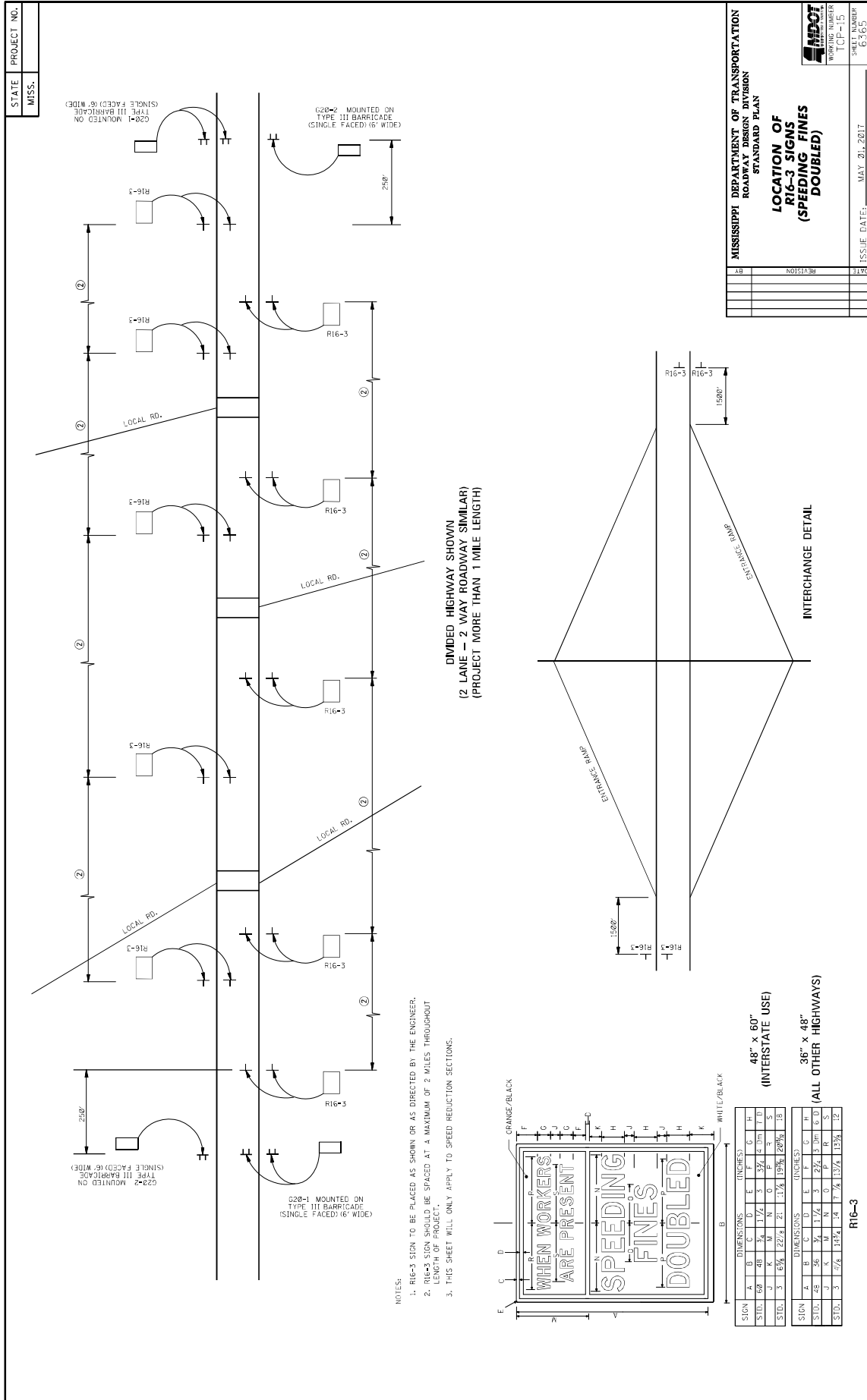

- NOTES:
1. R16-3 SIGN TO BE PLACED AS SHOWN OR AS DIRECTED BY THE ENGINEER.
  2. R16-3 SIGN SHOULD BE SPACED AT A MAXIMUM OF 2 MILES THROUGHOUT LENGTH OF PROJECT.
  3. THIS SHEET WILL ONLY APPLY TO SPEED REDUCTION SECTIONS.

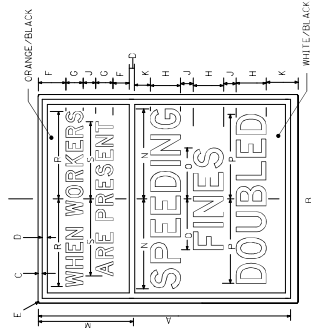

SIGN		DIMENSIONS (INCHES)											
A	B	C	D	E	F	G	H	I	J	K	L	M	N
STD.	6-0	48	36	1 1/4	5	3/4	4	3/16	1/2	3	3/4	1 1/2	1 1/2
STD.	3	1 1/2	1 1/4	1 1/4	1 1/4	1 1/4	1 1/4	1 1/4	1 1/4	1 1/4	1 1/4	1 1/4	1 1/4

SIGN		DIMENSIONS (INCHES)											
A	B	C	D	E	F	G	H	I	J	K	L	M	N
STD.	3	36	24	1 1/4	3	3/4	4	3/16	1/2	3	3/4	1 1/2	1 1/2
STD.	3	1 1/4	1 1/4	1 1/4	1 1/4	1 1/4	1 1/4	1 1/4	1 1/4	1 1/4	1 1/4	1 1/4	1 1/4

MISSISSIPPI DEPARTMENT OF TRANSPORTATION  
ROADWAY DESIGN DIVISION  
STANDARD PLAN

**LOCATION OF R16-3 SIGNS (SPEEDING FINES DOUBLED)**

ISSUE DATE: MAY 21, 2017

WORKING NUMBER ICF-15

SHEET NUMBER 6-163

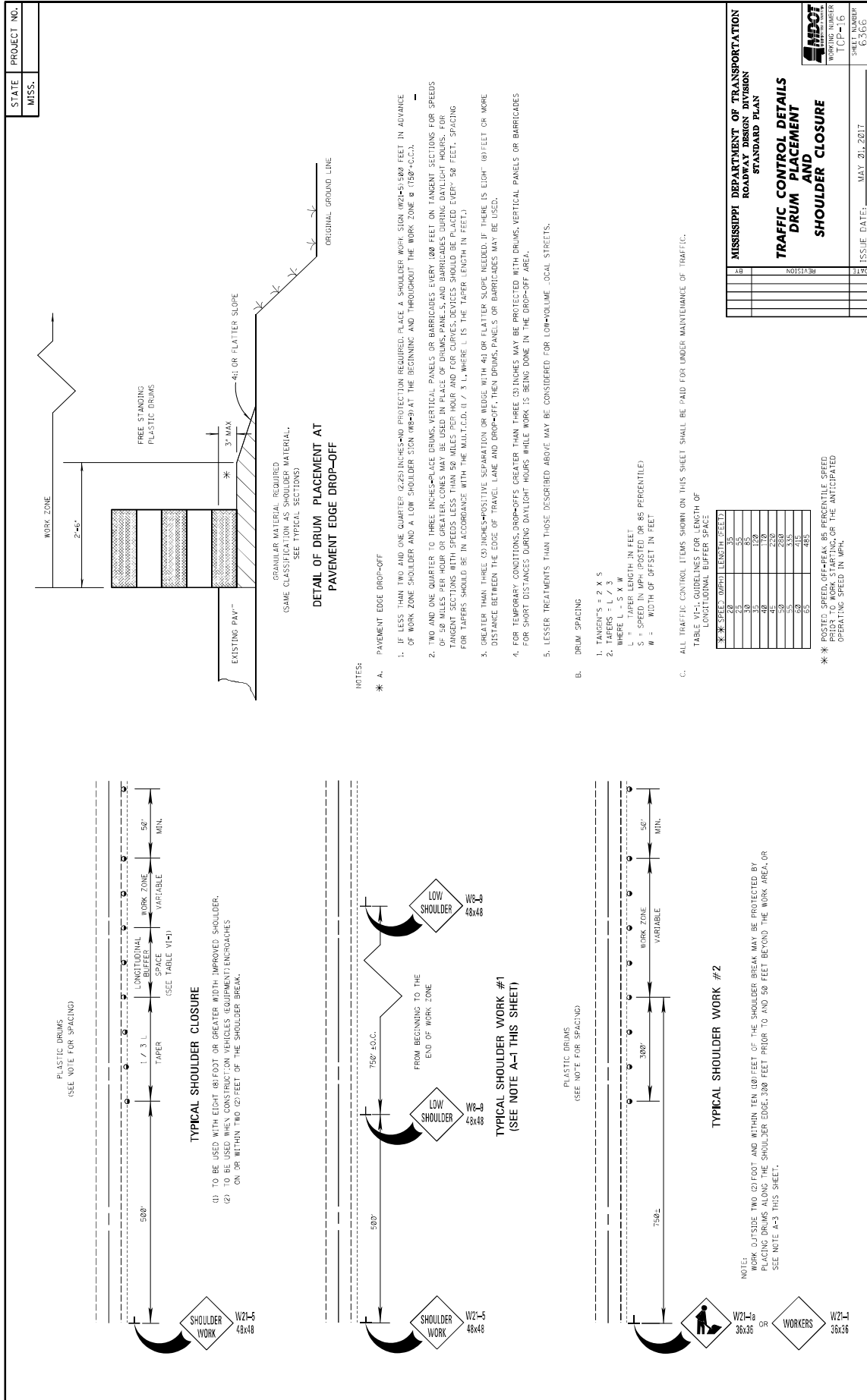

**MISSISSIPPI DEPARTMENT OF TRANSPORTATION**  
**ROADWAY DESIGN DIVISION**  
**STANDARD PLAN**

**TRAFFIC CONTROL DETAILS**  
**DRUM PLACEMENT**  
**SHOULDER CLOSURE**

ISSUE DATE: MAY 20, 2017

GENERAL NOTES

1. GROUND-IN RUMBLE STRIPES SHALL BE APPLIED TO ALL PAVED SHOULDERS OF ALL PAVED SHOULDERS ON THIS PROJECT.
2. GROUND-IN RUMBLE STRIPES SHALL BE APPLIED TO ALL EXISTING AND NEW ROADWAYS AND OTHER INTERSECTIONS IN NORMAL SHOULDER WIDTH AS DIRECTED BY THE ENGINEER.
3. COST TO BE PAID FOR USING APPROPRIATE PAY ITEMS.
4. GROUND-IN RUMBLE STRIPES SHALL BE APPLIED TO:
  - A. MAINLINE
  - B. INTERSECTING ROADWAY IF OVERLAP OR RECONSTRUCTED BEYOND NORMAL MAINLINE R.O.W.
  - C. ANY ROADWAY WITH EXISTING RUMBLE STRIPES PRIOR TO CONSTRUCTION.
5. DO NOT USE WHERE TRAVEL LANE IS LESS THAN 11' WIDE.

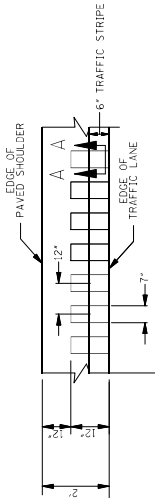

DETAIL "A"

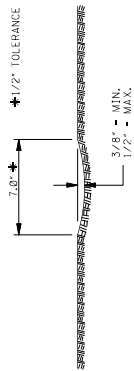

SECTION "A-A"

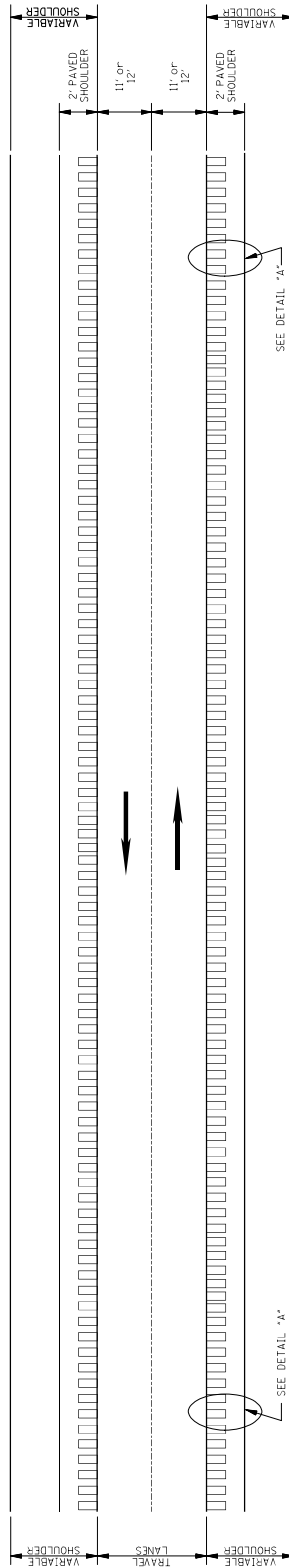

PLAN  
NOT TO SCALE

MISSISSIPPI DEPARTMENT OF TRANSPORTATION ROADWAY DESIGN DIVISION STANDARD PLAN	
DATE	ISSUE DATE: AUGUST 01, 2017
REVISION	PROJECT NUMBER RS-1
508	6064
REVISION	
DATE	

**RUMBLE STRIPES  
2-LANE HIGHWAYS  
(ASPHALT LANES,  
2-FT ASPHALT SHOULDERS)**

GENERAL NOTES

- GROUND-IN RUMBLE STRIPES SHALL BE APPLIED TO ALL PAVED SHOULDERS AND ALL PAVED SHOULDERS ON THIS PROJECT
- GROUND-IN RUMBLE STRIPES SHALL BE APPLIED TO ALL INTERSECTIONS, ROADWAYS AND OTHER INTERSECTIONS IN NORMAL SHOULDER WIDTH AS DIRECTED BY THE ENGINEER
- COST TO BE PAID FOR USING APPROPRIATE PAY ITEMS
- GROUND-IN RUMBLE STRIPES SHALL BE APPLIED TO:
  - MAINLINE
  - INTERSECTING ROADWAY IF OVERLAP OR RECONSTRUCTED BEYOND NORMAL MAINLINE R.O.W.
  - ANY ROADWAY WITH EXISTING RUMBLE STRIPES PRIOR TO CONSTRUCTION.

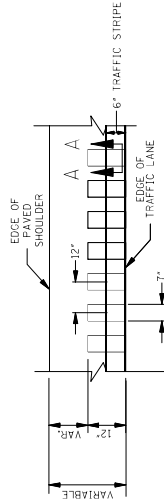
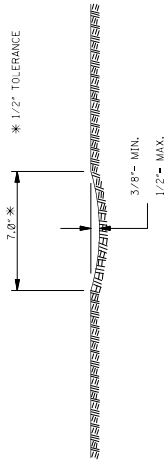

SECTION "A-A"

DETAIL "A"

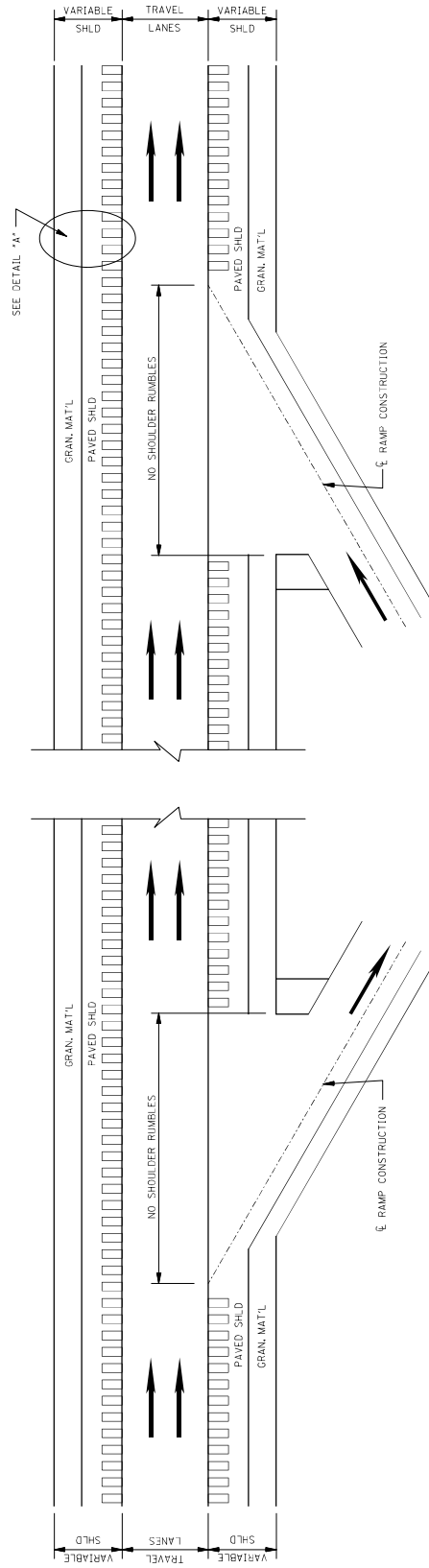

PLAN  
NOT TO SCALE

DETAILS OF  
RUMBLE STRIPS

MISSISSIPPI DEPARTMENT OF TRANSPORTATION  
ROADWAY DESIGN DIVISION  
STANDARD PLAN

**RUMBLE STRIPES  
4-LANE HIGHWAYS  
(ASPHALT LANES,  
2-FT OR WIDER,  
ASPHALT SHOULDERS)**

DATE	REVISION
05/08	05/08

ISSUE DATE: AUGUST 01, 2017

PROJECT NUMBER: 3599-2  
DRAWING NUMBER: 6065

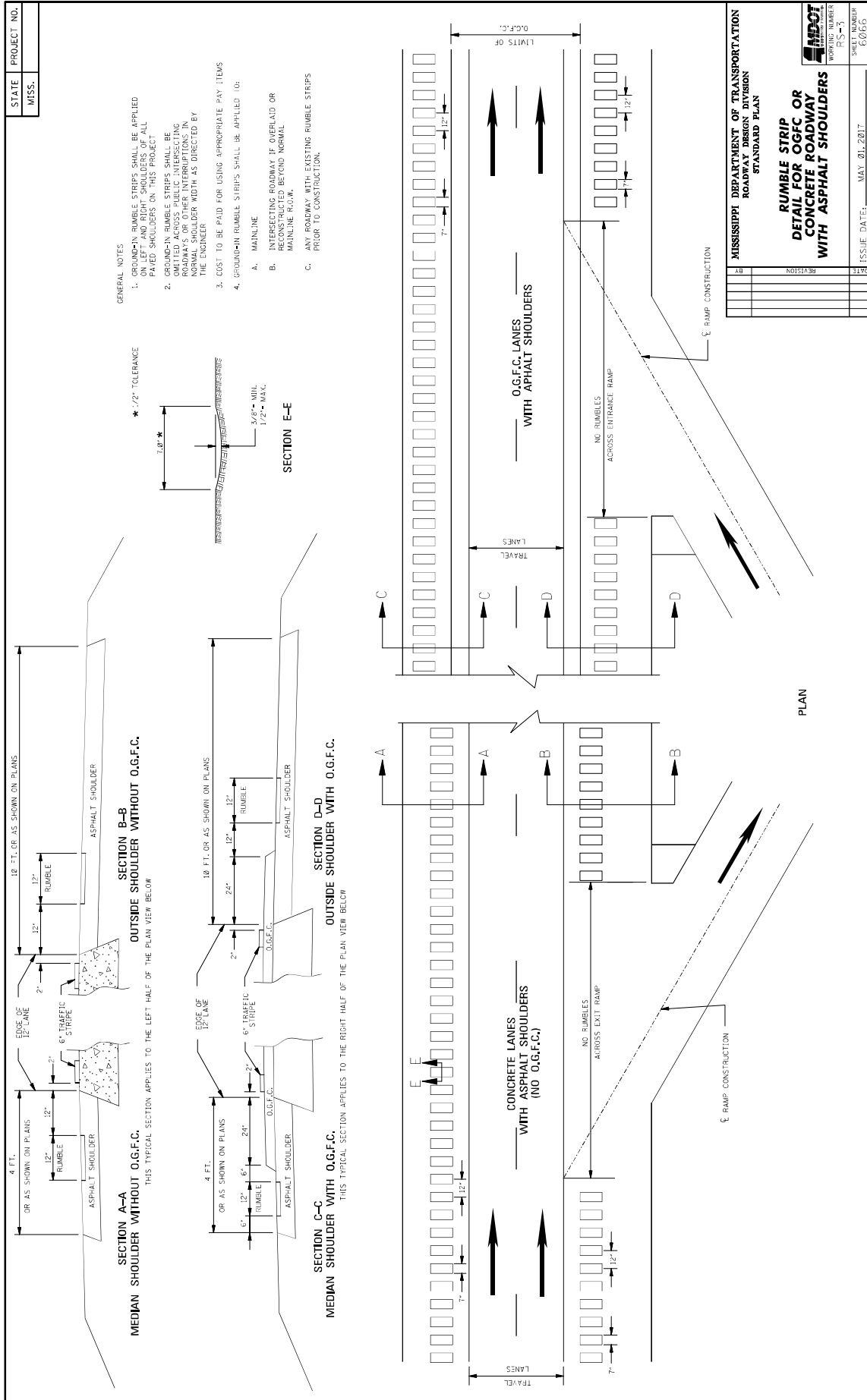



**MISSISSIPPI DEPARTMENT OF TRANSPORTATION**

**SECTION 904 - NOTICE TO BIDDERS NO. 3676**

**CODE: (SP)**

**DATE: 09/21/2021**

**SUBJECT: Asphalt Gyrotory Compactor Internal Angle Calibration**

Bidders are advised that by March 1, 2022, all asphalt gyrotory compactors shall be calibrated to an internal angle of  $1.16^{\circ} \pm 0.02^{\circ}$ . This requirement will be reflected in updates made to MT-78, MT-80, and MT-83. This calibration requirement also extends to all QC/QA testing.

## MISSISSIPPI DEPARTMENT OF TRANSPORTATION

SECTION 904 - NOTICE TO BIDDERS NO. 4113

CODE: (SP)

DATE: 03/23/2022

SUBJECT: Unique Entity ID (SAM) Requirement for Federal Funded Projects

Bidders are advised that the Prime Contractor must register and maintain a current registration in the System for Award Management (<http://sam.gov>) at all times during this project. Upon registration, the Contractor will be assigned a SAM Unique Entity ID.

Bidders are also advised that prior to the award of this contract, they MUST be registered, active, and have no active exclusions in the System for Award Management.

## MISSISSIPPI DEPARTMENT OF TRANSPORTATION

**SECTION 904 - NOTICE TO BIDDERS NO. 4702**

**CODE: (SP)**

**DATE: 11/22/2022**

**SUBJECT: App for Traffic Control Reports**

Bidders are advised that the Department has created a smart phone App for completing and submitting traffic control reports (Form CSD-762) required on this project. The Contractor who monitors traffic control activities and completes traffic control reports will be required to download and use this App when completing and submitting traffic control reports. The reports will then be readily available to all persons who need access to the forms. The App is free and is available for downloading at the following location.

<https://extacctmgmt.mdot.state.ms.us/>

**MISSISSIPPI DEPARTMENT OF TRANSPORTATION**

**SECTION 904 - NOTICE TO BIDDERS NO. 5518**

**CODE: (SP)**

**DATE: 01/11/2024**

**SUBJECT: Contract Time**

**PROJECT: STP-0018-02(059) / 108214301 & STP-0018-02(059) / 108214302  
Humphreys & Holmes Counties**

The completion of work to be performed by the Contractor for this project will not be a specified date but shall be when all allowable working days are assessed, or any extension thereto as provided in Subsection 108.06. It is anticipated that the Notice of Award will be issued no later than **March 12, 2024** and the date for Notice to Proceed / Beginning of Contract Time will be **April 11, 2024**.

Should the Contractor request a Notice to Proceed earlier than **April 11, 2024** and it is agreeable with the Department for an early Notice to Proceed, the requested date will become the new Notice to Proceed date. Regardless of whether or not an early Notice to Proceed is granted, contract time will start at the original Notice to Proceed date.

All requests for an early Notice to Proceed shall be sent to the Project Engineer who will forward it to the Contract Administration Division.

**121** Working Days have been allowed for the completion of work on this project.

## MISSISSIPPI DEPARTMENT OF TRANSPORTATION

SECTION 904 - NOTICE TO BIDDERS NO. 5519

DATE: 12/01/2023

SUBJECT: Specialty Items

PROJECT: STP-0018-02(059)/108214301 & STP-0018-02(059)/108214302 - HOLMES & HUMPHREYS

Pursuant to the provisions of Section 108, the following work items are hereby designated as "Specialty Items" for this contract. Bidders are reminded that these items must be subcontracted in order to be considered as specialty items.

### CATEGORY: DISPOSAL OF BUILDINGS, RIGHT OF WAY CLEARING & GRUBBING

---

Line No	Pay Item	Description
0040	202-B240	Removal of Traffic Stripe

### CATEGORY: GUARDRAIL, GUIDERAIL

---

Line No	Pay Item	Description
0150	606-B001	Guard Rail, Class A, Type 1
0160	606-D006	Guard Rail, Bridge End Section, Type A Modified
0170	606-D019	Guard Rail, Bridge End Section, Type H
0180	606-D022	Guard Rail, Bridge End Section, Type I
0190	606-E005	Guard Rail, Terminal End Section, Flared
0200	606-E007	Guard Rail, Terminal End Section, Non-Flared
0210	606-G001	Special Sections, Bridge Connector

### CATEGORY: MISCELLANEOUS/ SPECIALTY WORK ITEMS

---

Line No	Pay Item	Description
0130	423-A001	Rumble Strips, Ground In

### CATEGORY: PAVEMENT STRIPING AND MARKING

---

Line No	Pay Item	Description
0310	626-B002	6" Thermoplastic Double Drop Traffic Stripe, Continuous White
0320	626-D001	6" Thermoplastic Double Drop Traffic Stripe, Skip Yellow
0330	626-E001	6" Thermoplastic Double Drop Traffic Stripe, Continuous Yellow
0340	626-G004	Thermoplastic Double Drop Detail Stripe, White
0350	626-G005	Thermoplastic Double Drop Detail Stripe, Yellow
0360	626-H002	Thermoplastic Double Drop Legend, White
0370	627-J001	Two-Way Clear Reflective High Performance Raised Markers
0380	627-L001	Two-Way Yellow Reflective High Performance Raised Markers

### CATEGORY: TRAFFIC CONTROL - PERMANENT

---

Line No	Pay Item	Description
0390	630-G005	Type 3 Object Markers, OM-3R or OM-3L, Post Mounted

CATEGORY: TRAFFIC CONTROL - TEMPORARY

---

Line No	Pay Item	Description
0240	619-A1001	Temporary Traffic Stripe, Continuous White
0250	619-A2001	Temporary Traffic Stripe, Continuous Yellow
0260	619-A4002	Temporary Traffic Stripe, Skip Yellow
0270	619-A5001	Temporary Traffic Stripe, Detail
0280	619-A6002	Temporary Traffic Stripe, Legend
0290	619-F3001	Delineators, Guard Rail, White
0410	907-619-B001	Temporary Portable Rumble Strips

**MISSISSIPPI DEPARTMENT OF TRANSPORTATION**

**SECTION 904 – NOTICE TO BIDDERS NO. 5520**

**CODE: (SP)**

**DATE: 11/28/2023**

**SUBJECT: Scope of Work**

**PROJECT: STP-0018-02(059) / 108214301 & STP-0018-02(059) / 108214302  
Humphreys & Holmes Counties**

The contract documents do not include an official set of construction plans, but may, by reference, include some Standard Drawings when so specified in a Notice to Bidders entitled, “Standard Drawings.”

**MISSISSIPPI HIGHWAY 12  
MILL AND OVERLAY FROM US 49W AT BELZONI TO US 49E  
HUMPHREYS & HOLMES COUNTIES  
LOG MILE 0.000 to 3.389 - HOLMES COUNTY  
LOG MILE 11.047 to 22.446 - HUMPHREYS COUNTY**

In general, the work to be accomplished using the pay items and corresponding specifications set forth in this contract is to mill and overlay approximately 14.8 miles of SR 12 in Humphreys and Holmes Counties between the intersection of US 49W in Belzoni to the intersection of US 49E in Holmes County.

Work on the project shall consist of the following:

1. The Contractor shall erect and maintain construction signing, provide all signs, and traffic handling devices in accordance with the Traffic Control Plan. The costs for this work are to be included in the price bid for pay item number 618-A, Maintenance of Traffic. All traffic control devices on this project should comply with the latest version of the MUTCD. Fluorescent orange sheeting shall be used on all construction and traffic control signs except for those designated in the plans to be black legend and border on white background. The Contractor will be required to use 42-inch channelizer cones with 6-inch-wide reflective tape and 16-pound vertical panel bases for each cone.
2. The Contractor shall perform random clearing within the specified clearing limits, including vegetation overhanging the edge of the clearing limits. Overhanging vegetation shall be trimmed to a minimum height of seventy feet (70') above the ground elevation at the edge of the clearing limits. It is the intent of this Contract for the vegetation, except for any merchantable timber that the Contractor desires, to be mulched onsite and left in place. Mulched material shall be spread such that no more than four inches (4") in depth of material is placed in any location. This work shall be paid under pay item 201-D: Random Clearing, per Station. Each side of the roadway will be measured separately. Clearing within two feet (2') of fences, utilities, and other obstructions as directed by the Engineer within the R.O.W.

shall be omitted to avoid damage. The clearing limits are fifty feet (50') on each side of the roadway centerline within the limits of the project.

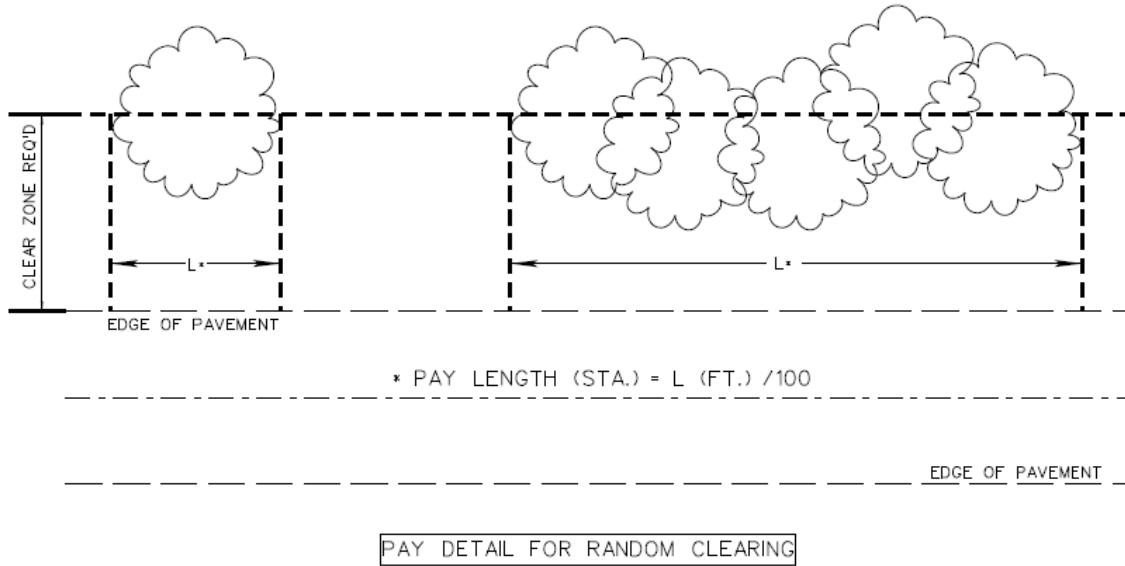

3. The Contractor shall fine mill SR 12 to a depth of 1½ “. The main roadway shall be milled on a 2% cross slope or the appropriate super-elevation in each direction from the center line. Milling shall be performed at bridge ends, guard rail pads, local roads, aprons, and other areas as designated by the Project Engineer to ensure smooth transition of the new overlay with existing grades. It is the Contractor’s responsibility to ensure the drainage of surface water from the milled areas including the use of shoulder cuts.

NOTE: There is an omitted section in the milling in Humphreys County from log mile 19.699 to log mile 20.742 (approximately 5,500 linear feet). The Contractor shall transition from the 1½ “milling depth to existing grade over 150 feet on each end of the omitted section.

NOTE: Temporary wedges of full lane width asphalt pavement shall be placed by the Contractor immediately after the fine milling process to allow the safe transition of traffic. The length of the wedges will be three feet (3’) for every ½ inch in height. These wedges shall be maintained in a satisfactory condition by the Contractor until the permanent asphalt pavement is placed. All costs for placing and maintaining these wedges shall be absorbed in other pay items. Cold mix will not be allowed.

4. The Contractor shall remove the designated failed areas on the main facility as directed by the Engineer. (See the Pavement Repair sheets for both Humphreys & Holmes Counties.)
  - A) Saw cut through the asphalt pavement.
  - B) Remove the failed pavement.
  - C) Remove any unsuitable material in the subgrade as directed by the Engineer. Removal of this material will be paid for as excess excavation.



- D) Back fill and stabilize the excavated subgrade and failed pavement with 19-mm, ST, Leveling asphalt. No lift of 19-mm asphalt pavement shall be greater than 3½” or as designated by the Engineer. There will be no density requirements on this asphalt. The Contractor shall compact each lift to refusal or as directed by the Engineer.

NOTE: Where the pavement repair is limited to the outside two (2’) of the lane, a minimum of 6” of 19-mm asphalt will be required.

5. The Contractor shall underseal the roadway and shoulders adjacent to each end of Bridge # 35.8 (Humphreys Co.) and Bridges # 47.5 & #49.5 (Holmes Co.). The undersealing shall extend from the bridge end out 25 feet along the center line. This work is to be paid under the 907-420-A: Underseal pay item. (See Special Provision 907-420).
6. The Contractor shall place a ¾” and variable lift of 9.5-mm, ST, Leveling asphalt on the main roadway between log mile 19.699 and log mile 20.742. The paving shall have a two percent (2%) cross slope or the appropriate super elevation rate in each direction from the centerline. The asphalt shall be placed in full lane width passes on the main roadway and in widths as necessary at intersections and other areas where the pavement width varies. Any work to control the laydown equipment for proper placement of the asphalt in the superelevated curves shall be absorbed by the Contractor at no additional cost to the State.
7. The Contractor shall place 1½” of 9.5-mm, ST asphalt on the main roadway having a two percent (2%) cross slope or the appropriate super elevation rate in each direction from the centerline. The asphalt shall be placed in full lane width passes on the main roadway and in widths as necessary at intersections and other areas where the pavement width varies. Any work to control the laydown equipment for proper placement of the asphalt in the superelevated curves shall be absorbed by the Contractor at no additional cost to the State.

Local roads shall be paved to the right-of-way or as directed by the Project Engineer. Any local roads that have not been paved shall receive 3” of asphalt pavement or as directed by the Project Engineer. Aprons shall be constructed at existing ramps that do not have paved aprons by placing 3” of asphalt pavement in widths and lengths as directed by the Project Engineer. Existing paved aprons are to be paved to match final main line grades. Any site grading at local roads, guardrail pads, aprons and other areas will not be measured for separate payment but will be considered an absorbed item. The asphalt for this work will be paid under 9.5-mm, ST, Leveling asphalt.

NOTE: Guard rail pads shall be paved on this project.

8. Temporary striping shall conform to finished stripe specifications for alignment, reflectivity, straightness, and neatness. Temporary striping shall be placed as needed for safe movement of traffic. All permanent pavement markings shall be hot thermoplastic. Edge line will be placed to maintain a 12-foot lane width. The Contractor shall mill a 12-inch rumble strip along the edge of pavement and spray 6-inch thermoplastic on the rumble strip to create a “Rumble Stripe” (See Rumble Stripe Detail.)

Note: The stripe removal pay item is for removal of existing striping on the concrete bridges.

9. The Contractor shall raise the grade of the shoulders to match the new asphalt pavement grade. The finished slope shall be a minimum of 4%. Vegetative material shall be removed prior to placement of material along the shoulders. Shoulders shall be bladed, shaped, and compacted throughout the length of the project regardless of whether new granular material is required. Any existing low shoulders or at any time there is a differential of more than 2", the Contractor shall raise the shoulder grade up to the current asphalt grade. This may be performed by pulling up existing shoulder material if possible or placing new granular material. Incidental work such as removing vegetation, blading shaping, and compacting shoulders including the base for paid aprons, and other incidental work that is necessary to complete this work will not be measured for separate payment and the cost will be included in the pay items bid. If a surplus of material occurs during the blading of the existing shoulder material, it shall be spread along the edge of the shoulders, fore slopes, or other adjacent areas as directed by the Project Engineer and will be an absorbed item. Material which cannot be placed in the adjacent areas and is deemed to be excess excavation by the Project Engineer shall be removed from the project site. Payment for the removal of excess material will be made using the pay item 203-G: Excess Excavation.
10. The Contractor shall install guard rail on the project using the guard rail pay items in the proposal. (See the included Guardrail sheets for both Humphreys & Holmes Counties.) Type III post mounted object markers shall be installed at all bridge ends.
11. Raised pavement markers shall be placed at 80-foot intervals in tangents and 40-foot intervals in curves & urban areas along the centerline or roadway. Existing raised pavement markers shall be removed prior to the placement of asphalt and shall be considered an absorbed item of work.

NOTE: As part of the final clean-up, the Contractor shall sweep clean and removal all debris on all bridges within the project limits. All costs for this work will be absorbed in the other pay items bid.

PAVEMENT REPAIR HUMPHREYS COUNTY

No.	Log Mile	Lane	Location Lat.	Location Long.	Length (LF)	Width (LF)	Area(SY)	Excess Excav. (CY)	Asphalt 19-mm (ton)	Saw Cut (LF)
1	12.9370	EB	33.16808	-90.46693	120	2	27	9	18	124
2	17.6420	EB	33.18454	-90.39150	40	2	9	3	6	44
3	18.6890	WB	33.17150	-90.38389	10	2	2	1	2	14
4	18.7220	WB	33.17115	-90.38351	12	2	3	1	2	16
5	19.3700	EB	33.16975	-90.37270	10	2	2	1	2	14
6	19.5600	WB	33.16950	-90.36944	10	4	4	1	3	18
					<b>Total</b>		<b>47</b>	<b>16</b>	<b>33</b>	<b>230</b>
							<b>SY</b>	<b>CY</b>	<b>Ton</b>	<b>LF</b>

**PAVEMENT REPAIR HOLMES COUNTY**

No.	Log Mile	Lane	Location		Length (LF)	Width (LF)	Area(SY)	Excess Excav. (CY)	Asphalt 19-mm (Ton)	Saw Cut (LF)
			Lat.	Long						
7	0.291	EB	33.14216	-90.32651	60	14	93	31	63	88
8	0.291	WB	33.14216	-90.32651	60	14	93	31	63	88
<b>Total</b>							<b>186</b>	<b>62</b>	<b>126</b>	<b>176</b>
							<b>(SY)</b>	<b>(CY)</b>	<b>Ton</b>	<b>(LF)</b>

GUARD RAIL HUMPHREYS CO.

Station	Removal	w-beam	Terminals		Br. End Sect.	Br. End Sect.	Br. End Sect.	Type H	Type I	Br. Rail Connector	Delinicator		Type 3
			Flared	Non-flared							EA	EA	
Br. 35.5	102	37,500	1				1				5	EA	1
Br. 35.5	202	137,500	1				1				10	EA	1
Br. 35.5	202	137,500	1				1				10	EA	1
Br. 35.5	102	37,500	1				1				5	EA	1
	<b>608</b>	<b>350</b>	<b>4</b>				<b>4</b>				<b>30</b>	<b>EA</b>	<b>4</b>
	LF	LF	EA				EA				EA	EA	EA

Station	Removal LF	w-beam LF	Terminals		Br. End Sect.		Br. End Sect.		Br. End Sect.		Br. Rail Connector EA	Delinator White EA	Type 3 Obj. Marks. EA
			Flared EA	Non-flared EA	Type A Mod EA	Type H EA	Type I EA	Type I EA					
Br. 47.5	225	163.000		1	1						1	6	1
Br. 47.5	125	62.500	1		1						1	5	1
Br. 47.5	125	62.500	1		1						1	5	1
Br. 47.5	213	150.000	1		1						1	6	1
Br. 49.5	208	150.000	1					1				6	1
Br. 49.5	121	62.5	1					1				5	1
Br. 49.5	121	62.5	1					1				5	1
Br. 49.5	208	150	1					1				6	1
	<b>1346</b>	<b>863</b>	<b>7</b>	<b>1</b>	<b>4</b>			<b>4</b>		<b>4</b>	<b>4</b>	<b>44</b>	<b>8</b>
	LF	LF	EA	EA	EA			EA		EA	EA	EA	EA

## MISSISSIPPI DEPARTMENT OF TRANSPORTATION

SECTION 904 - NOTICE TO BIDDERS NO. 5551

CODE: (IS)

DATE: 12/06/2023

SUBJECT: Federal Bridge Formula

Bidders are hereby advised that the latest revision of Federal Highway Administration Publication No. FHWA-HOP-06-105, **BRIDGE FORMULA WEIGHTS**, dated August 2006, is made a part of this contract when applicable.

Prior to the preconstruction conference, the Contractor shall advise the Engineer, in writing, what materials, if any, will be delivered to the jobsite via Interstate route(s).

Copies of the **BRIDGE FORMULA WEIGHTS** publication may be obtained by contacting:

Federal Highway Administration  
400 7<sup>th</sup> Street, SW  
Washington, DC 20590  
(202) 366-2212

or

[https://ops.fhwa.dot.gov/freight/publications/brdg\\_frm\\_wghts/](https://ops.fhwa.dot.gov/freight/publications/brdg_frm_wghts/)

## MISSISSIPPI DEPARTMENT OF TRANSPORTATION

### SUPPLEMENT TO NOTICE TO BIDDERS NO. 5605

**DATE: 01/12/2024**

The goal is 6 percent for the Disadvantaged Business Enterprise. All Bidders are required to submit Form OCR-481 for all DBEs. Bidders are advised to check the bid tabulation link for this project on the MDOT website at:

[https://mdot.ms.gov/portal/current\\_letting](https://mdot.ms.gov/portal/current_letting)

Bid tabulations are usually posted by 3:00 pm on Letting Day.



# MISSISSIPPI DEPARTMENT OF TRANSPORTATION

SECTION 904 – NOTICE TO BIDDERS NO. 5605

CODE: (IS)

DATE: 01/12/2024

SUBJECT: Disadvantaged Business Enterprises in Federal-Aid Highway Construction

## **DEFINITIONS**

For purposes of this provision, the following definitions will apply:

“DOT” means the United States Department of Transportation.

“DBE” means disadvantaged business enterprise.

“MDOT” means the Mississippi Department of Transportation.

“DBE Program” means MDOT’s DBE Program.

This Contract is subject to the “Moving Ahead for Progress in the 21st Century Act (Map-21)” and applicable requirements of 49 C.F.R. part 26. Portions of the Act are set forth in this Notice as applicable to compliance by the contractor and all of the Act, and MDOT’s DBE Program, is incorporated by reference herein.

MDOT has developed a Disadvantaged Business Enterprise Program (“DBE Program”) that is applicable to this Contract and is made a part thereof by reference.

Copies of the DBE Program Manual may be obtained from:

Office of Civil Rights  
Mississippi Department of Transportation  
P.O. Box 1850  
Jackson, Mississippi 39215-1850

or can be found on MDOT’s website at [www.mdot.ms.gov](http://www.mdot.ms.gov) under the Business Center under Civil Rights tab.

## **POLICY**

It is the policy of MDOT to provide a level playing field, to foster equal opportunity in all federally assisted contracts, to improve the flexibility of the DBE Program, to reduce the burdens on small businesses, and to achieve the amount of participation that would be obtained in a non-discriminatory marketplace. In doing so, it is the policy of MDOT that there will be no discrimination in the award and performance of federally assisted contracts on the basis of race, color, sex, or national origin.

### **DBE DIRECTORY**

A list of certified DBE contractors can be found on MDOT’s website at [www.mdot.ms.gov](http://www.mdot.ms.gov) under the Business Center and Project Letting tab. The DBE firm must be certified at the time the project is let and approved by MDOT to count towards meeting the DBE goal.

### **PRE-BID MEETING**

A pre-bid meeting for monthly lettings will be held either in the Commission Room on the 1st floor of MDOT’s Administration Building, 401 N. West St., Jackson, MS 39201, or via a teleconference source, at 2:00 p.m. on the Monday immediately preceding the fourth Tuesday. No pre-bid meeting is required for emergency lettings.

This meeting is to inform DBE firms of subcontracting and material supply opportunities. Attendance at this meeting is considered of prime importance in demonstrating good faith efforts to meet the contract goal.

### **AWARD**

Award of this Contract to the lowest bidder will be contingent upon the following conditions:

1. Concurrence with the Federal Highway Administration, when applicable.
2. All bidders must submit to the Office of Civil Rights Form OCR-481 no later than the 3rd business day after opening of the bids to satisfy MDOT or have documented in the bid package that adequate good faith efforts have been made to meet the Contract goal. For any questions regarding Form OCR-481, contact the Office of Civil Rights at 601.359.7466.
3. Bidders must include OCR-485 information with their bid proposal listing all firms that submitted quotes for material supplies or items to be subcontracted. The OCR-485 information must be signed and included with the bid proposal. If the OCR-485 information is not included and signed as part of the bid proposal, the bid will be deemed irregular.

Prior to the start of any Contract work, the bidder must notify the Project Engineer, in writing, of the designated “DBE Liaison Officer” for the project. This notification must be posted on the bulletin board at the project site.

### **DBE REPORTS**

1. OCR-481 is available on MDOT’s website at [www.mdot.ms.gov](http://www.mdot.ms.gov) under the Civil Rights tab, or by calling 601.359.7466. This form must contain:
  - a. The name and address of each certified DBE contractor and/or supplier; and
  - b. The Reference Number, percent of work to be completed by the DBE subcontractor, and the dollar amount of each item. If a portion of an item is subcontracted, a breakdown of that item, including quantities and unit price, must be attached

detailing what part of the item the DBE firm is to perform and who will perform the remainder of the item.

2. OCR-482: At the conclusion of the project, before the final estimate is paid and the project is closed out, the prime contractor will submit to the Project Engineer Form OCR-482. In this form, the contractor must certify the total amount paid to all DBE contractors/suppliers over the life of the Contract. The Project Engineer will submit the completed Form OCR-482 to the DBE Coordinator in the MDOT Office of Civil Rights. Final acceptance of the project is dependent upon MDOT’s Contract Administration Division’s receipt of the completed and approved Form OCR-482 as received from the Office of Civil Rights.
3. OCR-483: The Project Engineer or Inspector will complete Form OCR-483, the Commercially Useful Function Performance Report, in accordance with MDOT S.O.P. No. OCR-03-05-02-483. Evaluations reported on this form are used to determine whether or not the DBE firm is performing a commercially useful function. The prime contractor is expected to take corrective action when the report contains any negative evaluations. DBE credit may be disallowed and/or sanctions imposed if it is determined that the DBE firm is not performing a commercially useful function. This form is to be completed and submitted to the DBE Coordinator in the Office of Civil Rights.
4. OCR-484: Each month, the prime contractor will submit to the Project Engineer OCR-484, which certifies payments to all subcontractors and lists all firms to reflect payments made during the estimate period. The prime contractor will submit this form even if they have not paid any money to a firm during the estimate period. The Project Engineer will attach the form to the monthly estimate before forwarding it to MDOT’s Contract Administration Division for further processing. Failure of the contractor to submit the OCR-484 form will result in the estimate not being processed and paid.
5. OCR-485: ALL BIDDERS must submit the signed Form OCR-485 with bid proposals of all firms that submitted quotes for material supplies or items to be subcontracted. If the OCR-485 information is not included and signed as part of the bid proposal, the bid will be deemed irregular.
6. OCR-487: The OCR-487 is only used by prime contractors that are certified DBE firms. This form is used in determining the exact percentage of DBE credit for the specified project. The lowest bidder must submit this form to MDOT’s Office of Civil Rights with the OCR-481 form. It may also be submitted with the Permission to Subcontract Forms (CAD-720, CAD-725, and CAD-521).

DBE forms may be obtained from the Office of Civil Rights at the MDOT Administration Building, 401 N. West St., Jackson, MS, or at [www.mdot.ms.gov](http://www.mdot.ms.gov) under the Civil Rights tab.

### **CONTRACTOR ASSURANCES**

Each contract that MDOT signs with a contractor, and each subcontract that the prime contractor signs with a sub-contractor, must contain the following assurance set forth in 49 C.F.R. § 26.13:

The contractor, sub-recipient or subcontractor shall not discriminate on the basis of race, color, sex, or national origin in the performance of this Contract. The contractor shall carry out applicable requirements of 49 C.F.R. part 26 in the award and administration of federally assisted contracts. Failure by the contractor to carry

out these requirements is a material breach of this Contract, which may result in the termination of this Contract or such other remedy as MDOT deems appropriate.

**CONTRACTOR’S OBLIGATION**

The contractor and all subcontractors shall take all necessary and reasonable steps to ensure that DBE firms can compete for and participate in the performance of a portion of the work in this Contract and shall not discriminate on the basis of race, color, sex, or national origin. Failure on the part of the contractor to carry out the DBE requirements of the Contract constitutes a material breach of contract and, after proper notification, MDOT may terminate the Contract or take other appropriate action as determined by MDOT.

When a contract has a zero (0) percent goal, the contractor must take all necessary and reasonable steps to ensure that DBE firms can compete for and participate in the performance of the work in the Contract. In this case, all work performed by a certified DBE firm is considered to be a “race neutral” measure and MDOT will receive DBE credit towards the overall State goal when the DBE firm is paid for their work. If the prime contractor is a certified DBE firm, MDOT can receive DBE credit only for the work performed by the prime contractor’s work force or any work subcontracted to another DBE firm. Work performed by a non-DBE subcontractor is not eligible for DBE credit.

**CONTRACT GOAL**

The goal for participation by DBEs is established for the Contract in the attached Supplement. The contractor shall exercise all necessary and reasonable steps to ensure that participation is equal to or exceeds the Contract goal.

If the Contract goal established by MDOT is one (1) percent or greater, it must be met to fulfill the terms of the Contract. The contractor may list DBE subcontractors and items that exceed MDOT’s Contract goal, but should any unforeseen problems arise that would prevent a DBE from completing its total commitment percentage, the contractor will meet the terms of the Contract as long as it meets or exceeds MDOT’s Contract goal.

All Bidders shall submit to the Office of Civil Rights Form OCR-481, signed by the prime contractor and the DBE subcontractors, no later than the third business day after opening of the bids. Please refer to the “DBE Reports” section of this Notice to Bidders for what information must be contained in the OCR-481 Form.

If the DBE commitment shown on the last bid sheet of the proposal does not equal or exceed the Contract goal, the bidder must submit to MDOT’s Contract Administration Division information that shows that adequate good faith efforts have been made to meet the Contract goal. This information must be submitted to MDOT prior to bid opening.

Failure of the lowest bidder to furnish acceptable proof of good faith efforts submitted to MDOT’s Contract Administration Division prior to bid opening shall be just cause for rejection of the

proposal. Award may then be made to the next lowest responsive bidder, or the project may be re-advertised. For MDOT’s reconsideration process, please see MDOT’s DBE Manual.

**GOOD FAITH EFFORTS AT THE TIME OF THE BIDDING**

For the purposes of the DBE Program, Good Faith Effort means to have made every reasonable effort using, at a minimum, the guidelines outlined below, and any other steps deemed appropriate to initially find and/or replace a DBE to meet the established DBE Goal assigned to a project. Additional guidance can be found in Appendix A to 49 C.F.R. § 26.53(a).

The following factors are illustrative of matters that MDOT will consider in judging whether the bidder has made adequate good faith efforts to satisfy the Contract goal.

1. Whether the bidder attended the pre-bid meeting that was scheduled by MDOT to inform DBEs of subcontracting opportunities;
2. Whether the bidder reached out to the MDOT Office of Civil Rights for assistance;
3. Whether the bidder advertised in general circulation, trade association, and minority-focused media concerning the subcontracting opportunities;
4. Whether the bidder provided written notice to a reasonable number of specific DBEs that their interest in the Contract is being solicited;
5. Whether the bidder followed up initial solicitations of interest by contacting DBEs to determine with certainty whether they were interested;
6. Whether the bidder selected portions of the work of the work to be performed by DBEs in order to increase the likelihood of meeting the Contract goal;
7. Whether the bidder provided interested DBEs with adequate information about the plans, specifications, and requirements of the Contract;
8. Whether the bidder negotiated in good faith with interested DBEs and did not reject them as unqualified without sound reasons based on a thorough investigation of their capabilities;
9. Whether the bidder made efforts to assist interested DBEs in obtaining any required bonding or insurance;
10. Whether the bidder has written notification to certified DBE Contractors soliciting subcontracting for items of work in the Contract;
11. Whether the bidder has a statement of why an agreement was not reached; and
12. Proof of written notification to certified DBE Contractors by certified mail that their interest is solicited in subcontracting the work defaulted by the previous DBE or in subcontracting other items of work in the Contract.

The bidder’s execution of the signature portion of the proposal shall constitute execution of the following assurance:

The bidder hereby gives assurance pursuant to the applicable requirements of “Moving Ahead for Progress in the 21st Century Act (MAP-21)” and applicable requirements of 49 C.F.R. part 26 that the bidder has made a good faith effort to meet the contract goal for DBE participation for which this proposal is submitted.

In determining whether a bidder made good faith efforts, MDOT will:

1. Scrutinize the documented efforts of the bidder;
2. Review the performance of other bidders in meeting the Contract goal;
3. Require the bidder to submit copies of each DBE and non-DBE subcontractor’s quote submitted to the bidder when a non-DBE subcontractor was selected over a DBE for work on the Contract to review whether DBE prices were substantially higher; and
4. Contact the DBEs listed on a contractor’s solicitation to inquire as to whether they were contacted by the prime contractor.
5. MDOT will not consider standardized (i.e., bulk or generic) mailings to DBEs requesting bids as sufficient to satisfy good faith efforts.
6. MDOT will also not consider a promise to use DBEs after Contract award as responsive to Contract solicitation, nor will it constitute adequate good faith efforts.

### **GOOD FAITH EFFORTS DURING THE CONTRACT**

If a DBE subcontractor cannot perform satisfactorily, or at all, and this causes the OCR-481 commitment to fall below the Contract goal, the contractor must take all necessary and reasonable steps to replace the DBE with another certified DBE subcontractor or submit information to satisfy a good faith effort to MDOT. Contractor must notify the Office of Civil Rights immediately upon determination that the goal may not be achieved.

Information to be submitted to satisfy MDOT may include:

1. Did the prime contractor look at other areas of the Contract to subcontract out to DBEs?
2. Did the prime contractor look for new DBE firms to perform the same line of work?
3. Did the prime contractor identify other DBEs used in the performance of the Contract but that were not reported to MDOT?
4. Did the prime contractor select portions of the work to be performed by DBEs in order to increase the likelihood that the DBE goals would be achieved?
5. Did the prime contractor provide interested DBEs with adequate information about the plans, specifications, and requirements of the Contract in a timely manner?
6. Did the prime contractor negotiate in good faith with interested DBEs?
7. Did the prime contractor use good business judgment such as taking into consideration the DBE firm’s price and capabilities as compared to non-DBE firms?
8. Did the bidder reject the DBEs as being unqualified without sound reasons?
9. Did the prime contractor make efforts to assist interested DBEs in obtaining bonding, lines of credit, or insurance as required by the recipient or the prime contractor?
10. Did the prime contractor effectively use the services of available the agency’s DBE Supportive Services provider or other available minority/women community organizations; minority/women contractors’ groups; local, state, and federal minority/women business assistance offices; and other organizations as allowed on a case-by-case basis to aid in the recruitment and placement of DBEs?

When a contractor proposes to substitute/replace/terminate a DBE that was originally named on the OCR-481, the contractor must obtain a release, in writing, from the named DBE explaining

why the DBE subcontractor cannot perform the work. A copy of the original DBE’s release must be attached to the contractor’s written request to substitute/replace/terminate along with an appropriate Subcontract Forms for the substituted/replaced/terminated subcontractor, all of which must be submitted to the Project Engineer for forwarding to the Office of Civil Rights DBE Coordinator for review and approval actions. The replacement DBE must be a DBE who was on MDOT’s list of “Certified DBE Contractors” when the job was let, and who is still active.

**Under no circumstances may the prime contractor or a subcontractor perform the DBE’s work without prior written approval from MDOT.**

### **PARTICIPATION/DBE CREDIT**

Participation shall be counted toward meeting the goal in this Contract as follows:

1. If the prime contractor is a certified DBE firm, only the value of the work actually performed by the DBE prime contractor can be counted towards the project goal, along with any work subcontracted to a certified DBE firm.
2. If the contractor is not a DBE, the work subcontracted to a certified DBE contractor will be counted toward the goal.
3. The contractor may count a portion of the total dollar value of a contract with a joint venture eligible under the standards of the provision equal to the percentage of the DBE partner in the joint venture towards the Contract goal.
4. Expenditures to DBEs that perform a commercially useful function may be counted toward the goal. A business is considered to perform a commercially useful function when it is responsible for the execution of a distinct element of the work and carries out its responsibilities by actually performing, managing, and supervising the work involved.
5. The contractor may count one hundred (100) percent of the expenditures for materials and supplies obtained from certified DBE suppliers and manufacturers that produce goods from raw materials or substantially alters them for resale provided the suppliers and manufacturers assume the actual and contractual responsibility for the provision of the materials and supplies. The contractor may count sixty (60) percent of the expenditures to suppliers that are not manufacturers, provided the supplier performs a commercially useful function in the supply process. Within thirty (30) days after receipt of the materials, the contractor shall furnish to the Project Engineer invoices from the certified supplier whereby the DBE goal can be verified by MDOT’s DBE Coordinator.
6. Any work that a certified DBE firm subcontracts or sub-subcontracts to a non-DBE firm will not count towards the DBE goal.
7. Only the dollars actually paid to the DBE firm may be counted towards the DBE goal. The participation of a DBE Firm cannot be counted towards the Prime Contractor’s DBE goal until the amount being counted towards the goal has been paid to the DBE.

### **SANCTIONS**

If the prime Contractor fails to fulfill the contract DBE goal commitments on the OCR-481 forms, including administrative errors, and/or is found to have taken actions that are not in compliance

with the MDOT DBE Program and 49 CFR Part 26 , MDOT has the option to enforce any or all combination(s) of the following penalties:

1. Disallowing credit to go towards the DBE goal;
2. Withholding progress estimate payments;
3. Deducting from the final estimate or recovering an amount equal to the unmet portion of the DBE goal, which may include additional monetary penalties as outlined below based on the number of offenses and the severity of the violation, as determined by MDOT:

1st Offense	10% of unmet portion of goal	or	\$7,500 lump sum payment	or	Both
2nd Offense	20% of unmet portion of goal	or	\$15,000 lump sum payment	or	Both
3rd Offense	40% of unmet portion of goal	or	\$25,000 lump portion of goal	or	\$25,000 lump sum payment and debarment

4. MDOT may debar the contractor from bidding on MDOT’s federally funded projects for a period of up to twelve (12) months after notification by certified mail.

If the DBE goal is not met due to an administrative error by the contractor, MDOT has the discretion to assess a percentage of the unmet portion of the goal or any combination of the above as sanctions, in an amount that is deemed appropriate by MDOT.



"General Decision Number: MS20240126 01/05/2024

Superseded General Decision Number: MS20230126

State: Mississippi

Construction Type: Highway

Counties: Grenada, Humphreys, Montgomery, Quitman and Tallahatchie Counties in Mississippi.

HIGHWAY CONSTRUCTION PROJECTS

Note: Contracts subject to the Davis-Bacon Act are generally required to pay at least the applicable minimum wage rate required under Executive Order 14026 or Executive Order 13658. Please note that these Executive Orders apply to covered contracts entered into by the federal government that are subject to the Davis-Bacon Act itself, but do not apply to contracts subject only to the Davis-Bacon Related Acts, including those set forth at 29 CFR 5.1(a)(1).

<p>If the contract is entered into on or after January 30, 2022, or the contract is renewed or extended (e.g., an option is exercised) on or after January 30, 2022:</p>	<ul style="list-style-type: none"> <li>. Executive Order 14026 generally applies to the contract.</li> <li>. The contractor must pay all covered workers at least \$17.20 per hour (or the applicable wage rate listed on this wage determination, if it is higher) for all hours spent performing on the contract in 2024.</li> </ul>
<p>If the contract was awarded on or between January 1, 2015 and January 29, 2022, and the contract is not renewed or extended on or after January 30, 2022:</p>	<ul style="list-style-type: none"> <li>. Executive Order 13658 generally applies to the contract.</li> <li>. The contractor must pay all covered workers at least \$12.90 per hour (or the applicable wage rate listed on this wage determination, if it is higher) for all hours spent performing on that contract in 2024.</li> </ul>

The applicable Executive Order minimum wage rate will be adjusted annually. If this contract is covered by one of the Executive Orders and a classification considered necessary for performance of work on the contract does not appear on this wage determination, the contractor must still submit a conformance request.

Additional information on contractor requirements and worker protections under the Executive Orders is available at <http://www.dol.gov/whd/govcontracts>.

Modification Number      Publication Date  
 0                              01/05/2024

SUMS2010-049 08/04/2014

	Rates	Fringes
CARPENTER (Form Work Only).....	\$ 13.99 **	0.00
CARPENTER, Excludes Form Work....	\$ 14.03 **	0.00
CEMENT MASON/CONCRETE FINISHER...	\$ 14.09 **	0.00
ELECTRICIAN.....	\$ 21.80	7.93
HIGHWAY/PARKING LOT STRIPING: Truck Driver (Line Striping Truck).....	\$ 14.11 **	0.00
INSTALLER - GUARDRAIL.....	\$ 11.42 **	0.00
INSTALLER - SIGN.....	\$ 11.73 **	0.00
IRONWORKER, REINFORCING.....	\$ 16.29 **	0.00
LABORER: Common or General, Including Asphalt Raking, Shoveling, Spreading and Concrete Work.....	\$ 10.49 **	0.00
LABORER: Flagger.....	\$ 11.48 **	0.00
LABORER: Grade Checker.....	\$ 11.32 **	0.00
LABORER: Landscape.....	\$ 9.77 **	0.00
LABORER: Mason Tender - Cement/Concrete.....	\$ 11.08 **	0.00
LABORER: Pipelayer.....	\$ 11.34 **	0.00
LABORER: Laborer-Cones/ Barricades/Barrels - Setter/Mover/Sweeper.....	\$ 12.93 **	0.00
OPERATOR: Asphalt Spreader.....	\$ 16.03 **	0.00
OPERATOR: Backhoe/Excavator/Trackhoe.....	\$ 13.38 **	0.00
OPERATOR: Broom/Sweeper.....	\$ 10.77 **	0.00
OPERATOR: Bulldozer.....	\$ 13.67 **	0.00
OPERATOR: Concrete Saw.....	\$ 12.95 **	0.00
OPERATOR: Crane.....	\$ 21.25	0.00
OPERATOR: Distributor.....	\$ 12.38 **	0.00
OPERATOR: Drill.....	\$ 19.22	0.00
OPERATOR: Grader/Blade.....	\$ 14.44 **	0.00
OPERATOR: Grinding/Grooving Machine.....	\$ 15.94 **	0.00

OPERATOR: Loader.....	\$ 12.21 **	0.00
OPERATOR: Mechanic.....	\$ 15.32 **	0.00
OPERATOR: Milling Machine.....	\$ 18.16	0.00
OPERATOR: Oiler.....	\$ 12.33 **	0.48
OPERATOR: Paver (Asphalt, Aggregate, and Concrete).....	\$ 12.69 **	0.00
OPERATOR: Piledriver.....	\$ 15.13 **	0.00
OPERATOR: Roller (All Types)....	\$ 11.51 **	0.00
OPERATOR: Scraper.....	\$ 12.96 **	0.00
OPERATOR: Tractor.....	\$ 11.46 **	0.00
OPERATOR: Trencher.....	\$ 15.00 **	0.00
TRUCK DRIVER: Flatbed Truck.....	\$ 12.64 **	0.00
TRUCK DRIVER: Lowboy Truck.....	\$ 13.80 **	0.00
TRUCK DRIVER: Mechanic.....	\$ 14.08 **	0.00
TRUCK DRIVER: Off the Road Truck.....	\$ 12.29 **	0.00
TRUCK DRIVER: Water Truck.....	\$ 10.89 **	0.00
TRUCK DRIVER: Dump Truck (All Types).....	\$ 11.71 **	0.00
TRUCK DRIVER: Semi/Trailer Truck.....	\$ 15.29 **	0.00

-----  
WELDERS - Receive rate prescribed for craft performing operation to which welding is incidental.

=====  
\*\* Workers in this classification may be entitled to a higher minimum wage under Executive Order 14026 (\$17.20) or 13658 (\$12.90). Please see the Note at the top of the wage determination for more information. Please also note that the minimum wage requirements of Executive Order 14026 are not currently being enforced as to any contract or subcontract to which the states of Texas, Louisiana, or Mississippi, including their agencies, are a party.

Note: Executive Order (EO) 13706, Establishing Paid Sick Leave for Federal Contractors applies to all contracts subject to the Davis-Bacon Act for which the contract is awarded (and any solicitation was issued) on or after January 1, 2017. If this contract is covered by the EO, the contractor must provide employees with 1 hour of paid sick leave for every 30 hours they work, up to 56 hours of paid sick leave each year. Employees must be permitted to use paid sick leave for their own illness, injury or other health-related needs, including preventive care; to assist a family member (or person who is like family to the employee) who is ill, injured, or has other health-related needs, including preventive care; or for reasons

resulting from, or to assist a family member (or person who is like family to the employee) who is a victim of, domestic violence, sexual assault, or stalking. Additional information on contractor requirements and worker protections under the EO is available at <https://www.dol.gov/agencies/whd/government-contracts>.

Unlisted classifications needed for work not included within the scope of the classifications listed may be added after award only as provided in the labor standards contract clauses (29CFR 5.5 (a) (1) (iii)).

-----

The body of each wage determination lists the classification and wage rates that have been found to be prevailing for the cited type(s) of construction in the area covered by the wage determination. The classifications are listed in alphabetical order of ""identifiers"" that indicate whether the particular rate is a union rate (current union negotiated rate for local), a survey rate (weighted average rate) or a union average rate (weighted union average rate).

#### Union Rate Identifiers

A four letter classification abbreviation identifier enclosed in dotted lines beginning with characters other than ""SU"" or ""UAVG"" denotes that the union classification and rate were prevailing for that classification in the survey. Example: PLUM0198-005 07/01/2014. PLUM is an abbreviation identifier of the union which prevailed in the survey for this classification, which in this example would be Plumbers. 0198 indicates the local union number or district council number where applicable, i.e., Plumbers Local 0198. The next number, 005 in the example, is an internal number used in processing the wage determination. 07/01/2014 is the effective date of the most current negotiated rate, which in this example is July 1, 2014.

Union prevailing wage rates are updated to reflect all rate changes in the collective bargaining agreement (CBA) governing this classification and rate.

#### Survey Rate Identifiers

Classifications listed under the ""SU"" identifier indicate that no one rate prevailed for this classification in the survey and the published rate is derived by computing a weighted average rate based on all the rates reported in the survey for that classification. As this weighted average rate includes all rates reported in the survey, it may include both union and non-union rates. Example: SULA2012-007 5/13/2014. SU indicates the rates are survey rates based on a weighted average calculation of rates and are not majority rates. LA indicates the State of Louisiana. 2012 is the year of survey on which these classifications and rates are based. The next number, 007 in the example, is an internal number used in producing the wage determination. 5/13/2014 indicates the survey completion date for the classifications and rates under that identifier.

Survey wage rates are not updated and remain in effect until a new survey is conducted.

## Union Average Rate Identifiers

Classification(s) listed under the UAVG identifier indicate that no single majority rate prevailed for those classifications; however, 100% of the data reported for the classifications was union data. EXAMPLE: UAVG-OH-0010 08/29/2014. UAVG indicates that the rate is a weighted union average rate. OH indicates the state. The next number, 0010 in the example, is an internal number used in producing the wage determination. 08/29/2014 indicates the survey completion date for the classifications and rates under that identifier.

A UAVG rate will be updated once a year, usually in January of each year, to reflect a weighted average of the current negotiated/CBA rate of the union locals from which the rate is based.

---

## WAGE DETERMINATION APPEALS PROCESS

1.) Has there been an initial decision in the matter? This can be:

- \* an existing published wage determination
- \* a survey underlying a wage determination
- \* a Wage and Hour Division letter setting forth a position on a wage determination matter
- \* a conformance (additional classification and rate) ruling

On survey related matters, initial contact, including requests for summaries of surveys, should be with the Wage and Hour National Office because National Office has responsibility for the Davis-Bacon survey program. If the response from this initial contact is not satisfactory, then the process described in 2.) and 3.) should be followed.

With regard to any other matter not yet ripe for the formal process described here, initial contact should be with the Branch of Construction Wage Determinations. Write to:

Branch of Construction Wage Determinations  
Wage and Hour Division  
U.S. Department of Labor  
200 Constitution Avenue, N.W.  
Washington, DC 20210

2.) If the answer to the question in 1.) is yes, then an interested party (those affected by the action) can request review and reconsideration from the Wage and Hour Administrator (See 29 CFR Part 1.8 and 29 CFR Part 7). Write to:

Wage and Hour Administrator  
U.S. Department of Labor  
200 Constitution Avenue, N.W.  
Washington, DC 20210

The request should be accompanied by a full statement of the interested party's position and by any information (wage payment data, project description, area practice material, etc.) that the requestor considers relevant to the issue.

3.) If the decision of the Administrator is not favorable, an

interested party may appeal directly to the Administrative Review Board (formerly the Wage Appeals Board). Write to:

Administrative Review Board  
U.S. Department of Labor  
200 Constitution Avenue, N.W.  
Washington, DC 20210

4.) All decisions by the Administrative Review Board are final.

=====

END OF GENERAL DECISION"

"General Decision Number: MS20240090 01/05/2024

Superseded General Decision Number: MS20230090

State: Mississippi

Construction Type: Highway

County: Holmes County in Mississippi.

HIGHWAY CONSTRUCTION PROJECTS

Note: Contracts subject to the Davis-Bacon Act are generally required to pay at least the applicable minimum wage rate required under Executive Order 14026 or Executive Order 13658. Please note that these Executive Orders apply to covered contracts entered into by the federal government that are subject to the Davis-Bacon Act itself, but do not apply to contracts subject only to the Davis-Bacon Related Acts, including those set forth at 29 CFR 5.1(a)(1).

<p>If the contract is entered into on or after January 30, 2022, or the contract is renewed or extended (e.g., an option is exercised) on or after January 30, 2022:</p>	<ul style="list-style-type: none"> <li>. Executive Order 14026 generally applies to the contract.</li> <li>. The contractor must pay all covered workers at least \$17.20 per hour (or the applicable wage rate listed on this wage determination, if it is higher) for all hours spent performing on the contract in 2024.</li> </ul>
<p>If the contract was awarded on or between January 1, 2015 and January 29, 2022, and the contract is not renewed or extended on or after January 30, 2022:</p>	<ul style="list-style-type: none"> <li>. Executive Order 13658 generally applies to the contract.</li> <li>. The contractor must pay all covered workers at least \$12.90 per hour (or the applicable wage rate listed on this wage determination, if it is higher) for all hours spent performing on that contract in 2024.</li> </ul>

The applicable Executive Order minimum wage rate will be adjusted annually. If this contract is covered by one of the Executive Orders and a classification considered necessary for performance of work on the contract does not appear on this wage determination, the contractor must still submit a conformance request.

Additional information on contractor requirements and worker protections under the Executive Orders is available at <http://www.dol.gov/whd/govcontracts>.

Modification Number      Publication Date  
 0                              01/05/2024

SUMS2010-013 08/04/2014

	Rates	Fringes
CARPENTER (Form Work Only).....	\$ 13.99 **	0.00
CARPENTER, Excludes Form Work....	\$ 14.03 **	0.00
CEMENT MASON/CONCRETE FINISHER...	\$ 15.69 **	0.00
ELECTRICIAN.....	\$ 21.80	7.93
HIGHWAY/PARKING LOT STRIPING: Truck Driver (Line Striping Truck).....	\$ 14.11 **	0.00
INSTALLER - GUARDRAIL.....	\$ 11.42 **	0.00
INSTALLER - SIGN.....	\$ 11.65 **	0.00
IRONWORKER, REINFORCING.....	\$ 16.29 **	0.00
LABORER: Asphalt, Includes Raker, Shoveler, Spreader and Distributor.....	\$ 10.61 **	0.00
LABORER: Common or General.....	\$ 10.37 **	0.00
LABORER: Concrete Worker.....	\$ 10.91 **	0.00
LABORER: Flagger.....	\$ 10.06 **	0.00
LABORER: Grade Checker.....	\$ 11.32 **	0.00
LABORER: Landscape.....	\$ 9.77 **	0.00
LABORER: Mason Tender - Cement/Concrete.....	\$ 11.08 **	0.00
LABORER: Pipelayer.....	\$ 11.34 **	0.00
LABORER: Laborer-Cones/ Barricades/Barrels - Setter/Mover/Sweeper.....	\$ 12.93 **	0.00
OPERATOR: Asphalt Spreader.....	\$ 16.03 **	0.00
OPERATOR: Backhoe/Excavator/Trackhoe.....	\$ 15.25 **	0.00
OPERATOR: Broom/Sweeper.....	\$ 10.77 **	0.00
OPERATOR: Bulldozer.....	\$ 14.15 **	0.00
OPERATOR: Concrete Saw.....	\$ 10.25 **	0.00
OPERATOR: Crane.....	\$ 21.25	0.00
OPERATOR: Distributor.....	\$ 11.83 **	0.00
OPERATOR: Drill.....	\$ 19.22	0.00
OPERATOR: Grader/Blade.....	\$ 14.44 **	0.00
OPERATOR: Grinding/Grooving Machine.....	\$ 15.94 **	115 <sup>0.00</sup>



OPERATOR: Loader.....	\$ 12.21 **	0.00
OPERATOR: Mechanic.....	\$ 17.07 **	0.00
OPERATOR: Milling Machine.....	\$ 18.16	0.00
OPERATOR: Oiler.....	\$ 12.33 **	0.48
OPERATOR: Paver (Asphalt, Aggregate, and Concrete).....	\$ 12.05 **	0.00
OPERATOR: Piledriver.....	\$ 15.13 **	0.00
OPERATOR: Roller (All Types)....	\$ 11.88 **	0.00
OPERATOR: Scraper.....	\$ 12.96 **	0.00
OPERATOR: Tractor.....	\$ 12.56 **	0.00
OPERATOR: Trencher.....	\$ 15.00 **	0.00
TRUCK DRIVER: Flatbed Truck.....	\$ 12.64 **	0.00
TRUCK DRIVER: Lowboy Truck.....	\$ 13.80 **	0.00
TRUCK DRIVER: Mechanic.....	\$ 14.08 **	0.00
TRUCK DRIVER: Off the Road Truck.....	\$ 12.29 **	0.00
TRUCK DRIVER: Water Truck.....	\$ 10.89 **	0.00
TRUCK DRIVER: Dump Truck (All Types).....	\$ 11.99 **	0.00
TRUCK DRIVER: Semi/Trailer Truck.....	\$ 15.29 **	0.00

-----  
WELDERS - Receive rate prescribed for craft performing operation to which welding is incidental.

=====  
\*\* Workers in this classification may be entitled to a higher minimum wage under Executive Order 14026 (\$17.20) or 13658 (\$12.90). Please see the Note at the top of the wage determination for more information. Please also note that the minimum wage requirements of Executive Order 14026 are not currently being enforced as to any contract or subcontract to which the states of Texas, Louisiana, or Mississippi, including their agencies, are a party.

Note: Executive Order (EO) 13706, Establishing Paid Sick Leave for Federal Contractors applies to all contracts subject to the Davis-Bacon Act for which the contract is awarded (and any solicitation was issued) on or after January 1, 2017. If this contract is covered by the EO, the contractor must provide employees with 1 hour of paid sick leave for every 30 hours they work, up to 56 hours of paid sick leave each year. Employees must be permitted to use paid sick leave for their own illness, injury or other health-related needs, including preventive care; to assist a family member (or person who is like family to the employee) who is ill, injured, or has other

health-related needs, including preventive care; or for reasons resulting from, or to assist a family member (or person who is like family to the employee) who is a victim of, domestic violence, sexual assault, or stalking. Additional information on contractor requirements and worker protections under the EO is available at <https://www.dol.gov/agencies/whd/government-contracts>.

Unlisted classifications needed for work not included within the scope of the classifications listed may be added after award only as provided in the labor standards contract clauses (29CFR 5.5 (a) (1) (iii)).

-----

The body of each wage determination lists the classification and wage rates that have been found to be prevailing for the cited type(s) of construction in the area covered by the wage determination. The classifications are listed in alphabetical order of ""identifiers"" that indicate whether the particular rate is a union rate (current union negotiated rate for local), a survey rate (weighted average rate) or a union average rate (weighted union average rate).

#### Union Rate Identifiers

A four letter classification abbreviation identifier enclosed in dotted lines beginning with characters other than ""SU"" or ""UAVG"" denotes that the union classification and rate were prevailing for that classification in the survey. Example: PLUM0198-005 07/01/2014. PLUM is an abbreviation identifier of the union which prevailed in the survey for this classification, which in this example would be Plumbers. 0198 indicates the local union number or district council number where applicable, i.e., Plumbers Local 0198. The next number, 005 in the example, is an internal number used in processing the wage determination. 07/01/2014 is the effective date of the most current negotiated rate, which in this example is July 1, 2014.

Union prevailing wage rates are updated to reflect all rate changes in the collective bargaining agreement (CBA) governing this classification and rate.

#### Survey Rate Identifiers

Classifications listed under the ""SU"" identifier indicate that no one rate prevailed for this classification in the survey and the published rate is derived by computing a weighted average rate based on all the rates reported in the survey for that classification. As this weighted average rate includes all rates reported in the survey, it may include both union and non-union rates. Example: SULA2012-007 5/13/2014. SU indicates the rates are survey rates based on a weighted average calculation of rates and are not majority rates. LA indicates the State of Louisiana. 2012 is the year of survey on which these classifications and rates are based. The next number, 007 in the example, is an internal number used in producing the wage determination. 5/13/2014 indicates the survey completion date for the classifications and rates under that identifier.

Survey wage rates are not updated and remain in effect until a new survey is conducted.

## Union Average Rate Identifiers

Classification(s) listed under the UAVG identifier indicate that no single majority rate prevailed for those classifications; however, 100% of the data reported for the classifications was union data. EXAMPLE: UAVG-OH-0010 08/29/2014. UAVG indicates that the rate is a weighted union average rate. OH indicates the state. The next number, 0010 in the example, is an internal number used in producing the wage determination. 08/29/2014 indicates the survey completion date for the classifications and rates under that identifier.

A UAVG rate will be updated once a year, usually in January of each year, to reflect a weighted average of the current negotiated/CBA rate of the union locals from which the rate is based.

---

## WAGE DETERMINATION APPEALS PROCESS

1.) Has there been an initial decision in the matter? This can be:

- \* an existing published wage determination
- \* a survey underlying a wage determination
- \* a Wage and Hour Division letter setting forth a position on a wage determination matter
- \* a conformance (additional classification and rate) ruling

On survey related matters, initial contact, including requests for summaries of surveys, should be with the Wage and Hour National Office because National Office has responsibility for the Davis-Bacon survey program. If the response from this initial contact is not satisfactory, then the process described in 2.) and 3.) should be followed.

With regard to any other matter not yet ripe for the formal process described here, initial contact should be with the Branch of Construction Wage Determinations. Write to:

Branch of Construction Wage Determinations  
Wage and Hour Division  
U.S. Department of Labor  
200 Constitution Avenue, N.W.  
Washington, DC 20210

2.) If the answer to the question in 1.) is yes, then an interested party (those affected by the action) can request review and reconsideration from the Wage and Hour Administrator (See 29 CFR Part 1.8 and 29 CFR Part 7). Write to:

Wage and Hour Administrator  
U.S. Department of Labor  
200 Constitution Avenue, N.W.  
Washington, DC 20210

The request should be accompanied by a full statement of the interested party's position and by any information (wage payment data, project description, area practice material, etc.) that the requestor considers relevant to the issue.

3.) If the decision of the Administrator is not favorable, an interested party may appeal directly to the Administrative Review Board (formerly the Wage Appeals Board). Write to:

Administrative Review Board  
U.S. Department of Labor  
200 Constitution Avenue, N.W.  
Washington, DC 20210

4.) All decisions by the Administrative Review Board are final.

=====

END OF GENERAL DECISION"

**SUPPLEMENT TO FORM FHWA-1273**

**DATE: 07/26/2022**

**SUBJECT: Federal Contract Provisions for Subcontracts**

**Federal Contract Provisions for Subcontracts**

All subcontracts shall be in writing and contain all pertinent provisions and requirements of the prime contract.

Each “Request for Permission to Subcontract” (Mississippi Department of Transportation Form CAD-720) shall include a copy of the subcontract. The federal contract provisions (FHWA-1273, SUPPLEMENT TO FORM FHWA-1273, NOTICE OF REQUIREMENT FOR AFFIRMATIVE ACTION TO ENSURE EQUAL EMPLOYMENT OPPORTUNITY (EXECUTIVE ORDER 11246), DAVIS-BACON AND RELATED ACT PROVISIONS (WAGE RATES)) must be physically incorporated as part of the subcontract. A completed Mississippi Department of Transportation Form CAD-521 and Form CAD-725 must be attached to the CAD-720.

**REQUIRED CONTRACT PROVISIONS  
FEDERAL-AID CONSTRUCTION CONTRACTS**

- I. General
- II. Nondiscrimination
- III. Non-segregated Facilities
- IV. Davis-Bacon and Related Act Provisions
- V. Contract Work Hours and Safety Standards Act Provisions
- VI. Subletting or Assigning the Contract
- VII. Safety: Accident Prevention
- VIII. False Statements Concerning Highway Projects
- IX. Implementation of Clean Air Act and Federal Water Pollution Control Act
- X. Certification Regarding Debarment, Suspension, Ineligibility and Voluntary Exclusion
- XI. Certification Regarding Use of Contract Funds for Lobbying
- XII. Use of United States-Flag Vessels:

**ATTACHMENTS**

A. Employment and Materials Preference for Appalachian Development Highway System or Appalachian Local Access Road Contracts (included in Appalachian contracts only)

**I. GENERAL**

1. Form FHWA-1273 must be physically incorporated in each construction contract funded under title 23, United States Code, as required in 23 CFR 633.102(b) (excluding emergency contracts solely intended for debris removal). The contractor (or subcontractor) must insert this form in each subcontract and further require its inclusion in all lower tier subcontracts (excluding purchase orders, rental agreements and other agreements for supplies or services). 23 CFR 633.102(e).

The applicable requirements of Form FHWA-1273 are incorporated by reference for work done under any purchase order, rental agreement or agreement for other services. The prime contractor shall be responsible for compliance by any subcontractor, lower-tier subcontractor or service provider. 23 CFR 633.102(e).

Form FHWA-1273 must be included in all Federal-aid design-build contracts, in all subcontracts and in lower tier subcontracts (excluding subcontracts for design services, purchase orders, rental agreements and other agreements for supplies or services) in accordance with 23 CFR 633.102. The design-builder shall be responsible for compliance by any subcontractor, lower-tier subcontractor or service provider.

Contracting agencies may reference Form FHWA-1273 in solicitation-for-bids or request-for-proposals documents, however, the Form FHWA-1273 must be physically incorporated (not referenced) in all contracts, subcontracts and lower-tier subcontracts (excluding purchase orders, rental agreements and other agreements for supplies or services related to a construction contract). 23 CFR 633.102(b).

2. Subject to the applicability criteria noted in the following sections, these contract provisions shall apply to all work

performed on the contract by the contractor's own organization and with the assistance of workers under the contractor's immediate superintendence and to all work performed on the contract by piecework, station work, or by subcontract. 23 CFR 633.102(d).

3. A breach of any of the stipulations contained in these Required Contract Provisions may be sufficient grounds for withholding of progress payments, withholding of final payment, termination of the contract, suspension / debarment or any other action determined to be appropriate by the contracting agency and FHWA.

4. Selection of Labor: During the performance of this contract, the contractor shall not use convict labor for any purpose within the limits of a construction project on a Federal-aid highway unless it is labor performed by convicts who are on parole, supervised release, or probation. 23 U.S.C. 114(b). The term Federal-aid highway does not include roadways functionally classified as local roads or rural minor collectors. 23 U.S.C. 101(a).

**II. NONDISCRIMINATION** (23 CFR 230.107(a); 23 CFR Part 230, Subpart A, Appendix A; EO 11246)

The provisions of this section related to 23 CFR Part 230, Subpart A, Appendix A are applicable to all Federal-aid construction contracts and to all related construction subcontracts of \$10,000 or more. The provisions of 23 CFR Part 230 are not applicable to material supply, engineering, or architectural service contracts.

In addition, the contractor and all subcontractors must comply with the following policies: Executive Order 11246, 41 CFR Part 60, 29 CFR Parts 1625-1627, 23 U.S.C. 140, Section 504 of the Rehabilitation Act of 1973, as amended (29 U.S.C. 794), Title VI of the Civil Rights Act of 1964, as amended (42 U.S.C. 2000d et seq.), and related regulations including 49 CFR Parts 21, 26, and 27; and 23 CFR Parts 200, 230, and 633.

The contractor and all subcontractors must comply with: the requirements of the Equal Opportunity Clause in 41 CFR 60-1.4(b) and, for all construction contracts exceeding \$10,000, the Standard Federal Equal Employment Opportunity Construction Contract Specifications in 41 CFR 60-4.3.

Note: The U.S. Department of Labor has exclusive authority to determine compliance with Executive Order 11246 and the policies of the Secretary of Labor including 41 CFR Part 60, and 29 CFR Parts 1625-1627. The contracting agency and the FHWA have the authority and the responsibility to ensure compliance with 23 U.S.C. 140, Section 504 of the Rehabilitation Act of 1973, as amended (29 U.S.C. 794), and Title VI of the Civil Rights Act of 1964, as amended (42 U.S.C. 2000d et seq.), and related regulations including 49 CFR Parts 21, 26, and 27; and 23 CFR Parts 200, 230, and 633.

The following provision is adopted from 23 CFR Part 230, Subpart A, Appendix A, with appropriate revisions to conform to the U.S. Department of Labor (US DOL) and FHWA requirements.

**1. Equal Employment Opportunity:** Equal Employment Opportunity (EEO) requirements not to discriminate and to take affirmative action to assure equal opportunity as set forth under laws, executive orders, rules, regulations (see 28 CFR Part 35, 29 CFR Part 1630, 29 CFR Parts 1625-1627, 41 CFR Part 60 and 49 CFR Part 27) and orders of the Secretary of Labor as modified by the provisions prescribed herein, and imposed pursuant to 23 U.S.C. 140, shall constitute the EEO and specific affirmative action standards for the contractor's project activities under this contract. The provisions of the Americans with Disabilities Act of 1990 (42 U.S.C. 12101 et seq.) set forth under 28 CFR Part 35 and 29 CFR Part 1630 are incorporated by reference in this contract. In the execution of this contract, the contractor agrees to comply with the following minimum specific requirement activities of EEO:

a. The contractor will work with the contracting agency and the Federal Government to ensure that it has made every good faith effort to provide equal opportunity with respect to all of its terms and conditions of employment and in their review of activities under the contract. 23 CFR 230.409 (g)(4) & (5).

b. The contractor will accept as its operating policy the following statement:

"It is the policy of this Company to assure that applicants are employed, and that employees are treated during employment, without regard to their race, religion, sex, sexual orientation, gender identity, color, national origin, age or disability. Such action shall include: employment, upgrading, demotion, or transfer; recruitment or recruitment advertising; layoff or termination; rates of pay or other forms of compensation; and selection for training, including apprenticeship, pre-apprenticeship, and/or on-the-job training."

**2. EEO Officer:** The contractor will designate and make known to the contracting officers an EEO Officer who will have the responsibility for and must be capable of effectively administering and promoting an active EEO program and who must be assigned adequate authority and responsibility to do so.

**3. Dissemination of Policy:** All members of the contractor's staff who are authorized to hire, supervise, promote, and discharge employees, or who recommend such action or are substantially involved in such action, will be made fully cognizant of and will implement the contractor's EEO policy and contractual responsibilities to provide EEO in each grade and classification of employment. To ensure that the above agreement will be met, the following actions will be taken as a minimum:

a. Periodic meetings of supervisory and personnel office employees will be conducted before the start of work and then not less often than once every six months, at which time the contractor's EEO policy and its implementation will be reviewed and explained. The meetings will be conducted by the EEO Officer or other knowledgeable company official.

b. All new supervisory or personnel office employees will be given a thorough indoctrination by the EEO Officer, covering all major aspects of the contractor's EEO obligations within thirty days following their reporting for duty with the contractor.

c. All personnel who are engaged in direct recruitment for the project will be instructed by the EEO Officer in the contractor's procedures for locating and hiring minorities and women.

d. Notices and posters setting forth the contractor's EEO policy will be placed in areas readily accessible to employees, applicants for employment and potential employees.

e. The contractor's EEO policy and the procedures to implement such policy will be brought to the attention of employees by means of meetings, employee handbooks, or other appropriate means.

**4. Recruitment:** When advertising for employees, the contractor will include in all advertisements for employees the notation: "An Equal Opportunity Employer." All such advertisements will be placed in publications having a large circulation among minorities and women in the area from which the project work force would normally be derived.

a. The contractor will, unless precluded by a valid bargaining agreement, conduct systematic and direct recruitment through public and private employee referral sources likely to yield qualified minorities and women. To meet this requirement, the contractor will identify sources of potential minority group employees and establish with such identified sources procedures whereby minority and women applicants may be referred to the contractor for employment consideration.

b. In the event the contractor has a valid bargaining agreement providing for exclusive hiring hall referrals, the contractor is expected to observe the provisions of that agreement to the extent that the system meets the contractor's compliance with EEO contract provisions. Where implementation of such an agreement has the effect of discriminating against minorities or women, or obligates the contractor to do the same, such implementation violates Federal nondiscrimination provisions.

c. The contractor will encourage its present employees to refer minorities and women as applicants for employment. Information and procedures with regard to referring such applicants will be discussed with employees.

**5. Personnel Actions:** Wages, working conditions, and employee benefits shall be established and administered, and personnel actions of every type, including hiring, upgrading, promotion, transfer, demotion, layoff, and termination, shall be taken without regard to race, color, religion, sex, sexual orientation, gender identity, national origin, age or disability. The following procedures shall be followed:

a. The contractor will conduct periodic inspections of project sites to ensure that working conditions and employee facilities do not indicate discriminatory treatment of project site personnel.

b. The contractor will periodically evaluate the spread of wages paid within each classification to determine any evidence of discriminatory wage practices.

c. The contractor will periodically review selected personnel actions in depth to determine whether there is evidence of discrimination. Where evidence is found, the contractor will promptly take corrective action. If the review indicates that the discrimination may extend beyond the actions reviewed, such corrective action shall include all affected persons.

d. The contractor will promptly investigate all complaints of alleged discrimination made to the contractor in connection with its obligations under this contract, will attempt to resolve such complaints, and will take appropriate corrective action

within a reasonable time. If the investigation indicates that the discrimination may affect persons other than the complainant, such corrective action shall include such other persons. Upon completion of each investigation, the contractor will inform every complainant of all of their avenues of appeal.

#### **6. Training and Promotion:**

a. The contractor will assist in locating, qualifying, and increasing the skills of minorities and women who are applicants for employment or current employees. Such efforts should be aimed at developing full journey level status employees in the type of trade or job classification involved.

b. Consistent with the contractor's work force requirements and as permissible under Federal and State regulations, the contractor shall make full use of training programs (i.e., apprenticeship and on-the-job training programs for the geographical area of contract performance). In the event a special provision for training is provided under this contract, this subparagraph will be superseded as indicated in the special provision. The contracting agency may reserve training positions for persons who receive welfare assistance in accordance with 23 U.S.C. 140(a).

c. The contractor will advise employees and applicants for employment of available training programs and entrance requirements for each.

d. The contractor will periodically review the training and promotion potential of employees who are minorities and women and will encourage eligible employees to apply for such training and promotion.

**7. Unions:** If the contractor relies in whole or in part upon unions as a source of employees, the contractor will use good faith efforts to obtain the cooperation of such unions to increase opportunities for minorities and women. 23 CFR 230.409. Actions by the contractor, either directly or through a contractor's association acting as agent, will include the procedures set forth below:

a. The contractor will use good faith efforts to develop, in cooperation with the unions, joint training programs aimed toward qualifying more minorities and women for membership in the unions and increasing the skills of minorities and women so that they may qualify for higher paying employment.

b. The contractor will use good faith efforts to incorporate an EEO clause into each union agreement to the end that such union will be contractually bound to refer applicants without regard to their race, color, religion, sex, sexual orientation, gender identity, national origin, age, or disability.

c. The contractor is to obtain information as to the referral practices and policies of the labor union except that to the extent such information is within the exclusive possession of the labor union and such labor union refuses to furnish such information to the contractor, the contractor shall so certify to the contracting agency and shall set forth what efforts have been made to obtain such information.

d. In the event the union is unable to provide the contractor with a reasonable flow of referrals within the time limit set forth in the collective bargaining agreement, the contractor will, through independent recruitment efforts, fill the employment vacancies without regard to race, color, religion, sex, sexual orientation, gender identity, national origin, age, or disability; making full efforts to obtain qualified and/or qualifiable minorities and women. The failure of a union to provide

sufficient referrals (even though it is obligated to provide exclusive referrals under the terms of a collective bargaining agreement) does not relieve the contractor from the requirements of this paragraph. In the event the union referral practice prevents the contractor from meeting the obligations pursuant to Executive Order 11246, as amended, and these special provisions, such contractor shall immediately notify the contracting agency.

**8. Reasonable Accommodation for Applicants / Employees with Disabilities:** The contractor must be familiar with the requirements for and comply with the Americans with Disabilities Act and all rules and regulations established thereunder. Employers must provide reasonable accommodation in all employment activities unless to do so would cause an undue hardship.

**9. Selection of Subcontractors, Procurement of Materials and Leasing of Equipment:** The contractor shall not discriminate on the grounds of race, color, religion, sex, sexual orientation, gender identity, national origin, age, or disability in the selection and retention of subcontractors, including procurement of materials and leases of equipment. The contractor shall take all necessary and reasonable steps to ensure nondiscrimination in the administration of this contract.

a. The contractor shall notify all potential subcontractors, suppliers, and lessors of their EEO obligations under this contract.

b. The contractor will use good faith efforts to ensure subcontractor compliance with their EEO obligations.

#### **10. Assurances Required:**

a. The requirements of 49 CFR Part 26 and the State DOT's FHWA-approved Disadvantaged Business Enterprise (DBE) program are incorporated by reference.

b. The contractor, subrecipient or subcontractor shall not discriminate on the basis of race, color, national origin, or sex in the performance of this contract. The contractor shall carry out applicable requirements of 49 CFR part 26 in the award and administration of DOT-assisted contracts. Failure by the contractor to carry out these requirements is a material breach of this contract, which may result in the termination of this contract or such other remedy as the recipient deems appropriate, which may include, but is not limited to:

- (1) Withholding monthly progress payments;
- (2) Assessing sanctions;
- (3) Liquidated damages; and/or
- (4) Disqualifying the contractor from future bidding as non-responsible.

c. The Title VI and nondiscrimination provisions of U.S. DOT Order 1050.2A at Appendixes A and E are incorporated by reference. 49 CFR Part 21.

**11. Records and Reports:** The contractor shall keep such records as necessary to document compliance with the EEO requirements. Such records shall be retained for a period of three years following the date of the final payment to the contractor for all contract work and shall be available at reasonable times and places for inspection by authorized representatives of the contracting agency and the FHWA.

a. The records kept by the contractor shall document the following:



(1) The number and work hours of minority and non-minority group members and women employed in each work classification on the project;

(2) The progress and efforts being made in cooperation with unions, when applicable, to increase employment opportunities for minorities and women; and

(3) The progress and efforts being made in locating, hiring, training, qualifying, and upgrading minorities and women.

b. The contractors and subcontractors will submit an annual report to the contracting agency each July for the duration of the project indicating the number of minority, women, and non-minority group employees currently engaged in each work classification required by the contract work. This information is to be reported on [Form FHWA-1391](#). The staffing data should represent the project work force on board in all or any part of the last payroll period preceding the end of July. If on-the-job training is being required by special provision, the contractor will be required to collect and report training data. The employment data should reflect the work force on board during all or any part of the last payroll period preceding the end of July.

### III. NONSEGREGATED FACILITIES

This provision is applicable to all Federal-aid construction contracts and to all related construction subcontracts of more than \$10,000. 41 CFR 60-1.5.

As prescribed by 41 CFR 60-1.8, the contractor must ensure that facilities provided for employees are provided in such a manner that segregation on the basis of race, color, religion, sex, sexual orientation, gender identity, or national origin cannot result. The contractor may neither require such segregated use by written or oral policies nor tolerate such use by employee custom. The contractor's obligation extends further to ensure that its employees are not assigned to perform their services at any location under the contractor's control where the facilities are segregated. The term "facilities" includes waiting rooms, work areas, restaurants and other eating areas, time clocks, restrooms, washrooms, locker rooms and other storage or dressing areas, parking lots, drinking fountains, recreation or entertainment areas, transportation, and housing provided for employees. The contractor shall provide separate or single-user restrooms and necessary dressing or sleeping areas to assure privacy between sexes.

### IV. DAVIS-BACON AND RELATED ACT PROVISIONS

This section is applicable to all Federal-aid construction projects exceeding \$2,000 and to all related subcontracts and lower-tier subcontracts (regardless of subcontract size), in accordance with 29 CFR 5.5. The requirements apply to all projects located within the right-of-way of a roadway that is functionally classified as Federal-aid highway. 23 U.S.C. 113. This excludes roadways functionally classified as local roads or rural minor collectors, which are exempt. 23 U.S.C. 101. Where applicable law requires that projects be treated as a project on a Federal-aid highway, the provisions of this subpart will apply regardless of the location of the project. Examples include: Surface Transportation Block Grant Program projects funded under 23 U.S.C. 133 [excluding recreational trails projects], the Nationally Significant Freight and Highway

Projects funded under 23 U.S.C. 117, and National Highway Freight Program projects funded under 23 U.S.C. 167.

The following provisions are from the U.S. Department of Labor regulations in 29 CFR 5.5 "Contract provisions and related matters" with minor revisions to conform to the FHWA-1273 format and FHWA program requirements.

#### 1. Minimum wages (29 CFR 5.5)

a. *Wage rates and fringe benefits.* All laborers and mechanics employed or working upon the site of the work (or otherwise working in construction or development of the project under a development statute), will be paid unconditionally and not less often than once a week, and without subsequent deduction or rebate on any account (except such payroll deductions as are permitted by regulations issued by the Secretary of Labor under the Copeland Act ([29 CFR part 3](#))), the full amount of basic hourly wages and bona fide fringe benefits (or cash equivalents thereof) due at time of payment computed at rates not less than those contained in the wage determination of the Secretary of Labor which is attached hereto and made a part hereof, regardless of any contractual relationship which may be alleged to exist between the contractor and such laborers and mechanics. As provided in paragraphs (d) and (e) of 29 CFR 5.5, the appropriate wage determinations are effective by operation of law even if they have not been attached to the contract. Contributions made or costs reasonably anticipated for bona fide fringe benefits under the Davis-Bacon Act ([40 U.S.C. 3141\(2\)\(B\)](#)) on behalf of laborers or mechanics are considered wages paid to such laborers or mechanics, subject to the provisions of paragraph 1.e. of this section; also, regular contributions made or costs incurred for more than a weekly period (but not less often than quarterly) under plans, funds, or programs which cover the particular weekly period, are deemed to be constructively made or incurred during such weekly period. Such laborers and mechanics must be paid the appropriate wage rate and fringe benefits on the wage determination for the classification(s) of work actually performed, without regard to skill, except as provided in paragraph 4. of this section. Laborers or mechanics performing work in more than one classification may be compensated at the rate specified for each classification for the time actually worked therein: *Provided*, That the employer's payroll records accurately set forth the time spent in each classification in which work is performed. The wage determination (including any additional classifications and wage rates conformed under paragraph 1.c. of this section) and the Davis-Bacon poster (WH-1321) must be posted at all times by the contractor and its subcontractors at the site of the work in a prominent and accessible place where it can be easily seen by the workers.

b. *Frequently recurring classifications.* (1) In addition to wage and fringe benefit rates that have been determined to be prevailing under the procedures set forth in [29 CFR part 1](#), a wage determination may contain, pursuant to § 1.3(f), wage and fringe benefit rates for classifications of laborers and mechanics for which conformance requests are regularly submitted pursuant to paragraph 1.c. of this section, provided that:

(i) The work performed by the classification is not performed by a classification in the wage determination for which a prevailing wage rate has been determined;

(ii) The classification is used in the area by the construction industry; and

(iii) The wage rate for the classification bears a reasonable relationship to the prevailing wage rates contained in the wage determination.

(2) The Administrator will establish wage rates for such classifications in accordance with paragraph 1.c.(1)(iii) of this section. Work performed in such a classification must be paid at no less than the wage and fringe benefit rate listed on the wage determination for such classification.

c. *Conformance.* (1) The contracting officer must require that any class of laborers or mechanics, including helpers, which is not listed in the wage determination and which is to be employed under the contract be classified in conformance with the wage determination. Conformance of an additional classification and wage rate and fringe benefits is appropriate only when the following criteria have been met:

(i) The work to be performed by the classification requested is not performed by a classification in the wage determination; and

(ii) The classification is used in the area by the construction industry; and

(iii) The proposed wage rate, including any bona fide fringe benefits, bears a reasonable relationship to the wage rates contained in the wage determination.

(2) The conformance process may not be used to split, subdivide, or otherwise avoid application of classifications listed in the wage determination.

(3) If the contractor and the laborers and mechanics to be employed in the classification (if known), or their representatives, and the contracting officer agree on the classification and wage rate (including the amount designated for fringe benefits where appropriate), a report of the action taken will be sent by the contracting officer by email to [DBAconformance@dol.gov](mailto:DBAconformance@dol.gov). The Administrator, or an authorized representative, will approve, modify, or disapprove every additional classification action within 30 days of receipt and so advise the contracting officer or will notify the contracting officer within the 30-day period that additional time is necessary.

(4) In the event the contractor, the laborers or mechanics to be employed in the classification or their representatives, and the contracting officer do not agree on the proposed classification and wage rate (including the amount designated for fringe benefits, where appropriate), the contracting officer will, by email to [DBAconformance@dol.gov](mailto:DBAconformance@dol.gov), refer the questions, including the views of all interested parties and the recommendation of the contracting officer, to the Administrator for determination. The Administrator, or an authorized representative, will issue a determination within 30 days of receipt and so advise the contracting officer or will notify the contracting officer within the 30-day period that additional time is necessary.

(5) The contracting officer must promptly notify the contractor of the action taken by the Wage and Hour Division

under paragraphs 1.c.(3) and (4) of this section. The contractor must furnish a written copy of such determination to each affected worker or it must be posted as a part of the wage determination. The wage rate (including fringe benefits where appropriate) determined pursuant to paragraph 1.c.(3) or (4) of this section must be paid to all workers performing work in the classification under this contract from the first day on which work is performed in the classification.

d. *Fringe benefits not expressed as an hourly rate.* Whenever the minimum wage rate prescribed in the contract for a class of laborers or mechanics includes a fringe benefit which is not expressed as an hourly rate, the contractor may either pay the benefit as stated in the wage determination or may pay another bona fide fringe benefit or an hourly cash equivalent thereof.

e. *Unfunded plans.* If the contractor does not make payments to a trustee or other third person, the contractor may consider as part of the wages of any laborer or mechanic the amount of any costs reasonably anticipated in providing bona fide fringe benefits under a plan or program, *Provided*, That the Secretary of Labor has found, upon the written request of the contractor, in accordance with the criteria set forth in § 5.28, that the applicable standards of the Davis-Bacon Act have been met. The Secretary of Labor may require the contractor to set aside in a separate account assets for the meeting of obligations under the plan or program.

f. *Interest.* In the event of a failure to pay all or part of the wages required by the contract, the contractor will be required to pay interest on any underpayment of wages.

## 2. Withholding (29 CFR 5.5)

a. *Withholding requirements.* The contracting agency may, upon its own action, or must, upon written request of an authorized representative of the Department of Labor, withhold or cause to be withheld from the contractor so much of the accrued payments or advances as may be considered necessary to satisfy the liabilities of the prime contractor or any subcontractor for the full amount of wages and monetary relief, including interest, required by the clauses set forth in this section for violations of this contract, or to satisfy any such liabilities required by any other Federal contract, or federally assisted contract subject to Davis-Bacon labor standards, that is held by the same prime contractor (as defined in § 5.2). The necessary funds may be withheld from the contractor under this contract, any other Federal contract with the same prime contractor, or any other federally assisted contract that is subject to Davis-Bacon labor standards requirements and is held by the same prime contractor, regardless of whether the other contract was awarded or assisted by the same agency, and such funds may be used to satisfy the contractor liability for which the funds were withheld. In the event of a contractor's failure to pay any laborer or mechanic, including any apprentice or helper working on the site of the work all or part of the wages required by the contract, or upon the contractor's failure to submit the required records as discussed in paragraph 3.d. of this section, the contracting agency may on its own initiative and after written notice to the contractor, take such action as may be necessary to cause the suspension of any further payment, advance, or guarantee of funds until such violations have ceased.

b. *Priority to withheld funds.* The Department has priority to funds withheld or to be withheld in accordance with paragraph

2.a. of this section or Section V, paragraph 3.a., or both, over claims to those funds by:

- (1) A contractor's surety(ies), including without limitation performance bond sureties and payment bond sureties;
- (2) A contracting agency for its procurement costs;
- (3) A trustee(s) (either a court-appointed trustee or a U.S. trustee, or both) in bankruptcy of a contractor, or a contractor's bankruptcy estate;
- (4) A contractor's assignee(s);
- (5) A contractor's successor(s); or
- (6) A claim asserted under the Prompt Payment Act, [31 U.S.C. 3901–3907](#).

### 3. Records and certified payrolls (29 CFR 5.5)

a. *Basic record requirements (1) Length of record retention.* All regular payrolls and other basic records must be maintained by the contractor and any subcontractor during the course of the work and preserved for all laborers and mechanics working at the site of the work (or otherwise working in construction or development of the project under a development statute) for a period of at least 3 years after all the work on the prime contract is completed.

(2) *Information required.* Such records must contain the name; Social Security number; last known address, telephone number, and email address of each such worker; each worker's correct classification(s) of work actually performed; hourly rates of wages paid (including rates of contributions or costs anticipated for bona fide fringe benefits or cash equivalents thereof of the types described in [40 U.S.C. 3141\(2\)\(B\)](#) of the Davis-Bacon Act); daily and weekly number of hours actually worked in total and on each covered contract; deductions made; and actual wages paid.

(3) *Additional records relating to fringe benefits.* Whenever the Secretary of Labor has found under paragraph 1.e. of this section that the wages of any laborer or mechanic include the amount of any costs reasonably anticipated in providing benefits under a plan or program described in [40 U.S.C. 3141\(2\)\(B\)](#) of the Davis-Bacon Act, the contractor must maintain records which show that the commitment to provide such benefits is enforceable, that the plan or program is financially responsible, and that the plan or program has been communicated in writing to the laborers or mechanics affected, and records which show the costs anticipated or the actual cost incurred in providing such benefits.

(4) *Additional records relating to apprenticeship.* Contractors with apprentices working under approved programs must maintain written evidence of the registration of apprenticeship programs, the registration of the apprentices, and the ratios and wage rates prescribed in the applicable programs.

b. *Certified payroll requirements (1) Frequency and method of submission.* The contractor or subcontractor must submit weekly, for each week in which any DBA- or Related Acts-covered work is performed, certified payrolls to the contracting

agency. The prime contractor is responsible for the submission of all certified payrolls by all subcontractors. A contracting agency or prime contractor may permit or require contractors to submit certified payrolls through an electronic system, as long as the electronic system requires a legally valid electronic signature; the system allows the contractor, the contracting agency, and the Department of Labor to access the certified payrolls upon request for at least 3 years after the work on the prime contract has been completed; and the contracting agency or prime contractor permits other methods of submission in situations where the contractor is unable or limited in its ability to use or access the electronic system.

(2) *Information required.* The certified payrolls submitted must set out accurately and completely all of the information required to be maintained under paragraph 3.a.(2) of this section, except that full Social Security numbers and last known addresses, telephone numbers, and email addresses must not be included on weekly transmittals. Instead, the certified payrolls need only include an individually identifying number for each worker ( e.g., the last four digits of the worker's Social Security number). The required weekly certified payroll information may be submitted using Optional Form WH-347 or in any other format desired. Optional Form WH-347 is available for this purpose from the Wage and Hour Division website at <https://www.dol.gov/sites/dolgov/files/WHD/legacy/files/wh347.pdf> or its successor website. It is not a violation of this section for a prime contractor to require a subcontractor to provide full Social Security numbers and last known addresses, telephone numbers, and email addresses to the prime contractor for its own records, without weekly submission by the subcontractor to the contracting agency.

(3) *Statement of Compliance.* Each certified payroll submitted must be accompanied by a "Statement of Compliance," signed by the contractor or subcontractor, or the contractor's or subcontractor's agent who pays or supervises the payment of the persons working on the contract, and must certify the following:

(i) That the certified payroll for the payroll period contains the information required to be provided under paragraph 3.b. of this section, the appropriate information and basic records are being maintained under paragraph 3.a. of this section, and such information and records are correct and complete;

(ii) That each laborer or mechanic (including each helper and apprentice) working on the contract during the payroll period has been paid the full weekly wages earned, without rebate, either directly or indirectly, and that no deductions have been made either directly or indirectly from the full wages earned, other than permissible deductions as set forth in [29 CFR part 3](#); and

(iii) That each laborer or mechanic has been paid not less than the applicable wage rates and fringe benefits or cash equivalents for the classification(s) of work actually performed, as specified in the applicable wage determination incorporated into the contract.

(4) *Use of Optional Form WH-347.* The weekly submission of a properly executed certification set forth on the reverse side of Optional Form WH-347 will satisfy the requirement for submission of the "Statement of Compliance" required by paragraph 3.b.(3) of this section.

(5) *Signature*. The signature by the contractor, subcontractor, or the contractor's or subcontractor's agent must be an original handwritten signature or a legally valid electronic signature.

(6) *Falsification*. The falsification of any of the above certifications may subject the contractor or subcontractor to civil or criminal prosecution under [18 U.S.C. 1001](#) and [31 U.S.C. 3729](#).

(7) *Length of certified payroll retention*. The contractor or subcontractor must preserve all certified payrolls during the course of the work and for a period of 3 years after all the work on the prime contract is completed.

c. *Contracts, subcontracts, and related documents*. The contractor or subcontractor must maintain this contract or subcontract and related documents including, without limitation, bids, proposals, amendments, modifications, and extensions. The contractor or subcontractor must preserve these contracts, subcontracts, and related documents during the course of the work and for a period of 3 years after all the work on the prime contract is completed.

d. *Required disclosures and access* (1) *Required record disclosures and access to workers*. The contractor or subcontractor must make the records required under paragraphs 3.a. through 3.c. of this section, and any other documents that the contracting agency, the State DOT, the FHWA, or the Department of Labor deems necessary to determine compliance with the labor standards provisions of any of the applicable statutes referenced by § 5.1, available for inspection, copying, or transcription by authorized representatives of the contracting agency, the State DOT, the FHWA, or the Department of Labor, and must permit such representatives to interview workers during working hours on the job.

(2) *Sanctions for non-compliance with records and worker access requirements*. If the contractor or subcontractor fails to submit the required records or to make them available, or refuses to permit worker interviews during working hours on the job, the Federal agency may, after written notice to the contractor, sponsor, applicant, owner, or other entity, as the case may be, that maintains such records or that employs such workers, take such action as may be necessary to cause the suspension of any further payment, advance, or guarantee of funds. Furthermore, failure to submit the required records upon request or to make such records available, or to permit worker interviews during working hours on the job, may be grounds for debarment action pursuant to § 5.12. In addition, any contractor or other person that fails to submit the required records or make those records available to WHD within the time WHD requests that the records be produced will be precluded from introducing as evidence in an administrative proceeding under [29 CFR part 6](#) any of the required records that were not provided or made available to WHD. WHD will take into consideration a reasonable request from the contractor or person for an extension of the time for submission of records. WHD will determine the reasonableness of the request and may consider, among other things, the location of the records and the volume of production.

(3) *Required information disclosures*. Contractors and subcontractors must maintain the full Social Security number and last known address, telephone number, and email address

of each covered worker, and must provide them upon request to the contracting agency, the State DOT, the FHWA, the contractor, or the Wage and Hour Division of the Department of Labor for purposes of an investigation or other compliance action.

#### **4. Apprentices and equal employment opportunity (29 CFR 5.5)**

a. *Apprentices* (1) *Rate of pay*. Apprentices will be permitted to work at less than the predetermined rate for the work they perform when they are employed pursuant to and individually registered in a bona fide apprenticeship program registered with the U.S. Department of Labor, Employment and Training Administration, Office of Apprenticeship (OA), or with a State Apprenticeship Agency recognized by the OA. A person who is not individually registered in the program, but who has been certified by the OA or a State Apprenticeship Agency (where appropriate) to be eligible for probationary employment as an apprentice, will be permitted to work at less than the predetermined rate for the work they perform in the first 90 days of probationary employment as an apprentice in such a program. In the event the OA or a State Apprenticeship Agency recognized by the OA withdraws approval of an apprenticeship program, the contractor will no longer be permitted to use apprentices at less than the applicable predetermined rate for the work performed until an acceptable program is approved.

(2) *Fringe benefits*. Apprentices must be paid fringe benefits in accordance with the provisions of the apprenticeship program. If the apprenticeship program does not specify fringe benefits, apprentices must be paid the full amount of fringe benefits listed on the wage determination for the applicable classification. If the Administrator determines that a different practice prevails for the applicable apprentice classification, fringe benefits must be paid in accordance with that determination.

(3) *Apprenticeship ratio*. The allowable ratio of apprentices to journeyworkers on the job site in any craft classification must not be greater than the ratio permitted to the contractor as to the entire work force under the registered program or the ratio applicable to the locality of the project pursuant to paragraph 4.a.(4) of this section. Any worker listed on a payroll at an apprentice wage rate, who is not registered or otherwise employed as stated in paragraph 4.a.(1) of this section, must be paid not less than the applicable wage rate on the wage determination for the classification of work actually performed. In addition, any apprentice performing work on the job site in excess of the ratio permitted under this section must be paid not less than the applicable wage rate on the wage determination for the work actually performed.

(4) *Reciprocity of ratios and wage rates*. Where a contractor is performing construction on a project in a locality other than the locality in which its program is registered, the ratios and wage rates (expressed in percentages of the journeyworker's hourly rate) applicable within the locality in which the construction is being performed must be observed. If there is no applicable ratio or wage rate for the locality of the project, the ratio and wage rate specified in the contractor's registered program must be observed.

b. *Equal employment opportunity*. The use of apprentices and journeyworkers under this part must be in conformity with



the equal employment opportunity requirements of Executive Order 11246, as amended, and [29 CFR part 30](#).

c. Apprentices and Trainees (programs of the U.S. DOT).

Apprentices and trainees working under apprenticeship and skill training programs which have been certified by the Secretary of Transportation as promoting EEO in connection with Federal-aid highway construction programs are not subject to the requirements of paragraph 4 of this Section IV. 23 CFR 230.111(e)(2). The straight time hourly wage rates for apprentices and trainees under such programs will be established by the particular programs. The ratio of apprentices and trainees to journeyworkers shall not be greater than permitted by the terms of the particular program.

**5. Compliance with Copeland Act requirements.** The contractor shall comply with the requirements of 29 CFR part 3, which are incorporated by reference in this contract as provided in 29 CFR 5.5.

**6. Subcontracts.** The contractor or subcontractor must insert FHWA-1273 in any subcontracts, along with the applicable wage determination(s) and such other clauses or contract modifications as the contracting agency may by appropriate instructions require, and a clause requiring the subcontractors to include these clauses and wage determination(s) in any lower tier subcontracts. The prime contractor is responsible for the compliance by any subcontractor or lower tier subcontractor with all the contract clauses in this section. In the event of any violations of these clauses, the prime contractor and any subcontractor(s) responsible will be liable for any unpaid wages and monetary relief, including interest from the date of the underpayment or loss, due to any workers of lower-tier subcontractors, and may be subject to debarment, as appropriate. 29 CFR 5.5.

**7. Contract termination: debarment.** A breach of the contract clauses in 29 CFR 5.5 may be grounds for termination of the contract, and for debarment as a contractor and a subcontractor as provided in 29 CFR 5.12.

**8. Compliance with Davis-Bacon and Related Act requirements.** All rulings and interpretations of the Davis-Bacon and Related Acts contained in 29 CFR parts 1, 3, and 5 are herein incorporated by reference in this contract as provided in 29 CFR 5.5.

**9. Disputes concerning labor standards.** As provided in 29 CFR 5.5, disputes arising out of the labor standards provisions of this contract shall not be subject to the general disputes clause of this contract. Such disputes shall be resolved in accordance with the procedures of the Department of Labor set forth in 29 CFR parts 5, 6, and 7. Disputes within the meaning of this clause include disputes between the contractor (or any of its subcontractors) and the contracting agency, the U.S. Department of Labor, or the employees or their representatives.

**10. Certification of eligibility.** a. By entering into this contract, the contractor certifies that neither it nor any person or firm who has an interest in the contractor's firm is a person or firm ineligible to be awarded Government contracts by virtue of [40 U.S.C. 3144\(b\)](#) or § 5.12(a).

b. No part of this contract shall be subcontracted to any person or firm ineligible for award of a Government contract by virtue of [40 U.S.C. 3144\(b\)](#) or § 5.12(a).

c. The penalty for making false statements is prescribed in the U.S. Code, Title 18 Crimes and Criminal Procedure, [18 U.S.C. 1001](#).

**11. Anti-retaliation.** It is unlawful for any person to discharge, demote, intimidate, threaten, restrain, coerce, blacklist, harass, or in any other manner discriminate against, or to cause any person to discharge, demote, intimidate, threaten, restrain, coerce, blacklist, harass, or in any other manner discriminate against, any worker or job applicant for:

a. Notifying any contractor of any conduct which the worker reasonably believes constitutes a violation of the DBA, Related Acts, this part, or [29 CFR part 1](#) or [3](#);

b. Filing any complaint, initiating or causing to be initiated any proceeding, or otherwise asserting or seeking to assert on behalf of themselves or others any right or protection under the DBA, Related Acts, this part, or [29 CFR part 1](#) or [3](#);

c. Cooperating in any investigation or other compliance action, or testifying in any proceeding under the DBA, Related Acts, this part, or [29 CFR part 1](#) or [3](#); or

d. Informing any other person about their rights under the DBA, Related Acts, this part, or [29 CFR part 1](#) or [3](#).

## V. CONTRACT WORK HOURS AND SAFETY STANDARDS ACT

Pursuant to 29 CFR 5.5(b), the following clauses apply to any Federal-aid construction contract in an amount in excess of \$100,000 and subject to the overtime provisions of the Contract Work Hours and Safety Standards Act. These clauses shall be inserted in addition to the clauses required by 29 CFR 5.5(a) or 29 CFR 4.6. As used in this paragraph, the terms laborers and mechanics include watchpersons and guards.

**1. Overtime requirements.** No contractor or subcontractor contracting for any part of the contract work which may require or involve the employment of laborers or mechanics shall require or permit any such laborer or mechanic in any workweek in which he or she is employed on such work to work in excess of forty hours in such workweek unless such laborer or mechanic receives compensation at a rate not less than one and one-half times the basic rate of pay for all hours worked in excess of forty hours in such workweek. 29 CFR 5.5.

**2. Violation; liability for unpaid wages; liquidated damages.** In the event of any violation of the clause set forth in paragraph 1. of this section the contractor and any subcontractor responsible therefor shall be liable for the unpaid wages and interest from the date of the underpayment. In addition, such contractor and subcontractor shall be liable to the United States (in the case of work done under contract for the District of Columbia or a territory, to such District or to such territory), for liquidated damages. Such liquidated damages shall be computed with respect to each individual laborer or

mechanic, including watchpersons and guards, employed in violation of the clause set forth in paragraph 1. of this section, in the sum currently provided in 29 CFR 5.5(b)(2)\* for each calendar day on which such individual was required or permitted to work in excess of the standard workweek of forty hours without payment of the overtime wages required by the clause set forth in paragraph 1. of this section.

\* \$31 as of January 15, 2023 (See 88 FR 88 FR 2210) as may be adjusted annually by the Department of Labor, pursuant to the Federal Civil Penalties Inflation Adjustment Act of 1990.

### 3. Withholding for unpaid wages and liquidated damages

a. *Withholding process.* The FHWA or the contracting agency may, upon its own action, or must, upon written request of an authorized representative of the Department of Labor, withhold or cause to be withheld from the contractor so much of the accrued payments or advances as may be considered necessary to satisfy the liabilities of the prime contractor or any subcontractor for any unpaid wages; monetary relief, including interest; and liquidated damages required by the clauses set forth in this section on this contract, any other Federal contract with the same prime contractor, or any other federally assisted contract subject to the Contract Work Hours and Safety Standards Act that is held by the same prime contractor (as defined in § 5.2). The necessary funds may be withheld from the contractor under this contract, any other Federal contract with the same prime contractor, or any other federally assisted contract that is subject to the Contract Work Hours and Safety Standards Act and is held by the same prime contractor, regardless of whether the other contract was awarded or assisted by the same agency, and such funds may be used to satisfy the contractor liability for which the funds were withheld.

b. *Priority to withheld funds.* The Department has priority to funds withheld or to be withheld in accordance with Section IV paragraph 2.a. or paragraph 3.a. of this section, or both, over claims to those funds by:

- (1) A contractor's surety(ies), including without limitation performance bond sureties and payment bond sureties;
- (2) A contracting agency for its procurement costs;
- (3) A trustee(s) (either a court-appointed trustee or a U.S. trustee, or both) in bankruptcy of a contractor, or a contractor's bankruptcy estate;
- (4) A contractor's assignee(s);
- (5) A contractor's successor(s); or
- (6) A claim asserted under the Prompt Payment Act, [31 U.S.C. 3901](#)–3907.

4. **Subcontracts.** The contractor or subcontractor must insert in any subcontracts the clauses set forth in paragraphs 1. through 5. of this section and a clause requiring the subcontractors to include these clauses in any lower tier subcontracts. The prime contractor is responsible for compliance by any subcontractor or lower tier subcontractor with the clauses set forth in paragraphs 1. through 5. In the

event of any violations of these clauses, the prime contractor and any subcontractor(s) responsible will be liable for any unpaid wages and monetary relief, including interest from the date of the underpayment or loss, due to any workers of lower-tier subcontractors, and associated liquidated damages and may be subject to debarment, as appropriate.

5. **Anti-retaliation.** It is unlawful for any person to discharge, demote, intimidate, threaten, restrain, coerce, blacklist, harass, or in any other manner discriminate against, or to cause any person to discharge, demote, intimidate, threaten, restrain, coerce, blacklist, harass, or in any other manner discriminate against, any worker or job applicant for:

a. Notifying any contractor of any conduct which the worker reasonably believes constitutes a violation of the Contract Work Hours and Safety Standards Act (CWHSSA) or its implementing regulations in this part;

b. Filing any complaint, initiating or causing to be initiated any proceeding, or otherwise asserting or seeking to assert on behalf of themselves or others any right or protection under CWHSSA or this part;

c. Cooperating in any investigation or other compliance action, or testifying in any proceeding under CWHSSA or this part; or

d. Informing any other person about their rights under CWHSSA or this part.

### VI. SUBLETTING OR ASSIGNING THE CONTRACT

This provision is applicable to all Federal-aid construction contracts on the National Highway System pursuant to 23 CFR 635.116.

1. The contractor shall perform with its own organization contract work amounting to not less than 30 percent (or a greater percentage if specified elsewhere in the contract) of the total original contract price, excluding any specialty items designated by the contracting agency. Specialty items may be performed by subcontract and the amount of any such specialty items performed may be deducted from the total original contract price before computing the amount of work required to be performed by the contractor's own organization (23 CFR 635.116).

a. The term "perform work with its own organization" in paragraph 1 of Section VI refers to workers employed or leased by the prime contractor, and equipment owned or rented by the prime contractor, with or without operators. Such term does not include employees or equipment of a subcontractor or lower tier subcontractor, agents of the prime contractor, or any other assignees. The term may include payments for the costs of hiring leased employees from an employee leasing firm meeting all relevant Federal and State regulatory requirements. Leased employees may only be included in this term if the prime contractor meets all of the following conditions: (based on longstanding interpretation)

- (1) the prime contractor maintains control over the supervision of the day-to-day activities of the leased employees;
- (2) the prime contractor remains responsible for the quality of the work of the leased employees;

- (3) the prime contractor retains all power to accept or exclude individual employees from work on the project; and
- (4) the prime contractor remains ultimately responsible for the payment of predetermined minimum wages, the submission of payrolls, statements of compliance and all other Federal regulatory requirements.

b. "Specialty Items" shall be construed to be limited to work that requires highly specialized knowledge, abilities, or equipment not ordinarily available in the type of contracting organizations qualified and expected to bid or propose on the contract as a whole and in general are to be limited to minor components of the overall contract. 23 CFR 635.102.

2. Pursuant to 23 CFR 635.116(a), the contract amount upon which the requirements set forth in paragraph (1) of Section VI is computed includes the cost of material and manufactured products which are to be purchased or produced by the contractor under the contract provisions.

3. Pursuant to 23 CFR 635.116(c), the contractor shall furnish (a) a competent superintendent or supervisor who is employed by the firm, has full authority to direct performance of the work in accordance with the contract requirements, and is in charge of all construction operations (regardless of who performs the work) and (b) such other of its own organizational resources (supervision, management, and engineering services) as the contracting officer determines is necessary to assure the performance of the contract.

4. No portion of the contract shall be sublet, assigned or otherwise disposed of except with the written consent of the contracting officer, or authorized representative, and such consent when given shall not be construed to relieve the contractor of any responsibility for the fulfillment of the contract. Written consent will be given only after the contracting agency has assured that each subcontract is evidenced in writing and that it contains all pertinent provisions and requirements of the prime contract. (based on long-standing interpretation of 23 CFR 635.116).

5. The 30-percent self-performance requirement of paragraph (1) is not applicable to design-build contracts; however, contracting agencies may establish their own self-performance requirements. 23 CFR 635.116(d).

## **VII. SAFETY: ACCIDENT PREVENTION**

This provision is applicable to all Federal-aid construction contracts and to all related subcontracts.

1. In the performance of this contract the contractor shall comply with all applicable Federal, State, and local laws governing safety, health, and sanitation (23 CFR Part 635). The contractor shall provide all safeguards, safety devices and protective equipment and take any other needed actions as it determines, or as the contracting officer may determine, to be reasonably necessary to protect the life and health of employees on the job and the safety of the public and to protect property in connection with the performance of the work covered by the contract. 23 CFR 635.108.

2. It is a condition of this contract, and shall be made a condition of each subcontract, which the contractor enters into pursuant to this contract, that the contractor and any subcontractor shall not permit any employee, in performance of the contract, to work in surroundings or under conditions which are unsanitary, hazardous or dangerous to his/her health or safety, as determined under construction safety and

health standards (29 CFR Part 1926) promulgated by the Secretary of Labor, in accordance with Section 107 of the Contract Work Hours and Safety Standards Act (40 U.S.C. 3704). 29 CFR 1926.10.

3. Pursuant to 29 CFR 1926.3, it is a condition of this contract that the Secretary of Labor or authorized representative thereof, shall have right of entry to any site of contract performance to inspect or investigate the matter of compliance with the construction safety and health standards and to carry out the duties of the Secretary under Section 107 of the Contract Work Hours and Safety Standards Act (40 U.S.C. 3704).

## **VIII. FALSE STATEMENTS CONCERNING HIGHWAY PROJECTS**

This provision is applicable to all Federal-aid construction contracts and to all related subcontracts.

In order to assure high quality and durable construction in conformity with approved plans and specifications and a high degree of reliability on statements and representations made by engineers, contractors, suppliers, and workers on Federal-aid highway projects, it is essential that all persons concerned with the project perform their functions as carefully, thoroughly, and honestly as possible. Willful falsification, distortion, or misrepresentation with respect to any facts related to the project is a violation of Federal law. To prevent any misunderstanding regarding the seriousness of these and similar acts, Form FHWA-1022 shall be posted on each Federal-aid highway project (23 CFR Part 635) in one or more places where it is readily available to all persons concerned with the project:

18 U.S.C. 1020 reads as follows:

"Whoever, being an officer, agent, or employee of the United States, or of any State or Territory, or whoever, whether a person, association, firm, or corporation, knowingly makes any false statement, false representation, or false report as to the character, quality, quantity, or cost of the material used or to be used, or the quantity or quality of the work performed or to be performed, or the cost thereof in connection with the submission of plans, maps, specifications, contracts, or costs of construction on any highway or related project submitted for approval to the Secretary of Transportation; or

Whoever knowingly makes any false statement, false representation, false report or false claim with respect to the character, quality, quantity, or cost of any work performed or to be performed, or materials furnished or to be furnished, in connection with the construction of any highway or related project approved by the Secretary of Transportation; or

Whoever knowingly makes any false statement or false representation as to material fact in any statement, certificate, or report submitted pursuant to provisions of the Federal-aid Roads Act approved July 11, 1916, (39 Stat. 355), as amended and supplemented;

Shall be fined under this title or imprisoned not more than 5 years or both."

**IX. IMPLEMENTATION OF CLEAN AIR ACT AND FEDERAL WATER POLLUTION CONTROL ACT (42 U.S.C. 7606; 2 CFR 200.88; EO 11738)**

This provision is applicable to all Federal-aid construction contracts in excess of \$150,000 and to all related subcontracts. 48 CFR 2.101; 2 CFR 200.327.

By submission of this bid/proposal or the execution of this contract or subcontract, as appropriate, the bidder, proposer, Federal-aid construction contractor, subcontractor, supplier, or vendor agrees to comply with all applicable standards, orders or regulations issued pursuant to the Clean Air Act (42 U.S.C. 7401-7671q) and the Federal Water Pollution Control Act, as amended (33 U.S.C. 1251-1387). Violations must be reported to the Federal Highway Administration and the Regional Office of the Environmental Protection Agency. 2 CFR Part 200, Appendix II.

The contractor agrees to include or cause to be included the requirements of this Section in every subcontract, and further agrees to take such action as the contracting agency may direct as a means of enforcing such requirements. 2 CFR 200.327.

**X. CERTIFICATION REGARDING DEBARMENT, SUSPENSION, INELIGIBILITY AND VOLUNTARY EXCLUSION**

This provision is applicable to all Federal-aid construction contracts, design-build contracts, subcontracts, lower-tier subcontracts, purchase orders, lease agreements, consultant contracts or any other covered transaction requiring FHWA approval or that is estimated to cost \$25,000 or more – as defined in 2 CFR Parts 180 and 1200. 2 CFR 180.220 and 1200.220.

**1. Instructions for Certification – First Tier Participants:**

- a. By signing and submitting this proposal, the prospective first tier participant is providing the certification set out below.
- b. The inability of a person to provide the certification set out below will not necessarily result in denial of participation in this covered transaction. The prospective first tier participant shall submit an explanation of why it cannot provide the certification set out below. The certification or explanation will be considered in connection with the department or agency's determination whether to enter into this transaction. However, failure of the prospective first tier participant to furnish a certification or an explanation shall disqualify such a person from participation in this transaction. 2 CFR 180.320.
- c. The certification in this clause is a material representation of fact upon which reliance was placed when the contracting agency determined to enter into this transaction. If it is later determined that the prospective participant knowingly rendered an erroneous certification, in addition to other remedies available to the Federal Government, the contracting agency may terminate this transaction for cause of default. 2 CFR 180.325.
- d. The prospective first tier participant shall provide immediate written notice to the contracting agency to whom this proposal is submitted if any time the prospective first tier participant learns that its certification was erroneous when submitted or has become erroneous by reason of changed circumstances. 2 CFR 180.345 and 180.350.

e. The terms "covered transaction," "debarred," "suspended," "ineligible," "participant," "person," "principal," and "voluntarily excluded," as used in this clause, are defined in 2 CFR Parts 180, Subpart I, 180.900-180.1020, and 1200. "First Tier Covered Transactions" refers to any covered transaction between a recipient or subrecipient of Federal funds and a participant (such as the prime or general contract). "Lower Tier Covered Transactions" refers to any covered transaction under a First Tier Covered Transaction (such as subcontracts). "First Tier Participant" refers to the participant who has entered into a covered transaction with a recipient or subrecipient of Federal funds (such as the prime or general contractor). "Lower Tier Participant" refers any participant who has entered into a covered transaction with a First Tier Participant or other Lower Tier Participants (such as subcontractors and suppliers).

f. The prospective first tier participant agrees by submitting this proposal that, should the proposed covered transaction be entered into, it shall not knowingly enter into any lower tier covered transaction with a person who is debarred, suspended, declared ineligible, or voluntarily excluded from participation in this covered transaction, unless authorized by the department or agency entering into this transaction. 2 CFR 180.330.

g. The prospective first tier participant further agrees by submitting this proposal that it will include the clause titled "Certification Regarding Debarment, Suspension, Ineligibility and Voluntary Exclusion-Lower Tier Covered Transactions," provided by the department or contracting agency, entering into this covered transaction, without modification, in all lower tier covered transactions and in all solicitations for lower tier covered transactions exceeding the \$25,000 threshold. 2 CFR 180.220 and 180.300.

h. A participant in a covered transaction may rely upon a certification of a prospective participant in a lower tier covered transaction that is not debarred, suspended, ineligible, or voluntarily excluded from the covered transaction, unless it knows that the certification is erroneous. 2 CFR 180.300; 180.320, and 180.325. A participant is responsible for ensuring that its principals are not suspended, debarred, or otherwise ineligible to participate in covered transactions. 2 CFR 180.335. To verify the eligibility of its principals, as well as the eligibility of any lower tier prospective participants, each participant may, but is not required to, check the System for Award Management website (<https://www.sam.gov/>). 2 CFR 180.300, 180.320, and 180.325.

i. Nothing contained in the foregoing shall be construed to require the establishment of a system of records in order to render in good faith the certification required by this clause. The knowledge and information of the prospective participant is not required to exceed that which is normally possessed by a prudent person in the ordinary course of business dealings.

j. Except for transactions authorized under paragraph (f) of these instructions, if a participant in a covered transaction knowingly enters into a lower tier covered transaction with a person who is suspended, debarred, ineligible, or voluntarily excluded from participation in this transaction, in addition to other remedies available to the Federal Government, the department or agency may terminate this transaction for cause or default. 2 CFR 180.325.

\*\*\*\*\*



**2. Certification Regarding Debarment, Suspension, Ineligibility and Voluntary Exclusion – First Tier Participants:**

a. The prospective first tier participant certifies to the best of its knowledge and belief, that it and its principals:

(1) Are not presently debarred, suspended, proposed for debarment, declared ineligible, or voluntarily excluded from participating in covered transactions by any Federal department or agency, 2 CFR 180.335;

(2) Have not within a three-year period preceding this proposal been convicted of or had a civil judgment rendered against them for commission of fraud or a criminal offense in connection with obtaining, attempting to obtain, or performing a public (Federal, State, or local) transaction or contract under a public transaction; violation of Federal or State antitrust statutes or commission of embezzlement, theft, forgery, bribery, falsification or destruction of records, making false statements, or receiving stolen property, 2 CFR 180.800;

(3) Are not presently indicted for or otherwise criminally or civilly charged by a governmental entity (Federal, State or local) with commission of any of the offenses enumerated in paragraph (a)(2) of this certification, 2 CFR 180.700 and 180.800; and

(4) Have not within a three-year period preceding this application/proposal had one or more public transactions (Federal, State or local) terminated for cause or default. 2 CFR 180.335(d).

(5) Are not a corporation that has been convicted of a felony violation under any Federal law within the two-year period preceding this proposal (USDOT Order 4200.6 implementing appropriations act requirements); and

(6) Are not a corporation with any unpaid Federal tax liability that has been assessed, for which all judicial and administrative remedies have been exhausted, or have lapsed, and that is not being paid in a timely manner pursuant to an agreement with the authority responsible for collecting the tax liability (USDOT Order 4200.6 implementing appropriations act requirements).

b. Where the prospective participant is unable to certify to any of the statements in this certification, such prospective participant should attach an explanation to this proposal. 2 CFR 180.335 and 180.340.

\*\*\*\*\*

**3. Instructions for Certification - Lower Tier Participants:**

(Applicable to all subcontracts, purchase orders, and other lower tier transactions requiring prior FHWA approval or estimated to cost \$25,000 or more - 2 CFR Parts 180 and 1200). 2 CFR 180.220 and 1200.220.

a. By signing and submitting this proposal, the prospective lower tier participant is providing the certification set out below.

b. The certification in this clause is a material representation of fact upon which reliance was placed when this transaction was entered into. If it is later determined that the prospective lower tier participant knowingly rendered an erroneous certification, in addition to other remedies available to the Federal Government, the department, or agency with which

this transaction originated may pursue available remedies, including suspension and/or debarment.

c. The prospective lower tier participant shall provide immediate written notice to the person to which this proposal is submitted if at any time the prospective lower tier participant learns that its certification was erroneous by reason of changed circumstances. 2 CFR 180.365.

d. The terms "covered transaction," "debarred," "suspended," "ineligible," "participant," "person," "principal," and "voluntarily excluded," as used in this clause, are defined in 2 CFR Parts 180, Subpart I, 180.900 – 180.1020, and 1200. You may contact the person to which this proposal is submitted for assistance in obtaining a copy of those regulations. "First Tier Covered Transactions" refers to any covered transaction between a recipient or subrecipient of Federal funds and a participant (such as the prime or general contract). "Lower Tier Covered Transactions" refers to any covered transaction under a First Tier Covered Transaction (such as subcontracts). "First Tier Participant" refers to the participant who has entered into a covered transaction with a recipient or subrecipient of Federal funds (such as the prime or general contractor). "Lower Tier Participant" refers any participant who has entered into a covered transaction with a First Tier Participant or other Lower Tier Participants (such as subcontractors and suppliers).

e. The prospective lower tier participant agrees by submitting this proposal that, should the proposed covered transaction be entered into, it shall not knowingly enter into any lower tier covered transaction with a person who is debarred, suspended, declared ineligible, or voluntarily excluded from participation in this covered transaction, unless authorized by the department or agency with which this transaction originated. 2 CFR 1200.220 and 1200.332.

f. The prospective lower tier participant further agrees by submitting this proposal that it will include this clause titled "Certification Regarding Debarment, Suspension, Ineligibility and Voluntary Exclusion-Lower Tier Covered Transaction," without modification, in all lower tier covered transactions and in all solicitations for lower tier covered transactions exceeding the \$25,000 threshold. 2 CFR 180.220 and 1200.220.

g. A participant in a covered transaction may rely upon a certification of a prospective participant in a lower tier covered transaction that is not debarred, suspended, ineligible, or voluntarily excluded from the covered transaction, unless it knows that the certification is erroneous. A participant is responsible for ensuring that its principals are not suspended, debarred, or otherwise ineligible to participate in covered transactions. To verify the eligibility of its principals, as well as the eligibility of any lower tier prospective participants, each participant may, but is not required to, check the System for Award Management website (<https://www.sam.gov/>), which is compiled by the General Services Administration. 2 CFR 180.300, 180.320, 180.330, and 180.335.

h. Nothing contained in the foregoing shall be construed to require establishment of a system of records in order to render in good faith the certification required by this clause. The knowledge and information of participant is not required to exceed that which is normally possessed by a prudent person in the ordinary course of business dealings.

i. Except for transactions authorized under paragraph e of these instructions, if a participant in a covered transaction knowingly enters into a lower tier covered transaction with a person who is suspended, debarred, ineligible, or voluntarily

excluded from participation in this transaction, in addition to other remedies available to the Federal Government, the department or agency with which this transaction originated may pursue available remedies, including suspension and/or debarment. 2 CFR 180.325.

\*\*\*\*\*

#### **4. Certification Regarding Debarment, Suspension, Ineligibility and Voluntary Exclusion--Lower Tier Participants:**

a. The prospective lower tier participant certifies, by submission of this proposal, that neither it nor its principals:

(1) is presently debarred, suspended, proposed for debarment, declared ineligible, or voluntarily excluded from participating in covered transactions by any Federal department or agency, 2 CFR 180.355;

(2) is a corporation that has been convicted of a felony violation under any Federal law within the two-year period preceding this proposal (USDOT Order 4200.6 implementing appropriations act requirements); and

(3) is a corporation with any unpaid Federal tax liability that has been assessed, for which all judicial and administrative remedies have been exhausted, or have lapsed, and that is not being paid in a timely manner pursuant to an agreement with the authority responsible for collecting the tax liability. (USDOT Order 4200.6 implementing appropriations act requirements)

b. Where the prospective lower tier participant is unable to certify to any of the statements in this certification, such prospective participant should attach an explanation to this proposal.

\*\*\*\*\*

#### **XI. CERTIFICATION REGARDING USE OF CONTRACT FUNDS FOR LOBBYING**

This provision is applicable to all Federal-aid construction contracts and to all related subcontracts which exceed \$100,000. 49 CFR Part 20, App. A.

1. The prospective participant certifies, by signing and submitting this bid or proposal, to the best of his or her knowledge and belief, that:

a. No Federal appropriated funds have been paid or will be paid, by or on behalf of the undersigned, to any person for influencing or attempting to influence an officer or employee of any Federal agency, a Member of Congress, an officer or employee of Congress, or an employee of a Member of Congress in connection with the awarding of any Federal contract, the making of any Federal grant, the making of any Federal loan, the entering into of any cooperative agreement, and the extension, continuation, renewal, amendment, or modification of any Federal contract, grant, loan, or cooperative agreement.

b. If any funds other than Federal appropriated funds have been paid or will be paid to any person for influencing or attempting to influence an officer or employee of any Federal agency, a Member of Congress, an officer or employee of Congress, or an employee of a Member of Congress in connection with this Federal contract, grant, loan, or

cooperative agreement, the undersigned shall complete and submit Standard Form-LLL, "Disclosure Form to Report Lobbying," in accordance with its instructions.

2. This certification is a material representation of fact upon which reliance was placed when this transaction was made or entered into. Submission of this certification is a prerequisite for making or entering into this transaction imposed by 31 U.S.C. 1352. Any person who fails to file the required certification shall be subject to a civil penalty of not less than \$10,000 and not more than \$100,000 for each such failure.

3. The prospective participant also agrees by submitting its bid or proposal that the participant shall require that the language of this certification be included in all lower tier subcontracts, which exceed \$100,000 and that all such recipients shall certify and disclose accordingly.

#### **XII. USE OF UNITED STATES-FLAG VESSELS:**

This provision is applicable to all Federal-aid construction contracts, design-build contracts, subcontracts, lower-tier subcontracts, purchase orders, lease agreements, or any other covered transaction. 46 CFR Part 381.

This requirement applies to material or equipment that is acquired for a specific Federal-aid highway project. 46 CFR 381.7. It is not applicable to goods or materials that come into inventories independent of an FHWA funded-contract.

When oceanic shipments (or shipments across the Great Lakes) are necessary for materials or equipment acquired for a specific Federal-aid construction project, the bidder, proposer, contractor, subcontractor, or vendor agrees:

1. To utilize privately owned United States-flag commercial vessels to ship at least 50 percent of the gross tonnage (computed separately for dry bulk carriers, dry cargo liners, and tankers) involved, whenever shipping any equipment, material, or commodities pursuant to this contract, to the extent such vessels are available at fair and reasonable rates for United States-flag commercial vessels. 46 CFR 381.7.

2. To furnish within 20 days following the date of loading for shipments originating within the United States or within 30 working days following the date of loading for shipments originating outside the United States, a legible copy of a rated, 'on-board' commercial ocean bill-of-lading in English for each shipment of cargo described in paragraph (b)(1) of this section to both the Contracting Officer (through the prime contractor in the case of subcontractor bills-of-lading) and to the Office of Cargo and Commercial Sealift (MAR-620), Maritime Administration, Washington, DC 20590. (MARAD requires copies of the ocean carrier's (master) bills of lading, certified onboard, dated, with rates and charges. These bills of lading may contain business sensitive information and therefore may be submitted directly to MARAD by the Ocean Transportation Intermediary on behalf of the contractor). 46 CFR 381.7.

**ATTACHMENT A - EMPLOYMENT AND MATERIALS  
PREFERENCE FOR APPALACHIAN DEVELOPMENT  
HIGHWAY SYSTEM OR APPALACHIAN LOCAL ACCESS  
ROAD CONTRACTS (23 CFR 633, Subpart B, Appendix B)**

This provision is applicable to all Federal-aid projects funded under the Appalachian Regional Development Act of 1965.

1. During the performance of this contract, the contractor undertaking to do work which is, or reasonably may be, done as on-site work, shall give preference to qualified persons who regularly reside in the labor area as designated by the DOL wherein the contract work is situated, or the subregion, or the Appalachian counties of the State wherein the contract work is situated, except:

a. To the extent that qualified persons regularly residing in the area are not available.

b. For the reasonable needs of the contractor to employ supervisory or specially experienced personnel necessary to assure an efficient execution of the contract work.

c. For the obligation of the contractor to offer employment to present or former employees as the result of a lawful collective bargaining contract, provided that the number of nonresident persons employed under this subparagraph (1c) shall not exceed 20 percent of the total number of employees employed by the contractor on the contract work, except as provided in subparagraph (4) below.

2. The contractor shall place a job order with the State Employment Service indicating (a) the classifications of the laborers, mechanics and other employees required to perform the contract work, (b) the number of employees required in each classification, (c) the date on which the participant estimates such employees will be required, and (d) any other pertinent information required by the State Employment Service to complete the job order form. The job order may be placed with the State Employment Service in writing or by telephone. If during the course of the contract work, the information submitted by the contractor in the original job order is substantially modified, the participant shall promptly notify the State Employment Service.

3. The contractor shall give full consideration to all qualified job applicants referred to him by the State Employment Service. The contractor is not required to grant employment to any job applicants who, in his opinion, are not qualified to perform the classification of work required.

4. If, within one week following the placing of a job order by the contractor with the State Employment Service, the State Employment Service is unable to refer any qualified job applicants to the contractor, or less than the number requested, the State Employment Service will forward a certificate to the contractor indicating the unavailability of applicants. Such certificate shall be made a part of the contractor's permanent project records. Upon receipt of this certificate, the contractor may employ persons who do not normally reside in the labor area to fill positions covered by the certificate, notwithstanding the provisions of subparagraph (1c) above.

5. The provisions of 23 CFR 633.207(e) allow the contracting agency to provide a contractual preference for the use of mineral resource materials native to the Appalachian region.

6. The contractor shall include the provisions of Sections 1 through 4 of this Attachment A in every subcontract for work which is, or reasonably may be, done as on-site work.

**NOTICE OF REQUIREMENTS FOR AFFIRMATIVE  
ACTION TO ENSURE EQUAL EMPLOYMENT  
OPPORTUNITY (EXECUTIVE ORDER 11246)**

1. The Offeror's or Bidder's attention is called to the "Equal Opportunity Clause" and the "Standard Federal Equal Employment Opportunity Construction Contract Specifications" set forth herein.

2. The goal for female participation, expressed in percentage terms for the Contractor's aggregate workforce in each trade on all construction work, is 6.9%.

Until further notice	Goals for minority participation for each trade (percent)
----------------------	---

**SHSA Cities:**

Pascagoula - Moss Point -----	16.9
Biloxi - Gulfport -----	19.2
Jackson -----	30.3

**SMSA Counties:**

Desoto -----	32.3
Hancock, Harrison, Stone-----	19.2
Hinds, Rankin-----	30.3
Jackson -----	16.9

**Non-SMSA Counties:**

George, Greene-----	26.4
---------------------	------

Alcorn, Benton, Bolivar, Calhoun, Carroll, Chickasaw, Clay, Coahoma, Grenada, Itawamba, Lafayette, Lee, Leflore, Marshall, Monroe, Montgomery, Panola, Pontotoc, Prentiss, Quitman, Sunflower, Tallahatchie, Tate, Tippah, Tishomingo, Tunica, Union, Washington, Webster, Yalobusha -----	26.5
---	------

Attala, Choctaw, Claiborne, Clarke, Copiah, Covington, Franklin, Holmes, Humphreys, Issaquena, Jasper, Jefferson, Jefferson Davis, Jones Kemper, Lauderdale, Lawrence, Leake, Lincoln, Lowndes, Madison, Neshoba, Newton, Noxubee, Oktibbeha, Scott, Sharkey, Simpson, Smith, Warren, Wayne, Winston, Yazoo-----	32.0
---	------

Forrest, Lamar, Marion, Pearl River, Perry, Pike, Walthall-----	27.7
--	------

Adams, Amite, Wilkinson -----	30.4
-------------------------------	------

These goals are applicable to all the Contractor's construction work (whether or not it is Federal or federally assisted) performed in the covered area. If the contractor performs construction work in a geographical area located outside of the covered area, it shall apply the goals established for such geographical area where the work is actually performed. With regard to this second area, the contractor also is subject to the goals for both its federally involved and nonfederally involved construction.

The Contractor's compliance with the Executive Order and the regulations in 41 CFR Part 60-4 shall be based on its implementation of the Equal Opportunity clause, specific affirmative action obligations required by the specifications set forth in 41 CFR 60-4.3(a), and its efforts to meet the goals. The hours of minority and female employment and training must be substantially uniform throughout the length of the contract, and in each trade, and the Contractor shall make a good faith effort to employ minorities and women evenly on each of its projects. The transfer of minority or female employees or trainees from Contractor to Contractor or from project to project for the sole purpose of meeting the Contractor's goals shall be a violation of the contract, the Executive Order and the regulations in 41 CFR Part 60-4.2(d). Compliance with the goals will be measured against the total work hours performed.

3. The Contractor shall provide written notification to the Director of the Office of Federal Contract Compliance Programs within 10 working days of award of any construction subcontract in excess of \$10,000 at any tier for construction work under the contract resulting from this solicitation. The notification shall list the name, address and telephone number of the subcontractor, employer identification number of the subcontractor, estimated dollar amount of the subcontract; estimated starting and completion dates of the subcontract; and the geographical area in which the subcontract is to be performed.

4. As used in this Notice, and in the contract resulting from this solicitation, the "covered area" is to the county and city (if any), stated in the advertisement.

5. The notification required in Paragraph 3 shall be addressed to the following:

Contract Compliance Officer  
Mississippi Department of Transportation  
P.O. Box 1850  
Jackson, Mississippi 39215-1850

(12/04/2018)

# MISSISSIPPI DEPARTMENT OF TRANSPORTATION

SPECIAL PROVISION NO. 907-101-1

CODE: (IS)

DATE: 07/20/2023

SUBJECT: Definitions and Terms

Section 101, Definitions and Terms, of the 2017 Edition of the Mississippi Standard Specifications for Road and Bridge Construction is hereby amended as follows.

**907-101.01--Abbreviations.** After the abbreviation API on page 1, add the following.

APL Approved Products List

Replace the abbreviation for AWPA on page 1 with the following.

AWPA American Wood Protection Association

**907-101.02--Definitions.** Delete the sentence after the list of holidays in Subsection 101.02 on page 6 under **holidays, legal**, and substitute the following.

When a legal holiday falls on a Saturday or Sunday, the succeeding Monday, or as proclaimed by the Governor, will be observed as a legal holiday.

Delete the definition for Notice to Proceed in Subsection 101.02 on page 8, and substitute the following.

**Notice to Proceed** - Written notice to the Contractor to proceed with the contract work.

Delete the definition for “Plans” in Subsection 101.02 on page 8, and substitute the following.

**plans** - The approved plans, profiles, typical cross-sections, working drawings and supplemental drawings, or exact reproduction thereof, that show the location, character, dimensions, and details of the work to be done. The plans may also include electronic files, referred to on the plans as Electronic Files Identified as Plans, which may include engineering models, spreadsheets, CADD files or other electronic files used to convey design intent. When the contract does not have an official set of plans, reference to the plans shall mean the contract documents.

## MISSISSIPPI DEPARTMENT OF TRANSPORTATION

SPECIAL PROVISION NO. 907-102-2

CODE: (IS)

DATE: 11/22/2017

SUBJECT: **Bidding Requirements and Conditions**

Section 102, Bidding Requirements and Conditions, of the 2017 Edition of the Mississippi Standard Specifications for Road and Bridge Construction is hereby amended as follows.

**907-102.01--Prequalification of Bidders.** Delete the last sentence of the third paragraph of Subsection 102.01 on page 13, and substitute the following.

The Bidder's Certificate of Responsibility number must be on file with the Department's Contract Administration Division prior to request for permission to bid.

**907-102.02--Contents of Proposal Forms.** Delete the fourth paragraph in Subsection 102.02 on page 13, and substitute the following.

Prospective bidders must complete an online request for permission to be eligible to bid a project. Upon approval, the bidder will be authorized to submit a bid electronically using Bid Express at <http://bidx.com>.

## MISSISSIPPI DEPARTMENT OF TRANSPORTATION

SPECIAL PROVISION NO. 907-105-2

CODE: (IS)

DATE: 07/20/2023

SUBJECT: Control of Work

Section 105, Control of Work, of the 2017 Edition of the Mississippi Standard Specifications for Road and Bridge Construction is hereby amended as follows.

**907-105.01--Authority of the Engineer.** Delete the first sentence of the second paragraph of Subsection 105.01 on page 31, and substitute the following.

The Engineer has the right to suspend the work wholly or in part and to withhold payments because of the Contractor's failure to correct conditions unsafe for workmen or the general public, for failure to carry out provisions of the Contract, or for failure to carry out orders.

**907-105.02--Plans and Working Drawings.** Delete the first paragraph of Subsection 105.02 on page 31, and substitute the following.

After the contract is executed by the Executive Director, the Contractor will receive, free of charge, two bound copies of the proposal and contract documents (one executed and one blank) two full scale copies of the plans, five half-scale copies of the Plans, and Electronic Files Identified as Plans. The Contractor shall have one copy of the proposal and contract documents and one half-scale copy of the plans available at all times during work activity on the project.

## MISSISSIPPI DEPARTMENT OF TRANSPORTATION

SPECIAL PROVISION NO. 907-106-1

CODE: (IS)

DATE: 10/25/2022

SUBJECT: Control of Materials

Section 106, Control of Materials, of the 2017 Edition of the Mississippi Standard Specifications for Road and Bridge Construction is hereby amended as follows.

After Subsection 106.13 on page 47, add the following.

**907-106.14--Buy America Materials Sourcing Requirements for Federal-Aid Projects.** The “Infrastructure Investment and Jobs Act” (the “Act”), or Bipartisan Infrastructure Law (BIL), was enacted on November 15, 2021 (See Public Law No. 117-58, Sections 70901-70953). The Buy America provisions of the Act expand the previous Buy America requirements beyond what is currently required for steel and iron products.

Any steel and iron materials per Subsection 700.01 or construction materials per Subsection 907-700.01.1, that are used for a Federal-Aid highway construction project, shall be domestically manufactured (as further described in Subsection 700.01) and compliant with current requirements of the Act, as implemented by the Office of Management and Budget (OMB) in the “Preliminary Guidance for Construction Materials” in OMB Memorandum M-22-11.

As determined by the Department within the contract prior to award, all products and/or materials will only be classified under one of the following categories: Steel and Iron, Manufactured Products, and Construction Materials. It is the Prime Contractor’s responsibility to ensure all submittals required for Buy America are submitted to the Project Engineer prior to the products and/or materials being incorporated into the work.

The following items require Buy America Certification on Federal-Aid projects:

- (a) Steel and Iron
- (b) Construction Materials

A list of items that require Buy America Certification may be viewed at [www.goMDOT.com](http://www.goMDOT.com) under Business Center → Engineering Standards/Guides/Manuals → Construction Materials.

Items classified as a Manufactured Product that do not include steel and iron components do not require a Buy America Certification on a Federal-Aid project. Manufactured Products are currently exempted under the 1983 waiver from FHWA. Manufactured Products are determined by the Department’s Materials Division.

To be considered a Manufactured Product, an item shall meet one of the following requirements:



- (a) The item consists of two or more of the listed construction materials that have been combined through a manufacturing process.
- (b) The item consists of at least one of the listed construction materials that has been combined through a manufacturing process with a material that is not listed as a construction material.

Buy America provisions do not apply to temporarily used items that (1) are specified to be removed at the end of the project per the contract provisions or (2) are specified to remain in place per the contract provisions and are also documented by the Department in the contract provisions to be removed in a subsequent imminent, near-term phased project.

**MISSISSIPPI DEPARTMENT OF TRANSPORTATION**

**SPECIAL PROVISION NO. 907-108-4**

**CODE: (SP)**

**DATE: 10/07/2020**

**SUBJECT: Subletting of Contract**

Section 108, Prosecution and Progress, of the 2017 Edition of the Mississippi Standard Specifications for Road and Bridge Construction is hereby amended as follows.

**907-108.01--Subletting of Contract.**

**907-108.01.1--General.** Delete the third sentence of the tenth paragraph of Subsection 108.01.1 on the bottom of page 72.

## MISSISSIPPI DEPARTMENT OF TRANSPORTATION

SPECIAL PROVISION NO. 907-109-4

CODE: (IS)

DATE: 04/19/2021

SUBJECT: Measurement and Payment

Section 109, Measurement and Payment, of the 2017 Edition of the Mississippi Standard Specifications for Road and Bridge Construction is hereby amended as follows.

**907-109.01--Measurement of Quantities.** Delete the sixth full paragraph of Subsection 109.01 on page 88, and substitute the following.

If appropriate based on the specific circumstances of the project, the Contractor may request that material specified to be measured by the cubic yard or ton be converted to the other measure. The Contractor must submit this request to the Engineer. The Engineer will provide an approval or denial in writing. The decision is in the sole discretion of the Engineer. If approved, factors for this conversion will be determined by the District Materials Engineer and agreed to by the Contractor. The conversion of the materials along with the conversion factor will be incorporated into the Contract by supplemental agreement. The supplemental agreement must be executed before such method of measurement is used.

**907-109.04--Extra Work.**

**907-109.04.1--Supplemental Agreement.** Delete the second paragraph of Subsection 109.04.1 on page 90.

**907-109.06--Partial Payment.**

**907-109.06.2--Advancement on Materials.**

Delete the next to last paragraph of Subsection 109.06.2 on page 95, and substitute the following.

Materials for which an advanced payment has been allowed must be paid for by the Contractor within 30 days of the estimate on which the advanced payment was first allowed and proof of said payment must be verified by the supplier. If proof of payment is not furnished within the allowable 30 days, the advanced payment will be deducted on subsequent current estimates until such time that proof of payment is furnished.

**907-109.07--Changes in Material Costs.** After the fifth paragraph of Subsection 109.07 on page 96, change the web address to the following.

[https://mdot.ms.gov/portal/current\\_letting](https://mdot.ms.gov/portal/current_letting)

# MISSISSIPPI DEPARTMENT OF TRANSPORTATION

SPECIAL PROVISION NO. 907-420-4

CODE: (SP)

DATE: 02/19/2019

SUBJECT: Undersealing

Section 907-420, Undersealing, is hereby added to and made a part of the 2017 Edition of the Mississippi Standard Specifications for Road and Bridge Construction as follows.

## SECTION 907-420 -- UNDERSEALING

**907-420.01--Description.** This work shall consist of filling voids (undersealing) in the soil adjacent to a pipe culvert(s), box culverts(s), bridge structure(s), or other locations determined by the Engineer. It is intended that the voids around the pipe culverts will be filled from the surface and voids around the box culverts will be filled from within the box culvert.

**907-420.02--Material.** The material for filling the voids shall be a “hydro-sensitive” high density polyurethane meeting the following requirements.

<u>Properties</u>	<u>Test Value</u>	<u>Test Method</u>
Density, lbs./ft., minimum	4.0	ASTM D 1622
Tensile Strength, psi, minimum	100	ASTM D 1622
Compression Strength, psi (at yield point), minimum	90	ASTM D 1621

The Contractor shall furnish the Engineer with certified test reports showing that the material meets the requirements of the specification.

**907-420.03--Construction Requirements.** All undersealing will be done at the locations specified in the plans, or as directed by the Engineer.

**907-420.03.1--Equipment.** The equipment shall be that customarily used in undersealing operations. Generally, it shall consist of a pneumatic or electric drill capable of drilling holes of adequate size in the embankment soil or culvert wall to accomplish the work. The exact depth into the embankment shall be determined by the Contractor. The equipment shall be in satisfactory operating condition and operated in such a manner as to prevent unnecessary damage to existing roadways, structures, and the surrounding area. The pump shall be capable of injecting the high density polyurethane at a rate and to a depth necessary to fill the void adjacent to the existing structures.

**907-420.03.2--Drilling Holes.** Unless otherwise shown in the plans, the size and location of the injection holes shall be as determined by the Manufacturer/Contractor.

**907-420.03.3--Injection Process.** The nozzle of the discharge hose shall be secured in the drilled hole in a manner that provides an adequate seal during the pumping process. The polyurethane

material shall be injected through the drilled holes until all known or encountered voids are filled. The rate and amount of material injection shall be determined by the Manufacturer/Contractor.

When the nozzle is removed, the hole shall be plugged or sealed to the satisfaction of the Engineer. Any excess polyurethane material shall be removed.

**907-420.04--Method of Measurement.** Undersealing, complete and accepted, will be measured by the pound. The quantity of urethane will be based on the supplier's packaging information for the material delivered and incorporated into the project.

**907-420.05--Basis of Payment.** Undersealing, as measured prescribed above, will be paid for at the contract unit price per pound, which price shall include all mobilization, labor, equipment, tools, materials, and incidentals necessary to complete the required work.

Cost for maintenance of traffic and individual traffic control devices as required for undersealing operations shall be included in the unit price for undersealing and will not be measured for separate payment.

Payment will be made under:

907-420-A: Undersealing - per pound

# MISSISSIPPI DEPARTMENT OF TRANSPORTATION

## SUPPLEMENT TO SPECIAL PROVISION NO. 907-618-4

**DATE:** 11/28/2023

**PROJECT:** STP-0018-02(059) / 108214301 & STP-0018-02(059) / 108214302  
Humphreys & Holmes Counties

After the first paragraph of Subsection 907-618.01.2 on page 1, add the following.

Additional traffic control devices will be required as follows.

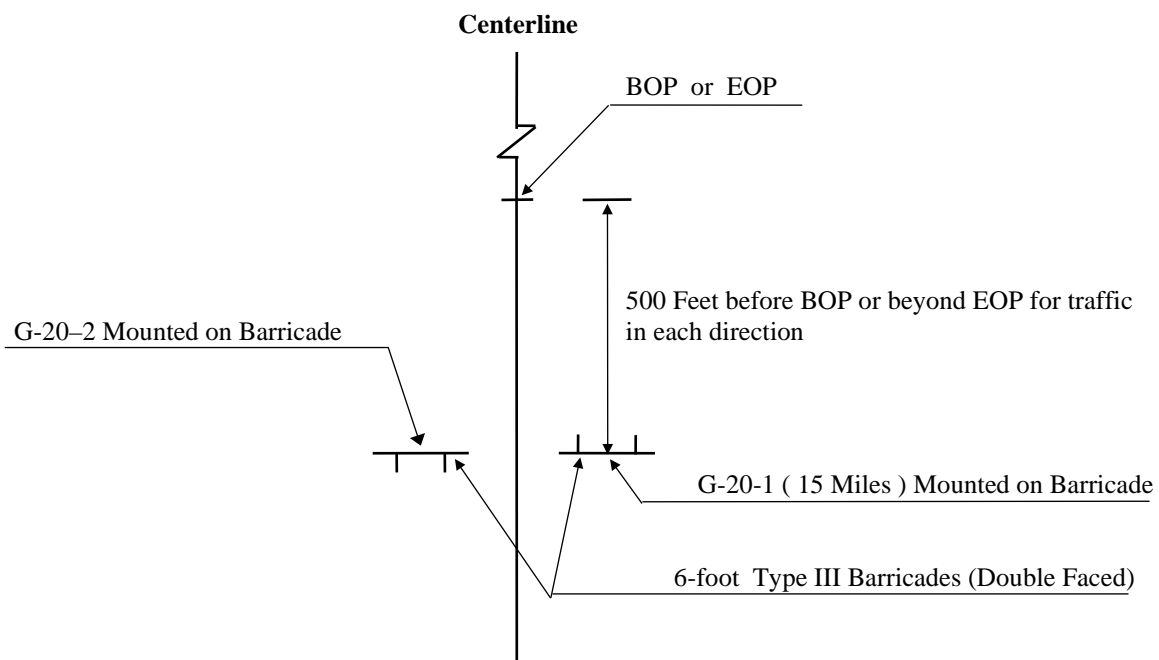

### ADDITIONAL TRAFFIC CONTROL SIGNS REQUIRED:

- 24 - W20-1 "AHEAD" signs required. One (1) W20-1 "AHEAD" sign is required at each local road or street entering the project.
- 37 - R4-1 "DO NOT PASS" signs required.
- 16 - R4-2 "PASS WITH CARE" signs required.
- 18 - W14-3 "NO PASSING ZONE" signs required.

R4-1 "DO NOT PASS", R4-2 "PASS WITH CARE", and W14-3 "NO PASSING ZONE" signs are required in accordance with Subsection 618.03.3, this drawing, and as specified in the Manual on Uniform Traffic Control Devices.

All construction signs and barricades shown on this page shall be included in the bid price for Pay Item 618-A, Maintenance of Traffic. Fluorescent orange sheeting shall be used on all construction and traffic control signs except for R4-1 and R4-2 signs which shall be black legend and border on white background.

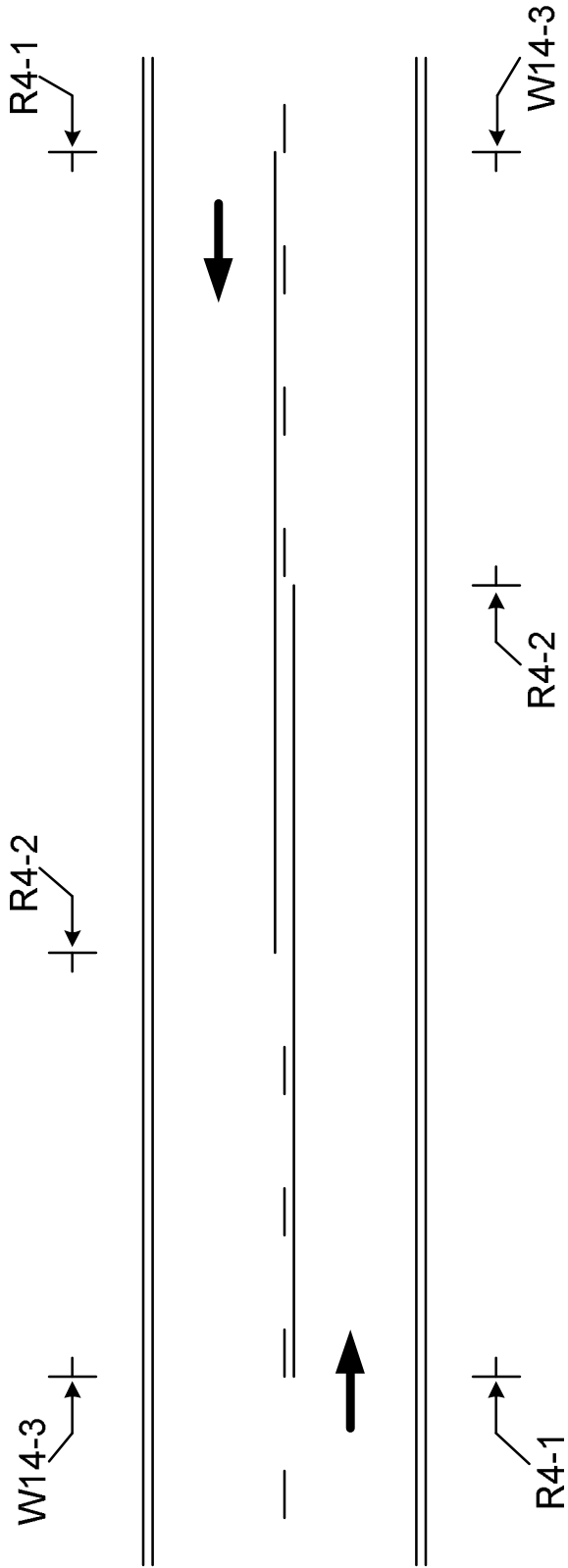

The W14-3, No Passing Zone sign, shall be placed on the left side of the road at the beginning of each no passing zone.

The R4-1, Do Not Pass signs, shall be placed on the right side of the road at the beginning of the no passing zone. Additional R4-1 signs shall be placed right and left in increments of 750 to 1000 feet throughout the length of the no passing zone.

The R4-2, Pass With Care sign, shall be placed on the right side of the road at the end of the no passing zone.

The R4-1, R4-2 and W14-3 signs are to be used when standard pavement markings are not in place. The signs may also be used to emphasize pavement markings.

## MISSISSIPPI DEPARTMENT OF TRANSPORTATION

SPECIAL PROVISION NO. 907-618-4

CODE: (SP)

DATE: 02/01/2018

SUBJECT: Additional Signing Requirements

Section 618, Maintenance of Traffic and Traffic Control Plan, of the 2017 Edition of the Mississippi Standard Specifications for Road and Bridge Construction is hereby amended as follows.

**907-618.01.2--Traffic Control Plan.** At the end of Subsection 618.01.2 on page 441, add the following:

For compliance with the traffic control plan, the Contractor will be required to install and maintain traffic control devices at various locations throughout the project. Payment for these devices will be included in the price bid for pay item no. 618-A, Maintenance of Traffic per lump sum.



## MISSISSIPPI DEPARTMENT OF TRANSPORTATION

SPECIAL PROVISION NO. 907-619-6

CODE: (SP)

DATE: 03/21/2018

SUBJECT: Temporary Portable Rumble Strips

Section 619, Traffic Control for Construction Zones, of the 2017 Edition of the Mississippi Standard Specifications for Road and Bridge Construction is hereby amended as follows.

**907-619.02--Materials.** After Subsection 619.02.15 on page 472, add the following.

**907-619.02.16--Temporary Portable Rumble Strips.** Temporary portable rumble strips shall be RoadQuake manufactured by PSS and meet the following requirements:

- capable of being installed without adhesives or bolts,
- have a minimum weight of 100 pounds,
- have a minimum overall length of 11 feet,
- have a minimum width of 12 inches, and
- have a maximum height of 3/4 inch.

Temporary portable rumble strips shall be installed in accordance with the attached details, or as directed by the Engineer.

**907-619.03--Construction Requirements.** After Subsection 619.03.11 on page 476, add the following.

**907-619.03.16--Temporary Portable Rumble Strips.** Temporary portable rumble strips shall be placed at locations shown on the traffic control plans, attached drawing, or as directed by the Engineer. The rumble strips shall be removed when lane closures are removed, relocated when lane closures are relocated, or as directed by the Engineer.

Prior to placement of the rumble strips, the roadway shall be cleaned to be free of dust, sand, and other materials that may cause slippage. The minimum roadway temperature at the time of installation shall be in accordance with manufacturer recommendations.

A minimum of three (3) temporary portable rumble strips shall be arranged in an array. The spacing of temporary portable rumble strips in each array shall be on 15-foot centers. One array of three (3) strips shall be used in each lane. The rumble strips shall be regularly monitored and maintained to ensure they stay in place under traffic.

**907-619.04--Method of Measurement.** At the end of Subsection 619.04 on page 478, add the following.

Temporary Portable Rumble Strips will be measured for payment by the linear foot only when a pay item for temporary portable rumble strips is included in the contract. Otherwise, temporary portable rumble strips will be included in the cost of pay item 618-A, Maintenance of Traffic. The quantity of temporary portable rumble strips will be the length of rumble strips approved by the Engineer to be in-place on the project at any one time.

**907-619.05--Basis of Payment.** After the fifth paragraph of Subsection 619.05 on page 478, add the following.

Temporary Portable Rumble Strips measured as prescribed above, will be paid for at the contract unit price per linear foot, which price shall be full compensation for cleaning the roadway surface, installing the rumble strips, maintenance and repair of the strips, cleaning and resetting of the strips, removal and replacement, and for all labor, equipment, tools, and incidentals necessary to complete the work.

After the last pay item listed on page 480, add the following.

907-619-B: Temporary Portable Rumble Strips - per linear foot

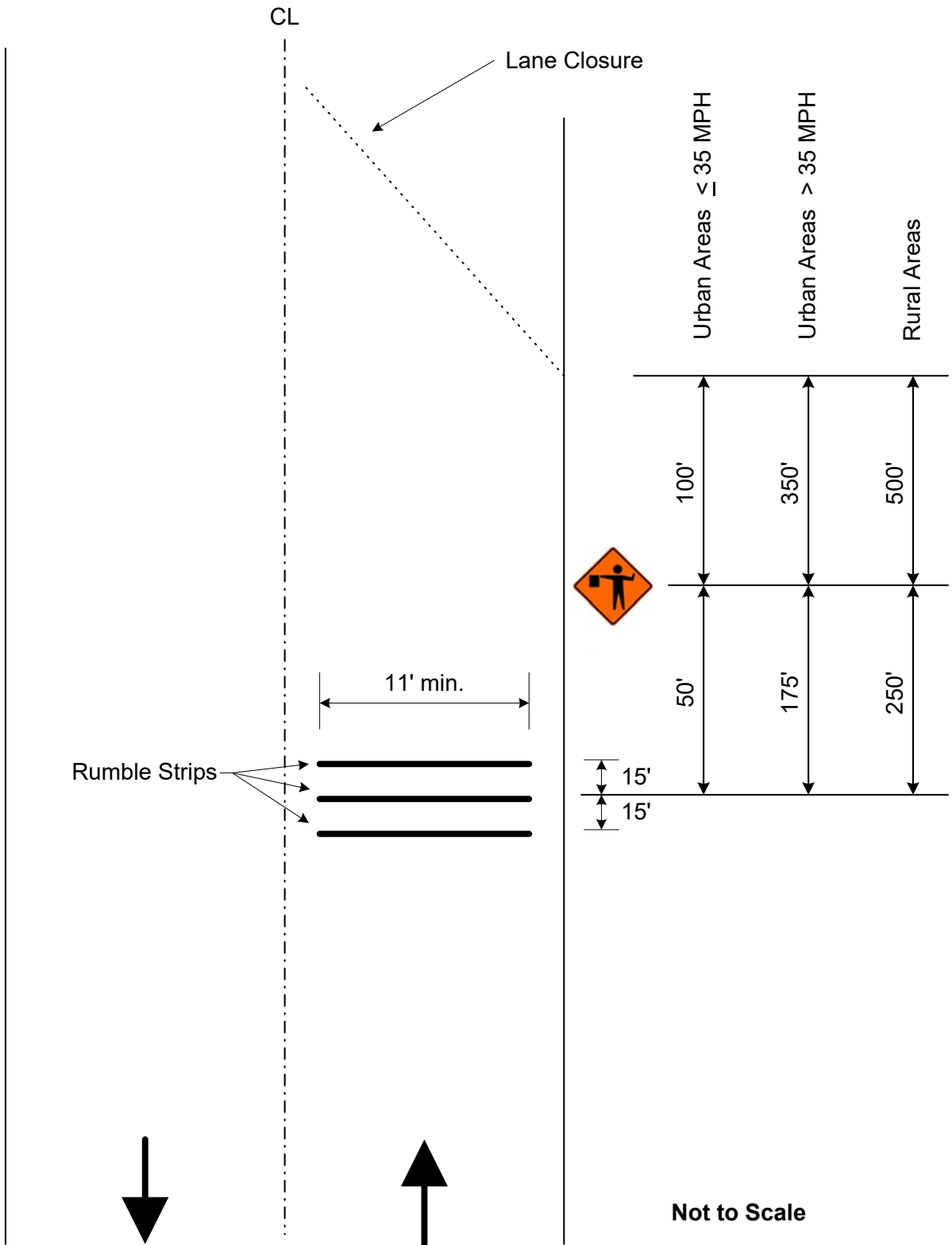

**Detail of Temporary Portable Rumble Strips**

## MISSISSIPPI DEPARTMENT OF TRANSPORTATION

SPECIAL PROVISION NO. 907-700-1

CODE: (IS)

DATE: 10/25/2022

SUBJECT: Materials and Tests

Section 700, Materials and Tests, of the 2017 Edition of the Mississippi Standard Specifications for Road and Bridge Construction is hereby amended as follows.

After Subsection 700.01 on page 713, add the following.

**907-700.01.1--Buy America Materials Sourcing Requirements for Construction Materials.**

As related to the requirements in Subsection 907-106.14, Construction Materials shall include an article or material that is or consists primarily of non-ferrous metals; plastic and polymer-based products (including polyvinylchloride, composite building materials, and polymers used in fiber optic cables); glass (including optic glass); lumber; or drywall. Construction Materials which are exempt from the requirements in Subsection 907-106.14 include the following: cement or cementitious materials; aggregates such as stone, sand, or gravel; or aggregate binding agents or additives.

For Construction Materials, both the final manufacturing process and the manufacturing stage immediately preceding the final manufacturing process shall occur domestically.

**907-700.01.2--Compliance Requirements.** Prior to incorporation into the work, the Contractor shall furnish the Project Engineer with certificates of compliance documenting conformance to the requirements of Subsection 907-106.14.

The certificates shall be on the Supplier's/Manufacturer's letterhead, containing the following:

- Project number
- Name of manufacturer and address of manufacture location
- Material description
- Batch number / Heat number / Lot number
- Bill of lading number
- Date received
- "I certify each material listed on this certificate to be permanently incorporated in this project has been manufactured domestically."
- Signature of an authorized representative of the Supplier/Manufacturer

MISSISSIPPI DEPARTMENT OF TRANSPORTATION

SPECIAL PROVISION NO. 907-701-3

CODE: (IS)

DATE: 05/04/2021

SUBJECT: Hydraulic Cement

Section 701, Hydraulic Cement, of the 2017 Edition of the Mississippi Standard Specifications for Road and Bridge Construction is hereby amended as follows.

**907-701.01--General.** In the first sentence of the second paragraph of Subsection 701.01 on page 718, change “mills” to “plants.”

In the second sentence of the sixth paragraph of Subsection 701.01 on pages 718 and 719, change “shall” to “will.”

**907-701.02--Portland Cement.**

**907-701.02.1-General.**

**907-701.02.1.2--Alkali Content.** Delete the sentence in Subsection 701.02.1.2 on page 719, and substitute the following.

When used in portland cement concrete, the total alkali contribution from all cement types in this Subsection shall not exceed 4.0 lb. per cubic yard of concrete calculated as follows:

$$\text{lb alkali per cu Yd} = \frac{(\text{lb cement per cu Yd}) \times (\% \text{Na}_2\text{O equivalent in cement})}{100}$$

In the above calculation, the maximum cement alkali content reported on the cement mill certificate shall be used. An example calculation can be found in the Department’s *Concrete Field Manual*.

**907-701.02.2--Replacement by Other Cementitious Materials.** Delete the paragraph in Subsection 701.02.2 on page 719, and substitute the following.

The maximum replacement of cement by weight is 25% for fly ash or 50% for ground granulated blast furnace slag (GGBFS). Replacement contents below 20% for fly ash or 45% for GGBFS may be used, but will not be given any special considerations, such as the maximum acceptance temperature for portland cement concrete containing pozzolans in Subsection 804.02.13.1.5. Special considerations shall only apply for replacement of cement by fly ash or GGBFS.

Delete Subsection 701.02.2.1 on pages 719 and 720, and substitute the following.

**907-701.02.2.1--Portland Cement Concrete Exposed to Soluble Sulfate Conditions or Seawater.**

When portland cement concrete is exposed to moderate or severe soluble sulfate conditions, or to seawater, cement types and replacement of cement by Class F fly ash or GGBFS shall be as follows in Table 1. Class C fly ash shall not be used as a replacement for cement in any of the sulfate exposure conditions listed in Table 1.

**Table 1- Cementitious Materials for Soluble Sulfate Conditions or Seawater**

Sulfate Exposure	Water-soluble sulfate (SO <sub>4</sub> ) in soil, % by mass	Sulfate (SO <sub>4</sub> ) in water, ppm	Cementitious material required
Moderate and Seawater	0.10 - 0.20	150 - 1,500	Type I cement with one of the following replacements of cement by weight: 24.5 - 25.0% Class F fly ash, or 49.5 - 50.0% GGBFS or Type II <sup>**</sup> cement
Severe	0.20 - 2.00	1,500 - 10,000	Type I cement with a replacement by weight of 49.5 - 50.0% GGBFS, or Type II <sup>*</sup> cement with one of the following replacements of cement by weight: 24.5 - 25.0% Class F fly ash, or 49.5 - 50.0% GGBFS

\* Type III cement conforming to AASHTO M85 with a maximum 8% tricalcium aluminate (C<sub>3</sub>A) may be used in lieu of Type II cement as allowed in Subsection 701.02.1; this cement is given the designation "Type III(MS)."

\*\* Class F fly ash or GGBFS may be added as a replacement for cement as allowed in Subsection 907-701.02.2.

Delete Subsection 701.02.2.2 on page 720, and substitute the following.

**907-701.02.2.2--Portland Cement for Soil Stabilization Exposed to Soluble Sulfate Conditions or Seawater.** When portland cement for use in soil stabilization is exposed to moderate or severe soluble sulfate conditions, or to seawater, cement types and replacement of cement by Class F fly ash or GGBFS shall meet the requirements of Subsection 701.02.2.1.

**907-701.04--Blended Hydraulic Cement.**

**907-701.04.1--General.** Delete Subsection 701.04.1.1 on page 720, and substitute the following.

**907-701.04.1.1--Types of Blended Hydraulic Cement.** Blended hydraulic cements (blended cements) shall be of the following types and conform to AASHTO M 240:

- Type IL – Portland-limestone cement
- Type IP – Portland-pozzolan cement
- Type IS – Portland blast-furnace slag cement

Blended cement Types IL, IP, and IS meeting the “MS” sulfate resistance requirement listed in AASHTO M 240, Table 3 shall have the “(MS)” suffix added to the type designation.

**907-701.04.1.2--Alkali Content.** Delete the sentence in Subsection 701.04.1.2 on page 720, and substitute the following.

All blended cement types shall be made with clinker that would result in cement meeting the requirements of Subsection 701.02.1.2 when used in the production of AASHTO M 85, Type I or Type II cement.

The blended cement manufacturer shall include the percent equivalent alkalis as Na<sub>2</sub>O on their cement mill reports.

When calculating the total alkali contribution with blended cements, use the equivalent alkali content of the base portland cement. An example calculation for cases where blended cements are used can be found in the Department’s *Concrete Field Manual*.

**907-701.04.2--Replacement by Other Cementitious Materials.** Delete the paragraph in Subsection 701.04.2 on page 720, and substitute the following.

The maximum replacement of blended cement Type IL by weight is 35% for fly ash or 50% for GGBFS. Replacement contents below 20% for fly ash or 45% for GGBFS may be used, but will not be given any special considerations, such as the maximum acceptance temperature for blended cement concrete containing pozzolans in Subsection 804.02.13.1.5. Special considerations shall only apply for replacement of blended cement by fly ash or GGBFS.

No additional cementitious materials, such as portland cement, blended cement, fly ash, GGBFS, or others, shall be added to or as a replacement for blended cement Types IP and IS.

Delete Subsection 701.04.2.1 on pages 720 and 721, and substitute the following.

**907-701.04.2.1--Blended Cement Concrete Exposed to Soluble Sulfate Conditions or Seawater.** When blended cement concrete is exposed to moderate or severe soluble sulfate conditions, or to seawater, cement types and replacement of cement by Class F fly ash or GGBFS shall be as follows in Table 2. Class C fly ash shall not be used as a replacement for cement in any of the sulfate exposure conditions listed in Table 2.

**Table 2- Cementitious Materials for Soluble Sulfate Conditions or Seawater**

Sulfate Exposure	Water-soluble sulfate (SO <sub>4</sub> ) in soil, % by mass	Sulfate (SO <sub>4</sub> ) in water, ppm	Cementitious material required
Moderate and Seawater	0.10 - 0.20	150 - 1,500	Type IL (MS) * cement, Type IL cement with one of the following replacements of cement by weight: 24.5 - 35.0% Class F fly ash, or 49.5 - 50.0% GGBFS, Type IP (MS) cement, or Type IS (MS) cement
Severe	0.20 - 2.00	1,500 - 10,000	Type IL cement with a replacement of cement by weight of 49.5 - 50.0% GGBFS, or Type IL (MS) cement with one of following replacements of cement by weight: 24.5 - 35.0% Class F fly ash, or 49.5 - 50.0% GGBFS

\* Class F fly ash or GGBFS may be added as a replacement for cement as allowed in Subsection 907-701.04.2.

Delete Subsection 701.04.2.2 on page 721, and substitute the following.

**907-701.04.2.2--Blended Cement for Soil Stabilization Exposed to Soluble Sulfate Conditions or Seawater.** When blended cement for use in soil stabilization is exposed to moderate or severe soluble sulfate conditions, or to seawater, cement types and replacement of cement by Class F fly ash or GGBFS shall meet the requirements of Subsection 701.04.2.1.

Delete Subsection 701.04.3 on page 721.



**MISSISSIPPI DEPARTMENT OF TRANSPORTATION**

**SPECIAL PROVISION NO. 907-702-4**

**CODE: (IS)**

**DATE: 09/11/2018**

**SUBJECT: Bituminous Materials**

Section 702, Bituminous Materials, of the 2017 Edition of the Mississippi Standard Specifications for Road and Bridge Construction is hereby amended as follows.

**907-702.04--Sampling.** Delete the sentence in Subsection 702.04 on page 722, and substitute the following.

Sampling of bituminous materials shall be as set out in AASHTO R 66.

**907-702.07--Emulsified Asphalt.** Delete the last sentence in Subsection 702.07 on page 724, and substitute the following.

Asphalt for fog seal shall conform to the requirements of Subsection 907-702.12, Table V.

**907-702.12--Tables.** Delete Table V in Subsection 702.12 on page 729, and substitute the following.

**TABLE V  
SPECIFICATION FOR FOG SEAL**

Test Requirements	LD-7		CHPF-1		Test Method
	Min.	Max.	Min.	Max.	
Viscosity, Saybolt Furol, @ 25°C, Sec.	10	100	-	100	AASHTO T 72
Storage Stability Test, 24 hr, %	-	1	-	1	AASHTO T 59
Settlement, 5 day, %	-	5	-	-	AASHTO T 59
Oil Distillate, %	-	1	-	-	AASHTO T 59
Sieve Test, % *	-	0.3	-	0.1	AASHTO T 59
Residue by Distillation, %	40	-	40	-	AASHTO T 59
<b>Test on Residue from Distillation</b>					
Penetration @ 25°C, 100g, 5 sec	-	20	40	90	AASHTO T 49
Softening Point, °C	65	-	-	-	ASTM D 36
Solubility in trichloroethylene, %	97.5	-	-	-	AASHTO T 44
Elastic Recovery @ 25°C, %	-	-	40	-	AASHTO T 301
Original DSR @ 82° (G*/Sinδ, 10 rad/sec)	1	-	-	-	AASHTO T 111

\* The Sieve Test result is tested for reporting purposes only and may be waived if no application problems are present in the field.

**MISSISSIPPI DEPARTMENT OF TRANSPORTATION**

**SPECIAL PROVISION NO. 907-703-2**

**CODE: (SP)**

**DATE: 11/29/2022**

**SUBJECT: Gradation**

Section 703, Aggregates, of the 2017 Edition of the Mississippi Standard Specifications for Road and Bridge Construction is hereby amended as follows.

**907-703.03--Coarse Aggregates for Hydraulic Cement Concrete.**

**907-703.03.2--Detail Requirements.**

**907-703.03.2.4--Gradation.** In the table in Subsection 703.03.2.4 on page 734, add 100 for the percent passing by weight on the 1½-inch sieve for Size No. 67 aggregates.

Delete Note 2 under the table in Subsection 703.03.2.4 on page 734, and substitute the following.

Note <sup>2</sup> – 100 percent shall pass the 1-inch sieve for Size 67 used in Class F and Class FX concrete.

**MISSISSIPPI DEPARTMENT OF TRANSPORTATION**

**SPECIAL PROVISION NO. 907-705-1**

**CODE: (IS)**

**DATE: 06/13/2018**

**SUBJECT: Stone Riprap**

Section 705, Stone Blanket Protection and Filter Blanket Materials, of the 2017 Edition of the Mississippi Standard Specifications for Road and Bridge Construction is hereby amended as follows.

**907-705.04--Stone Riprap.** Delete the last sentence of the first paragraph of Subsection 705.04 on page 750, and substitute the following.

Quality requirements for rock to be furnished under these specifications will come from a pre-approved source and be visually approved prior to use.

## MISSISSIPPI DEPARTMENT OF TRANSPORTATION

SPECIAL PROVISION NO. 907-707-3

CODE: (IS)

DATE: 10/27/2021

SUBJECT: Joint Materials

Section 707, Joint Materials, of the 2017 Edition of the Mississippi Standard Specifications for Road and Bridge Construction is hereby amended as follows.

### 907-707.02--Joint Filler.

907-707.02.2--Preformed Sponge, Rubber, Cork and Closed-Cell Polypropylene Foam Joint Fillers for concrete Paving and Structural Constructions. Delete the two paragraphs of Subsection 707.02.2 on page 755, and substitute the following.

Preformed joint filler shall conform to AASHTO M 153 for sponge, rubber, and cork and tested according to ASTM D545. The type required will be indicated on the plans.

Closed-cell polypropylene foam shall conform to the requirements in ASTM D8139 and tested in accordance with ASTM D545.

907-707.02.3--Wood. Delete paragraph (b) of Subsection 707.02.3 on page 755, and substitute the following:

- (b) Dimensions shall be as shown on the plans. Dimensions shown on the plans are “dressed” sizes in accordance with Table 3 of the American Softwood Lumber Standard, SP-20. At the discretion of the Engineer, a 3/4-inch dressed board may be used in lieu of a 1-inch dressed board. A tolerance of plus or minus 1/16 inch thickness and plus or minus 1/8 inch width will be permitted. For slip-form paving a tolerance of minus 1/4 inch on each end in length will be permitted.

907-707.06--Flexible Plastic Gasket for Joining Conduit. Delete the third paragraph of Subsection 707.06 on page 756, and substitute the following.

The Department may require the performance test described in ASTM C 990.

**MISSISSIPPI DEPARTMENT OF TRANSPORTATION**

**SPECIAL PROVISION NO. 907-711-2**

**CODE: (IS)**

**DATE: 09/11/2018**

**SUBJECT: Plain Steel Wire**

Section 711, Reinforcement and Wire Rope, of the 2017 Edition of the Mississippi Standard Specifications for Road and Bridge Construction is hereby amended as follows.

**907-711.02--Deformed and Plain Carbon-Steel Bars for Concrete Reinforcing.**

**907-711.02.3--Steel Welded and Non-Welded Wire Reinforcement, Plain and Deformed, for Concrete.**

**907-711.02.3.1--Plain Steel Wire.** Delete the sentence in Subsection 711.02.3.1 on pages 780 and 781, and substitute the following.

Plain steel wire and plain steel welded wire shall conform to the requirements of AASHTO M 336.

## MISSISSIPPI DEPARTMENT OF TRANSPORTATION

SPECIAL PROVISION NO. 907-712-1

CODE: (SP)

DATE: 12/07/2021

SUBJECT: Fence and Guardrail

Section 712, Fence and Guardrail, of the 2017 Edition of the Mississippi Standard Specifications for Road and Bridge Construction is hereby amended as follows.

**907-712.01--General.** After the sentence in Subsection 712.01 on page 785, add the following.

All materials' inspection, testing, and certification will be performed in accordance with the requirements of the current version of the Department's *Materials Division Inspection, Testing, and Certification Manual*.

Delete Subsections 712.02 and 712.03 on page 785, and substitute the following.

**907-712.02--Barbed Wire.** Barbed wire shall conform to the requirements of AASHTO M 280. In the coastal counties of Hancock, Harrison, and Jackson, either Coating Type Z Class 3 or Coating Type A shall be furnished. In all other areas of the State, either Coating Type Z Class 1, Coating Type Z Class 3, Coating Type ZA Class 60, or Coating Type A shall be furnished.

**907-712.03--Metallic-Coated, Steel Woven Wire Fence Fabric.** Woven wire fencing (i.e., "hog wire") shall conform to the requirements of AASHTO M 279. In the coastal counties of Hancock, Harrison, and Jackson, either Coating Type Z Class 3 or Coating Type A shall be furnished. In all other areas of the State, either Coating Type Z Class 1, Coating Type Z Class 3, Coating Type ZA Class 60, or Coating Type A shall be furnished.

**907-712.04--Chain Link Fence.** Delete Subsections 712.04.1 thru 712.04.7 on pages 785 & 786, and substitute the following.

**907-712.04.1--Fabric.** In the coastal counties of Hancock, Harrison, and Jackson, either Type I Class D, Type II, Type III, or Type IV fabrics shall be furnished. In all other areas of the State, either Type I Class C, Type I Class D, Type II, Type III, or Type IV fabrics shall be furnished.

**907-712.04.2--Tie Wire.** Tie wire shall be of the same material as the fencing wire being used, shall be of good commercial quality, and shall meet the requirements of AASHTO M 181. Either Type I, Type II, Type III, or Type IV tie wire shall be furnished.

**907-712.04.3--Tension Wire.** Tension wire shall be of the same material as the fencing wire being used, shall be of good commercial quality, and shall meet the requirements of AASHTO M 181. In the coastal counties of Hancock, Harrison, and Jackson, either Type I Class 3, Type II, Type III, or Type IV tension shall be furnished. In all other areas of the State, either Type II, Type III, Type IV, or Type I Classes 1, 2, or 3 tension wires shall be furnished.

**907-712.04.4--Posts Rails, Gate Frames, and Expansion Sleeves.** Posts, rails, gate frames, and expansion sleeves shall conform to the requirements for posts in Subsection 712.05.2, unless otherwise designated in the contract.

**907-712.04.5--Miscellaneous Fittings and Hardware.** Miscellaneous fittings and hardware shall conform to the requirements of Subsection 712.16.

**907-712.05--Fence Posts and Braces.**

**907-712.05.1--Treated Timber Posts and Braces.**

**907-712.05.1.1--General.** Delete the third, fourth, fifth, and sixth paragraphs of Subsection 712.05.1.1 on page 787, and substitute the following.

All wood posts and braces shall be treated in accordance with Subsections 718.03 and 718.04.

**907-712.05.1.2--Round Posts.** Delete the last sentence of the last paragraph of Subsection 712.05.1.2 on page 788.

**907-712.05.1.3--Sawed Posts.** Delete the last sentence of the paragraph of Subsection 712.05.1.3 on page 788.

**907-712.05.1.4--Sawed Braces.** Delete the last sentence of the paragraph of Subsection 712.05.1.4 on page 788.

Delete Subsection 712.05.2 on page 788, and substitute the following.

**907-712.05.2--Metal Posts.**

**907-712.05.2.1--Round Steel Pipe.** Round steel pipe shall meet the requirements of AASHTO M 181, either Grade 1 (i.e., meeting the requirements in ASTM F 1083) or Grade 2 (i.e., meeting the requirements of ASTM F 1043).

Round steel pipe shall be sized in accordance with NPS (nominal pipe size) designations as shown on Plans, and not according to the outer or inner pipe diameter.

**907-712.05.2.2--Steel Fence Post and Assemblies, Hot-Wrought.** Steel posts with the following section shapes, Tee, channel or U, and Y-Bar shall meet the requirements of AASHTO M 281, galvanized in accordance with the requirements of AASHTO M 111, unless otherwise specified in the contract. Acceptance of these steel posts shall be by certification from the manufacturer, producer, supplier, or fabricator, as applicable.

**907-712.05.2.3--Blank.**

**907-712.05.2.4--Steel H-Beam Posts.** Steel H-Beam posts shall be produced from structural quality weldable steel having a minimum yield strength of 45,000 psi and shall be galvanized in accordance with ASTM A 123. Steel H-Beam line posts shall be 2.250 inches by 1.625 inches and shall weigh 3.43 pounds per foot. A tolerance of plus or minus 5.0 percent is allowed for

weight per foot. A tolerance of plus or minus 1.0 percent is allowed for dimensions.

**907-712.05.2.5--Aluminum-Alloy Posts and Assemblies.** Round aluminum-alloy posts shall meet the requirements of ASTM B 241, Alloy 6061, T6. Aluminum-Alloy H-Beam posts shall meet the requirements of ASTM B 221, Alloy 6061, T6.

**907-712.05.2.6--Formed Steel Section Posts.** Formed steel section posts, "C" sections, shall be formed from sheet steel conforming to ASTM A 1011, Grade 45, and shall be galvanized in accordance with ASTM A 123.

**907-712.06--Guard and Guardrail Posts.**

**907-712.06.2--Treated Wood Posts.**

**907-712.06.2.1--Square Posts.** Delete the paragraph in Subsection 712.06.2.1 on page 789, and substitute the following.

All square posts shall be inspected for conformance with Section 712.05, except that the posts may be rough and shall be within  $\pm 3/8$ " of the dimensions shown on the plans.

**907-712.06.2.2--Round Posts.** Delete the paragraph in Subsection 712.06.2.2 on page 789, and substitute the following.

All round posts shall be inspected for conformance with Section 712.05, except that the posts shall be of the shape and dimensions shown on the plans.

**907-712.06.5--Treated Wood Blocks for Use with Metal Guardrail Posts.** Delete the paragraphs of Subsection 712.06.5 on pages 789 & 790, and substitute the following.

Treated wood blocks for use with metal guardrail posts shall be within  $\pm 3/8$ " of the size and dimensions shown on the plans, except that a minus tolerance shall not be allowed for the slotted width in which the metal post must fit.

Delete Subsection 712.16 on page 791, and substitute the following.

**907-712.16--Hardware.** All ferrous metal hardware for fencing such as bolts, nuts, washers, and metal straps shall be as specified on the plans and galvanizing shall not be less than 1.0 ounce per square foot of uncoated area. Aluminum coated hardware shall be coated with aluminum meeting the requirements of AASHTO M 181 for aluminum coating and at the rate of not less than 0.4 ounces per square foot of uncoated area.

Aluminum alloy hardware shall conform to the requirements of ASTM B 221 for extruded aluminum alloy 6063, T6. The finished members shall be of uniform quality.

Aluminum-zinc coated hardware shall be coated with an aluminum-zinc alloy meeting the chemical requirements and weight of coating specified for aluminum-zinc alloy coated metal gates.



## MISSISSIPPI DEPARTMENT OF TRANSPORTATION

SPECIAL PROVISION NO. 907-714-3

CODE: (SP)

DATE: 08/31/2021

SUBJECT: Miscellaneous Materials

Section 714, Miscellaneous Materials, of the 2017 Edition of the Mississippi Standard Specifications for Road and Bridge Construction is hereby amended as follows.

### 907-714.01--Water.

907-714.01.1--General. Delete the last sentence of the second paragraph in Subsection 714.01.1 on page 794.

907-714.01.2--Water for Use in Concrete. Delete Subsection 714.01.2 on page 794, and substitute the following:

Water from municipal sources is permitted be used as mixing water in concrete, mortar, and grout without Department testing. Water from non-municipal water sources used in mixing of concrete, mortar, and grout which does not meet the requirements in Subsection 714.01.1 shall be tested for conformance as required in AASHTO M157, Table 1 and Table 2.

907-714.01.3--Water for Use in Chemically Stabilized Based. Delete the first sentence of first paragraph in Subsection 714.01.3 on page 794, and substitute the following:

Water used in the construction of bases that contain cement, lime, or other chemical additive shall be as set out in Subsection 714.01.1. Water from municipal sources is permitted to be used without testing for conformance to the requirements below. If water is not from a municipal source, it shall not contain impurities in excess of the following limits:

Delete Subsection 714.01.6 on page 795, and substitute the following.

### 907-714.01.6--Blank.

### 907-714.05--Fly Ash.

907-714.05.1--General. Delete the first sentence of the fifth paragraph in Subsection 714.05.1 on page 797.

**907-714.13--Geotextiles.**

**907-714.13.11--Tables.** Delete Table 1 in Subsection 714.13.11 on page 813, and substitute the following.

**Table 1 - Geotextiles**

Type Designation	I <sup>1</sup> Sediment Control	II <sup>1</sup> Control	III Drainage	IV Paving	V Separation & Drainage		VI Separation, Stabilization & Reinforcement		VIII High Strength	IX High Strength	Test Method
					Woven	Non-Woven	Woven	Non-Woven			
Grab Strength (lb)	50	90	110	90	200	280	180	450	280	280	ASTM D 4632
Elongation (%)	----	50% max @ 45 lb	20% min	50% min @ break	50% min	50% max	50% min	50% max	50% min	50% min	ASTM D 4632
Seam Strength (lb)	----	----	70	----	180	240	160	400	240	240	ASTM D 4632
Puncture Strength (lb)	----	----	40	----	80	110	75	180	115	115	ASTM D 6241
Trapezoidal Tear (lb)	----	----	40	----	80	100	70	150	100	100	ASTM D 4533
Asphalt Retention (gal/yd <sup>2</sup> )	----	----	----	0.2	----	----	----	----	----	----	ASTM D 6140
Permittivity (sec <sup>-1</sup> ) min	0.05	0.05	0.5	----	0.2	0.2	0.2	0.2	0.2	0.2	ASTM D 4491
AOS Woven (mm) max	0.60	0.60	0.6	----	0.6	0.43	----	0.43	----	----	ASTM D 4751
AOS Non-Woven (mm) max	0.84	0.84	0.43	----	0.43	----	0.43	----	0.43	0.43	----
Tensile Strength after UV (% Retained)	70% @ 500 hr	70% @ 500 hr	50% @ 500 hr	----	50% @ 500 hr	50% @ 500 hr	50% @ 500 hr	50% @ 500 hr	50% @ 500 hr	50% @ 500 hr	ASTM D 4355
Melting Point °(F)	----	----	----	325	----	----	----	----	----	----	ASTM D 276
Minimum Ultimate Tensile Strength <sup>3</sup> (lb/in)	----	----	----	----	----	----	----	----	660	2000	ASTM D 4595

Notes: 1 - All property values, with the exception of apparent opening size (AOS), represent minimum average roll values in the weakest principal direction. Values for AOS represent the maximum average roll values, 2 - Values not identified in this table should meet manufacturer certification for the use and application, 3 - Machine direction

Delete Subsection 714.15 on pages 816 and 817 and substitute the following.

**907-714.15--Geogrids.**

**907-714.15.1--General.** A geogrid is defined as a geosynthetic formed by a regular network of connected elements with apertures greater than 0.25 inch to allow interlocking with surrounding soil, rock, and other surrounding materials to function primarily as reinforcement.

Geogrid shall be manufactured from an expanded strain hardened monolithic polymer sheet composed of one or more synthetic polymers and shall be mildew resistant and inert to biological degradation and naturally encountered chemicals, alkalis and acids. The geogrid shall contain stabilizers and/or inhibitors, or a resistance finish or covering to make it resistant to deterioration from direct sunlight, ultraviolet rays, and heat.

Geogrid manufacturers shall participate in and be in compliance with the American Association of State Highway Transportation Officials (AASHTO) National Transportation Product Evaluation Program's (NTPEP) Geosynthetics audit program. Geogrid shall meet the requirements of Table II for the application and type shown on the plans and shall be selected from the Department's Approved Lists.

**907-714.15.1.1--Geogrid for Retaining Walls and Reinforced Soil Slopes.** Geogrid for retaining walls and reinforced soil slopes shall be creep tested in accordance with AASHTO R69 and meet Long Term Design Load, Minimum Ultimate Tensile Strength, and open area criteria listed in Table II. Manufacturers shall perform at least one long-term creep test for no less than 10,000 hours in accordance to ASTM D 5262 for each polymer or composition of polymers from which the geogrid is produced. The long-term design load that shall be reported for design use, shall be that load at which no more than 10% strain occurs over a 100-year design life of the geogrid, as calculated in accordance with AASHTO R69. Long-term design loads shall be reported unfactored, and the AASHTO strength reduction factors (Durability and Installation, and safety factors) will be considered by the Department's Geotechnical Branch on a site specific design basis.

**907-714.15.1.2--Geogrid for Subgrade Stabilization.** Geogrid for subgrade stabilization shall meet Minimum Ultimate Tensile Strength and open area criteria listed in Table II.

**907-714.15.2--Marking, Shipment, and Storage.** Each roll or container of geogrid shall be visibly labeled with the name of the manufacturer, trade name of the product, lot number, and quantity of material. In addition, each roll or container shall be clearly tagged to show the type designation that corresponds to that required by the plans. During shipment and storage the geogrid shall be protected from direct sunlight, and temperatures above 120°F or below 0°F. The geogrid shall either be wrapped and maintained in a heavy duty protective covering or stored in a safe enclosed area to protect from damage during prolonged storage.

**907-714.15.3--Manufacturer Certification.** The Contractor shall furnish the Engineer three copies of the manufacturer's certified test reports indicating that the geogrid furnished conforms to the requirements of the specifications and is of the same composition as the originally approved

by the Department.

**907-714.15.4--Acceptance Sampling and Testing.** Final acceptance of each shipment will be based upon results of tests performed by the Department on verification samples submitted from the project, as compared to the manufacturer's certified test reports. The Engineer will select one roll or container at random from each shipment for sampling. As sample extending full width of the randomly selected roll or container and being at least five (5) square yards in area will be obtained and submitted by the Engineer. All material samples shall be provided at no cost to the State.

**TABLE II  
GEOGRIDS**

Physical Properties	Type Designation						Test Method
	I	II	III	IV	V	VI	
Long Term Design Load <sup>1</sup> , pounds per foot, Machine Direction	250	500	750	1500	2500	3500	AASHTO R69, ASTM D5262
Minimum Ultimate Tensile Strength <sup>2</sup> , pounds per foot, Machine Direction	500	1000	1500	3000	5000	7000	ASTM D6637
Open Area, percent	70	70	50	50	50	50	Direct Measurement

<sup>1</sup> Minimum design criteria requirement.

<sup>2</sup> Minimum Average Roll Value (MARV).

## MISSISSIPPI DEPARTMENT OF TRANSPORTATION

SPECIAL PROVISION NO. 907-718-1

CODE: (SP)

DATE: 12/07/2021

SUBJECT: Timber and Dimension Lumber

Section 718, Timber and Dimension Lumber, of the 2017 Edition of the Mississippi Standard Specifications for Road and Bridge Construction is hereby amended as follows.

Delete the Subsections in Section 718 on pages 836 thru 838, and substitute the following.

**907-718.01--General.** All timber and dimension lumber shall be Southern pine and shall conform in all respects to applicable requirements of AASHTO M 168. The Department reserves the right to sample and to test all materials at any time; all inspection, testing, and certification of materials will be performed in accordance with the requirements of the current version of the Department's *Materials Division Inspection, Testing, and Certification Manual*.

Timber and dimension lumber shall be furnished in the sizes shown on the plans or as specified. Unless otherwise specified, timber and dimension lumber shall be No. 1, or better, graded according to the latest American Lumber Standards.

Only one type of preservative shall be used for the treatment of materials for any one class of construction on a project, unless otherwise specified.

Where treated timber and dimensional lumber is to be used in non-highway construction or use, such as decking, handrails in walking trails, or in any manner where general public exposure by touch is possible, the treatment requirements will be as per project plans and/or approved by the State Materials Engineer.

**907-718.02--Untreated Timber and Dimension Lumber.** Untreated timber and dimension lumber shall conform to the requirements of AASHTO M 168.

**907-718.03--Treated Timber and Dimension Lumber.** Timber and dimension lumber to be treated shall meet the requirements herein specified and shall be treated as specified. Treated timber or dimensional lumber will not be accepted for use unless it has been inspected by an authorized representative of the Department and found to be satisfactory after treatment.

**907-718.03.1--Blank.**

**907-718.03.2--Treatment.**

**907-718.03.2.1--General.** All materials shall be treated in accordance with AASHTO M 133 unless otherwise directed by the Environmental Protection Agency (EPA).

**907-718.03.2.2--Blank.**

**907-718.03.2.3--Inspection.** Treated timber and dimension lumber shall be inspected by an authorized representative of the Department before being incorporated into the work. Treatment reports shall be provided to the Department for each lot of material supplied.

**907-718.03.3--Blank.**

**907-718.03.4--Storage of Treated Material.** All material treated for stock shall be stacked as compactly as possible on a well-drained surface. Material shall be supported on sills spaced as necessary, not to exceed 10 foot intervals and shall have at least one foot of air space beneath the stacks.

All materials treated with preservatives for use in buildings and applications where painting is required shall be dried after treatment. The treated wood shall be dried in accordance with American Lumber Standards.

**907-718.04--Preservative.** Preservatives shall be as specified in AASHTO M 133 unless otherwise directed by the Environmental Protection Agency (EPA).

**MISSISSIPPI DEPARTMENT OF TRANSPORTATION**

**SPECIAL PROVISION NO. 907-720-2**

**CODE: (IS)**

**DATE: 09/11/2018**

**SUBJECT: Acceptance Procedure for Glass Beads**

Section 720, Pavement Marking Materials, of the 2017 Edition of the Mississippi Standard Specifications for Road and Bridge Construction is hereby amended as follows.

**907-720.01--Glass Beads.**

**907-720.01.4--Acceptance Procedures.** Delete the last sentence of the paragraph in Subsection 720.01.4 on page 841, and substitute the following.

Acceptance sampling and testing of glass beads will be in accordance with the Department's Materials Division Inspection, Testing, and Certification Manual, Section 2.9.2 -- Glass Beads.

**MISSISSIPPI DEPARTMENT OF TRANSPORTATION**

**SPECIAL PROVISION NO. 907-721-4**

**CODE: (IS)**

**DATE: 04/19/2022**

**SUBJECT: Materials for Signing**

Section 721, Materials for Signing, of the 2017 Edition of the Mississippi Standard Specifications for Road and Bridge Construction is hereby amended as follows.

**907-721.06--Reflective Sheeting.**

**907-721.06.2--Performance Requirements.** Delete Table 4 and Table 5 in Subsection 721.06.2 on pages 860 & 861, and substitute the following.

**MINIMUM COEFFICIENTS OF RETROREFLECTION  
Candela per foot candle per square foot (cd/ft<sup>2</sup>)  
Per ASTM Designation D4956**

**TABLE 4  
Type IX Sheeting**

Observation Angle	Entrance Angle	White	Yellow	Green	Red	Blue	Fluorescent Yellow/Green	Fluorescent Yellow	Fluorescent Orange
0.2°	-4.0°	380	285	38	76	17	300	230	115
0.2°	+30.0°	215	162	22	43	10	170	130	65
0.5°	-4.0°	240	180	24	48	11	190	145	72
0.5°	+30.0°	135	100	14	27	6.0	110	81	41
1.0°	-4.0°	80	60	8.0	16	3.6	64	48	24
1.0°	+30.0°	45	34	4.5	9.0	2.0	36	27	14

**TABLE 5  
Type XI Sheeting**

Observation Angle	Entrance Angle	White	Yellow	Green	Red	Blue	Brown	Fluorescent Yellow/Green	Fluorescent Yellow	Fluorescent Orange
0.2°	-4.0°	580	435	58	87	26	17	460	350	175
0.2°	+30.0°	220	165	22	33	10	7.0	180	130	66
0.5°	-4.0°	420	315	42	63	19	13	340	250	125
0.5°	+30.0°	150	110	15	23	7.0	5.0	120	90	45
1.0°	-4.0°	120	90	12	18	5.0	4.0	96	72	36
1.0°	+30.0°	45	34	5.0	7.0	2.0	1.0	36	27	14

After Subsection 721.10 on page 864, add the following.

**907-721.11--Digital Applied Printing.** The following addresses the requirements for digitally printed finished retroreflective traffic control signs on flat sheet aluminum and digitally printed traffic sign faces intended to be applied to a sign substrate.

**907-721.11.1--Digitally Printed Ink Systems.** Traffic signs must be produced using components, and processes that comply with the retroreflective sheeting manufacturer’s recommendations.



Digital printed ink systems used to print traffic signs must meet and comply with daytime and nighttime chromaticity (color standards) as recognized in ASTM D4956 “Standard Specification for Retroreflective Sheeting for Traffic Control.”

Digital printed ink systems must meet 70% of the initial retroreflectivity specifications of each respective reflective film color as found in ASTM D4956 “Standard Specification for Retroreflective Sheeting for Traffic Control.”

Prior to fabrication and preferably at the preconstruction meeting, the Contractor shall advise the Project Engineer in writing as to which signs on the project will be digitally printed and which ones will be screen printed. The Contractor shall submit to the Project Engineer certifications for all digitally printed signs, which will be forwarded to the State Traffic Engineer for review.

**907-721.11.2--Protective Overlay Film.** Permanent traffic signs printed with digital ink systems will be fabricated with a full sign protective overlay film designed to provide a smooth surface needed for retroreflectivity, and to protect the sign from fading and UV degradation. The overlamine shall comply with the retroreflective sheeting manufacturer’s recommendations to ensure proper adhesion and transparency and will also meet the reflective film durability as identified in Table 1.

**Table 1  
Retroreflective Film Minimum Durability Requirements**

<b>ASTM D4956 Type</b>	<b>Full Sign Replacement Term (years)</b>	<b>Sheeting Replacement Term (years)</b>
IV	7	10
VIII	7	10
IX	7	12
XI	7	12

Temporary signs used in work zones printed with black ink only will not require a protective overlay film as long as the finished sign is warranted for a minimum outdoor durability of three years by the sheeting manufacturer.

**907-721.11.3--Inspection.** During fabrication, the Contractor shall provide sufficient testing and quality control throughout fabrication to insure good workmanship. Once the material has been received, it may be subject to random testing to ensure compliance with all requirements. If any test samples do not conform to the requirements, the entire order may be returned at the vendor’s expense.

**907-721.11.4--Traffic Sign Performance Warranty Provisions.** Based on the ASTM Type of sheeting specified, traffic control signs shall be warranted for the duration shown in Table 1. The Contractor shall supply a copy of the warranty document with complete details of terms and conditions upon request of the Department.

**907-721.11.5--Certified Digital Sign Fabricator.** Sign fabricators using digital imaging methods to produce regulated traffic signs must be certified by the reflective sheeting manufacturer whose materials are used to produce the delivered signs.

Certified sign fabricators must undergo an audit process by the sheeting manufacturer to ensure they have the proper equipment, manufacturing capabilities, manufacturing application processes and the materials required to fulfill the sheeting manufacturer's warranty obligations. Sign fabricators must recertify annually with reflective sheeting manufacturers or utilize a 3<sup>rd</sup> party certifier approved by the reflective sheeting manufacturer.

The Contractor shall submit proof of Sign Fabricator Certification as issued by the retroreflective sign sheeting manufacturer to the Project Engineer upon delivery of the signs, or with the Shop Drawings.

# SECTION 905 - PROPOSAL

Date \_\_\_\_\_

Mississippi Transportation Commission  
Jackson, Mississippi

Sirs: The following proposal is made on behalf of \_\_\_\_\_  
\_\_\_\_\_ of \_\_\_\_\_  
\_\_\_\_\_

for constructing the following designated project(s) within the time(s) hereinafter specified.

The plans are composed of drawings and blue prints on file in the offices of the Mississippi Department of Transportation, Jackson, Mississippi.

The Specifications are the current Standard Specifications of the Mississippi Department of Transportation approved by the Federal Highway Administration, except where superseded or amended by the plans, Special Provisions and Notice(s) to Bidders attached hereto and made a part thereof.

I (We) certify that I (we) possess a copy of said Standard and any Supplemental Specifications.

Evidence of my (our) authority to submit the Proposal is hereby furnished. The proposal is made without collusion on the part of any person, firm or corporation. I (We) certify that I (we) have carefully examined the Plans, the Specifications, including the Special Provisions and Notice(s) to Bidders, herein, and have personally examined the site of the work. On the basis of the Specifications, Special Provisions, Notice(s) to Bidders, and Plans, I (we) propose to furnish all necessary machinery, tools, apparatus and other means of construction and do all the work and furnish all the materials in the manner specified. I (We) understand that the quantities mentioned herein are approximate only and are subject to either increase or decrease, and hereby propose to perform any increased or decreased quantities of work at the unit prices bid, in accordance with the above.

I (We) acknowledge that this proposal will be found irregular and/or non-responsive unless a certified check, cashier's check, or Proposal Guaranty Bond in the amount as required in the Advertisement (or, by law) is submitted electronically with the proposal or is delivered to the Contract Administration Engineer prior to the bid opening time specified in the advertisement.

**INSTRUCTION TO BIDDERS: Alternate and Optional Items on Bid Schedule.**

1. Two or more items entered opposite a single unit quantity WITHOUT DEFINITE DESIGNATION AS "ALTERNATE ITEMS" are considered as "OPTIONAL ITEMS". Bidders may or may not indicate on bids the Optional Item proposed to be furnished or performed WITHOUT PREJUDICE IN REGARD TO IRREGULARITY OF BIDS.
2. Items classified on the bid schedule as "ALTERNATE ITEMS" and/or "ALTERNATE TYPES OF CONSTRUCTION" must be preselected and indicated on bids. However, "Alternate Types of Construction" may include Optional Items to be treated as set out in Paragraph 1, above.
3. Optional items not preselected and indicated on the bid schedule MUST be designated in accordance with Subsection 102.06 prior to or at the time of execution of the contract.
4. Optional and Alternate items designated must be used throughout the project.

I (We) further propose to perform all "force account or extra work" that may be required of me (us) on the basis provided in the Specifications and to give such work my (our) personal attention in order to see that it is economically performed.

I (We) further propose to execute the attached contract agreement (Section 902) as soon as the work is awarded to me (us), and to begin and complete the work within the time limit(s) provided for in the Specifications and Advertisement. I (We) also propose to execute the attached contract bond (Section 903) in an amount not less than one hundred (100) percent of the total of my (our) part, but also to guarantee the excellence of both workmanship and materials until the work is finally accepted.

I (We) shall submit electronically with our proposal or deliver prior to the bid opening time a certified check, cashier's check or bid bond for **five percent (5%) of total bid** and hereby agree that in case of my (our) failure to execute the contract and furnish bond within Ten (10) days after notice of award, the amount of this check (bid bond) will be forfeited to the State of Mississippi as liquidated damages arising out of my (our) failure to execute the contract as proposed. It is understood that in case I am (we are) not awarded the work, the check will be returned as provided in the Specifications.

**SECTION 905 -- PROPOSAL (CONTINUED)**

I (We) hereby certify by digital signature and electronic submission via Bid Express of the Section 905 proposal below, that all certifications, disclosures and affidavits incorporated herein are deemed to be duly executed in the aggregate, fully enforceable and binding upon delivery of the bid proposal. I (We) further acknowledge that this certification shall not extend to the bid bond or alternate security which must be separately executed for the benefit of the Commission. This signature does not cure deficiencies in any required certifications, disclosures and/or affidavits. I (We) also acknowledge the right of the Commission to require full and final execution on any certification, disclosure or affidavit contained in the proposal at the Commission's election upon award. Failure to so execute at the Commission's request within the time allowed in the Standard Specifications for execution of all contract documents will result in forfeiture of the bid bond or alternate security.

Respectfully Submitted,

DATE \_\_\_\_\_

\_\_\_\_\_  
Contractor

BY \_\_\_\_\_  
Signature

TITLE \_\_\_\_\_

ADDRESS \_\_\_\_\_

CITY, STATE, ZIP \_\_\_\_\_

PHONE \_\_\_\_\_

FAX \_\_\_\_\_

E-MAIL \_\_\_\_\_

(To be filled in if a corporation)

Our corporation is chartered under the Laws of the State of \_\_\_\_\_ and the names, titles and business addresses of the executives are as follows:

\_\_\_\_\_  
President Address

\_\_\_\_\_  
Secretary Address

\_\_\_\_\_  
Treasurer Address

The following is my (our) itemized proposal.

Mill & Overlay approximately 15 miles of SR 12 from US 49W to US 49E, known as Federal Aid Project No. STP-0018-02(059) / 108214301 & 302 in Humphreys & Holmes Counties.

Line no.	Item Code	Adj Code	Quantity	Units	Description[Fixed Unit Price]
<b>Roadway Items</b>					
0010	201-D001		433	Station	Random Clearing
0020	202-B007		233	Square Yard	Removal of Asphalt Pavement, All Depths
0030	202-B136		1,954	Linear Feet	Removal of Guard Rail
0040	202-B240		13,970	Linear Feet	Removal of Traffic Stripe
0050	203-G001	(E)	100	Cubic Yard	Excess Excavation, FM, AH
0060	304-D002	(GT)	3,900	Ton	Granular Material, Crushed Stone
0070	403-A015	(BA1)	19,600	Ton	9.5-mm, ST, Asphalt Pavement
0080	403-B006	(BA1)	159	Ton	19-mm, ST, Asphalt Pavement, Leveling
0090	403-B012	(BA1)	2,300	Ton	9.5-mm, ST, Asphalt Pavement, Leveling
0100	406-D003		17,700	Ton	Fine Milling of Bituminous Pavement, All Depths
0110	407-A001	(A2)	17,000	Gallon	Asphalt for Tack Coat
0120	412-A001		3,204	Square Feet	Pre-Grinding (\$3.25)
0130	423-A001		27	Mile	Rumble Strips, Ground In
0140	503-C010		406	Linear Feet	Saw Cut, Full Depth
0150	606-B001		1,213	Linear Feet	Guard Rail, Class A, Type 1
0160	606-D006		4	Each	Guard Rail, Bridge End Section, Type A Modified
0170	606-D019		4	Each	Guard Rail, Bridge End Section, Type H
0180	606-D022		4	Each	Guard Rail, Bridge End Section, Type I
0190	606-E005		11	Each	Guard Rail, Terminal End Section, Flared
0200	606-E007		1	Each	Guard Rail, Terminal End Section, Non-Flared
0210	606-G001		4	Each	Special Sections, Bridge Connector
0220	618-A001		1	Lump Sum	Maintenance of Traffic
0230	618-B001		2	Square Feet	Additional Construction Signs (\$10.00)
0240	619-A1001		57	Mile	Temporary Traffic Stripe, Continuous White
0250	619-A2001		8	Mile	Temporary Traffic Stripe, Continuous Yellow
0260	619-A4002		29	Mile	Temporary Traffic Stripe, Skip Yellow
0270	619-A5001		4,000	Linear Feet	Temporary Traffic Stripe, Detail
0280	619-A6002		900	Linear Feet	Temporary Traffic Stripe, Legend
0290	619-F3001		74	Each	Delineators, Guard Rail, White
0300	620-A001		1	Lump Sum	Mobilization
0310	626-B002		29	Mile	6" Thermoplastic Double Drop Traffic Stripe, Continuous White
0320	626-D001		15	Mile	6" Thermoplastic Double Drop Traffic Stripe, Skip Yellow
0330	626-E001		5	Mile	6" Thermoplastic Double Drop Traffic Stripe, Continuous Yellow
0340	626-G004		6,300	Linear Feet	Thermoplastic Double Drop Detail Stripe, White
0350	626-G005		1,200	Linear Feet	Thermoplastic Double Drop Detail Stripe, Yellow

<b>Line no.</b>	<b>Item Code</b>	<b>Adj Code</b>	<b>Quantity</b>	<b>Units</b>	<b>Description[Fixed Unit Price]</b>
0360	626-H002		2,000	Linear Feet	Thermoplastic Double Drop Legend, White
0370	627-J001		900	Each	Two-Way Clear Reflective High Performance Raised Markers
0380	627-L001		1,450	Each	Two-Way Yellow Reflective High Performance Raised Markers
0390	630-G005		12	Each	Type 3 Object Markers, OM-3R or OM-3L, Post Mounted
0400	907-420-A001		3,000	Pounds	Undersealing
0410	907-619-B001		66	Linear Feet	Temporary Portable Rumble Strips

For Informational Purposes Only

SECTION 905 - COMBINATION BID PROPOSAL (Continued)

**CONDITIONS FOR COMBINATION BID**

If a bidder elects to submit a combined bid for two or more of the contracts listed for this month's letting, the bidder must complete and execute these sheets of the proposal in each of the individual proposals to constitute a combination bid. In addition to this requirement, each individual contract shall be completed, executed and submitted in the usual specified manner.

Failure to execute this Combination Bid Proposal in each of the contracts combined will be just cause for each proposal to be received and evaluated as a separate bid.

It is understood that the Mississippi Transportation Commission not only reserves the right to reject any and all proposals, but also the right to award contracts upon the basis of lowest separate bids or combination bids most advantageous to the State.

It is further understood and agreed that the Combination Bid Proposal is for comparison of bids only and that each contract shall operate in every respect as a separate contract in accordance with its proposal and contract documents.

I (We) agree to complete each contract on or before its specified completion date.

\*\*\*\*\*

**COMBINATION BID PROPOSAL**

This proposal is tendered as one part of a Combination Bid Proposal utilizing option \_\_\_\* of Subsection 102.11 on the following contracts:

\* Option to be shown as either (a), (b), or (c).

	<u>Project No.</u>	<u>County</u>	<u>Project No.</u>	<u>County</u>
1.	_____	_____	6.	_____
2.	_____	_____	7.	_____
3.	_____	_____	8.	_____
4.	_____	_____	9.	_____
5.	_____	_____	10.	_____

(a) If Combination A has been selected, your Combination Bid is complete.

(b) If Combination B has been selected, then complete the following page.

SECTION 905 - COMBINATION BID PROPOSAL (Continued)

Project Number	Pay Item Number	Unit	Unit Price Reduction	Total Item Reduction	Total Contract Reduction
1.					
2.					
3.					
4.					
5.					
6.					
7.					
8.					

For Informational Purposes Only



SECTION 905 - COMBINATION BID PROPOSAL (Continued)

Project Number	Pay Item Number	Unit	Unit Price Reduction	Total Item Reduction	Total Contract Reduction
9.					
10.					

(c) If Combination C has been selected, then initial and complete ONE of the following.

\_\_\_\_\_ I (We) desire to be awarded work not to exceed a total monetary value of \$ \_\_\_\_\_.

\_\_\_\_\_ I (We) desire to be awarded work not to exceed \_\_\_\_\_ number of contracts.



**Certification with regard to the Performance of Previous  
Contracts or Subcontracts subject to the Equal Opportunity  
Clause and the filing of Required Reports**

The Bidder hereby certifies that he has \_\_\_\_\_, has not \_\_\_\_\_, participated in a previous contract or subcontract subject to the Equal Opportunity Clause, as required by Executive Orders 10925, 11114, or 11246, and that he has \_\_\_\_\_, has not \_\_\_\_\_, filed with the Joint Reporting Committee, the Director of the Office of Federal Contract Compliance, a Federal Government contracting or administering agency, or the former President's Committee on Equal Employment Opportunity, all reports due under the applicable filing requirements.

\_\_\_\_\_  
(COMPANY)

DATE: \_\_\_\_\_

NOTE: The above certification is required by the Equal Employment Opportunity Regulations of the Secretary of Labor (41 CFR 60-1.7 (b) (1)), and must be submitted by bidders and proposed subcontractors only in connection with contracts and subcontracts which are subject to the Equal Opportunity Clause. Contracts and Subcontracts which are exempt from the Equal Opportunity Clause are set forth in 41 CFR 60-1.5. (Generally only contracts or subcontracts of \$10,000 or under are exempt.)

Currently, Standard Form 100 (EEO-1) is the only report required by the Executive Orders or their implementing regulations.

Proposed prime Contractors and Subcontractors who have participated in a previous contract or subcontract subject to the Executive orders and have not filed the required reports should note that 41 CFR 60-1.7 (b) (1) prevents the award of contracts and subcontracts unless such Contractors submit a report covering the delinquent period or such other period specified by the Federal Highway Administration or by the Director, Office of Federal Contract Compliance, U. S. Department of Labor.

**MISSISSIPPI DEPARTMENT OF TRANSPORTATION**  
**CERTIFICATION**

I, \_\_\_\_\_,  
(Name of person signing bid)

individually, and in my capacity as \_\_\_\_\_ of  
(Title of person signing bid)

\_\_\_\_\_ do hereby certify under  
(Name of Firm, partnership, or Corporation)

penalty of perjury under the laws of the United States and the State of Mississippi that \_\_\_\_\_

\_\_\_\_\_, Bidder  
(Name of Firm, Partnership, or Corporation)

on Project No. **STP-0018-02(059)/ 108214301000 & STP-0018-02(059)/ 108214302000**

in **Humphreys & Holmes** County(ies), Mississippi, has not either

directly or indirectly entered into any agreement, participated in any collusion; or otherwise taken any action in restraint of free competitive bidding in connection with this contract; nor have any of its corporate officers or principal owners.

Except as noted hereafter, it is further certified that said legal entity and its corporate officers, principal owners, managers, auditors and others in a position of administering federal funds:

- a) Are not presently debarred, suspended, proposed for debarment, declared ineligible, or voluntarily excluded from covered transactions by any Federal department or agency;
- b) Have not within a three-year period preceding this proposal been convicted of or had a civil judgment rendered against them for commission of fraud or a criminal offense in connection with obtaining, attempting to obtain, or performing a public (Federal, State or local) transaction or contract under a public transaction; violation of Federal or State antitrust statutes or commission of embezzlement, theft, forgery, bribery, falsification or destruction of records, making false statements, or receiving stolen property;
- c) Are not presently indicted for or otherwise criminally or civilly charged by a governmental entity (Federal, State or local) with commission of any of the offenses enumerated in (b) above; and
- d) Have not within a three-year period preceding this application/ proposal had one or more public transactions (Federal, State or local) terminated for cause or default.

Do exceptions exist and are made a part thereof? Yes / No

Any exceptions shall address to whom it applies, initiating agency and dates of such action.

Note: Exceptions will not necessarily result in denial of award but will be considered in determining bidder responsibility. Providing false information may result in criminal prosecution or administrative sanctions.

The bidder further certifies that the certification requirements contained in Section XI of Form FHWA 1273, will be or have been included in all subcontracts, material supply agreements, purchase orders, etc. except those procurement contracts for goods or services that are expected to be less than the Federal procurement small purchase threshold fixed at 10 U.S.C. 2304(g) and 41 U.S.C. 253(g) (currently \$25,000) which are excluded from the certification requirements.

The bidder further certifies, to the best of his or her knowledge and belief, that:

1) No Federal appropriated funds have been paid or will be paid to any person for influencing or attempting to influence an officer or employee of any Federal agency, a Member of Congress, an officer or employee of Congress, or an employee of a Member of Congress in connection with the awarding of any Federal contract, the making of any Federal grant, the making of any Federal loan, the entering into of any cooperative agreement, and the extension, continuation, renewal, amendment, or modification of any Federal contract, grant, loan, or cooperative agreement.

2) If any funds other than Federal appropriated funds have been paid or will be paid to any person for influencing or attempting to influence an officer or employee of any Federal agency, a Member of Congress, an officer or employee of Congress, or an employee of a Member of Congress in connection with this contract, Standard Form-LLL, Disclosure Form to Report Lobbying, in accordance with its instructions will be completed and submitted.

The certification contained in (1) and (2) above is a material representation of fact upon which reliance is placed and a prerequisite imposed by Section 1352, Title 31, U.S. Code prior to entering into this contract. Failure to comply shall be subject to a civil penalty of not less than \$10,000 and not more than \$100,000. The bidder shall include the language of the certification in all subcontracts exceeding \$100,000 and all subcontractors shall certify and disclose accordingly.

All of the foregoing is true and correct.

Executed on \_\_\_\_\_

\_\_\_\_\_  
Signature

**MISSISSIPPI DEPARTMENT OF TRANSPORTATION**

SAM.GOV Registration and Unique Entity ID

Bidders are advised that the Prime Contractor must register and maintain a current registration in the **System for Award Management** (<http://sam.gov>) at all times during the project. Upon registration, the Contractor will be assigned a SAM Unique Entity ID.

Bidders are advised that prior to the award of this contract, they MUST be registered in the System for Award Management.

I (We) acknowledge that this contract cannot be awarded if I (We) are not registered in the System for Award Management prior to the award of this contract. \_\_\_\_\_ (Yes / No)

I (We) have a SAM Unique Entity ID. \_\_\_\_\_ (Yes / No)

SAM Unique Entity ID: \_\_\_\_\_

Company Name: \_\_\_\_\_

Company e-mail address: \_\_\_\_\_

## SECTION 902

CONTRACT FOR \_\_\_\_\_  
LOCATED IN THE COUNTY(IES) OF \_\_\_\_\_

STATE OF MISSISSIPPI  
COUNTY OF HINDS

This Contract is entered into by and between the Mississippi Transportation Commission (the "Commission") and the undersigned contractor (the "Contractor"), as follows:

As consideration for this Contract, the Commission agrees to pay the Contractor the amount(s) set out in the Proposal attached hereto. Said payment will be made in the manner and at the time(s) specified in the Specifications and/or Special Provisions, if any. In exchange for said consideration, the Contractor hereby agrees to accept the prices stated in the Proposal as full compensation for the furnishing of all labor, materials and equipment, and the execution of the scope of work identified for this referenced Project as contemplated in this Contract, and as more fully outlined in the Contract Documents (the "Work"). The Contract Documents consist of the Advertisement, the Notice to Bidders, the Proposal, the Specifications, the Special Provisions, and the approved Plans, all of which are hereby made a part of this Contract and incorporated herein by reference.

The Contractor shall be responsible for all loss or damage arising out of, or in any way in connection with the Work, or from any unforeseen obstructions or difficulties that may be encountered in the prosecution of the Work, and for all risks of every description connected with the Work, with the exception of any items specifically excluded in the Contract Documents. The Contractor shall fully and faithfully complete the Work in a good and workmanlike manner, according to the Contract Documents and any Supplemental Agreements thereto.

The Contractor further agrees that the Work shall be done under the direct supervision of, and to the complete satisfaction of, the Executive Director of the Mississippi Department of Transportation, or his authorized representative(s), and, when federal funds are involved, subject to the inspection and approval of the Federal Highway Administration, or its agents, and/or the agents of any other state or federal agency whose funds are involved. Further, the Work shall be done in accordance with any applicable state and federal laws, and any such rules and regulations issued by the Commission and/or any relevant Federal Agency.

The Contractor agrees that all labor as outlined in the Contract Documents may be secured from a list furnished by the Manager of the Win Job Center nearest the project location, or any successor thereto.

It is agreed and understood that each and every provision of law and clause required by law to be inserted into this Contract shall be deemed to be inserted herein, and this Contract shall be read and enforced as though it were included herein. If through mere mistake or otherwise, any such provision is not inserted, then upon the application of either party hereto, the Contract shall be physically amended to make such insertion.

The Contractor agrees that he has read each and every clause of the Contract Documents, and fully understands the meaning of same, and hereby acknowledges that he will comply with all terms, covenants and agreements therein.

Witness our signatures, this the \_\_\_\_ day of \_\_\_\_\_, 20\_\_.

\_\_\_\_\_  
Contractor

By: \_\_\_\_\_  
Title: \_\_\_\_\_

\_\_\_\_\_  
Signed and sealed in the presence of: (name and address of witness)

\_\_\_\_\_  
\_\_\_\_\_

MISSISSIPPI TRANSPORTATION COMMISSION

\_\_\_\_\_  
Executive Director

\_\_\_\_\_  
Secretary to the Commission

Award authorized by the Mississippi Transportation Commission in session on the \_\_\_\_ day of \_\_\_\_\_, \_\_\_\_\_, Minute Book No. \_\_\_\_\_, Page No. \_\_\_\_\_.

**SECTION 903  
PERFORMANCE BOND**

**PERFORMANCE BOND FOR THE FOLLOWING CONTRACT:**

Project No.: \_\_\_\_\_

For the construction of: \_\_\_\_\_

Contract date: \_\_\_\_\_ Contract amount: \_\_\_\_\_

**FOR OWNER: MISSISSIPPI TRANSPORTATION COMMISSION, 401 N. WEST STREET, JACKSON, MISSISSIPPI 39201.**

**CONTRACTOR** (full legal name, contact person, phone number and address):

\_\_\_\_\_  
\_\_\_\_\_  
\_\_\_\_\_  
\_\_\_\_\_

**SURETY** (legal name, phone number, principal place of business and address *for notice purposes*):

\_\_\_\_\_  
\_\_\_\_\_  
\_\_\_\_\_

Second Surety (if applicable):

\_\_\_\_\_  
\_\_\_\_\_  
\_\_\_\_\_

The Contractor and Surety, jointly and severally, bind themselves, their heirs, executors, administrators, successors and assigns, to the Owner for the performance of the Contract, which is incorporated herein by reference, and subject to the following terms:

1. If the Contractor fully and faithfully performs the Contract, the Surety and the Contractor shall have no obligation under this Bond.
2. The Surety's obligation under this Bond shall arise after:
  - (a) the Owner first provides notice to the Contractor and the Surety that termination is imminent, pursuant to the current edition of the Mississippi Standard Specifications for Road and Bridge Construction, which is a part of the Contract; and
  - (b) the Owner declares a Contractor Default, terminates the Contract, and notifies the Surety.
3. The Surety shall promptly and at the Surety's expense, take one of the following actions:
  - (a) Arrange for the Contractor, with the consent of the Owner, to perform and complete the Contract; or
  - (b) Undertake to perform and complete the Contract itself, through its agents or independent contractors.
4. If the Surety does not proceed as provided in Paragraph 3, within 20 calendar days as set forth in Section 108.08 of the current edition of the Mississippi Standard Specifications for Road and Bridge Construction, then the Surety shall be deemed to be in default on this Bond, and the Owner shall be entitled to enforce any remedy available to it under the Contract and applicable law.
5. Subject to the commitment by the Owner to pay the Balance of the Contract Price, the Surety is obligated, without duplication, for



- (a) the responsibilities of the Contractor for correction of defective work and completion of the Contract;
  - (b) additional legal, design professional and delay costs resulting from the Contractor's Default, and resulting from the actions or failure to act of the Surety under Paragraph 3; and
  - (c) liquidated damages, or if no liquidated damages are specified in the Contract, actual damages caused by delayed performance or non-performance of the Contractor.
6. The Surety hereby waives notice of any change, including changes of time, to the Contract or to related subcontracts, purchase orders and other obligations.
  7. The penal sum of the Bond shall be subject to increase or decrease based on any subsequent Supplemental Agreements and/or final contract quantities.
  8. Notice to the Surety, the Owner or the Contractor shall be mailed or delivered to the address listed for notice purposes on the first page of this Bond.

**CONTRACTOR AS PRINCIPAL**

Company: \_\_\_\_\_

Signature: \_\_\_\_\_

Name: \_\_\_\_\_

Title: \_\_\_\_\_

Address: \_\_\_\_\_

\_\_\_\_\_

**SURETY**

Company: \_\_\_\_\_

Signature: \_\_\_\_\_

MS Insurance ID # \_\_\_\_\_

Name: \_\_\_\_\_

Title: \_\_\_\_\_

Address: \_\_\_\_\_

\_\_\_\_\_

**SURETY (if applicable)**

Company: \_\_\_\_\_

Signature: \_\_\_\_\_

MS Insurance ID # \_\_\_\_\_

Name: \_\_\_\_\_

Title: \_\_\_\_\_

Address: \_\_\_\_\_

\_\_\_\_\_

**SECTION 903  
PAYMENT BOND**

**PAYMENT BOND FOR THE FOLLOWING CONTRACT:**

Project No.: \_\_\_\_\_

For the construction of: \_\_\_\_\_

Contract date: \_\_\_\_\_ Contract amount: \_\_\_\_\_

**FOR OWNER: MISSISSIPPI TRANSPORTATION COMMISSION, 401 N. WEST STREET, JACKSON, MISSISSIPPI 39201.**

**CONTRACTOR** (full legal name, contact person, phone number and address):

\_\_\_\_\_  
\_\_\_\_\_  
\_\_\_\_\_

**SURETY** (legal name, phone number, principal place of business and address *for notice purposes*):

\_\_\_\_\_  
\_\_\_\_\_  
\_\_\_\_\_

Second Surety (if applicable):

\_\_\_\_\_  
\_\_\_\_\_  
\_\_\_\_\_

The Contractor and Surety, jointly and severally, bind themselves, their heirs, executors, administrators, successors and assigns, to the Owner for payment of labor, materials and equipment furnished for use in the performance of the Contract, which is incorporated herein by reference, subject to the following terms:

1. If the Contractor promptly makes payment of all sums due to any and all subcontractors, suppliers and/or laborers, and defends, indemnifies and holds harmless the Owner from claims, demands, liens or suits by any person or entity seeking payment for labor, materials or equipment furnished for use in the performance of the Contract, then the Surety and the Contractor shall have no obligation under this Bond.
2. The Owner shall provide notice to the Surety of any claims, demands, liens or suits against the Owner or the Owner's property that it receives from any person or entity ("Claimants") seeking payment for labor, materials or equipment furnished for use in the performance of the Contract.
3. Upon notice of any claims, demands, liens or suits provided by the Owner or Contractor or given to the Surety by a Claimant, the Surety shall promptly and at the Surety's expense, defend, indemnify and hold harmless the Owner against said claim, demand, lien or suit and shall take the following additional actions:
  - (a) Send an answer to the Claimant, with a copy to the Owner, within sixty (60) days after receipt of the Claim, stating the amounts that are undisputed and the basis for challenging any amounts that are disputed; and
  - (b) Pay or arrange for payment of any undisputed amounts.
4. The Surety shall not be liable to the Owner, Claimants or others for obligations of the Contractor that are unrelated to the Contract. The Owner shall not be liable for the payment of any costs or expenses of any Claimant under this Bond, and shall have no obligation under this Bond to make payments to, or give notice on behalf of, Claimants or otherwise have any obligations to Claimants under this Bond.

5. The Surety hereby waives notice of any change, including changes of time, to the Contract or to related subcontracts, purchase orders and other obligations.
6. The penal sum of the Bond shall be subject to increase or decrease based on any subsequent Supplemental Agreements and/or final contract quantities.

**CONTRACTOR AS PRINCIPAL**

Company: \_\_\_\_\_  
Signature: \_\_\_\_\_  
Name: \_\_\_\_\_  
Title: \_\_\_\_\_  
Address: \_\_\_\_\_  
\_\_\_\_\_

**SURETY**

Company: \_\_\_\_\_  
Signature: \_\_\_\_\_ MS Insurance ID # \_\_\_\_\_  
Name: \_\_\_\_\_  
Title: \_\_\_\_\_  
Address: \_\_\_\_\_  
\_\_\_\_\_

**SURETY (if applicable)**

Company: \_\_\_\_\_  
Signature: \_\_\_\_\_ MS Insurance ID # \_\_\_\_\_  
Name: \_\_\_\_\_  
Title: \_\_\_\_\_  
Address: \_\_\_\_\_  
\_\_\_\_\_



# BID BOND

KNOW ALL MEN BY THESE PRESENTS, that we \_\_\_\_\_  
Contractor

\_\_\_\_\_  
Address

\_\_\_\_\_  
City, State ZIP

As principal, hereinafter called the Principal, and \_\_\_\_\_  
Surety

a corporation duly organized under the laws of the state of \_\_\_\_\_

as Surety, hereinafter called the Surety, are held and firmly bound unto State of Mississippi, Jackson, Mississippi

As Obligee, hereinafter called Obligee, in the sum of **Five Per Cent (5%) of Amount Bid**

Dollars(\$ \_\_\_\_\_ )

for the payment of which sum will and truly to be made, the said Principal and said Surety, bind ourselves, our heirs, executors, administrators, successors and assigns, jointly and severally, firmly by these presents.

WHEREAS, the Principal has submitted a bid for **Mill & Overlay approximately 15 miles of SR 12 from US 49W to US 49E, known as Federal Aid Project No. STP-0018-02(059) / 108214301 & 302 in Humphreys & Holmes Counties.**

NOW THEREFORE, the condition of this obligation is such that if the aforesaid Principal shall be awarded the contract, the said Principal will, within the time required, enter into a formal contract and give a good and sufficient bond to secure the performance of the terms and conditions of the contract, then this obligation to be void; otherwise the Principal and Surety will pay unto the Obligee the difference in money between the amount of the bid of the said Principal and the amount for which the Obligee legally contracts with another party to perform the work if the latter amount be in excess of the former, but in no event shall liability hereunder exceed the penal sum hereof.

Signed and sealed this \_\_\_\_\_ day of \_\_\_\_\_, 20\_\_

\_\_\_\_\_  
(Principal)

(Seal)

\_\_\_\_\_  
(Witness) (Name) By: \_\_\_\_\_ (Title)

\_\_\_\_\_  
(Surety) (Seal)

\_\_\_\_\_  
(Witness) (Attorney-in-Fact) By: \_\_\_\_\_

\_\_\_\_\_  
(MS Agent)

\_\_\_\_\_  
Mississippi Insurance ID Number

MISSISSIPPI DEPARTMENT OF TRANSPORTATION  
OFFICE OF CIVIL RIGHTS  
JACKSON, MISSISSIPPI

LIST OF FIRMS SUBMITTING QUOTES

I/we received quotes from the following firms on:

Letting Date: **February 27, 2024**

Project No: STP-0018-02(059)/ 108214301000 & STP-0018-02(059)/ 108214302000

County: Humphreys & Holmes

Disadvantaged Business Enterprise (DBE) Regulations as stated in 49 CFR 26.11 require the Mississippi Department of Transportation (MDOT) to create and maintain a comprehensive list of all firms quoting/bidding subcontracts on prime contracts and quoting/bidding subcontracts on federally-funded transportation projects. For every firm, we require the following information:

Firm Name: \_\_\_\_\_  
 Contact Name/Title: \_\_\_\_\_  
 Firm Mailing Address: \_\_\_\_\_  
 Phone Number: \_\_\_\_\_  
 \_\_\_\_\_ DBE Firm \_\_\_\_\_ Non-DBE Firm

Firm Name: \_\_\_\_\_  
 Contact Name/Title: \_\_\_\_\_  
 Firm Mailing Address: \_\_\_\_\_  
 Phone Number: \_\_\_\_\_  
 \_\_\_\_\_ DBE Firm \_\_\_\_\_ Non-DBE Firm

Firm Name: \_\_\_\_\_  
 Contact Name/Title: \_\_\_\_\_  
 Firm Mailing Address: \_\_\_\_\_  
 Phone Number: \_\_\_\_\_  
 \_\_\_\_\_ DBE Firm \_\_\_\_\_ Non-DBE Firm

Firm Name: \_\_\_\_\_  
 Contact Name/Title: \_\_\_\_\_  
 Firm Mailing Address: \_\_\_\_\_  
 Phone Number: \_\_\_\_\_  
 \_\_\_\_\_ DBE Firm \_\_\_\_\_ Non-DBE Firm

Firm Name: \_\_\_\_\_  
 Contact Name/Title: \_\_\_\_\_  
 Firm Mailing Address: \_\_\_\_\_  
 Phone Number: \_\_\_\_\_  
 \_\_\_\_\_ DBE Firm \_\_\_\_\_ Non-DBE Firm

\_\_\_\_\_  
SUBMITTED BY (Signature)

\_\_\_\_\_  
FIRM NAME

