

MDOT Use Only

Checked _____

Loaded _____

Keyed _____

02 -



SM No. CNHPP0008021211

PROPOSAL AND CONTRACT DOCUMENTS

FOR THE CONSTRUCTION OF

02

Mill & Overlay approximately 5 miles of US 49 from Richard Kendrick Drive to Seminary, known as Project No. NHPP-0008-02(121) / 108719301 in Covington County.

Project Completion: 103 Working Days

(STATE DELEGATED)

NOTICE

**BIDDERS MUST COMPLETE AN ONLINE REQUEST
FOR PERMISSION TO BID THIS PROJECT.**

Electronic addendum updates will be posted on www.gomdot.com

SECTION 900

OF THE CURRENT

2017 STANDARD SPECIFICATIONS

FOR ROAD AND BRIDGE CONSTRUCTION

JACKSON, MISSISSIPPI

**MISSISSIPPI DEPARTMENT OF TRANSPORTATION
TABLE OF CONTENTS**

PROJECT: NHPP-0008-02(121)/108719301 - Covington

Section 901 - Advertisement

Section 904 - Notice to Bidders

#1	Governing Specification, w/ Supplement
#2	Status of ROW, w/ Attachments
#3	Final Cleanup
#113	Tack Coat
#296	Reduced Speed Limit Signs
#445	Mississippi Agent or Qualified Nonresident Agent
#447	Traffic on Milled Surface in Rural Areas
#516	Errata and Modifications to the 2017 Standard Specifications
#1225	Early Notice to Proceed
#1226	Material Storage Under Bridges
#1241	Fuel and Material Adjustments
#1963	Guardrail Pads
#2206	MASH Compliant Devices
#2273	Mississippi Special Fuel Tax Law
#2397	Smoothness Tolerances for Ultra-Thin Asphalt Pavement
#2782	DBE Pre-Bid Meeting
#2954	Reflective Sheeting for Signs
#3676	Asphalt Gyratory Compactor Internal Angle Calibration
#4113	Unique Entity ID Requirement For Federal Funded Projects
#4702	App for Traffic Control Report
#5551	Federal Bridge Formula
#5605	Disadvantaged Business Enterprise In Federal-Aid Highway Construction, w/ Supplement
#5750	Manual on Uniform Traffic Control Devices (MUTCD)
#6078	ARPA Funded Projects
#6181	Contract Time
#6182	Scope of Work
#6183	Specialty Items
906	Required Federal Contract Provisions -- FHWA 1273, w/Supplements

Section 907 - Special Provisions

907-101-1	Definitions and Terms
907-102-2	Bidding Requirements and Conditions
907-105-2	Control of Work
907-106-1	Control of Materials
907-108-4	Subletting of Contract
907-109-5	Measurement and Payment
907-410-3	Fog Seals
907-413-2	Cleaning and Sealing Joints and Cracks
907-618-12	Traffic Control Management
907-626-11	Thermoplastic Markings

PROJECT: NHPP-0008-02(121)/108719301 - Covington

907-627-1	Raised Pavement Markings
907-700-1	Materials and Tests
907-701-3	Hydraulic Cement
907-702-4	Bituminous Materials
907-703-2	Gradation
907-705-1	Stone Riprap
907-707-3	Joint Materials
907-711-2	Plain Steel Wire
907-712-1	Fence and Guardrail
907-714-3	Miscellaneous Materials
907-718-1	Timber and Dimension Lumber
907-720-3	Pavement Marking Materials
907-721-4	Materials for Signing

Section 905 - Proposal, Proposal Bid Items, Combination Bid Proposal

Certification of Performance - Prior Federal-Aid Contracts

Certification Regarding Non-Collusion, Debarment and Suspension

SAM.GOV Registration and Unique Entity ID

Section 902 - Contract Form

Section 903 - Contract Bond Forms

Form -- OCR-485

Progress Schedule

(REVISIONS TO THE ABOVE WILL BE INDICATED ON THE SECOND SHEET
OF SECTION 905 AS ADDENDA)

08/28/2024 12:38 PM

MISSISSIPPI DEPARTMENT OF TRANSPORTATION

SECTION 901 - ADVERTISEMENT

Electronic bids will be received by the Mississippi Transportation Commission at 10:00 o'clock A.M., Wednesday, September 25, 2024, from the Bid Express Service and shortly thereafter publicly read on the Sixth Floor For:

Mill & Overlay approximately 5 miles of US 49 from Richard Kendrick Drive to Seminary, known as Project No. NHPP-0008-02(121) / 108719301 in Covington County.

The attention of bidders is directed to the Contract Provisions governing selection and employment of labor. Minimum wage rates have been predetermined by the Secretary of Labor and are subject to Public Law 87-581, Work Hours Act of 1962, as set forth in the Contract Provisions.

The Mississippi Department of Transportation hereby notifies all bidders that it will affirmatively insure that in any contract entered into pursuant to this advertisement, disadvantaged business enterprises will be afforded full opportunity to submit bids in response to this invitation and will not be discriminated against on the grounds of race, color, sex, age, disability, religion or national origin in consideration for an award.

The award of this contract will be contingent upon the Contractor satisfying the DBE requirements.

The specifications are on file in the offices of the Mississippi Department of Transportation.

Contractors may request permission to bid online at <http://shop.mdot.ms.gov> at no cost. Upon approval, Contractors shall be eligible to submit a bid using Bid Express at <http://bidx.com>. Specimen proposals may be viewed and downloaded online at no cost at <http://mdot.ms.gov> or purchased online at <http://shop.mdot.ms.gov> at a cost of Ten Dollars (\$10.00) per proposal plus a small convenience fee. Cash or checks will not be accepted as payment.

Bid bond, signed or countersigned by a Mississippi Agent or Qualified Nonresident Agent, with Power of Attorney attached, a Cashier's check or Certified Check for five (5%) percent of bid, payable to STATE OF MISSISSIPPI, must accompany each proposal.

The attention of bidders is directed to the provisions of Subsection 102.07 pertaining to irregular proposals and rejection of bids.

BRAD WHITE
EXECUTIVE DIRECTOR

MISSISSIPPI DEPARTMENT OF TRANSPORTATION

SUPPLEMENT TO NOTICE TO BIDDERS NO. 1

DATE: 06/08/2021

SUBJECT: Governing Specifications

Change the web address at the end of the first paragraph to the following.

<https://shop.mdot.ms.gov/default.aspx?StoreIndex=1>

MISSISSIPPI DEPARTMENT OF TRANSPORTATION

SECTION 904 - NOTICE TO BIDDERS NO. 1

CODE: (IS)

DATE: 03/01/2017

SUBJECT: Governing Specifications

The current (2017) Edition of the Standard Specifications for Road and Bridge Construction adopted by the Mississippi Transportation Commission is made a part hereof fully and completely as if it were attached hereto, except where superseded by special provisions, or amended by revisions of the Specifications contained within this proposal. Copies of the specification book may be purchased from the MDOT Construction Division, or online at shopmdot/default.aspx?StoreIndex=1.

A reference in any contract document to controlling requirements in another portion of the contract documents shall be understood to apply equally to any revision or amendment thereof included in the contract.

In the event the plans or proposal contain references to the 2004 Edition of the Standard Specifications for Road and Bridge Construction, it is to be understood that such references shall mean the comparable provisions of the 2017 Edition of the Standard Specifications.

MISSISSIPPI DEPARTMENT OF TRANSPORTATION

SECTION 904 - NOTICE TO BIDDERS NO. 2

CODE: (IS)

DATE: 03/01/2017

SUBJECT: Status of Right-of-Way

Although it is desirable to have acquired all rights-of-way and completed all railroad agreements, utility adjustments and work to be performed by others prior to receiving bids, sometimes it is not considered to be in the public interest to wait until each and every such clearance has been obtained. The bidder is hereby advised of possible unacquired rights-of-way, relocations, railroad agreements and utilities adjustments which have not been completed.

The status of right-of-way acquisition, utility adjustments, encroachments, potentially contaminated sites, railroad facilities, improvements, and asbestos contamination are set forth in the following attachments.

In the event right of entry is not available to ALL parcels of right-of-way and/or all work that is to be accomplished by others on the date set forth in the contract for the Notice to Proceed is not complete, the Department will issue a restricted Notice to Proceed.

STATUS OF RIGHT-OF-WAY

NHPP-0008-02(121)

108719/301000

Covington County

All rights of way and legal rights of entry have been acquired **except:**

None.

POTENTIALLY CONTAMINATED SITES STATUS REPORT

NHPP-0008-02(121), 108719-301000

Covington County

April 15, 2024

THERE IS NO RIGHT OF WAY REQUIRED FOR THIS PROJECT. NO INITIAL SITE ASSESSMENT WILL BE PERFORMED. IF CONTAMINATION ON EXISTING RIGHT OF WAY IS DISCOVERED, IT WILL BE HANDLED BY THE DEPARTMENT.

UTILITY STATUS REPORT					
Project Number		108719/301000			
County		Covington			
Project Description		US 49 From Richard Kendrick Dr to Seminary			
Utilities that were Relocated					
Utility Name & Contact Info	Relocation Site of Utility	Status of the conflict with Project Construction	Restriction information & other remarks, if applicable (i.e. location, date in effect, etc...)	Estimated date for Utility relocation completion	Restriction information & other remarks, if applicable (i.e. location, date in effect, etc...)
None					
Utilities to be relocated					
Utility Name & Contact Info	Current Utility Location	Status of plans, agreements, or permits	Proposed Relocation Site	Estimated date for Utility relocation completion	Restriction information & other remarks, if applicable (i.e. location, date in effect, etc...)
None					
Utilities to remain					
Utility Name & Contact Info	Utility Location to Remain	Status of the conflict with Project Construction	Restriction information & other remarks, if applicable (i.e. location, date in effect, etc...)	Estimated date for Utility relocation completion	Restriction information & other remarks, if applicable (i.e. location, date in effect, etc...)
None					

ASBESTOS ABATEMENT STATUS REPORT

NHPP-0008-02(121), 108719-301000

Covington County

April 15, 2024

Reference is made to notices to bidders entitled "Asbestos National Emission Standards for Hazardous Air Pollutants (NESHAP)" and "Removal of Obstructions".

The following pertinent information is furnished concerning asbestos-containing materials (ACMs), if any, found in buildings to be removed by the Contractor.

There is no Right of Way required for this project. There are no buildings to be removed by the contractor.

MISSISSIPPI DEPARTMENT OF TRANSPORTATION

Inter-Departmental Memorandum

TO: Mr. Lance Cutrer
Dist. 7 Preconstruction Engineer

DATE: April 8, 2024

FROM: Jordan Whittington 
Project Engineer 17-15

SUBJECT OR PROJECT NO: NHPP-0008-02(121)
108719/301000

INFORMATION COPY TO:
Project Office

COUNTY: Covington

The above captioned project was inspected and no encroachments were found within the right of way limits of the project.

If any other information is required, please advise.

JSW



Inter-Departmental Memorandum

to: Mr. Don Drake
Right-of-Way Division (84-01)

DATE: 4/9/2024

From: Lance Cutrer *LC 4/9/24*
District Seven Preconstruction (17-01)

Subject or Project No: 108719/301000
NHPP-0008-02 (121)

INFORMATION COPY TO:

COUNTY: Covington

- Preconstruction File
- Central File
- District Seven (Mr. White & Mr. Whittington)
- Right of Way Division (Ms. Brock)
- Construction Division (Mr. Zivic)

1. **STATUS OF RIGHT OF WAY:** None required.
2. **RIGHT OF WAY CLEARANCE:** There are no encroachments.
3. **STATUS OF AFFECTED RAILROAD OPERATING FACILITIES:** None affected.
4. **STATUS OF REQUIRED UTILITY RELOCATIONS:** None required.
5. **STATUS OF CONSTRUCTION AGREEMENT:** None required.

If any other information is required, please advise

IMPROVEMENTS STATUS REPORT

Improvements to be included in Notice to Bidders to be removed by the Construction Contractor

FMS Construction Project No: 108719-301000

FMS ROW Project No:

External ROW No: NHPP-0008-02(121)

Parcel No:

Station No:

Property Owner:

Description/Pictures:

MISSISSIPPI DEPARTMENT OF TRANSPORTATION

SECTION 904 - NOTICE TO BIDDERS NO. 3

CODE: (SP)

DATE: 01/17/2017

SUBJECT: Final Clean-Up

Immediately prior to final inspection for release of maintenance, the Contractor shall pick up, load, transport and properly dispose of all litter from the entire highway right-of-way that is within the termini of the project.

Litter shall include, but not be limited to, solid wastes such a glass, paper products, tires, wood products, metal, synthetic materials and other miscellaneous debris.

Litter removal is considered incidental to other items of work and will not be measured for separate payment.

MISSISSIPPI DEPARTMENT OF TRANSPORTATION

SECTION 904 - NOTICE TO BIDDERS NO. 113

CODE: (SP)

DATE: 04/18/2017

SUBJECT: Tack Coat

Bidders are advised that in addition to the products listed on the Department's APL as referenced in Subsection 401.03.1.2 on page 256, the Contractor may use one of the following as a tack coat.

- CSS-1
- CSS-1h
- SS-1
- SS-1h

MISSISSIPPI DEPARTMENT OF TRANSPORTATION

SECTION 904 - NOTICE TO BIDDERS NO. 296

CODE: (SP)

DATE: 07/25/2017

SUBJECT: Reduced Speed Limit Signs

Bidders are advised that when the plans or contract documents require the speed limit on a project to be reduced, the Contractor shall begin work within 48 hours of installing the reduced speed limit signs. Should the Contractor not start work or have no plans to start work within 48 hours of installing the signs, the reduced speed limit signs shall be covered and existing speed limit signs uncovered.

MISSISSIPPI DEPARTMENT OF TRANSPORTATION

SECTION 904 - NOTICE TO BIDDERS NO. 445

CODE: (SP)

DATE: 10/10/2017

SUBJECT: Mississippi Agent or Qualified Nonresident Agent

Bidders are hereby advised of the requirements of Subsections 102.08, 103.05.2, and 107.14.2.1 of the *2017 Standard Specifications for Road and Bridge Construction* as it refers to bonding agents. Proposal guaranties, bonds, and liability insurance policies must be signed by a **Mississippi Agent or Qualified Nonresident Agent.**

MISSISSIPPI DEPARTMENT OF TRANSPORTATION

SECTION 904 - NOTICE TO BIDDERS NO. 447

CODE: (SP)

DATE: 10/18/2017

SUBJECT: Traffic on Milled Surface in Rural Areas

Bidders are hereby advised that when the main lanes of a roadway are fine milled, traffic will be allowed to run on a milled surfaces for up to seven (7) calendar days. The Contractor will be assessed a penalty of **\$5,000 per calendar day** afterwards until the milled surfaces are covered with the next lift of asphalt. It shall be the Contractor's responsibility to ensure that the milling operations do not commence until such time as forecasted weather conditions are suitable enough to allow the placement of the asphalt pavement after the milling operations.

MISSISSIPPI DEPARTMENT OF TRANSPORTATION

SECTION 904 - NOTICE TO BIDDERS NO. 516

CODE: (IS)

DATE: 11/28/2017

SUBJECT: Errata and Modifications to the 2017 Standard Specifications

<u>Page</u>	<u>Subsection</u>	<u>Change</u>
16	102.06	In the seventh full paragraph, change “Engineer” to “Director.”
33	105.05.1	In the sixth sentence, change “Contract Administration Engineer” to “Contract Administration Director.”
34	105.05.2.1	In subparagraph 2, change “SWPPP, ECP” to “SWPPP and the ECP”
35	105.05.2.2	In subparagraphs 2, add “ and” to the end of the sentence. In subparagraph 3, remove “, and” and add “.”.
90	109.04.2	In the last paragraph of subparagraph (a), place a period “.” at the end of the sentence.
93	109.04.2	In the last paragraph of subparagraph (g), place a period “.” at the end of the sentence. Also, in the first paragraph of subparagraph (h), place a period “.” at the end of the sentence.
97	109.07	Under ADJUSTMENT CODE, subparagraph (A1), change “HMA mixture” to “Asphalt mixtures.”
98	109.11	In the third sentence, change “Engineer” to “Director.”
219	308.04	In the last sentence of the last paragraph, change “Contractor’s decision” to “Engineer’s decision.”
300	405.02.5.9	In the first sentence of the second paragraph, change “Hot Mix Asphalt” to “Asphalt Mixtures.”
502	630.01.1	In the first paragraph, change “AASHTO” to “AASHTO’s LRFD”.
636	646.05	Change “each” to “per each” for the pay item units of payment.
640	656.02.6.2	In item 7), change “down stream” to “downstream”.
688	630.03.2	Change the subsection number from “630.03.2” to “680.03.2.”

- | | | |
|-----|---------------|---|
| 725 | 702.08.3 | In the second sentence of the first paragraph, change “hot-mix” to “asphalt.” |
| 954 | 804.02.13.1.6 | In the definition for “M” in the % Reduction formulas, change “paragraph 7.3” to “paragraph 5.3.” |

MISSISSIPPI DEPARTMENT OF TRANSPORTATION

SECTION 904 - NOTICE TO BIDDERS NO. 1225

CODE: (SP)

DATE: 11/13/2018

SUBJECT: Early Notice to Proceed

Bidders are advised that if an early notice to proceed is allowed by the Department and the Contractor experiences problems or delays between the early notice to proceed date and the original notice to proceed date, this shall not be justification for any monetary compensation or an extension of contract time.

MISSISSIPPI DEPARTMENT OF TRANSPORTATION

SECTION 904 - NOTICE TO BIDDERS NO. 1226

CODE: (IS)

DATE: 11/16/2018

SUBJECT: Material Storage Under Bridges

Bidders are advised that Subsection 106.08 of the Standard Specifications allows the Contractor to store materials and equipment on portions of the right-of-way. However, the Contractor will not be allowed to store or stockpile materials under bridges without written permission from the Project Engineer. The Contractor shall submit a detailed request of all proposed materials to be stored under bridges to the Engineer a minimum of 14 calendar days prior to anticipated storage. This detail shall include, but not limited to, bridge location, material type, material quantity, and duration of storage. The Project Engineer and any other needed Division will review this information and determine whether to grant approval. The Contractor shall not store any material under any bridge without written approval from the Project Engineer.

MISSISSIPPI DEPARTMENT OF TRANSPORTATION

SECTION 904 - NOTICE TO BIDDERS NO. 1241

CODE: (IS)

DATE: 11/27/2018

SUBJECT: Fuel and Material Adjustments

Bidder's attention is brought to the last paragraph of Subsection 109.07 of the Standard Specifications which states that no fuel or material adjustment will be made after the completion of contract time. Any fuels consumed or materials incorporated into the work during the monthly estimate period falling wholly after the expiration of contract time will not be subject a fuel or material adjustment.

MISSISSIPPI DEPARTMENT OF TRANSPORTATION

SECTION 904 - NOTICE TO BIDDERS NO. 1963

CODE: (SP)

DATE: 9/23/2019

SUBJECT: Guardrail Pads

Bidders are hereby advised that prior to construction of the guardrail pads, the Contractor shall coordinate with the guardrail Subcontractor to determine the guardrail pad dimensions necessary to meet MASH compliance.

MISSISSIPPI DEPARTMENT OF TRANSPORTATION

SECTION 904 - NOTICE TO BIDDERS NO. 2206

CODE: (IS)

DATE: 01/14/2020

SUBJECT: MASH Compliant Devices

Bidders are hereby advised that compliance associated with the requirements of meeting either the National Cooperative Highway Research Program (NCHRP) Report 350 or the Manual for Assessing Safety Hardware (MASH) for installations of certain traffic control devices and permanent safety hardware devices (guardrails, guardrail terminals, permanent portable barriers, cast-in-place barriers, all other permanent longitudinal barriers, crash cushions, cable barriers, cable barrier terminals, bridge rails, bridge rail transitions, all other terminals, sign supports, and all other breakaway hardware) as listed throughout the Standard Specifications and/or the Standard Drawings, or both, is now replaced with the requirements of meeting the 2016 version of MASH after December 31, 2019. This change applies to new permanent installations and to full replacements of existing installations.

At the preconstruction conference or prior to starting any work on the project, the Contractor shall submit a letter stating that the traffic control devices and permanent safety hardware devices as outlined within the paragraph above that are to be used on the project are certified to meet MASH 2016.

When a MASH 2016-compliant device does not exist for the new permanent installations and/or full replacement installations of permanent safety hardware devices, as listed above, a MASH 2009-compliant or a NCHRP 350-compliant device may be proposed by the Contractor for the project. A written request for such instances must be submitted by the Contractor either at the preconstruction conference or prior to starting any work on the project. The Contractor shall submit the following items to the Project Engineer: (1) a detailed list of the proposed devices and locations thereof; and (2) certification letters indicating that the proposed devices are compliant with either MASH 2009 or NCHRP 350.

When a MASH 2016-compliant device does not exist for the temporary work zone traffic control devices (Category 1, Category 2, and Category 3 devices), a MASH 2009-compliant or a NCHRP 350-compliant device may be proposed by the Contractor for the project. Temporary work zone traffic control devices (Category 1, Category 2, and Category 3 devices) that are MASH 2009-compliant or NCHRP 350-compliant that have been in use prior to December 31, 2019, and that have a remaining service life may be proposed for use throughout their normal service life on the project by the Contractor. For either of these scenarios for temporary work zone traffic control devices, a written request must be submitted by the Contractor either at the preconstruction conference or prior to starting any work on the project. The Contractor shall submit the following items to the Project Engineer: (1) a detailed list of the proposed devices and locations thereof; and (2) certification letters indicating that the proposed devices are compliant with either MASH 2009 or NCHRP 350.

Work will only be allowed to proceed after the Department has granted written concurrence(s) with the proposed request(s) as listed above.

MISSISSIPPI DEPARTMENT OF TRANSPORTATION

SECTION 904 - NOTICE TO BIDDERS NO. 2273

CODE: (SP)

DATE: 02/12/2020

SUBJECT: Mississippi Special Fuel Tax Law

Bidder's attention is brought to the second paragraph of Subsection 107.02 of the Standard Specifications which states that all Contractors and Subcontractors must comply with all requirements contained in the Mississippi Special Fuel Tax Law, Section 27-55-501, *et seq.* Attached are two Fact Sheets provided by the Mississippi Department of Revenue (MDOR) with additional information.

Gasoline and Dyed Diesel Used for Non-Highway Purposes

Mississippi provides a reduced rate for gasoline and dyed diesel used for non-highway purposes. The reduced rates are 6.44 cents per gallon and 5.75 cents per gallon of gasoline or dyed diesel. These fuels are generally taxed at 18 cents per gallon if for on road use.

Gasoline Used for Non-Highway Purposes

You may be entitled to a refund of 11.56 cents per gallon (making this an equivalent to a tax rate of 6.44 cents per gallon) if you desire to purchase gasoline to be used off road. The gasoline must be used for agricultural, maritime, industrial, manufacturing, domestic or non-highway purposes only.

Examples of non-highway include gasoline used in boats, golf carts, machinery used for manufacturing or farm equipment used exclusively in plowing, planting or harvesting farm products.

Refund Gasoline User

The refund is based on the amount of gallons used. Before a refund is issued, you are required to...

1. Obtain a refund gasoline user's permit and a certificate for refund booklet from the Department of Revenue;
2. Have a storage tank marked "REFUND GASOLINE"; and,
3. Purchase the gasoline from someone who holds a refund gasoline dealer's permit.

No refund will be allowed for gasoline used in motor vehicles owned or operated by a government entity or used in Mississippi government contracts.

Refund Gasoline Dealer

You must obtain a refund gasoline dealer's permit from the Department of Revenue before selling refund gasoline. At no time should the gasoline be delivered to a tank that is not properly marked. The gasoline must be dyed a distinctive mahogany color at the time of delivery.

The Department of Revenue may waive the dye requirement if the dye may cause damage to the equipment. The refund gasoline user is required to obtain the waiver from the Department of Revenue.

Dyed Diesel Used for Non-Highway Purposes

Unlike gasoline, you are not required to apply for a refund if you desire to purchase dyed diesel to be used off road. Mississippi provides a reduced rate of 5.75 cents per gallon on dyed diesel used off road. Diesel used on road is subjected to 18 cents per gallon. Dyed diesel used in motor vehicles owned or operated by a government entity or used in Mississippi government contracts will be subjected to 18 cents per gallon.

Dyed Diesel Used on the Highway

Any person who purchases, receives, acquires or uses dyed diesel for highway use will be liable to pay 18 cents per gallon and subject to a penalty in the amount of \$1000.

Identifying Dyed Diesel

Storage facilities for dyed diesel must be plainly marked "NONHIGHWAY DIESEL FUEL" or "NONHIGHWAY KEROSENE". Retailers are also required to mark all pumps or dispensing equipment.



Special Fuel Used on Government Contracts

State and Local Government Contracts

Special fuel purchased, acquired or used in performing contracts with the State of Mississippi, counties, municipalities or any political subdivision is taxed at a rate of 18 cents per gallon. Special fuel includes but is not limited to the following:

- Dyed diesel fuel;
- Kerosene;
- Undyed diesel fuel; and,
- Fuel oil.

State and local government contracts include construction, reconstruction and maintenance or repairs of projects such as roads, bridges, water systems, sewer systems, buildings, drainage canals and recreational facilities. The Department of Revenue may require contractors to remit the excise tax directly to the state in lieu of paying the tax to a distributor.

Special Fuel Direct Pay Permit

Contractors that remit the excise tax to the state will be issued a Special Fuel Direct Pay Permit. This permit relieves the distributor from collecting the tax and requires the contractor to file a monthly special fuel return. The distributor should include the contractor’s permit number on all invoices that are related to tax-free sales.

The contractor is required to furnish a surety or cash bond guaranteeing the payment of the excise tax prior to receiving the Special Fuel Direct Pay Permit. The Department of Revenue may accept a contractors tax bond if the bond covers the excise tax levied on special fuel.

Special Fuel Distributors

If the contractor does not have a Special Fuel Direct Pay Permit, distributors are required to collect the 18 cents excise tax and remit the tax to the Department of Revenue. The additional 12.25 cents levied on special fuel (excluding undyed diesel) should be reported on schedules 5F and 5G of the special fuel return.

Environmental Protection Fee

Special fuel distributors are required to collect the environmental protection fee even if the contractor has a Special Fuel Direct Pay Permit. The fee is levied at 4/10^{ths} of a cent per gallon. The fee is suspended or reinstated when the trust fund has exceeded or fallen below the obligatory balance.

Penalties

Any person who knowingly and willfully purchases untaxed fuel for use in equipment utilized on a road or highway construction site in this state is guilty of a misdemeanor and, upon conviction, shall be fined not less than \$1,000 or more than \$100,000, or imprisoned in the county jail for not more than one year, or both.



MISSISSIPPI DEPARTMENT OF TRANSPORTATION

SECTION 904- NOTICE TO BIDDERS NO. 2397

CODE: (SP)

DATE: 03/24/2020

SUBJECT: Smoothness Tolerances for Ultra-Thin Asphalt Pavement

Bidders are hereby advised that the smoothness tolerances for ultra-thin asphalt pavement on this project shall meet the requirements of a Category C project in accordance with Subsection 403.03.2.1. There will be no final surface requirements or corrective action based for the short continuous interval. Bidders are responsible for the collection of a preliminary smoothness profile prior to any work being performed.

MISSISSIPPI DEPARTMENT OF TRANSPORTATION

SECTION 904 - NOTICE TO BIDDERS NO. 2782

CODE: (SP)

DATE: 8/13/2020

SUBJECT: DBE Pre-Bid Meeting

Due to the COVID-19 pandemic and the Department not allowing visitors in the Administration Building at this time, the DBE Pre-Bid Meeting referenced on Page 5 of Notice to Bidders No. 2611 will be held by **video conference only**. The meeting will be held at 2:00 P.M. on the day preceding the date of the bid opening using Zoom video conferencing software. Anyone interested in participating can download Zoom and connect to the meeting at the below link.

<https://zoom.us/j/5548736403?pwd=SDh5S2hQSE5pNG5FOEkzR3NsUnBYQT09>

Password (if prompted): 272147

For those unable to participate via Zoom, the below teleconference number may be used instead.

1-888-227-7517

Conference Code: 404496

MISSISSIPPI DEPARTMENT OF TRANSPORTATION

SECTION 904 - NOTICE TO BIDDERS NO. 2954

CODE: (IS)

DATE: 12/01/2020

SUBJECT: Reflective Sheeting for Signs

Bidders are hereby advised that the retroreflective sign sheeting used for signs on this project shall be as listed below and shall meet the requirements of Subsection 721.06.

Temporary Construction Signs

Temporary traffic control (orange) sign sheeting shall be a minimum Type IX Fluorescent Orange sheeting as shown in Special Provision 907-721.

Permanent Signs

Permanent signs, except signs on traffic signal poles/mast arms, shall be as follows:

- Brown background sheeting on guide signs shall be a minimum Type VIII sheeting,
- Green and blue background sheeting on guide signs shall be a minimum Type IX sheeting, and
- All white, yellow, red, fluorescent yellow, and fluorescent yellow/green sheeting shall be Type XI sheeting.

MISSISSIPPI DEPARTMENT OF TRANSPORTATION

SECTION 904 - NOTICE TO BIDDERS NO. 3676

CODE: (SP)

DATE: 09/21/2021

SUBJECT: Asphalt Gyrotory Compactor Internal Angle Calibration

Bidders are advised that by March 1, 2022, all asphalt gyrotory compactors shall be calibrated to an internal angle of $1.16^{\circ} \pm 0.02^{\circ}$. This requirement will be reflected in updates made to MT-78, MT-80, and MT-83. This calibration requirement also extends to all QC/QA testing.

MISSISSIPPI DEPARTMENT OF TRANSPORTATION

SECTION 904 - NOTICE TO BIDDERS NO. 4113

CODE: (SP)

DATE: 03/23/2022

SUBJECT: Unique Entity ID (SAM) Requirement for Federal Funded Projects

Bidders are advised that the Prime Contractor must register and maintain a current registration in the System for Award Management (<http://sam.gov>) at all times during this project. Upon registration, the Contractor will be assigned a SAM Unique Entity ID.

Bidders are also advised that prior to the award of this contract, they MUST be registered, active, and have no active exclusions in the System for Award Management.

MISSISSIPPI DEPARTMENT OF TRANSPORTATION

SECTION 904 - NOTICE TO BIDDERS NO. 4702

CODE: (SP)

DATE: 11/22/2022

SUBJECT: App for Traffic Control Reports

Bidders are advised that the Department has created a smart phone App for completing and submitting traffic control reports (Form CSD-762) required on this project. The Contractor who monitors traffic control activities and completes traffic control reports will be required to download and use this App when completing and submitting traffic control reports. The reports will then be readily available to all persons who need access to the forms. The App is free and is available for downloading at the following location.

<https://extacctmgmt.mdot.state.ms.us/>

MISSISSIPPI DEPARTMENT OF TRANSPORTATION

SECTION 904 - NOTICE TO BIDDERS NO. 5551

CODE: (IS)

DATE: 12/06/2023

SUBJECT: Federal Bridge Formula

Bidders are hereby advised that the latest revision of Federal Highway Administration Publication No. FHWA-HOP-06-105, **BRIDGE FORMULA WEIGHTS**, dated August 2006, is made a part of this contract when applicable.

Prior to the preconstruction conference, the Contractor shall advise the Engineer, in writing, what materials, if any, will be delivered to the jobsite via Interstate route(s).

Copies of the **BRIDGE FORMULA WEIGHTS** publication may be obtained by contacting:

Federal Highway Administration
400 7th Street, SW
Washington, DC 20590
(202) 366-2212

or

https://ops.fhwa.dot.gov/freight/publications/brdg_frm_wghts/

MISSISSIPPI DEPARTMENT OF TRANSPORTATION

SUPPLEMENT TO NOTICE TO BIDDERS NO. 5605

DATE: 01/12/2024

The goal is 4 percent for the Disadvantaged Business Enterprise. All Bidders are required to submit Form OCR-481 for all DBEs. Bidders are advised to check the bid tabulation link for this project on the MDOT website at:

https://mdot.ms.gov/portal/current_letting

Bid tabulations are usually posted by 3:00 pm on Letting Day.

MISSISSIPPI DEPARTMENT OF TRANSPORTATION

SECTION 904 – NOTICE TO BIDDERS NO. 5605

CODE: (IS)

DATE: 01/12/2024

SUBJECT: Disadvantaged Business Enterprises in Federal-Aid Highway Construction

DEFINITIONS

For purposes of this provision, the following definitions will apply:

“DOT” means the United States Department of Transportation.

“DBE” means disadvantaged business enterprise.

“MDOT” means the Mississippi Department of Transportation.

“DBE Program” means MDOT’s DBE Program.

This Contract is subject to the “Moving Ahead for Progress in the 21st Century Act (Map-21)” and applicable requirements of 49 C.F.R. part 26. Portions of the Act are set forth in this Notice as applicable to compliance by the contractor and all of the Act, and MDOT’s DBE Program, is incorporated by reference herein.

MDOT has developed a Disadvantaged Business Enterprise Program (“DBE Program”) that is applicable to this Contract and is made a part thereof by reference.

Copies of the DBE Program Manual may be obtained from:

Office of Civil Rights
Mississippi Department of Transportation
P.O. Box 1850
Jackson, Mississippi 39215-1850

or can be found on MDOT’s website at www.mdot.ms.gov under the Business Center under Civil Rights tab.

POLICY

It is the policy of MDOT to provide a level playing field, to foster equal opportunity in all federally assisted contracts, to improve the flexibility of the DBE Program, to reduce the burdens on small businesses, and to achieve the amount of participation that would be obtained in a non-discriminatory marketplace. In doing so, it is the policy of MDOT that there will be no discrimination in the award and performance of federally assisted contracts on the basis of race, color, sex, or national origin.

DBE DIRECTORY

A list of certified DBE contractors can be found on MDOT’s website at www.mdot.ms.gov under the Business Center and Project Letting tab. The DBE firm must be certified at the time the project is let and approved by MDOT to count towards meeting the DBE goal.

PRE-BID MEETING

A pre-bid meeting for monthly lettings will be held either in the Commission Room on the 1st floor of MDOT’s Administration Building, 401 N. West St., Jackson, MS 39201, or via a teleconference source, at 2:00 p.m. on the Monday immediately preceding the fourth Tuesday. No pre-bid meeting is required for emergency lettings.

This meeting is to inform DBE firms of subcontracting and material supply opportunities. Attendance at this meeting is considered of prime importance in demonstrating good faith efforts to meet the contract goal.

AWARD

Award of this Contract to the lowest bidder will be contingent upon the following conditions:

1. Concurrence with the Federal Highway Administration, when applicable.
2. All bidders must submit to the Office of Civil Rights Form OCR-481 no later than the 3rd business day after opening of the bids to satisfy MDOT or have documented in the bid package that adequate good faith efforts have been made to meet the Contract goal. For any questions regarding Form OCR-481, contact the Office of Civil Rights at 601.359.7466.
3. Bidders must include OCR-485 information with their bid proposal listing all firms that submitted quotes for material supplies or items to be subcontracted. The OCR-485 information must be signed and included with the bid proposal. If the OCR-485 information is not included and signed as part of the bid proposal, the bid will be deemed irregular.

Prior to the start of any Contract work, the bidder must notify the Project Engineer, in writing, of the designated “DBE Liaison Officer” for the project. This notification must be posted on the bulletin board at the project site.

DBE REPORTS

1. OCR-481 is available on MDOT’s website at www.mdot.ms.gov under the Civil Rights tab, or by calling 601.359.7466. This form must contain:
 - a. The name and address of each certified DBE contractor and/or supplier; and
 - b. The Reference Number, percent of work to be completed by the DBE subcontractor, and the dollar amount of each item. If a portion of an item is subcontracted, a breakdown of that item, including quantities and unit price, must be attached

detailing what part of the item the DBE firm is to perform and who will perform the remainder of the item.

2. OCR-482: At the conclusion of the project, before the final estimate is paid and the project is closed out, the prime contractor will submit to the Project Engineer Form OCR-482. In this form, the contractor must certify the total amount paid to all DBE contractors/suppliers over the life of the Contract. The Project Engineer will submit the completed Form OCR-482 to the DBE Coordinator in the MDOT Office of Civil Rights. Final acceptance of the project is dependent upon MDOT’s Contract Administration Division’s receipt of the completed and approved Form OCR-482 as received from the Office of Civil Rights.
3. OCR-483: The Project Engineer or Inspector will complete Form OCR-483, the Commercially Useful Function Performance Report, in accordance with MDOT S.O.P. No. OCR-03-05-02-483. Evaluations reported on this form are used to determine whether or not the DBE firm is performing a commercially useful function. The prime contractor is expected to take corrective action when the report contains any negative evaluations. DBE credit may be disallowed and/or sanctions imposed if it is determined that the DBE firm is not performing a commercially useful function. This form is to be completed and submitted to the DBE Coordinator in the Office of Civil Rights.
4. OCR-484: Each month, the prime contractor will submit to the Project Engineer OCR-484, which certifies payments to all subcontractors and lists all firms to reflect payments made during the estimate period. The prime contractor will submit this form even if they have not paid any money to a firm during the estimate period. The Project Engineer will attach the form to the monthly estimate before forwarding it to MDOT’s Contract Administration Division for further processing. Failure of the contractor to submit the OCR-484 form will result in the estimate not being processed and paid.
5. OCR-485: ALL BIDDERS must submit the signed Form OCR-485 with bid proposals of all firms that submitted quotes for material supplies or items to be subcontracted. If the OCR-485 information is not included and signed as part of the bid proposal, the bid will be deemed irregular.
6. OCR-487: The OCR-487 is only used by prime contractors that are certified DBE firms. This form is used in determining the exact percentage of DBE credit for the specified project. The lowest bidder must submit this form to MDOT’s Office of Civil Rights with the OCR-481 form. It may also be submitted with the Permission to Subcontract Forms (CAD-720, CAD-725, and CAD-521).

DBE forms may be obtained from the Office of Civil Rights at the MDOT Administration Building, 401 N. West St., Jackson, MS, or at www.mdot.ms.gov under the Civil Rights tab.

CONTRACTOR ASSURANCES

Each contract that MDOT signs with a contractor, and each subcontract that the prime contractor signs with a sub-contractor, must contain the following assurance set forth in 49 C.F.R. § 26.13:

The contractor, sub-recipient or subcontractor shall not discriminate on the basis of race, color, sex, or national origin in the performance of this Contract. The contractor shall carry out applicable requirements of 49 C.F.R. part 26 in the award and administration of federally assisted contracts. Failure by the contractor to carry

out these requirements is a material breach of this Contract, which may result in the termination of this Contract or such other remedy as MDOT deems appropriate.

CONTRACTOR’S OBLIGATION

The contractor and all subcontractors shall take all necessary and reasonable steps to ensure that DBE firms can compete for and participate in the performance of a portion of the work in this Contract and shall not discriminate on the basis of race, color, sex, or national origin. Failure on the part of the contractor to carry out the DBE requirements of the Contract constitutes a material breach of contract and, after proper notification, MDOT may terminate the Contract or take other appropriate action as determined by MDOT.

When a contract has a zero (0) percent goal, the contractor must take all necessary and reasonable steps to ensure that DBE firms can compete for and participate in the performance of the work in the Contract. In this case, all work performed by a certified DBE firm is considered to be a “race neutral” measure and MDOT will receive DBE credit towards the overall State goal when the DBE firm is paid for their work. If the prime contractor is a certified DBE firm, MDOT can receive DBE credit only for the work performed by the prime contractor’s work force or any work subcontracted to another DBE firm. Work performed by a non-DBE subcontractor is not eligible for DBE credit.

CONTRACT GOAL

The goal for participation by DBEs is established for the Contract in the attached Supplement. The contractor shall exercise all necessary and reasonable steps to ensure that participation is equal to or exceeds the Contract goal.

If the Contract goal established by MDOT is one (1) percent or greater, it must be met to fulfill the terms of the Contract. The contractor may list DBE subcontractors and items that exceed MDOT’s Contract goal, but should any unforeseen problems arise that would prevent a DBE from completing its total commitment percentage, the contractor will meet the terms of the Contract as long as it meets or exceeds MDOT’s Contract goal.

All Bidders shall submit to the Office of Civil Rights Form OCR-481, signed by the prime contractor and the DBE subcontractors, no later than the third business day after opening of the bids. Please refer to the “DBE Reports” section of this Notice to Bidders for what information must be contained in the OCR-481 Form.

If the DBE commitment shown on the last bid sheet of the proposal does not equal or exceed the Contract goal, the bidder must submit to MDOT’s Contract Administration Division information that shows that adequate good faith efforts have been made to meet the Contract goal. This information must be submitted to MDOT prior to bid opening.

Failure of the lowest bidder to furnish acceptable proof of good faith efforts submitted to MDOT’s Contract Administration Division prior to bid opening shall be just cause for rejection of the

proposal. Award may then be made to the next lowest responsive bidder, or the project may be re-advertised. For MDOT’s reconsideration process, please see MDOT’s DBE Manual.

GOOD FAITH EFFORTS AT THE TIME OF THE BIDDING

For the purposes of the DBE Program, Good Faith Effort means to have made every reasonable effort using, at a minimum, the guidelines outlined below, and any other steps deemed appropriate to initially find and/or replace a DBE to meet the established DBE Goal assigned to a project. Additional guidance can be found in Appendix A to 49 C.F.R. § 26.53(a).

The following factors are illustrative of matters that MDOT will consider in judging whether the bidder has made adequate good faith efforts to satisfy the Contract goal.

1. Whether the bidder attended the pre-bid meeting that was scheduled by MDOT to inform DBEs of subcontracting opportunities;
2. Whether the bidder reached out to the MDOT Office of Civil Rights for assistance;
3. Whether the bidder advertised in general circulation, trade association, and minority-focused media concerning the subcontracting opportunities;
4. Whether the bidder provided written notice to a reasonable number of specific DBEs that their interest in the Contract is being solicited;
5. Whether the bidder followed up initial solicitations of interest by contacting DBEs to determine with certainty whether they were interested;
6. Whether the bidder selected portions of the work of the work to be performed by DBEs in order to increase the likelihood of meeting the Contract goal;
7. Whether the bidder provided interested DBEs with adequate information about the plans, specifications, and requirements of the Contract;
8. Whether the bidder negotiated in good faith with interested DBEs and did not reject them as unqualified without sound reasons based on a thorough investigation of their capabilities;
9. Whether the bidder made efforts to assist interested DBEs in obtaining any required bonding or insurance;
10. Whether the bidder has written notification to certified DBE Contractors soliciting subcontracting for items of work in the Contract;
11. Whether the bidder has a statement of why an agreement was not reached; and
12. Proof of written notification to certified DBE Contractors by certified mail that their interest is solicited in subcontracting the work defaulted by the previous DBE or in subcontracting other items of work in the Contract.

The bidder’s execution of the signature portion of the proposal shall constitute execution of the following assurance:

The bidder hereby gives assurance pursuant to the applicable requirements of “Moving Ahead for Progress in the 21st Century Act (MAP-21)” and applicable requirements of 49 C.F.R. part 26 that the bidder has made a good faith effort to meet the contract goal for DBE participation for which this proposal is submitted.

In determining whether a bidder made good faith efforts, MDOT will:

1. Scrutinize the documented efforts of the bidder;
2. Review the performance of other bidders in meeting the Contract goal;
3. Require the bidder to submit copies of each DBE and non-DBE subcontractor’s quote submitted to the bidder when a non-DBE subcontractor was selected over a DBE for work on the Contract to review whether DBE prices were substantially higher; and
4. Contact the DBEs listed on a contractor’s solicitation to inquire as to whether they were contacted by the prime contractor.
5. MDOT will not consider standardized (i.e., bulk or generic) mailings to DBEs requesting bids as sufficient to satisfy good faith efforts.
6. MDOT will also not consider a promise to use DBEs after Contract award as responsive to Contract solicitation, nor will it constitute adequate good faith efforts.

GOOD FAITH EFFORTS DURING THE CONTRACT

If a DBE subcontractor cannot perform satisfactorily, or at all, and this causes the OCR-481 commitment to fall below the Contract goal, the contractor must take all necessary and reasonable steps to replace the DBE with another certified DBE subcontractor or submit information to satisfy a good faith effort to MDOT. Contractor must notify the Office of Civil Rights immediately upon determination that the goal may not be achieved.

Information to be submitted to satisfy MDOT may include:

1. Did the prime contractor look at other areas of the Contract to subcontract out to DBEs?
2. Did the prime contractor look for new DBE firms to perform the same line of work?
3. Did the prime contractor identify other DBEs used in the performance of the Contract but that were not reported to MDOT?
4. Did the prime contractor select portions of the work to be performed by DBEs in order to increase the likelihood that the DBE goals would be achieved?
5. Did the prime contractor provide interested DBEs with adequate information about the plans, specifications, and requirements of the Contract in a timely manner?
6. Did the prime contractor negotiate in good faith with interested DBEs?
7. Did the prime contractor use good business judgment such as taking into consideration the DBE firm’s price and capabilities as compared to non-DBE firms?
8. Did the bidder reject the DBEs as being unqualified without sound reasons?
9. Did the prime contractor make efforts to assist interested DBEs in obtaining bonding, lines of credit, or insurance as required by the recipient or the prime contractor?
10. Did the prime contractor effectively use the services of available the agency’s DBE Supportive Services provider or other available minority/women community organizations; minority/women contractors’ groups; local, state, and federal minority/women business assistance offices; and other organizations as allowed on a case-by-case basis to aid in the recruitment and placement of DBEs?

When a contractor proposes to substitute/replace/terminate a DBE that was originally named on the OCR-481, the contractor must obtain a release, in writing, from the named DBE explaining

why the DBE subcontractor cannot perform the work. A copy of the original DBE’s release must be attached to the contractor’s written request to substitute/replace/terminate along with an appropriate Subcontract Forms for the substituted/replaced/terminated subcontractor, all of which must be submitted to the Project Engineer for forwarding to the Office of Civil Rights DBE Coordinator for review and approval actions. The replacement DBE must be a DBE who was on MDOT’s list of “Certified DBE Contractors” when the job was let, and who is still active.

Under no circumstances may the prime contractor or a subcontractor perform the DBE’s work without prior written approval from MDOT.

PARTICIPATION/DBE CREDIT

Participation shall be counted toward meeting the goal in this Contract as follows:

1. If the prime contractor is a certified DBE firm, only the value of the work actually performed by the DBE prime contractor can be counted towards the project goal, along with any work subcontracted to a certified DBE firm.
2. If the contractor is not a DBE, the work subcontracted to a certified DBE contractor will be counted toward the goal.
3. The contractor may count a portion of the total dollar value of a contract with a joint venture eligible under the standards of the provision equal to the percentage of the DBE partner in the joint venture towards the Contract goal.
4. Expenditures to DBEs that perform a commercially useful function may be counted toward the goal. A business is considered to perform a commercially useful function when it is responsible for the execution of a distinct element of the work and carries out its responsibilities by actually performing, managing, and supervising the work involved.
5. The contractor may count one hundred (100) percent of the expenditures for materials and supplies obtained from certified DBE suppliers and manufacturers that produce goods from raw materials or substantially alters them for resale provided the suppliers and manufacturers assume the actual and contractual responsibility for the provision of the materials and supplies. The contractor may count sixty (60) percent of the expenditures to suppliers that are not manufacturers, provided the supplier performs a commercially useful function in the supply process. Within thirty (30) days after receipt of the materials, the contractor shall furnish to the Project Engineer invoices from the certified supplier whereby the DBE goal can be verified by MDOT’s DBE Coordinator.
6. Any work that a certified DBE firm subcontracts or sub-subcontracts to a non-DBE firm will not count towards the DBE goal.
7. Only the dollars actually paid to the DBE firm may be counted towards the DBE goal. The participation of a DBE Firm cannot be counted towards the Prime Contractor’s DBE goal until the amount being counted towards the goal has been paid to the DBE.

SANCTIONS

If the prime Contractor fails to fulfill the contract DBE goal commitments on the OCR-481 forms, including administrative errors, and/or is found to have taken actions that are not in compliance

with the MDOT DBE Program and 49 CFR Part 26 , MDOT has the option to enforce any or all combination(s) of the following penalties:

1. Disallowing credit to go towards the DBE goal;
2. Withholding progress estimate payments;
3. Deducting from the final estimate or recovering an amount equal to the unmet portion of the DBE goal, which may include additional monetary penalties as outlined below based on the number of offenses and the severity of the violation, as determined by MDOT:

1st Offense	10% of unmet portion of goal	or	\$7,500 lump sum payment	or	Both
2nd Offense	20% of unmet portion of goal	or	\$15,000 lump sum payment	or	Both
3rd Offense	40% of unmet portion of goal	or	\$25,000 lump portion of goal	or	\$25,000 lump sum payment and debarment

4. MDOT may debar the contractor from bidding on MDOT’s federally funded projects for a period of up to twelve (12) months after notification by certified mail.

If the DBE goal is not met due to an administrative error by the contractor, MDOT has the discretion to assess a percentage of the unmet portion of the goal or any combination of the above as sanctions, in an amount that is deemed appropriate by MDOT.

MISSISSIPPI DEPARTMENT OF TRANSPORTATION

SECTION 904 - NOTICE TO BIDDERS NO. 5750

CODE: (SP)

DATE: 03/19/2024

SUBJECT: Manual on Uniform Traffic Control Devices (MUTCD)

Bidders are advised that any reference to the current edition of the MUTCD or the latest edition of the MUTCD within plans, proposal, or standard specifications means the 2009 Edition and the 3 Revisions thereto.

MISSISSIPPI DEPARTMENT OF TRANSPORTATION

SECTION 904 - NOTICE TO BIDDERS NO. 6078

CODE: (SP)

DATE: 07/08/2024

SUBJECT: ARPA Funded Projects

PROJECT: NHPP-0008-02(121) / 108719301 -- Covington County

Bidders are hereby advised of the Federal requirements for ARPA Funded Projects. Special attention is called to Section 902 of the contract documents.

MISSISSIPPI DEPARTMENT OF TRANSPORTATION

SECTION 904 - NOTICE TO BIDDERS NO. 6181

CODE: (SP)

DATE: 08/23/2024

SUBJECT: Contract Time

PROJECT: NHPP-0008-02(121) / 108719301 -- Covington County

The completion of work to be performed by the Contractor for this project will not be a specified date but shall be when all allowable working days are assessed, or any extension thereto as provided in Subsection 108.06. It is anticipated that the Notice of Award will be issued no later than **October 8, 2024** and the date for Notice to Proceed / Beginning of Contract Time will be **November 7, 2024**.

Should the Contractor request a Notice to Proceed earlier than **November 7, 2024** and it is agreeable with the Department for an early Notice to Proceed, the requested date will become the new Notice to Proceed date. Regardless of whether or not an early Notice to Proceed is granted, contract time will start at the original Notice to Proceed date.

All requests for an early Notice to Proceed shall be sent to the Project Engineer who will forward it to the Contract Administration Division.

103 Working Days have been allowed for the completion of work on this project.

MISSISSIPPI DEPARTMENT OF TRANSPORTATION

SECTION 904 – NOTICE TO BIDDERS NO. 6182

CODE: (SP)

DATE: 02/26/2024

SUBJECT: Scope of Work

PROJECT: NHPP-0008-02(121) / 108719301 -- Covington County

The contract documents do not include an official set of construction plans, but may, by reference, include some Standard Drawings when so specified in a Notice to Bidders entitled, “Standard Drawings.”

The work to be accomplished using the pay items and corresponding specifications set forth in the contract is to mill and overlay the following section of US 49 in Covington County from Richard Kendrick Dr. to Seminary.

<u>Route</u>	<u>Length (Mile)</u>	<u>Width (Feet)</u>	<u>Surface Lift</u>	<u>Thickness (Inches)</u>
US 49 NB & SB	5.4	28' & Var.	9.5-mm, HT	1½

Typical section: TS-1 addresses requirements for US 49 NB & SB

Work on the Project shall consist of the following:

1. The Contractor shall erect and maintain construction signing, provide all signs, set up night time lane closures (if needed), and traffic handling devices in accordance with the Traffic Control Plan. The cost for this work shall be included in the price bid for pay item 618-A: Maintenance of Traffic. All traffic control devices on this project should comply with the latest version of the MUTCD. Fluorescent orange sheeting shall be used on all construction and traffic control signs except for those designated in the standards to be black legend and border on white background.
2. Prior to the overlay, the existing shoulders shall be clipped and surplus material shall be spread along the edge of the shoulders, fore slopes, or other adjacent areas as directed by the Project Engineer, and will be an absorbed item.
3. The Contractor shall fine mill at the following locations: As Directed by the Engineer

<u>ROUTE</u>	<u>LOCATION</u>	<u>LENGTH</u>	<u>REMARKS</u>
49 NB	685+15 – 970+00	5.4 Miles	Mainline (Approx. 28')
49 SB	685+15 – 970+00	5.4 Miles	Mainline (Approx. 28')

<u>Local Roads</u>	(As Directed)
Richard Kendrick Dr. /	
SR 598 (NB)	694+27
Kelly Lane (NB)	725+53
Fairchild Landing Rd. (NB)	888+10
Waste Tower	
Collection Site (SB)	756+72
JC Gandy Rd. (SB)	888+10

<u>Crossovers</u>	(As Directed)
	690+55
	706+62
	724+45
	756+72
	782+65
	865+79
	900+06
	927+66

4. The existing guardrail pads from the face of the rail extending outward shall be removed. The Contractor shall then place crushed stone at these locations (6” depth). Excess excavation may be required. Existing guardrail items shall then be removed, and the following shall be installed, as per the standard drawings.

5. Guardrail related items shall be placed at and/or removed from the following locations along US 49. Removal and placement of items shall be performed as one continuous operation per site.

Sta. 785+75 RT OF RT LN
 155’ RT Removal of Guardrail
 1-Non-Flared Terminal End Section
 112.5’ LF Guardrail Class A Type 1
 (“W” Beam) Req’d
 1 - Guardrail, Cable Anchor, Type 1
 5 - Guardrail Delineators (White)

Sta. 823+00 RT OF RT LN
 180’ LF Removal of Guardrail
 1- Non-Flared End Section
 150’ LF Guardrail Class A Type 1
 (“W” Beam) Req’d
 1 - Guardrail Cable Anchor, Type 1
 6 - Guardrail Delineators (White)

Sta. 860+50 RT OF RT LN
 150’ LF Removal of Guardrail
 1 - Non-Flared Terminal End Section
 112.5’ LF Guardrail Class A Type 1
 (“W” Beam) Req’d
 1 - Guardrail Cable Anchor, Type 1
 5 - Guardrail Delineators (White)

Sta. 880+90 RT OF RT LN
 90’ LF Removal of Guardrail
 1-Non-Flared Terminal End Section
 50 LF Guardrail Class A Type 1
 (“W” Beam) Req’d
 1 - Guardrail Cable Anchor, Type 1
 7 - Guardrail Delineators (White)

Sta. 888+85 RT OF RT LN
 105’ LF Removal of Guardrail
 1- Non-Flared Terminal End Section
 62.5’ LF Guardrail Class A, Type 1
 (“W” Beam) Req’d.
 1 - Guardrail Cable Anchor, Type 1
 4 - Guardrail Delineators (White)

Sta. 897+45 RT OF RT LN
 95’ LF Removal of Guardrail
 1- Non Flared Terminal End Section
 50’ LF Guardrail Class A, Type 1
 (“W” Beam) Req’d.
 1 - Guardrail Cable Anchor, Type 1
 4 - Guardrail Delineators

Sta. 927+65 RT OF RT LN
 205’ LF Removal of Guardrail
 1-Special Section BR End Connector
 1-Type A Bridge End Section
 1-Flared Terminal End Section
 162.5’ LF Guardrail Class A, Type 1
 (“W” Beam) Req’d.
 6 - Guardrail Delineators (White)

Sta. 927+70 LT OF RT LN
 200’ LF Removal of Asphalt
 1-Special Section BR End Connector
 1-Type A Bridge End Section
 1-Flared Terminal End Section
 125’ LF Guardrail Class A, Type I
 (“W” Beam) Req’d.
 6 - Guardrail Delineators (White)

Sta. 953+95 RT OF RT LN
 158’ LF Removal of Guardrail
 1-Non-Flared Terminal End Section
 112.5’ LF Guardrail Class A, Type I
 (“W” Beam) Req’d.
 1 - Guardrail Cable Anchor, Type I
 5 - Guardrail Delineators (White)

A saw cutting pay item has been included in the quantities to be utilized in the removal of the asphalt pavement. If the item is not utilized, no payment will be made under this item.

6. The Contractor shall place ¾” and variable of 9.5-mm, ST asphalt for leveling at locations directed by the Engineer.
7. The Contractor shall place top lifts of asphalt on the roadway left and right of the centerline from BOP to EOP as shown in TS-1 on US 49. The finished cross-slope is to be 2% in tangent sections and match the existing super elevation rate in horizontal curves.

The Contractor shall remove existing pavement markers prior to placing asphalt. The cost of removing these pavement markers shall be included in other items bid.

Asphalt surface shall be placed on all local roads, crossovers and driveway aprons (1½” Thickness).

Driveway aprons shall be paved 10’ wide or as directed by the Engineer. All local roads shall be paved to the normal right-of-way line or as directed by the Engineer.

Asphalt quantities were estimated as follows:

Mainline	15,667 Tons, HT Polymer-Modified
Cross Overs	1,296 Tons, ST
Local Roads	589 Tons, ST
Total	15,667 Tons, HT Polymer-Modified 1,885 Tons, ST

Note: The Contractor shall be responsible for traffic control while MDOT personnel conduct density testing on the asphalt. The cost shall be included in the price bid for pay item 618-A: Maintenance of Traffic.

The Contractor shall take due care to maintain a uniform outside edge of pavement, and shall place asphalt to establish an approximate vertical face in order for granular material to be placed directly against the surface and not on a shelf of an underlying course.

8. The Contractor shall place granular material on the shoulders where required to raise the existing shoulders to the new grade, bladed, shaped, and compacted to a minimum slope of 4%. Granular material will not be allowed to be placed directly on the top lift of asphalt, but must be placed directly on the gravel shoulder by means of a road widener machine approved by the Project Engineer. Light blading or mowing of the shoulders will be required prior to placement of the granular material. Please refer to Subsection 618.03.3 of the Standard Specifications as well as sheet SDTCP-16 for requirements related to pavement edge drop-offs.
9. The Contractor shall place rumble strips in the locations indicated in the typical section on sheet TS-1.
10. The Contractor shall perform sawing and sealing of transverse joints within the time frame specified in Subsection 413.03.3 of the Spec Book and proposal.
11. The Contractor shall place fog seal on the outside shoulders of the mainline from the BOP to the EOP as shown on TS-1.
12. The Contractor shall place all permanent pavement markings, including stripe and raised pavement markers, throughout the project as required by the Standard Drawings or as directed by the Engineer. Existing pavement markings located on all concrete surfaces shall be removed as required prior to placing new markings.

The Contractor shall be responsible for replacing crossover delineators throughout the project as required by the Standard Drawings or as directed by the Engineer.

An asphalt taper shall be placed at the temporary joints caused by the milling or overlay in order to provide for the safe movement of traffic. The taper shall be three feet (3') in length per one inch of depth and will be an absorbed item.

Temporary striping shall be required after milling and overlaying operations: Temporary striping

shall be placed in the same locations and layout as permanent stripe. All centerline, lane lines, edge lines, and no passing stripes that have been removed during the day's operations shall be replaced with temporary stripe before work is discontinued for the day or as soon thereafter as weather conditions will permit, except that:

- Replacement of no-passing stripes may be delayed for a period not to exceed three (3) days for a two or three lane road.
- Temporary edge lines on projects requiring shoulders constructed of granular material may be delayed for a period not to exceed three (3) days.

All asphalt and concrete curbs along local roads from BOP to EOP shall be painted (two applications) with traffic paint and traffic beads; color to correspond to adjacent pavement stripe; as shown on sheet DCIS-1; such costs shall be included in other items bid.

It shall be the responsibility of the Contractor to protect the roadway and all existing structures, such as bridges, culverts, signs, and curbs, from damage occurring as a result of the Contractor's operations. Damages to existing structures caused by the Contractor's operations shall be repaired or replaced at no cost to the Department.

Incidental work such as removing vegetation, shaping and compaction of shoulders, removing excess asphalt material, project clean-up, and other incidental work necessary to complete the project will not be measured for separate payment. Such costs shall be included in the price of other items bid.

It is the Contractor's responsibility to insure the drainage of surface water from milled areas. Temporary wedges (paper joints) of full lane width asphalt shall be placed by the Contractor immediately after the fine milling process to allow the safe transition of traffic. These wedges shall be maintained in a satisfactory condition by the Contractor until the permanent asphalt is placed; cost to be absorbed.



MISSISSIPPI DEPARTMENT OF TRANSPORTATION
MDOT

DESIGNED BY:
CHECKED BY:
DATE:

FMS CON: 108719/301000
PROJECT NO.: NHP-008-2(21)
COUNTY: COVINGTON

Notice To Bidders No. 6182 - Covington

U.S. 49
WK. NO. 1001
SHEET NO. 1

US 49
CL LN
NB LN

VARIABLE

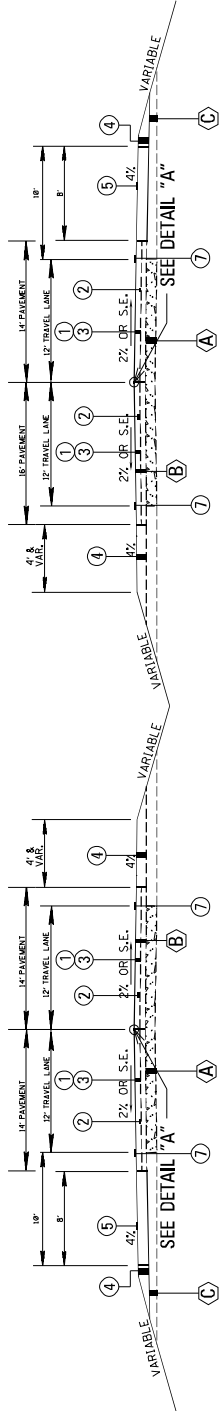

NORTHBOUND

STA. 685 + 15 - STA. 970 + 00

**TYPICAL SECTION
U.S. 49**

RT. LN.

LT. LN.

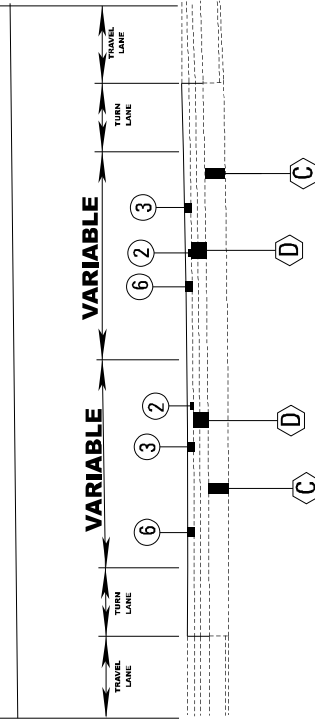

**TYPICAL SECTION
U.S. 49
CROSS-OVERS**

- EXISTING
- (A) EXISTING JRC CONCRETE PAVEMENT
 - (B) EXISTING ASPHALT PAVEMENT
 - (C) EXISTING GRANULAR MATERIAL
 - (D) EXISTING ASPHALT, ST

STA. 685 + 15 - STA. 970 + 00

SOUTHBOUND

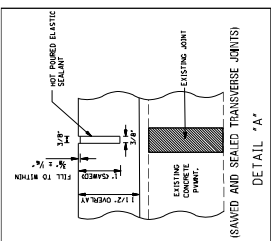

PROPOSED

- ① 1.50" OF 9.5MM HT POLYMER MODIFIED ASPHALT (1 @ 1.50") REQ'D
- ② TACK COAT REQ'D
- ③ 1.50" & VAR. FINE MILLING REQ'D
- ④ 1.50" & VAR. OF CL. 6, GR. D GRANULAR MATERIAL REQ'D WHERE REQ'D.
- ⑤ FOG SEAL REQ'D.
- ⑥ 1.50" - 9.5MM ST. ASPHALT REQ'D.
- ⑦ RUMBLE STRIPS REQ'D.



MDOT
MICHIGAN DEPARTMENT OF TRANSPORTATION

DATE: 07/12/2022

CHECKED BY:

DETAILED BY:

DESIGNED BY: Cynthia Holt

COUNTY: COVINGTON

PROJECT NO.: NHP-008-20(12)

FMS CON: 108719/301000

Notice To Bidders No. 6182

W.K.D. 10/21/2021

SHEET NO. 5

NOTE: W20-1 (48"X48") WILL BE REQ'D
ON ALL LOCAL ROADS.

** NOT TO SCALE **

ALL TRAFFIC CONTROL ITEMS SHOWN ON THIS SHEET SHALL BE INCLUDED IN BID FOR
PLACEMENT AND CONSTRUCTION. ALL TRAFFIC CONTROL ITEMS SHOWN
BEYOND THE BIDDING AREA SHALL BE INCLUDED IN THE BIDDING AREA
FOR THOSE DESIGNATED ON THE PLANS TO BE BLACK LEGEND AND BORDER ON WHITE BACKGROUND

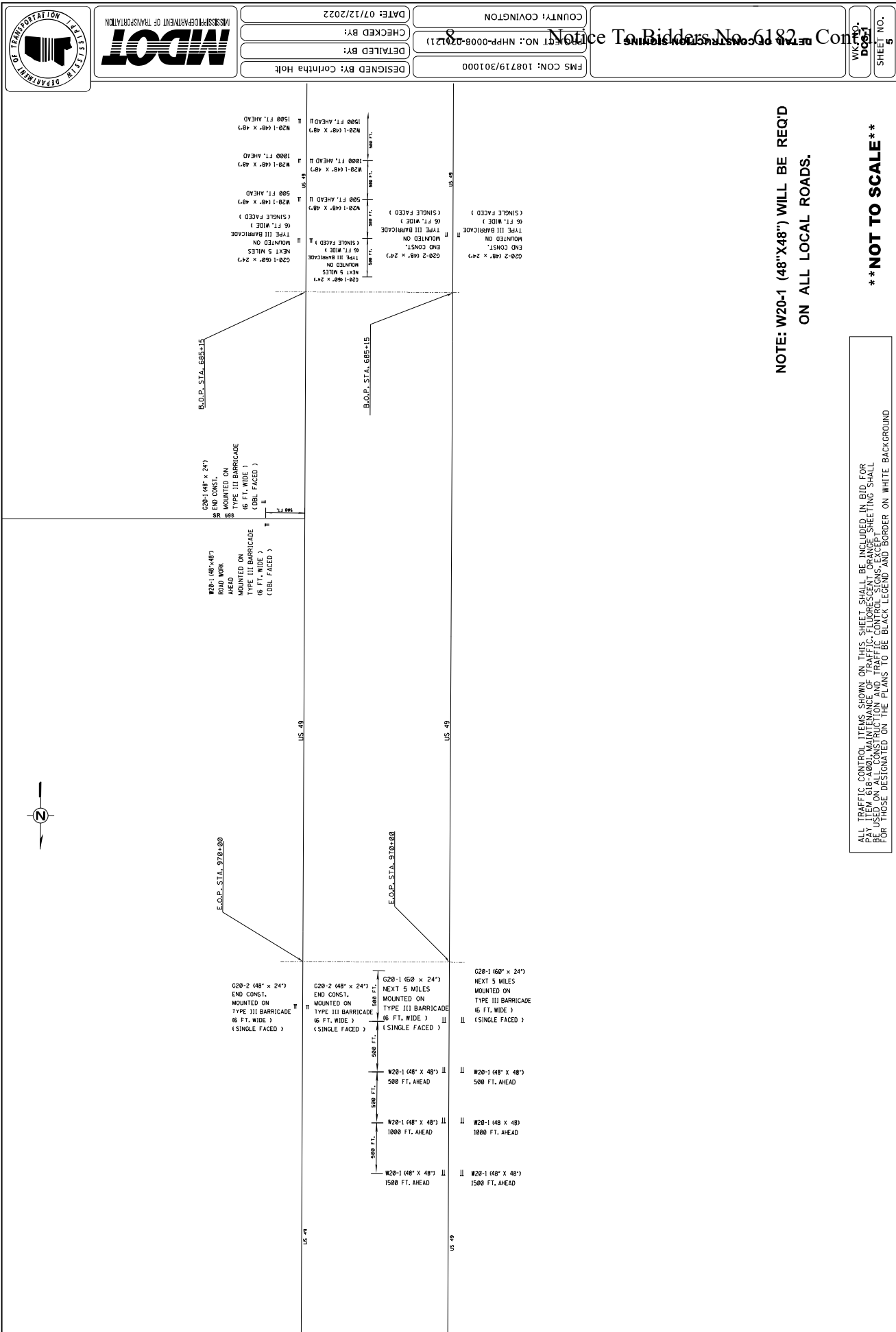



MISSISSIPPI DEPARTMENT OF TRANSPORTATION
MDOT

DESIGNED BY:	
DETAILED BY:	
CHECKED BY:	
DATE:	

FMS CON: 108719/301000
PROJECT NO.: NHP-008-07(21)
COUNTY: COVINGTON

DETAIL FOR CURBS
 AND STRIPING
 Notice To Bidders No. 6482 - Concrete

W.C.P.
D.C.P.
SHEET NO. 6

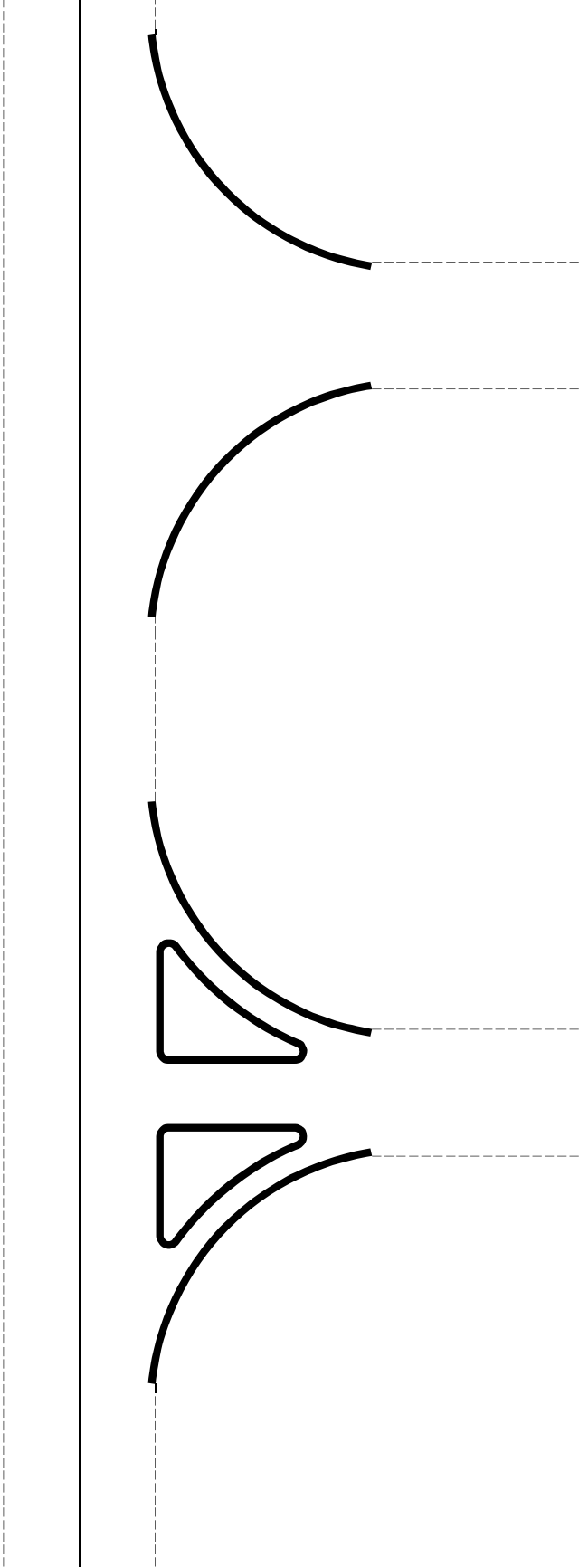

** ALL ASPHALT AND CONCRETE CURBS ALONG RAMPS, LOCAL ROADS, ETC. FROM B.O.P. TO E.O.P. SHALL BE PAINTED (TWO APPLICATIONS) WITH TRAFFIC PAINT AND TRAFFIC BEADS; COLOR TO CORRESPOND TO ADJACENT PAVEMENT STRIPE; COST TO BE ABSORBED IN OTHER PAY ITEMS.



MISSISSIPPI DEPARTMENT OF TRANSPORTATION
MDOT

DESIGNED BY:
CHECKED BY:
DATE:

FMS CON. NO.: 108719/301000
PROJECT NO.: NHP-0008-02(12)
COUNTY: COVINGTON

DETAIL OF STRIPING
CHANCELLER IN CROSSOVERS
4-LANE HIGHWAY
NOTICE TO BIDDERS 2182 - COV

SHEET NO. 7
SHEET TOTAL 10

SYMBOL	DESCRIPTION	TYPE	QUANTITY
(1)	TWO-WAY - CLEAR REF. RAISED MARKERS	EACH	
(2)	RED-CLEAR REFLECTIVE RAISED MARKERS	EACH	
(3)	TWO-WAY YELLOW REFLECTIVE RAISED MARKERS	EACH	
(4)	TRAFFIC SKIP WHITE (0'-30")	PLASTIC	
(5)	CONTINUOUS EDGE WHITE (SOLID)	PLASTIC	
(6)	CONTINUOUS EDGE YELLOW (SOLID)	PLASTIC	
(7)	CONTINUOUS TRAFFIC WHITE	PLASTIC	
(8)	DETAIL STRIPE WHITE (SOLID)	PLASTIC	
(9)	DETAIL STRIPE YELLOW (SOLID)	PLASTIC	
(10)	DETAIL STRIPE WHITE (SOLID)	PLASTIC	
(11)	DETAIL STRIPE YELLOW (SOLID)	PLASTIC	
(12)	24" THERMO LEGEND WHITE (STOP BAR)	PLASTIC	
(13)	24" THERMO LEGEND WHITE (YIELD BAR)	PLASTIC	

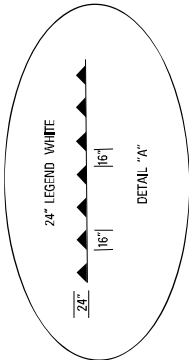
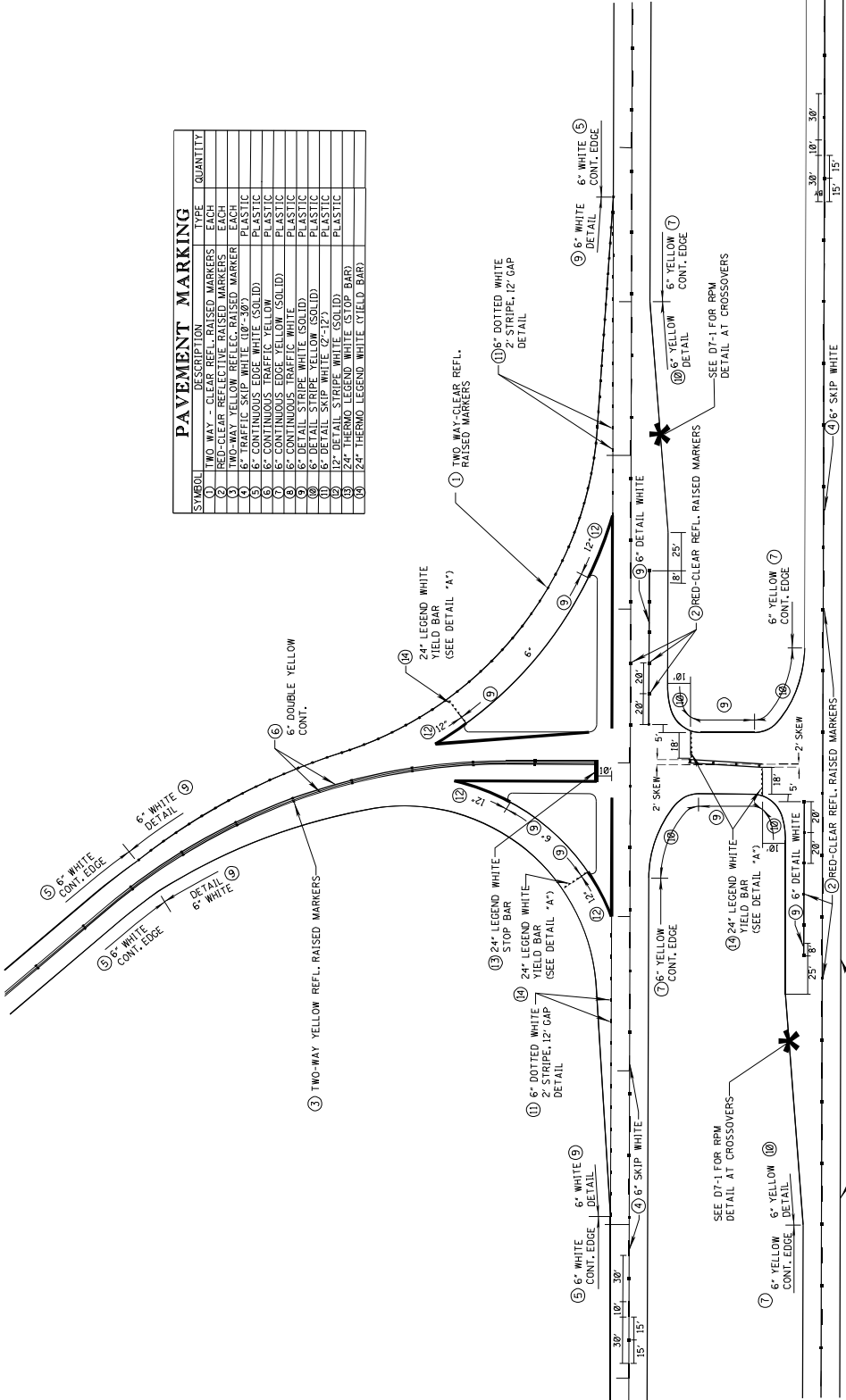



MDOT
MICHIGAN DEPARTMENT OF TRANSPORTATION

DESIGNED BY:
CHECKED BY:
DATE:

FMS CON: 108719/301000
PROJECT NO.: NHP-008.02(12)
COUNTY: COVINGTON

NOTICE TO BIDDERS
MICHIGAN DEPARTMENT OF TRANSPORTATION
D7 TYPICAL PAVEMENT
RAISED PAVEMENT
MEDIAN CROSSOVERS

WK NO. 001
SHEET NO. 7

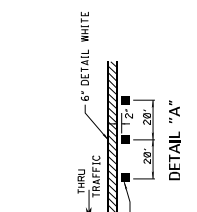
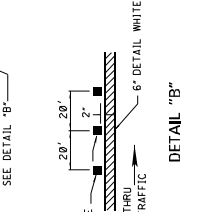
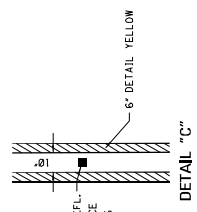
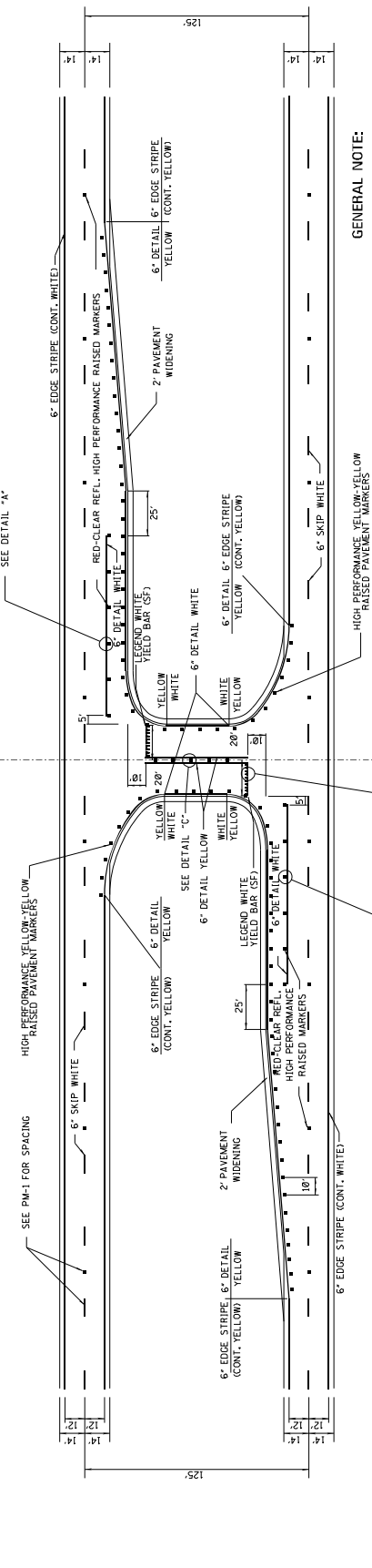
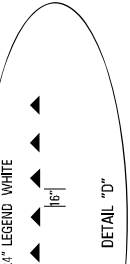
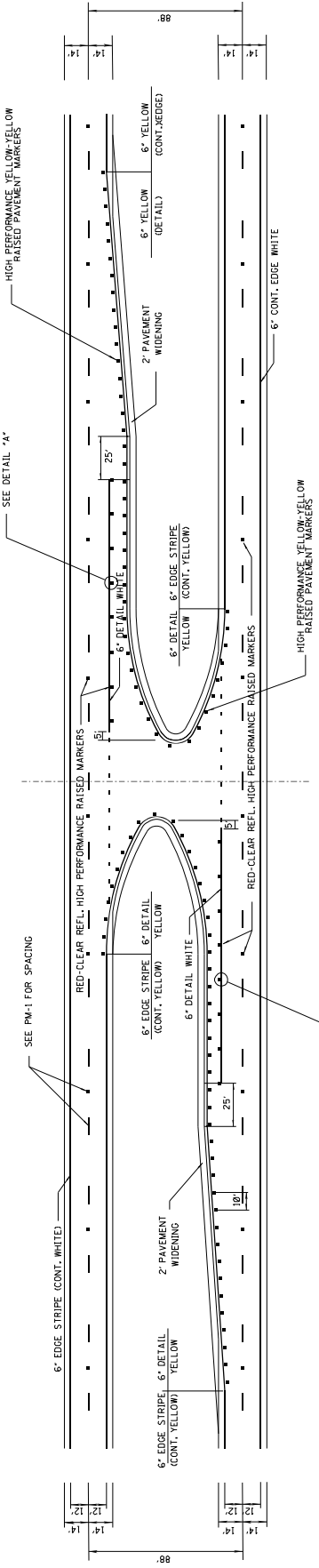

GENERAL NOTE:
 ① STOP BAR REQ'D IN LIEU OF YIELD BAR IF STOP SIGNS ARE IN PLACE, OR AS DIRECTED BY THE ENGINEER.

125' ≥ C TO C > 88'

NOTE: FOR WIDER C TO C SPACINGS, REPLACE STOP AND YIELD BARS WITH STOP AND YIELD BARS.

NOTE: FOR WIDER C TO C SPACINGS, REFER TO OTHER SHEETS IN PLANS



DESIGNED BY: _____
 DETAILED BY: _____
 CHECKED BY: _____
 DATE: _____

FMS CON: 108719/301000
 PROJECT NO.: NHP-0082(12)
 COUNTY: COVINGTON

TRAFFIC CONTROL DETAILS
 SHOULDER CLOSURE
 Notice To Bidders 182 - Control

WV NO. SDT08-16
 SHEET NO. 9

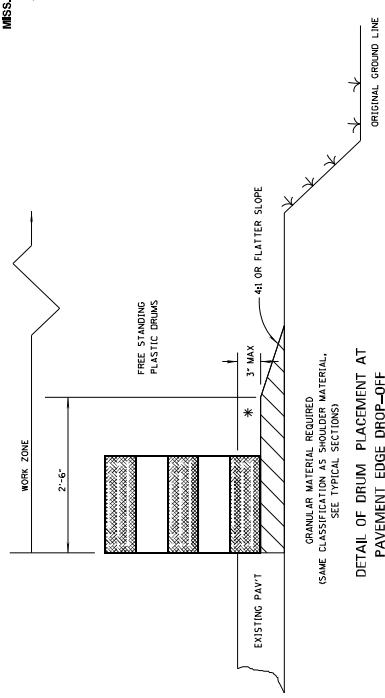

- NOTES:
- * A. PAVEMENT EDGE DROP-OFF
 1. IF LESS THAN TWO AND ONE QUARTER (2.25) INCHES NO PROTECTION REQUIRED. PLACE A SHOULDER WORK SIGN (W9-3) 500 FEET IN ADVANCE OF WORK ZONE SHOULDER AND A LOW SHOULDER SIGN (W8-9) AT THE BEGINNING AND THROUGHOUT THE WORK ZONE @ (1 MILE 10.C.).
 2. TWO AND ONE QUARTER TO THREE INCHES PLACE DRUMS, VERTICAL PANELS OR BARRICADES EVERY 100 FEET ON TANGENT SECTIONS FOR SPEEDS GREATER THAN 40 MPH. PLACE DRUMS, VERTICAL PANELS OR BARRICADES EVERY 50 FEET ON CURVED SECTIONS. FOR SPEEDS GREATER THAN 40 MPH, TANGENT SECTIONS WITH SPEEDS LESS THAN 50 MILES PER HOUR AND FOR CURVES, DEVICES SHOULD BE PLACED EVERY 50 FEET. SPACING FOR TAPERS SHOULD BE IN ACCORDANCE WITH THE MUTCD. (L / 3 L), WHERE L IS THE TAPER LENGTH IN FEET.)
 3. GREATER THAN THREE (3) INCHES POSITIVE SEPARATION OR WEDGE WITH 4:1 OR FLATTER SLOPE NEEDED, IF THERE IS EIGHT (8) FEET OR MORE DISTANCE BETWEEN THE EDGE OF TRAVEL LINE AND DROP-OFF, THEN DRUMS, PANELS OR BARRICADES MAY BE USED.
 4. FOR TEMPORARY CONDITIONS, DROP-OFFS GREATER THAN THREE (3) INCHES MAY BE PROTECTED WITH DRUMS, VERTICAL PANELS OR BARRICADES FOR SHORT DISTANCES DURING DAYLIGHT HOURS WHILE WORK IS BEING DONE IN THE DROP-OFF AREA.
 5. LESSER TREATMENTS THAN THOSE DESCRIBED ABOVE MAY BE CONSIDERED FOR LOW-VOLUME LOCAL STREETS.

- B. DRUM SPACING
1. TANGENTS = $2 \times S$
 2. CURVES = $S \times W$
 - WHERE:
 - L = TAPER LENGTH IN FEET
 - S = SPEED IN MPH (POSTED OR 85 PERCENTILE)
 - W = WIDTH OF OFFSET IN FEET

C. ALL TRAFFIC CONTROL ITEMS SHOWN ON THIS SHEET SHALL BE PAID FOR UNDER MAINTENANCE OF TRAFFIC.

TABLE V1-1: GUIDELINES FOR LENGTH OF LONGITUDINAL BUFFER SPACE

SPEED (MPH)	LENGTH (FEET)
20	35
30	45
40	65
50	85
60	105
70	125
80	145
90	165
100	185
110	205
120	225
130	245
140	265
150	285
160	305
170	325
180	345
190	365
200	385
210	405
220	425
230	445
240	465
250	485

* * * POSTED SPEED, OFF-PEAK 85 PERCENTILE SPEED PRIOR TO WORK STARTING, OR THE ANTICIPATED OPERATING SPEED IN MPH.

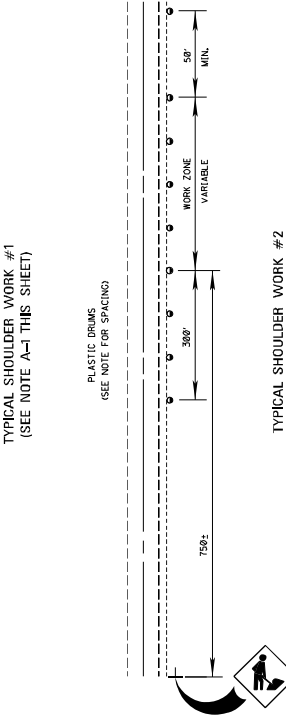
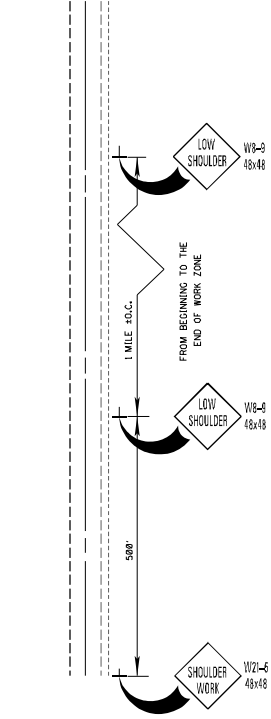
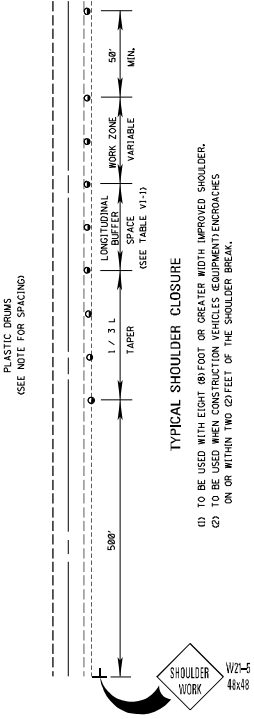

NOTE: WORK OUTSIDE TWO (2) FOOT AND WITHIN TEN (10) FEET OF THE SHOULDER BREAK MAY BE PROTECTED BY PLACING DRUMS ALONG THE SHOULDER EDGE, 300 FEET PRIOR TO AND 50 FEET BEYOND THE WORK AREA, OR SEE NOTE #3 THIS SHEET.



DESIGNED BY:	
DETAILED BY:	
CHECKED BY:	
DATE:	

FMS CON:	108719/301000
PROJECT NO.:	NHP-008-2(12)
COUNTY:	COVINGTON

Notice To Bidders
 GUARDRAIL TYPICAL INSTALLATION
 DIVIDED HIGHWAYS

WKS NO.:	SD009-4
SHEET NO.:	10

- GENERAL NOTES:
- VALUES FOR "A" AND "B" WILL BE SHOWN ELSEWHERE ON THE PLANS.
 - FOR DETAILS PERTINENT TO INSTALLATION OF THE TERMINAL SECTION, SEE MANUFACTURER'S SPECIFICATIONS AND DRAWINGS OR ELSEWHERE ON PLANS.
 - GUARDRAIL SECTIONS ARE TO BE LAPPED IN THE DIRECTION OF TRAFFIC FLOW NEAREST THE GUARDRAIL FACE.
 - THE OVERALL LENGTH OF GUARDRAIL IS MEASURED FROM THE CONNECTING END ON THE BRIDGE.
 - THE SHOULDER WIDTH AT THE BRIDGE END SHALL BE THE SAME AS THE SHOULDER WIDTH AT THE POINT OF BREAK (HINGEPOINT) BEHIND THE BACK OF POST BEFORE THE SLOPE BREAK (HINGEPOINT).
 - TYPE, DETAILS AND LIMITS OF GUARDRAIL BRIDGE END SECTION WILL BE SHOWN ELSEWHERE ON THE PLANS.

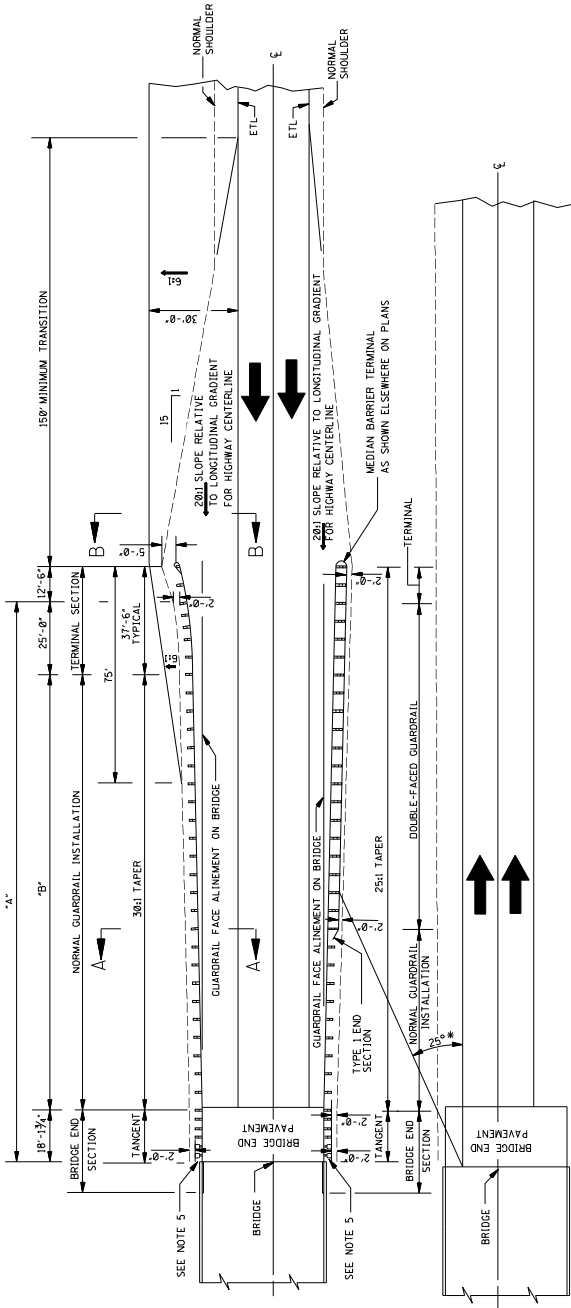

DIVIDED HIGHWAY WITH BARRIER INSIDE CLEAR ZONE OF OPPOSING TRAFFIC

* NOTE: THE 25' LINE IS USED TO DETERMINE THE LIMITS OF MEDIAN BARRIER AS SHOWN.

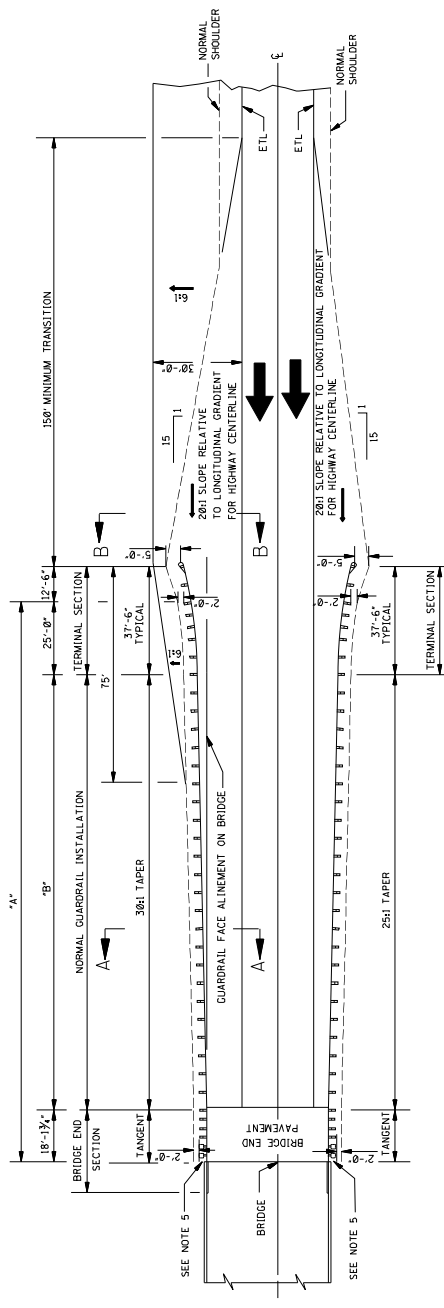

DIVIDED HIGHWAY WITH BARRIER OUTSIDE CLEAR ZONE OF OPPOSING TRAFFIC

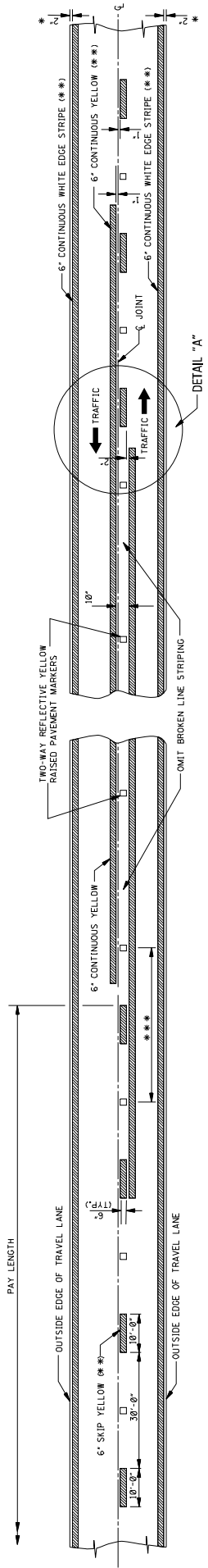

TWO-WAY TRAFFIC
(ASPHALT OR CONCRETE PAVEMENT)

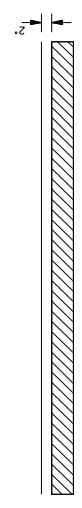

NOTE: THE CRITERIA FOR NO-PASSING ZONES CAN BE FOUND IN THE MOOT ROADWAY DESIGN MANUAL, SECTION 11-1.01.

GENERAL NOTES:

- * 1. 2" UNLESS SHOWN ELSEWHERE ON THE PLANS, FOR STRIPING ON RUMBLE STRIP SECTIONS REFER TO WK. SHEETS RS-1, RS-2, AND RS-3.
- ** 2. EDGE STRIPE SHALL BE SAME MATERIAL AS LANE-LINE STRIPE (PAINT OR PLASTIC AS INDICATED IN PAY ITEMS).
- *** 3. SPACING OF REFLECTIVE RAISED PAVEMENT MARKERS IS AS FOLLOWS:

TANGENT SECTIONS	RURAL AREA (40'-0" TO 80'-0")	URBAN AREA (80'-0" TO 400'-0")
HORIZONTAL CURVES	40'-0"	40'-0"
INTERCHANGE LIMITS	40'-0"	1-40'-0"

- 1. NOTE: ON THE MAIN FACILITY, REFLECTIVE RED-CLEAR RAISED PAVEMENT MARKERS ON A 40'-0" SPACING WILL BE REQUIRED UNLESS SHOWN OTHERWISE. REFLECTIVE RAISED PAVEMENT MARKERS ON A 40'-0" SPACING WILL BE REQUIRED THROUGHOUT THE INTERCHANGE AREAS INCLUDING 1000' TAPER AND CONTINUING THROUGH THE INTERCHANGE TO THE END OF THE ENTRANCE RAMP TAPER.
- 4. PAVEMENT MARKERS SHALL BE HIGH PERFORMANCE REFLECTIVE.
- 5. RAISED PAVEMENT MARKERS AS LISTED IN THE MOOT *APPROVED SOURCES OF MATERIALS.*

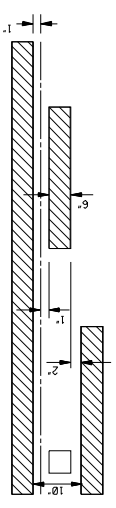

DETAIL "A"

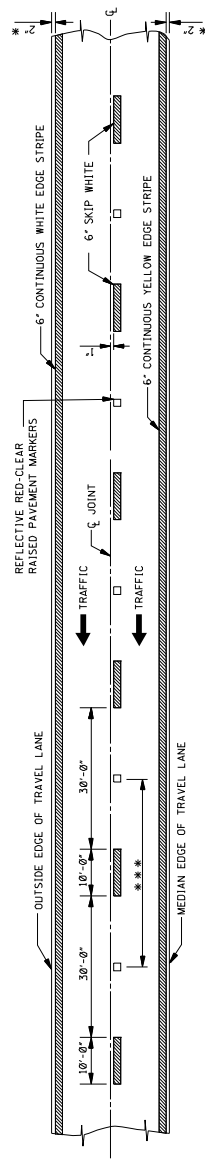

4-LANE WITH ONE-WAY TRAFFIC

MISSISSIPPI DEPARTMENT OF TRANSPORTATION
ROADWAY DESIGN DIVISION
STANDARD PLAN

**PAVEMENT MARKING
DETAILS FOR
2-LANE AND 4-LANE
DIVIDED ROADWAYS**

DATE: AUGUST 01, 2017

ISSUE DATE: AUGUST 01, 2017

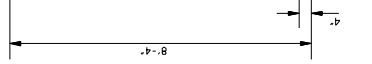
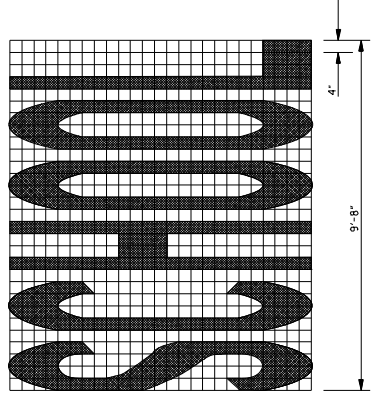
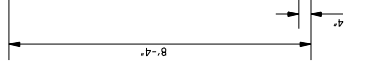
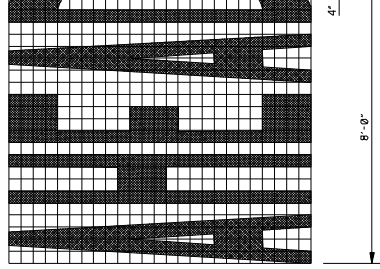
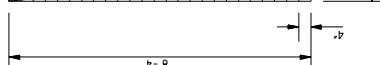
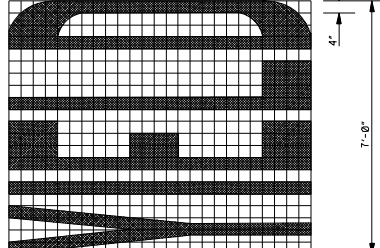
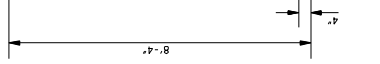
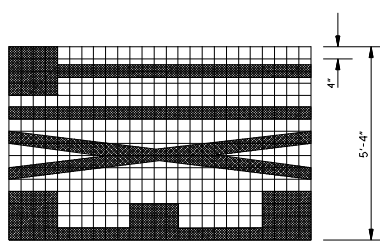
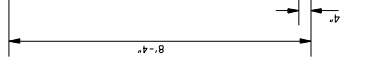
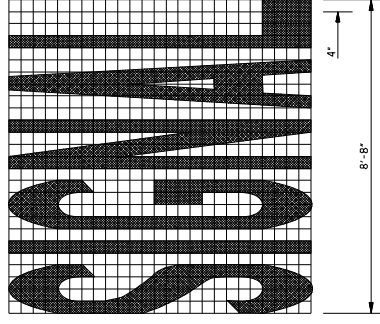
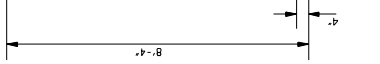
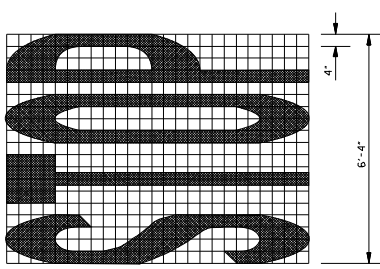
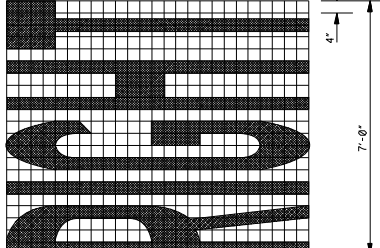
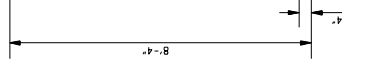
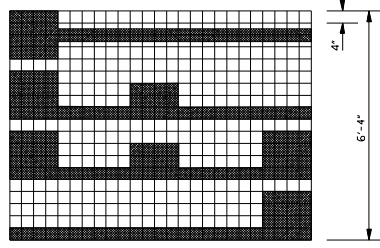
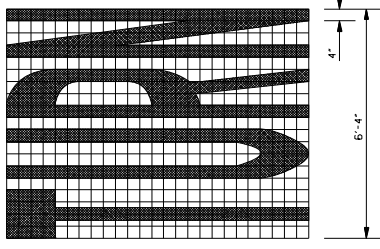
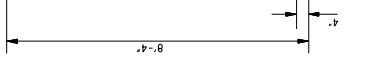
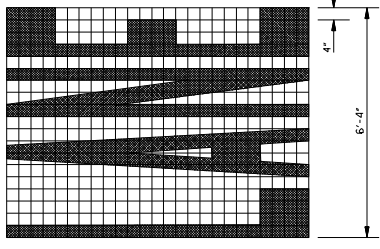

GENERAL NOTES:

1. TWO HORIZONTAL GAPS CAUSED BY SPACING OF CHARACTERS OR LESS AND EXTENDING THE FULL WIDTH ARE PERMITTED IN EACH LETTER.
2. FOR OTHER DETAILS, SEE THE MANUAL ON UNIFORM TRAFFIC CONTROL DEVICES.
3. PAY QUANTITIES FOR PAVEMENT MARKING LEGENDS ARE AS FOLLOWS:

PAY QUANTITIES	
LEGEND	AREA (SQ. FT.)
STOP	24.6
RIGHT	28.6
LEFT	27.3
TURN	22.7
LANE	32.3
AHEAD	26.8
YIELD	18.5
EXIT	32.5
SIGNAL	35.5
SCHOOL	

MISSISSIPPI DEPARTMENT OF TRANSPORTATION
ROADWAY DESIGN DIVISION
STANDARD PLAN

PAVEMENT MARKING LEGEND DETAILS

ISSUE DATE: AUGUST 01, 2017

6055

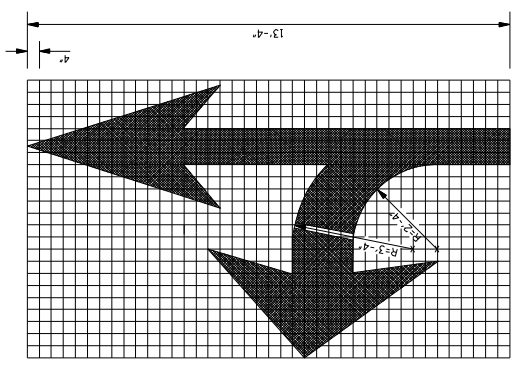

COMBINATION ARROW

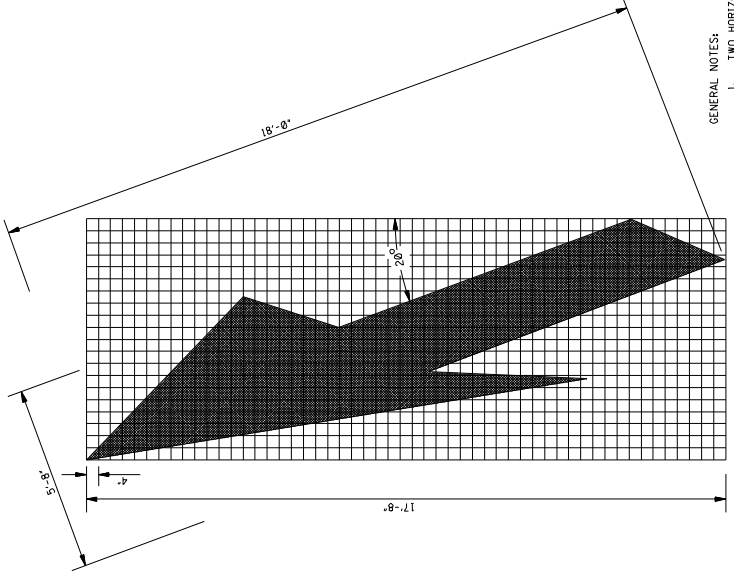

LANE-REDUCTION ARROW

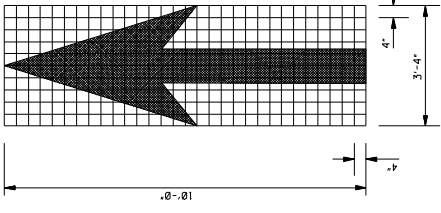

THRU ARROW

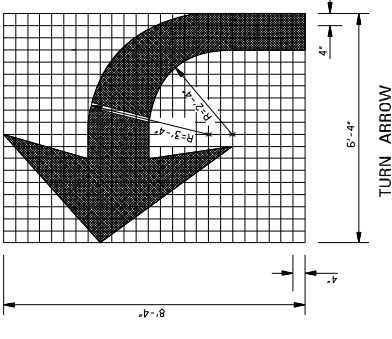

TURN ARROW

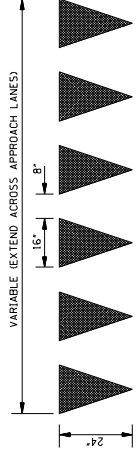
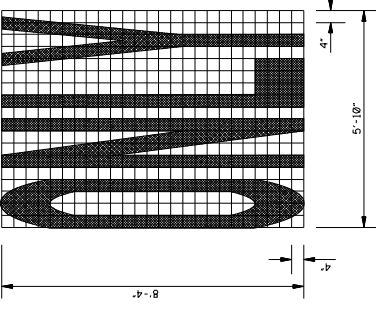

YIELD LINE

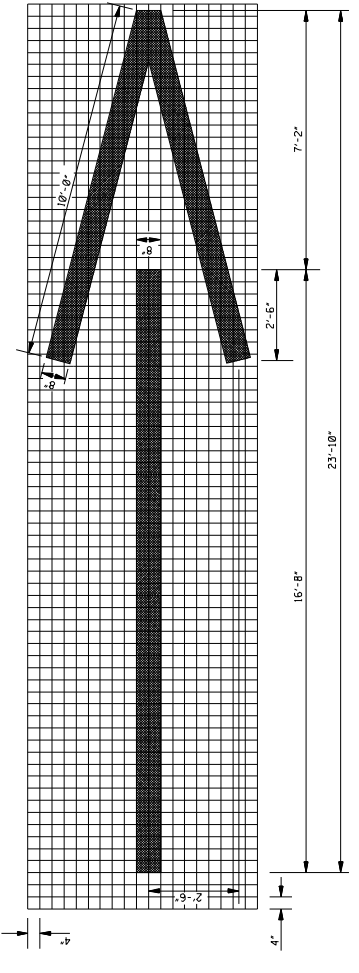

T-WAY ARROW

- GENERAL NOTES:**
1. TWO HORIZONTAL GAPS (CAUSED BY TEMPLATE CONNECTORS) OF 1/2" OR LESS AND EXTENDING THE FULL WIDTH ARE PERMITTED IN EACH LETTER.
 2. FOR OTHER DETAILS, SEE THE MANUAL ON UNIFORM TRAFFIC CONTROL DEVICES.
 3. DIMENSIONS OF THE YIELD LINE MAY VARY WITH APPROVAL OF THE ENGINEER. SEE MUTCD, LATEST EDITION, FOR ALLOWABLE DIMENSIONS.
 4. PAY QUANTITIES FOR PAVEMENT MARKING LEGENDS ARE AS FOLLOWS:

PAY QUANTITIES	
LEGEND/SYMBOL	AREA (SF)
ONLY	22.0
TURN ARROW	16.4
THRU ARROW	12.3
COMB. ARROW	21.5
T-WAY ARROW	24.3
LANE REDUCTION ARROW	40.0

MISSISSIPPI DEPARTMENT OF TRANSPORTATION
ROADWAY DESIGN DIVISION
STANDARD PLAN

PAVEMENT MARKING LEGEND DETAILS

ISSUE DATE: AUGUST 01, 2017

PROJECT NUMBER: 60556

MARKING NUMBER: PM-6

DATE: 08/01/17

BY: _____

REVISION: _____

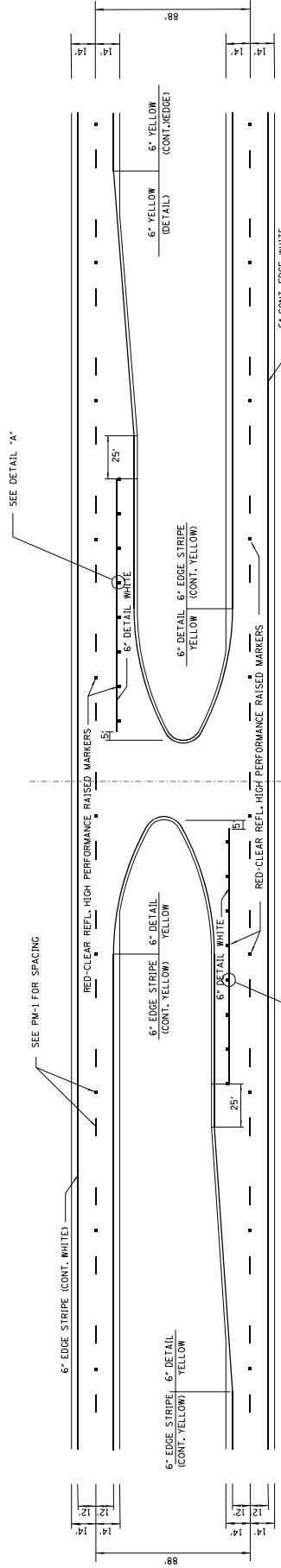

$C \text{ TO } C \leq 88'$

NOTE: FOR WIDER C TO C SPACINGS,
REFER TO OTHER SHEETS IN PLANS

NOTE: SEE PM-6 FOR
YIELD BAR DETAILS

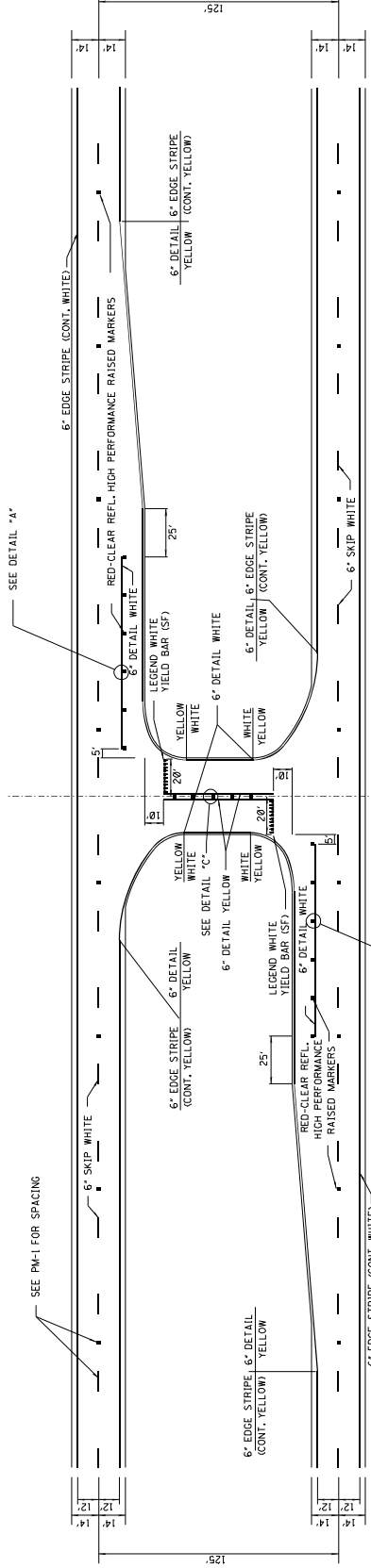

$125' \geq C \text{ TO } C > 88'$

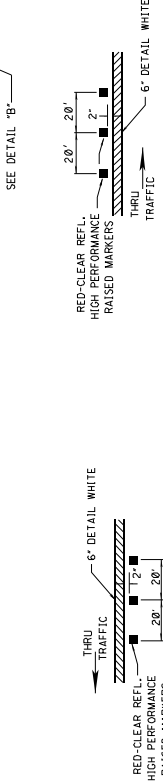

MISSISSIPPI DEPARTMENT OF TRANSPORTATION
ROADWAY DESIGN DIVISION
STANDARD PLAN

BY	REVISION

TYPICAL PAVEMENT MARKING DETAIL FOR MEDIAN CROSSEOVERS

PLANS
PM-9

DATE: AUGUST 01, 2017

ISSUE NUMBER: 6059

STATE	PROJECT NO.
MISS.	

TYPICAL PLACEMENT OF RAISED PAVEMENT MARKERS ON SIDE ROAD RADIUS 4-LANE, TWO WAY TRAFFIC

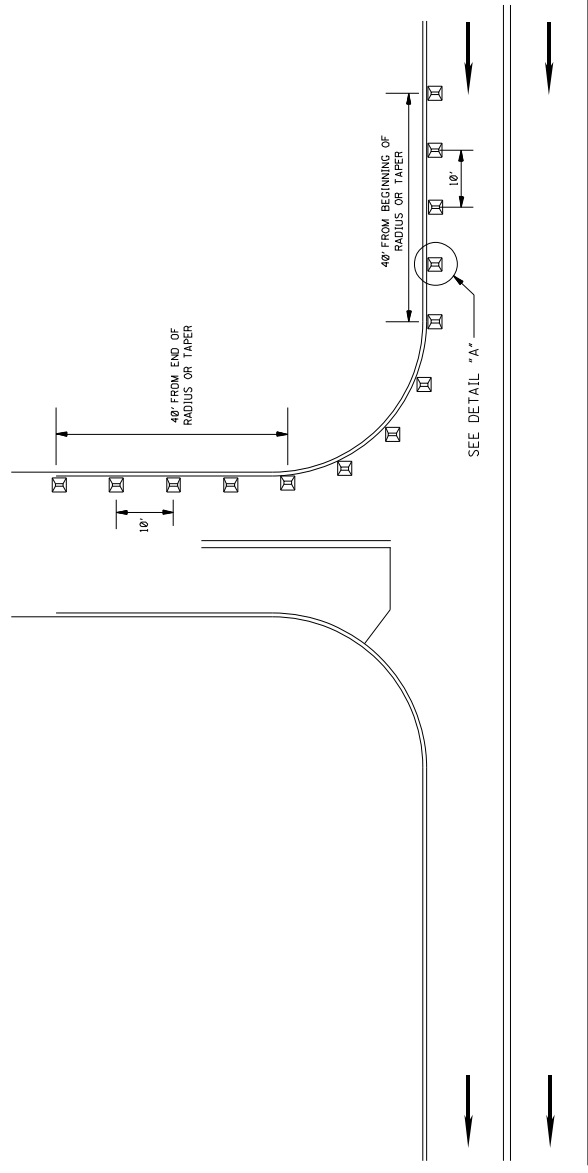

-18-

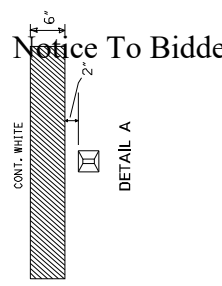

DIRECTION OF TRAFFIC →

GENERAL NOTES:

- MARKERS SHALL BE VISIBLE FROM THE TRAVELING MOTORIST ON STATE DESIGNATED HIGHWAYS.
- MARKERS SHALL BE HIGH PERFORMANCE TWO-WAY CLEAR.
- MARKERS SHALL NOT BE ROTATED WHEN BEING PLACED ALONG RADIUS AND TANGENT SECTIONS OF LOCAL ROAD.
- MARKERS SHALL BE INSTALLED AT SIMPLE AND CHANNELIZED INTERSECTIONS TO THE LIMITS SHOWN ABOVE.

Notice To Bidders No 6182 -

MISSISSIPPI DEPARTMENT OF TRANSPORTATION ROADWAY DESIGN DIVISION STANDARD PLAN			
		2-WAY RAISED PAVEMENT MARKERS AT INTERSECTING ROADS (4-LANE)	
DATE	ISSUE DATE:	PLAN NUMBER	DRAWING NUMBER
	AUGUST 01, 2017	6182	RM-12
REVISION		DATE	BY

GENERAL NOTES

1. GROUND-IN RUMBLE STRIPES SHALL BE APPLIED TO ALL PAVED SHOULDERS OF ALL PAVED SHOULDERS ON THIS PROJECT.
2. GROUND-IN RUMBLE STRIPES SHALL BE APPLIED TO ALL INTERSECTIONS, ROADWAYS OR OTHER INTERSECTIONS IN NORMAL SHOULDER WIDTH AS DIRECTED BY THE ENGINEER.
3. COST TO BE PAID FOR USING APPROPRIATE PAY ITEMS.
4. GROUND-IN RUMBLE STRIPES SHALL BE APPLIED TO:
 - A. MAINLINE
 - B. INTERSECTING ROADWAY IF OVERLAID OR RECONSTRUCTED BEYOND NORMAL MAINLINE R.O.W.
 - C. ANY ROADWAY WITH EXISTING RUMBLE STRIPES PRIOR TO CONSTRUCTION.

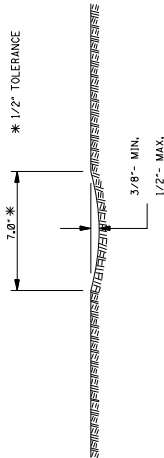

SECTION "A-A"

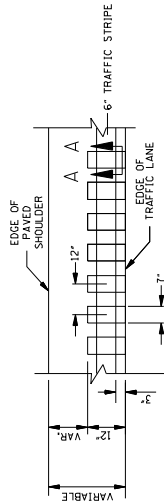

DETAIL "A"

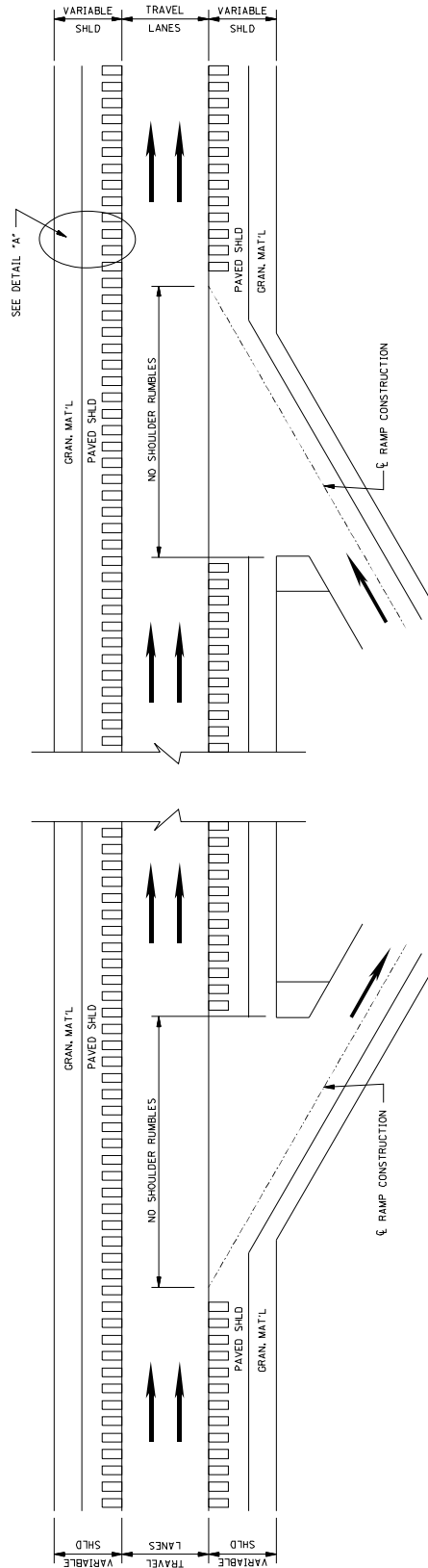

PLAN
NOT TO SCALE
DETAILS OF
RUMBLE STRIPS

MISSISSIPPI DEPARTMENT OF TRANSPORTATION
ROADWAY DESIGN DIVISION
STANDARD PLAN

BY	REVISION	DATE

**RUMBLE STRIPES
4-LANE HIGHWAYS
(ASPHALT LANES,
2-FT OR WIDER,
ASPHALT SHOULDERS)**

MS-2
DRAWING NUMBER
16065
ISSUE NUMBER
AUGUST 01, 2017
ISSUE DATE

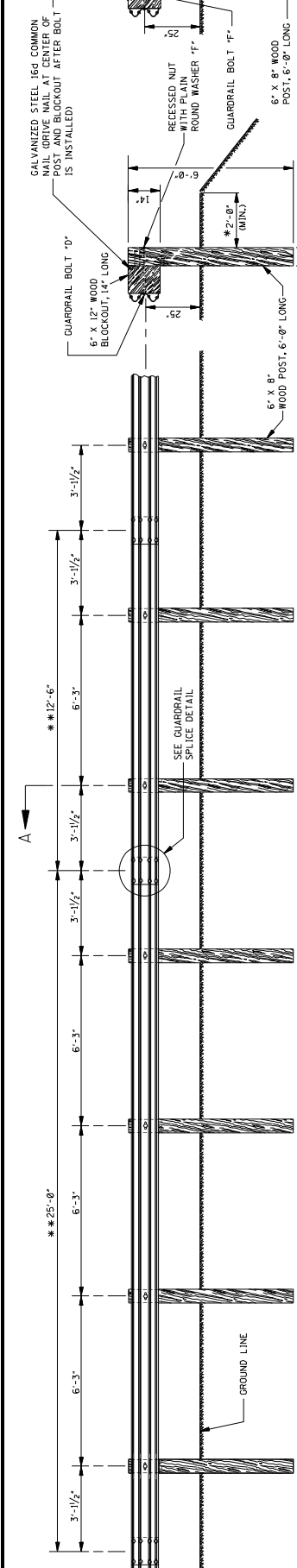

ELEVATION FROM ROADWAY
** NOTE: OPTIONAL BEAM LENGTHS.

ELEVATION FROM POST ADD
GUARDRAIL BOLT "D" OR "F"

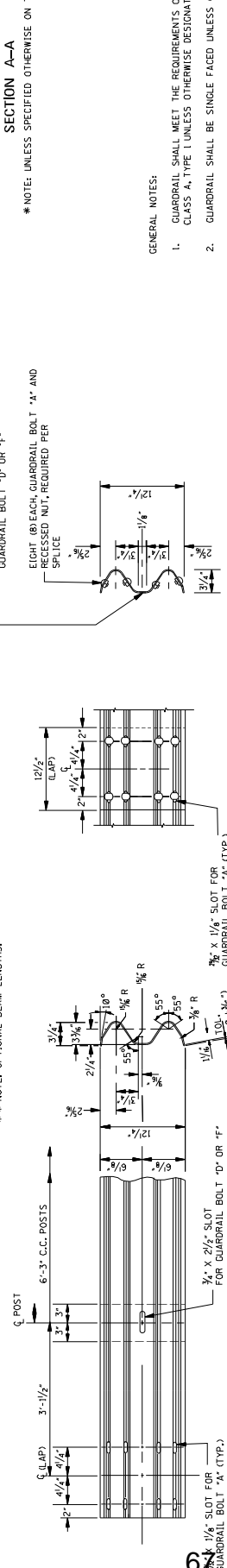

TYPICAL GUARDRAIL SECTION

SECTION A-A
** NOTE: UNLESS SPECIFIED OTHERWISE ON THE PLANS.

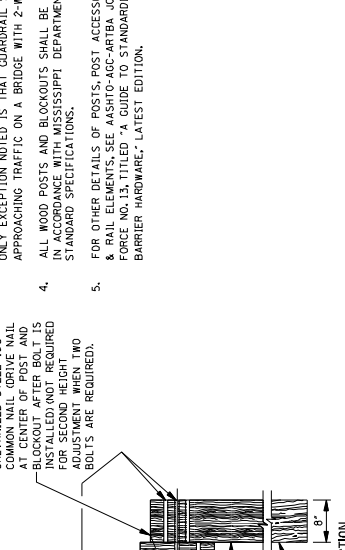

DETAILS OF ADJUSTABLE HEIGHT BLOCKOUT ASSEMBLY
SECTION
ELEVATION

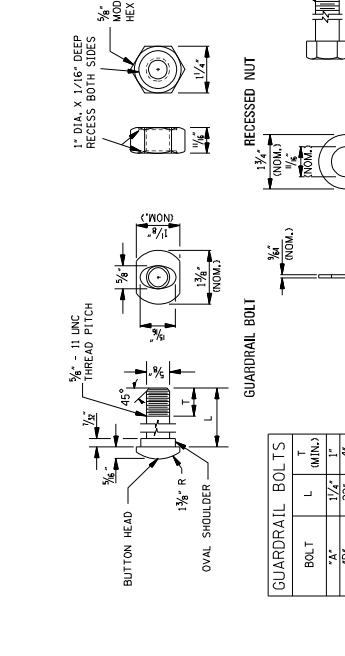

FASTENER DETAILS

NOTES:

1. ALL GUARDRAIL BOLTS ARE 3/8" - 11 UNC THREAD PITCH.
2. IF ANY BOLT EXTENDS MORE THAN 1/4" FROM THE NUT, THE BOLT SHOULD BE TRIMMED BACK.
3. GUARDRAIL BOLT "E" IS USED FOR SINGLE-FACED GUARDRAIL AND 6" X 8" WOOD POST, AND 6" X 12" WOOD BLOCKOUT.

GUARDRAIL BOLTS

BOLT	L	T
"A"	1 1/2"	1"
"D"	22"	4"
"E"	24"	4"
"F"	33"	4"

RECESSED NUT

PLAIN ROUND WASHER "F"

HEX NUT AND BOLT "F"

GENERAL NOTES:

1. GUARDRAIL SHALL MEET THE REQUIREMENTS OF AASHTO M 188, CLASS A, TYPE 1 UNLESS OTHERWISE DESIGNATED.
2. GUARDRAIL SHALL BE SINGLE FACED UNLESS OTHERWISE DESIGNATED.
3. GUARDRAIL SECTIONS SHALL BE LAPPED IN THE DIRECTION OF TRAFFIC FLOW FOR THE LANE NEAREST THE GUARDRAIL. THE ONLY EXCEPTION NOTED IS THAT GUARDRAIL SHALL BE LAPPED FOR APPROACHING TRAFFIC ON A BRIDGE WITH 2-WAY TRAFFIC.
4. ALL WOOD POSTS AND BLOCKOUTS SHALL BE TREATED TIMBER IN ACCORDANCE WITH MISSISSIPPI DEPARTMENT OF TRANSPORTATION STANDARD SPECIFICATIONS.
5. FOR OTHER DETAILS OF POSTS, POST ACCESSORIES, FASTENERS & RAIL ELEMENTS, SEE AASHTO-ACC-ARTBA JOINT TASK FORCE NO.13, TITLED "A GUIDE TO STANDARDIZED HIGHWAY BARRIER HARDWARE", LATEST EDITION.

MISSISSIPPI DEPARTMENT OF TRANSPORTATION
ROADWAY DESIGN DIVISION
STANDARD PLAN

GUARDRAIL:
"W" BEAM
(WOOD POSTS)

REVISION

ISSUE DATE: AUGUST 01, 2017

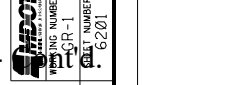

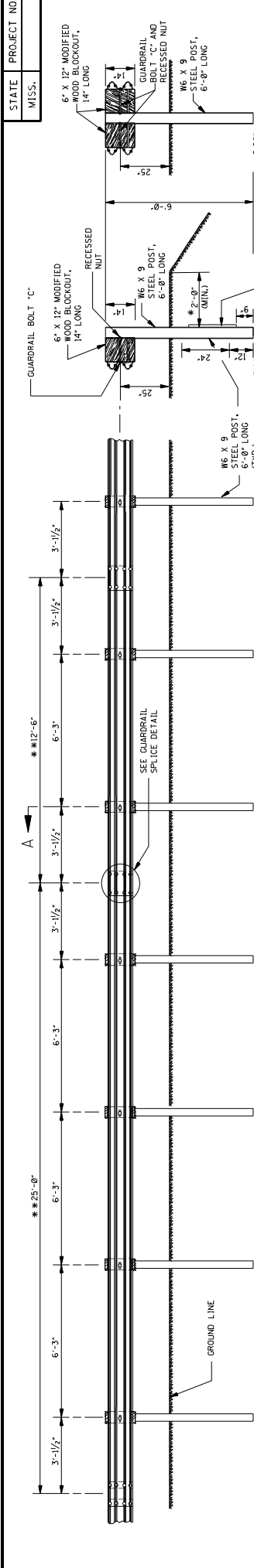

ELEVATION FROM C ROADWAY
** NOTE: OPTIONAL BEAM LENGTHS.

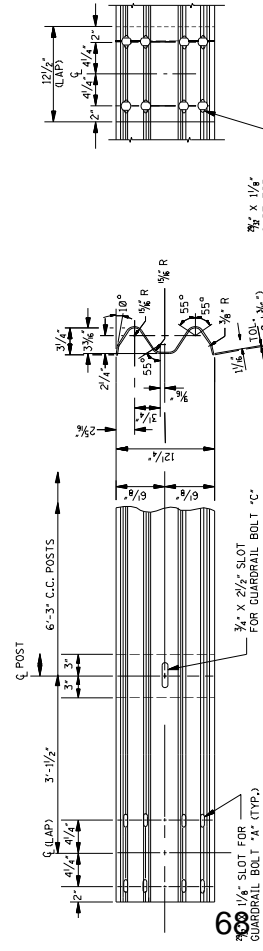

TYPICAL GUARDRAIL SECTION

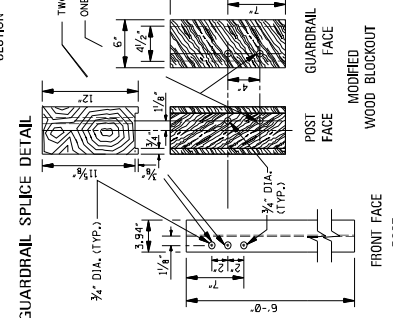

GUARDRAIL SPLICE DETAIL

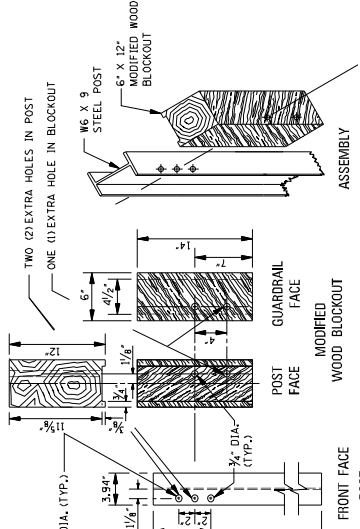

DETAILS OF ADJUSTABLE HEIGHT BLOCKOUT ASSEMBLY

- NOTES:
- ON INITIAL INSTALLATION, THE MODIFIED WOOD BLOCKOUT SHALL BE FASTENED TO THE BOTTOM HOLE IN THE STEEL POST. AND THE MODIFIED WOOD BLOCKOUT ARE FOR FUTURE 2" HEIGHT ADJUSTMENTS WHEN THE ROADWAY IS RESURFACED.
 - AN ADDITIONAL GUARDRAIL BOLT "C" AND RECESSED NUT IS REQUIRED FOR THE SECOND HEIGHT ADJUSTMENT.
 - HOLE DETAILS ARE REQUIRED ON ALL STEEL POSTS AND MODIFIED WOOD BLOCKOUTS.
 - STEEL POSTS ARE FABRICATED FROM W6 X 9 STRUCTURAL STEEL SHAPES.
 - MODIFIED WOOD BLOCKOUTS ARE FABRICATED FROM 6" X 12" TREATED TIMBER UNLESS SPECIFIED OTHERWISE ON THE PLANS.
 - ALL HOLES IN BOTH STEEL POSTS AND MODIFIED WOOD BLOCKOUTS ARE 3/4" IN DIAMETER.

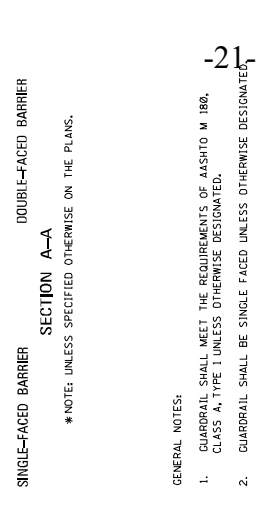

SECTION A-A

** NOTE: UNLESS SPECIFIED OTHERWISE ON THE PLANS.

GENERAL NOTES:

- GUARDRAIL SHALL MEET THE REQUIREMENTS OF AASHTO M 180, CLASS A, TYPE 1 UNLESS OTHERWISE DESIGNATED.
- GUARDRAIL SHALL BE SINGLE FACED UNLESS OTHERWISE DESIGNATED.
- GUARDRAIL SECTIONS SHALL BE LAPPED IN THE DIRECTION OF TRAFFIC FLOW FOR THE LANE NEAREST THE GUARDRAIL. THE ONLY EXCEPTION NOTED IS THAT GUARDRAIL SHALL BE LAPPED FOR APPROACHING TRAFFIC ON A BRIDGE WITH 2-WAY TRAFFIC.
- STEEL POSTS SHALL CONFORM TO ASTM A36 EXCEPT ULTRASONIC TESTING. THEY SHALL BE GALVANIZED IN ACCORDANCE WITH AASHTO M 288. EXCESS CORROSION RESISTANT STEEL EQUIPPED WITH GALVANIZING RESISTANCE SHALL NOT BE PERMITTED FOR GALVANIZING EXCEPT FOR HOLES TO MOUNT GUARDRAIL DELINEATORS. ALL MODIFIED WOOD BLOCKOUTS SHALL BE TREATED TIMBER IN ACCORDANCE WITH MISSISSIPPI DEPARTMENT OF TRANSPORTATION STANDARD SPECIFICATIONS.
- FOR OTHER DETAILS OF POSTS, POST ACCESSORIES, FASTENERS & RAIL ELEMENTS, SEE AASHTO-A02-AR08A JOINT TASK FORCE NO. 13, TITLED "A GUIDE TO STANDARDIZED HIGHWAY BARRIER HARDWARE", LATEST EDITION.

GUARDRAIL BOLTS		
BOLT	L	T
"A"	1 1/2"	1"
"B"	12"	4"
"C"	14"	4"

- NOTES:
- ALL GUARDRAIL BOLTS ARE 5/8" - 11 UNC THREAD PITCH.
 - IF ANY BOLT EXTENDS MORE THAN 1/4" FROM THE NUT, THE BOLT SHOULD BE TRIMMED BACK.

FASTENER DETAILS

MISSISSIPPI DEPARTMENT OF TRANSPORTATION
ROADWAY DESIGN DIVISION
STANDARD PLAN

**GUARDRAIL:
"W" BEAM
(STEEL POSTS)**

BY	REVISION

ISSUE DATE: AUGUST 01, 2017

PROJECT NUMBER: 6203

STATE PROJECT NO. MISS.

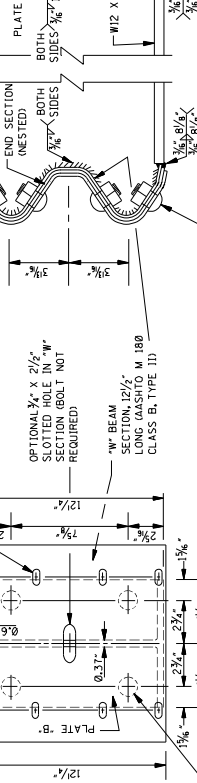
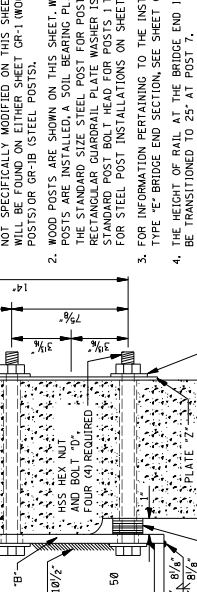
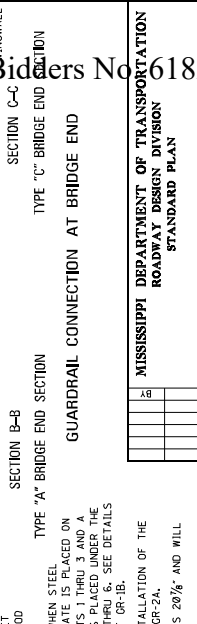
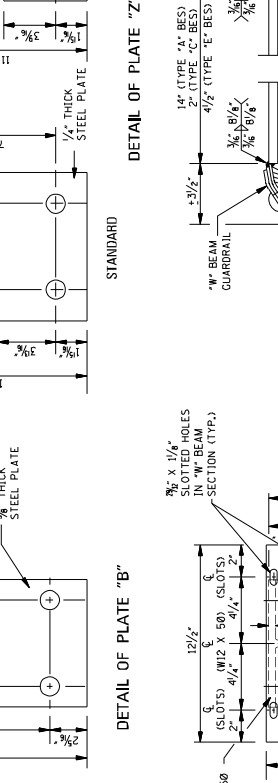
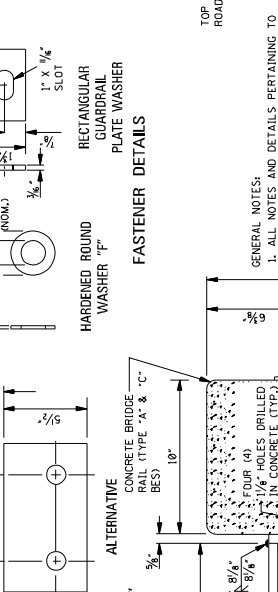
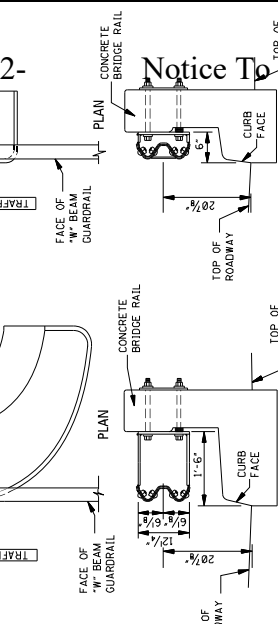
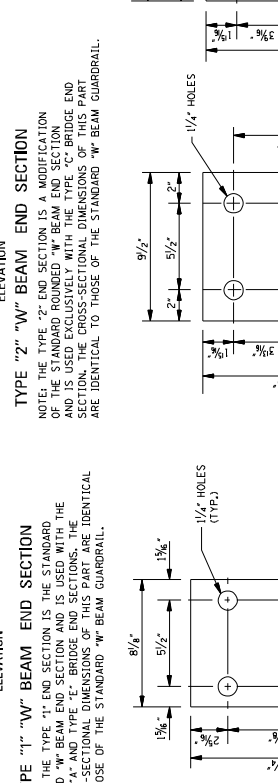
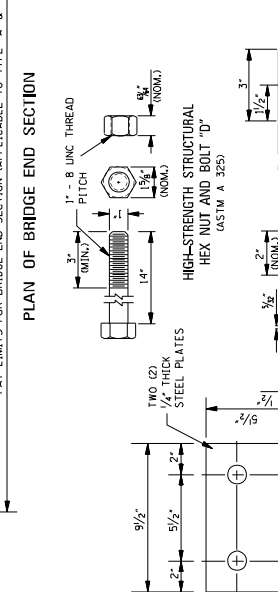
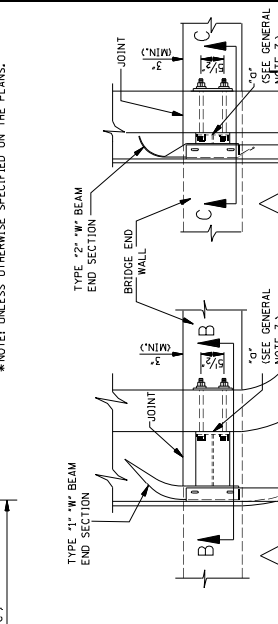
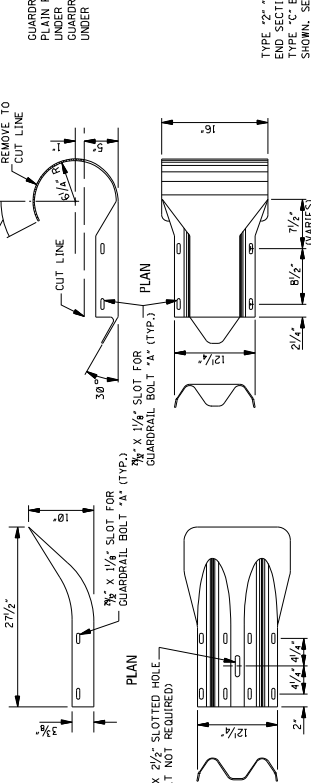
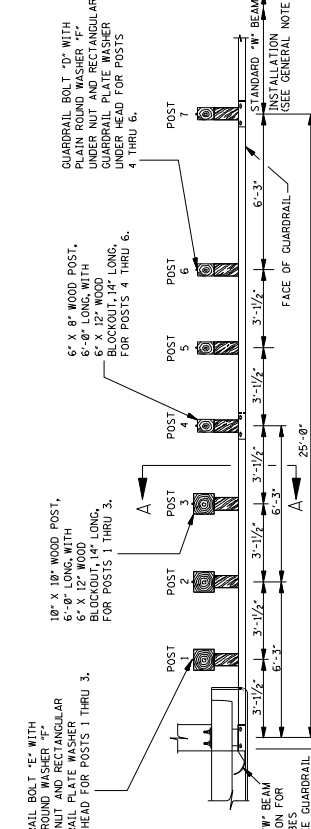
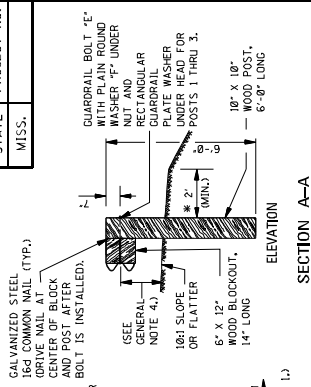

MISSISSIPPI DEPARTMENT OF TRANSPORTATION ROADWAY DESIGN DIVISION STANDARD PLAN. GUARDRAIL: BRIDGE END SECTIONS TYPE "A" & "C". Notice To Bidders No. 6182 -

REVISION table with columns for REVISION, DATE, and BY.

ISSUE DATE: AUGUST 01, 2017. SHEET NUMBER: 6204.

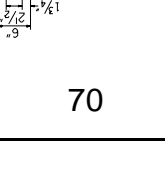
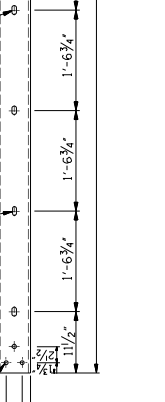
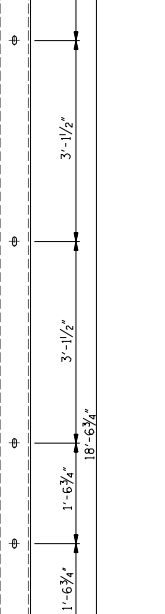
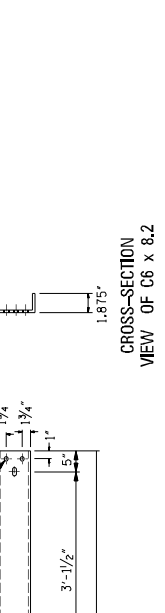
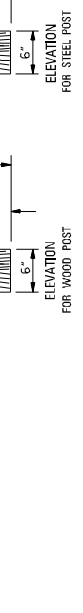
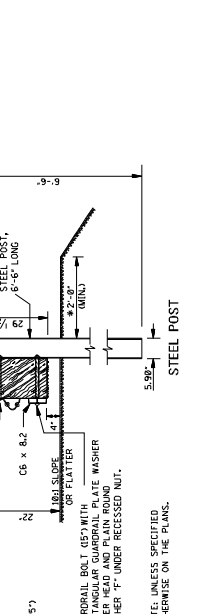
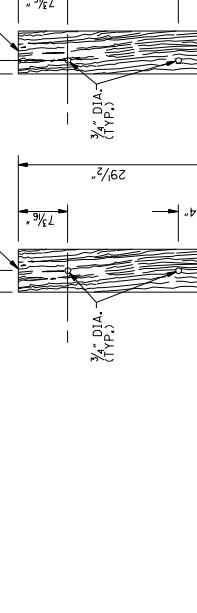
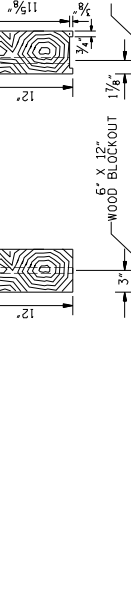

PROFILE VIEW OF POSTS

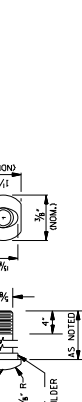
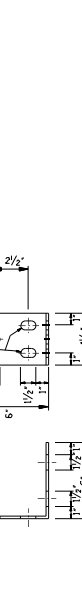
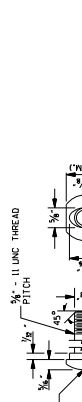
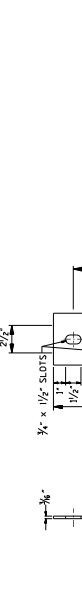
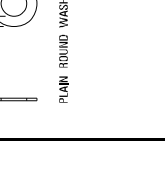
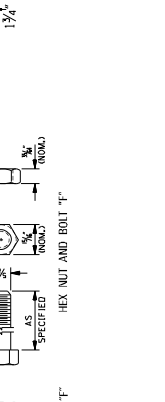
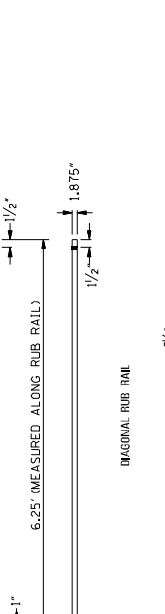
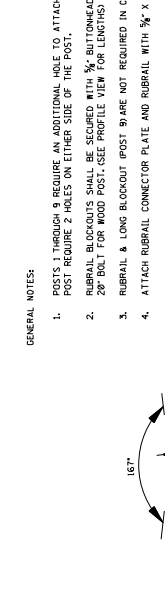
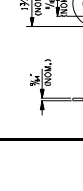
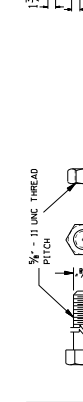
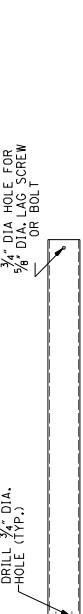
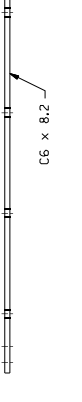
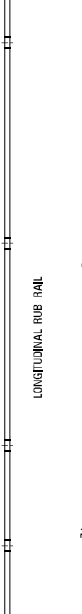
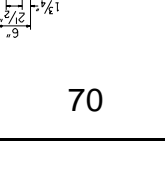
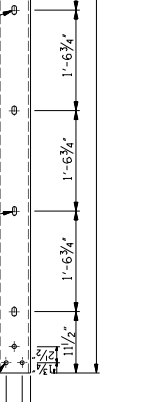
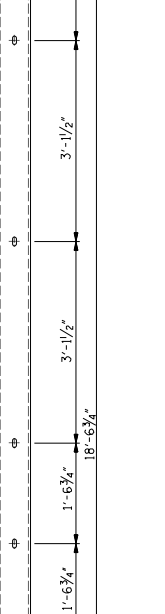
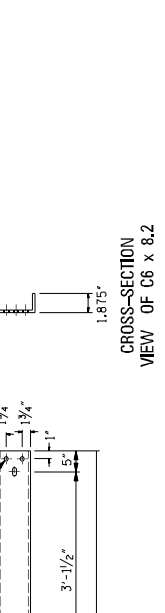
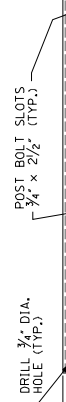

- GENERAL NOTES:
- POSTS 1 THROUGH 9 REQUIRE AN ADDITIONAL HOLE TO ATTACH LOWER BLOCKOUTS. STEEL POST REQUIRE 2 HOLES ON EITHER SIDE OF THE POST.
 - RUBRAIL BLOCKOUTS SHALL BE SECURED WITH 3/4" BUTT WASHERS FOR STEEL POST AND 2" BOLT FOR WOOD POST. (SEE PROFILE VIEW FOR LENGTHS)
 - RUBRAIL & LONG BLOCKOUT (POST 9) ARE NOT REQUIRED IN CURB & GUTTER SECTIONS OF ROADWAY.
 - ATTACH RUBRAIL CONNECTOR PLATE AND RUBRAIL WITH 3/8" x 1/2" HEX HEAD BOLTS 1"

MISSISSIPPI DEPARTMENT OF TRANSPORTATION
ROADWAY DESIGN DIVISION
STANDARD PLAN

**GUARDRAIL:
RUB RAIL HARDWARE**

DATE	BY	REVISION

ISSUE DATE: AUGUST 01, 2017

PROJECT NUMBER: 6218

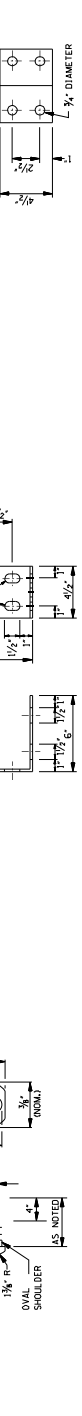
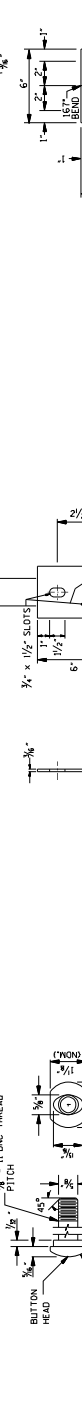
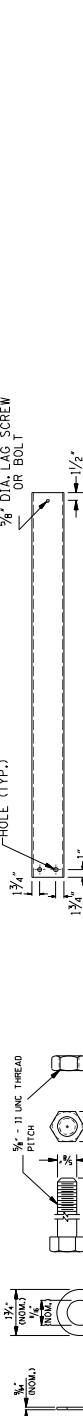
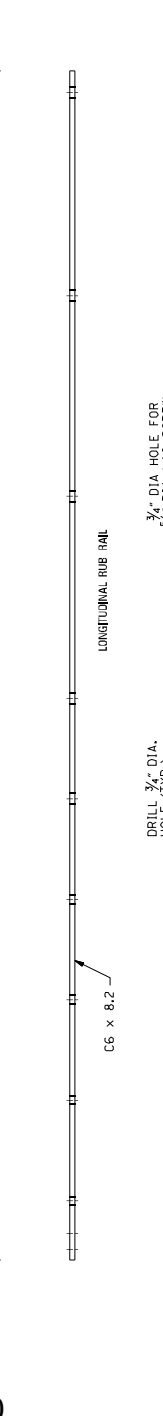
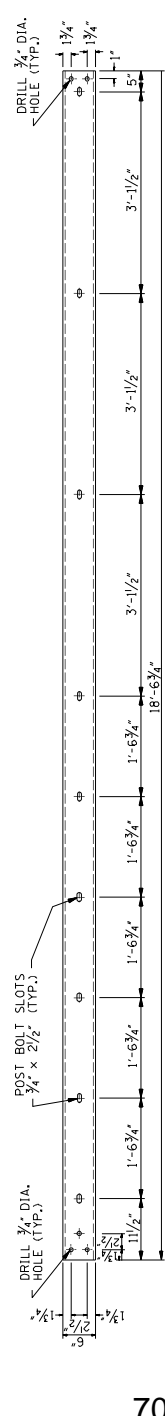

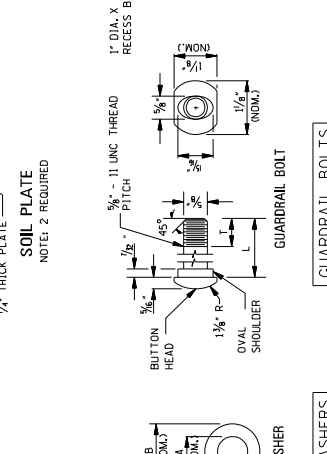
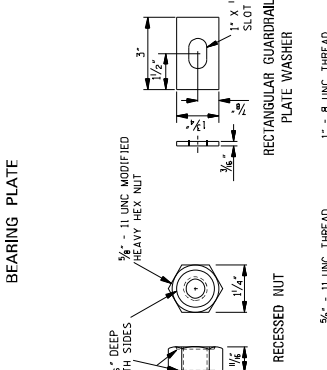
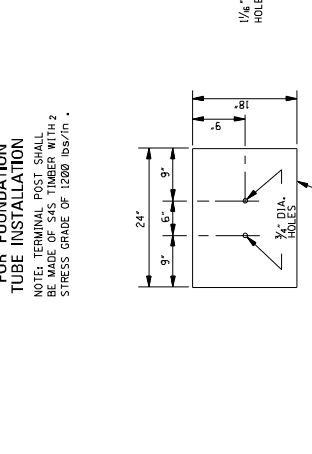
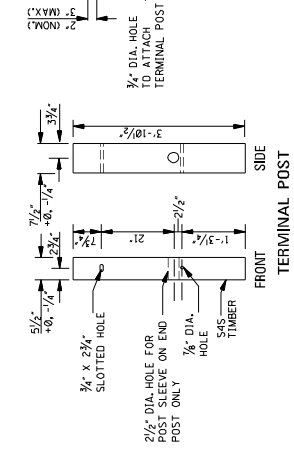
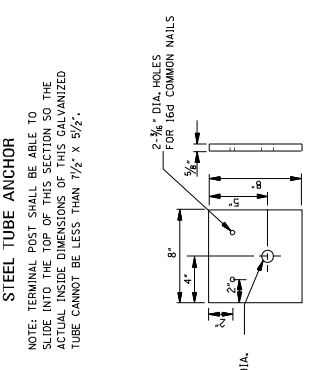
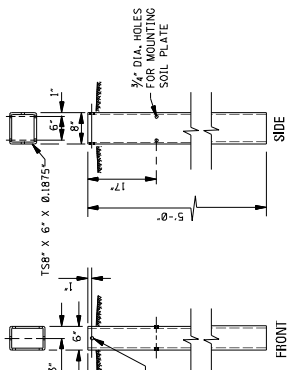
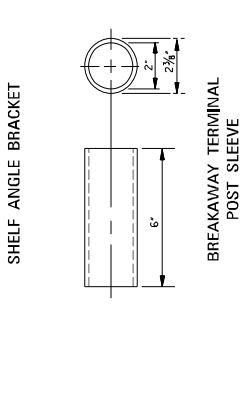
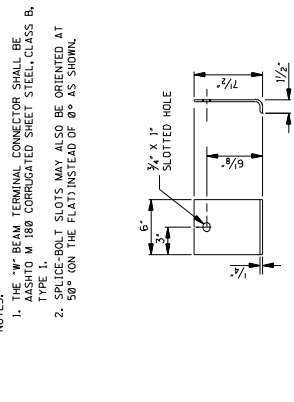
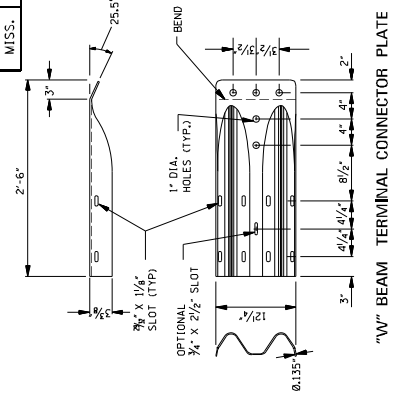

BOLT	L	T	(MIN.)
"A"	17"	1"	4"
"B"	14"	1"	4"
"C"	12"	1"	4"
"D"	12"	1"	4"
"E"	12"	1"	4"
"F"	12"	1"	4"
"G"	12"	1"	4"
"H"	12"	1"	4"
"I"	12"	1"	4"
"J"	12"	1"	4"
"K"	12"	1"	4"
"L"	12"	1"	4"
"M"	12"	1"	4"
"N"	12"	1"	4"
"O"	12"	1"	4"
"P"	12"	1"	4"
"Q"	12"	1"	4"
"R"	12"	1"	4"
"S"	12"	1"	4"
"T"	12"	1"	4"
"U"	12"	1"	4"
"V"	12"	1"	4"
"W"	12"	1"	4"
"X"	12"	1"	4"
"Y"	12"	1"	4"
"Z"	12"	1"	4"

NOTES:
1. ALL GUARDRAIL BOLTS ARE 3/8" - 11 UNC THREAD PITCH.
2. IF ANY BOLT EXTENDS MORE THAN 1/2" FROM THE BACK, THE BOLT SHOULD BE TRIMMED BACK.

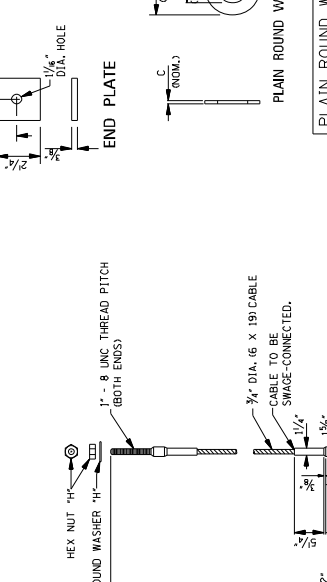
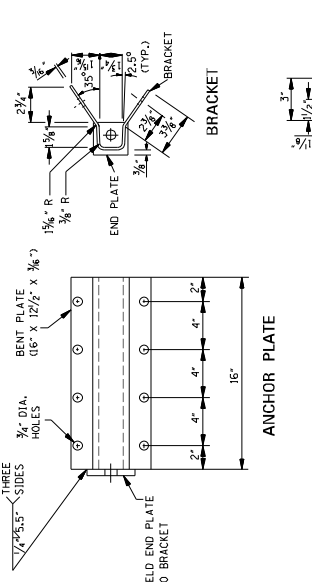
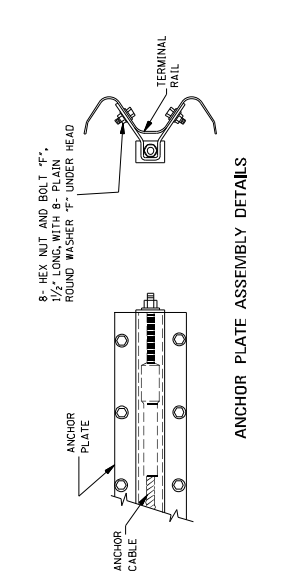

WASHER (NOM.)	A	B	C	(NOM.)
"A"	1 1/4"	1 1/4"	1 1/4"	1 1/4"
"B"	1 1/4"	1 1/4"	1 1/4"	1 1/4"
"C"	1 1/4"	1 1/4"	1 1/4"	1 1/4"
"D"	1 1/4"	1 1/4"	1 1/4"	1 1/4"
"E"	1 1/4"	1 1/4"	1 1/4"	1 1/4"
"F"	1 1/4"	1 1/4"	1 1/4"	1 1/4"
"G"	1 1/4"	1 1/4"	1 1/4"	1 1/4"
"H"	1 1/4"	1 1/4"	1 1/4"	1 1/4"
"I"	1 1/4"	1 1/4"	1 1/4"	1 1/4"
"J"	1 1/4"	1 1/4"	1 1/4"	1 1/4"
"K"	1 1/4"	1 1/4"	1 1/4"	1 1/4"
"L"	1 1/4"	1 1/4"	1 1/4"	1 1/4"
"M"	1 1/4"	1 1/4"	1 1/4"	1 1/4"
"N"	1 1/4"	1 1/4"	1 1/4"	1 1/4"
"O"	1 1/4"	1 1/4"	1 1/4"	1 1/4"
"P"	1 1/4"	1 1/4"	1 1/4"	1 1/4"
"Q"	1 1/4"	1 1/4"	1 1/4"	1 1/4"
"R"	1 1/4"	1 1/4"	1 1/4"	1 1/4"
"S"	1 1/4"	1 1/4"	1 1/4"	1 1/4"
"T"	1 1/4"	1 1/4"	1 1/4"	1 1/4"
"U"	1 1/4"	1 1/4"	1 1/4"	1 1/4"
"V"	1 1/4"	1 1/4"	1 1/4"	1 1/4"
"W"	1 1/4"	1 1/4"	1 1/4"	1 1/4"
"X"	1 1/4"	1 1/4"	1 1/4"	1 1/4"
"Y"	1 1/4"	1 1/4"	1 1/4"	1 1/4"
"Z"	1 1/4"	1 1/4"	1 1/4"	1 1/4"

NOTES:
1. ALL GUARDRAIL BOLTS ARE 3/8" - 11 UNC THREAD PITCH.
2. IF ANY BOLT EXTENDS MORE THAN 1/2" FROM THE BACK, THE BOLT SHOULD BE TRIMMED BACK.

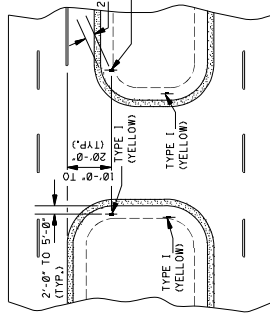

TYPICAL DELINEATION AT A CROSSOVER WITH USABLE SHOULDERS AND A MEDIAN WIDTH OVER 42'-0"

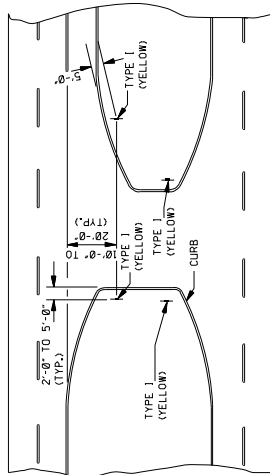

TYPICAL DELINEATION AT A CURBED CROSSOVER WITH A MEDIAN WIDTH OVER 42'-0"

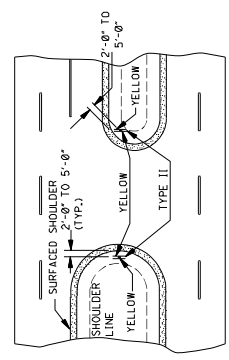

TYPICAL DELINEATION AT A CROSSOVER WITH USABLE SHOULDERS AND A MEDIAN WIDTH OF 42'-0" OR LESS

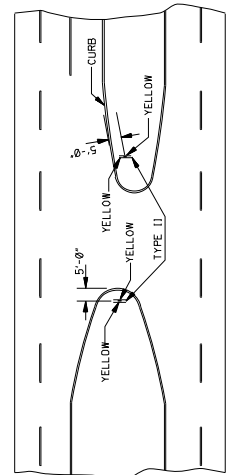

TYPICAL DELINEATION AT A CURBED CROSSOVER WITH A MEDIAN WIDTH OF 42'-0" OR LESS

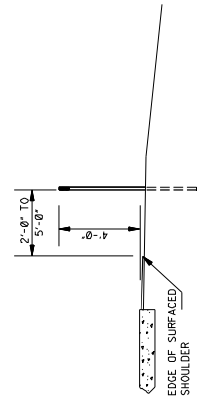

DELINEATOR MOUNTING ON CROSSOVER WITH USABLE SHOULDER

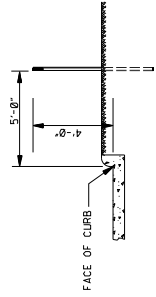

DELINEATOR MOUNTING ON CURBED CROSSOVER

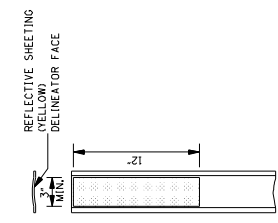

DETAIL OF TYPE I FLEXIBLE POST DELINEATOR

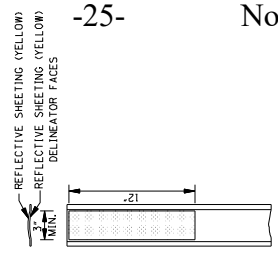

DETAIL OF TYPE II FLEXIBLE POST DELINEATOR

NOTE: CARBONITE'S CURV-FLEX DELINEATOR POSTS ARE SHOWN. OTHER FLEXIBLE POSTS THAT HAVE BEEN APPROVED FOR LISTING IN THE DEPARTMENT'S "APPROVED SOURCE OF MATERIALS" MAY BE FURNISHED.

NOTE: PLACE DELINEATORS NO MORE THAN 28'-0" FROM EDGE OF TRAVEL LANES EDGES.

GENERAL NOTES:

1. THE UNIT PRICE OF DELINEATOR INCLUDES COST(S) OF DELINEATOR FACE(S), POST, HARDWARE AND INSTALLATION.
2. DELINEATOR FACE WILL BE ENCAPSULATED LENS REFLECTIVE SHEETING.
3. POST REQUIRING THE INSTALLATION OF A BASE SHALL BE INSTALLED IN ACCORDANCE WITH THE MANUFACTURER'S RECOMMENDATION.
4. THE COLOR OF DELINEATORS SHALL BE THE COLOR OF THE ADJACENT EDGELINE PER MUTCD SECTION 3F.03.

MISSISSIPPI DEPARTMENT OF TRANSPORTATION
ROADWAY DESIGN DIVISION
STANDARD PLAN

TYPICAL CROSSOVER DELINEATION

ISSUE DATE: AUGUST 01, 2017
SHEET NUMBER 6316

DATE	REVISION

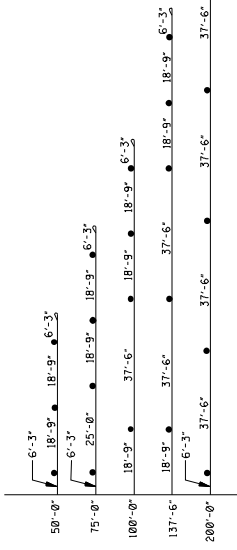

GRAPHIC SHOWING SPACINGS OF GUARDRAIL DELINEATORS AT SOME COMMONLY USED BRIDGE APPROACHES

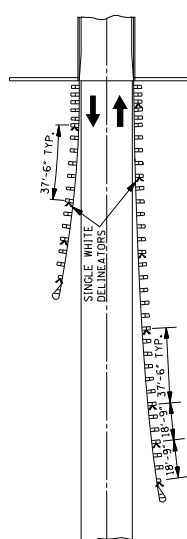

BRIDGE APPROACH INSTALLATION (TWO-WAY TRAFFIC)

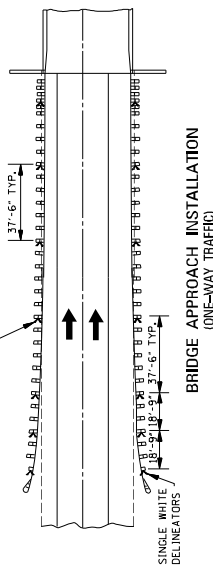

BRIDGE APPROACH INSTALLATION (ONE-WAY TRAFFIC)

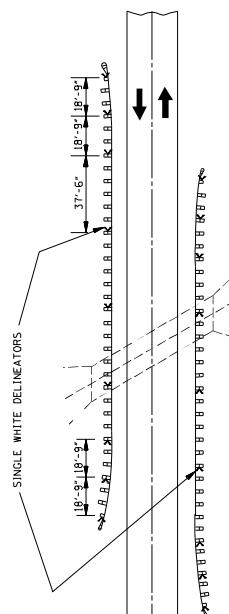

ROADSIDE OBSTACLE INSTALLATION-LENGTH 250' OR LESS (TWO-WAY TRAFFIC)

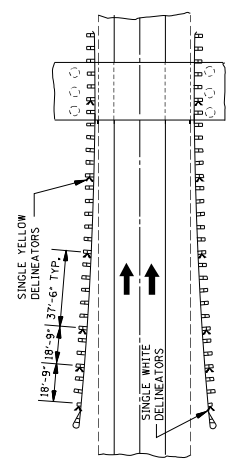

ROADSIDE OBSTACLE INSTALLATION-LENGTH 250' OR LESS (ONE-WAY TRAFFIC)

EMBANKMENT OR ROADSIDE OBSTACLE INSTALLATION-LENGTH GREATER THAN 250' (ONE-WAY TRAFFIC)

NOTE: ONE-WAY TRAFFIC SHOWN. DELINEATOR SPACING FOR TWO-WAY TRAFFIC SIMILAR. DELINEATOR COLOR WILL BE THE SAME AS THE ADJACENT PAVEMENT EDGE MARKING. THE FIRST THREE (3) MARKERS WILL FACE TRAFFIC IN OFF LANE FOR TWO-WAY TRAFFIC AS SHOWN IN DRAWING FOR OBSTACLE INSTALLATION FOR TWO-WAY TRAFFIC.

GENERAL NOTES:

1. THE UNIT PRICE OF DELINEATOR INCLUDES: COSTS OF DELINEATOR FACES, POST, HARDWARE AND INSTALLATION.
2. DELINEATOR FACE WILL BE ENCAPSULATED LENS REFLECTIVE SHEETING.
3. DELINEATORS FOR GUARDRAIL SHALL BE MOUNTED ON FLEXIBLE POSTS AS FOLLOWS; THE DELINEATOR POSTS WILL BE FROM THE DEPARTMENT'S "APPROVED SOURCE OF MATERIALS" AND WILL BE FASTENED TO GUARDRAIL POST IN ACCORDANCE WITH THE MANUFACTURER'S RECOMMENDATION.

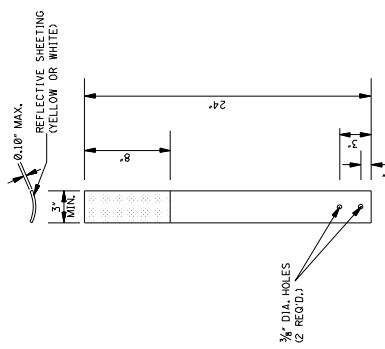
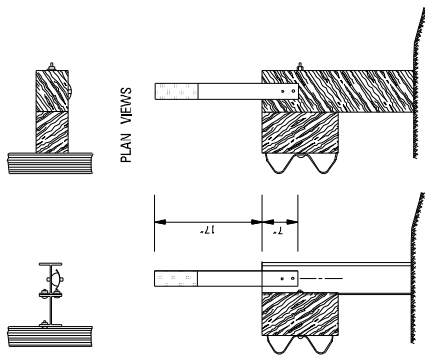

MISSISSIPPI DEPARTMENT OF TRANSPORTATION
ROADWAY DESIGN DIVISION
STANDARD PLAN

TYPICAL GUARDRAIL DELINEATION

MISSISSIPPI DEPARTMENT OF TRANSPORTATION
ROADWAY DESIGN DIVISION
STANDARD PLAN

NO.	REVISION	DATE

ISSUE DATE: AUGUST 01, 2017

6317

R16-3

WHEN WORKERS ARE PRESENT SPEEDING FINES DOUBLED

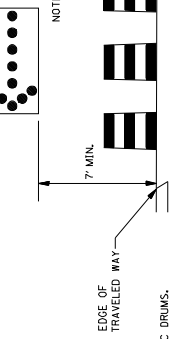
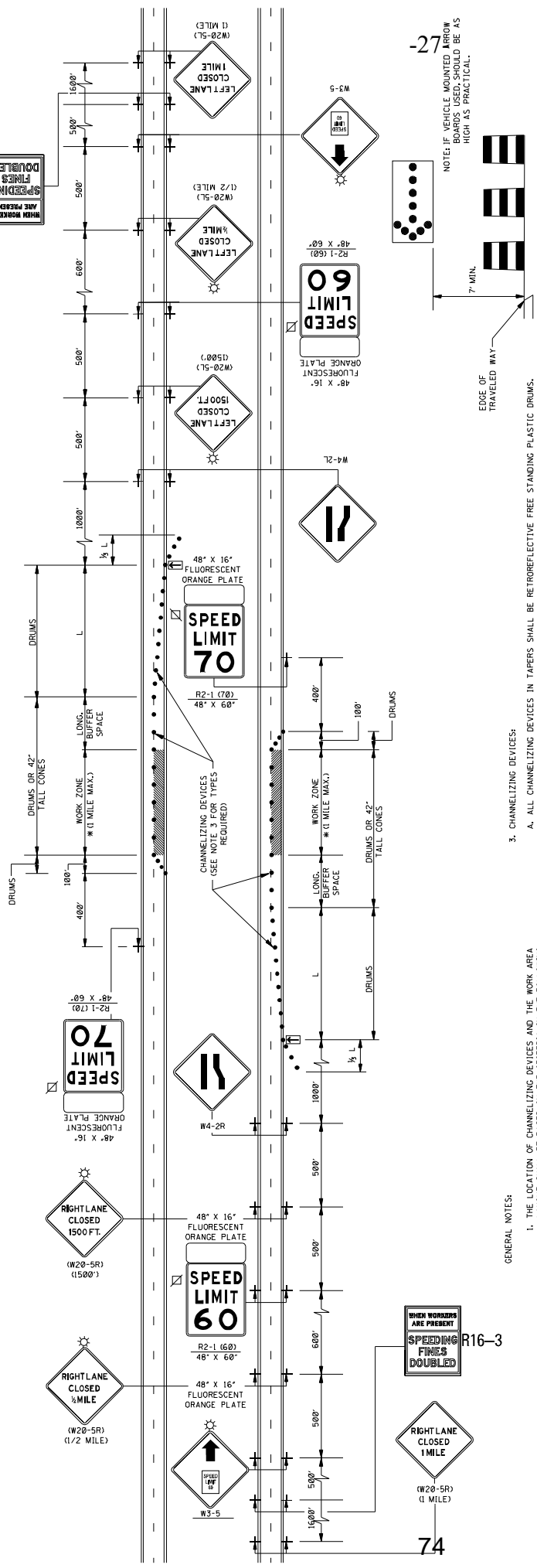

EDGE OF TRAVELED WAY

7' MIN.

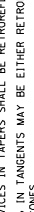

3. CHANNELIZING DEVICES:
 A. ALL CHANNELIZING DEVICES IN TAPERS SHALL BE RETROREFLECTIVE FREE STANDING PLASTIC DRUMS.
 B. CHANNELIZING DEVICES IN TANGENTS MAY BE EITHER RETROREFLECTIVE FREE STANDING PLASTIC DRUMS OR 42" TALL CONES.
 C. ALL CHANNELIZING DEVICES SHALL BE IN ACCORDANCE WITH THE LATEST EDITION OF THE M.U.T.I.C.D.
 D. DIAMOND SHAPED TRAFFIC CONTROL SIGNS SHOULD BE A MINIMUM OF 48" X 48".
 E. ALL EXISTING SPEED LIMIT SIGNS WHICH ARE INFLUENCED BY OR ADJACENT TO THE WORK ZONE SHALL BE CHANGED AS DIRECTED BY THE ENGINEER WHILE THE REDUCED SPEED LIMIT IS IN EFFECT. TAPE SHALL NOT BE USED ON FACE OF SIGN.
 F. ADDITIONAL REDUCED REGULATORY SPEED LIMIT SIGNS ARE REQUIRED AT EACH ENTRANCE AND EXIT WITH THE SPEED ZONE AND WILL BE REQUIRED FOR EACH RAMP AND LOCATION WILL BE DETERMINED BY THE ENGINEER.
 G. THIS TRAFFIC CONTROL PLAN WITH SPEED ZONE, MAY NOT BE USED ON ANY FACILITY WHERE THE POSTED SPEED LIMIT IS BELOW 65 MPH WITHOUT A COMMISSION ORDER REDUCING A SPEED LIMIT REDUCTION.
 H. LAYOUT SHOWN ABOVE IS FOR AN INTERSTATE WITH A POSTED SPEED LIMIT OF 70 MPH. FOR POSTED SPEED LIMIT OF 65 MPH, THE REDUCED SPEED LIMIT WILL BE 55 MPH.
 I. A FLOURESCENT ORANGE PLATE IS REQUIRED WITH ALL REGULATORY SPEED LIMIT SIGNS REQUIRED FOR LANE CLOSURE.
 J. ALL TRAFFIC CONTROL ITEMS SHOWN ON THIS SHEET WILL NOT BE MEASURED FOR SEPARATE PAYMENT. THIS WORK SHALL BE INCLUDED IN THE PRICE BID FOR MAINTENANCE OF TRAFFIC.

GENERAL NOTES:
 1. THE LOCATION OF CHANNELIZING DEVICES AND THE WORK AREA LAYOUT SHALL BE BASED ON THE CRITERIA IN THE FOLLOWING TABLE:

POSTED SPEED AND/OR DESIGN SPEED (MPH)	MAXIMUM CHANNELIZING DEVICE SPACING (FT)		LONGITUDINAL BUFFER SPACE (FT)	TAPER†† RATES
	TAPER	ALONG BUFFER SPACING & WORKSPACE		
40	40	80	305	27:1
45	45	90	360	45:1
50	50	100	425	50:1
55	55	110	485	55:1
60	60	120	510	60:1
65	65	130	645	65:1
70	70	140	730	70:1

† NOTE: BUFFER SPACE MAY BE ADJUSTED AS NEEDED ACCORDING TO ROADWAY GEOMETRY TO MEET SIGHT DISTANCE REQUIREMENTS, AS DIRECTED BY THE ENGINEER.
 †† TAPER RATES ARE DETERMINED USING THE FOLLOWING EQUATIONS:
 L = WS FOR SPEEDS OF 45 MPH OR GREATER
 L = WS²/100 FOR SPEEDS OF 30 MPH OR LESS
 WHERE: L = MINIMUM LENGTH OF TAPER IN FEET
 W = WIDTH OF OFFSET (USUALLY LANE WIDTH) IN FEET
 S = DESIGN SPEED OR 85TH PERCENTILE SPEED IN MILES PER HOUR

WHEN WORKERS ARE PRESENT SPEEDING FINES DOUBLED

FLASHING ARROW PANEL SHOULD BE AS LEVEL AS POSSIBLE AND SHOULD BE LOCATED AT THE BEGINNING OF THE TAPER OR, IF THE SHOULDER IS TOO NARROW, BEHIND THE CHANNELIZING DEVICES IN THE CLOSED LANE.

4. ALL CHANNELIZING DEVICES IN TANGENTS MAY BE EITHER RETROREFLECTIVE FREE STANDING PLASTIC DRUMS OR 42" TALL CONES.

5. ALL EXISTING SPEED LIMIT SIGNS WHICH ARE INFLUENCED BY OR ADJACENT TO THE WORK ZONE SHALL BE CHANGED AS DIRECTED BY THE ENGINEER WHILE THE REDUCED SPEED LIMIT IS IN EFFECT. TAPE SHALL NOT BE USED ON FACE OF SIGN.

6. ADDITIONAL REDUCED REGULATORY SPEED LIMIT SIGNS ARE REQUIRED AT EACH ENTRANCE AND EXIT WITH THE SPEED ZONE AND WILL BE REQUIRED FOR EACH RAMP AND LOCATION WILL BE DETERMINED BY THE ENGINEER.

7. THIS TRAFFIC CONTROL PLAN WITH SPEED ZONE, MAY NOT BE USED ON ANY FACILITY WHERE THE POSTED SPEED LIMIT IS BELOW 65 MPH WITHOUT A COMMISSION ORDER REDUCING A SPEED LIMIT REDUCTION.

8. LAYOUT SHOWN ABOVE IS FOR AN INTERSTATE WITH A POSTED SPEED LIMIT OF 70 MPH. FOR POSTED SPEED LIMIT OF 65 MPH, THE REDUCED SPEED LIMIT WILL BE 55 MPH.

9. A FLOURESCENT ORANGE PLATE IS REQUIRED WITH ALL REGULATORY SPEED LIMIT SIGNS REQUIRED FOR LANE CLOSURE.

10. ALL TRAFFIC CONTROL ITEMS SHOWN ON THIS SHEET WILL NOT BE MEASURED FOR SEPARATE PAYMENT. THIS WORK SHALL BE INCLUDED IN THE PRICE BID FOR MAINTENANCE OF TRAFFIC.

MISSISSIPPI DEPARTMENT OF TRANSPORTATION
 ROADWAY DESIGN DIVISION
 TRAFFIC CONTROL PLAN
 FOR POSTED SPEED LIMIT OF 65 OR 70 MPH (INTERSTATES AND OTHER 4-LANE DIVIDED HIGHWAYS) (MEDIAN LANE OR OUTSIDE LANE CLOSURE) (EXTENDED PERIOD)

PROJECT NUMBER: CP-4
 SHEET NUMBER: 6354
 ISSUE DATE: AUGUST 01, 2017

DATE	REVISION

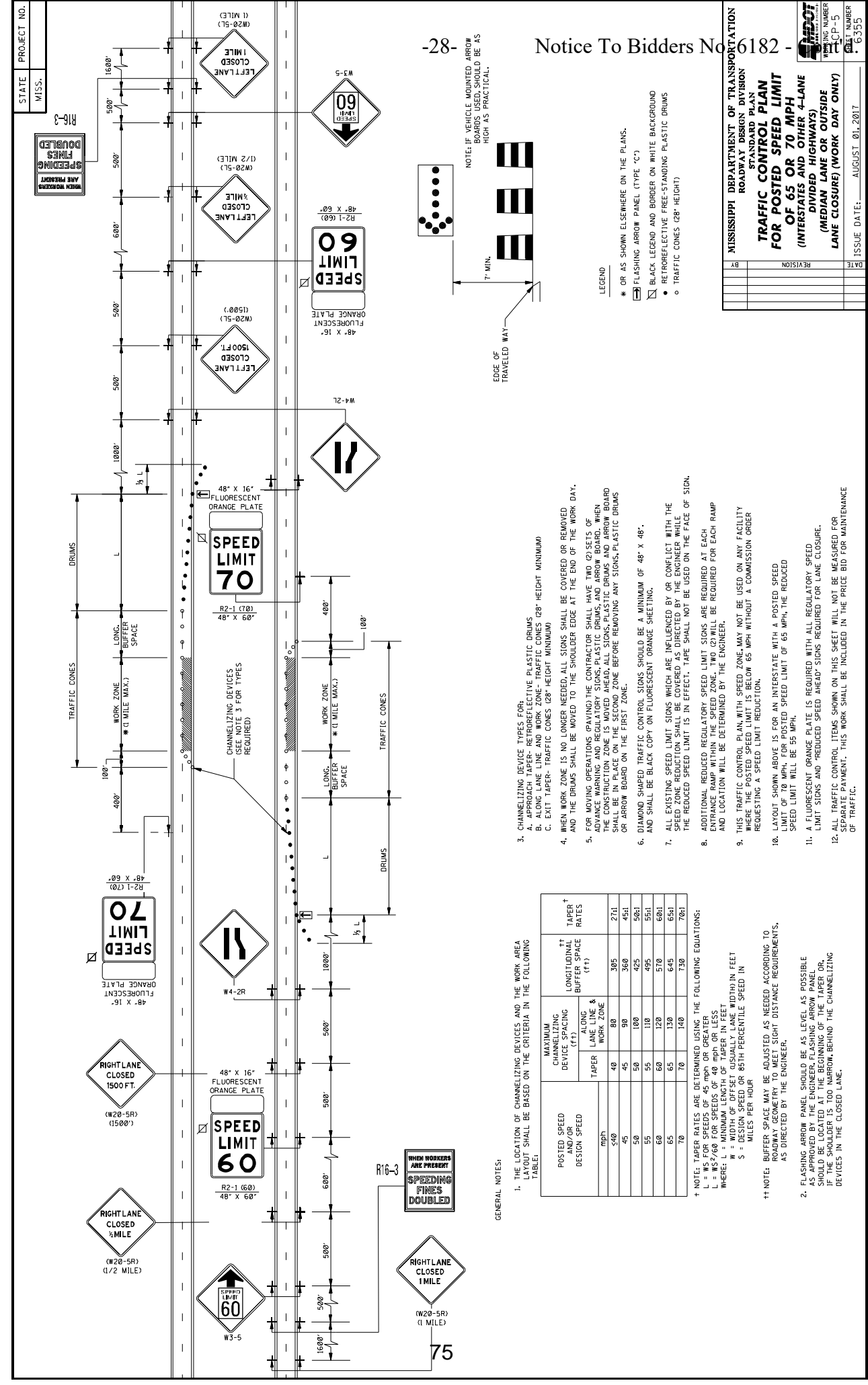

GENERAL NOTES:
 1. THE LOCATION OF CHANNELIZING DEVICES AND THE WORK AREA LIMIT SHALL BE BASED ON THE CRITERIA IN THE FOLLOWING TABLE.

POSTED SPEED (mph)	MAXIMUM CHANNELIZING DEVICE SPACING (ft)		LONGITUDINAL BUFFER SPACE (ft)	TAPER RATES
	TAPER	ALONG LANE LINE & WORK ZONE		
50	40	80	395	27H
45	45	90	360	45H
50	50	100	425	50H
55	55	110	495	55H
60	60	120	570	60H
65	65	130	645	65H
70	70	140	730	70H

† NOTE: TAPER RATES ARE DETERMINED USING THE FOLLOWING EQUATIONS:
 L = WS FOR SPEEDS OF 45 MPH OR GREATER
 L = WS²/60 FOR SPEEDS OF 40 MPH OR LESS
 WHERE: L = MINIMUM LENGTH OF TAPER IN FEET
 W = WIDTH OF OFFSET USUALLY LANE WIDTH IN FEET
 S = SPEED FOR 95TH PERCENTILE SPEED IN MILES PER HOUR

†† NOTE: BUFFER SPACE MAY BE ADJUSTED AS NEEDED ACCORDING TO ROADWAY GEOMETRY TO MEET SIGHT DISTANCE REQUIREMENTS, AS DIRECTED BY THE ENGINEER.

2. FLASHING ARROW PANEL SHOULD BE AS LEVEL AS POSSIBLE AS APPROVED BY THE ENGINEER. FLASHING ARROW PANEL SHOULD BE LOCATED AT THE BEGINNING OF THE TAPER OR, IF THE SHOULDER IS TOO NARROW, BEHIND THE CHANNELIZING DEVICES IN THE CLOSED LANE.

- CHANNELIZING DEVICE TYPES FOR:
 A. APPROACH TAPER- RETROREFLECTIVE PLASTIC DRUMS
 B. ALONG LANE LINE AND WORK ZONE- TRAFFIC CONES (28" HEIGHT MINIMUM)
 C. EXIT TAPER- TRAFFIC CONES (28" HEIGHT MINIMUM)
- WHEN WORK ZONE IS NO LONGER NEEDED, ALL SIGNS SHALL BE COVERED OR REMOVED AND THE DRUMS SHALL BE MOVED TO THE SHOULDER EDGE AT THE END OF THE WORK DAY.
- FOR MOVING OPERATIONS (PAVING) THE CONTRACTOR SHALL HAVE TWO (2) SETS OF ADVANCE WARNING AND REGULATORY SIGNS, PLASTIC DRUMS, AND ARROW BOARD. WHEN THE CONSTRUCTION ZONE IS MOVED AHEAD, ALL SIGNS, PLASTIC DRUMS AND ARROW BOARD SHALL BE IN PLACE ON THE SECOND ZONE BEFORE REMOVING ANY SIGNS, PLASTIC DRUMS OR ARROW BOARD ON THE FIRST ZONE.
- DIAMOND SHAPED TRAFFIC CONTROL SIGNS SHOULD BE A MINIMUM OF 48" X 48". AND SHALL BE BLACK COPY ON FLOURESCENT ORANGE SHEETING.
- ALL EXISTING SPEED LIMIT SIGNS WHICH ARE INFLUENCED BY OR CONFLICT WITH THE SPEED ZONE REDUCTION SHALL BE COVERED AS DIRECTED BY THE ENGINEER WHILE THE REDUCED SPEED LIMIT IS IN EFFECT. THESE SHALL NOT BE USED ON THE FACE OF SIGN.
- ADDITIONAL REDUCED REGULATORY SPEED LIMIT SIGNS ARE REQUIRED AT EACH ENTRANCE RAMP WITHIN THE SPEED ZONE. TWO (2) WILL BE REQUIRED FOR EACH RAMP AND LOCATION WILL BE DETERMINED BY THE ENGINEER.
- THIS TRAFFIC CONTROL PLAN WITH SPEED ZONE MAY NOT BE USED ON ANY FACILITY WHERE THE POSTED SPEED LIMIT IS BELOW 65 MPH WITHOUT A COMMISSION ORDER REQUESTING A SPEED LIMIT REDUCTION.
- LAYOUT SHOWN ABOVE IS FOR AN INTERSTATE WITH A POSTED SPEED LIMIT OF 70 MPH. FOR A STATE ROUTE WITH A POSTED SPEED LIMIT OF 65 MPH, THE REDUCED SPEED LIMIT WILL BE 65 MPH.
- A FLOURESCENT ORANGE PLATE IS REQUIRED WITH ALL REGULATORY SPEED LIMIT SIGNS AND "REDUCED SPEED AHEAD" SIGNS REQUIRED FOR LANE CLOSURE.
- ALL TRAFFIC CONTROL ITEMS SHOWN ON THIS SHEET WILL NOT BE MEASURED FOR SEPARATE PAYMENT. THIS WORK SHALL BE INCLUDED IN THE PRICE BID FOR MAINTENANCE OF TRAFFIC.

- LEGEND
- * OR AS SHOWN ELSEWHERE ON THE PLANS.
 - ◻ FLASHING ARROW PANEL (TYPE "C")
 - ◻ BLACK LEGEND AND BORDER ON WHITE BACKGROUND
 - RETROREFLECTIVE FREE-STANDING PLASTIC DRUMS
 - TRAFFIC CONES (28" HEIGHT)

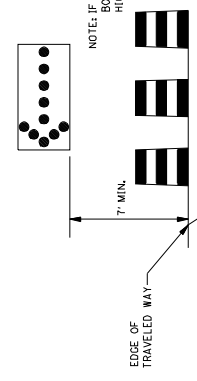

MISSISSIPPI DEPARTMENT OF TRANSPORTATION
 ROADWAY DESIGN DIVISION
 TRAFFIC CONTROL PLAN
 FOR POSTED SPEED LIMIT
 OF 65 OR 70 MPH
 (INTERSTATES AND OTHER 4-LANE
 DIVIDED HIGHWAYS)
 (MEDIAN LANE OR OUTSIDE
 LANE CLOSURE) (WORK DAY ONLY)

BY	REVISION

ISSUE DATE: AUGUST 01, 2017
 SHEET NUMBER: 63355

**SHORT DURATION
CLOSING OF DIVIDED
HIGHWAYS**

ISSUE DATE: AUGUST 01, 2017

BY

REVISION

DATE

BY

REVISION

DATE

BY

REVISION

DATE

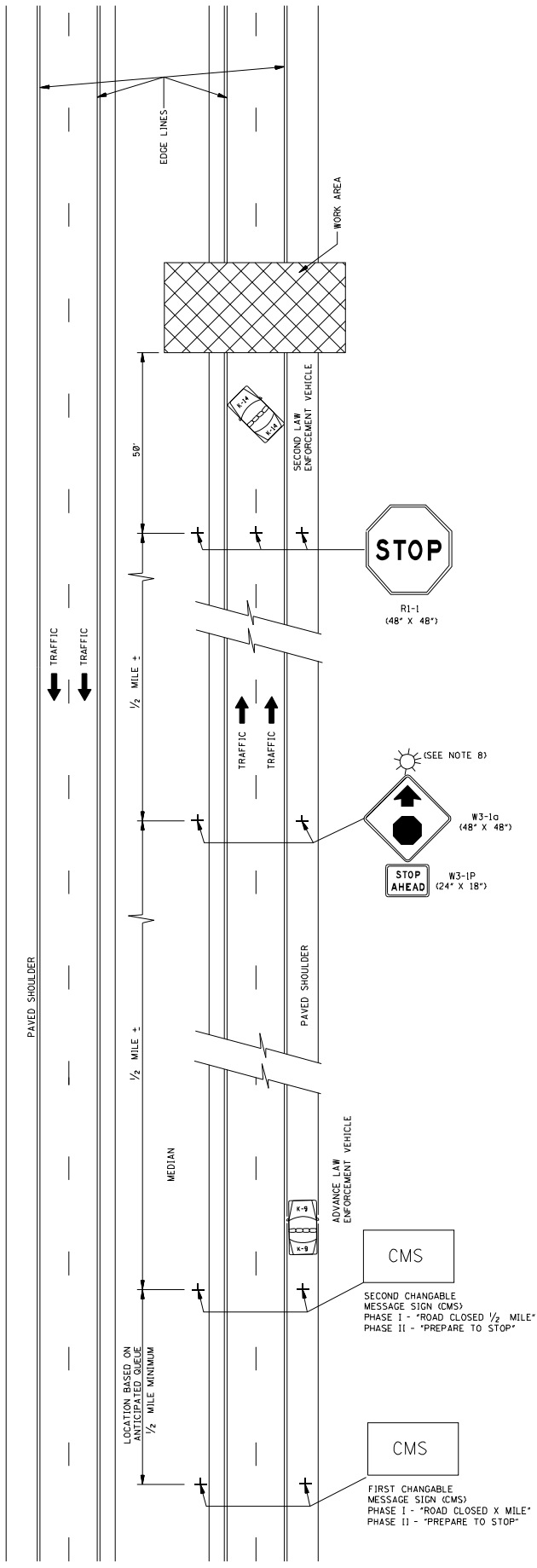

GENERAL NOTES:

- THIS TYPE OF HIGHWAY CLOSURE SHOULD ONLY BE USED FOR SHORT DURATION OPERATIONS WHEN THE DURATION OF CLOSURE WILL NOT EXCEED 30 MINUTES. AFTER THE HIGHWAY IS CLOSED, THE ADVANCE LAW ENFORCEMENT VEHICLE SHOULD ELAPSE A MINIMUM PERIOD OF 30 MINUTES BEFORE ANOTHER SHORT DURATION CLOSURE. EXCEPT WITH THE APPROVAL OF THE ENGINEER.
- AT LEAST TWO LAW ENFORCEMENT OFFICERS AND TWO LAW ENFORCEMENT VEHICLES SHOULD BE PROVIDED ON EACH APPROACH TO THE CLOSURE. EACH LAW ENFORCEMENT VEHICLE SHOULD BE EQUIPPED WITH A ROOF MOUNTED FLASHING BLUE LIGHT OR LIGHT BAR.
- RESTRICTIONS ON ROAD CLOSURES ARE SPECIFIED IN THE CONTRACT DOCUMENT.
- THE ADVANCE LAW ENFORCEMENT VEHICLE SHOULD BE MOVED BACK AS REQUIRED BY THE QUEUING OF STOPPED VEHICLES.
- IF QUEUE EXCEEDS THE FIRST CHANGABLE MESSAGE SIGN (CMS) AT ANY TIME DURING A CLOSURE, THE TRAFFIC CONTROL PLAN SHOULD BE ADJUSTED AS NECESSARY, WITH APPROVAL OF THE ENGINEER.
- TRAFFIC CONTROL FOR THE CLOSURE SHOULD BE ACCOMPLISHED IN THE FOLLOWING ORDER:
 - FIRST CHANGABLE MESSAGE SIGN (CMS)
 - SECOND CHANGABLE MESSAGE SIGN (CMS)
 - ADVANCE LAW ENFORCEMENT VEHICLE, LIGHTS AND FLASHERS ON.
 - "W3-10 (48" X 48") AND "W3-1P (24" X 18") SIGNS ERECTED.
 - "R1-1 (48" X 48") SIGNS ERECTED TO STOP TRAFFIC. THE ORDER OF ERECTION SHOULD BE: CENTER, THEN SHOULDER, THEN CENTER, THEN MEDIAN SHOULDER, THEN CENTER, THEN MEDIAN SHOULDER.
 - SECOND LAW ENFORCEMENT VEHICLE, LIGHTS AND FLASHERS ON.
 - TRAFFIC CONTROL SHOULD BE REMOVED IN THE FOLLOWING ORDER:
 - WITH TRAFFIC STOPPED REMOVE THE "R1-1 (48" X 48") SIGNS TOWARD THE RIGHT SHOULDER IN THE FOLLOWING ORDER: MEDIAN, THEN CENTER, THEN SIGN ON THE RIGHT SHOULDER. TRAFFIC ON THE RIGHT VEHICLE LEADS TRAFFIC THROUGH WORK AREA.
 - AFTER ALL STOPPED VEHICLES HAVE STARTED MOVING, THE "W3-10 (48" X 48") AND "W3-1P (24" X 18") SIGNS SHOULD BE REMOVED IN THE FOLLOWING ORDER: IF RELEASE IS IMMEDIATE.
 - AFTER ALL VEHICLES HAVE RESUMED APPROXIMATELY NORMAL SPEED, THE CHANGABLE MESSAGE SIGNS TURNED OFF.
- TRAFFIC CONTROL ITEMS SHOWN ON THIS SHEET WILL NOT BE MEASURED FOR SEPARATE PAYMENT. THIS WORK SHALL BE INCLUDED IN THE PRICE BID FOR MAINTENANCE OF TRAFFIC, INCLUDING SECURING LAW ENFORCEMENT SERVICES.
- UNILLUMINATED SECTIONS OF HIGHWAYS SHOULD NOT BE CLOSED DURING HOURS OF DARKNESS EXCEPT FOR MAINTENANCE OF TRAFFIC. WHEN THE HIGHWAY MUST BE CLOSED DURING HOURS OF DARKNESS, A TYPE B HIGH INTENSITY FLASHING BARRICADE WARNING LIGHT SHALL BE USED ON EACH W3-10 SIGN.
- IF AN ENTRANCE RAMP IS LOCATED BETWEEN THE SECOND CMS AND R1-1, THE CMS, SIGNS "W3-10 (48" X 48") AND "W3-1P (24" X 18") SHOULD ALSO BE ERECTED ON THE RAMP SHOULDER.
- THE ABOVE DURATION WILL APPLY TO EACH APPROACH TO THE CLOSURE.
- ALL TRAFFIC CONTROL ITEMS SHOWN ON THIS SHEET WILL NOT BE MEASURED FOR SEPARATE PAYMENT. THIS WORK SHALL BE INCLUDED IN THE PRICE BID FOR MAINTENANCE OF TRAFFIC, INCLUDING SECURING LAW ENFORCEMENT SERVICES.

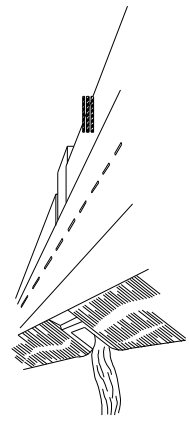

WING BARRICADES

- WING BARRICADES ARE TYPE III BARRICADES ERECTED ON THE SHOULDER ON ONE OR BOTH SIDES OF THE PAVEMENT TO GIVE THE SENSATION OF A NARROWING OR RESTRICTED ROADWAY. WING BARRICADES MAY BE USED AS A MOUNTING FOR THE ADVANCE WARNING SIGNS OR FLASHERS.
 - IN ADVANCE OF A CONSTRUCTION PROJECT EVEN WHEN NO PART OF THE ROADWAY IS ACTUALLY CLOSED.
 - IN ADVANCE OF ALL BRIDGE OR CULVERT WIDENING OPERATIONS.

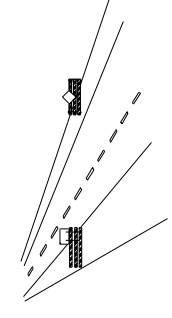

BARRICADE CLOSING A ROAD

BARRICADE CHARACTERISTICS

	I	II	III
WIDTH OF RAIL **	8" MIN. - 12" MAX.	8" MIN. - 12" MAX.	8" MIN. - 12" MAX.
LENGTH OF RAIL **	24" MIN.	24" MIN.	48" MIN.
WIDTH OF STRIPE *	6"	6"	6"
HEIGHT	36" MIN.	36" MIN.	60" MIN.
NUMBER OF FACTORIZED RAIL FACES	2 (ONE EACH DIRECTION)	4 (TWO EACH DIRECTION)	3 IF FACING TRAFFIC IN ONE DIRECTION 6 IF FACING TRAFFIC IN TWO DIRECTIONS

- * 1. FOR RAILS LESS THAN 36" LONG, 4" WIDE STRIPES MAY BE USED.
- ** 2. BARRICADES INTENDED FOR USE ON EXPRESSWAYS, FREEWAYS, AND OTHER HIGH SPEED ROADWAYS SHALL HAVE A MINIMUM OF 270 IN² OF REFLECTIVE AREA FACING TRAFFIC.

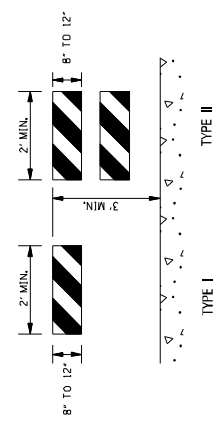

TYPE I

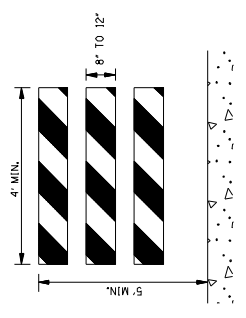

TYPE II

STANDARD BARRICADES

- THE MARKING FOR BARRICADE RAILS SHALL BE ORANGE AND WHITE (SLOPING DOWNWARD AT AN ANGLE OF 45° IN THE DIRECTION TRAFFIC IS TO PASS).
- RAIL STRIPE SHOULD BE 6 INCHES, EXCEPT THAT 4-INCH WIDE STRIPES MAY BE USED IF RAIL LENGTHS ARE LESS THAN 36 INCHES.
- DO NOT PLACE SANDBAGS OR OTHER DEVICES TO PROVIDE MASS ON THE BOTTOM RAIL THAT WILL BLOCK VIEW OR RAIL FACE.
- FOR ADDITIONAL INFORMATION OR DETAILS, SEE MUTCD, LATEST EDITION.
- BARRICADES ARE CLASSIFIED BY FHWA AS CATEGORY II WORK ZONE DEVICES WHICH REQUIRE CRASHWORTHINESS ACCEPTANCE LETTERS. TO DATE, 2-IN. THICK TIMBER RAILS HAVE NOT BEEN SUCCESSFULLY CRASH TESTED. A LIST OF CRASHWORTHY BARRICADES AND OTHER CATEGORY II DEVICES CAN BE FOUND ON FHWA'S WEBSITE: http://safety.fhwa.dot.gov/roadway_dept/policy_guide/road_hardware/cat2.cfm

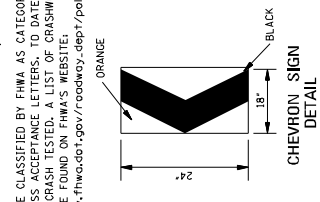

CHEVRON SIGN DETAIL

- A CHEVRON SIGN CONSISTS OF A BLACK CHEVRON TYPE MARKING ON AN ORANGE BACKGROUND AND SHALL POINT IN THE DIRECTION OF TRAFFIC FLOW.
- THE CHEVRON SIGN SHALL BE MOUNTED ON CRASHWORTHY SUPPORT.
- CHEVRON SIGNS MAY BE USED TO SUPPLEMENT OTHER STANDARD DEVICES WHERE ONE OR MORE LANES ARE CLOSED FOR CONSTRUCTION OR MAINTENANCE. THEY SHOULD BE PLACED APPROXIMATELY 2'-0" BEHIND THE LANE TRANSITION STRIPE.

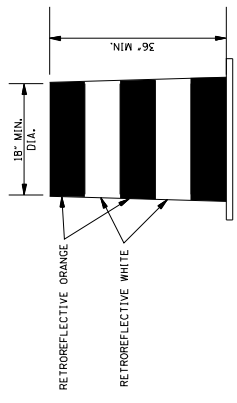

PLASTIC DRUM STRIPING DETAIL

- PLASTIC DRUMS SHALL BE ON END AND USED AS AN EXPEDIENT METHOD FOR STRIPING. PLASTIC DRUMS SHALL BE USED IN CONFORMANCE WITH THE FOLLOWING REQUIREMENTS:
 - PLASTIC DRUMS SHALL BE USED IN CONFORMANCE WITH MARKING STANDARDS FOR BARRICADE. THE PREDOMINANT COLOR ON DRUMS SHALL BE ORANGE WITH FOUR (4) RETROREFLECTIVE, HORIZONTAL, CIRCUMFERENTIAL STRIPES (2 ORANGE & 2 WHITE) 6" WIDE.
 - DRUMS SHOULD NEVER BE PLACED IN THE ROADWAY WITHOUT WARNING SIGNS.
 - WHERE PRACTICAL PLASTIC DRUMS SHOULD BE PLACED NO CLOSER THAN 100' FROM THE EDGE OF TRAVELED LANE.

MISSISSIPPI DEPARTMENT OF TRANSPORTATION
ROADWAY DESIGN DIVISION
STANDARD PLAN

HIGHWAY SIGN AND BARRICADE DETAILS FOR CONSTRUCTION PROJECTS

DATE: _____ ISSUE DATE: AUGUST 01, 2017

PROJECT NUMBER: _____

PLAN NUMBER: CP-8

SCALE: _____

DATE: _____

GENERAL NOTES:

1. UNEVEN LANE LINE OR EQUAL TO 1/2" NO SIGNS REQUIRED.
 A. IF GREATER THAN 1/2" AND LESS THAN OR EQUAL TO 3/4" PLACE SIGNS AS SHOWN ON THIS SHEET.
 B. IF GREATER THAN 3/4" AND LESS THAN OR EQUAL TO 1" TRAFFIC SHOULD NOT BE ALLOWED TO CROSS UNEVEN LANE LINE.
 C. IF GREATER THAN 1" TRAFFIC SHOULD NOT BE ALLOWED TO CROSS UNEVEN LANE LINE.
 2. THE WB-11 SIGNS SHOULD BE SPACED AT 1/4-MILE INTERVALS THROUGHOUT UNEVEN LANE LINE LIMITS.
 3. ALL TRAFFIC CONTROL ITEMS SHOWN ON THIS SHEET SHALL BE PAID FOR UNDER MAINTENANCE OF TRAFFIC.

MISSISSIPPI DEPARTMENT OF TRANSPORTATION
ROADWAY DESIGN DIVISION
STANDARD PLAN

**TRAFFIC CONTROL PLANS
UNEVEN PAVEMENT
DETAILS**

ISSUE DATE: AUGUST 01, 2017

PROJECT NUMBER: CP-12
SHEET NUMBER: 6362

DATE	REVISION

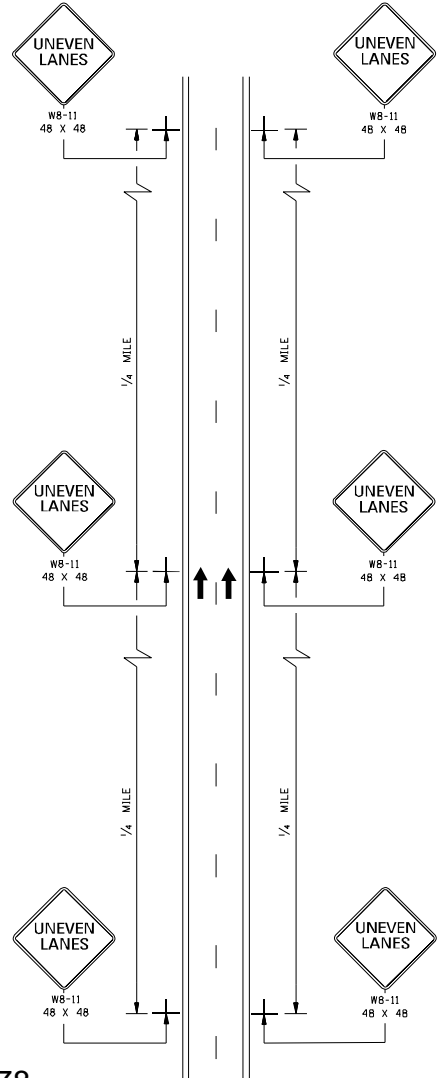
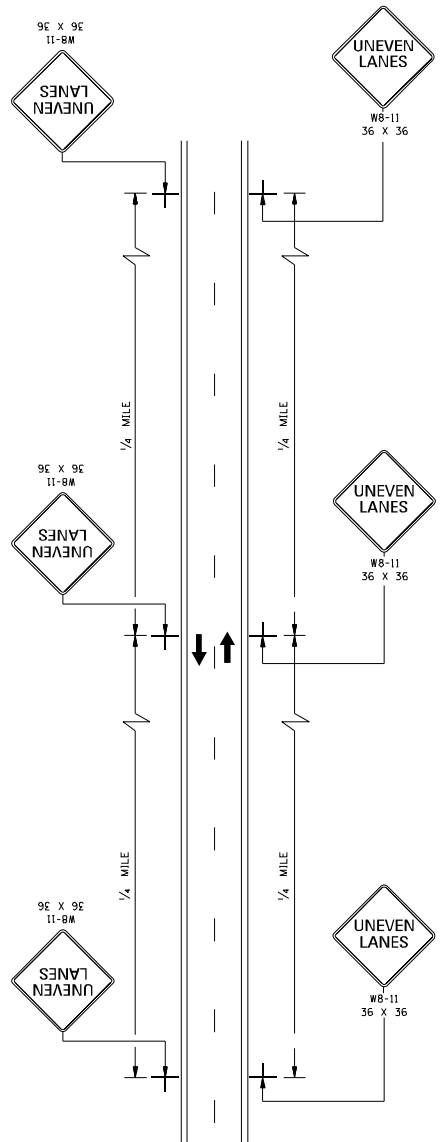

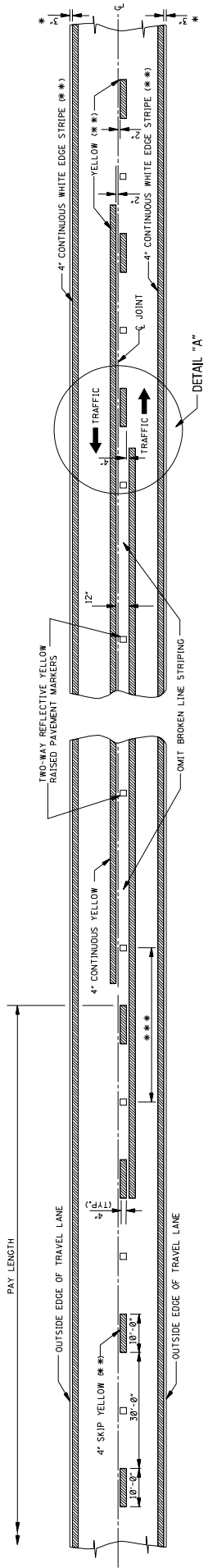

TWO-WAY TRAFFIC
(ASPHALT OR CONCRETE PAVEMENT)

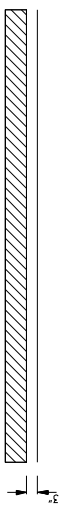
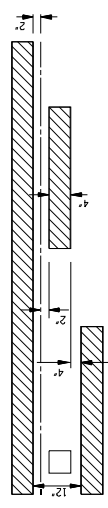
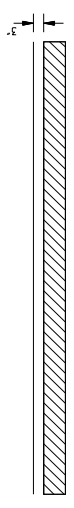

DETAIL "A"

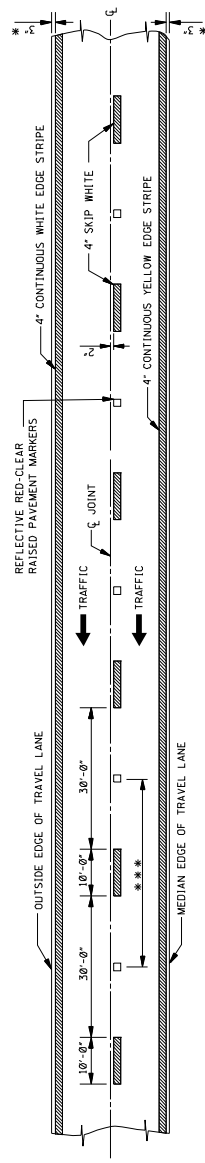

4-LANE WITH ONE-WAY TRAFFIC

GENERAL NOTES:

- * 1. 3" UNLESS SHOWN ELSEWHERE ON THE PLANS.
- ** 2. EDGE STRIPE SHALL BE SAME MATERIAL AS LANE-LINE STRIPE (PAINT OR TAPE AS INDICATED IN PAY ITEMS).
- 3. REFLECTIVE RAISED PAVEMENT MARKERS TO BE USED IF TEMPORARY MARKINGS ARE TO REMAIN IN PLACE OVER 3 MONTHS.
- *** 4. SPACING OF REFLECTIVE RAISED PAVEMENT MARKERS IS AS FOLLOWS.

TANGENT SECTIONS	URBAN AREA (F1-IN)	RURAL AREA (F1-IN)
HORIZONTAL CURVES	40'-0"	40'-0"
INTERCHANGE LIMITS	40'-0"	1-40'-0"

- 1. NOTE: ON THE MAIN FACILITY, REFLECTIVE RED-CLEAR RAISED PAVEMENT MARKERS ON A 40'-0" SPACING WILL BE REQUIRED ON LANE-LINES THROUGH ALL INTERCHANGE AREAS BEGINNING 1000' IN ADVANCE (IN DIRECTION OF TRAFFIC) OF THE EXIT RAMP. ON THE INTERCHANGE, REFLECTIVE RAISED PAVEMENT MARKERS SHALL BE USED THROUGHOUT THE INTERCHANGE TO THE END OF THE ENTRANCE RAMP TAPER.
- 5. PAVEMENT MARKERS SHALL BE HIGH PERFORMANCE REFLECTIVE RAISED PAVEMENT MARKERS AS LISTED IN THE MOOT "APPROVED SOURCES OF MATERIALS."

MISSISSIPPI DEPARTMENT OF TRANSPORTATION
ROADWAY DESIGN DIVISION
STANDARD PLAN

**TEMPORARY STRIPING FOR
TRAFFIC CONTROL
2-LANE AND 4-LANE
DIVIDED HIGHWAYS**

PROJECT NUMBER: CP-13
SHEET NUMBER: 6363

ISSUE DATE: AUGUST 01, 2017

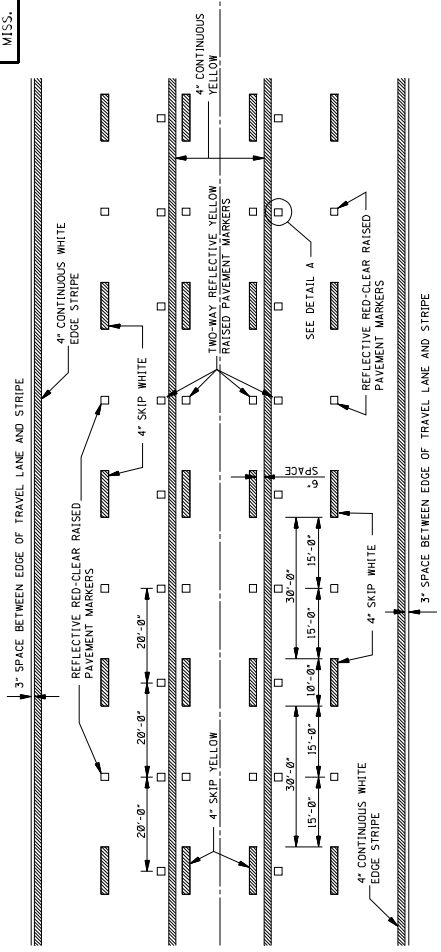

TYPICAL STRIPING AND RAISED PAVEMENT MARKERS FOR 5-LANE SECTION

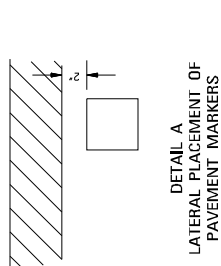

DETAIL A
LATERAL PLACEMENT OF PAVEMENT MARKERS

- GENERAL NOTE:
1. PAVEMENT MARKERS SHALL BE HIGH PERFORMANCE RAISED PAVEMENT MARKERS AS LISTED IN THE MDOT "APPROVED SOURCES OF MATERIALS".
 2. REFLECTIVE RAISED PAVEMENT MARKERS TO BE USED IF TEMPORARY MARKINGS ARE TO REMAIN IN PLACE OVER 3 MONTHS.
 3. TEMPORARY TURN ARROW TO BE PAID FOR AS TEMPORARY TRAFFIC STRIPE (LEGEND) ESTIMATED AT 10.9 SQ. FT. PER ARROW.

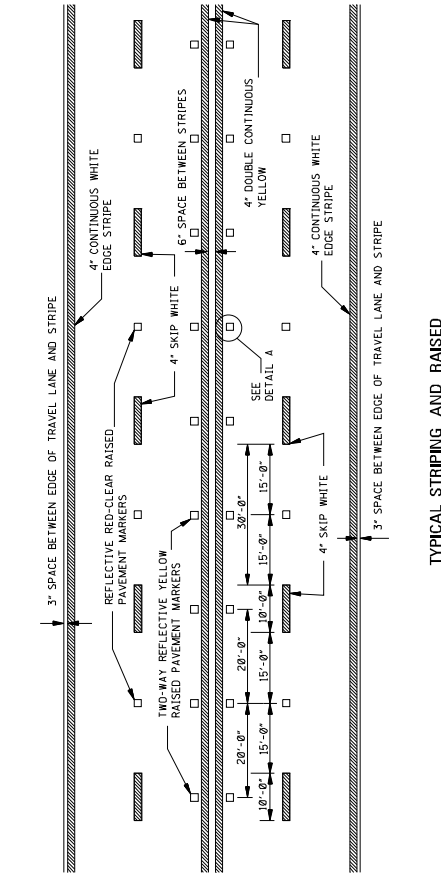

TYPICAL STRIPING AND RAISED PAVEMENT MARKERS FOR 4-LANE SECTION

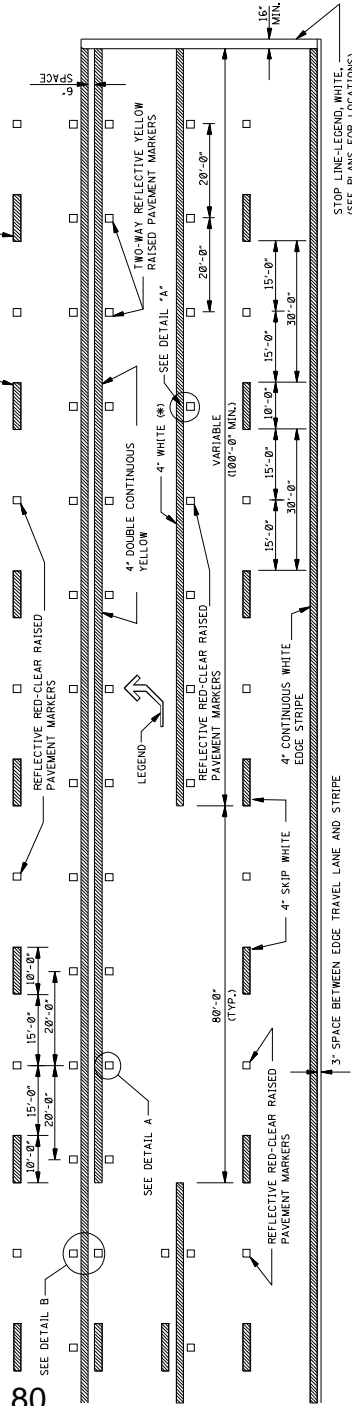

TYPICAL STRIPING AND RAISED PAVEMENT MARKERS AT LEFT TURN LANES

*NOTE: USE DETAIL STRIPING IF LENGTH $\leq 150'$ AT THIS LOCATION; OTHERWISE USE CONTINUOUS STRIPING.

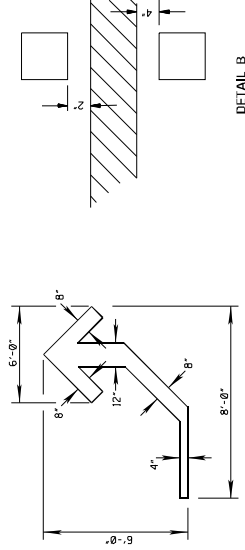

DETAIL B
LATERAL PLACEMENT OF PAVEMENT MARKERS

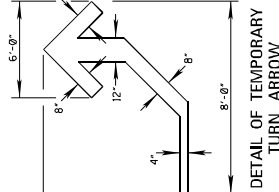

DETAIL OF TEMPORARY TURN ARROW

TYPICAL TWO-WAY ARROW INSTALLATION

- NOTES:
1. CONSIDER EACH SEGMENT OF CONTINUOUS TWO-WAY LEFT TURN LANE SEPARATELY.
 2. IF SEGMENT IS LESS THAN 350', PLACE ONE SET OF ARROWS IN CENTER OF SEGMENT.
 3. FROM BEGINNING AND/OR END OF SEGMENT, PLACE ONE SET OF ARROWS (250' O.C.).



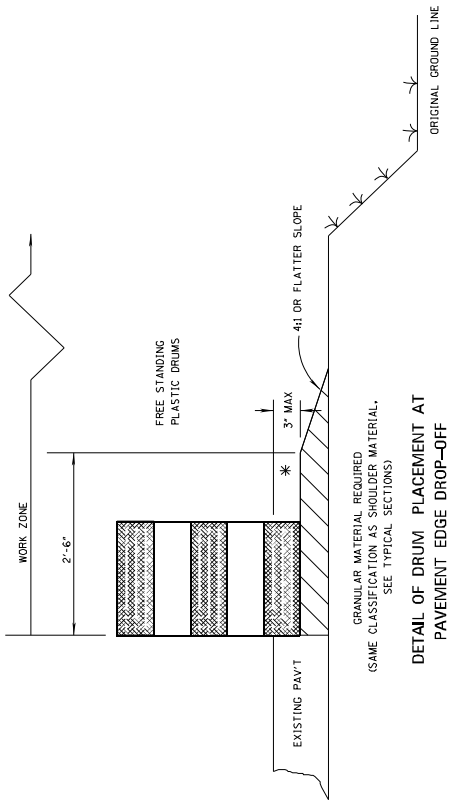

DETAIL OF DRUM PLACEMENT AT PAVEMENT EDGE DROP-OFF

NOTES:

- * A. PAVEMENT EDGE DROP-OFF
 1. IF LESS THAN TWO AND ONE QUARTER (2.25) INCHES-NO PROTECTION REQUIRED. PLACE A SHOULDER WORK SIGN (W21-5) 500 FEET IN ADVANCE OF WORK ZONE SHOULDER AND A LOW SHOULDER SIGN (W8-9) AT THE BEGINNING AND THROUGHOUT THE WORK ZONE @ (750'±O.C.).
 2. TWO AND ONE QUARTER TO THREE INCHES-PLACE DRUMS, VERTICAL PANELS OR BARRICADES EVERY 100 FEET ON TANGENT SECTIONS FOR SPEEDS OF 50 MILES PER HOUR OR GREATER, CONES MAY BE USED IN PLACE OF DRUMS, PANELS, AND BARRICADES DURING DAYLIGHT HOURS, FOR TANGENT SECTIONS WITH SPEEDS LESS THAN 50 MILES PER HOUR AND FOR CURVES, DEVICES SHOULD BE PLACED EVERY 50 FEET. SPACING FOR TAPERS SHOULD BE IN ACCORDANCE WITH THE M.U.T.C.D. (1 / 3 L, WHERE L IS THE TAPER LENGTH IN FEET).
 3. GREATER THAN THREE (3) INCHES-POSITIVE SEPARATION OR WEDGE WITH 4:1 OR FLATTER SLOPE NEEDED, IF THERE IS EIGHT (8) FEET OR MORE DISTANCE BETWEEN THE EDGE OF TRAVEL LANE AND DROP-OFF, THEN DRUMS, PANELS OR BARRICADES MAY BE USED.
 4. FOR TEMPORARY CONDITIONS, DROP-OFFS GREATER THAN THREE (3) INCHES MAY BE PROTECTED WITH DRUMS, VERTICAL PANELS OR BARRICADES FOR SHORT DISTANCES DURING DAYLIGHT HOURS WHILE WORK IS BEING DONE IN THE DROP-OFF AREA.
 5. LESSEER TREATMENTS THAN THOSE DESCRIBED ABOVE MAY BE CONSIDERED FOR LOW-VOLUME LOCAL STREETS.
- * B. DRUM SPACING
 1. TANGENTS = 2 X S
 2. TAPERS = L / 3
 - WHERE L = S X W
 - L = TAPER LENGTH IN FEET
 - S = SPEED IN MPH (POSTED OR 85 PERCENTILE)
 - W = WIDTH OF OFFSET IN FEET
- * C. ALL TRAFFIC CONTROL ITEMS SHOWN ON THIS SHEET SHALL BE PAID FOR UNDER MAINTENANCE OF TRAFFIC.

POSTED SPEED (MPH)	LENGTH (FEET)
20	35
25	55
30	75
35	100
40	120
45	150
50	200
55	250
60	300
65	350
70	400
75	450
80	500
85	550
90	600
95	650

* * * POSTED SPEED, OFF-PEAK 85 PERCENTILE SPEED (WHEN APPROPRIATE), OR THE ANTICIPATED OPERATING SPEED IN MPH.

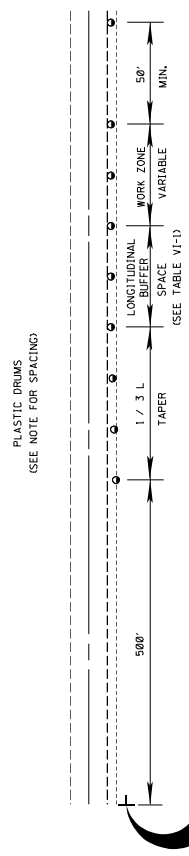

TYPICAL SHOULDER CLOSURE

- (1) TO BE USED WITH EIGHT (8) FOOT OR GREATER WIDTH IMPROVED SHOULDER.
- (2) TO BE USED WHEN CONSTRUCTION VEHICLES (EQUIPMENT) ENCROACHES ON OR WITHIN TWO (2) FEET OF THE SHOULDER BREAK.

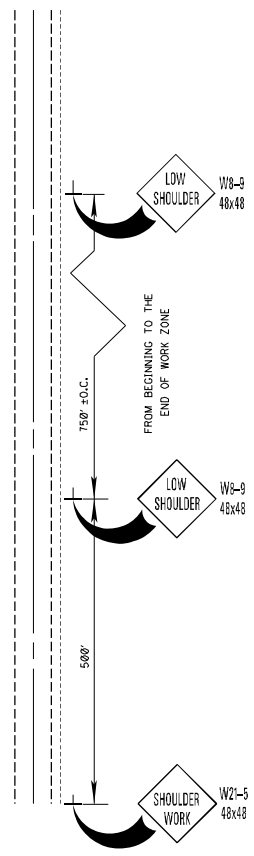

TYPICAL SHOULDER WORK #1
(SEE NOTE A-1 THIS SHEET)

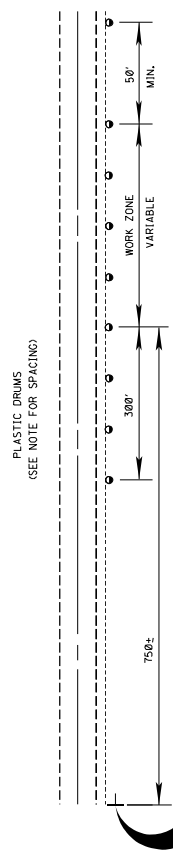

TYPICAL SHOULDER WORK #2

NOTE:
WORK OUTSIDE TWO (2) FOOT AND WITHIN TEN (10) FEET OF THE SHOULDER BREAK MAY BE PROTECTED BY PLACING DRUMS ALONG THE SHOULDER EDGE, 300 FEET PRIOR TO AND 50 FEET BEYOND THE WORK AREA, OR SEE NOTE A-3 THIS SHEET.

MISSISSIPPI DEPARTMENT OF TRANSPORTATION
ROADWAY DESIGN DIVISION
STANDARD PLAN

**TRAFFIC CONTROL DETAILS
DRUM PLACEMENT
AND
SHOULDER CLOSURE**

BY	REVISION

ISSUE DATE: AUGUST 01, 2017

PROJECT NUMBER: 6366

MISSISSIPPI DEPARTMENT OF TRANSPORTATION

SECTION 904 - NOTICE TO BIDDERS NO. 6183

DATE: 08/27/2024

SUBJECT: Specialty Items

PROJECT: NHPP-0008-02(121)/108719301 - COVINGTON

Pursuant to the provisions of Section 108, the following work items are hereby designated as "Specialty Items" for this contract. Bidders are reminded that these items must be subcontracted in order to be considered as specialty items.

CATEGORY: GUARDRAIL, GUIDERAIL

Line No	Pay Item	Description
0120	606-B002	Guard Rail, Class A, Type 1, 'W' Beam
0130	606-C003	Guard Rail, Cable Anchor, Type 1
0140	606-D005	Guard Rail, Bridge End Section, Type A
0150	606-E005	Guard Rail, Terminal End Section, Flared
0160	606-E007	Guard Rail, Terminal End Section, Non-Flared
0170	606-G002	Special Sections, Guard Rail Bridge End Connector

CATEGORY: MISCELLANEOUS/ SPECIALTY WORK ITEMS

Line No	Pay Item	Description
0100	423-A001	Rumble Strips, Ground In

CATEGORY: PAVEMENT STRIPING AND MARKING

Line No	Pay Item	Description
0320	907-626-A007	6" Thermoplastic Double Drop Traffic Stripe, Skip White
0330	907-626-C012	6" Thermoplastic Double Drop Edge Stripe, Continuous White
0340	907-626-F003	6" Thermoplastic Double Drop Edge Stripe, Continuous Yellow
0350	907-626-G004	Thermoplastic Detail Stripe, White
0360	907-626-G005	Thermoplastic Detail Stripe, Yellow
0370	907-626-H009	Thermoplastic Legend, White
0380	907-626-H010	Thermoplastic Legend, White
0390	907-627-J001	Two-Way Clear Reflective High Performance Raised Markers
0400	907-627-K001	Red-Clear Reflective High Performance Raised Markers
0410	907-627-L001	Two-Way Yellow Reflective High Performance Raised Markers

CATEGORY: TRAFFIC CONTROL - PERMANENT

Line No	Pay Item	Description
0260	630-F002	Delineators, Flexible Post Mounted, Crossover, Type I, Yellow
0270	630-F006	Delineators, Guard Rail, White
0280	630-F007	Delineators, Guard Rail, Yellow

CATEGORY: TRAFFIC CONTROL - TEMPORARY

Line No	Pay Item	Description
0190	619-A1001	Temporary Traffic Stripe, Continuous White
0200	619-A2001	Temporary Traffic Stripe, Continuous Yellow
0210	619-A3001	Temporary Traffic Stripe, Skip White
0220	619-A5001	Temporary Traffic Stripe, Detail

0230	619-A6001	Temporary Traffic Stripe, Legend
0240	619-A6002	Temporary Traffic Stripe, Legend

"General Decision Number: MS20240124 01/05/2024

Superseded General Decision Number: MS20230124

State: Mississippi

Construction Type: Highway

Counties: Claiborne, Covington, Franklin, Issaquena, Sharkey, Walthall and Wilkinson Counties in Mississippi.

HIGHWAY CONSTRUCTION PROJECTS

Note: Contracts subject to the Davis-Bacon Act are generally required to pay at least the applicable minimum wage rate required under Executive Order 14026 or Executive Order 13658. Please note that these Executive Orders apply to covered contracts entered into by the federal government that are subject to the Davis-Bacon Act itself, but do not apply to contracts subject only to the Davis-Bacon Related Acts, including those set forth at 29 CFR 5.1(a)(1).

<p>If the contract is entered into on or after January 30, 2022, or the contract is renewed or extended (e.g., an option is exercised) on or after January 30, 2022:</p>	<ul style="list-style-type: none"> . Executive Order 14026 generally applies to the contract. . The contractor must pay all covered workers at least \$17.20 per hour (or the applicable wage rate listed on this wage determination, if it is higher) for all hours spent performing on the contract in 2024.
<p>If the contract was awarded on or between January 1, 2015 and January 29, 2022, and the contract is not renewed or extended on or after January 30, 2022:</p>	<ul style="list-style-type: none"> . Executive Order 13658 generally applies to the contract. . The contractor must pay all covered workers at least \$12.90 per hour (or the applicable wage rate listed on this wage determination, if it is higher) for all hours spent performing on that contract in 2024.

The applicable Executive Order minimum wage rate will be adjusted annually. If this contract is covered by one of the Executive Orders and a classification considered necessary for performance of work on the contract does not appear on this wage determination, the contractor must still submit a conformance request.

Additional information on contractor requirements and worker protections under the Executive Orders is available at <http://www.dol.gov/whd/govcontracts>.

Modification Number Publication Date
 0 01/05/2024

SUMS2010-047 08/04/2014

	Rates	Fringes
CARPENTER (Form Work Only).....	\$ 12.26 **	0.12
CARPENTER, Excludes Form Work....	\$ 14.21 **	0.00
CEMENT MASON/CONCRETE FINISHER...	\$ 13.23 **	0.00
ELECTRICIAN.....	\$ 22.64	7.73
HIGHWAY/PARKING LOT STRIPING: Truck Driver (Line Striping Truck).....	\$ 12.63 **	0.00
INSTALLER - GUARDRAIL.....	\$ 11.42 **	0.00
INSTALLER - SIGN.....	\$ 12.04 **	0.00
IRONWORKER, REINFORCING.....	\$ 16.43 **	0.00
LABORER: Asphalt, Includes Raker, Shoveler, Spreader and Distributor.....	\$ 10.26 **	0.00
LABORER: Common or General, including concrete work.....	\$ 10.24 **	0.00
LABORER: Flagger.....	\$ 9.83 **	0.00
LABORER: Grade Checker.....	\$ 10.67 **	0.00
LABORER: Landscape.....	\$ 9.82 **	0.00
LABORER: Mason Tender - Cement/Concrete.....	\$ 11.69 **	0.00
LABORER: Pipelayer.....	\$ 13.13 **	0.00
LABORER: Laborer-Cones/ Barricades/Barrels - Setter/Mover/Sweeper.....	\$ 10.53 **	0.00
OPERATOR: Asphalt Spreader.....	\$ 16.13 **	0.00
OPERATOR: Backhoe/Excavator/Trackhoe.....	\$ 13.28 **	0.00
OPERATOR: Broom/Sweeper.....	\$ 10.17 **	0.00
OPERATOR: Bulldozer.....	\$ 13.30 **	0.00
OPERATOR: Concrete Saw.....	\$ 13.60 **	0.00
OPERATOR: Crane.....	\$ 16.00 **	0.00
OPERATOR: Distributor.....	\$ 11.70 **	0.00
OPERATOR: Drill.....	\$ 19.22	0.00
OPERATOR: Grader/Blade.....	\$ 13.84 **	0.00
OPERATOR: Loader.....	\$ 11.73 **	85 0.00

OPERATOR: Mechanic.....	\$ 16.28 **	0.00
OPERATOR: Milling Machine.....	\$ 15.38 **	0.00
OPERATOR: Mixer.....	\$ 14.85 **	0.00
OPERATOR: Oiler.....	\$ 13.08 **	0.48
OPERATOR: Paver (Asphalt, Aggregate, and Concrete).....	\$ 13.01 **	0.00
OPERATOR: Piledriver.....	\$ 15.13 **	0.00
OPERATOR: Roller (All Types)....	\$ 11.05 **	0.00
OPERATOR: Scraper.....	\$ 12.63 **	0.00
OPERATOR: Tractor.....	\$ 9.98 **	0.00
OPERATOR: Trencher.....	\$ 15.00 **	0.00
TRUCK DRIVER: Flatbed Truck.....	\$ 13.29 **	0.00
TRUCK DRIVER: Lowboy Truck.....	\$ 12.49 **	0.00
TRUCK DRIVER: Mechanic.....	\$ 12.35 **	0.00
TRUCK DRIVER: Off the Road Truck.....	\$ 12.31 **	0.00
TRUCK DRIVER: Water Truck.....	\$ 13.15 **	0.00
TRUCK DRIVER: Dump Truck (All Types).....	\$ 11.64 **	0.00
TRUCK DRIVER: Semi/Trailer Truck.....	\$ 17.34	0.00

WELDERS - Receive rate prescribed for craft performing operation to which welding is incidental.

=====
** Workers in this classification may be entitled to a higher minimum wage under Executive Order 14026 (\$17.20) or 13658 (\$12.90). Please see the Note at the top of the wage determination for more information. Please also note that the minimum wage requirements of Executive Order 14026 are not currently being enforced as to any contract or subcontract to which the states of Texas, Louisiana, or Mississippi, including their agencies, are a party.

Note: Executive Order (EO) 13706, Establishing Paid Sick Leave for Federal Contractors applies to all contracts subject to the Davis-Bacon Act for which the contract is awarded (and any solicitation was issued) on or after January 1, 2017. If this contract is covered by the EO, the contractor must provide employees with 1 hour of paid sick leave for every 30 hours they work, up to 56 hours of paid sick leave each year. Employees must be permitted to use paid sick leave for their own illness, injury or other health-related needs, including preventive care; to assist a family member (or person who is like family to the employee) who is ill, injured, or has other

health-related needs, including preventive care; or for reasons resulting from, or to assist a family member (or person who is like family to the employee) who is a victim of, domestic violence, sexual assault, or stalking. Additional information on contractor requirements and worker protections under the EO is available at <https://www.dol.gov/agencies/whd/government-contracts>.

Unlisted classifications needed for work not included within the scope of the classifications listed may be added after award only as provided in the labor standards contract clauses (29CFR 5.5 (a) (1) (iii)).

The body of each wage determination lists the classification and wage rates that have been found to be prevailing for the cited type(s) of construction in the area covered by the wage determination. The classifications are listed in alphabetical order of ""identifiers"" that indicate whether the particular rate is a union rate (current union negotiated rate for local), a survey rate (weighted average rate) or a union average rate (weighted union average rate).

Union Rate Identifiers

A four letter classification abbreviation identifier enclosed in dotted lines beginning with characters other than ""SU"" or ""UAVG"" denotes that the union classification and rate were prevailing for that classification in the survey. Example: PLUM0198-005 07/01/2014. PLUM is an abbreviation identifier of the union which prevailed in the survey for this classification, which in this example would be Plumbers. 0198 indicates the local union number or district council number where applicable, i.e., Plumbers Local 0198. The next number, 005 in the example, is an internal number used in processing the wage determination. 07/01/2014 is the effective date of the most current negotiated rate, which in this example is July 1, 2014.

Union prevailing wage rates are updated to reflect all rate changes in the collective bargaining agreement (CBA) governing this classification and rate.

Survey Rate Identifiers

Classifications listed under the ""SU"" identifier indicate that no one rate prevailed for this classification in the survey and the published rate is derived by computing a weighted average rate based on all the rates reported in the survey for that classification. As this weighted average rate includes all rates reported in the survey, it may include both union and non-union rates. Example: SULA2012-007 5/13/2014. SU indicates the rates are survey rates based on a weighted average calculation of rates and are not majority rates. LA indicates the State of Louisiana. 2012 is the year of survey on which these classifications and rates are based. The next number, 007 in the example, is an internal number used in producing the wage determination. 5/13/2014 indicates the survey completion date for the classifications and rates under that identifier.

Survey wage rates are not updated and remain in effect until a new survey is conducted.

Union Average Rate Identifiers

Classification(s) listed under the UAVG identifier indicate that no single majority rate prevailed for those classifications; however, 100% of the data reported for the classifications was union data. EXAMPLE: UAVG-OH-0010 08/29/2014. UAVG indicates that the rate is a weighted union average rate. OH indicates the state. The next number, 0010 in the example, is an internal number used in producing the wage determination. 08/29/2014 indicates the survey completion date for the classifications and rates under that identifier.

A UAVG rate will be updated once a year, usually in January of each year, to reflect a weighted average of the current negotiated/CBA rate of the union locals from which the rate is based.

WAGE DETERMINATION APPEALS PROCESS

1.) Has there been an initial decision in the matter? This can be:

- * an existing published wage determination
- * a survey underlying a wage determination
- * a Wage and Hour Division letter setting forth a position on a wage determination matter
- * a conformance (additional classification and rate) ruling

On survey related matters, initial contact, including requests for summaries of surveys, should be with the Wage and Hour National Office because National Office has responsibility for the Davis-Bacon survey program. If the response from this initial contact is not satisfactory, then the process described in 2.) and 3.) should be followed.

With regard to any other matter not yet ripe for the formal process described here, initial contact should be with the Branch of Construction Wage Determinations. Write to:

Branch of Construction Wage Determinations
Wage and Hour Division
U.S. Department of Labor
200 Constitution Avenue, N.W.
Washington, DC 20210

2.) If the answer to the question in 1.) is yes, then an interested party (those affected by the action) can request review and reconsideration from the Wage and Hour Administrator (See 29 CFR Part 1.8 and 29 CFR Part 7). Write to:

Wage and Hour Administrator
U.S. Department of Labor
200 Constitution Avenue, N.W.
Washington, DC 20210

The request should be accompanied by a full statement of the interested party's position and by any information (wage payment data, project description, area practice material, etc.) that the requestor considers relevant to the issue.

3.) If the decision of the Administrator is not favorable, an interested party may appeal directly to the Administrative Review Board (formerly the Wage Appeals Board). Write to:

Administrative Review Board
U.S. Department of Labor
200 Constitution Avenue, N.W.
Washington, DC 20210

4.) All decisions by the Administrative Review Board are final.

=====

END OF GENERAL DECISION"

SUPPLEMENT TO FORM FHWA-1273

DATE: 07/26/2022

SUBJECT: Federal Contract Provisions for Subcontracts

Federal Contract Provisions for Subcontracts

All subcontracts shall be in writing and contain all pertinent provisions and requirements of the prime contract.

Each “Request for Permission to Subcontract” (Mississippi Department of Transportation Form CAD-720) shall include a copy of the subcontract. The federal contract provisions (FHWA-1273, SUPPLEMENT TO FORM FHWA-1273, NOTICE OF REQUIREMENT FOR AFFIRMATIVE ACTION TO ENSURE EQUAL EMPLOYMENT OPPORTUNITY (EXECUTIVE ORDER 11246), DAVIS-BACON AND RELATED ACT PROVISIONS (WAGE RATES)) must be physically incorporated as part of the subcontract. A completed Mississippi Department of Transportation Form CAD-521 and Form CAD-725 must be attached to the CAD-720.

**REQUIRED CONTRACT PROVISIONS
FEDERAL-AID CONSTRUCTION CONTRACTS**

- I. General
- II. Nondiscrimination
- III. Non-segregated Facilities
- IV. Davis-Bacon and Related Act Provisions
- V. Contract Work Hours and Safety Standards Act Provisions
- VI. Subletting or Assigning the Contract
- VII. Safety: Accident Prevention
- VIII. False Statements Concerning Highway Projects
- IX. Implementation of Clean Air Act and Federal Water Pollution Control Act
- X. Certification Regarding Debarment, Suspension, Ineligibility and Voluntary Exclusion
- XI. Certification Regarding Use of Contract Funds for Lobbying
- XII. Use of United States-Flag Vessels:

ATTACHMENTS

A. Employment and Materials Preference for Appalachian Development Highway System or Appalachian Local Access Road Contracts (included in Appalachian contracts only)

I. GENERAL

1. Form FHWA-1273 must be physically incorporated in each construction contract funded under title 23, United States Code, as required in 23 CFR 633.102(b) (excluding emergency contracts solely intended for debris removal). The contractor (or subcontractor) must insert this form in each subcontract and further require its inclusion in all lower tier subcontracts (excluding purchase orders, rental agreements and other agreements for supplies or services). 23 CFR 633.102(e).

The applicable requirements of Form FHWA-1273 are incorporated by reference for work done under any purchase order, rental agreement or agreement for other services. The prime contractor shall be responsible for compliance by any subcontractor, lower-tier subcontractor or service provider. 23 CFR 633.102(e).

Form FHWA-1273 must be included in all Federal-aid design-build contracts, in all subcontracts and in lower tier subcontracts (excluding subcontracts for design services, purchase orders, rental agreements and other agreements for supplies or services) in accordance with 23 CFR 633.102. The design-builder shall be responsible for compliance by any subcontractor, lower-tier subcontractor or service provider.

Contracting agencies may reference Form FHWA-1273 in solicitation-for-bids or request-for-proposals documents, however, the Form FHWA-1273 must be physically incorporated (not referenced) in all contracts, subcontracts and lower-tier subcontracts (excluding purchase orders, rental agreements and other agreements for supplies or services related to a construction contract). 23 CFR 633.102(b).

2. Subject to the applicability criteria noted in the following sections, these contract provisions shall apply to all work

performed on the contract by the contractor's own organization and with the assistance of workers under the contractor's immediate superintendence and to all work performed on the contract by piecework, station work, or by subcontract. 23 CFR 633.102(d).

3. A breach of any of the stipulations contained in these Required Contract Provisions may be sufficient grounds for withholding of progress payments, withholding of final payment, termination of the contract, suspension / debarment or any other action determined to be appropriate by the contracting agency and FHWA.

4. Selection of Labor: During the performance of this contract, the contractor shall not use convict labor for any purpose within the limits of a construction project on a Federal-aid highway unless it is labor performed by convicts who are on parole, supervised release, or probation. 23 U.S.C. 114(b). The term Federal-aid highway does not include roadways functionally classified as local roads or rural minor collectors. 23 U.S.C. 101(a).

II. NONDISCRIMINATION (23 CFR 230.107(a); 23 CFR Part 230, Subpart A, Appendix A; EO 11246)

The provisions of this section related to 23 CFR Part 230, Subpart A, Appendix A are applicable to all Federal-aid construction contracts and to all related construction subcontracts of \$10,000 or more. The provisions of 23 CFR Part 230 are not applicable to material supply, engineering, or architectural service contracts.

In addition, the contractor and all subcontractors must comply with the following policies: Executive Order 11246, 41 CFR Part 60, 29 CFR Parts 1625-1627, 23 U.S.C. 140, Section 504 of the Rehabilitation Act of 1973, as amended (29 U.S.C. 794), Title VI of the Civil Rights Act of 1964, as amended (42 U.S.C. 2000d et seq.), and related regulations including 49 CFR Parts 21, 26, and 27; and 23 CFR Parts 200, 230, and 633.

The contractor and all subcontractors must comply with: the requirements of the Equal Opportunity Clause in 41 CFR 60-1.4(b) and, for all construction contracts exceeding \$10,000, the Standard Federal Equal Employment Opportunity Construction Contract Specifications in 41 CFR 60-4.3.

Note: The U.S. Department of Labor has exclusive authority to determine compliance with Executive Order 11246 and the policies of the Secretary of Labor including 41 CFR Part 60, and 29 CFR Parts 1625-1627. The contracting agency and the FHWA have the authority and the responsibility to ensure compliance with 23 U.S.C. 140, Section 504 of the Rehabilitation Act of 1973, as amended (29 U.S.C. 794), and Title VI of the Civil Rights Act of 1964, as amended (42 U.S.C. 2000d et seq.), and related regulations including 49 CFR Parts 21, 26, and 27; and 23 CFR Parts 200, 230, and 633.

The following provision is adopted from 23 CFR Part 230, Subpart A, Appendix A, with appropriate revisions to conform to the U.S. Department of Labor (US DOL) and FHWA requirements.

1. Equal Employment Opportunity: Equal Employment Opportunity (EEO) requirements not to discriminate and to take affirmative action to assure equal opportunity as set forth under laws, executive orders, rules, regulations (see 28 CFR Part 35, 29 CFR Part 1630, 29 CFR Parts 1625-1627, 41 CFR Part 60 and 49 CFR Part 27) and orders of the Secretary of Labor as modified by the provisions prescribed herein, and imposed pursuant to 23 U.S.C. 140, shall constitute the EEO and specific affirmative action standards for the contractor's project activities under this contract. The provisions of the Americans with Disabilities Act of 1990 (42 U.S.C. 12101 et seq.) set forth under 28 CFR Part 35 and 29 CFR Part 1630 are incorporated by reference in this contract. In the execution of this contract, the contractor agrees to comply with the following minimum specific requirement activities of EEO:

a. The contractor will work with the contracting agency and the Federal Government to ensure that it has made every good faith effort to provide equal opportunity with respect to all of its terms and conditions of employment and in their review of activities under the contract. 23 CFR 230.409 (g)(4) & (5).

b. The contractor will accept as its operating policy the following statement:

"It is the policy of this Company to assure that applicants are employed, and that employees are treated during employment, without regard to their race, religion, sex, sexual orientation, gender identity, color, national origin, age or disability. Such action shall include: employment, upgrading, demotion, or transfer; recruitment or recruitment advertising; layoff or termination; rates of pay or other forms of compensation; and selection for training, including apprenticeship, pre-apprenticeship, and/or on-the-job training."

2. EEO Officer: The contractor will designate and make known to the contracting officers an EEO Officer who will have the responsibility for and must be capable of effectively administering and promoting an active EEO program and who must be assigned adequate authority and responsibility to do so.

3. Dissemination of Policy: All members of the contractor's staff who are authorized to hire, supervise, promote, and discharge employees, or who recommend such action or are substantially involved in such action, will be made fully cognizant of and will implement the contractor's EEO policy and contractual responsibilities to provide EEO in each grade and classification of employment. To ensure that the above agreement will be met, the following actions will be taken as a minimum:

a. Periodic meetings of supervisory and personnel office employees will be conducted before the start of work and then not less often than once every six months, at which time the contractor's EEO policy and its implementation will be reviewed and explained. The meetings will be conducted by the EEO Officer or other knowledgeable company official.

b. All new supervisory or personnel office employees will be given a thorough indoctrination by the EEO Officer, covering all major aspects of the contractor's EEO obligations within thirty days following their reporting for duty with the contractor.

c. All personnel who are engaged in direct recruitment for the project will be instructed by the EEO Officer in the contractor's procedures for locating and hiring minorities and women.

d. Notices and posters setting forth the contractor's EEO policy will be placed in areas readily accessible to employees, applicants for employment and potential employees.

e. The contractor's EEO policy and the procedures to implement such policy will be brought to the attention of employees by means of meetings, employee handbooks, or other appropriate means.

4. Recruitment: When advertising for employees, the contractor will include in all advertisements for employees the notation: "An Equal Opportunity Employer." All such advertisements will be placed in publications having a large circulation among minorities and women in the area from which the project work force would normally be derived.

a. The contractor will, unless precluded by a valid bargaining agreement, conduct systematic and direct recruitment through public and private employee referral sources likely to yield qualified minorities and women. To meet this requirement, the contractor will identify sources of potential minority group employees and establish with such identified sources procedures whereby minority and women applicants may be referred to the contractor for employment consideration.

b. In the event the contractor has a valid bargaining agreement providing for exclusive hiring hall referrals, the contractor is expected to observe the provisions of that agreement to the extent that the system meets the contractor's compliance with EEO contract provisions. Where implementation of such an agreement has the effect of discriminating against minorities or women, or obligates the contractor to do the same, such implementation violates Federal nondiscrimination provisions.

c. The contractor will encourage its present employees to refer minorities and women as applicants for employment. Information and procedures with regard to referring such applicants will be discussed with employees.

5. Personnel Actions: Wages, working conditions, and employee benefits shall be established and administered, and personnel actions of every type, including hiring, upgrading, promotion, transfer, demotion, layoff, and termination, shall be taken without regard to race, color, religion, sex, sexual orientation, gender identity, national origin, age or disability. The following procedures shall be followed:

a. The contractor will conduct periodic inspections of project sites to ensure that working conditions and employee facilities do not indicate discriminatory treatment of project site personnel.

b. The contractor will periodically evaluate the spread of wages paid within each classification to determine any evidence of discriminatory wage practices.

c. The contractor will periodically review selected personnel actions in depth to determine whether there is evidence of discrimination. Where evidence is found, the contractor will promptly take corrective action. If the review indicates that the discrimination may extend beyond the actions reviewed, such corrective action shall include all affected persons.

d. The contractor will promptly investigate all complaints of alleged discrimination made to the contractor in connection with its obligations under this contract, will attempt to resolve such complaints, and will take appropriate corrective action

within a reasonable time. If the investigation indicates that the discrimination may affect persons other than the complainant, such corrective action shall include such other persons. Upon completion of each investigation, the contractor will inform every complainant of all of their avenues of appeal.

6. Training and Promotion:

a. The contractor will assist in locating, qualifying, and increasing the skills of minorities and women who are applicants for employment or current employees. Such efforts should be aimed at developing full journey level status employees in the type of trade or job classification involved.

b. Consistent with the contractor's work force requirements and as permissible under Federal and State regulations, the contractor shall make full use of training programs (i.e., apprenticeship and on-the-job training programs for the geographical area of contract performance). In the event a special provision for training is provided under this contract, this subparagraph will be superseded as indicated in the special provision. The contracting agency may reserve training positions for persons who receive welfare assistance in accordance with 23 U.S.C. 140(a).

c. The contractor will advise employees and applicants for employment of available training programs and entrance requirements for each.

d. The contractor will periodically review the training and promotion potential of employees who are minorities and women and will encourage eligible employees to apply for such training and promotion.

7. Unions: If the contractor relies in whole or in part upon unions as a source of employees, the contractor will use good faith efforts to obtain the cooperation of such unions to increase opportunities for minorities and women. 23 CFR 230.409. Actions by the contractor, either directly or through a contractor's association acting as agent, will include the procedures set forth below:

a. The contractor will use good faith efforts to develop, in cooperation with the unions, joint training programs aimed toward qualifying more minorities and women for membership in the unions and increasing the skills of minorities and women so that they may qualify for higher paying employment.

b. The contractor will use good faith efforts to incorporate an EEO clause into each union agreement to the end that such union will be contractually bound to refer applicants without regard to their race, color, religion, sex, sexual orientation, gender identity, national origin, age, or disability.

c. The contractor is to obtain information as to the referral practices and policies of the labor union except that to the extent such information is within the exclusive possession of the labor union and such labor union refuses to furnish such information to the contractor, the contractor shall so certify to the contracting agency and shall set forth what efforts have been made to obtain such information.

d. In the event the union is unable to provide the contractor with a reasonable flow of referrals within the time limit set forth in the collective bargaining agreement, the contractor will, through independent recruitment efforts, fill the employment vacancies without regard to race, color, religion, sex, sexual orientation, gender identity, national origin, age, or disability; making full efforts to obtain qualified and/or qualifiable minorities and women. The failure of a union to provide

sufficient referrals (even though it is obligated to provide exclusive referrals under the terms of a collective bargaining agreement) does not relieve the contractor from the requirements of this paragraph. In the event the union referral practice prevents the contractor from meeting the obligations pursuant to Executive Order 11246, as amended, and these special provisions, such contractor shall immediately notify the contracting agency.

8. Reasonable Accommodation for Applicants / Employees with Disabilities: The contractor must be familiar with the requirements for and comply with the Americans with Disabilities Act and all rules and regulations established thereunder. Employers must provide reasonable accommodation in all employment activities unless to do so would cause an undue hardship.

9. Selection of Subcontractors, Procurement of Materials and Leasing of Equipment: The contractor shall not discriminate on the grounds of race, color, religion, sex, sexual orientation, gender identity, national origin, age, or disability in the selection and retention of subcontractors, including procurement of materials and leases of equipment. The contractor shall take all necessary and reasonable steps to ensure nondiscrimination in the administration of this contract.

a. The contractor shall notify all potential subcontractors, suppliers, and lessors of their EEO obligations under this contract.

b. The contractor will use good faith efforts to ensure subcontractor compliance with their EEO obligations.

10. Assurances Required:

a. The requirements of 49 CFR Part 26 and the State DOT's FHWA-approved Disadvantaged Business Enterprise (DBE) program are incorporated by reference.

b. The contractor, subrecipient or subcontractor shall not discriminate on the basis of race, color, national origin, or sex in the performance of this contract. The contractor shall carry out applicable requirements of 49 CFR part 26 in the award and administration of DOT-assisted contracts. Failure by the contractor to carry out these requirements is a material breach of this contract, which may result in the termination of this contract or such other remedy as the recipient deems appropriate, which may include, but is not limited to:

- (1) Withholding monthly progress payments;
- (2) Assessing sanctions;
- (3) Liquidated damages; and/or
- (4) Disqualifying the contractor from future bidding as non-responsible.

c. The Title VI and nondiscrimination provisions of U.S. DOT Order 1050.2A at Appendixes A and E are incorporated by reference. 49 CFR Part 21.

11. Records and Reports: The contractor shall keep such records as necessary to document compliance with the EEO requirements. Such records shall be retained for a period of three years following the date of the final payment to the contractor for all contract work and shall be available at reasonable times and places for inspection by authorized representatives of the contracting agency and the FHWA.

a. The records kept by the contractor shall document the following:

(1) The number and work hours of minority and non-minority group members and women employed in each work classification on the project;

(2) The progress and efforts being made in cooperation with unions, when applicable, to increase employment opportunities for minorities and women; and

(3) The progress and efforts being made in locating, hiring, training, qualifying, and upgrading minorities and women.

b. The contractors and subcontractors will submit an annual report to the contracting agency each July for the duration of the project indicating the number of minority, women, and non-minority group employees currently engaged in each work classification required by the contract work. This information is to be reported on [Form FHWA-1391](#). The staffing data should represent the project work force on board in all or any part of the last payroll period preceding the end of July. If on-the-job training is being required by special provision, the contractor will be required to collect and report training data. The employment data should reflect the work force on board during all or any part of the last payroll period preceding the end of July.

III. NONSEGREGATED FACILITIES

This provision is applicable to all Federal-aid construction contracts and to all related construction subcontracts of more than \$10,000. 41 CFR 60-1.5.

As prescribed by 41 CFR 60-1.8, the contractor must ensure that facilities provided for employees are provided in such a manner that segregation on the basis of race, color, religion, sex, sexual orientation, gender identity, or national origin cannot result. The contractor may neither require such segregated use by written or oral policies nor tolerate such use by employee custom. The contractor's obligation extends further to ensure that its employees are not assigned to perform their services at any location under the contractor's control where the facilities are segregated. The term "facilities" includes waiting rooms, work areas, restaurants and other eating areas, time clocks, restrooms, washrooms, locker rooms and other storage or dressing areas, parking lots, drinking fountains, recreation or entertainment areas, transportation, and housing provided for employees. The contractor shall provide separate or single-user restrooms and necessary dressing or sleeping areas to assure privacy between sexes.

IV. DAVIS-BACON AND RELATED ACT PROVISIONS

This section is applicable to all Federal-aid construction projects exceeding \$2,000 and to all related subcontracts and lower-tier subcontracts (regardless of subcontract size), in accordance with 29 CFR 5.5. The requirements apply to all projects located within the right-of-way of a roadway that is functionally classified as Federal-aid highway. 23 U.S.C. 113. This excludes roadways functionally classified as local roads or rural minor collectors, which are exempt. 23 U.S.C. 101. Where applicable law requires that projects be treated as a project on a Federal-aid highway, the provisions of this subpart will apply regardless of the location of the project. Examples include: Surface Transportation Block Grant Program projects funded under 23 U.S.C. 133 [excluding recreational trails projects], the Nationally Significant Freight and Highway

Projects funded under 23 U.S.C. 117, and National Highway Freight Program projects funded under 23 U.S.C. 167.

The following provisions are from the U.S. Department of Labor regulations in 29 CFR 5.5 "Contract provisions and related matters" with minor revisions to conform to the FHWA-1273 format and FHWA program requirements.

1. Minimum wages (29 CFR 5.5)

a. *Wage rates and fringe benefits.* All laborers and mechanics employed or working upon the site of the work (or otherwise working in construction or development of the project under a development statute), will be paid unconditionally and not less often than once a week, and without subsequent deduction or rebate on any account (except such payroll deductions as are permitted by regulations issued by the Secretary of Labor under the Copeland Act ([29 CFR part 3](#))), the full amount of basic hourly wages and bona fide fringe benefits (or cash equivalents thereof) due at time of payment computed at rates not less than those contained in the wage determination of the Secretary of Labor which is attached hereto and made a part hereof, regardless of any contractual relationship which may be alleged to exist between the contractor and such laborers and mechanics. As provided in paragraphs (d) and (e) of 29 CFR 5.5, the appropriate wage determinations are effective by operation of law even if they have not been attached to the contract. Contributions made or costs reasonably anticipated for bona fide fringe benefits under the Davis-Bacon Act ([40 U.S.C. 3141\(2\)\(B\)](#)) on behalf of laborers or mechanics are considered wages paid to such laborers or mechanics, subject to the provisions of paragraph 1.e. of this section; also, regular contributions made or costs incurred for more than a weekly period (but not less often than quarterly) under plans, funds, or programs which cover the particular weekly period, are deemed to be constructively made or incurred during such weekly period. Such laborers and mechanics must be paid the appropriate wage rate and fringe benefits on the wage determination for the classification(s) of work actually performed, without regard to skill, except as provided in paragraph 4. of this section. Laborers or mechanics performing work in more than one classification may be compensated at the rate specified for each classification for the time actually worked therein: *Provided*, That the employer's payroll records accurately set forth the time spent in each classification in which work is performed. The wage determination (including any additional classifications and wage rates conformed under paragraph 1.c. of this section) and the Davis-Bacon poster (WH-1321) must be posted at all times by the contractor and its subcontractors at the site of the work in a prominent and accessible place where it can be easily seen by the workers.

b. *Frequently recurring classifications.* (1) In addition to wage and fringe benefit rates that have been determined to be prevailing under the procedures set forth in [29 CFR part 1](#), a wage determination may contain, pursuant to § 1.3(f), wage and fringe benefit rates for classifications of laborers and mechanics for which conformance requests are regularly submitted pursuant to paragraph 1.c. of this section, provided that:

(i) The work performed by the classification is not performed by a classification in the wage determination for which a prevailing wage rate has been determined;

(ii) The classification is used in the area by the construction industry; and

(iii) The wage rate for the classification bears a reasonable relationship to the prevailing wage rates contained in the wage determination.

(2) The Administrator will establish wage rates for such classifications in accordance with paragraph 1.c.(1)(iii) of this section. Work performed in such a classification must be paid at no less than the wage and fringe benefit rate listed on the wage determination for such classification.

c. *Conformance.* (1) The contracting officer must require that any class of laborers or mechanics, including helpers, which is not listed in the wage determination and which is to be employed under the contract be classified in conformance with the wage determination. Conformance of an additional classification and wage rate and fringe benefits is appropriate only when the following criteria have been met:

(i) The work to be performed by the classification requested is not performed by a classification in the wage determination; and

(ii) The classification is used in the area by the construction industry; and

(iii) The proposed wage rate, including any bona fide fringe benefits, bears a reasonable relationship to the wage rates contained in the wage determination.

(2) The conformance process may not be used to split, subdivide, or otherwise avoid application of classifications listed in the wage determination.

(3) If the contractor and the laborers and mechanics to be employed in the classification (if known), or their representatives, and the contracting officer agree on the classification and wage rate (including the amount designated for fringe benefits where appropriate), a report of the action taken will be sent by the contracting officer by email to DBAconformance@dol.gov. The Administrator, or an authorized representative, will approve, modify, or disapprove every additional classification action within 30 days of receipt and so advise the contracting officer or will notify the contracting officer within the 30-day period that additional time is necessary.

(4) In the event the contractor, the laborers or mechanics to be employed in the classification or their representatives, and the contracting officer do not agree on the proposed classification and wage rate (including the amount designated for fringe benefits, where appropriate), the contracting officer will, by email to DBAconformance@dol.gov, refer the questions, including the views of all interested parties and the recommendation of the contracting officer, to the Administrator for determination. The Administrator, or an authorized representative, will issue a determination within 30 days of receipt and so advise the contracting officer or will notify the contracting officer within the 30-day period that additional time is necessary.

(5) The contracting officer must promptly notify the contractor of the action taken by the Wage and Hour Division

under paragraphs 1.c.(3) and (4) of this section. The contractor must furnish a written copy of such determination to each affected worker or it must be posted as a part of the wage determination. The wage rate (including fringe benefits where appropriate) determined pursuant to paragraph 1.c.(3) or (4) of this section must be paid to all workers performing work in the classification under this contract from the first day on which work is performed in the classification.

d. *Fringe benefits not expressed as an hourly rate.* Whenever the minimum wage rate prescribed in the contract for a class of laborers or mechanics includes a fringe benefit which is not expressed as an hourly rate, the contractor may either pay the benefit as stated in the wage determination or may pay another bona fide fringe benefit or an hourly cash equivalent thereof.

e. *Unfunded plans.* If the contractor does not make payments to a trustee or other third person, the contractor may consider as part of the wages of any laborer or mechanic the amount of any costs reasonably anticipated in providing bona fide fringe benefits under a plan or program, *Provided*, That the Secretary of Labor has found, upon the written request of the contractor, in accordance with the criteria set forth in § 5.28, that the applicable standards of the Davis-Bacon Act have been met. The Secretary of Labor may require the contractor to set aside in a separate account assets for the meeting of obligations under the plan or program.

f. *Interest.* In the event of a failure to pay all or part of the wages required by the contract, the contractor will be required to pay interest on any underpayment of wages.

2. Withholding (29 CFR 5.5)

a. *Withholding requirements.* The contracting agency may, upon its own action, or must, upon written request of an authorized representative of the Department of Labor, withhold or cause to be withheld from the contractor so much of the accrued payments or advances as may be considered necessary to satisfy the liabilities of the prime contractor or any subcontractor for the full amount of wages and monetary relief, including interest, required by the clauses set forth in this section for violations of this contract, or to satisfy any such liabilities required by any other Federal contract, or federally assisted contract subject to Davis-Bacon labor standards, that is held by the same prime contractor (as defined in § 5.2). The necessary funds may be withheld from the contractor under this contract, any other Federal contract with the same prime contractor, or any other federally assisted contract that is subject to Davis-Bacon labor standards requirements and is held by the same prime contractor, regardless of whether the other contract was awarded or assisted by the same agency, and such funds may be used to satisfy the contractor liability for which the funds were withheld. In the event of a contractor's failure to pay any laborer or mechanic, including any apprentice or helper working on the site of the work all or part of the wages required by the contract, or upon the contractor's failure to submit the required records as discussed in paragraph 3.d. of this section, the contracting agency may on its own initiative and after written notice to the contractor, take such action as may be necessary to cause the suspension of any further payment, advance, or guarantee of funds until such violations have ceased.

b. *Priority to withheld funds.* The Department has priority to funds withheld or to be withheld in accordance with paragraph

2.a. of this section or Section V, paragraph 3.a., or both, over claims to those funds by:

- (1) A contractor's surety(ies), including without limitation performance bond sureties and payment bond sureties;
- (2) A contracting agency for its procurement costs;
- (3) A trustee(s) (either a court-appointed trustee or a U.S. trustee, or both) in bankruptcy of a contractor, or a contractor's bankruptcy estate;
- (4) A contractor's assignee(s);
- (5) A contractor's successor(s); or
- (6) A claim asserted under the Prompt Payment Act, [31 U.S.C. 3901–3907](#).

3. Records and certified payrolls (29 CFR 5.5)

a. *Basic record requirements (1) Length of record retention.* All regular payrolls and other basic records must be maintained by the contractor and any subcontractor during the course of the work and preserved for all laborers and mechanics working at the site of the work (or otherwise working in construction or development of the project under a development statute) for a period of at least 3 years after all the work on the prime contract is completed.

(2) *Information required.* Such records must contain the name; Social Security number; last known address, telephone number, and email address of each such worker; each worker's correct classification(s) of work actually performed; hourly rates of wages paid (including rates of contributions or costs anticipated for bona fide fringe benefits or cash equivalents thereof of the types described in [40 U.S.C. 3141\(2\)\(B\)](#) of the Davis-Bacon Act); daily and weekly number of hours actually worked in total and on each covered contract; deductions made; and actual wages paid.

(3) *Additional records relating to fringe benefits.* Whenever the Secretary of Labor has found under paragraph 1.e. of this section that the wages of any laborer or mechanic include the amount of any costs reasonably anticipated in providing benefits under a plan or program described in [40 U.S.C. 3141\(2\)\(B\)](#) of the Davis-Bacon Act, the contractor must maintain records which show that the commitment to provide such benefits is enforceable, that the plan or program is financially responsible, and that the plan or program has been communicated in writing to the laborers or mechanics affected, and records which show the costs anticipated or the actual cost incurred in providing such benefits.

(4) *Additional records relating to apprenticeship.* Contractors with apprentices working under approved programs must maintain written evidence of the registration of apprenticeship programs, the registration of the apprentices, and the ratios and wage rates prescribed in the applicable programs.

b. *Certified payroll requirements (1) Frequency and method of submission.* The contractor or subcontractor must submit weekly, for each week in which any DBA- or Related Acts-covered work is performed, certified payrolls to the contracting

agency. The prime contractor is responsible for the submission of all certified payrolls by all subcontractors. A contracting agency or prime contractor may permit or require contractors to submit certified payrolls through an electronic system, as long as the electronic system requires a legally valid electronic signature; the system allows the contractor, the contracting agency, and the Department of Labor to access the certified payrolls upon request for at least 3 years after the work on the prime contract has been completed; and the contracting agency or prime contractor permits other methods of submission in situations where the contractor is unable or limited in its ability to use or access the electronic system.

(2) *Information required.* The certified payrolls submitted must set out accurately and completely all of the information required to be maintained under paragraph 3.a.(2) of this section, except that full Social Security numbers and last known addresses, telephone numbers, and email addresses must not be included on weekly transmittals. Instead, the certified payrolls need only include an individually identifying number for each worker (e.g., the last four digits of the worker's Social Security number). The required weekly certified payroll information may be submitted using Optional Form WH-347 or in any other format desired. Optional Form WH-347 is available for this purpose from the Wage and Hour Division website at <https://www.dol.gov/sites/dolgov/files/WHD/legacy/files/wh347.pdf> or its successor website. It is not a violation of this section for a prime contractor to require a subcontractor to provide full Social Security numbers and last known addresses, telephone numbers, and email addresses to the prime contractor for its own records, without weekly submission by the subcontractor to the contracting agency.

(3) *Statement of Compliance.* Each certified payroll submitted must be accompanied by a "Statement of Compliance," signed by the contractor or subcontractor, or the contractor's or subcontractor's agent who pays or supervises the payment of the persons working on the contract, and must certify the following:

(i) That the certified payroll for the payroll period contains the information required to be provided under paragraph 3.b. of this section, the appropriate information and basic records are being maintained under paragraph 3.a. of this section, and such information and records are correct and complete;

(ii) That each laborer or mechanic (including each helper and apprentice) working on the contract during the payroll period has been paid the full weekly wages earned, without rebate, either directly or indirectly, and that no deductions have been made either directly or indirectly from the full wages earned, other than permissible deductions as set forth in [29 CFR part 3](#); and

(iii) That each laborer or mechanic has been paid not less than the applicable wage rates and fringe benefits or cash equivalents for the classification(s) of work actually performed, as specified in the applicable wage determination incorporated into the contract.

(4) *Use of Optional Form WH-347.* The weekly submission of a properly executed certification set forth on the reverse side of Optional Form WH-347 will satisfy the requirement for submission of the "Statement of Compliance" required by paragraph 3.b.(3) of this section.

(5) *Signature*. The signature by the contractor, subcontractor, or the contractor's or subcontractor's agent must be an original handwritten signature or a legally valid electronic signature.

(6) *Falsification*. The falsification of any of the above certifications may subject the contractor or subcontractor to civil or criminal prosecution under [18 U.S.C. 1001](#) and [31 U.S.C. 3729](#).

(7) *Length of certified payroll retention*. The contractor or subcontractor must preserve all certified payrolls during the course of the work and for a period of 3 years after all the work on the prime contract is completed.

c. *Contracts, subcontracts, and related documents*. The contractor or subcontractor must maintain this contract or subcontract and related documents including, without limitation, bids, proposals, amendments, modifications, and extensions. The contractor or subcontractor must preserve these contracts, subcontracts, and related documents during the course of the work and for a period of 3 years after all the work on the prime contract is completed.

d. *Required disclosures and access* (1) *Required record disclosures and access to workers*. The contractor or subcontractor must make the records required under paragraphs 3.a. through 3.c. of this section, and any other documents that the contracting agency, the State DOT, the FHWA, or the Department of Labor deems necessary to determine compliance with the labor standards provisions of any of the applicable statutes referenced by § 5.1, available for inspection, copying, or transcription by authorized representatives of the contracting agency, the State DOT, the FHWA, or the Department of Labor, and must permit such representatives to interview workers during working hours on the job.

(2) *Sanctions for non-compliance with records and worker access requirements*. If the contractor or subcontractor fails to submit the required records or to make them available, or refuses to permit worker interviews during working hours on the job, the Federal agency may, after written notice to the contractor, sponsor, applicant, owner, or other entity, as the case may be, that maintains such records or that employs such workers, take such action as may be necessary to cause the suspension of any further payment, advance, or guarantee of funds. Furthermore, failure to submit the required records upon request or to make such records available, or to permit worker interviews during working hours on the job, may be grounds for debarment action pursuant to § 5.12. In addition, any contractor or other person that fails to submit the required records or make those records available to WHD within the time WHD requests that the records be produced will be precluded from introducing as evidence in an administrative proceeding under [29 CFR part 6](#) any of the required records that were not provided or made available to WHD. WHD will take into consideration a reasonable request from the contractor or person for an extension of the time for submission of records. WHD will determine the reasonableness of the request and may consider, among other things, the location of the records and the volume of production.

(3) *Required information disclosures*. Contractors and subcontractors must maintain the full Social Security number and last known address, telephone number, and email address

of each covered worker, and must provide them upon request to the contracting agency, the State DOT, the FHWA, the contractor, or the Wage and Hour Division of the Department of Labor for purposes of an investigation or other compliance action.

4. Apprentices and equal employment opportunity (29 CFR 5.5)

a. *Apprentices* (1) *Rate of pay*. Apprentices will be permitted to work at less than the predetermined rate for the work they perform when they are employed pursuant to and individually registered in a bona fide apprenticeship program registered with the U.S. Department of Labor, Employment and Training Administration, Office of Apprenticeship (OA), or with a State Apprenticeship Agency recognized by the OA. A person who is not individually registered in the program, but who has been certified by the OA or a State Apprenticeship Agency (where appropriate) to be eligible for probationary employment as an apprentice, will be permitted to work at less than the predetermined rate for the work they perform in the first 90 days of probationary employment as an apprentice in such a program. In the event the OA or a State Apprenticeship Agency recognized by the OA withdraws approval of an apprenticeship program, the contractor will no longer be permitted to use apprentices at less than the applicable predetermined rate for the work performed until an acceptable program is approved.

(2) *Fringe benefits*. Apprentices must be paid fringe benefits in accordance with the provisions of the apprenticeship program. If the apprenticeship program does not specify fringe benefits, apprentices must be paid the full amount of fringe benefits listed on the wage determination for the applicable classification. If the Administrator determines that a different practice prevails for the applicable apprentice classification, fringe benefits must be paid in accordance with that determination.

(3) *Apprenticeship ratio*. The allowable ratio of apprentices to journeyworkers on the job site in any craft classification must not be greater than the ratio permitted to the contractor as to the entire work force under the registered program or the ratio applicable to the locality of the project pursuant to paragraph 4.a.(4) of this section. Any worker listed on a payroll at an apprentice wage rate, who is not registered or otherwise employed as stated in paragraph 4.a.(1) of this section, must be paid not less than the applicable wage rate on the wage determination for the classification of work actually performed. In addition, any apprentice performing work on the job site in excess of the ratio permitted under this section must be paid not less than the applicable wage rate on the wage determination for the work actually performed.

(4) *Reciprocity of ratios and wage rates*. Where a contractor is performing construction on a project in a locality other than the locality in which its program is registered, the ratios and wage rates (expressed in percentages of the journeyworker's hourly rate) applicable within the locality in which the construction is being performed must be observed. If there is no applicable ratio or wage rate for the locality of the project, the ratio and wage rate specified in the contractor's registered program must be observed.

b. *Equal employment opportunity*. The use of apprentices and journeyworkers under this part must be in conformity with

the equal employment opportunity requirements of Executive Order 11246, as amended, and [29 CFR part 30](#).

c. Apprentices and Trainees (programs of the U.S. DOT).

Apprentices and trainees working under apprenticeship and skill training programs which have been certified by the Secretary of Transportation as promoting EEO in connection with Federal-aid highway construction programs are not subject to the requirements of paragraph 4 of this Section IV. 23 CFR 230.111(e)(2). The straight time hourly wage rates for apprentices and trainees under such programs will be established by the particular programs. The ratio of apprentices and trainees to journeyworkers shall not be greater than permitted by the terms of the particular program.

5. Compliance with Copeland Act requirements. The contractor shall comply with the requirements of 29 CFR part 3, which are incorporated by reference in this contract as provided in 29 CFR 5.5.

6. Subcontracts. The contractor or subcontractor must insert FHWA-1273 in any subcontracts, along with the applicable wage determination(s) and such other clauses or contract modifications as the contracting agency may by appropriate instructions require, and a clause requiring the subcontractors to include these clauses and wage determination(s) in any lower tier subcontracts. The prime contractor is responsible for the compliance by any subcontractor or lower tier subcontractor with all the contract clauses in this section. In the event of any violations of these clauses, the prime contractor and any subcontractor(s) responsible will be liable for any unpaid wages and monetary relief, including interest from the date of the underpayment or loss, due to any workers of lower-tier subcontractors, and may be subject to debarment, as appropriate. 29 CFR 5.5.

7. Contract termination: debarment. A breach of the contract clauses in 29 CFR 5.5 may be grounds for termination of the contract, and for debarment as a contractor and a subcontractor as provided in 29 CFR 5.12.

8. Compliance with Davis-Bacon and Related Act requirements. All rulings and interpretations of the Davis-Bacon and Related Acts contained in 29 CFR parts 1, 3, and 5 are herein incorporated by reference in this contract as provided in 29 CFR 5.5.

9. Disputes concerning labor standards. As provided in 29 CFR 5.5, disputes arising out of the labor standards provisions of this contract shall not be subject to the general disputes clause of this contract. Such disputes shall be resolved in accordance with the procedures of the Department of Labor set forth in 29 CFR parts 5, 6, and 7. Disputes within the meaning of this clause include disputes between the contractor (or any of its subcontractors) and the contracting agency, the U.S. Department of Labor, or the employees or their representatives.

10. Certification of eligibility. a. By entering into this contract, the contractor certifies that neither it nor any person or firm who has an interest in the contractor's firm is a person or firm ineligible to be awarded Government contracts by virtue of [40 U.S.C. 3144\(b\)](#) or § 5.12(a).

b. No part of this contract shall be subcontracted to any person or firm ineligible for award of a Government contract by virtue of [40 U.S.C. 3144\(b\)](#) or § 5.12(a).

c. The penalty for making false statements is prescribed in the U.S. Code, Title 18 Crimes and Criminal Procedure, [18 U.S.C. 1001](#).

11. Anti-retaliation. It is unlawful for any person to discharge, demote, intimidate, threaten, restrain, coerce, blacklist, harass, or in any other manner discriminate against, or to cause any person to discharge, demote, intimidate, threaten, restrain, coerce, blacklist, harass, or in any other manner discriminate against, any worker or job applicant for:

a. Notifying any contractor of any conduct which the worker reasonably believes constitutes a violation of the DBA, Related Acts, this part, or [29 CFR part 1](#) or [3](#);

b. Filing any complaint, initiating or causing to be initiated any proceeding, or otherwise asserting or seeking to assert on behalf of themselves or others any right or protection under the DBA, Related Acts, this part, or [29 CFR part 1](#) or [3](#);

c. Cooperating in any investigation or other compliance action, or testifying in any proceeding under the DBA, Related Acts, this part, or [29 CFR part 1](#) or [3](#); or

d. Informing any other person about their rights under the DBA, Related Acts, this part, or [29 CFR part 1](#) or [3](#).

V. CONTRACT WORK HOURS AND SAFETY STANDARDS ACT

Pursuant to 29 CFR 5.5(b), the following clauses apply to any Federal-aid construction contract in an amount in excess of \$100,000 and subject to the overtime provisions of the Contract Work Hours and Safety Standards Act. These clauses shall be inserted in addition to the clauses required by 29 CFR 5.5(a) or 29 CFR 4.6. As used in this paragraph, the terms laborers and mechanics include watchpersons and guards.

1. Overtime requirements. No contractor or subcontractor contracting for any part of the contract work which may require or involve the employment of laborers or mechanics shall require or permit any such laborer or mechanic in any workweek in which he or she is employed on such work to work in excess of forty hours in such workweek unless such laborer or mechanic receives compensation at a rate not less than one and one-half times the basic rate of pay for all hours worked in excess of forty hours in such workweek. 29 CFR 5.5.

2. Violation; liability for unpaid wages; liquidated damages. In the event of any violation of the clause set forth in paragraph 1. of this section the contractor and any subcontractor responsible therefor shall be liable for the unpaid wages and interest from the date of the underpayment. In addition, such contractor and subcontractor shall be liable to the United States (in the case of work done under contract for the District of Columbia or a territory, to such District or to such territory), for liquidated damages. Such liquidated damages shall be computed with respect to each individual laborer or

mechanic, including watchpersons and guards, employed in violation of the clause set forth in paragraph 1. of this section, in the sum currently provided in 29 CFR 5.5(b)(2)* for each calendar day on which such individual was required or permitted to work in excess of the standard workweek of forty hours without payment of the overtime wages required by the clause set forth in paragraph 1. of this section.

* \$31 as of January 15, 2023 (See 88 FR 88 FR 2210) as may be adjusted annually by the Department of Labor, pursuant to the Federal Civil Penalties Inflation Adjustment Act of 1990.

3. Withholding for unpaid wages and liquidated damages

a. *Withholding process.* The FHWA or the contracting agency may, upon its own action, or must, upon written request of an authorized representative of the Department of Labor, withhold or cause to be withheld from the contractor so much of the accrued payments or advances as may be considered necessary to satisfy the liabilities of the prime contractor or any subcontractor for any unpaid wages; monetary relief, including interest; and liquidated damages required by the clauses set forth in this section on this contract, any other Federal contract with the same prime contractor, or any other federally assisted contract subject to the Contract Work Hours and Safety Standards Act that is held by the same prime contractor (as defined in § 5.2). The necessary funds may be withheld from the contractor under this contract, any other Federal contract with the same prime contractor, or any other federally assisted contract that is subject to the Contract Work Hours and Safety Standards Act and is held by the same prime contractor, regardless of whether the other contract was awarded or assisted by the same agency, and such funds may be used to satisfy the contractor liability for which the funds were withheld.

b. *Priority to withheld funds.* The Department has priority to funds withheld or to be withheld in accordance with Section IV paragraph 2.a. or paragraph 3.a. of this section, or both, over claims to those funds by:

- (1) A contractor's surety(ies), including without limitation performance bond sureties and payment bond sureties;
- (2) A contracting agency for its procurement costs;
- (3) A trustee(s) (either a court-appointed trustee or a U.S. trustee, or both) in bankruptcy of a contractor, or a contractor's bankruptcy estate;
- (4) A contractor's assignee(s);
- (5) A contractor's successor(s); or
- (6) A claim asserted under the Prompt Payment Act, [31 U.S.C. 3901](#)–3907.

4. Subcontracts. The contractor or subcontractor must insert in any subcontracts the clauses set forth in paragraphs 1. through 5. of this section and a clause requiring the subcontractors to include these clauses in any lower tier subcontracts. The prime contractor is responsible for compliance by any subcontractor or lower tier subcontractor with the clauses set forth in paragraphs 1. through 5. In the

event of any violations of these clauses, the prime contractor and any subcontractor(s) responsible will be liable for any unpaid wages and monetary relief, including interest from the date of the underpayment or loss, due to any workers of lower-tier subcontractors, and associated liquidated damages and may be subject to debarment, as appropriate.

5. Anti-retaliation. It is unlawful for any person to discharge, demote, intimidate, threaten, restrain, coerce, blacklist, harass, or in any other manner discriminate against, or to cause any person to discharge, demote, intimidate, threaten, restrain, coerce, blacklist, harass, or in any other manner discriminate against, any worker or job applicant for:

a. Notifying any contractor of any conduct which the worker reasonably believes constitutes a violation of the Contract Work Hours and Safety Standards Act (CWHSSA) or its implementing regulations in this part;

b. Filing any complaint, initiating or causing to be initiated any proceeding, or otherwise asserting or seeking to assert on behalf of themselves or others any right or protection under CWHSSA or this part;

c. Cooperating in any investigation or other compliance action, or testifying in any proceeding under CWHSSA or this part; or

d. Informing any other person about their rights under CWHSSA or this part.

VI. SUBLETTING OR ASSIGNING THE CONTRACT

This provision is applicable to all Federal-aid construction contracts on the National Highway System pursuant to 23 CFR 635.116.

1. The contractor shall perform with its own organization contract work amounting to not less than 30 percent (or a greater percentage if specified elsewhere in the contract) of the total original contract price, excluding any specialty items designated by the contracting agency. Specialty items may be performed by subcontract and the amount of any such specialty items performed may be deducted from the total original contract price before computing the amount of work required to be performed by the contractor's own organization (23 CFR 635.116).

a. The term "perform work with its own organization" in paragraph 1 of Section VI refers to workers employed or leased by the prime contractor, and equipment owned or rented by the prime contractor, with or without operators. Such term does not include employees or equipment of a subcontractor or lower tier subcontractor, agents of the prime contractor, or any other assignees. The term may include payments for the costs of hiring leased employees from an employee leasing firm meeting all relevant Federal and State regulatory requirements. Leased employees may only be included in this term if the prime contractor meets all of the following conditions: (based on longstanding interpretation)

- (1) the prime contractor maintains control over the supervision of the day-to-day activities of the leased employees;
- (2) the prime contractor remains responsible for the quality of the work of the leased employees;

- (3) the prime contractor retains all power to accept or exclude individual employees from work on the project; and
- (4) the prime contractor remains ultimately responsible for the payment of predetermined minimum wages, the submission of payrolls, statements of compliance and all other Federal regulatory requirements.

b. "Specialty Items" shall be construed to be limited to work that requires highly specialized knowledge, abilities, or equipment not ordinarily available in the type of contracting organizations qualified and expected to bid or propose on the contract as a whole and in general are to be limited to minor components of the overall contract. 23 CFR 635.102.

2. Pursuant to 23 CFR 635.116(a), the contract amount upon which the requirements set forth in paragraph (1) of Section VI is computed includes the cost of material and manufactured products which are to be purchased or produced by the contractor under the contract provisions.

3. Pursuant to 23 CFR 635.116(c), the contractor shall furnish (a) a competent superintendent or supervisor who is employed by the firm, has full authority to direct performance of the work in accordance with the contract requirements, and is in charge of all construction operations (regardless of who performs the work) and (b) such other of its own organizational resources (supervision, management, and engineering services) as the contracting officer determines is necessary to assure the performance of the contract.

4. No portion of the contract shall be sublet, assigned or otherwise disposed of except with the written consent of the contracting officer, or authorized representative, and such consent when given shall not be construed to relieve the contractor of any responsibility for the fulfillment of the contract. Written consent will be given only after the contracting agency has assured that each subcontract is evidenced in writing and that it contains all pertinent provisions and requirements of the prime contract. (based on long-standing interpretation of 23 CFR 635.116).

5. The 30-percent self-performance requirement of paragraph (1) is not applicable to design-build contracts; however, contracting agencies may establish their own self-performance requirements. 23 CFR 635.116(d).

VII. SAFETY: ACCIDENT PREVENTION

This provision is applicable to all Federal-aid construction contracts and to all related subcontracts.

1. In the performance of this contract the contractor shall comply with all applicable Federal, State, and local laws governing safety, health, and sanitation (23 CFR Part 635). The contractor shall provide all safeguards, safety devices and protective equipment and take any other needed actions as it determines, or as the contracting officer may determine, to be reasonably necessary to protect the life and health of employees on the job and the safety of the public and to protect property in connection with the performance of the work covered by the contract. 23 CFR 635.108.

2. It is a condition of this contract, and shall be made a condition of each subcontract, which the contractor enters into pursuant to this contract, that the contractor and any subcontractor shall not permit any employee, in performance of the contract, to work in surroundings or under conditions which are unsanitary, hazardous or dangerous to his/her health or safety, as determined under construction safety and

health standards (29 CFR Part 1926) promulgated by the Secretary of Labor, in accordance with Section 107 of the Contract Work Hours and Safety Standards Act (40 U.S.C. 3704). 29 CFR 1926.10.

3. Pursuant to 29 CFR 1926.3, it is a condition of this contract that the Secretary of Labor or authorized representative thereof, shall have right of entry to any site of contract performance to inspect or investigate the matter of compliance with the construction safety and health standards and to carry out the duties of the Secretary under Section 107 of the Contract Work Hours and Safety Standards Act (40 U.S.C. 3704).

VIII. FALSE STATEMENTS CONCERNING HIGHWAY PROJECTS

This provision is applicable to all Federal-aid construction contracts and to all related subcontracts.

In order to assure high quality and durable construction in conformity with approved plans and specifications and a high degree of reliability on statements and representations made by engineers, contractors, suppliers, and workers on Federal-aid highway projects, it is essential that all persons concerned with the project perform their functions as carefully, thoroughly, and honestly as possible. Willful falsification, distortion, or misrepresentation with respect to any facts related to the project is a violation of Federal law. To prevent any misunderstanding regarding the seriousness of these and similar acts, Form FHWA-1022 shall be posted on each Federal-aid highway project (23 CFR Part 635) in one or more places where it is readily available to all persons concerned with the project:

18 U.S.C. 1020 reads as follows:

"Whoever, being an officer, agent, or employee of the United States, or of any State or Territory, or whoever, whether a person, association, firm, or corporation, knowingly makes any false statement, false representation, or false report as to the character, quality, quantity, or cost of the material used or to be used, or the quantity or quality of the work performed or to be performed, or the cost thereof in connection with the submission of plans, maps, specifications, contracts, or costs of construction on any highway or related project submitted for approval to the Secretary of Transportation; or

Whoever knowingly makes any false statement, false representation, false report or false claim with respect to the character, quality, quantity, or cost of any work performed or to be performed, or materials furnished or to be furnished, in connection with the construction of any highway or related project approved by the Secretary of Transportation; or

Whoever knowingly makes any false statement or false representation as to material fact in any statement, certificate, or report submitted pursuant to provisions of the Federal-aid Roads Act approved July 11, 1916, (39 Stat. 355), as amended and supplemented;

Shall be fined under this title or imprisoned not more than 5 years or both."

IX. IMPLEMENTATION OF CLEAN AIR ACT AND FEDERAL WATER POLLUTION CONTROL ACT (42 U.S.C. 7606; 2 CFR 200.88; EO 11738)

This provision is applicable to all Federal-aid construction contracts in excess of \$150,000 and to all related subcontracts. 48 CFR 2.101; 2 CFR 200.327.

By submission of this bid/proposal or the execution of this contract or subcontract, as appropriate, the bidder, proposer, Federal-aid construction contractor, subcontractor, supplier, or vendor agrees to comply with all applicable standards, orders or regulations issued pursuant to the Clean Air Act (42 U.S.C. 7401-7671q) and the Federal Water Pollution Control Act, as amended (33 U.S.C. 1251-1387). Violations must be reported to the Federal Highway Administration and the Regional Office of the Environmental Protection Agency. 2 CFR Part 200, Appendix II.

The contractor agrees to include or cause to be included the requirements of this Section in every subcontract, and further agrees to take such action as the contracting agency may direct as a means of enforcing such requirements. 2 CFR 200.327.

X. CERTIFICATION REGARDING DEBARMENT, SUSPENSION, INELIGIBILITY AND VOLUNTARY EXCLUSION

This provision is applicable to all Federal-aid construction contracts, design-build contracts, subcontracts, lower-tier subcontracts, purchase orders, lease agreements, consultant contracts or any other covered transaction requiring FHWA approval or that is estimated to cost \$25,000 or more – as defined in 2 CFR Parts 180 and 1200. 2 CFR 180.220 and 1200.220.

1. Instructions for Certification – First Tier Participants:

- a. By signing and submitting this proposal, the prospective first tier participant is providing the certification set out below.
- b. The inability of a person to provide the certification set out below will not necessarily result in denial of participation in this covered transaction. The prospective first tier participant shall submit an explanation of why it cannot provide the certification set out below. The certification or explanation will be considered in connection with the department or agency's determination whether to enter into this transaction. However, failure of the prospective first tier participant to furnish a certification or an explanation shall disqualify such a person from participation in this transaction. 2 CFR 180.320.
- c. The certification in this clause is a material representation of fact upon which reliance was placed when the contracting agency determined to enter into this transaction. If it is later determined that the prospective participant knowingly rendered an erroneous certification, in addition to other remedies available to the Federal Government, the contracting agency may terminate this transaction for cause of default. 2 CFR 180.325.
- d. The prospective first tier participant shall provide immediate written notice to the contracting agency to whom this proposal is submitted if any time the prospective first tier participant learns that its certification was erroneous when submitted or has become erroneous by reason of changed circumstances. 2 CFR 180.345 and 180.350.

e. The terms "covered transaction," "debarred," "suspended," "ineligible," "participant," "person," "principal," and "voluntarily excluded," as used in this clause, are defined in 2 CFR Parts 180, Subpart I, 180.900-180.1020, and 1200. "First Tier Covered Transactions" refers to any covered transaction between a recipient or subrecipient of Federal funds and a participant (such as the prime or general contract). "Lower Tier Covered Transactions" refers to any covered transaction under a First Tier Covered Transaction (such as subcontracts). "First Tier Participant" refers to the participant who has entered into a covered transaction with a recipient or subrecipient of Federal funds (such as the prime or general contractor). "Lower Tier Participant" refers any participant who has entered into a covered transaction with a First Tier Participant or other Lower Tier Participants (such as subcontractors and suppliers).

f. The prospective first tier participant agrees by submitting this proposal that, should the proposed covered transaction be entered into, it shall not knowingly enter into any lower tier covered transaction with a person who is debarred, suspended, declared ineligible, or voluntarily excluded from participation in this covered transaction, unless authorized by the department or agency entering into this transaction. 2 CFR 180.330.

g. The prospective first tier participant further agrees by submitting this proposal that it will include the clause titled "Certification Regarding Debarment, Suspension, Ineligibility and Voluntary Exclusion-Lower Tier Covered Transactions," provided by the department or contracting agency, entering into this covered transaction, without modification, in all lower tier covered transactions and in all solicitations for lower tier covered transactions exceeding the \$25,000 threshold. 2 CFR 180.220 and 180.300.

h. A participant in a covered transaction may rely upon a certification of a prospective participant in a lower tier covered transaction that is not debarred, suspended, ineligible, or voluntarily excluded from the covered transaction, unless it knows that the certification is erroneous. 2 CFR 180.300; 180.320, and 180.325. A participant is responsible for ensuring that its principals are not suspended, debarred, or otherwise ineligible to participate in covered transactions. 2 CFR 180.335. To verify the eligibility of its principals, as well as the eligibility of any lower tier prospective participants, each participant may, but is not required to, check the System for Award Management website (<https://www.sam.gov/>). 2 CFR 180.300, 180.320, and 180.325.

i. Nothing contained in the foregoing shall be construed to require the establishment of a system of records in order to render in good faith the certification required by this clause. The knowledge and information of the prospective participant is not required to exceed that which is normally possessed by a prudent person in the ordinary course of business dealings.

j. Except for transactions authorized under paragraph (f) of these instructions, if a participant in a covered transaction knowingly enters into a lower tier covered transaction with a person who is suspended, debarred, ineligible, or voluntarily excluded from participation in this transaction, in addition to other remedies available to the Federal Government, the department or agency may terminate this transaction for cause or default. 2 CFR 180.325.

* * * * *

2. Certification Regarding Debarment, Suspension, Ineligibility and Voluntary Exclusion – First Tier Participants:

a. The prospective first tier participant certifies to the best of its knowledge and belief, that it and its principals:

(1) Are not presently debarred, suspended, proposed for debarment, declared ineligible, or voluntarily excluded from participating in covered transactions by any Federal department or agency, 2 CFR 180.335;

(2) Have not within a three-year period preceding this proposal been convicted of or had a civil judgment rendered against them for commission of fraud or a criminal offense in connection with obtaining, attempting to obtain, or performing a public (Federal, State, or local) transaction or contract under a public transaction; violation of Federal or State antitrust statutes or commission of embezzlement, theft, forgery, bribery, falsification or destruction of records, making false statements, or receiving stolen property, 2 CFR 180.800;

(3) Are not presently indicted for or otherwise criminally or civilly charged by a governmental entity (Federal, State or local) with commission of any of the offenses enumerated in paragraph (a)(2) of this certification, 2 CFR 180.700 and 180.800; and

(4) Have not within a three-year period preceding this application/proposal had one or more public transactions (Federal, State or local) terminated for cause or default. 2 CFR 180.335(d).

(5) Are not a corporation that has been convicted of a felony violation under any Federal law within the two-year period preceding this proposal (USDOT Order 4200.6 implementing appropriations act requirements); and

(6) Are not a corporation with any unpaid Federal tax liability that has been assessed, for which all judicial and administrative remedies have been exhausted, or have lapsed, and that is not being paid in a timely manner pursuant to an agreement with the authority responsible for collecting the tax liability (USDOT Order 4200.6 implementing appropriations act requirements).

b. Where the prospective participant is unable to certify to any of the statements in this certification, such prospective participant should attach an explanation to this proposal. 2 CFR 180.335 and 180.340.

3. Instructions for Certification - Lower Tier Participants:

(Applicable to all subcontracts, purchase orders, and other lower tier transactions requiring prior FHWA approval or estimated to cost \$25,000 or more - 2 CFR Parts 180 and 1200). 2 CFR 180.220 and 1200.220.

a. By signing and submitting this proposal, the prospective lower tier participant is providing the certification set out below.

b. The certification in this clause is a material representation of fact upon which reliance was placed when this transaction was entered into. If it is later determined that the prospective lower tier participant knowingly rendered an erroneous certification, in addition to other remedies available to the Federal Government, the department, or agency with which

this transaction originated may pursue available remedies, including suspension and/or debarment.

c. The prospective lower tier participant shall provide immediate written notice to the person to which this proposal is submitted if at any time the prospective lower tier participant learns that its certification was erroneous by reason of changed circumstances. 2 CFR 180.365.

d. The terms "covered transaction," "debarred," "suspended," "ineligible," "participant," "person," "principal," and "voluntarily excluded," as used in this clause, are defined in 2 CFR Parts 180, Subpart I, 180.900 – 180.1020, and 1200. You may contact the person to which this proposal is submitted for assistance in obtaining a copy of those regulations. "First Tier Covered Transactions" refers to any covered transaction between a recipient or subrecipient of Federal funds and a participant (such as the prime or general contract). "Lower Tier Covered Transactions" refers to any covered transaction under a First Tier Covered Transaction (such as subcontracts). "First Tier Participant" refers to the participant who has entered into a covered transaction with a recipient or subrecipient of Federal funds (such as the prime or general contractor). "Lower Tier Participant" refers any participant who has entered into a covered transaction with a First Tier Participant or other Lower Tier Participants (such as subcontractors and suppliers).

e. The prospective lower tier participant agrees by submitting this proposal that, should the proposed covered transaction be entered into, it shall not knowingly enter into any lower tier covered transaction with a person who is debarred, suspended, declared ineligible, or voluntarily excluded from participation in this covered transaction, unless authorized by the department or agency with which this transaction originated. 2 CFR 1200.220 and 1200.332.

f. The prospective lower tier participant further agrees by submitting this proposal that it will include this clause titled "Certification Regarding Debarment, Suspension, Ineligibility and Voluntary Exclusion-Lower Tier Covered Transaction," without modification, in all lower tier covered transactions and in all solicitations for lower tier covered transactions exceeding the \$25,000 threshold. 2 CFR 180.220 and 1200.220.

g. A participant in a covered transaction may rely upon a certification of a prospective participant in a lower tier covered transaction that is not debarred, suspended, ineligible, or voluntarily excluded from the covered transaction, unless it knows that the certification is erroneous. A participant is responsible for ensuring that its principals are not suspended, debarred, or otherwise ineligible to participate in covered transactions. To verify the eligibility of its principals, as well as the eligibility of any lower tier prospective participants, each participant may, but is not required to, check the System for Award Management website (<https://www.sam.gov/>), which is compiled by the General Services Administration. 2 CFR 180.300, 180.320, 180.330, and 180.335.

h. Nothing contained in the foregoing shall be construed to require establishment of a system of records in order to render in good faith the certification required by this clause. The knowledge and information of participant is not required to exceed that which is normally possessed by a prudent person in the ordinary course of business dealings.

i. Except for transactions authorized under paragraph e of these instructions, if a participant in a covered transaction knowingly enters into a lower tier covered transaction with a person who is suspended, debarred, ineligible, or voluntarily

excluded from participation in this transaction, in addition to other remedies available to the Federal Government, the department or agency with which this transaction originated may pursue available remedies, including suspension and/or debarment. 2 CFR 180.325.

4. Certification Regarding Debarment, Suspension, Ineligibility and Voluntary Exclusion--Lower Tier Participants:

a. The prospective lower tier participant certifies, by submission of this proposal, that neither it nor its principals:

(1) is presently debarred, suspended, proposed for debarment, declared ineligible, or voluntarily excluded from participating in covered transactions by any Federal department or agency, 2 CFR 180.355;

(2) is a corporation that has been convicted of a felony violation under any Federal law within the two-year period preceding this proposal (USDOT Order 4200.6 implementing appropriations act requirements); and

(3) is a corporation with any unpaid Federal tax liability that has been assessed, for which all judicial and administrative remedies have been exhausted, or have lapsed, and that is not being paid in a timely manner pursuant to an agreement with the authority responsible for collecting the tax liability. (USDOT Order 4200.6 implementing appropriations act requirements)

b. Where the prospective lower tier participant is unable to certify to any of the statements in this certification, such prospective participant should attach an explanation to this proposal.

XI. CERTIFICATION REGARDING USE OF CONTRACT FUNDS FOR LOBBYING

This provision is applicable to all Federal-aid construction contracts and to all related subcontracts which exceed \$100,000. 49 CFR Part 20, App. A.

1. The prospective participant certifies, by signing and submitting this bid or proposal, to the best of his or her knowledge and belief, that:

a. No Federal appropriated funds have been paid or will be paid, by or on behalf of the undersigned, to any person for influencing or attempting to influence an officer or employee of any Federal agency, a Member of Congress, an officer or employee of Congress, or an employee of a Member of Congress in connection with the awarding of any Federal contract, the making of any Federal grant, the making of any Federal loan, the entering into of any cooperative agreement, and the extension, continuation, renewal, amendment, or modification of any Federal contract, grant, loan, or cooperative agreement.

b. If any funds other than Federal appropriated funds have been paid or will be paid to any person for influencing or attempting to influence an officer or employee of any Federal agency, a Member of Congress, an officer or employee of Congress, or an employee of a Member of Congress in connection with this Federal contract, grant, loan, or

cooperative agreement, the undersigned shall complete and submit Standard Form-LLL, "Disclosure Form to Report Lobbying," in accordance with its instructions.

2. This certification is a material representation of fact upon which reliance was placed when this transaction was made or entered into. Submission of this certification is a prerequisite for making or entering into this transaction imposed by 31 U.S.C. 1352. Any person who fails to file the required certification shall be subject to a civil penalty of not less than \$10,000 and not more than \$100,000 for each such failure.

3. The prospective participant also agrees by submitting its bid or proposal that the participant shall require that the language of this certification be included in all lower tier subcontracts, which exceed \$100,000 and that all such recipients shall certify and disclose accordingly.

XII. USE OF UNITED STATES-FLAG VESSELS:

This provision is applicable to all Federal-aid construction contracts, design-build contracts, subcontracts, lower-tier subcontracts, purchase orders, lease agreements, or any other covered transaction. 46 CFR Part 381.

This requirement applies to material or equipment that is acquired for a specific Federal-aid highway project. 46 CFR 381.7. It is not applicable to goods or materials that come into inventories independent of an FHWA funded-contract.

When oceanic shipments (or shipments across the Great Lakes) are necessary for materials or equipment acquired for a specific Federal-aid construction project, the bidder, proposer, contractor, subcontractor, or vendor agrees:

1. To utilize privately owned United States-flag commercial vessels to ship at least 50 percent of the gross tonnage (computed separately for dry bulk carriers, dry cargo liners, and tankers) involved, whenever shipping any equipment, material, or commodities pursuant to this contract, to the extent such vessels are available at fair and reasonable rates for United States-flag commercial vessels. 46 CFR 381.7.

2. To furnish within 20 days following the date of loading for shipments originating within the United States or within 30 working days following the date of loading for shipments originating outside the United States, a legible copy of a rated, 'on-board' commercial ocean bill-of-lading in English for each shipment of cargo described in paragraph (b)(1) of this section to both the Contracting Officer (through the prime contractor in the case of subcontractor bills-of-lading) and to the Office of Cargo and Commercial Sealift (MAR-620), Maritime Administration, Washington, DC 20590. (MARAD requires copies of the ocean carrier's (master) bills of lading, certified onboard, dated, with rates and charges. These bills of lading may contain business sensitive information and therefore may be submitted directly to MARAD by the Ocean Transportation Intermediary on behalf of the contractor). 46 CFR 381.7.

**ATTACHMENT A - EMPLOYMENT AND MATERIALS
PREFERENCE FOR APPALACHIAN DEVELOPMENT
HIGHWAY SYSTEM OR APPALACHIAN LOCAL ACCESS
ROAD CONTRACTS (23 CFR 633, Subpart B, Appendix B)**

This provision is applicable to all Federal-aid projects funded under the Appalachian Regional Development Act of 1965.

1. During the performance of this contract, the contractor undertaking to do work which is, or reasonably may be, done as on-site work, shall give preference to qualified persons who regularly reside in the labor area as designated by the DOL wherein the contract work is situated, or the subregion, or the Appalachian counties of the State wherein the contract work is situated, except:

a. To the extent that qualified persons regularly residing in the area are not available.

b. For the reasonable needs of the contractor to employ supervisory or specially experienced personnel necessary to assure an efficient execution of the contract work.

c. For the obligation of the contractor to offer employment to present or former employees as the result of a lawful collective bargaining contract, provided that the number of nonresident persons employed under this subparagraph (1c) shall not exceed 20 percent of the total number of employees employed by the contractor on the contract work, except as provided in subparagraph (4) below.

2. The contractor shall place a job order with the State Employment Service indicating (a) the classifications of the laborers, mechanics and other employees required to perform the contract work, (b) the number of employees required in each classification, (c) the date on which the participant estimates such employees will be required, and (d) any other pertinent information required by the State Employment Service to complete the job order form. The job order may be placed with the State Employment Service in writing or by telephone. If during the course of the contract work, the information submitted by the contractor in the original job order is substantially modified, the participant shall promptly notify the State Employment Service.

3. The contractor shall give full consideration to all qualified job applicants referred to him by the State Employment Service. The contractor is not required to grant employment to any job applicants who, in his opinion, are not qualified to perform the classification of work required.

4. If, within one week following the placing of a job order by the contractor with the State Employment Service, the State Employment Service is unable to refer any qualified job applicants to the contractor, or less than the number requested, the State Employment Service will forward a certificate to the contractor indicating the unavailability of applicants. Such certificate shall be made a part of the contractor's permanent project records. Upon receipt of this certificate, the contractor may employ persons who do not normally reside in the labor area to fill positions covered by the certificate, notwithstanding the provisions of subparagraph (1c) above.

5. The provisions of 23 CFR 633.207(e) allow the contracting agency to provide a contractual preference for the use of mineral resource materials native to the Appalachian region.

6. The contractor shall include the provisions of Sections 1 through 4 of this Attachment A in every subcontract for work which is, or reasonably may be, done as on-site work.

**NOTICE OF REQUIREMENTS FOR AFFIRMATIVE
ACTION TO ENSURE EQUAL EMPLOYMENT
OPPORTUNITY (EXECUTIVE ORDER 11246)**

1. The Offeror's or Bidder's attention is called to the "Equal Opportunity Clause" and the "Standard Federal Equal Employment Opportunity Construction Contract Specifications" set forth herein.

2. The goal for female participation, expressed in percentage terms for the Contractor's aggregate workforce in each trade on all construction work, is 6.9%.

Until further notice	Goals for minority participation for each trade (percent)
----------------------	---

SHSA Cities:

Pascagoula - Moss Point -----	16.9
Biloxi - Gulfport -----	19.2
Jackson -----	30.3

SMSA Counties:

Desoto -----	32.3
Hancock, Harrison, Stone-----	19.2
Hinds, Rankin-----	30.3
Jackson -----	16.9

Non-SMSA Counties:

George, Greene-----	26.4
---------------------	------

Alcorn, Benton, Bolivar, Calhoun, Carroll, Chickasaw, Clay, Coahoma, Grenada, Itawamba, Lafayette, Lee, Leflore, Marshall, Monroe, Montgomery, Panola, Pontotoc, Prentiss, Quitman, Sunflower, Tallahatchie, Tate, Tippah, Tishomingo, Tunica, Union, Washington, Webster, Yalobusha -----	26.5
---	------

Attala, Choctaw, Claiborne, Clarke, Copiah, Covington, Franklin, Holmes, Humphreys, Issaquena, Jasper, Jefferson, Jefferson Davis, Jones Kemper, Lauderdale, Lawrence, Leake, Lincoln, Lowndes, Madison, Neshoba, Newton, Noxubee, Oktibbeha, Scott, Sharkey, Simpson, Smith, Warren, Wayne, Winston, Yazoo-----	32.0
---	------

Forrest, Lamar, Marion, Pearl River, Perry, Pike, Walthall-----	27.7
--	------

Adams, Amite, Wilkinson -----	30.4
-------------------------------	------

These goals are applicable to all the Contractor's construction work (whether or not it is Federal or federally assisted) performed in the covered area. If the contractor performs construction work in a geographical area located outside of the covered area, it shall apply the goals established for such geographical area where the work is actually performed. With regard to this second area, the contractor also is subject to the goals for both its federally involved and nonfederally involved construction.

The Contractor's compliance with the Executive Order and the regulations in 41 CFR Part 60-4 shall be based on its implementation of the Equal Opportunity clause, specific affirmative action obligations required by the specifications set forth in 41 CFR 60-4.3(a), and its efforts to meet the goals. The hours of minority and female employment and training must be substantially uniform throughout the length of the contract, and in each trade, and the Contractor shall make a good faith effort to employ minorities and women evenly on each of its projects. The transfer of minority or female employees or trainees from Contractor to Contractor or from project to project for the sole purpose of meeting the Contractor's goals shall be a violation of the contract, the Executive Order and the regulations in 41 CFR Part 60-4.2(d). Compliance with the goals will be measured against the total work hours performed.

3. The Contractor shall provide written notification to the Director of the Office of Federal Contract Compliance Programs within 10 working days of award of any construction subcontract in excess of \$10,000 at any tier for construction work under the contract resulting from this solicitation. The notification shall list the name, address and telephone number of the subcontractor, employer identification number of the subcontractor, estimated dollar amount of the subcontract; estimated starting and completion dates of the subcontract; and the geographical area in which the subcontract is to be performed.

4. As used in this Notice, and in the contract resulting from this solicitation, the "covered area" is to the county and city (if any), stated in the advertisement.

5. The notification required in Paragraph 3 shall be addressed to the following:

Contract Compliance Officer
Mississippi Department of Transportation
P.O. Box 1850
Jackson, Mississippi 39215-1850

(12/04/2018)

MISSISSIPPI DEPARTMENT OF TRANSPORTATION

SPECIAL PROVISION NO. 907-101-1

CODE: (IS)

DATE: 07/20/2023

SUBJECT: Definitions and Terms

Section 101, Definitions and Terms, of the 2017 Edition of the Mississippi Standard Specifications for Road and Bridge Construction is hereby amended as follows.

907-101.01--Abbreviations. After the abbreviation API on page 1, add the following.

APL Approved Products List

Replace the abbreviation for AWPA on page 1 with the following.

AWPA American Wood Protection Association

907-101.02--Definitions. Delete the sentence after the list of holidays in Subsection 101.02 on page 6 under **holidays, legal**, and substitute the following.

When a legal holiday falls on a Saturday or Sunday, the succeeding Monday, or as proclaimed by the Governor, will be observed as a legal holiday.

Delete the definition for Notice to Proceed in Subsection 101.02 on page 8, and substitute the following.

Notice to Proceed - Written notice to the Contractor to proceed with the contract work.

Delete the definition for “Plans” in Subsection 101.02 on page 8, and substitute the following.

plans - The approved plans, profiles, typical cross-sections, working drawings and supplemental drawings, or exact reproduction thereof, that show the location, character, dimensions, and details of the work to be done. The plans may also include electronic files, referred to on the plans as Electronic Files Identified as Plans, which may include engineering models, spreadsheets, CADD files or other electronic files used to convey design intent. When the contract does not have an official set of plans, reference to the plans shall mean the contract documents.

MISSISSIPPI DEPARTMENT OF TRANSPORTATION

SPECIAL PROVISION NO. 907-102-2

CODE: (IS)

DATE: 11/22/2017

SUBJECT: Bidding Requirements and Conditions

Section 102, Bidding Requirements and Conditions, of the 2017 Edition of the Mississippi Standard Specifications for Road and Bridge Construction is hereby amended as follows.

907-102.01--Prequalification of Bidders. Delete the last sentence of the third paragraph of Subsection 102.01 on page 13, and substitute the following.

The Bidder's Certificate of Responsibility number must be on file with the Department's Contract Administration Division prior to request for permission to bid.

907-102.02--Contents of Proposal Forms. Delete the fourth paragraph in Subsection 102.02 on page 13, and substitute the following.

Prospective bidders must complete an online request for permission to be eligible to bid a project. Upon approval, the bidder will be authorized to submit a bid electronically using Bid Express at <http://bidx.com>.

MISSISSIPPI DEPARTMENT OF TRANSPORTATION

SPECIAL PROVISION NO. 907-105-2

CODE: (IS)

DATE: 07/20/2023

SUBJECT: Control of Work

Section 105, Control of Work, of the 2017 Edition of the Mississippi Standard Specifications for Road and Bridge Construction is hereby amended as follows.

907-105.01--Authority of the Engineer. Delete the first sentence of the second paragraph of Subsection 105.01 on page 31, and substitute the following.

The Engineer has the right to suspend the work wholly or in part and to withhold payments because of the Contractor's failure to correct conditions unsafe for workmen or the general public, for failure to carry out provisions of the Contract, or for failure to carry out orders.

907-105.02--Plans and Working Drawings. Delete the first paragraph of Subsection 105.02 on page 31, and substitute the following.

After the contract is executed by the Executive Director, the Contractor will receive, free of charge, two bound copies of the proposal and contract documents (one executed and one blank) two full scale copies of the plans, five half-scale copies of the Plans, and Electronic Files Identified as Plans. The Contractor shall have one copy of the proposal and contract documents and one half-scale copy of the plans available at all times during work activity on the project.

MISSISSIPPI DEPARTMENT OF TRANSPORTATION

SPECIAL PROVISION NO. 907-106-1

CODE: (IS)

DATE: 10/25/2022

SUBJECT: Control of Materials

Section 106, Control of Materials, of the 2017 Edition of the Mississippi Standard Specifications for Road and Bridge Construction is hereby amended as follows.

After Subsection 106.13 on page 47, add the following.

907-106.14--Buy America Materials Sourcing Requirements for Federal-Aid Projects. The “Infrastructure Investment and Jobs Act” (the “Act”), or Bipartisan Infrastructure Law (BIL), was enacted on November 15, 2021 (See Public Law No. 117-58, Sections 70901-70953). The Buy America provisions of the Act expand the previous Buy America requirements beyond what is currently required for steel and iron products.

Any steel and iron materials per Subsection 700.01 or construction materials per Subsection 907-700.01.1, that are used for a Federal-Aid highway construction project, shall be domestically manufactured (as further described in Subsection 700.01) and compliant with current requirements of the Act, as implemented by the Office of Management and Budget (OMB) in the “Preliminary Guidance for Construction Materials” in OMB Memorandum M-22-11.

As determined by the Department within the contract prior to award, all products and/or materials will only be classified under one of the following categories: Steel and Iron, Manufactured Products, and Construction Materials. It is the Prime Contractor’s responsibility to ensure all submittals required for Buy America are submitted to the Project Engineer prior to the products and/or materials being incorporated into the work.

The following items require Buy America Certification on Federal-Aid projects:

- (a) Steel and Iron
- (b) Construction Materials

A list of items that require Buy America Certification may be viewed at www.goMDOT.com under Business Center → Engineering Standards/Guides/Manuals → Construction Materials.

Items classified as a Manufactured Product that do not include steel and iron components do not require a Buy America Certification on a Federal-Aid project. Manufactured Products are currently exempted under the 1983 waiver from FHWA. Manufactured Products are determined by the Department’s Materials Division.

To be considered a Manufactured Product, an item shall meet one of the following requirements:

- (a) The item consists of two or more of the listed construction materials that have been combined through a manufacturing process.
- (b) The item consists of at least one of the listed construction materials that has been combined through a manufacturing process with a material that is not listed as a construction material.

Buy America provisions do not apply to temporarily used items that (1) are specified to be removed at the end of the project per the contract provisions or (2) are specified to remain in place per the contract provisions and are also documented by the Department in the contract provisions to be removed in a subsequent imminent, near-term phased project.

MISSISSIPPI DEPARTMENT OF TRANSPORTATION

SPECIAL PROVISION NO. 907-108-4

CODE: (SP)

DATE: 10/07/2020

SUBJECT: Subletting of Contract

Section 108, Prosecution and Progress, of the 2017 Edition of the Mississippi Standard Specifications for Road and Bridge Construction is hereby amended as follows.

907-108.01--Subletting of Contract.

907-108.01.1--General. Delete the third sentence of the tenth paragraph of Subsection 108.01.1 on the bottom of page 72.

MISSISSIPPI DEPARTMENT OF TRANSPORTATION

SPECIAL PROVISION NO. 907-109-5

CODE: (IS)

DATE: 11/14/2023

SUBJECT: Measurement and Payment

Section 109, Measurement and Payment, of the 2017 Edition of the Mississippi Standard Specifications for Road and Bridge Construction is hereby amended as follows.

907-109.01--Measurement of Quantities. Delete the sixth full paragraph of Subsection 109.01 on page 88, and substitute the following.

If appropriate based on the specific circumstances of the project, the Contractor may request that material specified to be measured by the cubic yard or ton be converted to the other measure. The Contractor must submit this request to the Engineer. The Engineer will provide an approval or denial in writing. The decision is in the sole discretion of the Engineer. If approved, factors for this conversion will be determined by the District Materials Engineer and agreed to by the Contractor. The conversion of the materials along with the conversion factor will be incorporated into the Contract by supplemental agreement. The supplemental agreement must be executed before such method of measurement is used.

907-109.04--Extra Work.

907-109.04.1--Supplemental Agreement. Delete the second paragraph of Subsection 109.04.1 on page 90.

907-109.04.2--Force Account Agreement. Delete the last sentence of subparagraph (c) in Subsection 109.04.2 on page 91, and substitute the following.

An amount will be added equal to fifteen percent (15%) of the sum thereof, excluding sales tax.

Delete subparagraph (d) in Subsection 109.04.2 on pages 91 & 92, and substitute the following.

- (d) **Equipment.** Equipment used for force account work shall be of sufficient size and type necessary to perform the required work in an economic and expeditious manner. The Contractor must provide the manufacturer, make, model, year, type of fuel and other necessary information to determine proper hourly payment rates. Subject to advance approval of the Engineer, actual transportation cost for a distance of not more than 200 miles will be reimbursed for equipment not already on the project.

For equipment authorized by the Engineer for use on the force account work, the Engineer will use the equipment rental rates from the “*Rental Rate Blue Book*” as published on the Equipment Watch website www.equipmentwatch.com for the time period the force account work is authorized to determine payment to the Contractor. The maximum allowable rates

are determined as follows:

1. The hourly equipment rate will equal the FHWA total hourly rate. This rate takes into account adjustment factors for age and region.
2. The hourly estimated operating costs have been included in the FHWA total hourly rate.
3. The idle and standby rates shall be as listed in the "*Rental Rate Blue Book*" as reported by *Equipment Watch*.
4. These rates include the basic machine plus any necessary attachments.

Standby rates shall apply when equipment is not in operation and is approved by the Engineer to standby for later use to complete the work. Idle rates shall apply to equipment located on the project and the engine is burning fuel but no ground engaging or other components are actively engaged in meaningful work. In general, idle or standby rates shall apply when equipment is not in use, but will be needed again to complete the work and the cost of moving the equipment will exceed the accumulated standby cost. If the idle standby cost should exceed the equipment moving cost to or from the work site, the Contractor will be entitled to the moving cost only. Idle or standby rates will be used under the following conditions:

1. The equipment is totally dedicated to the force account work and not used intermittently on other work.
2. Idle or standby cost will be considered only after equipment has been operated on force account work.
3. The sum of idle or standby time and operating time shall not exceed eight (8) hours per day or 40 hours in a week.
4. Idle or standby payment will not apply to days not normally considered to be work days such as holidays, weekends, or days of inclement weather when no other work is taking place.

The Department will not pay for idle or standby time when equipment is inoperable, for time spent repairing equipment, or for the time elapsed after the Engineer has advised the Contractor that the equipment is no longer needed. The Department will determine if it will be more cost effective to pay standby time on approved equipment on site or for multiple mobilizations.

If equipment is needed, which is not included in the *Rental Rate Blue Book* as reported by *Equipment Watch*, the Department and Contractor will agree upon reasonable rental rates in writing before the equipment is used.

All equipment shall be subject to approval from day to day in accordance with the requirements of Subsection 108.05.

907-109.06--Partial Payment.

907-109.06.2--Advancement on Materials.

Delete the next to last paragraph of Subsection 109.06.2 on page 95, and substitute the following.

Materials for which an advanced payment has been allowed must be paid for by the Contractor within 30 days of the estimate on which the advanced payment was first allowed and proof of said payment must be verified by the supplier. If proof of payment is not furnished within the allowable 30 days, the advanced payment will be deducted on subsequent current estimates until such time that proof of payment is furnished.

907-109.07--Changes in Material Costs. After the fifth paragraph of Subsection 109.07 on page 96, change the web address to the following.

https://mdot.ms.gov/portal/current_letting

MISSISSIPPI DEPARTMENT OF TRANSPORTATION

SPECIAL PROVISION NO. 907-410-3

CODE: (SP)

DATE: 06/14/2018

SUBJECT: Fog Seals

Section 410, Bituminous Surface Treatment, of the 2017 Edition of the Mississippi Standard Specifications for Road and Bridge Construction is hereby amended as follows.

907-410.01--Description. After the paragraph in Subsection 410.01 on page 313, add the following.

When specified on the plans or in the contract documents, this work may require the placement of a fog seal coat on an existing or newly placed surface, or a rejuvenating fog seal coat on an existing pavement. The fog seals shall be placed at locations shown on the plans or as directed by the Engineer.

907-410.03--Construction Requirements. After Subsection 410.03.7 on page 319, add the following.

907-410.03.8--Fog Seals. The placement of the fog seals shall be in accordance with the requirements set forth in Subsections 410.03.2, 410.03.3, 410.03.5, and 410.03.7, as applicable.

Fog seals shall be placed at a rate of 0.11 gallons per square yard, or as directed by the Engineer. When placing on a newly installed surface, the fog seal shall not be placed until after final brooming.

907-410.04--Method of Measurement. After the last paragraph of Subsection 410.04 on page 319, add the following.

Accepted quantities for asphalt for fog seal and asphalt for rejuvenating fog seal will be measured by the gallon as prescribed in Subsection 109.01. Unless otherwise specified, distributor tank measurement will be used. The volume of material over five percent (5%) above the quantity ordered for each shot will be deducted from measured quantities, except that 15 percent will be allowed for irregular areas where hand spraying is necessary.

907-410.05--Basis of Payment. After the paragraph in Subsection 410.05 on page 319, add the following.

Asphalt for fog seal and asphalt for rejuvenating fog seal, measured as prescribed above, will be paid for at the contract unit price per gallon, which shall be full compensation for furnishing all labor, materials, equipment, applying and protecting the fog seal, and all incidentals necessary to complete the work.

After the last pay item listed on page 319, add the following.

907-410-C: Asphalt for Fog Seal, Grade - per gallon

907-410-D: Asphalt for Rejuvenating Fog Seal, Grade - per gallon

MISSISSIPPI DEPARTMENT OF TRANSPORTATION

SPECIAL PROVISION NO. 907-413-2

CODE: (SP)

DATE: 05/09/2023

SUBJECT: Cleaning and Sealing Joints and Cracks

Section 413, Cleaning and Sealing Joints and Cracks, of the 2017 Edition of the Mississippi Standard Specifications for Road and Bridge Construction is hereby amended as follows.

907-413.03--Construction Requirements.

907-413.03.3--Sawing and Sealing Transverse Joints in Asphalt Pavement.

907-413.03.3.4--Sealing. Delete the last sentence of the last paragraph of Subsection 413.03.3.4 on page 333, and substitute the following.

Poured joint sealing material shall only be placed when the air temperature is within the limits specified by the manufacturer.

907-413.05--Basis of Payment. Delete the last pay item listed on page 336, and substitute the following.

907-413-E: Sawing and Sealing Transverse Joints in Asphalt Pavement - per linear foot

MISSISSIPPI DEPARTMENT OF TRANSPORTATION

SPECIAL PROVISION NO. 907-618-12

CODE: (SP)

DATE: 05/03/2024

SUBJECT: Traffic Control Management

Section 618, Maintenance of Traffic and Traffic Control Plan, of the 2017 Edition of the Mississippi Standard Specifications for Road and Bridge Construction is hereby amended as follows.

907-618.01--Description.

907-618.01.2--Traffic Control Management. Delete subparagraph (g) of Subsection 618.01.2 on page 441, and substitute the following.

- g) Perform a minimum of once-a-week inspections from the Notice to Proceed until a Partial or Final Maintenance Release is obtained. Once work begins, daily daytime inspections and weekly nighttime inspections are required on projects with predominantly daytime work, and daily nighttime inspections and weekly daytime inspections are required on projects with predominantly nighttime work. Weekly inspections will be allowed for periods outside of active construction. When lane closures are present or any non-fixed signs or traffic handling devices such as cones or barrels are in place, inspections shall be performed daily whether work is being performed or not.

907-618.05--Basis of Payment. Delete pay item 618-A on page 449 and substitute the following.

907-618-A: Maintenance of Traffic

- lump sum

MISSISSIPPI DEPARTMENT OF TRANSPORTATION

SPECIAL PROVISION NO. 907-626-11

CODE: (IS)

DATE: 06/24/2024

SUBJECT: Thermoplastic Traffic Markings

Section 626, Thermoplastic Traffic Markings, of the 2017 Edition of the Mississippi Standard Specifications for Road and Bridge Construction is hereby amended as follows.

Delete Section 626 on pages 492 thru 496, and substitute the following.

SECTION 626 - THERMOPLASTIC TRAFFIC MARKINGS

907-626.01--Description. This work consists of furnishing materials and placing thermoplastic pavement markings of the type specified in conformity with these specifications and the details shown on the plans or established. All hot-applied thermoplastic pavement markings shall be coated with a double-drop combination of optics.

This work may also consist of placing an audible bump or puck style marking system on the edge line that provides an audible and vibratory warning when driven over. The marking system shall be a road marking system of the dimensions indicated at regular and predetermined intervals.

This work may also consist of placing a profile or raised shape marking system on centerline or edge line that provides audible and vibratory warning when driven over. The marking system shall be a road marking system of the dimensions indicated and at regular and predetermined intervals. When placed on centerline, the markings system shall consist of an extruded black transverse thermoplastic bar of the dimensions indicated at regular and predetermined intervals.

This work may also consist of placing high contrast thermoplastic markings. High contrast thermoplastic markings shall consist of placing thermoplastic pavement markings over a black thermoplastic pavement marking to enhance the marking's visibility.

All pavement marking material, excluding lines over rumble strips, shall be applied using the extrusion/ribbon method. Lines placed over rumble strips shall be applied using the atomization/spray method.

Permanent pavement marking tape (permanent cold plastic tape) may be used in lieu of hot applied thermoplastic markings. Substitution will only be allowed for pay items 907-626-A through H. Substituted pavement marking tape shall be of the same color and width as that required for the hot applied thermoplastic. Unless otherwise specified, the markings, whether hot applied or pavement marking tape, shall be of the same type of material for the entire project. Stop bars and crosswalks shall not be substituted with pavement marking tape and shall be alkylid hot-applied thermoplastic markings or heat-fused preformed pavement markings. Material and construction requirements for substituted pavement marking tape shall meet the requirements of Special

Provision 907-628. The layout and spacing for substituted pavement markings will remain as shown in the plans, or in the contract documents, for hot applied thermoplastic markings. Measurement of adhesive substituted pavement markings shall be made in accordance with Special Provision 907-628. Payment for adhesive substituted pavement markings shall be made at the unit price for the appropriate hot applied thermoplastic marking.

When thermoplastic pavement markings are used on bridge decks or concrete surfaces, the surface shall be sealed with an epoxy sealer prior to the application of thermoplastic.

907-626.02--Materials. All pavement marking materials shall meet the requirements of Special Provision 907-720-3.

Thermoplastic pavement marking material may be sampled in the field at the time of application by sampling from the marking equipment at the point of extrusion. Samples should be cooled until solid and then packaged into large re-closeable plastic bags and placed into a cardboard box for transport. Field samples will be tested at random or as determined necessary by the Department.

The Contractor shall supply the materials to be used for sampling and packaging. Department personnel shall witness the sampling and shall be responsible for transportation of the sample for testing.

907-626.02.1--Audible Bumps. Audible bumps shall have a profile such that the leading and trailing edges are sloped at a sufficient angle to create an audible and vibratory warning.

Audible bumps shall be at least 0.45 inches above the pavement surface at the highest point of the bump. The height shall be measured after the application of drop-on material. The bumps shall have a minimum dimension of two and one-half inches (2½") in both transverse and longitudinal directions. The bumps may have a drainage channel. The width of each drainage channel shall not exceed one-quarter of an inch (¼") at the bottom of the channel.

907-626.02.2--Audible Transverse Bars. The length of transverse bars is the measurement lateral to the direction of travel, also known as transverse width. The width of transverse bars is the measurement parallel to the travel way.

Transverse bars on centerline shall have a length of 10 inches, a width of three inches (3"), and a height of 350 mils. Transverse bars on centerline shall be placed on 2-foot centers through no-passing zones and 5-foot centers through passing zones. Transverse bars on centerline shall be placed in advance of permanent thermoplastic markings.

Transverse bars on edge lines shall have a length of six inches (6"), a width of three inches (3"), and a height of 350 mils. Transverse bars on edge lines shall be placed on 2-foot centers. Tolerance for the longitudinal and transverse measurements shall be one quarter of an inch (¼") and the tolerance for height shall be 50 mils. The above dimensions are based on 6-inch strip application.

Thermoplastic material for edge line transverse bars shall be as specified on the Plans and meet

the requirements of Special Provision 907-720-3 or as specified on the plans. Thermoplastic material for centerline transverse bars shall be black and shall meet the requirements of Special Provision 907-720.

907-626.02.3--High Contrast Markings. High contrast markings shall be black with the pertinent marking color overlaid on top and shall meet the requirements of Special Provision 907-720-3.

907-626.03--Construction Requirements.

907-626.03.1--Equipment. Equipment for hot application shall be of sufficient size and stability to ensure smooth, uniform, properly aligned markings of the dimensions specified. The equipment shall be suitably equipped for heating and controlling the flow of the material. The equipment shall be constructed to provide continuous mixing and agitation of the material. The conveying parts of the equipment, between the main material reservoir and applicator, shall be so constructed as to prevent accumulation and clogging. The equipment shall be constructed so that all mixing and conveying parts, up to and including the applicator, maintain the material at the plastic temperature. The thermoplastic material shall be dispensed at a temperature recommended by the manufacturer. The applicator shall include a cutoff device remotely controlled to provide clean, square stripe ends and to provide a method for applying skip lines. The thermoplastic reservoir shall be insulated and equipped with an automatic thermostatic control to maintain the proper temperature of the material.

The application equipment shall be capable of automatic placement of intermittent and continuous line patterns in single or double line applications simultaneously. The intermittent timer mechanism shall provide a variable ratio of materials applied and variable cycle length such that accurate placement of new patterns, or replacement of existing patterns can be achieved.

When edge lines are placed over rumble strips, the equipment must be able to apply the marking material using the atomization/spray method instead of extrusion/ribbon method.

The equipment shall also be capable of applying the top dressing of optics (beads) in a manner that firmly embeds them into the surface of the thermoplastic material for at least one half of the diameter of the larger gradation sizes of the optics. The dispensing equipment shall be equipped with an automatic cut-off control for the application of the optics that is synchronized with the cut-off of the thermoplastic material.

Optics applied to the surface of the completed stripe shall be applied by an automatic dispenser attached to the pavement marking equipment in such a manner that the optics are immediately dispensed upon the completed line. The dispenser shall be equipped with an automatic cutoff control, synchronized with the cutoff of the pavement marking equipment. The double-drop optics as defined in 907-720-3 shall be automatically applied at a uniform rate to achieve the minimum retroreflectivity requirements of 907-626.03.3.

Upon request, the Engineer will establish the control points for markings at necessary intervals not to exceed 600 feet on tangents and more often on curves. All additional work necessary to establish intermediate control points shall be performed by the Contractor. On curves, unsightly variations

from the normal curvature will not be permitted unless specifically shown on the plans or ordered by the Engineer.

When edge lines are placed over rumble strips, the equipment must be able to apply the marking material using the atomization/spray method instead of extrusion/ribbon method. To ensure the proper alignment of the rumble stripes, the Contractor will be required to place a layout line to be followed during installation of the edge lines over the rumble strips.

907-626.03.2--Construction Details. The thermoplastic compound shall be screed or ribbon extruded to the pavement surface. Heat-fused, pre-formed pavement markings shall be fusible to asphalt surfaces by means of the normal heat of a propane weed-burner type of torch or other heating device as recommended by the manufacturer. Heat-fused, pre-formed pavement markings shall be instantly highly reflective without the application of additional optics.

Thermoplastic markings shall not be applied to the pavement surface when the pavement surface temperature is less than 55°F. The pavement surface shall be dry, to the satisfaction of the Engineer, before application will be permitted. Unless otherwise specified by the manufacturer, thermoplastic pavement marking material shall be applied to the surface between 400°F and 450°F with a recommended application temperature being 420°F.

Immediately before application, all areas to be marked shall be thoroughly cleaned. Cleaning may be done by rotary brooms, air blast, scrapers, or whatever combination of equipment is necessary to clean the pavement thoroughly without damage to the pavement surface. On areas of pavement cured with compound, the membrane shall be removed completely by shot blasting, sand blasting or other approved method. Before edge striping, particular care shall be taken to remove all vegetation, loose soil, and the like from the area to be marked. Should other methods fail, the surface shall be wetted with a water jet and scrubbed as necessary to dislodge all foreign material. After washing, the surface shall be allowed to dry thoroughly, and all films of dried mud apparent after surface drying shall be removed before application of markings. Marking shall follow as closely as practicable after the surface has been cleaned and dried, but no markings shall be applied until the surface has been inspected and permission given to proceed. The cost for preparing the surface shall be included in the contract unit prices for the marking items.

Unless otherwise directed by the Engineer, traffic stripes that are conflicting with the thermoplastic stripe shall be removed prior to placement of the thermoplastic material. Removal of pavement markings shall be done by a means that will not gouge the surface of the pavement in a manner that requires patching to ensure the integrity of the pavement. Temporary paint stripe may be left in place when satisfactorily placed in the proper location. Any temporary stripe not covered shall be removed. Payment for removal of stripe, except temporary stripe, will be made under Section 202.

On newly constructed asphalt pavements, any sand, grit, or other surface contaminants shall be removed using compressed air and/or sweeping. Water blasting may be necessary to remove surface contaminants which cannot be removed by the use of compressed air and/or sweeping. This work is considered surface preparation.

The finished lines shall have well defined edges and the thickness of thermoplastic markings above the roadway surface shall be no less than 90 mils for edge lines, center lines, lane lines, barrier lines, and detail stripe including gore markings, and no less than 120 mils for crosswalks, stop lines, and railroad, word and symbol markings. The minimum thickness, as required above, will be measured in the center of the line when gauged. The minimum thickness one-half inch (1/2") from the edges shall not be less than 75% of the thickness required in the center.

Any thermoplastic traffic marking less than the required thickness shall be corrected by recapping at no additional costs to the Department. Although a thickness tolerance of 25 percent from center to edge is allowed, a consistent underrun of any amount in thickness as determined by the Engineer will not be acceptable.

The length and width of lines shall be within a tolerance of ±3 inches and ±1/8 inch, respectively. For skip markings, the tolerance for intervals shall not exceed the line length tolerance. On curves, unsightly variations from the normal curvature will not be permitted unless specifically shown on the plans or ordered by the Engineer.

Heat-fused, pre-formed pavement markings shall be supplied with a minimum average thickness of 90 mils before application on the roadway surface.

All newly applied thermoplastic material shall be protected from traffic until the material is sufficiently dry so as not to sustain damage from vehicle tires. Any material so damaged by traffic shall be repaired, and the thermoplastic material tracked onto the pavement shall be removed and replaced.

907-626.03.3--Reflectivity Requirements. The longitudinal pavement markings shall meet the following retroreflectivity values when measured within 10 to 30 calendar days of placement, after removing loose beads.

Table 1. Minimum Dry Retroreflectivity

Color	All Stripe without Rumble mcd/m ² /lx	Rumble Stripe mcd/m ² /lx
White	375	250
Yellow	275	150

907-626.03.3.1--Measuring Devices. Retroreflectivity measurements shall be taken using a vehicle mounted mobile retroreflectometer using 30-meter geometry with video and mapping capabilities as per AASHTO T-398. The retroreflectometer and operator shall be certified by the manufacturer, authorized representative of the manufacturer, or an MDOT approved program such as the Texas A&M Transportation Institute (TTI) Mobile Retroreflectometer Certification Program.

907-626.03.3.2--Acceptance Procedure. Averages of the mobile measurements shall be provided for every 0.1 miles unless otherwise specified or approved. Take measurements on each section of roadway for each series of markings (i.e., edge line, center skip line, each line of a double line, etc.) and for each direction of traffic flow. Measure each line in both directions for centerlines on two-way roadways (i.e., measure both double solid line in both directions and measure all center

skip lines in both directions). Furnish measurements in compliance with the below requirements. Use all equipment in accordance with the manufacturer's recommendations and directions. Inform the Engineer at least 24 hours before taking any measurements.

A marking meets the retroreflectivity requirements if:

- The combined average retroreflectivity measurement for a one-mile segment meets the minimum retroreflectivity values specified, and
- No more than 30% of all the retroreflectivity measurement values are below the minimum retroreflectivity requirements value within the one-mile segment.

The one-mile segment will start from the beginning of the data collection and end after a mile worth of measurements have been taken; each subsequent mile of measurements will be a new segment. Centerlines with two (2) stripes (either solid or broken) will result in two (2) miles of data for each mile segment. Each centerline stripe must be tested for compliance as a stand-alone stripe.

The Contractor may elect to restripe with a minimum of 0.060 in. (60 mils) at no cost to the Department each one-mile segment that failed to meet the minimum retroreflectivity requirements. Measurements shall be retaken within 10 to 30 calendar days after the second application for the mile segment for that series of markings. If the markings do not meet minimum retroreflectivity after the second application, the Engineer may require removal of all existing markings, a new application as initially specified, and a repeat of the application process until minimum retroreflectivity requirements are met.

907-626.03.3.3--Mobile Retroreflectivity Data Collection. Mobile Retroreflectivity Data Collection (MRDC) shall be conducted on dry pavement only and when the ambient air temperature is greater than 40°F. Data shall be submitted to the Engineer no later than 3 working days after the day the data is collected. Submit all raw data collected in addition to all other data submitted. Provide data files in Microsoft Excel format or a format approved by the Engineer. The data file and video must contain the following information.

907-626.03.3.3.1--Data File. Data files shall be provided with the following:

- Date;
- District;
- County;
- Name of mobile retroreflectometer operator;
- Route number with reference markers or other reference information provided by the Engineer to indicate the location of beginning and end data collection points on that roadway;
- Cardinal direction;
- Line type (single solid, single broken, double solid, etc.);
- Line color;
- File name corresponding to video;
- Data for each centerline listed separately;

- Average reading taken for each 0.1-mi. interval (or interval designated by the Engineer);
- Accurate GPS coordinates (within 20 ft.) for each interval;
- Color-coding for each interval indicating passing or failing, unless otherwise directed by the Engineer (passing and failing thresholds provided by the Engineer);
- Graphical representation of the MRDC (y-axis showing retroreflectivity and x-axis showing intervals) corresponding with each data file;
- Distance in miles driven while measuring the pavement markings;
- Event codes (pre-approved by the Engineer) indicating problems with measurement;
- Upper validation threshold (may be included separately with the raw data but must be clearly identified with the data collected using that threshold).

907-626.03.3.3.2--Map. A map shall be provided in an electronic format approved by the Engineer with each MRDC submission that includes the following information:

- Date;
- District number;
- County;
- Color-coded 1-mi. intervals (or interval length designated by the Engineer) for passing and failing retroreflectivity values or retroreflectivity threshold values provided by the Engineer; and
- Percentage of passing and failing intervals, if required by the Engineer.

907-626.03.3.3.3--Video. A high-quality video file shall be provided with the following information:

- Date and corresponding data file name on label;
- District number;
- County;
- Route number with reference markers or other designated reference information to indicate the location of beginning and end collection points on that roadway; and
- Retroreflectivity values presented on the same screen with the following information:
 - Date;
 - Location;
 - Starting and ending mileage;
 - Total miles;
 - Retroreflectivity readings; and
 - Upper validation thresholds (may be included separately with the raw data but must be clearly identified with the data collected using that threshold).

907-626.03.4--Reflectivity Verification Testing. The Engineer or a third party may perform retroreflectivity verification testing on any project. At a minimum, each Contractor performing work for the Department will be verified on an annual basis. The Contractor-submitted retroreflectivity data will be compared to the verification test data to determine acceptability of the Contractor's mobile retroreflectometer data. Comparison of the data will result in one of the two scenarios below:

- Contractor's Data is Validated – If the difference between Contractor's and Engineer/third party data is 20% or less, then the Contractor's data is validated. The Contractor's data will be used for acceptance.
- Contractor's Data is not Validated – If the difference between Contractor's and Engineer/third party data is more than 20%, then the Contractor's data is not validated. The Engineer/third party data will be used for acceptance and the Contractor will be required to take corrective action prior to additional Contractor data collection and may require re-certification of the mobile retroreflectometer.

907-626.04--Method of Measurement. Thermoplastic stripe completed in accordance with the plans and specifications will be measured by the mile or by the linear foot, as indicated, from end-to-end of individual stripes. In the case of skip lines the measurement will include skip intervals. The length used to measure centerline, lane lines, and edge stripes will be the horizontal length computed along the roadway.

Detail traffic stripe will be measured by the linear foot from end-to-end of individual stripes. Measurements will be made along the surface of each stripe and will exclude skip intervals where skips are specified. Stripes more than six inches (6") in width will be converted to equivalent lengths of 6-inch stripe.

Hot-applied legend, which is to include railroad markings, pedestrian crosswalks, and stop lines, will be measured by the square foot or linear foot. Pay areas of individual letters and symbols will usually be shown on the plans and measured by the square foot. Transverse railroad bands, pedestrian crosswalks and stop lines will generally be measured by the linear foot, in which case, stripes more than six inches (6") in width will be converted to equivalent lengths of 6-inch widths.

Pre-formed legend which is to include railroad markings and pedestrian crosswalks will be measured and paid for by each.

The length measured for thermoplastic audible bump edge stripe will not include the permanent thermoplastic edge stripe. Permanent thermoplastic edge stripe will be measured for payment under a separate pay item.

Thermoplastic audible bar centerline skip stripe will be measured by the linear foot or mile. Measurements will be made along the surface from end-to-end of the stripe and will include skip intervals. The length used to measure audible bar centerline stripe will be the horizontal length computed along the roadway. The length measured for thermoplastic audible bar centerline skip stripe will not include the permanent centerline continuous or skip stripe. Permanent centerline continuous and skip stripe will be measured for payment under separate pay items.

Thermoplastic audible bar edge stripe will be measured by the linear foot or mile. Measurements will be made along the surface from end-to-end of the stripe. The length used to measure thermoplastic audible bar edge stripe will be the horizontal length computed along the roadway. The length measured for thermoplastic audible bar edge stripe will not include the permanent thermoplastic edge stripe. Permanent thermoplastic edge stripe will be measured for payment

under a separate pay item.

907-626.05--Basis of Payment. Thermoplastic traffic markings will be paid for at the contract unit price per mile, linear foot, square foot or each as applicable. Any deductions for non-satisfactory material test results will be made after final testing has been performed.

Payment will be made under:

- 907-626-A: 6" Thermoplastic Traffic Stripe, Skip White - per linear foot or mile
- 907-626-B: 6" Thermoplastic Traffic Stripe, Continuous White - per linear foot or mile
- 907-626-C: 6" Thermoplastic Edge Stripe, Continuous White - per linear foot or mile
- 907-626-D: 6" Thermoplastic Traffic Stripe, Skip Yellow - per linear foot or mile
- 907-626-E: 6" Thermoplastic Traffic Stripe, Continuous Yellow - per linear foot or mile
- 907-626-F: 6" Thermoplastic Edge Stripe, Continuous Yellow - per linear foot or mile
- 907-626-G: Thermoplastic Detail Stripe, Color * - per linear foot
- 907-626-H: Thermoplastic Legend, Color * - per linear foot, square foot, or per each
- 907-626-Q: Thermoplastic Audible Bump Edge Stripe -per linear foot or mile
- 907-626-R: Thermoplastic Detail Audible *** Stripe, Color **, -per mile
- 907-626-AA: 6" High Contrast Thermoplastic Traffic Stripe, Skip White - per linear foot or mile
- 907-626-BB: 6" High Contrast Thermoplastic Traffic Stripe, Continuous White - per linear foot or mile
- 907-626-CC: 6" High Contrast Thermoplastic Edge Stripe, Continuous White - per linear foot or mile
- 907-626-DD: 6" High Contrast Thermoplastic Traffic Stripe, Skip Yellow - per linear foot or mile
- 907-626-EE: 6" High Contrast Thermoplastic Traffic Stripe, Continuous Yellow - per linear foot or mile
- 907-626-FF: 6" High Contrast Thermoplastic Edge Stripe, Continuous Yellow - per linear foot or mile

907-626-GG: High Contrast Thermoplastic Detail Stripe, Color * - per linear foot

907-626-HH: High Contrast Thermoplastic Legend, Color * - per linear foot, square foot,
or each

- * Indicate Blue - ADA if applicable
- ** Indicate White or Black
- *** Indicate Centerline - Passing Zone, Centerline - No-Passing Zone, or Edge Line

MISSISSIPPI DEPARTMENT OF TRANSPORTATION

SPECIAL PROVISION NO. 907-627-1

CODE: (IS)

DATE: 06/24/2024

SUBJECT: Raised Pavement Markers

Section 627, Raised Pavement Markers, of the 2017 Edition of the Mississippi Standard Specifications for Road and Bridge Construction is hereby amended as follows:

Delete Subsection 627.02 on page 496, and substitute the following.

907-627.02--Materials. Pavement and jiggle markers of the types specified shall conform to the applicable requirements of Subsection 907-720.06 and shall be listed on the Department's APL.

Type B through G High Performance reflective markers shall be listed on the Department's APL for high performance raised pavement markers.

The bituminous adhesive for pavement markers shall meet the requirements of Subsection 907-720.07.3.

907-627.05--Basis of Payment. Add the “907” prefix to the pay items listed on page 498.

MISSISSIPPI DEPARTMENT OF TRANSPORTATION

SPECIAL PROVISION NO. 907-700-1

CODE: (IS)

DATE: 10/25/2022

SUBJECT: Materials and Tests

Section 700, Materials and Tests, of the 2017 Edition of the Mississippi Standard Specifications for Road and Bridge Construction is hereby amended as follows.

After Subsection 700.01 on page 713, add the following.

907-700.01.1--Buy America Materials Sourcing Requirements for Construction Materials.

As related to the requirements in Subsection 907-106.14, Construction Materials shall include an article or material that is or consists primarily of non-ferrous metals; plastic and polymer-based products (including polyvinylchloride, composite building materials, and polymers used in fiber optic cables); glass (including optic glass); lumber; or drywall. Construction Materials which are exempt from the requirements in Subsection 907-106.14 include the following: cement or cementitious materials; aggregates such as stone, sand, or gravel; or aggregate binding agents or additives.

For Construction Materials, both the final manufacturing process and the manufacturing stage immediately preceding the final manufacturing process shall occur domestically.

907-700.01.2--Compliance Requirements. Prior to incorporation into the work, the Contractor shall furnish the Project Engineer with certificates of compliance documenting conformance to the requirements of Subsection 907-106.14.

The certificates shall be on the Supplier's/Manufacturer's letterhead, containing the following:

- Project number
- Name of manufacturer and address of manufacture location
- Material description
- Batch number / Heat number / Lot number
- Bill of lading number
- Date received
- "I certify each material listed on this certificate to be permanently incorporated in this project has been manufactured domestically."
- Signature of an authorized representative of the Supplier/Manufacturer

MISSISSIPPI DEPARTMENT OF TRANSPORTATION

SPECIAL PROVISION NO. 907-701-3

CODE: (IS)

DATE: 05/04/2021

SUBJECT: Hydraulic Cement

Section 701, Hydraulic Cement, of the 2017 Edition of the Mississippi Standard Specifications for Road and Bridge Construction is hereby amended as follows.

907-701.01--General. In the first sentence of the second paragraph of Subsection 701.01 on page 718, change “mills” to “plants.”

In the second sentence of the sixth paragraph of Subsection 701.01 on pages 718 and 719, change “shall” to “will.”

907-701.02--Portland Cement.

907-701.02.1-General.

907-701.02.1.2--Alkali Content. Delete the sentence in Subsection 701.02.1.2 on page 719, and substitute the following.

When used in portland cement concrete, the total alkali contribution from all cement types in this Subsection shall not exceed 4.0 lb. per cubic yard of concrete calculated as follows:

$$\text{lb alkali per cu Yd} = \frac{(\text{lb cement per cu Yd}) \times (\% \text{Na}_2\text{O equivalent in cement})}{100}$$

In the above calculation, the maximum cement alkali content reported on the cement mill certificate shall be used. An example calculation can be found in the Department’s *Concrete Field Manual*.

907-701.02.2--Replacement by Other Cementitious Materials. Delete the paragraph in Subsection 701.02.2 on page 719, and substitute the following.

The maximum replacement of cement by weight is 25% for fly ash or 50% for ground granulated blast furnace slag (GGBFS). Replacement contents below 20% for fly ash or 45% for GGBFS may be used, but will not be given any special considerations, such as the maximum acceptance temperature for portland cement concrete containing pozzolans in Subsection 804.02.13.1.5. Special considerations shall only apply for replacement of cement by fly ash or GGBFS.

Delete Subsection 701.02.2.1 on pages 719 and 720, and substitute the following.

907-701.02.2.1--Portland Cement Concrete Exposed to Soluble Sulfate Conditions or Seawater.

When portland cement concrete is exposed to moderate or severe soluble sulfate conditions, or to seawater, cement types and replacement of cement by Class F fly ash or GGBFS shall be as follows in Table 1. Class C fly ash shall not be used as a replacement for cement in any of the sulfate exposure conditions listed in Table 1.

Table 1- Cementitious Materials for Soluble Sulfate Conditions or Seawater

Sulfate Exposure	Water-soluble sulfate (SO ₄) in soil, % by mass	Sulfate (SO ₄) in water, ppm	Cementitious material required
Moderate and Seawater	0.10 - 0.20	150 - 1,500	Type I cement with one of the following replacements of cement by weight: 24.5 - 25.0% Class F fly ash, or 49.5 - 50.0% GGBFS or Type II ^{**} cement
Severe	0.20 - 2.00	1,500 - 10,000	Type I cement with a replacement by weight of 49.5 - 50.0% GGBFS, or Type II [*] cement with one of the following replacements of cement by weight: 24.5 - 25.0% Class F fly ash, or 49.5 - 50.0% GGBFS

* Type III cement conforming to AASHTO M85 with a maximum 8% tricalcium aluminate (C₃A) may be used in lieu of Type II cement as allowed in Subsection 701.02.1; this cement is given the designation “Type III(MS).”

** Class F fly ash or GGBFS may be added as a replacement for cement as allowed in Subsection 907-701.02.2.

Delete Subsection 701.02.2.2 on page 720, and substitute the following.

907-701.02.2.2--Portland Cement for Soil Stabilization Exposed to Soluble Sulfate Conditions or Seawater. When portland cement for use in soil stabilization is exposed to moderate or severe soluble sulfate conditions, or to seawater, cement types and replacement of cement by Class F fly ash or GGBFS shall meet the requirements of Subsection 701.02.2.1.

907-701.04--Blended Hydraulic Cement.

907-701.04.1--General. Delete Subsection 701.04.1.1 on page 720, and substitute the following.

907-701.04.1.1--Types of Blended Hydraulic Cement. Blended hydraulic cements (blended cements) shall be of the following types and conform to AASHTO M 240:

- Type II – Portland-limestone cement
- Type IP – Portland-pozzolan cement
- Type IS – Portland blast-furnace slag cement

Blended cement Types II, IP, and IS meeting the “MS” sulfate resistance requirement listed in AASHTO M 240, Table 3 shall have the “(MS)” suffix added to the type designation.

907-701.04.1.2--Alkali Content. Delete the sentence in Subsection 701.04.1.2 on page 720, and substitute the following.

All blended cement types shall be made with clinker that would result in cement meeting the requirements of Subsection 701.02.1.2 when used in the production of AASHTO M 85, Type I or Type II cement.

The blended cement manufacturer shall include the percent equivalent alkalis as Na₂O on their cement mill reports.

When calculating the total alkali contribution with blended cements, use the equivalent alkali content of the base portland cement. An example calculation for cases where blended cements are used can be found in the Department’s *Concrete Field Manual*.

907-701.04.2--Replacement by Other Cementitious Materials. Delete the paragraph in Subsection 701.04.2 on page 720, and substitute the following.

The maximum replacement of blended cement Type II by weight is 35% for fly ash or 50% for GGBFS. Replacement contents below 20% for fly ash or 45% for GGBFS may be used, but will not be given any special considerations, such as the maximum acceptance temperature for blended cement concrete containing pozzolans in Subsection 804.02.13.1.5. Special considerations shall only apply for replacement of blended cement by fly ash or GGBFS.

No additional cementitious materials, such as portland cement, blended cement, fly ash, GGBFS, or others, shall be added to or as a replacement for blended cement Types IP and IS.

Delete Subsection 701.04.2.1 on pages 720 and 721, and substitute the following.

907-701.04.2.1--Blended Cement Concrete Exposed to Soluble Sulfate Conditions or Seawater. When blended cement concrete is exposed to moderate or severe soluble sulfate conditions, or to seawater, cement types and replacement of cement by Class F fly ash or GGBFS shall be as follows in Table 2. Class C fly ash shall not be used as a replacement for cement in any of the sulfate exposure conditions listed in Table 2.

Table 2- Cementitious Materials for Soluble Sulfate Conditions or Seawater

Sulfate Exposure	Water-soluble sulfate (SO ₄) in soil, % by mass	Sulfate (SO ₄) in water, ppm	Cementitious material required
Moderate and Seawater	0.10 - 0.20	150 - 1,500	Type IL (MS) * cement, Type IL cement with one of the following replacements of cement by weight: 24.5 - 35.0% Class F fly ash, or 49.5 - 50.0% GGBFS, Type IP (MS) cement, or Type IS (MS) cement
Severe	0.20 - 2.00	1,500 - 10,000	Type IL cement with a replacement of cement by weight of 49.5 - 50.0% GGBFS, or Type IL (MS) cement with one of following replacements of cement by weight: 24.5 - 35.0% Class F fly ash, or 49.5 - 50.0% GGBFS

* Class F fly ash or GGBFS may be added as a replacement for cement as allowed in Subsection 907-701.04.2.

Delete Subsection 701.04.2.2 on page 721, and substitute the following.

907-701.04.2.2--Blended Cement for Soil Stabilization Exposed to Soluble Sulfate Conditions or Seawater. When blended cement for use in soil stabilization is exposed to moderate or severe soluble sulfate conditions, or to seawater, cement types and replacement of cement by Class F fly ash or GGBFS shall meet the requirements of Subsection 701.04.2.1.

Delete Subsection 701.04.3 on page 721.

MISSISSIPPI DEPARTMENT OF TRANSPORTATION

SPECIAL PROVISION NO. 907-702-4

CODE: (IS)

DATE: 09/11/2018

SUBJECT: Bituminous Materials

Section 702, Bituminous Materials, of the 2017 Edition of the Mississippi Standard Specifications for Road and Bridge Construction is hereby amended as follows.

907-702.04--Sampling. Delete the sentence in Subsection 702.04 on page 722, and substitute the following.

Sampling of bituminous materials shall be as set out in AASHTO R 66.

907-702.07--Emulsified Asphalt. Delete the last sentence in Subsection 702.07 on page 724, and substitute the following.

Asphalt for fog seal shall conform to the requirements of Subsection 907-702.12, Table V.

907-702.12--Tables. Delete Table V in Subsection 702.12 on page 729, and substitute the following.

**TABLE V
SPECIFICATION FOR FOG SEAL**

Test Requirements	LD-7		CHPF-1		Test Method
	Min.	Max.	Min.	Max.	
Viscosity, Saybolt Furol, @ 25°C, Sec.	10	100	-	100	AASHTO T 72
Storage Stability Test, 24 hr, %	-	1	-	1	AASHTO T 59
Settlement, 5 day, %	-	5	-	-	AASHTO T 59
Oil Distillate, %	-	1	-	-	AASHTO T 59
Sieve Test, % *	-	0.3	-	0.1	AASHTO T 59
Residue by Distillation, %	40	-	40	-	AASHTO T 59
Test on Residue from Distillation					
Penetration @ 25°C, 100g, 5 sec	-	20	40	90	AASHTO T 49
Softening Point, °C	65	-	-	-	ASTM D 36
Solubility in trichloroethylene, %	97.5	-	-	-	AASHTO T 44
Elastic Recovery @ 25°C, %	-	-	40	-	AASHTO T 301
Original DSR @ 82° (G*/Sinδ, 10 rad/sec)	1	-	-	-	AASHTO T 111

* The Sieve Test result is tested for reporting purposes only and may be waived if no application problems are present in the field.

MISSISSIPPI DEPARTMENT OF TRANSPORTATION

SPECIAL PROVISION NO. 907-703-2

CODE: (SP)

DATE: 11/29/2022

SUBJECT: Gradation

Section 703, Aggregates, of the 2017 Edition of the Mississippi Standard Specifications for Road and Bridge Construction is hereby amended as follows.

907-703.03--Coarse Aggregates for Hydraulic Cement Concrete.

907-703.03.2--Detail Requirements.

907-703.03.2.4--Gradation. In the table in Subsection 703.03.2.4 on page 734, add 100 for the percent passing by weight on the 1½-inch sieve for Size No. 67 aggregates.

Delete Note 2 under the table in Subsection 703.03.2.4 on page 734, and substitute the following.

Note ² – 100 percent shall pass the 1-inch sieve for Size 67 used in Class F and Class FX concrete.

MISSISSIPPI DEPARTMENT OF TRANSPORTATION

SPECIAL PROVISION NO. 907-705-1

CODE: (IS)

DATE: 06/13/2018

SUBJECT: Stone Riprap

Section 705, Stone Blanket Protection and Filter Blanket Materials, of the 2017 Edition of the Mississippi Standard Specifications for Road and Bridge Construction is hereby amended as follows.

907-705.04--Stone Riprap. Delete the last sentence of the first paragraph of Subsection 705.04 on page 750, and substitute the following.

Quality requirements for rock to be furnished under these specifications will come from a pre-approved source and be visually approved prior to use.

MISSISSIPPI DEPARTMENT OF TRANSPORTATION

SPECIAL PROVISION NO. 907-707-3

CODE: (IS)

DATE: 10/27/2021

SUBJECT: Joint Materials

Section 707, Joint Materials, of the 2017 Edition of the Mississippi Standard Specifications for Road and Bridge Construction is hereby amended as follows.

907-707.02--Joint Filler.

907-707.02.2--Preformed Sponge, Rubber, Cork and Closed-Cell Polypropylene Foam Joint Fillers for concrete Paving and Structural Constructions. Delete the two paragraphs of Subsection 707.02.2 on page 755, and substitute the following.

Preformed joint filler shall conform to AASHTO M 153 for sponge, rubber, and cork and tested according to ASTM D545. The type required will be indicated on the plans.

Closed-cell polypropylene foam shall conform to the requirements in ASTM D8139 and tested in accordance with ASTM D545.

907-707.02.3--Wood. Delete paragraph (b) of Subsection 707.02.3 on page 755, and substitute the following:

- (b) Dimensions shall be as shown on the plans. Dimensions shown on the plans are “dressed” sizes in accordance with Table 3 of the American Softwood Lumber Standard, SP-20. At the discretion of the Engineer, a 3/4-inch dressed board may be used in lieu of a 1-inch dressed board. A tolerance of plus or minus 1/16 inch thickness and plus or minus 1/8 inch width will be permitted. For slip-form paving a tolerance of minus 1/4 inch on each end in length will be permitted.

907-707.06--Flexible Plastic Gasket for Joining Conduit. Delete the third paragraph of Subsection 707.06 on page 756, and substitute the following.

The Department may require the performance test described in ASTM C 990.

MISSISSIPPI DEPARTMENT OF TRANSPORTATION

SPECIAL PROVISION NO. 907-711-2

CODE: (IS)

DATE: 09/11/2018

SUBJECT: Plain Steel Wire

Section 711, Reinforcement and Wire Rope, of the 2017 Edition of the Mississippi Standard Specifications for Road and Bridge Construction is hereby amended as follows.

907-711.02--Deformed and Plain Carbon-Steel Bars for Concrete Reinforcing.

907-711.02.3--Steel Welded and Non-Welded Wire Reinforcement, Plain and Deformed, for Concrete.

907-711.02.3.1--Plain Steel Wire. Delete the sentence in Subsection 711.02.3.1 on pages 780 and 781, and substitute the following.

Plain steel wire and plain steel welded wire shall conform to the requirements of AASHTO M 336.

MISSISSIPPI DEPARTMENT OF TRANSPORTATION

SPECIAL PROVISION NO. 907-712-1

CODE: (SP)

DATE: 12/07/2021

SUBJECT: Fence and Guardrail

Section 712, Fence and Guardrail, of the 2017 Edition of the Mississippi Standard Specifications for Road and Bridge Construction is hereby amended as follows.

907-712.01--General. After the sentence in Subsection 712.01 on page 785, add the following.

All materials' inspection, testing, and certification will be performed in accordance with the requirements of the current version of the Department's *Materials Division Inspection, Testing, and Certification Manual*.

Delete Subsections 712.02 and 712.03 on page 785, and substitute the following.

907-712.02--Barbed Wire. Barbed wire shall conform to the requirements of AASHTO M 280. In the coastal counties of Hancock, Harrison, and Jackson, either Coating Type Z Class 3 or Coating Type A shall be furnished. In all other areas of the State, either Coating Type Z Class 1, Coating Type Z Class 3, Coating Type ZA Class 60, or Coating Type A shall be furnished.

907-712.03--Metallic-Coated, Steel Woven Wire Fence Fabric. Woven wire fencing (i.e., "hog wire") shall conform to the requirements of AASHTO M 279. In the coastal counties of Hancock, Harrison, and Jackson, either Coating Type Z Class 3 or Coating Type A shall be furnished. In all other areas of the State, either Coating Type Z Class 1, Coating Type Z Class 3, Coating Type ZA Class 60, or Coating Type A shall be furnished.

907-712.04--Chain Link Fence. Delete Subsections 712.04.1 thru 712.04.7 on pages 785 & 786, and substitute the following.

907-712.04.1--Fabric. In the coastal counties of Hancock, Harrison, and Jackson, either Type I Class D, Type II, Type III, or Type IV fabrics shall be furnished. In all other areas of the State, either Type I Class C, Type I Class D, Type II, Type III, or Type IV fabrics shall be furnished.

907-712.04.2--Tie Wire. Tie wire shall be of the same material as the fencing wire being used, shall be of good commercial quality, and shall meet the requirements of AASHTO M 181. Either Type I, Type II, Type III, or Type IV tie wire shall be furnished.

907-712.04.3--Tension Wire. Tension wire shall be of the same material as the fencing wire being used, shall be of good commercial quality, and shall meet the requirements of AASHTO M 181. In the coastal counties of Hancock, Harrison, and Jackson, either Type I Class 3, Type II, Type III, or Type IV tension shall be furnished. In all other areas of the State, either Type II, Type III, Type IV, or Type I Classes 1, 2, or 3 tension wires shall be furnished.

907-712.04.4--Posts Rails, Gate Frames, and Expansion Sleeves. Posts, rails, gate frames, and expansion sleeves shall conform to the requirements for posts in Subsection 712.05.2, unless otherwise designated in the contract.

907-712.04.5--Miscellaneous Fittings and Hardware. Miscellaneous fittings and hardware shall conform to the requirements of Subsection 712.16.

907-712.05--Fence Posts and Braces.

907-712.05.1--Treated Timber Posts and Braces.

907-712.05.1.1--General. Delete the third, fourth, fifth, and sixth paragraphs of Subsection 712.05.1.1 on page 787, and substitute the following.

All wood posts and braces shall be treated in accordance with Subsections 718.03 and 718.04.

907-712.05.1.2--Round Posts. Delete the last sentence of the last paragraph of Subsection 712.05.1.2 on page 788.

907-712.05.1.3--Sawed Posts. Delete the last sentence of the paragraph of Subsection 712.05.1.3 on page 788.

907-712.05.1.4--Sawed Braces. Delete the last sentence of the paragraph of Subsection 712.05.1.4 on page 788.

Delete Subsection 712.05.2 on page 788, and substitute the following.

907-712.05.2--Metal Posts.

907-712.05.2.1--Round Steel Pipe. Round steel pipe shall meet the requirements of AASHTO M 181, either Grade 1 (i.e., meeting the requirements in ASTM F 1083) or Grade 2 (i.e., meeting the requirements of ASTM F 1043).

Round steel pipe shall be sized in accordance with NPS (nominal pipe size) designations as shown on Plans, and not according to the outer or inner pipe diameter.

907-712.05.2.2--Steel Fence Post and Assemblies, Hot-Wrought. Steel posts with the following section shapes, Tee, channel or U, and Y-Bar shall meet the requirements of AASHTO M 281, galvanized in accordance with the requirements of AASHTO M 111, unless otherwise specified in the contract. Acceptance of these steel posts shall be by certification from the manufacturer, producer, supplier, or fabricator, as applicable.

907-712.05.2.3--Blank.

907-712.05.2.4--Steel H-Beam Posts. Steel H-Beam posts shall be produced from structural quality weldable steel having a minimum yield strength of 45,000 psi and shall be galvanized in accordance with ASTM A 123. Steel H-Beam line posts shall be 2.250 inches by 1.625 inches and shall weigh 3.43 pounds per foot. A tolerance of plus or minus 5.0 percent is allowed for

weight per foot. A tolerance of plus or minus 1.0 percent is allowed for dimensions.

907-712.05.2.5--Aluminum-Alloy Posts and Assemblies. Round aluminum-alloy posts shall meet the requirements of ASTM B 241, Alloy 6061, T6. Aluminum-Alloy H-Beam posts shall meet the requirements of ASTM B 221, Alloy 6061, T6.

907-712.05.2.6--Formed Steel Section Posts. Formed steel section posts, "C" sections, shall be formed from sheet steel conforming to ASTM A 1011, Grade 45, and shall be galvanized in accordance with ASTM A 123.

907-712.06--Guard and Guardrail Posts.

907-712.06.2--Treated Wood Posts.

907-712.06.2.1--Square Posts. Delete the paragraph in Subsection 712.06.2.1 on page 789, and substitute the following.

All square posts shall be inspected for conformance with Section 712.05, except that the posts may be rough and shall be within $\pm 3/8$ " of the dimensions shown on the plans.

907-712.06.2.2--Round Posts. Delete the paragraph in Subsection 712.06.2.2 on page 789, and substitute the following.

All round posts shall be inspected for conformance with Section 712.05, except that the posts shall be of the shape and dimensions shown on the plans.

907-712.06.5--Treated Wood Blocks for Use with Metal Guardrail Posts. Delete the paragraphs of Subsection 712.06.5 on pages 789 & 790, and substitute the following.

Treated wood blocks for use with metal guardrail posts shall be within $\pm 3/8$ " of the size and dimensions shown on the plans, except that a minus tolerance shall not be allowed for the slotted width in which the metal post must fit.

Delete Subsection 712.16 on page 791, and substitute the following.

907-712.16--Hardware. All ferrous metal hardware for fencing such as bolts, nuts, washers, and metal straps shall be as specified on the plans and galvanizing shall not be less than 1.0 ounce per square foot of uncoated area. Aluminum coated hardware shall be coated with aluminum meeting the requirements of AASHTO M 181 for aluminum coating and at the rate of not less than 0.4 ounces per square foot of uncoated area.

Aluminum alloy hardware shall conform to the requirements of ASTM B 221 for extruded aluminum alloy 6063, T6. The finished members shall be of uniform quality.

Aluminum-zinc coated hardware shall be coated with an aluminum-zinc alloy meeting the chemical requirements and weight of coating specified for aluminum-zinc alloy coated metal gates.

MISSISSIPPI DEPARTMENT OF TRANSPORTATION

SPECIAL PROVISION NO. 907-714-3

CODE: (SP)

DATE: 08/31/2021

SUBJECT: Miscellaneous Materials

Section 714, Miscellaneous Materials, of the 2017 Edition of the Mississippi Standard Specifications for Road and Bridge Construction is hereby amended as follows.

907-714.01--Water.

907-714.01.1--General. Delete the last sentence of the second paragraph in Subsection 714.01.1 on page 794.

907-714.01.2--Water for Use in Concrete. Delete Subsection 714.01.2 on page 794, and substitute the following:

Water from municipal sources is permitted be used as mixing water in concrete, mortar, and grout without Department testing. Water from non-municipal water sources used in mixing of concrete, mortar, and grout which does not meet the requirements in Subsection 714.01.1 shall be tested for conformance as required in AASHTO M157, Table 1 and Table 2.

907-714.01.3--Water for Use in Chemically Stabilized Based. Delete the first sentence of first paragraph in Subsection 714.01.3 on page 794, and substitute the following:

Water used in the construction of bases that contain cement, lime, or other chemical additive shall be as set out in Subsection 714.01.1. Water from municipal sources is permitted to be used without testing for conformance to the requirements below. If water is not from a municipal source, it shall not contain impurities in excess of the following limits:

Delete Subsection 714.01.6 on page 795, and substitute the following.

907-714.01.6--Blank.

907-714.05--Fly Ash.

907-714.05.1--General. Delete the first sentence of the fifth paragraph in Subsection 714.05.1 on page 797.

907-714.13--Geotextiles.

907-714.13.11--Tables. Delete Table 1 in Subsection 714.13.11 on page 813, and substitute the following.

Table 1 - Geotextiles

Type Designation	I ¹ Sediment Control	II ¹ Control	III Drainage	IV Paving	V Separation & Drainage		VI Separation, Stabilization & Reinforcement		VIII High Strength	IX High Strength	Test Method
					Woven	Non-Woven	Woven	Non-Woven			
Grab Strength (lb)	50	90	110	90	200	280	180	450	280	280	ASTM D 4632
Elongation (%)	----	50% max @ 45 lb	20% min	50% min @ break	50% min	50% max	50% min	50% max	50% min	50% min	ASTM D 4632
Seam Strength (lb)	----	----	70	----	180	240	160	400	240	240	ASTM D 4632
Puncture Strength (lb)	----	----	40	----	80	110	75	180	115	115	ASTM D 6241
Trapezoidal Tear (lb)	----	----	40	----	80	100	70	150	100	100	ASTM D 4533
Asphalt Retention (gal/yd ²)	----	----	----	0.2	----	----	----	----	----	----	ASTM D 6140
Permittivity (sec ⁻¹) min	0.05	0.05	0.5	----	0.2	0.2	0.2	0.2	0.2	0.2	ASTM D 4491
AOS Woven (mm) max	0.60	0.60	0.6	----	0.6	0.43	----	0.43	----	----	ASTM D 4751
AOS Non-Woven (mm) max	0.84	0.84	0.43	----	0.43	----	0.43	----	0.43	0.43	----
Tensile Strength after UV (% Retained)	70% @ 500 hr	70% @ 500 hr	50% @ 500 hr	----	50% @ 500 hr	50% @ 500 hr	50% @ 500 hr	50% @ 500 hr	50% @ 500 hr	50% @ 500 hr	ASTM D 4355
Melting Point °(F)	----	----	----	325	----	----	----	----	----	----	ASTM D 276
Minimum Ultimate Tensile Strength ³ (lb/in)	----	----	----	----	----	----	----	----	660	2000	ASTM D 4595

Notes: 1 - All property values, with the exception of apparent opening size (AOS), represent minimum average roll values in the weakest principal direction. Values for AOS represent the maximum average roll values, 2 - Values not identified in this table should meet manufacturer certification for the use and application, 3 - Machine direction

Delete Subsection 714.15 on pages 816 and 817 and substitute the following.

907-714.15--Geogrids.

907-714.15.1--General. A geogrid is defined as a geosynthetic formed by a regular network of connected elements with apertures greater than 0.25 inch to allow interlocking with surrounding soil, rock, and other surrounding materials to function primarily as reinforcement.

Geogrid shall be manufactured from an expanded strain hardened monolithic polymer sheet composed of one or more synthetic polymers and shall be mildew resistant and inert to biological degradation and naturally encountered chemicals, alkalis and acids. The geogrid shall contain stabilizers and/or inhibitors, or a resistance finish or covering to make it resistant to deterioration from direct sunlight, ultraviolet rays, and heat.

Geogrid manufacturers shall participate in and be in compliance with the American Association of State Highway Transportation Officials (AASHTO) National Transportation Product Evaluation Program's (NTPEP) Geosynthetics audit program. Geogrid shall meet the requirements of Table II for the application and type shown on the plans and shall be selected from the Department's Approved Lists.

907-714.15.1.1--Geogrid for Retaining Walls and Reinforced Soil Slopes. Geogrid for retaining walls and reinforced soil slopes shall be creep tested in accordance with AASHTO R69 and meet Long Term Design Load, Minimum Ultimate Tensile Strength, and open area criteria listed in Table II. Manufacturers shall perform at least one long-term creep test for no less than 10,000 hours in accordance to ASTM D 5262 for each polymer or composition of polymers from which the geogrid is produced. The long-term design load that shall be reported for design use, shall be that load at which no more than 10% strain occurs over a 100-year design life of the geogrid, as calculated in accordance with AASHTO R69. Long-term design loads shall be reported unfactored, and the AASHTO strength reduction factors (Durability and Installation, and safety factors) will be considered by the Department's Geotechnical Branch on a site specific design basis.

907-714.15.1.2--Geogrid for Subgrade Stabilization. Geogrid for subgrade stabilization shall meet Minimum Ultimate Tensile Strength and open area criteria listed in Table II.

907-714.15.2--Marking, Shipment, and Storage. Each roll or container of geogrid shall be visibly labeled with the name of the manufacturer, trade name of the product, lot number, and quantity of material. In addition, each roll or container shall be clearly tagged to show the type designation that corresponds to that required by the plans. During shipment and storage the geogrid shall be protected from direct sunlight, and temperatures above 120°F or below 0°F. The geogrid shall either be wrapped and maintained in a heavy duty protective covering or stored in a safe enclosed area to protect from damage during prolonged storage.

907-714.15.3--Manufacturer Certification. The Contractor shall furnish the Engineer three copies of the manufacturer's certified test reports indicating that the geogrid furnished conforms to the requirements of the specifications and is of the same composition as the originally approved

by the Department.

907-714.15.4--Acceptance Sampling and Testing. Final acceptance of each shipment will be based upon results of tests performed by the Department on verification samples submitted from the project, as compared to the manufacturer's certified test reports. The Engineer will select one roll or container at random from each shipment for sampling. As sample extending full width of the randomly selected roll or container and being at least five (5) square yards in area will be obtained and submitted by the Engineer. All material samples shall be provided at no cost to the State.

**TABLE II
GEOGRIDS**

Physical Properties	Type Designation						Test Method
	I	II	III	IV	V	VI	
Long Term Design Load ¹ , pounds per foot, Machine Direction	250	500	750	1500	2500	3500	AASHTO R69, ASTM D5262
Minimum Ultimate Tensile Strength ² , pounds per foot, Machine Direction	500	1000	1500	3000	5000	7000	ASTM D6637
Open Area, percent	70	70	50	50	50	50	Direct Measurement

¹ Minimum design criteria requirement.
² Minimum Average Roll Value (MARV).

MISSISSIPPI DEPARTMENT OF TRANSPORTATION

SPECIAL PROVISION NO. 907-718-1

CODE: (SP)

DATE: 12/07/2021

SUBJECT: Timber and Dimension Lumber

Section 718, Timber and Dimension Lumber, of the 2017 Edition of the Mississippi Standard Specifications for Road and Bridge Construction is hereby amended as follows.

Delete the Subsections in Section 718 on pages 836 thru 838, and substitute the following.

907-718.01--General. All timber and dimension lumber shall be Southern pine and shall conform in all respects to applicable requirements of AASHTO M 168. The Department reserves the right to sample and to test all materials at any time; all inspection, testing, and certification of materials will be performed in accordance with the requirements of the current version of the Department's *Materials Division Inspection, Testing, and Certification Manual*.

Timber and dimension lumber shall be furnished in the sizes shown on the plans or as specified. Unless otherwise specified, timber and dimension lumber shall be No. 1, or better, graded according to the latest American Lumber Standards.

Only one type of preservative shall be used for the treatment of materials for any one class of construction on a project, unless otherwise specified.

Where treated timber and dimensional lumber is to be used in non-highway construction or use, such as decking, handrails in walking trails, or in any manner where general public exposure by touch is possible, the treatment requirements will be as per project plans and/or approved by the State Materials Engineer.

907-718.02--Untreated Timber and Dimension Lumber. Untreated timber and dimension lumber shall conform to the requirements of AASHTO M 168.

907-718.03--Treated Timber and Dimension Lumber. Timber and dimension lumber to be treated shall meet the requirements herein specified and shall be treated as specified. Treated timber or dimensional lumber will not be accepted for use unless it has been inspected by an authorized representative of the Department and found to be satisfactory after treatment.

907-718.03.1--Blank.

907-718.03.2--Treatment.

907-718.03.2.1--General. All materials shall be treated in accordance with AASHTO M 133 unless otherwise directed by the Environmental Protection Agency (EPA).

907-718.03.2.2--Blank.

907-718.03.2.3--Inspection. Treated timber and dimension lumber shall be inspected by an authorized representative of the Department before being incorporated into the work. Treatment reports shall be provided to the Department for each lot of material supplied.

907-718.03.3--Blank.

907-718.03.4--Storage of Treated Material. All material treated for stock shall be stacked as compactly as possible on a well-drained surface. Material shall be supported on sills spaced as necessary, not to exceed 10 foot intervals and shall have at least one foot of air space beneath the stacks.

All materials treated with preservatives for use in buildings and applications where painting is required shall be dried after treatment. The treated wood shall be dried in accordance with American Lumber Standards.

907-718.04--Preservative. Preservatives shall be as specified in AASHTO M 133 unless otherwise directed by the Environmental Protection Agency (EPA).

MISSISSIPPI DEPARTMENT OF TRANSPORTATION

SPECIAL PROVISION NO. 907-720-3

CODE: (IS)

DATE: 07/09/2024

SUBJECT: Pavement Marking Materials

Section 720, Pavement Marking Materials, of the 2017 Edition of the Mississippi Standard Specifications for Road and Bridge Construction is hereby amended as follows.

Delete Section 720 on pages 840 thru 854, and substitute the following.

SECTION 720 - PAVEMENT MARKING MATERIALS

907-720.01--General. The Department reserves the right to perform sampling and testing of any materials at any time. Upon request of the Engineer, samples of the material shall be furnished.

907-720.02--Color Requirements. All pavement markings except raised pavement markers are required to meet the color requirements of ASTM D6628.

907-720.03--Optics. Optics used in thermoplastic pavement markings shall consist of a double-drop system of glass beads or advanced optics.

907-720.03.1--Glass Beads. The manufacturer shall furnish the Engineer with a certified test report indicating that the glass beads meet AASHTO M 247. AASHTO Type 4 beads shall be applied to the newly placed stripe first, followed by the application of AASHTO Type 1 beads. Type 1 and 4 glass beads shall be transparent, clean, colorless glass, smooth and spherically shaped, free from milkiness, pits, or excessive air bubbles. Type 1 and 4 glass beads shall be coated with a bead coating that is compatible with the traffic marking material to which the glass beads will be applied and will provide adequate moisture proofing, increased adhesion, and optimum embedment of the glass beads.

907-720.03.1.1--Acceptance Procedure. The Contractor shall furnish the Engineer with a copy of the manufacturer's certified test reports for the lot(s) of materials from which the shipment originated. The test report shall show all the test results for the material properties and characteristics as specified herein. The test report shall state that the material represented by the test results meets all the requirements of the contract. It shall be the Contractor's responsibility to furnish the manufacturer's test report to the Engineer for each shipment of material to the project.

Acceptance sampling and testing will be in accordance with the Materials Division Inspection, Testing, and Certification Manual (Materials Manual). Samples of the material shall be furnished and shall be provided at no cost to the State.

907-720.03.2--Advanced Optics. Advanced optics are materials that do not meet the specific requirements of AASHTO M 247 but produce a final drop-on optics system that meets or exceeds

the reflectivity requirements in Special Provision 907-626. Advanced optics shall be a double-drop system that is pre-approved and listed on the Department's Approved Products List.

907-720.03.2.1--Acceptance Procedure. The Contractor shall furnish the Engineer with a copy of the manufacturer's certified test reports for the lot(s) of materials from which the shipment originated. The test report shall show all the test results for the material properties and characteristics as specified herein. The test report shall state that the material represented by the test results meets all the requirements of the contract. It shall be the Contractor's responsibility to furnish the manufacturer's test report to the Engineer for each shipment of material to the project.

Acceptance sampling and testing may be conducted at the request of the Engineer. Samples of the material shall be furnished and shall be provided at no cost to the State.

907-720.04--Thermoplastic Marking Material.

907-720.04.1--General. Thermoplastic marking material shall meet the color requirements of Subsection 907-720.02.

There shall be no obvious change in the color of the material if held at its plastic temperature for a period of four (4) hours nor by reason of four (4) re-heatings to its plastic temperature.

The pavement markings shall maintain its original dimension and placement. The material shall not be slippery when wet and it shall not lift from the pavement in freezing weather.

907-720.04.2--Extruded Thermoplastic Material. Extruded thermoplastic pavement marking material shall meet the requirements of AASHTO M 249, and shall meet the requirements of 907-720.04 with the following exceptions:

- Blue - ADA thermoplastic marking material shall meet the requirements of Subsection 907-720.04.2 with the exception that the color shall be Blue – ADA, and the Contractor may use hot applied thermoplastic materials meeting the satisfaction of the Engineer.

907-720.04.3--Spray-Applied Thermoplastic Material. Spray-applied thermoplastic pavement marking material shall meet the requirements of AASHTO M 249 and shall meet the requirements of 907-720.04.

907-720.04.4--Pre-formed Thermoplastic Material. Heat-fused, pre-formed thermoplastic pavement marking material shall meet the color requirements of 907-720.02.

907-720.04.5--Acceptance Procedure. The Contractor shall furnish the Engineer with a copy of the manufacturer's certified test reports for the lot(s) of materials from which the shipment originated. The test report shall show all the test results for the material properties and characteristics as specified herein. The test report shall state that the material represented by the test results meets all the requirements of the contract. It shall be the Contractor's responsibility to furnish the manufacturer's test report to the Engineer for each shipment of material to the project.

907-720.05--Pavement Marking Tape.

907-720.05.1--General. Pavement marking tape shall be listed on the Department's Approved Lists.

907-720.05.2--Cold Plastic Pavement Markings (Permanent Pavement Marking Tape). Pavement marking tape for use in roadway applications shall be designated on the Department's Approved Lists as permanent.

The prefabricated markings described shall consist of white or yellow pigmented plastic films with reflective optics uniformly distributed throughout their entire cross-sectional area, and be capable of being affixed by either a pressure sensitive pre-coated adhesive or a liquid contact cement. The markings shall be provided complete in a form that will facilitate rapid application and protect the markings in shipment and storage. The manufacturer shall identify proper solvents and/or adhesives to be applied at the time of application, all equipment necessary for proper application, and recommendations for application that will assure an effective performance life.

Prefabricated legends and symbols shall conform to the applicable shapes and sizes as outlined in the current "Manual on Uniform Traffic Control Devices."

907-720.05.2.1--Specific Requirements. Unless otherwise indicated on the plans, the patterned material without adhesive shall have a minimum caliper of 0.065 inch at the thickest portion of the patterned cross-section and a minimum caliper of 0.020 inch at the thinnest portion of the cross-section. The material shall be a pliant polymer film with 50±15% of the surface are raised and presenting a near vertical face angle of 0° to 60° to traffic from any direction. The channels between the raised areas shall be substantially free of exposed optics or particles.

The size and quality of the optics will be such that performance requirements of Subsection 907-720.02 for the retroreflective pliant polymer film shall be met. The pigments shall be selected and blended to provide a marking film that is white or yellow conforming to the performance requirements of Subsection 907-720.02 through the expected life of the film.

907-720.05.2.2--Conformability and Resealing. The marking shall be capable of conforming to pavement contours, breaks, faults, etc. through the action of traffic at normal pavement temperatures.

The marking shall have resealing characteristics that allows it to be capable of fusing with itself and previously applied marking of the same composition under normal conditions of use. The marking shall be capable of use for patching worn areas of the same type in accordance with manufacturer's instructions.

907-720.05.2.3--Tensile Strength and Elongation. The material shall have a minimum tensile strength of 40 pounds per square inch of cross section when tested according to ASTM D 638. A 6-inch x 1-inch x 0.06-inch sample shall be tested at a temperature between 70°F and 80°F using a jaw speed of 12 inches per minute.

The material shall have a minimum elongation of 75% at break when tested according to ASTM D 638 using a jaw speed of 12 inches per minute.

907-720.05.2.4--Skid Resistance. The surface of the material shall provide a minimum skid resistance value of 45 BPN when tested according to ASTM E 303 except values will be taken at downweb and at a 45-degree angle from downweb. These two values will then be averaged to find the skid resistance of the patterned surface.

907-720.05.2.5--Effective Performance Life and Warranty. When applied according to the recommendations of the manufacturer the pavement marking tape shall provide a neat and durable marking that will not flow or distort due to temperature if the pavement surface remains stable. The film shall be weather resistant and through normal traffic wear shall show no appreciable fading, lifting, or shrinkage throughout the useful life of the marking, nor shall it show significant tearing, roll back, or other signs of poor adhesion.

All manufacturer's standard warranties and guarantees on pavement marking tape, which are provided as customary trade practice, shall be delivered to the Engineer at the final inspection. All warranties and guarantees shall be made out to the Department.

907-720.05.2.6--Acceptance Procedure. The Contractor shall furnish the Engineer with a copy of the manufacturer's certified test reports for the lot(s) of materials from which the shipment originated. The test report shall show all the test results for the material properties and characteristics as specified herein. The test report shall state that the material represented by the test results meets all the requirements of the contract. It shall be the Contractor's responsibility to furnish the manufacturer's test report to the Engineer for each shipment of material to the project.

Acceptance sampling and testing will be in accordance with the Materials Division Inspection, Testing, and Certification Manual (Materials Manual). Samples of the material shall be furnished and shall be provided at no cost to the State.

907-720.05.3--Preformed Pavement Markings for Construction Zones. Preformed pavement markings for construction zones shall be designated Department's Approved Lists as temporary. Retroreflective preformed pavement markings for construction zones shall be as specified on the plans or in the contract documents.

The markings shall be provided in specified widths and shapes. Preformed words and symbols shall conform to the applicable shapes and sizes as outlined in the current "Manual on Uniform Traffic Control Devices for Streets and Highways," or as modified.

The materials shall be packaged in accordance with accepted commercial standards and when stored indoors in a cool dry place, shall be suitable for use one year after date of purchase.

907-720.05.3.1--Specific Requirements. Preformed markings shall consist of retroreflective materials on a conformable backing and shall meet the performance requirements of Subsection 907-720.02. The markings shall consist of a mixture of high-quality polymeric materials, pigments, and optics with a reflective layer of optics bonded to the top surface. The markings shall

be pre-coated with a pressure sensitive adhesive capable of adhering to pavement in accordance with the manufacturer's instructions without the use of heat, solvents, or other additional adhesives. The markings and/or adhesive shall not require any curing time after application. A coated non-metallic medium shall be incorporated with the pressure sensitive adhesive to facilitate removal.

907-720.05.3.2--Acceptance Procedure. The Contractor shall furnish the Engineer with a copy of the manufacturer's certified test reports for the lot(s) of materials from which the shipment originated. The test report shall show all the test results for the material properties and characteristics as specified herein. The test report shall state that the material represented by the test results meets all the requirements of the contract. It shall be the Contractor's responsibility to furnish the manufacturer's test report to the Engineer for each shipment of material to the project.

907-720.06--Raised Pavement Markers.

907-720.06.1--General. Pavement markers shall be listed on the Department's Approved Lists and shall conform to ASTM D 4280.

907-720.06.2--Packaging. Shipments shall be made in containers acceptable to common carriers and packaged in such a manner as to ensure delivery in perfect condition. All damaged shipments shall be replaced by the Contractor. Each package shall be clearly marked as to the name of the manufacturer, type, quantity enclosed, lot number, and date of manufacture.

907-720.06.3--Non-Reflective Pavement Markers. Non-reflective pavement markers are occasionally referred to as "jiggle markers". Non-reflective markers consisting of a heat-fired, vitreous, ceramic base, and a heat-fired, opaque, glazed surface are permitted for use; the bottom of the marker shall not be glazed. Ceramic markers shall be produced from any suitable combination of intimately mixed clays, shales, talcs, flints, feldspars, or other inorganic material. Ceramic markers shall be thoroughly and evenly matured, and all non-reflective pavement markers shall be free from defects which affect appearance or serviceability.

Ceramic non-reflective markers shall conform to the following finish and testing requirements in Table 2 below.

Table 2

Ceramic Non-Reflective Marker Requirements	
Glaze Thickness	0.005 inch, minimum
Mohs Hardness	6, minimum
Autoclave	Glaze shall not spall, craze, or peel.
Compressive Strength	750 psi, minimum
Water Absorption	2.0%, maximum

907-720.06.4--Acceptance Procedure. The Contractor shall furnish the Engineer with a copy of the manufacturer's certified test reports for the lot(s) of materials from which the shipment originated. The test report shall show all the test results for the material properties and characteristics as specified herein. The test report shall state that the material represented by the test results meets all the requirements of the contract. It shall be the Contractor's responsibility to

furnish the manufacturer's test report to the Engineer for each shipment of material to the project.

907-720.07--Adhesive for Pavement Markers.

907-720.07.1--General. The adhesive shall be listed on the Department’s Approved Lists and shall be an asphaltic material suitable for bonding pavement markers to surfaces when the road surface and marker temperatures are in the range of 50°F to 160°F. The composition of the adhesive must be such that its properties will not deteriorate when heated to and applied at temperatures up to 425°F. Samples may be submitted in the form of an adhesive testing package from each batch or material obtained from a package shipped to the project.

907-720.07.2--Packaging and Labeling. The adhesive shall be packaged in self-releasing cardboard containers that will stack properly. The label shall show the manufacturer, quantity, and lot or batch number. "Adhesive for Pavement Markers" or "Adhesive for Traffic Markers" shall be printed in bold lettering on the label.

907-720.07.3--Bituminous Adhesive. The asphaltic adhesive material shall be flexible type.

907-720.07.3.1--Flexible Bituminous Adhesive. Flexible bituminous adhesive shall be designated on the Department’s Approved Lists as flexible and shall comply with requirements of Table 3 below.

Table 3

Flexible Bituminous Adhesive Properties			
	Min	Max	Test Method
Penetration @ 77°F	-	25	ASTM D 5
Softening Point, °F	200	-	ASTM D 36
Brookfield Viscosity @ 400°F, cp.	-	10,000	ASTM D 3236
Ductility @ 77°F, 5 cm/min	15	-	ASTM D 113
Ductility @ 39.2°F, 1 cm/min	5	-	ASTM D 113
Asphalt Compatibility	Pass		ASTM D 5329
Flexibility @ 20°F	Pass		Per Subsection

907-720.07.4--Acceptance Procedure. The Contractor shall furnish the Engineer with a copy of the manufacturer's certified test reports for the lot(s) of materials from which the shipment originated. The test report shall show all the test results for the material properties and characteristics as specified herein. The test report shall state that the material represented by the test results meets all the requirements of the contract. It shall be the Contractor's responsibility to furnish the manufacturer's test report to the Engineer for each shipment of material to the project.

Acceptance sampling and testing will be in accordance with the Materials Division Inspection, Testing, and Certification Manual (Materials Manual). Samples of the material shall be furnished and shall be provided at no cost to the State.

MISSISSIPPI DEPARTMENT OF TRANSPORTATION

SPECIAL PROVISION NO. 907-721-4

CODE: (IS)

DATE: 04/19/2022

SUBJECT: Materials for Signing

Section 721, Materials for Signing, of the 2017 Edition of the Mississippi Standard Specifications for Road and Bridge Construction is hereby amended as follows.

907-721.06--Reflective Sheeting.

907-721.06.2--Performance Requirements. Delete Table 4 and Table 5 in Subsection 721.06.2 on pages 860 & 861, and substitute the following.

**MINIMUM COEFFICIENTS OF RETROREFLECTION
Candela per foot candle per square foot (cd/ft²)
Per ASTM Designation D4956**

**TABLE 4
Type IX Sheeting**

Observation Angle	Entrance Angle	White	Yellow	Green	Red	Blue	Fluorescent Yellow/Green	Fluorescent Yellow	Fluorescent Orange
0.2°	-4.0°	380	285	38	76	17	300	230	115
0.2°	+30.0°	215	162	22	43	10	170	130	65
0.5°	-4.0°	240	180	24	48	11	190	145	72
0.5°	+30.0°	135	100	14	27	6.0	110	81	41
1.0°	-4.0°	80	60	8.0	16	3.6	64	48	24
1.0°	+30.0°	45	34	4.5	9.0	2.0	36	27	14

**TABLE 5
Type XI Sheeting**

Observation Angle	Entrance Angle	White	Yellow	Green	Red	Blue	Brown	Fluorescent Yellow/Green	Fluorescent Yellow	Fluorescent Orange
0.2°	-4.0°	580	435	58	87	26	17	460	350	175
0.2°	+30.0°	220	165	22	33	10	7.0	180	130	66
0.5°	-4.0°	420	315	42	63	19	13	340	250	125
0.5°	+30.0°	150	110	15	23	7.0	5.0	120	90	45
1.0°	-4.0°	120	90	12	18	5.0	4.0	96	72	36
1.0°	+30.0°	45	34	5.0	7.0	2.0	1.0	36	27	14

After Subsection 721.10 on page 864, add the following.

907-721.11--Digital Applied Printing. The following addresses the requirements for digitally printed finished retroreflective traffic control signs on flat sheet aluminum and digitally printed traffic sign faces intended to be applied to a sign substrate.

907-721.11.1--Digitally Printed Ink Systems. Traffic signs must be produced using components, and processes that comply with the retroreflective sheeting manufacturer’s recommendations.

Digital printed ink systems used to print traffic signs must meet and comply with daytime and nighttime chromaticity (color standards) as recognized in ASTM D4956 “Standard Specification for Retroreflective Sheeting for Traffic Control.”

Digital printed ink systems must meet 70% of the initial retroreflectivity specifications of each respective reflective film color as found in ASTM D4956 “Standard Specification for Retroreflective Sheeting for Traffic Control.”

Prior to fabrication and preferably at the preconstruction meeting, the Contractor shall advise the Project Engineer in writing as to which signs on the project will be digitally printed and which ones will be screen printed. The Contractor shall submit to the Project Engineer certifications for all digitally printed signs, which will be forwarded to the State Traffic Engineer for review.

907-721.11.2--Protective Overlay Film. Permanent traffic signs printed with digital ink systems will be fabricated with a full sign protective overlay film designed to provide a smooth surface needed for retroreflectivity, and to protect the sign from fading and UV degradation. The overlamine shall comply with the retroreflective sheeting manufacturer’s recommendations to ensure proper adhesion and transparency and will also meet the reflective film durability as identified in Table 1.

**Table 1
Retroreflective Film Minimum Durability Requirements**

ASTM D4956 Type	Full Sign Replacement Term (years)	Sheeting Replacement Term (years)
IV	7	10
VIII	7	10
IX	7	12
XI	7	12

Temporary signs used in work zones printed with black ink only will not require a protective overlay film as long as the finished sign is warranted for a minimum outdoor durability of three years by the sheeting manufacturer.

907-721.11.3--Inspection. During fabrication, the Contractor shall provide sufficient testing and quality control throughout fabrication to insure good workmanship. Once the material has been received, it may be subject to random testing to ensure compliance with all requirements. If any test samples do not conform to the requirements, the entire order may be returned at the vendor’s expense.

907-721.11.4--Traffic Sign Performance Warranty Provisions. Based on the ASTM Type of sheeting specified, traffic control signs shall be warranted for the duration shown in Table 1. The Contractor shall supply a copy of the warranty document with complete details of terms and conditions upon request of the Department.

907-721.11.5--Certified Digital Sign Fabricator. Sign fabricators using digital imaging methods to produce regulated traffic signs must be certified by the reflective sheeting manufacturer whose materials are used to produce the delivered signs.

Certified sign fabricators must undergo an audit process by the sheeting manufacturer to ensure they have the proper equipment, manufacturing capabilities, manufacturing application processes and the materials required to fulfill the sheeting manufacturer's warranty obligations. Sign fabricators must recertify annually with reflective sheeting manufacturers or utilize a 3rd party certifier approved by the reflective sheeting manufacturer.

The Contractor shall submit proof of Sign Fabricator Certification as issued by the retroreflective sign sheeting manufacturer to the Project Engineer upon delivery of the signs, or with the Shop Drawings.

SECTION 905 - PROPOSAL

Date _____

Mississippi Transportation Commission
Jackson, Mississippi

Sirs: The following proposal is made on behalf of _____
_____ of _____

for constructing the following designated project(s) within the time(s) hereinafter specified.

The plans are composed of drawings and blue prints on file in the offices of the Mississippi Department of Transportation, Jackson, Mississippi.

The Specifications are the current Standard Specifications of the Mississippi Department of Transportation approved by the Federal Highway Administration, except where superseded or amended by the plans, Special Provisions and Notice(s) to Bidders attached hereto and made a part thereof.

I (We) certify that I (we) possess a copy of said Standard and any Supplemental Specifications.

Evidence of my (our) authority to submit the Proposal is hereby furnished. The proposal is made without collusion on the part of any person, firm or corporation. I (We) certify that I (we) have carefully examined the Plans, the Specifications, including the Special Provisions and Notice(s) to Bidders, herein, and have personally examined the site of the work. On the basis of the Specifications, Special Provisions, Notice(s) to Bidders, and Plans, I (we) propose to furnish all necessary machinery, tools, apparatus and other means of construction and do all the work and furnish all the materials in the manner specified. I (We) understand that the quantities mentioned herein are approximate only and are subject to either increase or decrease, and hereby propose to perform any increased or decreased quantities of work at the unit prices bid, in accordance with the above.

I (We) acknowledge that this proposal will be found irregular and/or non-responsive unless a certified check, cashier's check, or Proposal Guaranty Bond in the amount as required in the Advertisement (or, by law) is submitted electronically with the proposal or is delivered to the Contract Administration Engineer prior to the bid opening time specified in the advertisement.

INSTRUCTION TO BIDDERS: Alternate and Optional Items on Bid Schedule.

1. Two or more items entered opposite a single unit quantity WITHOUT DEFINITE DESIGNATION AS "ALTERNATE ITEMS" are considered as "OPTIONAL ITEMS". Bidders may or may not indicate on bids the Optional Item proposed to be furnished or performed WITHOUT PREJUDICE IN REGARD TO IRREGULARITY OF BIDS.
2. Items classified on the bid schedule as "ALTERNATE ITEMS" and/or "ALTERNATE TYPES OF CONSTRUCTION" must be preselected and indicated on bids. However, "Alternate Types of Construction" may include Optional Items to be treated as set out in Paragraph 1, above.
3. Optional items not preselected and indicated on the bid schedule MUST be designated in accordance with Subsection 102.06 prior to or at the time of execution of the contract.
4. Optional and Alternate items designated must be used throughout the project.

I (We) further propose to perform all "force account or extra work" that may be required of me (us) on the basis provided in the Specifications and to give such work my (our) personal attention in order to see that it is economically performed.

I (We) further propose to execute the attached contract agreement (Section 902) as soon as the work is awarded to me (us), and to begin and complete the work within the time limit(s) provided for in the Specifications and Advertisement. I (We) also propose to execute the attached contract bond (Section 903) in an amount not less than one hundred (100) percent of the total of my (our) part, but also to guarantee the excellence of both workmanship and materials until the work is finally accepted.

I (We) shall submit electronically with our proposal or deliver prior to the bid opening time a certified check, cashier's check or bid bond for **five percent (5%) of total bid** and hereby agree that in case of my (our) failure to execute the contract and furnish bond within Ten (10) days after notice of award, the amount of this check (bid bond) will be forfeited to the State of Mississippi as liquidated damages arising out of my (our) failure to execute the contract as proposed. It is understood that in case I am (we are) not awarded the work, the check will be returned as provided in the Specifications.

SECTION 905 -- PROPOSAL (CONTINUED)

I (We) hereby certify by digital signature and electronic submission via Bid Express of the Section 905 proposal below, that all certifications, disclosures and affidavits incorporated herein are deemed to be duly executed in the aggregate, fully enforceable and binding upon delivery of the bid proposal. I (We) further acknowledge that this certification shall not extend to the bid bond or alternate security which must be separately executed for the benefit of the Commission. This signature does not cure deficiencies in any required certifications, disclosures and/or affidavits. I (We) also acknowledge the right of the Commission to require full and final execution on any certification, disclosure or affidavit contained in the proposal at the Commission's election upon award. Failure to so execute at the Commission's request within the time allowed in the Standard Specifications for execution of all contract documents will result in forfeiture of the bid bond or alternate security.

Respectfully Submitted,

DATE _____

Contractor

BY _____
Signature

TITLE _____

ADDRESS _____

CITY, STATE, ZIP _____

PHONE _____

FAX _____

E-MAIL _____

(To be filled in if a corporation)

Our corporation is chartered under the Laws of the State of _____ and the names, titles and business addresses of the executives are as follows:

President Address

Secretary Address

Treasurer Address

The following is my (our) itemized proposal.

Mill & Overlay approximately 5 miles of US 49 from Richard Kendrick Drive to Seminary, known as Project No. NHPP-0008-02(121) / 108719301 in Covington County.

Line no.	Item Code	Adj Code	Quantity	Units	Description[Fixed Unit Price]
Roadway Items					
0010	202-B150		1,338	Linear Feet	Removal of Guard Rail Including Post, Blockouts & Hardware
0020	202-B188		870	Square Yard	Removal of Pavement, All Types and Depths
0030	202-B240		180	Linear Feet	Removal of Traffic Stripe
0040	203-G002	(E)	107	Cubic Yard	Excess Excavation, LVM, AH
0050	304-A008	(GY)	4,220	Cubic Yard	Granular Material, LVM, Class 6, Group D
0060	403-A015	(BA1)	1,885	Ton	9.5-mm, ST, Asphalt Pavement
0070	403-D007	(BA1)	15,667	Ton	9.5-mm, HT, Asphalt Pavement, Polymer Modified
0080	406-D001		204,409	Square Yard	Fine Milling of Bituminous Pavement, All Depths
0090	407-A001	(A2)	15,310	Gallon	Asphalt for Tack Coat
0100	423-A001		19	Mile	Rumble Strips, Ground In
0110	503-C010		1,410	Linear Feet	Saw Cut, Full Depth
0120	606-B002		938	Linear Feet	Guard Rail, Class A, Type 1, 'W' Beam
0130	606-C003		7	Each	Guard Rail, Cable Anchor, Type 1
0140	606-D005		4	Each	Guard Rail, Bridge End Section, Type A
0150	606-E005		4	Each	Guard Rail, Terminal End Section, Flared
0160	606-E007		7	Each	Guard Rail, Terminal End Section, Non-Flared
0170	606-G002		4	Each	Special Sections, Guard Rail Bridge End Connector
0180	618-B001		1	Square Feet	Additional Construction Signs (\$10.00)
0190	619-A1001		20	Mile	Temporary Traffic Stripe, Continuous White
0200	619-A2001		19	Mile	Temporary Traffic Stripe, Continuous Yellow
0210	619-A3001		22	Mile	Temporary Traffic Stripe, Skip White
0220	619-A5001		48,966	Linear Feet	Temporary Traffic Stripe, Detail
0230	619-A6001		205	Square Feet	Temporary Traffic Stripe, Legend
0240	619-A6002		1,320	Linear Feet	Temporary Traffic Stripe, Legend
0250	620-A001		1	Lump Sum	Mobilization
0260	630-F002		16	Each	Delineators, Flexible Post Mounted, Crossover, Type I, Yellow
0270	630-F006		45	Each	Delineators, Guard Rail, White
0280	630-F007		16	Each	Delineators, Guard Rail, Yellow
0290	907-410-D001	(A2)	5,096	Gallon	Asphalt for Rejuvenating Fog Seal, Grade CMS-1PF
0300	907-413-E001		39,350	Linear Feet	Sawing and Sealing Transverse Joints in Asphalt Pavement
0310	907-618-A001		1	Lump Sum	Maintenance of Traffic
0320	907-626-A007		11	Mile	6" Thermoplastic Double Drop Traffic Stripe, Skip White
0330	907-626-C012		10	Mile	6" Thermoplastic Double Drop Edge Stripe, Continuous White
0340	907-626-F003		9	Mile	6" Thermoplastic Double Drop Edge Stripe, Continuous Yellow
0350	907-626-G004		12,081	Linear Feet	Thermoplastic Detail Stripe, White

Line no.	Item Code	Adj Code	Quantity	Units	Description	Fixed Unit Price
0360	907-626-G005		12,402	Linear Feet	Thermoplastic Detail Stripe, Yellow	
0370	907-626-H009		205	Square Feet	Thermoplastic Legend, White	
0380	907-626-H010		660	Linear Feet	Thermoplastic Legend, White	
0390	907-627-J001		441	Each	Two-Way Clear Reflective High Performance Raised Markers	
0400	907-627-K001		1,186	Each	Red-Clear Reflective High Performance Raised Markers	
0410	907-627-L001		1,203	Each	Two-Way Yellow Reflective High Performance Raised Markers	
ALTERNATE GROUP AA NUMBER 1						
0420	304-H001	(GY)	102	Cubic Yard	3/4" and Down Crushed Stone Base, LVM	
ALTERNATE GROUP AA NUMBER 2						
0430	304-H002	(GY)	102	Cubic Yard	Size 610 Crushed Stone Base, LVM	
ALTERNATE GROUP AA NUMBER 3						
0440	304-H003	(GY)	102	Cubic Yard	Size 825B Crushed Stone Base, LVM	

SECTION 905 - COMBINATION BID PROPOSAL (Continued)

CONDITIONS FOR COMBINATION BID

If a bidder elects to submit a combined bid for two or more of the contracts listed for this month's letting, the bidder must complete and execute these sheets of the proposal in each of the individual proposals to constitute a combination bid. In addition to this requirement, each individual contract shall be completed, executed and submitted in the usual specified manner.

Failure to execute this Combination Bid Proposal in each of the contracts combined will be just cause for each proposal to be received and evaluated as a separate bid.

It is understood that the Mississippi Transportation Commission not only reserves the right to reject any and all proposals, but also the right to award contracts upon the basis of lowest separate bids or combination bids most advantageous to the State.

It is further understood and agreed that the Combination Bid Proposal is for comparison of bids only and that each contract shall operate in every respect as a separate contract in accordance with its proposal and contract documents.

I (We) agree to complete each contract on or before its specified completion date.

COMBINATION BID PROPOSAL

This proposal is tendered as one part of a Combination Bid Proposal utilizing option ___* of Subsection 102.11 on the following contracts:

* Option to be shown as either (a), (b), or (c).

	<u>Project No.</u>	<u>County</u>	<u>Project No.</u>	<u>County</u>
1.	_____	_____	6.	_____
2.	_____	_____	7.	_____
3.	_____	_____	8.	_____
4.	_____	_____	9.	_____
5.	_____	_____	10.	_____

(a) If Combination A has been selected, your Combination Bid is complete.

(b) If Combination B has been selected, then complete the following page.

SECTION 905 - COMBINATION BID PROPOSAL (Continued)

Project Number	Pay Item Number	Unit	Unit Price Reduction	Total Item Reduction	Total Contract Reduction
1.					
2.					
3.					
4.					
5.					
6.					
7.					
8.					

For Informational Purposes Only

SECTION 905 - COMBINATION BID PROPOSAL (Continued)

Project Number	Pay Item Number	Unit	Unit Price Reduction	Total Item Reduction	Total Contract Reduction
9.					
10.					

(c) If Combination C has been selected, then initial and complete ONE of the following.

_____ I (We) desire to be awarded work not to exceed a total monetary value of \$ _____.

_____ I (We) desire to be awarded work not to exceed _____ number of contracts.



**Certification with regard to the Performance of Previous
Contracts or Subcontracts subject to the Equal Opportunity
Clause and the filing of Required Reports**

The Bidder hereby certifies that he has _____, has not _____, participated in a previous contract or subcontract subject to the Equal Opportunity Clause, as required by Executive Orders 10925, 11114, or 11246, and that he has _____, has not _____, filed with the Joint Reporting Committee, the Director of the Office of Federal Contract Compliance, a Federal Government contracting or administering agency, or the former President's Committee on Equal Employment Opportunity, all reports due under the applicable filing requirements.

(COMPANY)

DATE: _____

NOTE: The above certification is required by the Equal Employment Opportunity Regulations of the Secretary of Labor (41 CFR 60-1.7 (b) (1)), and must be submitted by bidders and proposed subcontractors only in connection with contracts and subcontracts which are subject to the Equal Opportunity Clause. Contracts and Subcontracts which are exempt from the Equal Opportunity Clause are set forth in 41 CFR 60-1.5. (Generally only contracts or subcontracts of \$10,000 or under are exempt.)

Currently, Standard Form 100 (EEO-1) is the only report required by the Executive Orders or their implementing regulations.

Proposed prime Contractors and Subcontractors who have participated in a previous contract or subcontract subject to the Executive orders and have not filed the required reports should note that 41 CFR 60-1.7 (b) (1) prevents the award of contracts and subcontracts unless such Contractors submit a report covering the delinquent period or such other period specified by the Federal Highway Administration or by the Director, Office of Federal Contract Compliance, U. S. Department of Labor.

MISSISSIPPI DEPARTMENT OF TRANSPORTATION
CERTIFICATION

I, _____,
(Name of person signing bid)

individually, and in my capacity as _____ of
(Title of person signing bid)

_____ do hereby certify under
(Name of Firm, partnership, or Corporation)

penalty of perjury under the laws of the United States and the State of Mississippi that _____

_____, Bidder
(Name of Firm, Partnership, or Corporation)

on Project No. **NHPP-0008-02(121)/ 108719301000**

in **Covington** County(ies), Mississippi, has not either

directly or indirectly entered into any agreement, participated in any collusion; or otherwise taken any action in restraint of free competitive bidding in connection with this contract; nor have any of its corporate officers or principal owners.

Except as noted hereafter, it is further certified that said legal entity and its corporate officers, principal owners, managers, auditors and others in a position of administering federal funds:

- a) Are not presently debarred, suspended, proposed for debarment, declared ineligible, or voluntarily excluded from covered transactions by any Federal department or agency;
- b) Have not within a three-year period preceding this proposal been convicted of or had a civil judgment rendered against them for commission of fraud or a criminal offense in connection with obtaining, attempting to obtain, or performing a public (Federal, State or local) transaction or contract under a public transaction; violation of Federal or State antitrust statutes or commission of embezzlement, theft, forgery, bribery, falsification or destruction of records, making false statements, or receiving stolen property;
- c) Are not presently indicted for or otherwise criminally or civilly charged by a governmental entity (Federal, State or local) with commission of any of the offenses enumerated in (b) above; and
- d) Have not within a three-year period preceding this application/ proposal had one or more public transactions (Federal, State or local) terminated for cause or default.

Do exceptions exist and are made a part thereof? Yes / No

Any exceptions shall address to whom it applies, initiating agency and dates of such action.

Note: Exceptions will not necessarily result in denial of award but will be considered in determining bidder responsibility. Providing false information may result in criminal prosecution or administrative sanctions.

The bidder further certifies that the certification requirements contained in Section XI of Form FHWA 1273, will be or have been included in all subcontracts, material supply agreements, purchase orders, etc. except those procurement contracts for goods or services that are expected to be less than the Federal procurement small purchase threshold fixed at 10 U.S.C. 2304(g) and 41 U.S.C. 253(g) (currently \$25,000) which are excluded from the certification requirements.

The bidder further certifies, to the best of his or her knowledge and belief, that:

1) No Federal appropriated funds have been paid or will be paid to any person for influencing or attempting to influence an officer or employee of any Federal agency, a Member of Congress, an officer or employee of Congress, or an employee of a Member of Congress in connection with the awarding of any Federal contract, the making of any Federal grant, the making of any Federal loan, the entering into of any cooperative agreement, and the extension, continuation, renewal, amendment, or modification of any Federal contract, grant, loan, or cooperative agreement.

2) If any funds other than Federal appropriated funds have been paid or will be paid to any person for influencing or attempting to influence an officer or employee of any Federal agency, a Member of Congress, an officer or employee of Congress, or an employee of a Member of Congress in connection with this contract, Standard Form-LLL, Disclosure Form to Report Lobbying, in accordance with its instructions will be completed and submitted.

The certification contained in (1) and (2) above is a material representation of fact upon which reliance is placed and a prerequisite imposed by Section 1352, Title 31, U.S. Code prior to entering into this contract. Failure to comply shall be subject to a civil penalty of not less than \$10,000 and not more than \$100,000. The bidder shall include the language of the certification in all subcontracts exceeding \$100,000 and all subcontractors shall certify and disclose accordingly.

All of the foregoing is true and correct.

Executed on _____

Signature

MISSISSIPPI DEPARTMENT OF TRANSPORTATION

SAM.GOV Registration and Unique Entity ID

Bidders are advised that the Prime Contractor must register and maintain a current registration in the **System for Award Management** (<http://sam.gov>) at all times during the project. Upon registration, the Contractor will be assigned a SAM Unique Entity ID.

Bidders are advised that prior to the award of this contract, they MUST be registered in the System for Award Management.

I (We) acknowledge that this contract cannot be awarded if I (We) are not registered in the System for Award Management prior to the award of this contract. _____ (Yes / No)

I (We) have a SAM Unique Entity ID. _____ (Yes / No)

SAM Unique Entity ID: _____

Company Name: _____

Company e-mail address: _____

SECTION 902

**AMERICAN RESCUE PLAN ACT STATE AND LOCAL FISCAL RECOVERY FUNDS
SURFACE TRANSPORTATION CONTRACT**

NOTICE: THIS IS NOT A STANDARD MDOT CONTRACT. READ CAREFULLY.

CONTRACT FOR _____
LOCATED IN COUNTY(IES) OF _____

STATE OF MISSISSIPPI
COUNTY OF HINDS

This Contract is entered into by and between the Mississippi Transportation Commission (MTC), with its principal office at 401 North West Street, Jackson, Mississippi 39201, acting by and through the duly authorized Executive Director of the Mississippi Department of Transportation (MDOT) and the undersigned Contractor.

As consideration for this Contract, MTC agrees to pay the Contractor the amount(s) set out in the Proposal attached hereto. Said payment will be made in the manner and at the time(s) specified in the Specifications and/or Special Provisions, if any. In exchange for said consideration, the Contractor hereby agrees to accept the prices stated in the Proposal as full compensation for the furnishing of all labor, materials and equipment, and the execution of the scope of work identified for this referenced Project as contemplated in this Contract, and as more fully outlined in the Contract Documents (the "Work"). The Contract Documents consist of the Advertisement, the Notice to Bidders, the Proposal, the Specifications, the Special Provisions, and the approved Plans, all of which are hereby made a part of this Contract and incorporated herein by reference.

The Contractor further agrees that the Work shall be done under the direct supervision of, and to the complete satisfaction of, the Executive Director of MDOT, or his authorized representative(s), and, when federal American Rescue Plan Act, Coronavirus State and Local Fiscal Recovery Funds ("ARPA SLFRF") are involved, subject to the inspection and approval of the Federal Highway Administration (FHWA) and/or the United States Department of Treasury ("Treasury"), or its agents, and/or the agents of any other state or federal agency whose funds are involved. Further, the Work shall be done in accordance with any applicable state and federal laws, and any such rules and regulations issued by MTC and/or any relevant Federal Agency.

The Contractor agrees that all labor as outlined in the Contract Documents may be secured from a list furnished by the Manager of the Win Job Center nearest the project location, or any successor thereto.

It is agreed and understood that each and every provision of law and clause required by law to be inserted into this Contract shall be deemed to be inserted herein, and this Contract shall be read and enforced as though it were included herein. If through mere mistake or otherwise, any such provision is not inserted, then upon the application of either party hereto, the Contract shall be physically amended to make such insertion.

This Contract is executed to address specific contracting requirements for contracts made under federal awards by Non-Federal Entities. These required contracting provisions are outlined in Appendix II to Part 200, Title 2 of the Code of Federal Regulations and in the specific requirements of ARPA SLFRF.

The Parties enter into this Contract for the surface transportation projects herein described and under the terms provided.

The Federal Government is not a party to this Contract and is not subject to any obligations or liabilities to MDOT, the Contractor, or any other party pertaining to any matter resulting from the Contract.

In addition to all other terms and provisions contained herein and in the Contract Documents, the following specific terms apply to this Contract, as required by the Code of Federal Regulations in 2 CFR 200 and the ARPA SLFRF final rule:

- A. The Contractor acknowledges that financial assistance from ARPA SLFRF may be used to fund all or a portion of this Contract. The Contractor shall comply with and follow all requirements of the most recent version of the ARPA SLFRF final rule, as well as any other applicable local, state, and federal laws and regulations, executive orders, ARPA SLFRF program policies, procedures, and directives, whether listed and/or referred to in this Contract or not.
- B. Contractor acknowledges that 31 U.S.C. Ch. 38 (Administrative Remedies for False Claims and Statements) applies to Contractor's actions pertaining to this Contract.
- C. **INSURANCE.** The Contractor shall obtain the insurance products required in accordance with Section 107.14 of the most recent version of the *Mississippi Standard Specifications for Road and Bridge Construction*, and/or any amendment thereto.
- D. **BONDING.** The Contractor shall obtain payment and performance bonds as required in accordance with Section 103.05 of the most recent version of the *Mississippi Standard Specifications for Road and Bridge Construction*, and/or any amendment thereto.
- E. **LICENSES AND PERMITS.** Contractors and subcontractors must maintain all licenses, permits, and certificates, including all professional licenses as required by any statute, ordinance, rule, or regulation. Contractor agrees to immediately notify MDOT of any suspension, revocation, or other detrimental action against Contractor's license during the term of this Contract.
- F. **SUBCONTRACTING**
 - 1. The Contractor acknowledges that if the Contractor intends to enter into subcontracts for any portion of the Work under this Contract, the Contractor must take the affirmative steps described in 2 C.F.R. § 200.321 to ensure that small business firms, minority business firms, women's business enterprises, and labor surplus area firms are used when possible.

2. The Contractor must document its efforts to comply with these requirements. Affirmative steps include:
 - a. Placing qualified small and minority businesses and women's business enterprises on solicitation lists.
 - b. Assuring that small and minority businesses, and women's business enterprises are solicited whenever they are potential sources.
 - c. Dividing total requirements, when economically feasible, into smaller tasks or quantities to permit maximum participation by small and minority businesses, and women's business enterprises.
 - d. Establishing delivery schedules, where the requirement permits, which encourages participation by small and minority businesses, and women's business enterprises.
 - e. Using the services and assistance, as appropriate, of such organizations as the Small Business Administration and the Minority Business Development Agency of the Department of Commerce.

G. DEBARMENT AND SUSPENSION

1. This Contract is a covered transaction for purposes of 2 C.F.R. pt. 180. Contractor is required to verify that neither it, its principals (defined at 2 C.F.R. § 180.995), nor its affiliates (defined at 2 C.F.R. § 180.905) are excluded (defined at 2 C.F.R. § 180.940) or disqualified (defined at 2 C.F.R. § 180.935).
2. The Contractor must comply with 2 C.F.R. pt. 180, subpart C, and must include a requirement to comply with these regulations in any lower-tier-covered transaction it enters into.
3. The certification set out in Section 905 of the Proposal is a material representation of fact relied upon by MTC. If it is later determined that Contractor did not comply with 2 C.F.R. pt. 180, subpart C, in addition to remedies available to MTC, the federal government may pursue available remedies, including but not limited to suspension and/or debarment. The Contractor agrees that it must comply with the requirements of 2 C.F.R. pt. 180, subpart C, while this Contract is valid and throughout the term of this Contract. The Contractor further agrees to include a provision requiring such compliance in its lower tier covered transactions.

H. BYRD ANTI-LOBBYING AMENDMENT

1. Contractors who apply or bid for an award of \$100,000 or more shall submit to MTC a Certification Regarding Lobbying. Each tier must certify to the tier above that it will not and has not used Federal appropriated funds to pay any person or organization for influencing or attempting to influence an officer or employee of any agency, a Member of Congress, officer or employee of Congress, or an employee of a Member of Congress in connection with obtaining any Federal contract, grant, or any other award covered by 31 U.S.C. § 1352. Each tier shall also disclose any lobbying with non-Federal funds that takes place in connection

with obtaining any Federal award. Such disclosures are forwarded from tier to tier up to the recipient who in turn will forward the certification(s) to the awarding agency.

2. Contractor shall include a requirement to comply with these regulations (31 U.S.C. § 1352) in any subcontractor or lower tier covered transaction it enters into.

I. DAVIS-BACON ACT COMPLIANCE

1. Minimum Wages

- a. All laborers and mechanics employed or working upon the site of the work will be paid unconditionally and not less often than once a week, and without subsequent deduction or rebate on any account (except such payroll deductions as are permitted by regulations issued by the Secretary of Labor under the Copeland Act (29 CFR Part 3)), the full amounts due at time of payment computed at wage rates not less than those contained in the wage determination of the Secretary of Labor, regardless of any contractual relationship which may be alleged to exist between the contractor and such laborers and mechanics. The wage determination decision of the Secretary of Labor (original or modified) at the time of contract award shall be effective.
- b. The contractor shall post the scale of wages to be paid in a prominent and easily accessible place at the site of the work.

2. Withholding

- a. MDOT shall, upon its own action or upon written request of an authorized representative of the Department of Labor, withhold or cause to be withheld from the contractor under this contract or any other federal contract with the same prime contractor, or any other federally-assisted contract subject to Davis-Bacon prevailing wage requirements, which is held by the same prime contractor, so much of the accrued payments or advances as may be considered necessary to pay laborers and mechanics, including apprentices, trainees, and helpers, employed by the contractor or any subcontractor, the full amount of wages required by the contract. In the event of failure to pay any laborer or mechanic, including any apprentice, trainee, or helper, employed or working on the site of the work, all or part of the wages required by the contract, MDOT may, after written notice to the contractor, take such action as may be necessary to cause the suspension of any further payment, advance, or guarantee of funds until such violations have ceased.

3. Payrolls and Basic Records

- a. Payrolls and basic records relating thereto shall be maintained by the contractor during the course of the work and preserved for a period of three years thereafter for all laborers and mechanics working at the site of the work. Such records shall contain the name, address, and social security number of each such worker, his or her correct classifications, hourly rates of wages paid (including

rates of contributions or costs anticipated for bona fide fringe benefits or cash equivalents thereof of the types described in section 1(b)(2)(B) of the Davis-Bacon Act), daily and weekly number of hours worked, deductions made, and actual wages paid. Whenever the Secretary of Labor has found, under 29 CFR 5.5(a)(3)(ii), that the wages of any laborer or mechanic include the amount of any costs reasonably anticipated in providing benefits under a plan or program described in section 1(b)(2)(B) of the Davis-Bacon Act, the contractor shall maintain records which show that the commitment to provide such benefits is enforceable, that the plan or program is financially responsible, and that the plan or program has been communicated in writing to the laborers and mechanics affected, and records which show the costs anticipated or the actual cost incurred in providing such benefits.

- b. The contractor shall submit weekly for each week in which any contract work is performed a copy of all payrolls to MDOT for transmission to the Secretary of Labor in accordance with 29 CFR 5.5(a)(3)(ii). The payrolls submitted shall set out accurately and completely all of the information required to be maintained under 29 CFR 5.5(a)(3)(i). This information may be submitted in any form desired. Optional Form WH-347 (Federal Stock Number 029-005-00014-1) is available for this purpose and may be purchased from the Superintendent of Documents, U.S. Government Printing Office, Washington, D.C. 20402. The prime contractor is responsible for the submission of copies of payrolls by all subcontractors. Contractors and subcontractors shall maintain the full social security number and current address of each covered worker, and shall provide them to MDOT upon request. The payrolls and basic records shall be preserved for a period of three years after the completion of the contract.

4. Apprentices and Trainees

- a. Apprentices will be permitted to work at less than the predetermined rate for the work they performed when they are employed pursuant to and individually registered in a bona fide apprenticeship program registered with the U.S. Department of Labor, Employment and Training Administration, Office of Apprenticeship Training, Employer and Labor Services, or with a State Apprenticeship Agency recognized by the Office, or if a person is employed in his or her first 90 days of probationary employment as an apprentice in such an apprenticeship program, who is not individually registered in the program, but who has been certified by the Office of Apprenticeship Training, Employer and Labor Services or a State Apprenticeship Agency (where appropriate) to be eligible for probationary employment as an apprentice. The allowable ratio of apprentices to journeymen on the job site in any craft classification shall not be greater than the ratio permitted to the contractor as to the entire work force under the registered program.
- b. Trainees: Except as provided in 29 CFR 5.16, trainees will not be permitted to work at less than the predetermined rate for the work performed unless they are employed pursuant to and individually registered in a program which has received prior approval, evidenced by formal certification by the U.S. Department of Labor, Employment and Training Administration. The ratio of

trainees to journeymen on the job site shall not be greater than permitted under the plan approved by the Employment and Training Administration.

5. Subcontracts

- a. The contractor or subcontractor will insert in any subcontracts the clauses contained in 29 CFR 5.5(a)(1) through (10) and such other clauses as MDOT may by appropriate instructions require, and also a clause requiring the subcontractors to include these clauses in any lower-tier subcontracts. The prime contractor shall be responsible for the compliance by any subcontractor or lower-tier subcontractor with all the contract clauses in 29 CFR 5.5.

J. CONTRACT WORK HOURS AND SAFETY STANDARDS ACT REQUIREMENTS

1. Overtime requirements. No contractor or subcontractor contracting for any part of the Contract work that may require or involve the employment of laborers or mechanics shall require or permit any such laborer or mechanic in any workweek in which he or she is employed on such work to work in excess of forty hours in such workweek unless such laborer or mechanic receives compensation at a rate not less than one and one-half times the basic rate of pay for all hours worked in excess of forty hours in such workweek.
2. Violation; liability for unpaid wages; liquidated damages. In the event of any violation of this section, the Contractor, and any subcontractor responsible therefor, shall be liable for the unpaid wages. In addition, such Contractor and subcontractor shall be liable for liquidated damages. Such liquidated damages shall be computed with respect to each individual laborer or mechanic, including watchmen and guards, employed in violation of the clause set forth above in this section, in the sum of \$27 for each calendar day on which such individual was required or permitted to work in excess of the standard workweek of forty hours without payment of the overtime wages required by the clause set forth in above.
3. Withholding for unpaid wages and liquidated damages. The federal agency or recipient shall, upon its own action or upon written request of an authorized representative of the Department of Labor, withhold or cause to be withheld, from any moneys payable on account of work performed by the Contractor or subcontractor under any such contract or any other Federal contract with the same prime contractor, or any other federally-assisted contract subject to the Contract Work Hours and Safety Standards Act, which is held by the same prime contractor, such sums as may be determined to be necessary to satisfy any liabilities of such Contractor or subcontractor for unpaid wages and liquidated damages as provided in the clause set forth above in this section.
4. Subcontracts. The Contractor shall insert in any subcontracts the clauses set forth above in this section and also a clause requiring the subcontractors to include these

same clauses in any lower tier subcontracts. The Contractor shall be responsible for compliance by any subcontractor or lower tier subcontractor with this section.

K. ENVIRONMENT AND COMPLIANCE

1. The Contractor shall comply with all applicable standards, orders, or regulations issued pursuant to the Clean Air Act (42 U.S.C. § 7401 et seq.).
 - a. The Contractor agrees to comply with all applicable standards, orders, or regulations issued pursuant to the Clean Air Act, as amended, 42 U.S.C. § 7401 et seq.
 - b. The Contractor agrees to report each violation to MTC and understands and agrees that MTC will, in turn, report each violation as required to assure notification to the Federal Emergency Management Agency, and the appropriate Environmental Protection Agency Regional Office.
 - c. The Contractor agrees to include these requirements in each subcontract exceeding \$150,000 financed in whole or in part with Federal assistance provided by Treasury.
2. The Contractor shall comply with all applicable standards, orders, or regulations issued pursuant to the Federal Water Pollution Control Act as amended (33 U.S.C. 1251 § et seq.).
 - a. The Contractor agrees to comply with all applicable standards, orders, or regulations issued pursuant to the Federal Water Pollution Control Act as amended (33 U.S.C. 1251 § et seq.).
 - b. The Contractor agrees to report each violation to MTC and understands and agrees that MTC will, in turn, report each violation as required to assure notification to the Federal Emergency Management Agency, and the appropriate Environmental Protection Agency Regional Office.
 - c. The Contractor agrees to include these requirements in each subcontract exceeding \$150,000 financed in whole or in part with Federal assistance provided by Treasury.

L. EQUAL EMPLOYMENT OPPORTUNITY

1. This provision is applicable to all federally assisted construction contracts, as that term is defined at 41 C.F.R. § 60-1.3.
2. During the performance of this contract, the contractor agrees as follows:
 - a. The Contractor will not discriminate against any employee or applicant for employment because of race, color, religion, sex, sexual orientation, gender identity, or national origin. The Contractor will take affirmative action to ensure that applicants are employed, and that employees are treated during employment without regard to their race, color, religion, sex, sexual orientation, gender identity, or national origin. Such action shall include, but not be limited

to the following: Employment, upgrading, demotion, or transfer; recruitment or recruitment advertising; layoff or termination; rates of pay or other forms of compensation; and selection for training, including apprenticeship. The Contractor agrees to post in conspicuous places, available to employees and applicants for employment, notices to be provided setting forth the provisions of this nondiscrimination clause.

- b. The Contractor will, in all solicitations or advertisements for employees placed by or on behalf of the Contractor, state that all qualified applicants will receive consideration for employment without regard to race, color, religion, sex, sexual orientation, gender identity, or national origin.
- c. The Contractor will not discharge or in any other manner discriminate against any employee or applicant for employment because such employee or applicant has inquired about, discussed, or disclosed the compensation of the employee or applicant or another employee or applicant. This provision shall not apply to instances in which an employee who has access to the compensation information of other employees or applicants as a part of such employee's essential job functions discloses the compensation of such other employees or applicants to individuals who do not otherwise have access to such information, unless such disclosure is in response to a formal complaint or charge, in furtherance of an investigation, proceeding, hearing, or action, including an investigation conducted by the employer, or is consistent with the Contractor's legal duty to furnish information.
- d. The Contractor will send to each labor union or representative of workers with which he has a collective bargaining agreement or other contract or understanding, a notice to be provided advising the said labor union or workers' representatives of the Contractor's commitments under this section and shall post copies of the notice in conspicuous places available to employees and applicants for employment.
- e. The Contractor will comply with all provisions of Executive Order 11246 of September 24, 1965, and of the rules, regulations, and relevant orders of the Secretary of Labor.
- f. The Contractor will furnish all information and reports required by Executive Order 11246 of September 24, 1965, and by rules, regulations, and orders of the Secretary of Labor, or pursuant thereto, and will permit access to his books, records, and accounts by the administering agency and the Secretary of Labor for purposes of investigation to ascertain compliance with such rules, regulations, and orders.
- g. In the event of the Contractor's noncompliance with the nondiscrimination clauses of this Contract or with any of the said rules, regulations, or orders, this Contract may be canceled, terminated, or suspended in whole or in part and the Contractor may be declared ineligible for further Government contracts or federally assisted construction contracts in accordance with procedures authorized in Executive Order 11246 of September 24, 1965, and such other sanctions may be imposed and remedies invoked as provided in Executive Order 11246 of September 24, 1965, or by rule, regulation, or order of the Secretary of Labor, or as otherwise provided by law.

- h. The Contractor will include the above and forgoing provisions of this section in every subcontract or purchase order unless exempted by rules, regulations, or orders of the Secretary of Labor issued pursuant to section 204 of Executive Order 11246 of September 24, 1965, so that such provisions will be binding upon each subcontractor or vendor. The Contractor will take such action with respect to any subcontract or purchase order as the administering agency may direct as a means of enforcing such provisions, including sanctions for noncompliance: *Provided, however*, that in the event a Contractor becomes involved in, or is threatened with, litigation with a subcontractor or vendor because of such direction by the administering agency, the Contractor may request the United States to enter into such litigation to protect the interests of the United States.
3. MTC agrees as follows:
- a. MTC agrees that it will be bound by the above equal opportunity clause with respect to its own employment practices when it participates in federally assisted construction work; provided, that if MTC is a state or local government, the above equal opportunity clause is not applicable to any agency, instrumentality or subdivision of such government that does not participate in work on or under the Contract.
 - b. MTC agrees that it will assist and cooperate actively with the administering agency and the Secretary of Labor in obtaining the compliance of contractors and subcontractors with the equal opportunity clause and the rules, regulations, and relevant orders of the Secretary of Labor, that it will furnish the administering agency and the Secretary of Labor such information as they may require for the supervision of such compliance, and that it will otherwise assist the administering agency in the discharge of the agency's primary responsibility for securing compliance.
 - c. MTC agrees that it will refrain from entering into any contract or contract modification subject to Executive Order 11246 of September 24, 1965, with a contractor debarred from, or who has not demonstrated eligibility for, Government contracts and federally assisted construction contracts pursuant to the Executive Order and will carry out such sanctions and penalties for violation of the equal opportunity clause as may be imposed upon contractors and subcontractors by the administering agency or the Secretary of Labor pursuant to Part II, Subpart D of the Executive Order. In addition, MTC agrees that if it fails or refuses to comply with these undertakings, the administering agency may take any or all of the following actions: Cancel, terminate, or suspend in whole or in part this grant (contract, loan, insurance, guarantee); refrain from extending any further assistance to the applicant under the program with respect to which the failure or refund occurred until satisfactory assurance of future compliance has been received from such applicant; and refer the case to the Department of Justice for appropriate legal proceedings.

M. PROCUREMENT OF RECOVERED MATERIALS

1. In the performance of this Contract, the Contractor shall make maximum use of products containing recovered materials that are EPA-designated items unless the product cannot be acquired:
 - a. Competitively within a timeframe providing for compliance with the Contract performance schedule.
 - b. Meeting Contract performance requirements; or
 - c. At a reasonable price.
2. Information about this requirement, along with the list of EPA-designated items, is available at EPA's Comprehensive Procurement Guidelines webpage: "<https://www.epa.gov/smm/comprehensive-procurement-guideline-cpg-program>".
3. The Contractor also agrees to comply with all other applicable requirements of Section 6002 of the Solid Waste Disposal Act.

N. PROHIBITION ON CONTRACTING FOR COVERED TELECOMMUNICATIONS AND EQUIPMENT OR SERVICES

1. Definitions. As used in this clause, the terms backhaul, covered foreign country, covered telecommunications equipment or services, interconnection arrangements, roaming, substantial or essential component, and telecommunications equipment or services have the meaning as defined in Federal Acquisition Regulation 52.204-25.
2. Prohibitions. Section 889(b) of the John S. McCain National Defense Authorization Act for Fiscal Year 2019, Pub. L. No. 115-232, and 2 C.F.R. § 200.216 prohibit the head of an executive agency on or after Aug. 13, 2020, from obligating or expending grant, cooperative agreement, loan, or loan guarantee funds on certain telecommunications products or from certain entities for national security reasons. Unless an exception listed in subparagraph 3 of this section applies, the Contractor and its subcontractors may not use grant, cooperative agreement, loan, or loan guarantee funds from Treasury to:
 - a. Procure or obtain any equipment, system, or service that uses covered telecommunications equipment or services as a substantial or essential component of any system, or as critical technology of any system.
 - b. Enter into, extend, or renew a contract to procure or obtain any equipment, system, or service that uses covered telecommunications equipment or services as a substantial or essential component of any system, or as critical technology of any system.
 - c. Enter into, extend, or renew contracts with entities that use covered telecommunications equipment or services as a substantial or essential component of any system, or as critical technology as part of any system; or
 - d. Provide, as part of its performance of this Contract, subcontract, or other contractual instrument, any equipment, system, or service that uses covered

telecommunications equipment or services as a substantial or essential component of any system, or as critical technology as part of any system.

3. Exceptions. This clause does not prohibit contractors from providing:
 - a. A service that connects to the facilities of a third-party, such as backhaul, roaming, or interconnection arrangements: or
 - b. Telecommunications equipment that cannot route or redirect user data traffic or permit visibility into any user data or packets that such equipment transmits or otherwise handles.
 - c. Covered telecommunications equipment or services that:
 - i. Are not used as a substantial or essential component of any system;
 - ii. Are not used as critical technology of any system; and
 - iii. Other telecommunications equipment or services that are not considered covered telecommunications equipment or services.
4. Reporting requirement.
 - a. In the event the Contractor identifies covered telecommunications equipment or services used as a substantial or essential component of any system, or as critical technology as part of any system, during Contract performance, or the Contractor is notified of such by a subcontractor at any tier or by any other source, the Contractor shall report the information in subparagraph 2 of this section to MTC unless elsewhere in this Contract are established procedures for reporting the information.
 - b. The Contractor shall report the following information pursuant to this section:
 - i. Within one business day from the date of such identification or notification: The contract number; the order number(s), if applicable; supplier name; supplier unique entity identifier (if known); supplier Commercial and Government Entity (CAGE) code (if known); brand; model number (original equipment manufacturer number, manufacturer part number, or wholesaler number); item description; and any readily available information about mitigation actions undertaken or recommended.
 - ii. Within 10 business days of submitting the information of this section: Any further available information about mitigation actions undertaken or recommended. In addition, the Contractor shall describe the efforts it undertook to prevent use or submission of covered telecommunications equipment or services, and any additional efforts that will be incorporated to prevent future use or submission of covered telecommunications equipment or services.
5. Subcontracts. The Contractor shall insert the substance of this section in all subcontracts and other contractual instruments.

O. DOMESTIC PREFERENCES FOR PROCUREMENTS

1. The Contractor shall comply with all current requirements of “Buy America or Buy American” requirements of the laws or regulations promulgated thereunder of the United States of America.
2. As appropriate, and to the extent consistent with law, Contractor should, to the greatest extent practicable, provide a preference for the purchase, acquisition, or use of goods, products, or materials produced in the United States. This includes, but is not limited to iron, aluminum, steel, cement, and other manufactured products.
3. For purposes of this clause:
 - a. *Produced in the United States* means, for iron and steel products, that all manufacturing processes, from the initial melting stage through the application of coatings, occurred in the United States.
 - b. *Manufactured products* mean items and construction materials composed in whole or in part of non-ferrous metals such as aluminum, plastics and polymer-based products such as polyvinyl chloride pipe, aggregates such as concrete, glass, including optical fiber, and lumber.

P. INDEMNIFICATION

1. Contractor agrees to defend, indemnify and hold MTC and MDOT, and their agents, employees, officers, and legal representatives, harmless for all loss or damage arising out of, or in any way connected to the Work, or from any unforeseen obstructions or difficulties that may be encountered in the prosecution of the Work, and for all risks of every description connected with the Work, with the exception of any items specifically excluded in the Contract Documents. Contractor shall fully and faithfully complete the Work in a good and workmanlike manner, according to the Contract Documents and any Supplemental Agreements thereto.
2. Contractor agrees to defend, indemnify and hold MTC and MDOT, and their agents, employees, officers, and legal representatives, harmless in connection with any Determination Memorandum from Treasury that arises out of any failure and/or violation of the Contractor to follow any of Treasury’s requirements.
3. Contractor agrees to defend, indemnify and hold MTC and MDOT, and their agents, employees, officers, and legal representatives, harmless for all claims, causes of action, liabilities, fines, and expenses (including, without limitation, attorneys’ fees, court costs, and all other defense costs and interest) for injury, death, damage, or loss to persons or property sustained in connection with or incidental to performance under this Contract including, without limitation, those caused by:
 - a. Contractor’s and/or its agents’, employees’, officers’, directors’, or contractors’ actual or alleged negligence or intentional acts or omissions; and/or

- b. Contractor's actual or alleged strict products liability or strict statutory liability, whether Contractor is immune from liability or not.
4. The Contractor shall defend, indemnify, and hold MTC and MDOT and their agents, employees, officers, and legal representatives harmless during the term of this Contract and for four (4) years after the completion of the Contract. The Contractor shall not be required to indemnify MTC or MDOT for MTC's or MDOT's sole negligence.

Q. PAYMENT TERMS

1. MTC shall make payment to the Contractor in accordance with the Contract Documents. Pay Estimates must be verified by MDOT's designated Project Engineer before being paid.
2. MTC may reject a deficient Pay Estimate. MTC's rejection should specify the deficiency and the action necessary to correct the deficiency and to make the Pay Estimate proper.
3. MTC may decline to make payment, may withhold funds, and, if necessary, may demand the return of some or all of the amounts previously paid to the Contractor, to protect MTC from loss because of:
 - a. Defective Work not remedied by Contractor or, in the opinion of MTC, not likely to be remedied by the Contractor;
 - b. Claims of third parties against MTC or MTC's property;
 - c. Failure by Contractor to pay subcontractors or others in a prompt and proper fashion;
 - d. Evidence that the balance of the Work cannot be completed in accordance with the Contract or at the agreed to rates in the Contract Documents;
 - e. Evidence that the Work will not be completed in the time required for substantial or final completion (final completion meaning the full and final completion of all Work called for by this Contract and final Acceptance by MTC);
 - f. Recurring or persistent failure to carry out the Work in accordance with the Contract Documents;
 - g. Damage to MTC or a third party to whom MTC is, or may be, liable; or
 - h. Recurring or persistent failure to submit required reports or other information requested by MTC.
4. In the event that MTC makes written demand upon the Contractor for amounts previously paid by MTC as contemplated in this section, the Contractor shall promptly comply with such demand. MTC shall have no duty to third parties to withhold payment to the Contractor and shall incur no liability for a failure to withhold funds.
5. If MTC disputes a Pay Estimate that the Contractor submits for any reason, including lack of supporting documentation (as may be required by MTC in its sole

discretion), MTC shall temporarily delete the disputed item and pay the remainder of the estimate. MTC shall promptly notify the Contractor of the dispute and request remedial action. After the dispute is settled, the Contractor shall include the settled amount, if any, on a subsequent regularly scheduled Pay Estimate as directed by the Project Engineer.

R. TERMINATION

1. **TERMINATION FOR CONVENIENCE BY MTC.** Termination for Convenience of the Contractor may occur in accordance with Section 108.09 of the most recent version of the *Mississippi Standard Specifications for Road and Bridge Construction*, and/or any amendment thereto.
2. **TERMINATION FOR CAUSE BY MTC.** Termination for Cause of the Contractor may occur in accordance with Section 108.08 of the most recent version of the *Mississippi Standard Specifications for Road and Bridge Construction*, and/or any amendment thereto.

S. INSPECTIONS AND AUDITS

1. Designated Representatives of MTC, which may include MDOT employees, may perform, or have performed, (i) audits of Contractor's books and records, and (ii) inspections of all places where the Work is undertaken in connection with this Contract. Contractor shall keep its books and records available for this purpose for at least five years after this Contract terminates. This provision does not affect the applicable statute of limitations.
2. Contractor shall provide MTC, Treasury, the Comptroller General of the United States, or any of their authorized representatives, access to any books, documents, papers, and records of the Contractor that are directly pertinent to this Contract for the purposes of making audits, examinations, excerpts, and transcriptions. The Contractor shall keep its books, documents, papers, and records available for this purpose for at least five years after this Contract terminates or expires. This provision does not limit the applicable statute of limitations.
3. The Contractor shall permit any of the foregoing parties to reproduce by any means whatsoever or to copy excerpts and transcriptions as reasonably needed.
4. The Contractor shall provide Treasury access to construction or other Work sites pertaining to the Work being completed, or already completed, under this Contract.
5. MTC and the Contractor acknowledge and agree that no language in this Contract is intended to prohibit audits or internal reviews by Treasury or the Comptroller General of the United States.

T. DISPUTE RESOLUTION

The Contractor shall follow the provisions of the *Mississippi Standard Specifications for Road and Bridge Construction*, and/or any amendment thereto, for submitting a claim for consideration by MTC.

The Contractor agrees that he has read each and every clause of this Contract, and fully understands the meaning of same and that he will comply with all the terms, covenants and agreements therein set forth. In the event of a conflict arising between the terms of this Contract and any provision of the applicable version of the *Mississippi Standard Specifications for Road and Bridge Construction*, the Special Provisions attached thereto, or the Plans, then the provisions contained in this document (Section 902) shall control.

WITNESS OUR SIGNATURES this the ____ day of _____, _____.

Contractor(s)

By _____

MISSISSIPPI TRANSPORTATION
COMMISSION

Title _____

By _____

Signed and sealed in the presence of:
(Names and address of witnesses)

Executive Director

Secretary to the Commission

Award authorized by the Mississippi Transportation Commission in session on the ____ day of _____, 20____, Minute Book No. _____, Page No. _____

**SECTION 903
PERFORMANCE BOND**

PERFORMANCE BOND FOR THE FOLLOWING CONTRACT:

Project No.: _____

For the construction of: _____

Contract date: _____ Contract amount: _____

FOR OWNER: MISSISSIPPI TRANSPORTATION COMMISSION, 401 N. WEST STREET, JACKSON, MISSISSIPPI 39201.

CONTRACTOR (full legal name, contact person, phone number and address):

SURETY (legal name, phone number, principal place of business and address *for notice purposes*):

Second Surety (if applicable):

The Contractor and Surety, jointly and severally, bind themselves, their heirs, executors, administrators, successors and assigns, to the Owner for the performance of the Contract, which is incorporated herein by reference, and subject to the following terms:

1. If the Contractor fully and faithfully performs the Contract, the Surety and the Contractor shall have no obligation under this Bond.
2. The Surety's obligation under this Bond shall arise after:
 - (a) the Owner first provides notice to the Contractor and the Surety that termination is imminent, pursuant to the current edition of the Mississippi Standard Specifications for Road and Bridge Construction, which is a part of the Contract; and
 - (b) the Owner declares a Contractor Default, terminates the Contract, and notifies the Surety.
3. The Surety shall promptly and at the Surety's expense, take one of the following actions:
 - (a) Arrange for the Contractor, with the consent of the Owner, to perform and complete the Contract; or
 - (b) Undertake to perform and complete the Contract itself, through its agents or independent contractors.
4. If the Surety does not proceed as provided in Paragraph 3, within 20 calendar days as set forth in Section 108.08 of the current edition of the Mississippi Standard Specifications for Road and Bridge Construction, then the Surety shall be deemed to be in default on this Bond, and the Owner shall be entitled to enforce any remedy available to it under the Contract and applicable law.
5. Subject to the commitment by the Owner to pay the Balance of the Contract Price, the Surety is obligated, without duplication, for

- (a) the responsibilities of the Contractor for correction of defective work and completion of the Contract;
 - (b) additional legal, design professional and delay costs resulting from the Contractor's Default, and resulting from the actions or failure to act of the Surety under Paragraph 3; and
 - (c) liquidated damages, or if no liquidated damages are specified in the Contract, actual damages caused by delayed performance or non-performance of the Contractor.
6. The Surety hereby waives notice of any change, including changes of time, to the Contract or to related subcontracts, purchase orders and other obligations.
 7. The penal sum of the Bond shall be subject to increase or decrease based on any subsequent Supplemental Agreements and/or final contract quantities.
 8. Notice to the Surety, the Owner or the Contractor shall be mailed or delivered to the address listed for notice purposes on the first page of this Bond.

CONTRACTOR AS PRINCIPAL

Company: _____

Signature: _____

Name: _____

Title: _____

Address: _____

SURETY

Company: _____

Signature: _____

MS Insurance ID # _____

Name: _____

Title: _____

Address: _____

SURETY (if applicable)

Company: _____

Signature: _____

MS Insurance ID # _____

Name: _____

Title: _____

Address: _____

**SECTION 903
PAYMENT BOND**

PAYMENT BOND FOR THE FOLLOWING CONTRACT:

Project No.: _____

For the construction of: _____

Contract date: _____ Contract amount: _____

FOR OWNER: MISSISSIPPI TRANSPORTATION COMMISSION, 401 N. WEST STREET, JACKSON, MISSISSIPPI 39201.

CONTRACTOR (full legal name, contact person, phone number and address):

SURETY (legal name, phone number, principal place of business and address *for notice purposes*):

Second Surety (if applicable):

The Contractor and Surety, jointly and severally, bind themselves, their heirs, executors, administrators, successors and assigns, to the Owner for payment of labor, materials and equipment furnished for use in the performance of the Contract, which is incorporated herein by reference, subject to the following terms:

1. If the Contractor promptly makes payment of all sums due to any and all subcontractors, suppliers and/or laborers, and defends, indemnifies and holds harmless the Owner from claims, demands, liens or suits by any person or entity seeking payment for labor, materials or equipment furnished for use in the performance of the Contract, then the Surety and the Contractor shall have no obligation under this Bond.
2. The Owner shall provide notice to the Surety of any claims, demands, liens or suits against the Owner or the Owner's property that it receives from any person or entity ("Claimants") seeking payment for labor, materials or equipment furnished for use in the performance of the Contract.
3. Upon notice of any claims, demands, liens or suits provided by the Owner or Contractor or given to the Surety by a Claimant, the Surety shall promptly and at the Surety's expense, defend, indemnify and hold harmless the Owner against said claim, demand, lien or suit and shall take the following additional actions:
 - (a) Send an answer to the Claimant, with a copy to the Owner, within sixty (60) days after receipt of the Claim, stating the amounts that are undisputed and the basis for challenging any amounts that are disputed; and
 - (b) Pay or arrange for payment of any undisputed amounts.
4. The Surety shall not be liable to the Owner, Claimants or others for obligations of the Contractor that are unrelated to the Contract. The Owner shall not be liable for the payment of any costs or expenses of any Claimant under this Bond, and shall have no obligation under this Bond to make payments to, or give notice on behalf of, Claimants or otherwise have any obligations to Claimants under this Bond.

5. The Surety hereby waives notice of any change, including changes of time, to the Contract or to related subcontracts, purchase orders and other obligations.
6. The penal sum of the Bond shall be subject to increase or decrease based on any subsequent Supplemental Agreements and/or final contract quantities.

CONTRACTOR AS PRINCIPAL

Company: _____
Signature: _____
Name: _____
Title: _____
Address: _____

SURETY

Company: _____
Signature: _____ MS Insurance ID # _____
Name: _____
Title: _____
Address: _____

SURETY (if applicable)

Company: _____
Signature: _____ MS Insurance ID # _____
Name: _____
Title: _____
Address: _____



BID BOND

KNOW ALL MEN BY THESE PRESENTS, that we _____
Contractor

Address

City, State ZIP

As principal, hereinafter called the Principal, and _____
Surety

a corporation duly organized under the laws of the state of _____

as Surety, hereinafter called the Surety, are held and firmly bound unto State of Mississippi, Jackson, Mississippi

As Obligee, hereinafter called Obligee, in the sum of **Five Per Cent (5%) of Amount Bid**

Dollars(\$ _____)

for the payment of which sum will and truly to be made, the said Principal and said Surety, bind ourselves, our heirs, executors, administrators, successors and assigns, jointly and severally, firmly by these presents.

WHEREAS, the Principal has submitted a bid for **Mill & Overlay approximately 5 miles of US 49 from Richard Kendrick Drive to Seminary, known as Project No. NHPP-0008-02(121) / 108719301 in Covington County.**

NOW THEREFORE, the condition of this obligation is such that if the aforesaid Principal shall be awarded the contract, the said Principal will, within the time required, enter into a formal contract and give a good and sufficient bond to secure the performance of the terms and conditions of the contract, then this obligation to be void; otherwise the Principal and Surety will pay unto the Obligee the difference in money between the amount of the bid of the said Principal and the amount for which the Obligee legally contracts with another party to perform the work if the latter amount be in excess of the former, but in no event shall liability hereunder exceed the penal sum hereof.

Signed and sealed this _____ day of _____, 20__

(Principal) (Seal)

(Witness) (Name) By: _____ (Title)

(Surety) (Seal)

(Witness) (Attorney-in-Fact) By: _____

(MS Agent)

Mississippi Insurance ID Number

CERTIFICATION REGARDING LOBBYING

The undersigned certifies, to the best of his or her knowledge and belief, that:

(1) No Federal appropriated funds have been paid or will be paid, by or on behalf of the undersigned, to any person for influencing or attempting to influence an officer or employee of any agency, a Member of Congress, an officer or employee of Congress, or an employee of a Member of Congress in connection with the awarding of any Federal grant, the making of any Federal loan, the entering into of any cooperative agreement, and the extension, continuation, renewal, amendment or modification of any Federal contract, grant, loan, or cooperative agreement.

(2) If any funds other than Federal appropriated funds have been paid or will be paid to any person for influencing or attempting to influence an officer or employee of any agency, a Member of Congress, an officer or employee of Congress, or an employee of a Member of Congress in connection with this Federal contract, grant, loan, or cooperative agreement, the undersigned shall complete and submit Standard Form-LLL, "Disclosure of Lobbying Activities," in accordance with its instructions.

(3) The undersigned shall require that the language of this certification be included in the award documents of all sub-awards at all tiers (including subcontracts, sub-grants, and contracts under grants, loans, and cooperative agreements) and that all sub-recipients shall certify and disclose accordingly.

This certification is a material representation of fact upon which reliance was placed when this transaction was made or entered into. Submission of this certification is a prerequisite for making or entering into this transaction imposed by section 1352, title 31, United States Code. Any person who fails to file the required certification shall be subject to a civil penalty of not less than \$10,000 and not more than \$100,000 for each such failure.

Organization: _____

Street address: _____

City, State, Zip: _____

CERTIFIED BY: (type or print)

TITLE:

(signature)

(date)

Disclosure of Lobbying Activities

Complete this form to disclose lobbying activities pursuant to 31 U.S.C. 1352
(See reverse for public burden disclosure)

<p>1. Type of Federal Action: a. contract _____ b. grant c. cooperative agreement d. loan e. loan guarantee f. loan insurance</p>	<p>2. Status of Federal Action: a. bid/offer/application _____ b. initial award c. post-award</p>	<p>3. Report Type: a. initial filing _____ b. material change</p> <p>For material change only: Year _____ quarter _____ Date of last report _____</p>
<p>4. Name and Address of Reporting Entity: _____ Prime _____ Subawardee Tier _____, if Known:</p> <p>Congressional District, if known:</p>	<p>5. If Reporting Entity in No. 4 is Subawardee, Enter Name and Address of Prime:</p> <p>Congressional District, if known:</p>	
<p>6. Federal Department/Agency:</p>	<p>7. Federal Program Name/Description:</p> <p>CFDA Number, <i>if applicable</i>: _____</p>	
<p>8. Federal Action Number, if known:</p>	<p>9. Award Amount, if known:</p> <p>\$ _____</p>	
<p>10. a. Name and Address of Lobbying Registrant <i>(if individual, last name, first name, MI):</i></p>	<p>b. Individuals Performing Services <i>(including address if different from No. 10a)</i> <i>(last name, first name, MI):</i></p>	
<p>11. Information requested through this form is authorized by title 31 U.S.C. section 1352. This disclosure of lobbying activities is a material representation of fact upon which reliance was placed by the tier above when this transaction was made or entered into. This disclosure is required pursuant to 31 U.S.C. 1352. This information will be reported to the Congress semi-annually and will be available for public inspection. Any person who fails to file the required disclosure shall be subject to a civil penalty of not less than \$10,000 and not more than \$100,000 for each such failure.</p>	<p>Signature: _____</p> <p>Print Name: _____</p> <p>Title: _____</p> <p>Telephone No.: _____ Date: _____</p>	
<p>Federal Use Only</p>	<p>Authorized for Local Reproduction Standard Form - LLL (Rev. 7-97)</p>	

INSTRUCTIONS FOR COMPLETION OF SF-LLL, DISCLOSURE OF LOBBYING ACTIVITIES

This disclosure form shall be completed by the reporting entity, whether subawardee or prime Federal recipient, at the initiation or receipt of a covered Federal action, or a material change to a previous filing, pursuant to title 31 U.S.C. section 1352. The filing of a form is required for each payment or agreement to make payment to any lobbying entity for influencing or attempting to influence an officer or employee of any agency, a Member of Congress, an officer or employee of Congress, or an employee of a Member of Congress in connection with a covered Federal action. Complete all items that apply for both the initial filing and material change report. Refer to the implementing guidance published by the Office of Management and Budget for additional information.

1. Identify the type of covered Federal action for which lobbying activity is and/or has been secured to influence the outcome of a covered Federal action.
2. Identify the status of the covered Federal action.
3. Identify the appropriate classification of this report. If this is a followup report caused by a material change to the information previously reported, enter the year and quarter in which the change occurred. Enter the date of the last previously submitted report by this reporting entity for this covered Federal action.
4. Enter the full name, address, city, State and zip code of the reporting entity. Include Congressional District, if known. Check the appropriate classification of the reporting entity that designates if it is, or expects to be, a prime or subaward recipient. Identify the tier of the subawardee, e.g., the first subawardee of the prime is the 1st tier. Subawards include but are not limited to subcontracts, subgrants and contract awards under grants.
5. If the organization filing the report in item 4 checks "Subawardee," then enter the full name, address, city, State and zip code of the prime Federal recipient. Include Congressional District, if known.
6. Enter the name of the federal agency making the award or loan commitment. Include at least one organizational level below agency name, if known. For example, Department of Transportation, United States Coast Guard.
7. Enter the Federal program name or description for the covered Federal action (item 1). If known, enter the full Catalog of Federal Domestic Assistance (CFDA) number for grants, cooperative agreements, loans, and loan commitments.
8. Enter the most appropriate Federal identifying number available for the Federal action identified in item 1 (e.g., Request for Proposal (RFP) number; Invitations for Bid (IFB) number; grant announcement number; the contract, grant, or loan award number; the application/proposal control number assigned by the Federal agency). Included prefixes, e.g., "RFP-DE-90-001."
9. For a covered Federal action where there has been an award or loan commitment by the Federal agency, enter the Federal amount of the award/loan commitment for the prime entity identified in item 4 or 5.
10. (a) Enter the full name, address, city, State and zip code of the lobbying registrant under the Lobbying Disclosure Act of 1995 engaged by the reporting entity identified in item 4 to influence the covered Federal action.

(b) Enter the full names of the individual(s) performing services, and include full address if different from 10(a). Enter Last Name, First Name, and Middle Initial (MI).
11. The certifying official shall sign and date the form, print his/her name, title, and telephone number.

According to the Paperwork Reduction Act, as amended, no persons are required to respond to a collection of information unless it displays a valid OMB control Number. The valid OMB control number for this information collection is OMB No. 0348-0046. Public reporting burden for this collection of information is estimated to average 10 minutes per response, including time for reviewing instructions, searching existing data sources, gathering and maintaining the data needed, and completing and reviewing the collection of information. Send comments regarding the burden estimate or any other aspect of this collection of information, including suggestions for reducing this burden, to the Office of Management and Budget, Paperwork Reduction Project (0348-0046), Washington, DC 20503

MISSISSIPPI DEPARTMENT OF TRANSPORTATION
OFFICE OF CIVIL RIGHTS
JACKSON, MISSISSIPPI

LIST OF FIRMS SUBMITTING QUOTES

I/we received quotes from the following firms on:

Letting Date: **September 25, 2024**

Project No: **NHPP-0008-02(121)/ 108719301000**

County: **Covington**

Disadvantaged Business Enterprise (DBE) Regulations as stated in 49 CFR 26.11 require the Mississippi Department of Transportation (MDOT) to create and maintain a comprehensive list of all firms quoting/bidding subcontracts on prime contracts and quoting/bidding subcontracts on federally-funded transportation projects. For every firm, we require the following information:

Firm Name: _____
Contact Name/Title: _____
Firm Mailing Address: _____
Phone Number: _____
_____ DBE Firm _____ Non-DBE Firm

Firm Name: _____
Contact Name/Title: _____
Firm Mailing Address: _____
Phone Number: _____
_____ DBE Firm _____ Non-DBE Firm

Firm Name: _____
Contact Name/Title: _____
Firm Mailing Address: _____
Phone Number: _____
_____ DBE Firm _____ Non-DBE Firm

Firm Name: _____
Contact Name/Title: _____
Firm Mailing Address: _____
Phone Number: _____
_____ DBE Firm _____ Non-DBE Firm

Firm Name: _____
Contact Name/Title: _____
Firm Mailing Address: _____
Phone Number: _____
_____ DBE Firm _____ Non-DBE Firm

SUBMITTED BY (Signature)

FIRM NAME

