



SM No. CSP0037040611

# PROPOSAL AND CONTRACT DOCUMENTS

## FOR THE CONSTRUCTION OF

13

Overlay approximately 10 miles of SR 43 from SR 481 to the Madison County Line, known as State Project No. SP-0037-04(061) / 107633301 in Rankin County.

Project Completion: Flexible

**(STATE DELEGATED)**

### NOTICE

**BIDDERS MUST COMPLETE AN ONLINE REQUEST  
FOR PERMISSION TO BID THIS PROJECT.**

Electronic addendum updates will be posted on [www.gomdot.com](http://www.gomdot.com)

**SECTION 900  
OF THE CURRENT  
2017 STANDARD SPECIFICATIONS  
FOR ROAD AND BRIDGE CONSTRUCTION  
JACKSON, MISSISSIPPI**

**MISSISSIPPI DEPARTMENT OF TRANSPORTATION  
TABLE OF CONTENTS**

**PROJECT: SP-0037-04(061)/107633301 - Rankin**

Section 901 - Advertisement

Section 904 - Notice to Bidders

#1	Governing Specification, w/ Supplement
#3	Final Cleanup
#13	Safety Edge
#296	Reduced Speed Limit Signs
#445	Mississippi Agent or Qualified Nonresident Agent
#516	Errata and Modifications to the 2017 Standard Specifications
#1225	Early Notice to Proceed
#1226	Material Storage Under Bridges
#1241	Fuel and Material Adjustments
#1963	Guardrail Pads
#2206	MASH Compliant Devices
#2273	Mississippi Special Fuel Tax Law
#2654	Disadvantaged Business Enterprises In Special Funded Projects, w/ Supplement
#2782	DBE Pre-Bid Meeting
#2954	Reflective Sheeting for Signs
#3599	Standard Drawings w/Supplement
#3676	Asphalt Gyrotory Compactor Internal Angle Calibration
#4113	Unique Entity ID Requirement For Federal Funded Projects
#4702	App for Traffic Control Report
#5086	Detail of Square Tube Sign Posts
#5551	Federal Bridge Formula
#5750	Manual on Uniform Traffic Control Devices (MUTCD)
#6569	Contract Time
#6570	Scope of Work
#6571	Project Number Change
#6572	Temporary Construction Signs
#6573	Underground Utilities
#6574	Lane Closure Restrictions

Section 907 - Special Provisions

907-101-1	Definitions and Terms
907-102-2	Bidding Requirements and Conditions
907-103-2	Award and Execution of Contract
907-105-2	Control of Work
907-106-2	Control of Materials
907-108-4	Subletting of Contract
907-109-5	Measurement and Payment
907-401-1	Tack Coat
907-618-12	Traffic Control Management
907-626-11	Thermoplastic Markings
907-627-1	Raised Pavement Markings
907-700-1	Materials and Tests

**PROJECT: SP-0037-04(061)/107633301 - Rankin**

907-701-3	Hydraulic Cement
907-702-4	Bituminous Materials
907-703-2	Gradation
907-705-1	Stone Riprap
907-707-3	Joint Materials
907-708-4	Concrete Pipe
907-711-2	Plain Steel Wire
907-712-1	Fence and Guardrail
907-714-3	Miscellaneous Materials
907-718-1	Timber and Dimension Lumber
907-720-3	Pavement Marking Materials
907-721-4	Materials for Signing

Section 905 - Proposal, Proposal Bid Items, Combination Bid Proposal  
State Board of Contractors Requirement  
State Certification Regarding Non-Collusion, Debarment and Suspensions  
Section 902 - Contract Form  
Section 903 - Contract Bond Forms

OCR-485  
Progress Schedule

(REVISIONS TO THE ABOVE WILL BE INDICATED ON THE SECOND SHEET  
OF SECTION 905 AS ADDENDA)

01/02/2025 02:40 PM

# MISSISSIPPI DEPARTMENT OF TRANSPORTATION

## SECTION 901 - ADVERTISEMENT

Electronic bids will be received by the Mississippi Transportation Commission at 10:00 o'clock A.M., Tuesday, January 28, 2025, from the Bid Express Service and shortly thereafter publicly read on the Sixth Floor for:

Overlay approximately 10 miles of SR 43 from SR 481 to the Madison County Line, known as State Project No. SP-0037-04(061) / 107633301 in Rankin County.

The attention of bidders is directed to the predetermined minimum wage rate set by the U. S. Department of Labor under the Fair Labor Standards Act.

The Mississippi Department of Transportation hereby notifies all bidders that it will affirmatively insure that in any contract entered into pursuant to this advertisement, disadvantaged business enterprises will be afforded full opportunity to submit bids in response to this invitation and will not be discriminated against on the grounds of race, color, sex, age, disability, religion or national origin in consideration for an award.

The specifications are on file in the offices of the Mississippi Department of Transportation.

Contractors may request permission to bid online at <http://shop.mdot.ms.gov> at no cost. Upon approval, Contractors shall be eligible to submit a bid using Bid Express at <http://bidx.com>. Specimen proposals may be viewed and downloaded online at no cost at <http://mdot.ms.gov> or purchased online at <http://shop.mdot.ms.gov> at a cost of Ten Dollars (\$10.00) per proposal plus a small convenience fee. Cash or checks will not be accepted as payment.

Bid bond, signed or countersigned by a Mississippi Agent or Qualified Nonresident Agent, with Power of Attorney attached, a Cashier's check or Certified Check for five (5%) percent of bid, payable to STATE OF MISSISSIPPI, must accompany each proposal.

The attention of bidders is directed to the provisions of Subsection 102.07 pertaining to irregular proposals and rejection of bids.

BRAD WHITE  
EXECUTIVE DIRECTOR

**MISSISSIPPI DEPARTMENT OF TRANSPORTATION**

**SUPPLEMENT TO NOTICE TO BIDDERS NO. 1**

**DATE: 06/08/2021**

**SUBJECT: Governing Specifications**

Change the web address at the end of the first paragraph to the following.

<https://shop.mdot.ms.gov/default.aspx?StoreIndex=1>

# MISSISSIPPI DEPARTMENT OF TRANSPORTATION

**SECTION 904 - NOTICE TO BIDDERS NO. 1**

**CODE: (IS)**

**DATE: 03/01/2017**

**SUBJECT: Governing Specifications**

The current (2017) Edition of the Standard Specifications for Road and Bridge Construction adopted by the Mississippi Transportation Commission is made a part hereof fully and completely as if it were attached hereto, except where superseded by special provisions, or amended by revisions of the Specifications contained within this proposal. Copies of the specification book may be purchased from the MDOT Construction Division, or online at [shopmdot/default.aspx?StoreIndex=1](http://shopmdot/default.aspx?StoreIndex=1).

A reference in any contract document to controlling requirements in another portion of the contract documents shall be understood to apply equally to any revision or amendment thereof included in the contract.

In the event the plans or proposal contain references to the 2004 Edition of the Standard Specifications for Road and Bridge Construction, it is to be understood that such references shall mean the comparable provisions of the 2017 Edition of the Standard Specifications.

**MISSISSIPPI DEPARTMENT OF TRANSPORTATION**

**SECTION 904 - NOTICE TO BIDDERS NO. 3**

**CODE: (SP)**

**DATE: 01/17/2017**

**SUBJECT: Final Clean-Up**

Immediately prior to final inspection for release of maintenance, the Contractor shall pick up, load, transport and properly dispose of all litter from the entire highway right-of-way that is within the termini of the project.

Litter shall include, but not be limited to, solid wastes such a glass, paper products, tires, wood products, metal, synthetic materials and other miscellaneous debris.

Litter removal is considered incidental to other items of work and will not be measured for separate payment.

**MISSISSIPPI DEPARTMENT OF TRANSPORTATION**

**SECTION 904 - NOTICE TO BIDDERS NO. 13**

**CODE: (IS)**

**DATE: 03/01/2017**

**SUBJECT: Safety Edge**

Bidders are hereby advised that the Shoulder Wedge (Safety Edge) specified in Section 401, Asphalt Pavements, shall only apply to the top two (2) lifts of asphalt. Open Graded Friction Courses (OGFC) are not to be considered a lift as it pertains to safety edge. Attached is a drawing showing the safety edge. Note that the shoulder dimensions in the bottom two drawings will be less than three feet (3').





**MISSISSIPPI DEPARTMENT OF TRANSPORTATION**

**SECTION 904 - NOTICE TO BIDDERS NO. 296**

**CODE: (SP)**

**DATE: 07/25/2017**

**SUBJECT: Reduced Speed Limit Signs**

Bidders are advised that when the plans or contract documents require the speed limit on a project to be reduced, the Contractor shall begin work within 48 hours of installing the reduced speed limit signs. Should the Contractor not start work or have no plans to start work within 48 hours of installing the signs, the reduced speed limit signs shall be covered and existing speed limit signs uncovered.

**MISSISSIPPI DEPARTMENT OF TRANSPORTATION**

**SECTION 904 - NOTICE TO BIDDERS NO. 445**

**CODE: (SP)**

**DATE: 10/10/2017**

**SUBJECT: Mississippi Agent or Qualified Nonresident Agent**

Bidders are hereby advised of the requirements of Subsections 102.08, 103.05.2, and 107.14.2.1 of the *2017 Standard Specifications for Road and Bridge Construction* as it refers to bonding agents. Proposal guaranties, bonds, and liability insurance policies must be signed by a **Mississippi Agent or Qualified Nonresident Agent.**

## MISSISSIPPI DEPARTMENT OF TRANSPORTATION

SECTION 904 - NOTICE TO BIDDERS NO. 516

CODE: (IS)

DATE: 11/28/2017

SUBJECT: Errata and Modifications to the 2017 Standard Specifications

<u>Page</u>	<u>Subsection</u>	<u>Change</u>
16	102.06	In the seventh full paragraph, change “Engineer” to “Director.”
33	105.05.1	In the sixth sentence, change “Contract Administration Engineer” to “Contract Administration Director.”
34	105.05.2.1	In subparagraph 2, change “SWPPP, ECP” to “SWPPP and the ECP”
35	105.05.2.2	In subparagraphs 2, add “ and” to the end of the sentence. In subparagraph 3, remove “, and” and add “.”.
90	109.04.2	In the last paragraph of subparagraph (a), place a period “.” at the end of the sentence.
93	109.04.2	In the last paragraph of subparagraph (g), place a period “.” at the end of the sentence. Also, in the first paragraph of subparagraph (h), place a period “.” at the end of the sentence.
97	109.07	Under ADJUSTMENT CODE, subparagraph (A1), change “HMA mixture” to “Asphalt mixtures.”
98	109.11	In the third sentence, change “Engineer” to “Director.”
219	308.04	In the last sentence of the last paragraph, change “Contractor’s decision” to “Engineer’s decision.”
300	405.02.5.9	In the first sentence of the second paragraph, change “Hot Mix Asphalt” to “Asphalt Mixtures.”
502	630.01.1	In the first paragraph, change “AASHTO” to “AASHTO’s LRFD”.
636	646.05	Change “each” to “per each” for the pay item units of payment.
640	656.02.6.2	In item 7), change “down stream” to “downstream”.
688	630.03.2	Change the subsection number from “630.03.2” to “680.03.2.”

725      702.08.3      In the second sentence of the first paragraph, change “hot-mix” to “asphalt.”

954      804.02.13.1.6      In the definition for “M” in the % Reduction formulas, change “paragraph 7.3” to “paragraph 5.3.”

**MISSISSIPPI DEPARTMENT OF TRANSPORTATION**

**SECTION 904 - NOTICE TO BIDDERS NO. 1225**

**CODE: (SP)**

**DATE: 11/13/2018**

**SUBJECT: Early Notice to Proceed**

Bidders are advised that if an early notice to proceed is allowed by the Department and the Contractor experiences problems or delays between the early notice to proceed date and the original notice to proceed date, this shall not be justification for any monetary compensation or an extension of contract time.

**MISSISSIPPI DEPARTMENT OF TRANSPORTATION**

**SECTION 904 - NOTICE TO BIDDERS NO. 1226**

**CODE: (IS)**

**DATE: 11/16/2018**

**SUBJECT: Material Storage Under Bridges**

Bidders are advised that Subsection 106.08 of the Standard Specifications allows the Contractor to store materials and equipment on portions of the right-of-way. However, the Contractor will not be allowed to store or stockpile materials under bridges without written permission from the Project Engineer. The Contractor shall submit a detailed request of all proposed materials to be stored under bridges to the Engineer a minimum of 14 calendar days prior to anticipated storage. This detail shall include, but not limited to, bridge location, material type, material quantity, and duration of storage. The Project Engineer and any other needed Division will review this information and determine whether to grant approval. The Contractor shall not store any material under any bridge without written approval from the Project Engineer.

**MISSISSIPPI DEPARTMENT OF TRANSPORTATION**

**SECTION 904 - NOTICE TO BIDDERS NO. 1241**

**CODE: (IS)**

**DATE: 11/27/2018**

**SUBJECT: Fuel and Material Adjustments**

Bidder's attention is brought to the last paragraph of Subsection 109.07 of the Standard Specifications which states that no fuel or material adjustment will be made after the completion of contract time. Any fuels consumed or materials incorporated into the work during the monthly estimate period falling wholly after the expiration of contract time will not be subject a fuel or material adjustment.



**MISSISSIPPI DEPARTMENT OF TRANSPORTATION**

**SECTION 904 - NOTICE TO BIDDERS NO. 1963**

**CODE: (SP)**

**DATE: 9/23/2019**

**SUBJECT: Guardrail Pads**

Bidders are hereby advised that prior to construction of the guardrail pads, the Contractor shall coordinate with the guardrail Subcontractor to determine the guardrail pad dimensions necessary to meet MASH compliance.

## MISSISSIPPI DEPARTMENT OF TRANSPORTATION

**SECTION 904 - NOTICE TO BIDDERS NO. 2206**

**CODE: (IS)**

**DATE: 01/14/2020**

**SUBJECT: MASH Compliant Devices**

Bidders are hereby advised that compliance associated with the requirements of meeting either the National Cooperative Highway Research Program (NCHRP) Report 350 or the Manual for Assessing Safety Hardware (MASH) for installations of certain traffic control devices and permanent safety hardware devices (guardrails, guardrail terminals, permanent portable barriers, cast-in-place barriers, all other permanent longitudinal barriers, crash cushions, cable barriers, cable barrier terminals, bridge rails, bridge rail transitions, all other terminals, sign supports, and all other breakaway hardware) as listed throughout the Standard Specifications and/or the Standard Drawings, or both, is now replaced with the requirements of meeting the 2016 version of MASH after December 31, 2019. This change applies to new permanent installations and to full replacements of existing installations.

At the preconstruction conference or prior to starting any work on the project, the Contractor shall submit a letter stating that the traffic control devices and permanent safety hardware devices as outlined within the paragraph above that are to be used on the project are certified to meet MASH 2016.

When a MASH 2016-compliant device does not exist for the new permanent installations and/or full replacement installations of permanent safety hardware devices, as listed above, a MASH 2009-compliant or a NCHRP 350-compliant device may be proposed by the Contractor for the project. A written request for such instances must be submitted by the Contractor either at the preconstruction conference or prior to starting any work on the project. The Contractor shall submit the following items to the Project Engineer: (1) a detailed list of the proposed devices and locations thereof; and (2) certification letters indicating that the proposed devices are compliant with either MASH 2009 or NCHRP 350.

When a MASH 2016-compliant device does not exist for the temporary work zone traffic control devices (Category 1, Category 2, and Category 3 devices), a MASH 2009-compliant or a NCHRP 350-compliant device may be proposed by the Contractor for the project. Temporary work zone traffic control devices (Category 1, Category 2, and Category 3 devices) that are MASH 2009-compliant or NCHRP 350-compliant that have been in use prior to December 31, 2019, and that have a remaining service life may be proposed for use throughout their normal service life on the project by the Contractor. For either of these scenarios for temporary work zone traffic control devices, a written request must be submitted by the Contractor either at the preconstruction conference or prior to starting any work on the project. The Contractor shall submit the following items to the Project Engineer: (1) a detailed list of the proposed devices and locations thereof; and (2) certification letters indicating that the proposed devices are compliant with either MASH 2009 or NCHRP 350.

Work will only be allowed to proceed after the Department has granted written concurrence(s) with the proposed request(s) as listed above.

**MISSISSIPPI DEPARTMENT OF TRANSPORTATION**

**SECTION 904 - NOTICE TO BIDDERS NO. 2273**

**CODE: (SP)**

**DATE: 02/12/2020**

**SUBJECT: Mississippi Special Fuel Tax Law**

Bidder's attention is brought to the second paragraph of Subsection 107.02 of the Standard Specifications which states that all Contractors and Subcontractors must comply with all requirements contained in the Mississippi Special Fuel Tax Law, Section 27-55-501, *et seq.* Attached are two Fact Sheets provided by the Mississippi Department of Revenue (MDOR) with additional information.

## Gasoline and Dyed Diesel Used for Non-Highway Purposes

*Mississippi provides a reduced rate for gasoline and dyed diesel used for non-highway purposes. The reduced rates are 6.44 cents per gallon and 5.75 cents per gallon of gasoline or dyed diesel. These fuels are generally taxed at 18 cents per gallon if for on road use.*

### Gasoline Used for Non-Highway Purposes

You may be entitled to a refund of 11.56 cents per gallon (making this an equivalent to a tax rate of 6.44 cents per gallon) if you desire to purchase gasoline to be used off road. The gasoline must be used for agricultural, maritime, industrial, manufacturing, domestic or non-highway purposes only.

Examples of non-highway include gasoline used in boats, golf carts, machinery used for manufacturing or farm equipment used exclusively in plowing, planting or harvesting farm products.

### Refund Gasoline User

The refund is based on the amount of gallons used. Before a refund is issued, you are required to...

1. Obtain a refund gasoline user's permit and a certificate for refund booklet from the Department of Revenue;
2. Have a storage tank marked "REFUND GASOLINE"; and,
3. Purchase the gasoline from someone who holds a refund gasoline dealer's permit.

No refund will be allowed for gasoline used in motor vehicles owned or operated by a government entity or used in Mississippi government contracts.

### Refund Gasoline Dealer

You must obtain a refund gasoline dealer's permit from the Department of Revenue before selling refund gasoline. At no time should the gasoline be delivered to a tank that is not properly marked. The gasoline must be dyed a distinctive mahogany color at the time of delivery.

The Department of Revenue may waive the dye requirement if the dye may cause damage to the equipment. The refund gasoline user is required to obtain the waiver from the Department of Revenue.

### Dyed Diesel Used for Non-Highway Purposes

Unlike gasoline, you are not required to apply for a refund if you desire to purchase dyed diesel to be used off road. Mississippi provides a reduced rate of 5.75 cents per gallon on dyed diesel used off road. Diesel used on road is subjected to 18 cents per gallon. Dyed diesel used in motor vehicles owned or operated by a government entity or used in Mississippi government contracts will be subjected to 18 cents per gallon.

### Dyed Diesel Used on the Highway

Any person who purchases, receives, acquires or uses dyed diesel for highway use will be liable to pay 18 cents per gallon and subject to a penalty in the amount of \$1000.

### Identifying Dyed Diesel

Storage facilities for dyed diesel must be plainly marked "NONHIGHWAY DIESEL FUEL" or "NONHIGHWAY KEROSENE". Retailers are also required to mark all pumps or dispensing equipment.



## Special Fuel Used on Government Contracts

### State and Local Government Contracts

Special fuel purchased, acquired or used in performing contracts with the State of Mississippi, counties, municipalities or any political subdivision is taxed at a rate of 18 cents per gallon. Special fuel includes but is not limited to the following:

- Dyed diesel fuel;
- Kerosene;
- Undyed diesel fuel; and,
- Fuel oil.

State and local government contracts include construction, reconstruction and maintenance or repairs of projects such as roads, bridges, water systems, sewer systems, buildings, drainage canals and recreational facilities. The Department of Revenue may require contractors to remit the excise tax directly to the state in lieu of paying the tax to a distributor.

### Special Fuel Direct Pay Permit

Contractors that remit the excise tax to the state will be issued a Special Fuel Direct Pay Permit. This permit relieves the distributor from collecting the tax and requires the contractor to file a monthly special fuel return. The distributor should include the contractor's permit number on all invoices that are related to tax-free sales.

The contractor is required to furnish a surety or cash bond guaranteeing the payment of the excise tax prior to receiving the Special Fuel Direct Pay Permit. The Department of Revenue may accept a contractors tax bond if the bond covers the excise tax levied on special fuel.

### Special Fuel Distributors

If the contractor does not have a Special Fuel Direct Pay Permit, distributors are required to collect the 18 cents excise tax and remit the tax to the Department of Revenue. The additional 12.25 cents levied on special fuel (excluding undyed diesel) should be reported on schedules 5F and 5G of the special fuel return.

### Environmental Protection Fee

Special fuel distributors are required to collect the environmental protection fee even if the contractor has a Special Fuel Direct Pay Permit. The fee is levied at 4/10<sup>ths</sup> of a cent per gallon. The fee is suspended or reinstated when the trust fund has exceeded or fallen below the obligatory balance.

### Penalties

Any person who knowingly and willfully purchases untaxed fuel for use in equipment utilized on a road or highway construction site in this state is guilty of a misdemeanor and, upon conviction, shall be fined not less than \$1,000 or more than \$100,000, or imprisoned in the county jail for not more than one year, or both.



## MISSISSIPPI DEPARTMENT OF TRANSPORTATION

### SUPPLEMENT TO NOTICE TO BIDDERS NO. 2654

**DATE:** 05/02/2020

The goal is 7 percent for the Disadvantaged Business Enterprise. All Bidders are required to submit Form OCR-481 for all DBEs. Bidders are advised to check the bid tabulation link for this project on the MDOT website at:

[https://mdot.ms.gov/portal/current\\_letting](https://mdot.ms.gov/portal/current_letting)

Bid tabulations are usually posted by 3:00 pm on Letting Day.

# MISSISSIPPI DEPARTMENT OF TRANSPORTATION

SECTION 904 - NOTICE TO BIDDERS NO. 2654

CODE: (SP)

DATE: 05/02/2020

**SUBJECT: Disadvantaged Business Enterprises In Special Funded Projects**

The Department has developed a Disadvantaged Business Enterprise Program that is applicable to this contract and is made a part thereof by reference, except approvals and concurrences by the Federal Highway Administration is not applicable to this contract since it is not financed in whole or in part with Federal Funds.

Copies of the program may be obtained from:

Office of Civil Rights  
Mississippi Department of Transportation  
P. O. Box 1850  
Jackson, Mississippi 39215-1850

## **POLICY**

It is the policy of the Mississippi Department of Transportation to provide a level playing field, to foster equal opportunity in all contracts, to improve the flexibility of the DBE Program, to reduce the burdens on small businesses, and to achieve that amount of participation that would be obtained in a non-discriminatory market place. In doing so, it is the policy of MDOT that there will be no discrimination in the award and performance of these contracts on the basis of race, color, sex, or national origin.

## **ASSURANCES THAT CONTRACTORS MUST TAKE:**

MDOT will require that each contract which MDOT signs with a subrecipient or a Contractor, and each subcontract the Prime Contractor signs with a Subcontractor, includes the following assurances:

“The Contractor, subrecipient or Subcontractor shall not discriminate on the basis of race, color, sex or national origin in the performance of this contract. Failure by the Contractor to carry out these requirements is a material breach of this contract, which may result in the termination of this contract or such other remedy as MDOT deems appropriate.”

## **DEFINITIONS**

For purposes of this provision the following definitions will apply:

"Disadvantaged Business" means a small business concern: (a) which is at least 51 percent owned by one or more socially and economically disadvantaged individual(s) or in the case of any publicly owned business, at least 51 percent of the stock of which is owned by one or more socially

and economically disadvantaged individual(s); and (b) whose management and daily business operations are controlled by one or more of the socially and economically disadvantaged individual(s) who own it. It is important to note that the business owners themselves must control the operations of the business. Absentee ownership or title ownership by an individual who does not take an active role in controlling the business is not consistent with eligibility as a DBE under 49 CFR Part 26.71.

### **CONTRACTOR'S OBLIGATION**

The Contractor and all Subcontractors shall take all necessary and reasonable steps to ensure that DBE firms compete for and participate in the performance of a portion of the work in this contract and shall not discriminate on the basis of race, color, sex or national origin. Failure on the part of the Contractor to carry out the DBE requirements of this contract constitutes a breach of contract and after proper notification the Department may terminate the contract or take other appropriate action as determined by the Department.

When a contract has a zero percent (0%) DBE goal, the Contractor still has the responsibility to take all necessary and reasonable steps to ensure that DBE firms can compete for and participate in the performance of the work in the contract. In this case, all work performed by a certified DBE firm is considered to be a “race neutral” measure and the Department will receive DBE credit towards the overall State goals when the DBE firm is paid for their work. If the Prime Contractor is a certified DBE firm, the Department can receive DBE credit only for the work performed by the Prime Contractor’s work force or any work subcontracted to another DBE firm. Work performance by a non-DBE Subcontractor is not eligible for DBE credit.

### **CONTRACT GOAL**

The goal for participation by DBEs is established for this contract in the attached Supplement. The Contractor shall exercise all necessary and reasonable steps to ensure that participation is equal to or exceeds the contract goal.

If the percentage of the contract that is proposed for DBEs is 1% or greater, shall be so stated on the last bid sheet of the proposal.

All Bidders shall submit to the Office of Civil Rights Form OCR-481, signed by the Prime Contractor and the DBE Subcontractors, no later than the 3<sup>rd</sup> business day after opening of the bids.

Form OCR-481 is available on the MDOT website at [www.mdot.ms.gov](http://www.mdot.ms.gov) under the Civil Rights tab, or by calling 601-359-7466.

The OCR-481 Form must contain the following information:

The name and address of each certified DBE Contractor/Supplier;

The Reference Number, percent of work to be completed by the DBE subcontractor and the dollar amount of each item. If a portion of an item is subcontracted, a breakdown of that item



including quantities and unit price must be attached, detailing what part of the item the DBE firm is to perform and who will perform the remainder of the item.

If the DBE Commitment shown on the last bid sheet of the proposal, does not equal or exceed the contract goal, the bidder must submit, to MDOT Contract Administration Division prior to bid opening, information to satisfy the Department that adequate good faith efforts have been made to meet the contract goal.

Failure of the lowest bidder to furnish acceptable proof of good faith efforts, submitted to MDOT Contract Administration Division prior to bid opening, shall be just cause for rejection of the proposal. Award may then be made to the next lowest responsive bidder or the **project** may be re-advertised.

### **GOOD FAITH EFFORTS**

The following factors are illustrative of matters the Department will consider in judging whether or not the bidder has made adequate good faith effort to satisfy the contract goal.

- (1) Whether the bidder attended the pre-bid meeting that was scheduled by the Department to inform DBEs of subcontracting opportunities;
- (2) whether the bidder advertised in general circulation, trade association, and minority-focus media concerning the subcontracting opportunities;
- (3) whether the bidder provided written notice to a reasonable number of specific DBEs that their interest in the contract is being solicited;
- (4) whether the bidder followed up initial solicitations of interest by contacting DBEs to determine with certainty whether they were interested;
- (5) whether the bidder selected portions of the work to be performed by DBEs in order to increase the likelihood of meeting the contract goal;
- (6) whether the bidder provided interested DBEs with adequate information about the plans, specifications and requirements of the contract;
- (7) whether the bidder negotiated in good faith with interested DBEs and did not reject them as unqualified without sound reasons based on a thorough investigation of their capabilities; and
- (8) whether the bidder made efforts to assist interested DBEs in obtaining any required bonding or insurance.
- (9) whether the bidder has written notification to certified DBE Contractors soliciting subcontracting for items of work in the contract.
- (10) whether the bidder has a statement of why an agreement was not reached.

- (11) Proof of written notification to certified DBE Contractors by certified mail that their interest is solicited in subcontracting the work defaulted by the previous DBE or in subcontracting other items of work in the contract.

The bidder's execution of the signature portion of the proposal shall constitute execution of the following assurance:

The bidder hereby gives assurance that a good faith effort has been made to meet the contract goal for DBE participation for which this proposal is submitted.

### **DIRECTORY**

A list of “Certified DBE Contractors” which have been certified as such by the Mississippi Department of Transportation and other Unified Certification Partners (UPC) can be found on the Mississippi Department of Transportation website at [www.mdot.ms.gov](http://www.mdot.ms.gov). The DBE firm must be certified at the time the project is let and approved by MDOT to count towards meeting the DBE goal.

### **REPLACEMENT**

If a DBE Subcontractor cannot perform satisfactorily, and this causes the OCR-481 commitment to fall below the contract goal, the Contractor shall take all necessary reasonable steps to replace the DBE with another certified DBE Subcontractor or submit information to satisfy the Mississippi Department of Transportation that adequate good faith efforts have been made to replace the DBE. The good faith efforts outlined previously in this document still apply. The replacement DBE must be a DBE who was on the Department's list of "Certified DBE Contractors" when the job was let, and who is still active All DBE replacements must be approved by the Department.

Under no circumstances shall the Prime or any Subcontractor perform the DBE's work (as shown on the OCR-481) without prior written approval from the Department. See "Sanctions" at the end of this document for penalties for performing DBE's work.

When a Contractor proposes to substitute/replace/terminate a DBE that was originally named on the OCR-481, the Contractor must obtain a release, in writing, from the named DBE explaining why the DBE Subcontractor cannot perform the work. A copy of the original DBE's release must be attached to the Contractor's written request to substitute/replace/terminate along with appropriate subcontract forms for the substitute/replacement/terminated Subcontractor, all of which must be submitted to the DBE Coordinator and approved, in advance, by MDOT.

### **PREBID MEETING**

A pre-bid meeting will be held in the Commission Room on the 1<sup>st</sup> floor of the MDOT Administration Building in Jackson at 2:00 P.M. on the day preceding the date of the bid opening.

This meeting is to inform DBE firms of subcontracting and material supply opportunities. Attendance at this meeting is considered of prime importance in demonstrating good faith effort to meet the contract goal.

### **PARTICIPATION / DBE CREDIT**

Participation shall be counted toward meeting the goal in this contract as follows:

- (1) If the Prime Contractor is a certified DBE firm, only the value of the work actually performed by the DBE Prime can be counted towards the project goal, along with any work subcontracted to a certified DBE firm.
- (2) If the Prime Contractor is not a DBE, the work subcontracted to a certified DBE Contractor will be counted toward the goal.
- (3) The Contractor may count toward the goal a portion of the total dollar value of a contract with a joint venture eligible under the standards of this provision equal to the percentage of the DBE partner in the joint venture. The joint venture must submit a Joint Venture Eligibility Form provided by the Mississippi Department of Transportation.
- (4) Expenditures to DBEs that perform a commercially useful function may be counted toward the goal. A business is considered to perform a commercially useful function when it is responsible for the execution of a distinct element of the work and carries out its responsibilities by actually performing, managing, and supervising the work involved.
- (5) The Contractor may count 100% of the expenditures for materials and supplies obtained from certified DBE suppliers and manufacturers that produce goods from raw materials or substantially alters them for resale provided the suppliers and manufacturers assume the actual and contractual responsibility for the provision of the materials and supplies. The Contractor may count 60 percent of the expenditures to suppliers that are not manufacturers, provided the supplier performs a commercially useful function in the supply process. Within 30 days after receipt of the materials, the Prime Contractor shall furnish to the DBE Coordinator invoices from the certified supplier to verify the DBE goal.
- (6) Any work that a certified DBE firm subcontracts or sub-subcontracts to a non-DBE firm will not count towards the DBE goal
- (7) Only the dollars actually paid to the DBE firm may be counted towards the DBE goal.

### **AWARD**

Award of this contract to the low bidder will be contingent upon the following condition:

- (1) **All Bidders** must submit to the Office of Civil Rights for approval, Form OCR-481 (DBE Commitment) no later than the 3<sup>rd</sup> business day after opening of the bids, or submit information with the bid proposal to satisfy the Department and that adequate good faith

efforts have been made to meet the contract goal. For answers to questions regarding Form OCR-481, contact the MDOT Office of Civil Rights at (601) 359-7466.

- (2) Bidder must include OCR-485 information with their bid proposal listing all firms that submitted quotes for material supplies or items to be subcontracted. OCR-485 information must be signed and included with the bid proposal. If the OCR-485 information is not included as part of bid proposal, your bid will be deemed irregular.

Prior to the start of any work, the bidder must notify the Project Engineer, in writing, of the name of the designated "DBE Liaison Officer" for this project. This notification must be posted on the bulletin board at the project site.

### **DEFAULT**

If the contract goal established by MDOT in this proposal is 1% or greater, it must be met to fulfill the terms of the contract. The Contractor may list DBE Subcontractors and items that exceed MDOT's contract goal, but should unforeseen problems arise that would prevent a DBE from completing its total commitment percentage, the Contractor will meet the terms of the contract as long as it meets or exceeds MDOT's Contract Goal. For additional information, refer to "Replacement" section of this Notice.

### **DBE REPORTS**

- (1) OCR-481: Refer to "CONTRACT GOAL" section of this Notice to Bidders for information regarding this form.
- (2) OCR-482: At the conclusion of the project the Contractor will submit to the Project Engineer for verification of quantities and further handling Form OCR-482 whereby the Contractor certifies to the amounts of payments made to each Contractor/Supplier. The Project Engineer shall submit the completed Form OCR-482 to the DBE Coordinator (Office of Civil Rights). Final acceptance of the project is dependent upon Contract Administration Division's receipt of completed Form OCR-482 which they will receive from the Office of Civil Rights.
- (3) OCR-483: The Project Engineer/Inspector will complete Form OCR-483, the Commercially Useful Function (CUF) Performance Report, in accordance with MDOT S.O.P. No. OCR-03-05-02-483. Evaluations reported on this form are used to determine whether or not the DBE firm is performing a CUF. The Prime Contractor should take corrective action when the report contains any negative evaluations. DBE credit may be disallowed and/or other sanctions imposed if it is determined the DBE firm is not performing a CUF. This form should also be completed and returned to the DBE Coordinator (Office of Civil Rights).
- (4) OCR-484: Each month, the Prime Contractor will submit to the Project Engineer OCR-484 that certifies payments to all Subcontractors and shows all firms even if

the Prime Contractor has paid no monies to the firm during that estimate period (negative report). The Project Engineer will attach the form to the monthly estimate before forwarding to the Contract Administration Division for further processing. Failure of the Contractor to submit the OCR-484 will result in the estimate not being processed and paid.

- (5) OCR-485: Bidder must submit **signed form with bid proposal** of all firms that submitted quotes for material supplies or items to be subcontracted. If the OCR-485 information is not included as part of bid proposal, your bid will be deemed irregular.
- (6) OCR-487: Only used by Prime Contractors that are certified DBE firms. This form is used in determining the exact percentage of DBE credit for the specified project. **The low Bidder** should **return this form** to MDOT with the OCR-481 form, or can also be returned with the Permission to Subcontract Forms (CAD-720, CAD-725 and CAD-521).

DBE Forms, can be obtained from the Office of Civil Rights Division, MDOT Administration Building, 401 North West Street, Jackson, MS, or at [www.mdot.ms.gov](http://www.mdot.ms.gov) under the Civil Rights tab.

**SANCTIONS**

The Department has the option to enforce any of the following penalties for failure of the Prime Contractor to fulfill the DBE goal as stated on the OCR-481 form or any violations of the DBE program guidelines:

- (1) Disallow credit towards the DBE goal
- (2) Withhold progress estimate payments
- (3) Deduct from the final estimate or recover an amount equal to the unmet portion of the DBE goal which may include additional monetary penalties as outlined below based on the number of offenses and the severity of the violation as determined by MDOT.

Offense #1	10% of unmet portion of goal	or	\$5,000 lump sum payment	or	Both
Offense #2	20% of unmet portion of goal	or	\$10,000 lump sum payment	or	Both
Offense #3	40% of unmet portion of goal	or	\$20,000 lump sum payment	or	\$20,000 lump sum payment and debarment

- (4) Debar the Contractor involved from bidding on Mississippi Department of Transportation projects **for a period of up to 12 months after notification by certified email.**

## MISSISSIPPI DEPARTMENT OF TRANSPORTATION

**SECTION 904 - NOTICE TO BIDDERS NO. 2782**

**CODE: (SP)**

**DATE: 8/13/2020**

**SUBJECT: DBE Pre-Bid Meeting**

Due to the COVID-19 pandemic and the Department not allowing visitors in the Administration Building at this time, the DBE Pre-Bid Meeting referenced on Page 5 of Notice to Bidders No. 2611 will be held by **video conference only**. The meeting will be held at 2:00 P.M. on the day preceding the date of the bid opening using Zoom video conferencing software. Anyone interested in participating can download Zoom and connect to the meeting at the below link.

<https://zoom.us/j/5548736403?pwd=SDh5S2hQSE5pNG5FOEkzR3NsUnBYQT09>

Password (if prompted): 272147

For those unable to participate via Zoom, the below teleconference number may be used instead.

1-888-227-7517

Conference Code: 404496

## MISSISSIPPI DEPARTMENT OF TRANSPORTATION

SECTION 904 - NOTICE TO BIDDERS NO. 2954

CODE: (IS)

DATE: 12/01/2020

SUBJECT: Reflective Sheeting for Signs

Bidders are hereby advised that the retroreflective sign sheeting used for signs on this project shall be as listed below and shall meet the requirements of Subsection 721.06.

### Temporary Construction Signs

Temporary traffic control (orange) sign sheeting shall be a minimum Type IX Fluorescent Orange sheeting as shown in Special Provision 907-721.

### Permanent Signs

Permanent signs, except signs on traffic signal poles/mast arms, shall be as follows:

- Brown background sheeting on guide signs shall be a minimum Type VIII sheeting,
- Green and blue background sheeting on guide signs shall be a minimum Type IX sheeting, and
- All white, yellow, red, fluorescent yellow, and fluorescent yellow/green sheeting shall be Type XI sheeting.

**MISSISSIPPI DEPARTMENT OF TRANSPORTATION**

| **SUPPLEMENT TO NOTICE TO BIDDERS NO. 3599**

| **DATE: 08/11/2021**

| After the last drawing on page 33, add the following.



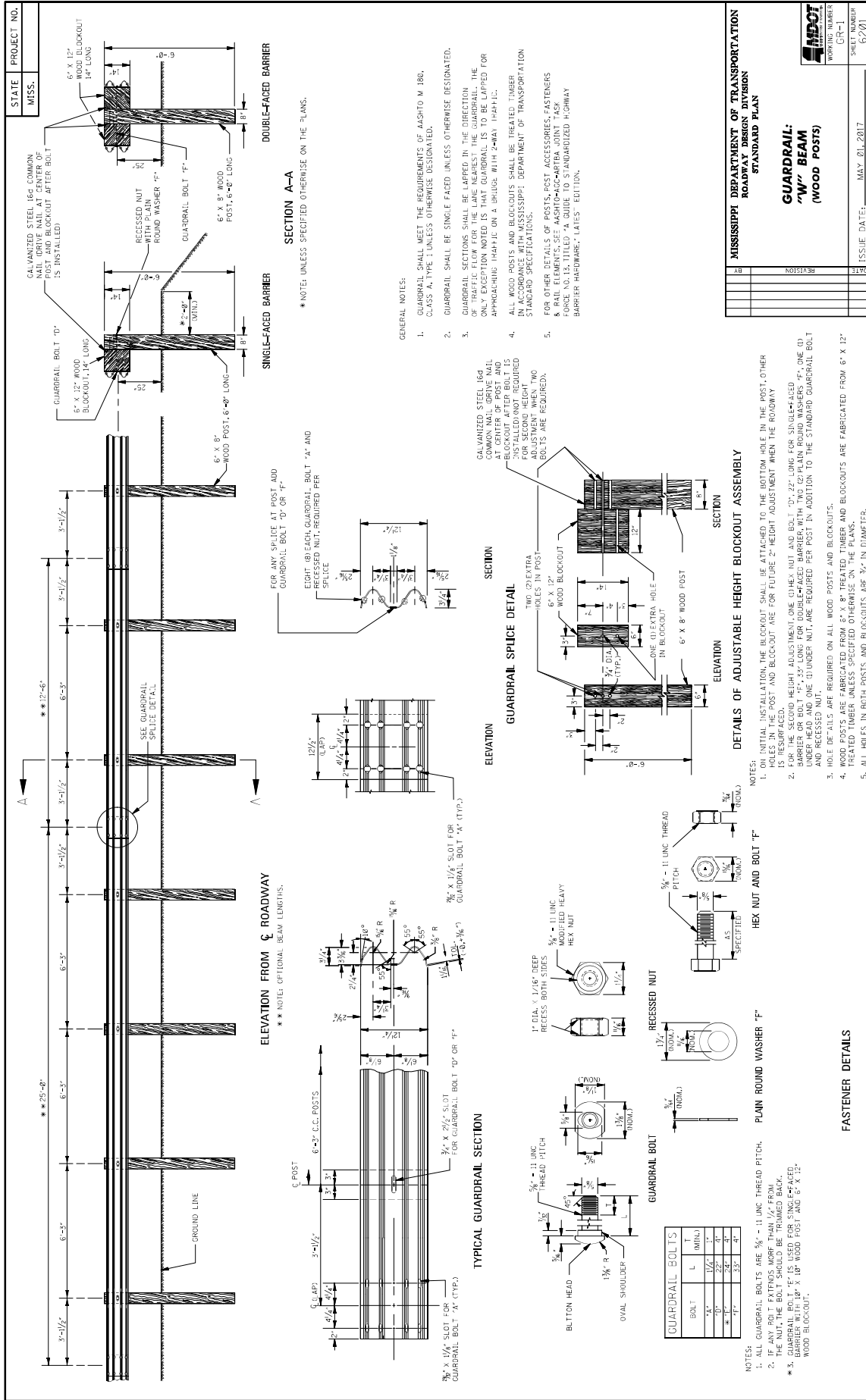

**MISSISSIPPI DEPARTMENT OF TRANSPORTATION**  
**ROADWAY DESIGN DIVISION**  
**STANDARD PLAN**

**GUARDRAIL:**  
**"W" BEAM**  
**(WOOD POSTS)**

**WORKING NUMBER**  
CR-1

**SHEET NUMBER**  
0201

**ISSUE DATE:** MAY 01, 2017

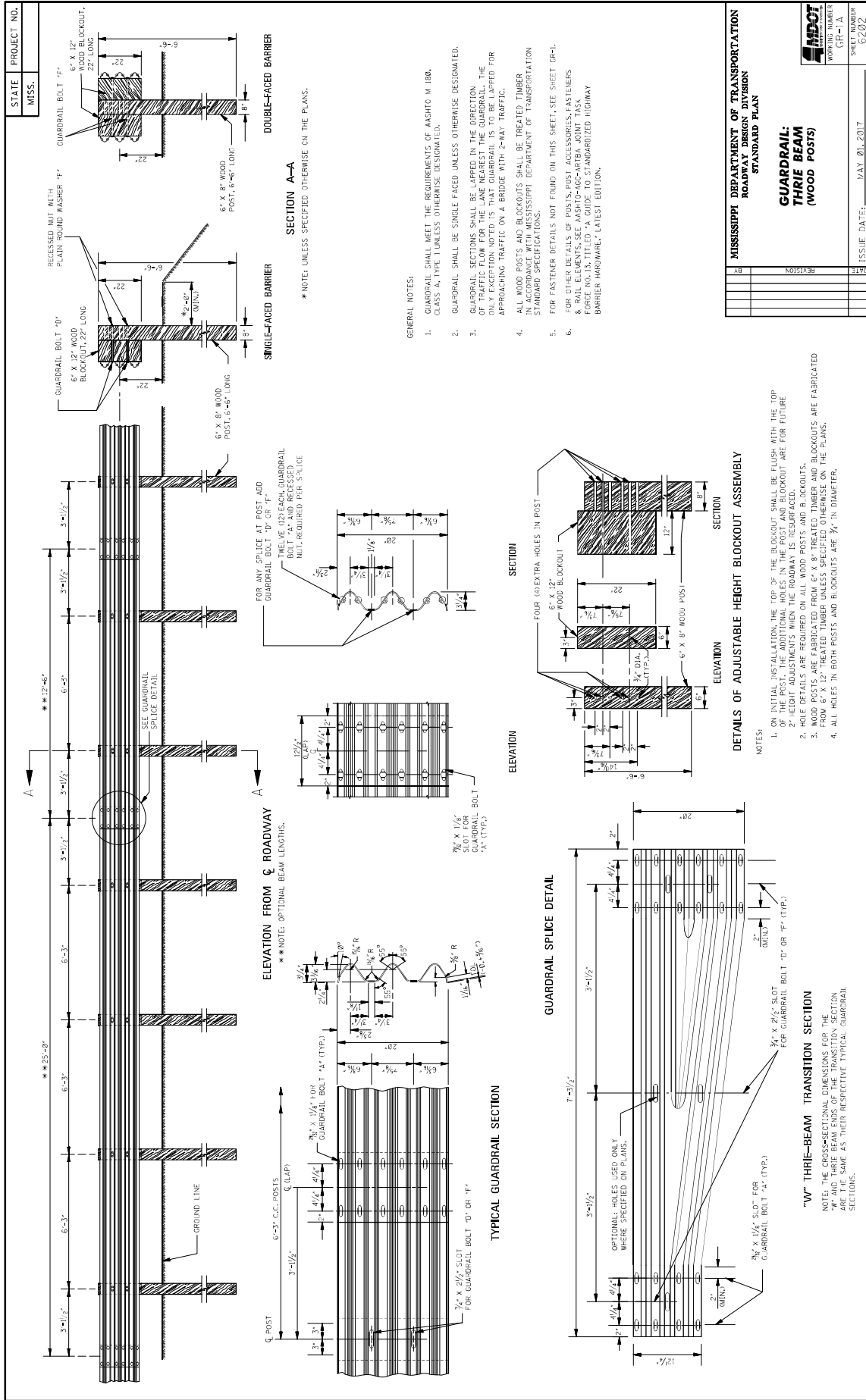

MISSISSIPPI DEPARTMENT OF TRANSPORTATION ROADWAY DESIGN DIVISION STANDARD PLAN	
<b>GUARDRAIL: THRIE BEAM (WOOD POSTS)</b>	
SHEET NUMBER GP-1A	ISSUE DATE: MAY 01, 2017
DATE	REVISION

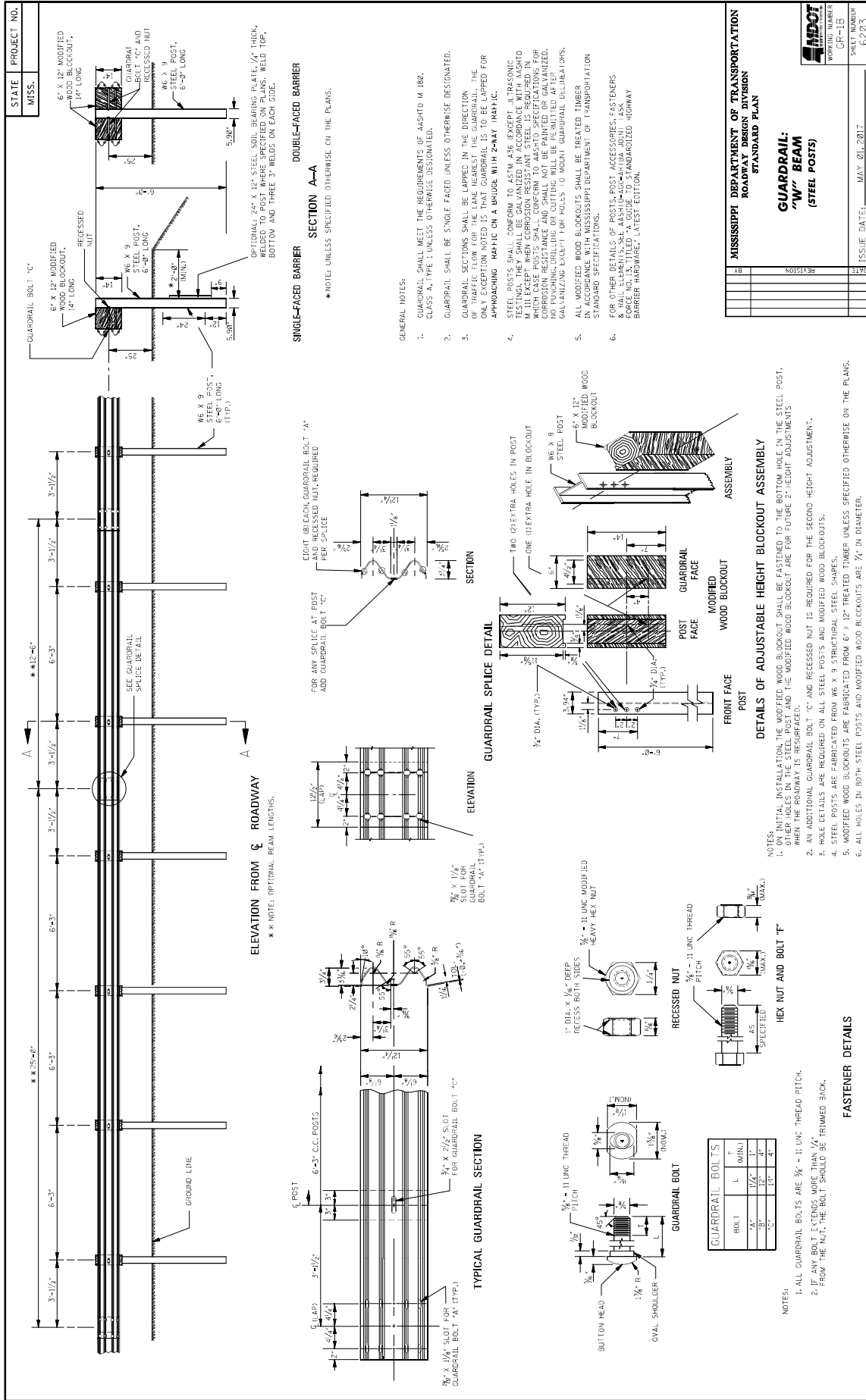

**MISSISSIPPI DEPARTMENT OF TRANSPORTATION**  
ROADWAY DESIGN DIVISION  
STANDARD PLAN

**GUARDRAIL:**  
"W" BEAM  
(STEEL POSTS)

**WORKING NUMBER:** GH-15  
**SHEET NUMBER:** 6283

**ISSUE DATE:** MAY 01, 2011



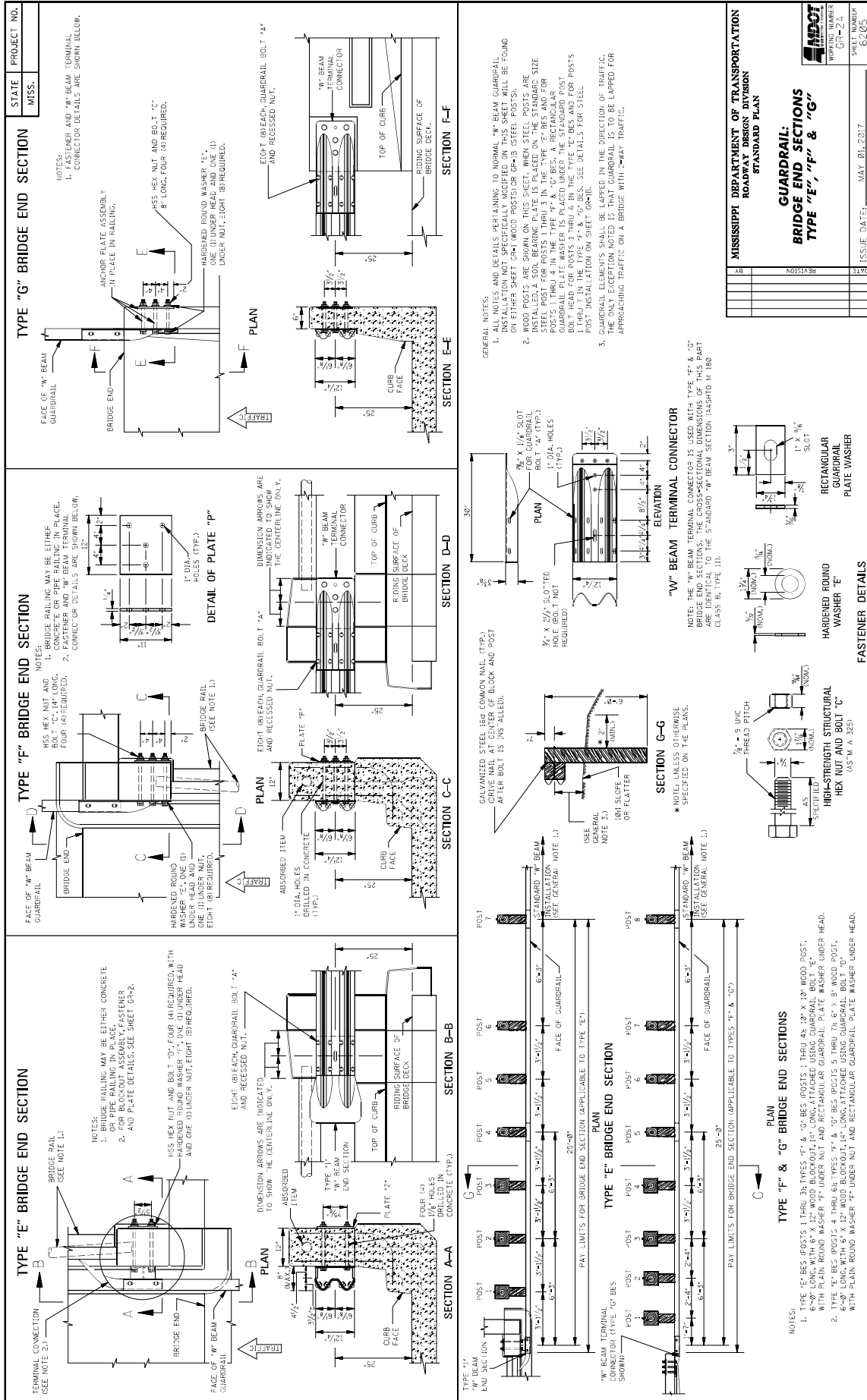

STATE	MISS.
PROJECT NO.	
MISSISSIPPI DEPARTMENT OF TRANSPORTATION ROADWAY DESIGN DIVISION STANDARD PLAN	
GUARDRAIL: BRIDGE END SECTIONS TYPE "E", "F" & "G"	
WORKING NUMBER	GH-24
SHEET NUMBER	62 OF 62
ISSUE DATE:	MAY 01, 2017

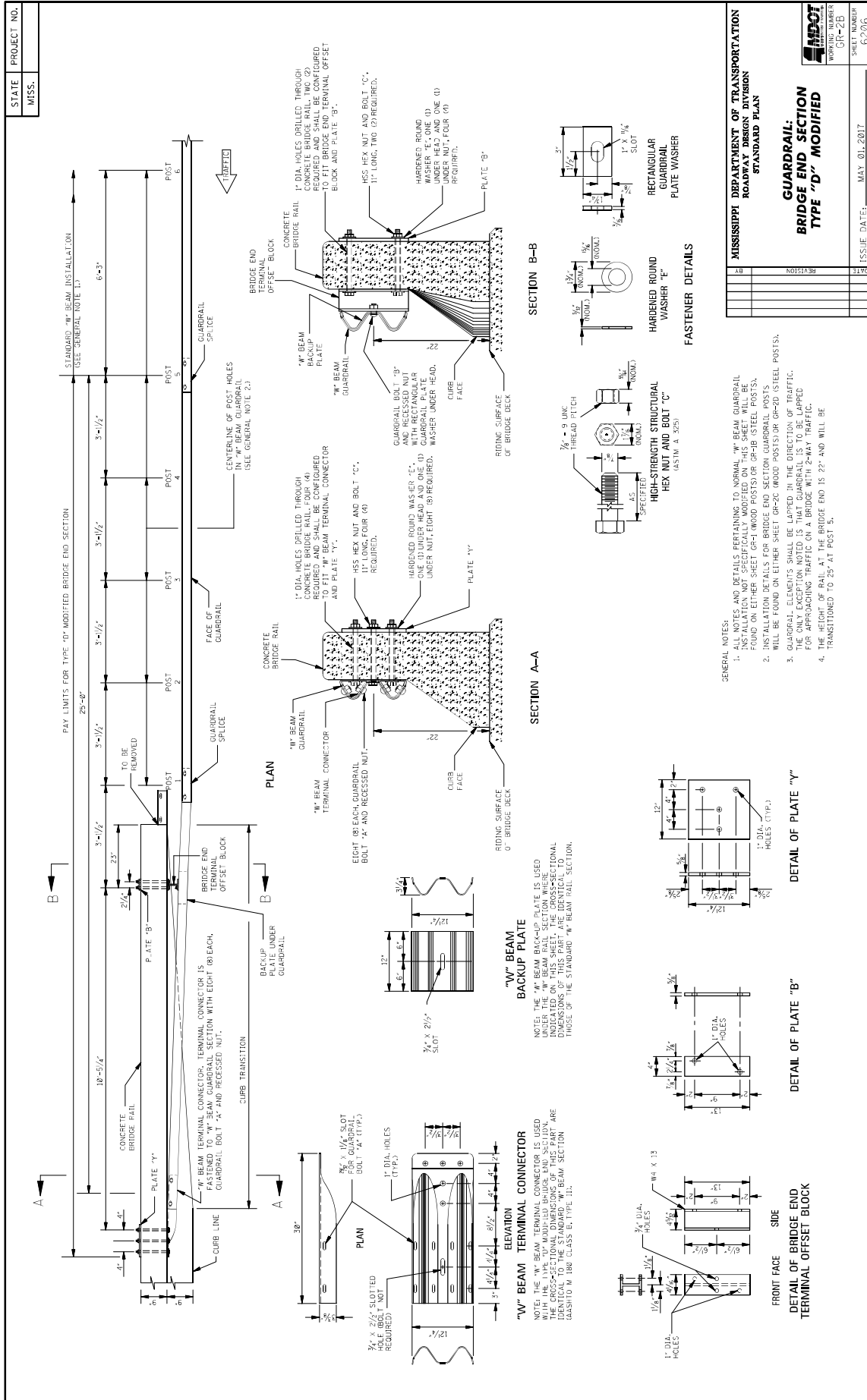



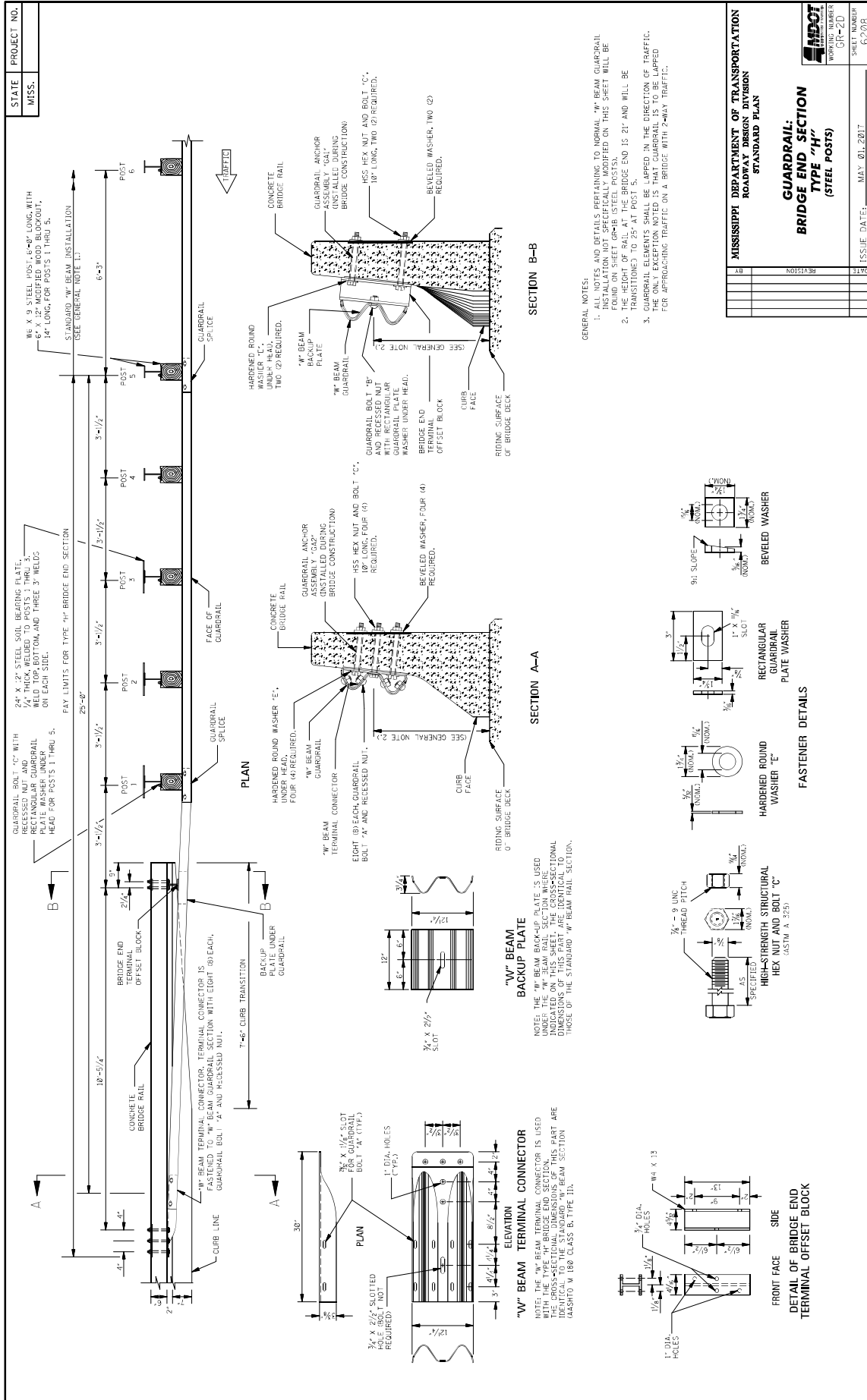

STATE	PROJECT NO.
MISS.	

MISSISSIPPI DEPARTMENT OF TRANSPORTATION ROADWAY DESIGN DIVISION STANDARD PLAN	
<b>GUARDRAIL: BRIDGE END SECTION TYPE "H" (STEEL POSTS)</b>	
DATE	ISSUE DATE: MAY 01, 2017
BY	WORKING NUMBER: GH-ZU
	SHEET NUMBER: 02/05

- GENERAL NOTES:
1. ALL DIMENSIONS AND DETAILS PERTAINING TO NORMAL "H" BEAM GUARDRAIL INSTALLATION NOT SPECIFICALLY MODIFIED ON THIS SHEET WILL BE FOUND ON SHEET GR-B (STEEL POSTS).
  2. THE HEIGHT OF RAIL AT THE BRIDGE END IS 21" AND WILL BE TRANSITIONED TO 29" AT POST 5.
  3. GUARDRAILS ARE TO BE INSTALLED IN THE DIRECTION OF TRAFFIC. THE ONLY EXCEPTION NOTED IS THAT GUARDRAIL IS TO BE LAPPED FOR APPROACHING TRAFFIC ON A BRIDGE WITH 2-WAY TRAFFIC.

SECTION B-B

SECTION A-A

"W" BEAM BACKUP PLATE

"W" BEAM TERMINAL CONNECTOR

FASTENER DETAILS

DETAIL OF BRIDGE END TERMINAL OFFSET BLOCK



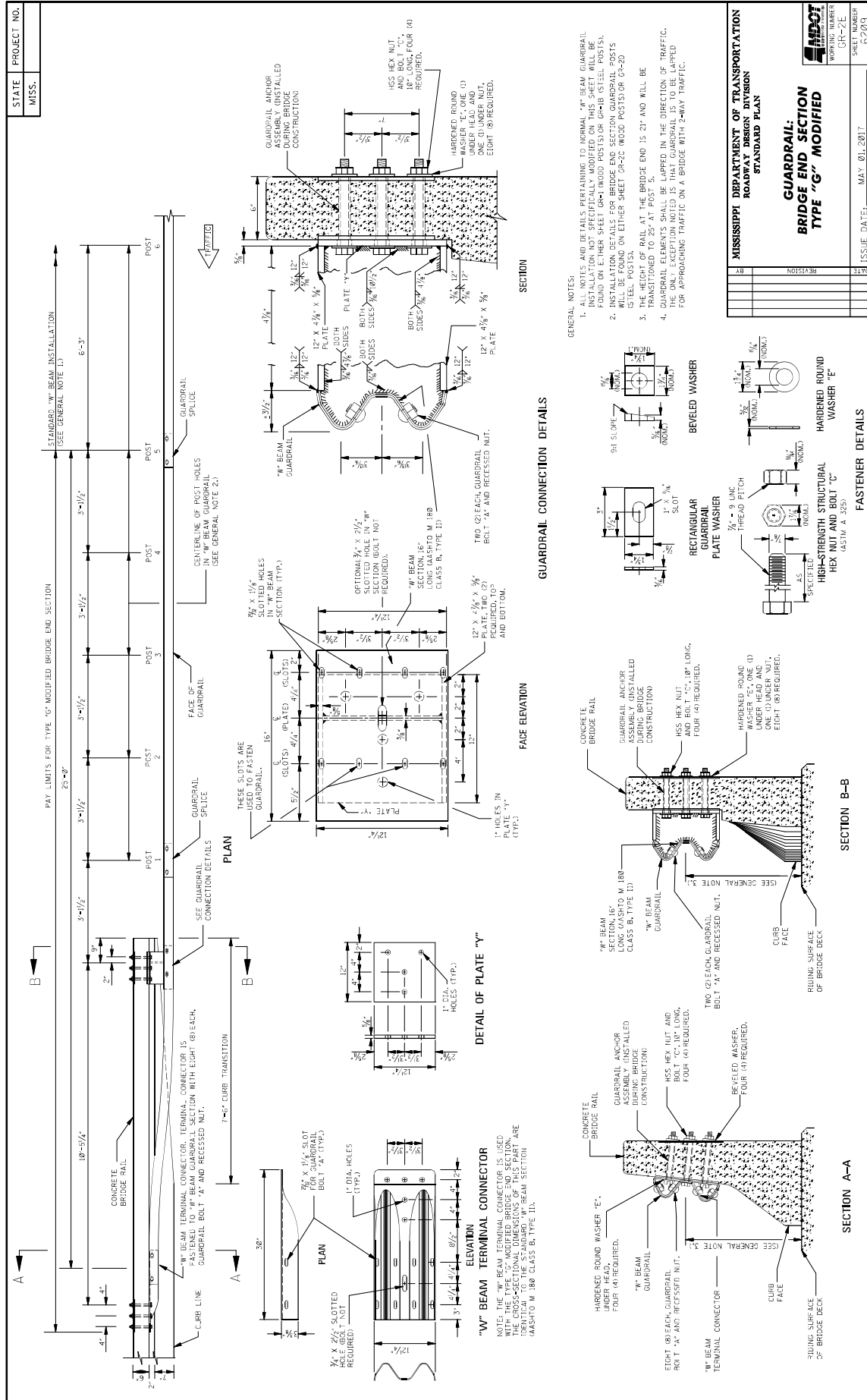

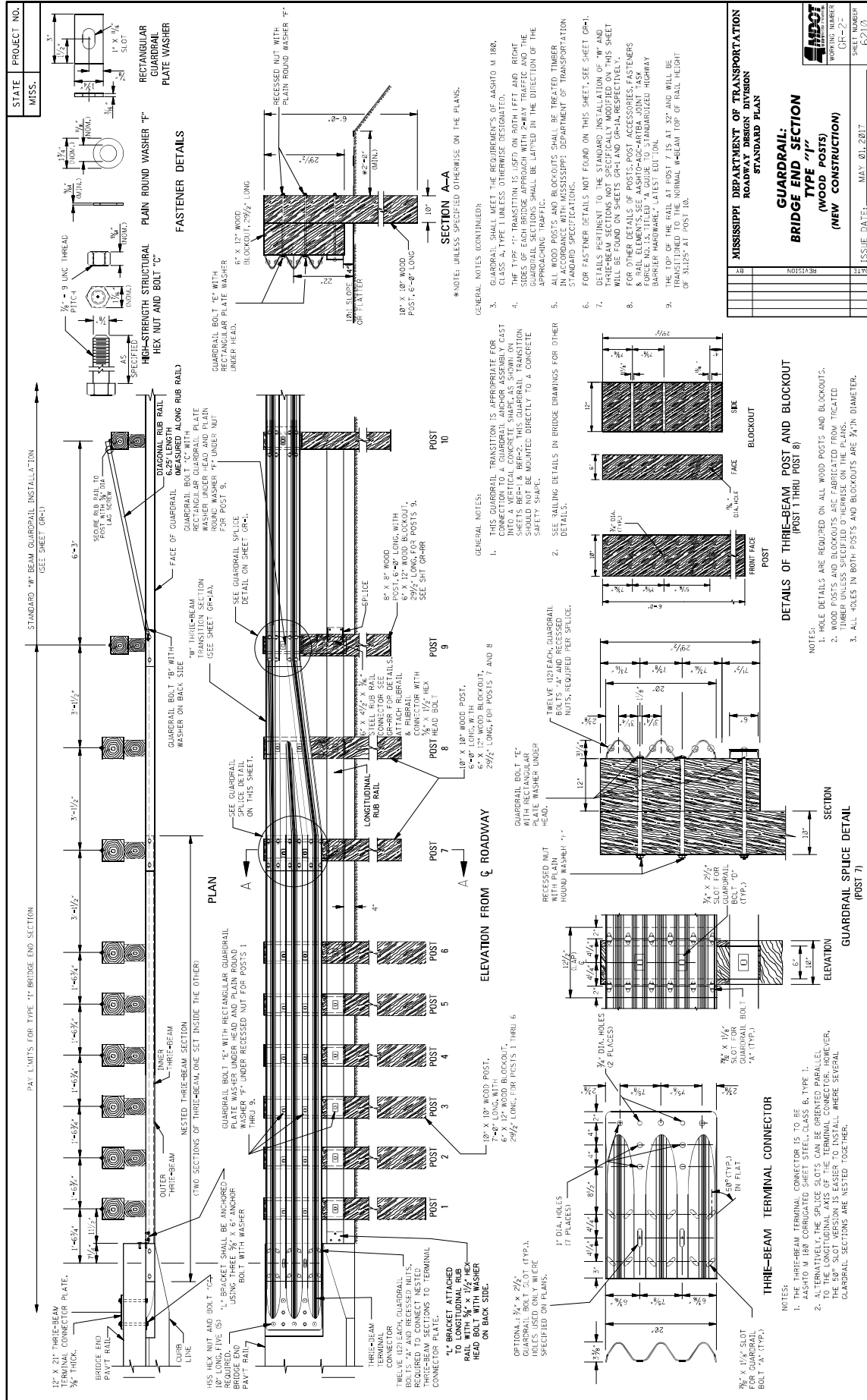

STATE	MISS.
PROJECT NO.	

MISSISSIPPI DEPARTMENT OF TRANSPORTATION ROADWAY DESIGN DIVISION STANDARD PLAN	
<b>GUARDRAIL: BRIDGE END SECTION TYPE "1" (WOOD POSTS) (NEW CONSTRUCTION)</b>	
DATE	ISSUE DATE: MAY 01, 2017
REVISION	WORKING NUMBER CH-2
	SHEET NUMBER 6210

GENERAL NOTES (CONTINUED):

- GUARDRAIL SHALL MEET THE REQUIREMENTS OF AASHTO M 188, CLASS A, TYPE 1 UNLESS OTHERWISE DESIGNATED.
- WOOD POSTS AND BLOCKOUTS ARE FABRICATED FROM TREATED TIMBER UNLESS SPECIFIED OTHERWISE ON THE PLANS.
- THE TOP OF THE RAIL AT POST 7 IS AT 32" AND WILL BE TRANSMITTED TO THE NORMAL W-BEAM TOP OF RAIL HEIGHT OF 31.25" AT POST 10.
- FOR FASTENER DETAILS NOT FOUND ON THIS SHEET, SEE SHEET GR-1.
- FOR OTHER DETAILS OF POSTS, POST ACCESSORIES, FASTENERS & RAIL ELEMENTS, SEE AASHTO-AOC-ARTBA JOINT TASK FORCE REPORT, "DESIGN AND CONSTRUCTION OF UNGRADE HIGHWAY BARRIER HARDWARE," LATEST EDITION.
- ALL WOOD POSTS AND BLOCKOUTS SHALL BE TREATED TIMBER PER THE STANDARD SPECIFICATIONS, MISSISSIPPI DEPARTMENT OF TRANSPORTATION.
- FOR FASTENER DETAILS NOT FOUND ON THIS SHEET, SEE SHEET GR-1.
- FOR OTHER DETAILS OF POSTS, POST ACCESSORIES, FASTENERS & RAIL ELEMENTS, SEE AASHTO-AOC-ARTBA JOINT TASK FORCE REPORT, "DESIGN AND CONSTRUCTION OF UNGRADE HIGHWAY BARRIER HARDWARE," LATEST EDITION.
- THE TOP OF THE RAIL AT POST 7 IS AT 32" AND WILL BE TRANSMITTED TO THE NORMAL W-BEAM TOP OF RAIL HEIGHT OF 31.25" AT POST 10.

GENERAL NOTES:

- THIS GUARDRAIL TRANSITION IS APPROPRIATE FOR USE ON BRIDGE ENDS AND SHALL BE CAST INTO A VERTICAL CONCRETE SHAPE AS SHOWN ON SHEETS BR-1 & BR-2. THIS GUARDRAIL TRANSITION SHOULD NOT BE MOUNTED DIRECTLY TO A CONCRETE SUPPORT SHAPE.
- SEE RAILING DETAILS IN BRIDGE DRAWINGS FOR OTHER DETAILS.

OPTIONAL: 3/4" x 2 1/2" (TYP.) HOLES (SEE ONLY W/ W/ C SPECIFIED ON PLANS).

THREE-BEAM TERMINAL CONNECTOR

NOTES:

- THE THREE-BEAM TERMINAL CONNECTOR IS TO BE TYPE 1, AASHTO M 188 CORRUGATED SHEET STEEL, CLASS B, TYPE 1.
- TO THE LONGITUDINAL AXIS OF THE TERMINAL CONNECTOR, HOWEVER, THE 58" SLOT VERSION IS EASIER TO INSTALL, WHERE SEVERAL GUARDRAIL SECTIONS ARE NESTED TOGETHER.

THREE-BEAM TERMINAL CONNECTOR

NOTES:

- THE THREE-BEAM TERMINAL CONNECTOR IS TO BE TYPE 1, AASHTO M 188 CORRUGATED SHEET STEEL, CLASS B, TYPE 1.
- TO THE LONGITUDINAL AXIS OF THE TERMINAL CONNECTOR, HOWEVER, THE 58" SLOT VERSION IS EASIER TO INSTALL, WHERE SEVERAL GUARDRAIL SECTIONS ARE NESTED TOGETHER.

THREE-BEAM TERMINAL CONNECTOR

NOTES:

- THE THREE-BEAM TERMINAL CONNECTOR IS TO BE TYPE 1, AASHTO M 188 CORRUGATED SHEET STEEL, CLASS B, TYPE 1.
- TO THE LONGITUDINAL AXIS OF THE TERMINAL CONNECTOR, HOWEVER, THE 58" SLOT VERSION IS EASIER TO INSTALL, WHERE SEVERAL GUARDRAIL SECTIONS ARE NESTED TOGETHER.

THREE-BEAM TERMINAL CONNECTOR

NOTES:

- THE THREE-BEAM TERMINAL CONNECTOR IS TO BE TYPE 1, AASHTO M 188 CORRUGATED SHEET STEEL, CLASS B, TYPE 1.
- TO THE LONGITUDINAL AXIS OF THE TERMINAL CONNECTOR, HOWEVER, THE 58" SLOT VERSION IS EASIER TO INSTALL, WHERE SEVERAL GUARDRAIL SECTIONS ARE NESTED TOGETHER.



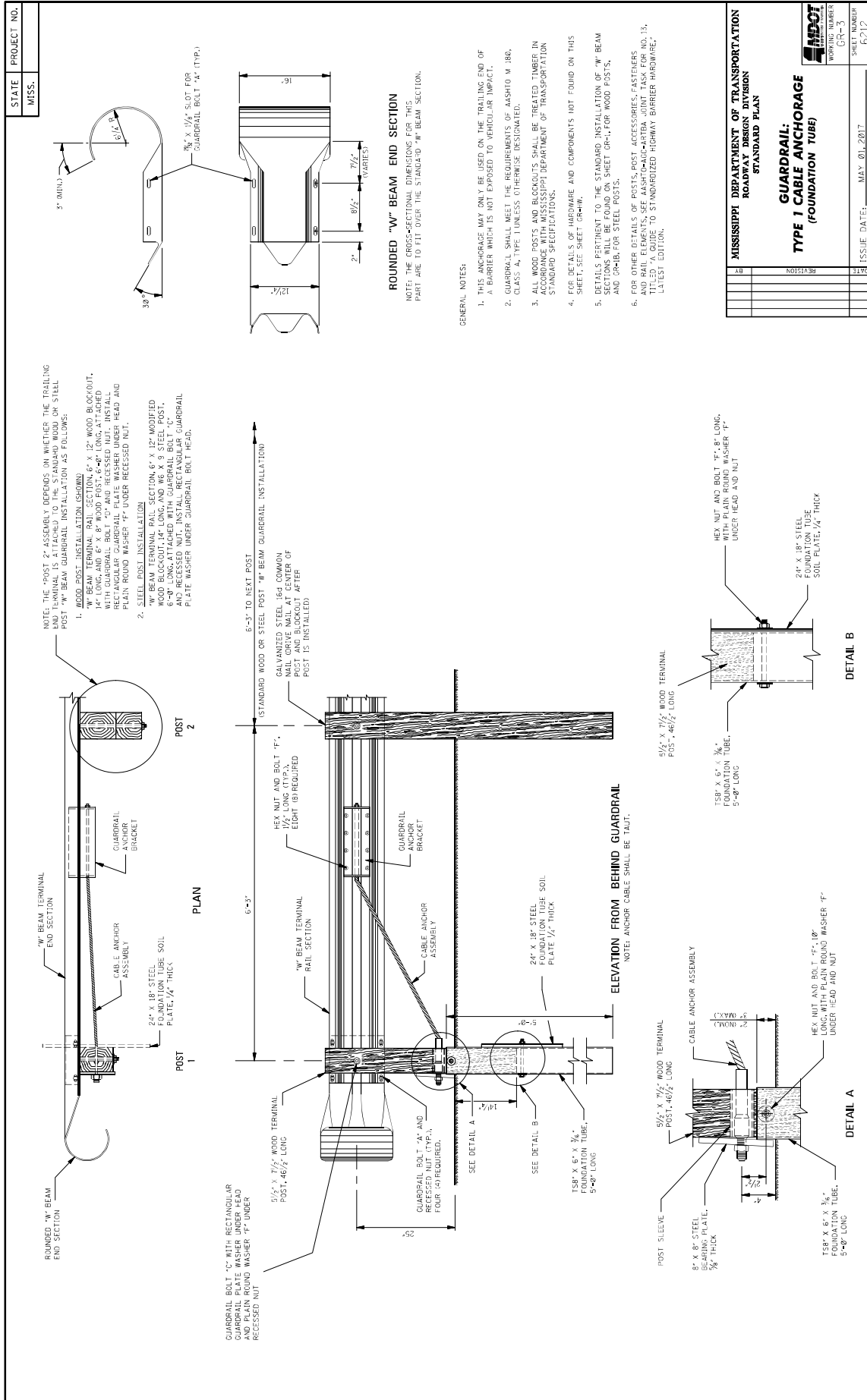

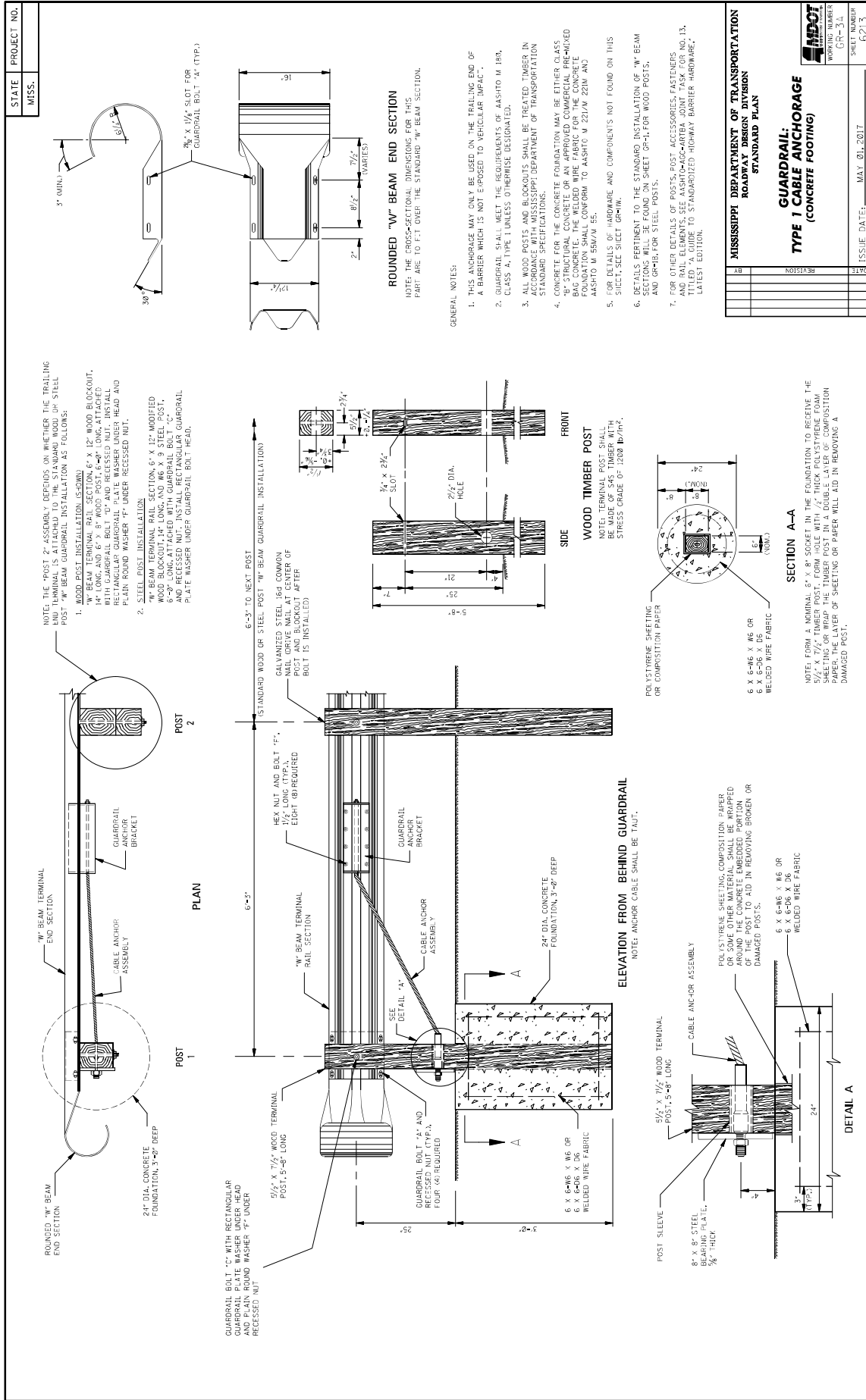

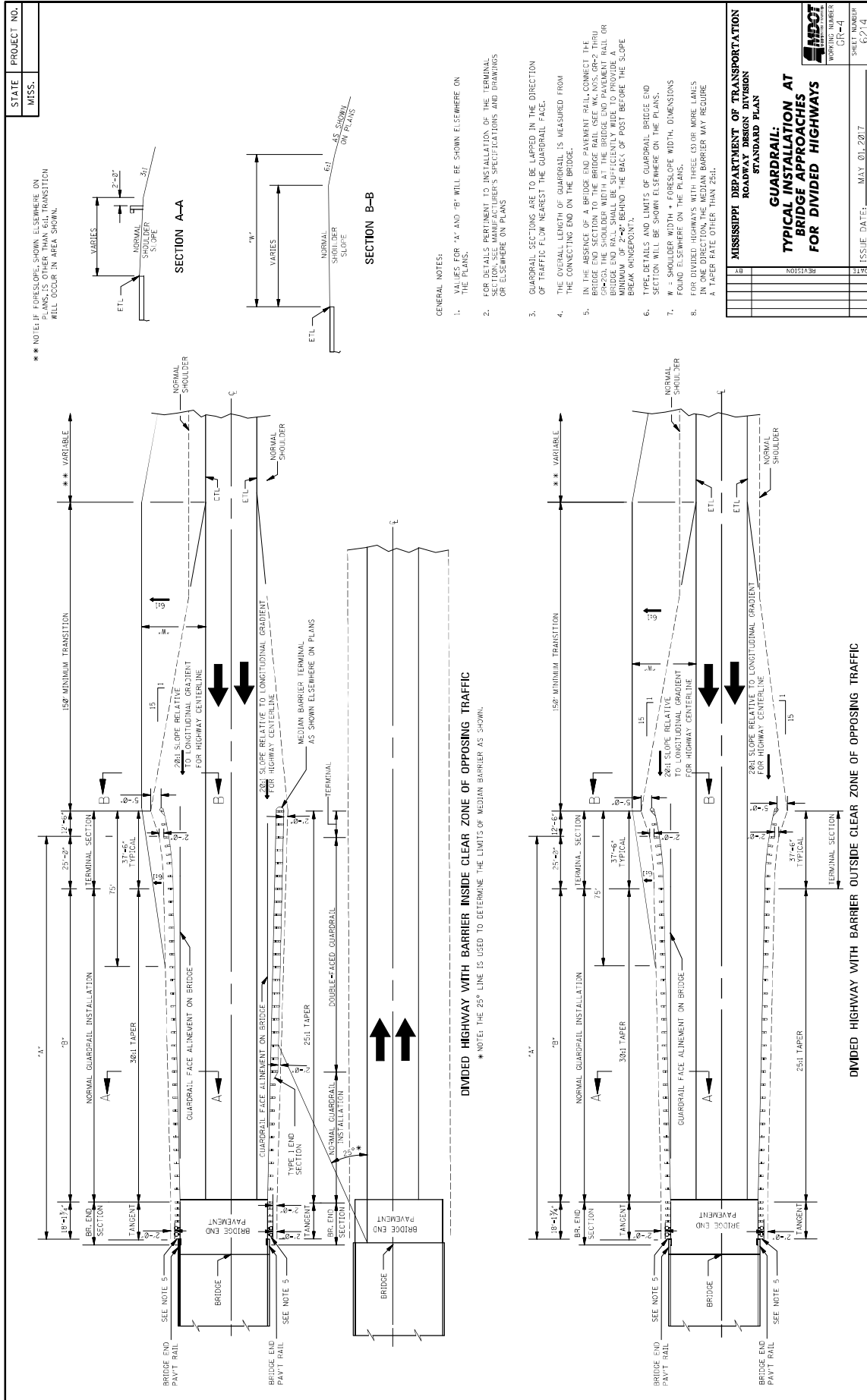

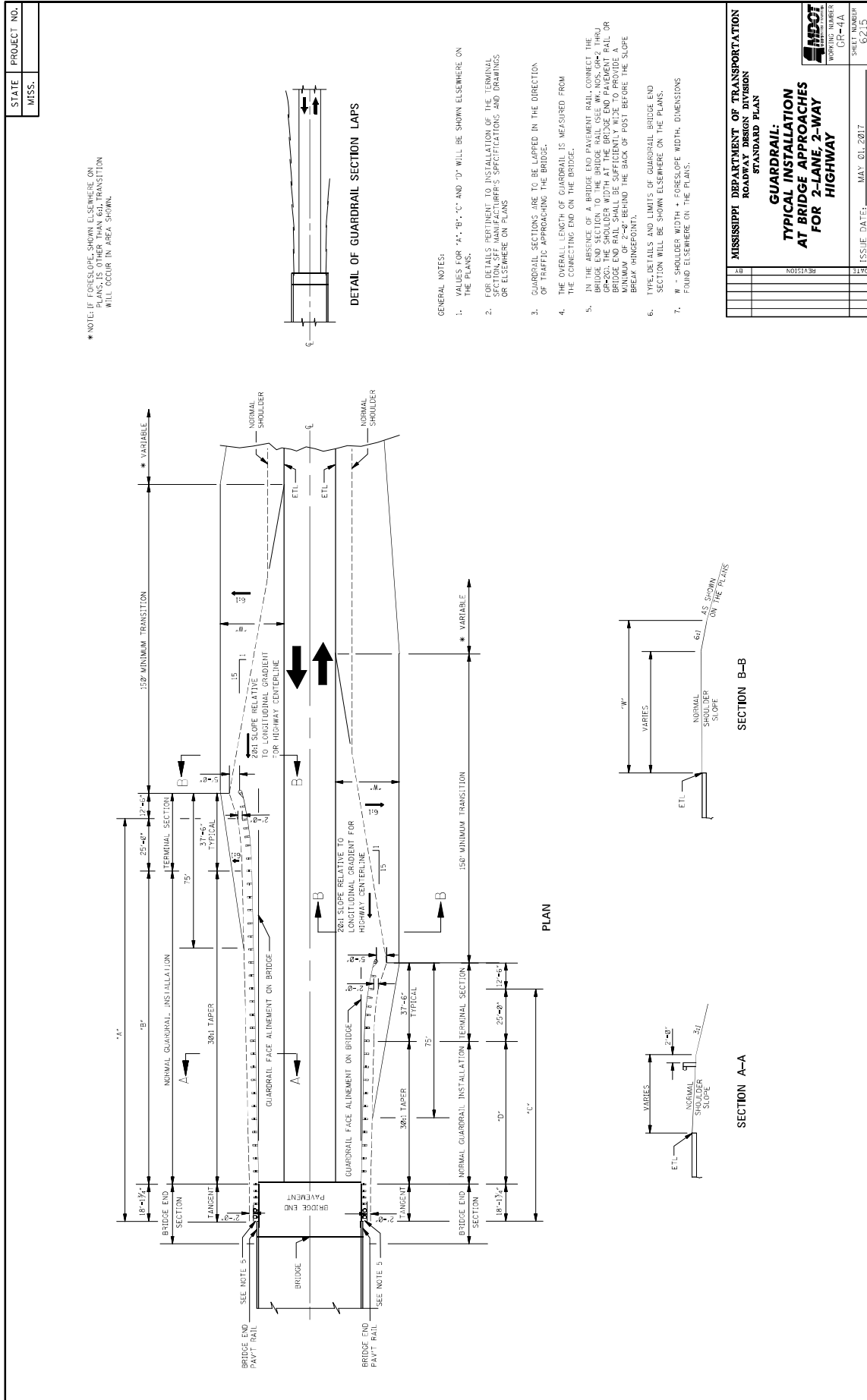

<b>MISSISSIPPI DEPARTMENT OF TRANSPORTATION</b>	
<b>ROADWAY DESIGN DIVISION</b>	
<b>STANDARD PLAN</b>	
<b>GUARDRAIL: TYPICAL INSTALLATION AT BRIDGE APPROACHES FOR 2-LANE, 2-WAY HIGHWAY</b>	
WORKING NUMBER	CR-414
SHEET NUMBER	0215
ISSUE DATE:	MAY 01, 2017

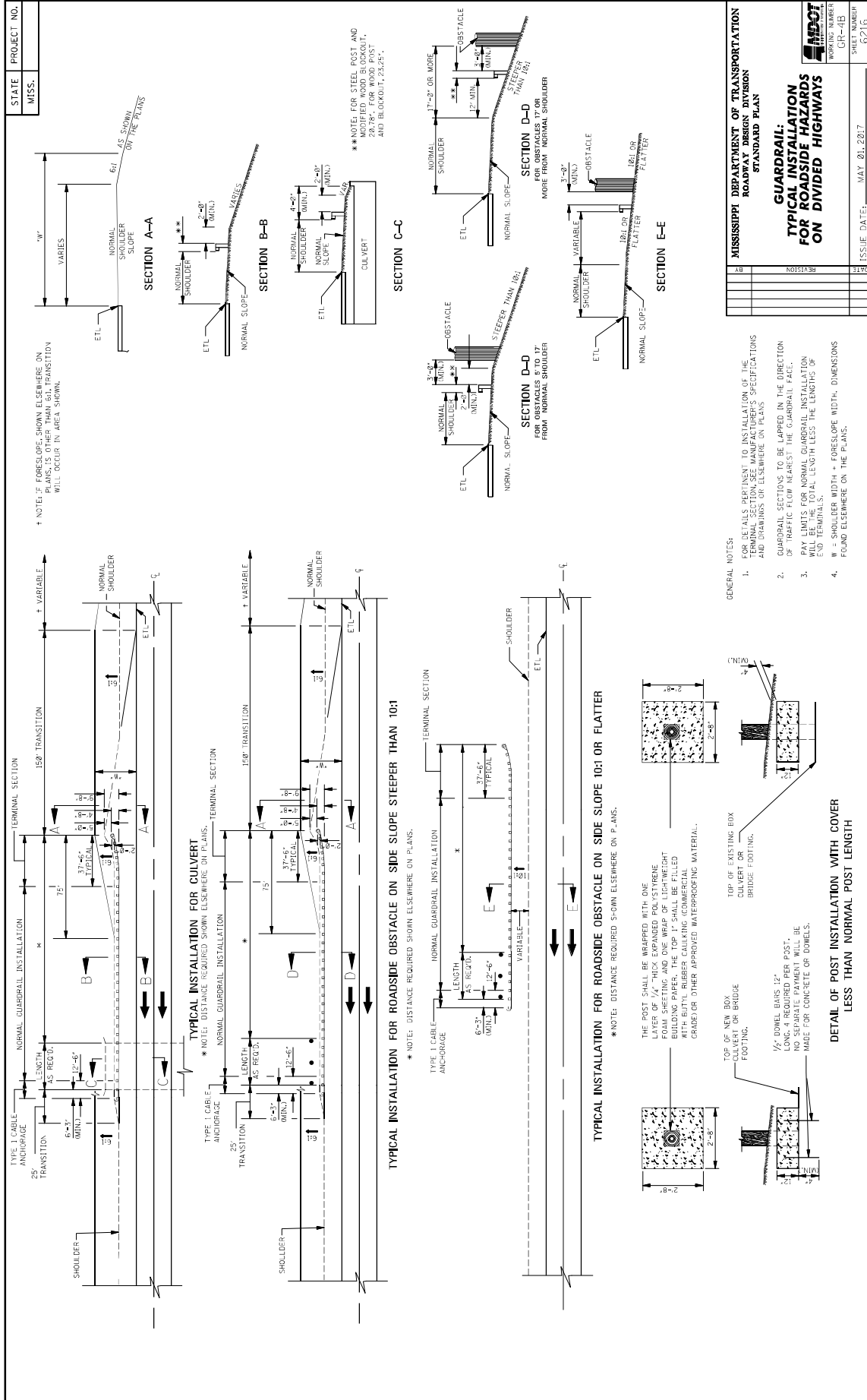



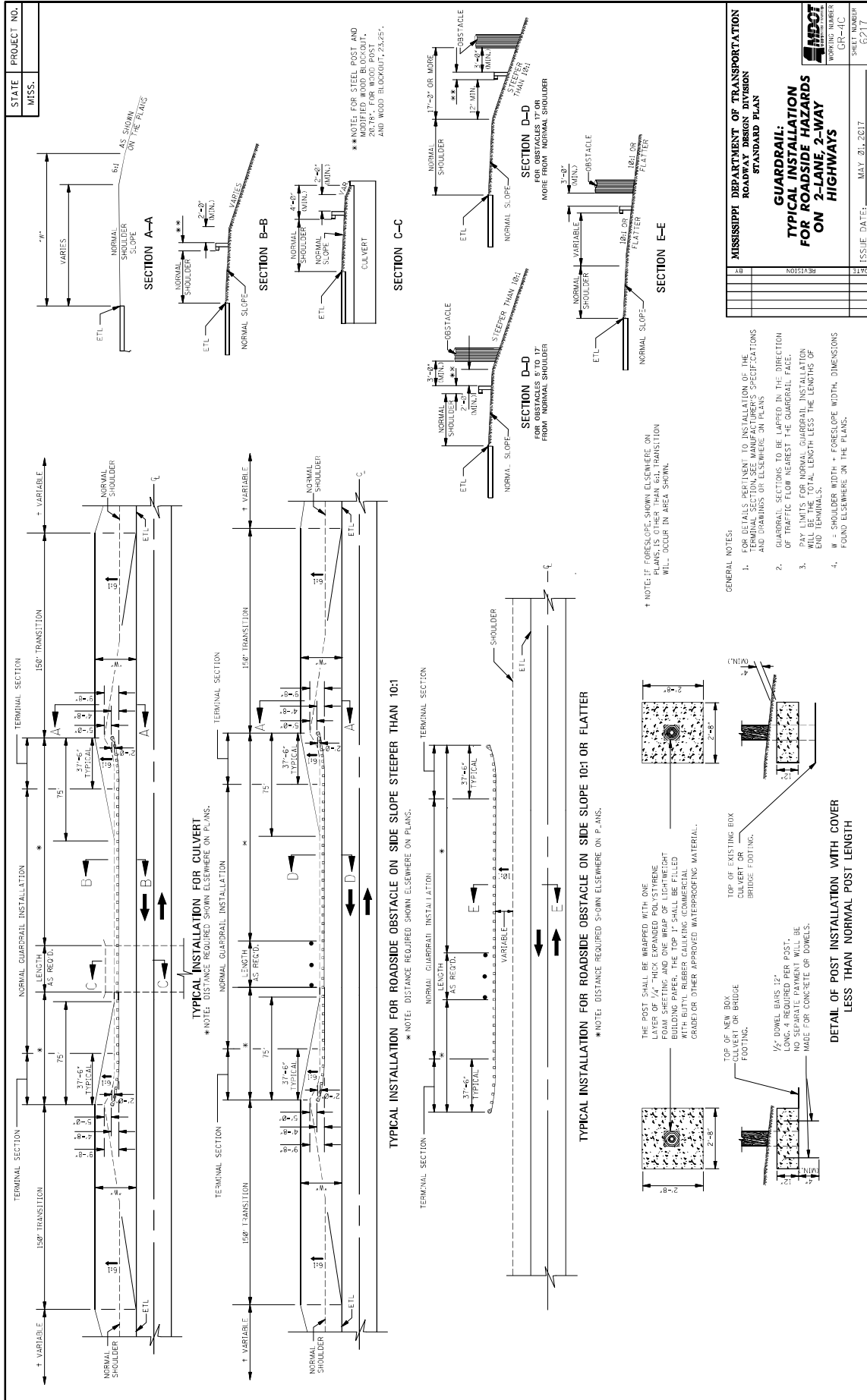

MISSISSIPPI DEPARTMENT OF TRANSPORTATION ROADWAY DESIGN DIVISION STANDARD PLAN	
<b>GUARAIL: TYPICAL INSTALLATION FOR ROADSIDE HAZARDS ON 2-LANE, 2-WAY HIGHWAYS</b>	
WORKING NUMBER CH-11C	SHEET NUMBER G217
ISSUE DATE: MAY 20, 2017	DATE
REVISION	DATE



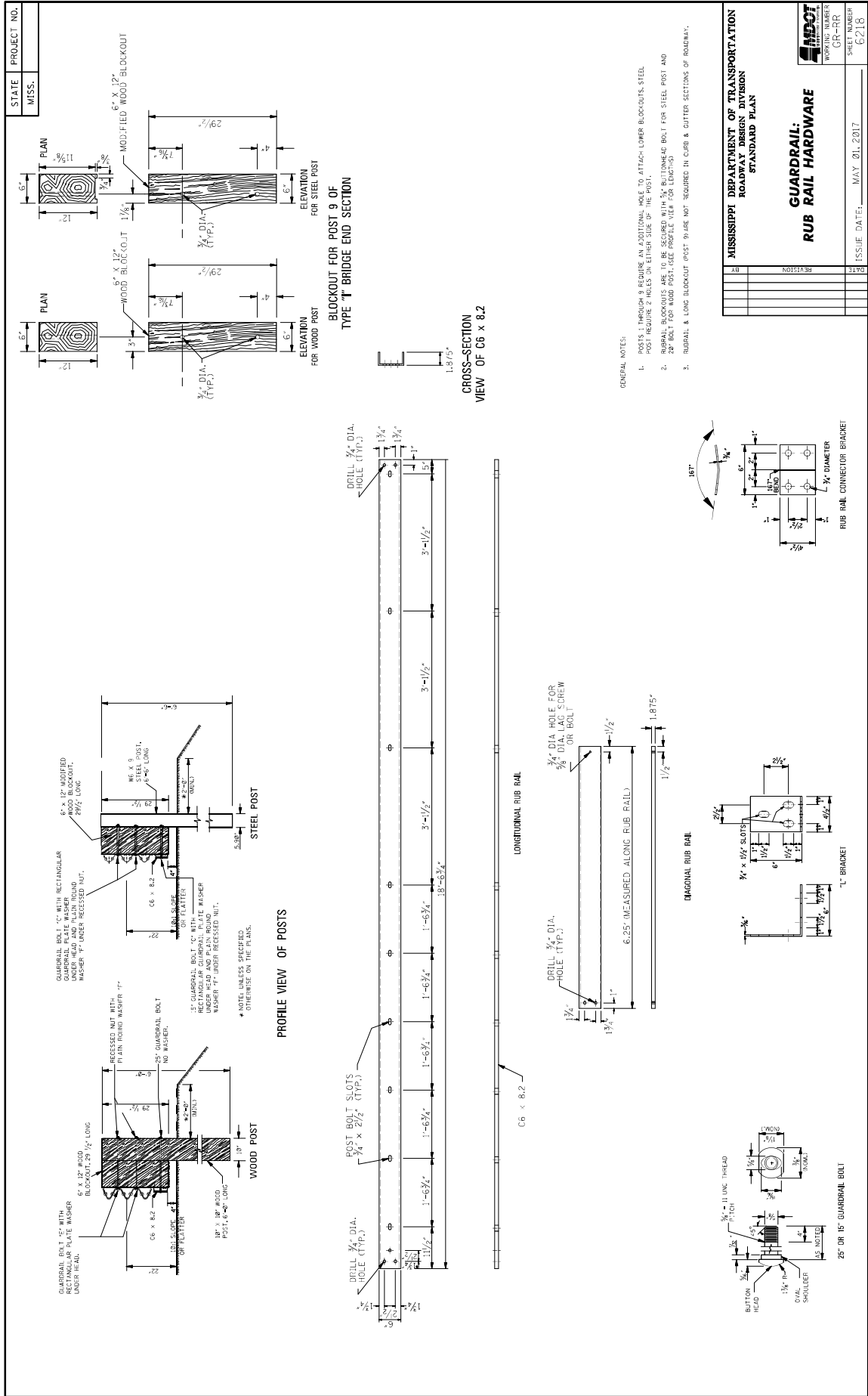

STATE MISS.	PROJECT NO.		
----------------	-------------	--	--

**DISTANCE REFERENCE SIGN MOUNTING ON OUTSIDE SHOULDER ALONG MAIN FACILITY**

NOTE: SIGN MOUNTING ON LEFT LANE SHOULDER SHALL BE 90° OPPOSITE THE RIGHT LANE STATION. SIGN MOUNTING ON RIGHT LANE SHOULDER SHALL BE LOCATED WITHIN 500 FEET OF ITS TRUE LOCATION. IT SHALL BE OMITTED ENTIRELY.

**DELINICATOR MOUNTING ON OUTSIDE SHOULDER ALONG MAIN FACILITY OR RAMP**

**DELINICATOR MOUNTING ON OUTSIDE SHOULDER WITH MOUNTABLE CURB ALONG MAIN FACILITY OR RAMP**

**DELINICATOR MOUNTING ON INTERCHANGE LOOPS WITH UNMOUNTABLE CURB ON INSIDE**

**REAR VIEW OF TYPE 3 OBJECT MARKER OR DISTANCE REFERENCE SIGN ASSEMBLY**

NOTE: TYPE 3 OBJECT MARKER AND DISTANCE REFERENCE SIGNS ARE TO BE FASTENED TO U-SECTION POSTS WITH 3/8" DIA. HOOK FASTENERS OR CHERRY RIVETS OF THE COLLAR TYPE OR OTHER APPROVED EQUAL.

**DETAIL OF TYPE 3 OBJECT MARKER INSTALLATION**

**DETAIL OF TYPE 3 OBJECT MARKER**

NOTE: COLORS - BLACK AND YELLOW. STRIPING SLANT DOWNWARD TO THE RIGHT FOR LEFT SIDE OF BRIDGE END. SEE DETAIL BELOW.

**DETAIL OF TYPE 3 OBJECT MARKER INSTALLATION**

**DETAIL OF SINGLE WHITE OR SINGLE YELLOW DELINICATOR**

**DETAIL OF DOUBLE WHITE OR DOUBLE YELLOW DELINICATOR**

**REAR VIEW OF DELINICATOR ASSEMBLY**

**MOUNTING DETAIL**

DELINICATORS, OBJECT MARKERS OR DISTANCE REFERENCE SIGNS 1018-1, 1018-2, OR 1018-3 ARE MOUNTED TO THIS FACE AS SHOWN.

NOTE: DELINICATORS ARE TO BE FASTENED TO U-SECTION POSTS WITH 3/8" DIA. HOOK FASTENERS OR CHERRY RIVETS OF THE COLLAR TYPE OR OTHER APPROVED EQUAL.

GENERAL NOTES:

1. DELINICATORS AND TYPE 3 OBJECT MARKER SHALL BE REFLECTIVE SHEETING ON 0.200" THICK ALUMINUM SHEET OR 14 GAUGE GALVANIZED SHEET STEEL.
2. DELINICATOR, TYPE 3 OBJECT MARKER AND DISTANCE REFERENCE SIGN POSTS SHALL BE GALVANIZED STEEL. THE POSTS ARE TO BE FABRICATED BEFORE THE METAL IS GALVANIZED.
3. WEIGHT WITHOUT GROUND PLATES:
  - A. DELINICATOR POST 7'-0" = 2.0 LB/FT
  - B. TYPE 3 OBJECT MARKER POSTS 9'-0" = 2.5 LB/FT TO 3.0 LB/FT
  - C. DISTANCE REFERENCE SIGN POSTS 12'-0" = 3.0 LB/FT TO 3.5 LB/FT
  - D. 12'-0" = 3.0 LB/FT TO 3.5 LB/FT
4. UNIT PRICE OF DELINICATORS AND TYPE 3 OBJECT MARKERS SHALL INCLUDE COST OF POST. DISTANCE REFERENCE SIGN POST WILL BE PAID PER FOOT.
5. RADIUS IN BENDS OF POST CROSS SECTION NOT TO EXCEED 3% FOR HOT ROLLED SECTION.
6. GROUND PLATE NOT REQUIRED ON U-SECTION POST.

DATE	REVISION	

**MISSISSIPPI DEPARTMENT OF TRANSPORTATION**  
ROADWAY DESIGN DIVISION  
STANDARD PLAN

**TYPICAL INSTALLATION AND DETAILS OF DELINICATORS AND DISTANCE REFERENCE SIGNS**

WORKING NUMBER: SN-5  
SHEET NUMBER: 6214

ISSUE DATE: MAY 01, 2017

**MISSISSIPPI DEPARTMENT OF TRANSPORTATION**

**SECTION 904 – NOTICE TO BIDDERS NO. 3599**

**CODE: (SP)**

**DATE: 08/11/2021**

**SUBJECT: Standard Drawings**

Standard Drawings attached hereto shall govern appropriate items of required work.

Larger copies of Standard Drawings may be purchased from:

MDOT Plans Print Shop  
MDOT Shop Complex, Building C, Room 114  
2567 North West Street  
P.O. Box 1850  
Jackson, MS 39215-1850  
Telephone: (601) 359-7460  
or FAX: (601) 359-7461  
or e-mail: [plans@mdot.state.ms.us](mailto:plans@mdot.state.ms.us)

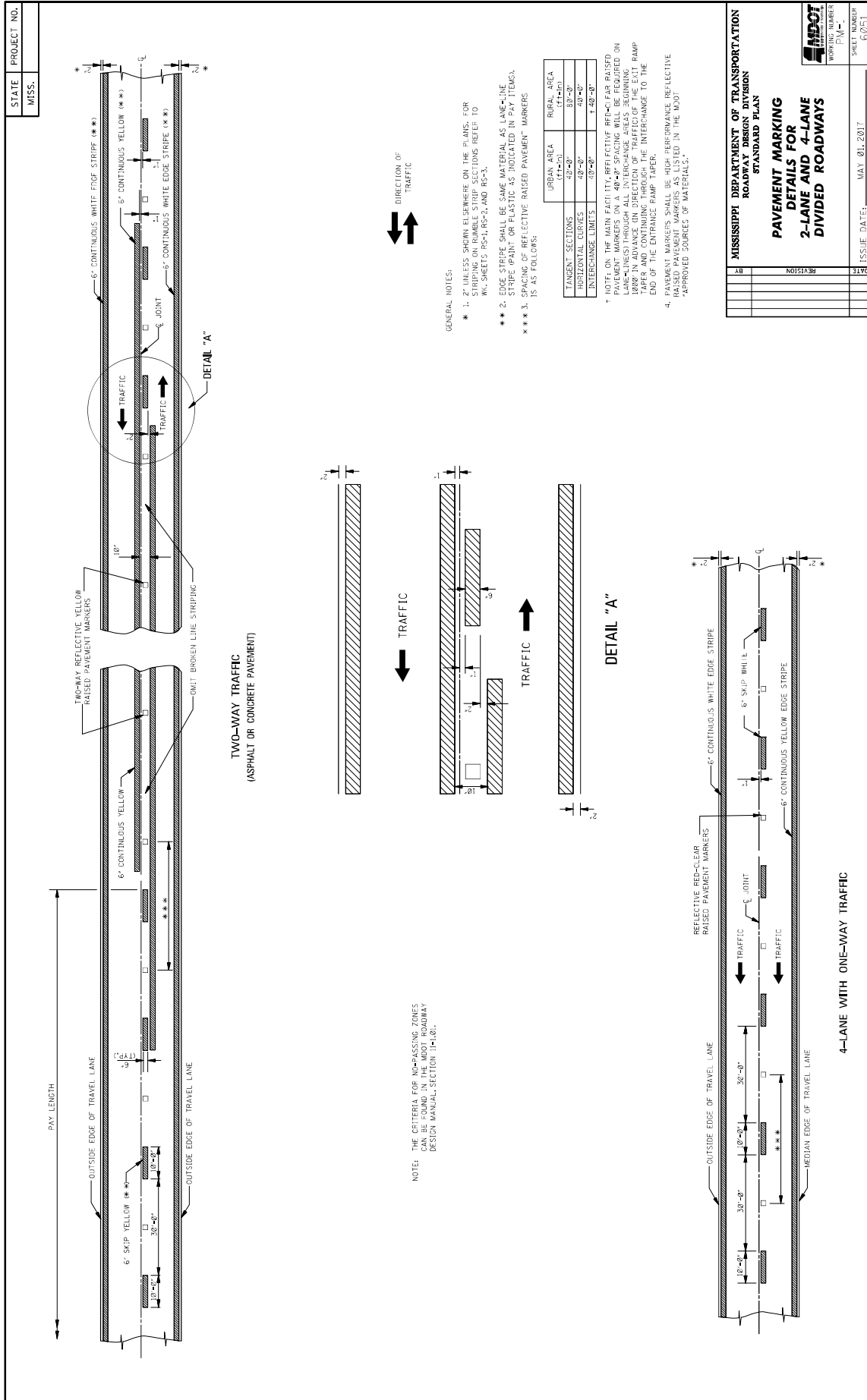

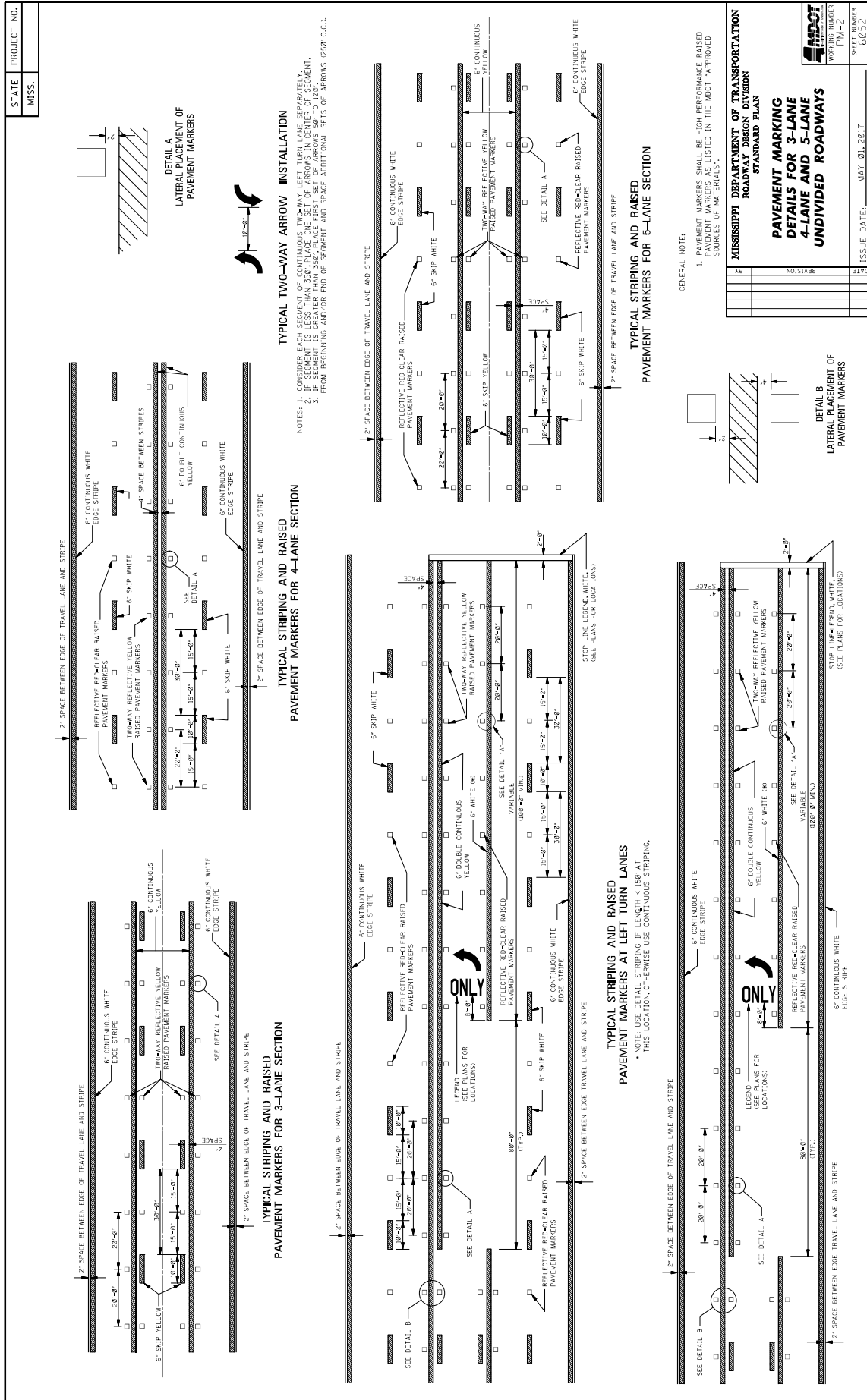

**DETAIL A**  
LATERAL PLACEMENT OF PAVEMENT MARKERS

**DETAIL B**  
LATERAL PLACEMENT OF PAVEMENT MARKERS

**GENERAL NOTE:**

- PAVEMENT MARKERS SHALL BE HIGH PERFORMANCE RAISED PAVEMENT MARKERS AS LISTED IN THE MOST APPROVED SOURCE OF MATERIALS.

**MISSISSIPPI DEPARTMENT OF TRANSPORTATION**  
ROADWAY DESIGN DIVISION  
STANDARD PLAN

**PAVEMENT MARKING**  
**DETAILS FOR 3-LANE**  
**4-LANE AND 3-LANE**  
**UNDIVIDED ROADWAYS**

DATE	REVISION	ISSUE DATE: MAY 01, 2017

SHEET NUMBER: P10-2  
SHEET TOTAL: 02/22

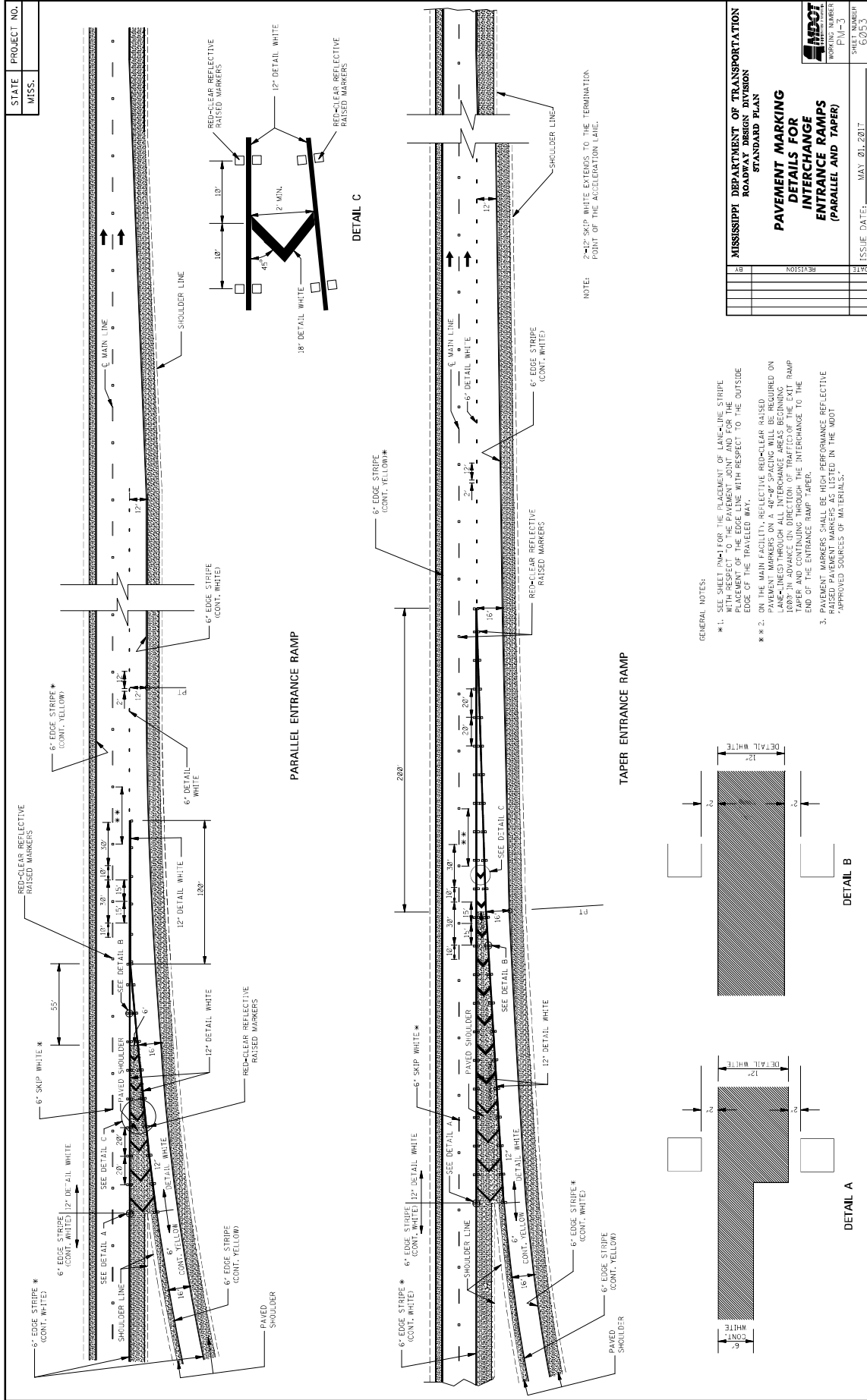



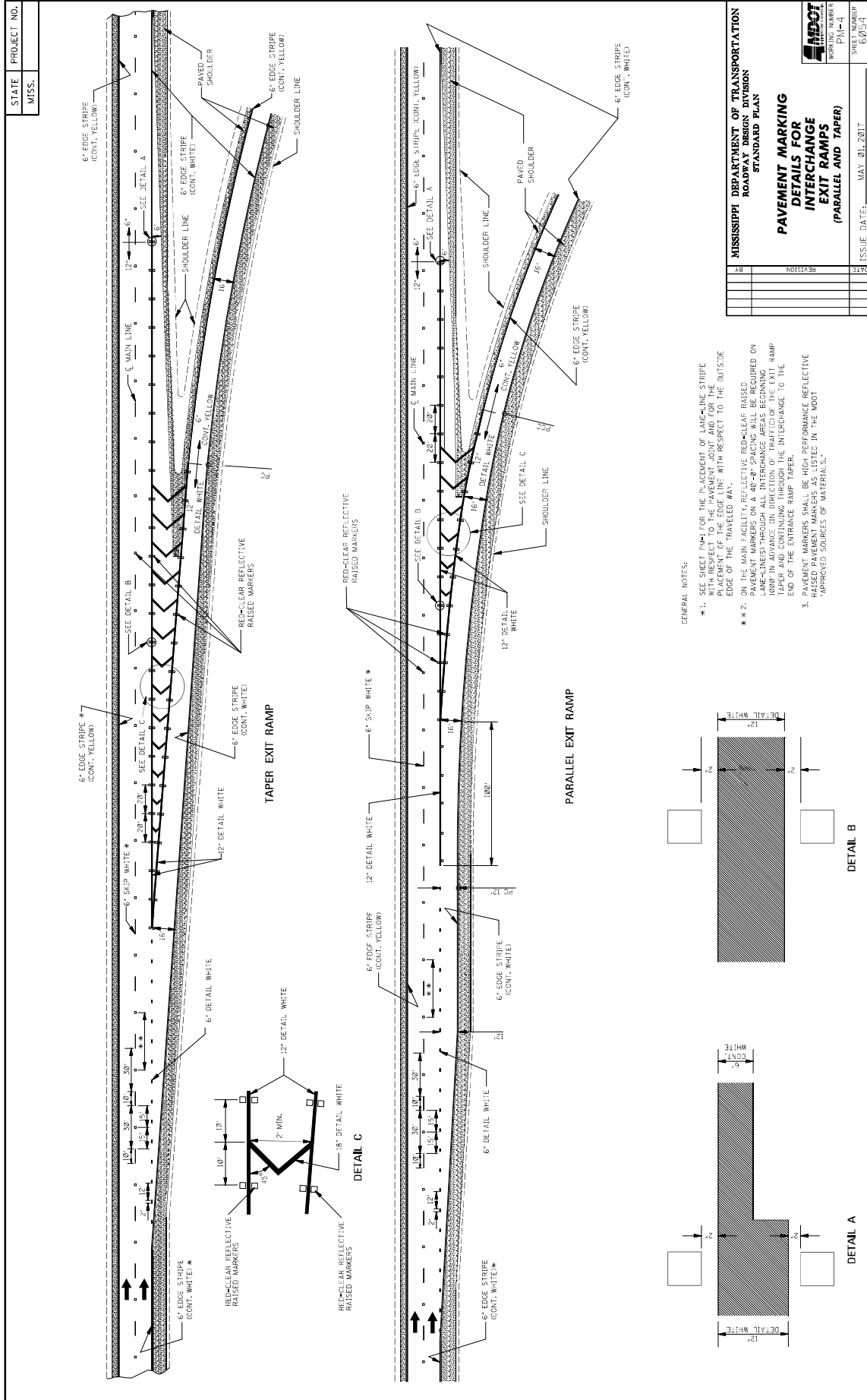

STATE MISS.	PROJECT NO.										
----------------	-------------	--	--	--	--	--	--	--	--	--	--

  

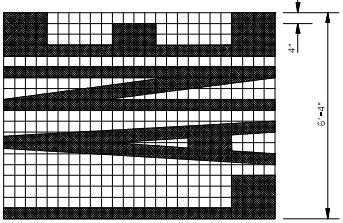

8'-4" x 6'-4" x 4"

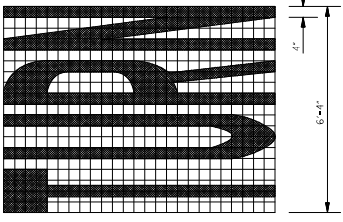

8'-4" x 6'-4" x 4"

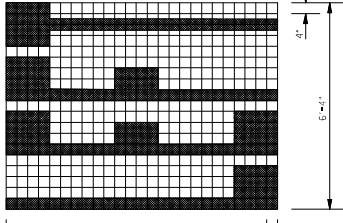

8'-4" x 6'-4" x 4"

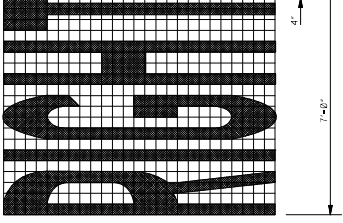

8'-4" x 7'-0" x 4"

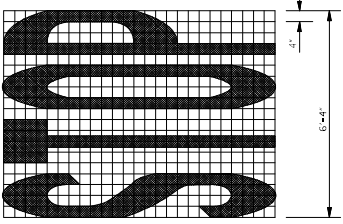

8'-4" x 6'-4" x 4"

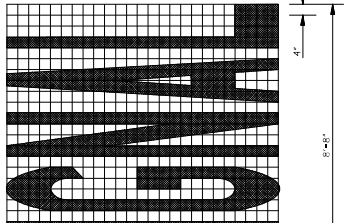

8'-4" x 6'-4" x 4"

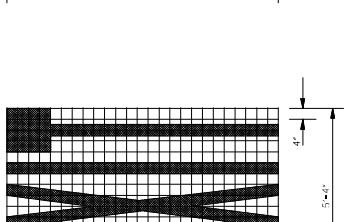

8'-4" x 5'-4" x 4"

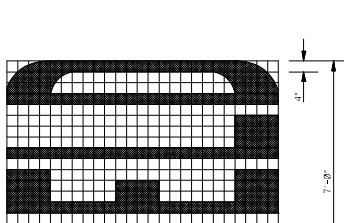

8'-4" x 7'-0" x 4"

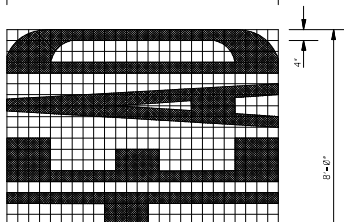

8'-4" x 8'-0" x 4"

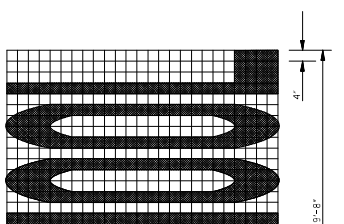

8'-4" x 9'-8" x 4"

GENERAL NOTES:

- TWO HORIZONTAL GAPS (USED BY TEMPLATE CONNECTIONS) OF 1/2" SHALL EXTEND THROUGH ALL WIDTH OF LETTERS.
- FOR OTHER DETAILS, SEE THE MANUAL ON UNIFORM TRAFFIC CONTROL DEVICES.
- PAY QUANTITIES FOR PAVEMENT MARKING LEGENDS ARE AS FOLLOWS:

LEGEND	AREA (sq ft)
STOP	24.6
RIGHT	28.6
LEFT	19.5
YIELD	22.2
AHEAD	32.4
YIELD	26.8
EXIT	18.5
SIGNAL	32.5
SCHOOL	35.2

MISSISSIPPI DEPARTMENT OF TRANSPORTATION  
ROADWAY DESIGN DIVISION  
STANDARD PLAN

**PAVEMENT MARKING  
LEGEND DETAILS**

DATE	ISSUE DATE: MAY 01, 2017
BY	
REVISION	

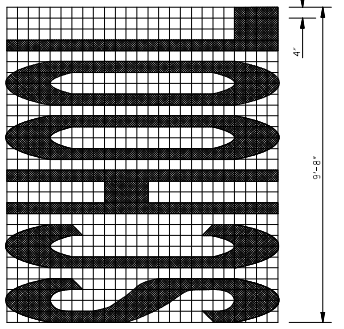

WORKING NUMBER  
PM-5

SHEET NUMBER  
6035

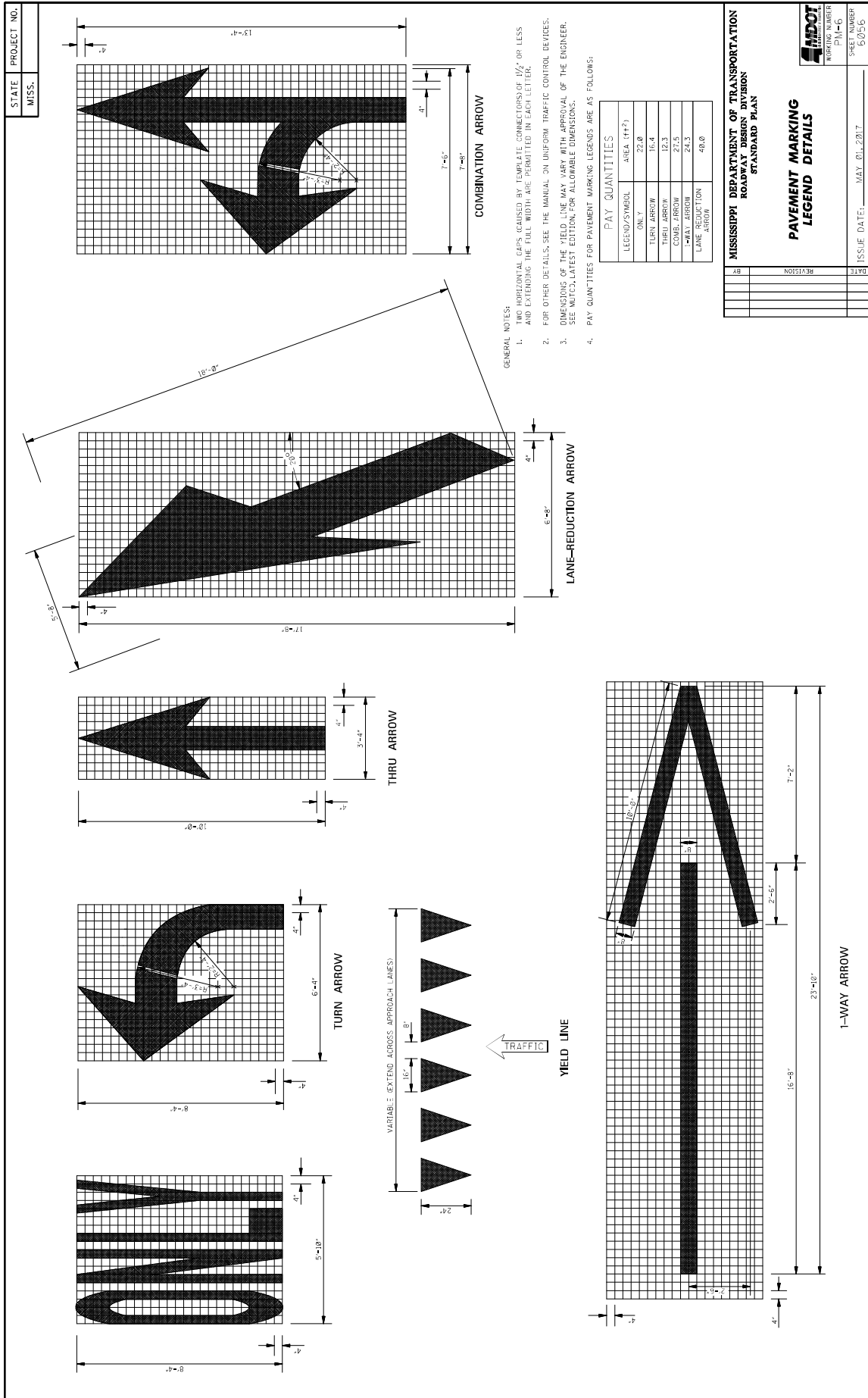

**MISSISSIPPI DEPARTMENT OF TRANSPORTATION**  
ROADWAY DESIGN DIVISION  
STANDARD PLAN

**PAVEMENT MARKING  
LEGEND DETAILS**

DATE	BY	REVISION	DATE	BY	REVISION	DATE	BY	REVISION

SHEET NUMBER: PM-6  
ISSUE DATE: MAY 01, 2017  
60516

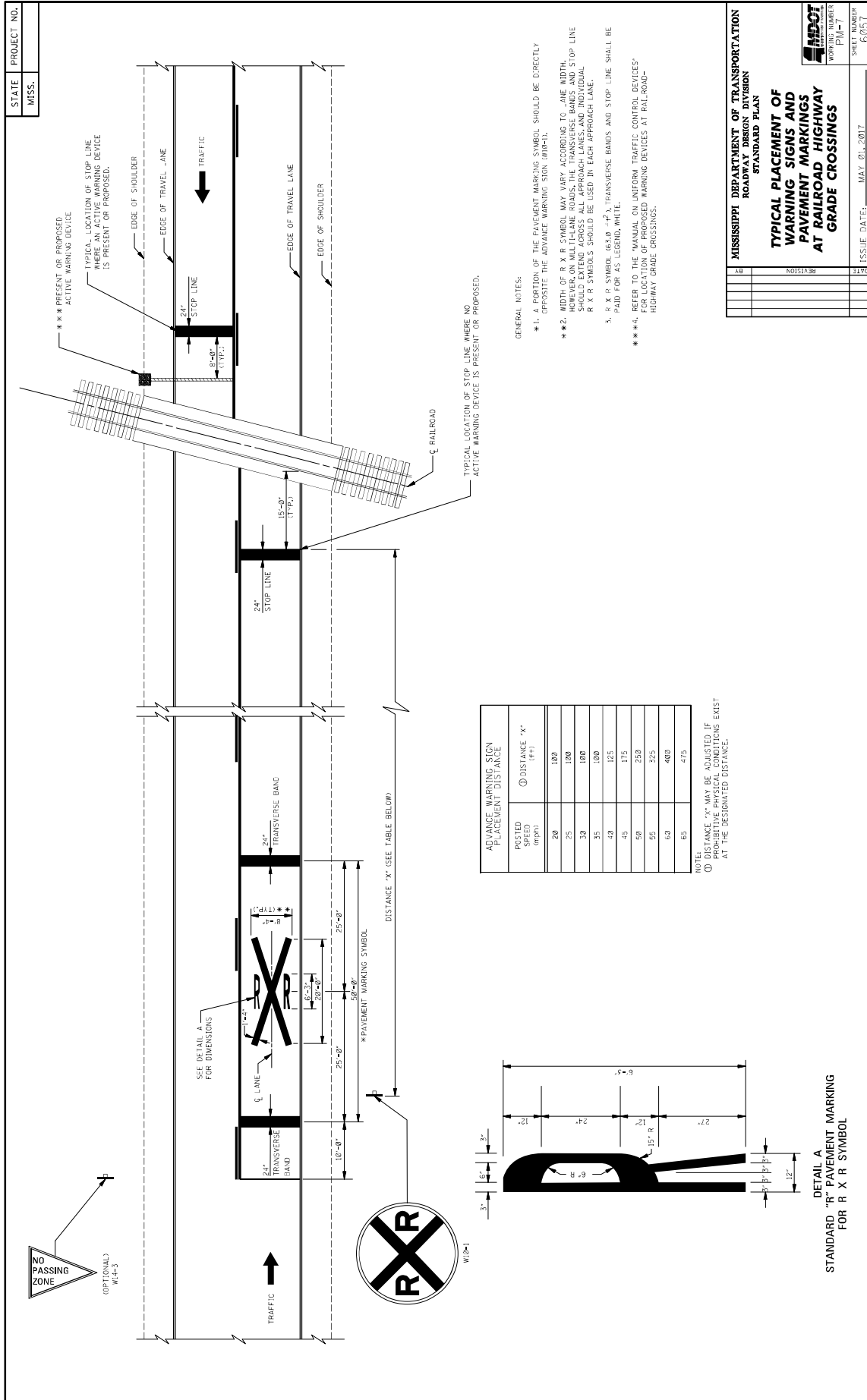





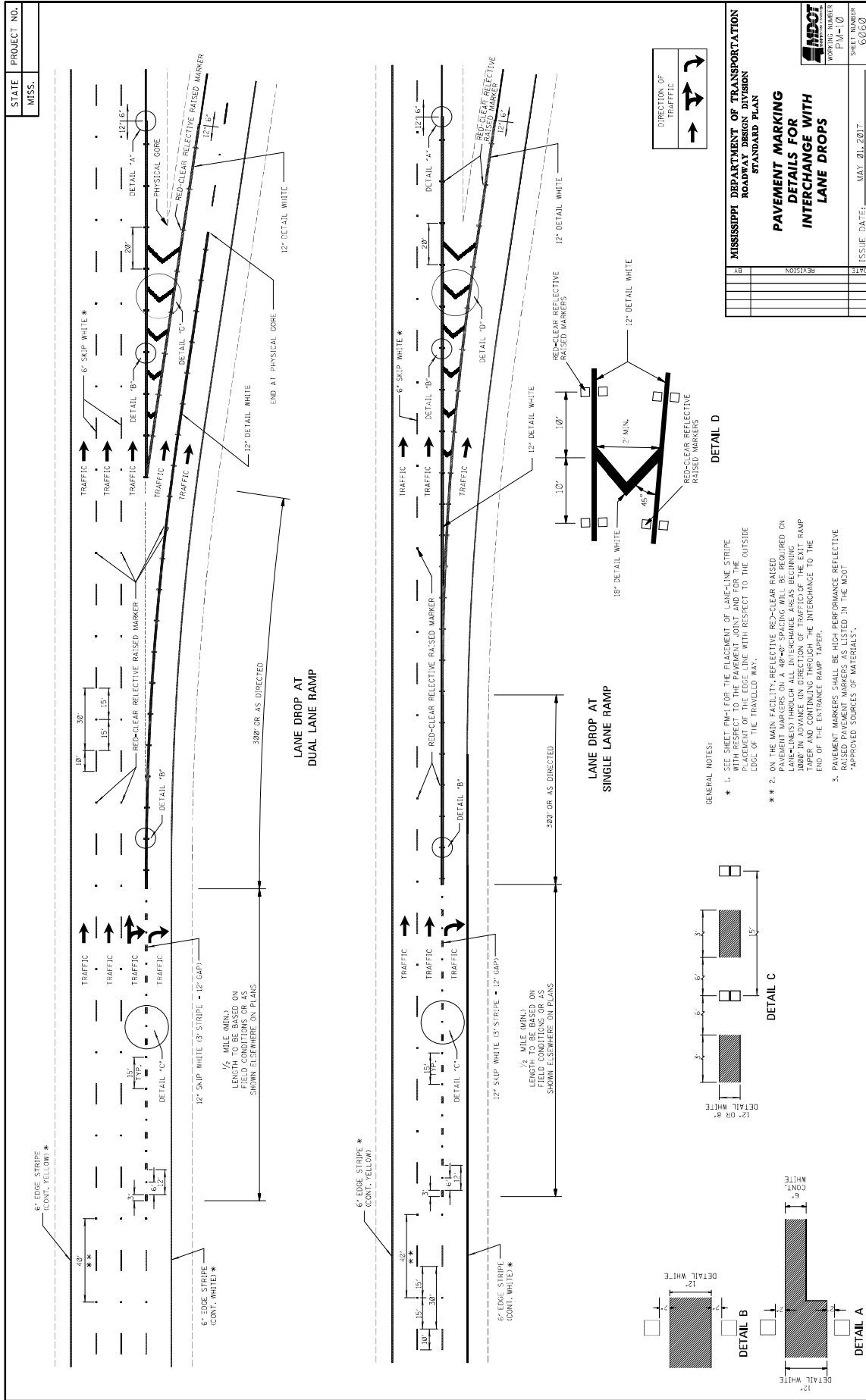

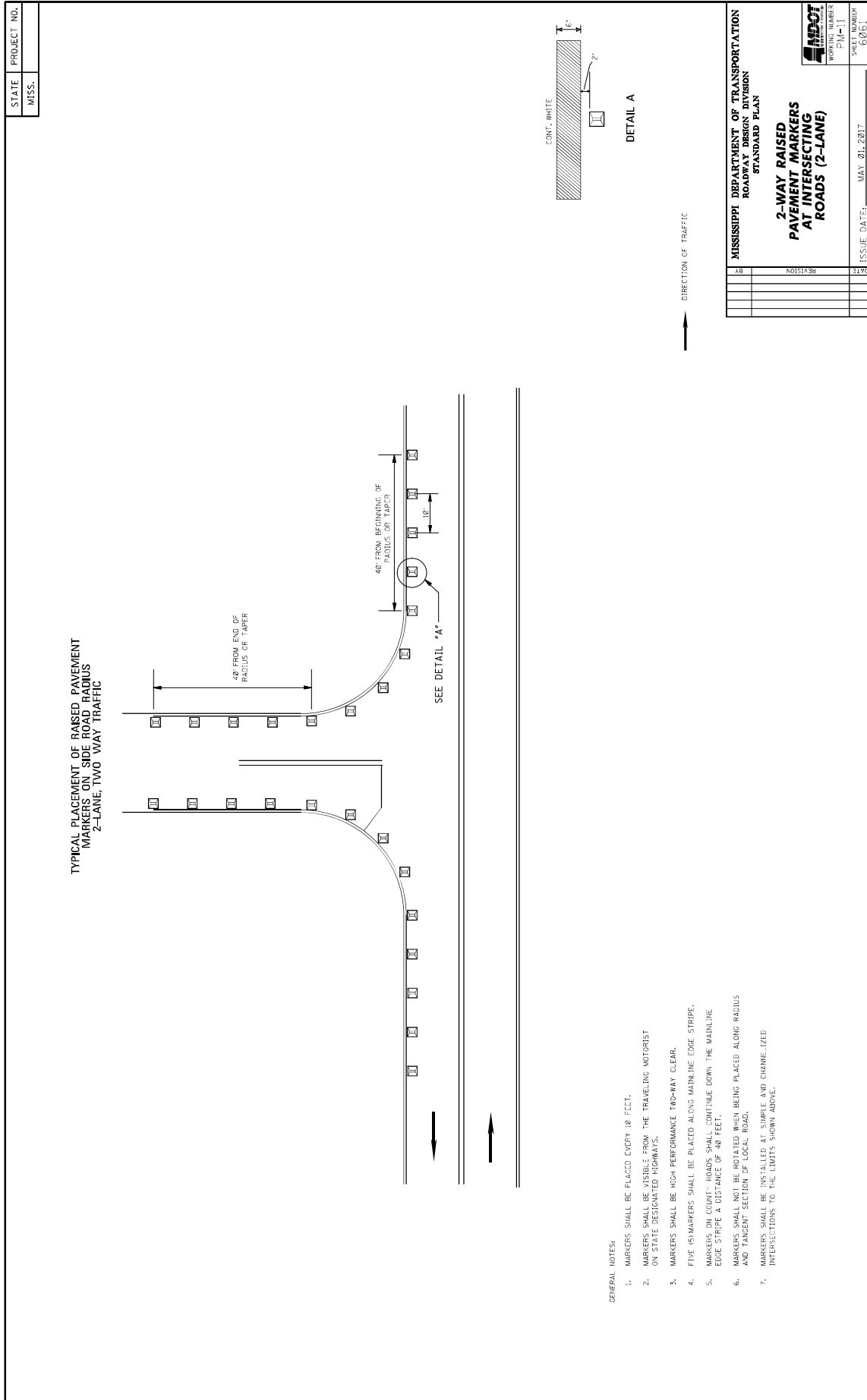



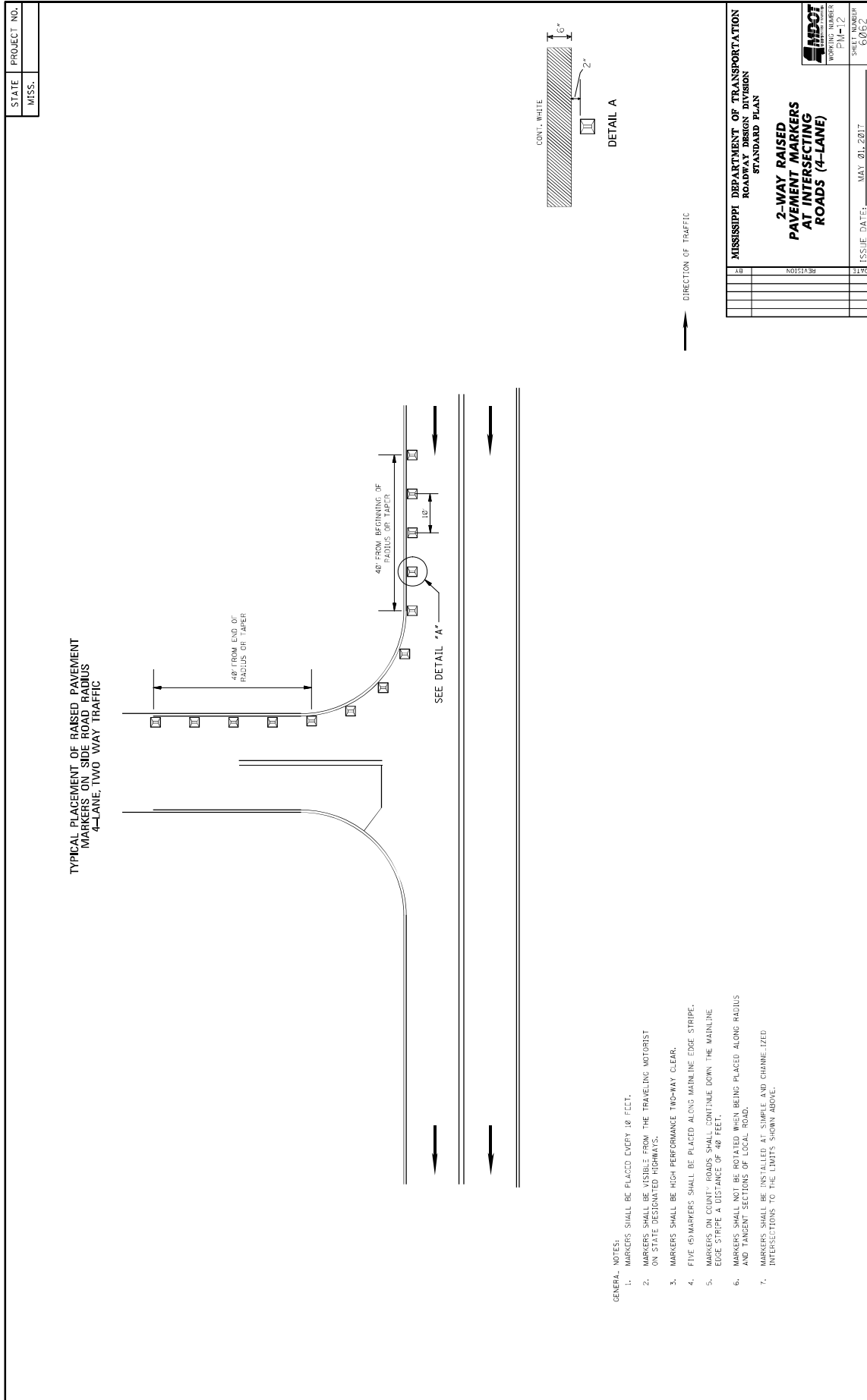

- GENERAL NOTES:
1. MARKERS SHALL BE FLACCO EVERY 18' FEET.
  2. MARKERS SHALL BE VISIBLE FROM THE TRAVELING MOTORIST ON STATE DESIGNATED HIGHWAYS.
  3. MARKERS SHALL BE HIGH PERFORMANCE TWO-WAY CLEAR.
  4. FIVE (5) MARKERS SHALL BE PLACED ALONG MAINLINE EDGE STRIPE.
  5. MARKERS ON COUNTY ROADS SHALL CONTINUE DOWN THE MAINLINE EDGE STRIPE A DISTANCE OF 40 FEET.
  6. MARKERS SHALL NOT BE ROTATED WHEN BEING PLACED ALONG RADIUS AND TANGENT SECTIONS OF LOCAL ROAD.
  7. MARKERS SHALL BE INSTALLED AT SIMPLE AND CHANNELIZED INTERSECTIONS TO THE LIMITS SHOWN ABOVE.

MISSISSIPPI DEPARTMENT OF TRANSPORTATION ROADWAY DESIGN DIVISION STANDARD PLAN	
<b>2-WAY RAISED PAVEMENT MARKERS AT INTERSECTING ROADS (4-LANE)</b>	
DATE	ISSUE DATE: MAY 01, 2017
BY	SHEET NUMBER P.M. 12 69/62
REVISION	SHEET NUMBER P.M. 12 69/62

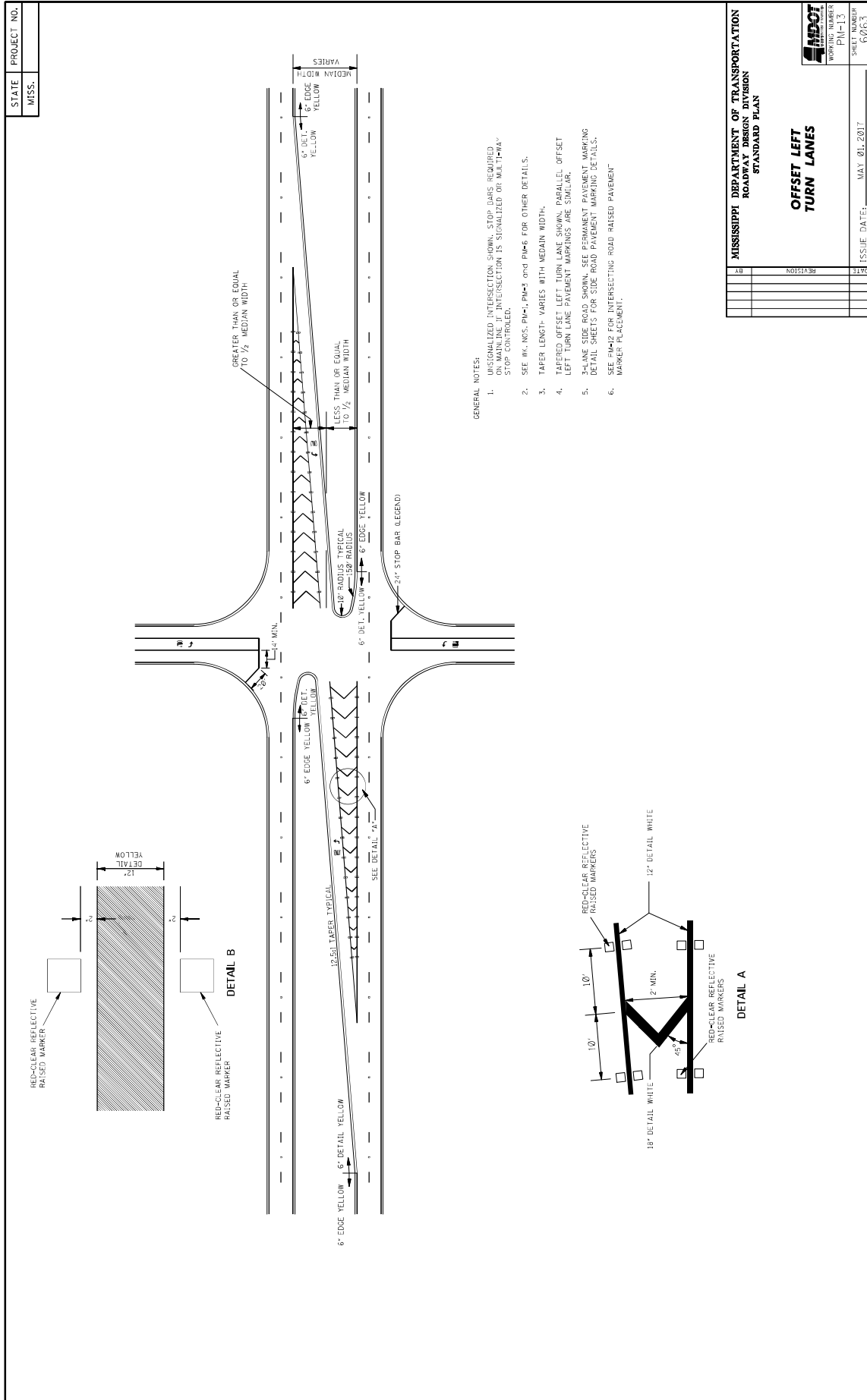

<b>MISSISSIPPI DEPARTMENT OF TRANSPORTATION</b>	
<b>ROADWAY DESIGN DIVISION</b>	
<b>STANDARD PLAN</b>	
<b>OFFSET LEFT TURN LANES</b>	
DATE	ISSUE DATE: MAY 01, 2017
BY	SHEET NUMBER 0263
REVISION	WORKING NUMBER PM-13

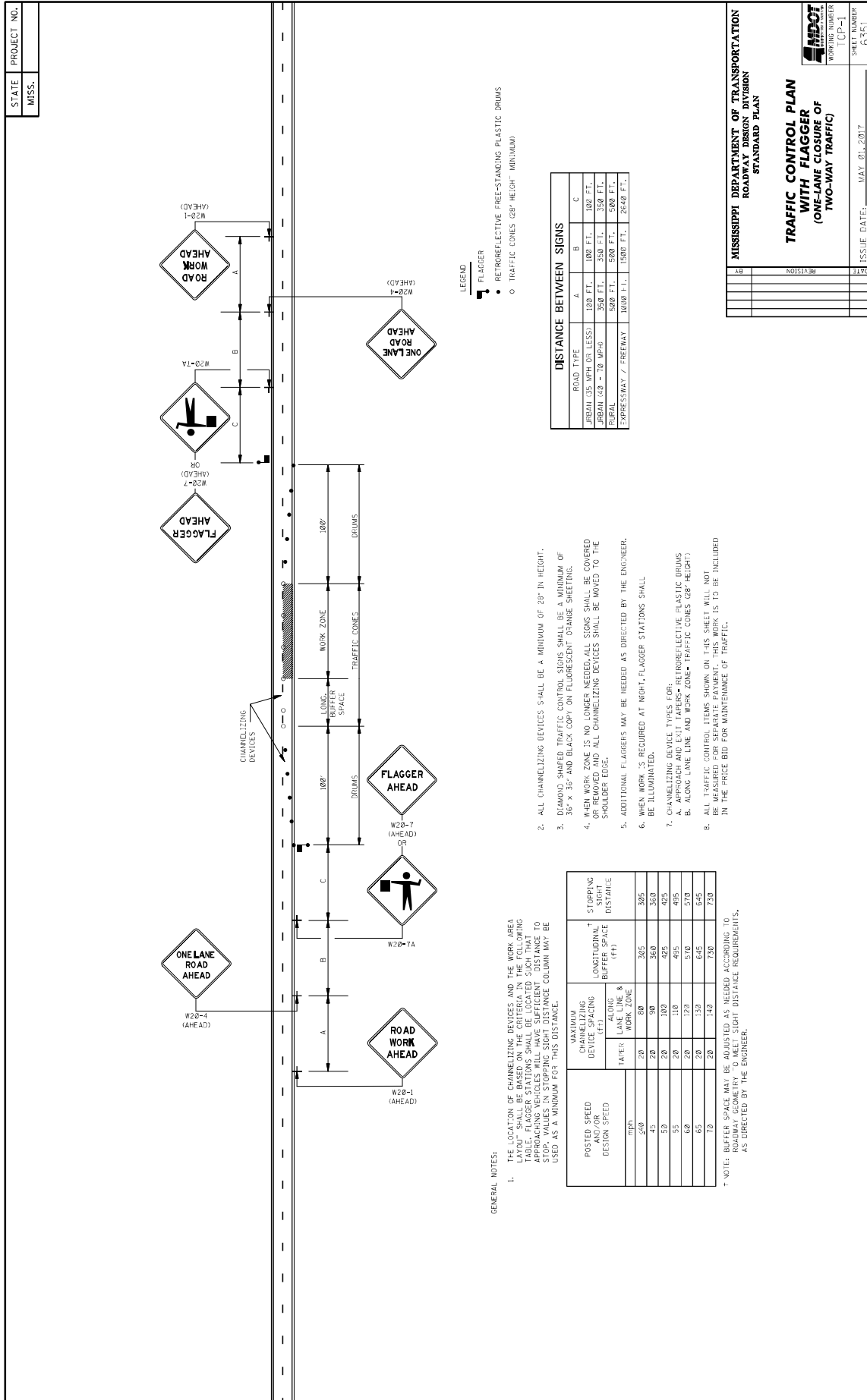

**MISSISSIPPI DEPARTMENT OF TRANSPORTATION**  
**ROADWAY DESIGN DIVISION**  
**STANDARD PLAN**

**TRAFFIC CONTROL PLAN**  
**WITH FLAGGER**  
**(ONE-LANE CLOSURE OF TWO-WAY TRAFFIC)**

ISSUE DATE: MAY 01, 2017

WORKING NUMBER [CP-1]  
 SHEET NUMBER 6351

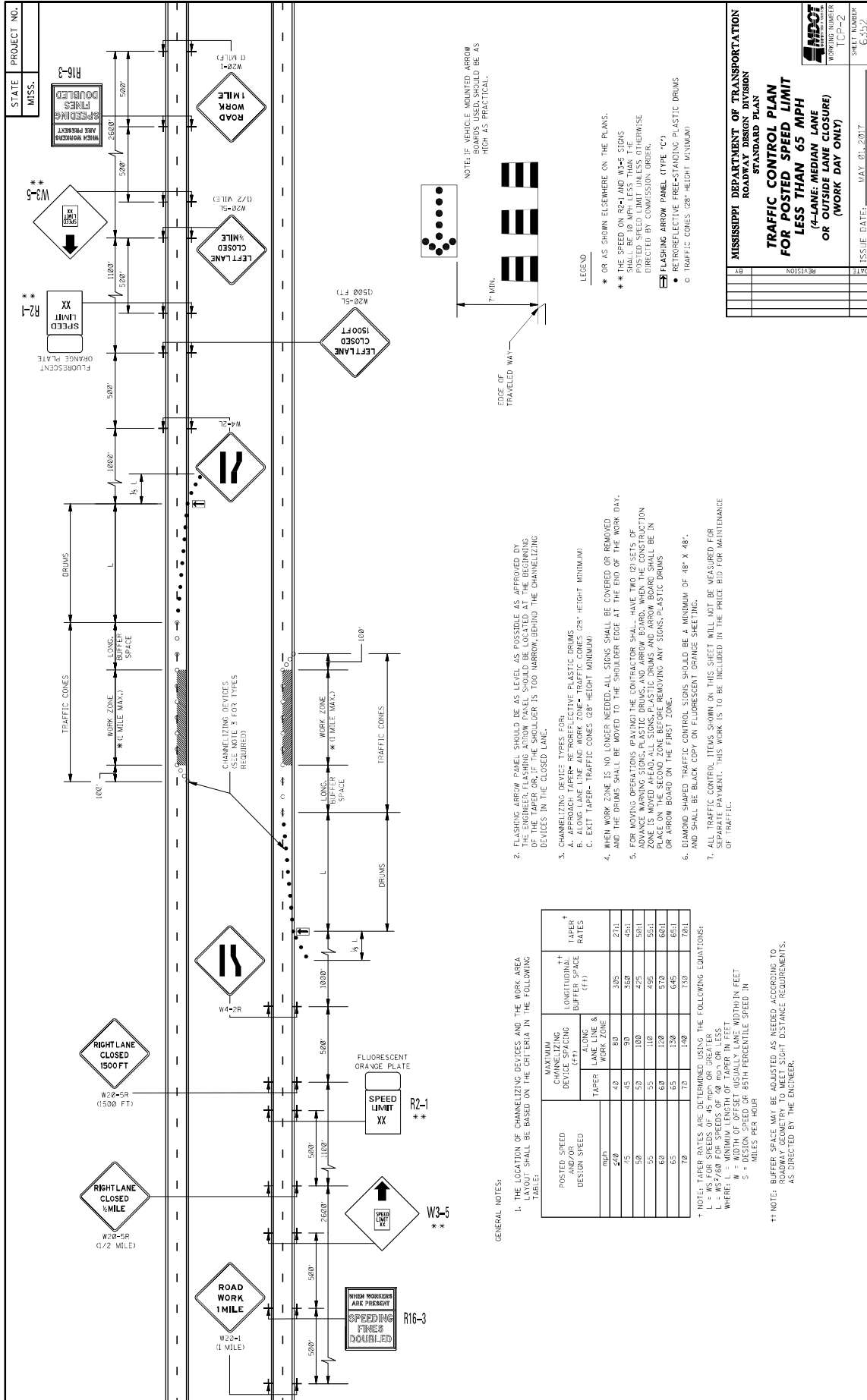

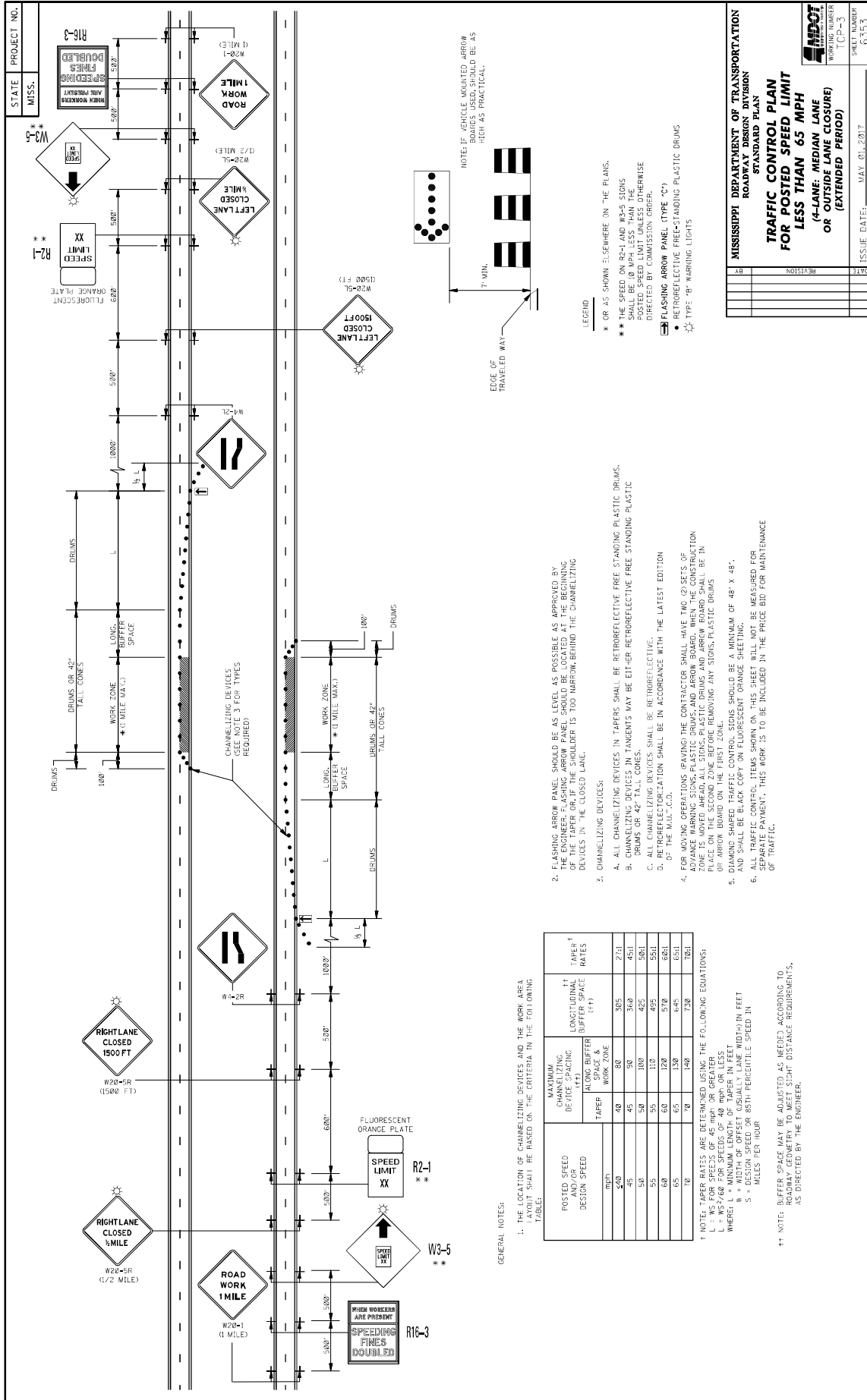

POSTED SPEED DESIGN SPEED	MAXIMUM CHANNELIZING DEVICE SPACING (FT)		LONGITUDINAL BUFFER SPACE (ft)	TAPER RATES
	ALONG BUFFER	WORK ZONE		
30	40	80	305	2/31
40	45	90	360	4/51
50	50	100	425	5/61
60	55	110	495	6/71
70	60	120	570	8/81
80	65	130	645	10/91
90	70	140	730	12/11

† NOTE: TAPER RATES ARE DETERMINED USING THE FOLLOWING EQUATIONS:  
 L = AS FOR SPEEDS OF 45 MPH OR GREATER  
 L = WS/60 FOR SPEEDS OF 40 MPH OR LESS  
 WHERE: W = WIDTH OF OFFSET, USUALLY LANE WIDTH IN FEET  
 S = DESIGN SPEED OR 85TH PERCENTILE SPEED IN MILES PER HOUR

†† NOTE: BUFFER SPACE MAY BE ADJUSTED AS NECESSARY ACCORDING TO ROADWAY GEOMETRY TO MEET SIGHT DISTANCE REQUIREMENTS, AS DIRECTED BY THE ENGINEER.

GENERAL NOTES:

1. THE LOCATION OF CHANNELIZING DEVICES AND THE WORK AREA LAYOUT SHALL BE BASED ON THE CRITERIA IN THE FOLLOWING TABLE:

- FLASHING ARROW PANEL SHOULD BE AS LEVEL AS POSSIBLE AS APPROVED BY THE ENGINEER. FLASHING ARROW PANEL SHOULD BE LOCATED AT THE BEGINNING OF THE WORK ZONE. THE BUFFER IS 100' AHEAD OF THE CHANNELIZING DEVICES IN THE CLOSED LANE.
- CHANNELIZING DEVICES:
  - ALL CHANNELIZING DEVICES IN TAPERS SHALL BE RETROREFLECTIVE FREE STANDING PLASTIC DRUMS.
  - DRUMS OR 42" TALL CONES.
  - ALL CHANNELIZING DEVICES SHALL BE RETROREFLECTIVE.
  - RETROREFLECTORIZATION SHALL BE IN ACCORDANCE WITH THE LATEST EDITION OF THE M.I.T.C.O.
- FOR WORKING DRUMS (BANKS) THE CONTRACTOR SHALL HAVE TWO (2) FEET OF CHANNELIZING DEVICES (STANDING PLASTIC DRUMS AND ARROW BOARD) IN THE CONSTRUCTION ZONE IS MOVED AHEAD ALL SIGNS, PLASTIC DRUMS AND ARROW BOARD SHALL BE IN PLACE ON THE SECOND ZONE BEFORE REMOVING ANY SIGNS, PLASTIC DRUMS OR ARROW BOARD ON THE FIRST ZONE.
- ALL CHANNELIZING DEVICES SHALL BE A MINIMUM OF 48" X 48", AND SHALL BE BLACK COPY OR FLUORESCENT ORANGE SHEETING.
- ALL TRAFFIC CONTROL ITEMS SHOWN ON THIS SHEET WILL NOT BE MEASURED FOR SEPARATE PAYMENT. THIS WORK IS TO BE INCLUDED IN THE PRICE BID FOR MAINTENANCE OF TRAFFIC.

- LEGEND
- \* OR AS SHOWN ELSEWHERE ON THE PLANS.
  - \*\* THE SPEED ON R2-1 AND R2-5 SIGNS SHOULD BE 10 MPH LESS THAN THE POSTED SPEED LIMIT UNLESS OTHERWISE DIRECTED BY COMMISSION ORDER.
  - ◻ FLASHING ARROW PANEL (TYPE 'C')
  - RETROREFLECTIVE FREE-STANDING PLASTIC DRUMS
  - ◻ TYPE 'B' WARNING LIGHTS

STATE PROJECT NO. MISS. \_\_\_\_\_

MISSISSIPPI DEPARTMENT OF TRANSPORTATION  
 ROADWAY DESIGN DIVISION  
 STANDARD PLAN  
**TRAFFIC CONTROL PLAN  
 FOR POSTED SPEED LIMIT  
 LESS THAN 65 MPH  
 (4-LANE MEDIAN LANE  
 OR OUTSIDE LANE CLOSURE  
 (EXTENDED PERIOD))**

WORKING NUMBER: TCR-3  
 SHEET NUMBER: 6253  
 ISSUE DATE: MAY 01, 2017

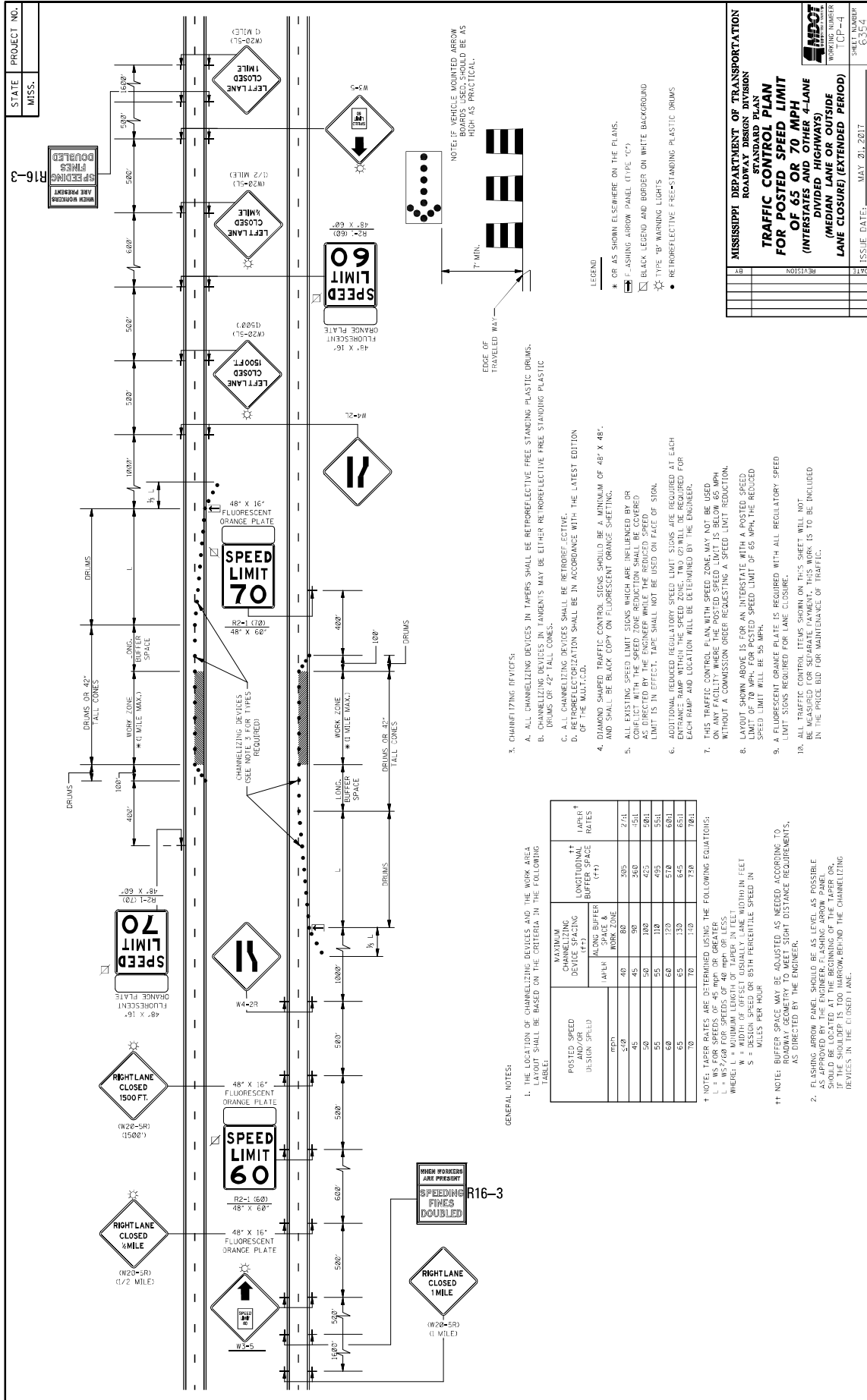

STATE PROJECT NO. MISS. R16-3

MISSISSIPPI DEPARTMENT OF TRANSPORTATION  
ROADWAY DESIGN DIVISION  
**TRAFFIC CONTROL PLAN  
FOR POSTED SPEED LIMIT  
OF 65 OR 70 MPH  
(INTERSTATES AND OTHER 4-LANE  
DIVIDED HIGHWAYS)  
(MEDIUM LANE OR OUTSIDE  
LANE CLOSED) (EXTENDED PERIOD)**

ISSUE DATE: MAY 20, 2012

WORKING NUMBER: CP-44  
SHEET NUMBER: 6554

- GENERAL NOTES:
1. THE LOCATION OF CHANNELIZING DEVICES AND THE WORK AREA LIMITS SHALL BE BASED ON THE CRITERIA IN THE FOLLOWING TABLE:
- | POSTED SPEED<br>DESIGN SPEED) | MAXIMUM<br>CHANNELIZING<br>DEVICE SPACING<br>ALONG BUFFER<br>SPACE &<br>WORK ZONE | LONGITUDINAL<br>BUFFER SPACE<br>(FT) |         |
|-------------------------------|---|--------------------------------------|---------|
|                               |   | MINIMUM                              | MAXIMUM |
| 50                            | 40  | 305                                  | 270     |
| 55                            | 45  | 360                                  | 315     |
| 60                            | 50  | 420                                  | 360     |
| 65                            | 55  | 480                                  | 405     |
| 70                            | 60  | 540                                  | 450     |
| 75                            | 65  | 600                                  | 495     |
| 80                            | 70  | 660                                  | 540     |
| 85                            | 75  | 720                                  | 585     |
| 90                            | 80  | 780                                  | 630     |
- † NOTE: TAPER RATES ARE DETERMINED USING THE FOLLOWING EQUATIONS:  
 †† NOTE: BUFFER SPACE MAY BE ADJUSTED AS NEEDED ACCORDING TO ROADWAY GEOMETRY TO MEET SIGHT DISTANCE REQUIREMENTS, AS DIRECTED BY THE ENGINEER.  
 L = WS<sup>2</sup>/400 FOR SPEEDS OF 45 MPH OR GREATER  
 L = WS/2 FOR SPEEDS OF 40 MPH OR LESS  
 WHERE: L = MINIMUM BUFFER SPACE IN FEET  
 W = DESIGN SPEED OR 85TH PERCENTILE SPEED IN MILES PER HOUR
2. FLASHING ARROW PANEL SHOULD BE AS LEVEL AS POSSIBLE AS APPROVED BY THE ENGINEER. FLASHING ARROW PANEL SHOULD BE LOCATED AT THE BEGINNING OF THE TAPER OR THE END OF THE TAPER. CHANNELIZING DEVICES IN THE CLOSED LANE.
  3. CHANNELIZING DEVICES:
    - A. ALL CHANNELIZING DEVICES IN TAPERS SHALL BE RETROREFLECTIVE FREE STANDING PLASTIC DRUMS.
    - B. CHANNELIZING DEVICES IN TANGENTS MAY BE EITHER RETROREFLECTIVE FREE STANDING PLASTIC DRUMS OR 42" TALL CONES.
    - C. ALL CHANNELIZING DEVICES SHALL BE RETROREFLECTIVE.
    - D. RETROREFLECTIVIZATION SHALL BE IN ACCORDANCE WITH THE LATEST EDITION OF THE MUTCD-6A.
  4. DIAMOND SHAPED TRAFFIC CONTROL SIGNS SHOULD BE A MINIMUM OF 48" X 48" AND SHALL BE BLACK COPY ON FLUORESCENT ORANGE SHEETING.
  5. ALL EXISTING SPEED LIMIT SIGNS WHICH ARE INFLUENCED BY OR CONFLICT WITH THE SPEED ZONE REDUCTION SHALL BE COVERED WITH A BLACK LEADED AND BORDER ON WHITE BACKGROUND. LIMIT IS IN EFFECT. TAPE SHALL NOT BE USED ON FACE OF SIGN.
  6. ADDITIONAL REQUIRED REGULATORY SPEED LIMIT SIGNS ARE REQUIRED AT EACH ENTRANCE RAMP AND LEGALION WILL BE DETERMINED BY THE ENGINEER.
  7. THIS TRAFFIC CONTROL PLAN WITH SPEED ZONE MAY NOT BE USED ON ANY FACILITY WHERE THE POSTED SPEED LIMIT IS BELOW 65 MPH WITHOUT A COMMISSION ORDER REQUESTING A SPEED LIMIT REDUCTION.
  8. LAYOUT SHOWN ABOVE IS FOR AN INTERSTATE WITH A POSTED SPEED LIMIT OF 70 MPH FOR PASTED SPEED LIMIT OF 65 MPH. THE REDUCED SPEED LIMIT WILL BE 55 MPH.
  9. A FLUORESCENT ORANGE PLATE IS REQUIRED WITH ALL REGULATORY SPEED LIMIT SIGNS REQUIRED FOR LANE CLOSURE.
  10. ALL TRAFFIC CONTROL ITEMS SHOWN ON THIS SHEET WILL NOT BE MEASURED FOR SEPARATE PAYMENT. THIS WORK IS TO BE INCLUDED IN THE PRICE BID FOR MAINTENANCE OF TRAFFIC.

- LEGEND
- \* OR AS SHOWN ELSEWHERE ON THE PLANS.
  - † FLASHING ARROW PANEL (TYPE "C")
  - BLACK LEADED AND BORDER ON WHITE BACKGROUND
  - ☆ TYPE "B" MARKING LIGHTS
  - RETROREFLECTIVE FREE-STANDING PLASTIC DRUMS

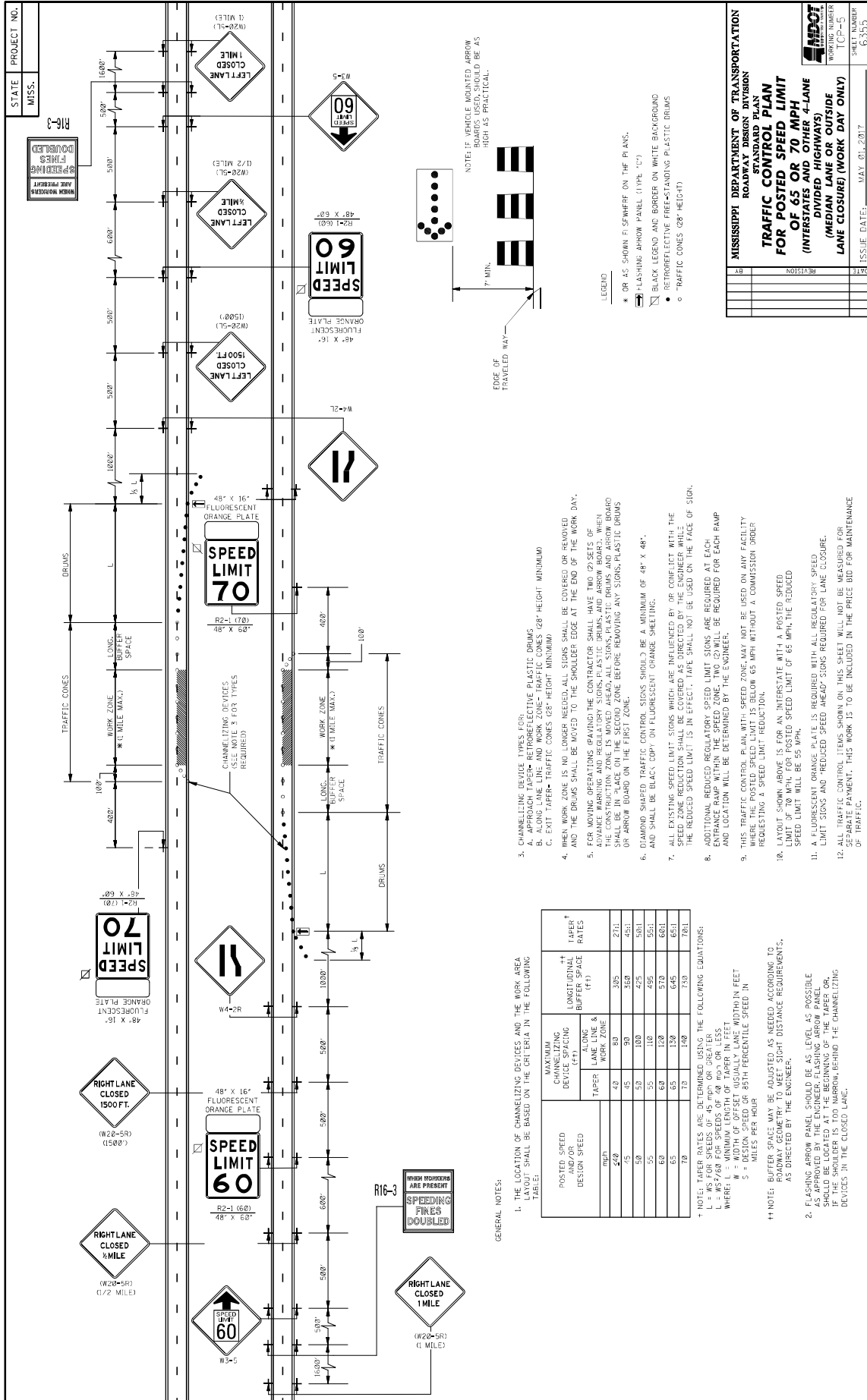

STATE PROJECT NO.  
MISS.

WORKING NUMBER  
ICP-5

SHEET NUMBER  
03500

**WING BARRICADES**

- WING BARRICADES ARE TYPE II BARRICADES ERECTED ON THE SHOULDER OF A ROADWAY OR RESTRICTED ROADWAY. WING BARRICADES MAY BE USED AS A MOUNTING FOR THE ADVANCE WARNING SIGNS OR FLASHERS.
- WING BARRICADES SHOULD BE USED:
  - IN ADVANCE OF A CONSTRUCTION PROJECT EVEN WHEN NO PART OF THE ROADWAY IS ACTUALLY CLOSED.
  - IN ADVANCE OF ALL BRIDGE OR CULVERT WIDENING OPERATIONS.

**BARRICADE CLOSING A ROAD**

	I	II	III
WIDTH OF RAIL **	8" MIN. - 12" MAX.	8" MIN. - 12" MAX.	8" MIN. - 12" MAX.
LENGTH OF RAIL **	24' MIN.	24' MIN.	48' MIN.
WIDTH OF STRIPE *	6"	6"	6"
HEIGHT	36" MIN.	36" MIN.	60" MIN.
NUMBER OF RETROREFLECTORIZED RAIL FACES	2 (ONE EACH DIRECTION)	4 (TWO EACH DIRECTION)	3 IF FACING TRAFFIC IN ONE DIRECTION 4 IF FACING TRAFFIC IN TWO DIRECTIONS

**BARRICADE CHARACTERISTICS**

\* 1. FOR RAILS LESS THAN 36" LONG, 4" WIDE STRIPES MAY BE USED.

\*\* 2. BARRICADES INTENDED FOR USE ON EXPRESSWAYS, FREEWAYS AND OTHER HIGH SPEED ROADWAYS, SHALL HAVE A MINIMUM OF 270' OF REFLECTIVE AREA FACING TRAFFIC.

**STANDARD BARRICADES**

- THE MARKING FOR BARRICADE RAILS SHALL BE ORANGE AND WHITE (SLOPING DOWNWARD AT AN ANGLE OF 45° IN THE DIRECTION OF TRAFFIC IS TO PASS).
- RAIL STRIPE SHALL BE 6 INCHES, EXCEPT THAT 4-INCH WIDE STRIPES MAY BE USED IF RAIL LENGTHS ARE LESS THAN 36 INCHES.
- DO NOT PLACE SANDBAGS OR OTHER DEVICES TO PROVIDE MASS ON THE BOTTOM RAIL THAT WILL BLOCK VIEW OR RAIL FACE.
- FOR ADDITIONAL INFORMATION OR DETAILS, SEE METHOD, LATEST EDITION.
- BARRICADES ARE CLASSIFIED BY FHWA AS CATEGORY II WHEN DEVICES WHICH REQUIRE SUCCESSFULLY CRASH TESTED. A LIST OF CRASHWORTHY BARRICADES AND OTHER CATEGORY II DEVICES CAN BE FOUND ON FHWA'S WEBSITE: [http://safety.fhwa.dot.gov/roadway\\_dept/pafety\\_guidance/road\\_hardware/cat2.cfm](http://safety.fhwa.dot.gov/roadway_dept/pafety_guidance/road_hardware/cat2.cfm)

**CHEVRON SIGN DETAIL**

- A CHEVRON SIGN CONSISTS OF A BLACK CHEVRON TYPE MARKING ON AN ORANGE BACKGROUND AND SHALL POINT IN THE DIRECTION OF TRAFFIC FLOW.
- THE CHEVRON SIGN SHALL BE MOUNTED ON CRASHWORTHY SUPPORT.
- CHEVRON SIGNS MAY BE USED TO SUPPLEMENT OTHER STANDARD DEVICES WHERE ONE OR MORE LANES ARE CLOSED FOR CONSTRUCTION OR MAINTENANCE. THEY SHOULD BE PLACED APPROXIMATELY 2' 40" BEHIND THE LANE TRANSITION STRIPE.

**PLASTIC DRUM STRIPING DETAIL**

- PLASTIC DRUMS SHALL BE ON END AND USED AS AN EXPEDITED METHOD FOR TRAFFIC CHANNELIZATION. THE COLOR AND MARKING OF DRUMS SHALL BE CONSISTENT WITH MARKING STANDARDS. THE COLOR OF DRUMS SHALL BE RETROREFLECTIVE. DRUMS SHALL BE MARKED WITH FOUR RETROREFLECTIVE STRIPES (2 ORANGE & 2 WHITE) 6" WIDE.
- DRUMS SHOULD NEVER BE PLACED IN THE ROADWAY WITHOUT WARNING SIGNS.
- WHERE PRACTICAL PLASTIC DRUMS SHOULD BE PLACED NO CLOSER THAN 3'-0" FROM THE EDGE OF TRAVELED LANE.

**TYPE 3 OBJECT MARKER (OM-3R)**

- TYPE 3 OBJECT MARKERS SHALL BE USED AT ALL EXPOSED BRIDGE ABUTMENTS AND AT OTHER LOCATIONS AS DETERMINED NECESSARY BY THE ENGINEER.
- THE OM-3R IS SIMILAR EXCEPT THE STRIPES SLOPE DOWNWARD FROM THE UPPER LEFT SIDE TO THE LOWER RIGHT SIDE AND SHALL BE PLACED ON THE LEFT SIDE OF THE OBJECT.
- THE INSIDE EDGE OF THE MARKER SHALL BE IN LINE WITH THE INNER EDGE OF THE OBSTRUCTION.

**MISSISSIPPI DEPARTMENT OF TRANSPORTATION  
ROADWAY DESIGN DIVISION  
STANDARD PLAN**

**HIGHWAY SIGN AND  
BARRICADE DETAILS  
FOR CONSTRUCTION  
PROJECTS**

REV	REVISION	DATE

ISSUE DATE: MAY 20, 2017



STATE MISS.	PROJECT NO.	
----------------	-------------	--

### MOBILE OPERATIONS ON MULTILANE ROAD

**MOBILE OPERATIONS ON MULTILANE ROAD**

### MOBILE OPERATIONS ON TWO-LANE ROAD

**MOBILE OPERATIONS ON TWO-LANE ROAD**

**NOTES FOR MULTILANE LANE OPERATION:**

- VEHICLES USED FOR THESE OPERATIONS SHOULD BE MADE HIGHLY VISIBLE WITH APPROPRIATE EQUIPMENT, SUCH AS FLASHING LIGHTS, ROTATING BEACONS, FLASERS, SIGNS, OR ARROW PANELS.
- SHADOW VEHICLE 2 SHOULD BE EQUIPPED WITH AN ARROW PANEL AND TRUCK MOUNTED ATTENUATOR (TMA), AN APPROPRIATE LANE CLOSURE SIGN SHOULD BE PLACED IN FRONT OF SHADOW VEHICLE 2 SO AS NOT TO OBSCURE THE ARROW PANEL.
- SHADOW VEHICLE 1 SHOULD BE EQUIPPED WITH AN ARROW PANEL AND TRUCK MOUNTED ATTENUATOR (TMA).
- SHADOW VEHICLE 2 SHOULD TRAVEL AT A VARYING DISTANCE FROM THE WORK OPERATION SO AS TO PROVIDE ADEQUATE SIGHT DISTANCE FOR TRAFFIC APPROACHING FROM THE REAR.
- WHEN ADEQUATE SHOULDER WIDTH IS NOT AVAILABLE, SHADOW VEHICLE 2 SHOULD BE ELIMINATED.
- ON HIGH-SPEED ROADWAYS, A THIRD SHADOW VEHICLE SHOULD BE USED (i.e., VEHICLE 3 ON THE SHOULDER OF PRACTICALLY, VEHICLE 2 IN THE CLOSED LANE, AND VEHICLE 1 IN THE CLOSED LANE).
- ARROW PANELS SHALL BE AS A MINIMUM TYPE B, 60" X 30" IN ACCORDANCE WITH THE CRITERIA PRESENTED IN THE MUTCD.
- WORK SHOULD NORMALLY BE DONE DURING OFF-PEAK HOURS.
- VEHICLE-MOUNTED SIGNS SHOULD BE MOUNTED WITH THE BOTTOM OF THE SIGN LOCATED AT A MINIMUM HEIGHT OF 48" ABOVE THE PAVEMENT AND SHALL NOT BE OBTURED BY EQUIPMENT OR SUPPLIES. SIGN LEGENDS SHALL BE COVERED OR TURNED FROM VIEW WHEN WORK IS NOT IN PROGRESS.
- ALL TRAFFIC CONTROL ITEMS SHOWN ON THIS SHEET WILL NOT BE MEASURED FOR SEPARATE PAYMENT. THIS WORK IS TO BE INCLUDED IN THE PRICE BID FOR MAINTENANCE OF TRAFFIC.

**NOTES FOR TWO-LANE OPERATION:**

- WHERE PRACTICAL AND WHEN NEEDED, THE WORK AND SHADOW VEHICLES SHOULD PULL OVER PERIODICALLY TO ALLOW TRAFFIC TO PASS. IF THIS CAN NOT BE DONE FREQUENTLY AS AN ALTERNATIVE, A "DO NOT PASS" SIGN MAY BE PLACED ON THE REAR OF THE VEHICLE BLOCKING THE LANE.
- THE DISTANCE BETWEEN THE WORK AND SHADOW VEHICLES MAY VARY ACCORDING TO TERRAIN, PAINT DRYING TIME, AND OTHER FACTORS. SHADOW VEHICLES ARE USED TO WARN TRAFFIC OF THE OPERATION AHEAD. WHENEVER ADEQUATE SIGHT DISTANCE IS NOT AVAILABLE, THE SHADOW VEHICLE SHOULD BE PLACED AS CLOSE AS POSSIBLE TO THE WORK VEHICLE. THE SHADOW VEHICLE SHOULD SLOW DOWN IN ADVANCE OF VERTICAL OR HORIZONTAL CURVES THAT RESTRICT SIGHT DISTANCE.
- ADDITIONAL SHADOW VEHICLES TO WARN AND REDUCE THE SPEED OF ONCOMING OR OPPOSING TRAFFIC MAY BE USED. POLICE PATROL CARS MAY BE USED FOR THIS PURPOSE.
- A TRUCK-MOUNTED ATTENUATOR (TMA) SHOULD BE USED ON THE SHADOW VEHICLE AND MAY BE USED ON THE WORK VEHICLE.
- THE WORK VEHICLE SHALL BE EQUIPPED WITH BEACONS AND THE SHADOW VEHICLE SHALL BE EQUIPPED WITH BEACONS AND LIGHTS. TRUCK MOUNTED LIGHTS MOUNTED ON THE REAR, ADJACENT TO THE SIGN, SHADOW AND WORK VEHICLES SHALL DISPLAY FLASHING OR ROTATING BEACONS BOTH FORWARD AND TO THE REAR.
- VEHICLE-MOUNTED SIGNS SHOULD BE MOUNTED WITH THE BOTTOM OF THE SIGN LOCATED AT A MINIMUM HEIGHT OF 48" ABOVE THE PAVEMENT AND SHALL NOT BE OBTURED BY EQUIPMENT OR SUPPLIES. SIGN LEGENDS SHALL BE COVERED OR TURNED FROM VIEW WHEN WORK IS NOT IN PROGRESS.
- ARROW BOARD TO BE USED IN CAUTION MODE.
- ALL TRAFFIC CONTROL ITEMS SHOWN ON THIS SHEET WILL NOT BE MEASURED FOR SEPARATE PAYMENT. THIS WORK IS TO BE INCLUDED IN THE PRICE BID FOR MAINTENANCE OF TRAFFIC.

  

**MISSISSIPPI DEPARTMENT OF TRANSPORTATION**  
ROADWAY DESIGN DIVISION  
STANDARD PLAN

**TRAFFIC CONTROL PLAN**  
**MOBILE OPERATIONS**  
**MULTILANE ROADS**  
**TWO-LANE ROADS**

REV	REVISION	
1		
2		
3		
4		
5		
6		
7		
8		
9		
10		

ISSUE DATE: MAY 01, 2017  
SHEET NUMBER: TCP-9  
PROJECT NUMBER: 6359

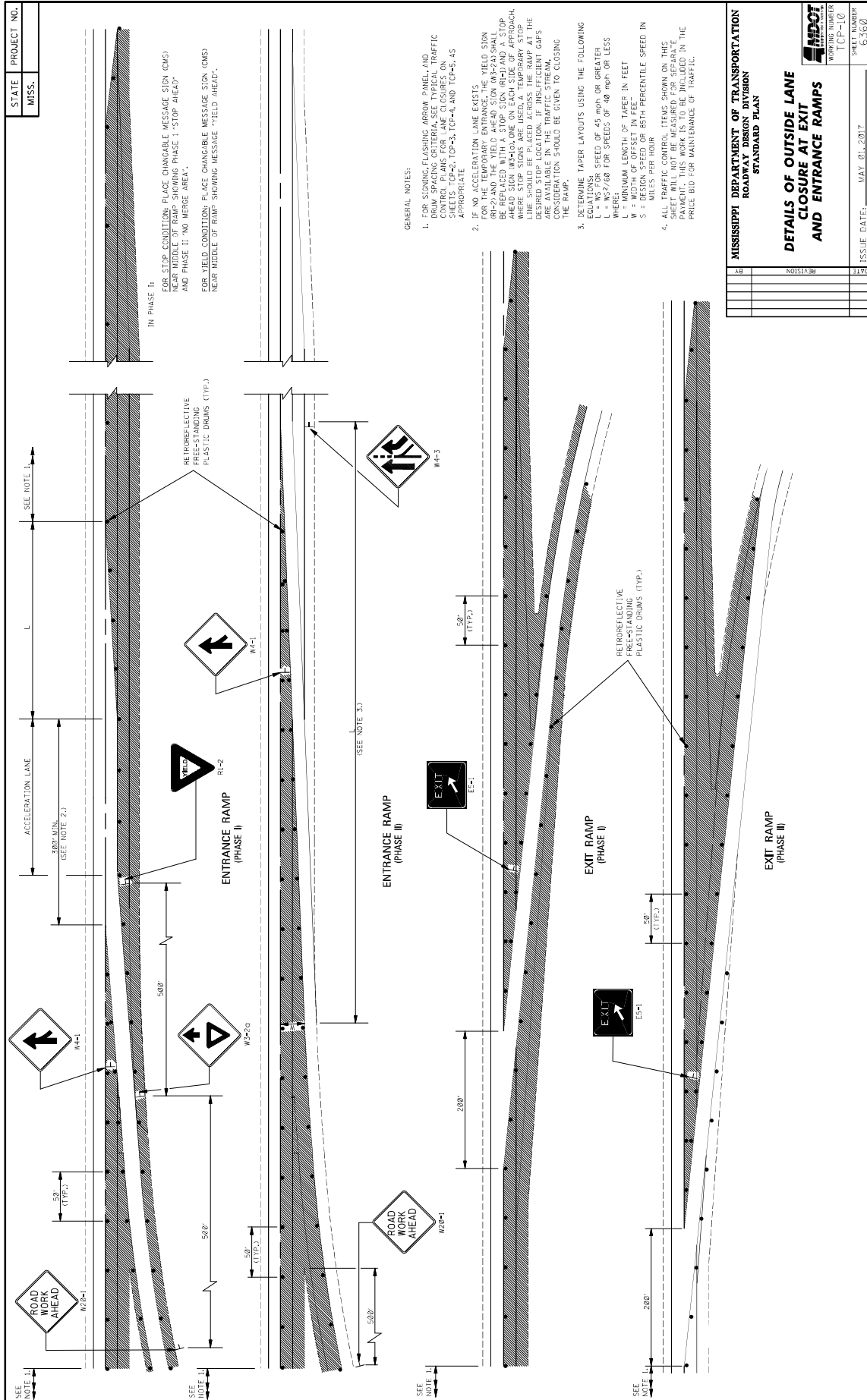

STATE PROJECT NO.  
MISS.

MISSISSIPPI DEPARTMENT OF TRANSPORTATION  
ROADWAY DESIGN DIVISION  
STANDARD PLAN

**DETAILS OF OUTSIDE LANE CLOSURE AT EXIT AND ENTRANCE RAMP**

ISSUE DATE: MAY 01, 2017

WORKING NUMBER: TCF-110  
SHEET NUMBER: 6360

DATE	REVISION

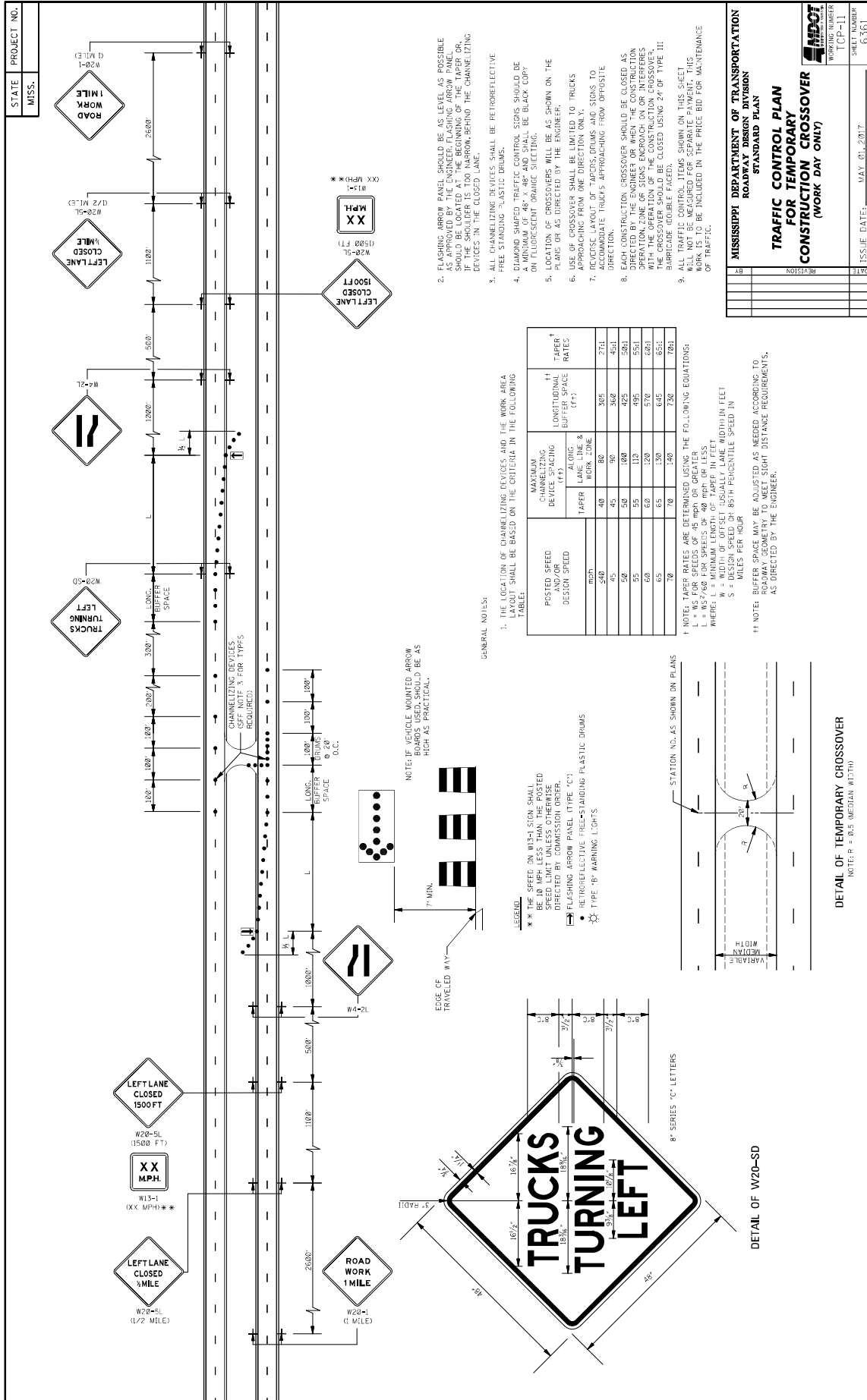

1. THE LOCATION OF CHANNELIZING DEVICES AND THE WORK AREA TAPER SHALL BE BASED ON THE CRITERIA IN THE FOLLOWING TABLE:
2. FLASHING ARROW PANELS SHOULD BE AS LEVEL AS POSSIBLE AS APPROVED BY THE ENGINEER. FLASHING ARROW PANELS SHOULD BE LOCATED AT THE BEGINNING OF THE TAPER OR, IF THE SHOULDER IS TOO NARROW, BEHIND THE CHANNELIZING DEVICES IN THE CLOSED LANE.
3. ALL CHANNELIZING DEVICES SHALL BE RETROREFLECTIVE FREE STANDING PLASTIC DRUMS.
4. DIAMOND SHAPED TRAFFIC CONTROL SIGNS SHOULD BE BLACK COPY ON FLUORESCENT ORANGE SUCTING.
5. LOCATION OF CROSSOVERS WILL BE AS SHOWN ON THE PLANS OR AS DIRECTED BY THE ENGINEER.
6. USE OF CROSSOVERS SHALL BE LIMITED TO TRUCKS APPROACHING FROM ONE DIRECTION ONLY.
7. REVERSE LAYOUT OF TAPERS, DRUMS AND SIGNS TO ACCOMMODATE TRUCKS APPROACHING FROM OPPOSITE DIRECTION.
8. EACH CONSTRUCTION CROSSOVER SHOULD BE CLOSED AS EARLY AS POSSIBLE AND REMAIN CLOSED THROUGH THE OPERATION ZONE OF SIGNS ENOUGH ON OR INTERFERES WITH THE OPERATION OF THE CONSTRUCTION CROSSOVER. THE CROSSOVER SHOULD BE CLOSED USING 24" OF TYPE III BUREAU OF ROAD CONSTRUCTION TAPERS.
9. ALL TRAFFIC CONTROL ITEMS SHOWN ON THIS SHEET WILL NOT BE MEASURED FOR SEPARATE PAYMENT. THIS WORK IS TO BE INCLUDED IN THE PRICE BID FOR MAINTENANCE OF TRAFFIC.

GENERAL NOTES:

1. THE LOCATION OF CHANNELIZING DEVICES AND THE WORK AREA TAPER SHALL BE BASED ON THE CRITERIA IN THE FOLLOWING TABLE:
- † NOTE: TAPER RATES ARE DETERMINED USING THE FOLLOWING EQUATIONS:  
 $L = W \times S$   
 WHERE: L = MINIMUM LENGTH OF TAPER IN FEET  
 W = WIDTH OF OFFSET USUALLY LANE WIDTH IN FEET  
 S = 65TH PERCENTILE SPEED IN MILES PER HOUR
- ‡ NOTE: BUFFER SPACE MAY BE ADJUSTED AS NEEDED ACCORDING TO ROADWAY GEOMETRY TO MEET SIGHT DISTANCE REQUIREMENTS, AS DIRECTED BY THE ENGINEER.

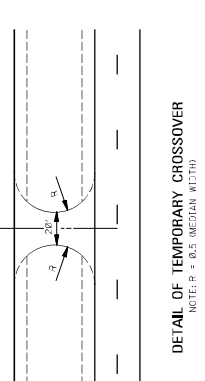
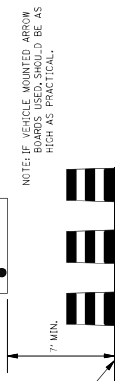

STATE PROJECT NO. MISS.

MISSISSIPPI DEPARTMENT OF TRANSPORTATION  
ROADWAY DESIGN DIVISION  
STANDARD PLAN  
TRAFFIC CONTROL PLAN  
FOR TEMPORARY  
CONSTRUCTION CROSSOVER  
(WORK DAY ONLY)

WORKING NUMBER: TCR-11  
SHEET NUMBER: 6361  
ISSUE DATE: MAY 01, 2017

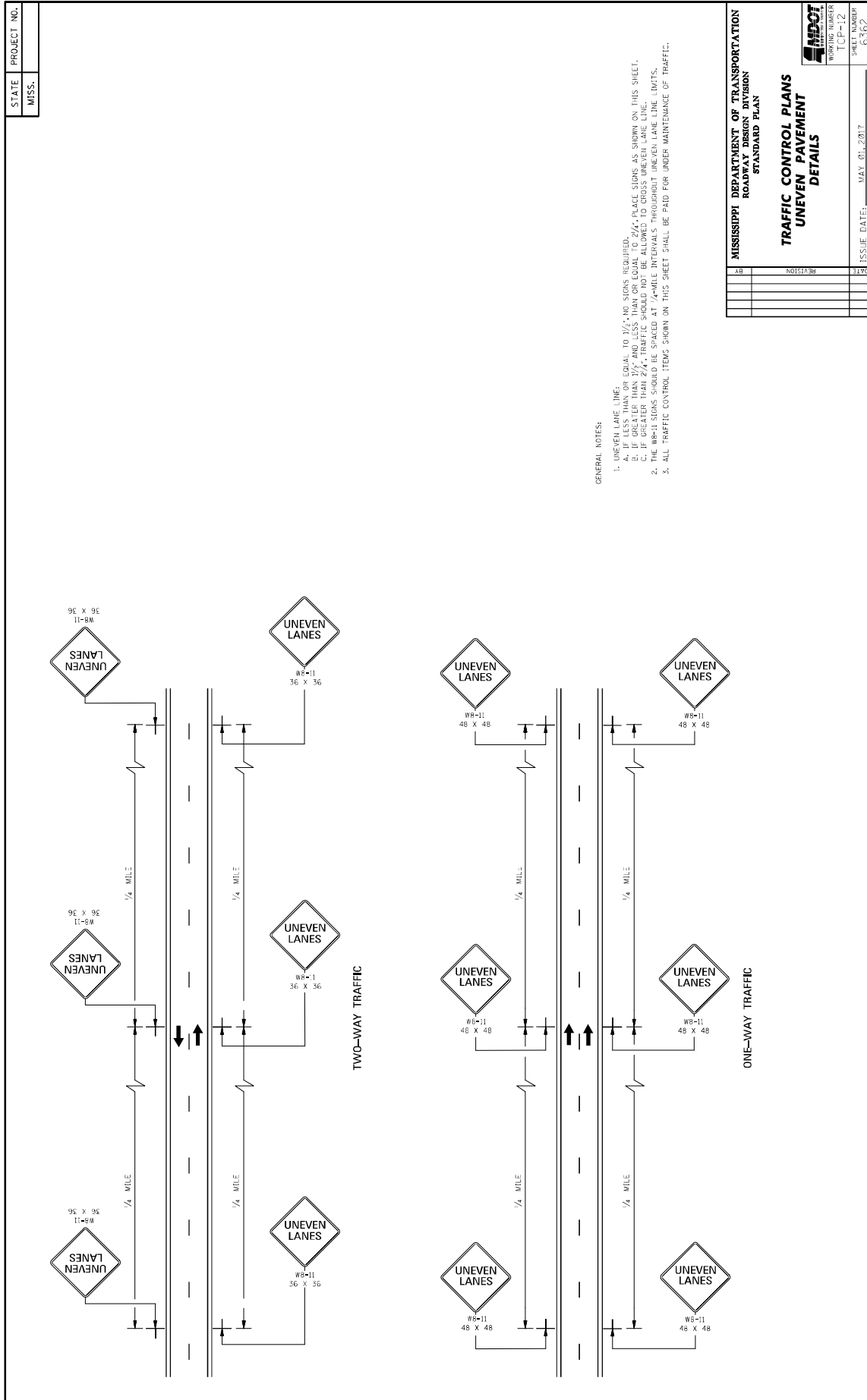

MISSISSIPPI DEPARTMENT OF TRANSPORTATION ROADWAY DESIGN DIVISION STANDARD PLAN	
<b>TRAFFIC CONTROL PLANS UNEVEN PAVEMENT DETAILS</b>	
ISSUE DATE: MAY 01, 2017	SHEET NUMBER TCP-12 6262
REVISION	DATE

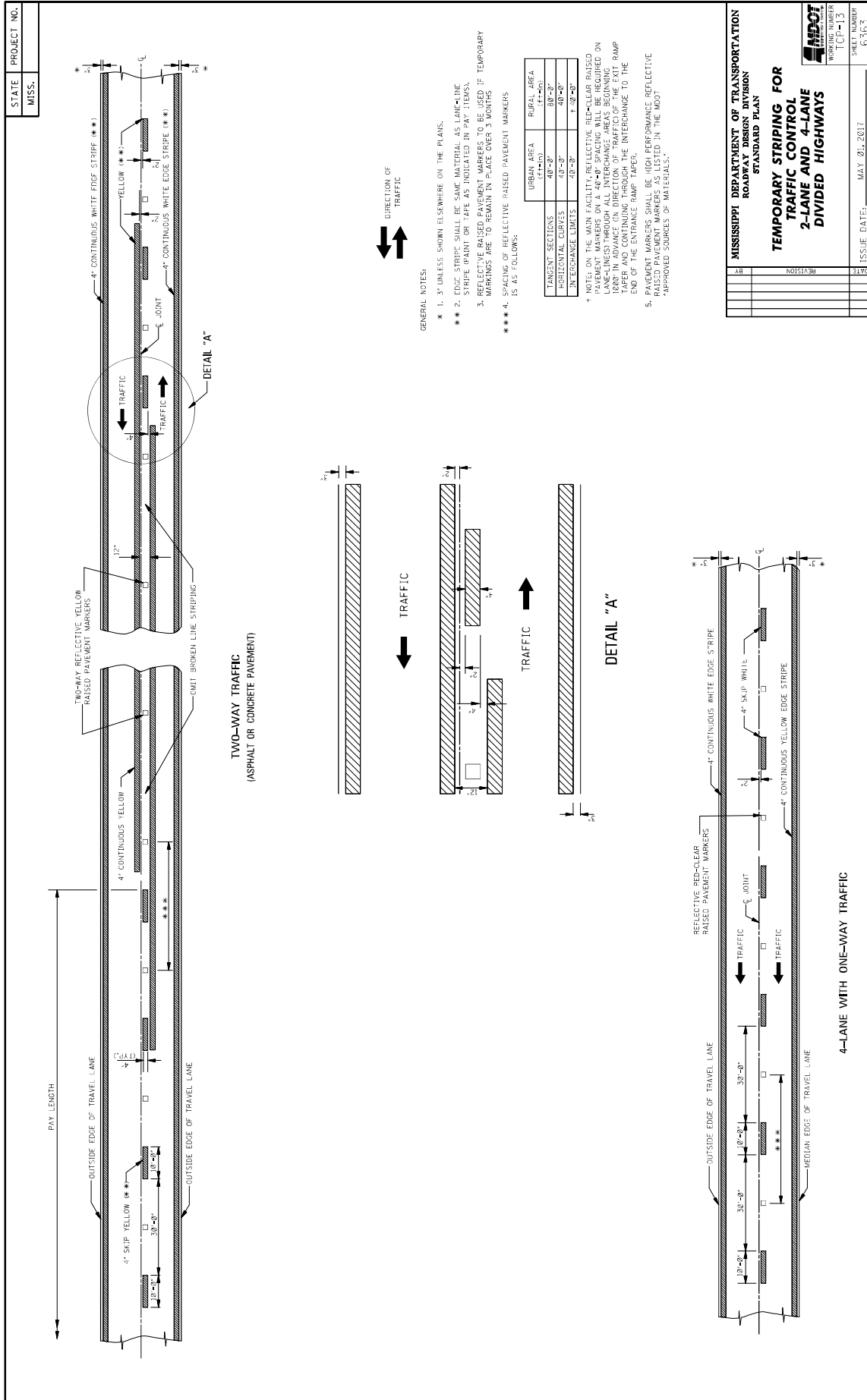

REVISION		DATE
ISSUE DATE:	MAY 01, 2017	
SHEET NUMBER	TCP-13	6363

MISSISSIPPI DEPARTMENT OF TRANSPORTATION  
ROADWAY DESIGN DIVISION  
STANDARD PLAN

TEMPORARY STRIPING FOR  
2-LANE AND 4-LANE  
DIVIDED HIGHWAYS

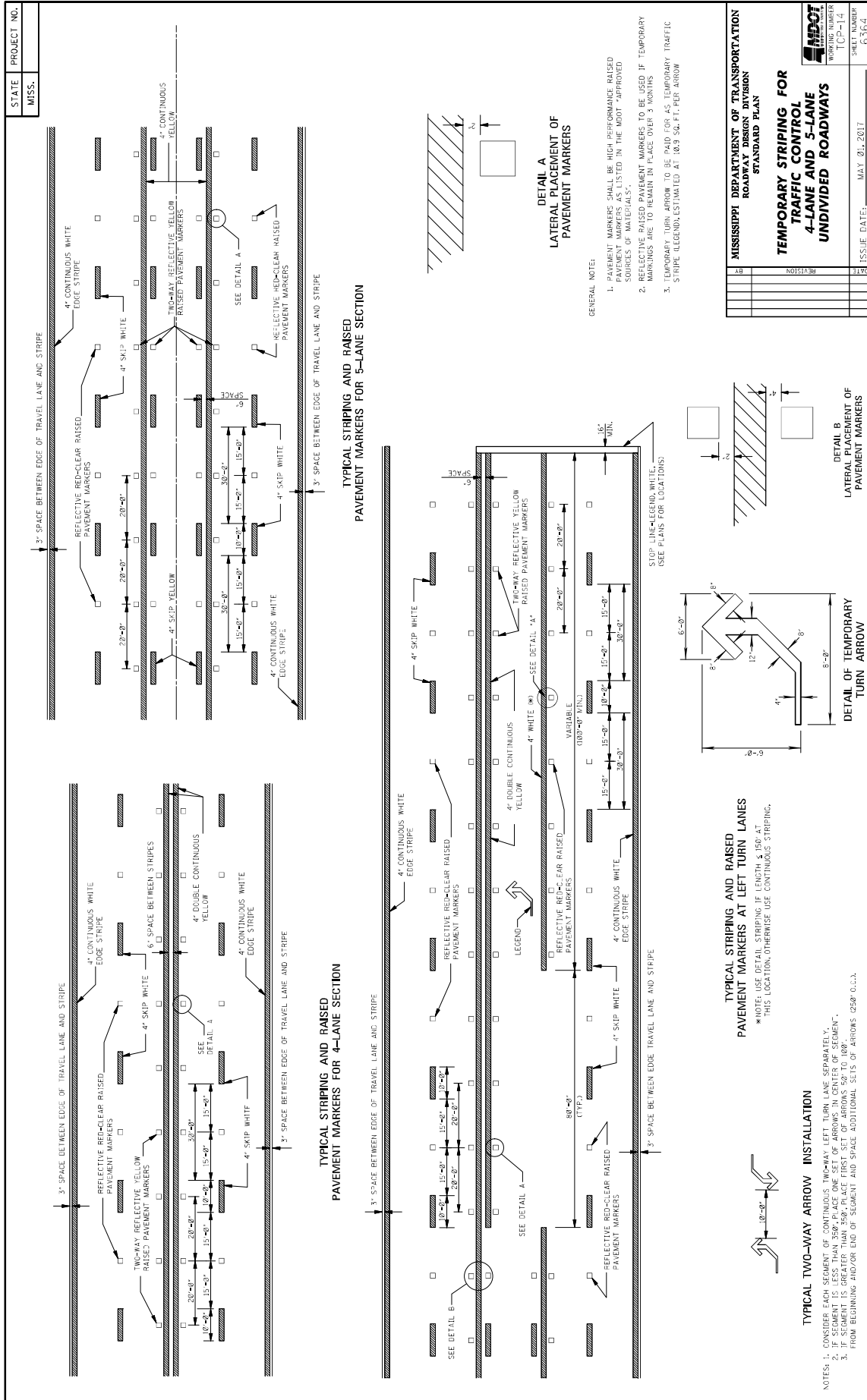



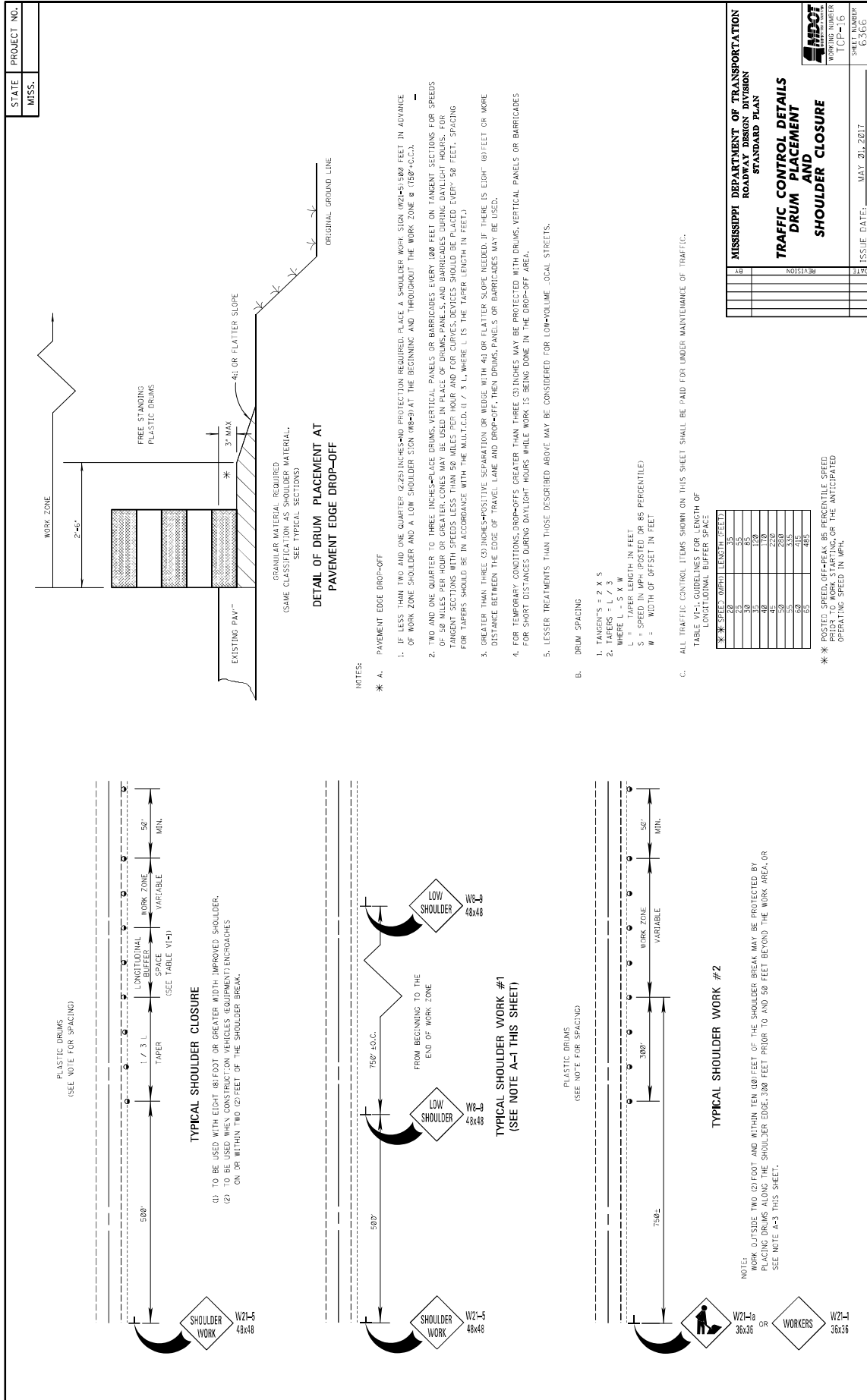



GENERAL NOTES

1. GROUND-IN RUMBLE STRIPES SHALL BE APPLIED TO ALL PAVED SHOULDERS OF ALL PAVED SHOULDERS ON THIS PROJECT.
2. GROUND-IN RUMBLE STRIPES SHALL BE APPLIED TO ALL EXISTING AND NEW ROADS, INCLUDING OTHER INTERSECTIONS IN NORMAL SHOULDER WIDTH AS DIRECTED BY THE ENGINEER.
3. COST TO BE PAID FOR USING APPROPRIATE PAY ITEMS.
4. GROUND-IN RUMBLE STRIPES SHALL BE APPLIED TO:
  - A. MAINLINE
  - B. INTERSECTING ROADWAY IF OVERLAP OR RECONSTRUCTED BEYOND NORMAL MAINLINE R.O.W.
  - C. ANY ROADWAY WITH EXISTING RUMBLE STRIPES PRIOR TO CONSTRUCTION.
5. DO NOT USE WHERE TRAVEL LANE IS LESS THAN 11' WIDE.

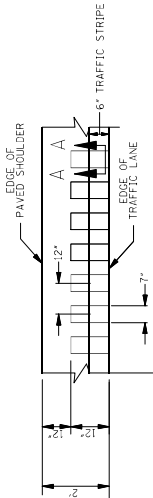

SECTION "A-A"

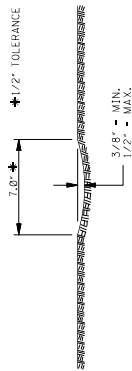

SECTION "A-A"

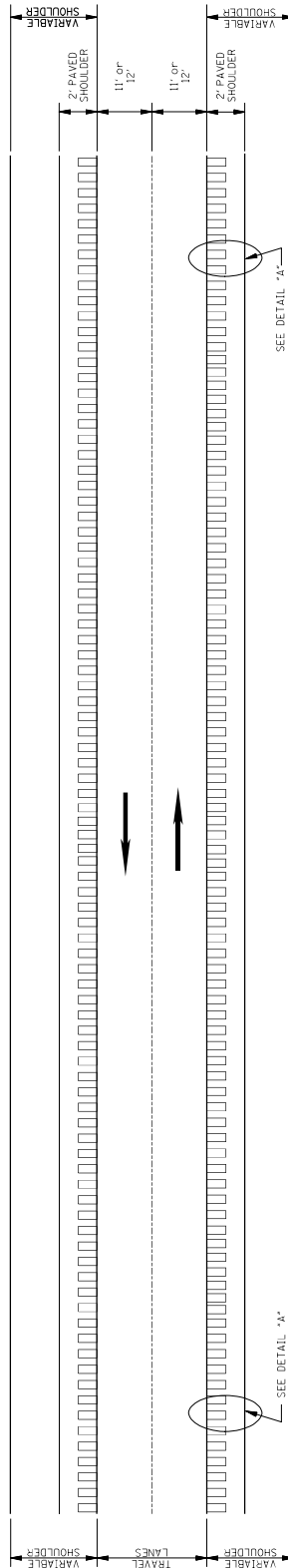

PLAN

NOT TO SCALE

MISSISSIPPI DEPARTMENT OF TRANSPORTATION	
ROADWAY DESIGN DIVISION	
STANDARD PLAN	
<b>RUMBLE STRIPES 2-LANE HIGHWAYS (ASPHALT LANES, 2-FT ASPHALT SHOULDERS)</b>	
DATE	ISSUE DATE: AUGUST 01, 2017
REVISION	PROJECT NUMBER 6064
DATE	ISSUE DATE: AUGUST 01, 2017
REVISION	PROJECT NUMBER 6064
DATE	ISSUE DATE: AUGUST 01, 2017
REVISION	PROJECT NUMBER 6064



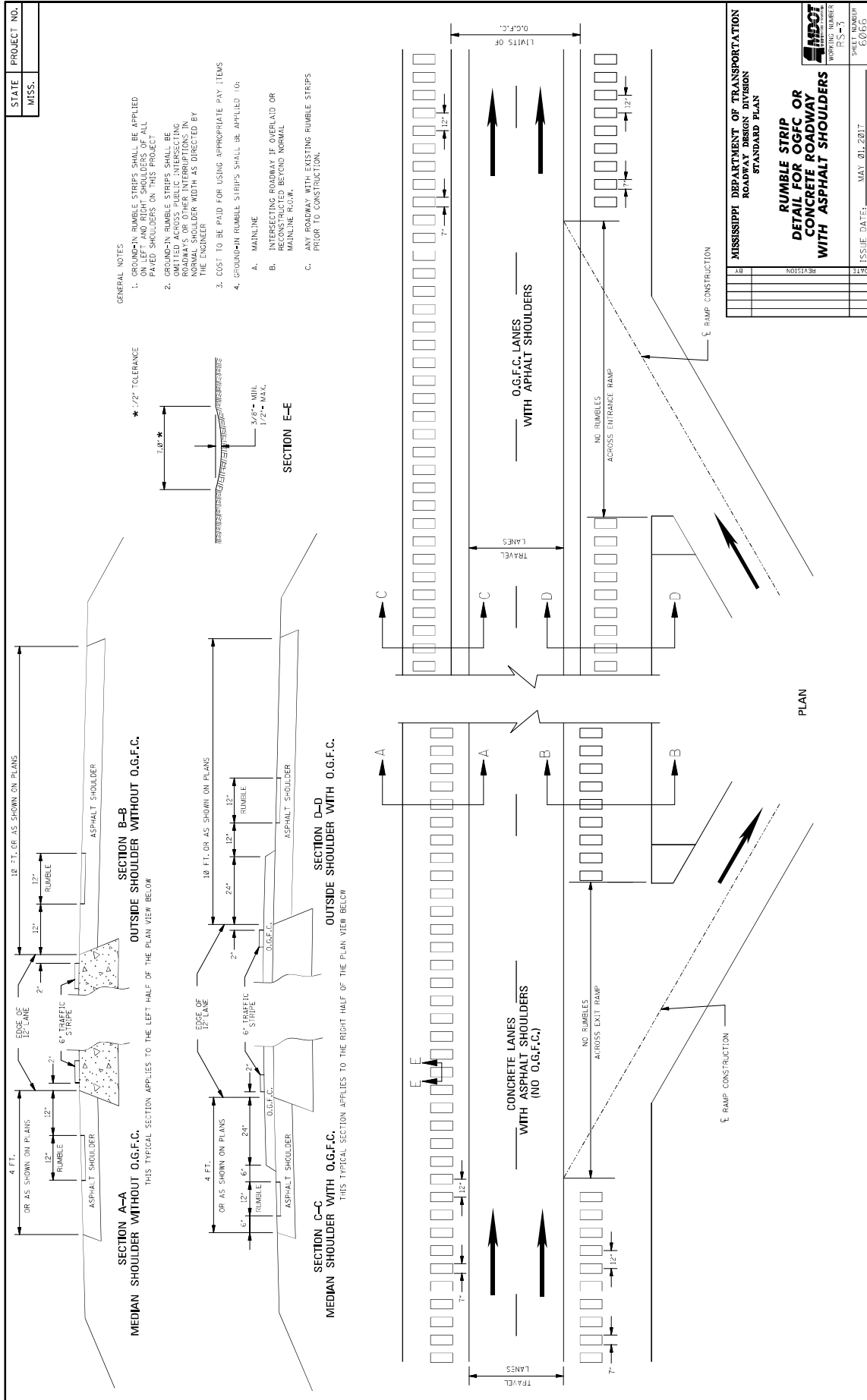

**MISSISSIPPI DEPARTMENT OF TRANSPORTATION**

**SECTION 904 - NOTICE TO BIDDERS NO. 3676**

**CODE: (SP)**

**DATE: 09/21/2021**

**SUBJECT: Asphalt Gyrotory Compactor Internal Angle Calibration**

Bidders are advised that by March 1, 2022, all asphalt gyrotory compactors shall be calibrated to an internal angle of  $1.16^{\circ} \pm 0.02^{\circ}$ . This requirement will be reflected in updates made to MT-78, MT-80, and MT-83. This calibration requirement also extends to all QC/QA testing.

## MISSISSIPPI DEPARTMENT OF TRANSPORTATION

SECTION 904 - NOTICE TO BIDDERS NO. 4113

CODE: (SP)

DATE: 03/23/2022

SUBJECT: Unique Entity ID (SAM) Requirement for Federal Funded Projects

Bidders are advised that the Prime Contractor must register and maintain a current registration in the System for Award Management (<http://sam.gov>) at all times during this project. Upon registration, the Contractor will be assigned a SAM Unique Entity ID.

Bidders are also advised that prior to the award of this contract, they MUST be registered, active, and have no active exclusions in the System for Award Management.

## MISSISSIPPI DEPARTMENT OF TRANSPORTATION

**SECTION 904 - NOTICE TO BIDDERS NO. 4702**

**CODE: (SP)**

**DATE: 11/22/2022**

**SUBJECT: App for Traffic Control Reports**

Bidders are advised that the Department has created a smart phone App for completing and submitting traffic control reports (Form CSD-762) required on this project. The Contractor who monitors traffic control activities and completes traffic control reports will be required to download and use this App when completing and submitting traffic control reports. The reports will then be readily available to all persons who need access to the forms. The App is free and is available for downloading at the following location.

<https://extacctmgmt.mdot.state.ms.us/>

**MISSISSIPPI DEPARTMENT OF TRANSPORTATION**

**SECTION 904 - NOTICE TO BIDDERS NO. 5086**

**CODE: (SP)**

**DATE: 05/02/2023**

**SUBJECT: Detail of Square Tube Sign Posts**

Bidders are advised that the following drawings shall be used in the manufacture and installation of square tube sign posts, unless otherwise directed by the Engineer.





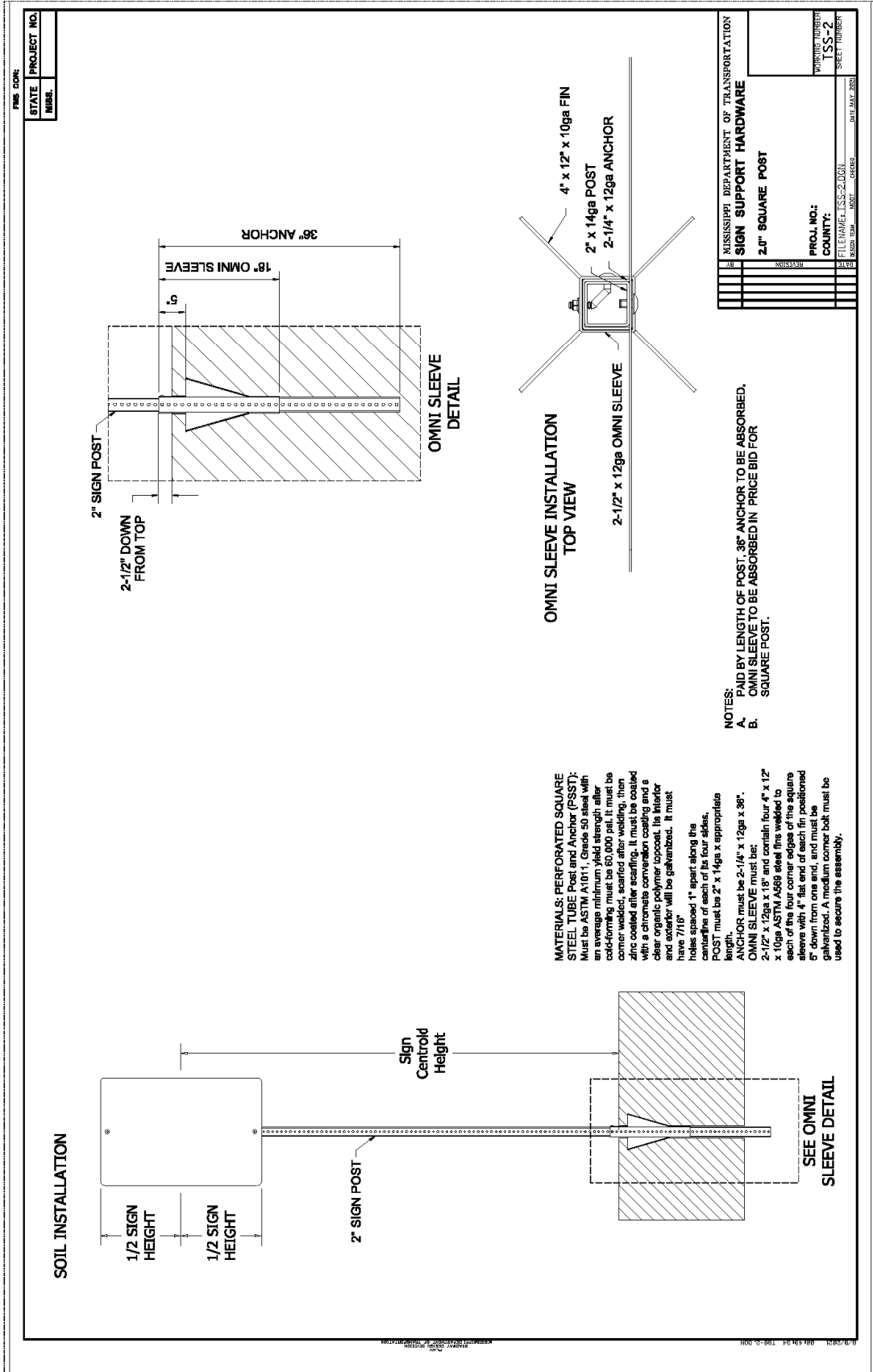

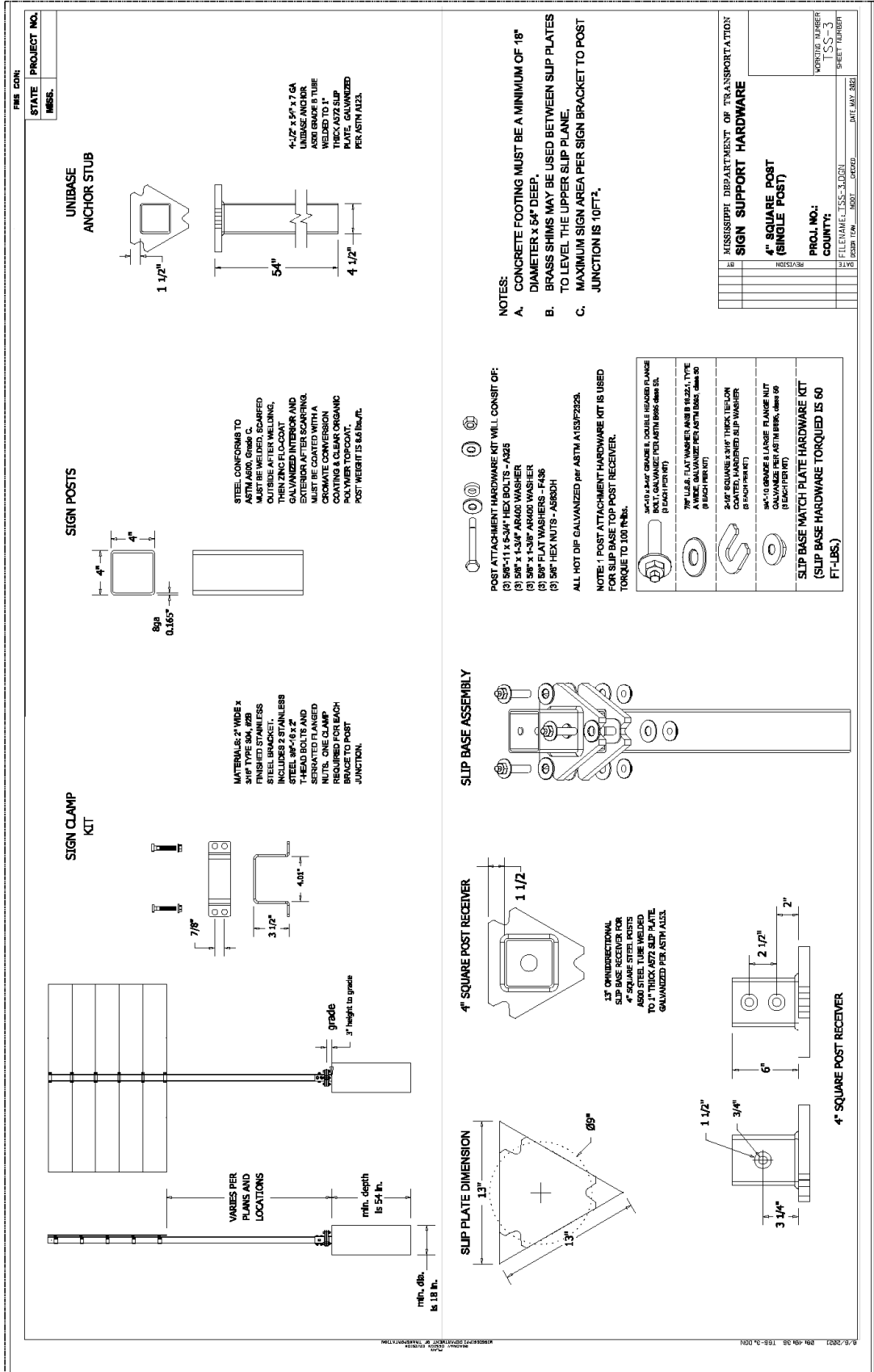



**MISSISSIPPI DEPARTMENT OF TRANSPORTATION**

**SECTION 904 - NOTICE TO BIDDERS NO. 5551**

**CODE: (IS)**

**DATE: 12/06/2023**

**SUBJECT: Federal Bridge Formula**

Bidders are hereby advised that the latest revision of Federal Highway Administration Publication No. FHWA-HOP-06-105, **BRIDGE FORMULA WEIGHTS**, dated August 2006, is made a part of this contract when applicable.

Prior to the preconstruction conference, the Contractor shall advise the Engineer, in writing, what materials, if any, will be delivered to the jobsite via Interstate route(s).

Copies of the **BRIDGE FORMULA WEIGHTS** publication may be obtained by contacting:

Federal Highway Administration  
400 7<sup>th</sup> Street, SW  
Washington, DC 20590  
(202) 366-2212

or

[https://ops.fhwa.dot.gov/freight/publications/brdg\\_frm\\_wghts/](https://ops.fhwa.dot.gov/freight/publications/brdg_frm_wghts/)

**MISSISSIPPI DEPARTMENT OF TRANSPORTATION**

**SECTION 904 - NOTICE TO BIDDERS NO. 5750**

**CODE: (SP)**

**DATE: 03/19/2024**

**SUBJECT: Manual on Uniform Traffic Control Devices (MUTCD)**

Bidders are advised that any reference to the current edition of the MUTCD or the latest edition of the MUTCD within plans, proposal, or standard specifications means the 2009 Edition and the 3 Revisions thereto.

**MISSISSIPPI DEPARTMENT OF TRANSPORTATION**

**SECTION 904 - NOTICE TO BIDDERS NO. 6569**

**CODE: (SP)**

**DATE: 12/12/2024**

**SUBJECT: Contract Time**

**PROJECT: SP-0037-04(061) / 107633301 – Rankin County**

The completion of work to be performed by the Contractor for this project will not be a specified date but shall be when all allowable working days are assessed, or any extension thereto as provided in Subsection 108.06. It is anticipated that the Notice of Award will be issued no later than **February 11, 2025**.

The Contractor shall request a Notice to Proceed/Beginning of Contract Time date between the dates of the **March 13, 2025 and April 8, 2025**.

Should the Contractor request a Notice to Proceed earlier than **March 13, 2025** and it is agreeable with the Department for an early Notice to Proceed, the requested date will become the new Notice to Proceed and Beginning of Contract Time date.

Should the Contractor not request a Notice to Proceed by **April 8, 2025**, the date for the Notice to Proceed and Beginning of Contract Time will be **April 8, 2025**.

All requests for an early Notice to Proceed shall be sent to the Project Engineer who will forward it to the Contract Administration Division.

**97** Working Days have been allowed for the completion of work on this project.

The progress schedule for this project shows the Notice to Proceed and Beginning of Contract Time starting at the latest possible date. If the Contractor requests a Notice to Proceed earlier than this date, the Contractor shall submit a revised progress schedule showing the work beginning at the new Notice to Proceed and Beginning of Contract Time date.

# MISSISSIPPI DEPARTMENT OF TRANSPORTATION

**SECTION 904 - NOTICE TO BIDDERS NO. 6570**

**CODE: (SP)**

**DATE: 12/03/2024**

**SUBJECT: Scope of Work**

**PROJECT: SP-0037-04(061) / 107633301 – Rankin County**

The contract documents do not include an official set of construction plans but may, by reference, include some Standard Drawings when so specified in a Notice to Bidders entitled, “Standard Drawings”.

Work on the project shall consist of overlaying approximately 10 miles of SR 43 in Rankin County from the intersection of SR 481/SR43 (BOP Sta. 0+00) to the Madison County Line (EOP Sta. 529+35).

## **Project-Wide Work**

### **Station 0+00 (BOP) to Station 292+14**

Trench widening will be required from BOP station 0+00 to the end of the 4 lane section at station 292+14, to widen existing 12-foot lanes to 14 feet. Widening shall consist of excavating 5” in depth at the edge of pavement by 2’ wide. Two (2) lifts @ 2½” of 19-mm, MT, Trench Widening asphalt shall be placed. Trench widening shall be paid under pay item 403-C002 19-mm, MT, Asphalt Pavement, Trench Widening.

### **Station 0+00 (BOP) to Station 344+38 ( End of 4-Lane)**

The Contractor shall mill 2” minimum depth, and variable, in locations where ruts/dips/humps exist, where surface has previously been patched, or is severely alligator cracked, but not deemed to be a full depth failure. An overlay of 2” and variable of 12.5-mm, MT asphalt shall be placed.

### **Station 344+38 to Station 529+35**

The Contractor shall mill 2” and overlay with an average of 2” of 12.5-mm, MT asphalt, correcting locations where the slope is 1½% to 2% by placing 2½” at centerline and 2” at the edge of pavement, extending new pavement to the face of guardrail.

**GENERAL NOTES:** These general notes are applicable to all sites.

## **Milling**

Milling/paving will not begin until an **approved** asphalt mix design has been received, nor until such time that, in the opinion of the Engineer, weather conditions have been consistently suitable enough to allow placement of the asphalt pavement after the milling operations.

The reclaimed asphalt pavement (RAP) material removed by the milling operation shall become the property of the Contractor.

Fine milling shall be performed in accordance with the attached drawings, and on all mainline tie-ins, driveway pads, county roads, etc. Publicly maintained roads and streets shall be milled sufficiently, including around concrete gutters, to tie in overlay at the existing right-of-way. Intersecting roads shall be milled 1½” to End of State Maintenance, then replace with 2” of 12.5-mm, MT, asphalt transitioning into mainline overlay. Asphalt at concrete gutters at curbs and islands shall be milled sufficient to tie in and as directed by the Engineer. Payment for milling and asphalt will be under pay items 406-D001 Fine Milling of Bituminous Pavement, All Depths and 403-A002 12.5-mm, MT, Asphalt Pavement. A milling/paving transition is required to tie local roads to mainline overlay section.

Milling operations shall be performed in accordance with the Contract documents and the Standard Specifications. Variable width and length transitions may be required for ties at ramps, local roads, project limits.

Milling of driveway pads shall be conducted in a manner to prevent gouging or otherwise affecting the roadway pavement structure and slope. Milling of driveway pads shall not be performed in simultaneous path with main line milling.

Traffic will be allowed to travel on the mainline milled surface for five (5) days, and the Contractor will be assessed a penalty of **\$5,000.00** per calendar day afterwards until the mainline milled surface is covered with the next lift of asphalt. This period is applicable to mainline through lanes, mainline turn lanes, and mainline auxiliary lanes. Additionally, traffic will be allowed to run on all milled surfaces other than the mainline for 30 days unless otherwise stated, and the Contractor will be assessed a penalty of **\$1,000.00** per calendar day afterwards until the non-mainline milled surface is covered with the next lift of asphalt. The additional allowance for the non-mainline milled surface is for the Contractor’s convenience, and thus, the Contractor is responsible for any pavement failures or damage sustained during this period.

**Paving**

Per Subsection 401.02.3.2, the asphalt mix design shall be submitted to the Engineer at least 10 working days prior to its proposed use.

Prior to mainline milling and paving operations, failed areas in the existing pavement shall be removed and backfilled with 12.5-mm, MT, Leveling asphalt as per the attached typical sections and details. Asphalt shall be placed in multiple lifts with a maximum lift thickness of 3”. Any granular/chemically treated/stone/etc. base or subgrade material deemed unsuitable by the Engineer shall be removed as directed and backfilled with 12.5-mm, MT, Leveling asphalt. Payment for the excavation of the granular base and subgrade will be made using the 203-G: Excess Excavation pay item. A list of the failed areas is shown in the attached tables. Pavement repairs shall be completed as a continuous operation in order to minimize traffic impacts. Lane closures shall remain in place until the failed area has been completely repaired. Lane closures may not be left unattended.



Prior to mainline paving operations and subsequent to the repair of failed areas, spot milling shall be performed in the areas listed in the attached tables and at other areas as directed by the Engineer. Spot milling and leveling will be variable depth at each location and will be determined in the field by the engineer.

The surface lift for failed area repair or concrete punchout repair shall have a maximum deviation of 3/8" as determined by a 10 foot straight edge. Any location that deviates more than this tolerance, as determined by the Engineer, shall be corrected at no additional cost to the State.

Privately owned entrances shall be paved to the shoulder line as per the included typical drawing. Pads shall be shaped horizontally and vertically to prevent excessive drop-offs. All residential pads exceeding a 2" drop off from the edge of pavement to the pad shall be corrected before the end of the day using paper joints to minimize damage to vehicles.

If traditional excavation methods are used, the removal area shall first be saw cut full depth including concrete, where applicable, to create a neat line and prevent damage to the adjacent pavement structure. Payment for saw cuts will be made using the appropriate items. If milling techniques are used, the area will not require saw cuts but care should be exercised to create a neat removal line and to prevent damaged to the adjacent pavement structure. If saw cuts are used in conjunction with milling, payment will be made using the appropriate pay items. Payment will not be made for saw cuts that are not performed.

**Granular Shoulder Material**

Where applicable, the existing shoulders shall be raised to match the new pavement elevation by placing variable depth granular material. The shoulders shall be graded and pulled up on a daily basis to eliminate drop-offs in excess of 2¼". Placement of the granular material on the finished asphalt course shall not be permitted. The existing shoulder shall be scarified to allow incorporation of the new shoulder material. The material shall be bladed, rolled, and compacted to a finished slope of four percent (4%) in normal crown sections. Placement of this material shall be performed to provide a uniform and compacted shoulder with a minimum depth and width of material placed. Shoulders with adequate shoulder material in place shall be bladed to a slope of four percent (4%) in normal crown sections. The cost of blading will be an absorbed item and is to be included in the price of other items bid. Crushed concrete will not be allowed.

Any material excavated from the existing shoulder during pavement widening operations or as a result of shoulder blading shall be used on the existing shoulder to match the new pavement elevation and any surplus material shall be spread along the edge of the shoulders, fore slopes, or other adjacent areas as directed by the Engineer and will be an absorbed item. Material which cannot be suitably placed in adjacent areas and deemed to be excess excavation by the Engineer shall be removed from the project site. Payment for removal of excess material will be made using pay item 203-G: Excess Excavation.

Granular material (crushed stone) shall be provided around driveway pads as directed to prevent shoulder drop-offs and shall be placed in a timely manner. Drop-offs exceeding 2¼" shall be corrected within two (2) calendar days of the placement of the pad.

**Temporary and Permanent Pavement Markings**

Temporary traffic stripe will be required immediately after the milling and/or required overlay and prior to opening area to traffic. Temporary stripe shall be placed in the same location and configuration as the permanent stripe except that it may be offset as required for milling and paving operations. If temporary stripe is offset, the Contractor shall conduct operations in a manner to ensure the final temporary stripe is placed at the required location of the permanent stripe. If removal of temporary offset stripe is required in order to achieve the correct location and alignment of permanent stripe; the cost of removal will be absorbed in other items bid. Placing double temporary centerline will not be allowed.

Temporary striping shall conform to finished stripe specifications for alignment, neatness, and straightness.

The use of short strips of traffic tape will not be allowed unless approved by the Engineer.

All permanent striping will be double drop thermoplastic, 90-mil thickness unless otherwise specified in Subsection 907-626.03.2. Edge lines will be placed to accommodate the lane widths shown on the attached applicable typical sections unless prevented by field conditions.

Rumble strip shall be placed throughout the project limits in accordance with the attached details and Standard Drawings.

Existing raised pavement markers shall be removed prior to beginning the overlay operation. No measurement will be made for separate payment; the cost shall be included in the price for other items bid.

Permanent raised pavement markers shall be installed on mainline and local public roads after completion of all paving operations. Edge line RPM's shall be installed as per Special Design Drawing RPM-1. If the usable space outside of the traffic stripe is insufficient to install the RPM's as per Special Design Drawing RPM-1, the Contractor shall be allowed to install the outside edge of the RPM flush with the inside edge of the traffic stripe.

Payment for edge stripe on local roads shall be made under pay item 907-626-G006: Thermoplastic Double Drop Detail Stripe, White when the length of said stripe is less than 150 feet when measured from the end of the radius. If the measured length is greater than 150 feet, then payment shall be made under pay item 907-626-C012: 6" Thermoplastic Double Drop Edge Stripe, Continuous White.

Payment for centerline stripe on local roads shall be made under pay item 907-626-G007: Thermoplastic Double Drop Detail Stripe, Yellow when the length of said stripe is less than 150 feet when measured from the stop bar. If the measured length is greater than 150 feet, then payment shall be made under pay item 907-626-E003: 6" Thermoplastic Double Drop Traffic Stripe, Continuous Yellow.

Centerline Stripe shall be omitted on local roads whose width is less than 20 feet.

The face of all existing undisturbed curbs shall be painted with at least two coats of white traffic paint with glass beads being required in the top coat. The cost associated with the painting of new or existing curb is to be included in other items bid.

The face of all existing, painted, concrete islands shall be painted with at least two coats of white traffic paint with glass beads being required in the top coat. The cost associated with the painting of new or existing curb is to be included in other items bid.

**Guardrail**

Guardrails shall be replaced at the locations shown on the attached table. Removal of guardrail shall consist of removal of bridge end section, w-beam/thrie beam, terminal end section, posts, and all other appurtenances. All guardrail removed is to be replaced the same day and prior to reopening the adjacent lane of traffic. Voids created by the removal of posts, concrete anchors, footings, etc. shall be backfilled and compacted in accordance with Section 203 of the Standard Specifications.

The asphalt guardrail pad shall be milled and paved up to the face of the guardrail. The remaining asphalt guardrail pad behind the face of the guardrail shall be removed and shall be paid for using the milling pay item. The guardrail pad shall be reconstructed using crushed stone granular material and shall be a minimum of 4” in depth. If blading is required in order to meet the minimum depth, said blading shall be an absorbed item and the excavated material shall be retained and used to raise the existing shoulder to match the new pavement elevation. Material which cannot be placed and blended in adjacent areas and deemed to be excess excavation by the Engineer shall be removed under pay item 203-G: Excess Excavation. Prior to the placement of the crushed stone, a soil sterilant shall be applied as per Subsection 616.03.2 and Geotextile Stabilization, Type V, Non-Woven installed underneath the limits of the crushed stone. The installed guardrail shall meet all requirements in order to be MASH compliant.

Guardrail lengths are based on terminal end length of 37.5’. If terminal of length other than this is used, an adjustment in w-beam length is required.

Delineators will be required on all guardrails within the project. Existing guardrail delineators shall be removed and replaced. The cost of removal shall be included in the price of items bid.

All dimensions and spacings for bridge rail connectors shall be verified in the field by the Contractor prior to fabrication.

**Permanent Signs**

Permanent signs as listed on the attached tables are to be replaced. Unless otherwise listed in the attached tables, existing posts, anchors, angles/bars, and other components are to be reused. The Contractor shall use new bolts, screws, washers, nuts, etc. of the required sizes in the installation of signs. If required as part of the sign replacement activities, all post and I-beam lengths in these plans are estimated. Post lengths for all signs shall be verified in the field by the Contractor prior to fabrication. Installation dates shall be clearly written in bold black markings on the back bottom half off all signs with a permanent marking stick that is waterproof, fade resistant, and marks on

wet or dry surfaces. If existing sign posts or footings are to be replaced, the existing posts and footings shall be removed and the area backfilled and compacted in accordance with Section 203 of the Standard Specifications. Removal of sign, post, and footing and backfilling will be paid using the removal of sign pay item.

Object markers at bridge approaches and other locations shall be replaced as shown in the attached table. Removal of object markers shall be absorbed in the cost of other items bid

**Traffic Control**

The Contractor shall erect and maintain construction signing and provide all signs and traffic control devices necessary to safely maintain traffic around and through the work areas in accordance with the Traffic Control Plan and the MUTCD. The cost shall be included in the price bid for pay item 907-618-A: Maintenance of Traffic. Fluorescent orange sheeting shall be used on all construction and traffic control signs except those designated in the plans to be black legend and border on white background.

Standard roadside construction signs, barricades, etc. shall be placed in accordance with the attached tables, drawings, and as directed by the Engineer. W20-1 signs shall be placed on all public road approaches as shown or as directed. Payment for standard roadside construction signs, barricades, etc. will be made using the appropriate pay items.

The Contractor shall on a daily basis, remove all debris from within the roadway and a 30-foot clear zone which, in the opinion of the Engineer, is a hazard to the traveling public. This activity shall begin with the beginning of work or the beginning of the contract time, whichever comes first. No direct payment will be made for the debris removal; the cost is to be included in the prices of items bid. Failure of the Contractor to remove the debris as prescribed herein shall be just cause for withholding the monthly progress estimate payment or suspending active operations until the debris is satisfactorily removed by the Contractor.

Temporary asphalt joints (aka paper joints) shall be employed at all locations requiring traffic to traverse an uneven, transverse, pavement joint. Paper joints shall be a minimum of nine feet (9') in length and for the full width of the milled/paved surface. Paper joints shall be adequately maintained.

Potholes that may exist or occur in the existing pavement shall be patched in a timely manner as required. Patching of potholes shall be considered an absorbed item.

Temporary portable rumble strips, as described in Special Provision No. 907-619, shall be used in advance of each lane closure. Direct payment will not be made for this item and shall be considered absorbed under pay item 907-618-A001: Maintenance of Traffic.

**Miscellaneous Notes**

It shall be the responsibility of the Contractor to protect existing structures such as pipes, inlets, aprons, bridges, etc. from damage which might occur during construction. The Contractor shall replace or repair, as directed by the Engineer, any structures damaged by the Contractor during the life of the contract. No payment will be made for replacement or repair of damaged items.

Any signs that are in conflict with construction of this project shall be removed and relocated by the Contractor as directed by the Engineer, the cost of which is to be absorbed in other items bid. Removal of existing raised pavement markers shall be included in the prices for other items bid.

Incidental work such as removing vegetation, shaping and compacting shoulders, removing and resetting signs and/or mailboxes, removing excess asphalt material, project clean-up, and other items of incidental work necessary to complete the project will not be measured for separate payment and will be considered included in the prices of items bid.

Prior to the final inspection, bridges, islands, and areas with curb shall be swept/cleaned. Care should be taken to prevent milled asphalt, asphalt debris, vegetative/granular debris, etc. from entering drainage structures or clogging other drainage ways. Disposal of material will not be measured for separate payments.

The 48" RCP cross drain in front of Pisgah High School at approximately station 272+80 shall be removed and replaced. Details of the work required are included in the remove and replace pipe table. The cross drain repair at Station 272+80 will involve removal and replacement of the existing pipe which shall be completed as a continuous operation in order to minimize traffic impacts and will require special traffic control according to the current edition of the Manual on Uniform Traffic Control Devices. Lane closures shall remain in place until the failed area has been completely repaired. Lane closures shall not be left unattended. The Contractor will be allowed to place the crushed stone to the top of the roadway temporarily until asphalt can be placed. If the Contractor elects to place the crushed stone to the top of the roadway, the crushed stone shall be adequately maintained as directed by the Engineer in order to provide a safe riding surface for the traveling public. Any crushed stone needed in order to accomplish this shall not be paid for directly and shall be absorbed under other items bid. Once the asphalt operations are ready to commence, the crushed stone shall be removed to a depth of 6" below the roadway surface and 6" (3 lifts at 2" apiece) of 12.5-mm, MT, Leveling asphalt shall be placed. The removal of the crushed stone shall not be paid for directly and shall be absorbed under other items bid. If the Contractor elects to utilize the removed crushed stone elsewhere on the project, it shall not be paid for directly and shall be absorbed under other items bid. If the Contractor elects to perform this work over a weekend closure, crushed stone shall not be used and the asphalt structure shall be placed. In lieu of lift holes for this pipe, the producer may cast an approved lifting device during the manufacturing process. Should a lifting device be included with the pipe, the Contractor shall cut off or grind down the lifting device flush with the pipe surface after placement of the pipe. The area around the lifting device shall be coated with a sealer approved by the Engineer. Work related to the lifting device will be considered incidental and absorbed in other items bid.

Pipe repairs and paved ditch repairs are required at the locations included in the tables provided.

The Madison County/Pearl River sign at the EOP shall be straightened up to be perpendicular to the roadway. The cost for all work involved shall be included in other items bid.

**SR43 OVERLAY PROJECT**  
**FROM SR481 TO MADISON COUNTY LINE**  
**RANKIN COUNTY**  
**107633/301000**

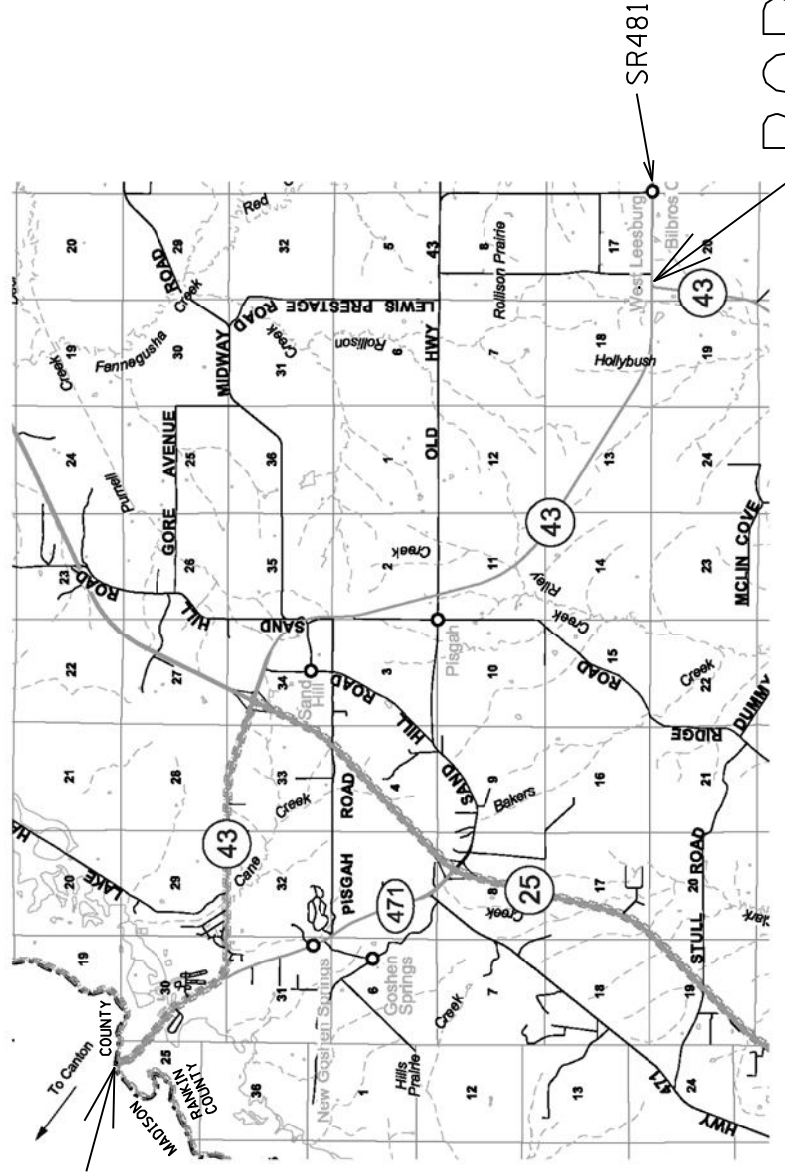

SR481

BOP 0+00

EOP 529+35

**107633/301000**  
**RANKIN COUNTY**  
**TYPICAL SECTION**  
**HWY 43 OVERLAY**

STA 0+00 TO STA 292+14

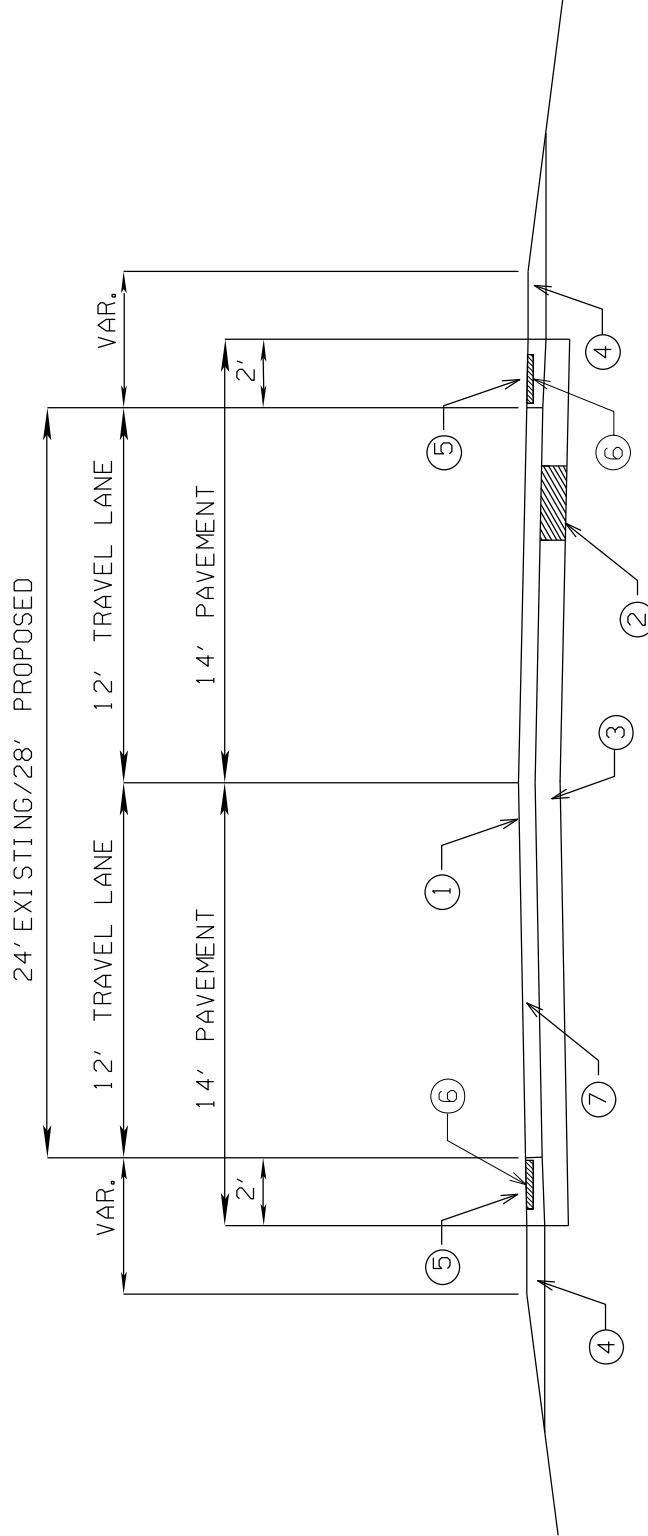

- ① Mill 2" & Variable in locations where ruts/dips/humps exist then Overlay 2" Asphalt Pavement 12.5mm, MT
- ② Failed areas to be removed and back filled with asphalt pavement 12.5mm Mix, MT leveling as directed.
- ③ Existing Pavement Structure (6-18" & VARIABLE ASPHALT PAVEMENT OVER 6-8" OF LIME TREATED OR UNTREATED GRANULAR MATERIAL)
- ④ 2' & VAR. Crushed Stone as Required
- ⑤ 2' Trench Widening pavement structure
- ⑥ Rumble Stripe Required
- ⑦ Variable Depth Spot Milling required at locations in table provided.

**107633/301000**  
**RANKIN COUNTY**  
**TYPICAL SECTION**  
**HWY 43 OVERLAY**

STA 292+14 TO STA 344+38 NB & SB

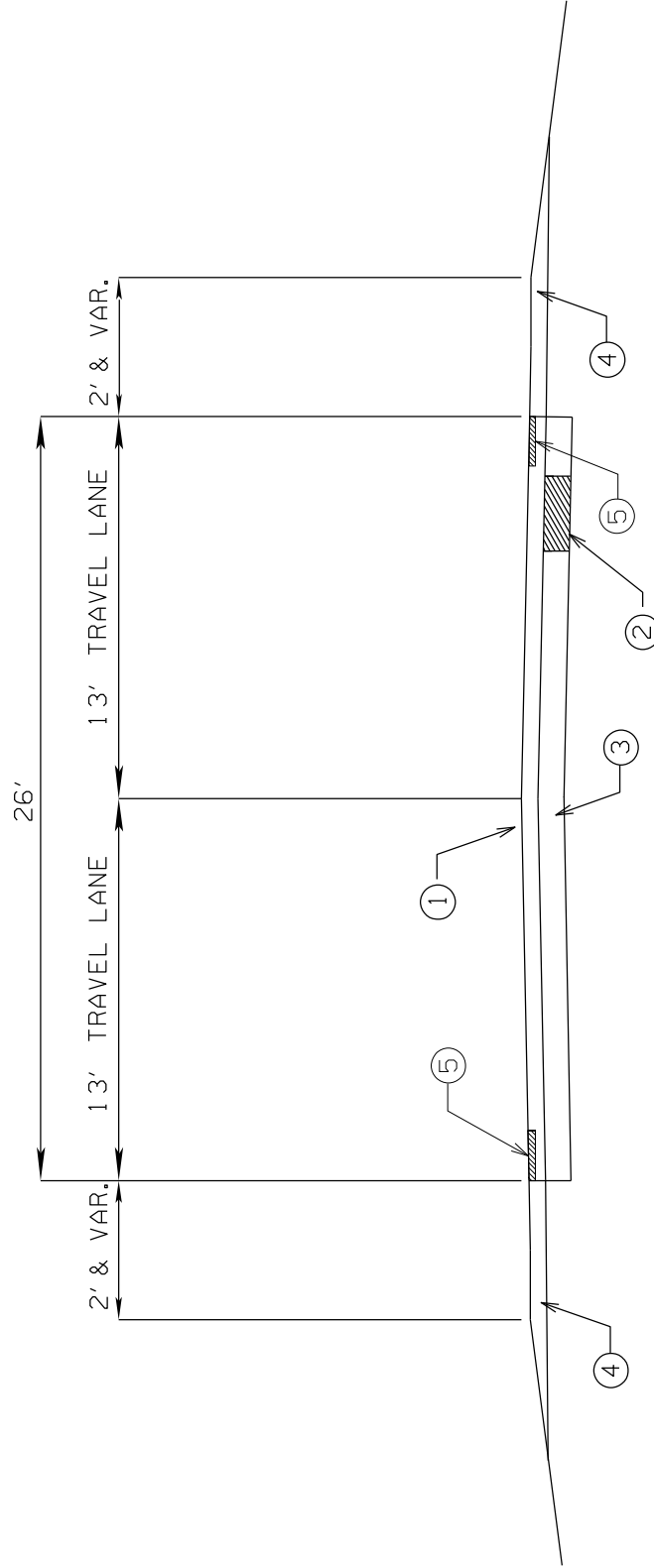

- ① Mill 2" & Overlay 2" HMA Asphalt Pavement 12.5mm,MT
- ② Failed areas to be removed and back filled with asphalt pavement 12.5mm Mix,MT leveling as directed.
- ③ Existing Pavement Structure (6-18" & VARIABLE ASPHALT PAVEMENT OVER 6-8" OF LIME TREATED OR UNTREATED GRANDULAR MATERIAL)
- ④ 2' & VAR. Crushed Stones as Required
- ⑤ Rumble Stripe Required



**107633/301000**  
**RANKIN COUNTY**  
**TYPICAL SECTION**  
**HWY 43 OVERLAY**

STA 344+38 TO STA 529+35

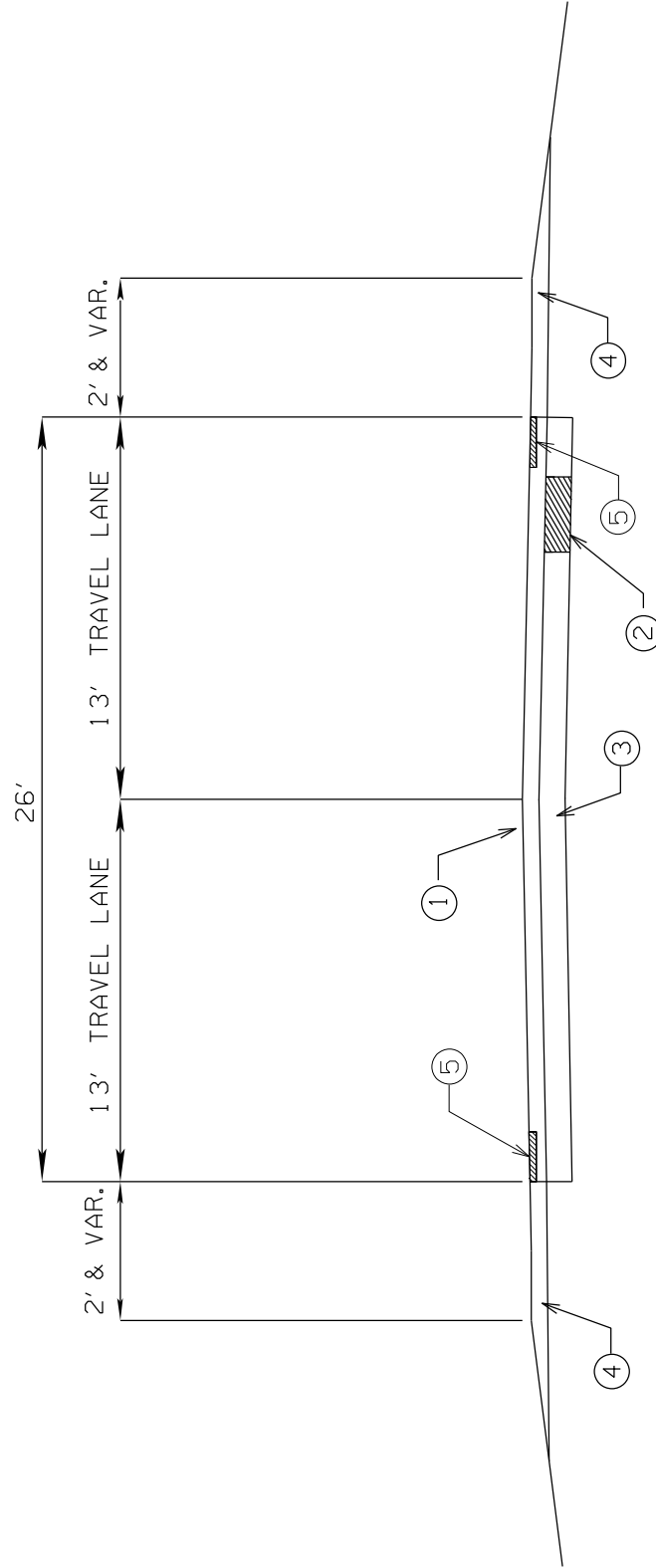

- ① Mill 2" & Overlay 2" HMA Asphalt Pavement 12.5mm, MT
- ② Failed areas to be removed and back filled with asphalt pavement 12.5mm Mix, MT leveling as directed.
- ③ Existing Pavement Structure (6-18" & VARIABLE ASPHALT PAVEMENT OVER 6-8" OF LIME TREATED OR UNTREATED GRANDULAR MATERIAL)
- ④ 2' & VAR. Crushed Stone as Required
- ⑤ Rumble Stripe Required

CONSTRUCTION SIGNING DETAIL  
 SR 43  
 RANKIN COUNTY  
 107633/301000

ESTIMATED

Traffic Control Signs Required:

- 2 - G20-1 "ROAD WORK NEXT (10) MILES"
- 2 - G20-2 "END ROAD WORK"
- 26 - W20-1 "ROAD WORK AHEAD"
- 32 - R4-1 "DO NOT PASS"
- 17 - R4-2 "PASS WITH CARE"
- 32 - W14-3 "NO PASSING ZONE"
- 24 - TYPE III DBL. FACE BARRICADES

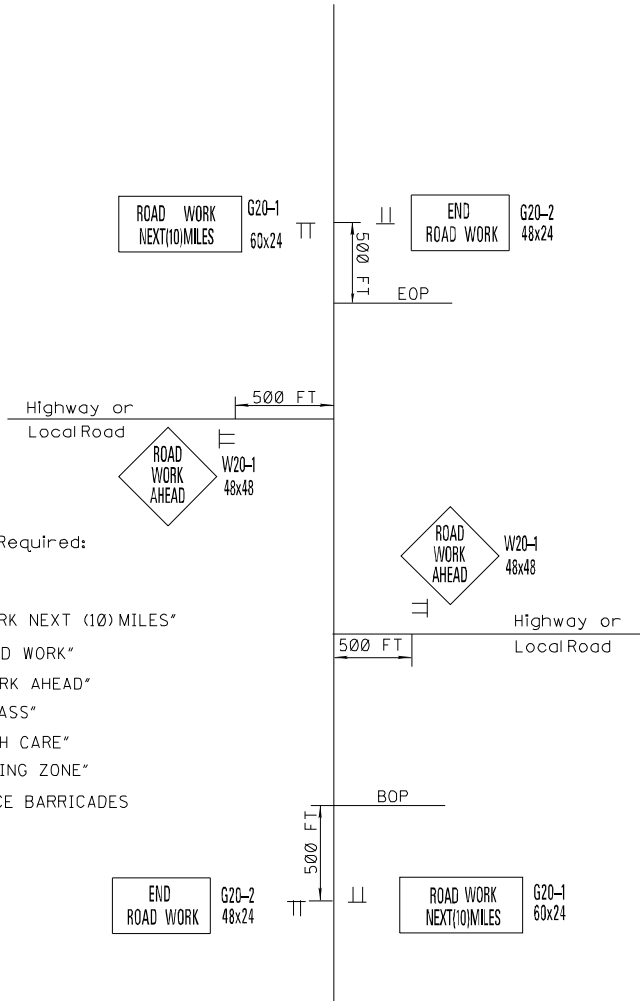

NOTES: One (1) W20-1 "ROAD WORK AHEAD" Sign is Required at each Local Road, Street or Highway Entering the Project.

G20-1 and G20-2 signs mounted on Type III Double Faced Barricade.

R4-1 "DO NOT PASS", R4-2 "PASS WITH CARE" AND W14-3 "NO PASSING ZONE" signs are required in accordance with Subsection 618.03.3 and as specified in the MUTCD. If No Passing zones are 1000 ft or more, install additional "DO NOT PASS" signs on maximum spacing of 750 ft.

Payment for these signs will be under the appropriate pay item numbers in the summary of quantities

PROJECT NO. 107633-301000  
 COUNTY: Rankin

STANDARD ROADSIDE SIGNS - 0.080" THICKNESS												
STATION	SIGN NUMBER	SIZE (in. x in.)	AREA (sf)	PIPE POSTS (lf)				U POST (lf)		" x 2-1/2" (lf)	Class "B" Conc (cy)	REMARKS
				3"	3-1/2"	4"	5"	4 lb/ft	2 lb/ft			
523+65	W8-13	36 x 36	9						15.00			
458+38	M3-3	12 x 24	2						15.00			
458+38	M1-4	24 x 24	4						15.00			
458+00	D9-3a	24 x 24	4									
458+00	M6-3	12 x 9	0.75									
458+00	Drawing	66 x 48	22								3	
458+00	Drawing		0									
343+43	M1-4	24 x 24	4						15.00			
343+43	M3-1	12 x 24	2						15.00			
339+57	R2-1	30 x 24	5						15.00			
295+05	R2-1	30 x 24	5						15.00			
282+00	R2-1	30 x 24	5						15.00			
277+80	S1-1	36 x 36	9						15.00			
255+17	S1-1	36 x 36	9						15.00			
462+06	W1-8	18 x 24	3.00						15.00			
462+06	W1-8	18 x 24	3.00						15.00			
462+06	W1-8	18 x 24	3.00						15.00			
462+06	W1-8	18 x 24	3.00						15.00			
273+27	R1-2	36 x 36	3.900						15.00			
271+90	R1-2	36 x 36	3.900						15.00			
Total this sheet =			100.55	0.00	0.00	0.00	0.00	0.00	240.00		3.00	

<b>107633/301000 Rankin County</b>					
<b>Spot Milling/ Leveling Locations</b>					
Location	Length	Width	CY	12.5mm-MT Leveling (Ton)	Spot Milling SY
150+70 - 173+83	2313	12	257	509	800
234+18 - 244+40	1022	12	114	225	1067
			Total	734	1867



PROJECT NO. 107633-301000  
 COUNTY: Rankin

STANDARD ROADSIDE SIGNS - 0.125" THICKNESS												
STATION	SIGN NUMBER	SIZE (in. x in.)	AREA (sf)	PIPE POSTS (lf)				U POST (lf)		" x 2-1/2" (lf)	Class "B" Conc (cy)	REMARKS
				3"	3-1/2"	4"	5"	4 lb/ft	2 lb/ft			
494+96	D1-1	6 x 36	1.5						15.00			
473+04	W1-2L	36 x 36	9						15.00			
448+41	W2-1	36 x 36	9						15.00			
448+41	W1-2R	36 x 36	9						15.00			
349+57	W6-1	48 x 48	16						15.00			
341+91	W6-3	36 x 36	9						15.00			
330+00	W4-2L	48 x 48	16						15.00			
326+88	W9-1L	48 x 48	16						15.00			
309+31	W9-1L	48 x 48	16						15.00			
304+14	W4-2L	48 x 48	16						15.00			
298+36	W6-1	36 x 36	9						15.00			
278+82	W2-1	36 x 36	9						15.00			
277+12	D1-1a	6 x 18	0.75						15.00			
268+69	D1-1	6 x 18	0.75						15.00			
267+24	W2-1	36 x 36	9						15.00			
208+82	D1-1a	6 x 18	0.75						15.00			
199+13	D1-1a	6 x 18	0.75						15.00			
Total this sheet =			147.50	0.00	0.00	0.00	0.00	0.00	255.00		0.00	

**107633-301000  
202-B009 Removal of Failed Areas  
Rankin County**

**12.5mm MT, Leveling**

Location	STA	to	STA	Length (ft)	Depth (ft)	Width (ft)	Saw Cuts (ft)	Removal of Asphalt	Estimated Asphalt Req. (TONS)	Estimated Excess	Tack (Gal.)
Rt	374+00		377+00	300	2	9	318	300.000	396.900	317.52	33.00
Rt	386+50		388+00	150	2	9	168	150.000	198.450	158.76	16.50
Rt	392+25		393+00	75	2	9	93	75.000	99.225	79.38	8.25
Rt	398+25		404+00	275	2	9	293	275.000	363.825	291.06	30.25
LT	158+50		156+50	200	2	9	218	200.000	264.600	211.68	22.00
LT	168+50		170+00	150	2	9	168	150.000	198.450	158.76	16.50
LT	311+00		313+00	200	2	14	228	311.111	411.600	329.28	34.22
LT	327+00		328+25	125	2	9	143	125.000	165.375	132.30	13.75
LT	352+00		352+50	50	2	9	68	50.000	66.150	52.92	5.50
LT	354+00		354+50	50	2	9	68	50.000	66.150	52.92	5.50
<b>Totals</b>								<b>1854.7222</b>	<b>2230.725</b>	<b>1784.58</b>	<b>185</b>

\*Stations are approximate and may be adjusted to match field conditions





<b>107633/301000 Rankin County</b>			
<b>Paved Ditch Repair</b>			
<b>Location</b>	<b>300 lb Rip Rap</b>	<b>Geotextile Fabric</b>	<b>Minor Structure Concrete</b>
17+86	16 Ton	20 SY	0.114 CY Toewall

<b>107633/301000 Rankin County</b>					
<b>Reinforced Concrete Pipe Repair</b>					
<b>Location</b>	<b>Pipe Size</b>	<b>300lb RipRap</b>	<b>Minor Structure Concrete</b>	<b>Geotextile Fabric</b>	<b>Borrow Excavation</b>
16+54 L	18"	16 Ton	0.316 CY Toewall & Collar	20 SY	
253+84 R	48"		0.85 CY Collar		
308+79 Median	36"		0.369 CY Collar (3)		20 CY

<b>107633/301000 Rankin County</b>		
<b>202-B052 Removal of Concrete Driveways, All Depths</b>		
Location	Saw Cut LF	Removal SY
205+97	10 LF	7 SY

107633/301000 Rankin County											
Remove and Replace Pipe											
Location	Pipe Size	300lb RipRap	Minor Structure Concrete	Geotextile Fabric	Structure Excavation	Removal Of Pipe	Crushed Stone	48" RCP, Class III	48" End Sections	Removal of Asphalt	Saw Cut
272+80	48"	16 Ton (Headwalls)	0.145 CY Toewall & 1.7 CY Collar (2)	20 SY	155	115 LF	110	104 LF	2 EA	22 SY	48 LF

**107633/301000  
RANKIN COUNTY  
BRIDGE END PAVING DETAIL**

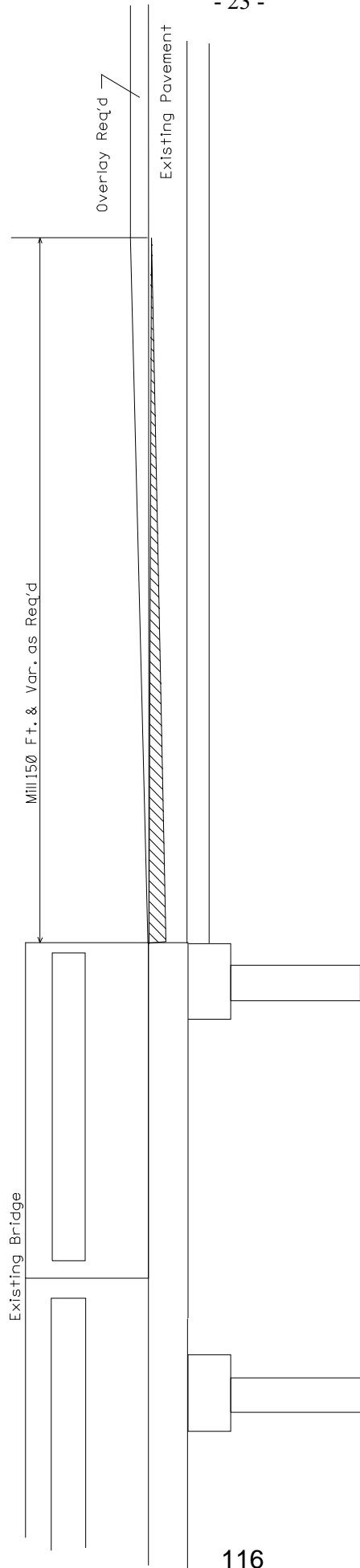

**BOP & EOP PAVING DETAIL**

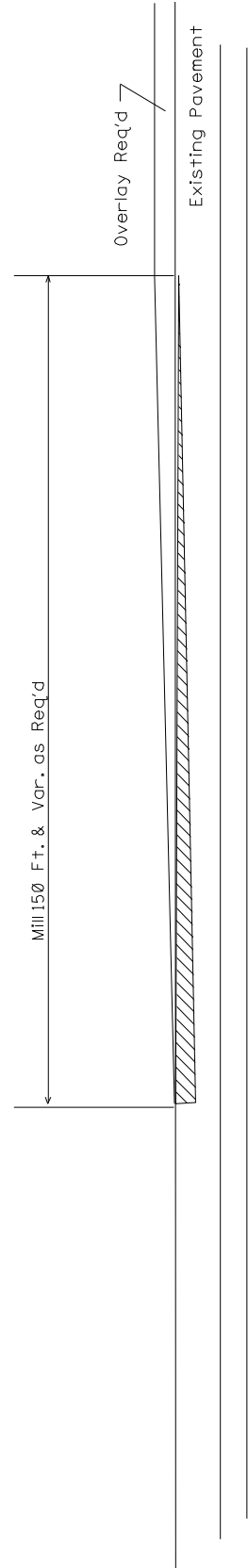

Typical Section - County Roads

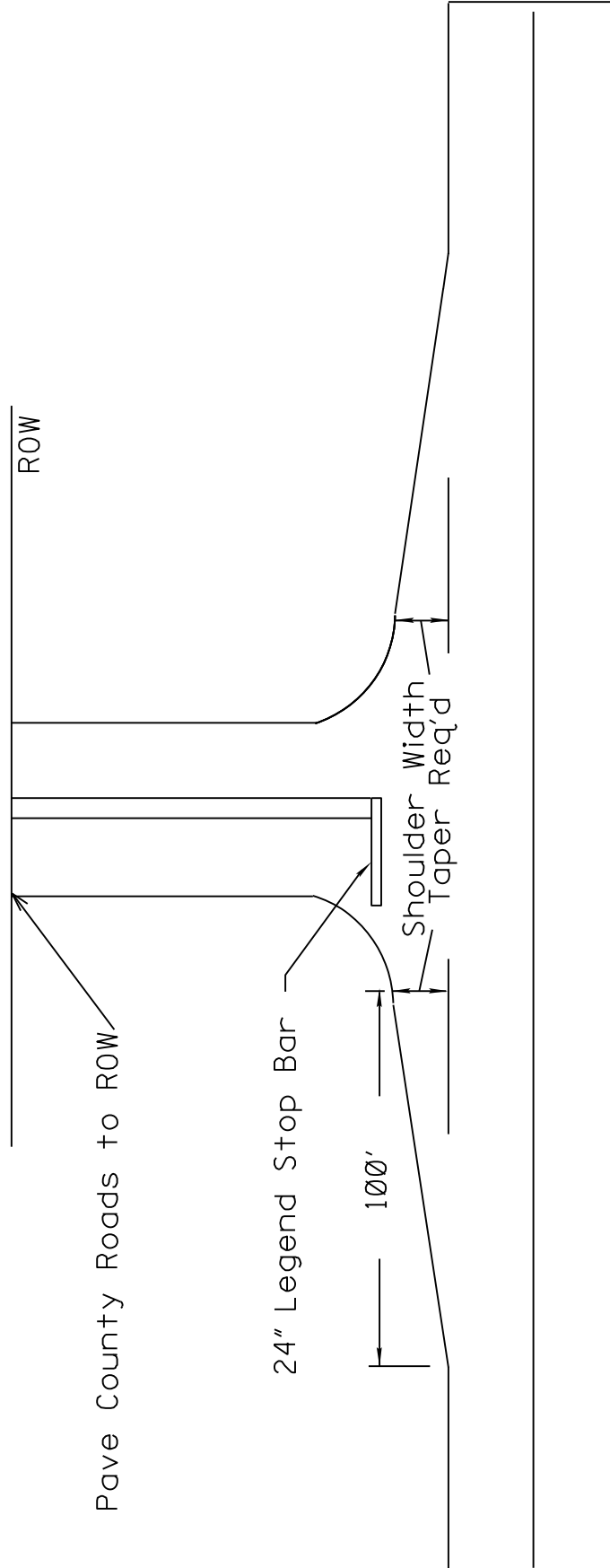

**SR 43  
RANKIN COUNTY  
107633/301000**

**STRIPE DETAIL - LOCAL ROADS**

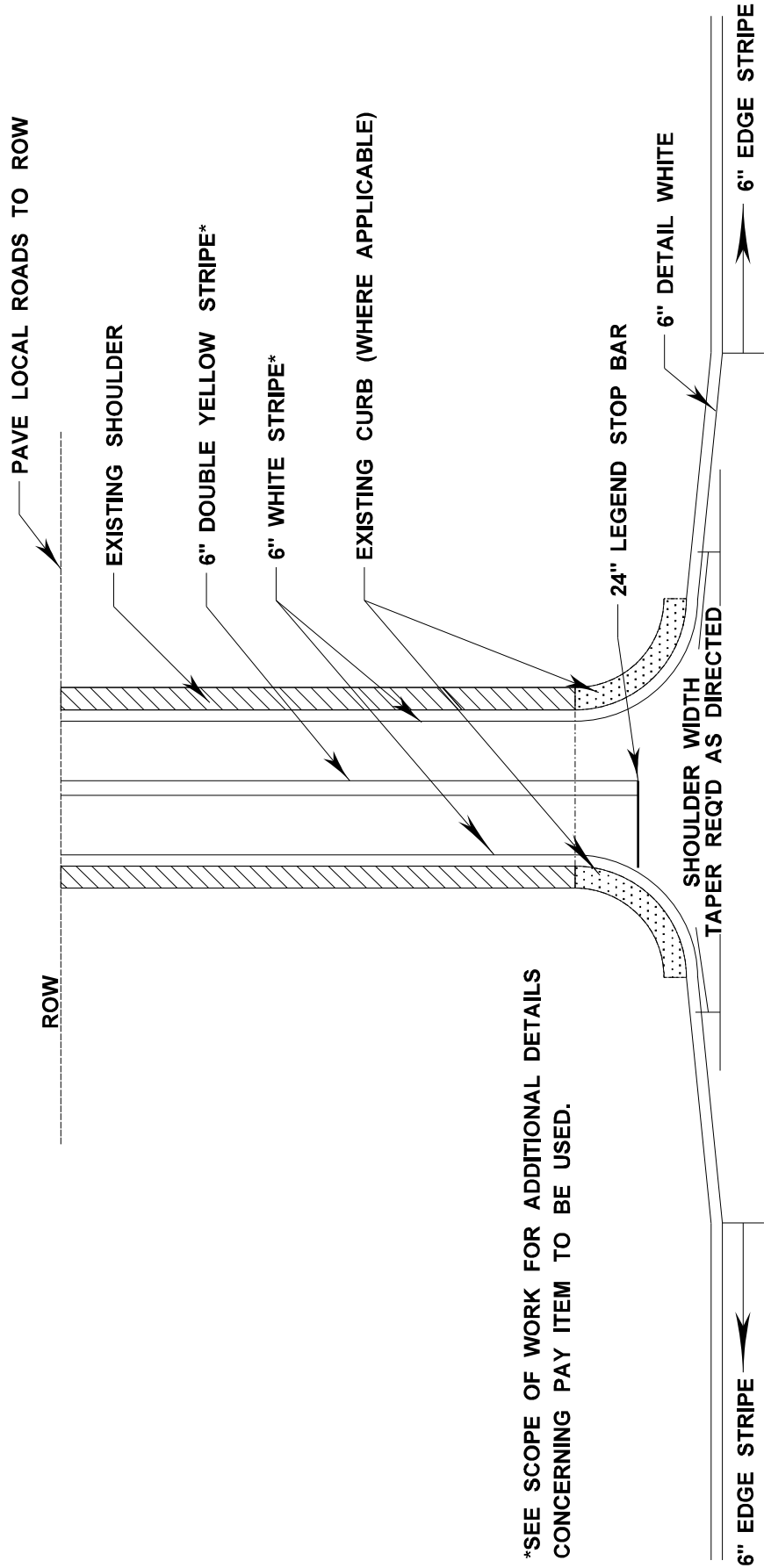

\*SEE SCOPE OF WORK FOR ADDITIONAL DETAILS CONCERNING PAY ITEM TO BE USED.

**NOTE: CENTERLINE STRIPE SHALL BE OMITTED ON LOCAL ROADS WHOSE WIDTH IS LESS THAN 20 FEET.**

**107633/301000**

**SR 43**

**RANKIN COUNTY  
DRIVEWAY PAD DETAIL**

TYPICAL RAMP/PAD DETAIL

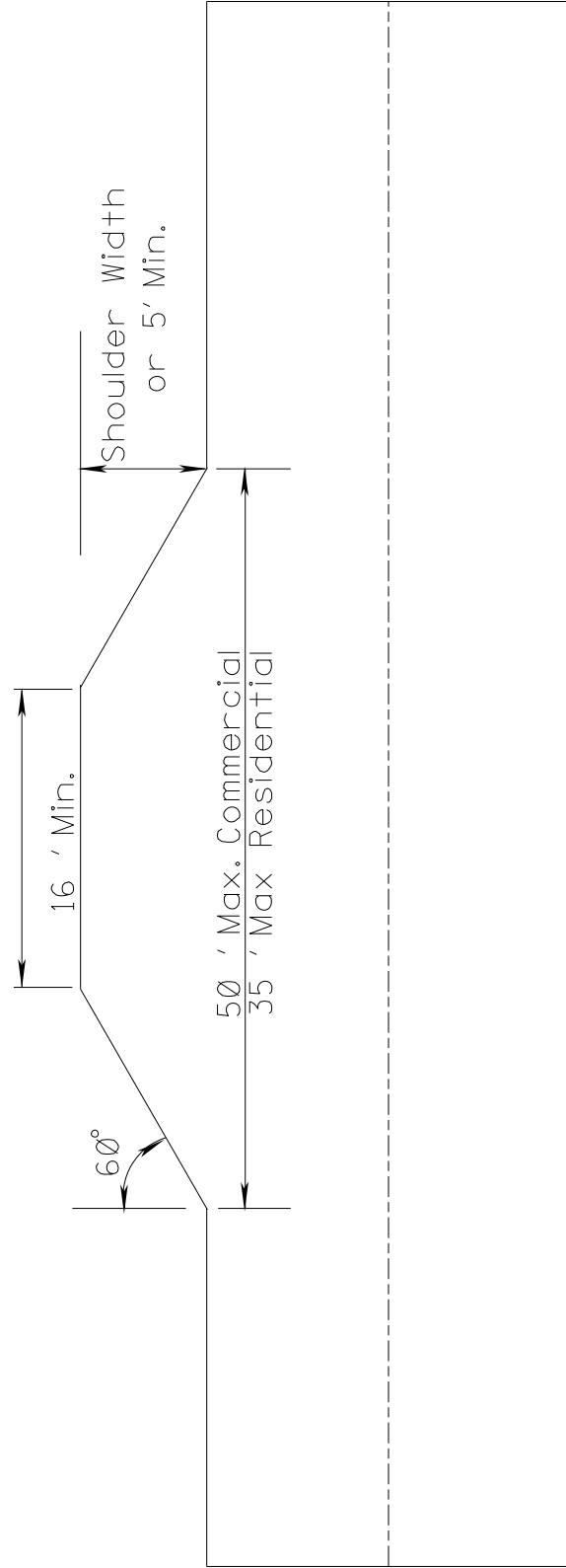



**107633/301000** Notice to Bidders No. 6750 -- Cont'd.  
**RANKIN COUNTY**  
**STA. 458+00 RTLN**

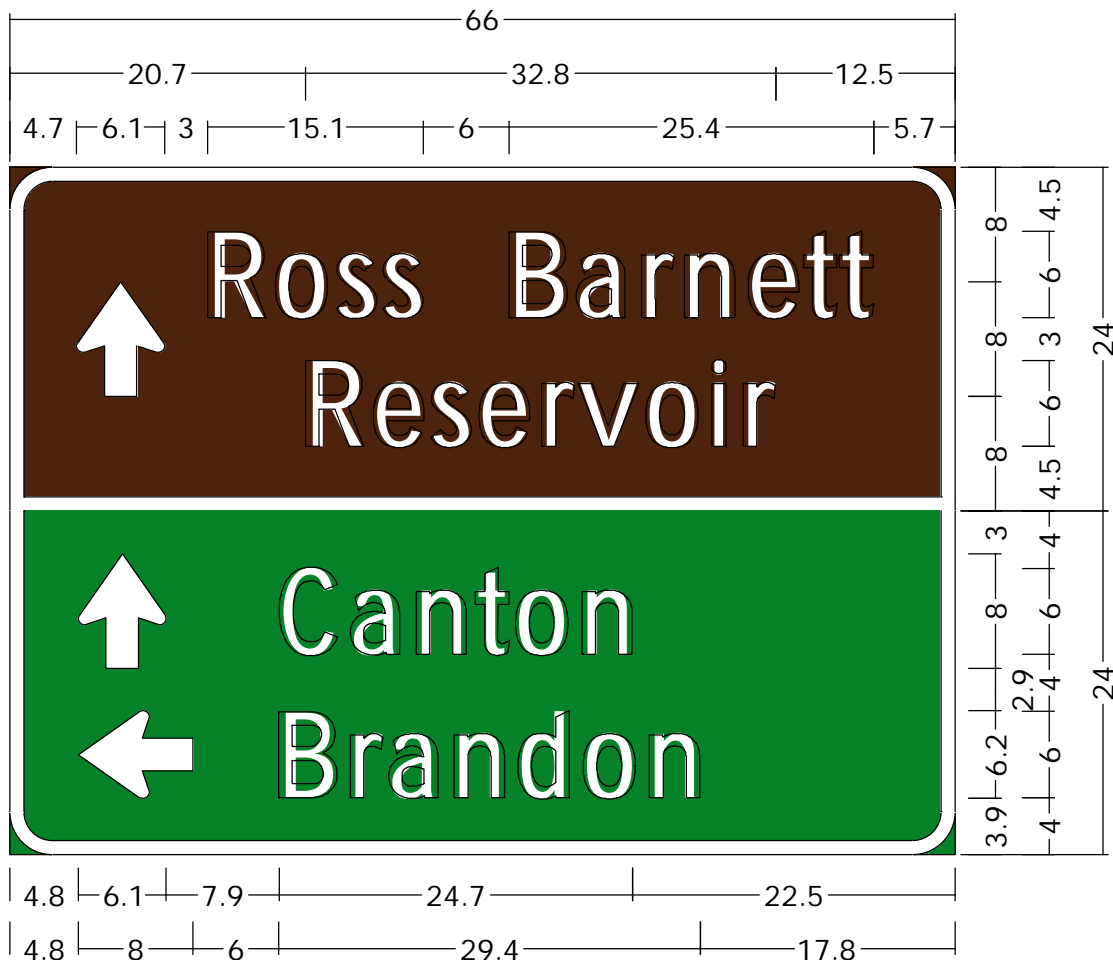

3.0" Radius, 1.0" Border, White on, Brown;  
 Standard Arrow Custom 8.0" X 6.1" 90'; "Ross Barnett", D 2K;  
 "Reservoir", D 2K;

3.0" Radius, 1.0" Border, White on, Green;  
 Standard Arrow Custom 8.0" X 6.1" 90'; "Canton", D 2K;  
 Standard Arrow Custom 8.0" X 6.1" 180'; "Brandon", D 2K;  
 Table of widths and spaces

4.7	↑	6.1	3.0	R	4.1	0.7	o	3.6	0.6	s	2.8	0.5	s	2.8													
		6.0	B	4.1	0.6	a	3.4	1.1	r	2.3	0.7	n	3.6	0.9	e	3.5	0.3	t	2.4	0.1	t	2.4	5.7				
20.7	R	4.0	0.7	e	3.5	0.5	s	2.8	0.6	e	3.5	0.9	r	2.2	0.3	v	4.2	0.5	o	3.7	0.9	i	1.0	1.2	r	2.3	12.5
4.8	↑	6.1	7.9	C	4.1	0.9	a	3.4	1.2	n	3.5	0.6	t	2.4	0.4	o	3.7	0.9	n	3.6	22.5						
4.8	←	8.0																									
		6.0	B	4.1	0.9	r	2.3	0.4	a	3.4	1.1	n	3.6	12.0	0.9	o	3.7	0.9	o	3.7	1.0	n	3.5	17.8			

SR 43  
RANKIN COUNTY  
107633/301000

FMS CONG.	STATE PROJECT NO.
	MISS.

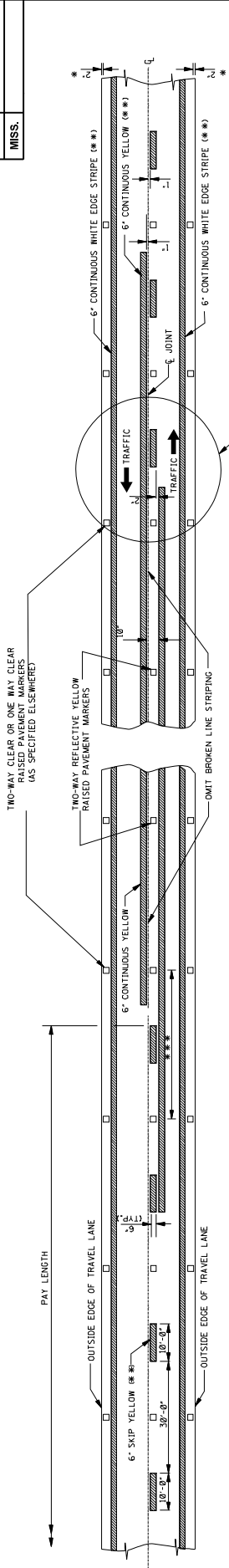

TWO-WAY TRAFFIC  
(ASPHALT OR CONCRETE PAVEMENT)



DIRECTION OF TRAFFIC

GENERAL NOTES:

- \* 1. 2' UNLESS SHOWN ELSEWHERE ON THE PLANS, FOR STRIPING ON RUMBLE STRIP SECTIONS REFER TO WK. SHEETS RS-1, RS-2, AND RS-3.
- \*\* 2. EDGE STRIPE SHALL BE SAME MATERIAL AS LANE-LINE STRIPE (PAINT OR PLASTIC AS INDICATED IN PAY ITEMS).
- \*\*\* 3. SPACING OF REFLECTIVE RAISED PAVEMENT MARKERS IS AS FOLLOWS:

TANGENT SECTIONS	40'-0"	URBAN AREA	44'-0"
HORIZONTAL CURVES	40'-0"	RURAL AREA	44'-0"
INTERCHANGE LIMITS	40'-0"	(41'-0")	

† NOTE: ON THE MAIN FACILITY, REFLECTIVE RED-CLEAR RAISED PAVEMENT MARKERS ON A 40'-0" SPACING WILL BE REQUIRED ON ALL RUMBLE STRIP SECTIONS. THE SPACING SHALL BE 1000' IN ADVANCE ON DIRECTION OF TRAFFIC TO THE EXIT RAMP TAPER AND CONTINUING THROUGH THE INTERCHANGE TO THE END OF THE ENTRANCE RAMP TAPER.

- 4. EDGE LINE RAISED PAVEMENT MARKERS ARE TO BE PLACED AT THE SAME SPACING AS THE CENTERLINE MARKERS. EDGE LINE MARKERS WILL BE OMITTED WHERE CONFLICTS OCCUR WITHIN INTERSECTIONS, CROSSOVERS, ETC. EDGE LINE RPMs WILL NOT BE PLACED IN URBAN AREAS UNLESS OTHERWISE SPECIFIED BY APPROVED SOURCES OF MATERIALS.
- 5. PAVEMENT MARKERS SHALL BE HIGH PERFORMANCE REFLECTIVE RAISED PAVEMENT MARKERS AS LISTED IN THE MOOT
- 6. THE CRITERIA FOR NO-PASSING ZONES CAN BE FOUND IN THE MOTORWAY DESIGN MANUAL, SECTION 17-100.
- 7. WHERE RUMBLE STRIPS ARE PRESENT, THE EDGE LINE MARKERS WILL BE PLACED AT THE SAME SPACING AS THE RUMBLE STRIPS AS DIRECTED BY THE ENGINEER.

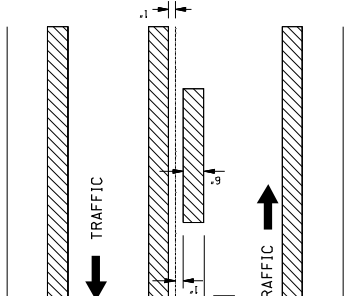

DETAIL "A"  
PLACEMENTS WITHOUT RUMBLE STRIPS

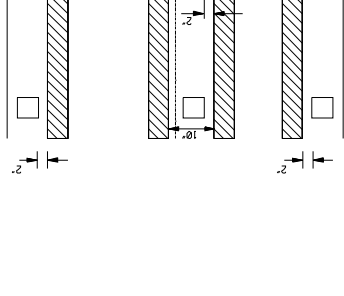

DETAIL "A"  
PLACEMENTS WITH RUMBLE STRIPS

DETAIL "A"  
PLACEMENTS WITH RUMBLE STRIPS ON PAVEMENTS WITHOUT RUMBLE STRIPS

DETAIL "A"  
PLACEMENTS WITH RUMBLE STRIPS ON PAVEMENTS WITH RUMBLE STRIPS

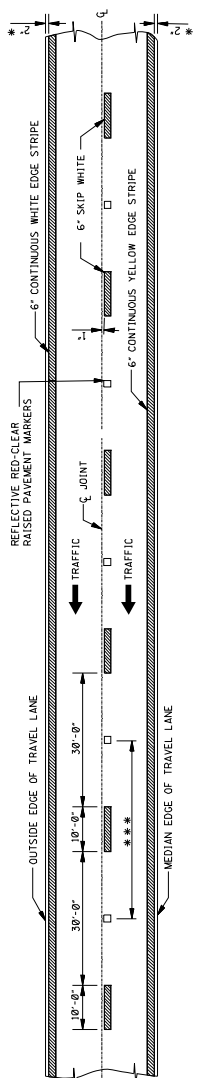

4-LANE WITH ONE-WAY TRAFFIC

MISSISSIPPI DEPARTMENT OF TRANSPORTATION	
ROADWAY DESIGN DIVISION	
PROJECT NO. 107633/301000	
COUNTY: RANKIN	
FILE NAME: RPM-1	DATE:
WORKING NUMBER: RPM-1	SHEET NUMBER:

**SR 43  
RANKIN COUNTY  
107633/301000**

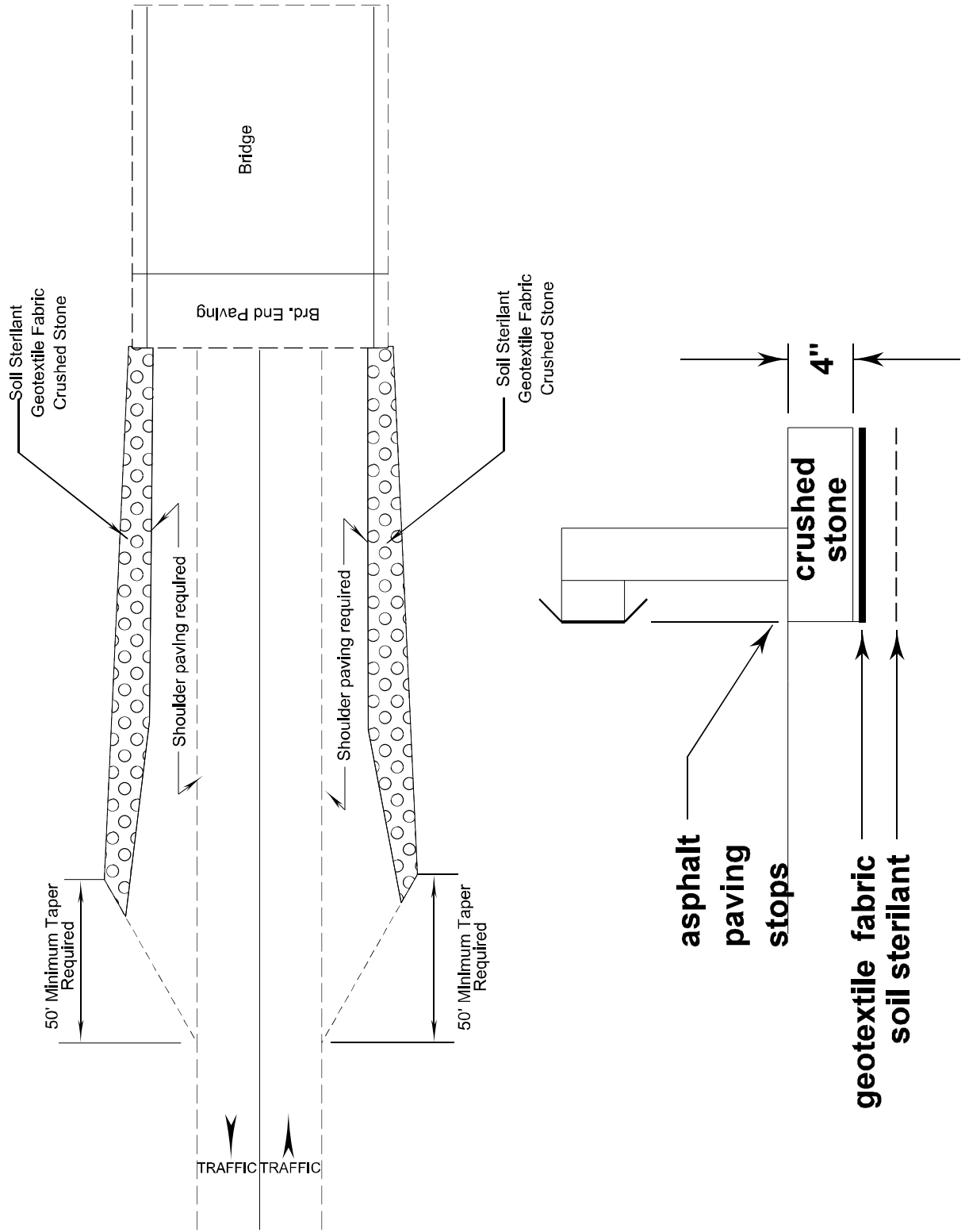

**FLAT PANEL SIGN BRACE**

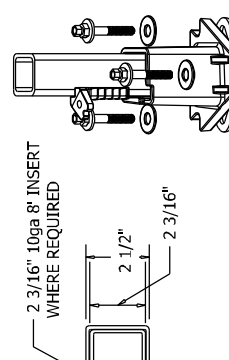

**EXTRUDED PANEL SIGN CLAMP**

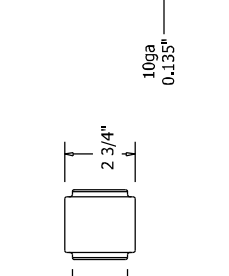

**POST CAP**

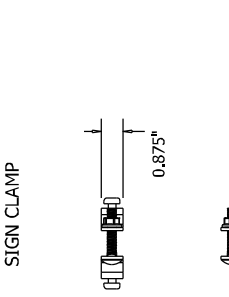

**SIGN DRIVE RIVET W/WASHER**

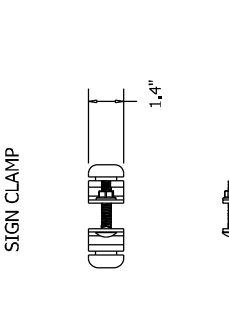

**EXTRUDED PANEL SIGN CLAMP**

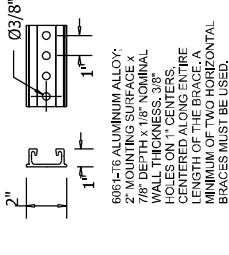

**POST CAP**



**SIGN POSTS**

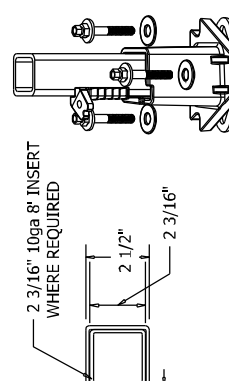

**EXTRUDED PANEL SIGN CLAMP**

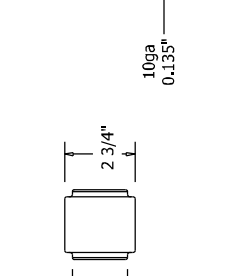

**POST CAP**

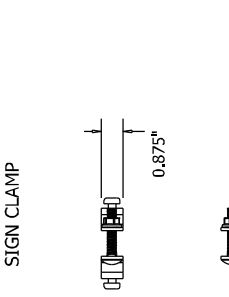

**SIGN DRIVE RIVET W/WASHER**

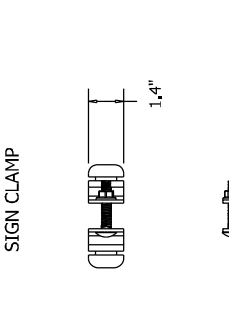

**EXTRUDED PANEL SIGN CLAMP**

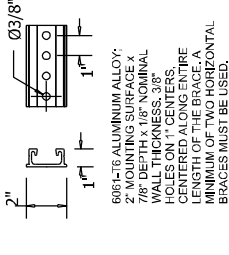

**POST CAP**



**FLAT PANEL SIGN BRACE**

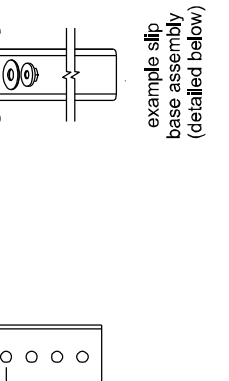

**EXTRUDED PANEL SIGN CLAMP**

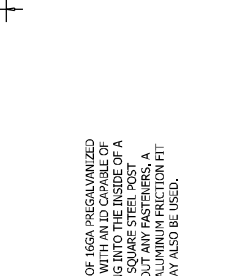

**POST CAP**

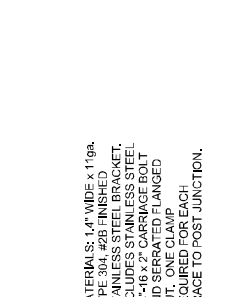

**SIGN DRIVE RIVET W/WASHER**

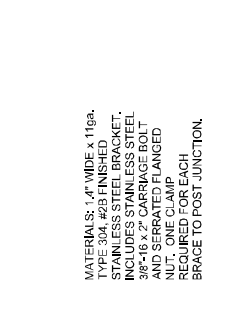

**EXTRUDED PANEL SIGN CLAMP**

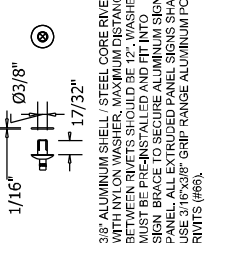

**POST CAP**



MATERIALS: 1 1/4" WIDE x 1 1/8" TYPE 304 #2B FINISHED STAINLESS STEEL BRACKET. INCLUDES STAINLESS STEEL WITHOUT ANY FASTENERS. A CAST ALUMINUM FRICTION FIT CAP PIN ALSO BE USED.

MATERIALS: 1 1/4" WIDE x 1 1/8" TYPE 304 #2B FINISHED STAINLESS STEEL BRACKET. INCLUDES STAINLESS STEEL WITHOUT ANY FASTENERS. A CAST ALUMINUM FRICTION FIT CAP PIN ALSO BE USED.

MATERIALS: 1 1/4" WIDE x 1 1/8" TYPE 304 #2B FINISHED STAINLESS STEEL BRACKET. INCLUDES STAINLESS STEEL WITHOUT ANY FASTENERS. A CAST ALUMINUM FRICTION FIT CAP PIN ALSO BE USED.

MATERIALS: 1 1/4" WIDE x 1 1/8" TYPE 304 #2B FINISHED STAINLESS STEEL BRACKET. INCLUDES STAINLESS STEEL WITHOUT ANY FASTENERS. A CAST ALUMINUM FRICTION FIT CAP PIN ALSO BE USED.

MATERIALS: 1 1/4" WIDE x 1 1/8" TYPE 304 #2B FINISHED STAINLESS STEEL BRACKET. INCLUDES STAINLESS STEEL WITHOUT ANY FASTENERS. A CAST ALUMINUM FRICTION FIT CAP PIN ALSO BE USED.

MATERIALS: 1 1/4" WIDE x 1 1/8" TYPE 304 #2B FINISHED STAINLESS STEEL BRACKET. INCLUDES STAINLESS STEEL WITHOUT ANY FASTENERS. A CAST ALUMINUM FRICTION FIT CAP PIN ALSO BE USED.

**FLAT PANEL SIGN BRACE**

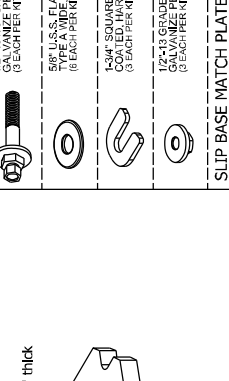

**EXTRUDED PANEL SIGN CLAMP**

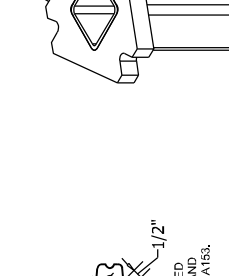

**POST CAP**

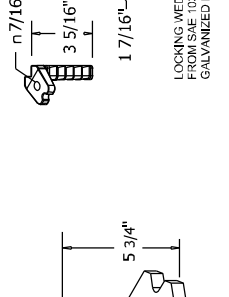

**SIGN DRIVE RIVET W/WASHER**

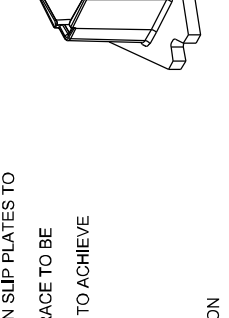

**EXTRUDED PANEL SIGN CLAMP**

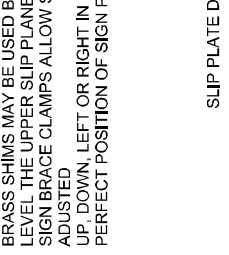

**POST CAP**



**FLAT PANEL SIGN BRACE**

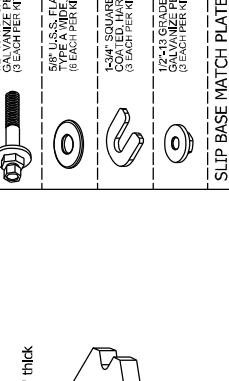

**EXTRUDED PANEL SIGN CLAMP**

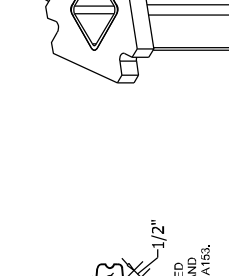

**POST CAP**

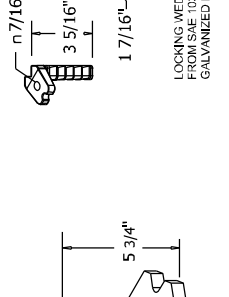

**SIGN DRIVE RIVET W/WASHER**

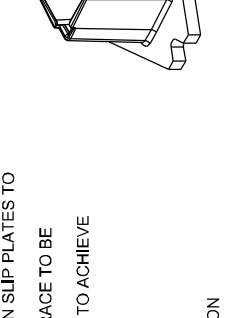

**EXTRUDED PANEL SIGN CLAMP**

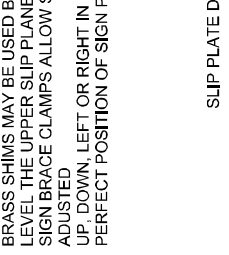

**POST CAP**



**FLAT PANEL SIGN BRACE**

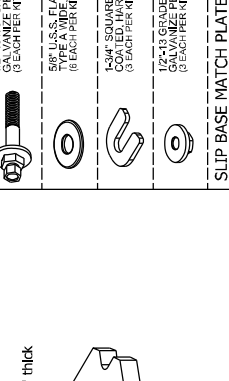

**EXTRUDED PANEL SIGN CLAMP**

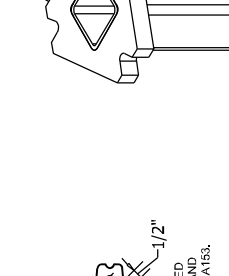

**POST CAP**

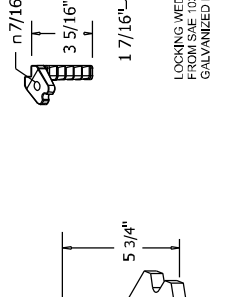

**SIGN DRIVE RIVET W/WASHER**

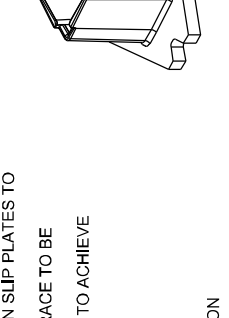

**EXTRUDED PANEL SIGN CLAMP**

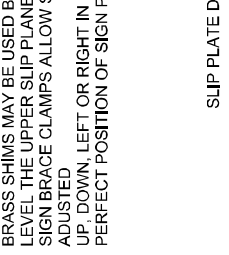

**POST CAP**



**FLAT PANEL SIGN BRACE**

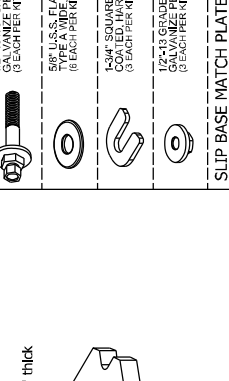

**EXTRUDED PANEL SIGN CLAMP**

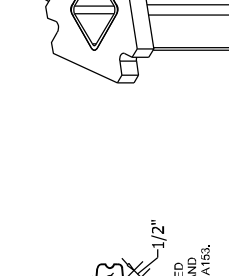

**POST CAP**

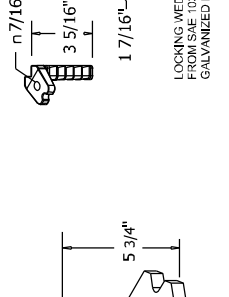

**SIGN DRIVE RIVET W/WASHER**

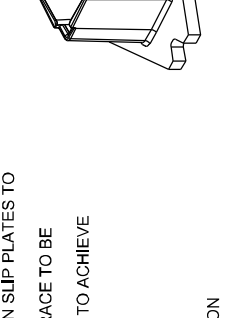

**EXTRUDED PANEL SIGN CLAMP**

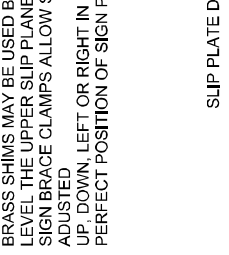

**POST CAP**



**FLAT PANEL SIGN BRACE**

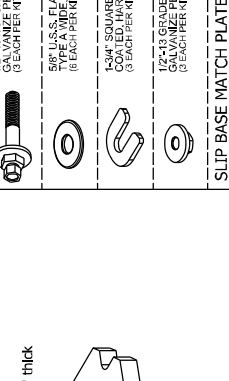

**EXTRUDED PANEL SIGN CLAMP**

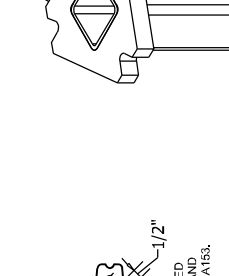

**POST CAP**

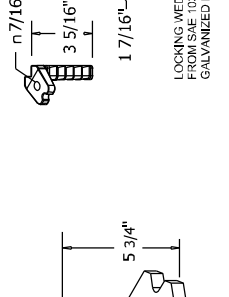

**SIGN DRIVE RIVET W/WASHER**

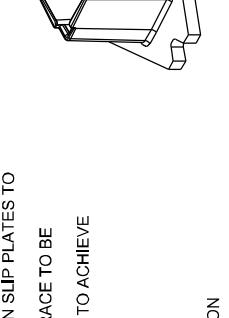

**EXTRUDED PANEL SIGN CLAMP**

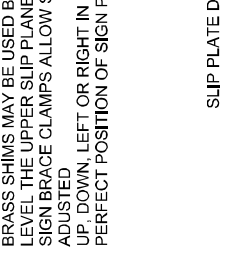

**POST CAP**



**FLAT PANEL SIGN BRACE**

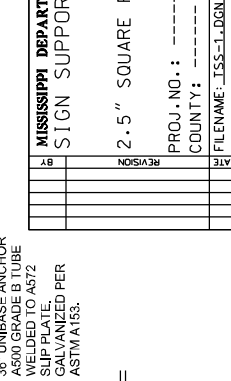

**EXTRUDED PANEL SIGN CLAMP**

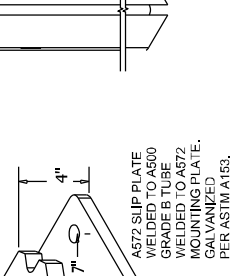

**POST CAP**

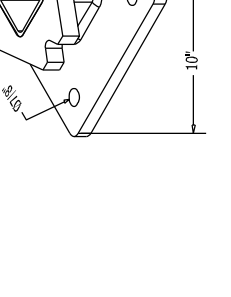

**SIGN DRIVE RIVET W/WASHER**

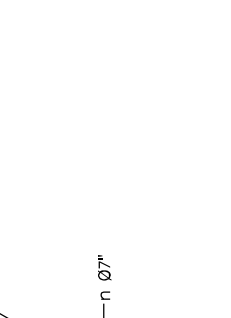

**EXTRUDED PANEL SIGN CLAMP**

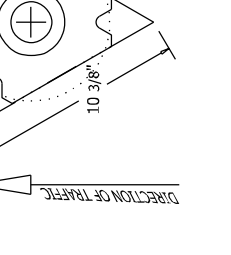

**POST CAP**



**FLAT PANEL SIGN BRACE**

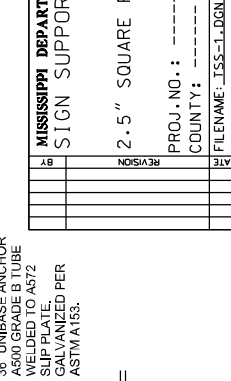

**EXTRUDED PANEL SIGN CLAMP**

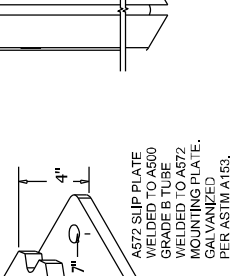

**POST CAP**

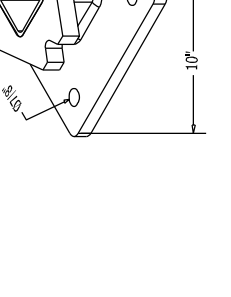

**SIGN DRIVE RIVET W/WASHER**

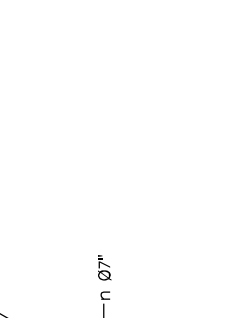

**EXTRUDED PANEL SIGN CLAMP**

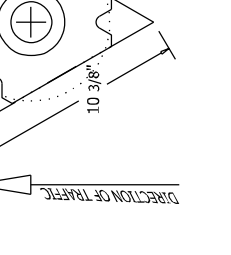

**POST CAP**



**FLAT PANEL SIGN BRACE**

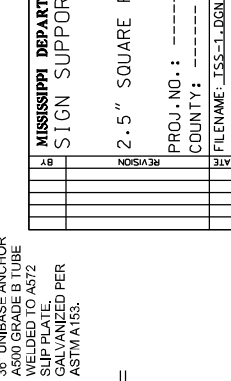

**EXTRUDED PANEL SIGN CLAMP**

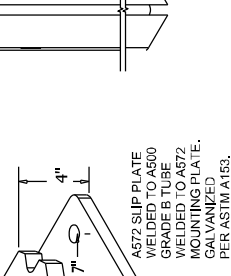

**POST CAP**

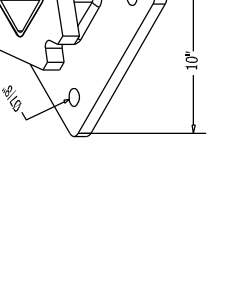

**SIGN DRIVE RIVET W/WASHER**

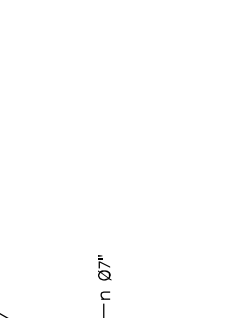

**EXTRUDED PANEL SIGN CLAMP**

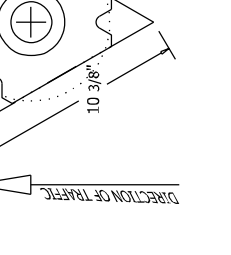

**POST CAP**



**FLAT PANEL SIGN BRACE**

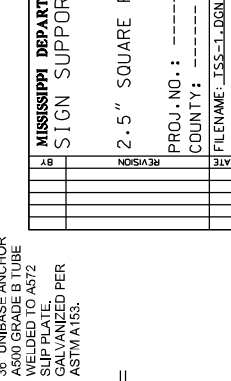

**EXTRUDED PANEL SIGN CLAMP**

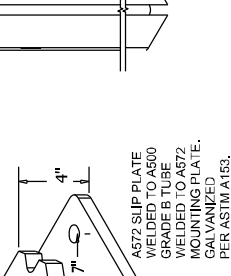

**POST CAP**

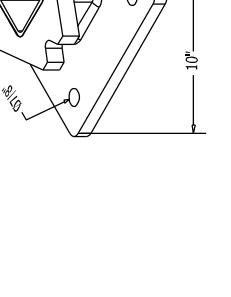

**SIGN DRIVE RIVET W/WASHER**

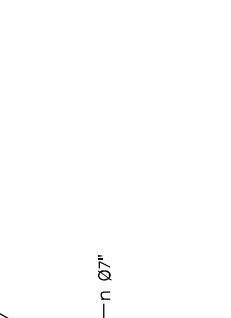

**EXTRUDED PANEL SIGN CLAMP**

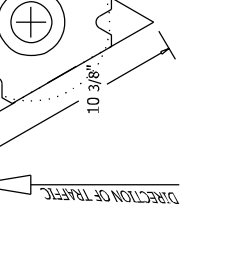

**POST CAP**



**FLAT PANEL SIGN BRACE**

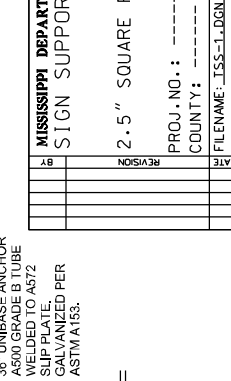

**EXTRUDED PANEL SIGN CLAMP**

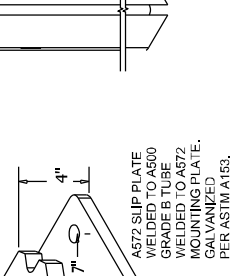

**POST CAP**

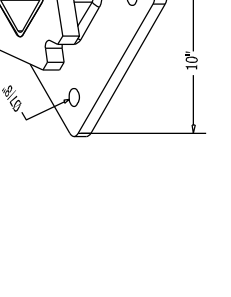

**SIGN DRIVE RIVET W/WASHER**

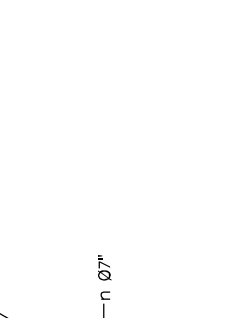

**EXTRUDED PANEL SIGN CLAMP**

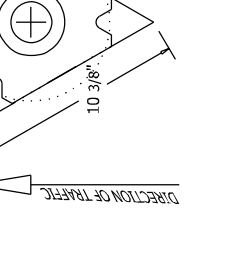

**POST CAP**



**FLAT PANEL SIGN BRACE**

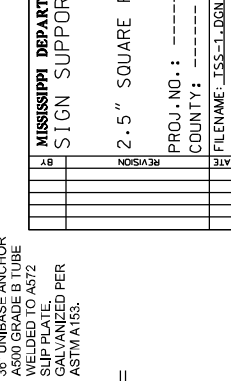

**EXTRUDED PANEL SIGN CLAMP**

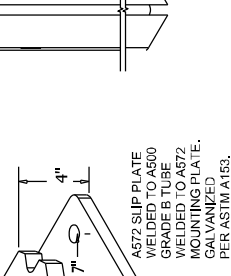

**POST CAP**

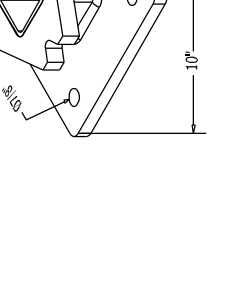

**SIGN DRIVE RIVET W/WASHER**

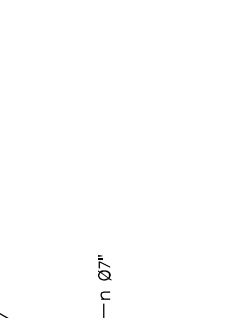

**EXTRUDED PANEL SIGN CLAMP**

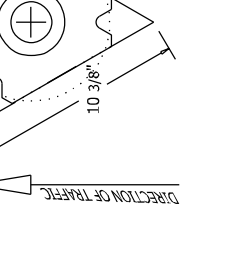

**POST CAP**



**FLAT PANEL SIGN BRACE**

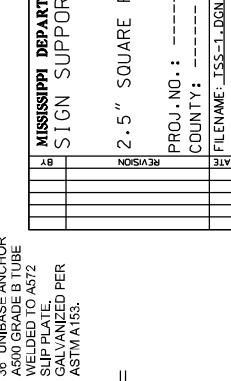

**EXTRUDED PANEL SIGN CLAMP**

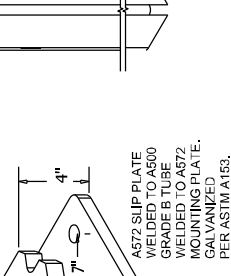

**POST CAP**

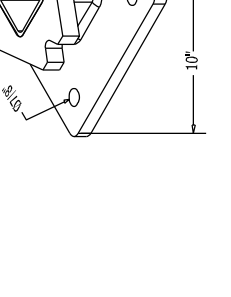

**SIGN DRIVE RIVET W/WASHER**

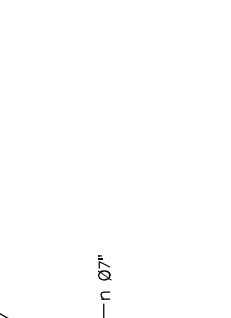

**EXTRUDED PANEL SIGN CLAMP**

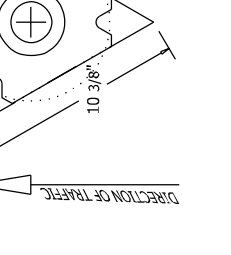

**POST CAP**



**FLAT PANEL SIGN BRACE**

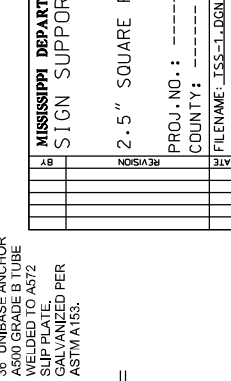

**EXTRUDED PANEL SIGN CLAMP**

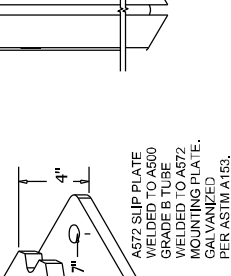

**POST CAP**

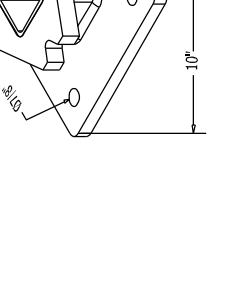

**SIGN DRIVE RIVET W/WASHER**

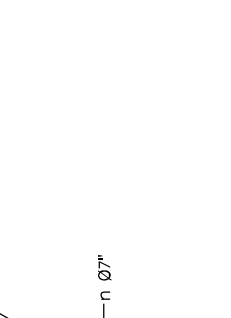

**EXTRUDED PANEL SIGN CLAMP**

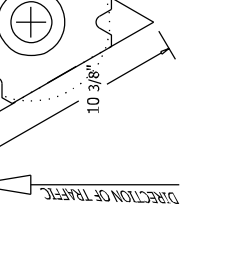

**POST CAP**



**FLAT PANEL SIGN BRACE**

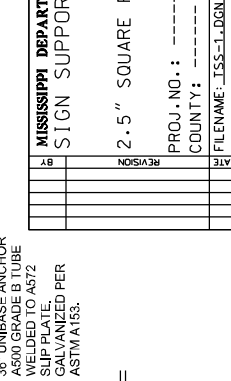

**EXTRUDED PANEL SIGN CLAMP**

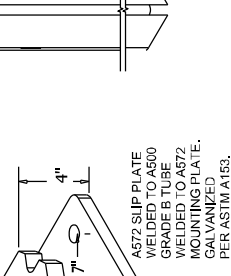



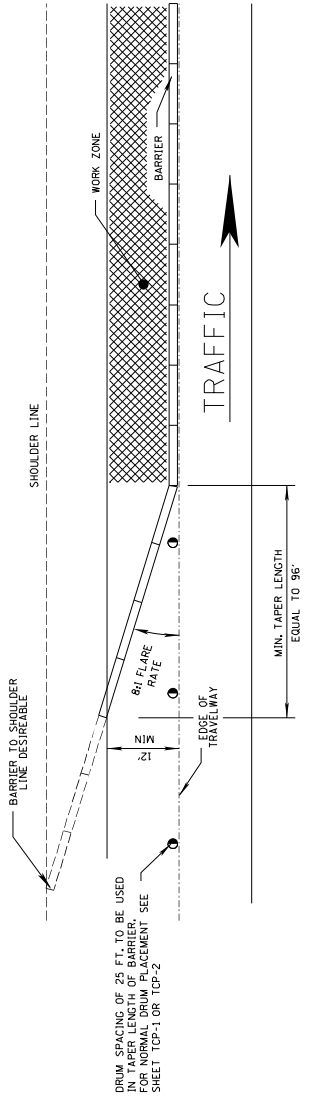

DETAIL OF POSITIVE BARRIER WITH TAPER

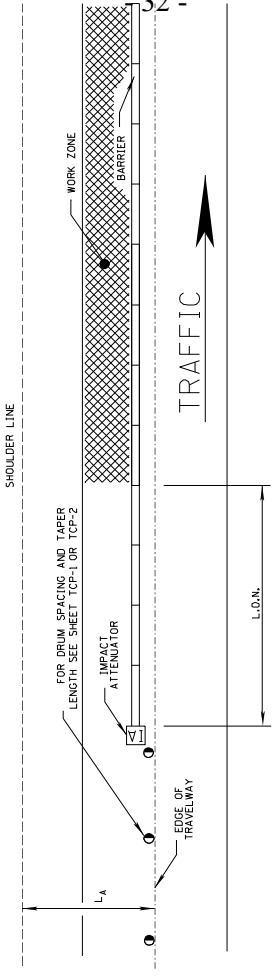

DETAIL OF POSITIVE BARRIER WITH IMPACT ATTENUATOR

NOTES:  
1. LENGTH OF NEED, L.O.N. =  $\frac{L_1 L_2}{L_1 + L_2}$

WHERE:  $L_1$  = LATERAL EXTENT OF THE AREA OF CONCERN  
 $L_1$  = RUNOUT LENGTH  
 $L_2$  = LATERAL OFFSET FROM EDGE OF TRAVELED WAY TO BARRIER.

GENERAL NOTES:

1. ALL TRAFFIC CONTROL ITEMS SHOWN ON THIS SHEET SHALL BE PAID FOR UNDER OTHER BID ITEMS.
2. FOR DETAILS OF DRUM PLACEMENT SEE OTHER TRAFFIC CONTROL PLANS.

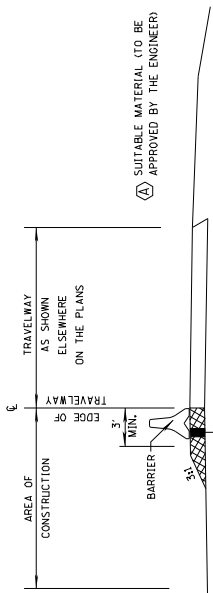

ELEVATION VIEW FOR POSITIVE BARRIER

- NOTES:
1. POSITIVE BARRIER IS REQUIRED IN THE AREA OF OPEN PUNCH OUTS THAT ARE WITHIN SIX (6) FEET OF THE TRAVELWAY WHENEVER ACTUAL REPAIR WORK IS NOT BEING PERFORMED WITHIN THE LANE CLOSURE.
  2. MATERIAL USED TO SUPPORT POSITIVE BARRIER MUST BE AT SAME ELEVATION AS PAVEMENT IN ADJACENT TRAVELWAY.
  3. DELINEATORS REQUIRED ON ALL NON-REFLECTIVE BARRIER, AS SHOWN ON WORKING NO. OMB-3.

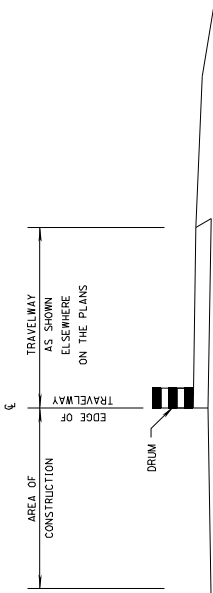

ELEVATION VIEW FOR DRUM

- NOTES:
1. WHILE WORK IS BEING PERFORMED WITHIN THE LANE CLOSURE DROP-OFFS MUST BE PROTECTED WITH DRUMS, ETC. IN EMERGENCIES EXCAVATED SECTION MAY BE BACKFILLED WITH GRANULAR MATERIAL TO AVOID OVERNIGHT DROP-OFFS.
  2. LANE CLOSURES WITH OPEN PUNCH OUT AREAS MAY NOT BE LEFT UNATTENDED WHEN DRUMS ARE BEING USED FOR LANE CLOSURE

DESIGN SPEED (mph)	OVER 10,000 veh/day	5,000-10,000 veh/day	1,000-5,000 veh/day	UNDER 1,000 veh/day
70	360	330	290	250
60	300	250	210	200
50	230	190	160	150
40	160	130	110	100
30	110	90	80	70

2. RUNOUT LENGTH ( $L_R$ ) IS TO BE DETERMINED USING THE FOLLOWING TABLE:

Notice to Bidders No. 6750 -- Co

MISSISSIPPI DEPARTMENT OF TRANSPORTATION

**LANE CLOSURE DETAILS FOR GREATER THAN 3 INCH DROPOFF**

PROJ. NO.: \_\_\_\_\_  
COUNTY: \_\_\_\_\_

WORKING NUMBER: \_\_\_\_\_  
SHEET NUMBER: \_\_\_\_\_

FILE NAME: SDTOP-CADGN  
DESIGN TEAM: \_\_\_\_\_  
DATE: \_\_\_\_\_  
REVISION: \_\_\_\_\_  
CHECKED: \_\_\_\_\_  
DATE: \_\_\_\_\_

**MISSISSIPPI DEPARTMENT OF TRANSPORTATION**

**SECTION 904 - NOTICE TO BIDDERS NO. 6571**

**CODE: (SP)**

**DATE: 12/13/2024**

**SUBJECT: Project Number Change**

**PROJECT: SP-0037-04(061) / 107633301 Rankin**

Bidders are hereby advised that any references to Project Number **STP-0037-04(061) / 107633301** in the plans or specifications shall be understood to mean Project Number **SP-0037-04(061) / 107633301**.

**MISSISSIPPI DEPARTMENT OF TRANSPORTATION**

**SECTION 904 - NOTICE TO BIDDERS NO. 6572**

**CODE: (SP)**

**DATE: 12/13/2024**

**SUBJECT: Temporary Construction Signs**

**PROJECT: SP-0037-04(061) / 107633301 – Rankin County**

Bidders are hereby advised of the following regarding the Temporary Construction Signs required:

Should the Bidders elect to install Temporary Construction Signs by first driving short u-channel sections and then bolting the longer, correct height u-channel sections to them, the Bidders are advised that these short sections shall be a minimum of five (5) feet from the ground level when driven and the splice must consist of a minimum of eighteen (18) inches of overlap with a total of four (4) bolts. Bidders are also advised that it is mandatory that these short sections be removed at the completion of the project.



**MISSISSIPPI DEPARTMENT OF TRANSPORTATION**

**SECTION 904 - NOTICE TO BIDDERS NO. 6573**

**CODE: (SP)**

**DATE: 10/17/2023**

**SUBJECT: Underground Utilities**

**PROJECT: SP-0037-04(061) / 107633301 – Rankin County**

Bidders are hereby advised that utility lines owned and maintained by MDOT may be present within the project limits. These utilities are not located by Mississippi 811. It shall be the Contractor's responsibility to coordinate with MDOT to have the utility lines located and marked prior to beginning work. The Contractor shall give a minimum of three (3) working days of advance notice for locate requests. Also, the Contractor shall be responsible for contacting local public agencies that are not members of Mississippi 811.

Additionally, it shall be the Contractor's responsibility to maintain the utility markings and have the ability to survey the marked utilities and re-establish said utility markings as needed. The Department shall only be responsible for locating and marking the utilities once per Contract.

The contacts for MDOT utility lines are as follows:

**Underground Power Lines:**

Michael Lee – 601-683-3341 – [mlee@mdot.ms.gov](mailto:mlee@mdot.ms.gov)

Billy Coward – 601-683-3341 – [bcoward@mdot.ms.gov](mailto:bcoward@mdot.ms.gov)

**Underground Communication Lines:**

Kerby McFarland – 601-359-7450 – [kmcfarland@mdot.ms.gov](mailto:kmcfarland@mdot.ms.gov)

Steven Newell – 601-359-7450 – [snewell@mdot.ms.gov](mailto:snewell@mdot.ms.gov)

Henry Lewis – 601-359-1454 – [hlewis@mdot.ms.gov](mailto:hlewis@mdot.ms.gov)

**Underground Signal Lines:**

Amrik Singh – 601-359-1454 – [asingh@mdot.ms.gov](mailto:asingh@mdot.ms.gov)

Kenneth Welch – 601-359-1454 – [kwelch@mdot.ms.gov](mailto:kwelch@mdot.ms.gov)

**MISSISSIPPI DEPARTMENT OF TRANSPORTATION**

**SECTION 904 - NOTICE TO BIDDERS NO. 6574**

**CODE: (SP)**

**DATE: 12/16/2024**

**SUBJECT: Lane Closure Restrictions**

**PROJECT: SP-0037-04(061) / 107633301 –Rankin County**

Bidders are hereby advised of the following lane closure restrictions on the above captioned project:

**Remove and Replace Pipe at Station 272+80 Operations**

Lane closures for this work shall only be allowed when Pisgah Schools are not in session.

**All Operations**

Lane closures shall NOT be allowed during the following hours:

- Old SR 43 to SR 25 When Pisgah Schools Are In Session
  - Monday Through Friday - 6:00 AM to 8:00 AM and 2:00 PM to 6:00 PM
- Old SR 43 to SR 25 When Pisgah Schools Are Not In Session
  - Monday Through Friday - 6:00 AM to 8:00 AM
- SR 25 to the Madison County Line
  - Monday through Friday – 6:00 AM to 8:00 AM

The Contractor will be charged a fee of **\$500.00** for each full or partial 5 - minute period until the roadway is back in compliance with the requirements stated above.

Official time can be obtained by calling the following Jackson area phone number: 601-355-9311.

# MISSISSIPPI DEPARTMENT OF TRANSPORTATION

SPECIAL PROVISION NO. 907-101-1

CODE: (IS)

DATE: 07/20/2023

SUBJECT: Definitions and Terms

Section 101, Definitions and Terms, of the 2017 Edition of the Mississippi Standard Specifications for Road and Bridge Construction is hereby amended as follows.

**907-101.01--Abbreviations.** After the abbreviation API on page 1, add the following.

APL Approved Products List

Replace the abbreviation for AWPA on page 1 with the following.

AWPA American Wood Protection Association

**907-101.02--Definitions.** Delete the sentence after the list of holidays in Subsection 101.02 on page 6 under **holidays, legal**, and substitute the following.

When a legal holiday falls on a Saturday or Sunday, the succeeding Monday, or as proclaimed by the Governor, will be observed as a legal holiday.

Delete the definition for Notice to Proceed in Subsection 101.02 on page 8, and substitute the following.

**Notice to Proceed** - Written notice to the Contractor to proceed with the contract work.

Delete the definition for “Plans” in Subsection 101.02 on page 8, and substitute the following.

**plans** - The approved plans, profiles, typical cross-sections, working drawings and supplemental drawings, or exact reproduction thereof, that show the location, character, dimensions, and details of the work to be done. The plans may also include electronic files, referred to on the plans as Electronic Files Identified as Plans, which may include engineering models, spreadsheets, CADD files or other electronic files used to convey design intent. When the contract does not have an official set of plans, reference to the plans shall mean the contract documents.

## MISSISSIPPI DEPARTMENT OF TRANSPORTATION

SPECIAL PROVISION NO. 907-102-2

CODE: (IS)

DATE: 11/22/2017

SUBJECT: **Bidding Requirements and Conditions**

Section 102, Bidding Requirements and Conditions, of the 2017 Edition of the Mississippi Standard Specifications for Road and Bridge Construction is hereby amended as follows.

**907-102.01--Prequalification of Bidders.** Delete the last sentence of the third paragraph of Subsection 102.01 on page 13, and substitute the following.

The Bidder's Certificate of Responsibility number must be on file with the Department's Contract Administration Division prior to request for permission to bid.

**907-102.02--Contents of Proposal Forms.** Delete the fourth paragraph in Subsection 102.02 on page 13, and substitute the following.

Prospective bidders must complete an online request for permission to be eligible to bid a project. Upon approval, the bidder will be authorized to submit a bid electronically using Bid Express at <http://bidx.com>.

## MISSISSIPPI DEPARTMENT OF TRANSPORTATION

SPECIAL PROVISION NO. 907-103-2

CODE: (SP)

DATE: 06/22/2017

SUBJECT: Award and Execution of Contract

Section 103, Award and Execution of Contract, of the 2017 Edition of the Mississippi Standard Specifications for Road and Bridge Construction is hereby amended as follows.

**907-103.01--Consideration of Proposal.** Delete the second and third paragraphs of Subsection 103.01 on page 19, and substitute the following.

**907-103.01.1--For Projects Constructed Without Federal Funds.** Resident Contractors actually domiciled in Mississippi are to be granted preference over nonresidents in awarding of Contracts financed 100% with State funds.

In consideration of proposals that are equal to or in excess of \$50,000 and financed 100% with State funds, a nonresident bidder domiciled in a state having laws granting preference to local Contractors will be considered for such contracts on the same basis as the nonresident bidder's state awards contracts to Mississippi Contractors bidding under similar circumstances. When a nonresident Contractor submits a bid equal to or in excess of \$50,000 on a contract financed 100% with State funds, a copy of the current laws from the state of domicile and an explanation thereof pertaining to treatment of nonresident Contractors shall be attached. If no preferential treatment is provided for Contractors in the state of domicile and contracts are awarded to the lowest responsible bidder, a statement to this effect shall be attached. Should the attachment not accompany the bid when submitted, the Contractor shall have 10 days following the opening of the bids to furnish the required information to the Contract Administration Director for attachment to the bid. Failure to provide the attachment within 10 days will result in the nonresident Contractor's bid being rejected and not considered for award. As used herein, the term "resident Contractor" includes a nonresident person, firm or corporation that has been qualified to do business in this State and has maintained a permanent full-time office in the State of Mississippi for two years prior to the submission of the bid, and the subsidiaries and affiliates of such a person, firm or corporation.

## MISSISSIPPI DEPARTMENT OF TRANSPORTATION

SPECIAL PROVISION NO. 907-105-2

CODE: (IS)

DATE: 07/20/2023

SUBJECT: Control of Work

Section 105, Control of Work, of the 2017 Edition of the Mississippi Standard Specifications for Road and Bridge Construction is hereby amended as follows.

**907-105.01--Authority of the Engineer.** Delete the first sentence of the second paragraph of Subsection 105.01 on page 31, and substitute the following.

The Engineer has the right to suspend the work wholly or in part and to withhold payments because of the Contractor's failure to correct conditions unsafe for workmen or the general public, for failure to carry out provisions of the Contract, or for failure to carry out orders.

**907-105.02--Plans and Working Drawings.** Delete the first paragraph of Subsection 105.02 on page 31, and substitute the following.

After the contract is executed by the Executive Director, the Contractor will receive, free of charge, two bound copies of the proposal and contract documents (one executed and one blank) two full scale copies of the plans, five half-scale copies of the Plans, and Electronic Files Identified as Plans. The Contractor shall have one copy of the proposal and contract documents and one half-scale copy of the plans available at all times during work activity on the project.

## MISSISSIPPI DEPARTMENT OF TRANSPORTATION

SPECIAL PROVISION NO. 907-106-2

CODE: (IS)

DATE: 09/24/2024

SUBJECT: Control of Materials

Section 106, Control of Materials, of the 2017 Edition of the Mississippi Standard Specifications for Road and Bridge Construction is hereby amended as follows.

After Subsection 106.13 on page 47, add the following.

**907-106.14--Buy America Materials Sourcing Requirements for Federal-Aid Projects.** The “Infrastructure Investment and Jobs Act” (the “Act”), or Bipartisan Infrastructure Law (BIL), was enacted on November 15, 2021 (See Public Law No. 117-58, Sections 70901-70953). The Buy America provisions of the Act expand the previous Buy America requirements beyond what is currently required for steel and iron products.

Any steel and iron materials per Subsection 700.01 or construction materials per Subsection 907-700.01.1, that are used for a Federal-Aid highway construction project, shall be domestically manufactured (as further described in Subsection 700.01) and compliant with current requirements of the Act, as implemented in [2 CFR 184](#), [2 CFR 200.322](#), and [OMB 24-02 Memo and related requirements therein](#).

As determined by the Department within the contract prior to award, all products and/or materials will only be classified under one of the following categories: Steel and Iron, Manufactured Products, and Construction Materials. It is the Prime Contractor’s responsibility to ensure all submittals required for Buy America are submitted to the Project Engineer prior to the products and/or materials being incorporated into the work.

The following items require Buy America Certification on Federal-Aid projects:

- (a) Steel and Iron
- (b) Construction Materials

A list of items that require Buy America Certification may be viewed at [www.goMDOT.com](http://www.goMDOT.com) under Business Center → Engineering Standards/Guides/Manuals → Construction Materials.

Items classified as a Manufactured Product that do not include steel and iron components do not require a Buy America Certification on a Federal-Aid project. Manufactured Products are currently exempted under the 1983 waiver from FHWA. Manufactured Products are determined by the Department’s Materials Division.

To be considered a Manufactured Product, an item shall meet one of the following requirements:

- (a) The item consists of two or more of the listed construction materials that have been combined through a manufacturing process.
- (b) The item consists of at least one of the listed construction materials that has been combined through a manufacturing process with a material that is not listed as a construction material.

Buy America provisions do not apply to temporarily used items that (1) are specified to be removed at the end of the project per the contract provisions or (2) are specified to remain in place per the contract provisions and are also documented by the Department in the contract provisions to be removed in a subsequent imminent, near-term phased project.



**MISSISSIPPI DEPARTMENT OF TRANSPORTATION**

**SPECIAL PROVISION NO. 907-108-4**

**CODE: (SP)**

**DATE: 10/07/2020**

**SUBJECT: Subletting of Contract**

Section 108, Prosecution and Progress, of the 2017 Edition of the Mississippi Standard Specifications for Road and Bridge Construction is hereby amended as follows.

**907-108.01--Subletting of Contract.**

**907-108.01.1--General.** Delete the third sentence of the tenth paragraph of Subsection 108.01.1 on the bottom of page 72.

## MISSISSIPPI DEPARTMENT OF TRANSPORTATION

SPECIAL PROVISION NO. 907-109-5

CODE: (IS)

DATE: 11/14/2023

SUBJECT: Measurement and Payment

Section 109, Measurement and Payment, of the 2017 Edition of the Mississippi Standard Specifications for Road and Bridge Construction is hereby amended as follows.

**907-109.01--Measurement of Quantities.** Delete the sixth full paragraph of Subsection 109.01 on page 88, and substitute the following.

If appropriate based on the specific circumstances of the project, the Contractor may request that material specified to be measured by the cubic yard or ton be converted to the other measure. The Contractor must submit this request to the Engineer. The Engineer will provide an approval or denial in writing. The decision is in the sole discretion of the Engineer. If approved, factors for this conversion will be determined by the District Materials Engineer and agreed to by the Contractor. The conversion of the materials along with the conversion factor will be incorporated into the Contract by supplemental agreement. The supplemental agreement must be executed before such method of measurement is used.

**907-109.04--Extra Work.**

**907-109.04.1--Supplemental Agreement.** Delete the second paragraph of Subsection 109.04.1 on page 90.

**907-109.04.2--Force Account Agreement.** Delete the last sentence of subparagraph (c) in Subsection 109.04.2 on page 91, and substitute the following.

An amount will be added equal to fifteen percent (15%) of the sum thereof, excluding sales tax.

Delete subparagraph (d) in Subsection 109.04.2 on pages 91 & 92, and substitute the following.

- (d) **Equipment.** Equipment used for force account work shall be of sufficient size and type necessary to perform the required work in an economic and expeditious manner. The Contractor must provide the manufacturer, make, model, year, type of fuel and other necessary information to determine proper hourly payment rates. Subject to advance approval of the Engineer, actual transportation cost for a distance of not more than 200 miles will be reimbursed for equipment not already on the project.

For equipment authorized by the Engineer for use on the force account work, the Engineer will use the equipment rental rates from the “*Rental Rate Blue Book*” as published on the Equipment Watch website [www.equipmentwatch.com](http://www.equipmentwatch.com) for the time period the force account work is authorized to determine payment to the Contractor. The maximum allowable rates

are determined as follows:

1. The hourly equipment rate will equal the FHWA total hourly rate. This rate takes into account adjustment factors for age and region.
2. The hourly estimated operating costs have been included in the FHWA total hourly rate.
3. The idle and standby rates shall be as listed in the "*Rental Rate Blue Book*" as reported by *Equipment Watch*.
4. These rates include the basic machine plus any necessary attachments.

Standby rates shall apply when equipment is not in operation and is approved by the Engineer to standby for later use to complete the work. Idle rates shall apply to equipment located on the project and the engine is burning fuel but no ground engaging or other components are actively engaged in meaningful work. In general, idle or standby rates shall apply when equipment is not in use, but will be needed again to complete the work and the cost of moving the equipment will exceed the accumulated standby cost. If the idle standby cost should exceed the equipment moving cost to or from the work site, the Contractor will be entitled to the moving cost only. Idle or standby rates will be used under the following conditions:

1. The equipment is totally dedicated to the force account work and not used intermittently on other work.
2. Idle or standby cost will be considered only after equipment has been operated on force account work.
3. The sum of idle or standby time and operating time shall not exceed eight (8) hours per day or 40 hours in a week.
4. Idle or standby payment will not apply to days not normally considered to be work days such as holidays, weekends, or days of inclement weather when no other work is taking place.

The Department will not pay for idle or standby time when equipment is inoperable, for time spent repairing equipment, or for the time elapsed after the Engineer has advised the Contractor that the equipment is no longer needed. The Department will determine if it will be more cost effective to pay standby time on approved equipment on site or for multiple mobilizations.

If equipment is needed, which is not included in the *Rental Rate Blue Book* as reported by *Equipment Watch*, the Department and Contractor will agree upon reasonable rental rates in writing before the equipment is used.

All equipment shall be subject to approval from day to day in accordance with the requirements of Subsection 108.05.

**907-109.06--Partial Payment.**

**907-109.06.2--Advancement on Materials.**

Delete the next to last paragraph of Subsection 109.06.2 on page 95, and substitute the following.

Materials for which an advanced payment has been allowed must be paid for by the Contractor within 30 days of the estimate on which the advanced payment was first allowed and proof of said payment must be verified by the supplier. If proof of payment is not furnished within the allowable 30 days, the advanced payment will be deducted on subsequent current estimates until such time that proof of payment is furnished.

**907-109.07--Changes in Material Costs.** After the fifth paragraph of Subsection 109.07 on page 96, change the web address to the following.

[https://mdot.ms.gov/portal/current\\_letting](https://mdot.ms.gov/portal/current_letting)

**MISSISSIPPI DEPARTMENT OF TRANSPORTATION**

**SPECIAL PROVISION NO. 907-401-1**

**CODE: (SP)**

**DATE: 10/22/2024**

**SUBJECT: Tack Coat**

Section 401, Asphalt Pavement - General, of the 2017 Edition of the Mississippi Standard Specifications for Road and Bridge Construction is hereby amended as follows..

**907-401.03--Construction Requirements.**

**907-401.03.1--Specific Requirements.**

**907-401.03.1.2--Tack Coat.** After the first sentence in Subsection 401.03.1.2 on page 256, add the following.

In addition to the products listed on the Department's APL, the Contractor may use one of the following as a tack coat.

- CSS-1
- CSS-1h
- SS-1
- SS-1h

# MISSISSIPPI DEPARTMENT OF TRANSPORTATION

SPECIAL PROVISION NO. 907-618-12

CODE: (SP)

DATE: 05/03/2024

SUBJECT: Traffic Control Management

Section 618, Maintenance of Traffic and Traffic Control Plan, of the 2017 Edition of the Mississippi Standard Specifications for Road and Bridge Construction is hereby amended as follows.

## **907-618.01--Description.**

**907-618.01.2--Traffic Control Management.** Delete subparagraph (g) of Subsection 618.01.2 on page 441, and substitute the following.

- g) Perform a minimum of once-a-week inspections from the Notice to Proceed until a Partial or Final Maintenance Release is obtained. Once work begins, daily daytime inspections and weekly nighttime inspections are required on projects with predominantly daytime work, and daily nighttime inspections and weekly daytime inspections are required on projects with predominantly nighttime work. Weekly inspections will be allowed for periods outside of active construction. When lane closures are present or any non-fixed signs or traffic handling devices such as cones or barrels are in place, inspections shall be performed daily whether work is being performed or not.

**907-618.05--Basis of Payment.** Delete pay item 618-A on page 449 and substitute the following.

907-618-A: Maintenance of Traffic

- lump sum

# MISSISSIPPI DEPARTMENT OF TRANSPORTATION

SPECIAL PROVISION NO. 907-626-11

CODE: (IS)

DATE: 06/24/2024

SUBJECT: Thermoplastic Traffic Markings

Section 626, Thermoplastic Traffic Markings, of the 2017 Edition of the Mississippi Standard Specifications for Road and Bridge Construction is hereby amended as follows.

Delete Section 626 on pages 492 thru 496, and substitute the following.

## SECTION 626 - THERMOPLASTIC TRAFFIC MARKINGS

**907-626.01--Description.** This work consists of furnishing materials and placing thermoplastic pavement markings of the type specified in conformity with these specifications and the details shown on the plans or established. All hot-applied thermoplastic pavement markings shall be coated with a double-drop combination of optics.

This work may also consist of placing an audible bump or puck style marking system on the edge line that provides an audible and vibratory warning when driven over. The marking system shall be a road marking system of the dimensions indicated at regular and predetermined intervals.

This work may also consist of placing a profile or raised shape marking system on centerline or edge line that provides audible and vibratory warning when driven over. The marking system shall be a road marking system of the dimensions indicated and at regular and predetermined intervals. When placed on centerline, the markings system shall consist of an extruded black transverse thermoplastic bar of the dimensions indicated at regular and predetermined intervals.

This work may also consist of placing high contrast thermoplastic markings. High contrast thermoplastic markings shall consist of placing thermoplastic pavement markings over a black thermoplastic pavement marking to enhance the marking's visibility.

All pavement marking material, excluding lines over rumble strips, shall be applied using the extrusion/ribbon method. Lines placed over rumble strips shall be applied using the atomization/spray method.

Permanent pavement marking tape (permanent cold plastic tape) may be used in lieu of hot applied thermoplastic markings. Substitution will only be allowed for pay items 907-626-A through H. Substituted pavement marking tape shall be of the same color and width as that required for the hot applied thermoplastic. Unless otherwise specified, the markings, whether hot applied or pavement marking tape, shall be of the same type of material for the entire project. Stop bars and crosswalks shall not be substituted with pavement marking tape and shall be alkylid hot-applied thermoplastic markings or heat-fused preformed pavement markings. Material and construction requirements for substituted pavement marking tape shall meet the requirements of Special

Provision 907-628. The layout and spacing for substituted pavement markings will remain as shown in the plans, or in the contract documents, for hot applied thermoplastic markings. Measurement of adhesive substituted pavement markings shall be made in accordance with Special Provision 907-628. Payment for adhesive substituted pavement markings shall be made at the unit price for the appropriate hot applied thermoplastic marking.

When thermoplastic pavement markings are used on bridge decks or concrete surfaces, the surface shall be sealed with an epoxy sealer prior to the application of thermoplastic.

**907-626.02--Materials.** All pavement marking materials shall meet the requirements of Special Provision 907-720-3.

Thermoplastic pavement marking material may be sampled in the field at the time of application by sampling from the marking equipment at the point of extrusion. Samples should be cooled until solid and then packaged into large re-closeable plastic bags and placed into a cardboard box for transport. Field samples will be tested at random or as determined necessary by the Department.

The Contractor shall supply the materials to be used for sampling and packaging. Department personnel shall witness the sampling and shall be responsible for transportation of the sample for testing.

**907-626.02.1--Audible Bumps.** Audible bumps shall have a profile such that the leading and trailing edges are sloped at a sufficient angle to create an audible and vibratory warning.

Audible bumps shall be at least 0.45 inches above the pavement surface at the highest point of the bump. The height shall be measured after the application of drop-on material. The bumps shall have a minimum dimension of two and one-half inches (2½") in both transverse and longitudinal directions. The bumps may have a drainage channel. The width of each drainage channel shall not exceed one-quarter of an inch (¼") at the bottom of the channel.

**907-626.02.2--Audible Transverse Bars.** The length of transverse bars is the measurement lateral to the direction of travel, also known as transverse width. The width of transverse bars is the measurement parallel to the travel way.

Transverse bars on centerline shall have a length of 10 inches, a width of three inches (3"), and a height of 350 mils. Transverse bars on centerline shall be placed on 2-foot centers through no-passing zones and 5-foot centers through passing zones. Transverse bars on centerline shall be placed in advance of permanent thermoplastic markings.

Transverse bars on edge lines shall have a length of six inches (6"), a width of three inches (3"), and a height of 350 mils. Transverse bars on edge lines shall be placed on 2-foot centers. Tolerance for the longitudinal and transverse measurements shall be one quarter of an inch (¼") and the tolerance for height shall be 50 mils. The above dimensions are based on 6-inch strip application.

Thermoplastic material for edge line transverse bars shall be as specified on the Plans and meet



the requirements of Special Provision 907-720-3 or as specified on the plans. Thermoplastic material for centerline transverse bars shall be black and shall meet the requirements of Special Provision 907-720.

**907-626.02.3--High Contrast Markings.** High contrast markings shall be black with the pertinent marking color overlaid on top and shall meet the requirements of Special Provision 907-720-3.

**907-626.03--Construction Requirements.**

**907-626.03.1--Equipment.** Equipment for hot application shall be of sufficient size and stability to ensure smooth, uniform, properly aligned markings of the dimensions specified. The equipment shall be suitably equipped for heating and controlling the flow of the material. The equipment shall be constructed to provide continuous mixing and agitation of the material. The conveying parts of the equipment, between the main material reservoir and applicator, shall be so constructed as to prevent accumulation and clogging. The equipment shall be constructed so that all mixing and conveying parts, up to and including the applicator, maintain the material at the plastic temperature. The thermoplastic material shall be dispensed at a temperature recommended by the manufacturer. The applicator shall include a cutoff device remotely controlled to provide clean, square stripe ends and to provide a method for applying skip lines. The thermoplastic reservoir shall be insulated and equipped with an automatic thermostatic control to maintain the proper temperature of the material.

The application equipment shall be capable of automatic placement of intermittent and continuous line patterns in single or double line applications simultaneously. The intermittent timer mechanism shall provide a variable ratio of materials applied and variable cycle length such that accurate placement of new patterns, or replacement of existing patterns can be achieved.

When edge lines are placed over rumble strips, the equipment must be able to apply the marking material using the atomization/spray method instead of extrusion/ribbon method.

The equipment shall also be capable of applying the top dressing of optics (beads) in a manner that firmly embeds them into the surface of the thermoplastic material for at least one half of the diameter of the larger gradation sizes of the optics. The dispensing equipment shall be equipped with an automatic cut-off control for the application of the optics that is synchronized with the cut-off of the thermoplastic material.

Optics applied to the surface of the completed stripe shall be applied by an automatic dispenser attached to the pavement marking equipment in such a manner that the optics are immediately dispensed upon the completed line. The dispenser shall be equipped with an automatic cutoff control, synchronized with the cutoff of the pavement marking equipment. The double-drop optics as defined in 907-720-3 shall be automatically applied at a uniform rate to achieve the minimum retroreflectivity requirements of 907-626.03.3.

Upon request, the Engineer will establish the control points for markings at necessary intervals not to exceed 600 feet on tangents and more often on curves. All additional work necessary to establish intermediate control points shall be performed by the Contractor. On curves, unsightly variations

from the normal curvature will not be permitted unless specifically shown on the plans or ordered by the Engineer.

When edge lines are placed over rumble strips, the equipment must be able to apply the marking material using the atomization/spray method instead of extrusion/ribbon method. To ensure the proper alignment of the rumble stripes, the Contractor will be required to place a layout line to be followed during installation of the edge lines over the rumble strips.

**907-626.03.2--Construction Details.** The thermoplastic compound shall be screed or ribbon extruded to the pavement surface. Heat-fused, pre-formed pavement markings shall be fusible to asphalt surfaces by means of the normal heat of a propane weed-burner type of torch or other heating device as recommended by the manufacturer. Heat-fused, pre-formed pavement markings shall be instantly highly reflective without the application of additional optics.

Thermoplastic markings shall not be applied to the pavement surface when the pavement surface temperature is less than 55°F. The pavement surface shall be dry, to the satisfaction of the Engineer, before application will be permitted. Unless otherwise specified by the manufacturer, thermoplastic pavement marking material shall be applied to the surface between 400°F and 450°F with a recommended application temperature being 420°F.

Immediately before application, all areas to be marked shall be thoroughly cleaned. Cleaning may be done by rotary brooms, air blast, scrapers, or whatever combination of equipment is necessary to clean the pavement thoroughly without damage to the pavement surface. On areas of pavement cured with compound, the membrane shall be removed completely by shot blasting, sand blasting or other approved method. Before edge striping, particular care shall be taken to remove all vegetation, loose soil, and the like from the area to be marked. Should other methods fail, the surface shall be wetted with a water jet and scrubbed as necessary to dislodge all foreign material. After washing, the surface shall be allowed to dry thoroughly, and all films of dried mud apparent after surface drying shall be removed before application of markings. Marking shall follow as closely as practicable after the surface has been cleaned and dried, but no markings shall be applied until the surface has been inspected and permission given to proceed. The cost for preparing the surface shall be included in the contract unit prices for the marking items.

Unless otherwise directed by the Engineer, traffic stripes that are conflicting with the thermoplastic stripe shall be removed prior to placement of the thermoplastic material. Removal of pavement markings shall be done by a means that will not gouge the surface of the pavement in a manner that requires patching to ensure the integrity of the pavement. Temporary paint stripe may be left in place when satisfactorily placed in the proper location. Any temporary stripe not covered shall be removed. Payment for removal of stripe, except temporary stripe, will be made under Section 202.

On newly constructed asphalt pavements, any sand, grit, or other surface contaminants shall be removed using compressed air and/or sweeping. Water blasting may be necessary to remove surface contaminants which cannot be removed by the use of compressed air and/or sweeping. This work is considered surface preparation.

The finished lines shall have well defined edges and the thickness of thermoplastic markings above the roadway surface shall be no less than 90 mils for edge lines, center lines, lane lines, barrier lines, and detail stripe including gore markings, and no less than 120 mils for crosswalks, stop lines, and railroad, word and symbol markings. The minimum thickness, as required above, will be measured in the center of the line when gauged. The minimum thickness one-half inch (1/2") from the edges shall not be less than 75% of the thickness required in the center.

Any thermoplastic traffic marking less than the required thickness shall be corrected by recapping at no additional costs to the Department. Although a thickness tolerance of 25 percent from center to edge is allowed, a consistent underrun of any amount in thickness as determined by the Engineer will not be acceptable.

The length and width of lines shall be within a tolerance of ±3 inches and ±1/8 inch, respectively. For skip markings, the tolerance for intervals shall not exceed the line length tolerance. On curves, unsightly variations from the normal curvature will not be permitted unless specifically shown on the plans or ordered by the Engineer.

Heat-fused, pre-formed pavement markings shall be supplied with a minimum average thickness of 90 mils before application on the roadway surface.

All newly applied thermoplastic material shall be protected from traffic until the material is sufficiently dry so as not to sustain damage from vehicle tires. Any material so damaged by traffic shall be repaired, and the thermoplastic material tracked onto the pavement shall be removed and replaced.

**907-626.03.3--Reflectivity Requirements.** The longitudinal pavement markings shall meet the following retroreflectivity values when measured within 10 to 30 calendar days of placement, after removing loose beads.

**Table 1. Minimum Dry Retroreflectivity**

Color	All Stripe without Rumble mcd/m <sup>2</sup> /lx	Rumble Stripe mcd/m <sup>2</sup> /lx
White	375	250
Yellow	275	150

**907-626.03.3.1--Measuring Devices.** Retroreflectivity measurements shall be taken using a vehicle mounted mobile retroreflectometer using 30-meter geometry with video and mapping capabilities as per AASHTO T-398. The retroreflectometer and operator shall be certified by the manufacturer, authorized representative of the manufacturer, or an MDOT approved program such as the Texas A&M Transportation Institute (TTI) Mobile Retroreflectometer Certification Program.

**907-626.03.3.2--Acceptance Procedure.** Averages of the mobile measurements shall be provided for every 0.1 miles unless otherwise specified or approved. Take measurements on each section of roadway for each series of markings (i.e., edge line, center skip line, each line of a double line, etc.) and for each direction of traffic flow. Measure each line in both directions for centerlines on two-way roadways (i.e., measure both double solid line in both directions and measure all center

skip lines in both directions). Furnish measurements in compliance with the below requirements. Use all equipment in accordance with the manufacturer's recommendations and directions. Inform the Engineer at least 24 hours before taking any measurements.

A marking meets the retroreflectivity requirements if:

- The combined average retroreflectivity measurement for a one-mile segment meets the minimum retroreflectivity values specified, and
- No more than 30% of all the retroreflectivity measurement values are below the minimum retroreflectivity requirements value within the one-mile segment.

The one-mile segment will start from the beginning of the data collection and end after a mile worth of measurements have been taken; each subsequent mile of measurements will be a new segment. Centerlines with two (2) stripes (either solid or broken) will result in two (2) miles of data for each mile segment. Each centerline stripe must be tested for compliance as a stand-alone stripe.

The Contractor may elect to restripe with a minimum of 0.060 in. (60 mils) at no cost to the Department each one-mile segment that failed to meet the minimum retroreflectivity requirements. Measurements shall be retaken within 10 to 30 calendar days after the second application for the mile segment for that series of markings. If the markings do not meet minimum retroreflectivity after the second application, the Engineer may require removal of all existing markings, a new application as initially specified, and a repeat of the application process until minimum retroreflectivity requirements are met.

**907-626.03.3.3--Mobile Retroreflectivity Data Collection.** Mobile Retroreflectivity Data Collection (MRDC) shall be conducted on dry pavement only and when the ambient air temperature is greater than 40°F. Data shall be submitted to the Engineer no later than 3 working days after the day the data is collected. Submit all raw data collected in addition to all other data submitted. Provide data files in Microsoft Excel format or a format approved by the Engineer. The data file and video must contain the following information.

**907-626.03.3.3.1--Data File.** Data files shall be provided with the following:

- Date;
- District;
- County;
- Name of mobile retroreflectometer operator;
- Route number with reference markers or other reference information provided by the Engineer to indicate the location of beginning and end data collection points on that roadway;
- Cardinal direction;
- Line type (single solid, single broken, double solid, etc.);
- Line color;
- File name corresponding to video;
- Data for each centerline listed separately;

- Average reading taken for each 0.1-mi. interval (or interval designated by the Engineer);
- Accurate GPS coordinates (within 20 ft.) for each interval;
- Color-coding for each interval indicating passing or failing, unless otherwise directed by the Engineer (passing and failing thresholds provided by the Engineer);
- Graphical representation of the MRDC (y-axis showing retroreflectivity and x-axis showing intervals) corresponding with each data file;
- Distance in miles driven while measuring the pavement markings;
- Event codes (pre-approved by the Engineer) indicating problems with measurement;
- Upper validation threshold (may be included separately with the raw data but must be clearly identified with the data collected using that threshold).

**907-626.03.3.3.2--Map.** A map shall be provided in an electronic format approved by the Engineer with each MRDC submission that includes the following information:

- Date;
- District number;
- County;
- Color-coded 1-mi. intervals (or interval length designated by the Engineer) for passing and failing retroreflectivity values or retroreflectivity threshold values provided by the Engineer; and
- Percentage of passing and failing intervals, if required by the Engineer.

**907-626.03.3.3.3--Video.** A high-quality video file shall be provided with the following information:

- Date and corresponding data file name on label;
- District number;
- County;
- Route number with reference markers or other designated reference information to indicate the location of beginning and end collection points on that roadway; and
- Retroreflectivity values presented on the same screen with the following information:
  - Date;
  - Location;
  - Starting and ending mileage;
  - Total miles;
  - Retroreflectivity readings; and
  - Upper validation thresholds (may be included separately with the raw data but must be clearly identified with the data collected using that threshold).

**907-626.03.4--Reflectivity Verification Testing.** The Engineer or a third party may perform retroreflectivity verification testing on any project. At a minimum, each Contractor performing work for the Department will be verified on an annual basis. The Contractor-submitted retroreflectivity data will be compared to the verification test data to determine acceptability of the Contractor's mobile retroreflectometer data. Comparison of the data will result in one of the two scenarios below:

- Contractor's Data is Validated – If the difference between Contractor's and Engineer/third party data is 20% or less, then the Contractor's data is validated. The Contractor's data will be used for acceptance.
- Contractor's Data is not Validated – If the difference between Contractor's and Engineer/third party data is more than 20%, then the Contractor's data is not validated. The Engineer/third party data will be used for acceptance and the Contractor will be required to take corrective action prior to additional Contractor data collection and may require re-certification of the mobile retroreflectometer.

**907-626.04--Method of Measurement.** Thermoplastic stripe completed in accordance with the plans and specifications will be measured by the mile or by the linear foot, as indicated, from end-to-end of individual stripes. In the case of skip lines the measurement will include skip intervals. The length used to measure centerline, lane lines, and edge stripes will be the horizontal length computed along the roadway.

Detail traffic stripe will be measured by the linear foot from end-to-end of individual stripes. Measurements will be made along the surface of each stripe and will exclude skip intervals where skips are specified. Stripes more than six inches (6") in width will be converted to equivalent lengths of 6-inch stripe.

Hot-applied legend, which is to include railroad markings, pedestrian crosswalks, and stop lines, will be measured by the square foot or linear foot. Pay areas of individual letters and symbols will usually be shown on the plans and measured by the square foot. Transverse railroad bands, pedestrian crosswalks and stop lines will generally be measured by the linear foot, in which case, stripes more than six inches (6") in width will be converted to equivalent lengths of 6-inch widths.

Pre-formed legend which is to include railroad markings and pedestrian crosswalks will be measured and paid for by each.

The length measured for thermoplastic audible bump edge stripe will not include the permanent thermoplastic edge stripe. Permanent thermoplastic edge stripe will be measured for payment under a separate pay item.

Thermoplastic audible bar centerline skip stripe will be measured by the linear foot or mile. Measurements will be made along the surface from end-to-end of the stripe and will include skip intervals. The length used to measure audible bar centerline stripe will be the horizontal length computed along the roadway. The length measured for thermoplastic audible bar centerline skip stripe will not include the permanent centerline continuous or skip stripe. Permanent centerline continuous and skip stripe will be measured for payment under separate pay items.

Thermoplastic audible bar edge stripe will be measured by the linear foot or mile. Measurements will be made along the surface from end-to-end of the stripe. The length used to measure thermoplastic audible bar edge stripe will be the horizontal length computed along the roadway. The length measured for thermoplastic audible bar edge stripe will not include the permanent thermoplastic edge stripe. Permanent thermoplastic edge stripe will be measured for payment

under a separate pay item.

**907-626.05--Basis of Payment.** Thermoplastic traffic markings will be paid for at the contract unit price per mile, linear foot, square foot or each as applicable. Any deductions for non-satisfactory material test results will be made after final testing has been performed.

Payment will be made under:

- 907-626-A: 6" Thermoplastic Traffic Stripe, Skip White - per linear foot or mile
- 907-626-B: 6" Thermoplastic Traffic Stripe, Continuous White - per linear foot or mile
- 907-626-C: 6" Thermoplastic Edge Stripe, Continuous White - per linear foot or mile
- 907-626-D: 6" Thermoplastic Traffic Stripe, Skip Yellow - per linear foot or mile
- 907-626-E: 6" Thermoplastic Traffic Stripe, Continuous Yellow - per linear foot or mile
- 907-626-F: 6" Thermoplastic Edge Stripe, Continuous Yellow - per linear foot or mile
- 907-626-G: Thermoplastic Detail Stripe, Color \* - per linear foot
- 907-626-H: Thermoplastic Legend, Color \* - per linear foot, square foot, or per each
- 907-626-Q: Thermoplastic Audible Bump Edge Stripe -per linear foot or mile
- 907-626-R: Thermoplastic Detail Audible \*\*\* Stripe, Color \*\*, -per mile
- 907-626-AA: 6" High Contrast Thermoplastic Traffic Stripe, Skip White - per linear foot or mile
- 907-626-BB: 6" High Contrast Thermoplastic Traffic Stripe, Continuous White - per linear foot or mile
- 907-626-CC: 6" High Contrast Thermoplastic Edge Stripe, Continuous White - per linear foot or mile
- 907-626-DD: 6" High Contrast Thermoplastic Traffic Stripe, Skip Yellow - per linear foot or mile
- 907-626-EE: 6" High Contrast Thermoplastic Traffic Stripe, Continuous Yellow - per linear foot or mile
- 907-626-FF: 6" High Contrast Thermoplastic Edge Stripe, Continuous Yellow - per linear foot or mile

907-626-GG: High Contrast Thermoplastic Detail Stripe, Color \* - per linear foot

907-626-HH: High Contrast Thermoplastic Legend, Color \* - per linear foot, square foot,  
or each

- \* Indicate Blue - ADA if applicable
- \*\* Indicate White or Black
- \*\*\* Indicate Centerline - Passing Zone, Centerline - No-Passing Zone, or Edge Line



**MISSISSIPPI DEPARTMENT OF TRANSPORTATION**

**SPECIAL PROVISION NO. 907-627-1**

**CODE: (IS)**

**DATE: 06/24/2024**

**SUBJECT: Raised Pavement Markers**

Section 627, Raised Pavement Markers, of the 2017 Edition of the Mississippi Standard Specifications for Road and Bridge Construction is hereby amended as follows:

Delete Subsection 627.02 on page 496, and substitute the following.

**907-627.02--Materials.** Pavement and jiggle markers of the types specified shall conform to the applicable requirements of Subsection 907-720.06 and shall be listed on the Department's APL.

Type B through G High Performance reflective markers shall be listed on the Department's APL for high performance raised pavement markers.

The bituminous adhesive for pavement markers shall meet the requirements of Subsection 907-720.07.3.

**907-627.05--Basis of Payment.** Add the “907” prefix to the pay items listed on page 498.

## MISSISSIPPI DEPARTMENT OF TRANSPORTATION

SPECIAL PROVISION NO. 907-700-1

CODE: (IS)

DATE: 10/25/2022

SUBJECT: Materials and Tests

Section 700, Materials and Tests, of the 2017 Edition of the Mississippi Standard Specifications for Road and Bridge Construction is hereby amended as follows.

After Subsection 700.01 on page 713, add the following.

**907-700.01.1--Buy America Materials Sourcing Requirements for Construction Materials.**

As related to the requirements in Subsection 907-106.14, Construction Materials shall include an article or material that is or consists primarily of non-ferrous metals; plastic and polymer-based products (including polyvinylchloride, composite building materials, and polymers used in fiber optic cables); glass (including optic glass); lumber; or drywall. Construction Materials which are exempt from the requirements in Subsection 907-106.14 include the following: cement or cementitious materials; aggregates such as stone, sand, or gravel; or aggregate binding agents or additives.

For Construction Materials, both the final manufacturing process and the manufacturing stage immediately preceding the final manufacturing process shall occur domestically.

**907-700.01.2--Compliance Requirements.** Prior to incorporation into the work, the Contractor shall furnish the Project Engineer with certificates of compliance documenting conformance to the requirements of Subsection 907-106.14.

The certificates shall be on the Supplier's/Manufacturer's letterhead, containing the following:

- Project number
- Name of manufacturer and address of manufacture location
- Material description
- Batch number / Heat number / Lot number
- Bill of lading number
- Date received
- "I certify each material listed on this certificate to be permanently incorporated in this project has been manufactured domestically."
- Signature of an authorized representative of the Supplier/Manufacturer

# MISSISSIPPI DEPARTMENT OF TRANSPORTATION

SPECIAL PROVISION NO. 907-701-3

CODE: (IS)

DATE: 05/04/2021

SUBJECT: Hydraulic Cement

Section 701, Hydraulic Cement, of the 2017 Edition of the Mississippi Standard Specifications for Road and Bridge Construction is hereby amended as follows.

**907-701.01--General.** In the first sentence of the second paragraph of Subsection 701.01 on page 718, change “mills” to “plants.”

In the second sentence of the sixth paragraph of Subsection 701.01 on pages 718 and 719, change “shall” to “will.”

**907-701.02--Portland Cement.**

**907-701.02.1-General.**

**907-701.02.1.2--Alkali Content.** Delete the sentence in Subsection 701.02.1.2 on page 719, and substitute the following.

When used in portland cement concrete, the total alkali contribution from all cement types in this Subsection shall not exceed 4.0 lb. per cubic yard of concrete calculated as follows:

$$\text{lb alkali per cu Yd} = \frac{(\text{lb cement per cu Yd}) \times (\% \text{Na}_2\text{O equivalent in cement})}{100}$$

In the above calculation, the maximum cement alkali content reported on the cement mill certificate shall be used. An example calculation can be found in the Department’s *Concrete Field Manual*.

**907-701.02.2--Replacement by Other Cementitious Materials.** Delete the paragraph in Subsection 701.02.2 on page 719, and substitute the following.

The maximum replacement of cement by weight is 25% for fly ash or 50% for ground granulated blast furnace slag (GGBFS). Replacement contents below 20% for fly ash or 45% for GGBFS may be used, but will not be given any special considerations, such as the maximum acceptance temperature for portland cement concrete containing pozzolans in Subsection 804.02.13.1.5. Special considerations shall only apply for replacement of cement by fly ash or GGBFS.

Delete Subsection 701.02.2.1 on pages 719 and 720, and substitute the following.

**907-701.02.2.1--Portland Cement Concrete Exposed to Soluble Sulfate Conditions or Seawater.**

When portland cement concrete is exposed to moderate or severe soluble sulfate conditions, or to seawater, cement types and replacement of cement by Class F fly ash or GGBFS shall be as follows in Table 1. Class C fly ash shall not be used as a replacement for cement in any of the sulfate exposure conditions listed in Table 1.

**Table 1- Cementitious Materials for Soluble Sulfate Conditions or Seawater**

Sulfate Exposure	Water-soluble sulfate (SO <sub>4</sub> ) in soil, % by mass	Sulfate (SO <sub>4</sub> ) in water, ppm	Cementitious material required
Moderate and Seawater	0.10 - 0.20	150 - 1,500	Type I cement with one of the following replacements of cement by weight: 24.5 - 25.0% Class F fly ash, or 49.5 - 50.0% GGBFS or Type II <sup>**</sup> cement
Severe	0.20 - 2.00	1,500 - 10,000	Type I cement with a replacement by weight of 49.5 - 50.0% GGBFS, or Type II <sup>*</sup> cement with one of the following replacements of cement by weight: 24.5 - 25.0% Class F fly ash, or 49.5 - 50.0% GGBFS

\* Type III cement conforming to AASHTO M85 with a maximum 8% tricalcium aluminate (C<sub>3</sub>A) may be used in lieu of Type II cement as allowed in Subsection 701.02.1; this cement is given the designation “Type III(MS).”

\*\* Class F fly ash or GGBFS may be added as a replacement for cement as allowed in Subsection 907-701.02.2.

Delete Subsection 701.02.2.2 on page 720, and substitute the following.

**907-701.02.2.2--Portland Cement for Soil Stabilization Exposed to Soluble Sulfate Conditions or Seawater.** When portland cement for use in soil stabilization is exposed to moderate or severe soluble sulfate conditions, or to seawater, cement types and replacement of cement by Class F fly ash or GGBFS shall meet the requirements of Subsection 701.02.2.1.

**907-701.04--Blended Hydraulic Cement.**

**907-701.04.1--General.** Delete Subsection 701.04.1.1 on page 720, and substitute the following.

**907-701.04.1.1--Types of Blended Hydraulic Cement.** Blended hydraulic cements (blended cements) shall be of the following types and conform to AASHTO M 240:

- Type II – Portland-limestone cement
- Type IP – Portland-pozzolan cement
- Type IS – Portland blast-furnace slag cement

Blended cement Types II, IP, and IS meeting the “MS” sulfate resistance requirement listed in AASHTO M 240, Table 3 shall have the “(MS)” suffix added to the type designation.

**907-701.04.1.2--Alkali Content.** Delete the sentence in Subsection 701.04.1.2 on page 720, and substitute the following.

All blended cement types shall be made with clinker that would result in cement meeting the requirements of Subsection 701.02.1.2 when used in the production of AASHTO M 85, Type I or Type II cement.

The blended cement manufacturer shall include the percent equivalent alkalis as Na<sub>2</sub>O on their cement mill reports.

When calculating the total alkali contribution with blended cements, use the equivalent alkali content of the base portland cement. An example calculation for cases where blended cements are used can be found in the Department’s *Concrete Field Manual*.

**907-701.04.2--Replacement by Other Cementitious Materials.** Delete the paragraph in Subsection 701.04.2 on page 720, and substitute the following.

The maximum replacement of blended cement Type II by weight is 35% for fly ash or 50% for GGBFS. Replacement contents below 20% for fly ash or 45% for GGBFS may be used, but will not be given any special considerations, such as the maximum acceptance temperature for blended cement concrete containing pozzolans in Subsection 804.02.13.1.5. Special considerations shall only apply for replacement of blended cement by fly ash or GGBFS.

No additional cementitious materials, such as portland cement, blended cement, fly ash, GGBFS, or others, shall be added to or as a replacement for blended cement Types IP and IS.

Delete Subsection 701.04.2.1 on pages 720 and 721, and substitute the following.

**907-701.04.2.1--Blended Cement Concrete Exposed to Soluble Sulfate Conditions or Seawater.** When blended cement concrete is exposed to moderate or severe soluble sulfate conditions, or to seawater, cement types and replacement of cement by Class F fly ash or GGBFS shall be as follows in Table 2. Class C fly ash shall not be used as a replacement for cement in any of the sulfate exposure conditions listed in Table 2.

**Table 2- Cementitious Materials for Soluble Sulfate Conditions or Seawater**

Sulfate Exposure	Water-soluble sulfate (SO <sub>4</sub> ) in soil, % by mass	Sulfate (SO <sub>4</sub> ) in water, ppm	Cementitious material required
Moderate and Seawater	0.10 - 0.20	150 - 1,500	Type IL (MS) * cement, Type IL cement with one of the following replacements of cement by weight: 24.5 - 35.0% Class F fly ash, or 49.5 - 50.0% GGBFS, Type IP (MS) cement, or Type IS (MS) cement
Severe	0.20 - 2.00	1,500 - 10,000	Type IL cement with a replacement of cement by weight of 49.5 - 50.0% GGBFS, or Type IL (MS) cement with one of following replacements of cement by weight: 24.5 - 35.0% Class F fly ash, or 49.5 - 50.0% GGBFS

\* Class F fly ash or GGBFS may be added as a replacement for cement as allowed in Subsection 907-701.04.2.

Delete Subsection 701.04.2.2 on page 721, and substitute the following.

**907-701.04.2.2--Blended Cement for Soil Stabilization Exposed to Soluble Sulfate Conditions or Seawater.** When blended cement for use in soil stabilization is exposed to moderate or severe soluble sulfate conditions, or to seawater, cement types and replacement of cement by Class F fly ash or GGBFS shall meet the requirements of Subsection 701.04.2.1.

Delete Subsection 701.04.3 on page 721.

# MISSISSIPPI DEPARTMENT OF TRANSPORTATION

**SPECIAL PROVISION NO. 907-702-4**

**CODE: (IS)**

**DATE: 09/11/2018**

**SUBJECT: Bituminous Materials**

Section 702, Bituminous Materials, of the 2017 Edition of the Mississippi Standard Specifications for Road and Bridge Construction is hereby amended as follows.

**907-702.04--Sampling.** Delete the sentence in Subsection 702.04 on page 722, and substitute the following.

Sampling of bituminous materials shall be as set out in AASHTO R 66.

**907-702.07--Emulsified Asphalt.** Delete the last sentence in Subsection 702.07 on page 724, and substitute the following.

Asphalt for fog seal shall conform to the requirements of Subsection 907-702.12, Table V.

**907-702.12--Tables.** Delete Table V in Subsection 702.12 on page 729, and substitute the following.

**TABLE V  
SPECIFICATION FOR FOG SEAL**

Test Requirements	LD-7		CHPF-1		Test Method
	Min.	Max.	Min.	Max.	
Viscosity, Saybolt Furol, @ 25°C, Sec.	10	100	-	100	AASHTO T 72
Storage Stability Test, 24 hr, %	-	1	-	1	AASHTO T 59
Settlement, 5 day, %	-	5	-	-	AASHTO T 59
Oil Distillate, %	-	1	-	-	AASHTO T 59
Sieve Test, % *	-	0.3	-	0.1	AASHTO T 59
Residue by Distillation, %	40	-	40	-	AASHTO T 59
<b>Test on Residue from Distillation</b>					
Penetration @ 25°C, 100g, 5 sec	-	20	40	90	AASHTO T 49
Softening Point, °C	65	-	-	-	ASTM D 36
Solubility in trichloroethylene, %	97.5	-	-	-	AASHTO T 44
Elastic Recovery @ 25°C, %	-	-	40	-	AASHTO T 301
Original DSR @ 82° (G*/Sinδ, 10 rad/sec)	1	-	-	-	AASHTO T 111

\* The Sieve Test result is tested for reporting purposes only and may be waived if no application problems are present in the field.

**MISSISSIPPI DEPARTMENT OF TRANSPORTATION**

**SPECIAL PROVISION NO. 907-703-2**

**CODE: (SP)**

**DATE: 11/29/2022**

**SUBJECT: Gradation**

Section 703, Aggregates, of the 2017 Edition of the Mississippi Standard Specifications for Road and Bridge Construction is hereby amended as follows.

**907-703.03--Coarse Aggregates for Hydraulic Cement Concrete.**

**907-703.03.2--Detail Requirements.**

**907-703.03.2.4--Gradation.** In the table in Subsection 703.03.2.4 on page 734, add 100 for the percent passing by weight on the 1½-inch sieve for Size No. 67 aggregates.

Delete Note 2 under the table in Subsection 703.03.2.4 on page 734, and substitute the following.

Note <sup>2</sup> – 100 percent shall pass the 1-inch sieve for Size 67 used in Class F and Class FX concrete.



**MISSISSIPPI DEPARTMENT OF TRANSPORTATION**

**SPECIAL PROVISION NO. 907-705-1**

**CODE: (IS)**

**DATE: 06/13/2018**

**SUBJECT: Stone Riprap**

Section 705, Stone Blanket Protection and Filter Blanket Materials, of the 2017 Edition of the Mississippi Standard Specifications for Road and Bridge Construction is hereby amended as follows.

**907-705.04--Stone Riprap.** Delete the last sentence of the first paragraph of Subsection 705.04 on page 750, and substitute the following.

Quality requirements for rock to be furnished under these specifications will come from a pre-approved source and be visually approved prior to use.

## MISSISSIPPI DEPARTMENT OF TRANSPORTATION

SPECIAL PROVISION NO. 907-707-3

CODE: (IS)

DATE: 10/27/2021

SUBJECT: Joint Materials

Section 707, Joint Materials, of the 2017 Edition of the Mississippi Standard Specifications for Road and Bridge Construction is hereby amended as follows.

### 907-707.02--Joint Filler.

907-707.02.2--Preformed Sponge, Rubber, Cork and Closed-Cell Polypropylene Foam Joint Fillers for concrete Paving and Structural Constructions. Delete the two paragraphs of Subsection 707.02.2 on page 755, and substitute the following.

Preformed joint filler shall conform to AASHTO M 153 for sponge, rubber, and cork and tested according to ASTM D545. The type required will be indicated on the plans.

Closed-cell polypropylene foam shall conform to the requirements in ASTM D8139 and tested in accordance with ASTM D545.

907-707.02.3--Wood. Delete paragraph (b) of Subsection 707.02.3 on page 755, and substitute the following:

- (b) Dimensions shall be as shown on the plans. Dimensions shown on the plans are “dressed” sizes in accordance with Table 3 of the American Softwood Lumber Standard, SP-20. At the discretion of the Engineer, a 3/4-inch dressed board may be used in lieu of a 1-inch dressed board. A tolerance of plus or minus 1/16 inch thickness and plus or minus 1/8 inch width will be permitted. For slip-form paving a tolerance of minus 1/4 inch on each end in length will be permitted.

907-707.06--Flexible Plastic Gasket for Joining Conduit. Delete the third paragraph of Subsection 707.06 on page 756, and substitute the following.

The Department may require the performance test described in ASTM C 990.

## MISSISSIPPI DEPARTMENT OF TRANSPORTATION

SPECIAL PROVISION NO. 907-708-4

CODE: (IS)

DATE: 09/21/2021

SUBJECT: Concrete Pipe

Section 708, Non-Metal Structures and Cattlepasses, of the 2017 Edition of the Mississippi Standard Specifications for Road and Bridge Construction is hereby amended as follows.

### **907-708.02--Concrete Pipe.**

#### **907-708.02.1--Materials for Use in Concrete Pipe.**

**907-708.02.1.2--Fly Ash.** Delete Subsection 708.02.1.2 on page 758, and substitute the following.

Fly ash conforming to the requirements of Subsection 714.05 may be used to replace hydraulic cement on a one to one replacement rate. If a type IL cement conforming to the requirements of Subsection 701.04 is used, the fly ash replacement shall not exceed 35% by weight of the cement. For all other Types of cement, the fly ash replacement rate shall not exceed 25% by weight of hydraulic cement.

**907-708.02.3--Exceptions to AASHTO Standard Specifications.** After Subsection 708.02.3.7 on page 760, add the following.

**907-708.02.3.8--Lifting Device.** In lieu of lift holes, the producer may cast an approved lifting device in the pipe during the manufacturing process. Should a lifting device be included with the pipe, the Contractor shall cut off or grind down the lifting device flush with the pipe surface after placement of the pipe. The area around the lifting device shall be coated with a sealer approved by the Engineer.

**907-708.02.5--Reinforced Concrete Pipe.** Delete the second paragraph in Subsection 708.02.5 on page 760, and substitute the following.

**907-708.02.5.1--Class V Pipe With Diameter 54 Inches and Greater.** Class V pipe with diameters of 54 inches and larger shall meet the requirements of AASHTO M 170 or M 242 as modified by Subsection 708.02 and herein.

**MISSISSIPPI DEPARTMENT OF TRANSPORTATION**

**SPECIAL PROVISION NO. 907-711-2**

**CODE: (IS)**

**DATE: 09/11/2018**

**SUBJECT: Plain Steel Wire**

Section 711, Reinforcement and Wire Rope, of the 2017 Edition of the Mississippi Standard Specifications for Road and Bridge Construction is hereby amended as follows.

**907-711.02--Deformed and Plain Carbon-Steel Bars for Concrete Reinforcing.**

**907-711.02.3--Steel Welded and Non-Welded Wire Reinforcement, Plain and Deformed, for Concrete.**

**907-711.02.3.1--Plain Steel Wire.** Delete the sentence in Subsection 711.02.3.1 on pages 780 and 781, and substitute the following.

Plain steel wire and plain steel welded wire shall conform to the requirements of AASHTO M 336.

## MISSISSIPPI DEPARTMENT OF TRANSPORTATION

SPECIAL PROVISION NO. 907-712-1

CODE: (SP)

DATE: 12/07/2021

SUBJECT: Fence and Guardrail

Section 712, Fence and Guardrail, of the 2017 Edition of the Mississippi Standard Specifications for Road and Bridge Construction is hereby amended as follows.

**907-712.01--General.** After the sentence in Subsection 712.01 on page 785, add the following.

All materials' inspection, testing, and certification will be performed in accordance with the requirements of the current version of the Department's *Materials Division Inspection, Testing, and Certification Manual*.

Delete Subsections 712.02 and 712.03 on page 785, and substitute the following.

**907-712.02--Barbed Wire.** Barbed wire shall conform to the requirements of AASHTO M 280. In the coastal counties of Hancock, Harrison, and Jackson, either Coating Type Z Class 3 or Coating Type A shall be furnished. In all other areas of the State, either Coating Type Z Class 1, Coating Type Z Class 3, Coating Type ZA Class 60, or Coating Type A shall be furnished.

**907-712.03--Metallic-Coated, Steel Woven Wire Fence Fabric.** Woven wire fencing (i.e., "hog wire") shall conform to the requirements of AASHTO M 279. In the coastal counties of Hancock, Harrison, and Jackson, either Coating Type Z Class 3 or Coating Type A shall be furnished. In all other areas of the State, either Coating Type Z Class 1, Coating Type Z Class 3, Coating Type ZA Class 60, or Coating Type A shall be furnished.

**907-712.04--Chain Link Fence.** Delete Subsections 712.04.1 thru 712.04.7 on pages 785 & 786, and substitute the following.

**907-712.04.1--Fabric.** In the coastal counties of Hancock, Harrison, and Jackson, either Type I Class D, Type II, Type III, or Type IV fabrics shall be furnished. In all other areas of the State, either Type I Class C, Type I Class D, Type II, Type III, or Type IV fabrics shall be furnished.

**907-712.04.2--Tie Wire.** Tie wire shall be of the same material as the fencing wire being used, shall be of good commercial quality, and shall meet the requirements of AASHTO M 181. Either Type I, Type II, Type III, or Type IV tie wire shall be furnished.

**907-712.04.3--Tension Wire.** Tension wire shall be of the same material as the fencing wire being used, shall be of good commercial quality, and shall meet the requirements of AASHTO M 181. In the coastal counties of Hancock, Harrison, and Jackson, either Type I Class 3, Type II, Type III, or Type IV tension shall be furnished. In all other areas of the State, either Type II, Type III, Type IV, or Type I Classes 1, 2, or 3 tension wires shall be furnished.

**907-712.04.4--Posts Rails, Gate Frames, and Expansion Sleeves.** Posts, rails, gate frames, and expansion sleeves shall conform to the requirements for posts in Subsection 712.05.2, unless otherwise designated in the contract.

**907-712.04.5--Miscellaneous Fittings and Hardware.** Miscellaneous fittings and hardware shall conform to the requirements of Subsection 712.16.

**907-712.05--Fence Posts and Braces.**

**907-712.05.1--Treated Timber Posts and Braces.**

**907-712.05.1.1--General.** Delete the third, fourth, fifth, and sixth paragraphs of Subsection 712.05.1.1 on page 787, and substitute the following.

All wood posts and braces shall be treated in accordance with Subsections 718.03 and 718.04.

**907-712.05.1.2--Round Posts.** Delete the last sentence of the last paragraph of Subsection 712.05.1.2 on page 788.

**907-712.05.1.3--Sawed Posts.** Delete the last sentence of the paragraph of Subsection 712.05.1.3 on page 788.

**907-712.05.1.4--Sawed Braces.** Delete the last sentence of the paragraph of Subsection 712.05.1.4 on page 788.

Delete Subsection 712.05.2 on page 788, and substitute the following.

**907-712.05.2--Metal Posts.**

**907-712.05.2.1--Round Steel Pipe.** Round steel pipe shall meet the requirements of AASHTO M 181, either Grade 1 (i.e., meeting the requirements in ASTM F 1083) or Grade 2 (i.e., meeting the requirements of ASTM F 1043).

Round steel pipe shall be sized in accordance with NPS (nominal pipe size) designations as shown on Plans, and not according to the outer or inner pipe diameter.

**907-712.05.2.2--Steel Fence Post and Assemblies, Hot-Wrought.** Steel posts with the following section shapes, Tee, channel or U, and Y-Bar shall meet the requirements of AASHTO M 281, galvanized in accordance with the requirements of AASHTO M 111, unless otherwise specified in the contract. Acceptance of these steel posts shall be by certification from the manufacturer, producer, supplier, or fabricator, as applicable.

**907-712.05.2.3--Blank.**

**907-712.05.2.4--Steel H-Beam Posts.** Steel H-Beam posts shall be produced from structural quality weldable steel having a minimum yield strength of 45,000 psi and shall be galvanized in accordance with ASTM A 123. Steel H-Beam line posts shall be 2.250 inches by 1.625 inches and shall weigh 3.43 pounds per foot. A tolerance of plus or minus 5.0 percent is allowed for

weight per foot. A tolerance of plus or minus 1.0 percent is allowed for dimensions.

**907-712.05.2.5--Aluminum-Alloy Posts and Assemblies.** Round aluminum-alloy posts shall meet the requirements of ASTM B 241, Alloy 6061, T6. Aluminum-Alloy H-Beam posts shall meet the requirements of ASTM B 221, Alloy 6061, T6.

**907-712.05.2.6--Formed Steel Section Posts.** Formed steel section posts, "C" sections, shall be formed from sheet steel conforming to ASTM A 1011, Grade 45, and shall be galvanized in accordance with ASTM A 123.

**907-712.06--Guard and Guardrail Posts.**

**907-712.06.2--Treated Wood Posts.**

**907-712.06.2.1--Square Posts.** Delete the paragraph in Subsection 712.06.2.1 on page 789, and substitute the following.

All square posts shall be inspected for conformance with Section 712.05, except that the posts may be rough and shall be within  $\pm 3/8$ " of the dimensions shown on the plans.

**907-712.06.2.2--Round Posts.** Delete the paragraph in Subsection 712.06.2.2 on page 789, and substitute the following.

All round posts shall be inspected for conformance with Section 712.05, except that the posts shall be of the shape and dimensions shown on the plans.

**907-712.06.5--Treated Wood Blocks for Use with Metal Guardrail Posts.** Delete the paragraphs of Subsection 712.06.5 on pages 789 & 790, and substitute the following.

Treated wood blocks for use with metal guardrail posts shall be within  $\pm 3/8$ " of the size and dimensions shown on the plans, except that a minus tolerance shall not be allowed for the slotted width in which the metal post must fit.

Delete Subsection 712.16 on page 791, and substitute the following.

**907-712.16--Hardware.** All ferrous metal hardware for fencing such as bolts, nuts, washers, and metal straps shall be as specified on the plans and galvanizing shall not be less than 1.0 ounce per square foot of uncoated area. Aluminum coated hardware shall be coated with aluminum meeting the requirements of AASHTO M 181 for aluminum coating and at the rate of not less than 0.4 ounces per square foot of uncoated area.

Aluminum alloy hardware shall conform to the requirements of ASTM B 221 for extruded aluminum alloy 6063, T6. The finished members shall be of uniform quality.

Aluminum-zinc coated hardware shall be coated with an aluminum-zinc alloy meeting the chemical requirements and weight of coating specified for aluminum-zinc alloy coated metal gates.

## MISSISSIPPI DEPARTMENT OF TRANSPORTATION

SPECIAL PROVISION NO. 907-714-3

CODE: (SP)

DATE: 08/31/2021

SUBJECT: Miscellaneous Materials

Section 714, Miscellaneous Materials, of the 2017 Edition of the Mississippi Standard Specifications for Road and Bridge Construction is hereby amended as follows.

**907-714.01--Water.**

**907-714.01.1--General.** Delete the last sentence of the second paragraph in Subsection 714.01.1 on page 794.

**907-714.01.2--Water for Use in Concrete.** Delete Subsection 714.01.2 on page 794, and substitute the following:

Water from municipal sources is permitted be used as mixing water in concrete, mortar, and grout without Department testing. Water from non-municipal water sources used in mixing of concrete, mortar, and grout which does not meet the requirements in Subsection 714.01.1 shall be tested for conformance as required in AASHTO M157, Table 1 and Table 2.

**907-714.01.3--Water for Use in Chemically Stabilized Based.** Delete the first sentence of first paragraph in Subsection 714.01.3 on page 794, and substitute the following:

Water used in the construction of bases that contain cement, lime, or other chemical additive shall be as set out in Subsection 714.01.1. Water from municipal sources is permitted to be used without testing for conformance to the requirements below. If water is not from a municipal source, it shall not contain impurities in excess of the following limits:

Delete Subsection 714.01.6 on page 795, and substitute the following.

**907-714.01.6--Blank.**

**907-714.05--Fly Ash.**

**907-714.05.1--General.** Delete the first sentence of the fifth paragraph in Subsection 714.05.1 on page 797.



**907-714.13--Geotextiles.**

**907-714.13.11--Tables.** Delete Table 1 in Subsection 714.13.11 on page 813, and substitute the following.

**Table 1 - Geotextiles**

Type Designation	I <sup>1</sup> Sediment Control	II <sup>1</sup> Control	III Drainage	IV Paving	V Separation & Drainage		VI Separation, Stabilization & Reinforcement		VIII High Strength	IX High Strength	Test Method
					Woven	Non-Woven	Woven	Non-Woven			
Grab Strength (lb)	50	90	110	90	200	280	180	450	280	280	ASTM D 4632
Elongation (%)	----	50% max @ 45 lb	20% min	50% min @ break	50% min	50% max	50% min	50% max	50% min	50% min	ASTM D 4632
Seam Strength (lb)	----	----	70	----	180	240	160	400	240	240	ASTM D 4632
Puncture Strength (lb)	----	----	40	----	80	110	75	180	115	115	ASTM D 6241
Trapezoidal Tear (lb)	----	----	40	----	80	100	70	150	100	100	ASTM D 4533
Asphalt Retention (gal/yd <sup>2</sup> )	----	----	----	0.2	----	----	----	----	----	----	ASTM D 6140
Permittivity (sec <sup>-1</sup> ) min	0.05	0.05	0.5	----	0.2	0.2	0.2	0.2	0.2	0.2	ASTM D 4491
AOS Woven (mm) max	0.60	0.60	0.6	----	0.6	0.43	----	0.43	----	----	ASTM D 4751
AOS Non-Woven (mm) max	0.84	0.84	0.43	----	0.43	----	0.43	----	0.43	0.43	----
Tensile Strength after UV (% Retained)	70% @ 500 hr	70% @ 500 hr	50% @ 500 hr	----	50% @ 500 hr	50% @ 500 hr	50% @ 500 hr	50% @ 500 hr	50% @ 500 hr	50% @ 500 hr	ASTM D 4355
Melting Point °(F)	----	----	----	325	----	----	----	----	----	----	ASTM D 276
Minimum Ultimate Tensile Strength <sup>3</sup> (lb/in)	----	----	----	----	----	----	----	----	660	2000	ASTM D 4595

Notes: 1 - All property values, with the exception of apparent opening size (AOS), represent minimum average roll values in the weakest principal direction. Values for AOS represent the maximum average roll values, 2 - Values not identified in this table should meet manufacturer certification for the use and application, 3 - Machine direction

Delete Subsection 714.15 on pages 816 and 817 and substitute the following.

**907-714.15--Geogrids.**

**907-714.15.1--General.** A geogrid is defined as a geosynthetic formed by a regular network of connected elements with apertures greater than 0.25 inch to allow interlocking with surrounding soil, rock, and other surrounding materials to function primarily as reinforcement.

Geogrid shall be manufactured from an expanded strain hardened monolithic polymer sheet composed of one or more synthetic polymers and shall be mildew resistant and inert to biological degradation and naturally encountered chemicals, alkalis and acids. The geogrid shall contain stabilizers and/or inhibitors, or a resistance finish or covering to make it resistant to deterioration from direct sunlight, ultraviolet rays, and heat.

Geogrid manufacturers shall participate in and be in compliance with the American Association of State Highway Transportation Officials (AASHTO) National Transportation Product Evaluation Program's (NTPEP) Geosynthetics audit program. Geogrid shall meet the requirements of Table II for the application and type shown on the plans and shall be selected from the Department's Approved Lists.

**907-714.15.1.1--Geogrid for Retaining Walls and Reinforced Soil Slopes.** Geogrid for retaining walls and reinforced soil slopes shall be creep tested in accordance with AASHTO R69 and meet Long Term Design Load, Minimum Ultimate Tensile Strength, and open area criteria listed in Table II. Manufacturers shall perform at least one long-term creep test for no less than 10,000 hours in accordance to ASTM D 5262 for each polymer or composition of polymers from which the geogrid is produced. The long-term design load that shall be reported for design use, shall be that load at which no more than 10% strain occurs over a 100-year design life of the geogrid, as calculated in accordance with AASHTO R69. Long-term design loads shall be reported unfactored, and the AASHTO strength reduction factors (Durability and Installation, and safety factors) will be considered by the Department's Geotechnical Branch on a site specific design basis.

**907-714.15.1.2--Geogrid for Subgrade Stabilization.** Geogrid for subgrade stabilization shall meet Minimum Ultimate Tensile Strength and open area criteria listed in Table II.

**907-714.15.2--Marking, Shipment, and Storage.** Each roll or container of geogrid shall be visibly labeled with the name of the manufacturer, trade name of the product, lot number, and quantity of material. In addition, each roll or container shall be clearly tagged to show the type designation that corresponds to that required by the plans. During shipment and storage the geogrid shall be protected from direct sunlight, and temperatures above 120°F or below 0°F. The geogrid shall either be wrapped and maintained in a heavy duty protective covering or stored in a safe enclosed area to protect from damage during prolonged storage.

**907-714.15.3--Manufacturer Certification.** The Contractor shall furnish the Engineer three copies of the manufacturer's certified test reports indicating that the geogrid furnished conforms to the requirements of the specifications and is of the same composition as the originally approved

by the Department.

**907-714.15.4--Acceptance Sampling and Testing.** Final acceptance of each shipment will be based upon results of tests performed by the Department on verification samples submitted from the project, as compared to the manufacturer's certified test reports. The Engineer will select one roll or container at random from each shipment for sampling. As sample extending full width of the randomly selected roll or container and being at least five (5) square yards in area will be obtained and submitted by the Engineer. All material samples shall be provided at no cost to the State.

**TABLE II  
GEOGRIDS**

Physical Properties	Type Designation						Test Method
	I	II	III	IV	V	VI	
Long Term Design Load <sup>1</sup> , pounds per foot, Machine Direction	250	500	750	1500	2500	3500	AASHTO R69, ASTM D5262
Minimum Ultimate Tensile Strength <sup>2</sup> , pounds per foot, Machine Direction	500	1000	1500	3000	5000	7000	ASTM D6637
Open Area, percent	70	70	50	50	50	50	Direct Measurement

<sup>1</sup> Minimum design criteria requirement.

<sup>2</sup> Minimum Average Roll Value (MARV).

## MISSISSIPPI DEPARTMENT OF TRANSPORTATION

SPECIAL PROVISION NO. 907-718-1

CODE: (SP)

DATE: 12/07/2021

SUBJECT: Timber and Dimension Lumber

Section 718, Timber and Dimension Lumber, of the 2017 Edition of the Mississippi Standard Specifications for Road and Bridge Construction is hereby amended as follows.

Delete the Subsections in Section 718 on pages 836 thru 838, and substitute the following.

**907-718.01--General.** All timber and dimension lumber shall be Southern pine and shall conform in all respects to applicable requirements of AASHTO M 168. The Department reserves the right to sample and to test all materials at any time; all inspection, testing, and certification of materials will be performed in accordance with the requirements of the current version of the Department's *Materials Division Inspection, Testing, and Certification Manual*.

Timber and dimension lumber shall be furnished in the sizes shown on the plans or as specified. Unless otherwise specified, timber and dimension lumber shall be No. 1, or better, graded according to the latest American Lumber Standards.

Only one type of preservative shall be used for the treatment of materials for any one class of construction on a project, unless otherwise specified.

Where treated timber and dimensional lumber is to be used in non-highway construction or use, such as decking, handrails in walking trails, or in any manner where general public exposure by touch is possible, the treatment requirements will be as per project plans and/or approved by the State Materials Engineer.

**907-718.02--Untreated Timber and Dimension Lumber.** Untreated timber and dimension lumber shall conform to the requirements of AASHTO M 168.

**907-718.03--Treated Timber and Dimension Lumber.** Timber and dimension lumber to be treated shall meet the requirements herein specified and shall be treated as specified. Treated timber or dimensional lumber will not be accepted for use unless it has been inspected by an authorized representative of the Department and found to be satisfactory after treatment.

**907-718.03.1--Blank.**

**907-718.03.2--Treatment.**

**907-718.03.2.1--General.** All materials shall be treated in accordance with AASHTO M 133 unless otherwise directed by the Environmental Protection Agency (EPA).

**907-718.03.2.2--Blank.**

**907-718.03.2.3--Inspection.** Treated timber and dimension lumber shall be inspected by an authorized representative of the Department before being incorporated into the work. Treatment reports shall be provided to the Department for each lot of material supplied.

**907-718.03.3--Blank.**

**907-718.03.4--Storage of Treated Material.** All material treated for stock shall be stacked as compactly as possible on a well-drained surface. Material shall be supported on sills spaced as necessary, not to exceed 10 foot intervals and shall have at least one foot of air space beneath the stacks.

All materials treated with preservatives for use in buildings and applications where painting is required shall be dried after treatment. The treated wood shall be dried in accordance with American Lumber Standards.

**907-718.04--Preservative.** Preservatives shall be as specified in AASHTO M 133 unless otherwise directed by the Environmental Protection Agency (EPA).

# MISSISSIPPI DEPARTMENT OF TRANSPORTATION

SPECIAL PROVISION NO. 907-720-3

CODE: (IS)

DATE: 07/09/2024

SUBJECT: Pavement Marking Materials

Section 720, Pavement Marking Materials, of the 2017 Edition of the Mississippi Standard Specifications for Road and Bridge Construction is hereby amended as follows.

Delete Section 720 on pages 840 thru 854, and substitute the following.

## **SECTION 720 - PAVEMENT MARKING MATERIALS**

**907-720.01--General.** The Department reserves the right to perform sampling and testing of any materials at any time. Upon request of the Engineer, samples of the material shall be furnished.

**907-720.02--Color Requirements.** All pavement markings except raised pavement markers are required to meet the color requirements of ASTM D6628.

**907-720.03--Optics.** Optics used in thermoplastic pavement markings shall consist of a double-drop system of glass beads or advanced optics.

**907-720.03.1--Glass Beads.** The manufacturer shall furnish the Engineer with a certified test report indicating that the glass beads meet AASHTO M 247. AASHTO Type 4 beads shall be applied to the newly placed stripe first, followed by the application of AASHTO Type 1 beads. Type 1 and 4 glass beads shall be transparent, clean, colorless glass, smooth and spherically shaped, free from milkiness, pits, or excessive air bubbles. Type 1 and 4 glass beads shall be coated with a bead coating that is compatible with the traffic marking material to which the glass beads will be applied and will provide adequate moisture proofing, increased adhesion, and optimum embedment of the glass beads.

**907-720.03.1.1--Acceptance Procedure.** The Contractor shall furnish the Engineer with a copy of the manufacturer's certified test reports for the lot(s) of materials from which the shipment originated. The test report shall show all the test results for the material properties and characteristics as specified herein. The test report shall state that the material represented by the test results meets all the requirements of the contract. It shall be the Contractor's responsibility to furnish the manufacturer's test report to the Engineer for each shipment of material to the project.

Acceptance sampling and testing will be in accordance with the Materials Division Inspection, Testing, and Certification Manual (Materials Manual). Samples of the material shall be furnished and shall be provided at no cost to the State.

**907-720.03.2--Advanced Optics.** Advanced optics are materials that do not meet the specific requirements of AASHTO M 247 but produce a final drop-on optics system that meets or exceeds

the reflectivity requirements in Special Provision 907-626. Advanced optics shall be a double-drop system that is pre-approved and listed on the Department's Approved Products List.

**907-720.03.2.1--Acceptance Procedure.** The Contractor shall furnish the Engineer with a copy of the manufacturer's certified test reports for the lot(s) of materials from which the shipment originated. The test report shall show all the test results for the material properties and characteristics as specified herein. The test report shall state that the material represented by the test results meets all the requirements of the contract. It shall be the Contractor's responsibility to furnish the manufacturer's test report to the Engineer for each shipment of material to the project.

Acceptance sampling and testing may be conducted at the request of the Engineer. Samples of the material shall be furnished and shall be provided at no cost to the State.

**907-720.04--Thermoplastic Marking Material.**

**907-720.04.1--General.** Thermoplastic marking material shall meet the color requirements of Subsection 907-720.02.

There shall be no obvious change in the color of the material if held at its plastic temperature for a period of four (4) hours nor by reason of four (4) re-heatings to its plastic temperature.

The pavement markings shall maintain its original dimension and placement. The material shall not be slippery when wet and it shall not lift from the pavement in freezing weather.

**907-720.04.2--Extruded Thermoplastic Material.** Extruded thermoplastic pavement marking material shall meet the requirements of AASHTO M 249, and shall meet the requirements of 907-720.04 with the following exceptions:

- Blue - ADA thermoplastic marking material shall meet the requirements of Subsection 907-720.04.2 with the exception that the color shall be Blue – ADA, and the Contractor may use hot applied thermoplastic materials meeting the satisfaction of the Engineer.

**907-720.04.3--Spray-Applied Thermoplastic Material.** Spray-applied thermoplastic pavement marking material shall meet the requirements of AASHTO M 249 and shall meet the requirements of 907-720.04.

**907-720.04.4--Pre-formed Thermoplastic Material.** Heat-fused, pre-formed thermoplastic pavement marking material shall meet the color requirements of 907-720.02.

**907-720.04.5--Acceptance Procedure.** The Contractor shall furnish the Engineer with a copy of the manufacturer's certified test reports for the lot(s) of materials from which the shipment originated. The test report shall show all the test results for the material properties and characteristics as specified herein. The test report shall state that the material represented by the test results meets all the requirements of the contract. It shall be the Contractor's responsibility to furnish the manufacturer's test report to the Engineer for each shipment of material to the project.

**907-720.05--Pavement Marking Tape.**

**907-720.05.1--General.** Pavement marking tape shall be listed on the Department's Approved Lists.

**907-720.05.2--Cold Plastic Pavement Markings (Permanent Pavement Marking Tape).** Pavement marking tape for use in roadway applications shall be designated on the Department's Approved Lists as permanent.

The prefabricated markings described shall consist of white or yellow pigmented plastic films with reflective optics uniformly distributed throughout their entire cross-sectional area, and be capable of being affixed by either a pressure sensitive pre-coated adhesive or a liquid contact cement. The markings shall be provided complete in a form that will facilitate rapid application and protect the markings in shipment and storage. The manufacturer shall identify proper solvents and/or adhesives to be applied at the time of application, all equipment necessary for proper application, and recommendations for application that will assure an effective performance life.

Prefabricated legends and symbols shall conform to the applicable shapes and sizes as outlined in the current "Manual on Uniform Traffic Control Devices."

**907-720.05.2.1--Specific Requirements.** Unless otherwise indicated on the plans, the patterned material without adhesive shall have a minimum caliper of 0.065 inch at the thickest portion of the patterned cross-section and a minimum caliper of 0.020 inch at the thinnest portion of the cross-section. The material shall be a pliant polymer film with 50±15% of the surface are raised and presenting a near vertical face angle of 0° to 60° to traffic from any direction. The channels between the raised areas shall be substantially free of exposed optics or particles.

The size and quality of the optics will be such that performance requirements of Subsection 907-720.02 for the retroreflective pliant polymer film shall be met. The pigments shall be selected and blended to provide a marking film that is white or yellow conforming to the performance requirements of Subsection 907-720.02 through the expected life of the film.

**907-720.05.2.2--Conformability and Resealing.** The marking shall be capable of conforming to pavement contours, breaks, faults, etc. through the action of traffic at normal pavement temperatures.

The marking shall have resealing characteristics that allows it to be capable of fusing with itself and previously applied marking of the same composition under normal conditions of use. The marking shall be capable of use for patching worn areas of the same type in accordance with manufacturer's instructions.

**907-720.05.2.3--Tensile Strength and Elongation.** The material shall have a minimum tensile strength of 40 pounds per square inch of cross section when tested according to ASTM D 638. A 6-inch x 1-inch x 0.06-inch sample shall be tested at a temperature between 70°F and 80°F using a jaw speed of 12 inches per minute.



The material shall have a minimum elongation of 75% at break when tested according to ASTM D 638 using a jaw speed of 12 inches per minute.

**907-720.05.2.4--Skid Resistance.** The surface of the material shall provide a minimum skid resistance value of 45 BPN when tested according to ASTM E 303 except values will be taken at downweb and at a 45-degree angle from downweb. These two values will then be averaged to find the skid resistance of the patterned surface.

**907-720.05.2.5--Effective Performance Life and Warranty.** When applied according to the recommendations of the manufacturer the pavement marking tape shall provide a neat and durable marking that will not flow or distort due to temperature if the pavement surface remains stable. The film shall be weather resistant and through normal traffic wear shall show no appreciable fading, lifting, or shrinkage throughout the useful life of the marking, nor shall it show significant tearing, roll back, or other signs of poor adhesion.

All manufacturer's standard warranties and guarantees on pavement marking tape, which are provided as customary trade practice, shall be delivered to the Engineer at the final inspection. All warranties and guarantees shall be made out to the Department.

**907-720.05.2.6--Acceptance Procedure.** The Contractor shall furnish the Engineer with a copy of the manufacturer's certified test reports for the lot(s) of materials from which the shipment originated. The test report shall show all the test results for the material properties and characteristics as specified herein. The test report shall state that the material represented by the test results meets all the requirements of the contract. It shall be the Contractor's responsibility to furnish the manufacturer's test report to the Engineer for each shipment of material to the project.

Acceptance sampling and testing will be in accordance with the Materials Division Inspection, Testing, and Certification Manual (Materials Manual). Samples of the material shall be furnished and shall be provided at no cost to the State.

**907-720.05.3--Preformed Pavement Markings for Construction Zones.** Preformed pavement markings for construction zones shall be designated Department's Approved Lists as temporary. Retroreflective preformed pavement markings for construction zones shall be as specified on the plans or in the contract documents.

The markings shall be provided in specified widths and shapes. Preformed words and symbols shall conform to the applicable shapes and sizes as outlined in the current "Manual on Uniform Traffic Control Devices for Streets and Highways," or as modified.

The materials shall be packaged in accordance with accepted commercial standards and when stored indoors in a cool dry place, shall be suitable for use one year after date of purchase.

**907-720.05.3.1--Specific Requirements.** Preformed markings shall consist of retroreflective materials on a conformable backing and shall meet the performance requirements of Subsection 907-720.02. The markings shall consist of a mixture of high-quality polymeric materials, pigments, and optics with a reflective layer of optics bonded to the top surface. The markings shall

be pre-coated with a pressure sensitive adhesive capable of adhering to pavement in accordance with the manufacturer's instructions without the use of heat, solvents, or other additional adhesives. The markings and/or adhesive shall not require any curing time after application. A coated non-metallic medium shall be incorporated with the pressure sensitive adhesive to facilitate removal.

**907-720.05.3.2--Acceptance Procedure.** The Contractor shall furnish the Engineer with a copy of the manufacturer's certified test reports for the lot(s) of materials from which the shipment originated. The test report shall show all the test results for the material properties and characteristics as specified herein. The test report shall state that the material represented by the test results meets all the requirements of the contract. It shall be the Contractor's responsibility to furnish the manufacturer's test report to the Engineer for each shipment of material to the project.

**907-720.06--Raised Pavement Markers.**

**907-720.06.1--General.** Pavement markers shall be listed on the Department's Approved Lists and shall conform to ASTM D 4280.

**907-720.06.2--Packaging.** Shipments shall be made in containers acceptable to common carriers and packaged in such a manner as to ensure delivery in perfect condition. All damaged shipments shall be replaced by the Contractor. Each package shall be clearly marked as to the name of the manufacturer, type, quantity enclosed, lot number, and date of manufacture.

**907-720.06.3--Non-Reflective Pavement Markers.** Non-reflective pavement markers are occasionally referred to as "jiggle markers". Non-reflective markers consisting of a heat-fired, vitreous, ceramic base, and a heat-fired, opaque, glazed surface are permitted for use; the bottom of the marker shall not be glazed. Ceramic markers shall be produced from any suitable combination of intimately mixed clays, shales, talcs, flints, feldspars, or other inorganic material. Ceramic markers shall be thoroughly and evenly matured, and all non-reflective pavement markers shall be free from defects which affect appearance or serviceability.

Ceramic non-reflective markers shall conform to the following finish and testing requirements in Table 2 below.

**Table 2**

<b>Ceramic Non-Reflective Marker Requirements</b>	
Glaze Thickness	0.005 inch, minimum
Mohs Hardness	6, minimum
Autoclave	Glaze shall not spall, craze, or peel.
Compressive Strength	750 psi, minimum
Water Absorption	2.0%, maximum

**907-720.06.4--Acceptance Procedure.** The Contractor shall furnish the Engineer with a copy of the manufacturer's certified test reports for the lot(s) of materials from which the shipment originated. The test report shall show all the test results for the material properties and characteristics as specified herein. The test report shall state that the material represented by the test results meets all the requirements of the contract. It shall be the Contractor's responsibility to

furnish the manufacturer's test report to the Engineer for each shipment of material to the project.

**907-720.07--Adhesive for Pavement Markers.**

**907-720.07.1--General.** The adhesive shall be listed on the Department’s Approved Lists and shall be an asphaltic material suitable for bonding pavement markers to surfaces when the road surface and marker temperatures are in the range of 50°F to 160°F. The composition of the adhesive must be such that its properties will not deteriorate when heated to and applied at temperatures up to 425°F. Samples may be submitted in the form of an adhesive testing package from each batch or material obtained from a package shipped to the project.

**907-720.07.2--Packaging and Labeling.** The adhesive shall be packaged in self-releasing cardboard containers that will stack properly. The label shall show the manufacturer, quantity, and lot or batch number. "Adhesive for Pavement Markers" or "Adhesive for Traffic Markers" shall be printed in bold lettering on the label.

**907-720.07.3--Bituminous Adhesive.** The asphaltic adhesive material shall be flexible type.

**907-720.07.3.1--Flexible Bituminous Adhesive.** Flexible bituminous adhesive shall be designated on the Department’s Approved Lists as flexible and shall comply with requirements of Table 3 below.

**Table 3**

<b>Flexible Bituminous Adhesive Properties</b>			
	Min	Max	Test Method
Penetration @ 77°F	-	25	ASTM D 5
Softening Point, °F	200	-	ASTM D 36
Brookfield Viscosity @ 400°F, cp.	-	10,000	ASTM D 3236
Ductility @ 77°F, 5 cm/min	15	-	ASTM D 113
Ductility @ 39.2°F, 1 cm/min	5	-	ASTM D 113
Asphalt Compatibility	Pass		ASTM D 5329
Flexibility @ 20°F	Pass		Per Subsection

**907-720.07.4--Acceptance Procedure.** The Contractor shall furnish the Engineer with a copy of the manufacturer's certified test reports for the lot(s) of materials from which the shipment originated. The test report shall show all the test results for the material properties and characteristics as specified herein. The test report shall state that the material represented by the test results meets all the requirements of the contract. It shall be the Contractor's responsibility to furnish the manufacturer's test report to the Engineer for each shipment of material to the project.

Acceptance sampling and testing will be in accordance with the Materials Division Inspection, Testing, and Certification Manual (Materials Manual). Samples of the material shall be furnished and shall be provided at no cost to the State.

**MISSISSIPPI DEPARTMENT OF TRANSPORTATION**

**SPECIAL PROVISION NO. 907-721-4**

**CODE: (IS)**

**DATE: 04/19/2022**

**SUBJECT: Materials for Signing**

Section 721, Materials for Signing, of the 2017 Edition of the Mississippi Standard Specifications for Road and Bridge Construction is hereby amended as follows.

**907-721.06--Reflective Sheeting.**

**907-721.06.2--Performance Requirements.** Delete Table 4 and Table 5 in Subsection 721.06.2 on pages 860 & 861, and substitute the following.

**MINIMUM COEFFICIENTS OF RETROREFLECTION  
Candela per foot candle per square foot (cd/ft<sup>2</sup>)  
Per ASTM Designation D4956**

**TABLE 4  
Type IX Sheeting**

Observation Angle	Entrance Angle	White	Yellow	Green	Red	Blue	Fluorescent Yellow/Green	Fluorescent Yellow	Fluorescent Orange
0.2°	-4.0°	380	285	38	76	17	300	230	115
0.2°	+30.0°	215	162	22	43	10	170	130	65
0.5°	-4.0°	240	180	24	48	11	190	145	72
0.5°	+30.0°	135	100	14	27	6.0	110	81	41
1.0°	-4.0°	80	60	8.0	16	3.6	64	48	24
1.0°	+30.0°	45	34	4.5	9.0	2.0	36	27	14

**TABLE 5  
Type XI Sheeting**

Observation Angle	Entrance Angle	White	Yellow	Green	Red	Blue	Brown	Fluorescent Yellow/Green	Fluorescent Yellow	Fluorescent Orange
0.2°	-4.0°	580	435	58	87	26	17	460	350	175
0.2°	+30.0°	220	165	22	33	10	7.0	180	130	66
0.5°	-4.0°	420	315	42	63	19	13	340	250	125
0.5°	+30.0°	150	110	15	23	7.0	5.0	120	90	45
1.0°	-4.0°	120	90	12	18	5.0	4.0	96	72	36
1.0°	+30.0°	45	34	5.0	7.0	2.0	1.0	36	27	14

After Subsection 721.10 on page 864, add the following.

**907-721.11--Digital Applied Printing.** The following addresses the requirements for digitally printed finished retroreflective traffic control signs on flat sheet aluminum and digitally printed traffic sign faces intended to be applied to a sign substrate.

**907-721.11.1--Digitally Printed Ink Systems.** Traffic signs must be produced using components, and processes that comply with the retroreflective sheeting manufacturer’s recommendations.

Digital printed ink systems used to print traffic signs must meet and comply with daytime and nighttime chromaticity (color standards) as recognized in ASTM D4956 “Standard Specification for Retroreflective Sheeting for Traffic Control.”

Digital printed ink systems must meet 70% of the initial retroreflectivity specifications of each respective reflective film color as found in ASTM D4956 “Standard Specification for Retroreflective Sheeting for Traffic Control.”

Prior to fabrication and preferably at the preconstruction meeting, the Contractor shall advise the Project Engineer in writing as to which signs on the project will be digitally printed and which ones will be screen printed. The Contractor shall submit to the Project Engineer certifications for all digitally printed signs, which will be forwarded to the State Traffic Engineer for review.

**907-721.11.2--Protective Overlay Film.** Permanent traffic signs printed with digital ink systems will be fabricated with a full sign protective overlay film designed to provide a smooth surface needed for retroreflectivity, and to protect the sign from fading and UV degradation. The overlamine shall comply with the retroreflective sheeting manufacturer’s recommendations to ensure proper adhesion and transparency and will also meet the reflective film durability as identified in Table 1.

**Table 1  
Retroreflective Film Minimum Durability Requirements**

<b>ASTM D4956 Type</b>	<b>Full Sign Replacement Term (years)</b>	<b>Sheeting Replacement Term (years)</b>
IV	7	10
VIII	7	10
IX	7	12
XI	7	12

Temporary signs used in work zones printed with black ink only will not require a protective overlay film as long as the finished sign is warranted for a minimum outdoor durability of three years by the sheeting manufacturer.

**907-721.11.3--Inspection.** During fabrication, the Contractor shall provide sufficient testing and quality control throughout fabrication to insure good workmanship. Once the material has been received, it may be subject to random testing to ensure compliance with all requirements. If any test samples do not conform to the requirements, the entire order may be returned at the vendor’s expense.

**907-721.11.4--Traffic Sign Performance Warranty Provisions.** Based on the ASTM Type of sheeting specified, traffic control signs shall be warranted for the duration shown in Table 1. The Contractor shall supply a copy of the warranty document with complete details of terms and conditions upon request of the Department.

**907-721.11.5--Certified Digital Sign Fabricator.** Sign fabricators using digital imaging methods to produce regulated traffic signs must be certified by the reflective sheeting manufacturer whose materials are used to produce the delivered signs.

Certified sign fabricators must undergo an audit process by the sheeting manufacturer to ensure they have the proper equipment, manufacturing capabilities, manufacturing application processes and the materials required to fulfill the sheeting manufacturer's warranty obligations. Sign fabricators must recertify annually with reflective sheeting manufacturers or utilize a 3<sup>rd</sup> party certifier approved by the reflective sheeting manufacturer.

The Contractor shall submit proof of Sign Fabricator Certification as issued by the retroreflective sign sheeting manufacturer to the Project Engineer upon delivery of the signs, or with the Shop Drawings.

# SECTION 905 - PROPOSAL

Date \_\_\_\_\_

Mississippi Transportation Commission  
Jackson, Mississippi

Sirs: The following proposal is made on behalf of \_\_\_\_\_  
\_\_\_\_\_ of \_\_\_\_\_

for constructing the following designated project(s) within the time(s) hereinafter specified.

The plans are composed of drawings and blue prints on file in the offices of the Mississippi Department of Transportation, Jackson, Mississippi.

The Specifications are the current Standard Specifications of the Mississippi Department of Transportation approved by the Federal Highway Administration, except where superseded or amended by the plans, Special Provisions and Notice(s) to Bidders attached hereto and made a part thereof.

I (We) certify that I (we) possess a copy of said Standard and any Supplemental Specifications.

Evidence of my (our) authority to submit the Proposal is hereby furnished. The proposal is made without collusion on the part of any person, firm or corporation. I (We) certify that I (we) have carefully examined the Plans, the Specifications, including the Special Provisions and Notice(s) to Bidders, herein, and have personally examined the site of the work. On the basis of the Specifications, Special Provisions, Notice(s) to Bidders, and Plans, I (we) propose to furnish all necessary machinery, tools, apparatus and other means of construction and do all the work and furnish all the materials in the manner specified. I (We) understand that the quantities mentioned herein are approximate only and are subject to either increase or decrease, and hereby propose to perform any increased or decreased quantities of work at the unit prices bid, in accordance with the above.

I (We) acknowledge that this proposal will be found irregular and/or non-responsive unless a certified check, cashier's check, or Proposal Guaranty Bond in the amount as required in the Advertisement (or, by law) is submitted electronically with the proposal or is delivered to the Contract Administration Engineer prior to the bid opening time specified in the advertisement.

**INSTRUCTION TO BIDDERS: Alternate and Optional Items on Bid Schedule.**

1. Two or more items entered opposite a single unit quantity WITHOUT DEFINITE DESIGNATION AS "ALTERNATE ITEMS" are considered as "OPTIONAL ITEMS". Bidders may or may not indicate on bids the Optional Item proposed to be furnished or performed WITHOUT PREJUDICE IN REGARD TO IRREGULARITY OF BIDS.
2. Items classified on the bid schedule as "ALTERNATE ITEMS" and/or "ALTERNATE TYPES OF CONSTRUCTION" must be preselected and indicated on bids. However, "Alternate Types of Construction" may include Optional Items to be treated as set out in Paragraph 1, above.
3. Optional items not preselected and indicated on the bid schedule MUST be designated in accordance with Subsection 102.06 prior to or at the time of execution of the contract.
4. Optional and Alternate items designated must be used throughout the project.

I (We) further propose to perform all "force account or extra work" that may be required of me (us) on the basis provided in the Specifications and to give such work my (our) personal attention in order to see that it is economically performed.

I (We) further propose to execute the attached contract agreement (Section 902) as soon as the work is awarded to me (us), and to begin and complete the work within the time limit(s) provided for in the Specifications and Advertisement. I (We) also propose to execute the attached contract bond (Section 903) in an amount not less than one hundred (100) percent of the total of my (our) part, but also to guarantee the excellence of both workmanship and materials until the work is finally accepted.

I (We) shall submit electronically with our proposal or deliver prior to the bid opening time a certified check, cashier's check or bid bond for **five percent (5%) of total bid** and hereby agree that in case of my (our) failure to execute the contract and furnish bond within Ten (10) days after notice of award, the amount of this check (bid bond) will be forfeited to the State of Mississippi as liquidated damages arising out of my (our) failure to execute the contract as proposed. It is understood that in case I am (we are) not awarded the work, the check will be returned as provided in the Specifications.

**SECTION 905 -- PROPOSAL (CONTINUED)**

I (We) hereby certify by digital signature and electronic submission via Bid Express of the Section 905 proposal below, that all certifications, disclosures and affidavits incorporated herein are deemed to be duly executed in the aggregate, fully enforceable and binding upon delivery of the bid proposal. I (We) further acknowledge that this certification shall not extend to the bid bond or alternate security which must be separately executed for the benefit of the Commission. This signature does not cure deficiencies in any required certifications, disclosures and/or affidavits. I (We) also acknowledge the right of the Commission to require full and final execution on any certification, disclosure or affidavit contained in the proposal at the Commission's election upon award. Failure to so execute at the Commission's request within the time allowed in the Standard Specifications for execution of all contract documents will result in forfeiture of the bid bond or alternate security.

Respectfully Submitted,

DATE \_\_\_\_\_

\_\_\_\_\_  
Contractor

BY \_\_\_\_\_  
Signature

TITLE \_\_\_\_\_

ADDRESS \_\_\_\_\_

CITY, STATE, ZIP \_\_\_\_\_

PHONE \_\_\_\_\_

FAX \_\_\_\_\_

E-MAIL \_\_\_\_\_

(To be filled in if a corporation)

Our corporation is chartered under the Laws of the State of \_\_\_\_\_ and the names, titles and business addresses of the executives are as follows:

\_\_\_\_\_  
President Address

\_\_\_\_\_  
Secretary Address

\_\_\_\_\_  
Treasurer Address

The following is my (our) itemized proposal.



Overlay approximately 10 miles of SR 43 from SR 481 to the Madison County Line, known as State Project No. SP-0037-04(061) / 107633301 in Rankin County.

Line no.	Item Code	Adj Code	Quantity	Units	Description[Fixed Unit Price]
<b>Roadway Items</b>					
0010	202-B009		1,876	Square Yard	Removal of Asphalt Pavement, Failed Areas
0020	202-B052		7	Square Yard	Removal of Concrete Driveways, All Depths
0030	202-B158		6,450	Linear Feet	Removal of Guard Rail, Including Rails, Posts and Terminal Ends
0040	202-B191		115	Linear Feet	Removal of Pipe, 8" And Above
0050	202-B213		1	Each	Removal of Sign
0060	203-G001	(E)	1,785	Cubic Yard	Excess Excavation, FM, AH
0070	206-A001	(S)	155	Cubic Yard	Structure Excavation
0080	304-D002	(GT)	5,638	Ton	Granular Material, Crushed Stone
0090	403-A002	(BA1)	24,539	Ton	12.5-mm, MT, Asphalt Pavement
0100	403-B002	(BA1)	2,965	Ton	12.5-mm, MT, Asphalt Pavement, Leveling
0110	403-C002	(BA1)	3,940	Ton	19-mm, MT, Asphalt Pavement, Trench Widening
0120	406-D001		222,128	Square Yard	Fine Milling of Bituminous Pavement, All Depths
0130	407-A001	(A2)	19,640	Gallon	Asphalt for Tack Coat
0140	423-A001		24	Mile	Rumble Strips, Ground In
0150	503-C010		1,823	Linear Feet	Saw Cut, Full Depth
0160	601-B001	(S)	9	Cubic Yard	Class "B" Structural Concrete, Minor Structures
0170	603-CA076	(S)	104	Linear Feet	48" Reinforced Concrete Pipe, Class III
0180	603-CB008	(S)	2	Each	48" Reinforced Concrete End Section
0190	606-B003		6,870	Linear Feet	Guard Rail, Class A, Type 1, 'W' Beam, Metal Post
0200	606-D005		2	Each	Guard Rail, Bridge End Section, Type A
0210	606-E005		6	Each	Guard Rail, Terminal End Section, Flared
0220	606-G002		2	Each	Special Sections, Guard Rail Bridge End Connector
0230	619-A1001		86	Mile	Temporary Traffic Stripe, Continuous White
0240	619-A2001		14	Mile	Temporary Traffic Stripe, Continuous Yellow
0250	619-A3001		6	Mile	Temporary Traffic Stripe, Skip White
0260	619-A4002		26	Mile	Temporary Traffic Stripe, Skip Yellow
0270	619-A5001		56,230	Linear Feet	Temporary Traffic Stripe, Detail
0280	619-A6001		48	Square Feet	Temporary Traffic Stripe, Legend
0290	619-A6002		3,348	Linear Feet	Temporary Traffic Stripe, Legend
0300	619-D1001		439	Square Feet	Standard Roadside Construction Signs, Less than 10 Square Feet
0310	619-D2001		436	Square Feet	Standard Roadside Construction Signs, 10 Square Feet or More
0320	619-G4001		24	Linear Feet	Barricades, Type III, Double Faced
0330	620-A001		1	Lump Sum	Mobilization
0340	630-A001		101	Square Feet	Standard Roadside Signs, Sheet Aluminum, 0.080" Thickness
0350	630-A003		148	Square Feet	Standard Roadside Signs, Sheet Aluminum, 0.125" Thickness

Line no.	Item Code	Adj Code	Quantity	Units	Description[Fixed Unit Price]
0360	630-A005		91	Square Feet	Standard Roadside Signs, Sheet Aluminum, 0.1" Thickness
0370	630-C005		675	Linear Feet	Square Tube Posts, 2.0 lb/ft
0380	630-C1001		6	Linear Feet	Square Post Inner Sleeve
0390	630-F006		168	Each	Delineators, Guard Rail, White
0400	630-G005		8	Each	Type 3 Object Markers, OM-3R or OM-3L, Post Mounted
0410	815-A007	(S)	60	Ton	Loose Riprap, Size 300
0420	815-E001	(S)	60	Square Yard	Geotextile under Riprap
0430	907-618-A001		1	Lump Sum	Maintenance of Traffic
0440	907-626-A007		2	Mile	6" Thermoplastic Double Drop Traffic Stripe, Skip White
0450	907-626-C012		19	Mile	6" Thermoplastic Double Drop Edge Stripe, Continuous White
0460	907-626-D003		9	Mile	6" Thermoplastic Double Drop Traffic Stripe, Skip Yellow
0470	907-626-E003		5	Mile	6" Thermoplastic Double Drop Traffic Stripe, Continuous Yellow
0480	907-626-G006		13,705	Linear Feet	Thermoplastic Double Drop Detail Stripe, White
0490	907-626-G007		14,410	Linear Feet	Thermoplastic Double Drop Detail Stripe, Yellow
0500	907-626-H006		48	Square Feet	Thermoplastic Double Drop Legend, White
0510	907-626-H007		1,674	Linear Feet	Thermoplastic Double Drop Legend, White
0520	907-627-J001		3,646	Each	Two-Way Clear Reflective High Performance Raised Markers
0530	907-627-K001		409	Each	Red-Clear Reflective High Performance Raised Markers
0540	907-627-L001		1,510	Each	Two-Way Yellow Reflective High Performance Raised Markers

SECTION 905 - COMBINATION BID PROPOSAL (Continued)

**CONDITIONS FOR COMBINATION BID**

If a bidder elects to submit a combined bid for two or more of the contracts listed for this month's letting, the bidder must complete and execute these sheets of the proposal in each of the individual proposals to constitute a combination bid. In addition to this requirement, each individual contract shall be completed, executed and submitted in the usual specified manner.

Failure to execute this Combination Bid Proposal in each of the contracts combined will be just cause for each proposal to be received and evaluated as a separate bid.

It is understood that the Mississippi Transportation Commission not only reserves the right to reject any and all proposals, but also the right to award contracts upon the basis of lowest separate bids or combination bids most advantageous to the State.

It is further understood and agreed that the Combination Bid Proposal is for comparison of bids only and that each contract shall operate in every respect as a separate contract in accordance with its proposal and contract documents.

I (We) agree to complete each contract on or before its specified completion date.

\*\*\*\*\*

**COMBINATION BID PROPOSAL**

This proposal is tendered as one part of a Combination Bid Proposal utilizing option \_\_\_\* of Subsection 102.11 on the following contracts:

\* Option to be shown as either (a), (b), or (c).

	<u>Project No.</u>	<u>County</u>	<u>Project No.</u>	<u>County</u>
1.	_____	_____	6.	_____
2.	_____	_____	7.	_____
3.	_____	_____	8.	_____
4.	_____	_____	9.	_____
5.	_____	_____	10.	_____

(a) If Combination A has been selected, your Combination Bid is complete.

(b) If Combination B has been selected, then complete the following page.

SECTION 905 - COMBINATION BID PROPOSAL (Continued)

Project Number	Pay Item Number	Unit	Unit Price Reduction	Total Item Reduction	Total Contract Reduction
1.					
2.					
3.					
4.					
5.					
6.					
7.					
8.					

For Informational Purposes Only

SECTION 905 - COMBINATION BID PROPOSAL (Continued)

Project Number	Pay Item Number	Unit	Unit Price Reduction	Total Item Reduction	Total Contract Reduction
9.	_____	_____	_____	_____	_____
10.	_____	_____	_____	_____	_____

(c) If Combination C has been selected, then initial and complete ONE of the following.

- \_\_\_\_\_ I (We) desire to be awarded work not to exceed a total monetary value of \$ \_\_\_\_\_.
- \_\_\_\_\_ I (We) desire to be awarded work not to exceed \_\_\_\_\_ number of contracts.

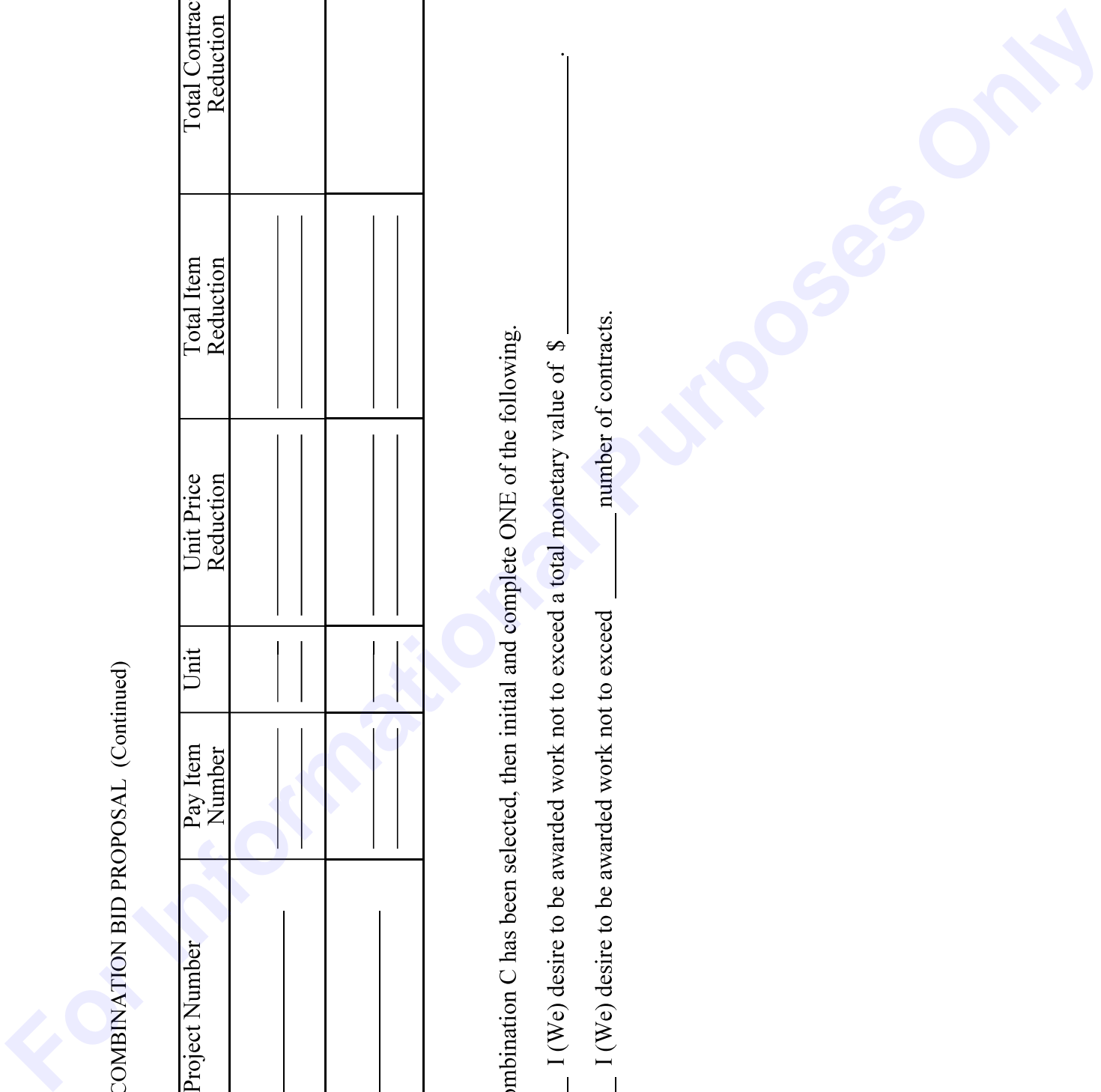

TO: EXECUTIVE DIRECTOR, MISSISSIPPI DEPARTMENT OF TRANSPORTATION  
JACKSON, MISSISSIPPI

**CERTIFICATE**

If awarded this contract, I (we) contemplate that portions of the contract will be sublet. I (we) certify that those subcontracts which are equal to or in excess of fifty thousand dollars (\$50,000.00) will be in accordance with regulations promulgated and adopted by the Mississippi State Board of Contractors on September 8, 2011.

I (we) agree that this notification of intent DOES NOT constitute APPROVAL of the subcontracts.

_____	_____
(Individual or Firm)	(Address)
_____	_____
(Individual or Firm)	(Address)
_____	_____
(Individual or Firm)	(Address)
_____	_____
(Individual or Firm)	(Address)

NOTE: Failure to complete the above DOES NOT preclude subsequent subcontracts. Subsequent subcontracts, if any, equal to or in excess of fifty thousand dollars (\$50,000.00) will be in accordance with regulations promulgated and adopted by the Mississippi State Board of Contractors on September 8, 2011.

Contractor \_\_\_\_\_

**MISSISSIPPI DEPARTMENT OF TRANSPORTATION**  
**CERTIFICATION**

I, \_\_\_\_\_,  
(Name of person signing bid)

individually, and in my capacity as \_\_\_\_\_ of  
(Title of person signing bid)

\_\_\_\_\_  
(Name of Firm, partnership, or Corporation)

do hereby certify under penalty of perjury under the laws of the United States and the State of Mississippi

that \_\_\_\_\_, Bidder  
(Name of Firm, Partnership, or Corporation)

on Project No. **SP-0037-04(061)/ 107633301000**

in **Rankin** County(ies), Mississippi, has not either directly or indirectly entered into any agreement, participated in any collusion; or otherwise taken any action in restraint of free competitive bidding in connection with this contract; nor have any of its corporate officers or principal owners.

Except as noted hereafter, it is further certified that said legal entity and its corporate officers, principal owners, managers, auditors and others in a position of administering federal funds are not currently under suspension, debarment, voluntary exclusion or determination of ineligibility; nor have a debarment pending; nor been suspended, debarred, voluntarily excluded or determined ineligible within the past three years by the Mississippi Transportation Commission, the State of Mississippi, any other State or a federal agency; nor been indicted, convicted or had a civil judgment rendered by a court of competent jurisdiction in any matter involving fraud or official misconduct within the past three years.

Do exceptions exist and are made a part thereof?            Yes / No

Any exceptions shall address to whom it applies, initiating agency and dates of such action.

Note: Exceptions will not necessarily result in denial of award but will be considered in determining bidder responsibility. Providing false information may result in criminal prosecution or administrative sanctions.

All of the foregoing is true and correct.

(1/2016 S)

## SECTION 902

CONTRACT FOR \_\_\_\_\_  
LOCATED IN THE COUNTY(IES) OF \_\_\_\_\_

STATE OF MISSISSIPPI  
COUNTY OF HINDS

This Contract is entered into by and between the Mississippi Transportation Commission (the "Commission") and the undersigned contractor (the "Contractor"), as follows:

As consideration for this Contract, the Commission agrees to pay the Contractor the amount(s) set out in the Proposal attached hereto. Said payment will be made in the manner and at the time(s) specified in the Specifications and/or Special Provisions, if any. In exchange for said consideration, the Contractor hereby agrees to accept the prices stated in the Proposal as full compensation for the furnishing of all labor, materials and equipment, and the execution of the scope of work identified for this referenced Project as contemplated in this Contract, and as more fully outlined in the Contract Documents (the "Work"). The Contract Documents consist of the Advertisement, the Notice to Bidders, the Proposal, the Specifications, the Special Provisions, and the approved Plans, all of which are hereby made a part of this Contract and incorporated herein by reference.

The Contractor shall be responsible for all loss or damage arising out of, or in any way in connection with the Work, or from any unforeseen obstructions or difficulties that may be encountered in the prosecution of the Work, and for all risks of every description connected with the Work, with the exception of any items specifically excluded in the Contract Documents. The Contractor shall fully and faithfully complete the Work in a good and workmanlike manner, according to the Contract Documents and any Supplemental Agreements thereto.

The Contractor further agrees that the Work shall be done under the direct supervision of, and to the complete satisfaction of, the Executive Director of the Mississippi Department of Transportation, or his authorized representative(s), and, when federal funds are involved, subject to the inspection and approval of the Federal Highway Administration, or its agents, and/or the agents of any other state or federal agency whose funds are involved. Further, the Work shall be done in accordance with any applicable state and federal laws, and any such rules and regulations issued by the Commission and/or any relevant Federal Agency.

The Contractor agrees that all labor as outlined in the Contract Documents may be secured from a list furnished by the Manager of the Win Job Center nearest the project location, or any successor thereto.

It is agreed and understood that each and every provision of law and clause required by law to be inserted into this Contract shall be deemed to be inserted herein, and this Contract shall be read and enforced as though it were included herein. If through mere mistake or otherwise, any such provision is not inserted, then upon the application of either party hereto, the Contract shall be physically amended to make such insertion.



The Contractor agrees that he has read each and every clause of the Contract Documents, and fully understands the meaning of same, and hereby acknowledges that he will comply with all terms, covenants and agreements therein.

Witness our signatures, this the \_\_\_\_ day of \_\_\_\_\_, 20\_\_.

\_\_\_\_\_  
Contractor

By: \_\_\_\_\_  
Title: \_\_\_\_\_

\_\_\_\_\_  
Signed and sealed in the presence of: (name and address of witness)

\_\_\_\_\_  
\_\_\_\_\_

MISSISSIPPI TRANSPORTATION COMMISSION

\_\_\_\_\_  
Executive Director

\_\_\_\_\_  
Secretary to the Commission

Award authorized by the Mississippi Transportation Commission in session on the \_\_\_\_ day of \_\_\_\_\_, \_\_\_\_\_, Minute Book No. \_\_\_\_\_, Page No. \_\_\_\_\_.

**SECTION 903  
PERFORMANCE BOND**

**PERFORMANCE BOND FOR THE FOLLOWING CONTRACT:**

Project No.: \_\_\_\_\_

For the construction of: \_\_\_\_\_

Contract date: \_\_\_\_\_ Contract amount: \_\_\_\_\_

**FOR OWNER: MISSISSIPPI TRANSPORTATION COMMISSION, 401 N. WEST STREET, JACKSON, MISSISSIPPI 39201.**

**CONTRACTOR** (full legal name, contact person, phone number and address):

\_\_\_\_\_  
\_\_\_\_\_  
\_\_\_\_\_

**SURETY** (legal name, phone number, principal place of business and address *for notice purposes*):

\_\_\_\_\_  
\_\_\_\_\_

Second Surety (if applicable):

\_\_\_\_\_  
\_\_\_\_\_

The Contractor and Surety, jointly and severally, bind themselves, their heirs, executors, administrators, successors and assigns, to the Owner for the performance of the Contract, which is incorporated herein by reference, and subject to the following terms:

1. If the Contractor fully and faithfully performs the Contract, the Surety and the Contractor shall have no obligation under this Bond.
2. The Surety's obligation under this Bond shall arise after:
  - (a) the Owner first provides notice to the Contractor and the Surety that termination is imminent, pursuant to the current edition of the Mississippi Standard Specifications for Road and Bridge Construction, which is a part of the Contract; and
  - (b) the Owner declares a Contractor Default, terminates the Contract, and notifies the Surety.
3. The Surety shall promptly and at the Surety's expense, take one of the following actions:
  - (a) Arrange for the Contractor, with the consent of the Owner, to perform and complete the Contract; or
  - (b) Undertake to perform and complete the Contract itself, through its agents or independent contractors.
4. If the Surety does not proceed as provided in Paragraph 3, within 20 calendar days as set forth in Section 108.08 of the current edition of the Mississippi Standard Specifications for Road and Bridge Construction, then the Surety shall be deemed to be in default on this Bond, and the Owner shall be entitled to enforce any remedy available to it under the Contract and applicable law.
5. Subject to the commitment by the Owner to pay the Balance of the Contract Price, the Surety is obligated, without duplication, for

- (a) the responsibilities of the Contractor for correction of defective work and completion of the Contract;
  - (b) additional legal, design professional and delay costs resulting from the Contractor's Default, and resulting from the actions or failure to act of the Surety under Paragraph 3; and
  - (c) liquidated damages, or if no liquidated damages are specified in the Contract, actual damages caused by delayed performance or non-performance of the Contractor.
6. The Surety hereby waives notice of any change, including changes of time, to the Contract or to related subcontracts, purchase orders and other obligations.
  7. The penal sum of the Bond shall be subject to increase or decrease based on any subsequent Supplemental Agreements and/or final contract quantities.
  8. Notice to the Surety, the Owner or the Contractor shall be mailed or delivered to the address listed for notice purposes on the first page of this Bond.

**CONTRACTOR AS PRINCIPAL**

Company: \_\_\_\_\_

Signature: \_\_\_\_\_

Name: \_\_\_\_\_

Title: \_\_\_\_\_

Address: \_\_\_\_\_

\_\_\_\_\_

**SURETY**

Company: \_\_\_\_\_

Signature: \_\_\_\_\_

MS Insurance ID # \_\_\_\_\_

Name: \_\_\_\_\_

Title: \_\_\_\_\_

Address: \_\_\_\_\_

\_\_\_\_\_

**SURETY (if applicable)**

Company: \_\_\_\_\_

Signature: \_\_\_\_\_

MS Insurance ID # \_\_\_\_\_

Name: \_\_\_\_\_

Title: \_\_\_\_\_

Address: \_\_\_\_\_

\_\_\_\_\_

**SECTION 903  
PAYMENT BOND**

**PAYMENT BOND FOR THE FOLLOWING CONTRACT:**

Project No.: \_\_\_\_\_

For the construction of: \_\_\_\_\_

Contract date: \_\_\_\_\_ Contract amount: \_\_\_\_\_

**FOR OWNER: MISSISSIPPI TRANSPORTATION COMMISSION, 401 N. WEST STREET, JACKSON, MISSISSIPPI 39201.**

**CONTRACTOR** (full legal name, contact person, phone number and address):

\_\_\_\_\_  
\_\_\_\_\_  
\_\_\_\_\_

**SURETY** (legal name, phone number, principal place of business and address *for notice purposes*):

\_\_\_\_\_  
\_\_\_\_\_  
\_\_\_\_\_

Second Surety (if applicable):

\_\_\_\_\_  
\_\_\_\_\_  
\_\_\_\_\_

The Contractor and Surety, jointly and severally, bind themselves, their heirs, executors, administrators, successors and assigns, to the Owner for payment of labor, materials and equipment furnished for use in the performance of the Contract, which is incorporated herein by reference, subject to the following terms:

1. If the Contractor promptly makes payment of all sums due to any and all subcontractors, suppliers and/or laborers, and defends, indemnifies and holds harmless the Owner from claims, demands, liens or suits by any person or entity seeking payment for labor, materials or equipment furnished for use in the performance of the Contract, then the Surety and the Contractor shall have no obligation under this Bond.
2. The Owner shall provide notice to the Surety of any claims, demands, liens or suits against the Owner or the Owner's property that it receives from any person or entity ("Claimants") seeking payment for labor, materials or equipment furnished for use in the performance of the Contract.
3. Upon notice of any claims, demands, liens or suits provided by the Owner or Contractor or given to the Surety by a Claimant, the Surety shall promptly and at the Surety's expense, defend, indemnify and hold harmless the Owner against said claim, demand, lien or suit and shall take the following additional actions:
  - (a) Send an answer to the Claimant, with a copy to the Owner, within sixty (60) days after receipt of the Claim, stating the amounts that are undisputed and the basis for challenging any amounts that are disputed; and
  - (b) Pay or arrange for payment of any undisputed amounts.
4. The Surety shall not be liable to the Owner, Claimants or others for obligations of the Contractor that are unrelated to the Contract. The Owner shall not be liable for the payment of any costs or expenses of any Claimant under this Bond, and shall have no obligation under this Bond to make payments to, or give notice on behalf of, Claimants or otherwise have any obligations to Claimants under this Bond.

- 5. The Surety hereby waives notice of any change, including changes of time, to the Contract or to related subcontracts, purchase orders and other obligations.
- 6. The penal sum of the Bond shall be subject to increase or decrease based on any subsequent Supplemental Agreements and/or final contract quantities.

**CONTRACTOR AS PRINCIPAL**

Company: \_\_\_\_\_  
Signature: \_\_\_\_\_  
Name: \_\_\_\_\_  
Title: \_\_\_\_\_  
Address: \_\_\_\_\_  
\_\_\_\_\_

**SURETY**

Company: \_\_\_\_\_  
Signature: \_\_\_\_\_ MS Insurance ID # \_\_\_\_\_  
Name: \_\_\_\_\_  
Title: \_\_\_\_\_  
Address: \_\_\_\_\_  
\_\_\_\_\_

**SURETY (if applicable)**

Company: \_\_\_\_\_  
Signature: \_\_\_\_\_ MS Insurance ID # \_\_\_\_\_  
Name: \_\_\_\_\_  
Title: \_\_\_\_\_  
Address: \_\_\_\_\_  
\_\_\_\_\_

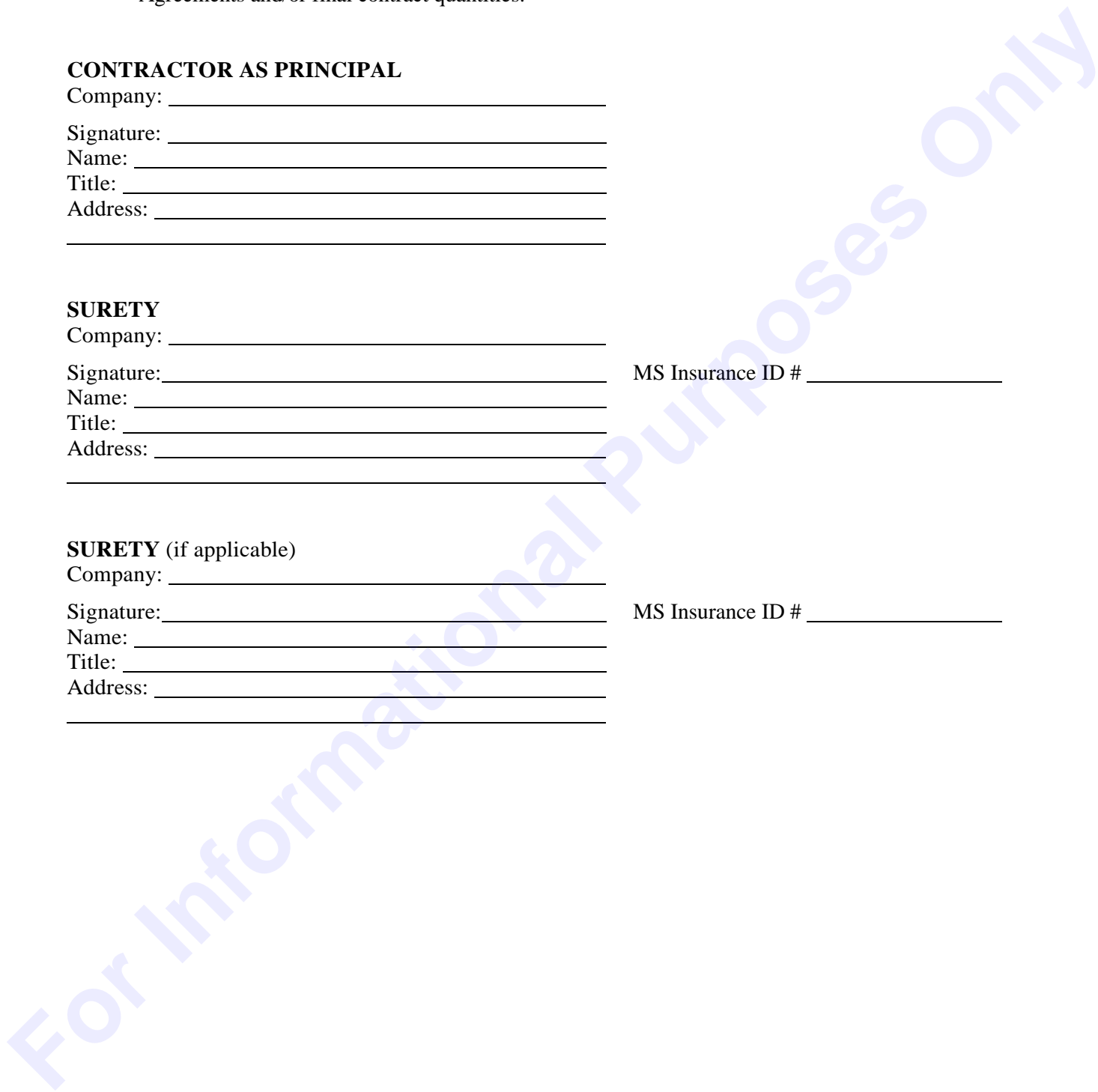



# BID BOND

KNOW ALL MEN BY THESE PRESENTS, that we \_\_\_\_\_  
Contractor

\_\_\_\_\_  
Address

\_\_\_\_\_  
City, State ZIP

As principal, hereinafter called the Principal, and \_\_\_\_\_  
Surety

a corporation duly organized under the laws of the state of \_\_\_\_\_

as Surety, hereinafter called the Surety, are held and firmly bound unto State of Mississippi, Jackson, Mississippi

As Obligee, hereinafter called Obligee, in the sum of **Five Per Cent (5%) of Amount Bid**

Dollars(\$ \_\_\_\_\_ )

for the payment of which sum will and truly to be made, the said Principal and said Surety, bind ourselves, our heirs, executors, administrators, successors and assigns, jointly and severally, firmly by these presents.

WHEREAS, the Principal has submitted a bid for **Overlay approximately 10 miles of SR 43 from SR 481 to the Madison County Line, known as State Project No. SP-0037-04(061) / 107633301 in Rankin County.**

NOW THEREFORE, the condition of this obligation is such that if the aforesaid Principal shall be awarded the contract, the said Principal will, within the time required, enter into a formal contract and give a good and sufficient bond to secure the performance of the terms and conditions of the contract, then this obligation to be void; otherwise the Principal and Surety will pay unto the Obligee the difference in money between the amount of the bid of the said Principal and the amount for which the Obligee legally contracts with another party to perform the work if the latter amount be in excess of the former, but in no event shall liability hereunder exceed the penal sum hereof.

Signed and sealed this \_\_\_\_\_ day of \_\_\_\_\_, 20\_\_

\_\_\_\_\_  
(Principal) (Seal)

\_\_\_\_\_  
(Witness) (Name) By: \_\_\_\_\_ (Title)

\_\_\_\_\_  
(Surety) (Seal)

\_\_\_\_\_  
(Witness) (Attorney-in-Fact) By: \_\_\_\_\_

\_\_\_\_\_  
(MS Agent)

\_\_\_\_\_  
Mississippi Insurance ID Number

MISSISSIPPI DEPARTMENT OF TRANSPORTATION  
OFFICE OF CIVIL RIGHTS  
JACKSON, MISSISSIPPI

LIST OF FIRMS SUBMITTING QUOTES

I/we received quotes from the following firms on:

Letting Date: **January 28, 2025**

Project No: SP-0037-04(061) / 107633301

County: Rankin County

Disadvantaged Business Enterprise (DBE) Regulations as stated in 49 CFR 26.11 require the Mississippi Department of Transportation (MDOT) to create and maintain a comprehensive list of all firms quoting/bidding subcontracts on prime contracts and quoting/bidding subcontracts on federally-funded transportation projects. For every firm, we require the following information:

Firm Name: \_\_\_\_\_  
Contact Name/Title: \_\_\_\_\_  
Firm Mailing Address \_\_\_\_\_  
Phone Number: \_\_\_\_\_  
\_\_\_\_\_ DBE Firm \_\_\_\_\_ Non-DBE Firm

Firm Name: \_\_\_\_\_  
Contact Name/Title: \_\_\_\_\_  
Firm Mailing Address \_\_\_\_\_  
Phone Number: \_\_\_\_\_  
\_\_\_\_\_ DBE Firm \_\_\_\_\_ Non-DBE Firm

Firm Name: \_\_\_\_\_  
Contact Name/Title: \_\_\_\_\_  
Firm Mailing Address \_\_\_\_\_  
Phone Number: \_\_\_\_\_  
\_\_\_\_\_ DBE Firm \_\_\_\_\_ Non-DBE Firm

Firm Name: \_\_\_\_\_  
Contact Name/Title: \_\_\_\_\_  
Firm Mailing Address \_\_\_\_\_  
Phone Number: \_\_\_\_\_  
\_\_\_\_\_ DBE Firm \_\_\_\_\_ Non-DBE Firm

Firm Name: \_\_\_\_\_  
Contact Name/Title: \_\_\_\_\_  
Firm Mailing Address \_\_\_\_\_  
Phone Number: \_\_\_\_\_  
\_\_\_\_\_ DBE Firm \_\_\_\_\_ Non-DBE Firm

\_\_\_\_\_  
**FIRM NAME**

