

MDOT Use Only

Checked _____

Loaded _____

Keyed _____

10 -



SM No. CNHPP0070030261

PROPOSAL AND CONTRACT DOCUMENTS

FOR THE CONSTRUCTION OF

10

Mill & Overlay approximately 7 miles of US 278 from the east side of the ICGRR Overpass to east of Terza Road, known as Federal Aid Project Nos NHPP-0070-03(026) / 108710301 & NHPP-0070-03(028) / 109439301 in Panola County.

Project Completion: 52 Working Days

(STATE DELEGATED)

NOTICE

**BIDDERS MUST COMPLETE AN ONLINE REQUEST
FOR PERMISSION TO BID THIS PROJECT.**

Electronic addendum updates will be posted on www.gomdot.com

**SECTION 900
OF THE CURRENT
2017 STANDARD SPECIFICATIONS
FOR ROAD AND BRIDGE CONSTRUCTION
JACKSON, MISSISSIPPI**

**MISSISSIPPI DEPARTMENT OF TRANSPORTATION
TABLE OF CONTENTS**

**PROJECT: NHPP-0070-03(026)/108710301 - Panola
NHPP-0070-03(028)/109439301 - Panola**

Section 901 - Advertisement

Section 904 - Notice to Bidders

#1	Governing Specification, w/ Supplement
#2	Status of ROW, w/ Attachments
#3	Final Cleanup
#13	Safety Edge
#296	Reduced Speed Limit Signs
#445	Mississippi Agent or Qualified Nonresident Agent
#516	Errata and Modifications to the 2017 Standard Specifications
#1225	Early Notice to Proceed
#1226	Material Storage Under Bridges
#1241	Fuel and Material Adjustments
#1963	Guardrail Pads
#2206	MASH Compliant Devices
#2273	Mississippi Special Fuel Tax Law
#2782	DBE Pre-Bid Meeting
#2812	Traffic Signal and ITS Components
#2954	Reflective Sheeting for Signs
#3599	Standard Drawings w/Supplement
#3676	Asphalt Gyratory Compactor Internal Angle Calibration
#3875	General ITS Requirements
#4113	Unique Entity ID Requirement For Federal Funded Projects
#4702	App for Traffic Control Report
#5551	Federal Bridge Formula
#5605	Disadvantaged Business Enterprise In Federal-Aid Highway Construction, w/ Supplement
#5750	Manual on Uniform Traffic Control Devices (MUTCD)
#6621	Contract Time
#6622	Scope of Work
#6623	Specialty Items
906	Required Federal Contract Provisions -- FHWA 1273, w/Supplements

Section 907 - Special Provisions

907-101-1	Definitions and Terms
907-102-2	Bidding Requirements and Conditions
907-105-2	Control of Work
907-106-2	Control of Materials
907-108-4	Subletting of Contract
907-109-5	Measurement and Payment
907-401-2	Asphalt Pavements - General
907-403-3	Asphalt Pavements
907-413-2	Cleaning and Sealing Joints and Cracks

PROJECT: NHPP-0070-03(026)/108710301 - Panola
NHPP-0070-03(028)/109439301 - Panola

907-618-12	Traffic Control Management
907-626-11	Thermoplastic Markings
907-627-1	Raised Pavement Markings
907-631-1	Traffic Signal Systems - General, w/Supplement
907-632-1	Traffic Signal Cabinet Assemblies
907-641-4	Radar Vehicle Detection
907-700-1	Materials and Tests
907-701-4	Hydraulic Cement, w/ Supplement
907-702-4	Bituminous Materials
907-703-2	Gradation
907-705-1	Stone Riprap
907-707-3	Joint Materials
907-711-2	Plain Steel Wire
907-712-1	Fence and Guardrail
907-714-3	Miscellaneous Materials
907-718-1	Timber and Dimension Lumber
907-720-3	Pavement Marking Materials
907-721-4	Materials for Signing
907-722-1	Materials for Traffic Signal Installation

Section 905 - Proposal, Proposal Bid Items, Combination Bid Proposal
Certification of Performance - Prior Federal-Aid Contracts
Certification Regarding Non-Collusion, Debarment and Suspension
SAM.GOV Registration and Unique Entity ID
Section 902 - Contract Form
Section 903 - Contract Bond Forms
Form -- OCR-485

Progress Schedule

(REVISIONS TO THE ABOVE WILL BE INDICATED ON THE SECOND SHEET
OF SECTION 905 AS ADDENDA)

01/30/2025 02:28 PM

MISSISSIPPI DEPARTMENT OF TRANSPORTATION

SECTION 901 - ADVERTISEMENT

Electronic bids will be received by the Mississippi Transportation Commission at 10:00 o'clock A.M., Tuesday, February 25, 2025, from the Bid Express Service and shortly thereafter publicly read on the Sixth Floor For:

Mill & Overlay approximately 7 miles of US 278 from the east side of the ICGRR Overpass to east of Terza Road, known as Federal Aid Project Nos NHPP-0070-03(026) / 108710301 & NHPP-0070-03(028) / 109439301 in Panola County.

The attention of bidders is directed to the Contract Provisions governing selection and employment of labor. Minimum wage rates have been predetermined by the Secretary of Labor and are subject to Public Law 87-581, Work Hours Act of 1962, as set forth in the Contract Provisions.

The Mississippi Department of Transportation hereby notifies all bidders that it will affirmatively insure that in any contract entered into pursuant to this advertisement, disadvantaged business enterprises will be afforded full opportunity to submit bids in response to this invitation and will not be discriminated against on the grounds of race, color, sex, age, disability, religion or national origin in consideration for an award.

The award of this contract will be contingent upon the Contractor satisfying the DBE requirements.

The specifications are on file in the offices of the Mississippi Department of Transportation.

Contractors may request permission to bid online at <http://shop.mdot.ms.gov> at no cost. Upon approval, Contractors shall be eligible to submit a bid using Bid Express at <http://bidx.com>. Specimen proposals may be viewed and downloaded online at no cost at <http://mdot.ms.gov> or purchased online at <http://shop.mdot.ms.gov> at a cost of Ten Dollars (\$10.00) per proposal plus a small convenience fee. Cash or checks will not be accepted as payment.

Bid bond, signed or countersigned by a Mississippi Agent or Qualified Nonresident Agent, with Power of Attorney attached, a Cashier's check or Certified Check for five (5%) percent of bid, payable to STATE OF MISSISSIPPI, must accompany each proposal.

The attention of bidders is directed to the provisions of Subsection 102.07 pertaining to irregular proposals and rejection of bids.

BRAD WHITE
EXECUTIVE DIRECTOR

MISSISSIPPI DEPARTMENT OF TRANSPORTATION

SUPPLEMENT TO NOTICE TO BIDDERS NO. 1

DATE: 06/08/2021

SUBJECT: Governing Specifications

Change the web address at the end of the first paragraph to the following.

<https://shop.mdot.ms.gov/default.aspx?StoreIndex=1>

MISSISSIPPI DEPARTMENT OF TRANSPORTATION

SECTION 904 - NOTICE TO BIDDERS NO. 1

CODE: (IS)

DATE: 03/01/2017

SUBJECT: Governing Specifications

The current (2017) Edition of the Standard Specifications for Road and Bridge Construction adopted by the Mississippi Transportation Commission is made a part hereof fully and completely as if it were attached hereto, except where superseded by special provisions, or amended by revisions of the Specifications contained within this proposal. Copies of the specification book may be purchased from the MDOT Construction Division, or online at shopmdot/default.aspx?StoreIndex=1.

A reference in any contract document to controlling requirements in another portion of the contract documents shall be understood to apply equally to any revision or amendment thereof included in the contract.

In the event the plans or proposal contain references to the 2004 Edition of the Standard Specifications for Road and Bridge Construction, it is to be understood that such references shall mean the comparable provisions of the 2017 Edition of the Standard Specifications.

MISSISSIPPI DEPARTMENT OF TRANSPORTATION

SECTION 904 - NOTICE TO BIDDERS NO. 2

CODE: (IS)

DATE: 03/01/2017

SUBJECT: Status of Right-of-Way

Although it is desirable to have acquired all rights-of-way and completed all railroad agreements, utility adjustments and work to be performed by others prior to receiving bids, sometimes it is not considered to be in the public interest to wait until each and every such clearance has been obtained. The bidder is hereby advised of possible unacquired rights-of-way, relocations, railroad agreements and utilities adjustments which have not been completed.

The status of right-of-way acquisition, utility adjustments, encroachments, potentially contaminated sites, railroad facilities, improvements, and asbestos contamination are set forth in the following attachments.

In the event right of entry is not available to ALL parcels of right-of-way and/or all work that is to be accomplished by others on the date set forth in the contract for the Notice to Proceed is not complete, the Department will issue a restricted Notice to Proceed.

STATUS OF RIGHT-OF-WAY

NHPP-0070-03(026)

108710/301000

Panola County

All rights of way and legal rights of entry have been acquired **except:**

None.

ASBESTOS ABATEMENT STATUS REPORT

NHPP-0070-03(026),108710-301000

Panola County

January 2, 2025

Reference is made to notices to bidders entitled "Asbestos National Emission Standards for Hazardous Air Pollutants (NESHAP)" and "Removal of Obstructions".

The following pertinent information is furnished concerning asbestos-containing materials (ACMs), if any, found in buildings to be removed by the Contractor.

There is no Right of Way required for this project. There are no buildings to be removed by the contractor.

POTENTIALLY CONTAMINATED SITES STATUS REPORT

NHPP-0070-03(026),108710-301000

Panola County

January 2, 2025

THERE IS NO RIGHT OF WAY REQUIRED FOR THIS PROJECT. NO INITIAL SITE ASSESSMENT WILL BE PERFORMED. IF CONTAMINATION ON EXISTING RIGHT OF WAY IS DISCOVERED, IT WILL BE HANDLED BY THE DEPARTMENT.

MISSISSIPPI DEPARTMENT OF TRANSPORTATION

Inter-Departmental Memorandum

TO: ROW DIVISION
Don Drake

DATE: January 2, 2025

FROM: Daniel Norris *DN*
District 2 Construction Engineer

SUBJECT OR PROJECT NO: NHPP-0070-03(026)
108710/301000

INFORMATION COPY TO:

COUNTY:

File
Vance (73-01)
Shows (84-01)

PANOLA

1. STATUS OF RIGHT OF WAY: All work will be done within the existing ROW.
2. RIGHT OF WAY CLEARANCE: There are no encroachments on the ROW.
3. STATUS OF AFFECTED RAILROAD OPERATION FACILITIES: None Affected.
4. STATUS OF REQUIRED UTILITY LOCATIONS: None required.
5. STATUS OF CONSTRUCTION AGREEMENT: None required.

IMPROVEMENTS STATUS REPORT

Improvements to be included in Notice to Bidders to be removed by the Construction Contractor

FMS Construction Project No: 108710-301000

FMS ROW Project No:

External ROW No: NHPP-0070-03(026)

Parcel No:
Station No:
Property Owner:
Description/Pictures:

STATUS OF RIGHT-OF-WAY

NHPP-0070-03(028)

109439/301000

Panola County

All rights of way and legal rights of entry have been acquired **except:**

None.

ASBESTOS ABATEMENT STATUS REPORT

NHPP-0070-03(028),109439-301000

Panola County

January 2, 2025

Reference is made to notices to bidders entitled "Asbestos National Emission Standards for Hazardous Air Pollutants (NESHAP)" and "Removal of Obstructions".

The following pertinent information is furnished concerning asbestos-containing materials (ACMs), if any, found in buildings to be removed by the Contractor.

There is no Right of Way required for this project. There are no buildings to be removed by the contractor.

POTENTIALLY CONTAMINATED SITES STATUS REPORT

NHPP-0070-03(028), 109439-301000

Panola County

January 2, 2025

THERE IS NO RIGHT OF WAY REQUIRED FOR THIS PROJECT. NO INITIAL SITE ASSESSMENT WILL BE PERFORMED. IF CONTAMINATION ON EXISTING RIGHT OF WAY IS DISCOVERED, IT WILL BE HANDLED BY THE DEPARTMENT.

MISSISSIPPI DEPARTMENT OF TRANSPORTATION

Inter-Departmental Memorandum

TO: ROW DIVISION
Don Drake

DATE: January 2, 2025

FROM: Daniel Norris *DN*
District 2 Construction Engineer

SUBJECT OR PROJECT NO: NHPP-0070-03(028)
109439/301000

INFORMATION COPY TO:

COUNTY:

File
Vance (73-01)
Shows (84-01)

PANOLA

1. STATUS OF RIGHT OF WAY: All work will be done within the existing ROW.
2. RIGHT OF WAY CLEARANCE: There are no encroachments on the ROW.
3. STATUS OF AFFECTED RAILROAD OPERATION FACILITIES: None Affected.
4. STATUS OF REQUIRED UTILITY LOCATIONS: None required.
5. STATUS OF CONSTRUCTION AGREEMENT: None required.

IMPROVEMENTS STATUS REPORT

Improvements to be included in Notice to Bidders to be removed by the Construction Contractor

FMS Construction Project No: 109439-301000

FMS ROW Project No:

External ROW No: NHPP-0070-03(028)

Parcel No:
Station No:
Property Owner:
Description/Pictures:

MISSISSIPPI DEPARTMENT OF TRANSPORTATION

SECTION 904 - NOTICE TO BIDDERS NO. 3

CODE: (SP)

DATE: 01/17/2017

SUBJECT: Final Clean-Up

Immediately prior to final inspection for release of maintenance, the Contractor shall pick up, load, transport and properly dispose of all litter from the entire highway right-of-way that is within the termini of the project.

Litter shall include, but not be limited to, solid wastes such a glass, paper products, tires, wood products, metal, synthetic materials and other miscellaneous debris.

Litter removal is considered incidental to other items of work and will not be measured for separate payment.

MISSISSIPPI DEPARTMENT OF TRANSPORTATION

SECTION 904 - NOTICE TO BIDDERS NO. 13

CODE: (IS)

DATE: 03/01/2017

SUBJECT: Safety Edge

Bidders are hereby advised that the Shoulder Wedge (Safety Edge) specified in Section 401, Asphalt Pavements, shall only apply to the top two (2) lifts of asphalt. Open Graded Friction Courses (OGFC) are not to be considered a lift as it pertains to safety edge. Attached is a drawing showing the safety edge. Note that the shoulder dimensions in the bottom two drawings will be less than three feet (3').

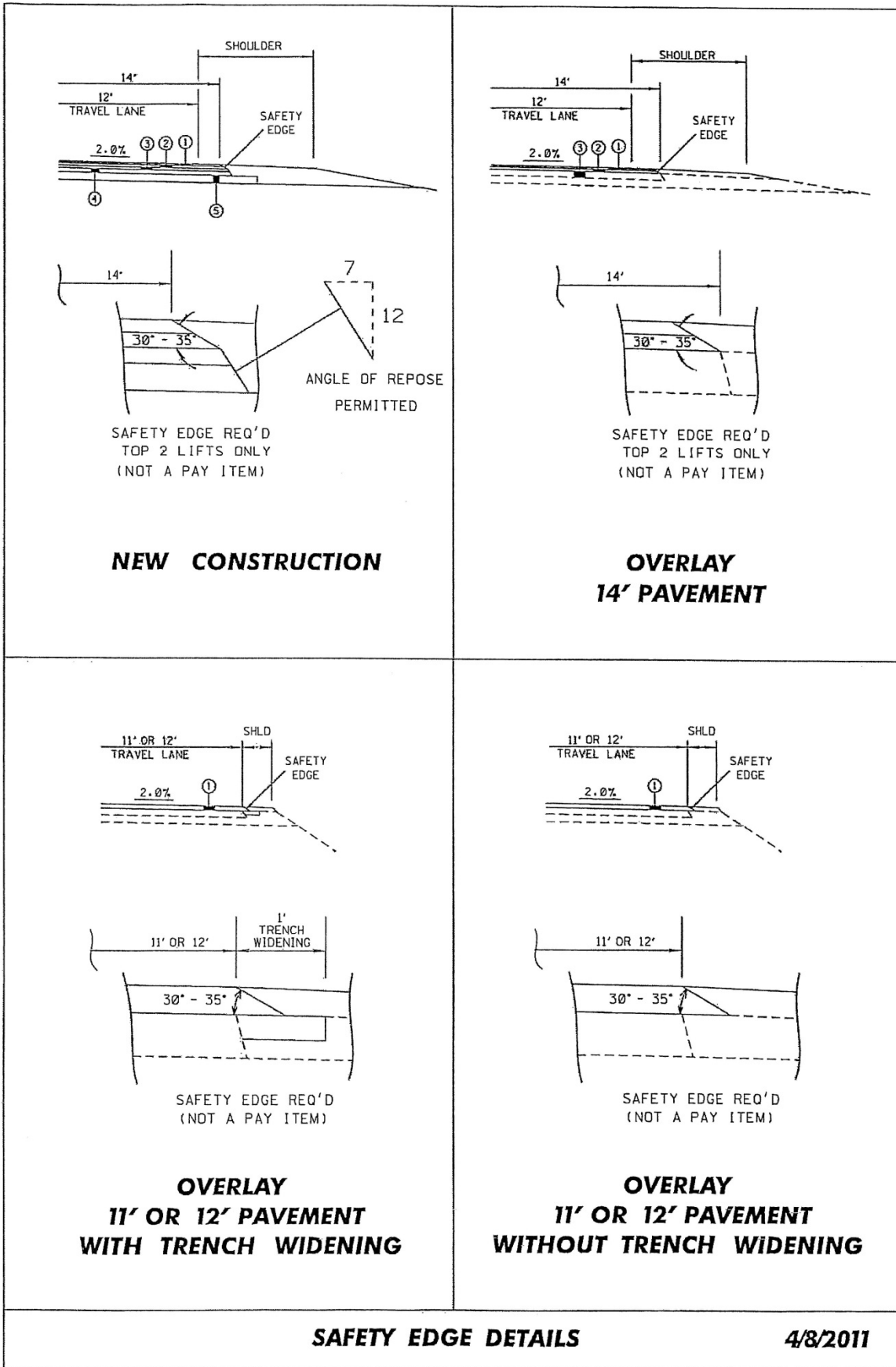

MISSISSIPPI DEPARTMENT OF TRANSPORTATION

SECTION 904 - NOTICE TO BIDDERS NO. 296

CODE: (SP)

DATE: 07/25/2017

SUBJECT: Reduced Speed Limit Signs

Bidders are advised that when the plans or contract documents require the speed limit on a project to be reduced, the Contractor shall begin work within 48 hours of installing the reduced speed limit signs. Should the Contractor not start work or have no plans to start work within 48 hours of installing the signs, the reduced speed limit signs shall be covered and existing speed limit signs uncovered.

MISSISSIPPI DEPARTMENT OF TRANSPORTATION

SECTION 904 - NOTICE TO BIDDERS NO. 445

CODE: (SP)

DATE: 10/10/2017

SUBJECT: Mississippi Agent or Qualified Nonresident Agent

Bidders are hereby advised of the requirements of Subsections 102.08, 103.05.2, and 107.14.2.1 of the *2017 Standard Specifications for Road and Bridge Construction* as it refers to bonding agents. Proposal guaranties, bonds, and liability insurance policies must be signed by a **Mississippi Agent or Qualified Nonresident Agent.**

MISSISSIPPI DEPARTMENT OF TRANSPORTATION

SECTION 904 - NOTICE TO BIDDERS NO. 516

CODE: (IS)

DATE: 11/28/2017

SUBJECT: Errata and Modifications to the 2017 Standard Specifications

<u>Page</u>	<u>Subsection</u>	<u>Change</u>
16	102.06	In the seventh full paragraph, change “Engineer” to “Director.”
33	105.05.1	In the sixth sentence, change “Contract Administration Engineer” to “Contract Administration Director.”
34	105.05.2.1	In subparagraph 2, change “SWPPP, ECP” to “SWPPP and the ECP”
35	105.05.2.2	In subparagraphs 2, add “ and” to the end of the sentence. In subparagraph 3, remove “, and” and add “.”.
90	109.04.2	In the last paragraph of subparagraph (a), place a period “.” at the end of the sentence.
93	109.04.2	In the last paragraph of subparagraph (g), place a period “.” at the end of the sentence. Also, in the first paragraph of subparagraph (h), place a period “.” at the end of the sentence.
97	109.07	Under ADJUSTMENT CODE, subparagraph (A1), change “HMA mixture” to “Asphalt mixtures.”
98	109.11	In the third sentence, change “Engineer” to “Director.”
219	308.04	In the last sentence of the last paragraph, change “Contractor’s decision” to “Engineer’s decision.”
300	405.02.5.9	In the first sentence of the second paragraph, change “Hot Mix Asphalt” to “Asphalt Mixtures.”
502	630.01.1	In the first paragraph, change “AASHTO” to “AASHTO’s LRFD”.
636	646.05	Change “each” to “per each” for the pay item units of payment.
640	656.02.6.2	In item 7), change “down stream” to “downstream”.
688	630.03.2	Change the subsection number from “630.03.2” to “680.03.2.”

- | | | |
|-----|---------------|---|
| 725 | 702.08.3 | In the second sentence of the first paragraph, change “hot-mix” to “asphalt.” |
| 954 | 804.02.13.1.6 | In the definition for “M” in the % Reduction formulas, change “paragraph 7.3” to “paragraph 5.3.” |

MISSISSIPPI DEPARTMENT OF TRANSPORTATION

SECTION 904 - NOTICE TO BIDDERS NO. 1225

CODE: (SP)

DATE: 11/13/2018

SUBJECT: Early Notice to Proceed

Bidders are advised that if an early notice to proceed is allowed by the Department and the Contractor experiences problems or delays between the early notice to proceed date and the original notice to proceed date, this shall not be justification for any monetary compensation or an extension of contract time.

MISSISSIPPI DEPARTMENT OF TRANSPORTATION

SECTION 904 - NOTICE TO BIDDERS NO. 1226

CODE: (IS)

DATE: 11/16/2018

SUBJECT: Material Storage Under Bridges

Bidders are advised that Subsection 106.08 of the Standard Specifications allows the Contractor to store materials and equipment on portions of the right-of-way. However, the Contractor will not be allowed to store or stockpile materials under bridges without written permission from the Project Engineer. The Contractor shall submit a detailed request of all proposed materials to be stored under bridges to the Engineer a minimum of 14 calendar days prior to anticipated storage. This detail shall include, but not limited to, bridge location, material type, material quantity, and duration of storage. The Project Engineer and any other needed Division will review this information and determine whether to grant approval. The Contractor shall not store any material under any bridge without written approval from the Project Engineer.

MISSISSIPPI DEPARTMENT OF TRANSPORTATION

SECTION 904 - NOTICE TO BIDDERS NO. 1241

CODE: (IS)

DATE: 11/27/2018

SUBJECT: Fuel and Material Adjustments

Bidder's attention is brought to the last paragraph of Subsection 109.07 of the Standard Specifications which states that no fuel or material adjustment will be made after the completion of contract time. Any fuels consumed or materials incorporated into the work during the monthly estimate period falling wholly after the expiration of contract time will not be subject a fuel or material adjustment.

MISSISSIPPI DEPARTMENT OF TRANSPORTATION

SECTION 904 - NOTICE TO BIDDERS NO. 1963

CODE: (SP)

DATE: 9/23/2019

SUBJECT: Guardrail Pads

Bidders are hereby advised that prior to construction of the guardrail pads, the Contractor shall coordinate with the guardrail Subcontractor to determine the guardrail pad dimensions necessary to meet MASH compliance.

MISSISSIPPI DEPARTMENT OF TRANSPORTATION

SECTION 904 - NOTICE TO BIDDERS NO. 2206

CODE: (IS)

DATE: 01/14/2020

SUBJECT: MASH Compliant Devices

Bidders are hereby advised that compliance associated with the requirements of meeting either the National Cooperative Highway Research Program (NCHRP) Report 350 or the Manual for Assessing Safety Hardware (MASH) for installations of certain traffic control devices and permanent safety hardware devices (guardrails, guardrail terminals, permanent portable barriers, cast-in-place barriers, all other permanent longitudinal barriers, crash cushions, cable barriers, cable barrier terminals, bridge rails, bridge rail transitions, all other terminals, sign supports, and all other breakaway hardware) as listed throughout the Standard Specifications and/or the Standard Drawings, or both, is now replaced with the requirements of meeting the 2016 version of MASH after December 31, 2019. This change applies to new permanent installations and to full replacements of existing installations.

At the preconstruction conference or prior to starting any work on the project, the Contractor shall submit a letter stating that the traffic control devices and permanent safety hardware devices as outlined within the paragraph above that are to be used on the project are certified to meet MASH 2016.

When a MASH 2016-compliant device does not exist for the new permanent installations and/or full replacement installations of permanent safety hardware devices, as listed above, a MASH 2009-compliant or a NCHRP 350-compliant device may be proposed by the Contractor for the project. A written request for such instances must be submitted by the Contractor either at the preconstruction conference or prior to starting any work on the project. The Contractor shall submit the following items to the Project Engineer: (1) a detailed list of the proposed devices and locations thereof; and (2) certification letters indicating that the proposed devices are compliant with either MASH 2009 or NCHRP 350.

When a MASH 2016-compliant device does not exist for the temporary work zone traffic control devices (Category 1, Category 2, and Category 3 devices), a MASH 2009-compliant or a NCHRP 350-compliant device may be proposed by the Contractor for the project. Temporary work zone traffic control devices (Category 1, Category 2, and Category 3 devices) that are MASH 2009-compliant or NCHRP 350-compliant that have been in use prior to December 31, 2019, and that have a remaining service life may be proposed for use throughout their normal service life on the project by the Contractor. For either of these scenarios for temporary work zone traffic control devices, a written request must be submitted by the Contractor either at the preconstruction conference or prior to starting any work on the project. The Contractor shall submit the following items to the Project Engineer: (1) a detailed list of the proposed devices and locations thereof; and (2) certification letters indicating that the proposed devices are compliant with either MASH 2009 or NCHRP 350.

Work will only be allowed to proceed after the Department has granted written concurrence(s) with the proposed request(s) as listed above.

MISSISSIPPI DEPARTMENT OF TRANSPORTATION

SECTION 904 - NOTICE TO BIDDERS NO. 2273

CODE: (SP)

DATE: 02/12/2020

SUBJECT: Mississippi Special Fuel Tax Law

Bidder's attention is brought to the second paragraph of Subsection 107.02 of the Standard Specifications which states that all Contractors and Subcontractors must comply with all requirements contained in the Mississippi Special Fuel Tax Law, Section 27-55-501, *et seq.* Attached are two Fact Sheets provided by the Mississippi Department of Revenue (MDOR) with additional information.

Gasoline and Dyed Diesel Used for Non-Highway Purposes

Mississippi provides a reduced rate for gasoline and dyed diesel used for non-highway purposes. The reduced rates are 6.44 cents per gallon and 5.75 cents per gallon of gasoline or dyed diesel. These fuels are generally taxed at 18 cents per gallon if for on road use.

Gasoline Used for Non-Highway Purposes

You may be entitled to a refund of 11.56 cents per gallon (making this an equivalent to a tax rate of 6.44 cents per gallon) if you desire to purchase gasoline to be used off road. The gasoline must be used for agricultural, maritime, industrial, manufacturing, domestic or non-highway purposes only.

Examples of non-highway include gasoline used in boats, golf carts, machinery used for manufacturing or farm equipment used exclusively in plowing, planting or harvesting farm products.

Refund Gasoline User

The refund is based on the amount of gallons used. Before a refund is issued, you are required to...

1. Obtain a refund gasoline user's permit and a certificate for refund booklet from the Department of Revenue;
2. Have a storage tank marked "REFUND GASOLINE"; and,
3. Purchase the gasoline from someone who holds a refund gasoline dealer's permit.

No refund will be allowed for gasoline used in motor vehicles owned or operated by a government entity or used in Mississippi government contracts.

Refund Gasoline Dealer

You must obtain a refund gasoline dealer's permit from the Department of Revenue before selling refund gasoline. At no time should the gasoline be delivered to a tank that is not properly marked. The gasoline must be dyed a distinctive mahogany color at the time of delivery.

The Department of Revenue may waive the dye requirement if the dye may cause damage to the equipment. The refund gasoline user is required to obtain the waiver from the Department of Revenue.

Dyed Diesel Used for Non-Highway Purposes

Unlike gasoline, you are not required to apply for a refund if you desire to purchase dyed diesel to be used off road. Mississippi provides a reduced rate of 5.75 cents per gallon on dyed diesel used off road. Diesel used on road is subjected to 18 cents per gallon. Dyed diesel used in motor vehicles owned or operated by a government entity or used in Mississippi government contracts will be subjected to 18 cents per gallon.

Dyed Diesel Used on the Highway

Any person who purchases, receives, acquires or uses dyed diesel for highway use will be liable to pay 18 cents per gallon and subject to a penalty in the amount of \$1000.

Identifying Dyed Diesel

Storage facilities for dyed diesel must be plainly marked "NONHIGHWAY DIESEL FUEL" or "NONHIGHWAY KEROSENE". Retailers are also required to mark all pumps or dispensing equipment.



Special Fuel Used on Government Contracts

State and Local Government Contracts

Special fuel purchased, acquired or used in performing contracts with the State of Mississippi, counties, municipalities or any political subdivision is taxed at a rate of 18 cents per gallon. Special fuel includes but is not limited to the following:

- Dyed diesel fuel;
- Kerosene;
- Undyed diesel fuel; and,
- Fuel oil.

State and local government contracts include construction, reconstruction and maintenance or repairs of projects such as roads, bridges, water systems, sewer systems, buildings, drainage canals and recreational facilities. The Department of Revenue may require contractors to remit the excise tax directly to the state in lieu of paying the tax to a distributor.

Special Fuel Direct Pay Permit

Contractors that remit the excise tax to the state will be issued a Special Fuel Direct Pay Permit. This permit relieves the distributor from collecting the tax and requires the contractor to file a monthly special fuel return. The distributor should include the contractor’s permit number on all invoices that are related to tax-free sales.

The contractor is required to furnish a surety or cash bond guaranteeing the payment of the excise tax prior to receiving the Special Fuel Direct Pay Permit. The Department of Revenue may accept a contractors tax bond if the bond covers the excise tax levied on special fuel.

Special Fuel Distributors

If the contractor does not have a Special Fuel Direct Pay Permit, distributors are required to collect the 18 cents excise tax and remit the tax to the Department of Revenue. The additional 12.25 cents levied on special fuel (excluding undyed diesel) should be reported on schedules 5F and 5G of the special fuel return.

Environmental Protection Fee

Special fuel distributors are required to collect the environmental protection fee even if the contractor has a Special Fuel Direct Pay Permit. The fee is levied at 4/10^{ths} of a cent per gallon. The fee is suspended or reinstated when the trust fund has exceeded or fallen below the obligatory balance.

Penalties

Any person who knowingly and willfully purchases untaxed fuel for use in equipment utilized on a road or highway construction site in this state is guilty of a misdemeanor and, upon conviction, shall be fined not less than \$1,000 or more than \$100,000, or imprisoned in the county jail for not more than one year, or both.



MISSISSIPPI DEPARTMENT OF TRANSPORTATION

SECTION 904 - NOTICE TO BIDDERS NO. 2782

CODE: (SP)

DATE: 8/13/2020

SUBJECT: DBE Pre-Bid Meeting

Due to the COVID-19 pandemic and the Department not allowing visitors in the Administration Building at this time, the DBE Pre-Bid Meeting referenced on Page 5 of Notice to Bidders No. 2611 will be held by **video conference only**. The meeting will be held at 2:00 P.M. on the day preceding the date of the bid opening using Zoom video conferencing software. Anyone interested in participating can download Zoom and connect to the meeting at the below link.

<https://zoom.us/j/5548736403?pwd=SDh5S2hQSE5pNG5FOEkzR3NsUnBYQT09>

Password (if prompted): 272147

For those unable to participate via Zoom, the below teleconference number may be used instead.

1-888-227-7517

Conference Code: 404496

MISSISSIPPI DEPARTMENT OF TRANSPORTATION

SECTION 904 - NOTICE TO BIDDERS NO. 2812

CODE; (SP)

DATE: 09/01/2020

SUBJECT: Traffic Signal and ITS Components

Bidders are hereby advised that all products selected for use on this project shall be in compliance with 2 CFR 200.216. No telecommunication and video surveillance equipment or services shall be manufactured by the following companies: Huawei Technologies Company, ZTE Corporation, Hytera Communications Corporation, Hangzhou Hikvision Digital Technology Company, Dahua Technology Company, and any subsidiary or affiliate of these entities.

The Contractor shall provide a Certification Statement that the referenced product(s) is not manufactured by any of the following: Huawei Technologies Company, ZTE Corporation, Hytera Communications Corporation, Hangzhou Hikvision Digital Technology Company, Dahua Technology Company, and any subsidiary or affiliate of these entities. (as per 2 CFR 200.216)

MISSISSIPPI DEPARTMENT OF TRANSPORTATION

SECTION 904 - NOTICE TO BIDDERS NO. 2954

CODE: (IS)

DATE: 12/01/2020

SUBJECT: Reflective Sheeting for Signs

Bidders are hereby advised that the retroreflective sign sheeting used for signs on this project shall be as listed below and shall meet the requirements of Subsection 721.06.

Temporary Construction Signs

Temporary traffic control (orange) sign sheeting shall be a minimum Type IX Fluorescent Orange sheeting as shown in Special Provision 907-721.

Permanent Signs

Permanent signs, except signs on traffic signal poles/mast arms, shall be as follows:

- Brown background sheeting on guide signs shall be a minimum Type VIII sheeting,
- Green and blue background sheeting on guide signs shall be a minimum Type IX sheeting, and
- All white, yellow, red, fluorescent yellow, and fluorescent yellow/green sheeting shall be Type XI sheeting.

MISSISSIPPI DEPARTMENT OF TRANSPORTATION

| **SUPPLEMENT TO NOTICE TO BIDDERS NO. 3599**

| **DATE: 08/11/2021**

| After the last drawing on page 33, add the following.

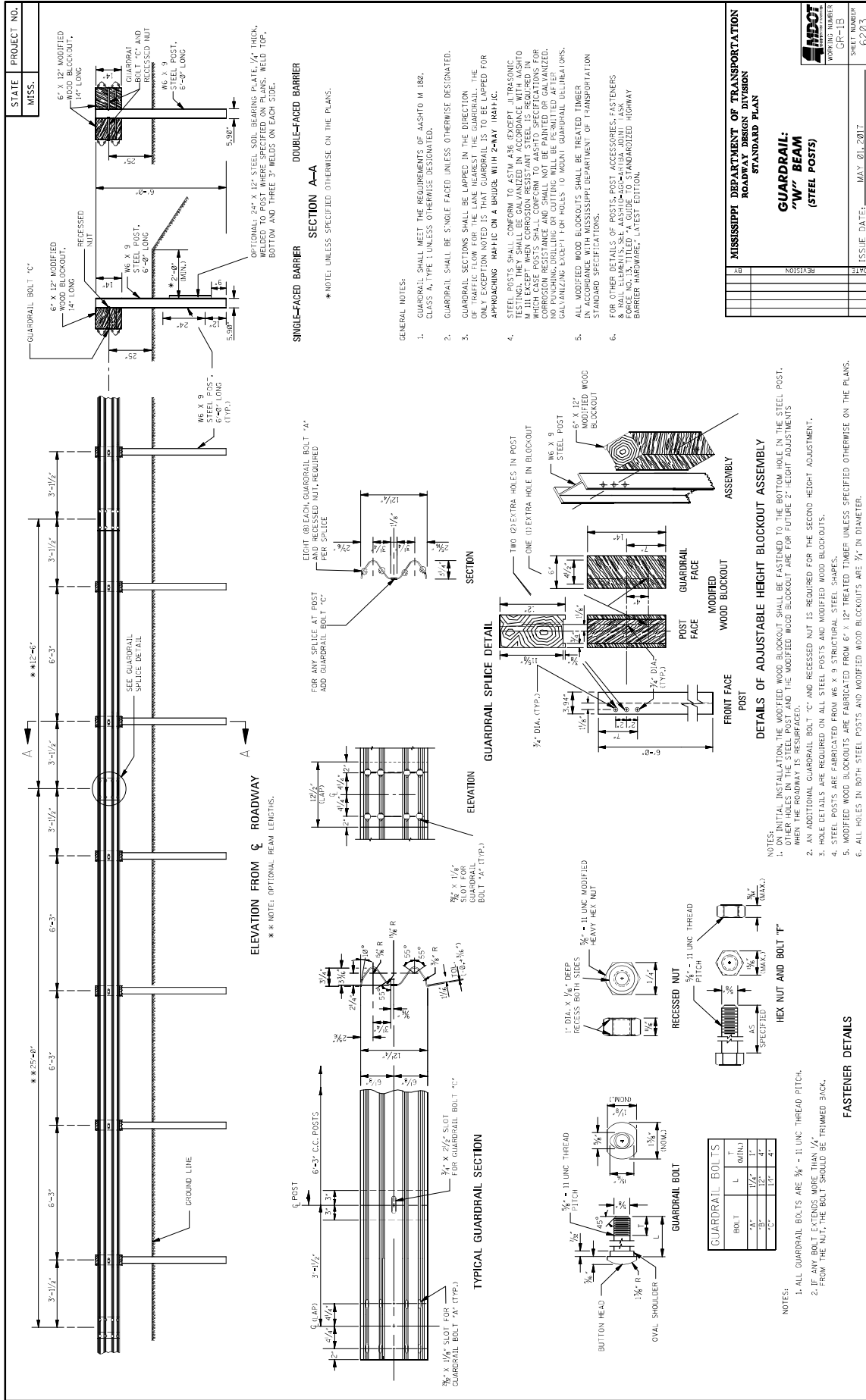

DATE	REVISION

MISSISSIPPI DEPARTMENT OF TRANSPORTATION
ROADWAY DESIGN DIVISION
STANDARD PLAN

GUARDRAIL:
"W" BEAM
(STEEL POSTS)

WORKING NUMBER
GT-15

SHEET NUMBER
6283

ISSUE DATE: MAY 01, 2011

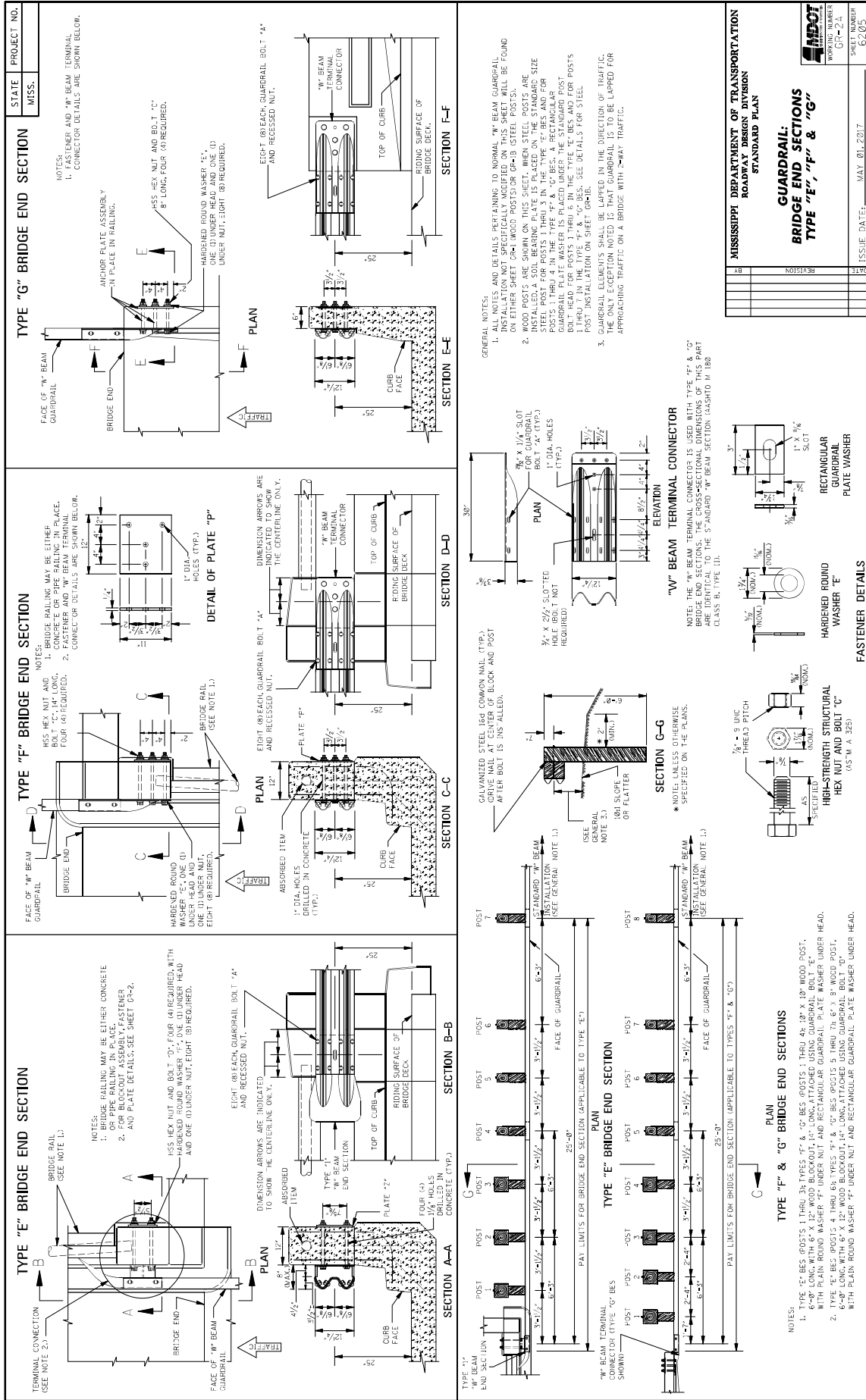

STATE	MISS.
PROJECT NO.	
DATE	
REVISION	
ISSUE DATE:	MAY 01, 2017
SHEET NUMBER	02 OF 05
WORKING NUMBER	GH-2.4

MISSISSIPPI DEPARTMENT OF TRANSPORTATION
ROADWAY DESIGN DIVISION
STANDARD PLAN

**GUARDRAIL:
BRIDGE END SECTIONS
TYPE "E", "F" & "G"**

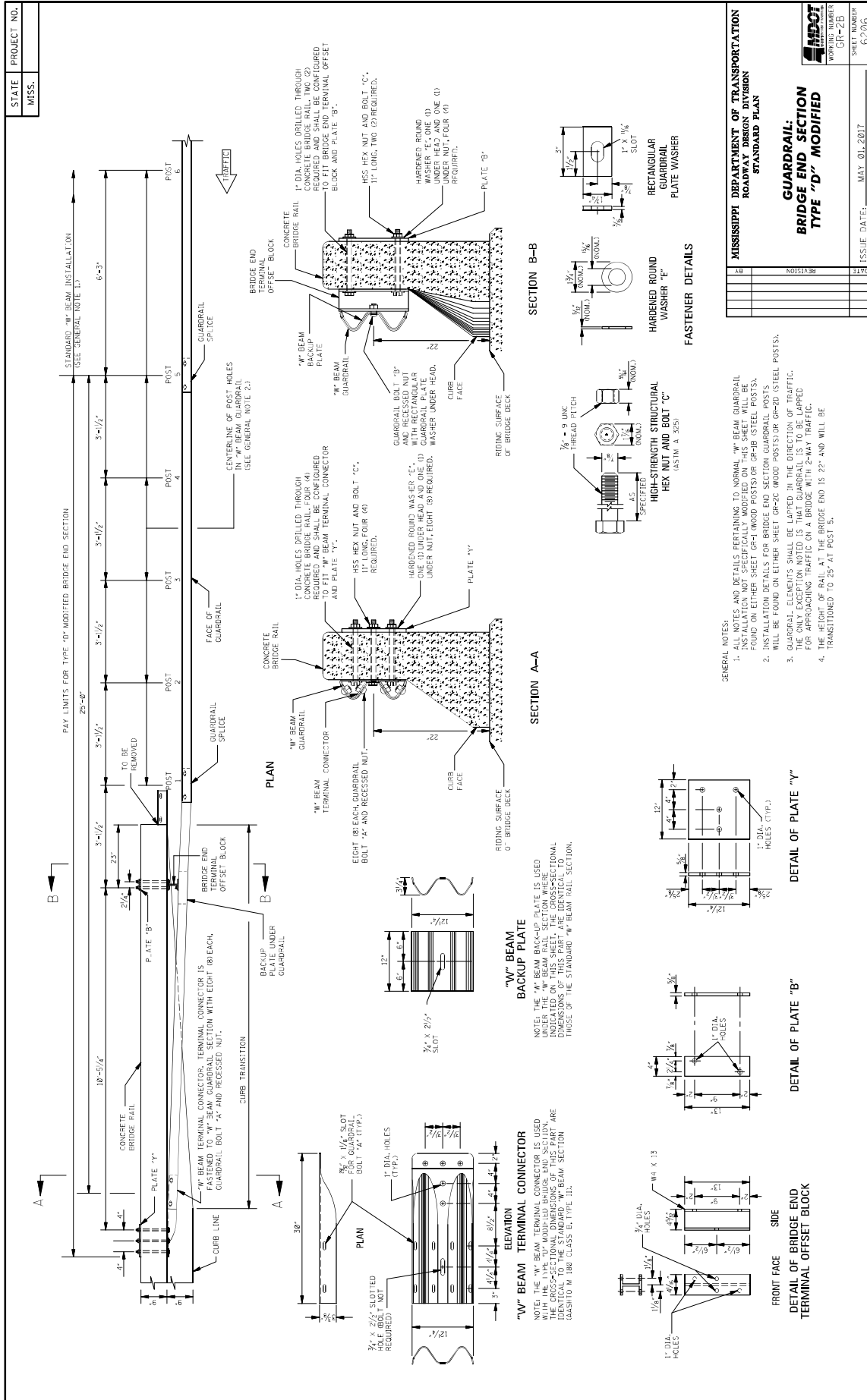

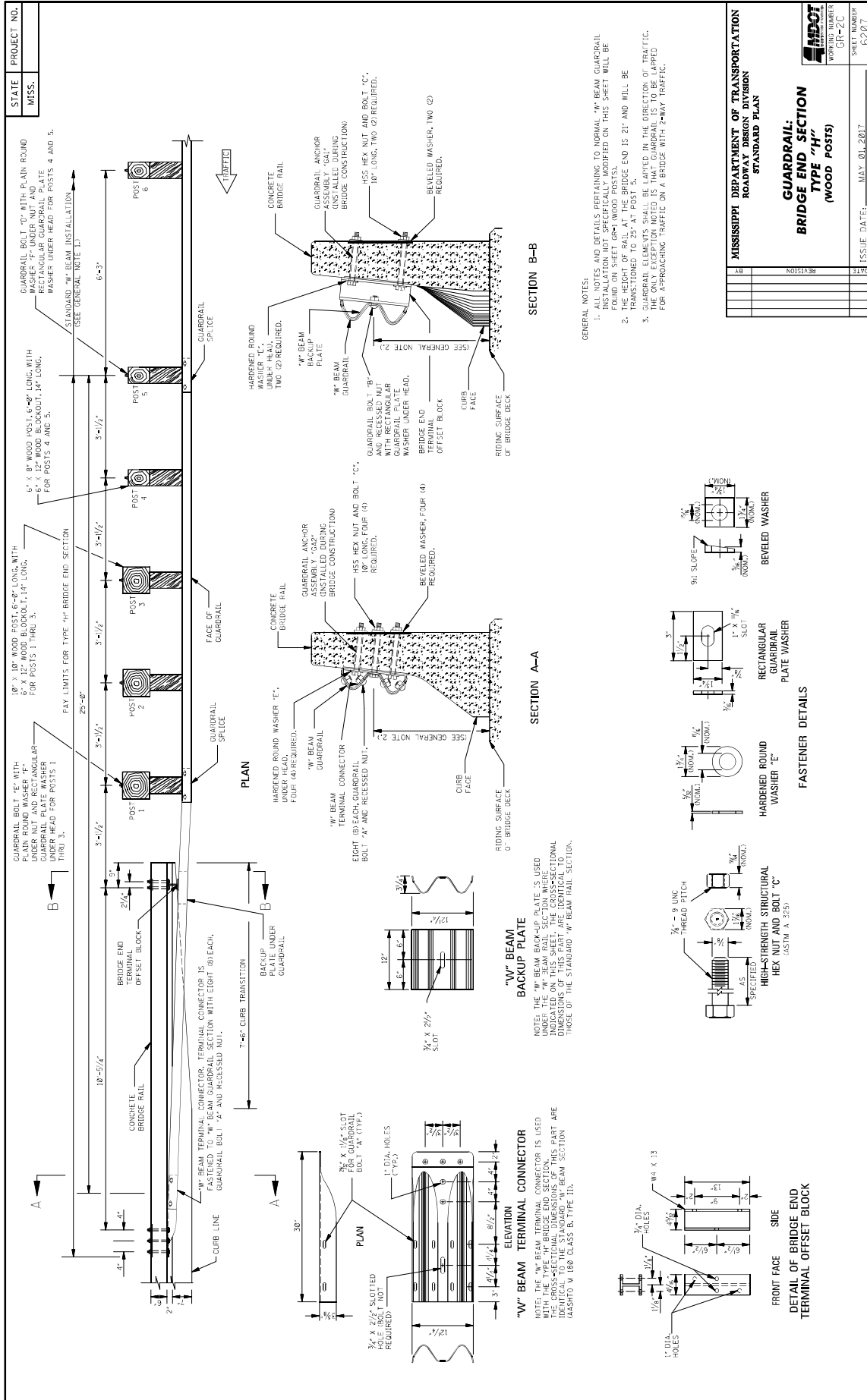

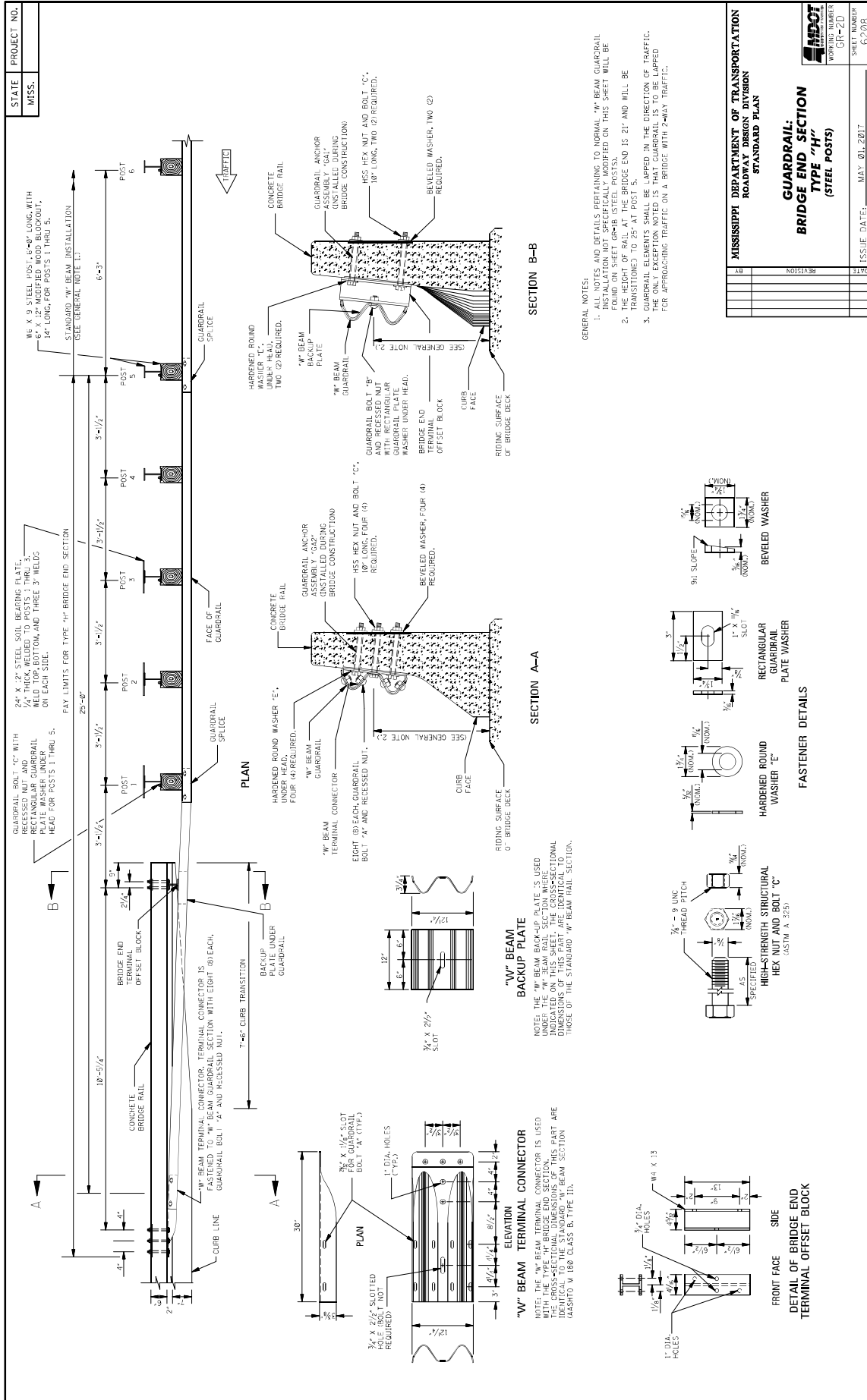

STATE	PROJECT NO.
MISS.	

MISSISSIPPI DEPARTMENT OF TRANSPORTATION ROADWAY DESIGN DIVISION STANDARD PLAN	
GUARDRAIL: BRIDGE END SECTION TYPE "H" (STEEL POSTS)	
DATE	ISSUE DATE: MAY 01, 2017
BY	WORKING NUMBER: GH-ZU
	SHEET NUMBER: 02/05

- GENERAL NOTES:
1. ALL DIMENSIONS AND DETAILS PERTAINING TO NORMAL "H" BEAM GUARDRAIL INSTALLATION NOT SPECIFICALLY MODIFIED ON THIS SHEET WILL BE FOUND ON SHEET GR-B (STEEL POSTS).
 2. THE HEIGHT OF RAIL AT THE BRIDGE END IS 21" AND WILL BE TRANSITIONED TO 29" AT POST 5.
 3. GUARDRAIL SHALL BE INSTALLED IN THE DIRECTION OF TRAFFIC. THE ONLY EXCEPTION NOTED IS THAT GUARDRAIL IS TO BE LAPPED FOR APPROACHING TRAFFIC ON A BRIDGE WITH 2-WAY TRAFFIC.

"W" BEAM BACKUP PLATE

NOTE: THE "W" BEAM BACKUP PLATE IS USED UNDER THE "H" BEAM RAIL SECTION WHERE INDICATED ON THIS SHEET. THE CROSS-SECTIONAL DIMENSIONS OF THIS PART ARE THOSE OF THE STANDARD "W" BEAM RAIL SECTION.

"W" BEAM TERMINAL CONNECTOR

NOTE: THE "W" BEAM TERMINAL CONNECTOR IS USED WITH THE TYPE "H" BRIDGE END SECTION WHERE INDICATED ON THIS SHEET. THE CROSS-SECTIONAL DIMENSIONS OF THIS PART ARE THOSE OF THE STANDARD "W" BEAM SECTION.

DETAIL OF BRIDGE END TERMINAL OFFSET BLOCK

FRONT FACE SIDE

FASTENER DETAILS

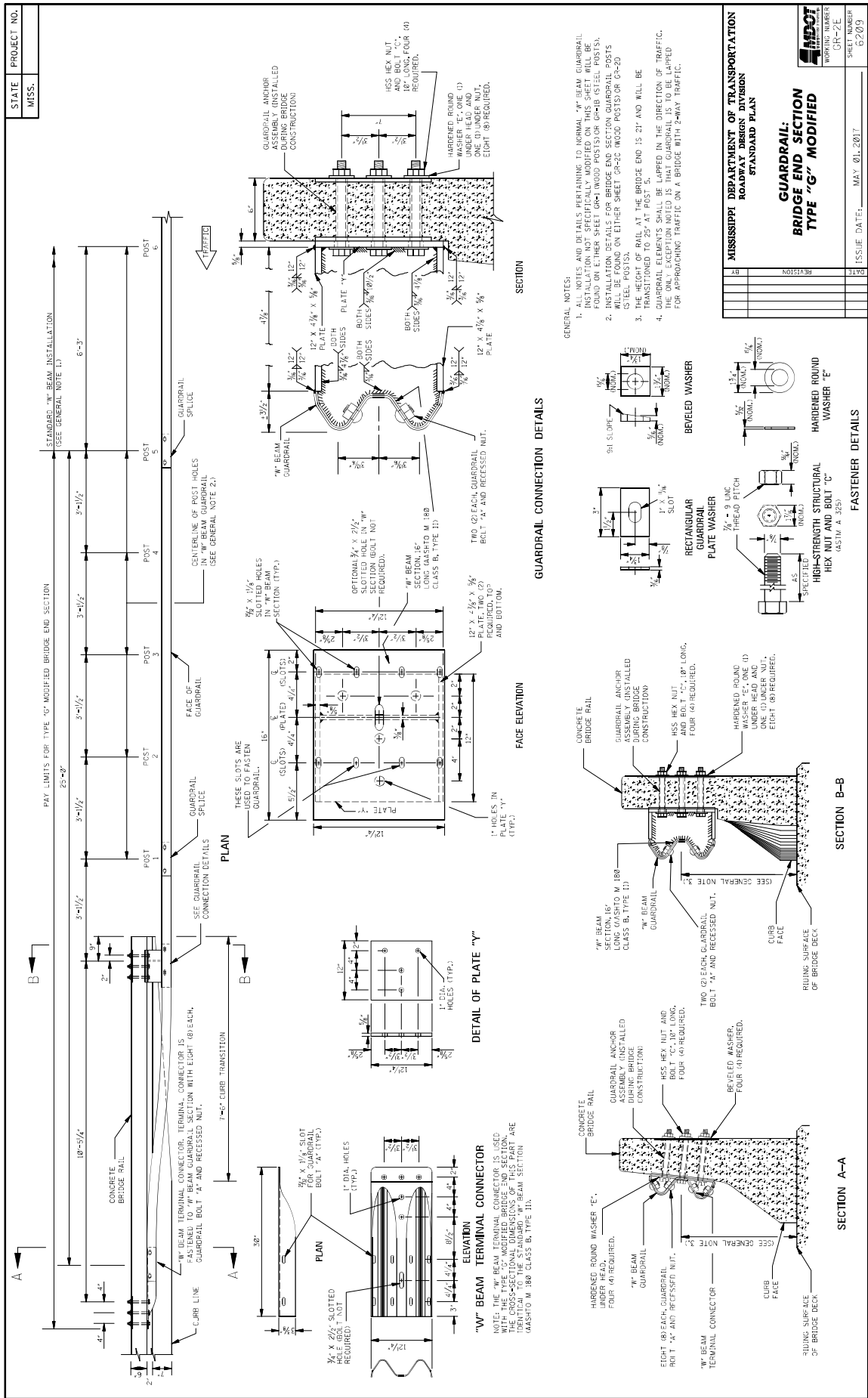

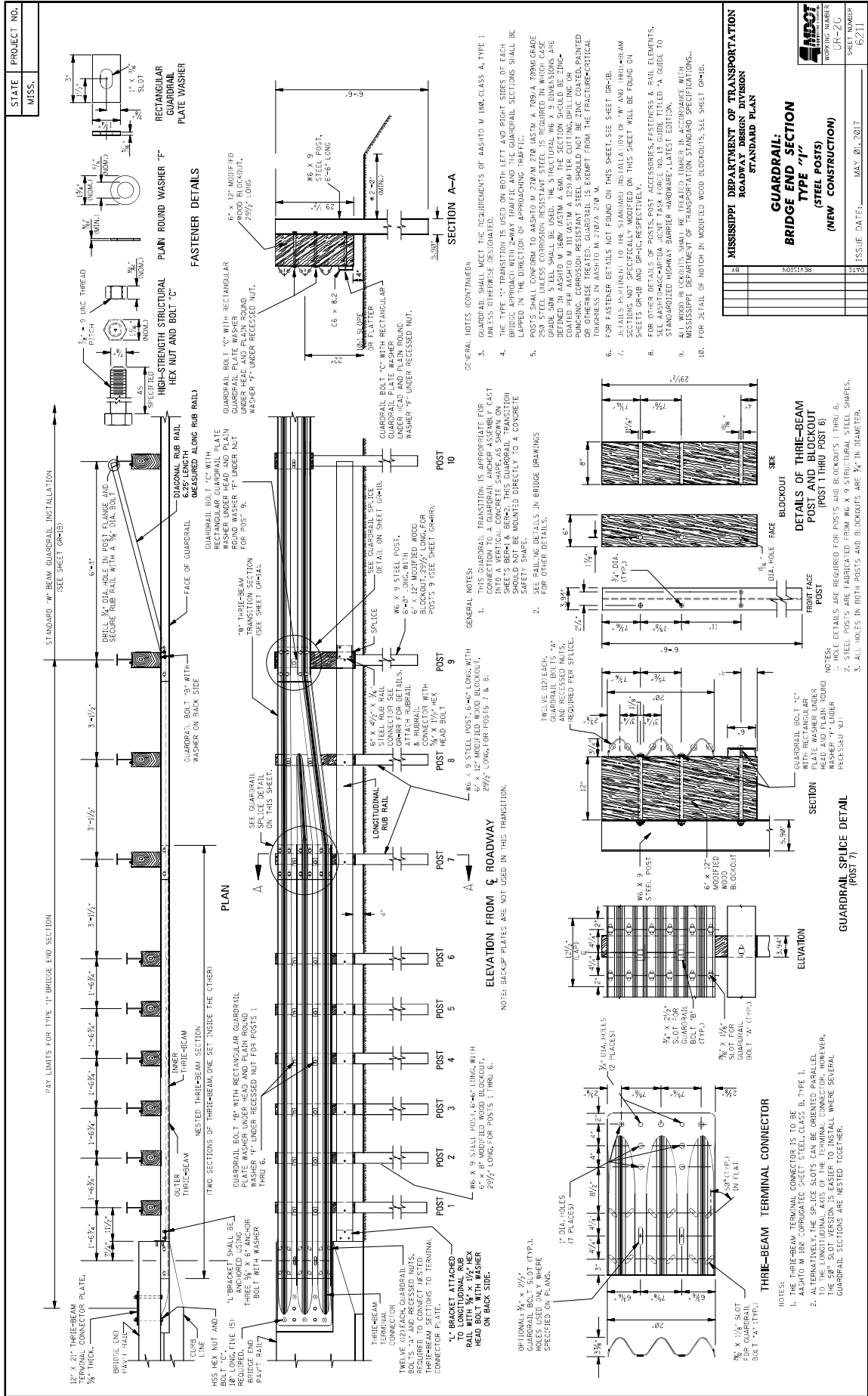

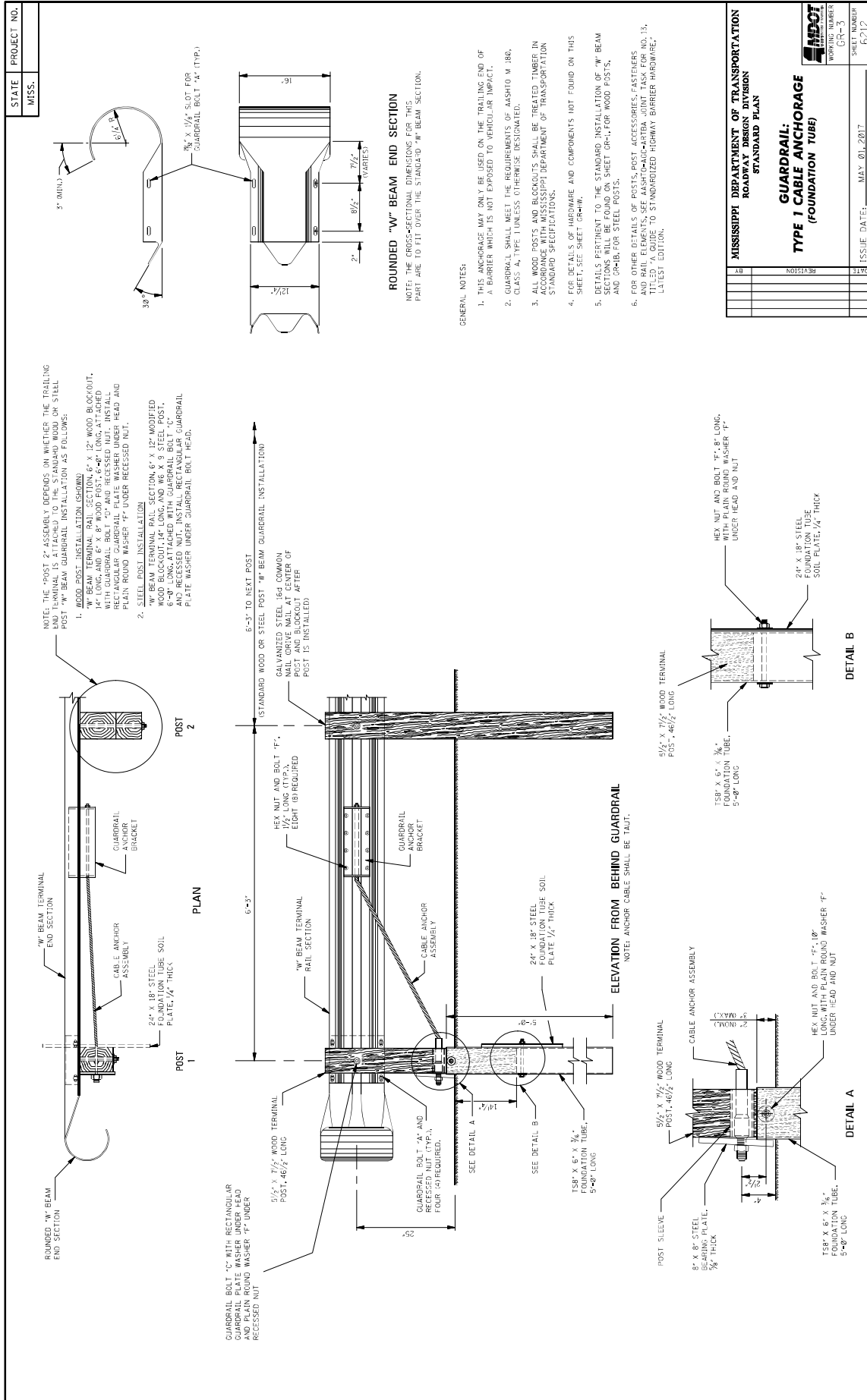

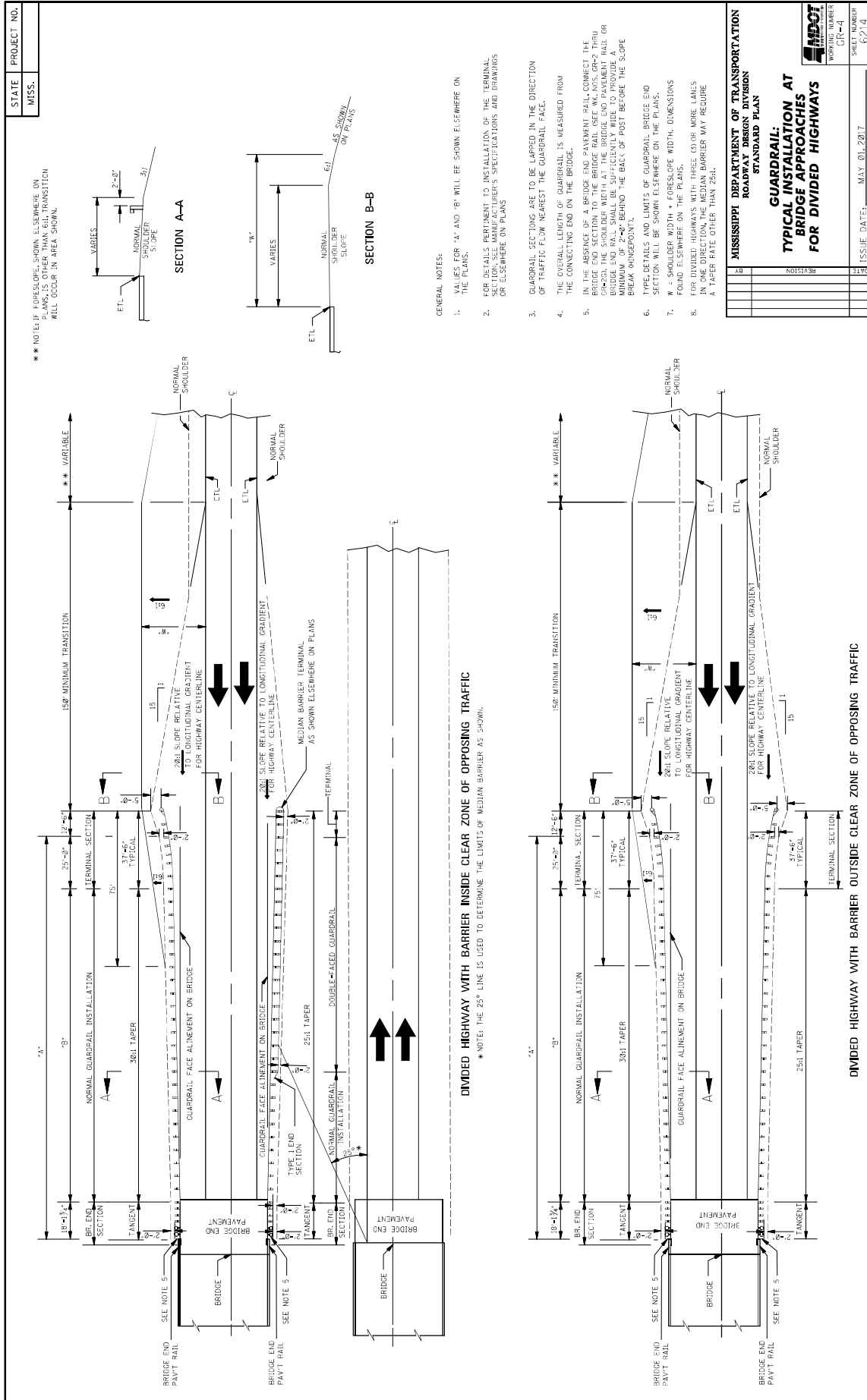

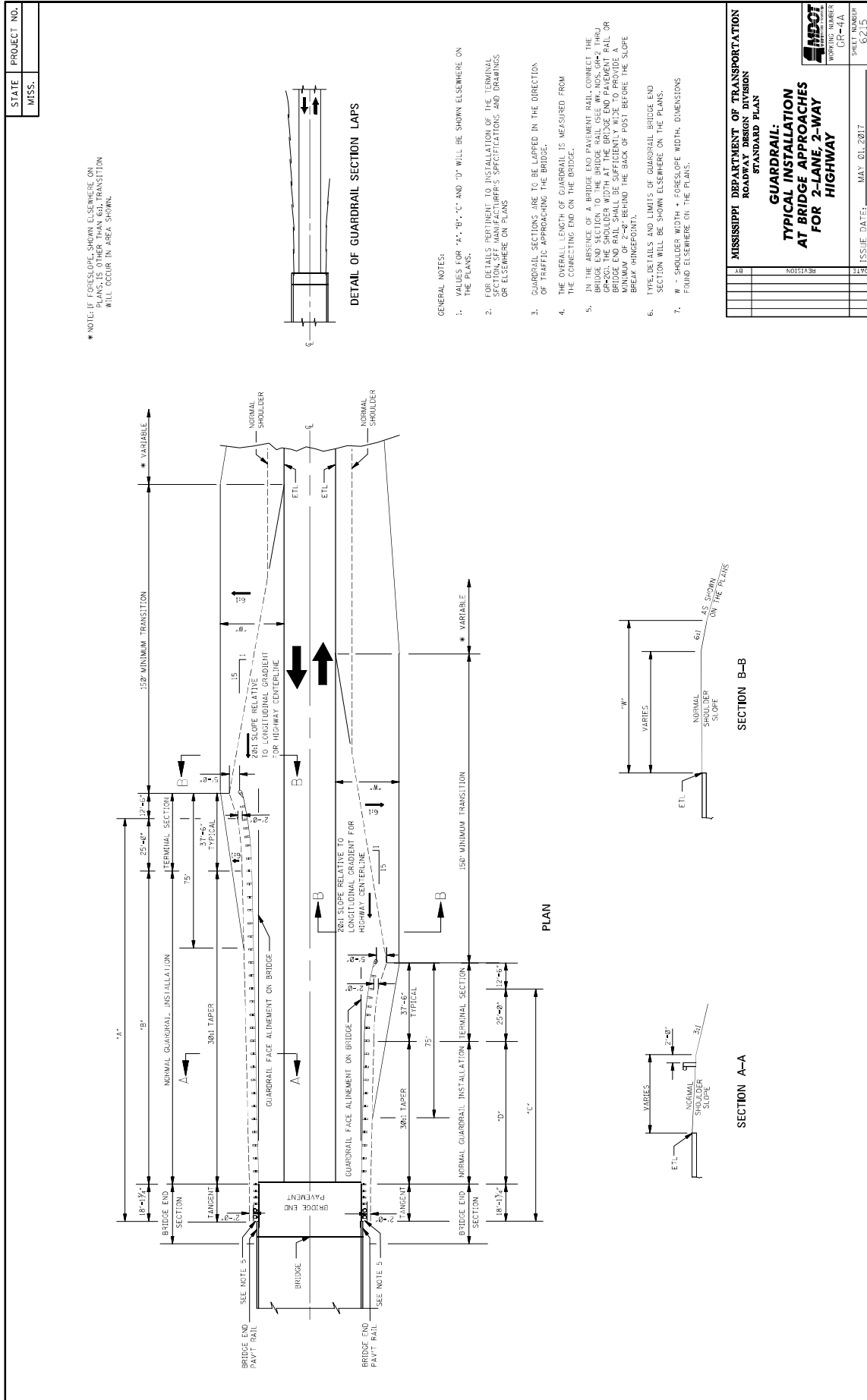

MISSISSIPPI DEPARTMENT OF TRANSPORTATION

SECTION 904 – NOTICE TO BIDDERS NO. 3599

CODE: (SP)

DATE: 08/11/2021

SUBJECT: Standard Drawings

Standard Drawings attached hereto shall govern appropriate items of required work.

Larger copies of Standard Drawings may be purchased from:

MDOT Plans Print Shop
MDOT Shop Complex, Building C, Room 114
2567 North West Street
P.O. Box 1850
Jackson, MS 39215-1850
Telephone: (601) 359-7460
or FAX: (601) 359-7461
or e-mail: plans@mdot.state.ms.us

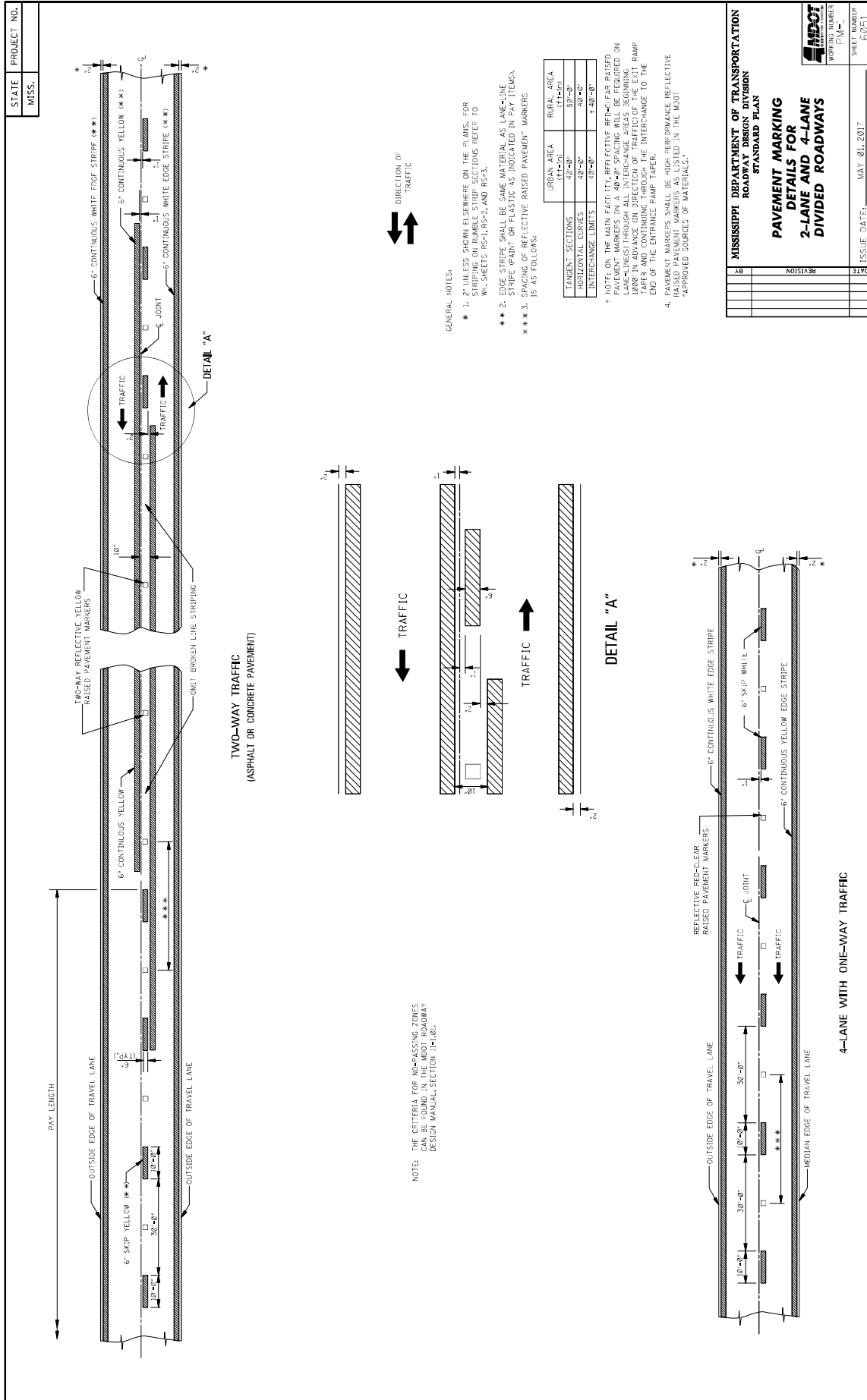

MISSISSIPPI DEPARTMENT OF TRANSPORTATION	
ROADWAY DESIGN DIVISION	
STANDARD PLAN	
PAVEMENT MARKING	
2-LANE AND 4-LANE	
DIVIDED ROADWAYS	
DATE	ISSUE DATE: MAY 01, 2017
BY	SHEET NUMBER: 6001
REVISION	WORKING NUMBER: P100-

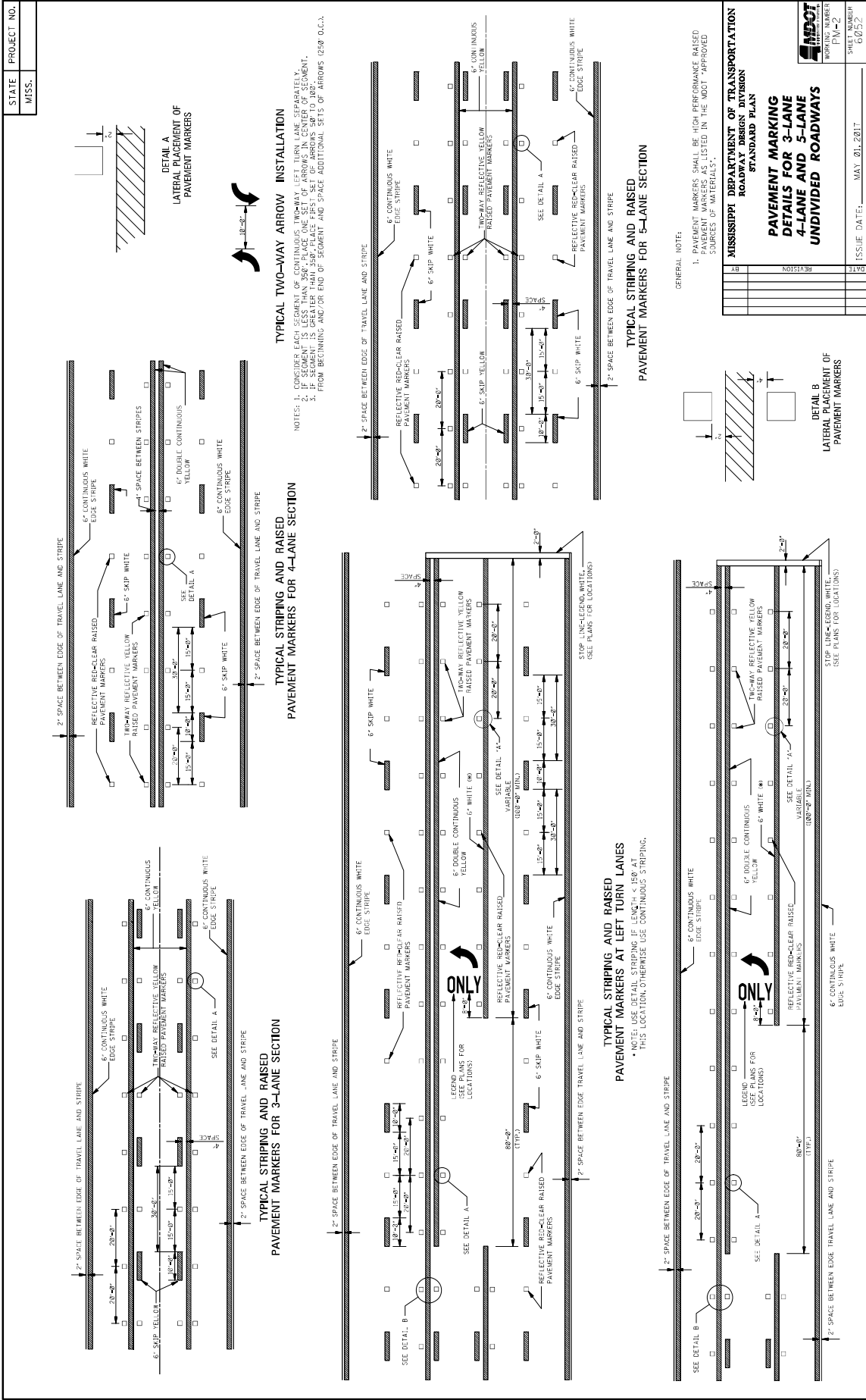

GENERAL NOTE:

- PAVEMENT MARKERS SHALL BE HIGH PERFORMANCE RAISED PAVEMENT MARKERS AS LISTED IN THE MOST APPROVED SOURCE OF MATERIALS.

MISSISSIPPI DEPARTMENT OF TRANSPORTATION
ROADWAY DESIGN DIVISION
STANDARD PLAN

PAVEMENT MARKING
DETAILS FOR 3-LANE
4-LANE AND 5-LANE
UNDIVIDED ROADWAYS

DATE	ISSUE DATE: MAY 01, 2017
SECTION	SHEET NUMBER
REV	PLAN-N

SHEET NUMBER
PLAN-N
06/25

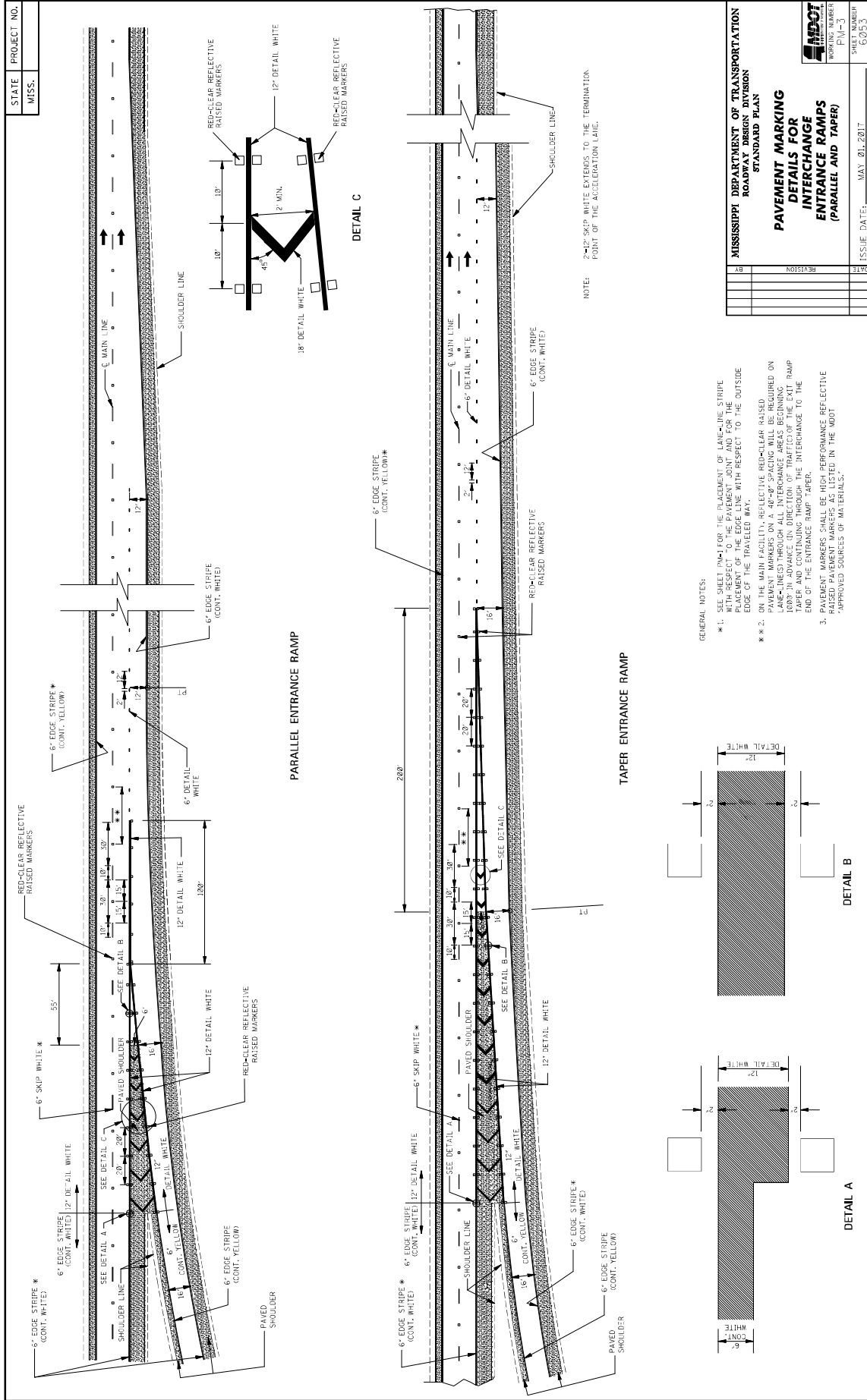

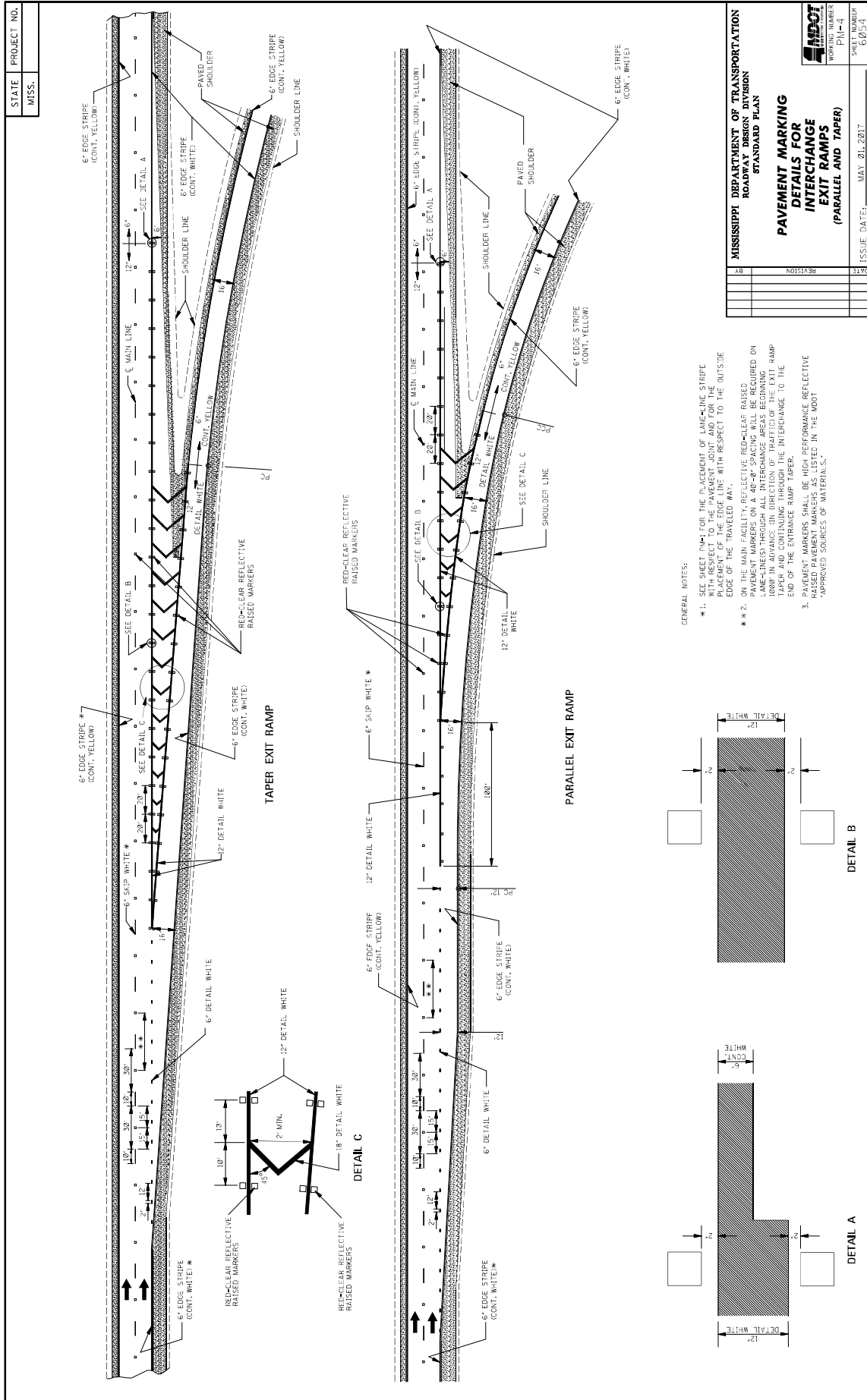

MISSISSIPPI DEPARTMENT OF TRANSPORTATION	
ROADWAY DESIGN DIVISION	
STANDARD PLAN	
PAVEMENT MARKING	
INTERCHANGE	
EXIT RAMP	
(PARALLEL AND TAPER)	
ISSUE DATE:	MAY 01, 2017
SHEET NUMBER	PM-4
WORKING NUMBER	672/34
DATE	REVISION

STATE MISS.	PROJECT NO.		
----------------	-------------	--	--

PAVE

TRAFFIC

STOP

SIGNAL

EXIT

RIGHT

YIELD

AHEAD

SCHOOL

GENERAL NOTES:

- TWO HORIZONTAL GAPS (USED BY TEMPLATE CONNECTIONS) OF 1/4" SHALL EXTEND THROUGH ALL WIDTH OF LETTERS.
- FOR OTHER DETAILS, SEE THE MANUAL ON UNIFORM TRAFFIC CONTROL DEVICES.
- PAY QUANTITIES FOR PAVEMENT MARKING LEGENDS ARE AS FOLLOWS:

LEGEND	AREA (FT ²)
STOP	24.6
RIGHT	28.6
LEFT	19.5
YIELD	27.2
AHEAD	32.4
YIELD	26.8
EXIT	18.5
SIGNAL	32.5
SCHOOL	35.2

MISSISSIPPI DEPARTMENT OF TRANSPORTATION
ROADWAY DESIGN DIVISION
STANDARD PLAN

**PAVEMENT MARKING
LEGEND DETAILS**

	ISSUE DATE: MAY 01, 2017
	SHEET NUMBER 6035
	WORKING NUMBER PM-5

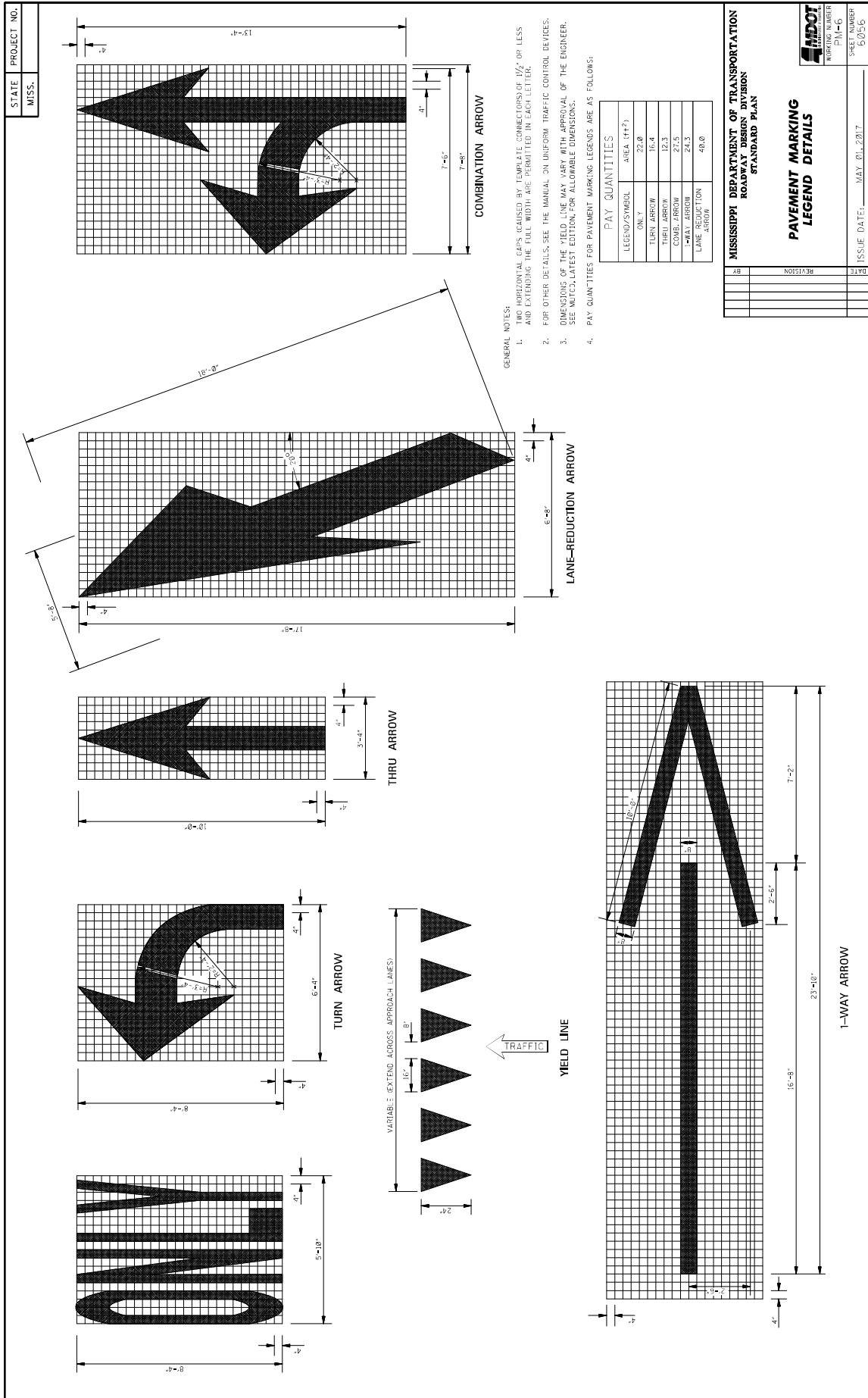

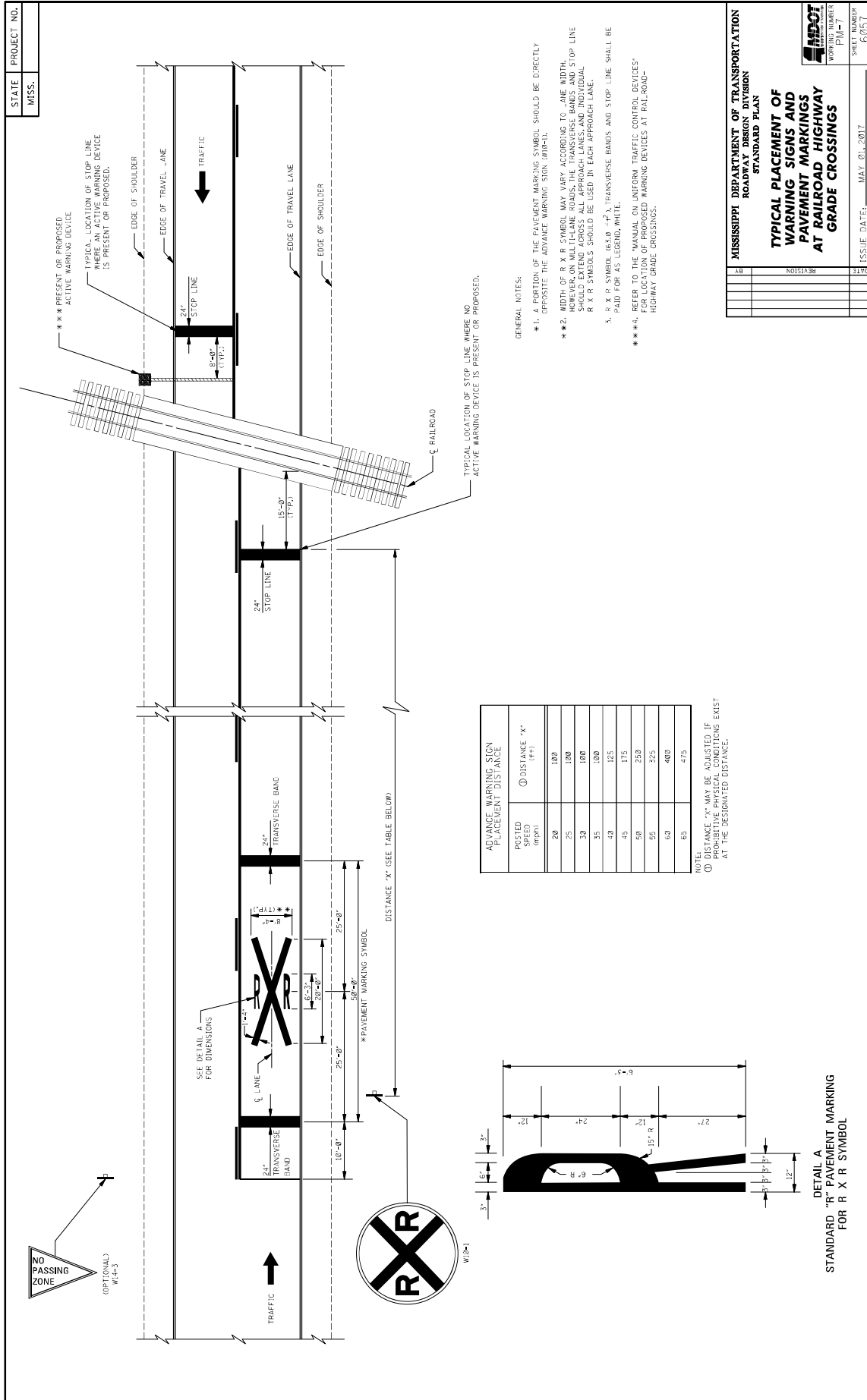

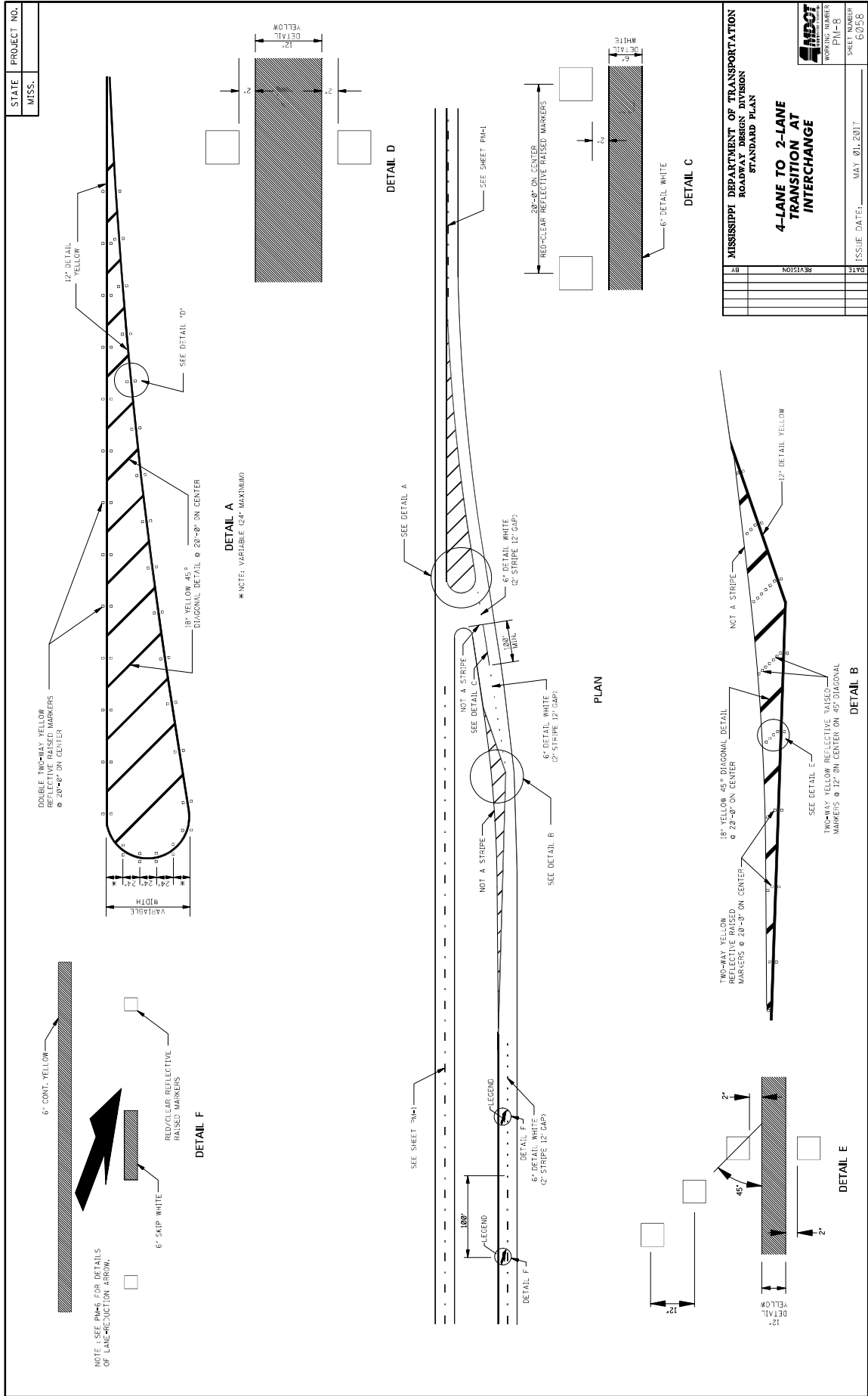

NOTE: FOR WIDER ϕ TO ϕ SPACINGS, REFER TO OTHER SHEETS IN PLANS

NOTE: FOR WIDER ϕ TO ϕ SPACINGS, REFER TO OTHER SHEETS IN PLANS

NOTE: SEE PHASE FOR YIELD BAR DETAILS

NOTE: SEE PHASE FOR YIELD BAR DETAILS

DETAIL "A"

THRU TRAFFIC

RED-CLEAR REEL, HIGH PERFORMANCE RAISED MARKERS

2' x 12' x 2"

2' x 12' x 2"

2' x 12' x 2"

6" DETAIL WHITE

DETAIL "B"

THRU TRAFFIC

RED-CLEAR REEL, HIGH PERFORMANCE RAISED MARKERS

2' x 20' x 2"

2' x 20' x 2"

2' x 20' x 2"

6" DETAIL WHITE

DETAIL "C"

2' x 18' x 2" (CONC.)

RED-CLEAR REEL, HIGH PERFORMANCE RAISED MARKERS

6" DETAIL YELLOW

STATE MISS. PROJECT NO. _____

MISS. _____

MSDOT WORKING NUMBER PM-5
PROJECT NUMBER 3170
ISSUE DATE: MAY 01, 2017

MISSISSIPPI DEPARTMENT OF TRANSPORTATION
ROADWAY DESIGN DIVISION
STANDARD PLAN

TYPICAL PAVEMENT MARKING DETAIL FOR MEDIAN CROSSOVERS

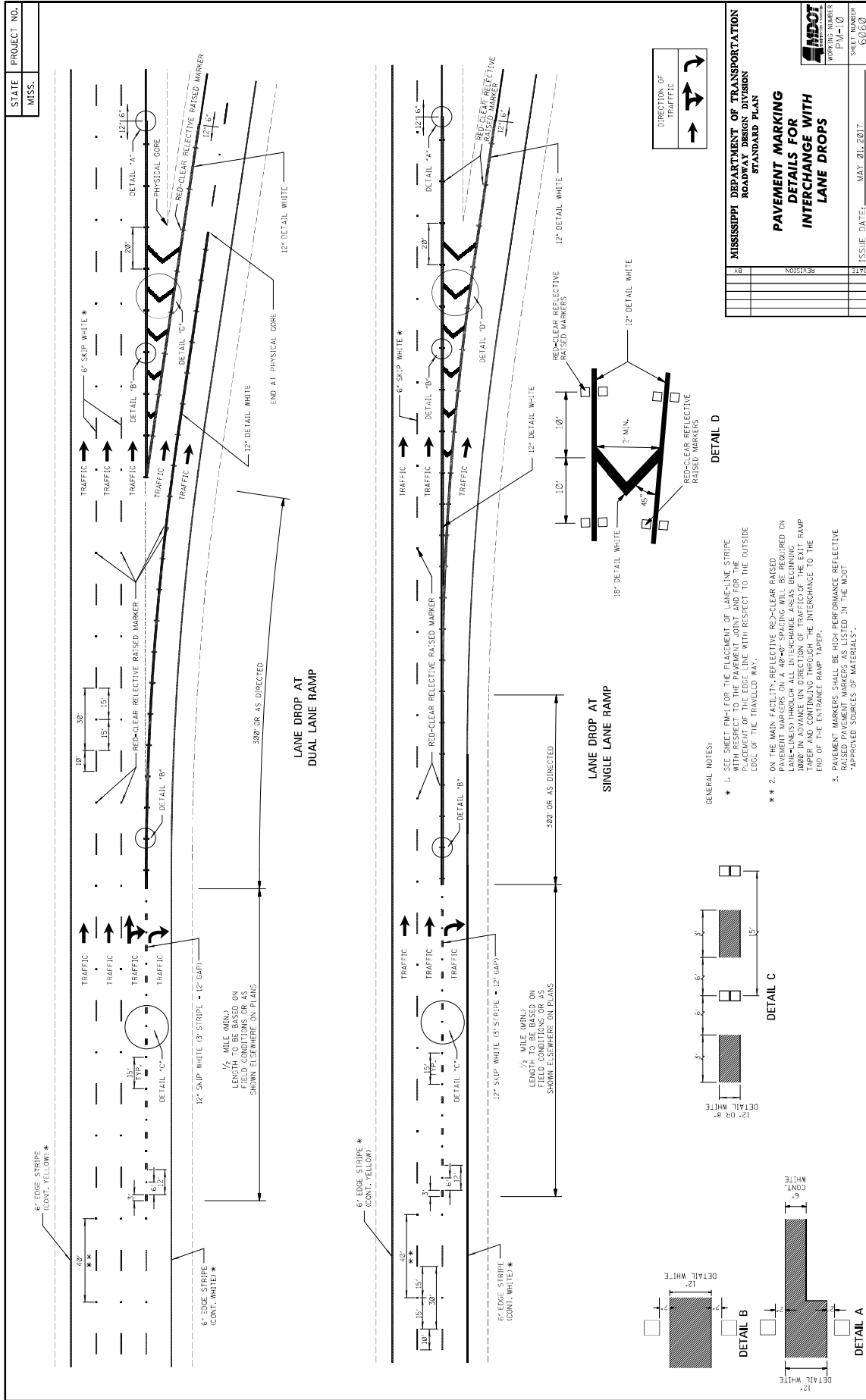

STATE MISS.	PROJECT NO.	
----------------	-------------	--

**TYPICAL PLACEMENT OF RAISED PAVEMENT MARKERS ON SIDE ROAD RADIUS
2-LANE, TWO WAY TRAFFIC**

DETAIL A

GENERAL NOTES:

1. MARKERS SHALL BE FLACCO EVERY 18' FEET.
2. MARKERS SHALL BE VISIBLE FROM THE TRAVELING MOTORIST ON STATE DESIGNATED HIGHWAYS.
3. MARKERS SHALL BE HIGH PERFORMANCE TWO-WAY CLEAR.
4. FIVE (5) MARKERS SHALL BE PLACED ALONG MAINLINE EDGE STRIPE.
5. MARKERS ON COUNTY ROADS SHALL CONTINUE DOWN THE MAINLINE EDGE STRIPE A DISTANCE OF 48 FEET.
6. MARKERS SHALL NOT BE ROTATED WHEN BEING PLACED ALONG RADIUS AND TANGENT SECTION OF LOCAL ROAD.
7. MARKERS SHALL BE INSTALLED AT SIMPLE AND CHANNELIZED INTERSECTIONS TO THE LIMITS SHOWN ABOVE.

	MISSISSIPPI DEPARTMENT OF TRANSPORTATION ROADWAY DESIGN DIVISION STANDARD PLAN	2-WAY RAISED PAVEMENT MARKERS AT INTERSECTING ROADS (2-LANE)
DATE	BY	REVISION
ISSUE DATE: MAY 01, 2017		

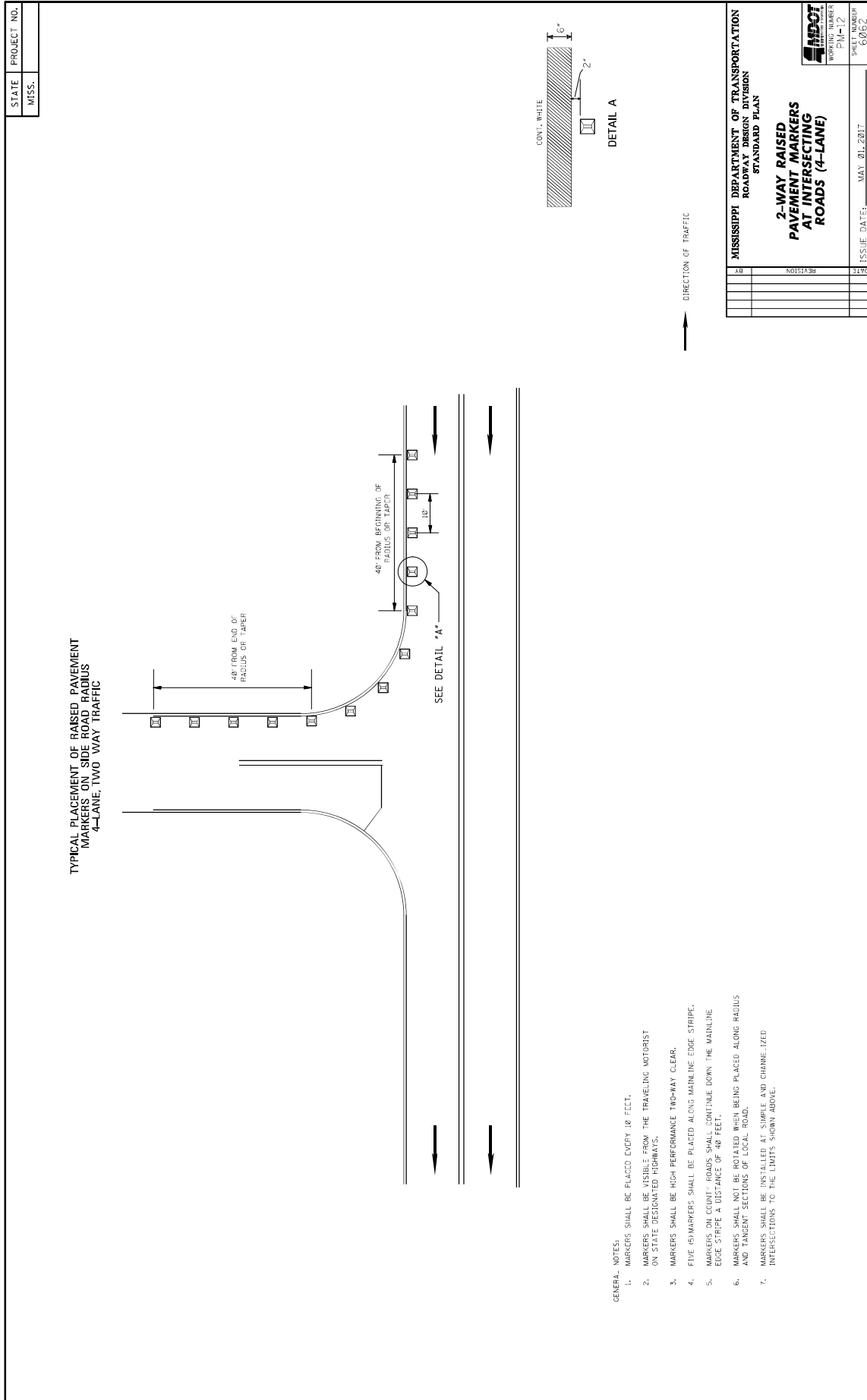

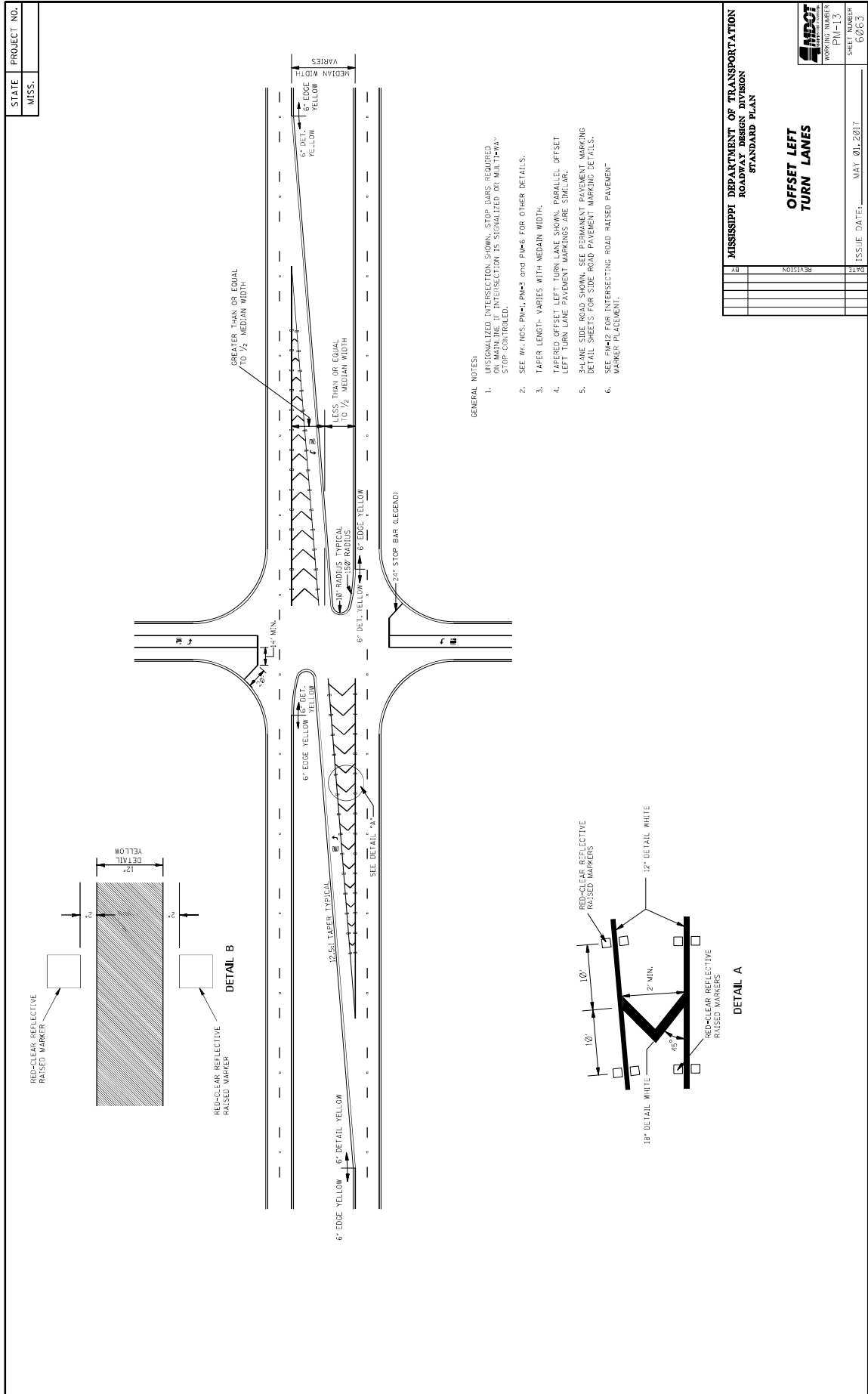

MISSISSIPPI DEPARTMENT OF TRANSPORTATION ROADWAY DESIGN DIVISION STANDARD PLAN	
OFFSET LEFT TURN LANES	SHEET NUMBER PM-13 GZGJ
DATE	ISSUE DATE: MAY 01, 2017
BY	REVISION

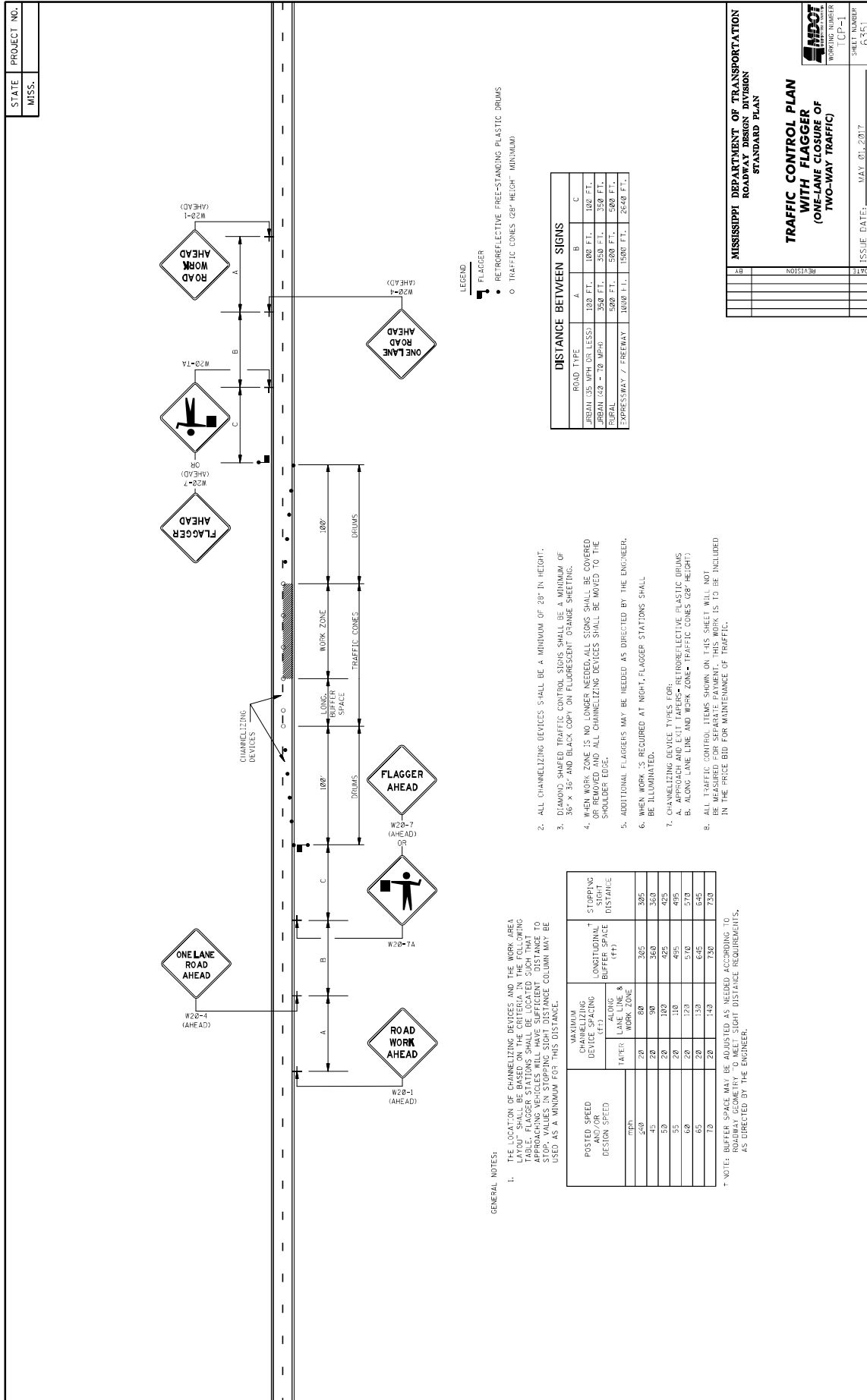

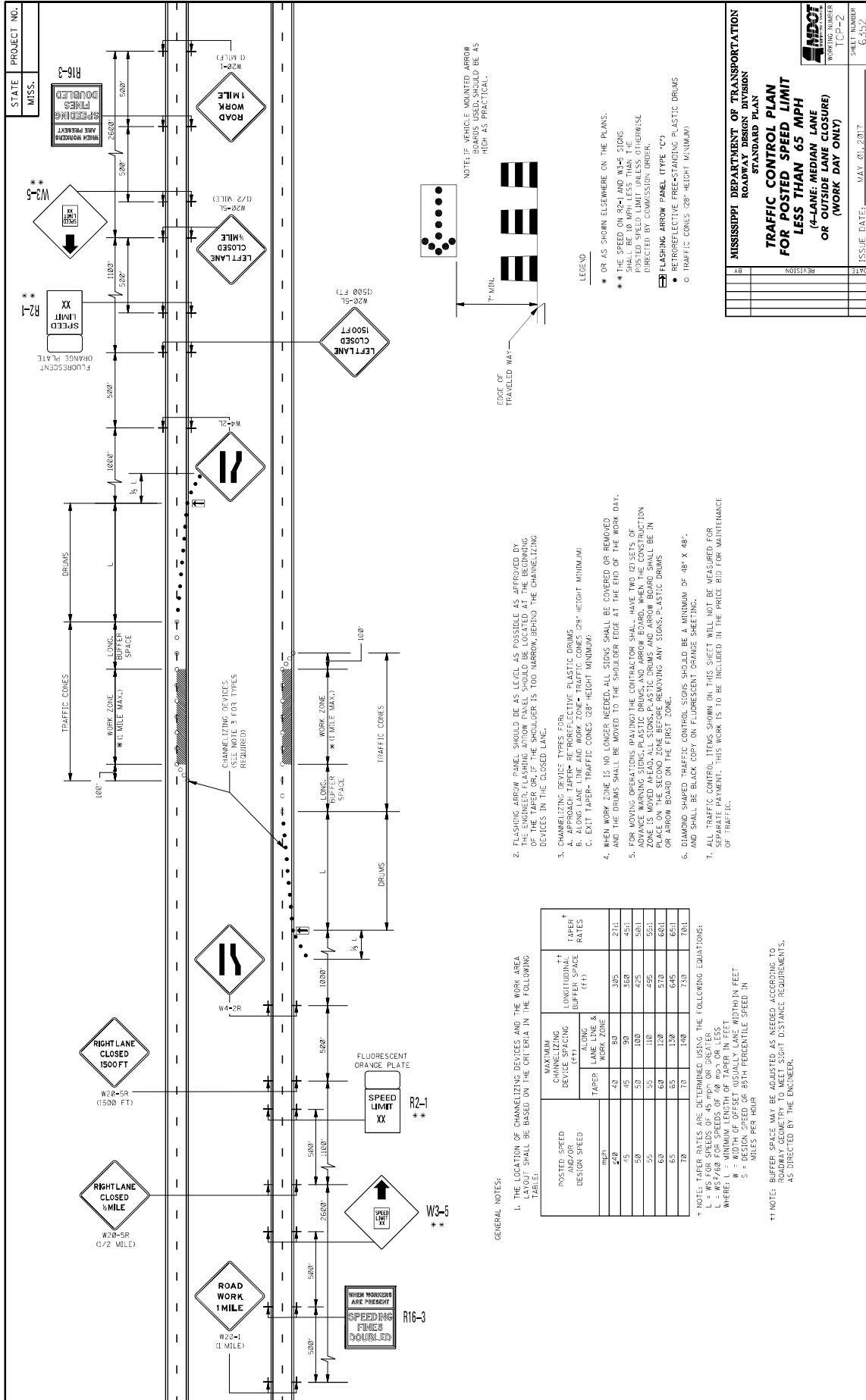

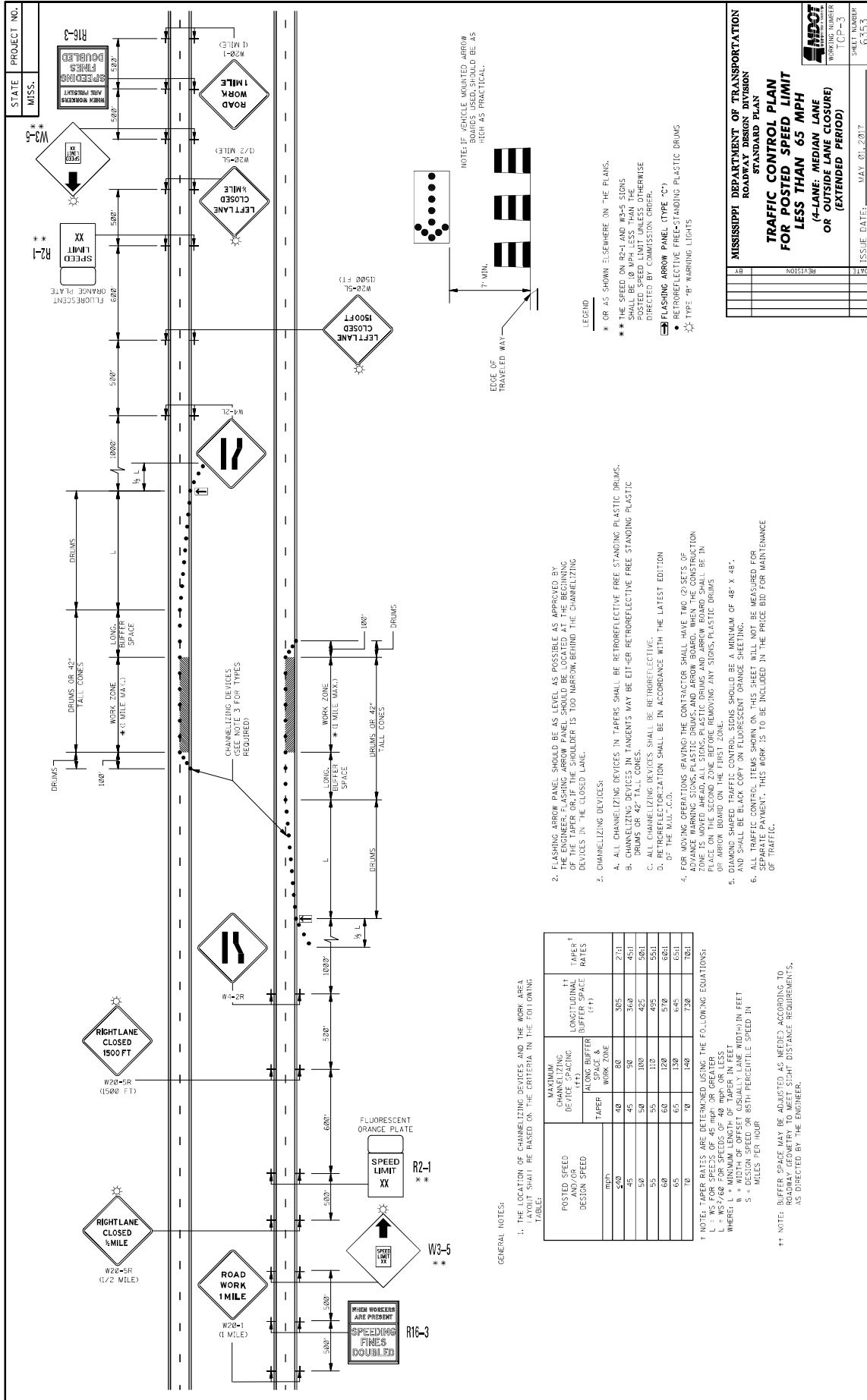

POSTED SPEED DESIGN SPEED	MAXIMUM CHANNELIZING DEVICE SPACING (FEET)		LONGITUDINAL BUFFER SPACE (FEET)	TAPER RATES
	ALONG BUFFER	WORK ZONE		
30	40	80	305	2/31
40	45	90	360	4/51
50	50	100	425	5/61
60	55	110	495	6/71
70	60	120	570	8/81
80	65	130	645	10/91
90	70	140	730	12/11

† NOTE: TAPER RATES ARE DETERMINED USING THE FOLLOWING EQUATIONS:
 L = AS FOR SPEEDS OF 45 MPH OR GREATER
 L = WS/60 FOR SPEEDS OF 40 MPH OR LESS
 WHERE: W = WIDTH OF OFFSET, USUALLY LANE WIDTH IN FEET
 S = DESIGN SPEED OR 85TH PERCENTILE SPEED IN MILES PER HOUR

†† NOTE: BUFFER SPACE MAY BE ADJUSTED AS NECESSARY ACCORDING TO ROADWAY GEOMETRY TO MEET SIGHT DISTANCE REQUIREMENTS, AS DIRECTED BY THE ENGINEER.

GENERAL NOTES:
 1. THE LOCATION OF CHANNELIZING DEVICES AND THE WORK AREA LAYOUT SHALL BE BASED ON THE CRITERIA IN THE FOLLOWING TABLE:

- FLASHING ARROW PANEL SHOULD BE AS LEVEL AS POSSIBLE AS APPROVED BY THE ENGINEER. FLASHING ARROW PANEL SHOULD BE LOCATED AT THE BEGINNING OF THE WORK ZONE. BUFFER SHOULD BE 100' AHEAD OF THE CHANNELIZING DEVICES IN THE CLOSED LANE.
- CHANNELIZING DEVICES:
 - ALL CHANNELIZING DEVICES IN TAPERS SHALL BE RETROREFLECTIVE FREE STANDING PLASTIC DRUMS.
 - DRUMS OR 42" TALL CONES.
 - ALL CHANNELIZING DEVICES SHALL BE RETROREFLECTIVE.
 - RETROREFLECTORIZATION SHALL BE IN ACCORDANCE WITH THE LATEST EDITION OF THE M.I.T.S.D.C.
- FOR WORKING DRUMS, TAPERS THE CONTRACTOR SHALL HAVE TWO (2) FEET OF CHANNELIZING DEVICES (STANDING PLASTIC DRUMS AND ARROW BOARD) IN THE CONSTRUCTION ZONE IS MOVED AHEAD ALL STANDING PLASTIC DRUMS AND ARROW BOARD SHALL BE IN PLACE ON THE SECOND ZONE BEFORE REMOVING ANY STANDING PLASTIC DRUMS OR ARROW BOARD ON THE FIRST ZONE.
- ALL CHANNELIZING DEVICES SHALL BE A MINIMUM OF 48" X 48" AND SHALL BE BLACK COPY ON FLUORESCENT ORANGE SHEETING.
- ALL TRAFFIC CONTROL ITEMS SHOWN ON THIS SHEET WILL NOT BE MEASURED FOR SEPARATE PAYMENT. THIS WORK IS TO BE INCLUDED IN THE PRICE BID FOR MAINTENANCE OF TRAFFIC.

- LEGEND
- * OR AS SHOWN ELSEWHERE ON THE PLANS.
 - ** THE SPEED ON R2-1 AND R2-5 SIGNS SHALL BE 10 MPH LESS THAN THE POSTED SPEED LIMIT UNLESS OTHERWISE DIRECTED BY COMMISSION ORDER.
 - ◻ FLASHING ARROW PANEL (TYPE 'C')
 - RETROREFLECTIVE FREE-STANDING PLASTIC DRUMS
 - ◻ TYPE 'B' WARNING LIGHTS
- NOTE: IF VEHICLE MOUNTED ARROW BOARDS USED, SHOULD BE AS HIGH AS PRACTICAL.

MISSISSIPPI DEPARTMENT OF TRANSPORTATION
 ROADWAY DESIGN DIVISION
 STANDARD PLAN
**TRAFFIC CONTROL PLAN
 FOR POSTED SPEED LIMIT
 LESS THAN 65 MPH
 (4-LANE, MEDIAN LANE
 OR OUTSIDE LANE CLOSURE
 (EXTENDED PERIOD))**

ISSUE DATE: MAY 01, 2017
 SHEET NUMBER: 6253
 PROJECT NO.: MISS.

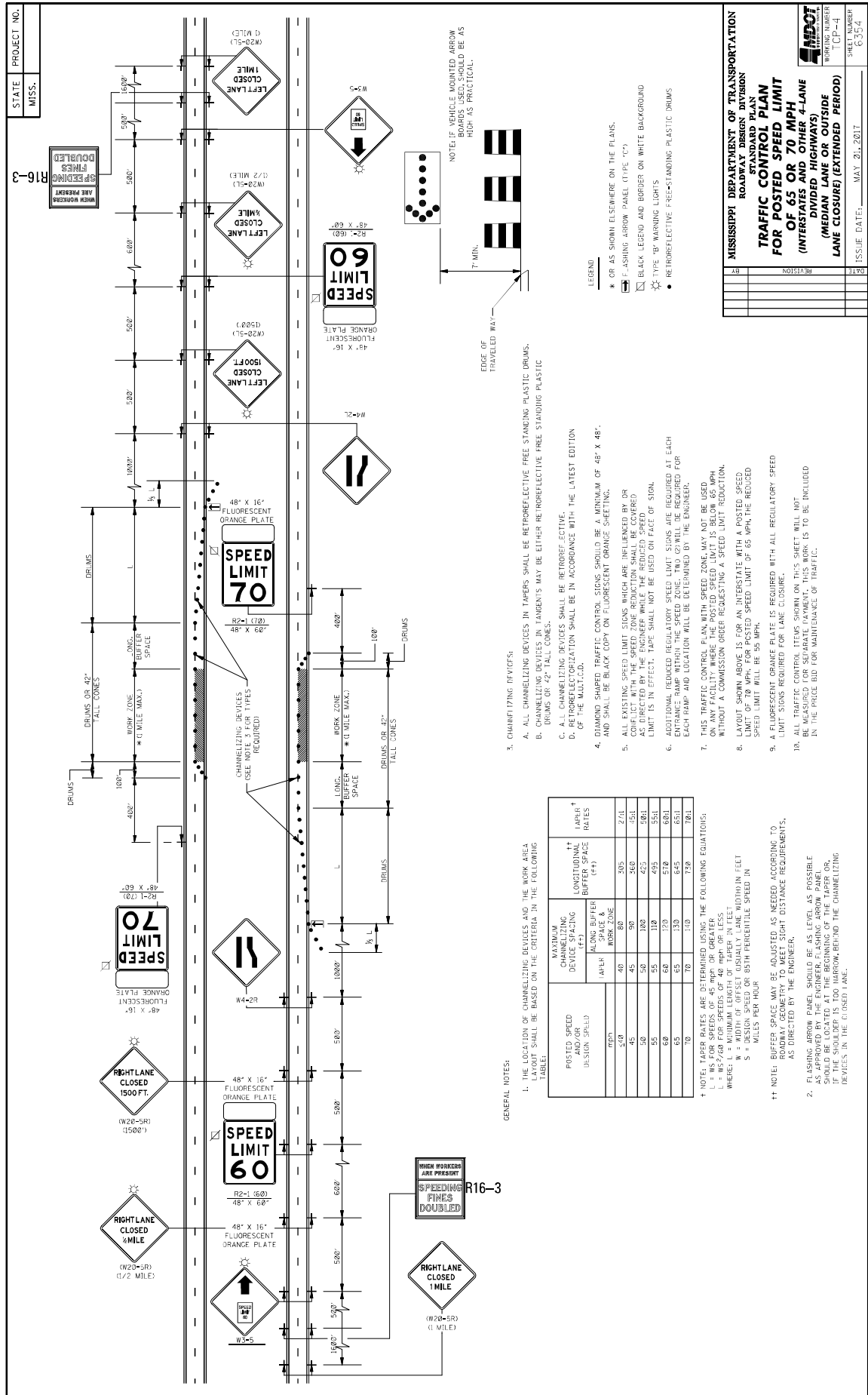

MISSISSIPPI DEPARTMENT OF TRANSPORTATION
ROADWAY DESIGN DIVISION
TRAFFIC CONTROL PLAN
FOR POSTED SPEED LIMIT
OF 65 OR 70 MPH
(INTERSTATES AND OTHER 4-LANE
DIVIDED HIGHWAYS)
(MEDIAN LANE OR OUTSIDE
LANE CLOSED/EXTENDED PERIOD)

ISSUE DATE: MAY 20, 2012

- GENERAL NOTES:
1. THE LOCATION OF CHANNELIZING DEVICES AND THE WORK AREA LENGTH SHALL BE BASED ON THE CRITERIA IN THE FOLLOWING TABLE:
- | POSTED SPEED AND/OR DESIGN SPEED (MPH) | MAXIMUM CHANNELIZING DEVICE SPACING ALONG BUFFER SPACE & WORK ZONE (FT) | LONGITUDINAL BUFFER SPACE (FT) | TAPER RATES |
|--|---|--------------------------------|-------------|
| 50 | 40 | 305 | 2:1 |
| 55 | 45 | 330 | 2:1 |
| 60 | 50 | 355 | 2:1 |
| 65 | 55 | 380 | 2:1 |
| 70 | 60 | 405 | 2:1 |
| 75 | 65 | 430 | 2:1 |
2. TAPER RATES ARE DETERMINED USING THE FOLLOWING EQUATIONS:
T = WS/240 FOR SPEEDS OF 45 MPH OR GREATER
T = WS/240 FOR SPEEDS OF 40 MPH OR LESS
WHERE: L = MINIMUM LEGAL CLEARANCE IN FEET
S = DESIGN SPEED OR 85TH PERCENTILE SPEED IN MILES PER HOUR
 3. CHANNELIZING DEVICES IN TAPERS SHALL BE RETROREFLECTIVE. CHANNELIZING DEVICES IN TANGENTS MAY BE EITHER RETROREFLECTIVE OR FREE STANDING PLASTIC DRUMS OR 42" TALL CONES.
 4. ALL CHANNELIZING DEVICES SHALL BE RETROREFLECTIVE. THE LATEST EDITION OF THE MUTCD-6A.
 5. DIAMOND SHAPED TRAFFIC CONTROL SIGNS SHOULD BE A MINIMUM OF 48" X 48" AND SHALL BE BLACK COPY ON FLUORESCENT ORANGE SHEETING.
 6. ALL EXISTING SPEED LIMIT SIGNS WHICH ARE INFLUENCED BY OR CONFLICT WITH THE SPEED ZONE REDUCTION SHALL BE COVERED. THE SPEED ZONE REDUCTION SIGN SHALL NOT BE USED ON FACE OF SIGNS. LEGISLATION REQUIRES REGULATORY SPEED LIMIT SIGNS ARE REQUIRED AT EACH ENTRANCE RAMP AND LEGALION WILL BE DETERMINED BY THE ENGINEER.
 7. THIS TRAFFIC CONTROL PLAN WITH SPEED ZONE MAY NOT BE USED ON ANY FACILITY WHERE THE POSTED SPEED LIMIT IS BELOW 65 MPH WITHOUT A COMMISSION ORDER REQUESTING A SPEED LIMIT REDUCTION.
 8. LAYOUT SHOWN ABOVE IS FOR AN INTERSTATE WITH A POSTED SPEED LIMIT OF 70 MPH FOR PASTED SPEED LIMIT OF 65 MPH. THE REDUCED SPEED LIMIT WILL BE 55 MPH.
 9. A FLUORESCENT ORANGE PLATE IS REQUIRED WITH ALL REGULATORY SPEED LIMIT SIGNS REQUIRED FOR LANE CLOSURE.
 10. ALL TRAFFIC CONTROL ITEMS SHOWN ON THIS SHEET WILL NOT BE MEASURED FOR SEPARATE PAYMENT. THIS WORK IS TO BE INCLUDED IN THE PRICE BID FOR MAINTENANCE OF TRAFFIC.

LEGEND

- * OR AS SHOWN ELSEWHERE ON THE PLANS.
- F FLASHING ARROW PANEL (TYPE "C")
- BLACK LEGEND AND BORDER ON WHITE BACKGROUND
- TYPE "B" MARKING LIGHTS
- RETROREFLECTIVE FREE-STANDING PLASTIC DRUMS

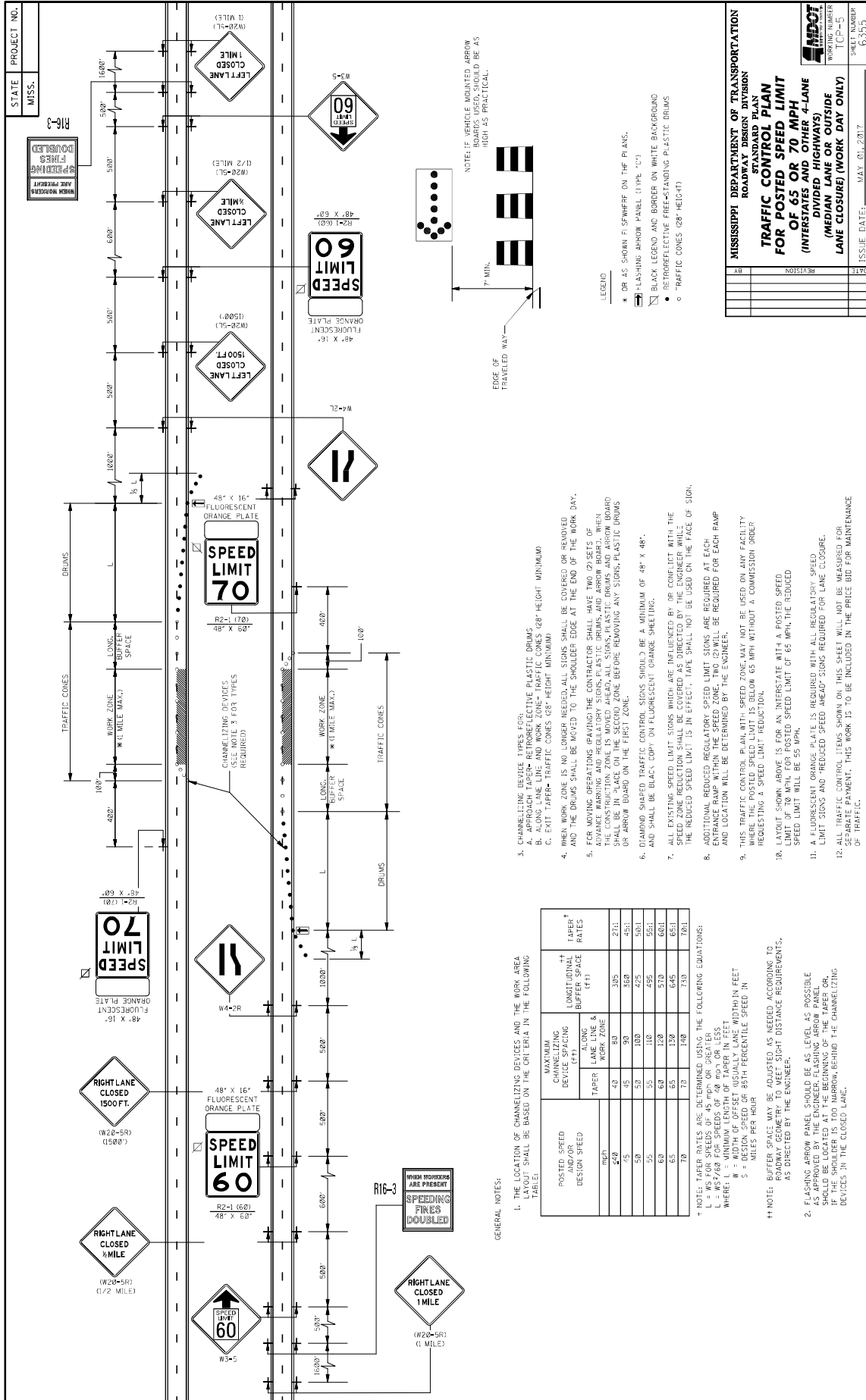

STATE PROJECT NO.

MISS.

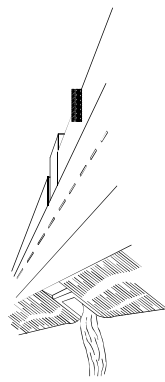

WING BARRICADES

1. WING BARRICADES ARE TYPE II BARRICADES ERECTED ON THE SHOULDER OF A ROADWAY OR RESTRICTED ROADWAY. WING BARRICADES MAY BE USED AS A MOUNTING FOR THE ADVANCE WARNING SIGNS OR FLASHERS.

2. WING BARRICADES SHOULD BE USED:

A. IN ADVANCE OF A CONSTRUCTION PROJECT EVEN WHEN NO PART OF THE ROADWAY IS ACTUALLY CLOSED.

B. IN ADVANCE OF ALL BRIDGE OR CULVERT WIDENING OPERATIONS.

WORKING NUMBER
TCP-5

SHEET NUMBER
03300

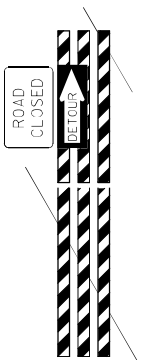

BARRICADE CLOSING A ROAD

	I	II	III
WIDTH OF RAIL **	8" MIN. - 12" MAX.	8" MIN. - 12" MAX.	8" MIN. - 12" MAX.
LENGTH OF RAIL **	24" MIN.	24" MIN.	48" MIN.
WIDTH OF STRIPE *	6"	6"	6"
HEIGHT	36" MIN.	36" MIN.	60" MIN.
NUMBER OF RETROREFLECTORIZED RAIL FACES	2 (ONE EACH DIRECTION)	4 (TWO EACH DIRECTION)	3 IF FACING TRAFFIC IN ONE DIRECTION 4 IF FACING TRAFFIC IN TWO DIRECTIONS

BARRICADE CHARACTERISTICS

* 1. FOR RAILS LESS THAN 36" LONG, 4" WIDE STRIPES MAY BE USED.

** 2. BARRICADES INTENDED FOR USE ON EXPRESSWAYS, FREEWAYS AND OTHER HIGH SPEED ROADWAYS, SHALL HAVE A MINIMUM OF 270 IN² OF REFLECTIVE AREA FACING TRAFFIC.

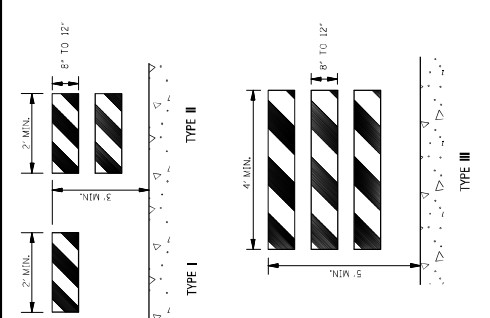

STANDARD BARRICADES

1. THE MARKING FOR BARRICADE RAILS SHALL BE ORANGE AND WHITE (SLOPING DOWNWARD AT AN ANGLE OF 45° IN THE DIRECTION TRAFFIC IS TO PASS).

2. RAIL STRIPE SHALL BE 6 INCHES, EXCEPT THAT 4-INCH WIDE STRIPES MAY BE USED IF RAIL LENGTHS ARE LESS THAN 36 INCHES.

3. DO NOT PLACE SANDBAGS OR OTHER DEVICES TO PROVIDE MASS ON THE BOTTOM RAIL THAT WILL BLOCK VIEW OR RAIL FACE.

4. FOR ADDITIONAL INFORMATION OR DETAILS, SEE MUTCD, LATEST EDITION.

5. BARRICADES ARE CLASSIFIED BY FHWA AS CATEGORY II WHEN ZONE DEVICES WHICH REQUIRE SUCCESSFULLY CRASH TESTED. A LIST OF CRASHWORTHY BARRICADES AND OTHER CATEGORY II DEVICES CAN BE FOUND ON FHWA'S WEBSITE: http://safety.fhwa.dot.gov/roadway_dept/pafety_guidance/road_hardware/cat2.cfm

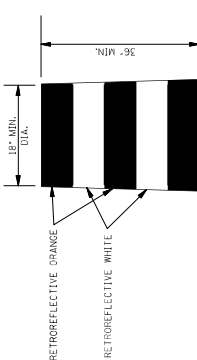

PLASTIC DRUM STRIPING DETAIL

1. PLASTIC DRUMS SHALL BE ON END AND USED AS AN EXPEDIENT METHOD FOR TRAFFIC CHANNELIZATION. THE COLOR AND MARKING OF DRUMS SHALL BE CONSISTENT WITH MARKING STANDARD FOR ROADWAY SAFETY DEVICES. THE PREFERRED COLOR OF DRUMS WITH MARKING STRIPES SHALL BE RETROREFLECTIVE. HORIZONTAL, CIRCUMFERENTIAL STRIPES (2 ORANGE & 2 WHITE) 6" WIDE.

2. DRUMS SHOULD NEVER BE PLACED IN THE ROADWAY WITHOUT WARNING SIGNS.

3. WHERE PRACTICAL PLASTIC DRUMS SHOULD BE PLACED NO CLOSER THAN 3'-0" FROM THE EDGE OF TRAVELED LANE.

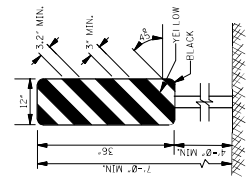

TYPE 3 OBJECT MARKER (OM-3R)

1. TYPE 3 OBJECT MARKERS SHALL BE USED AT ALL EXPOSED BRIDGE ABUTMENTS AND AT OTHER LOCATIONS AS DETERMINED NECESSARY BY THE ENGINEER.

2. THE OM-3R IS SIMILAR EXCEPT THE STRIPES SLOPE DOWNWARD FROM THE UPPER LEFT SIDE TO THE LOWER RIGHT SIDE AND SHALL BE PLACED ON THE LEFT SIDE OF THE OBJECT.

3. THE INSIDE EDGE OF THE MARKER SHALL BE IN LINE WITH THE INNER EDGE OF THE OBSTRUCTION.

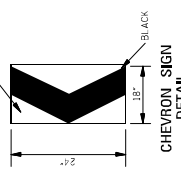

CHEVRON SIGN DETAIL

1. A CHEVRON SIGN CONSISTS OF A BLACK CHEVRON TYPE MARKING ON AN ORANGE BACKGROUND AND SHALL POINT IN THE DIRECTION OF TRAFFIC FLOW.

2. THE CHEVRON SIGN SHALL BE MOUNTED ON CRASHWORTHY SUPPORT.

3. CHEVRON SIGNS MAY BE USED TO SUPPLEMENT OTHER STANDARD DEVICES WHERE ONE OR MORE LANES ARE CLOSED FOR CONSTRUCTION OR MAINTENANCE. THEY SHOULD BE PLACED APPROXIMATELY 2'-0" BEHIND THE LANE TRANSITION STRIPE.

REVISION

MISSISSIPPI DEPARTMENT OF TRANSPORTATION
ROADWAY DESIGN DIVISION
STANDARD PLAN

HIGHWAY SIGN AND BARRICADE DETAILS FOR CONSTRUCTION PROJECTS

ISSUE DATE: MAY 20, 2017

STATE MISS.	PROJECT NO.	
----------------	-------------	--

MOBILE OPERATIONS ON MULTILANE ROAD

MOBILE OPERATIONS ON MULTILANE ROAD

MOBILE OPERATIONS ON TWO-LANE ROAD

MOBILE OPERATIONS ON TWO-LANE ROAD

NOTES FOR MULTILANE LANE OPERATION:

- VEHICLES USED FOR THESE OPERATIONS SHOULD BE MADE HIGHLY VISIBLE WITH APPROPRIATE EQUIPMENT, SUCH AS FLASHING LIGHTS, ROTATING BEACONS, FLASGS, SIGNS, OR ARROW PANELS.
- SHADOW VEHICLE 2 SHOULD BE EQUIPPED WITH AN ARROW PANEL AND TRUCK MOUNTED ATTENUATOR (TMA), AN APPROPRIATE LANE CLOSURE SIGN SHOULD BE MOUNTED ON SHADOW VEHICLE 2 SO AS NOT TO OBSCURE THE ARROW PANEL.
- SHADOW VEHICLE 1 SHOULD BE EQUIPPED WITH AN ARROW PANEL AND TRUCK MOUNTED ATTENUATOR (TMA).
- SHADOW VEHICLE 2 SHOULD TRAVEL AT A VARYING DISTANCE FROM THE WORK OPERATION SO AS TO PROVIDE ADEQUATE SIGHT DISTANCE FOR TRAFFIC APPROACHING FROM THE REAR.
- WHEN ADEQUATE SHOULDER WIDTH IS NOT AVAILABLE, SHADOW VEHICLE 2 SHOULD BE ELIMINATED.
- ON HIGH-SPEED ROADWAYS, A THIRD SHADOW VEHICLE SHOULD BE USED (i.e., VEHICLE 3 ON THE SHOULDER OF PRACTICALLY, VEHICLE 2 IN THE CLOSED LANE, AND VEHICLE 1 IN THE CLOSED LANE).
- ARROW PANELS SHALL BE AS A MINIMUM TYPE B, 60" X 36" IN ACCORDANCE WITH THE CRITERIA PRESENTED IN THE MUTCD.
- WORK SHOULD NORMALLY BE DONE DURING OFF-PEAK HOURS.
- TRUCK-MOUNTED SIGNS SHOULD BE MOUNTED WITH THE BOTTOM OF THE SIGN LOCATED AT A MINIMUM HEIGHT OF 48" ABOVE THE PAVEMENT AND SHALL NOT BE OBTURED BY EQUIPMENT. SIGN LEGENDS SHALL BE COVERED OR TURNED FROM VIEW WHEN WORK IS NOT IN PROGRESS.
- ALL TRAFFIC CONTROL ITEMS SHOWN ON THIS SHEET WILL NOT BE MEASURED FOR SEPARATE PAYMENT. THIS WORK IS TO BE INCLUDED IN THE PRICE BID FOR MAINTENANCE OF TRAFFIC.

NOTES FOR TWO-LANE OPERATION:

- WHERE PRACTICAL AND WHEN NEEDED, THE WORK AND SHADOW VEHICLES SHOULD PULL OVER PERIODICALLY TO ALLOW TRAFFIC TO PASS. IF THIS CAN NOT BE DONE FREQUENTLY AS AN ALTERNATIVE, A "DO NOT PASS" SIGN MAY BE PLACED ON THE REAR OF THE VEHICLE BLOCKING THE LANE.
- THE DISTANCE BETWEEN THE WORK AND SHADOW VEHICLES MAY VARY ACCORDING TO TERRAIN, PAINT DRYING TIME, AND OTHER FACTORS. SHADOW VEHICLES ARE USED TO WARN TRAFFIC OF THE OPERATION AHEAD. WHENEVER ADEQUATE SHOULD MAINTAIN THE MINIMUM DISTANCE AND PROCEED AT THE SAME SPEED AS THE WORK VEHICLE. THE SHADOW VEHICLE SHOULD SLOW DOWN IN ADVANCE OF VERTICAL OR HORIZONTAL CURVES THAT RESTRICT SIGHT DISTANCE.
- ADDITIONAL SHADOW VEHICLES TO WARN AND REDUCE THE SPEED OF ONCOMING OR OPPOSING TRAFFIC MAY BE USED. POLICE PATROL CARS MAY BE USED FOR THIS PURPOSE.
- A TRUCK-MOUNTED ATTENUATOR (TMA) SHOULD BE USED ON THE SHADOW VEHICLE AND MAY BE USED ON THE WORK VEHICLE.
- THE WORK VEHICLE SHALL BE EQUIPPED WITH BEACONS AND THE SHADOW VEHICLE SHALL BE EQUIPPED WITH BEACONS AND LIGHTS. TRUCK-MOUNTED LIGHTS MOUNTED ON THE REAR, ADJACENT TO THE SIGN, SHADOW AND WORK VEHICLES SHALL DISPLAY FLASHING OR ROTATING BEACONS BOTH FORWARD AND TO THE REAR.
- VEHICLE-MOUNTED SIGNS SHOULD BE MOUNTED WITH THE BOTTOM OF THE SIGN LOCATED AT A MINIMUM HEIGHT OF 48" ABOVE THE PAVEMENT AND SHALL NOT BE OBTURED BY EQUIPMENT OR SIGN LEGENDS SHALL BE COVERED OR TURNED FROM VIEW WHEN WORK IS NOT IN PROGRESS.
- ARROW BOARD TO BE USED IN CAUTION MODE.
- ALL TRAFFIC CONTROL ITEMS SHOWN ON THIS SHEET WILL NOT BE MEASURED FOR SEPARATE PAYMENT. THIS WORK IS TO BE INCLUDED IN THE PRICE BID FOR MAINTENANCE OF TRAFFIC.

MISSISSIPPI DEPARTMENT OF TRANSPORTATION
ROADWAY DESIGN DIVISION
STANDARD PLAN

TRAFFIC CONTROL PLAN
MOBILE OPERATIONS
MULTILANE ROADS
TWO-LANE ROADS

REV	REVISION	
1		
2		
3		
4		
5		
6		
7		
8		
9		
10		

ISSUE DATE: MAY 01, 2017

SHEET NUMBER TCP-9	PROJECT NUMBER 6359
-----------------------	------------------------

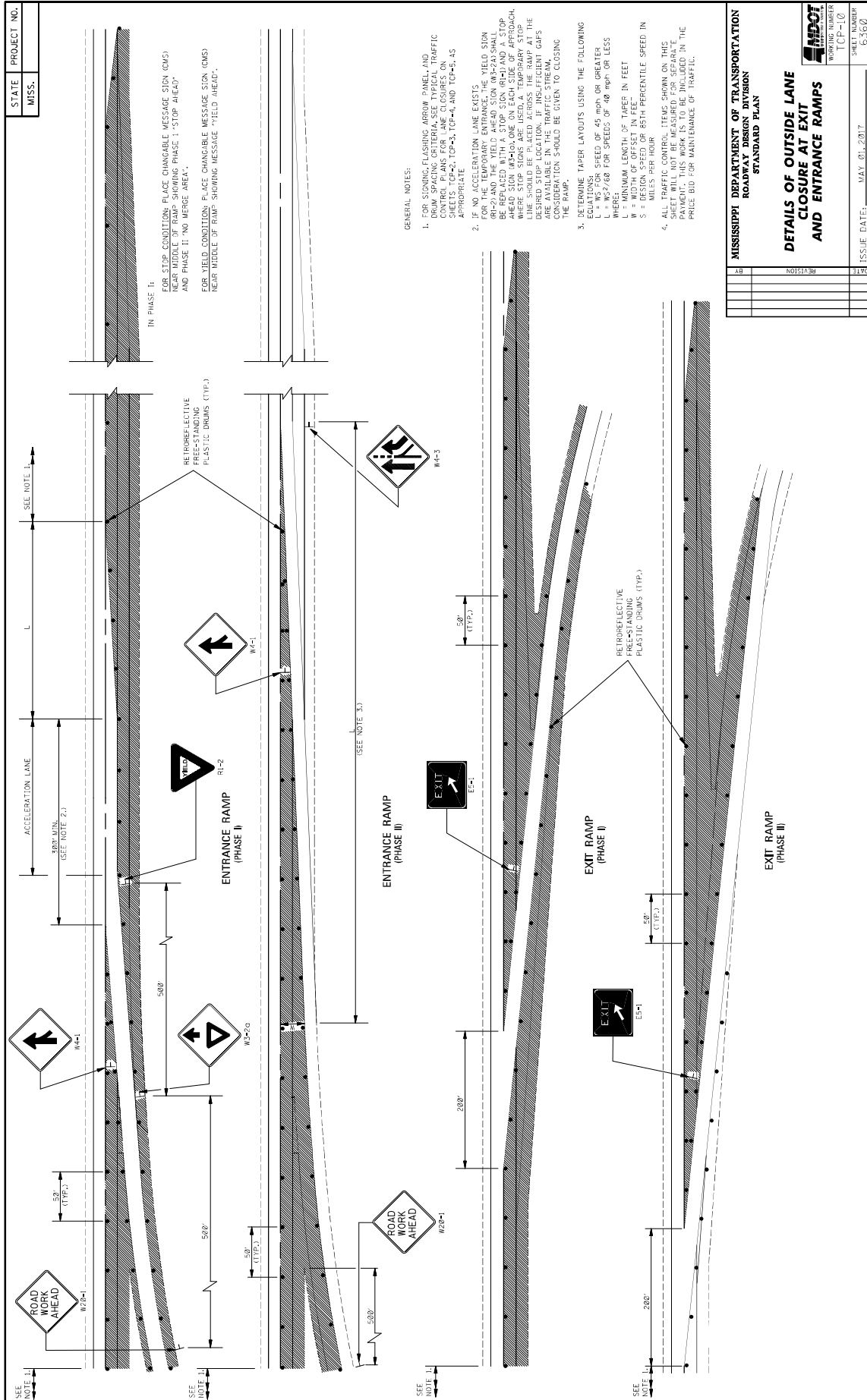

STATE PROJECT NO.
MISS.

MISSISSIPPI DEPARTMENT OF TRANSPORTATION
ROADWAY DESIGN DIVISION
STANDARD PLAN

**DETAILS OF OUTSIDE LANE
CLOSURE AT EXIT
AND ENTRANCE RAMP**

ISSUE DATE: MAY 01, 2017

WORKING NUMBER: TCR-110
SHEET NUMBER: 6360

NO.	REVISION	DATE

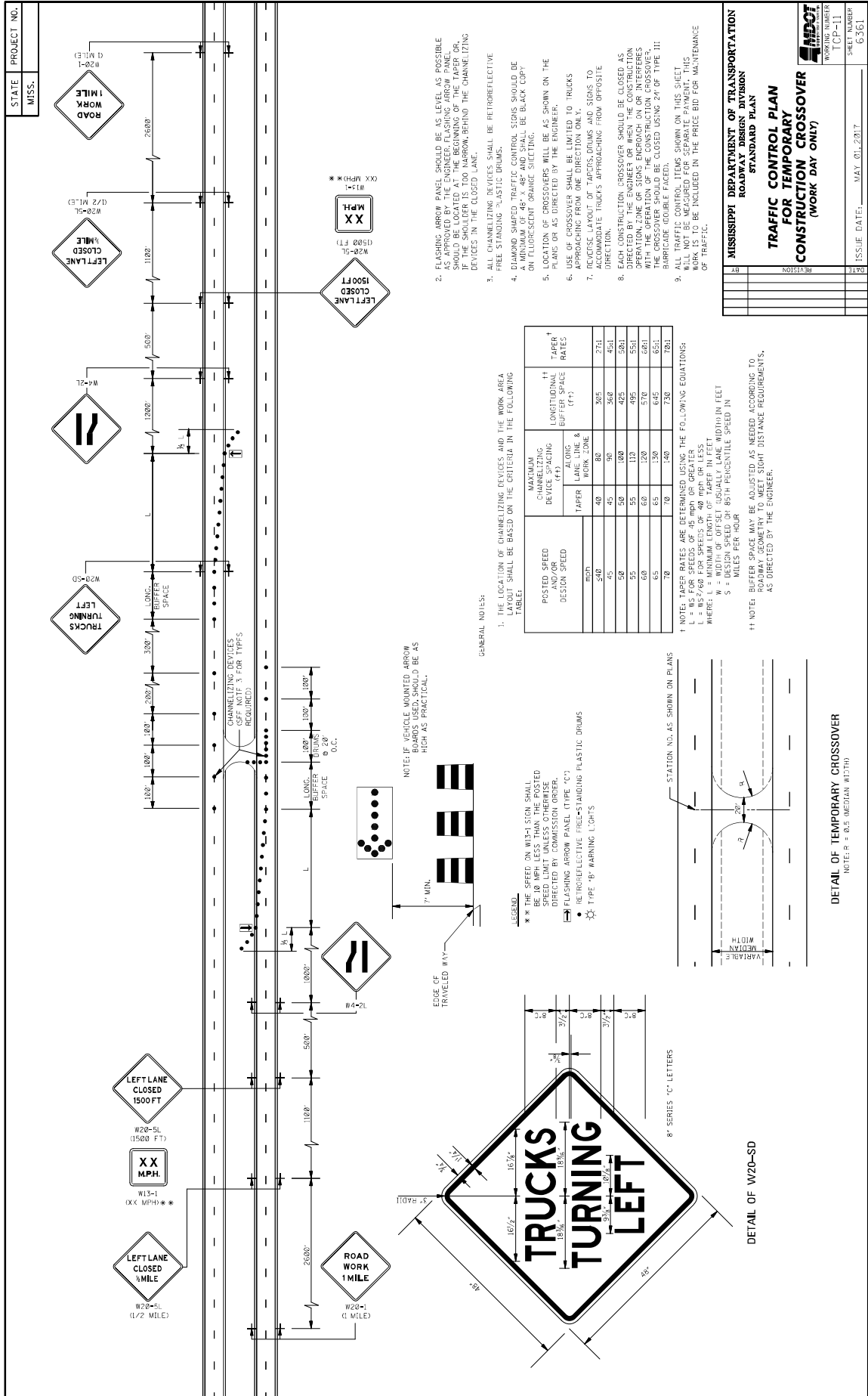

POSTED SPEED DESIGN SPEED	MAXIMUM CHANNELIZING DEVICE SPACING (FT)	LONGITUDINAL BUFFER SPACE (FT)	TAPER [†] RATES
50	49	82	305
45	45	90	362
50	50	100	425
55	55	112	495
60	60	120	570
65	65	130	645
70	70	140	730

† NOTE: TAPER RATES ARE DETERMINED USING THE FOLLOWING EQUATIONS:
 $L = W \times S$
 WHERE: L = MINIMUM LENGTH OF TAPER IN FEET
 W = WIDTH OF OFFSET USUALLY LANE WIDTH IN FEET
 S = 65TH PERCENTILE SPEED IN MILES PER HOUR
 †† NOTE: BUFFER SPACE MAY BE ADJUSTED AS NEEDED ACCORDING TO ROADWAY GEOMETRY TO MEET SIGHT DISTANCE REQUIREMENTS, AS DIRECTED BY THE ENGINEER.

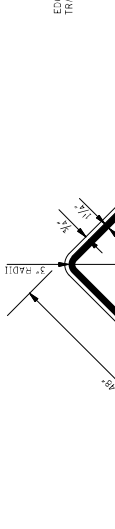
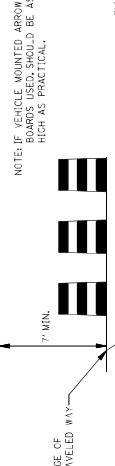

1. THE LOCATION OF CHANNELIZING DEVICES AND THE WORK AREA TAPER SHALL BE BASED ON THE CRITERIA IN THE FOLLOWING TABLE:
2. FLASHING ARROW PANELS SHOULD BE AS LEVEL AS POSSIBLE AS APPROVED BY THE ENGINEER. FLASHING ARROW PANELS SHOULD BE LOCATED AT THE BEGINNING OF THE TAPER OR, IF THE SHOULDER IS TOO NARROW, BEHIND THE CHANNELIZING DEVICES IN THE CLOSED LANE.
3. ALL CHANNELIZING DEVICES SHALL BE RETROREFLECTIVE FREE STANDING PLASTIC DRUMS.
4. DIAMOND SHAPED TRAFFIC CONTROL SIGNS SHOULD BE BLACK COPY ON FLUORESCENT ORANGE SUCTING.
5. LOCATION OF CROSSOVERS WILL BE AS SHOWN ON THE PLANS OR AS DIRECTED BY THE ENGINEER.
6. USE OF CROSSOVERS SHALL BE LIMITED TO TRUCKS APPROACHING FROM ONE DIRECTION ONLY.
7. REVERSE LAYOUT OF TAPERS, DRUMS AND SIGNS TO ACCOMMODATE TRUCKS APPROACHING FROM OPPOSITE DIRECTION.
8. EACH CONSTRUCTION CROSSOVER SHOULD BE CLOSED AS EARLY AS POSSIBLE AND REMAIN CLOSED THROUGH THE OPERATION ZONE OF SIGNS ENOUGH ON OR INTERFERES WITH THE OPERATION OF THE CONSTRUCTION CROSSOVER. THE CROSSOVER SHOULD BE CLOSED USING 24" OF TYPE III BUFFER SPACE.
9. ALL TRAFFIC CONTROL ITEMS SHOWN ON THIS SHEET WILL NOT BE MEASURED FOR SEPARATE PAYMENT. THIS WORK IS TO BE INCLUDED IN THE PRICE BID FOR MAINTENANCE OF TRAFFIC.

STATE PROJECT NO. MISS.

MISSISSIPPI DEPARTMENT OF TRANSPORTATION
 ROADWAY DESIGN DIVISION
 STANDARD PLAN
**TRAFFIC CONTROL PLAN
 FOR TEMPORARY
 CONSTRUCTION CROSSOVER
 (WORK DAY ONLY)**

WORKING NUMBER: TCR-11
 SHEET NUMBER: 6361
 ISSUE DATE: MAY 01, 2017

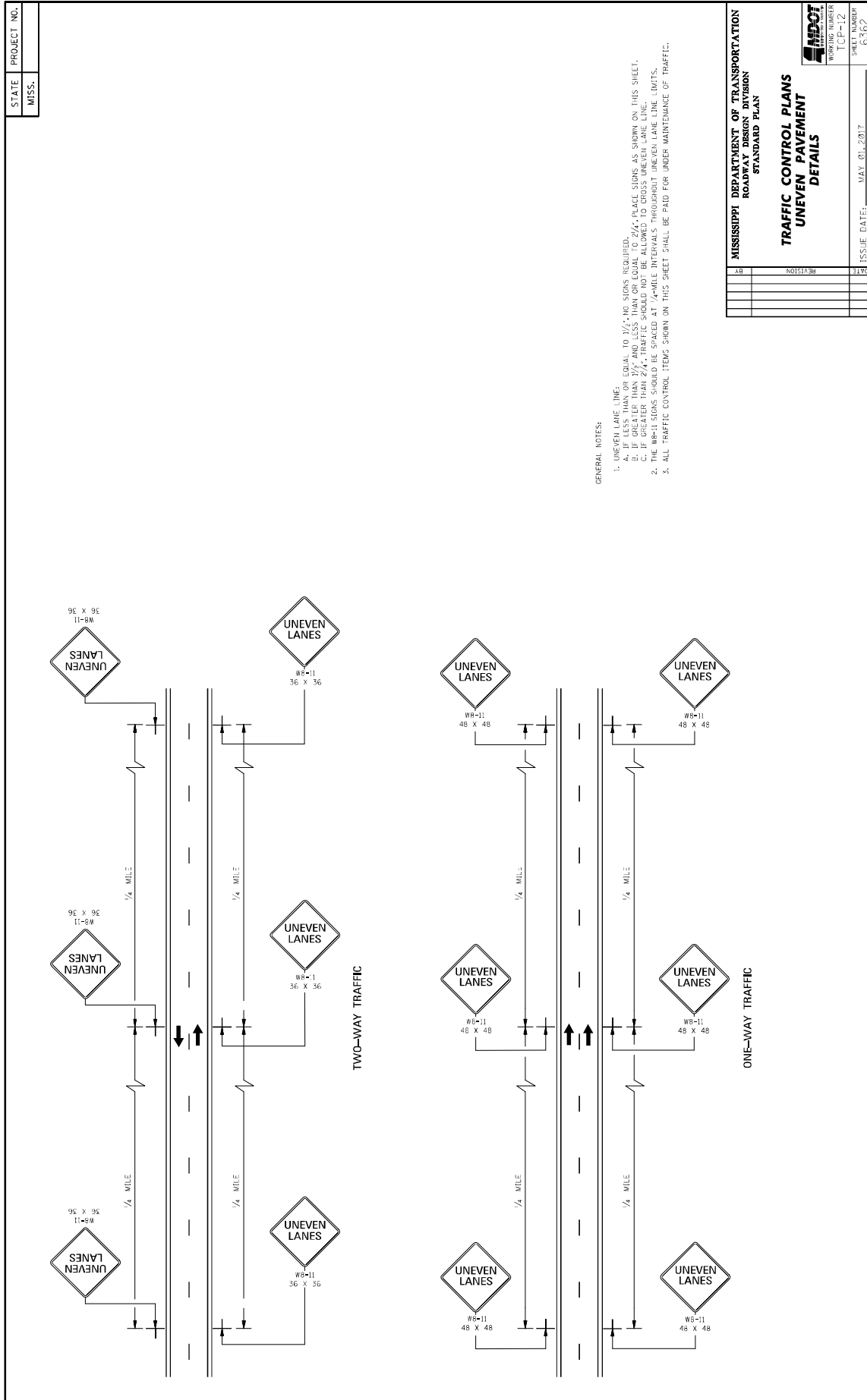

GENERAL NOTES:

1. UNEVEN LANE LINE.
 - A. IF LESS THAN OR EQUAL TO 1/2", NO SIGNS REQUIRED.
 - B. IF MORE THAN 1/2" AND LESS THAN 1", PLACE SIGNS AS SHOWN ON THIS SHEET.
 - C. IF GREATER THAN 1", TRAFFIC SHOULD NOT BE ALLOWED TO CROSS UNEVEN LANE LINE.
2. THE WB-11 SIGNS SHOULD BE SPACED AT 1/4-MILE INTERVALS THROUGHOUT UNEVEN LANE LINE LIMITS.
3. ALL TRAFFIC CONTROL ITEMS SHOWN ON THIS SHEET SHALL BE PAID FOR UNDER MAINTENANCE OF TRAFFIC.

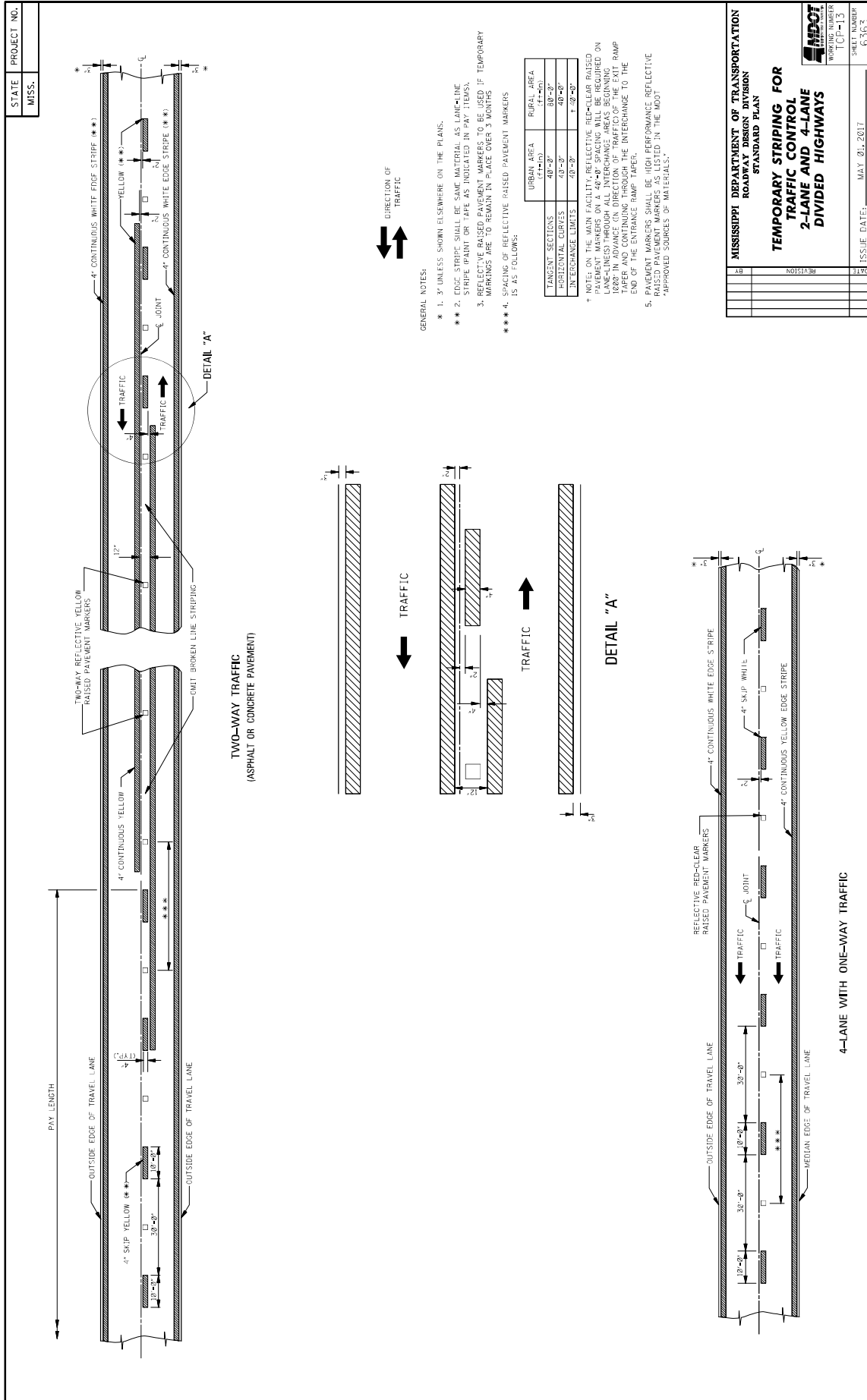

MISSISSIPPI DEPARTMENT OF TRANSPORTATION	
ROADWAY DESIGN DIVISION	
STANDARD PLAN	
TEMPORARY STRIPING FOR	
2-LANE AND 4-LANE	
DIVIDED HIGHWAYS	
WORKING NUMBER TCP-113	SHEET NUMBER 6363
REVISION	ISSUE DATE: MAY 01, 2017

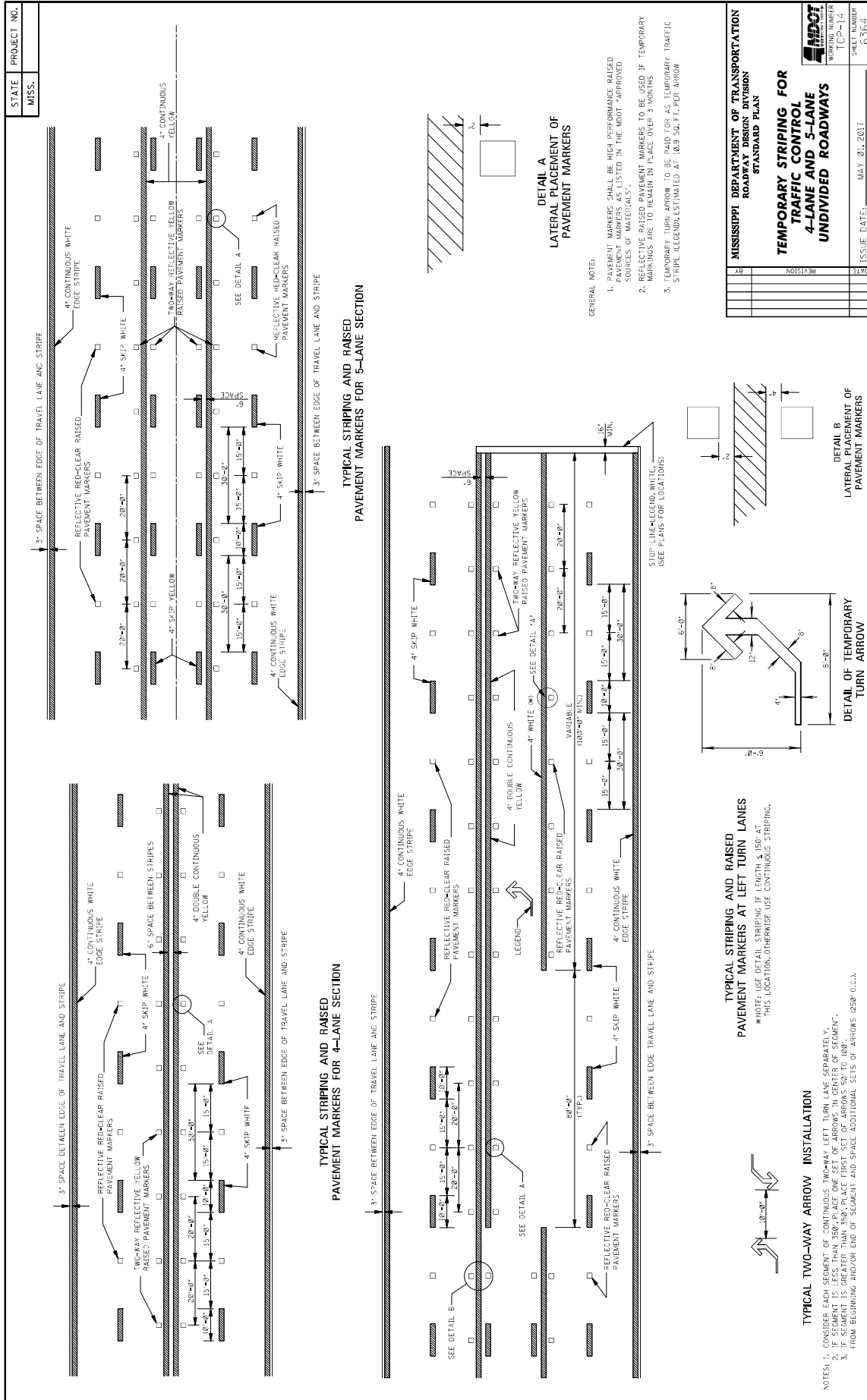

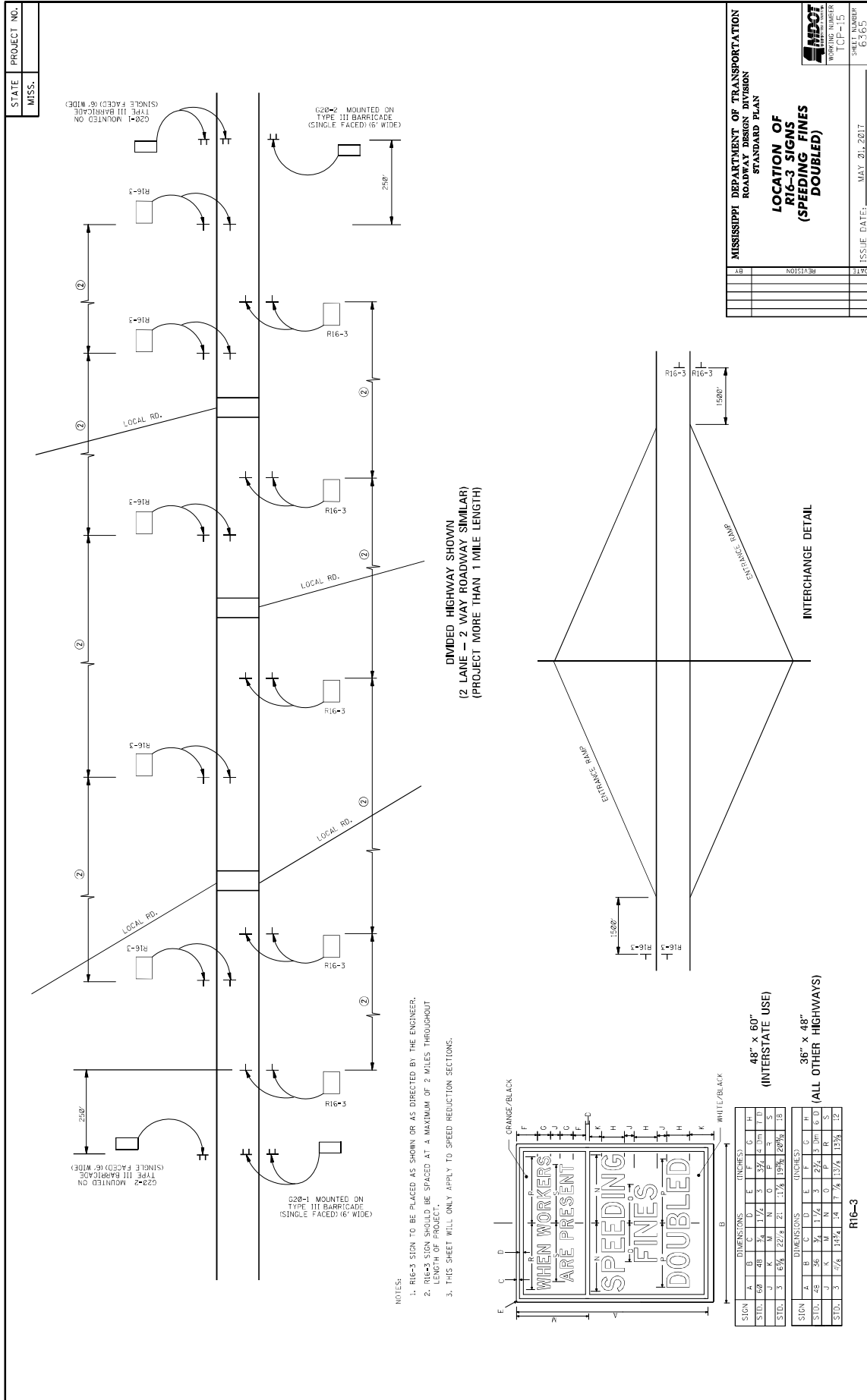

- NOTES:
1. R16-3 SIGN TO BE PLACED AS SHOWN OR AS DIRECTED BY THE ENGINEER.
 2. R16-3 SIGN SHOULD BE SPACED AT A MAXIMUM OF 2 MILES THROUGHOUT LENGTH OF PROJECT.
 3. THIS SHEET WILL ONLY APPLY TO SPEED REDUCTION SECTIONS.

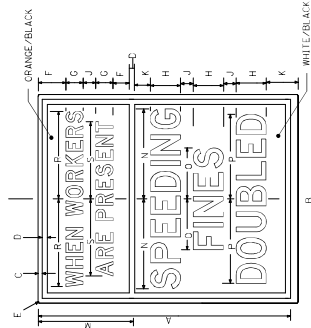

SIGN		DIMENSIONS (INCHES)											
TYPE	48" X 60"	A	B	C	D	E	F	G	H	I	J	K	L
STD.	600	48	36	1 1/4	5	3/4	4	3/16	1 1/2	5	3/4	1 1/2	1 1/2
MIN.	3	1 1/2	1 1/4	1 1/4	1 1/4	1 1/4	1 1/4	1 1/4	1 1/4	1 1/4	1 1/4	1 1/4	1 1/4
MAX.	3	1 1/4	1 1/4	1 1/4	1 1/4	1 1/4	1 1/4	1 1/4	1 1/4	1 1/4	1 1/4	1 1/4	1 1/4
MIN.	3	1 1/4	1 1/4	1 1/4	1 1/4	1 1/4	1 1/4	1 1/4	1 1/4	1 1/4	1 1/4	1 1/4	1 1/4
MAX.	3	1 1/4	1 1/4	1 1/4	1 1/4	1 1/4	1 1/4	1 1/4	1 1/4	1 1/4	1 1/4	1 1/4	1 1/4

MISSISSIPPI DEPARTMENT OF TRANSPORTATION
ROADWAY DESIGN DIVISION
STANDARD PLAN
LOCATION OF R16-3 SIGNS (SPEEDING FINES DOUBLED)

ISSUE DATE: MAY 21, 2017

WORKING NUMBER ICF-15

SHEET NUMBER 63663

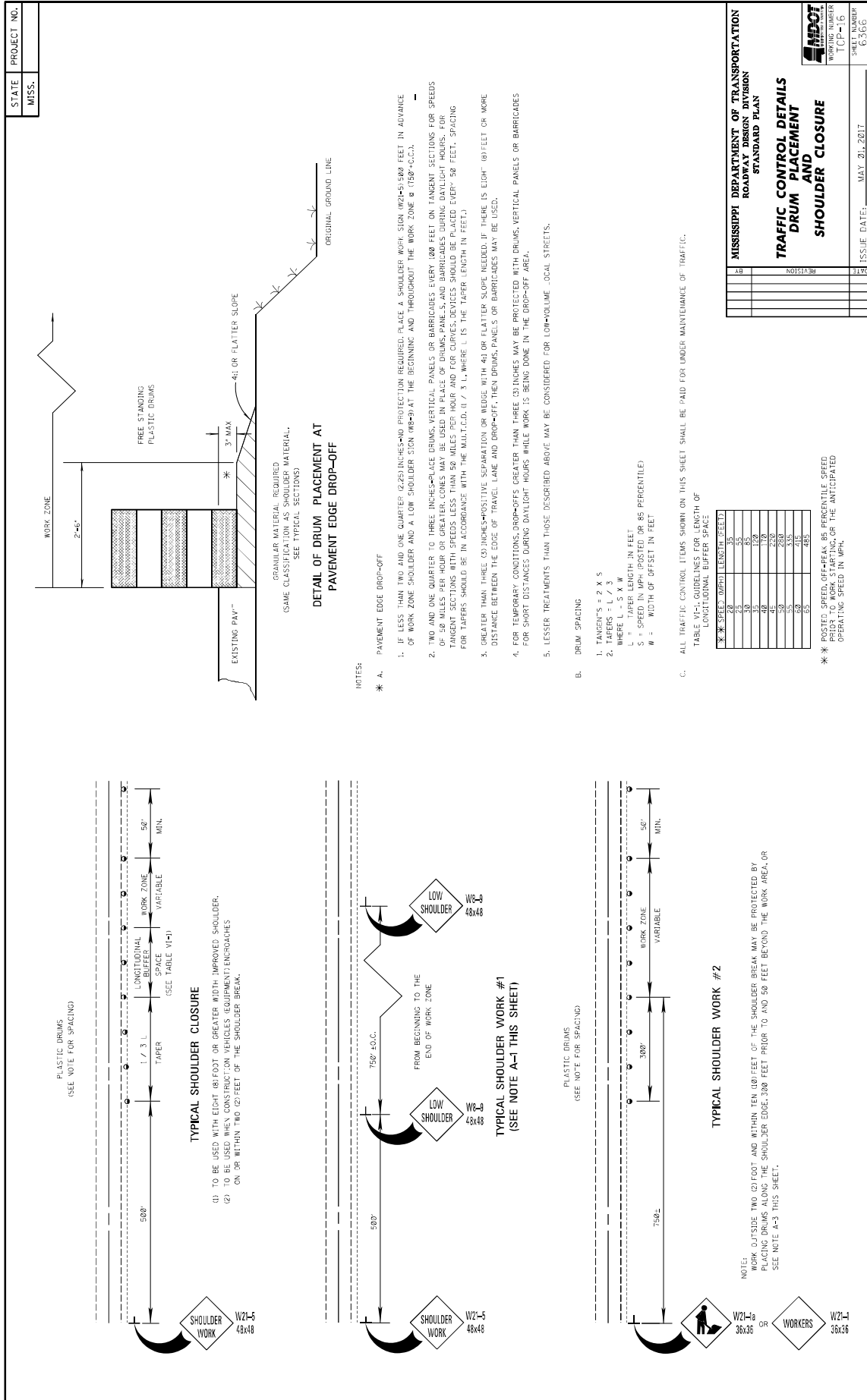

MISSISSIPPI DEPARTMENT OF TRANSPORTATION
ROADWAY DESIGN DIVISION
STANDARD PLAN

TRAFFIC CONTROL DETAILS
DRUM PLACEMENT
SHOULDER CLOSURE

ISSUE DATE: MAY 20, 2017

GENERAL NOTES

- GROUND-IN RUMBLE STRIPES SHALL BE APPLIED TO ALL PAVED SHOULDERS OF ALL PAVED SHOULDERS ON THIS PROJECT.
- GROUND-IN RUMBLE STRIPES SHALL BE APPLIED TO ALL EXISTING AND NEW ROADWAYS WITH OTHER INTERSECTIONS IN NORMAL SHOULDER WIDTH AS DIRECTED BY THE ENGINEER.
- COST TO BE PAID FOR USING APPROPRIATE PAY ITEMS.
- GROUND-IN RUMBLE STRIPES SHALL BE APPLIED TO:
 - MAINLINE
 - INTERSECTING ROADWAY IF OVERLAP OR RECONSTRUCTED BEYOND NORMAL MAINLINE R.O.W.
 - ANY ROADWAY WITH EXISTING RUMBLE STRIPES PRIOR TO CONSTRUCTION.
- DO NOT USE WHERE TRAVEL LANE IS LESS THAN 11' WIDE.

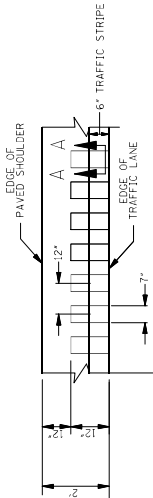

DETAIL "A"

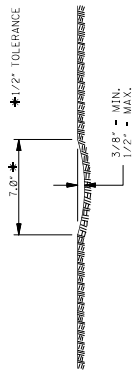

SECTION "A-A"

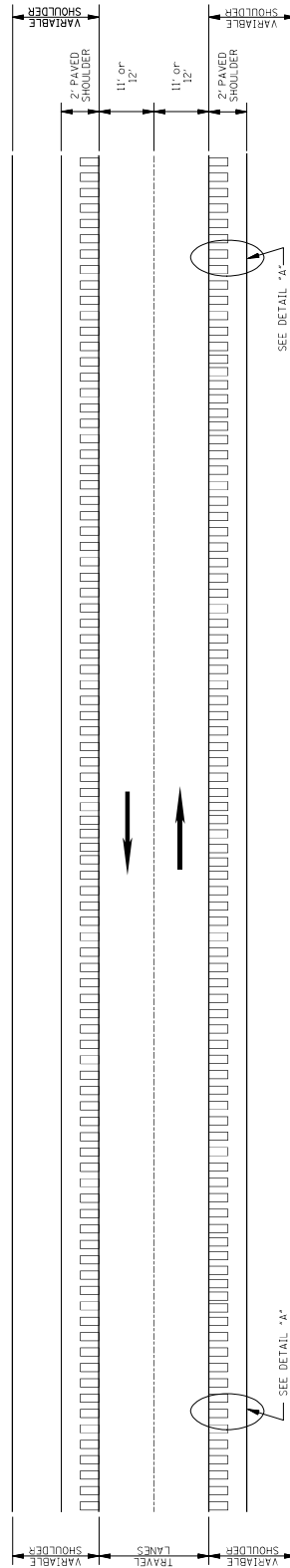

PLAN
NOT TO SCALE

MISSISSIPPI DEPARTMENT OF TRANSPORTATION	
ROADWAY DESIGN DIVISION	
STANDARD PLAN	
RUMBLE STRIPES 2-LANE HIGHWAYS (ASPHALT LANES, 2-FT ASPHALT SHOULDERS)	
DATE	ISSUE DATE: AUGUST 01, 2017
REVISION	
508	
6064	

GENERAL NOTES

1. GROUND-IN RUMBLE STRIPES SHALL BE APPLIED TO ALL PAVED SHOULDERS AND ALL PAVED SHOULDERS ON THIS PROJECT.
2. GROUND-IN RUMBLE STRIPES SHALL BE APPLIED TO ALL INTERSECTIONS, ROADWAYS, AND OTHER INTERSECTIONS IN NORMAL SHOULDER WIDTH AS DIRECTED BY THE ENGINEER.
3. COST TO BE PAID FOR USING APPROPRIATE PAY ITEMS.
4. GROUND-IN RUMBLE STRIPES SHALL BE APPLIED TO:
 - A. MAINLINE
 - B. INTERSECTING ROADWAY IF OVERLAP OR RECONSTRUCTED BEYOND NORMAL MAINLINE R.O.W.
 - C. ANY ROADWAY WITH EXISTING RUMBLE STRIPES PRIOR TO CONSTRUCTION.

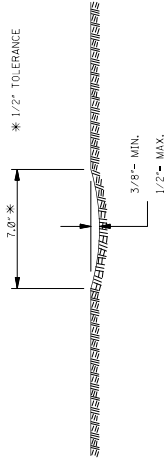

SECTION "A-A"

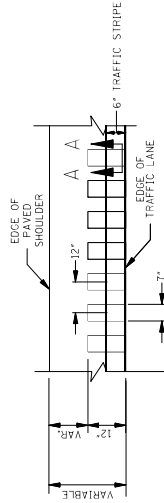

DETAIL "A"

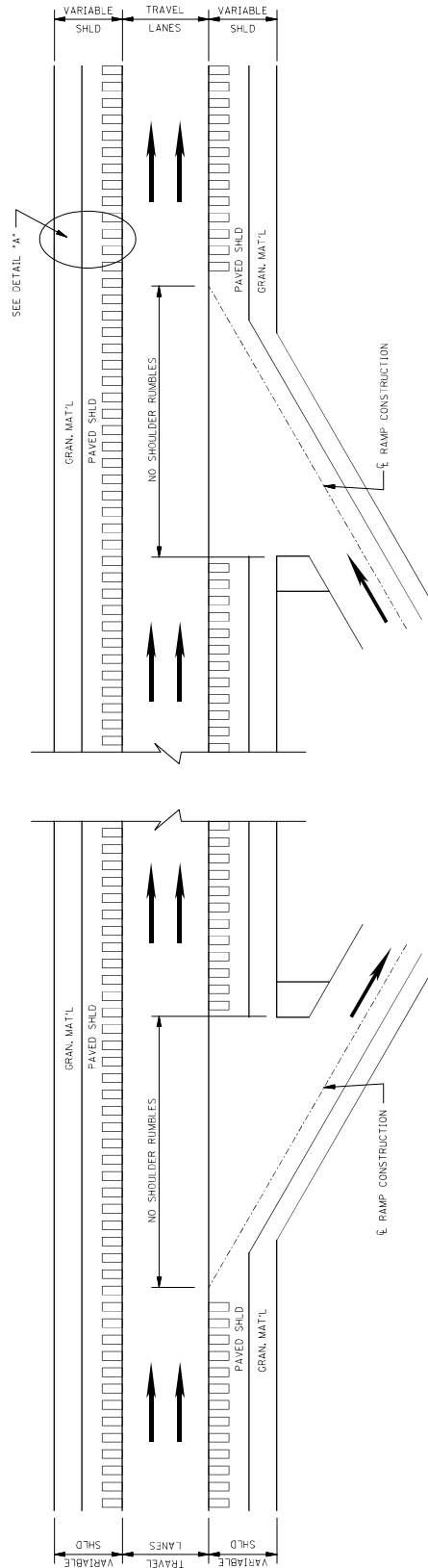

PLAN
NOT TO SCALE
DETAILS OF
RUMBLE STRIPS

MISSISSIPPI DEPARTMENT OF TRANSPORTATION	
ROADWAY DESIGN DIVISION	
STANDARD PLAN	
RUMBLE STRIPES 4-LANE HIGHWAYS (ASPHALT LANES, 2-FT OR WIDER, ASPHALT SHOULDERS)	
DATE	ISSUE DATE: AUGUST 01, 2017
BY	
DESIGNED BY	
REVISION	
DATE	
REVISION	
DATE	
REVISION	
DATE	
REVISION	
DATE	
REVISION	

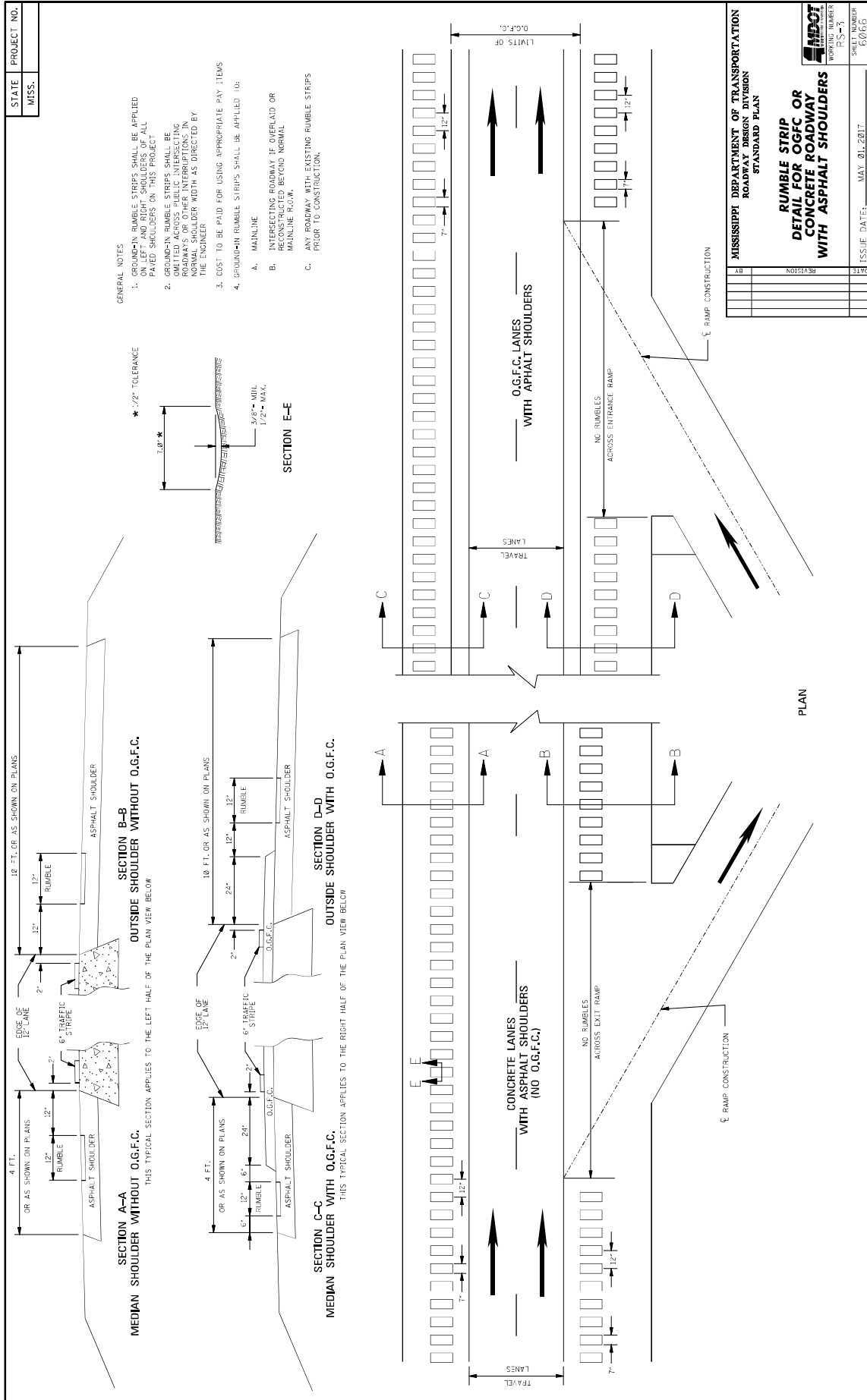

MISSISSIPPI DEPARTMENT OF TRANSPORTATION

SECTION 904 - NOTICE TO BIDDERS NO. 3676

CODE: (SP)

DATE: 09/21/2021

SUBJECT: Asphalt Gyrotory Compactor Internal Angle Calibration

Bidders are advised that by March 1, 2022, all asphalt gyrotory compactors shall be calibrated to an internal angle of $1.16^{\circ} \pm 0.02^{\circ}$. This requirement will be reflected in updates made to MT-78, MT-80, and MT-83. This calibration requirement also extends to all QC/QA testing.

MISSISSIPPI DEPARTMENT OF TRANSPORTATION

SECTION 904 - NOTICE TO BIDDERS NO. 3875

CODE: (IS)

DATE: 12/15/2021

SUBJECT: ITS General Requirements

For this Notice to Bidders, the “Engineer” shall mean the Project Engineer and/or their designee(s) throughout the rest of this NTB, unless stated otherwise.

Submittals

All submittals covered under this section shall be made electronically to the Project Engineer and to the ITS Engineer, shall clearly state the project name and project number, and should be in as few separate submittals as possible.

All products selected for use on this project shall be in compliance with 2 CFR 200.216, in addition to all other contract requirements as outlined throughout the specifications, special provisions and plans. No telecommunication and video surveillance equipment or services shall be manufactured by the following companies: Huawei Technologies Company, ZTE Corporation, Hytera Communications Corporation, Hangzhou Hikvision Digital Technology Company, Dahua Technology Company, and any subsidiary or affiliate of these entities.

Product Data. Manufacturers’ product data including specifications/cut-sheets, design guides, installation manuals, operating manuals, and maintenance/service manuals shall be submitted by the Contractor for each component of the ITS system, including but not limited to cabinets, controllers, sensors, conduit, pull boxes, hardware, and all other parts of the system selected for installation.

The complete information for the original product data submittal shall be contained in as few submittals as possible and be in an organized fashion.

The product data submittal shall be accompanied by a specification checklist. At a minimum, this checklist shall clearly state the following:

- 1) The project name and project number
- 2) The date of the submittal
- 3) The pay item number and description
- 4) The part and/or model number, matching the cut-sheet
- 5) The manufacturer
- 6) A Certification Statement that the referenced product is not manufactured by any of the following: Huawei Technologies Company, ZTE Corporation, Hytera Communications Corporation, Hangzhou Hikvision Digital Technology Company, Dahua Technology Company, and any subsidiary or affiliate of these entities. (as per 2 CFR 200.216)
- 7) Every material requirement as stated in in this Notice to Bidders and as outlined elsewhere within this contract.

- 8) A statement of whether the product complies with the requirements set forth in the specifications, special provisions, plans and NTB. If product is not compliant, an explanation of non-compliance shall be provided.

All subsections of a particular section may be omitted if the section heading is included, is indicated to be not applicable, and that it is evident that all subsections being omitted are also not applicable.

It shall be the responsibility of the Contractor to guarantee the accuracy of the checklist.

Other Submittals. The following submittals shall be required:

- 1) Shop Drawings
- 2) Cabinet wiring diagrams with system labeling schedule.
- 3) Site wiring/connection drawings.
- 4) Rack diagrams showing rack mounted equipment.
- 5) All documentation as described in the Project Testing Plan Requirements section below.
- 6) Project Record Drawings:
 - a. The purpose of Project Record Drawings is to provide factual information regarding all aspects of the Work, to enable future service, modifications, and additions to the Work.
 - b. Project Record Drawings are an important element of this Work. Contractor shall accurately maintain Project Record Drawings throughout the course of this project.
 - c. Project Record Drawings shall include documentation of all Work, including the conduit locations, pull box locations, equipment locations, foundation details, setup parameters and wiring and block diagrams.
 - d. Project Record Drawings shall accurately show the physical placement of the following:
 - i. Cabinets, sensors, pull boxes, and other materials installed at each site.
 - ii. Conduit runs and splicing information.
 - e. Project Record Drawings shall show the physical placement of each system component installed during the project at each site. Where the plan details do not depict actual field conditions, the Contractor shall amend the construction plan as required.
- 7) Upon completion of Work, and prior to Final Acceptance, the Contractor shall prepare and submit the final record set of Project Record Drawings. This set shall reflect the installed Work.
- 8) Closeout Submittals - A set of Project Record Drawings shall be provided to the Project Engineer and ITS Engineer for any items that changed or were not previously submitted, including:
 - a. Project Record Drawings
 - b. Product Data
 - c. Installation Manuals
 - d. Operating Manuals
 - e. Maintenance/Service Manuals

As-Built Plans. The Contractor shall provide GPS locations of all pull boxes, splices,

termination equipment cabinets, ITS field locations and all pole locations. The Contractor shall record and submit the sequential footage markers from the fiber optic trunk and drop cables for each GPS location. The Contractor shall provide scanned PDF files of all plan sheets with pen and ink markups. The Contractor shall provide a site location inventory of ITS devices to include manufacturer model, serial numbers, MAC addresses, and IP addresses (as applicable) for all installed devices. All documentation will be due to the Department a minimum of thirty (30) calendar days after the installation.

Additional Quality Assurance Measures

The project shall be constructed in such a manner as to comply with environmental regulations and erosion control as specified in the plans and elsewhere in MDOT standard specifications.

At the completion of the Work, the site shall be cleaned, restored, grassed and otherwise stabilized to a condition consistent with conditions before work began. This work shall be paid for under other items of work.

All disturbed signs, guardrail, markers, fencing, and other roadway appurtenances shall be restored. Disturbed roadway appurtenances that require complete removal and replacement will be identified within the contract and will have separate pay items and quantities set forth for such work.

The Contractor shall clean-up debris caused by Contractor's activities on a daily basis as the work progresses. This work shall be paid for under other items of work.

All work-related accidents shall be reported immediately to the Project Engineer or his/her representative.

Maintenance and Technical Support. The supplier must provide and have a parts support system capable of providing parts for the length of the warranty period.

Project Testing Plan Requirements

The Contractor shall conduct a Project Testing Plan as required below in addition to all other project testing and acceptance procedures required elsewhere in the specifications and Plans. Some specifications contain details regarding the testing for individual device types or attributes, but this section outlines the overall testing plans for the entire project as a whole. The Project Testing Plan shall include a series of tests on all project materials occurring at various stages in the project. All costs associated with the Project Testing Plan shall be absorbed in contract pay items; no separate payment will be made for any testing.

General Requirements. The Contractor is responsible for planning, coordinating, conducting and documenting all aspects of the Project Testing Plan as detailed below and providing all required equipment for the tests. The Engineer reserves the right to attend and observe all tests.

Each test shall be an individual and separate event for each type of test and for each type of equipment as defined elsewhere within this NTB. The Contractor shall follow the testing sequence as described in this NTB and shall perform the required tests on all applicable

devices and infrastructure.

Test procedures shall be submitted and approved for each test as part of the project submittals programs. Test procedures shall include every action necessary to fully demonstrate that the material under test is clearly and definitively in full compliance with all project requirements. Test procedure actions shall cross-reference to the specifications or Plans requirement that is the subject of the test action. Test procedure actions shall cross-reference the applicable sections of the final approved Project Submittal Compliance Form and the submittal materials for the subject of the test action. Test procedures shall contain test setup and block/wiring diagrams showing all materials being tested and all test and measurement equipment, with calibration documentation, and shall contain documentation regarding the equipment configurations and programming. Test procedures shall include checkoff blanks for each project requirement included in that test and shall include forms for the documentation of all measured test results.

No testing shall be scheduled until approval of all project submittals for all materials covered under a given test and approval of the test procedures for the given test has been granted.

Unless otherwise required herein, the Contractor shall request in writing the Engineer's approval for each test occurrence a minimum of 14 days prior to the requested test date. Test requests shall include the test to be performed and the material to be tested. The Engineer reserves the right to reschedule tests if needed.

For any series of tests on different installations of a given material (e.g., different sections of cable), the Contractor shall request in writing the Engineer's approval for the first test occurrence of the series a minimum of 14 days prior to the requested test date, regardless of the notification requirements for subsequent test occurrences.

The Contractor shall provide all ancillary equipment, materials, diagnostic and test software, and computers as required in the approved test procedures.

All test results shall be documented in writing by the Contractor in accordance with the test procedure and submitted to the Engineer within seven (7) days of the completion of the test. Any given test session is considered incomplete until the Engineer has approved the documentation for that test session.

The Contractor shall provide test results documentation in electronic format and printed format (3 copies). Electronic formats shall be provided in both PDF and Microsoft Excel or other approved application. Printed copies shall be bound and organized by test, equipment type, and individual unit.

- Two sets are for the Traffic Engineering ITS Department
- One set is for the Engineer

All test results shall be provided in English units of measure.

All test results deemed by the Engineer to be unsatisfactorily completed shall be repeated by the Contractor, following all test requirements as defined elsewhere in this NTB and contract specifications. This shall include a request in writing for the Engineer's approval for the repeated test a minimum of 14 days prior to the requested test date, unless this requirement is waived by the Engineer. In the written request for each test occurrence that is a repeat of a previous test, the Contractor shall summarize the diagnosis and correction of each aspect of the previous test that was deemed unsatisfactory. Any revisions to the test procedures for a repeated test occurrence shall meet all requirements for the original test procedures, including review and approval by the Engineer.

The satisfactory completion of any test shall not relieve the Contractor of his responsibility to provide a completely acceptable and operating system that meets all requirements of this project.

It is possible for the Contractor to schedule multiple test dates and revise the actual test being performed on a particular day if; 1) the Engineer approves of the change, 2) all test scheduling requirements above have still been met for the actual test to be performed on the date, and 3) there is not an unreasonable change of location, time, duration, or requirement of the Engineer.

Factory Acceptance Test (FAT). FATs shall be conducted at the Manufacturer or Contractor's facility or at a facility acceptable to all parties prior to shipping from the factory. The goal of the FAT is to verify that the equipment meets the requirements of the specifications. All equipment to be utilized for this project shall be subject to tests that demonstrate the suitability of the design and manufacturing procedures and compliance with the contract requirements, unless an exception for a specific equipment item is granted by the Engineer. The tests shall be performed on production units identified to be delivered under this Contract. As a minimum, a FAT is required for each of the following project materials:

- Dynamic Message Signs

The FAT testing procedures and results for specifically identified materials shall demonstrate that all testing requirements as outlined within the contract (standard specifications, plans, special provisions, and notice to bidders) are met, including, but not limited to: functional/system performance requirements, electrical requirements, data transmission/communication requirements, safety/password requirements, environmental requirements, and interface requirements with other components of the project system.

The Engineer reserves the right to waive FATs which are deemed to be unnecessary and reserves the right to witness all FATs that are determined to be critical to the project. At the Engineer's discretion, the Engineer may be in attendance at the FAT for any units tested. The FAT for the first three (3) units shall be conducted during the same time period and shall be completed before additional units are produced.

The Engineer shall be notified a minimum of 45 calendar days in advance of such tests. Salary and travel expenses of the Engineer and his/her representatives will be the responsibility of the Department. In case of equipment or other failures that make a retest necessary, travel expenses associated with retests for the Engineer and his/her representatives shall be the responsibility of

the Contractor. The travel expenses shall include all costs associated with having a two-person Engineer review team on site, including but not limited to airfare, automobile rental, lodging, and per diem. These costs, excluding airfare, shall not exceed \$500.00 per representative, per day. These costs shall be deducted from the payments due or charged to the withholding account of the Contractor when the project is terminated.

The vendor must complete the FAT on all remaining units on their own and submit documentation to the Engineer that the FATs were completed. The Engineer reserves the right to randomly attend those FAT tests.

No equipment for which a FAT is required shall be shipped to the project site without successful completion of factory acceptance testing as approved by the Engineer and the Engineer's approval to ship.

Bench Test Components (BTC). The Contractor shall perform a complete BTC on the lesser of the full contract quantity of units of equipment and materials or the number of units required as specified in this subsection below. The quantity listed in the subsection below is a "minimum" quantity and the Engineer reserves the right to require testing of additional quantities if the initial testing is not deemed adequate. The Contractor shall provide the testing location and facility, which shall be in Mississippi and within a 25-mile radius of the project limits. The test location must be approved by the Engineer as part of the BTC test procedure submittal.

The BTC shall demonstrate that all equipment and materials are in full compliance with all project requirements and works "out of the box" by visual inspection, setup and operation "on the bench", functional testing of the component including manufacturer's recommended startup diagnostics, and testing prior to any field installation of that equipment or material. Test results documentation shall be provided for each equipment item and material in the full contract quantity; test results documentation shall include the manufacturer's serial number and the project location ID for each item.

As a minimum, a BTC is required for each of the following project materials for quantities as shown.

- Closed Circuit Television Equipment, 4 PTZ units & 6 fixed units
- Dynamic Message Sign, 2 complete units of each type
- Travel Time Signs, 2 complete units
- Network Switches Type A, 4 units
- Network Switches Type B & F, 2 units each
- Network Switches, Type C, D, & E, 1 unit each
- ITS Radar Vehicle Detection Sensors, 6 units
- Highway Advisory Radios, 2 units
- Radio Interconnect System, 4 units of each type
- Bluetooth Detection System, 6 units
- DSRC devices, 6 units
- Roadway Weather Information System, 2 complete units
- Traveler Information Video Kiosk, 2 complete units

- Smart Work Zone System
 - Portable CCTV station, 2 complete units
 - Non-Intrusive Vehicle Detection Devices / Portable Traffic Sensors, 4 complete units
 - Highway Advisory Radio, 2 complete units
 - Portable Changeable Message Signs, 2 complete units
 - Portable Traffic Signal, 2 complete units
- Off-the-shelf and Vendor Software, all necessary
- Equipment Cabinet (Type A), 2 cabinets
- Equipment Cabinet (Type B), 4 cabinets
- Equipment Cabinet (Type C), 2 cabinets

Pre-Installation Tests (PIT). The Contractor shall perform Pre-Installation Tests (PIT) on all device quantities that are not included in the BTC. The Contractor shall provide the testing location and facility, which shall be within a 25-mile radius of the project limits or as approved by the Engineer. The test location must be approved by the Engineer as part of the PIT test procedure submittal. The PIT shall be a shortened version of the BTC to ensure the equipment will power up, operate, and was not damaged during shipment. The Engineer reserves the right to attend any PIT as desired; however, the contractor shall submit documentation of the PITs whether the Engineer is present or not. In addition to these requirements, see the DMS, TTS, and Fiber Optic Cable Special Provisions for more details.

Stand Alone Site Tests (SAT). The Contractor shall perform a complete SAT on all equipment and materials associated with the field device site, including but not limited to electrical service, conduit, pull boxes, communication links infrastructure (fiber, leased copper, wireless), cable, poles, camera lowering devices, device communication cables, cabinet apparatus, etc. The goal of the SAT is to verify that the equipment has been properly installed and commissioned according to the manufacturer requirements. A SAT shall be conducted at every field device site including communications hubs. A SAT shall be conducted for a fully installed and completed control center in the TMC as described in the TMC modification NTB. A SAT shall be conducted for all fiber optic infrastructure.

The SAT shall demonstrate that all equipment and materials are in full compliance with all project requirements, are fully functional as installed, and are in their final configuration. As part of this demonstration, SATs shall include but are not limited to the following:

- A visual inspection of the cabinet and all construction elements at the site to ensure they are compliant with the Specifications and have no physical damage or deformities.
- The inspection of the cabinet at each site shall include the functional test of all cabinet equipment, including circuit breaker, receptacles, fan and thermostat, lights, and door switches.
- Verify that manufacturer documentation for each device is present.
- A measurement of the DC power supply shall be made at the cabinet when it is operating under full load.
- Verify that all equipment has proper power, surge protector, and grounding connections.
- Inspect the integrity of all cable connections and terminations and verify that the cables are

connected and terminated as specified in the Plans.

The SATs for each site type shall include but are not limited to the following:

- *CCTV Stand Alone Site Test*: Shall be conducted at the CCTV Cabinet and shall demonstrate the complete operation of the CCTV, Network Switch, and the link(s) to any devices that are connected to the Power Supply in the CCTV Cabinet. The SAT shall include a 5-minute recording of each PTZ and Fixed camera showing the field of view and video quality. Two copies of the recording shall be provided to the Engineer on USB flash drives. The recording will start at the preset default position(s) and will demonstrate the full zoom capabilities of the cameras, as well as the full range of the pan and tilt functions of PTZ cameras. This recording shall be in a format playable with Windows Media Player or pre-approved by the Engineer.
- *ITS Communications HUT Stand Alone Site Test*: Shall be conducted at the HUT and shall demonstrate the complete operation of all equipment inside the HUT including Network Switches. This also includes visual inspection of the Site elements associated with the HUT.
- *ITS Termination Cabinet Stand Alone Site Test*: Shall be conducted at the termination cabinet and shall demonstrate the complete operation of all equipment inside the cabinet including Network Switches. This also includes visual inspection of the Site elements associated with the termination cabinet.
- *Radio Interconnect System Stand Alone Site Test*: Shall be conducted from the cabinets at both ends of the communications link (even if one end consists of existing equipment) and shall demonstrate that the radios, the antennas, the entire link, the Network Switch, and the transmission of video and/or data are fully operational. See Radio Interconnect Special Provision for more details.
- *Highway Advisory Radio Site Test*: Shall be conducted at the HAR cabinet, antenna, and advisory signs and shall demonstrate complete operation of recordings, transmissions, and remote flashing beacon unit(s). See HAR Special Provision for more details.
- *Fiber Optic Cable Stand Alone Site Test*: Shall be conducted at each Cabinet and at each HUB and shall include both power meter tests and OTDR tests. See Fiber Optic Special Provision for more details.
- *Conduit Detection Wire Stand Alone Site Test*: Shall be conducted at each pull box and shall demonstrate that a continuous run of conduit detection wire was installed between pull boxes, vaults, cabinets, and structures as required.
- *ITS Radar Vehicle Detection Stand Alone Site Test*: Shall be conducted at the IRVD Cabinet and shall demonstrate the complete operation, proper configuration, and verification of detection for each lane of traffic or zone of the IRVD unit(s).
- *BDS Stand Alone Site Test*: Shall be conducted at the Device Cabinet and shall demonstrate the complete operation and proper configuration of the unit(s), verify network connection to the BDS through ping and telnet sessions from a remote PC, and confirm that the system is fully functional by detecting Bluetooth devices at a sample rate approved by the Engineer.
- *RWIS Stand Alone Site Test*: Shall be conducted at the RWIS Cabinet and shall demonstrate the complete operation and proper configuration of the RWIS and shall verify that the remote flashing beacon unit(s) on the warning signs are activated properly as

specified and will de-activate automatically without renewal at preset intervals.

- *SWZ Stand Alone Site Test:* Shall be conducted at each device at its initial location and shall demonstrate the complete operation and proper configuration of the device as described in the Smart Work Zone Special Provision and NTB. At any subsequent locations, at a minimum, a document verifying that the device is configured for the new location shall be submitted to the Engineer.
- *Kiosk Stand Alone Site Test:* Shall be conducted at the device, verify all required video layouts and displays, demonstrate all required software features, and demonstrate the complete operation of the device and Network Switch. Refer to the Traveler Information Video Kiosk specification for more details.

DMS & TTS Stand Alone Site Test: Shall be conducted at the Device Cabinet, verify that all pixels are operational, verify that the sign can be controlled locally through both the serial and Ethernet ports, and demonstrate the complete operation of the device and Network Switch. The signs shall be delivered with and tested using default fonts and sizes that are provided by the MDOT ATMS drivers.

The Contractor shall request in writing the Engineer's approval for each test occurrence a minimum of 14 days prior to the requested test date. The Contractor shall arrange, at no additional expense to the State, the attendance of a qualified technical representative of the equipment manufacturer to attend each test until a minimum of two (2) sites of that type are approved.

Sub-System Test (SST). The Contractor shall perform an SST on each DMS and TTS to verify and document that all remote TTS and DMS functions and alarms are operational from the TMC.

An SST is required for at least ten percent (10%) of each of the following devices being placed for the project, taken by a random sampling: BDS, Network Switch, IRVD, HAR, Radio, CCTV, Video Vehicle Detection, and RWIS including beacons. The SST will require the Contractor to demonstrate and document that all functions and alarms are operational from the TMC.

An SST is required for each Traveler Information Kiosk in the project and will require the Contractor to demonstrate and document the features demonstrated in the Kiosk SAT using remote access from the TMC.

An SST is required for each Smart Work Zone device in the project and will require the Contractor to demonstrate and document the connection between the device and the central data/video collection site. Once a Smart Work Zone device has been verified to be properly configured, working, and communicating at its current location, the device can be utilized without further testing. The Conditional System Acceptance Test, Burn-in period, Final Inspection, or Final System Acceptance is not required for a device being solely utilized as part of the temporary Smart Work Zone System. Devices moved to a new location do require verification that they are still working as intended in the new location.

The Contractor shall coordinate the SST to be performed with the Project Engineer or designee present. The Contractor shall provide an SST plan to the Project Engineer for review and approval a minimum of two weeks in advance of tests being performed.

Conditional System Acceptance Test. The Contractor shall perform a complete conditional system acceptance test on all equipment and materials in the project. The Contractor shall not request the conditional system acceptance test until the SATs have been satisfactorily completed, all as-built documentation has been submitted and approved, and all other project work has been completed to the satisfaction of the Engineer. Prior to a Conditional System Acceptance Test, the Contractor shall provide advance notice of and written test results documenting that the Contractor has performed a dry-run of the conditional system acceptance test. The Engineer reserves the right to attend a dry-run test session.

The Contractor shall coordinate the CSAT with the Engineer. The Contractor shall provide a CSAT plan to the Engineer and be approved a minimum of fourteen (14) calendar days in advance of tests being performed. The CSAT plan shall be inclusive of steps and procedures to be performed and scheduled times to perform test procedures.

The Contractor shall test all project systems simultaneously from the State TMC in a manner equivalent to the normal day-to-day operation of the system. The Conditional System Acceptance Test shall demonstrate that all equipment and materials in the network are in full compliance with all project requirements and fully functional as installed and in final configuration, communicating with and being controlled through the control center at the State TMC. If pre-processing systems (e.g., edge computing) or post-processing systems (e.g., video image processing and analytics, detection in one device triggering an alarm or event in another device, etc.) are present, these shall be tested, verified, and documented as working as intended during the CSAT. Edge computing is where data-handling activities, such as analysis and event-triggering, takes place near the physical location that the data is collected.

The Engineer reserves the right to require, at no additional expense to the State, the attendance of a qualified technical representative of the equipment and/or software manufacturers to attend any given Conditional System Acceptance Test.

Upon completion and full approval of the Conditional System Acceptance Test for all equipment in all phases, Conditional System Acceptance will be given and the Burn-in Period will begin.

Burn-In Period. Following the Engineer's written notice of successful completion of the Conditional System Acceptance Test, the entire newly installed system must operate successfully for a **thirty (30) day** burn-in period. The Contractor shall be responsible for the full maintenance of the newly installed equipment during the burn-in period. This maintenance includes all troubleshooting and repairs as well as providing preventive maintenance that meets the equipment manufacturer's recommendations. However, no separate payment will be made during the burn-in period. Successful completion of the burn-in period will occur at the end of **thirty (30) complete days** of operation without a system failure attributable to hardware, software or communications components. Each system failure during the burn-in period will require an additional **thirty (30) days** of successful operation prior to being eligible for Final Acceptance (i.e., if the initial burn-in period is **thirty (30) days** and there are two (2) system failures during this time, the burn-in period would be increased to **ninety (90) days**).

Burn-In General Requirements:

- Determination of a system failure shall be at the sole discretion of the Engineer.
- System failure is defined as a condition under which the system is unable to function as a whole or in significant part to provide the services as designed. While a single component failure will not constitute a system failure, chronic failure of that component or component type may be sufficient to be considered a system failure. Chronic failure of a component or component type is defined as three (3) or more failures for the same component during the burn-in period.
- Components are defined as contract items or major material elements in a contract item. For electrical and electronic contract items, components are defined as the complete assembly of materials that makes up the contract item.
- Specifically exempted as system failures are failures caused by accident, acts of God, or other external forces that are beyond the control of the Contractor. However, failure of the contractor to respond to the repair request for that failure within 24 hours may be considered a system failure.
- The Department will advise the Contractor in writing when it considers that a system failure has occurred or chronic failure exists.
- If multiple system and/or chronic failures continue to occur throughout the burn-in period due to a single component type, the Contractor may be required to replace all units of that component type with a different model or manufacturer.
- The Contractor shall document all failures and subsequent diagnosis and repair. The repair documentation shall include as a minimum:
 - Description of the problem
 - Troubleshooting and diagnosis steps
 - Repairs made
 - List of all equipment and materials changed including serial numbers.
 - Update of the equipment inventory where needed.
 - The Contractor shall provide the repair documentation to the Engineer within two (2) days of completing the repair; failure to provide acceptable documentation as required shall be reason to not approve the repair as complete. The Engineer will provide acceptance or rejection of the repair and documentation within seven (7) days of receiving the repair documentation.
 - The Engineer reserves the right to require, at no additional expense to the State, the presence of a qualified technical representative of the equipment and/or software manufacturers as related to the diagnosis and/or repair of any system failure.
- During the burn-in period, the Contractor shall perform incidental work such as touching up, cleaning of exposed surfaces, leveling and repair of sites, sodding/grassing and other maintenance work as may be deemed necessary by the Engineer to ensure the effectiveness and neat appearance of the work sites.
- During the burn-in period, the Engineer shall maintain a “burn-in period punch list” that contains required Contractor actions but that the Engineer does not define as a system failure. Each burn-in period punch list action item shall be completed by the Contractor to the Engineer’s satisfaction within seven (7) days of Contractor notification of the action item.
- During the burn-in period, the Contractor is required to meet the following response times

once notified there is a problem. A response is defined as being on-site to begin diagnosing the problem.

- Monday thru Friday: The Contractor shall respond no later than 9:00 a.m. the following morning after being notified.
- Weekends: If the Contractor is notified on Friday afternoon or during the weekend, the Contractor shall respond by 9:00 a.m. on Monday morning.
- During the burn-in period, the Contractor shall provide all labor, materials, equipment and replacement parts to completely maintain, troubleshoot and repair all items installed under this contract. No separate payment will be made for any labor, materials, equipment, or replacement parts needed during the burn-in period.
- The overall burn-in period will be considered complete upon the successful completion of the burn-in time periods, the Engineer's acceptance of all repairs and repair documentation, completion of all burn-in period punch list actions, and a final inspection as described below.

Contract time will not cease during the burn-in period(s). Contract time for the burn-in period was considered when determining the original contract time.

Final Inspection. Upon successful completion of the burn-in period, the entire project shall be eligible for Final Inspection. The Final Inspection will be conducted provided the burn-in period has demonstrated the entire system is operating successfully. The Final Inspection shall include but is not limited to:

1. monitoring of all system functions at the State TMC to demonstrate the overall system is operational
2. a field visit to each site to ensure all field components are in their correct final configuration
3. verification that all burn-in punch list items have been completed
4. verification that all final cleanup requirements have been completed
5. approval of final as-built documentation

Prior to conducting the Final Inspection, the burn-in period shall demonstrate that all requirements defined in the specifications have been met, including, but not limited to: functional/system performance requirements, electrical requirements, data transmission/communication requirements, safety/password requirements, environmental requirements, and interface requirements with other components of the system.

The Contractor shall request in writing the Engineer's approval to start the Final Inspection a minimum of 14 days prior to the requested start date. The Engineer reserves the right to reschedule the start date if needed. The start date for the Final Inspection cannot be prior to the successful completion of the overall burn-in period.

An unsuccessful or incomplete Final Inspection shall require a new Final Inspection after the Contractor has made the necessary corrections. Up to 14 days shall be allowed for the Engineer to conduct a Final Inspection. The presence of the MDOT ITS Engineer or his/her designee is required during the final inspection.

The Engineer reserves the right to require, at no additional expense to the State, the attendance of a qualified technical representative of the equipment and/or software manufacturers to attend a portion of a Final Inspection.

The Contractor shall be responsible for the full maintenance of all project equipment and materials during the entire time period from the successful completion of the burn-in period until Final System Acceptance is granted.

Final System Acceptance. Upon successful completion of the Final Inspection and all other items of work on the project, the Engineer will grant Final System Acceptance in accordance with Subsection 105.20 of the Standard Specifications.

Beneficial Use of Dynamic Message Signs During Construction. Each DMS shall be roadside controllable (by sign vendor software) within 30 days of attachment to structures (visible to motorists). The Contractor's construction schedule shall clearly identify when installation of the signs over the roadway shall occur, and when roadside control shall be established for each sign. The Contractor shall not install a DMS over the roadway until all ancillary and infrastructure elements, including cabinets, controllers, conduits, cabling, etc. necessary to operate the sign are in place and functional. Once roadside controllable, the Contractor shall display emergency, special event, construction, safety or traveler information messages approved by MDOT, only when requested by MDOT, at no additional cost to MDOT. Normal diagnostic messaging for the purpose of installation and testing shall be determined by the Contractor but shall not be allowed to the extent that excessive power consumption or distraction to motorists occurs as determined by the Engineer. Any beneficial use of the signs to MDOT and the public prior to Final Acceptance does not constitute MDOT acceptance or waive any Contractor testing requirements. The cost that may be incurred by the Contractor to display messages as described above during this construction contract shall be considered incidental and included in the cost of other items.

Warranties

The following components of the Project shall be warranted against manufacturing defects and workmanship for a period of at least one (1) year:

- Radio interconnect system components as listed under SP 907-662-2
- Layer 2, Type A; Layer 3, Type C, Type C4, Type E1, and Type E2 Network Switches; and Network Terminal Server & Network Cellular Modem as listed under SP 907-663-5
- Communication Node Hut & Hut Modifications under SP 907-664-4
- Video Communication Equipment components under SP 907-665-1
- Bluetooth Detection System components under SP 907-666-3
- Roadway Weather Information System & Warning Signs with Flashing Beacon under SP 907-670-3
- Kiosk Monitoring Camera under SP 907-671-1
- Travel Time Sign under SP 907-674-1
- ITS Radar Vehicle Detector under SP 907-641-2
- On Street Video Equipment under SP 907-650-4;
- Highway Advisory System components under SP 907-655-2;
- Dynamic Message Signs under SP 907-656-1.

The following components of the Project shall be warranted against manufacturing defects and workmanship for a period as listed below for each respective item from the date of Final Maintenance Release.

- *Fiber Optic Cable*: Ten (10) year warranty on materials and workmanship
- *Traveler Information Video Kiosk*: Two (2) year extended warranty on materials/hardware
- *TMC Modification*: Two (2) year warranty on hardware and one (1) year warranty on software
- *Type C1, C2, & C3 Network Switches*: Five (5) year warranty on hardware
- *Type D, E, & F Network Switches*: Five (5) year warranty on hardware

The Contractor shall supply the warranties in writing with the Final Maintenance Release date documented on them. These warranties shall cover complete replacement at no charge for the equipment. The Contractor will be responsible for all labor, shipping, insurance and other charges until Final System Acceptance. Equipment covered by the manufacturers' warranties shall have the registration of that component placed in the Department's name prior to Final Inspection. The Contractor is responsible for ensuring that the vendors or manufacturers supplying the components and providing the equipment warranties recognize MDOT as the original purchaser and owner/end user of the components from new.

During the warranty period, the supplier shall repair or replace with new material of equal or greater kind and quality and meeting all of the applicable specifications herein, at no additional cost to the State, any product containing a warranty defect, provided the product is returned postage-paid by the Department to the supplier's factory or authorized warranty site. Products repaired or replaced under warranty by the supplier shall be returned prepaid by the supplier. During the warranty period, technical support shall be available from the Contractor via telephone within four (4) hours of the time a call is made by the Department. If it is deemed necessary by the Engineer, technical support shall be available from factory certified personnel of the supplier via telephone within eight (8) hours of the time of the initial call made by the Department. During the warranty period, updates, patches, performance improvements, and corrections to all software and firmware used during the project shall be made available to the Department by the supplier at no additional cost.

Training

After the Stand Alone Site Tests have been conducted but prior to Conditional System Acceptance, the Contractor shall provide separate training sessions for each subsystem training pay item included in the project. The training sessions may require multiple classes as noted below) and shall accommodate from six (6) to twelve (12) personnel per class. Additional sessions for additional personnel may be required if the make and model of the subject component is not currently in the MDOT system.

The training must include formal classroom and "hands-on" operations training with a complete demonstration of the configuration, operation, and capabilities of each component in the system. The training should also consist of a hands-on demonstration of all software configuration and functionality where applicable. Each training day shall include a mixture of classroom style

training in equipment operations, hands-on operator training using the same models of equipment furnished for the project, and question and answer sessions.

During the burn-in period, the Contractor shall also provide two (2) identical non-consecutive training sessions on the maintenance of the overall system. The training shall be provided for at least ten (10) personnel with individual copies of all training materials provided to each participant. The training must include both classroom style training and hands-on training in the field of the maintenance and troubleshooting procedures required for each component. Additional sessions for additional personnel may be required if the make and model of certain components are not currently in the MDOT system.

Prior to scheduling the training, the Contractor shall submit resume and references of the training instructor(s) to the Engineer for approval. The qualifications of the trainers must meet, at a minimum, the recommended qualifications of the equipment manufacturer with a minimum of four years of experience in training personnel. If qualified personnel are not on the Contractor's staff, a representative of the manufacturer shall provide the training.

The training shall be provided at an agreed upon location. If training requires travel on the part of training instructors, then the cost of travel shall be included.

The Contractor shall provide individual copies of documentation, training, and maintenance materials for each participant. These materials shall include detailed specifications and information pertaining to each device in the system. The documentation shall include details of the technical and operational aspects of the completed system. This shall include operational and maintenance manuals, system diagrams, cabling diagrams and mounting/positioning details. The Contractor shall supply emergency contact information and necessary procedures for obtaining vital replacement parts within a designated, agreed upon time frame.

The Contractor shall submit a detailed Training Plan including course agendas, detailed description of functions to be demonstrated, and a general schedule to the Engineer for approval within 90 days of Contract Notice-to-Proceed. The exact date of the training shall be submitted to the Engineer for approval at least four (4) weeks ahead of the date.

Grounding

The Contractor shall provide a grounding and lightning protection system to protect from electrical power surges caused by lightning or disruptions in the power supply system. Ground rods, ground conductor, lightning collectors and appurtenances shall be as detailed on the plans and as required by these specifications.

General. All non-current carrying metal parts of the site shall be grounded according to NEC specifications. In addition, all non-current carrying metal parts shall have a voltage potential of zero relative to reference ground. This reference ground shall be achieved via the equipment-grounding conductor.

Support cable, metallic cable sheaths, conduit, metal poles, pedestals, and communication building shall be made mechanically and electrically secure and grounded. Bonding and grounding jumpers

shall be properly sized according to the NEC and in no case shall they be smaller than a #6 AWG copper wire. Ground pole-mounted accessories to the pole. Equipment on wood poles shall be grounded.

Permanently ground the poles by bonding the No. 6 AWG solid copper wire to a separate ground rod.

Metal raceways, metal enclosures of electrical devices, lighting fixtures, panelboards, and other non-current carrying metallic parts of equipment shall be securely grounded.

Ground rods shall be installed according to plan details. A length of copper conductor shall be attached to the ground rod, utilizing the specified grounding methods, and connected to the grounding system. Do not ground to a permanent water system instead of the driven ground rod. Ensure that grounding devices conform to the requirements of the NEC and NEMA.

Cabinet Grounding. A single-point grounding system shall be constructed.

All grounds for the cabinet shall be installed on the side of the building that utilities, communication cables, and fiber enter. All earth grounds shall be connected to this point, including the grounding system for Surge Protection Devices (SPD). All connections to SPDs shall be made according to the manufacturer's recommendations.

A single ground bus bar shall be mounted on the side of the cabinet wall adjacent to the power panel for the connection of AC neutral wires and chassis ground wires.

The Contractor shall ensure that communication cables, AC power, emergency generator, and equipment frames are connected by the shortest practical route to the grounding system. The lead lengths from each device to the SPD shall be protected. Electrical continuity of all connections shall be verified. All non-conducting surface coatings shall be removed before each connection is made. Ground conductors shall be downward coursing, vertical, and as short and straight as possible. Sharp bends and multiple bends shall be avoided in grounding conductors.

Surge Suppressor

Surge protection device (SPD) shall be provided to protect electronics from lightning, transient voltage surges, and induced current. All SPDs shall be installed at the top and bottom of each pole to provide reliable lightning protection. SPDs shall be installed on all power, data, video and any other conductive circuit.

SPD for 120 Volt or 120/240 Volt Power. A SPD shall be installed at the utility disconnect to the cabinet. The SPD at the utility disconnect shall include L-N, L-G, and N-G protection. The SPD shall meet the requirements of UL 1449, Third Edition and be listed by a NRTL.

A SPD shall be provided where the supply circuit enters the cabinet. The SPD shall be located on the load side of the main disconnect and ahead of any and all electronic devices and connected in parallel with the AC supply. The SPD in the cabinet shall include L-N, L-G, and N-G protection. The SPD shall meet the requirements of UL 1449, Third Edition and be listed by a NRTL.

The SPD shall have a visual indication system that monitors the weakest link in each mode and shows normal operation or failure status and also provides one set of normally open (NO)/normally closed (NC) Form C contacts for remote alarm monitoring. The enclosure for a SPD shall have a NEMA 4 rating

SPDs for Low-Voltage Power, Control, Data and Signal Systems. A specialized SPD shall be installed on all conductive circuits including, but not limited to, data communication cables, coaxial video cables, and low-voltage power cables. These devices shall comply with recommendations from the device manufacturer.

SPD at Point of Use. A SPD shall be installed at the point the ITS devices receive 120 volt power and connected in series with the circuits. SPDs shall be selected and installed according to recommendation from the device manufacturer. The units shall be rated at 15 or 20 amps load and configured with receptacles. These units shall have internal fuse protection and provide common mode (L+N-G) protection.

SPDs shall meet the requirements of UL 497B or UL 497C, as applicable, and are listed by a NRTL.

Solar Power Systems

The Contractor shall provide a solar power system meeting the following requirements:

1. The supplier shall provide documentation specifying approximate daily power generation, power consumption, storage capacity, and charge rates representing an optimal power source to the satisfaction and approval of the Project Engineer.
2. Shall include a solar controller with automatic battery temperature compensation and automatic charging circuitry to prevent overcharging.
3. The battery back-up system chargers shall meet all specified requirements while operating between -40 °C to +74 °C (-40 °F to +165 °F), and 95% relative humidity.
4. Shall include metering for voltage and charging current.
5. Solar panels shall be Jet Propulsion Laboratory Block-5 tested and approved.
6. Solar panels shall be compliant with IEC 61215 and IEEE 1262.
7. Solar panels shall be break-resistant and sealed.
8. Battery shall be maintenance-free, sealed, gel-cell.
9. The Contractor shall test the battery for faulty irregularities and provide documentation to the Project Engineer stating the battery's voltage, and resistance. The battery voltage and resistance shall meet the manufacturer's specifications.

The Solar Power Systems for each site type shall include but are not limited to the following:

- *HAR Flashing Beacons:*
 1. A performance design study shall be conducted and submitted for approval for the proposed solar power system. The solar power system shall be designed on the performance design study.
 2. The solar system shall, at a minimum, operate the flashing beacons continuously at

- full power for at least three (3) days with no sunlight. This must be accomplished without an auxiliary generator or AC power connection.
3. Solar panels shall have a power rating of 80-watts.
 4. The Solar power system shall include a separate aluminum NEMA 3R enclosure to house the battery. This enclosure shall be designed to provide protection from rain, sleet, snow and corrosion.
 - a. The enclosure shall be constructed from 0.125" thick aluminum alloy type 5052- H32.
 - b. The enclosure shall be lockable.
 - c. The enclosure door shall include a EDPM rubber or equivalent closed-cell gasket
- *Type A BDS:*
 1. All solar panels shall be in accordance with UL1703, or equivalent.
 2. The solar cell shall have a minimum power capacity of 30 watts.
 3. The battery shall provide sufficient power for all BDS component operation for a minimum of 168 hours (7 days).
 4. Should solar power be specified with the Type A BDS, the NEMA 4 enclosure shall be sized appropriately for the solar power components.

Performance Design Study. A performance design study shall be conducted where required before the installation of a Solar Power System. The performance design study shall include, but is not limited to:

1. The daily Solar Insulation data averaged on a monthly basis.
2. The correct Tilt Angle for the solar array.
3. The daily Array Output, in Amp-Hours, averaged on a monthly basis.
4. The total Daily Load requirement, in Amp Hours, averaged on a monthly basis.
5. A monthly Loss of Load Probability (LOLP) of the designed power supply.
6. The number of Battery Reserve Days, averaged on a monthly basis.
7. The monthly Average Battery State of Charge.
8. The statistical Interval to Loss of Load, in years.

MISSISSIPPI DEPARTMENT OF TRANSPORTATION

SECTION 904 - NOTICE TO BIDDERS NO. 4113

CODE: (SP)

DATE: 03/23/2022

SUBJECT: **Unique Entity ID (SAM) Requirement for Federal Funded Projects**

Bidders are advised that the Prime Contractor must register and maintain a current registration in the System for Award Management (<http://sam.gov>) at all times during this project. Upon registration, the Contractor will be assigned a SAM Unique Entity ID.

Bidders are also advised that prior to the award of this contract, they MUST be registered, active, and have no active exclusions in the System for Award Management.

MISSISSIPPI DEPARTMENT OF TRANSPORTATION

SECTION 904 - NOTICE TO BIDDERS NO. 4702

CODE: (SP)

DATE: 11/22/2022

SUBJECT: App for Traffic Control Reports

Bidders are advised that the Department has created a smart phone App for completing and submitting traffic control reports (Form CSD-762) required on this project. The Contractor who monitors traffic control activities and completes traffic control reports will be required to download and use this App when completing and submitting traffic control reports. The reports will then be readily available to all persons who need access to the forms. The App is free and is available for downloading at the following location.

<https://extacctmgmt.mdot.state.ms.us/>

MISSISSIPPI DEPARTMENT OF TRANSPORTATION

SECTION 904 - NOTICE TO BIDDERS NO. 5551

CODE: (IS)

DATE: 12/06/2023

SUBJECT: Federal Bridge Formula

Bidders are hereby advised that the latest revision of Federal Highway Administration Publication No. FHWA-HOP-06-105, **BRIDGE FORMULA WEIGHTS**, dated August 2006, is made a part of this contract when applicable.

Prior to the preconstruction conference, the Contractor shall advise the Engineer, in writing, what materials, if any, will be delivered to the jobsite via Interstate route(s).

Copies of the **BRIDGE FORMULA WEIGHTS** publication may be obtained by contacting:

Federal Highway Administration
400 7th Street, SW
Washington, DC 20590
(202) 366-2212

or

https://ops.fhwa.dot.gov/freight/publications/brdg_frm_wghts/

MISSISSIPPI DEPARTMENT OF TRANSPORTATION

SUPPLEMENT TO NOTICE TO BIDDERS NO. 5605

DATE: 01/12/2024

The goal is 5 percent for the Disadvantaged Business Enterprise. All Bidders are required to submit Form OCR-481 for all DBEs. Bidders are advised to check the bid tabulation link for this project on the MDOT website at:

https://mdot.ms.gov/portal/current_letting

Bid tabulations are usually posted by 3:00 pm on Letting Day.

MISSISSIPPI DEPARTMENT OF TRANSPORTATION

SECTION 904 – NOTICE TO BIDDERS NO. 5605

CODE: (IS)

DATE: 01/12/2024

SUBJECT: Disadvantaged Business Enterprises in Federal-Aid Highway Construction

DEFINITIONS

For purposes of this provision, the following definitions will apply:

“DOT” means the United States Department of Transportation.

“DBE” means disadvantaged business enterprise.

“MDOT” means the Mississippi Department of Transportation.

“DBE Program” means MDOT’s DBE Program.

This Contract is subject to the “Moving Ahead for Progress in the 21st Century Act (Map-21)” and applicable requirements of 49 C.F.R. part 26. Portions of the Act are set forth in this Notice as applicable to compliance by the contractor and all of the Act, and MDOT’s DBE Program, is incorporated by reference herein.

MDOT has developed a Disadvantaged Business Enterprise Program (“DBE Program”) that is applicable to this Contract and is made a part thereof by reference.

Copies of the DBE Program Manual may be obtained from:

Office of Civil Rights
Mississippi Department of Transportation
P.O. Box 1850
Jackson, Mississippi 39215-1850

or can be found on MDOT’s website at www.mdot.ms.gov under the Business Center under Civil Rights tab.

POLICY

It is the policy of MDOT to provide a level playing field, to foster equal opportunity in all federally assisted contracts, to improve the flexibility of the DBE Program, to reduce the burdens on small businesses, and to achieve the amount of participation that would be obtained in a non-discriminatory marketplace. In doing so, it is the policy of MDOT that there will be no discrimination in the award and performance of federally assisted contracts on the basis of race, color, sex, or national origin.

DBE DIRECTORY

A list of certified DBE contractors can be found on MDOT’s website at www.mdot.ms.gov under the Business Center and Project Letting tab. The DBE firm must be certified at the time the project is let and approved by MDOT to count towards meeting the DBE goal.

PRE-BID MEETING

A pre-bid meeting for monthly lettings will be held either in the Commission Room on the 1st floor of MDOT’s Administration Building, 401 N. West St., Jackson, MS 39201, or via a teleconference source, at 2:00 p.m. on the Monday immediately preceding the fourth Tuesday. No pre-bid meeting is required for emergency lettings.

This meeting is to inform DBE firms of subcontracting and material supply opportunities. Attendance at this meeting is considered of prime importance in demonstrating good faith efforts to meet the contract goal.

AWARD

Award of this Contract to the lowest bidder will be contingent upon the following conditions:

1. Concurrence with the Federal Highway Administration, when applicable.
2. All bidders must submit to the Office of Civil Rights Form OCR-481 no later than the 3rd business day after opening of the bids to satisfy MDOT or have documented in the bid package that adequate good faith efforts have been made to meet the Contract goal. For any questions regarding Form OCR-481, contact the Office of Civil Rights at 601.359.7466.
3. Bidders must include OCR-485 information with their bid proposal listing all firms that submitted quotes for material supplies or items to be subcontracted. The OCR-485 information must be signed and included with the bid proposal. If the OCR-485 information is not included and signed as part of the bid proposal, the bid will be deemed irregular.

Prior to the start of any Contract work, the bidder must notify the Project Engineer, in writing, of the designated “DBE Liaison Officer” for the project. This notification must be posted on the bulletin board at the project site.

DBE REPORTS

1. OCR-481 is available on MDOT’s website at www.mdot.ms.gov under the Civil Rights tab, or by calling 601.359.7466. This form must contain:
 - a. The name and address of each certified DBE contractor and/or supplier; and
 - b. The Reference Number, percent of work to be completed by the DBE subcontractor, and the dollar amount of each item. If a portion of an item is subcontracted, a breakdown of that item, including quantities and unit price, must be attached

detailing what part of the item the DBE firm is to perform and who will perform the remainder of the item.

2. OCR-482: At the conclusion of the project, before the final estimate is paid and the project is closed out, the prime contractor will submit to the Project Engineer Form OCR-482. In this form, the contractor must certify the total amount paid to all DBE contractors/suppliers over the life of the Contract. The Project Engineer will submit the completed Form OCR-482 to the DBE Coordinator in the MDOT Office of Civil Rights. Final acceptance of the project is dependent upon MDOT’s Contract Administration Division’s receipt of the completed and approved Form OCR-482 as received from the Office of Civil Rights.
3. OCR-483: The Project Engineer or Inspector will complete Form OCR-483, the Commercially Useful Function Performance Report, in accordance with MDOT S.O.P. No. OCR-03-05-02-483. Evaluations reported on this form are used to determine whether or not the DBE firm is performing a commercially useful function. The prime contractor is expected to take corrective action when the report contains any negative evaluations. DBE credit may be disallowed and/or sanctions imposed if it is determined that the DBE firm is not performing a commercially useful function. This form is to be completed and submitted to the DBE Coordinator in the Office of Civil Rights.
4. OCR-484: Each month, the prime contractor will submit to the Project Engineer OCR-484, which certifies payments to all subcontractors and lists all firms to reflect payments made during the estimate period. The prime contractor will submit this form even if they have not paid any money to a firm during the estimate period. The Project Engineer will attach the form to the monthly estimate before forwarding it to MDOT’s Contract Administration Division for further processing. Failure of the contractor to submit the OCR-484 form will result in the estimate not being processed and paid.
5. OCR-485: ALL BIDDERS must submit the signed Form OCR-485 with bid proposals of all firms that submitted quotes for material supplies or items to be subcontracted. If the OCR-485 information is not included and signed as part of the bid proposal, the bid will be deemed irregular.
6. OCR-487: The OCR-487 is only used by prime contractors that are certified DBE firms. This form is used in determining the exact percentage of DBE credit for the specified project. The lowest bidder must submit this form to MDOT’s Office of Civil Rights with the OCR-481 form. It may also be submitted with the Permission to Subcontract Forms (CAD-720, CAD-725, and CAD-521).

DBE forms may be obtained from the Office of Civil Rights at the MDOT Administration Building, 401 N. West St., Jackson, MS, or at www.mdot.ms.gov under the Civil Rights tab.

CONTRACTOR ASSURANCES

Each contract that MDOT signs with a contractor, and each subcontract that the prime contractor signs with a sub-contractor, must contain the following assurance set forth in 49 C.F.R. § 26.13:

The contractor, sub-recipient or subcontractor shall not discriminate on the basis of race, color, sex, or national origin in the performance of this Contract. The contractor shall carry out applicable requirements of 49 C.F.R. part 26 in the award and administration of federally assisted contracts. Failure by the contractor to carry

out these requirements is a material breach of this Contract, which may result in the termination of this Contract or such other remedy as MDOT deems appropriate.

CONTRACTOR’S OBLIGATION

The contractor and all subcontractors shall take all necessary and reasonable steps to ensure that DBE firms can compete for and participate in the performance of a portion of the work in this Contract and shall not discriminate on the basis of race, color, sex, or national origin. Failure on the part of the contractor to carry out the DBE requirements of the Contract constitutes a material breach of contract and, after proper notification, MDOT may terminate the Contract or take other appropriate action as determined by MDOT.

When a contract has a zero (0) percent goal, the contractor must take all necessary and reasonable steps to ensure that DBE firms can compete for and participate in the performance of the work in the Contract. In this case, all work performed by a certified DBE firm is considered to be a “race neutral” measure and MDOT will receive DBE credit towards the overall State goal when the DBE firm is paid for their work. If the prime contractor is a certified DBE firm, MDOT can receive DBE credit only for the work performed by the prime contractor’s work force or any work subcontracted to another DBE firm. Work performed by a non-DBE subcontractor is not eligible for DBE credit.

CONTRACT GOAL

The goal for participation by DBEs is established for the Contract in the attached Supplement. The contractor shall exercise all necessary and reasonable steps to ensure that participation is equal to or exceeds the Contract goal.

If the Contract goal established by MDOT is one (1) percent or greater, it must be met to fulfill the terms of the Contract. The contractor may list DBE subcontractors and items that exceed MDOT’s Contract goal, but should any unforeseen problems arise that would prevent a DBE from completing its total commitment percentage, the contractor will meet the terms of the Contract as long as it meets or exceeds MDOT’s Contract goal.

All Bidders shall submit to the Office of Civil Rights Form OCR-481, signed by the prime contractor and the DBE subcontractors, no later than the third business day after opening of the bids. Please refer to the “DBE Reports” section of this Notice to Bidders for what information must be contained in the OCR-481 Form.

If the DBE commitment shown on the last bid sheet of the proposal does not equal or exceed the Contract goal, the bidder must submit to MDOT’s Contract Administration Division information that shows that adequate good faith efforts have been made to meet the Contract goal. This information must be submitted to MDOT prior to bid opening.

Failure of the lowest bidder to furnish acceptable proof of good faith efforts submitted to MDOT’s Contract Administration Division prior to bid opening shall be just cause for rejection of the

proposal. Award may then be made to the next lowest responsive bidder, or the project may be re-advertised. For MDOT’s reconsideration process, please see MDOT’s DBE Manual.

GOOD FAITH EFFORTS AT THE TIME OF THE BIDDING

For the purposes of the DBE Program, Good Faith Effort means to have made every reasonable effort using, at a minimum, the guidelines outlined below, and any other steps deemed appropriate to initially find and/or replace a DBE to meet the established DBE Goal assigned to a project. Additional guidance can be found in Appendix A to 49 C.F.R. § 26.53(a).

The following factors are illustrative of matters that MDOT will consider in judging whether the bidder has made adequate good faith efforts to satisfy the Contract goal.

1. Whether the bidder attended the pre-bid meeting that was scheduled by MDOT to inform DBEs of subcontracting opportunities;
2. Whether the bidder reached out to the MDOT Office of Civil Rights for assistance;
3. Whether the bidder advertised in general circulation, trade association, and minority-focused media concerning the subcontracting opportunities;
4. Whether the bidder provided written notice to a reasonable number of specific DBEs that their interest in the Contract is being solicited;
5. Whether the bidder followed up initial solicitations of interest by contacting DBEs to determine with certainty whether they were interested;
6. Whether the bidder selected portions of the work of the work to be performed by DBEs in order to increase the likelihood of meeting the Contract goal;
7. Whether the bidder provided interested DBEs with adequate information about the plans, specifications, and requirements of the Contract;
8. Whether the bidder negotiated in good faith with interested DBEs and did not reject them as unqualified without sound reasons based on a thorough investigation of their capabilities;
9. Whether the bidder made efforts to assist interested DBEs in obtaining any required bonding or insurance;
10. Whether the bidder has written notification to certified DBE Contractors soliciting subcontracting for items of work in the Contract;
11. Whether the bidder has a statement of why an agreement was not reached; and
12. Proof of written notification to certified DBE Contractors by certified mail that their interest is solicited in subcontracting the work defaulted by the previous DBE or in subcontracting other items of work in the Contract.

The bidder’s execution of the signature portion of the proposal shall constitute execution of the following assurance:

The bidder hereby gives assurance pursuant to the applicable requirements of “Moving Ahead for Progress in the 21st Century Act (MAP-21)” and applicable requirements of 49 C.F.R. part 26 that the bidder has made a good faith effort to meet the contract goal for DBE participation for which this proposal is submitted.

In determining whether a bidder made good faith efforts, MDOT will:

1. Scrutinize the documented efforts of the bidder;
2. Review the performance of other bidders in meeting the Contract goal;
3. Require the bidder to submit copies of each DBE and non-DBE subcontractor’s quote submitted to the bidder when a non-DBE subcontractor was selected over a DBE for work on the Contract to review whether DBE prices were substantially higher; and
4. Contact the DBEs listed on a contractor’s solicitation to inquire as to whether they were contacted by the prime contractor.
5. MDOT will not consider standardized (i.e., bulk or generic) mailings to DBEs requesting bids as sufficient to satisfy good faith efforts.
6. MDOT will also not consider a promise to use DBEs after Contract award as responsive to Contract solicitation, nor will it constitute adequate good faith efforts.

GOOD FAITH EFFORTS DURING THE CONTRACT

If a DBE subcontractor cannot perform satisfactorily, or at all, and this causes the OCR-481 commitment to fall below the Contract goal, the contractor must take all necessary and reasonable steps to replace the DBE with another certified DBE subcontractor or submit information to satisfy a good faith effort to MDOT. Contractor must notify the Office of Civil Rights immediately upon determination that the goal may not be achieved.

Information to be submitted to satisfy MDOT may include:

1. Did the prime contractor look at other areas of the Contract to subcontract out to DBEs?
2. Did the prime contractor look for new DBE firms to perform the same line of work?
3. Did the prime contractor identify other DBEs used in the performance of the Contract but that were not reported to MDOT?
4. Did the prime contractor select portions of the work to be performed by DBEs in order to increase the likelihood that the DBE goals would be achieved?
5. Did the prime contractor provide interested DBEs with adequate information about the plans, specifications, and requirements of the Contract in a timely manner?
6. Did the prime contractor negotiate in good faith with interested DBEs?
7. Did the prime contractor use good business judgment such as taking into consideration the DBE firm’s price and capabilities as compared to non-DBE firms?
8. Did the bidder reject the DBEs as being unqualified without sound reasons?
9. Did the prime contractor make efforts to assist interested DBEs in obtaining bonding, lines of credit, or insurance as required by the recipient or the prime contractor?
10. Did the prime contractor effectively use the services of available the agency’s DBE Supportive Services provider or other available minority/women community organizations; minority/women contractors’ groups; local, state, and federal minority/women business assistance offices; and other organizations as allowed on a case-by-case basis to aid in the recruitment and placement of DBEs?

When a contractor proposes to substitute/replace/terminate a DBE that was originally named on the OCR-481, the contractor must obtain a release, in writing, from the named DBE explaining

why the DBE subcontractor cannot perform the work. A copy of the original DBE’s release must be attached to the contractor’s written request to substitute/replace/terminate along with an appropriate Subcontract Forms for the substituted/replaced/terminated subcontractor, all of which must be submitted to the Project Engineer for forwarding to the Office of Civil Rights DBE Coordinator for review and approval actions. The replacement DBE must be a DBE who was on MDOT’s list of “Certified DBE Contractors” when the job was let, and who is still active.

Under no circumstances may the prime contractor or a subcontractor perform the DBE’s work without prior written approval from MDOT.

PARTICIPATION/DBE CREDIT

Participation shall be counted toward meeting the goal in this Contract as follows:

1. If the prime contractor is a certified DBE firm, only the value of the work actually performed by the DBE prime contractor can be counted towards the project goal, along with any work subcontracted to a certified DBE firm.
2. If the contractor is not a DBE, the work subcontracted to a certified DBE contractor will be counted toward the goal.
3. The contractor may count a portion of the total dollar value of a contract with a joint venture eligible under the standards of the provision equal to the percentage of the DBE partner in the joint venture towards the Contract goal.
4. Expenditures to DBEs that perform a commercially useful function may be counted toward the goal. A business is considered to perform a commercially useful function when it is responsible for the execution of a distinct element of the work and carries out its responsibilities by actually performing, managing, and supervising the work involved.
5. The contractor may count one hundred (100) percent of the expenditures for materials and supplies obtained from certified DBE suppliers and manufacturers that produce goods from raw materials or substantially alters them for resale provided the suppliers and manufacturers assume the actual and contractual responsibility for the provision of the materials and supplies. The contractor may count sixty (60) percent of the expenditures to suppliers that are not manufacturers, provided the supplier performs a commercially useful function in the supply process. Within thirty (30) days after receipt of the materials, the contractor shall furnish to the Project Engineer invoices from the certified supplier whereby the DBE goal can be verified by MDOT’s DBE Coordinator.
6. Any work that a certified DBE firm subcontracts or sub-subcontracts to a non-DBE firm will not count towards the DBE goal.
7. Only the dollars actually paid to the DBE firm may be counted towards the DBE goal. The participation of a DBE Firm cannot be counted towards the Prime Contractor’s DBE goal until the amount being counted towards the goal has been paid to the DBE.

SANCTIONS

If the prime Contractor fails to fulfill the contract DBE goal commitments on the OCR-481 forms, including administrative errors, and/or is found to have taken actions that are not in compliance

with the MDOT DBE Program and 49 CFR Part 26 , MDOT has the option to enforce any or all combination(s) of the following penalties:

1. Disallowing credit to go towards the DBE goal;
2. Withholding progress estimate payments;
3. Deducting from the final estimate or recovering an amount equal to the unmet portion of the DBE goal, which may include additional monetary penalties as outlined below based on the number of offenses and the severity of the violation, as determined by MDOT:

1st Offense	10% of unmet portion of goal	or	\$7,500 lump sum payment	or	Both
2nd Offense	20% of unmet portion of goal	or	\$15,000 lump sum payment	or	Both
3rd Offense	40% of unmet portion of goal	or	\$25,000 lump portion of goal	or	\$25,000 lump sum payment and debarment

4. MDOT may debar the contractor from bidding on MDOT’s federally funded projects for a period of up to twelve (12) months after notification by certified mail.

If the DBE goal is not met due to an administrative error by the contractor, MDOT has the discretion to assess a percentage of the unmet portion of the goal or any combination of the above as sanctions, in an amount that is deemed appropriate by MDOT.

MISSISSIPPI DEPARTMENT OF TRANSPORTATION

SECTION 904 - NOTICE TO BIDDERS NO. 5750

CODE: (SP)

DATE: 03/19/2024

SUBJECT: Manual on Uniform Traffic Control Devices (MUTCD)

Bidders are advised that any reference to the current edition of the MUTCD or the latest edition of the MUTCD within plans, proposal, or standard specifications means the 2009 Edition and the 3 Revisions thereto.

MISSISSIPPI DEPARTMENT OF TRANSPORTATION

SECTION 904 - NOTICE TO BIDDERS NO. 6621

CODE: (SP)

DATE: 01/13/2025

SUBJECT: Contract Time

PROJECT: NHPP-0070-03(026) / 108710301 & NHPP-0070-03(028) / 109439301 -- Panola County

The completion of work to be performed by the Contractor for this project will not be a specified date but shall be when all allowable working days are assessed, or any extension thereto as provided in Subsection 108.06. It is anticipated that the Notice of Award will be issued no later than **March 11, 2025** and the date for Notice to Proceed / Beginning of Contract Time will be **April 10, 2025**.

Should the Contractor request a Notice to Proceed earlier than **April 10, 2025** and it is agreeable with the Department for an early Notice to Proceed, the requested date will become the new Notice to Proceed date. Regardless of whether or not an early Notice to Proceed is granted, contract time will start at the original Notice to Proceed date.

All requests for an early Notice to Proceed shall be sent to the Project Engineer who will forward it to the Contract Administration Division.

263 Working Days have been allowed for the completion of work on this project.

MISSISSIPPI DEPARTMENT OF TRANSPORTATION

SECTION 904 - NOTICE TO BIDDERS NO. 6622

CODE: (SP)

DATE: 12/19/2024

SUBJECT: Scope of Work

PROJECT: NHPP-0070-03(026) / 108710301 & NHPP-0070-03(028) / 109439301 -- Panola County

The contract documents do not include an official set of construction plans but may, by reference; include some Standard Drawings when so specified in a Notice to Bidders entitled, “Standard Drawings”.

PROJECT NUMBER: NHPP-0070-03(026) / 108710301

The work to be accomplished using the pay items and corresponding specifications set forth in this contract, is for milling and overlay of US Highway No. 278 beginning from east side of the ICGRR Overpass (Station 1887+00) and going easterly for approximately 6.9 miles to east of Terza Road (Station 349+00).

It shall be the responsibility of the Contractor to protect the roadway and all existing structures, such as bridges and curb, from damage occurring as a result of the Contractor’s operations. Damages to existing features caused by the Contractor’s operations shall be repaired or replaced at no cost to the Mississippi Department of Transportation.

At bridge ends and at the end of workday, a taper of one (1) vertical inch for each three horizontal feet (3’) shall be provided.

The Contractor shall make a utility location request to 811 prior to any excavation, except for trench widening or pavement removal/repair.

In order to expedite the safe movement of traffic and to protect each phase of the work as it is performed, a firm sequence of operations is essential. The work shall be begun and continually prosecuted.

The work shall consist of the following:

1. Failed areas shall be repaired using the following:
 - 202-B, Removal of Asphalt Pavement, All Depths — for pavement structure
 - 202-B, Removal of Concrete Pavement Punchouts, 9” Depth
 - 202-B, Removal of Concrete Pavement w/Variable Depth Overlay
 - 203-G, Excess Excavation – for material below the pavement structure
 - 304-F, Crushed Stone Base

- 403-A, 19-mm, ST Asphalt Pavement
- 501-D, Expansion Joints, with Dowels
- 503-A, 9” and Variable Reinforced Concrete Pavement, Broom Finish
- 503-C, Saw Cut Full Depth
- 503-E, Tie Bars, No. 5 Deformed Drilled and Epoxied or Grouted

Station	Side		Length	Concrete		Asphalt		Saw Cuts (LF)
	Inside Lane	Outside Lane		Width	Area (SY)	Width	Area (SY)	
Eastbound Lanes								
15+00	X		10	11	12.222	3	3.333	38
24+50	X		10	11	12.222	3	3.333	38
28+75 **	TURN		6	12	8.000	0	0.000	30
30+00 **	TURN		10	12	13.333	0	0.000	34
45+00		TURN	10	12	13.333	0	0.000	34
47+50	X		10	11	12.222	3	3.333	38
48+00		X	10	11	12.222	3	3.333	38
51+50	X		10	11	12.222	3	3.333	38
Total Eastbound					95.78		16.67	288

Station	Side		Length	Concrete		Asphalt		Saw Cuts (LF)
	Inside Lane	Outside Lane		Width	Area (SY)	Width	Area (SY)	
Westbound Lanes								
660+00	X	X	10	22	24.44	6	6.67	66
650+00	X	X	10	22	24.44	6	6.67	66
645+50	X	X	10	22	24.44	6	6.67	66
637+00	X	X	10	22	24.44	6	6.67	66
619+00	X	X	10	22	24.44	6	6.67	66
602+00	X	X	10	22	24.44	6	6.67	66
599+00	X	X	10	22	24.44	6	6.67	66
589+50		X	10	11	12.22	3	3.33	38
589+00	X		10	11	12.22	3	3.33	38
588+00	X		10	11	12.22	3	3.33	38
572+00		X	10	11	12.22	3	3.33	38

Station	Side		Length	Concrete		Asphalt		Saw Cuts (LF)
	Inside Lane	Outside Lane		Width	Area (SY)	Width	Area (SY)	
Westbound Lanes								
567+50		X	10	11	12.22	3	3.33	38
540+00		X	10	11	12.22	3	3.33	38
490+00	X	X	10	22	24.44	6	6.67	66
485+00	X	X	10	22	24.44	6	6.67	66
479+00	X	X	10	22	24.44	6	6.67	66
470+00	X	X	10	22	24.44	6	6.67	66
464+00	X	X	10	22	24.44	6	6.67	66
455+50		X	10	11	12.22	3	3.33	38
455+00	X	X	10	22	24.44	6	6.67	66
454+50	X	X	10	22	24.44	6	6.67	66
445+50	X	X	10	22	24.44	6	6.67	66
442+00	X	X	10	22	24.44	6	6.67	66
441+50	X	X	10	22	24.44	6	6.67	66
436+50	X	X	10	22	24.44	6	6.67	66
433+50	X	X	10	22	24.44	6	6.67	66
425+50	X	X	10	22	24.44	6	6.67	66
419+00	X	X	10	22	24.44	6	6.67	66
417+00		X	10	11	12.22	3	3.33	38
413+00	X	X	10	22	24.44	6	6.67	66
411+00	X	X	10	22	24.44	6	6.67	66
406+50	X	X	10	22	24.44	6	6.67	66
402+50	X	X	10	22	24.44	6	6.67	66
393+00	X	X	10	22	24.44	6	6.67	66
391+00	X	X	10	22	24.44	6	6.67	66
387+00	X		10	11	12.22	3	3.33	38
386+50	X	X	10	22	24.44	6	6.67	66
378+00	X	X	10	22	24.44	6	6.67	66
373+00	X	X	10	22	24.44	6	6.67	66
365+50		X	10	11	12.22	3	3.33	38
356+00	X	X	10	22	24.44	6	6.67	66
346+00	X	X	10	22	24.44	6	6.67	66
340+00	X	X	10	22	24.44	6	6.67	66
333+00	X	X	10	22	24.44	6	6.67	66
327+50	X	X	10	22	24.44	6	6.67	66
325+00	X	X	10	22	24.44	6	6.67	66
321+00	X	X	10	22	24.44	6	6.67	66

Station	Side		Length	Concrete		Asphalt		Saw Cuts (LF)
	Inside Lane	Outside Lane		Width	Area (SY)	Width	Area (SY)	
Westbound Lanes								
320+50		X	10	11	12.22	3	3.33	38
315+00	X	X	10	22	24.44	6	6.67	66
304+00	X	X	10	22	24.44	6	6.67	66
302+00	X	X	10	22	24.44	6	6.67	66
296+50	X	X	10	22	24.44	6	6.67	66
289+50	X	X	10	22	24.44	6	6.67	66
277+00	X	X	10	22	24.44	6	6.67	66
268+50	X	X	10	22	24.44	6	6.67	66
260+00	X	X	10	22	24.44	6	6.67	66
246+00		X	10	11	12.22	3	3.33	38
229+00	X	X	10	22	24.44	6	6.67	66
226+00	X	X	10	22	24.44	6	6.67	66
217+00	X	X	10	22	24.44	6	6.67	66
214+50		X	10	11	12.22	3	3.33	38
208+50	X	X	10	22	24.44	6	6.67	66
205+50	X	X	10	22	24.44	6	6.67	66
199+50	X		10	11	12.22	3	3.33	38
198+50		X	10	11	12.22	3	3.33	38
194+00	X	X	10	22	24.44	6	6.67	66
186+50	X		10	11	12.22	3	3.33	38
186+00		X	10	11	12.22	3	3.33	38
173+50		X	10	11	12.22	3	3.33	38
173+00	X		10	11	12.22	3	3.33	38
169+00	X	X	10	22	24.44	6	6.67	66
160+50	X	X	10	22	24.44	6	6.67	66
155+50		X	10	11	12.22	3	3.33	38
148+50		X	10	11	12.22	3	3.33	38
148+00	X		10	11	12.22	3	3.33	38
140+00	X	X	10	22	24.44	6	6.67	66
139+00		X	10	11	12.22	3	3.33	38
126+00	X	X	10	22	24.44	6	6.67	66
EQUATION								
49+00	X	X	10	22	24.44	6	6.67	66
43+50		X	10	11	12.22	3	3.33	38
43+00	X		10	11	12.22	3	3.33	38
38+00	X		10	11	12.22	3	3.33	38

Station	Side		Length	Concrete		Asphalt		Saw Cuts (LF)
	Inside Lane	Outside Lane		Width	Area (SY)	Width	Area (SY)	
Westbound Lanes								
29+00 **	TURN		6	12	8.00	0	0.00	30
28+75 **	TURN		6	12	8.00	0	0.00	30
19+50		TURN	10	11	12.22	3	3.33	38
13+50		X	10	11	12.22	3	3.33	38
11+50	X		10	11	12.22	3	3.33	38
EQUATION								
1970+50	Inside WB and Center		10	24	26.67	0	0.00	58
1930+00	Inside EB/WB and Center		10	36	40.00	0	0.00	82
1907+50	Right and Center		10	24	26.67	0	0.00	58
1902+00	Left		100	0	0.00	6	66.67	112
1901+50	Left and Center		10	24	26.67	0	0.00	58
1893+00	Left, Center, and Right		10	36	40.00	0	0.00	82
1892+00	Right and Center		100	0	0.00	6	66.67	112
1889+00	Left and Right		10	24	26.67	0	0.00	58
Total Westbound					1926.00		603.33	5478.00
Total					2021.78		620.00	5766.00

NOTE: ** Stations are in the concrete section.

- There will be 1,939 LF of Cleaning and Filling Joints in PCC Pavement, paid under 413-D003, between Station 28+50 and Station 31+27.

3. Random clearing shall be performed within the specified clearing limits, including vegetation overhanging the edge of the clearing limits. Overhanging vegetation shall be trimmed to a minimum height of thirty feet (30') above the ground elevation at the edge of the clearing limits. It is the intent of this Contract for the vegetation, with the exception of any merchantable timber that the Contractor desires, shall be mulched onsite and left in place. Mulched material shall be spread such that no more than four inches (4") in depth of material is placed in any location. This work shall be paid under pay item 201-D002: Random Clearing, per acre. Clearing within two feet (2') of fences, utilities, and other obstructions as directed by the Engineer within the ROW shall be omitted in order to avoid damages. Random clearing will be required as shown in the table and may be required at other sites as directed by the Engineer.

Random Clearing					
	Starting Station	Ending Station	Length (ft)	Surveyed Acreage	Location
Area A	138+90	144+45	555	0.1616	Lt. of Lt. (WB outside)
Area B	161+85	169+30	745	0.3275	Lt. of Lt. (WB outside)
Area C	169+90	182+55	1265	0.6246	Lt. of Lt. (WB outside)
Area D	183+50	192+30	880	0.3096	Lt. of Lt. (WB outside)
Area E	216+50	225+15	865	0.194	Lt. of Lt. (WB outside)
Area F	229+80	253+45	2365	0.7684	Lt. of Lt. (WB outside)
Area G	271+45	275+25	380	0.0486	Lt. of Lt. (WB outside)
Area H	275+80	279+20	340	0.1002	Lt. of Lt. (WB outside)
Area I	316+40	323+10	670	0.186	Lt. of Lt. (WB outside)
				2.7205	Acres Total

NOTE: Due care should be taken to prevent damage in areas within the ROW that are outside the clearing limits as shown in the table. Any disturbed areas not shown above will not be measured for separate payment and shall be reestablished at no additional cost to the Department.

NOTE: An herbicide shall be used for sprout control of cut stumps. Paint or spray freshly cut stump surface thoroughly covering cambium area next to bark until the herbicide runs down around the root collar. Treat stump as soon as practical after cutting for more effective control but no later than day of cutting except when spraying must be postponed due to inclement weather. Pine stumps and all other stumps larger than 15 inches in diameter do not require spraying for control of sprouting. Permissible herbicides are 2,4-D (amine);

picloram +2,4-D; ammonium sulfamate; and dicamba. Specific requirements such as mixing, diluting, rate, application, use restrictions, safety precautions, etc. will be in accordance with the manufacturer’s printed container label.

NOTE: Re-spraying will be required when the herbicide is washed off by rain within eight hours of application or diluted to such an extent that it is rendered ineffective.

NOTE: Grinding of all stumps will be required to be flush with the ground.

- 4. The existing asphalt pavement shall be fine milled to a depth of one and one half inches (1½”). Milling operations shall be on the mainline, local roads, crossovers, and driveway pads. Fifty percent (50%) or a maximum of 10,000 tons of the milling material obtained shall become the property of the Mississippi Department of Transportation. The Contractor will deliver the milling material to the Panola County Maintenance Lot located at 150 Highway 51 North, Batesville. The Contractor shall provide all necessary equipment and qualified personnel to push material into a suitable stockpile.

Area	Quantity (SY)
US 278 Mainline	225,520
Paved Shoulder and Decel Lane	11,670
County Roads, Pads, and Crossovers	57,960
Total	295,150

NOTE: Payment for fine milling of pavement will be made under pay item 406-D, per square yard, and shall include all cost associated with the milling operation.

NOTE: From Station 1887+00 to Station 135+00, milled surfaces shall be covered with surface asphalt within five (5) calendar days of removal. The Contractor will be charged a fee of \$5,000.00 for each full or partial day in which the milled surface is left uncovered after the five (5) calendar days.

NOTE: From Station 135+00 to Station 349+00, milled surfaces shall be covered within seven (7) calendar days of removal. The Contractor will be charged a fee of \$5,000.00 for each full or partial day in which the milled surface is left uncovered after the seven (7) calendar days.

NOTE: During this operation and prior to placement of the asphalt, due care shall be required to keep surface water from ponding on the roadway surface; continuous monitoring of the project may be required.

NOTE: During this operation and prior to placement of the asphalt, Contractor shall repair and maintain all potholes.

5. A quantity of 4,525 tons of 9.5-mm, HT, Leveling asphalt on the previously milled mainline has been set up for curve correction. The high side of the curves are the only lane to be slope corrected. The low sides will only receive three quarters of an inch (3/4”) scratch leveling to match the centerline joint. A maximum lift of three inches (3”) shall be maintained for curve leveling. Granular material shall be placed on the shoulder prior to leveling of curves to maintain the legal drop-off requirements.

9.5mm, HT, Leveling Asphalt		
Curve Correction		
# Curves	Length (feet)	Tons
9	18,860	4525

6. The Contractor shall place the surface course on the previously milled surface.

Location	Type Mix	Area	Thickness	Asphalt
		SY	Inches	Tons
Mainline	9.5-mm, HT poly	225520	1.5	18650
Accel/Decel Lanes	9.5-mm, HT	2934	1.5	250
County Roads	9.5-mm, HT	40093	2	3775
Crossovers and Pads	9.5-mm, ST	17867	2	1975
Paved Shoulders around I-55	9.5-mm, ST	8736	1.5	725

Mix Type	Tons
9.5mm, HT poly	18650
9.5mm, HT	4025
9.5mm, ST	2700

7. Granular material shall be placed on the shoulders as directed to raise the existing shoulders to the new surface course grade.

NOTE: Shoulders shall be bladed, shaped and compacted throughout the length of the project regardless of whether granular material is required.

NOTE: Granular material not required for the final shape of the shoulders may require removal under the pay item for excess excavation and may include small amounts of asphalt.

NOTE: Due care shall be taken during this operation to blade material to the roadway and away from the ditch line. Material inadvertently bladed to the roadway vegetation shall be removed at no cost to the Department.

8. Temporary traffic stripe shall be placed daily per Section 618.
9. Guardrails shall be removed and replaced at the following locations:

BR #	Guardrail Removal	Guardrail Installation	Terminal Section, Non-Flared	Cable Anchor, Type 1, Metal Post	Terminal Section, Flared	Bridge End Sections, Type I	Delineators	
							White	Yellow
57.1A	400	300			2	2	6	6
57.1B	400	300			2	2	6	6
I-55 underpass WB	660	550	2	2			7	7
I-55 underpass EB	660	550	2	2			7	7
Sta. 245+00 WB inside lane	425	375		1	1			21
Total	2545	2075	4	5	5	4	26	47

10. Rumble strips for rumble stripe shall be installed on the outside of edge of the roadway.

11. Traffic stripe shall be removed from bridge decks and concrete pavement. The Contractor shall remove the existing traffic stripe by an approved non-destructive method. Length of bridge and concrete section is 958 LF.

12. Permanent pavement markings (thermoplastic striping, reflective high performance raised markers) shall be placed as required. Double-drop thermoplastic striping shall be required on the bridge decks. Contractor shall protect the preformed joint material. Any damage caused by the thermoplastic shall be repaired at no cost to the State.

13. Radar detection shall be installed at the traffic signals at the intersections of Eureka Road, Bates Street, US 51, Keating Drive, Power Drive, I-55 West Ramp, I-55 East Ramp, and House Carlson Drive per the attached information.

TRAFFIC SIGNAL RADAR DETECTION CHART									
Intersection	Detection Location	Zone	Phase #	Detection Zone Size	STOPBAR Radar Unit	Advance Radar Unit	Radar Cable (ft)	Processor	Existing Pole Configuration
MS 6 at Eureka	WB Left Turn Lane		1	6'X50'	1		150		Mast Arm Poles
	EB Thru Lane		2	Existing					
	NB Left Turn Lane		3	6'X50'	1		230		
	NB Thru Lane		8	6'X50'					
	SB Thru Lane		4	Existing					
	SB Left Turn Lane		7	Existing					
	EB Left Turn Lane		5	6'X50'	1		150		
WB Thru Lane		6	Priority Zone		1	180			
MS 6 at Bates	WB Left Turn Lane		1	6'X50'	1		170		Mast Arm Poles
	EB Thru Lanes		2	Priority Zone		1	200		
	NB Left Turn Lane		3	Existing					
	NB Thru Lane		8	Existing					
	SB Thru Lane		4	Existing					
	SB Left Turn Lane		7	Existing					
	EB Left Turn Lane		5	Existing					
WB Thru Lanes		6	Existing						
US 51 at MS 6	WB Left Turn Lane		1	6'X50'	1		200	1	Mast Arm Poles
	EB Thru Lanes		2	Priority Zone		1	130		
	NB Left Turn Lane		3	6'X50'	1		300		
	NB Thru Lane		8	6'X50'					
	SB Thru Lane		4	6'X50'	1		90		
	SB Left Turn Lane		7	6'X50'					
	EB Left Turn Lane		5	6'X50'	1		190		
WB Thru Lanes		6	Priority Zone		1	220			

TRAFFIC SIGNAL RADAR DETECTION CHART								
Intersection	Detection Zone Location	Phase #	Detection Zone Size	STOPBAR Radar Unit	Advance Radar Unit	Radar Cable (ft)	Processor	Existing Pole Configuration
MS 6 at Keating	WB Left Turn Lane	1	6'X50'	1		165		Mast Arm Poles
	EB Thru Lanes	2	Priority Zone		1	195		
	NB Left Turn Lane	3	6'X50'	1		165		
	NB Thru Lane	8	6'X50'					
	SB Thru Lane	4A	Existing					
	SB Thru Lane	4B	Existing					
	SB Left Turn Lane	7	Existing					
	EB Left Turn Lane	5	6'X50'	1		60		
	WB Thru Lanes	6	Priority Zone		1	90		
MS 6 at Power/Lakewood	WB Left Turn Lane	1	6'X50'	1		70		Mast Arm Poles
	EB Thru Lanes	2	Existing					
	NB Left Turn Lane	3	Existing					
	NB Thru Lane	8	Existing	1		220		
	SB Thru Lane	4	6'X50'					
	SB Left Turn Lane	7	6'X50'					
	EB Left Turn Lane	5	6'X50'	1		220		
	WB Thru Lanes	6	Existing					
I-55 SB Ramp at MS 6	EB Thru Lanes	2	Priority Zone		1	230		Mast Arm Poles
	SB Lanes	4	Existing					
	WB Thru Lanes	6	Priority Zone		1	120		
I-55 NB Ramp at MS 6	EB Thru Lanes	2	Priority Zone		1	220	1	Mast Arm Poles
	NB Lanes	3	6'X50'	1		195		
	WB Thru Lanes	6	Priority Zone		1	105		
MS 6 at Forest/Stone	WB Left Turn Lane	1	6'X50'	1		355		Mast Arm Poles
	EB Thru Lanes	2	Priority Zone		1	385		
	NB Lanes	3	Existing					
	SB Lanes	4	6'X50'	1		145		
	EB Left Turn Lane	5	6'X50'	1		145		
	WB Thru Lanes	6	Priority Zone		1	175		
Total				18	12	5470	2	

Note 1: Includes the replacement of controllers, conflict monitors, and installation of SDLC Hubs where called for.

Note 2: Radar units shall be mounted per manufacturer recommendations. Contractor shall be responsible for setting up all new signal controllers and detection units as per manufacturer recommendations.

Note 3: Contractor may remove existing detection loop cable, if necessary.

Note 4: Cable quantities may be adjusted based on radar locations per manufacturer.

The Contractor shall provide all signs and traffic handling devices necessary to safely maintain traffic around or through the work areas.

The Engineer may direct the use of additional cones at County roads or intersections within lane closures and shall be included in pay item 907-618-A: Maintenance of Traffic.

PROJECT NUMBER: NHPP-0070-03(028) / 109439301

The work to be accomplished using the pay items and corresponding specifications set forth in this contract is for the milling and overlaying of US Highway 278 beginning at Terza Road and going easterly for approximately 7.2 miles to the Panola/Lafayette County Line in Panola County. The ramps at SR 315 and SR 315 will be milled and overlaid under this project.

Bidders are advised that cross-slopes for curve super elevations are to be constructed in accordance with information provided by the Department. To assist the Contractor in correctly placing the cross-slope transitions, the Department will provide at the preconstruction conference the stationing and percent slope information.

It shall be the responsibility of the Contractor to protect the roadway and all existing structures, such as bridges and curb, from damage occurring as a result of the Contractor's operations. Damages to existing features caused by the Contractor's operations shall be repaired or replaced at no cost to the Department.

At bridge ends and at the end of workday, a taper of one vertical inch (1") for each three horizontal feet (3') shall be provided.

The Contractor shall make a utility location request to 811 prior to any excavation, except for trench widening or pavement removal/repair.

In order to expedite the safe movement of traffic and to protect each phase of the work as it is performed, a firm sequence of operations is essential. The work shall be begun and continually prosecuted.

The work shall consist of the following:

1. Repair failed areas using the following:
 - 202-B, Removal of Asphalt Pavement, All Depths - for pavement structure
 - 202-B, Removal of Concrete Pavement w/Variable Depth Overlay
 - 203-G, Excess Excavation – for material below the pavement structure
 - 304-F, Crushed Stone Base
 - 403-A, 19-mm, ST Asphalt Pavement
 - 503-C, Saw Cut Full Depth

Station	Side		Length	Roadway		Trench (Asphalt)	
	Inside Lane	Outside Lane		Width	Area (SY)	Width	Area (SY)
Westbound Lanes							
660+00	X	X	10	22	24.44	6	6.67
650+00	X	X	10	22	24.44	6	6.67
645+50	X	X	10	22	24.44	6	6.67
637+00	X	X	10	22	24.44	6	6.67
619+00	X	X	10	22	24.44	6	6.67
602+00	X	X	10	22	24.44	6	6.67
599+00	X	X	10	22	24.44	6	6.67
589+50		X	10	11	12.22	3	3.33
589+00	X		10	11	12.22	3	3.33
588+00	X		10	11	12.22	3	3.33
572+00		X	10	11	12.22	3	3.33
567+50		X	10	11	12.22	3	3.33
540+00		X	10	11	12.22	3	3.33
490+00	X	X	10	22	24.44	6	6.67
485+00	X	X	10	22	24.44	6	6.67
479+00	X	X	10	22	24.44	6	6.67
470+00	X	X	10	22	24.44	6	6.67
464+00	X	X	10	22	24.44	6	6.67
455+50		X	10	11	12.22	3	3.33
455+00	X	X	10	22	24.44	6	6.67
454+50	X	X	10	22	24.44	6	6.67
445+50	X	X	10	22	24.44	6	6.67
442+00	X	X	10	22	24.44	6	6.67
441+50	X	X	10	22	24.44	6	6.67
436+50	X	X	10	22	24.44	6	6.67
433+50	X	X	10	22	24.44	6	6.67
425+50	X	X	10	22	24.44	6	6.67
419+00	X	X	10	22	24.44	6	6.67
417+00		X	10	11	12.22	3	3.33
413+00	X	X	10	22	24.44	6	6.67
411+00	X	X	10	22	24.44	6	6.67
406+50	X	X	10	22	24.44	6	6.67
402+50	X	X	10	22	24.44	6	6.67
393+00	X	X	10	22	24.44	6	6.67
391+00	X	X	10	22	24.44	6	6.67

387+00	X		10	11	12.22	3	3.33
386+50	X	X	10	22	24.44	6	6.67
378+00	X	X	10	22	24.44	6	6.67
373+00	X	X	10	22	24.44	6	6.67
365+50		X	10	11	12.22	3	3.33
356+00	X	X	10	22	24.44	6	6.67
Total (Westbound)					880.00		240.00

NOTE: Failed areas are estimated as one foot (1') of excavation and backfilled with one foot (1') (maximum 3½" lifts) of 19-mm, ST asphalt. The asphalt shall be placed per the Project Engineer's instructions.

NOTE: Failed areas shall be backfilled the same day as excavation.

2. Random clearing shall be performed within the specified clearing limits, including vegetation overhanging the edge of the clearing limits. Overhanging vegetation shall be trimmed to a minimum height of thirty feet (30') above the ground elevation at the edge of the clearing limits. It is the intent of this Contract for the vegetation, with the exception of any merchantable timber that the Contractor desires, shall be mulched onsite and left in place. Mulched material shall be spread such that no more than four inches (4") in depth of material is placed in any location. This work shall be paid under pay item 201-D002: Random Clearing, per acre. Clearing within two feet (2') of fences, utilities, and other obstructions as directed by the Engineer with the ROW shall be omitted in order to avoid damages. Random clearing will be required as shown in the table and may be required at other sites as directed by the Engineer.

Random Clearing					
	Starting Station	Ending Station	Length (ft)	Surveyed Acreage	Location
Area J	462+00	465+00	300	0.1815	Lt. of Lt. (WB outside)
Area K	479+00	481+20	220	0.1308	Lt. of Lt. (WB outside)
Area L	553+00	590+25	3725	1.7756	Lt. of Lt. (WB outside)
Area M	608+00	636+00	2800	1.2083	Lt. of Lt. (WB outside)
Area N	724+20	728+58	438	0.261	Lt. of Lt. (WB outside)
				3.5572	Acres Total

NOTE: Due care should be taken to prevent damage in areas within the ROW that are outside the clearing limits as shown in the table. Any disturbed areas not shown above will not be measured for separate payment and shall be reestablished at no additional cost to the Department.

NOTE: An herbicide shall be used for sprout control of cut stumps. Paint or spray freshly cut stump surface thoroughly covering cambium area next to bark until the herbicide runs down around the root collar. Treat stump as soon as practical after cutting for more effective

control but no later than day of cutting except when spraying must be postponed due to inclement weather. Pine stumps and all other stumps larger than 15 inches in diameter do not require spraying for control of sprouting. Permissible herbicides are 2,4-D (amine); picloram +2,4-D; ammonium sulfamate; and dicamba. Specific requirements such as mixing, diluting, rate, application, use restrictions, safety precautions, etc. will be in accordance with the manufacturer’s printed container label.

NOTE: Re-spraying will be required when the herbicide is washed off by rain within eight hours of application or diluted to such an extent that it is rendered ineffective.

NOTE: Grinding of all stumps will be required to be flush with the ground.

- 3. The existing asphalt pavement shall be fine milling of to a depth of 1½”. Milling operations shall be on the mainline, local roads, crossovers, and driveway pads. Fifty (50%) percent or a maximum of 10,000 tons of the milling material obtained shall become the property of the Department. The Contractor will deliver the milling material to the Lafayette County Maintenance Lot located at 495 Highway 7 South, Oxford. The Contractor shall provide all necessary equipment and qualified personnel to push material into a suitable stockpile.

Area	Fine Milling of Bituminous Pavement (SY)
Mainline	236,200
SR 315 Ramps	11,200
SR 315	4,200
Crossovers	18,700
Local Roads	11,400
Pads	6,150
Total	287,850

NOTE: Milling of local roads will be to right-of-way limits.

NOTE: Payment for fine milling of pavement will be made under pay item 406-D, per square yard, and shall include all cost associated with the milling operation.

NOTE: During this operation and prior to placement of the asphalt, due care shall be required to keep surface water of ponding on the roadway surface; continuous monitoring of the project may be required.

NOTE: During this operation and prior to placement of the asphalt surface course, the Contractor shall maintain potholes.

NOTE: Milled surfaces are to be covered within seven (7) calendar days of removal. The Contractor will be charged a fee of \$5,000.00 for each full or partial day in which the milled surface is left uncovered after the seven (7) calendar days.

4. A quantity of 3,425 tons of 9.5-mm, HT, Leveling asphalt on the previously milled mainline has been set up for curve correction. The high side of the curves are the only lane to be slope corrected. The low sides will only receive three quarters of an inch (¾”) scratch leveling to match the centerline joint. A maximum lift of three inches (3”) shall be maintained for curve leveling. Granular material shall be placed on the shoulder prior to leveling of curves to maintain the legal drop-off requirements.

9.5-mm, HT, Leveling Asphalt		
Curve Correction		
# Curves	Length (feet)	Tons
6	15,200	3425

5. The Contractor shall place the surface course on the previously milled surface.

Location	Station		Type Mix	Area	Thickness	Asphalt
	Begin	End		SY	Inches	Tons
Mainline	349+00	728+57	9.5-mm, HT Poly	236,200	1½	19,550
Local Roads			9.5-mm, HT	11,400	2	1,275
SR 315 Mainline	900+00	913+50	9.5-mm, ST	4,200	1½	350
SR 315 Ramps			9.5-mm, ST	11,200	1½	950
Crossovers			9.5-mm, ST	18,700	2	2,075
Pads			9.5-mm, ST	6,150	2	700

Mix Type	Tons
9.5-mm, ST	4075
9.5-mm, HT	1,275
9.5-mm, HT Poly	19,550

NOTE: Contractor shall saw and seal the transverse joint on the mainline surface course on the Westbound Lanes.

6. Granular material shall be placed on the shoulders as directed to raise the existing shoulders to the new surface course grade.

NOTE: Shoulders shall be bladed, shaped and compacted throughout the length of the project regardless of whether granular material is required.

NOTE: Granular material not required for the final shape of the shoulders may require removal under the pay item for excess excavation and may include small amounts of asphalt.

NOTE: Due care shall be taken during this operation to blade material to the roadway and away from the ditch line. Material inadvertently bladed to the roadway vegetation shall be removed at no cost to the Department.

- 7. Temporary traffic stripe shall be placed daily as per Section 618.
- 8. Guard rail at Bridges # 60.4A and 60.4B (SR 315) shall be removed and replaced.

BR #	Guardrail Removal	Guardrail Installation	Terminal Section, Flared	Bridge End Sections, Type I	Delineators	
					White	Yellow
60.4A	400	300	2	2	6	6
60.4B	400	300	2	2	6	6
	800	600	4	4	12	12

- 9. Rumble strips for rumble stripe shall be installed on the outside of edge of the roadway.
- 10. Permanent pavement markings (thermoplastic striping, two-way clear reflective high-performance marker, red-clear reflective high-performance markers, and two-way yellow reflective high performance raised markers) shall be placed as required. A 6-inch thermoplastic stripe shall be placed on the inside six inches (6”) of the rumble strip using an atomization method to create a “rumble strip.” There is 468 feet of concrete bridge deck.

The Contractor shall provide all signs and traffic handling devices necessary to safely maintain traffic around or through the work areas.

Incidental work such as removing vegetation, shaping and compaction of shoulder, necessary and incidental grading of roadway ditches and other incidental work that is necessary to complete the work will not be measured for separate payment and the cost will be included in the bid items provided.

The Engineer may direct the use of additional cones at County Roads or Intersections within lane closures and will be absorbed in pay item 907-618-A: Maintenance of Traffic.

STATE	PROJECT NO.
MISS.	

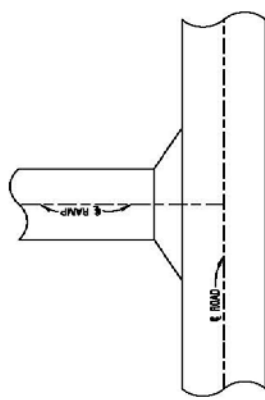

PLAN VIEW OF RAMP

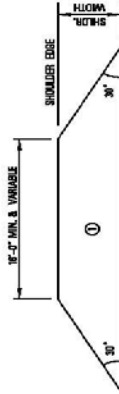

DETAIL OF PAVED APRON

① 1'-1/2" & VARIABLE DEPTH ASPHALT PAVEMENT REQUIRED



MISSISSIPPI DEPARTMENT OF TRANSPORTATION	
MISCELLANEOUS DETAIL	
SECTION	
PROJECT	
DATE	
FILE NAME	MOBILE
DESIGNER	DATE
SCALE	DATE
PROJECT NUMBER	
SHEET NUMBER	

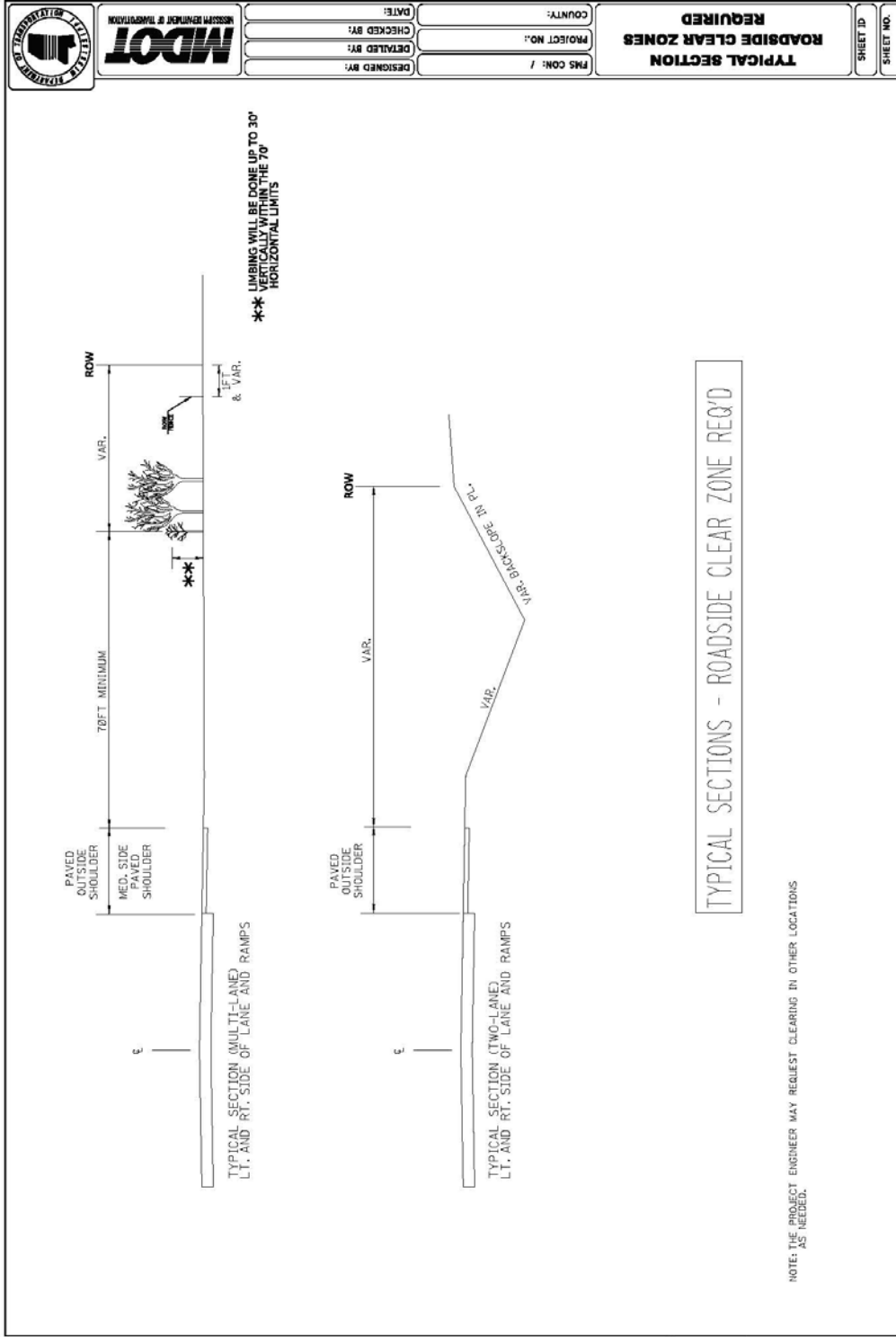



MISSISSIPPI DEPARTMENT OF TRANSPORTATION
MDOT

DESIGNED BY:	
DETAILED BY:	
CHECKED BY:	
DATE:	

FMS CON: /	
PROJECT NO.:	
COUNTY:	

TYPICAL SECTION
ROADSIDE CLEAR ZONES
 REQUIRED
 REQUIRED

SHEET NO.	
SHEET ID	

-20-

Notice To Bidders No. 6622 Cont'd.

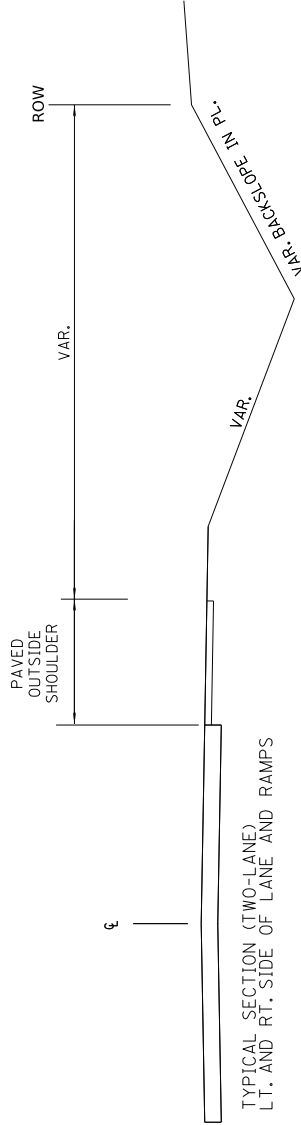
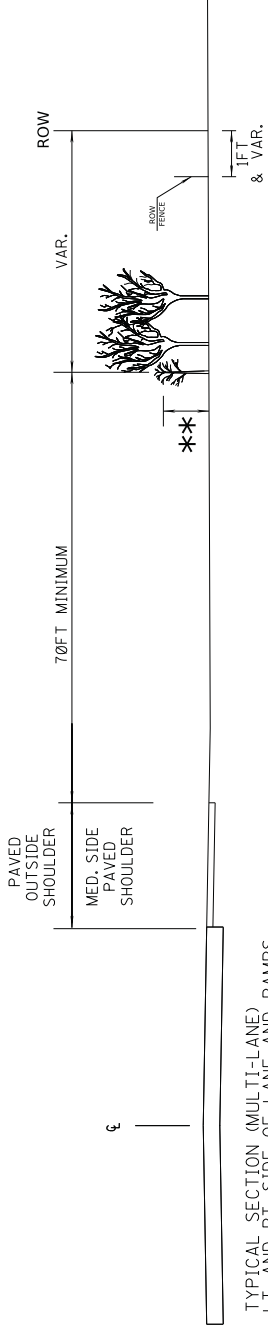

TYPICAL SECTIONS - ROADSIDE CLEAR ZONE REQ'D

NOTE: THE PROJECT ENGINEER MAY REQUEST CLEARING IN OTHER LOCATIONS AS NEEDED.

MISSISSIPPI DEPARTMENT OF TRANSPORTATION

SECTION 904 - NOTICE TO BIDDERS NO. 6623

DATE: 01/07/2025

SUBJECT: Specialty Items

PROJECT: NHPP-0070-03(026)/108710301 & NHPP-0070-03(028)/109439301 - PANOLA

Pursuant to the provisions of Section 108, the following work items are hereby designated as "Specialty Items" for this contract. Bidders are reminded that these items must be subcontracted in order to be considered as specialty items.

CATEGORY: GUARDRAIL, GUIDERAIL

Line No	Pay Item	Description
0230	606-B002	Guard Rail, Class A, Type 1, 'W' Beam
0240	606-C001	Guard Rail, Cable Anchor Type 1, Metal Post
0250	606-D022	Guard Rail, Bridge End Section, Type I
0260	606-E005	Guard Rail, Terminal End Section, Flared
0270	606-E007	Guard Rail, Terminal End Section, Non-Flared

CATEGORY: MISCELLANEOUS/ SPECIALTY WORK ITEMS

Line No	Pay Item	Description
0180	423-A001	Rumble Strips, Ground In

CATEGORY: PAVEMENT STRIPING AND MARKING

Line No	Pay Item	Description
0420	907-626-A007	6" Thermoplastic Double Drop Traffic Stripe, Skip White
0430	907-626-C012	6" Thermoplastic Double Drop Edge Stripe, Continuous White
0440	907-626-D003	6" Thermoplastic Double Drop Traffic Stripe, Skip Yellow
0450	907-626-E003	6" Thermoplastic Double Drop Traffic Stripe, Continuous Yellow
0460	907-626-G006	Thermoplastic Double Drop Detail Stripe, White
0470	907-626-G007	Thermoplastic Double Drop Detail Stripe, Yellow
0480	907-626-H006	Thermoplastic Double Drop Legend, White
0490	907-626-H007	Thermoplastic Double Drop Legend, White
0500	907-627-J001	Two-Way Clear Reflective High Performance Raised Markers
0510	907-627-K001	Red-Clear Reflective High Performance Raised Markers
0520	907-627-L001	Two-Way Yellow Reflective High Performance Raised Markers

CATEGORY: TRAFFIC CONTROL - PERMANENT

Line No	Pay Item	Description
0360	630-F002	Delineators, Flexible Post Mounted, Crossover, Type I, Yellow
0370	630-F006	Delineators, Guard Rail, White
0380	630-F007	Delineators, Guard Rail, Yellow
0540	907-641-A002	Signal Stop Bar Radar Vehicle Detection Sensor, Type 2
0550	907-641-B002	Signal Advanced Radar Vehicle Detection Sensor, Type 2
0560	907-641-D001	Radar Vehicle Detection Cable
0570	907-641-F002	Signal Radar Vehicle Detection Processor, Type 2

CATEGORY: TRAFFIC CONTROL - TEMPORARY

Line No	Pay Item	Description
---------	----------	-------------

0290	619-A1001	Temporary Traffic Stripe, Continuous White
0300	619-A2001	Temporary Traffic Stripe, Continuous Yellow
0310	619-A3001	Temporary Traffic Stripe, Skip White
0320	619-A4002	Temporary Traffic Stripe, Skip Yellow
0330	619-A5001	Temporary Traffic Stripe, Detail
0340	619-A6002	Temporary Traffic Stripe, Legend

"General Decision Number: MS20250108 01/03/2025

Superseded General Decision Number: MS20240108

State: Mississippi

Construction Type: Highway

County: Panola County in Mississippi.

HIGHWAY CONSTRUCTION PROJECTS

Note: Contracts subject to the Davis-Bacon Act are generally required to pay at least the applicable minimum wage rate required under Executive Order 14026 or Executive Order 13658. Please note that these Executive Orders apply to covered contracts entered into by the federal government that are subject to the Davis-Bacon Act itself, but do not apply to contracts subject only to the Davis-Bacon Related Acts, including those set forth at 29 CFR 5.1(a)(1).

<p>If the contract is entered into on or after January 30, 2022, or the contract is renewed or extended (e.g., an option is exercised) on or after January 30, 2022:</p>	<ul style="list-style-type: none"> . Executive Order 14026 generally applies to the contract. . The contractor must pay all covered workers at least \$17.75 per hour (or the applicable wage rate listed on this wage determination, if it is higher) for all hours spent performing on the contract in 2025.
<p>If the contract was awarded on or between January 1, 2015 and January 29, 2022, and the contract is not renewed or extended on or after January 30, 2022:</p>	<ul style="list-style-type: none"> . Executive Order 13658 generally applies to the contract. . The contractor must pay all covered workers at least \$13.30 per hour (or the applicable wage rate listed on this wage determination, if it is higher) for all hours spent performing on that contract in 2025.

The applicable Executive Order minimum wage rate will be adjusted annually. If this contract is covered by one of the Executive Orders and a classification considered necessary for performance of work on the contract does not appear on this wage determination, the contractor must still submit a conformance request.

Additional information on contractor requirements and worker protections under the Executive Orders is available at <http://www.dol.gov/whd/govcontracts>.

Modification Number Publication Date
 0 01/03/2025

SUMS2010-031 08/04/2014

	Rates	Fringes
CARPENTER (Form Work Only).....	\$ 13.99 **	0.00
CARPENTER, Excludes Form Work....	\$ 14.03 **	0.00
CEMENT MASON/CONCRETE FINISHER...	\$ 14.09 **	0.00
ELECTRICIAN.....	\$ 21.80	7.93
HIGHWAY/PARKING LOT STRIPING: Truck Driver (Line Striping Truck).....	\$ 15.60 **	0.00
INSTALLER - GUARDRAIL.....	\$ 11.42 **	0.00
INSTALLER - SIGN.....	\$ 11.73 **	0.00
IRONWORKER, REINFORCING.....	\$ 16.29 **	0.00
LABORER: Common or General, Including Asphalt Raking, Shoveling, Spreading.....	\$ 11.36 **	0.00
LABORER: Concrete Worker.....	\$ 10.91 **	0.00
LABORER: Flagger.....	\$ 11.48 **	0.00
LABORER: Grade Checker.....	\$ 11.32 **	0.00
LABORER: Landscape.....	\$ 9.77 **	0.00
LABORER: Mason Tender - Cement/Concrete.....	\$ 11.08 **	0.00
LABORER: Pipelayer.....	\$ 11.34 **	0.00
LABORER: Laborer-Cones/ Barricades/Barrels - Setter/Mover/Sweeper.....	\$ 12.93 **	0.00
OPERATOR: Asphalt Spreader.....	\$ 16.03 **	0.00
OPERATOR: Backhoe/Excavator/Trackhoe.....	\$ 13.77 **	0.00
OPERATOR: Broom/Sweeper.....	\$ 10.77 **	0.00
OPERATOR: Bulldozer.....	\$ 13.67 **	0.00
OPERATOR: Concrete Saw.....	\$ 12.95 **	0.00
OPERATOR: Crane.....	\$ 21.25	0.00
OPERATOR: Distributor.....	\$ 12.38 **	0.00
OPERATOR: Drill.....	\$ 19.22	0.00
OPERATOR: Grader/Blade.....	\$ 14.44 **	0.00
OPERATOR: Grinding/Grooving Machine.....	\$ 15.94 **	0.00
OPERATOR: Loader.....	\$ 12.21 **	144 0.00

OPERATOR: Mechanic.....	\$ 15.32 **	0.00
OPERATOR: Milling Machine.....	\$ 18.16	0.00
OPERATOR: Oiler.....	\$ 12.33 **	0.48
OPERATOR: Paver (Asphalt, Aggregate, and Concrete).....	\$ 12.69 **	0.00
OPERATOR: Piledriver.....	\$ 15.13 **	0.00
OPERATOR: Roller (All Types)....	\$ 11.51 **	0.00
OPERATOR: Scraper.....	\$ 12.96 **	0.00
OPERATOR: Tractor.....	\$ 11.46 **	0.00
OPERATOR: Trencher.....	\$ 15.00 **	0.00
TRUCK DRIVER: Flatbed Truck.....	\$ 12.64 **	0.00
TRUCK DRIVER: Lowboy Truck.....	\$ 13.80 **	0.00
TRUCK DRIVER: Mechanic.....	\$ 14.08 **	0.00
TRUCK DRIVER: Off the Road Truck.....	\$ 12.29 **	0.00
TRUCK DRIVER: Water Truck.....	\$ 10.89 **	0.00
TRUCK DRIVER: Dump Truck (All Types).....	\$ 11.71 **	0.00
TRUCK DRIVER: Semi/Trailer Truck.....	\$ 15.29 **	0.00

WELDERS - Receive rate prescribed for craft performing operation to which welding is incidental.

=====
 ** Workers in this classification may be entitled to a higher minimum wage under Executive Order 14026 (\$17.75) or 13658 (\$13.30). Please see the Note at the top of the wage determination for more information. Please also note that the minimum wage requirements of Executive Order 14026 are not currently being enforced as to any contract or subcontract to which the states of Texas, Louisiana, or Mississippi, including their agencies, are a party.

Note: Executive Order (EO) 13706, Establishing Paid Sick Leave for Federal Contractors applies to all contracts subject to the Davis-Bacon Act for which the contract is awarded (and any solicitation was issued) on or after January 1, 2017. If this contract is covered by the EO, the contractor must provide employees with 1 hour of paid sick leave for every 30 hours they work, up to 56 hours of paid sick leave each year. Employees must be permitted to use paid sick leave for their own illness, injury or other health-related needs, including preventive care; to assist a family member (or person who is like family to the employee) who is ill, injured, or has other health-related needs, including preventive care; or for reasons resulting from, or to assist a family member (or person who is

like family to the employee) who is a victim of, domestic violence, sexual assault, or stalking. Additional information on contractor requirements and worker protections under the EO is available at <https://www.dol.gov/agencies/whd/government-contracts>.

Unlisted classifications needed for work not included within the scope of the classifications listed may be added after award only as provided in the labor standards contract clauses (29CFR 5.5 (a) (1) (iii)).

The body of each wage determination lists the classifications and wage rates that have been found to be prevailing for the type(s) of construction and geographic area covered by the wage determination. The classifications are listed in alphabetical order under rate identifiers indicating whether the particular rate is a union rate (current union negotiated rate), a survey rate, a weighted union average rate, a state adopted rate, or a supplemental classification rate.

Union Rate Identifiers

A four-letter identifier beginning with characters other than ""SU"", ""UAVG"", ?SA?, or ?SC? denotes that a union rate was prevailing for that classification in the survey. Example: PLUM0198-005 07/01/2024. PLUM is an identifier of the union whose collectively bargained rate prevailed in the survey for this classification, which in this example would be Plumbers. 0198 indicates the local union number or district council number where applicable, i.e., Plumbers Local 0198. The next number, 005 in the example, is an internal number used in processing the wage determination. The date, 07/01/2024 in the example, is the effective date of the most current negotiated rate.

Union prevailing wage rates are updated to reflect all changes over time that are reported to WHD in the rates in the collective bargaining agreement (CBA) governing the classification.

Union Average Rate Identifiers

The UAVG identifier indicates that no single rate prevailed for those classifications, but that 100% of the data reported for the classifications reflected union rates. EXAMPLE: UAVG-OH-0010 01/01/2024. UAVG indicates that the rate is a weighted union average rate. OH indicates the State of Ohio. The next number, 0010 in the example, is an internal number used in producing the wage determination. The date, 01/01/2024 in the example, indicates the date the wage determination was updated to reflect the most current union average rate.

A UAVG rate will be updated once a year, usually in January, to reflect a weighted average of the current rates in the collective bargaining agreements on which the rate is based.

Survey Rate Identifiers

The ""SU"" identifier indicates that either a single non-union rate prevailed (as defined in 29 CFR 1.2) for this classification in the survey or that the rate was derived by computing a weighted average rate based on all the rates

reported in the survey for that classification. As a weighted average rate includes all rates reported in the survey, it may include both union and non-union rates. Example: SUFL2022-007 6/27/2024. SU indicates the rate is a single non-union prevailing rate or a weighted average of survey data for that classification. FL indicates the State of Florida. 2022 is the year of the survey on which these classifications and rates are based. The next number, 007 in the example, is an internal number used in producing the wage determination. The date, 6/27/2024 in the example, indicates the survey completion date for the classifications and rates under that identifier.

?SU? wage rates typically remain in effect until a new survey is conducted. However, the Wage and Hour Division (WHD) has the discretion to update such rates under 29 CFR 1.6(c)(1).

State Adopted Rate Identifiers

The ""SA"" identifier indicates that the classifications and prevailing wage rates set by a state (or local) government were adopted under 29 C.F.R 1.3(g)-(h). Example: SAME2023-007 01/03/2024. SA reflects that the rates are state adopted. ME refers to the State of Maine. 2023 is the year during which the state completed the survey on which the listed classifications and rates are based. The next number, 007 in the example, is an internal number used in producing the wage determination. The date, 01/03/2024 in the example, reflects the date on which the classifications and rates under the ?SA? identifier took effect under state law in the state from which the rates were adopted.

WAGE DETERMINATION APPEALS PROCESS

1) Has there been an initial decision in the matter? This can be:

- a) a survey underlying a wage determination
- b) an existing published wage determination
- c) an initial WHD letter setting forth a position on a wage determination matter
- d) an initial conformance (additional classification and rate) determination

On survey related matters, initial contact, including requests for summaries of surveys, should be directed to the WHD Branch of Wage Surveys. Requests can be submitted via email to davisbaconinfo@dol.gov or by mail to:

Branch of Wage Surveys
Wage and Hour Division
U.S. Department of Labor
200 Constitution Avenue, N.W.
Washington, DC 20210

Regarding any other wage determination matter such as conformance decisions, requests for initial decisions should be directed to the WHD Branch of Construction Wage Determinations. Requests can be submitted via email to BCWD-Office@dol.gov or by mail to:

Branch of Construction Wage Determinations
Wage and Hour Division
U.S. Department of Labor

200 Constitution Avenue, N.W.
Washington, DC 20210

2) If an initial decision has been issued, then any interested party (those affected by the action) that disagrees with the decision can request review and reconsideration from the Wage and Hour Administrator (See 29 CFR Part 1.8 and 29 CFR Part 7). Requests for review and reconsideration can be submitted via email to dba.reconsideration@dol.gov or by mail to:

Wage and Hour Administrator
U.S. Department of Labor
200 Constitution Avenue, N.W.
Washington, DC 20210

The request should be accompanied by a full statement of the interested party's position and any information (wage payment data, project description, area practice material, etc.) that the requestor considers relevant to the issue.

3) If the decision of the Administrator is not favorable, an interested party may appeal directly to the Administrative Review Board (formerly the Wage Appeals Board). Write to:

Administrative Review Board
U.S. Department of Labor
200 Constitution Avenue, N.W.
Washington, DC 20210.

=====

END OF GENERAL DECISION"

SUPPLEMENT TO FORM FHWA-1273

DATE: 07/26/2022

SUBJECT: Federal Contract Provisions for Subcontracts

Federal Contract Provisions for Subcontracts

All subcontracts shall be in writing and contain all pertinent provisions and requirements of the prime contract.

Each “Request for Permission to Subcontract” (Mississippi Department of Transportation Form CAD-720) shall include a copy of the subcontract. The federal contract provisions (FHWA-1273, SUPPLEMENT TO FORM FHWA-1273, NOTICE OF REQUIREMENT FOR AFFIRMATIVE ACTION TO ENSURE EQUAL EMPLOYMENT OPPORTUNITY (EXECUTIVE ORDER 11246), DAVIS-BACON AND RELATED ACT PROVISIONS (WAGE RATES)) must be physically incorporated as part of the subcontract. A completed Mississippi Department of Transportation Form CAD-521 and Form CAD-725 must be attached to the CAD-720.

**REQUIRED CONTRACT PROVISIONS
FEDERAL-AID CONSTRUCTION CONTRACTS**

- I. General
- II. Nondiscrimination
- III. Non-segregated Facilities
- IV. Davis-Bacon and Related Act Provisions
- V. Contract Work Hours and Safety Standards Act Provisions
- VI. Subletting or Assigning the Contract
- VII. Safety: Accident Prevention
- VIII. False Statements Concerning Highway Projects
- IX. Implementation of Clean Air Act and Federal Water Pollution Control Act
- X. Certification Regarding Debarment, Suspension, Ineligibility and Voluntary Exclusion
- XI. Certification Regarding Use of Contract Funds for Lobbying
- XII. Use of United States-Flag Vessels:

ATTACHMENTS

A. Employment and Materials Preference for Appalachian Development Highway System or Appalachian Local Access Road Contracts (included in Appalachian contracts only)

I. GENERAL

1. Form FHWA-1273 must be physically incorporated in each construction contract funded under title 23, United States Code, as required in 23 CFR 633.102(b) (excluding emergency contracts solely intended for debris removal). The contractor (or subcontractor) must insert this form in each subcontract and further require its inclusion in all lower tier subcontracts (excluding purchase orders, rental agreements and other agreements for supplies or services). 23 CFR 633.102(e).

The applicable requirements of Form FHWA-1273 are incorporated by reference for work done under any purchase order, rental agreement or agreement for other services. The prime contractor shall be responsible for compliance by any subcontractor, lower-tier subcontractor or service provider. 23 CFR 633.102(e).

Form FHWA-1273 must be included in all Federal-aid design-build contracts, in all subcontracts and in lower tier subcontracts (excluding subcontracts for design services, purchase orders, rental agreements and other agreements for supplies or services) in accordance with 23 CFR 633.102. The design-builder shall be responsible for compliance by any subcontractor, lower-tier subcontractor or service provider.

Contracting agencies may reference Form FHWA-1273 in solicitation-for-bids or request-for-proposals documents, however, the Form FHWA-1273 must be physically incorporated (not referenced) in all contracts, subcontracts and lower-tier subcontracts (excluding purchase orders, rental agreements and other agreements for supplies or services related to a construction contract). 23 CFR 633.102(b).

2. Subject to the applicability criteria noted in the following sections, these contract provisions shall apply to all work

performed on the contract by the contractor's own organization and with the assistance of workers under the contractor's immediate superintendence and to all work performed on the contract by piecework, station work, or by subcontract. 23 CFR 633.102(d).

3. A breach of any of the stipulations contained in these Required Contract Provisions may be sufficient grounds for withholding of progress payments, withholding of final payment, termination of the contract, suspension / debarment or any other action determined to be appropriate by the contracting agency and FHWA.

4. Selection of Labor: During the performance of this contract, the contractor shall not use convict labor for any purpose within the limits of a construction project on a Federal-aid highway unless it is labor performed by convicts who are on parole, supervised release, or probation. 23 U.S.C. 114(b). The term Federal-aid highway does not include roadways functionally classified as local roads or rural minor collectors. 23 U.S.C. 101(a).

II. NONDISCRIMINATION (23 CFR 230.107(a); 23 CFR Part 230, Subpart A, Appendix A; EO 11246)

The provisions of this section related to 23 CFR Part 230, Subpart A, Appendix A are applicable to all Federal-aid construction contracts and to all related construction subcontracts of \$10,000 or more. The provisions of 23 CFR Part 230 are not applicable to material supply, engineering, or architectural service contracts.

In addition, the contractor and all subcontractors must comply with the following policies: Executive Order 11246, 41 CFR Part 60, 29 CFR Parts 1625-1627, 23 U.S.C. 140, Section 504 of the Rehabilitation Act of 1973, as amended (29 U.S.C. 794), Title VI of the Civil Rights Act of 1964, as amended (42 U.S.C. 2000d et seq.), and related regulations including 49 CFR Parts 21, 26, and 27; and 23 CFR Parts 200, 230, and 633.

The contractor and all subcontractors must comply with: the requirements of the Equal Opportunity Clause in 41 CFR 60-1.4(b) and, for all construction contracts exceeding \$10,000, the Standard Federal Equal Employment Opportunity Construction Contract Specifications in 41 CFR 60-4.3.

Note: The U.S. Department of Labor has exclusive authority to determine compliance with Executive Order 11246 and the policies of the Secretary of Labor including 41 CFR Part 60, and 29 CFR Parts 1625-1627. The contracting agency and the FHWA have the authority and the responsibility to ensure compliance with 23 U.S.C. 140, Section 504 of the Rehabilitation Act of 1973, as amended (29 U.S.C. 794), and Title VI of the Civil Rights Act of 1964, as amended (42 U.S.C. 2000d et seq.), and related regulations including 49 CFR Parts 21, 26, and 27; and 23 CFR Parts 200, 230, and 633.

The following provision is adopted from 23 CFR Part 230, Subpart A, Appendix A, with appropriate revisions to conform to the U.S. Department of Labor (US DOL) and FHWA requirements.

1. Equal Employment Opportunity: Equal Employment Opportunity (EEO) requirements not to discriminate and to take affirmative action to assure equal opportunity as set forth under laws, executive orders, rules, regulations (see 28 CFR Part 35, 29 CFR Part 1630, 29 CFR Parts 1625-1627, 41 CFR Part 60 and 49 CFR Part 27) and orders of the Secretary of Labor as modified by the provisions prescribed herein, and imposed pursuant to 23 U.S.C. 140, shall constitute the EEO and specific affirmative action standards for the contractor's project activities under this contract. The provisions of the Americans with Disabilities Act of 1990 (42 U.S.C. 12101 et seq.) set forth under 28 CFR Part 35 and 29 CFR Part 1630 are incorporated by reference in this contract. In the execution of this contract, the contractor agrees to comply with the following minimum specific requirement activities of EEO:

a. The contractor will work with the contracting agency and the Federal Government to ensure that it has made every good faith effort to provide equal opportunity with respect to all of its terms and conditions of employment and in their review of activities under the contract. 23 CFR 230.409 (g)(4) & (5).

b. The contractor will accept as its operating policy the following statement:

"It is the policy of this Company to assure that applicants are employed, and that employees are treated during employment, without regard to their race, religion, sex, sexual orientation, gender identity, color, national origin, age or disability. Such action shall include: employment, upgrading, demotion, or transfer; recruitment or recruitment advertising; layoff or termination; rates of pay or other forms of compensation; and selection for training, including apprenticeship, pre-apprenticeship, and/or on-the-job training."

2. EEO Officer: The contractor will designate and make known to the contracting officers an EEO Officer who will have the responsibility for and must be capable of effectively administering and promoting an active EEO program and who must be assigned adequate authority and responsibility to do so.

3. Dissemination of Policy: All members of the contractor's staff who are authorized to hire, supervise, promote, and discharge employees, or who recommend such action or are substantially involved in such action, will be made fully cognizant of and will implement the contractor's EEO policy and contractual responsibilities to provide EEO in each grade and classification of employment. To ensure that the above agreement will be met, the following actions will be taken as a minimum:

a. Periodic meetings of supervisory and personnel office employees will be conducted before the start of work and then not less often than once every six months, at which time the contractor's EEO policy and its implementation will be reviewed and explained. The meetings will be conducted by the EEO Officer or other knowledgeable company official.

b. All new supervisory or personnel office employees will be given a thorough indoctrination by the EEO Officer, covering all major aspects of the contractor's EEO obligations within thirty days following their reporting for duty with the contractor.

c. All personnel who are engaged in direct recruitment for the project will be instructed by the EEO Officer in the contractor's procedures for locating and hiring minorities and women.

d. Notices and posters setting forth the contractor's EEO policy will be placed in areas readily accessible to employees, applicants for employment and potential employees.

e. The contractor's EEO policy and the procedures to implement such policy will be brought to the attention of employees by means of meetings, employee handbooks, or other appropriate means.

4. Recruitment: When advertising for employees, the contractor will include in all advertisements for employees the notation: "An Equal Opportunity Employer." All such advertisements will be placed in publications having a large circulation among minorities and women in the area from which the project work force would normally be derived.

a. The contractor will, unless precluded by a valid bargaining agreement, conduct systematic and direct recruitment through public and private employee referral sources likely to yield qualified minorities and women. To meet this requirement, the contractor will identify sources of potential minority group employees and establish with such identified sources procedures whereby minority and women applicants may be referred to the contractor for employment consideration.

b. In the event the contractor has a valid bargaining agreement providing for exclusive hiring hall referrals, the contractor is expected to observe the provisions of that agreement to the extent that the system meets the contractor's compliance with EEO contract provisions. Where implementation of such an agreement has the effect of discriminating against minorities or women, or obligates the contractor to do the same, such implementation violates Federal nondiscrimination provisions.

c. The contractor will encourage its present employees to refer minorities and women as applicants for employment. Information and procedures with regard to referring such applicants will be discussed with employees.

5. Personnel Actions: Wages, working conditions, and employee benefits shall be established and administered, and personnel actions of every type, including hiring, upgrading, promotion, transfer, demotion, layoff, and termination, shall be taken without regard to race, color, religion, sex, sexual orientation, gender identity, national origin, age or disability. The following procedures shall be followed:

a. The contractor will conduct periodic inspections of project sites to ensure that working conditions and employee facilities do not indicate discriminatory treatment of project site personnel.

b. The contractor will periodically evaluate the spread of wages paid within each classification to determine any evidence of discriminatory wage practices.

c. The contractor will periodically review selected personnel actions in depth to determine whether there is evidence of discrimination. Where evidence is found, the contractor will promptly take corrective action. If the review indicates that the discrimination may extend beyond the actions reviewed, such corrective action shall include all affected persons.

d. The contractor will promptly investigate all complaints of alleged discrimination made to the contractor in connection with its obligations under this contract, will attempt to resolve such complaints, and will take appropriate corrective action

within a reasonable time. If the investigation indicates that the discrimination may affect persons other than the complainant, such corrective action shall include such other persons. Upon completion of each investigation, the contractor will inform every complainant of all of their avenues of appeal.

6. Training and Promotion:

a. The contractor will assist in locating, qualifying, and increasing the skills of minorities and women who are applicants for employment or current employees. Such efforts should be aimed at developing full journey level status employees in the type of trade or job classification involved.

b. Consistent with the contractor's work force requirements and as permissible under Federal and State regulations, the contractor shall make full use of training programs (i.e., apprenticeship and on-the-job training programs for the geographical area of contract performance). In the event a special provision for training is provided under this contract, this subparagraph will be superseded as indicated in the special provision. The contracting agency may reserve training positions for persons who receive welfare assistance in accordance with 23 U.S.C. 140(a).

c. The contractor will advise employees and applicants for employment of available training programs and entrance requirements for each.

d. The contractor will periodically review the training and promotion potential of employees who are minorities and women and will encourage eligible employees to apply for such training and promotion.

7. Unions: If the contractor relies in whole or in part upon unions as a source of employees, the contractor will use good faith efforts to obtain the cooperation of such unions to increase opportunities for minorities and women. 23 CFR 230.409. Actions by the contractor, either directly or through a contractor's association acting as agent, will include the procedures set forth below:

a. The contractor will use good faith efforts to develop, in cooperation with the unions, joint training programs aimed toward qualifying more minorities and women for membership in the unions and increasing the skills of minorities and women so that they may qualify for higher paying employment.

b. The contractor will use good faith efforts to incorporate an EEO clause into each union agreement to the end that such union will be contractually bound to refer applicants without regard to their race, color, religion, sex, sexual orientation, gender identity, national origin, age, or disability.

c. The contractor is to obtain information as to the referral practices and policies of the labor union except that to the extent such information is within the exclusive possession of the labor union and such labor union refuses to furnish such information to the contractor, the contractor shall so certify to the contracting agency and shall set forth what efforts have been made to obtain such information.

d. In the event the union is unable to provide the contractor with a reasonable flow of referrals within the time limit set forth in the collective bargaining agreement, the contractor will, through independent recruitment efforts, fill the employment vacancies without regard to race, color, religion, sex, sexual orientation, gender identity, national origin, age, or disability; making full efforts to obtain qualified and/or qualifiable minorities and women. The failure of a union to provide

sufficient referrals (even though it is obligated to provide exclusive referrals under the terms of a collective bargaining agreement) does not relieve the contractor from the requirements of this paragraph. In the event the union referral practice prevents the contractor from meeting the obligations pursuant to Executive Order 11246, as amended, and these special provisions, such contractor shall immediately notify the contracting agency.

8. Reasonable Accommodation for Applicants / Employees with Disabilities: The contractor must be familiar with the requirements for and comply with the Americans with Disabilities Act and all rules and regulations established thereunder. Employers must provide reasonable accommodation in all employment activities unless to do so would cause an undue hardship.

9. Selection of Subcontractors, Procurement of Materials and Leasing of Equipment: The contractor shall not discriminate on the grounds of race, color, religion, sex, sexual orientation, gender identity, national origin, age, or disability in the selection and retention of subcontractors, including procurement of materials and leases of equipment. The contractor shall take all necessary and reasonable steps to ensure nondiscrimination in the administration of this contract.

a. The contractor shall notify all potential subcontractors, suppliers, and lessors of their EEO obligations under this contract.

b. The contractor will use good faith efforts to ensure subcontractor compliance with their EEO obligations.

10. Assurances Required:

a. The requirements of 49 CFR Part 26 and the State DOT's FHWA-approved Disadvantaged Business Enterprise (DBE) program are incorporated by reference.

b. The contractor, subrecipient or subcontractor shall not discriminate on the basis of race, color, national origin, or sex in the performance of this contract. The contractor shall carry out applicable requirements of 49 CFR part 26 in the award and administration of DOT-assisted contracts. Failure by the contractor to carry out these requirements is a material breach of this contract, which may result in the termination of this contract or such other remedy as the recipient deems appropriate, which may include, but is not limited to:

- (1) Withholding monthly progress payments;
- (2) Assessing sanctions;
- (3) Liquidated damages; and/or
- (4) Disqualifying the contractor from future bidding as non-responsible.

c. The Title VI and nondiscrimination provisions of U.S. DOT Order 1050.2A at Appendixes A and E are incorporated by reference. 49 CFR Part 21.

11. Records and Reports: The contractor shall keep such records as necessary to document compliance with the EEO requirements. Such records shall be retained for a period of three years following the date of the final payment to the contractor for all contract work and shall be available at reasonable times and places for inspection by authorized representatives of the contracting agency and the FHWA.

a. The records kept by the contractor shall document the following:

(1) The number and work hours of minority and non-minority group members and women employed in each work classification on the project;

(2) The progress and efforts being made in cooperation with unions, when applicable, to increase employment opportunities for minorities and women; and

(3) The progress and efforts being made in locating, hiring, training, qualifying, and upgrading minorities and women.

b. The contractors and subcontractors will submit an annual report to the contracting agency each July for the duration of the project indicating the number of minority, women, and non-minority group employees currently engaged in each work classification required by the contract work. This information is to be reported on [Form FHWA-1391](#). The staffing data should represent the project work force on board in all or any part of the last payroll period preceding the end of July. If on-the-job training is being required by special provision, the contractor will be required to collect and report training data. The employment data should reflect the work force on board during all or any part of the last payroll period preceding the end of July.

III. NONSEGREGATED FACILITIES

This provision is applicable to all Federal-aid construction contracts and to all related construction subcontracts of more than \$10,000. 41 CFR 60-1.5.

As prescribed by 41 CFR 60-1.8, the contractor must ensure that facilities provided for employees are provided in such a manner that segregation on the basis of race, color, religion, sex, sexual orientation, gender identity, or national origin cannot result. The contractor may neither require such segregated use by written or oral policies nor tolerate such use by employee custom. The contractor's obligation extends further to ensure that its employees are not assigned to perform their services at any location under the contractor's control where the facilities are segregated. The term "facilities" includes waiting rooms, work areas, restaurants and other eating areas, time clocks, restrooms, washrooms, locker rooms and other storage or dressing areas, parking lots, drinking fountains, recreation or entertainment areas, transportation, and housing provided for employees. The contractor shall provide separate or single-user restrooms and necessary dressing or sleeping areas to assure privacy between sexes.

IV. DAVIS-BACON AND RELATED ACT PROVISIONS

This section is applicable to all Federal-aid construction projects exceeding \$2,000 and to all related subcontracts and lower-tier subcontracts (regardless of subcontract size), in accordance with 29 CFR 5.5. The requirements apply to all projects located within the right-of-way of a roadway that is functionally classified as Federal-aid highway. 23 U.S.C. 113. This excludes roadways functionally classified as local roads or rural minor collectors, which are exempt. 23 U.S.C. 101. Where applicable law requires that projects be treated as a project on a Federal-aid highway, the provisions of this subpart will apply regardless of the location of the project. Examples include: Surface Transportation Block Grant Program projects funded under 23 U.S.C. 133 [excluding recreational trails projects], the Nationally Significant Freight and Highway

Projects funded under 23 U.S.C. 117, and National Highway Freight Program projects funded under 23 U.S.C. 167.

The following provisions are from the U.S. Department of Labor regulations in 29 CFR 5.5 "Contract provisions and related matters" with minor revisions to conform to the FHWA-1273 format and FHWA program requirements.

1. Minimum wages (29 CFR 5.5)

a. *Wage rates and fringe benefits.* All laborers and mechanics employed or working upon the site of the work (or otherwise working in construction or development of the project under a development statute), will be paid unconditionally and not less often than once a week, and without subsequent deduction or rebate on any account (except such payroll deductions as are permitted by regulations issued by the Secretary of Labor under the Copeland Act ([29 CFR part 3](#))), the full amount of basic hourly wages and bona fide fringe benefits (or cash equivalents thereof) due at time of payment computed at rates not less than those contained in the wage determination of the Secretary of Labor which is attached hereto and made a part hereof, regardless of any contractual relationship which may be alleged to exist between the contractor and such laborers and mechanics. As provided in paragraphs (d) and (e) of 29 CFR 5.5, the appropriate wage determinations are effective by operation of law even if they have not been attached to the contract. Contributions made or costs reasonably anticipated for bona fide fringe benefits under the Davis-Bacon Act ([40 U.S.C. 3141\(2\)\(B\)](#)) on behalf of laborers or mechanics are considered wages paid to such laborers or mechanics, subject to the provisions of paragraph 1.e. of this section; also, regular contributions made or costs incurred for more than a weekly period (but not less often than quarterly) under plans, funds, or programs which cover the particular weekly period, are deemed to be constructively made or incurred during such weekly period. Such laborers and mechanics must be paid the appropriate wage rate and fringe benefits on the wage determination for the classification(s) of work actually performed, without regard to skill, except as provided in paragraph 4. of this section. Laborers or mechanics performing work in more than one classification may be compensated at the rate specified for each classification for the time actually worked therein: *Provided*, That the employer's payroll records accurately set forth the time spent in each classification in which work is performed. The wage determination (including any additional classifications and wage rates conformed under paragraph 1.c. of this section) and the Davis-Bacon poster (WH-1321) must be posted at all times by the contractor and its subcontractors at the site of the work in a prominent and accessible place where it can be easily seen by the workers.

b. *Frequently recurring classifications.* (1) In addition to wage and fringe benefit rates that have been determined to be prevailing under the procedures set forth in [29 CFR part 1](#), a wage determination may contain, pursuant to § 1.3(f), wage and fringe benefit rates for classifications of laborers and mechanics for which conformance requests are regularly submitted pursuant to paragraph 1.c. of this section, provided that:

(i) The work performed by the classification is not performed by a classification in the wage determination for which a prevailing wage rate has been determined;

(ii) The classification is used in the area by the construction industry; and

(iii) The wage rate for the classification bears a reasonable relationship to the prevailing wage rates contained in the wage determination.

(2) The Administrator will establish wage rates for such classifications in accordance with paragraph 1.c.(1)(iii) of this section. Work performed in such a classification must be paid at no less than the wage and fringe benefit rate listed on the wage determination for such classification.

c. *Conformance.* (1) The contracting officer must require that any class of laborers or mechanics, including helpers, which is not listed in the wage determination and which is to be employed under the contract be classified in conformance with the wage determination. Conformance of an additional classification and wage rate and fringe benefits is appropriate only when the following criteria have been met:

(i) The work to be performed by the classification requested is not performed by a classification in the wage determination; and

(ii) The classification is used in the area by the construction industry; and

(iii) The proposed wage rate, including any bona fide fringe benefits, bears a reasonable relationship to the wage rates contained in the wage determination.

(2) The conformance process may not be used to split, subdivide, or otherwise avoid application of classifications listed in the wage determination.

(3) If the contractor and the laborers and mechanics to be employed in the classification (if known), or their representatives, and the contracting officer agree on the classification and wage rate (including the amount designated for fringe benefits where appropriate), a report of the action taken will be sent by the contracting officer by email to DBAconformance@dol.gov. The Administrator, or an authorized representative, will approve, modify, or disapprove every additional classification action within 30 days of receipt and so advise the contracting officer or will notify the contracting officer within the 30-day period that additional time is necessary.

(4) In the event the contractor, the laborers or mechanics to be employed in the classification or their representatives, and the contracting officer do not agree on the proposed classification and wage rate (including the amount designated for fringe benefits, where appropriate), the contracting officer will, by email to DBAconformance@dol.gov, refer the questions, including the views of all interested parties and the recommendation of the contracting officer, to the Administrator for determination. The Administrator, or an authorized representative, will issue a determination within 30 days of receipt and so advise the contracting officer or will notify the contracting officer within the 30-day period that additional time is necessary.

(5) The contracting officer must promptly notify the contractor of the action taken by the Wage and Hour Division

under paragraphs 1.c.(3) and (4) of this section. The contractor must furnish a written copy of such determination to each affected worker or it must be posted as a part of the wage determination. The wage rate (including fringe benefits where appropriate) determined pursuant to paragraph 1.c.(3) or (4) of this section must be paid to all workers performing work in the classification under this contract from the first day on which work is performed in the classification.

d. *Fringe benefits not expressed as an hourly rate.* Whenever the minimum wage rate prescribed in the contract for a class of laborers or mechanics includes a fringe benefit which is not expressed as an hourly rate, the contractor may either pay the benefit as stated in the wage determination or may pay another bona fide fringe benefit or an hourly cash equivalent thereof.

e. *Unfunded plans.* If the contractor does not make payments to a trustee or other third person, the contractor may consider as part of the wages of any laborer or mechanic the amount of any costs reasonably anticipated in providing bona fide fringe benefits under a plan or program, *Provided*, That the Secretary of Labor has found, upon the written request of the contractor, in accordance with the criteria set forth in § 5.28, that the applicable standards of the Davis-Bacon Act have been met. The Secretary of Labor may require the contractor to set aside in a separate account assets for the meeting of obligations under the plan or program.

f. *Interest.* In the event of a failure to pay all or part of the wages required by the contract, the contractor will be required to pay interest on any underpayment of wages.

2. Withholding (29 CFR 5.5)

a. *Withholding requirements.* The contracting agency may, upon its own action, or must, upon written request of an authorized representative of the Department of Labor, withhold or cause to be withheld from the contractor so much of the accrued payments or advances as may be considered necessary to satisfy the liabilities of the prime contractor or any subcontractor for the full amount of wages and monetary relief, including interest, required by the clauses set forth in this section for violations of this contract, or to satisfy any such liabilities required by any other Federal contract, or federally assisted contract subject to Davis-Bacon labor standards, that is held by the same prime contractor (as defined in § 5.2). The necessary funds may be withheld from the contractor under this contract, any other Federal contract with the same prime contractor, or any other federally assisted contract that is subject to Davis-Bacon labor standards requirements and is held by the same prime contractor, regardless of whether the other contract was awarded or assisted by the same agency, and such funds may be used to satisfy the contractor liability for which the funds were withheld. In the event of a contractor's failure to pay any laborer or mechanic, including any apprentice or helper working on the site of the work all or part of the wages required by the contract, or upon the contractor's failure to submit the required records as discussed in paragraph 3.d. of this section, the contracting agency may on its own initiative and after written notice to the contractor, take such action as may be necessary to cause the suspension of any further payment, advance, or guarantee of funds until such violations have ceased.

b. *Priority to withheld funds.* The Department has priority to funds withheld or to be withheld in accordance with paragraph

2.a. of this section or Section V, paragraph 3.a., or both, over claims to those funds by:

- (1) A contractor's surety(ies), including without limitation performance bond sureties and payment bond sureties;
- (2) A contracting agency for its procurement costs;
- (3) A trustee(s) (either a court-appointed trustee or a U.S. trustee, or both) in bankruptcy of a contractor, or a contractor's bankruptcy estate;
- (4) A contractor's assignee(s);
- (5) A contractor's successor(s); or
- (6) A claim asserted under the Prompt Payment Act, [31 U.S.C. 3901–3907](#).

3. Records and certified payrolls (29 CFR 5.5)

a. Basic record requirements (1) Length of record retention. All regular payrolls and other basic records must be maintained by the contractor and any subcontractor during the course of the work and preserved for all laborers and mechanics working at the site of the work (or otherwise working in construction or development of the project under a development statute) for a period of at least 3 years after all the work on the prime contract is completed.

(2) Information required. Such records must contain the name; Social Security number; last known address, telephone number, and email address of each such worker; each worker's correct classification(s) of work actually performed; hourly rates of wages paid (including rates of contributions or costs anticipated for bona fide fringe benefits or cash equivalents thereof of the types described in [40 U.S.C. 3141\(2\)\(B\)](#) of the Davis-Bacon Act); daily and weekly number of hours actually worked in total and on each covered contract; deductions made; and actual wages paid.

(3) Additional records relating to fringe benefits. Whenever the Secretary of Labor has found under paragraph 1.e. of this section that the wages of any laborer or mechanic include the amount of any costs reasonably anticipated in providing benefits under a plan or program described in [40 U.S.C. 3141\(2\)\(B\)](#) of the Davis-Bacon Act, the contractor must maintain records which show that the commitment to provide such benefits is enforceable, that the plan or program is financially responsible, and that the plan or program has been communicated in writing to the laborers or mechanics affected, and records which show the costs anticipated or the actual cost incurred in providing such benefits.

(4) Additional records relating to apprenticeship. Contractors with apprentices working under approved programs must maintain written evidence of the registration of apprenticeship programs, the registration of the apprentices, and the ratios and wage rates prescribed in the applicable programs.

b. Certified payroll requirements (1) Frequency and method of submission. The contractor or subcontractor must submit weekly, for each week in which any DBA- or Related Acts-covered work is performed, certified payrolls to the contracting

agency. The prime contractor is responsible for the submission of all certified payrolls by all subcontractors. A contracting agency or prime contractor may permit or require contractors to submit certified payrolls through an electronic system, as long as the electronic system requires a legally valid electronic signature; the system allows the contractor, the contracting agency, and the Department of Labor to access the certified payrolls upon request for at least 3 years after the work on the prime contract has been completed; and the contracting agency or prime contractor permits other methods of submission in situations where the contractor is unable or limited in its ability to use or access the electronic system.

(2) Information required. The certified payrolls submitted must set out accurately and completely all of the information required to be maintained under paragraph 3.a.(2) of this section, except that full Social Security numbers and last known addresses, telephone numbers, and email addresses must not be included on weekly transmittals. Instead, the certified payrolls need only include an individually identifying number for each worker (e.g., the last four digits of the worker's Social Security number). The required weekly certified payroll information may be submitted using Optional Form WH-347 or in any other format desired. Optional Form WH-347 is available for this purpose from the Wage and Hour Division website at <https://www.dol.gov/sites/dolgov/files/WHD/legacy/files/wh347.pdf> or its successor website. It is not a violation of this section for a prime contractor to require a subcontractor to provide full Social Security numbers and last known addresses, telephone numbers, and email addresses to the prime contractor for its own records, without weekly submission by the subcontractor to the contracting agency.

(3) Statement of Compliance. Each certified payroll submitted must be accompanied by a "Statement of Compliance," signed by the contractor or subcontractor, or the contractor's or subcontractor's agent who pays or supervises the payment of the persons working on the contract, and must certify the following:

(i) That the certified payroll for the payroll period contains the information required to be provided under paragraph 3.b. of this section, the appropriate information and basic records are being maintained under paragraph 3.a. of this section, and such information and records are correct and complete;

(ii) That each laborer or mechanic (including each helper and apprentice) working on the contract during the payroll period has been paid the full weekly wages earned, without rebate, either directly or indirectly, and that no deductions have been made either directly or indirectly from the full wages earned, other than permissible deductions as set forth in [29 CFR part 3](#); and

(iii) That each laborer or mechanic has been paid not less than the applicable wage rates and fringe benefits or cash equivalents for the classification(s) of work actually performed, as specified in the applicable wage determination incorporated into the contract.

(4) Use of Optional Form WH-347. The weekly submission of a properly executed certification set forth on the reverse side of Optional Form WH-347 will satisfy the requirement for submission of the "Statement of Compliance" required by paragraph 3.b.(3) of this section.

(5) *Signature*. The signature by the contractor, subcontractor, or the contractor's or subcontractor's agent must be an original handwritten signature or a legally valid electronic signature.

(6) *Falsification*. The falsification of any of the above certifications may subject the contractor or subcontractor to civil or criminal prosecution under [18 U.S.C. 1001](#) and [31 U.S.C. 3729](#).

(7) *Length of certified payroll retention*. The contractor or subcontractor must preserve all certified payrolls during the course of the work and for a period of 3 years after all the work on the prime contract is completed.

c. *Contracts, subcontracts, and related documents*. The contractor or subcontractor must maintain this contract or subcontract and related documents including, without limitation, bids, proposals, amendments, modifications, and extensions. The contractor or subcontractor must preserve these contracts, subcontracts, and related documents during the course of the work and for a period of 3 years after all the work on the prime contract is completed.

d. *Required disclosures and access* (1) *Required record disclosures and access to workers*. The contractor or subcontractor must make the records required under paragraphs 3.a. through 3.c. of this section, and any other documents that the contracting agency, the State DOT, the FHWA, or the Department of Labor deems necessary to determine compliance with the labor standards provisions of any of the applicable statutes referenced by § 5.1, available for inspection, copying, or transcription by authorized representatives of the contracting agency, the State DOT, the FHWA, or the Department of Labor, and must permit such representatives to interview workers during working hours on the job.

(2) *Sanctions for non-compliance with records and worker access requirements*. If the contractor or subcontractor fails to submit the required records or to make them available, or refuses to permit worker interviews during working hours on the job, the Federal agency may, after written notice to the contractor, sponsor, applicant, owner, or other entity, as the case may be, that maintains such records or that employs such workers, take such action as may be necessary to cause the suspension of any further payment, advance, or guarantee of funds. Furthermore, failure to submit the required records upon request or to make such records available, or to permit worker interviews during working hours on the job, may be grounds for debarment action pursuant to § 5.12. In addition, any contractor or other person that fails to submit the required records or make those records available to WHD within the time WHD requests that the records be produced will be precluded from introducing as evidence in an administrative proceeding under [29 CFR part 6](#) any of the required records that were not provided or made available to WHD. WHD will take into consideration a reasonable request from the contractor or person for an extension of the time for submission of records. WHD will determine the reasonableness of the request and may consider, among other things, the location of the records and the volume of production.

(3) *Required information disclosures*. Contractors and subcontractors must maintain the full Social Security number and last known address, telephone number, and email address

of each covered worker, and must provide them upon request to the contracting agency, the State DOT, the FHWA, the contractor, or the Wage and Hour Division of the Department of Labor for purposes of an investigation or other compliance action.

4. Apprentices and equal employment opportunity (29 CFR 5.5)

a. *Apprentices* (1) *Rate of pay*. Apprentices will be permitted to work at less than the predetermined rate for the work they perform when they are employed pursuant to and individually registered in a bona fide apprenticeship program registered with the U.S. Department of Labor, Employment and Training Administration, Office of Apprenticeship (OA), or with a State Apprenticeship Agency recognized by the OA. A person who is not individually registered in the program, but who has been certified by the OA or a State Apprenticeship Agency (where appropriate) to be eligible for probationary employment as an apprentice, will be permitted to work at less than the predetermined rate for the work they perform in the first 90 days of probationary employment as an apprentice in such a program. In the event the OA or a State Apprenticeship Agency recognized by the OA withdraws approval of an apprenticeship program, the contractor will no longer be permitted to use apprentices at less than the applicable predetermined rate for the work performed until an acceptable program is approved.

(2) *Fringe benefits*. Apprentices must be paid fringe benefits in accordance with the provisions of the apprenticeship program. If the apprenticeship program does not specify fringe benefits, apprentices must be paid the full amount of fringe benefits listed on the wage determination for the applicable classification. If the Administrator determines that a different practice prevails for the applicable apprentice classification, fringe benefits must be paid in accordance with that determination.

(3) *Apprenticeship ratio*. The allowable ratio of apprentices to journeyworkers on the job site in any craft classification must not be greater than the ratio permitted to the contractor as to the entire work force under the registered program or the ratio applicable to the locality of the project pursuant to paragraph 4.a.(4) of this section. Any worker listed on a payroll at an apprentice wage rate, who is not registered or otherwise employed as stated in paragraph 4.a.(1) of this section, must be paid not less than the applicable wage rate on the wage determination for the classification of work actually performed. In addition, any apprentice performing work on the job site in excess of the ratio permitted under this section must be paid not less than the applicable wage rate on the wage determination for the work actually performed.

(4) *Reciprocity of ratios and wage rates*. Where a contractor is performing construction on a project in a locality other than the locality in which its program is registered, the ratios and wage rates (expressed in percentages of the journeyworker's hourly rate) applicable within the locality in which the construction is being performed must be observed. If there is no applicable ratio or wage rate for the locality of the project, the ratio and wage rate specified in the contractor's registered program must be observed.

b. *Equal employment opportunity*. The use of apprentices and journeyworkers under this part must be in conformity with

the equal employment opportunity requirements of Executive Order 11246, as amended, and [29 CFR part 30](#).

c. Apprentices and Trainees (programs of the U.S. DOT).

Apprentices and trainees working under apprenticeship and skill training programs which have been certified by the Secretary of Transportation as promoting EEO in connection with Federal-aid highway construction programs are not subject to the requirements of paragraph 4 of this Section IV. 23 CFR 230.111(e)(2). The straight time hourly wage rates for apprentices and trainees under such programs will be established by the particular programs. The ratio of apprentices and trainees to journeyworkers shall not be greater than permitted by the terms of the particular program.

5. Compliance with Copeland Act requirements. The contractor shall comply with the requirements of 29 CFR part 3, which are incorporated by reference in this contract as provided in 29 CFR 5.5.

6. Subcontracts. The contractor or subcontractor must insert FHWA-1273 in any subcontracts, along with the applicable wage determination(s) and such other clauses or contract modifications as the contracting agency may by appropriate instructions require, and a clause requiring the subcontractors to include these clauses and wage determination(s) in any lower tier subcontracts. The prime contractor is responsible for the compliance by any subcontractor or lower tier subcontractor with all the contract clauses in this section. In the event of any violations of these clauses, the prime contractor and any subcontractor(s) responsible will be liable for any unpaid wages and monetary relief, including interest from the date of the underpayment or loss, due to any workers of lower-tier subcontractors, and may be subject to debarment, as appropriate. 29 CFR 5.5.

7. Contract termination: debarment. A breach of the contract clauses in 29 CFR 5.5 may be grounds for termination of the contract, and for debarment as a contractor and a subcontractor as provided in 29 CFR 5.12.

8. Compliance with Davis-Bacon and Related Act requirements. All rulings and interpretations of the Davis-Bacon and Related Acts contained in 29 CFR parts 1, 3, and 5 are herein incorporated by reference in this contract as provided in 29 CFR 5.5.

9. Disputes concerning labor standards. As provided in 29 CFR 5.5, disputes arising out of the labor standards provisions of this contract shall not be subject to the general disputes clause of this contract. Such disputes shall be resolved in accordance with the procedures of the Department of Labor set forth in 29 CFR parts 5, 6, and 7. Disputes within the meaning of this clause include disputes between the contractor (or any of its subcontractors) and the contracting agency, the U.S. Department of Labor, or the employees or their representatives.

10. Certification of eligibility. a. By entering into this contract, the contractor certifies that neither it nor any person or firm who has an interest in the contractor's firm is a person or firm ineligible to be awarded Government contracts by virtue of [40 U.S.C. 3144\(b\)](#) or § 5.12(a).

b. No part of this contract shall be subcontracted to any person or firm ineligible for award of a Government contract by virtue of [40 U.S.C. 3144\(b\)](#) or § 5.12(a).

c. The penalty for making false statements is prescribed in the U.S. Code, Title 18 Crimes and Criminal Procedure, [18 U.S.C. 1001](#).

11. Anti-retaliation. It is unlawful for any person to discharge, demote, intimidate, threaten, restrain, coerce, blacklist, harass, or in any other manner discriminate against, or to cause any person to discharge, demote, intimidate, threaten, restrain, coerce, blacklist, harass, or in any other manner discriminate against, any worker or job applicant for:

a. Notifying any contractor of any conduct which the worker reasonably believes constitutes a violation of the DBA, Related Acts, this part, or [29 CFR part 1](#) or [3](#);

b. Filing any complaint, initiating or causing to be initiated any proceeding, or otherwise asserting or seeking to assert on behalf of themselves or others any right or protection under the DBA, Related Acts, this part, or [29 CFR part 1](#) or [3](#);

c. Cooperating in any investigation or other compliance action, or testifying in any proceeding under the DBA, Related Acts, this part, or [29 CFR part 1](#) or [3](#); or

d. Informing any other person about their rights under the DBA, Related Acts, this part, or [29 CFR part 1](#) or [3](#).

V. CONTRACT WORK HOURS AND SAFETY STANDARDS ACT

Pursuant to 29 CFR 5.5(b), the following clauses apply to any Federal-aid construction contract in an amount in excess of \$100,000 and subject to the overtime provisions of the Contract Work Hours and Safety Standards Act. These clauses shall be inserted in addition to the clauses required by 29 CFR 5.5(a) or 29 CFR 4.6. As used in this paragraph, the terms laborers and mechanics include watchpersons and guards.

1. Overtime requirements. No contractor or subcontractor contracting for any part of the contract work which may require or involve the employment of laborers or mechanics shall require or permit any such laborer or mechanic in any workweek in which he or she is employed on such work to work in excess of forty hours in such workweek unless such laborer or mechanic receives compensation at a rate not less than one and one-half times the basic rate of pay for all hours worked in excess of forty hours in such workweek. 29 CFR 5.5.

2. Violation; liability for unpaid wages; liquidated damages. In the event of any violation of the clause set forth in paragraph 1. of this section the contractor and any subcontractor responsible therefor shall be liable for the unpaid wages and interest from the date of the underpayment. In addition, such contractor and subcontractor shall be liable to the United States (in the case of work done under contract for the District of Columbia or a territory, to such District or to such territory), for liquidated damages. Such liquidated damages shall be computed with respect to each individual laborer or

mechanic, including watchpersons and guards, employed in violation of the clause set forth in paragraph 1. of this section, in the sum currently provided in 29 CFR 5.5(b)(2)* for each calendar day on which such individual was required or permitted to work in excess of the standard workweek of forty hours without payment of the overtime wages required by the clause set forth in paragraph 1. of this section.

* \$31 as of January 15, 2023 (See 88 FR 88 FR 2210) as may be adjusted annually by the Department of Labor, pursuant to the Federal Civil Penalties Inflation Adjustment Act of 1990.

3. Withholding for unpaid wages and liquidated damages

a. *Withholding process.* The FHWA or the contracting agency may, upon its own action, or must, upon written request of an authorized representative of the Department of Labor, withhold or cause to be withheld from the contractor so much of the accrued payments or advances as may be considered necessary to satisfy the liabilities of the prime contractor or any subcontractor for any unpaid wages; monetary relief, including interest; and liquidated damages required by the clauses set forth in this section on this contract, any other Federal contract with the same prime contractor, or any other federally assisted contract subject to the Contract Work Hours and Safety Standards Act that is held by the same prime contractor (as defined in § 5.2). The necessary funds may be withheld from the contractor under this contract, any other Federal contract with the same prime contractor, or any other federally assisted contract that is subject to the Contract Work Hours and Safety Standards Act and is held by the same prime contractor, regardless of whether the other contract was awarded or assisted by the same agency, and such funds may be used to satisfy the contractor liability for which the funds were withheld.

b. *Priority to withheld funds.* The Department has priority to funds withheld or to be withheld in accordance with Section IV paragraph 2.a. or paragraph 3.a. of this section, or both, over claims to those funds by:

- (1) A contractor's surety(ies), including without limitation performance bond sureties and payment bond sureties;
- (2) A contracting agency for its procurement costs;
- (3) A trustee(s) (either a court-appointed trustee or a U.S. trustee, or both) in bankruptcy of a contractor, or a contractor's bankruptcy estate;
- (4) A contractor's assignee(s);
- (5) A contractor's successor(s); or
- (6) A claim asserted under the Prompt Payment Act, [31 U.S.C. 3901](#)–3907.

4. **Subcontracts.** The contractor or subcontractor must insert in any subcontracts the clauses set forth in paragraphs 1. through 5. of this section and a clause requiring the subcontractors to include these clauses in any lower tier subcontracts. The prime contractor is responsible for compliance by any subcontractor or lower tier subcontractor with the clauses set forth in paragraphs 1. through 5. In the

event of any violations of these clauses, the prime contractor and any subcontractor(s) responsible will be liable for any unpaid wages and monetary relief, including interest from the date of the underpayment or loss, due to any workers of lower-tier subcontractors, and associated liquidated damages and may be subject to debarment, as appropriate.

5. Anti-retaliation. It is unlawful for any person to discharge, demote, intimidate, threaten, restrain, coerce, blacklist, harass, or in any other manner discriminate against, or to cause any person to discharge, demote, intimidate, threaten, restrain, coerce, blacklist, harass, or in any other manner discriminate against, any worker or job applicant for:

a. Notifying any contractor of any conduct which the worker reasonably believes constitutes a violation of the Contract Work Hours and Safety Standards Act (CWHSSA) or its implementing regulations in this part;

b. Filing any complaint, initiating or causing to be initiated any proceeding, or otherwise asserting or seeking to assert on behalf of themselves or others any right or protection under CWHSSA or this part;

c. Cooperating in any investigation or other compliance action, or testifying in any proceeding under CWHSSA or this part; or

d. Informing any other person about their rights under CWHSSA or this part.

VI. SUBLETTING OR ASSIGNING THE CONTRACT

This provision is applicable to all Federal-aid construction contracts on the National Highway System pursuant to 23 CFR 635.116.

1. The contractor shall perform with its own organization contract work amounting to not less than 30 percent (or a greater percentage if specified elsewhere in the contract) of the total original contract price, excluding any specialty items designated by the contracting agency. Specialty items may be performed by subcontract and the amount of any such specialty items performed may be deducted from the total original contract price before computing the amount of work required to be performed by the contractor's own organization (23 CFR 635.116).

a. The term "perform work with its own organization" in paragraph 1 of Section VI refers to workers employed or leased by the prime contractor, and equipment owned or rented by the prime contractor, with or without operators. Such term does not include employees or equipment of a subcontractor or lower tier subcontractor, agents of the prime contractor, or any other assignees. The term may include payments for the costs of hiring leased employees from an employee leasing firm meeting all relevant Federal and State regulatory requirements. Leased employees may only be included in this term if the prime contractor meets all of the following conditions: (based on longstanding interpretation)

- (1) the prime contractor maintains control over the supervision of the day-to-day activities of the leased employees;
- (2) the prime contractor remains responsible for the quality of the work of the leased employees;

- (3) the prime contractor retains all power to accept or exclude individual employees from work on the project; and
- (4) the prime contractor remains ultimately responsible for the payment of predetermined minimum wages, the submission of payrolls, statements of compliance and all other Federal regulatory requirements.

b. "Specialty Items" shall be construed to be limited to work that requires highly specialized knowledge, abilities, or equipment not ordinarily available in the type of contracting organizations qualified and expected to bid or propose on the contract as a whole and in general are to be limited to minor components of the overall contract. 23 CFR 635.102.

2. Pursuant to 23 CFR 635.116(a), the contract amount upon which the requirements set forth in paragraph (1) of Section VI is computed includes the cost of material and manufactured products which are to be purchased or produced by the contractor under the contract provisions.

3. Pursuant to 23 CFR 635.116(c), the contractor shall furnish (a) a competent superintendent or supervisor who is employed by the firm, has full authority to direct performance of the work in accordance with the contract requirements, and is in charge of all construction operations (regardless of who performs the work) and (b) such other of its own organizational resources (supervision, management, and engineering services) as the contracting officer determines is necessary to assure the performance of the contract.

4. No portion of the contract shall be sublet, assigned or otherwise disposed of except with the written consent of the contracting officer, or authorized representative, and such consent when given shall not be construed to relieve the contractor of any responsibility for the fulfillment of the contract. Written consent will be given only after the contracting agency has assured that each subcontract is evidenced in writing and that it contains all pertinent provisions and requirements of the prime contract. (based on long-standing interpretation of 23 CFR 635.116).

5. The 30-percent self-performance requirement of paragraph (1) is not applicable to design-build contracts; however, contracting agencies may establish their own self-performance requirements. 23 CFR 635.116(d).

VII. SAFETY: ACCIDENT PREVENTION

This provision is applicable to all Federal-aid construction contracts and to all related subcontracts.

1. In the performance of this contract the contractor shall comply with all applicable Federal, State, and local laws governing safety, health, and sanitation (23 CFR Part 635). The contractor shall provide all safeguards, safety devices and protective equipment and take any other needed actions as it determines, or as the contracting officer may determine, to be reasonably necessary to protect the life and health of employees on the job and the safety of the public and to protect property in connection with the performance of the work covered by the contract. 23 CFR 635.108.

2. It is a condition of this contract, and shall be made a condition of each subcontract, which the contractor enters into pursuant to this contract, that the contractor and any subcontractor shall not permit any employee, in performance of the contract, to work in surroundings or under conditions which are unsanitary, hazardous or dangerous to his/her health or safety, as determined under construction safety and

health standards (29 CFR Part 1926) promulgated by the Secretary of Labor, in accordance with Section 107 of the Contract Work Hours and Safety Standards Act (40 U.S.C. 3704). 29 CFR 1926.10.

3. Pursuant to 29 CFR 1926.3, it is a condition of this contract that the Secretary of Labor or authorized representative thereof, shall have right of entry to any site of contract performance to inspect or investigate the matter of compliance with the construction safety and health standards and to carry out the duties of the Secretary under Section 107 of the Contract Work Hours and Safety Standards Act (40 U.S.C. 3704).

VIII. FALSE STATEMENTS CONCERNING HIGHWAY PROJECTS

This provision is applicable to all Federal-aid construction contracts and to all related subcontracts.

In order to assure high quality and durable construction in conformity with approved plans and specifications and a high degree of reliability on statements and representations made by engineers, contractors, suppliers, and workers on Federal-aid highway projects, it is essential that all persons concerned with the project perform their functions as carefully, thoroughly, and honestly as possible. Willful falsification, distortion, or misrepresentation with respect to any facts related to the project is a violation of Federal law. To prevent any misunderstanding regarding the seriousness of these and similar acts, Form FHWA-1022 shall be posted on each Federal-aid highway project (23 CFR Part 635) in one or more places where it is readily available to all persons concerned with the project:

18 U.S.C. 1020 reads as follows:

"Whoever, being an officer, agent, or employee of the United States, or of any State or Territory, or whoever, whether a person, association, firm, or corporation, knowingly makes any false statement, false representation, or false report as to the character, quality, quantity, or cost of the material used or to be used, or the quantity or quality of the work performed or to be performed, or the cost thereof in connection with the submission of plans, maps, specifications, contracts, or costs of construction on any highway or related project submitted for approval to the Secretary of Transportation; or

Whoever knowingly makes any false statement, false representation, false report or false claim with respect to the character, quality, quantity, or cost of any work performed or to be performed, or materials furnished or to be furnished, in connection with the construction of any highway or related project approved by the Secretary of Transportation; or

Whoever knowingly makes any false statement or false representation as to material fact in any statement, certificate, or report submitted pursuant to provisions of the Federal-aid Roads Act approved July 11, 1916, (39 Stat. 355), as amended and supplemented;

Shall be fined under this title or imprisoned not more than 5 years or both."

IX. IMPLEMENTATION OF CLEAN AIR ACT AND FEDERAL WATER POLLUTION CONTROL ACT (42 U.S.C. 7606; 2 CFR 200.88; EO 11738)

This provision is applicable to all Federal-aid construction contracts in excess of \$150,000 and to all related subcontracts. 48 CFR 2.101; 2 CFR 200.327.

By submission of this bid/proposal or the execution of this contract or subcontract, as appropriate, the bidder, proposer, Federal-aid construction contractor, subcontractor, supplier, or vendor agrees to comply with all applicable standards, orders or regulations issued pursuant to the Clean Air Act (42 U.S.C. 7401-7671q) and the Federal Water Pollution Control Act, as amended (33 U.S.C. 1251-1387). Violations must be reported to the Federal Highway Administration and the Regional Office of the Environmental Protection Agency. 2 CFR Part 200, Appendix II.

The contractor agrees to include or cause to be included the requirements of this Section in every subcontract, and further agrees to take such action as the contracting agency may direct as a means of enforcing such requirements. 2 CFR 200.327.

X. CERTIFICATION REGARDING DEBARMENT, SUSPENSION, INELIGIBILITY AND VOLUNTARY EXCLUSION

This provision is applicable to all Federal-aid construction contracts, design-build contracts, subcontracts, lower-tier subcontracts, purchase orders, lease agreements, consultant contracts or any other covered transaction requiring FHWA approval or that is estimated to cost \$25,000 or more – as defined in 2 CFR Parts 180 and 1200. 2 CFR 180.220 and 1200.220.

1. Instructions for Certification – First Tier Participants:

- a. By signing and submitting this proposal, the prospective first tier participant is providing the certification set out below.
- b. The inability of a person to provide the certification set out below will not necessarily result in denial of participation in this covered transaction. The prospective first tier participant shall submit an explanation of why it cannot provide the certification set out below. The certification or explanation will be considered in connection with the department or agency's determination whether to enter into this transaction. However, failure of the prospective first tier participant to furnish a certification or an explanation shall disqualify such a person from participation in this transaction. 2 CFR 180.320.
- c. The certification in this clause is a material representation of fact upon which reliance was placed when the contracting agency determined to enter into this transaction. If it is later determined that the prospective participant knowingly rendered an erroneous certification, in addition to other remedies available to the Federal Government, the contracting agency may terminate this transaction for cause of default. 2 CFR 180.325.
- d. The prospective first tier participant shall provide immediate written notice to the contracting agency to whom this proposal is submitted if any time the prospective first tier participant learns that its certification was erroneous when submitted or has become erroneous by reason of changed circumstances. 2 CFR 180.345 and 180.350.

e. The terms "covered transaction," "debarred," "suspended," "ineligible," "participant," "person," "principal," and "voluntarily excluded," as used in this clause, are defined in 2 CFR Parts 180, Subpart I, 180.900-180.1020, and 1200. "First Tier Covered Transactions" refers to any covered transaction between a recipient or subrecipient of Federal funds and a participant (such as the prime or general contract). "Lower Tier Covered Transactions" refers to any covered transaction under a First Tier Covered Transaction (such as subcontracts). "First Tier Participant" refers to the participant who has entered into a covered transaction with a recipient or subrecipient of Federal funds (such as the prime or general contractor). "Lower Tier Participant" refers any participant who has entered into a covered transaction with a First Tier Participant or other Lower Tier Participants (such as subcontractors and suppliers).

f. The prospective first tier participant agrees by submitting this proposal that, should the proposed covered transaction be entered into, it shall not knowingly enter into any lower tier covered transaction with a person who is debarred, suspended, declared ineligible, or voluntarily excluded from participation in this covered transaction, unless authorized by the department or agency entering into this transaction. 2 CFR 180.330.

g. The prospective first tier participant further agrees by submitting this proposal that it will include the clause titled "Certification Regarding Debarment, Suspension, Ineligibility and Voluntary Exclusion-Lower Tier Covered Transactions," provided by the department or contracting agency, entering into this covered transaction, without modification, in all lower tier covered transactions and in all solicitations for lower tier covered transactions exceeding the \$25,000 threshold. 2 CFR 180.220 and 180.300.

h. A participant in a covered transaction may rely upon a certification of a prospective participant in a lower tier covered transaction that is not debarred, suspended, ineligible, or voluntarily excluded from the covered transaction, unless it knows that the certification is erroneous. 2 CFR 180.300; 180.320, and 180.325. A participant is responsible for ensuring that its principals are not suspended, debarred, or otherwise ineligible to participate in covered transactions. 2 CFR 180.335. To verify the eligibility of its principals, as well as the eligibility of any lower tier prospective participants, each participant may, but is not required to, check the System for Award Management website (<https://www.sam.gov/>). 2 CFR 180.300, 180.320, and 180.325.

i. Nothing contained in the foregoing shall be construed to require the establishment of a system of records in order to render in good faith the certification required by this clause. The knowledge and information of the prospective participant is not required to exceed that which is normally possessed by a prudent person in the ordinary course of business dealings.

j. Except for transactions authorized under paragraph (f) of these instructions, if a participant in a covered transaction knowingly enters into a lower tier covered transaction with a person who is suspended, debarred, ineligible, or voluntarily excluded from participation in this transaction, in addition to other remedies available to the Federal Government, the department or agency may terminate this transaction for cause or default. 2 CFR 180.325.

2. Certification Regarding Debarment, Suspension, Ineligibility and Voluntary Exclusion – First Tier Participants:

a. The prospective first tier participant certifies to the best of its knowledge and belief, that it and its principals:

(1) Are not presently debarred, suspended, proposed for debarment, declared ineligible, or voluntarily excluded from participating in covered transactions by any Federal department or agency, 2 CFR 180.335;.

(2) Have not within a three-year period preceding this proposal been convicted of or had a civil judgment rendered against them for commission of fraud or a criminal offense in connection with obtaining, attempting to obtain, or performing a public (Federal, State, or local) transaction or contract under a public transaction; violation of Federal or State antitrust statutes or commission of embezzlement, theft, forgery, bribery, falsification or destruction of records, making false statements, or receiving stolen property, 2 CFR 180.800;

(3) Are not presently indicted for or otherwise criminally or civilly charged by a governmental entity (Federal, State or local) with commission of any of the offenses enumerated in paragraph (a)(2) of this certification, 2 CFR 180.700 and 180.800; and

(4) Have not within a three-year period preceding this application/proposal had one or more public transactions (Federal, State or local) terminated for cause or default. 2 CFR 180.335(d).

(5) Are not a corporation that has been convicted of a felony violation under any Federal law within the two-year period preceding this proposal (USDOT Order 4200.6 implementing appropriations act requirements); and

(6) Are not a corporation with any unpaid Federal tax liability that has been assessed, for which all judicial and administrative remedies have been exhausted, or have lapsed, and that is not being paid in a timely manner pursuant to an agreement with the authority responsible for collecting the tax liability (USDOT Order 4200.6 implementing appropriations act requirements).

b. Where the prospective participant is unable to certify to any of the statements in this certification, such prospective participant should attach an explanation to this proposal. 2 CFR 180.335 and 180.340.

3. Instructions for Certification - Lower Tier Participants:

(Applicable to all subcontracts, purchase orders, and other lower tier transactions requiring prior FHWA approval or estimated to cost \$25,000 or more - 2 CFR Parts 180 and 1200). 2 CFR 180.220 and 1200.220.

a. By signing and submitting this proposal, the prospective lower tier participant is providing the certification set out below.

b. The certification in this clause is a material representation of fact upon which reliance was placed when this transaction was entered into. If it is later determined that the prospective lower tier participant knowingly rendered an erroneous certification, in addition to other remedies available to the Federal Government, the department, or agency with which

this transaction originated may pursue available remedies, including suspension and/or debarment.

c. The prospective lower tier participant shall provide immediate written notice to the person to which this proposal is submitted if at any time the prospective lower tier participant learns that its certification was erroneous by reason of changed circumstances. 2 CFR 180.365.

d. The terms "covered transaction," "debarred," "suspended," "ineligible," "participant," "person," "principal," and "voluntarily excluded," as used in this clause, are defined in 2 CFR Parts 180, Subpart I, 180.900 – 180.1020, and 1200. You may contact the person to which this proposal is submitted for assistance in obtaining a copy of those regulations. "First Tier Covered Transactions" refers to any covered transaction between a recipient or subrecipient of Federal funds and a participant (such as the prime or general contract). "Lower Tier Covered Transactions" refers to any covered transaction under a First Tier Covered Transaction (such as subcontracts). "First Tier Participant" refers to the participant who has entered into a covered transaction with a recipient or subrecipient of Federal funds (such as the prime or general contractor). "Lower Tier Participant" refers any participant who has entered into a covered transaction with a First Tier Participant or other Lower Tier Participants (such as subcontractors and suppliers).

e. The prospective lower tier participant agrees by submitting this proposal that, should the proposed covered transaction be entered into, it shall not knowingly enter into any lower tier covered transaction with a person who is debarred, suspended, declared ineligible, or voluntarily excluded from participation in this covered transaction, unless authorized by the department or agency with which this transaction originated. 2 CFR 1200.220 and 1200.332.

f. The prospective lower tier participant further agrees by submitting this proposal that it will include this clause titled "Certification Regarding Debarment, Suspension, Ineligibility and Voluntary Exclusion-Lower Tier Covered Transaction," without modification, in all lower tier covered transactions and in all solicitations for lower tier covered transactions exceeding the \$25,000 threshold. 2 CFR 180.220 and 1200.220.

g. A participant in a covered transaction may rely upon a certification of a prospective participant in a lower tier covered transaction that is not debarred, suspended, ineligible, or voluntarily excluded from the covered transaction, unless it knows that the certification is erroneous. A participant is responsible for ensuring that its principals are not suspended, debarred, or otherwise ineligible to participate in covered transactions. To verify the eligibility of its principals, as well as the eligibility of any lower tier prospective participants, each participant may, but is not required to, check the System for Award Management website (<https://www.sam.gov/>), which is compiled by the General Services Administration. 2 CFR 180.300, 180.320, 180.330, and 180.335.

h. Nothing contained in the foregoing shall be construed to require establishment of a system of records in order to render in good faith the certification required by this clause. The knowledge and information of participant is not required to exceed that which is normally possessed by a prudent person in the ordinary course of business dealings.

i. Except for transactions authorized under paragraph e of these instructions, if a participant in a covered transaction knowingly enters into a lower tier covered transaction with a person who is suspended, debarred, ineligible, or voluntarily

excluded from participation in this transaction, in addition to other remedies available to the Federal Government, the department or agency with which this transaction originated may pursue available remedies, including suspension and/or debarment. 2 CFR 180.325.

4. Certification Regarding Debarment, Suspension, Ineligibility and Voluntary Exclusion--Lower Tier Participants:

a. The prospective lower tier participant certifies, by submission of this proposal, that neither it nor its principals:

(1) is presently debarred, suspended, proposed for debarment, declared ineligible, or voluntarily excluded from participating in covered transactions by any Federal department or agency, 2 CFR 180.355;

(2) is a corporation that has been convicted of a felony violation under any Federal law within the two-year period preceding this proposal (USDOT Order 4200.6 implementing appropriations act requirements); and

(3) is a corporation with any unpaid Federal tax liability that has been assessed, for which all judicial and administrative remedies have been exhausted, or have lapsed, and that is not being paid in a timely manner pursuant to an agreement with the authority responsible for collecting the tax liability. (USDOT Order 4200.6 implementing appropriations act requirements)

b. Where the prospective lower tier participant is unable to certify to any of the statements in this certification, such prospective participant should attach an explanation to this proposal.

XI. CERTIFICATION REGARDING USE OF CONTRACT FUNDS FOR LOBBYING

This provision is applicable to all Federal-aid construction contracts and to all related subcontracts which exceed \$100,000. 49 CFR Part 20, App. A.

1. The prospective participant certifies, by signing and submitting this bid or proposal, to the best of his or her knowledge and belief, that:

a. No Federal appropriated funds have been paid or will be paid, by or on behalf of the undersigned, to any person for influencing or attempting to influence an officer or employee of any Federal agency, a Member of Congress, an officer or employee of Congress, or an employee of a Member of Congress in connection with the awarding of any Federal contract, the making of any Federal grant, the making of any Federal loan, the entering into of any cooperative agreement, and the extension, continuation, renewal, amendment, or modification of any Federal contract, grant, loan, or cooperative agreement.

b. If any funds other than Federal appropriated funds have been paid or will be paid to any person for influencing or attempting to influence an officer or employee of any Federal agency, a Member of Congress, an officer or employee of Congress, or an employee of a Member of Congress in connection with this Federal contract, grant, loan, or

cooperative agreement, the undersigned shall complete and submit Standard Form-LLL, "Disclosure Form to Report Lobbying," in accordance with its instructions.

2. This certification is a material representation of fact upon which reliance was placed when this transaction was made or entered into. Submission of this certification is a prerequisite for making or entering into this transaction imposed by 31 U.S.C. 1352. Any person who fails to file the required certification shall be subject to a civil penalty of not less than \$10,000 and not more than \$100,000 for each such failure.

3. The prospective participant also agrees by submitting its bid or proposal that the participant shall require that the language of this certification be included in all lower tier subcontracts, which exceed \$100,000 and that all such recipients shall certify and disclose accordingly.

XII. USE OF UNITED STATES-FLAG VESSELS:

This provision is applicable to all Federal-aid construction contracts, design-build contracts, subcontracts, lower-tier subcontracts, purchase orders, lease agreements, or any other covered transaction. 46 CFR Part 381.

This requirement applies to material or equipment that is acquired for a specific Federal-aid highway project. 46 CFR 381.7. It is not applicable to goods or materials that come into inventories independent of an FHWA funded-contract.

When oceanic shipments (or shipments across the Great Lakes) are necessary for materials or equipment acquired for a specific Federal-aid construction project, the bidder, proposer, contractor, subcontractor, or vendor agrees:

1. To utilize privately owned United States-flag commercial vessels to ship at least 50 percent of the gross tonnage (computed separately for dry bulk carriers, dry cargo liners, and tankers) involved, whenever shipping any equipment, material, or commodities pursuant to this contract, to the extent such vessels are available at fair and reasonable rates for United States-flag commercial vessels. 46 CFR 381.7.

2. To furnish within 20 days following the date of loading for shipments originating within the United States or within 30 working days following the date of loading for shipments originating outside the United States, a legible copy of a rated, 'on-board' commercial ocean bill-of-lading in English for each shipment of cargo described in paragraph (b)(1) of this section to both the Contracting Officer (through the prime contractor in the case of subcontractor bills-of-lading) and to the Office of Cargo and Commercial Sealift (MAR-620), Maritime Administration, Washington, DC 20590. (MARAD requires copies of the ocean carrier's (master) bills of lading, certified onboard, dated, with rates and charges. These bills of lading may contain business sensitive information and therefore may be submitted directly to MARAD by the Ocean Transportation Intermediary on behalf of the contractor). 46 CFR 381.7.

**ATTACHMENT A - EMPLOYMENT AND MATERIALS
PREFERENCE FOR APPALACHIAN DEVELOPMENT
HIGHWAY SYSTEM OR APPALACHIAN LOCAL ACCESS
ROAD CONTRACTS (23 CFR 633, Subpart B, Appendix B)**

This provision is applicable to all Federal-aid projects funded under the Appalachian Regional Development Act of 1965.

1. During the performance of this contract, the contractor undertaking to do work which is, or reasonably may be, done as on-site work, shall give preference to qualified persons who regularly reside in the labor area as designated by the DOL wherein the contract work is situated, or the subregion, or the Appalachian counties of the State wherein the contract work is situated, except:

a. To the extent that qualified persons regularly residing in the area are not available.

b. For the reasonable needs of the contractor to employ supervisory or specially experienced personnel necessary to assure an efficient execution of the contract work.

c. For the obligation of the contractor to offer employment to present or former employees as the result of a lawful collective bargaining contract, provided that the number of nonresident persons employed under this subparagraph (1c) shall not exceed 20 percent of the total number of employees employed by the contractor on the contract work, except as provided in subparagraph (4) below.

2. The contractor shall place a job order with the State Employment Service indicating (a) the classifications of the laborers, mechanics and other employees required to perform the contract work, (b) the number of employees required in each classification, (c) the date on which the participant estimates such employees will be required, and (d) any other pertinent information required by the State Employment Service to complete the job order form. The job order may be placed with the State Employment Service in writing or by telephone. If during the course of the contract work, the information submitted by the contractor in the original job order is substantially modified, the participant shall promptly notify the State Employment Service.

3. The contractor shall give full consideration to all qualified job applicants referred to him by the State Employment Service. The contractor is not required to grant employment to any job applicants who, in his opinion, are not qualified to perform the classification of work required.

4. If, within one week following the placing of a job order by the contractor with the State Employment Service, the State Employment Service is unable to refer any qualified job applicants to the contractor, or less than the number requested, the State Employment Service will forward a certificate to the contractor indicating the unavailability of applicants. Such certificate shall be made a part of the contractor's permanent project records. Upon receipt of this certificate, the contractor may employ persons who do not normally reside in the labor area to fill positions covered by the certificate, notwithstanding the provisions of subparagraph (1c) above.

5. The provisions of 23 CFR 633.207(e) allow the contracting agency to provide a contractual preference for the use of mineral resource materials native to the Appalachian region.

6. The contractor shall include the provisions of Sections 1 through 4 of this Attachment A in every subcontract for work which is, or reasonably may be, done as on-site work.

**NOTICE OF REQUIREMENTS FOR AFFIRMATIVE
ACTION TO ENSURE EQUAL EMPLOYMENT
OPPORTUNITY (EXECUTIVE ORDER 11246)**

1. The Offeror's or Bidder's attention is called to the "Equal Opportunity Clause" and the "Standard Federal Equal Employment Opportunity Construction Contract Specifications" set forth herein.

2. The goal for female participation, expressed in percentage terms for the Contractor's aggregate workforce in each trade on all construction work, is 6.9%.

Until further notice	Goals for minority participation for each trade (percent)
----------------------	---

SHSA Cities:

Pascagoula - Moss Point -----	16.9
Biloxi - Gulfport -----	19.2
Jackson -----	30.3

SMSA Counties:

Desoto -----	32.3
Hancock, Harrison, Stone-----	19.2
Hinds, Rankin-----	30.3
Jackson -----	16.9

Non-SMSA Counties:

George, Greene ----- 26.4

Alcorn, Benton, Bolivar, Calhoun, Carroll, Chickasaw, Clay, Coahoma, Grenada, Itawamba, Lafayette, Lee, Leflore, Marshall, Monroe, Montgomery, Panola, Pontotoc, Prentiss, Quitman, Sunflower, Tallahatchie, Tate, Tippah, Tishomingo, Tunica, Union, Washington, Webster, Yalobusha ----- 26.5

Attala, Choctaw, Claiborne, Clarke, Copiah, Covington, Franklin, Holmes, Humphreys, Issaquena, Jasper, Jefferson, Jefferson Davis, Jones Kemper, Lauderdale, Lawrence, Leake, Lincoln, Lowndes, Madison, Neshoba, Newton, Noxubee, Oktibbeha, Scott, Sharkey, Simpson, Smith, Warren, Wayne, Winston, Yazoo----- 32.0

Forrest, Lamar, Marion, Pearl River, Perry, Pike, Walthall----- 27.7

Adams, Amite, Wilkinson ----- 30.4

These goals are applicable to all the Contractor's construction work (whether or not it is Federal or federally assisted) performed in the covered area. If the contractor performs construction work in a geographical area located outside of the covered area, it shall apply the goals established for such geographical area where the work is actually performed. With regard to this second area, the contractor also is subject to the goals for both its federally involved and nonfederally involved construction.

The Contractor's compliance with the Executive Order and the regulations in 41 CFR Part 60-4 shall be based on its implementation of the Equal Opportunity clause, specific affirmative action obligations required by the specifications set forth in 41 CFR 60-4.3(a), and its efforts to meet the goals. The hours of minority and female employment and training must be substantially uniform throughout the length of the contract, and in each trade, and the Contractor shall make a good faith effort to employ minorities and women evenly on each of its projects. The transfer of minority or female employees or trainees from Contractor to Contractor or from project to project for the sole purpose of meeting the Contractor's goals shall be a violation of the contract, the Executive Order and the regulations in 41 CFR Part 60-4.2(d). Compliance with the goals will be measured against the total work hours performed.

3. The Contractor shall provide written notification to the Director of the Office of Federal Contract Compliance Programs within 10 working days of award of any construction subcontract in excess of \$10,000 at any tier for construction work under the contract resulting from this solicitation. The notification shall list the name, address and telephone number of the subcontractor, employer identification number of the subcontractor, estimated dollar amount of the subcontract; estimated starting and completion dates of the subcontract; and the geographical area in which the subcontract is to be performed.

4. As used in this Notice, and in the contract resulting from this solicitation, the "covered area" is to the county and city (if any), stated in the advertisement.

5. The notification required in Paragraph 3 shall be addressed to the following:

Contract Compliance Officer
Mississippi Department of Transportation
P.O. Box 1850
Jackson, Mississippi 39215-1850

(12/04/2018)

MISSISSIPPI DEPARTMENT OF TRANSPORTATION

SPECIAL PROVISION NO. 907-101-1

CODE: (IS)

DATE: 07/20/2023

SUBJECT: Definitions and Terms

Section 101, Definitions and Terms, of the 2017 Edition of the Mississippi Standard Specifications for Road and Bridge Construction is hereby amended as follows.

907-101.01--Abbreviations. After the abbreviation API on page 1, add the following.

APL Approved Products List

Replace the abbreviation for AWPA on page 1 with the following.

AWPA American Wood Protection Association

907-101.02--Definitions. Delete the sentence after the list of holidays in Subsection 101.02 on page 6 under **holidays, legal**, and substitute the following.

When a legal holiday falls on a Saturday or Sunday, the succeeding Monday, or as proclaimed by the Governor, will be observed as a legal holiday.

Delete the definition for Notice to Proceed in Subsection 101.02 on page 8, and substitute the following.

Notice to Proceed - Written notice to the Contractor to proceed with the contract work.

Delete the definition for “Plans” in Subsection 101.02 on page 8, and substitute the following.

plans - The approved plans, profiles, typical cross-sections, working drawings and supplemental drawings, or exact reproduction thereof, that show the location, character, dimensions, and details of the work to be done. The plans may also include electronic files, referred to on the plans as Electronic Files Identified as Plans, which may include engineering models, spreadsheets, CADD files or other electronic files used to convey design intent. When the contract does not have an official set of plans, reference to the plans shall mean the contract documents.

MISSISSIPPI DEPARTMENT OF TRANSPORTATION

SPECIAL PROVISION NO. 907-102-2

CODE: (IS)

DATE: 11/22/2017

SUBJECT: **Bidding Requirements and Conditions**

Section 102, Bidding Requirements and Conditions, of the 2017 Edition of the Mississippi Standard Specifications for Road and Bridge Construction is hereby amended as follows.

907-102.01--Prequalification of Bidders. Delete the last sentence of the third paragraph of Subsection 102.01 on page 13, and substitute the following.

The Bidder's Certificate of Responsibility number must be on file with the Department's Contract Administration Division prior to request for permission to bid.

907-102.02--Contents of Proposal Forms. Delete the fourth paragraph in Subsection 102.02 on page 13, and substitute the following.

Prospective bidders must complete an online request for permission to be eligible to bid a project. Upon approval, the bidder will be authorized to submit a bid electronically using Bid Express at <http://bidx.com>.

MISSISSIPPI DEPARTMENT OF TRANSPORTATION

SPECIAL PROVISION NO. 907-105-2

CODE: (IS)

DATE: 07/20/2023

SUBJECT: Control of Work

Section 105, Control of Work, of the 2017 Edition of the Mississippi Standard Specifications for Road and Bridge Construction is hereby amended as follows.

907-105.01--Authority of the Engineer. Delete the first sentence of the second paragraph of Subsection 105.01 on page 31, and substitute the following.

The Engineer has the right to suspend the work wholly or in part and to withhold payments because of the Contractor's failure to correct conditions unsafe for workmen or the general public, for failure to carry out provisions of the Contract, or for failure to carry out orders.

907-105.02--Plans and Working Drawings. Delete the first paragraph of Subsection 105.02 on page 31, and substitute the following.

After the contract is executed by the Executive Director, the Contractor will receive, free of charge, two bound copies of the proposal and contract documents (one executed and one blank) two full scale copies of the plans, five half-scale copies of the Plans, and Electronic Files Identified as Plans. The Contractor shall have one copy of the proposal and contract documents and one half-scale copy of the plans available at all times during work activity on the project.

MISSISSIPPI DEPARTMENT OF TRANSPORTATION

SPECIAL PROVISION NO. 907-106-2

CODE: (IS)

DATE: 09/24/2024

SUBJECT: Control of Materials

Section 106, Control of Materials, of the 2017 Edition of the Mississippi Standard Specifications for Road and Bridge Construction is hereby amended as follows.

After Subsection 106.13 on page 47, add the following.

907-106.14--Buy America Materials Sourcing Requirements for Federal-Aid Projects. The “Infrastructure Investment and Jobs Act” (the “Act”), or Bipartisan Infrastructure Law (BIL), was enacted on November 15, 2021 (See Public Law No. 117-58, Sections 70901-70953). The Buy America provisions of the Act expand the previous Buy America requirements beyond what is currently required for steel and iron products.

Any steel and iron materials per Subsection 700.01 or construction materials per Subsection 907-700.01.1, that are used for a Federal-Aid highway construction project, shall be domestically manufactured (as further described in Subsection 700.01) and compliant with current requirements of the Act, as implemented in [2 CFR 184](#), [2 CFR 200.322](#), and [OMB 24-02 Memo and related requirements therein](#).

As determined by the Department within the contract prior to award, all products and/or materials will only be classified under one of the following categories: Steel and Iron, Manufactured Products, and Construction Materials. It is the Prime Contractor’s responsibility to ensure all submittals required for Buy America are submitted to the Project Engineer prior to the products and/or materials being incorporated into the work.

The following items require Buy America Certification on Federal-Aid projects:

- (a) Steel and Iron
- (b) Construction Materials

A list of items that require Buy America Certification may be viewed at www.goMDOT.com under Business Center → Engineering Standards/Guides/Manuals → Construction Materials.

Items classified as a Manufactured Product that do not include steel and iron components do not require a Buy America Certification on a Federal-Aid project. Manufactured Products are currently exempted under the 1983 waiver from FHWA. Manufactured Products are determined by the Department’s Materials Division.

To be considered a Manufactured Product, an item shall meet one of the following requirements:

- (a) The item consists of two or more of the listed construction materials that have been combined through a manufacturing process.
- (b) The item consists of at least one of the listed construction materials that has been combined through a manufacturing process with a material that is not listed as a construction material.

Buy America provisions do not apply to temporarily used items that (1) are specified to be removed at the end of the project per the contract provisions or (2) are specified to remain in place per the contract provisions and are also documented by the Department in the contract provisions to be removed in a subsequent imminent, near-term phased project.

MISSISSIPPI DEPARTMENT OF TRANSPORTATION

SPECIAL PROVISION NO. 907-108-4

CODE: (SP)

DATE: 10/07/2020

SUBJECT: Subletting of Contract

Section 108, Prosecution and Progress, of the 2017 Edition of the Mississippi Standard Specifications for Road and Bridge Construction is hereby amended as follows.

907-108.01--Subletting of Contract.

907-108.01.1--General. Delete the third sentence of the tenth paragraph of Subsection 108.01.1 on the bottom of page 72.

MISSISSIPPI DEPARTMENT OF TRANSPORTATION

SPECIAL PROVISION NO. 907-109-5

CODE: (IS)

DATE: 11/14/2023

SUBJECT: Measurement and Payment

Section 109, Measurement and Payment, of the 2017 Edition of the Mississippi Standard Specifications for Road and Bridge Construction is hereby amended as follows.

907-109.01--Measurement of Quantities. Delete the sixth full paragraph of Subsection 109.01 on page 88, and substitute the following.

If appropriate based on the specific circumstances of the project, the Contractor may request that material specified to be measured by the cubic yard or ton be converted to the other measure. The Contractor must submit this request to the Engineer. The Engineer will provide an approval or denial in writing. The decision is in the sole discretion of the Engineer. If approved, factors for this conversion will be determined by the District Materials Engineer and agreed to by the Contractor. The conversion of the materials along with the conversion factor will be incorporated into the Contract by supplemental agreement. The supplemental agreement must be executed before such method of measurement is used.

907-109.04--Extra Work.

907-109.04.1--Supplemental Agreement. Delete the second paragraph of Subsection 109.04.1 on page 90.

907-109.04.2--Force Account Agreement. Delete the last sentence of subparagraph (c) in Subsection 109.04.2 on page 91, and substitute the following.

An amount will be added equal to fifteen percent (15%) of the sum thereof, excluding sales tax.

Delete subparagraph (d) in Subsection 109.04.2 on pages 91 & 92, and substitute the following.

- (d) **Equipment.** Equipment used for force account work shall be of sufficient size and type necessary to perform the required work in an economic and expeditious manner. The Contractor must provide the manufacturer, make, model, year, type of fuel and other necessary information to determine proper hourly payment rates. Subject to advance approval of the Engineer, actual transportation cost for a distance of not more than 200 miles will be reimbursed for equipment not already on the project.

For equipment authorized by the Engineer for use on the force account work, the Engineer will use the equipment rental rates from the “*Rental Rate Blue Book*” as published on the Equipment Watch website www.equipmentwatch.com for the time period the force account work is authorized to determine payment to the Contractor. The maximum allowable rates

are determined as follows:

1. The hourly equipment rate will equal the FHWA total hourly rate. This rate takes into account adjustment factors for age and region.
2. The hourly estimated operating costs have been included in the FHWA total hourly rate.
3. The idle and standby rates shall be as listed in the "*Rental Rate Blue Book*" as reported by *Equipment Watch*.
4. These rates include the basic machine plus any necessary attachments.

Standby rates shall apply when equipment is not in operation and is approved by the Engineer to standby for later use to complete the work. Idle rates shall apply to equipment located on the project and the engine is burning fuel but no ground engaging or other components are actively engaged in meaningful work. In general, idle or standby rates shall apply when equipment is not in use, but will be needed again to complete the work and the cost of moving the equipment will exceed the accumulated standby cost. If the idle standby cost should exceed the equipment moving cost to or from the work site, the Contractor will be entitled to the moving cost only. Idle or standby rates will be used under the following conditions:

1. The equipment is totally dedicated to the force account work and not used intermittently on other work.
2. Idle or standby cost will be considered only after equipment has been operated on force account work.
3. The sum of idle or standby time and operating time shall not exceed eight (8) hours per day or 40 hours in a week.
4. Idle or standby payment will not apply to days not normally considered to be work days such as holidays, weekends, or days of inclement weather when no other work is taking place.

The Department will not pay for idle or standby time when equipment is inoperable, for time spent repairing equipment, or for the time elapsed after the Engineer has advised the Contractor that the equipment is no longer needed. The Department will determine if it will be more cost effective to pay standby time on approved equipment on site or for multiple mobilizations.

If equipment is needed, which is not included in the *Rental Rate Blue Book* as reported by *Equipment Watch*, the Department and Contractor will agree upon reasonable rental rates in writing before the equipment is used.

All equipment shall be subject to approval from day to day in accordance with the requirements of Subsection 108.05.

907-109.06--Partial Payment.

907-109.06.2--Advancement on Materials.

Delete the next to last paragraph of Subsection 109.06.2 on page 95, and substitute the following.

Materials for which an advanced payment has been allowed must be paid for by the Contractor within 30 days of the estimate on which the advanced payment was first allowed and proof of said payment must be verified by the supplier. If proof of payment is not furnished within the allowable 30 days, the advanced payment will be deducted on subsequent current estimates until such time that proof of payment is furnished.

907-109.07--Changes in Material Costs. After the fifth paragraph of Subsection 109.07 on page 96, change the web address to the following.

https://mdot.ms.gov/portal/current_letting

MISSISSIPPI DEPARTMENT OF TRANSPORTATION

SPECIAL PROVISION NO. 907-401-2

CODE: (SP)

DATE: 01/06/2025

SUBJECT: Asphalt Pavement - General

Section 401, Asphalt Pavement - General, of the 2017 Edition of the Mississippi Standard Specifications for Road and Bridge Construction is hereby amended as follows..

907-401.02--Materials.

907-401.02.6--Standards of Acceptance.

907-401.02.6.8--Acceptance Procedure for Pavement Smoothness Using Mean Roughness Index (MRI). Delete the third sentence of the second paragraph of Subsection 401.02.6.8 on page 253, and substitute the following.

The surface shall be tested and corrected to a smoothness index as described herein except those locations or specific projects that are excluded from smoothness testing with an IPS.

Delete the third, fourth and fifth paragraphs of Subsection 401.02.6.8 on pages 253 & 254, and substitute the following.

The smoothness of the surface lift will be determined for traffic lanes, auxiliary lanes, climbing lane and two-way turn lanes. Areas excluded from a smoothness test with the IPS are acceleration and deceleration lanes, tapered sections, transition sections for width, shoulders, crossovers, ramps, side street returns, etc. The roadway pavement on bridge replacement projects having 1,000 feet or less of pavement on each side of the structure will be excluded from a smoothness test. Smoothness testing shall exclude 264 feet from each transverse joint that separates the pavement from a bridge deck, bridge approach slab or existing pavement not constructed under the contract. This can apply to any other exceptions including, but not limited to, railroad crossings and manholes. Segments containing a considerable number of encroachments such as intersections, manholes, curb and gutter sections, etc. may be excluded at the Engineer's discretion.

Once paving has concluded, one final smoothness measurement shall be performed for both pay adjustments and corrective action. Multiple smoothness measurements for pay adjustments and correction can still be performed at the Engineer's discretion. These measurements must be performed at the posted speed limit or 50 miles per hour (± 5 miles per hour), whichever is lower. Measurements will be made in both wheel paths of exterior and interior lanes. The wheel paths shall be designated as being located three feet (3') and nine feet (9') from centerline or longitudinal joint, respectively. Testing will also be required on sections that have been surface corrected. No smoothness testing shall be performed when there is any residual moisture on the

pavement surface. Any additional testing shall meet the requirements of Subsection 907-403.03.2.

The surface lift will be accepted on a continuous interval basis for pavement smoothness. Continuous reporting is based upon all MRI values for a specified running interval. These values are averaged and presented at the midpoint of the specified running interval.

Delete the last sentence of the last paragraph of Subsection 401.02.6.8 on page 254, and substitute the following.

All tests and corrections shall be in accordance with AASHTO R 54, Accepting Pavement Ride Quality When Measured Using Inertial Profiling Systems.

Delete Subsection 401.02.6.9 on pages 254 & 255, and substitute the following.

907-401.02.6.9--Inertial Profiling System.

907-401.02.6.9.1--General. The Inertial Profiling System (IPS), furnished and operated by the Contractor under the supervision of the Engineer or the Engineer's representative, shall be a dual-line laser on a high speed vehicle meeting the requirements of AASHTO M 328, Standard Specification for Inertial Profiler. Additionally, each IPS should be equipped with a GPS to ensure distance measurement accuracy. The profiler system and operator shall be certified at an MDOT approved regional calibration facility in accordance with AASHTO R 56, Standard Practice for Certification of Inertial Profiler Systems and AASHTO R 57, Operating Inertial Profiler Systems.

907-401.02.6.9.2--Computer Requirements. The computer measurement program must be menu driven, Windows compatible, and able to produce unfiltered profiler runs in the Pavement Profile (*.ppf) file format. The computer shall have the ability to display and print data on site for verification and shall have the ability to save and transfer data via Universal Serial Bus (USB) flash drive, which shall be provided by the Contractor.

All runs must be stored in a directory named in the following format for acceptance by the Project Engineer:

Project_County_Route

All profiler runs must be named in the following format for acceptance by the Project Engineer:

Direction_Lane_BeginStation_EndStation

In addition to manufacturers' software; the latest version of FHWA's ProVAL software shall be installed on the IPS computer.

907-401.03--Construction Requirements.

907-401.03.1--Specific Requirements.

907-401.03.1.2--Tack Coat. After the first sentence in Subsection 401.03.1.2 on page 256, add the following.

In addition to the products listed on the Department's APL, the Contractor may use one of the following as a tack coat.

- CSS-1
- CSS-1h
- SS-1
- SS-1h

907-401.03.1.4--Density. In the first sentence of the first paragraph of Subsection 401.03.1.4 on page 256, change "preleveling" to "pre-leveling".

907-401.03.9--Material Transfer Equipment. In the third sentence of Subsection 401.03.9 on page 261, change "include:" to "include".

907-401.03.14--Shoulder Wedge. In the second sentence of the first paragraph of Subsection 401.03.14 on page 263, change "cross roads" to "crossroads".

MISSISSIPPI DEPARTMENT OF TRANSPORTATION

SPECIAL PROVISION NO. 907-403-3

CODE: (SP)

DATE: 01/06/2025

SUBJECT: Asphalt Pavements

Section 403, Asphalt Pavements, of the 2017 Edition of the Mississippi Standard Specifications for Road and Bridge Construction is hereby amended as follows:

907-403.03--Construction Requirements.

907-403.03.2--Smoothness Tolerances. In the tenth paragraph of Subsection 403.03.2 on page 283, change “Sections(s)” to “Segment(s)”.

907-403.03.2.1--Smoothness Tolerances for Mean Roughness Index (MRI). After the second paragraph of Subsection 403.03.2.1 on page 283, add the following.

For all projects, smoothness data shall be reported by two MRI methods:

1. A continuous long interval MRI report
2. A continuous 25-foot short interval MRI report

At the bottom of page 283 and top of 284 in Subsection 403.03.2.1, delete the paragraphs for Category, A, Category B, and Category C, and substitute the following.

Category A projects shall have a long interval surface MRI of not more than 60 inches per mile.

Category B projects shall have a long interval surface MRI of not more than 70 inches per mile.

Category C projects shall have the existing surface profiled at no additional cost to the State. These projects shall be measured by a long fixed interval (528-foot) surface MRI and meet the following requirements:

- A 50% improvement in MRI from the existing surface
- or
- 80 inches per mile (whichever value is higher)

Delete the first, second, and third full paragraphs on page 284, and substitute the following.

When a project has multiple lifts, the intermediate lift shall meet the short interval requirement of 160 inches per mile. Corrective action must be taken on those segments that do not meet this requirement. No unit price adjustment will be applied on the underlying lift.

Delete the table at the bottom of page 284, and substitute the following.

Mean Roughness Index (inches / mile)	Contract Price Adjustment Percent of Asphalt Unit Bid Price
Above 20.0 Over	REMOVE AND REPLACE *
15.1 to 20.0 Over	80
10.1 to 15.0 Over	85
5.1 to 10.0 Over	90
0.1 to 5.0 Over	95
Required Surface MRI	100

* In lieu of removal and replacement, segments may be brought into compliance through corrective action at the discretion of the Project Engineer.

Delete the table and footnote at the top of page 285, and substitute the following.

Mean Roughness Index (inches/mile) Percent Improvement	Contract Price Adjustment Percent of Asphalt Unit Bid Price
Below 30.1 Percent	80 **
30.1 to 35.0 Percent	80
35.1 to 40.0 Percent	85
40.1 to 45.0 Percent	90
45.1 to 50.0 Percent	95
Above 50%	100

** Segments that show less than 30 percent improvement as well as a final surface MRI greater than 100 inches/mile will be subject to removal.

Before the last paragraph on Subsection 403.03.2.1 on page 285, add the following.

Corrective action for all categories must be taken on those segments that exceed the localized roughness or the ‘Remove and Replace’ threshold. All locations must be located and marked by the Contractor and approved by the Project Engineer before corrective action shall take place. The minimum remove and replace length will be 528 feet (0.1 mile). Additional smoothness testing shall be required on segments following corrective action and/or replacement and will be required to meet *at least* the maximum surface MRI short of ‘Remove and Replace’ tolerance.

907-403.05--Basis of Payment.

907-403.05.2--Pay Items. Add the “907” prefix to the list of pay items on page 291.

MISSISSIPPI DEPARTMENT OF TRANSPORTATION

SPECIAL PROVISION NO. 907-413-2

CODE: (SP)

DATE: 05/09/2023

SUBJECT: Cleaning and Sealing Joints and Cracks

Section 413, Cleaning and Sealing Joints and Cracks, of the 2017 Edition of the Mississippi Standard Specifications for Road and Bridge Construction is hereby amended as follows.

907-413.03--Construction Requirements.

907-413.03.3--Sawing and Sealing Transverse Joints in Asphalt Pavement.

907-413.03.3.4--Sealing. Delete the last sentence of the last paragraph of Subsection 413.03.3.4 on page 333, and substitute the following.

Poured joint sealing material shall only be placed when the air temperature is within the limits specified by the manufacturer.

907-413.05--Basis of Payment. Delete the last pay item listed on page 336, and substitute the following.

907-413-E: Sawing and Sealing Transverse Joints in Asphalt Pavement - per linear foot

MISSISSIPPI DEPARTMENT OF TRANSPORTATION

SPECIAL PROVISION NO. 907-618-12

CODE: (SP)

DATE: 05/03/2024

SUBJECT: Traffic Control Management

Section 618, Maintenance of Traffic and Traffic Control Plan, of the 2017 Edition of the Mississippi Standard Specifications for Road and Bridge Construction is hereby amended as follows.

907-618.01--Description.

907-618.01.2--Traffic Control Management. Delete subparagraph (g) of Subsection 618.01.2 on page 441, and substitute the following.

- g) Perform a minimum of once-a-week inspections from the Notice to Proceed until a Partial or Final Maintenance Release is obtained. Once work begins, daily daytime inspections and weekly nighttime inspections are required on projects with predominantly daytime work, and daily nighttime inspections and weekly daytime inspections are required on projects with predominantly nighttime work. Weekly inspections will be allowed for periods outside of active construction. When lane closures are present or any non-fixed signs or traffic handling devices such as cones or barrels are in place, inspections shall be performed daily whether work is being performed or not.

907-618.05--Basis of Payment. Delete pay item 618-A on page 449 and substitute the following.

907-618-A: Maintenance of Traffic

- lump sum

MISSISSIPPI DEPARTMENT OF TRANSPORTATION

SPECIAL PROVISION NO. 907-626-11

CODE: (IS)

DATE: 06/24/2024

SUBJECT: Thermoplastic Traffic Markings

Section 626, Thermoplastic Traffic Markings, of the 2017 Edition of the Mississippi Standard Specifications for Road and Bridge Construction is hereby amended as follows.

Delete Section 626 on pages 492 thru 496, and substitute the following.

SECTION 626 - THERMOPLASTIC TRAFFIC MARKINGS

907-626.01--Description. This work consists of furnishing materials and placing thermoplastic pavement markings of the type specified in conformity with these specifications and the details shown on the plans or established. All hot-applied thermoplastic pavement markings shall be coated with a double-drop combination of optics.

This work may also consist of placing an audible bump or puck style marking system on the edge line that provides an audible and vibratory warning when driven over. The marking system shall be a road marking system of the dimensions indicated at regular and predetermined intervals.

This work may also consist of placing a profile or raised shape marking system on centerline or edge line that provides audible and vibratory warning when driven over. The marking system shall be a road marking system of the dimensions indicated and at regular and predetermined intervals. When placed on centerline, the markings system shall consist of an extruded black transverse thermoplastic bar of the dimensions indicated at regular and predetermined intervals.

This work may also consist of placing high contrast thermoplastic markings. High contrast thermoplastic markings shall consist of placing thermoplastic pavement markings over a black thermoplastic pavement marking to enhance the marking's visibility.

All pavement marking material, excluding lines over rumble strips, shall be applied using the extrusion/ribbon method. Lines placed over rumble strips shall be applied using the atomization/spray method.

Permanent pavement marking tape (permanent cold plastic tape) may be used in lieu of hot applied thermoplastic markings. Substitution will only be allowed for pay items 907-626-A through H. Substituted pavement marking tape shall be of the same color and width as that required for the hot applied thermoplastic. Unless otherwise specified, the markings, whether hot applied or pavement marking tape, shall be of the same type of material for the entire project. Stop bars and crosswalks shall not be substituted with pavement marking tape and shall be alkylid hot-applied thermoplastic markings or heat-fused preformed pavement markings. Material and construction requirements for substituted pavement marking tape shall meet the requirements of Special

Provision 907-628. The layout and spacing for substituted pavement markings will remain as shown in the plans, or in the contract documents, for hot applied thermoplastic markings. Measurement of adhesive substituted pavement markings shall be made in accordance with Special Provision 907-628. Payment for adhesive substituted pavement markings shall be made at the unit price for the appropriate hot applied thermoplastic marking.

When thermoplastic pavement markings are used on bridge decks or concrete surfaces, the surface shall be sealed with an epoxy sealer prior to the application of thermoplastic.

907-626.02--Materials. All pavement marking materials shall meet the requirements of Special Provision 907-720-3.

Thermoplastic pavement marking material may be sampled in the field at the time of application by sampling from the marking equipment at the point of extrusion. Samples should be cooled until solid and then packaged into large re-closeable plastic bags and placed into a cardboard box for transport. Field samples will be tested at random or as determined necessary by the Department.

The Contractor shall supply the materials to be used for sampling and packaging. Department personnel shall witness the sampling and shall be responsible for transportation of the sample for testing.

907-626.02.1--Audible Bumps. Audible bumps shall have a profile such that the leading and trailing edges are sloped at a sufficient angle to create an audible and vibratory warning.

Audible bumps shall be at least 0.45 inches above the pavement surface at the highest point of the bump. The height shall be measured after the application of drop-on material. The bumps shall have a minimum dimension of two and one-half inches (2½") in both transverse and longitudinal directions. The bumps may have a drainage channel. The width of each drainage channel shall not exceed one-quarter of an inch (¼") at the bottom of the channel.

907-626.02.2--Audible Transverse Bars. The length of transverse bars is the measurement lateral to the direction of travel, also known as transverse width. The width of transverse bars is the measurement parallel to the travel way.

Transverse bars on centerline shall have a length of 10 inches, a width of three inches (3"), and a height of 350 mils. Transverse bars on centerline shall be placed on 2-foot centers through no-passing zones and 5-foot centers through passing zones. Transverse bars on centerline shall be placed in advance of permanent thermoplastic markings.

Transverse bars on edge lines shall have a length of six inches (6"), a width of three inches (3"), and a height of 350 mils. Transverse bars on edge lines shall be placed on 2-foot centers. Tolerance for the longitudinal and transverse measurements shall be one quarter of an inch (¼") and the tolerance for height shall be 50 mils. The above dimensions are based on 6-inch strip application.

Thermoplastic material for edge line transverse bars shall be as specified on the Plans and meet

the requirements of Special Provision 907-720-3 or as specified on the plans. Thermoplastic material for centerline transverse bars shall be black and shall meet the requirements of Special Provision 907-720.

907-626.02.3--High Contrast Markings. High contrast markings shall be black with the pertinent marking color overlaid on top and shall meet the requirements of Special Provision 907-720-3.

907-626.03--Construction Requirements.

907-626.03.1--Equipment. Equipment for hot application shall be of sufficient size and stability to ensure smooth, uniform, properly aligned markings of the dimensions specified. The equipment shall be suitably equipped for heating and controlling the flow of the material. The equipment shall be constructed to provide continuous mixing and agitation of the material. The conveying parts of the equipment, between the main material reservoir and applicator, shall be so constructed as to prevent accumulation and clogging. The equipment shall be constructed so that all mixing and conveying parts, up to and including the applicator, maintain the material at the plastic temperature. The thermoplastic material shall be dispensed at a temperature recommended by the manufacturer. The applicator shall include a cutoff device remotely controlled to provide clean, square stripe ends and to provide a method for applying skip lines. The thermoplastic reservoir shall be insulated and equipped with an automatic thermostatic control to maintain the proper temperature of the material.

The application equipment shall be capable of automatic placement of intermittent and continuous line patterns in single or double line applications simultaneously. The intermittent timer mechanism shall provide a variable ratio of materials applied and variable cycle length such that accurate placement of new patterns, or replacement of existing patterns can be achieved.

When edge lines are placed over rumble strips, the equipment must be able to apply the marking material using the atomization/spray method instead of extrusion/ribbon method.

The equipment shall also be capable of applying the top dressing of optics (beads) in a manner that firmly embeds them into the surface of the thermoplastic material for at least one half of the diameter of the larger gradation sizes of the optics. The dispensing equipment shall be equipped with an automatic cut-off control for the application of the optics that is synchronized with the cut-off of the thermoplastic material.

Optics applied to the surface of the completed stripe shall be applied by an automatic dispenser attached to the pavement marking equipment in such a manner that the optics are immediately dispensed upon the completed line. The dispenser shall be equipped with an automatic cutoff control, synchronized with the cutoff of the pavement marking equipment. The double-drop optics as defined in 907-720-3 shall be automatically applied at a uniform rate to achieve the minimum retroreflectivity requirements of 907-626.03.3.

Upon request, the Engineer will establish the control points for markings at necessary intervals not to exceed 600 feet on tangents and more often on curves. All additional work necessary to establish intermediate control points shall be performed by the Contractor. On curves, unsightly variations

from the normal curvature will not be permitted unless specifically shown on the plans or ordered by the Engineer.

When edge lines are placed over rumble strips, the equipment must be able to apply the marking material using the atomization/spray method instead of extrusion/ribbon method. To ensure the proper alignment of the rumble stripes, the Contractor will be required to place a layout line to be followed during installation of the edge lines over the rumble strips.

907-626.03.2--Construction Details. The thermoplastic compound shall be screed or ribbon extruded to the pavement surface. Heat-fused, pre-formed pavement markings shall be fusible to asphalt surfaces by means of the normal heat of a propane weed-burner type of torch or other heating device as recommended by the manufacturer. Heat-fused, pre-formed pavement markings shall be instantly highly reflective without the application of additional optics.

Thermoplastic markings shall not be applied to the pavement surface when the pavement surface temperature is less than 55°F. The pavement surface shall be dry, to the satisfaction of the Engineer, before application will be permitted. Unless otherwise specified by the manufacturer, thermoplastic pavement marking material shall be applied to the surface between 400°F and 450°F with a recommended application temperature being 420°F.

Immediately before application, all areas to be marked shall be thoroughly cleaned. Cleaning may be done by rotary brooms, air blast, scrapers, or whatever combination of equipment is necessary to clean the pavement thoroughly without damage to the pavement surface. On areas of pavement cured with compound, the membrane shall be removed completely by shot blasting, sand blasting or other approved method. Before edge striping, particular care shall be taken to remove all vegetation, loose soil, and the like from the area to be marked. Should other methods fail, the surface shall be wetted with a water jet and scrubbed as necessary to dislodge all foreign material. After washing, the surface shall be allowed to dry thoroughly, and all films of dried mud apparent after surface drying shall be removed before application of markings. Marking shall follow as closely as practicable after the surface has been cleaned and dried, but no markings shall be applied until the surface has been inspected and permission given to proceed. The cost for preparing the surface shall be included in the contract unit prices for the marking items.

Unless otherwise directed by the Engineer, traffic stripes that are conflicting with the thermoplastic stripe shall be removed prior to placement of the thermoplastic material. Removal of pavement markings shall be done by a means that will not gouge the surface of the pavement in a manner that requires patching to ensure the integrity of the pavement. Temporary paint stripe may be left in place when satisfactorily placed in the proper location. Any temporary stripe not covered shall be removed. Payment for removal of stripe, except temporary stripe, will be made under Section 202.

On newly constructed asphalt pavements, any sand, grit, or other surface contaminants shall be removed using compressed air and/or sweeping. Water blasting may be necessary to remove surface contaminants which cannot be removed by the use of compressed air and/or sweeping. This work is considered surface preparation.

The finished lines shall have well defined edges and the thickness of thermoplastic markings above the roadway surface shall be no less than 90 mils for edge lines, center lines, lane lines, barrier lines, and detail stripe including gore markings, and no less than 120 mils for crosswalks, stop lines, and railroad, word and symbol markings. The minimum thickness, as required above, will be measured in the center of the line when gauged. The minimum thickness one-half inch (1/2") from the edges shall not be less than 75% of the thickness required in the center.

Any thermoplastic traffic marking less than the required thickness shall be corrected by recapping at no additional costs to the Department. Although a thickness tolerance of 25 percent from center to edge is allowed, a consistent underrun of any amount in thickness as determined by the Engineer will not be acceptable.

The length and width of lines shall be within a tolerance of ±3 inches and ±1/8 inch, respectively. For skip markings, the tolerance for intervals shall not exceed the line length tolerance. On curves, unsightly variations from the normal curvature will not be permitted unless specifically shown on the plans or ordered by the Engineer.

Heat-fused, pre-formed pavement markings shall be supplied with a minimum average thickness of 90 mils before application on the roadway surface.

All newly applied thermoplastic material shall be protected from traffic until the material is sufficiently dry so as not to sustain damage from vehicle tires. Any material so damaged by traffic shall be repaired, and the thermoplastic material tracked onto the pavement shall be removed and replaced.

907-626.03.3--Reflectivity Requirements. The longitudinal pavement markings shall meet the following retroreflectivity values when measured within 10 to 30 calendar days of placement, after removing loose beads.

Table 1. Minimum Dry Retroreflectivity

Color	All Stripe without Rumble mcd/m ² /lx	Rumble Stripe mcd/m ² /lx
White	375	250
Yellow	275	150

907-626.03.3.1--Measuring Devices. Retroreflectivity measurements shall be taken using a vehicle mounted mobile retroreflectometer using 30-meter geometry with video and mapping capabilities as per AASHTO T-398. The retroreflectometer and operator shall be certified by the manufacturer, authorized representative of the manufacturer, or an MDOT approved program such as the Texas A&M Transportation Institute (TTI) Mobile Retroreflectometer Certification Program.

907-626.03.3.2--Acceptance Procedure. Averages of the mobile measurements shall be provided for every 0.1 miles unless otherwise specified or approved. Take measurements on each section of roadway for each series of markings (i.e., edge line, center skip line, each line of a double line, etc.) and for each direction of traffic flow. Measure each line in both directions for centerlines on two-way roadways (i.e., measure both double solid line in both directions and measure all center

skip lines in both directions). Furnish measurements in compliance with the below requirements. Use all equipment in accordance with the manufacturer's recommendations and directions. Inform the Engineer at least 24 hours before taking any measurements.

A marking meets the retroreflectivity requirements if:

- The combined average retroreflectivity measurement for a one-mile segment meets the minimum retroreflectivity values specified, and
- No more than 30% of all the retroreflectivity measurement values are below the minimum retroreflectivity requirements value within the one-mile segment.

The one-mile segment will start from the beginning of the data collection and end after a mile worth of measurements have been taken; each subsequent mile of measurements will be a new segment. Centerlines with two (2) stripes (either solid or broken) will result in two (2) miles of data for each mile segment. Each centerline stripe must be tested for compliance as a stand-alone stripe.

The Contractor may elect to restripe with a minimum of 0.060 in. (60 mils) at no cost to the Department each one-mile segment that failed to meet the minimum retroreflectivity requirements. Measurements shall be retaken within 10 to 30 calendar days after the second application for the mile segment for that series of markings. If the markings do not meet minimum retroreflectivity after the second application, the Engineer may require removal of all existing markings, a new application as initially specified, and a repeat of the application process until minimum retroreflectivity requirements are met.

907-626.03.3.3--Mobile Retroreflectivity Data Collection. Mobile Retroreflectivity Data Collection (MRDC) shall be conducted on dry pavement only and when the ambient air temperature is greater than 40°F. Data shall be submitted to the Engineer no later than 3 working days after the day the data is collected. Submit all raw data collected in addition to all other data submitted. Provide data files in Microsoft Excel format or a format approved by the Engineer. The data file and video must contain the following information.

907-626.03.3.3.1--Data File. Data files shall be provided with the following:

- Date;
- District;
- County;
- Name of mobile retroreflectometer operator;
- Route number with reference markers or other reference information provided by the Engineer to indicate the location of beginning and end data collection points on that roadway;
- Cardinal direction;
- Line type (single solid, single broken, double solid, etc.);
- Line color;
- File name corresponding to video;
- Data for each centerline listed separately;

- Average reading taken for each 0.1-mi. interval (or interval designated by the Engineer);
- Accurate GPS coordinates (within 20 ft.) for each interval;
- Color-coding for each interval indicating passing or failing, unless otherwise directed by the Engineer (passing and failing thresholds provided by the Engineer);
- Graphical representation of the MRDC (y-axis showing retroreflectivity and x-axis showing intervals) corresponding with each data file;
- Distance in miles driven while measuring the pavement markings;
- Event codes (pre-approved by the Engineer) indicating problems with measurement;
- Upper validation threshold (may be included separately with the raw data but must be clearly identified with the data collected using that threshold).

907-626.03.3.3.2--Map. A map shall be provided in an electronic format approved by the Engineer with each MRDC submission that includes the following information:

- Date;
- District number;
- County;
- Color-coded 1-mi. intervals (or interval length designated by the Engineer) for passing and failing retroreflectivity values or retroreflectivity threshold values provided by the Engineer; and
- Percentage of passing and failing intervals, if required by the Engineer.

907-626.03.3.3.3--Video. A high-quality video file shall be provided with the following information:

- Date and corresponding data file name on label;
- District number;
- County;
- Route number with reference markers or other designated reference information to indicate the location of beginning and end collection points on that roadway; and
- Retroreflectivity values presented on the same screen with the following information:
 - Date;
 - Location;
 - Starting and ending mileage;
 - Total miles;
 - Retroreflectivity readings; and
 - Upper validation thresholds (may be included separately with the raw data but must be clearly identified with the data collected using that threshold).

907-626.03.4--Reflectivity Verification Testing. The Engineer or a third party may perform retroreflectivity verification testing on any project. At a minimum, each Contractor performing work for the Department will be verified on an annual basis. The Contractor-submitted retroreflectivity data will be compared to the verification test data to determine acceptability of the Contractor's mobile retroreflectometer data. Comparison of the data will result in one of the two scenarios below:

- Contractor's Data is Validated – If the difference between Contractor's and Engineer/third party data is 20% or less, then the Contractor's data is validated. The Contractor's data will be used for acceptance.
- Contractor's Data is not Validated – If the difference between Contractor's and Engineer/third party data is more than 20%, then the Contractor's data is not validated. The Engineer/third party data will be used for acceptance and the Contractor will be required to take corrective action prior to additional Contractor data collection and may require re-certification of the mobile retroreflectometer.

907-626.04--Method of Measurement. Thermoplastic stripe completed in accordance with the plans and specifications will be measured by the mile or by the linear foot, as indicated, from end-to-end of individual stripes. In the case of skip lines the measurement will include skip intervals. The length used to measure centerline, lane lines, and edge stripes will be the horizontal length computed along the roadway.

Detail traffic stripe will be measured by the linear foot from end-to-end of individual stripes. Measurements will be made along the surface of each stripe and will exclude skip intervals where skips are specified. Stripes more than six inches (6") in width will be converted to equivalent lengths of 6-inch stripe.

Hot-applied legend, which is to include railroad markings, pedestrian crosswalks, and stop lines, will be measured by the square foot or linear foot. Pay areas of individual letters and symbols will usually be shown on the plans and measured by the square foot. Transverse railroad bands, pedestrian crosswalks and stop lines will generally be measured by the linear foot, in which case, stripes more than six inches (6") in width will be converted to equivalent lengths of 6-inch widths.

Pre-formed legend which is to include railroad markings and pedestrian crosswalks will be measured and paid for by each.

The length measured for thermoplastic audible bump edge stripe will not include the permanent thermoplastic edge stripe. Permanent thermoplastic edge stripe will be measured for payment under a separate pay item.

Thermoplastic audible bar centerline skip stripe will be measured by the linear foot or mile. Measurements will be made along the surface from end-to-end of the stripe and will include skip intervals. The length used to measure audible bar centerline stripe will be the horizontal length computed along the roadway. The length measured for thermoplastic audible bar centerline skip stripe will not include the permanent centerline continuous or skip stripe. Permanent centerline continuous and skip stripe will be measured for payment under separate pay items.

Thermoplastic audible bar edge stripe will be measured by the linear foot or mile. Measurements will be made along the surface from end-to-end of the stripe. The length used to measure thermoplastic audible bar edge stripe will be the horizontal length computed along the roadway. The length measured for thermoplastic audible bar edge stripe will not include the permanent thermoplastic edge stripe. Permanent thermoplastic edge stripe will be measured for payment

under a separate pay item.

907-626.05--Basis of Payment. Thermoplastic traffic markings will be paid for at the contract unit price per mile, linear foot, square foot or each as applicable. Any deductions for non-satisfactory material test results will be made after final testing has been performed.

Payment will be made under:

- 907-626-A: 6" Thermoplastic Traffic Stripe, Skip White - per linear foot or mile
- 907-626-B: 6" Thermoplastic Traffic Stripe, Continuous White - per linear foot or mile
- 907-626-C: 6" Thermoplastic Edge Stripe, Continuous White - per linear foot or mile
- 907-626-D: 6" Thermoplastic Traffic Stripe, Skip Yellow - per linear foot or mile
- 907-626-E: 6" Thermoplastic Traffic Stripe, Continuous Yellow - per linear foot or mile
- 907-626-F: 6" Thermoplastic Edge Stripe, Continuous Yellow - per linear foot or mile
- 907-626-G: Thermoplastic Detail Stripe, Color * - per linear foot
- 907-626-H: Thermoplastic Legend, Color * - per linear foot, square foot, or per each
- 907-626-Q: Thermoplastic Audible Bump Edge Stripe -per linear foot or mile
- 907-626-R: Thermoplastic Detail Audible *** Stripe, Color **, -per mile
- 907-626-AA: 6" High Contrast Thermoplastic Traffic Stripe, Skip White - per linear foot or mile
- 907-626-BB: 6" High Contrast Thermoplastic Traffic Stripe, Continuous White - per linear foot or mile
- 907-626-CC: 6" High Contrast Thermoplastic Edge Stripe, Continuous White - per linear foot or mile
- 907-626-DD: 6" High Contrast Thermoplastic Traffic Stripe, Skip Yellow - per linear foot or mile
- 907-626-EE: 6" High Contrast Thermoplastic Traffic Stripe, Continuous Yellow - per linear foot or mile
- 907-626-FF: 6" High Contrast Thermoplastic Edge Stripe, Continuous Yellow - per linear foot or mile

907-626-GG: High Contrast Thermoplastic Detail Stripe, Color * - per linear foot

907-626-HH: High Contrast Thermoplastic Legend, Color * - per linear foot, square foot,
or each

- * Indicate Blue - ADA if applicable
- ** Indicate White or Black
- *** Indicate Centerline - Passing Zone, Centerline - No-Passing Zone, or Edge Line

MISSISSIPPI DEPARTMENT OF TRANSPORTATION

SPECIAL PROVISION NO. 907-627-1

CODE: (IS)

DATE: 06/24/2024

SUBJECT: Raised Pavement Markers

Section 627, Raised Pavement Markers, of the 2017 Edition of the Mississippi Standard Specifications for Road and Bridge Construction is hereby amended as follows:

Delete Subsection 627.02 on page 496, and substitute the following.

907-627.02--Materials. Pavement and jiggle markers of the types specified shall conform to the applicable requirements of Subsection 907-720.06 and shall be listed on the Department's APL.

Type B through G High Performance reflective markers shall be listed on the Department's APL for high performance raised pavement markers.

The bituminous adhesive for pavement markers shall meet the requirements of Subsection 907-720.07.3.

907-627.05--Basis of Payment. Add the "907" prefix to the pay items listed on page 498.

MISSISSIPPI DEPARTMENT OF TRANSPORTATION

SUPPLEMENT TO SPECIAL PROVISION NO. 907-631-1

DATE: 08/27/2024

SUBJECT: Traffic Signal Systems - General

Before Subsection 907-631.02.4 on page 1, add the following.

907-631.02.3--Regulations and Code. At the end of the second paragraph, add the following.

The Certified IMSA Traffic Signal Construction Technician Level II employee is not required to be on-site during construction. Proof of this certification shall be provided prior to award of contract.

MISSISSIPPI DEPARTMENT OF TRANSPORTATION

SPECIAL PROVISION NO. 907-631-1

CODE: (IS)

DATE: 11/15/2017

SUBJECT: Traffic Signal Systems - General

Section 631, Traffic Signal Systems - General, of the 2017 Edition of the Mississippi Standard Specifications for Road and Bridge Construction is hereby amended as follows.

907-631.02--Materials.

907-631.02.4--Operations. Delete the second paragraph in Subsection 631.02.4 on page 513 and substitute the following.

The Contractor shall conduct the work at all times in such a manner as to ensure the least possible inconvenience to the traveling public, and to property owners on the streets, alleys, and other public places where the construction will take place.

907-631.02.5--Electrical Service. Delete the first paragraph in Subsection 631.02.5 on page 515 and substitute the following.

It shall be the Contractor's responsibility to make the necessary arrangements with the local power company to provide the electrical service for any new installation. The Contractor shall pay for, at no cost to the Department, all deposits, hook-up charges, or other service fees required by the power company for the establishment of new service. The cost of all such fees shall be considered incidental and absorbed within existing pay items. The Department or the local agency will be responsible for payment of the monthly service bill for the new power service installation. It shall be the responsibility of the Contractor to swap the electrical service account over to the Department or local agency.

907-631.03--Construction Requirements.

907-631.03.2--Electrical Service Equipment. Delete the paragraphs of Subsection 631.03.2 on pages 515 and 516, and substitute the following.

The power supply assembly shall consist of all equipment mounted in a Power Service Pedestal as described in Subsection 722.13 or as otherwise shown in the plans. The configuration and installation of the equipment mounted on the assembly shall meet the safety requirements and approval of the utility company or municipality furnishing power for operation.

When required, service poles shall be provided by the Contractor and consist of wood poles with required pole line hardware, conduit, ground rods, guy wires and anchors and all other accessories and appurtenances mounted on the pole, except those items furnished by the utility company or

municipality, or as specified separately in the contract or plans. Costs of service poles shall be included in other items bids.

Main disconnect switches shall be separately housed on the power supply assembly. Circuit breaker cabinets and meters shall not be installed on the street or walk side of the pole or pedestal.

907-631.03.3--Performance Tests. Delete the second sentence of Subsection 631.03.3 on page 516.

MISSISSIPPI DEPARTMENT OF TRANSPORTATION

SPECIAL PROVISION NO. 907-632-1

CODE: (IS)

DATE: 11/15/2017

SUBJECT: Traffic Signal Cabinet Assemblies

Section 632, Traffic Signal Cabinet Assemblies, of the 2017 Edition of the Mississippi Standard Specifications for Road and Bridge Construction is hereby amended as follows.

Delete Section 632 on pages 517 thru 538, and substitute the following.

SECTION 907-632 - TRAFFIC SIGNAL CABINET ASSEMBLIES

907-632.01--Description. This work consists of furnishing, assembling, configuring and installing all component materials and software required to form completed traffic signal controller assemblies, closed loop master controller assemblies and signal system installation of the types specified, in conformity with these specifications, to ensure fully operational traffic signal installations as shown on the plans.

907-632.02--Materials.

907-632.02.1--Cabinet Assembly. Cabinet Assemblies shall meet the NEMA 3R requirements and be constructed principally of 0.125-inch thick, 5052-H32 aluminum. The aluminum shall have a mill finish per NEMA TS 2 7.7.3. Intermittent welds may be used for construction and any unwelded cabinet seams shall be sealed with clear RTV silicone. All external fasteners shall be stainless steel and no holes will be allowed in top of cabinet.

The door handles shall be stainless steel or cast aluminum. Door hinges shall be of the continuous type with a stainless steel hinge pin. Rivets are not be used to attach the hinge. The main door stop rod shall be constructed using stainless steel. The door stop mechanism shall be adjustable and capable of being securely latched in multiple opened positions including 90 degrees and a maximum of 120 degrees. The brackets attaching the stop rod to the door and cabinet shall be aluminum and welded in place. The main door cylinder lock shall be a #2 key type lock. Two (2) traffic industry standard No. 2 keys shall be provided with each cabinet and shall be made using heavy duty key blanks.

Extruded aluminum channels permanently attached to the right and left cabinet sides shall be provided for attaching adjustable shelving and mounting of other component panels. The cabinet shall have two (2) shelves installed. Both shelves shall be provided with the front edge pre-drilled with 0.25-inch holes located twelve (12) inches apart.

907-632.02.2--Physical Features.

907-632.02.2.1--Pull Out Drawer. A pull out drawer shall be installed and centered under the

bottom shelf. The drawer shall be made of 0.080-inch thick, 5052-H32 aluminum and come out on full extension drawer slides. The pull out drawer shall provide an approximate 16-inch x 14-inch working area and have the ability to bear a constant 25 pound burden. There shall be a compartment for document storage. The lid shall be hinged at the rear, to gain access to the storage area. The drawer will be used to store documents as well as support a notebook computer. The drawer slides shall be of the full extension ball bearing type. Dimensions of the drawer shall be large enough to support a notebook computer and a drawer of sufficient size to hold at least two (2) copies of the cabinet drawings and other related cabinet documentation. The surface of the lid shall have a non-slip surface.

907-632.02.2.2--Cabinet Lighting. Cabinets shall be provided with a minimum of two (2) white light LED modules. One (1) lighting module shall be installed along the front top section of the cabinet and the second lighting module shall be installed underneath the bottom cabinet shelf in such a location as to provide direct lighting of the load bay area of the cabinet but must not interfere with the cabinet drawer operation.

Both LED lighting modules shall be controlled by a NEMA rated, commercial quality, pushbutton door switch. The cabinet lighting shall turn on when the cabinet main door is opened and shall turn off when the main door is closed or an ON/OFF NEMA rated, commercial quality, toggle switch mounted on the inside cabinet door service panel shall be provided to turn both LED lighting modules on or off.

907-632.02.2.3--Police Panel Switches. Police panel switches shall be provided with all controller cabinets. All switches shall be hard wired and labeled as to their function.

NORMAL-FLASH: When this switch is in the FLASH position, all signal indications shall transfer to the flashing mode. AC power shall be removed from the load switches when the signal indications transfer to the flashing mode.

The controller unit shall operate in accordance with appropriate specifications during the flashing mode. When the switch is placed in the NORMAL position, transfer from the flash mode to normal operation shall be made in accordance with uniform code flash requirements.

SIGNAL ON-OFF: AC power shall be removed from the signal heads and the intersection will become dark when this switch is in the OFF position.

MANUAL CONTROL ON-OFF: When this switch is in the ON position, a logic ground shall be applied to the manual control enable input of the controller unit.

INTERVAL ADVANCE INPUT JACK: A manual jack shall be installed on the police panel. The jack shall inter-mate with a 3-circuit, ¼-inch diameter phone plug. The tip and ring (middle) circuits of the jack shall be connected to the logic ground and the interval advance inputs of the controller unit. When the manual hand cord is plugged into the jack and the pushbutton is pressed, logic ground shall be connected to the interval advance input of the controller unit.

When specified in the contract documents, an interval advance cord shall be provided. The cord

shall have a minimum length of three (3) feet. It shall have a 1/4-inch diameter, three circuit plug connected to one end and a manual pushbutton enclosed in a hand-held enclosure at the other end. A complete cycle (push-release) of the manual pushbutton shall terminate the controller unit interval which is active except the vehicular yellow and red clearance intervals. Cycling the push-button during the vehicular yellow or all red clearance intervals shall not terminate the timing of those intervals.

907-632.02.2.4--Service Panel Switches. Service panel switches shall be hard wired and clearly labeled to identify as to their functions. Service panel switches shall be mounted on the service panel located on the inside of the main cabinet door. Alternate switch locations may be described in the plans or contract documents but final switch design and location shall be approved by the Engineer prior to cabinet fabrication.

NORMAL-FLASH: When this switch is in the FLASH position, all signal indications shall transfer to the flashing mode. AC power shall be removed from the load switches when the signal indications transfer to the flashing mode.

The controller unit shall operate in accordance with appropriate specifications during the flashing mode. When the switch is placed in the NORMAL position transfer from the flash mode to normal operation shall be made in accordance with uniform code flash requirements.

CONTROLLER ON-OFF: When this switch is in the OFF position, AC power shall be removed from the controller. When this switch is returned to the ON position, the controller unit shall perform normal start up functions and resume normal operation in accordance with the applicable specification.

STOP TIME-RUN-NORMAL: A 3-position manual switch shall be provided which places the controller into Stop Time mode manually or through remote input.

VEHICLE DETECTORS: A 3-position switch shall be provided for each vehicle and pedestrian detector circuit. All switches shall be located on a panel mounted on the inside of the main cabinet door. The switch panel shall be labeled CALL SWITCH. Labeling of phase number and intended function (vehicles or pedestrian calls) shall be provided for each switch.

The vehicle detector switch functions are defined as follows:

- Locked Call Call is continually placed into the controller unit.
- Off (center) Vehicle detector is connected to the controller unit vehicle detector input, i.e. normal detector operation.
- Momentary Call Call is continuous as long as the switch is manually held in this position.

907-632.02.2.5--Police and Service Panel Locations. The police and service panels shall be constructed of 5052-H32 0.125-inch thick aluminum.

The police panel shall be located behind the police door which is enclosed within the main door.

The police door shall be hinged and provided with a neoprene gasket seal. Access to any portion or equipment contained behind the main cabinet door shall not be accessible through any part of the police panel. The police panel shall be of appropriate dimensions to accommodate all switch or devices described within this specification, the plans or contract document. The police door shall be provided with a treasury #2 key type lock and two (2) keys for the police door lock shall be provided with each cabinet.

The service panel shall be mounted on the inside portion of the main cabinet door, adjacent to the back side of the police panel or on the left hand side of the cabinet.

907-632.02.2.6--Cabinet Ventilation. Cabinets shall be vented to allow dissipation of the heat generated by the equipment contained within. All cabinets shall have a thermostatically controlled exhaust fan located at the top of the cabinet that is capable of 100 cubic feet per minute air displacement. The thermostat shall be mounted on the inside top of the cabinet and shall have a nominal temperature range from 80°F to 170°F.

The intake vent shall be louvered or equivalent design to prevent rain infiltration. The vent area will be located along the bottom portion of the cabinet door. A 16-inch x 12-inch x 1-inch disposable pleated air filter shall be provided on the inside portion of the cabinet and shall fully cover the vent area.

907-632.02.2.7--Air Filter Assembly. Air filters shall be one piece and shall be held firmly in place against the cabinet door in order to prevent dust from bypassing the perimeter of the filter and shall fully cover the vent area. Wing nuts or thumbscrews are preferred. Air filter shall be a 16-inch x 12-inch x 1-inch disposable pleated filter.

907-632.02.2.8--Cabinet Sizes.

907-632.02.2.8.1--Type I Cabinet. A Type I cabinet, 51”H x 30”W x 18”D, may be used for both pole and base mounted cabinets that require a maximum eight (8) position load bay. Pole mounted cabinets do not require rear access.

907-632.02.2.8.2--Type II Cabinet. A Type II cabinet, 51”H x 36”W x 18”D, may be used for both pole and base mounted cabinets that require a maximum twelve (12) position load bay. Pole mounted cabinets do not require rear access.

907-632.02.2.8.3--Type III Cabinet. A Type III cabinet, 56”H x 44”W x 27”D, shall be used for base mount installations and shall require a sixteen (16) position load bay and rear access door.

907-632.02.2.8.4--Type IV Cabinet. A Type IV dual chamber cabinet, 56”H x 57”W x 29”D, shall be used for base mount installations and shall require a sixteen (16) position load bay, rear access door, and external generator plug. When called for in the plans, a UPS shall be housed inside this cabinet.

907-632.02.2.8.5--Type V Cabinet. A Type V cabinet, 77”H x 44”W x 27”D, shall be used for base mount installations and shall require a sixteen (16) position load bay and rear access door.

907-632.02.3--Power Distribution Panel. The power panel shall be wired to provide the necessary power to all equipment. It shall be manufactured from 0.125-inch thick, 5052- H32 aluminum. The power panel shall house the following components: Main Breaker, Auxiliary Breakers, and Terminal Block. The panel shall be of such design so as to allow a technician to easily access the main and auxiliary breakers.

A 3-position terminal block with a removable insulated cover accepting up to AWG #4 stranded wire shall be supplied for accepting only the incoming power lines. This terminal block shall be in advance of and supply only the 30-amp main breaker, 10-amp and 5-amp Auxiliary breakers, AC neutral buss and earth ground buss.

907-632.02.3.1--Ground and Neutral Busbars. Cabinet grounding shall meet the requirements set forth in Subsection 722.09 for grounding and ground rods. A solid copper ground busbar shall be mounted on the side of the cabinet wall adjacent to the power panel for the connection of chassis ground wires. If more than one (1) ground busbar is used in a cabinet, a minimum of an AWG #6 copper wire shall be used to bond them.

The copper ground busbar shall have a minimum of thirteen (13) connector points, each capable of securing at least one (1) AWG #6 conductor.

A solid copper neutral busbar shall be mounted on the side of the cabinet wall adjacent to the power panel for the connection of AC neutral wires.

The copper neutral busbar shall have a minimum of thirteen (13) connector points, each capable of securing at least one (1) AWG #6 conductor.

907-632.02.3.2--Terminal Strips. Conductors shall be terminated on terminal strips with insulated terminal lugs. When two (2) or more conductors are terminated on field wiring terminal strip screws, a terminal ring lug shall be used for termination of those conductors. The voltage and current rating of terminal strips shall be greater than the voltage and current rating of the wire which is terminated on the terminal strip.

907-632.02.3.3--Cabinet Receptacles. A 3-wire 115 Volt AC (15A) Ground Fault Circuit Interrupt (GFCI) duplex receptacle shall be provided in the cabinet for maintenance use. It shall be securely mounted near the bottom right side of the cabinet and easily accessible.

Two (2) 3-wire 115 Volt AC (15A) non-GFCI protected outlets shall be installed, one on each side of the cabinet. These two (2) outlets are used for communication or other auxiliary equipment.

907-632.02.3.4--Operating Line Voltage. All equipment shall be designed to operate from a 120 volt, 60 cycle AC supply. Operation shall be satisfactory at voltages from 105 volts to 130 volts. All operating voltages into and out of the controller shall be NEMA level DC voltages except for the controller AC power source (Connector A, Pin p – AC-Control and Pin U – AC Common).

907-632.02.3.5--Circuit Breakers. Circuit breakers shall meet the requirements set forth in

Subsection 722.07. A 30-amp main breaker, with a minimum of 10,000 amp interrupting capacity, shall be provided for all cabinets to supply power to the controller, MMU, signals, and rack power supply.

Two (2) auxiliary breakers shall be provided. The first breaker, 10-amp, shall supply power to the fan, light, GFCI utility receptacle and two (2) auxiliary standard receptacles. The second breaker, 5-amp, shall be installed to supply power for the Controller Unit and MMU2. The above circuit breakers line side shall be jumpered together and will be fed from an external main circuit. A third 5-amp breaker shall be required if an ITS camera panel is called for in the plans.

907-632.02.3.6--Main Line Arrestors. Surge protection shall be provided that meets the requirements set forth in Subsection 722.12. A main line arrestor shall be provided to reduce the effects of voltage transients on the AC power line. It shall be installed after the circuit breaker. The main line arrestor shall be sufficient to protect all equipment and devices as per the plans and the following minimum specifications.

- Multi-stage Hybrid Design
- Series induction filtering
- Thermally protected Metal Oxide Varistors (TMOV's)
- Operating Voltage: 120 VAC
- Clamping Voltage: 395 VAC
- Operating Current: 15 A
- Peak Surge Current: 50 kA/Mode, 100 kA/Phase
- Operating Frequency: 47-63Hz
- EMI Attenuation: 40 dB Typ
- SPD Technology: TMOV's w/ W-C Filter
- Modes of Protection: L-N, L-G, N-G
- Status Indication: Power On & TMOV's Functional
- Connection Type: ¼-20 Stainless Steel Stud
- Operating Temperature: -40°F to +185°F

907-632.02.3.7--Solid State Main Line Relay (SSR). A normally-open, 75-amp, hybrid SSR shall be provided on the power distribution panel. The relay shall include a LED indicator to verify circuit power.

907-632.02.4--Terminal Facilities Board. The Terminal Facility shall be a hardwired load bay for NEMA TS 2 Type 1 actuated controllers. The load bay shall include either eight (8), twelve (12) or sixteen (16) load switch positions, as specified by the plans, and shall be centered along the back of the cabinet below the bottom shelf.

All wires terminated behind the backboard, as well as any additional panels, shall be soldered. No pressure or solderless connectors shall be used, unless they are soldered to the wire and tab after connection.

907-632.02.4.1--Load Switches and Flashers. Solid State Load Switches, compatible with low

wattage LED signals, shall be provided for the sequence called for on the plans. The load switch sockets shall be wired for triple-signal load switches conforming to NEMA TS 1-1994 and NEMA TS 2-2003 requirements.

The flasher socket shall be wired for and provided with a Type 3, two (2) circuit Solid State Flasher conforming to NEMA TS 1-1994 and NEMA TS 2-2003 requirements. It shall be possible to flash either the amber or red indication on any load switch outputs. It shall be possible to easily change the flash indication from the front side of the panel using readily available tools such as a screwdriver. A nominal flash rate of 50 to 60 FPM shall be provided. Flash rate shall be stable when used with generators or inverters.

Support(s) shall be provided to support the Flasher and Load Switches at some point approximately half of the total length from the panel surface. Sufficient area beneath the Load Switch or Flasher shall be clear in order to allow for free flow of air across the Load Switches or Flasher. Load Switches and Flashers must be provided with LED indicator lights on the side facing the cabinet door.

907-632.02.4.2--Flash Transfer Relay. All flash transfer relays, as a minimum, shall meet NEMA TS 1 requirements. The number of relays that shall be supplied with each cabinet shall accommodate the number of signal phases as indicated in the project plans. The coil of the flash transfer relay must be de-energized for flash operation.

907-632.02.5--Cabinet Wiring. Controller cabinets shall be wired in accordance with the signal phasing plans. If phases are indicated as omitted for future use, or if phases are not shown to be used in the plans, the cabinet shall be wired for use of the phases shown as future or unused. Load Switches shall not be provided for future or unused phases.

Wiring in the cabinets shall conform to the requirements of the National Electrical Code (NEC) and all of these specifications. All conductors in the cabinet shall be stranded copper. All wiring shall be laced. All wiring shall be in accordance as specified by Section 636 and Subsection 722.03 for Electric Cable and IMSA Specification 19 and/or 20 for Signal Wiring.

Connector harnesses for controller, conflict monitor, vehicle detectors, and accessory equipment (including NEMA defined Card Rack with power supply and pre-wired optical detection slots) shall be provided and wired into the cabinet circuitry. Connecting cables for controller and conflict monitor harnesses shall be sleeved in a braided mesh. All wires shall be securely terminated on terminal strips. The lay of the interconnect cable between the components must be such that when the door is closed, it does not press against the cables or force the cables against the various components inside the cabinets.

All communication wiring shall be bundled and routed independently of all other wiring. All live conductors shall be covered with suitable insulating material. All equipment grounds shall run directly and independently to the grounding bus.

All wires shall be cut and terminated as close as possible to the proper length before assembly. Consideration of equipment location adjustments must be made when determining appropriate

wire lengths. Excessive lengths of wire or cable shall not be allowed. All line voltage conductors used in controller cabinet shall conform to the following color code:

- AC Neutral: White
- AC Hot: Black
- Safety Ground: Green

907-632.02.5.1--Signal Terminal Arrestor Grounding Bar. A field terminal arrestor grounding bar shall be provided along the back portion of the cabinet for the installation of signal arrestors. This bar shall be attached using an AWG #10 stranded copper to the earth ground circuitry.

907-632.02.5.2--Signal Terminal Arrestors. The field terminal arrestor shall be a three (3) circuit protective device intended for use on traffic control load relay outputs. The arrestor shall be furnished with three (3) leads and a grounding stud which will be used to attach the arrestor to the grounding bar. The field terminal arrestor shall meet the following minimum specifications:

- Operating Voltage: 120 VAC
- Clamping Voltage: 475 VAC
- Peak Surge Current: 10 kA
- Operating Frequency: 47 – 63 Hz
- SPD Technology: MOV's
- Connection Type: Wire Leads
- Lead Wire: 14 AWG 12" Length
- Ground Stud: 10 x 32 5/8" Length
- Operating Temperature: -40°F to +185°F

907-632.02.6--Accessory Components.

907-632.02.6.1--Traffic Actuated Controller Unit. The fully actuated controller unit shall, at a minimum, meet the requirements of both NEMA TS 1-1989 and NEMA TS 2-2003 requirements for actuated controller units. The controller shall be of the TS 2 Type 2 configuration. The controller shall be provided with the multiple communication interface devices or properties as defined below.

- 10 Base-T Ethernet with front panel RJ-45 connector
- IEEE defined MAC address
- EIA-232 port
- External Serial Fiber options for both single and multi-mode (optional as per plans)
- External FSK 1200 bps modem (optional as per plans)
- D connector with 37 pin configuration for TS 1 compatibility
- USB port for signal controller database upload/download to the controller flash
- Controller
- ECOMM Compatible

The controller unit must have an alphanumeric backlit LCD display with a minimum of sixteen

(16) lines at 40 characters per line. The controller must be air-cooled with sufficient ventilation openings and capable of operating between -30°F and 165°F. The controller unit must be provided with a time-of-day clock, automatic daylight savings time adjustment and a power supply for maintaining SRAM during a power outage. The controller unit shall be capable of being used in a Closed-Loop System and must be capable of operating in the role of master controller in a Closed Loop System. The controller unit firmware shall be fully compatible with the Department's existing Traffic Signal Management Software. The Contractor shall ensure all controller firmware versions are compatible with the existing Traffic Signal Management Software that the Regional Department staff currently utilizes prior to submitting the controller for approval. The Contractor shall notify the Department if any special controller configuration or firmware is needed prior to submitting the controller for approval based on project requirements.

Where Flashing Yellow Arrow (FYA) operations are being used, all traffic signal controller firmware shall be capable of delaying the onset of the flashing yellow arrow.

All operator entered data shall be stored and backed up on to a flash memory device provided with the controller unit at no cost. This flash memory device shall require no battery to support value storage. No internal components of circuitry shall require battery support. The database shall be able to be backed up to a USB drive via the USB drive on the controller.

Traffic Actuated Controllers shall be of the Type shown on the plans. Type 1 Controllers shall have a Linux based processor and a minimum of one (1) USB port. Type 2 Controllers shall have the same features as Type 1 Controllers with the addition of an ATC backplane.

Type 3 Controllers shall have all features of the Type 2 Controller with the addition of the ATC module. All three (3) types of actuated controllers shall have Master controller capability, and if required shall be designated with 'M' in the plans.

907-632.02.6.2--Closed Loop Master Controller Unit. When called for in the plans, this work also consists of furnishing, installing and configuring the equipment, software and accessories necessary to connect one (1) traffic Closed-Loop Master Controller to its corresponding central or portable PC-based Traffic Computer Facility Control System via a communications connection. The communications or network connection device will be either existing or provided by the Contractor.

907-632.02.6.2.1--General. The Master shall monitor intersections in the system, display status and operational state and provide traffic flow data from intersection vehicle detectors. The Master shall include all communications equipment and software necessary to provide reporting to a remote terminal as well as upload/download of all local intersection data and provide timing synchronization. Communications to local controllers from the Master and from the Master to the central-office computer facility shall be by FSK, 900 MHz Radio, Broadband Radio, Serial Fiber, Ethernet, Fiber, Cell Modem or Leased Line, as indicated in the plans. The Master shall be able to run on the same controller simultaneously operating the intersection, with the local signal control software, on any given controller unit.

907-632.02.6.2.2--System Configuration. The system architecture shall be designed to minimize

the effect of equipment failures on system operation and performance. The system consists of four (4) principal elements:

- Local System Intersection Controllers
- Communication (Telemetry Links)
- On-Street Master(s)
- Central-Office Computer Software

907-632.02.6.2.3--Local System Intersection Controller. The local system intersection controllers connected to the Master controller unit shall be capable of controlling a fully actuated two (2) to sixteen (16) phase intersection and shall meet or exceed NEMA TS 1-1989 and TS 2-2003 standards for fully actuated traffic control units. The local controller shall have internal communication capability with direct access to the data memory. The local system controller shall be capable of processing controller and detector data and provide all necessary intersection control functions. The local system intersection controller shall meet the requirements of the Traffic Actuated Controller Unit.

907-632.02.6.2.4--Communications (Telemetry) Links. The communications links for the "Closed-Loop" System shall perform the following functions:

- Provide the medium (radio/fiber/hardwire/etc.) for two-way communications between the On-Street Master and the local intersection controllers.
- Provide the medium for two-way communication between the On-Street Master and the central-office computer facility.
- Error checking shall be included in both mediums to assure transmission and reception of valid data.

907-632.02.6.2.5--On-Street Master. The On-Street Master may be located at an intersection and connected via the communication network to at least 32 local intersection controllers. The Master shall be capable of implementing Traffic Responsive Control, Time Base Control, Manual Control or Remote Control modes of operation.

Analysis of sampling sensor data from at least 64 system detectors and corresponding selection of the best Traffic Responsive timing pattern shall be provided by the On-Street Master during the Traffic Responsive mode of operation.

Automatic and continuous monitoring of system activity shall be provided by the On-Street Master to include both Master and intersection alarm conditions.

System parameter entry shall be provided via the On-Street Master including all Master and local intersection assignment and group parameters. Master parameters shall include:

- System coordination setup and pattern data entry by group
- System time base event scheduler
- System traffic responsive computational and pattern selection setup by group
- Intersection system group and detector assignments

The On-Street Master shall provide comprehensive system report generation including, as a minimum: system, intersection, detector and failure status and history reports in addition to system performance reporting.

A RS-232C interface shall be provided on the On-Street Master to allow for printing of reports or for interconnecting to a remote central site.

To enhance overall system operation and increase system management flexibility, the On- Street Master shall also support two-way dial-up communications to a central office computer for control, monitoring, data collection and for timing pattern updating purposes, all from a remote central office location. Continuous, seven (7) days/week - 24 hours/day, system monitoring shall be enhanced by the On-Street Master's capability to automatically dial-up the central office computer upon detection of user defined critical alarm conditions.

907-632.02.6.2.6--System Functional Requirements.

907-632.02.6.2.6.1--Operator Interface. In order to provide ease in programming and operation, the system shall provide a simplified user-friendly menu format at each local, master and central office facility. No special programming skills shall be required for the user to fully access and operate this control and monitoring system at any level.

All programming, both of the local intersection controllers and the On-Street Master(s) shall be via a front panel keyboard and display, driven by English Language menus. All data change entries will be automatically verified against established ranges prior to acceptance to prevent programming data errors. Data access shall be controlled by user- definable access controls.

907-632.02.6.2.6.2--System Traffic Control. The system shall have the capability of controlling a minimum of sixteen (16) vehicle phases and eight (8) pedestrian phases. The system shall have the capability of implementing a minimum of four (4) timing rings, fifteen (15) alternate sequences, and sixteen (16) offsets.

The system shall provide the capability of selecting any of the following operational modes on a group basis:

- Traffic Responsive
- Time Base (Time-of-Day/Day-of-Week)
- Remote (External Command)
- Manual (Operator Entry)

The system shall be capable of implementing system FLASH and system FREE operation. The system shall have the capability to command, on/off based on time, up to eight (8) independent special functions.

907-632.02.6.2.6.3--Detectors. The system shall have the capability of accepting and processing data from at least 632 system detectors for Traffic Responsive program selection.

907-632.02.6.2.6.4--Pattern Selection. In addition to providing Manual and Remote program selection capability, the Master shall provide for Traffic Responsive and Time Base modes of operation for timing pattern selection.

907-632.02.6.2.6.4.1--Traffic Responsive Mode. Traffic plan selection in the Traffic Responsive mode shall be user-enabled and supplied with the controller, per the plans and specifications. The pattern selection shall be based on sampling detector volume and occupancy analysis by the On-Street Master.

907-632.02.6.2.6.4.2--Time Base Mode. The system shall provide the capability of implementing time-of-day, day-of-week and week-of-year control for each of the two (2) groups using an internal time clock referenced to the 60-Hz AC power line frequency for its time base. The Time Base mode shall contain automatic adjustment for leap year and daylight savings time changes.

The system Time Base mode shall provide, as a minimum, 100 events each capable of requesting any of the 48 traffic control patterns along with Traffic Responsive override enable or auxiliary events consisting of enable/disable any of up to four (4) system-wide special functions and setting sample and log interval time periods.

907-632.02.6.2.6.5--System Control Priority. The system coordination control (program-in-effect) for each group shall be selected on a priority basis. The priority from highest to lowest shall be as follows:

- Manual Control Entry
- External Control (Remote Command)
- Time Base Control (Time-of-Day/Day-of-Week) (Traffic Responsive control will prevail whenever Traffic Responsive Override Enable is active and the selected cycle length is greater than that being commanded by Time Base)
- Traffic Responsive Control

907-632.02.6.2.6.6--Measures of Effectiveness. The system shall have the capability to report selected Measures of Effectiveness (MOE's) on an intersection basis. MOE calculations shall be made on all phases by the local system intersection controller and as a minimum shall include measures such as: volume, number of stops, delays and green utilization. These measures shall be calculated on the basis of the active timing plan. Alternate ways of reporting MOE'S may be approved on a case-by-case review.

907-632.02.6.2.6.7--Uploading and Downloading. The system shall provide, for any selected local system intersection controller, the capability of uploading and downloading any or all, new or modified local intersection parameters from the central-office computer and the Department Central Traffic Signal Management Software, and shall include, as a minimum, all: Phase Timing and Unit Data; Coordination Data, Time Base Data; Preemption Data, System Communication Parameters, System Traffic Responsive Data, and any other System Data residing at the intersection such as Detector Diagnostic Values, Report Parameters and Speed Parameters.

During either uploading or downloading operations, normal traffic control operations shall not be suspended. All data shall be continually accessible and may be displayed at the On- Street Master or the central office computer.

907-632.02.6.2.6.8--System Monitoring and Diagnostics. The system shall automatically and continually monitor system activity and log/report occurrences of Master and intersection alarm conditions. All alarm condition events shall include at the intersection, (Master and central-office computer) an alpha-numeric description of the event as well as the time and date of occurrence.

As a minimum, monitored master alarms conditions shall include:

- Insufficient or Improper Data
- Failed Computational Channels
- Failed System Detectors
- Intersection Communication Failure
- Failed Controllers
- Minimum of six (6) special user defined alarms for user application flexibility
- Monitored intersection alarms conditions shall include as a minimum:
 - Cycle Faults and Failures
 - Coordination Failures
 - Voltage Monitor
 - Conflict, Local and Remote Flash Conditions
 - Preempt
 - Local Free
- Minimum of six (6) special user defined alarms for additional user flexibility.

When the Master detects a critical alarm condition, as defined by the user, it shall automatically dial-up the central office computer and report the condition. On a BUSY or NO ANSWER, the system may be programmed, at user option, to alert a secondary computer.

The system shall also automatically and continually monitor, verify and attempt to correct Sync Pulse, Time Base Clock and Pattern-In-Effect. The system shall provide capabilities to perform diagnostics on system and local detectors, communications and intersection operations. When a fault has been detected, an indication shall be provided. It shall be possible to isolate the fault to the failed unit from controls and indicators available on the Master unit. Auxiliary equipment such as a data terminal or CRT shall not be required to identify the failure.

907-632.02.6.2.6.9--Real Time Display. The Master shall provide for any selected local system intersection controller, real-time status information on its front panel. Real-time intersection status information shall include simultaneous display of: vehicle and pedestrian signal and detector status by phase, overlap signal status and cars waiting count by phase. Real-time controller status information shall include simultaneous display of: two (2) Ring Active timers, On/Next, Call/Recall and Hold/Omit Status by phase, Coordination, Preempt and Stop Time Status.

907-632.02.6.2.6.10--System Management. The system, without hardware changes but with its

ability to directly modify Master and intersection parameters, shall provide the user system configuration and operational controls of the following functions: add/delete controllers and system detectors, enable Traffic Responsive mode, assign intersections to groups, assign system detectors to computational channels and channels to pattern select routines, and assign special and/or standard detectors as system detectors for use with computational channels or to track activity.

907-632.02.6.2.6.11--System Logging and Reports. The system shall automatically and continually process system data and log/report on occurrence of changes in intersection status, system detector status, communications status, controller status and local detector status in addition to system program changes, Traffic Responsive computations, measures of effectiveness and performance.

907-632.02.6.2.6.12--Security. The On-Street Master shall provide for a user-specified security code entry before any data may be altered. In order to view any parameter, security code entry shall not be required. Security access shall be automatically rescinded approximately ten (10) minutes after either access was gained or the last parameter change was entered. The Master and local controller shall have the ability via keyboard to disable security code requirements, allowing for perpetual access without requiring hardware changes.

907-632.02.6.2.7--Design Characteristics. The On-Street Master shall be designed to operate in either an office or field environment and shall be suitably housed in a separate enclosure or in a local intersection cabinet. The Master shall be designed to meet the following electrical and mechanical requirements:

907-632.02.6.2.7.1--Programming and Security. Operator programmable data entry shall be accomplished through panel keyboard(s). The Master shall prevent the alteration of keyboard set variables prior to the user having entered a specific access code through the keyboard. The Master shall maintain user-programmable variables in non-volatile memory with a battery-backed RAM to assure continued efficient system operation.

907-632.02.6.2.7.2--Test and Repair. To enhance maintenance and trouble-shooting activities, On-Street Masters shall include resident diagnostics as a standard. No extender- cards, special tools or PROMs shall be necessary to fully maintain these components. The Master unit design shall ensure that all printed circuit boards be readily accessible for maintenance testing purposes. All fuses, connectors and controls shall be accessible from the front of the Master unit.

907-632.02.6.2.8--Traffic Signal System Software. All Traffic Signal System Software shall be compatible with the latest version of the Department's existing Master and local controllers and existing Traffic Signal Management Software for the Department region.

907-632.02.6.2.8.1--Traffic Signal Closed Loop Software. The Traffic Signal Closed-Loop Software shall provide the ability to manage Master and local controller databases including the uploading and downloading of data parameters. The software shall provide status information and provide reporting capabilities for Master and local controller data, alarms and logs.

907-632.02.6.2.8.2--Traffic Signal System Workstation Software. The Traffic Signal System Workstation shall provide the ability to manage Master and local controller databases including the uploading and downloading of data parameters. The software shall provide status information and provide reporting capabilities for Master and local controller data, alarms and logs.

The Traffic Signal System Workstation Software shall also be capable of operating as a network-connected user workstation to existing centralized signal systems and their associated databases.

When disconnected from the centralized signal system, the software shall be capable of running as a standalone system similar to the Closed-Loop Software. Under this mode, the software shall provide management, report and status functions for Master and local controllers. Under Standalone Mode of operation the software shall allow for its own database(s) for data management without the need for connecting to a centralized signal system database.

907-632.02.6.2.9--Services. Technical services shall be provided, as required, to assist in installation and initial setup of the Closed-Loop Master System and its sub-components. Technical assistance with database migration and/or setup, as well as the development of graphics (such as master maps and local intersection depictions) and the assignment of associated attributes such as detectors, phasing, signals, etc., shall be provided as required. Additionally, training shall be provided on a basic or advanced target user level, as required.

907-632.02.6.3--Malfunction Management Unit (MMU2). The Malfunction Management Unit (MMU2) shall be a shelf-mountable, sixteen (16) channel, solid-state, IP addressable MMU. The MMU2 shall accomplish the detection of, and response to, improper and conflicting signals and improper operating voltages in a traffic signal controller assembly, including support for four (4) section Flashing Yellow Arrow (FYA) left turn displays. The MMU2 shall be capable of running a minimum of twelve (12) different modes of FYA operation.

The MMU2 shall meet or exceed Section 4 requirements of the NEMA Standards Publication No. TS 2-2003 including NEMA TS 2 Amendment #4-2012 and provide downward compatibility to NEMA Standards Publication No. TS 1-1989: Type 12 Operation, in addition to those specifications set forth in this document.

The MMU2 shall include a graphics based Liquid Crystal Display (LCD) to view the current monitor status and navigate the unit's menus. An RJ-45 Ethernet Port shall be provided for communications.

A built-in Diagnostic Wizard shall be provided that displays detailed diagnostic information regarding the fault being analyzed. This mode shall provide a concise view of the signal states involved in the fault, pinpoint faulty signal inputs and provide guidance on how the technician should isolate the cause of the malfunction. The Diagnostic Wizard shall be automatically invoked when the MMU2 is in the fault mode and the HELP button is pressed. It shall also be automatically invoked when the MMU2 is in the Previous Fail (PF) event log display and the HELP button is pressed.

A built-in Setup Mode shall be provided that automatically configures the Dual Indication Enable, Field Check Enable, Red Fail Enable and Minimum Yellow Plus Red Clearance Enable parameters from user input consisting only of channel assignment and class (vehicle, ped, pp-turn, FYA, etc.) responses.

The MMU2 shall be capable of operating in the Type 12 mode with SDLC communications enabled on Port 1. The Channel Status display shall operate in the Type 12 configuration and provide the Field Check function for up to four (4) Pedestrian Walk inputs.

In the interest of reliability and repair ability, printed circuit board mounted MS connectors shall not be acceptable. Internal MS harness wire shall be a minimum of nineteen (19) strand AWG 22 wire.

907-632.02.6.4--NEMA defined Card Rack and Power Supply. A minimum of one (1) NEMA compliant detector card rack with five (5) slot positions (first slot for power supply and four (4) available slots) shall be provided in each cabinet. The detector rack shall be installed on the bottom shelf of the cabinet. The power supply for the NEMA defined card slots shall be provided as a 175W minimum with four (4) independent regulated channels of 24 VDC each rated at 0.75 amps over the full NEMA operating temperature range of -30°F to +165°F. The output should be regulated to 24 VDC +/- 15%. Each of the four (4) outputs shall be independently fused, each with a separate LED for displaying output and fuse status for each of the four (4) outputs. Each of the four (4) outputs shall be protected against voltage transients by a minimum 1500 watt suppressor. All card racks shall be wired for the type detection shown in the plan sheets.

Card Guides shall be provided on the top and bottom of the card rack for each connector position.

907-632.02.6.5--In-Cabinet Network.

907-632.02.6.5.1--Communications Arrestor. The Controller Cabinet network shall consist of an SDLC connection between the Controller Unit and MMU2. Surge suppression for this network shall meet the requirements set forth in Subsection 722.12 and the following minimum requirements below:

- Operating Voltage: 5 VDC
- Clamping Voltage: 8 VDC
- Operating Current: 1.5 A
- Peak Surge Current: 47 A (10x1000 μ s)
- Frequency Range: 0 to 20 MHz
- Insertion Loss: < 0.1 dB at 20 MHz
- SPD Technology: SAD
- Connection Type: DB-15
- Operating Temperature: -40°F to +185°F

907-632.02.6.6--System Communications.

907-632.02.6.6.1--Traffic Signal Ethernet Switch. When specified in the plans or contract

documents, a traffic signal Ethernet switch shall be installed in the cabinet assembly. It shall meet the requirements for the type specified in Section 907-663. Ethernet patch cables of sufficient length shall be provided for all supplied Ethernet ready cabinet components. The switch and all components shall be connected and configured.

907-632.02.6.6.2--Fiber Optic Patch Panel. When specified in the plans or contract documents, fiber optic attenuator patch cords shall be installed in the cabinet assembly as specified in Section 907-661.

907-632.02.6.6.3--Wireless Communications. When specified in the plans or contract documents, wireless communication components shall be installed in the cabinet assembly and shall be as specified in Section 907-662.

907-632.02.6.6.4--Serial Port Server or Terminal Server. When specified in the plans or contract documents, serial port servers shall be installed in the cabinet assembly and shall be as specified in Subsection 907-663.02.2.

907-632.02.6.6.5--GPS Clock. This work includes furnishing a Global Positioning System (GPS) Synchronization clock that can be used to sync the internal clocks in traffic signal controllers when coordination is desired, but communication is not necessary. The GPS Clock System shall provide GPS based time and date synchronization to provide coordination of traffic controllers to a common time base. The system shall process GPS Time data using a tamper/vandal resistant GPS antenna and correct for Time Zone, Daylight Savings Time, Leap Years, and GPS Leap Seconds. The processed time information shall be sent to the traffic controller in the native format for the respective controller. A contact closure synchronization pulse with variable pulse width shall be available for a once per day update. If the GPS antenna is blocked for up to one (1) hour prior to scheduled time of synchronization, the system shall synchronize the traffic controllers with less than 0.4 seconds variance from the accuracy provided under normal operation with GPS satellites in view.

- The GPS Clock shall also meet the following minimum specifications:
- Input Voltage: 9-24 VDC
- Current Draw: 150 mA (max) at 12 VDC: 125 mA (max) at 24 VDC
- Contact Closure: 750 mA at 30 VDC
- Temperature Rating: -29.4°F to +167°F

GPS unit shall be mounted to the traffic signal controller cabinet as per the manufacturer's recommendation. Any and all holes created in the cabinet for the purpose of mounting the GPS unit shall be sealed to the satisfaction of the Engineer at no direct pay.

907-632.02.6.6.6--Power-Over-Ethernet Arrestor. Surge suppression that meets the requirements set forth in Subsection 722.12 shall be provided. In addition, the following minimum specifications shall be supplied for loads that require Power-Over-Ethernet with isolated shielded or non-shielded cable:

- Operating Voltage: 48 VDC
- Clamping Voltage: 68 VDC
- Operating Current: 0.75 A per Pin Continuous
- Peak Surge Current: 10 kA
- Insertion Loss: < 0.1 dB
- SPD Technology: GDT, SAD, with series PTC
- Modes of Protection: All Lines (1-8) Protected (L-L) and (L-G): Signal High- Low; High-Ground; Low-Ground
- Transmission Speeds: 10BaseT; 100BaseT; 1000BaseT
- Connection Type: RJ-45
- Operating Temperature: -40°F to +185°F

907-632.02.7--Detector Panel. A vehicle detector harness shall be provided to connect the detector panel to the card rack. The detector panel shall accept the connection of sixteen (16) field loop inputs and four (4) pedestrian detector inputs.

907-632.02.7.1--Detector Input Arrestors. Field Loop and Pedestrian input arrestors shall meet the requirements set forth in Subsection 722.12. Field loop arrestors shall have differential and common mode protection and be provided with the following minimum specifications:

- Operating Voltage: 75 VDC
- Clamping Voltage: 130 VDC
- Peak Surge Current: 250 A
- SPD Technology: Silicon Break-Over
- Operating Temperature: -40°F to +185°F

Pedestrian input arrestors shall be a four (4) circuit device provided with the following minimum specifications:

- Operating Voltage: 30 VDC
- Clamping Voltage: 36 VDC
- Operating Current: 0.15 A
- Peak Surge Current: 10 kA (8 x 20 μ s)
- Frequency Range: 0 to 20 MHz
- Insertion Loss: < 0.1 dB at 20 MHz
- SPD Technology: GDT, SAD, with Series PTC
- Connection Type: Terminal Block with compression lugs; Terminals accept up to 10 AWG
- Operating Temperature: -40°F to +185°F

907-632.02.8--System Detectors. The controller shall have the ability to receive input data from up to eight (8) special system detectors in addition to the normal actuated controller unit phase detectors. The user shall have the option to assign any of the phase detectors as “system detectors”.

907-632.02.9--Preemption. The cabinet shall be completely wired to accept and service calls from preemption phase selector modules, associated optical detector units and GPS units. Optical detector units and GPS unit cabinet components shall be as specified in Section 639. Provision for two (2) standard card modules shall be accommodated in a separate card rack for preemption. The preemption card rack shall provide a minimum of eight (8) channels.

Provisions shall also be made in the cabinet to accommodate Railroad Preemption when specified in the plans or contract documents. Railroad Preemption shall meet the requirements set forth in Section 639. While it is not necessary that a Railroad Preemption interface board be provided with the cabinet, the cabinet and back panel shall be designed so that a Railroad Preemption interface panel that uses a relay to isolate the track switch from the controller cabinet circuitry can be installed. Preempt 1 and 2, in the case of gate down preemption, shall be reserved for Railroad Preemptions; all subsequent preemptions shall be reserved for Emergency Vehicle, Fire Station, or Police Preemption.

907-632.02.10--Uninterruptable Power Supply. When specified in the plans or contract documents an Uninterruptable Power Supply (UPS) System shall be installed in the cabinet assembly. The UPS shall be installed in the cabinet and meet the requirements set forth in Section 633.

907-632.02.11--Power Service Pedestal. A Power Service Pedestal shall be provided as described in Section 631.03.2.

907-632.03--Construction Requirements.

907-632.03.1--Mounting. Traffic Signal Cabinet Assemblies shall be wall or pole mounted, base mounted on a concrete cabinet pad, or base mounted using a composite enclosure as specified below and as shown in the plans.

Power Service Pedestal shall be base mounted on a concrete cabinet pad or on a composite enclosure as specified below and as shown in the plans.

907-632.03.1.1--Wall or Pole Mounted. Wall or pole mount hardware shall be provided for mounting cabinets in specific installations as indicated in the design plans. Wall or pole mounted cabinets shall be manufactured with rigid tabs, rigid brackets or other acceptable configuration for attachment of the cabinet to the wall or pole support. Rigid attachment devices must allow for field alignment of cabinet to the wall or pole support.

907-632.03.1.2--Concrete Cabinet Pad. Concrete foundations shall be constructed of Class B concrete in specific installations as indicated in the design plans.

Cabinets for installation on a concrete base shall be manufactured with rigid tabs, rigid brackets or other acceptable configuration for attachment of the cabinet bottom to its flat support structure. Rigid attachment devices must allow for field alignment of cabinet with the support base. Concrete base construction details shall be provided in the design plan drawings.

907-632.03.1.3--Composite Enclosure. Cabinets for installation on a composite enclosure base shall be manufactured with rigid tabs, rigid brackets or other acceptable configuration for attachment of the cabinet bottom to its' flat support structure. Rigid attachment devices must allow for field alignment of cabinet with the composite enclosure. Composite enclosure attachment details shall be provided as shown in the plans.

907-632.03.2--Documentation. Documentation packages shall be delivered for each unit at the same time as the equipment to which it pertains.

A minimum of two (2) sets of complete schematic drawings and equipment documentation shall be supplied with each cabinet. The first copy shall be placed in a clear re-sealable print pouch of sufficient size to accommodate one (1) complete set of folded cabinet prints and placed in the pull-out drawer of the cabinet and the second copy shall be provided to the Department. Comprehensive controller data shall be included as part of the cabinet documentation package and shall be placed in the cabinet drawer pouch. Digital copies of all cabinet documentation shall be provided to the Department before final acceptance.

The documentation packages shall contain a schematic wiring diagram of the controller cabinet assembly and all auxiliary equipment. The schematic wiring diagram, including a symbols legend, shall show in detail all integrated circuits, transistors, resistors, capacitors, inductors as well as switches and indicators. All parts shown shall be easily identified on both in the cabinet and on the schematic diagram. Model numbers shall be used on schematic diagram when available.

A complete physical description of the signal cabinet assembly shall be provided to include at least the physical dimensions of the unit, weight, temperature ratings, voltage requirements, power requirements, material of construction, and complete performance specifications.

A complete set of operation guides, user manuals, and performance specifications shall be provided.

Detailed programming instructions, preventative maintenance requirements, and troubleshooting procedures shall also be provided for the controllers. These documents shall fully cover all programming procedures and programmable options capable of being made to the controllers and associated traffic control equipment. Instructions for modifications within the range of the capabilities of the unit such as changes in phases or sequences and programming matrix boards shall be included.

An intersection diagram shall be provided on the cabinet door showing geometric configuration, lane use assignments, controller cabinet and signal pole locations, vehicle and pedestrian signal head locations, vehicle and pedestrian detector zone locations, ring-barrier phasing diagram, and detector channel assignments. The intersection diagram shall be labeled with, at a minimum, a North Arrow, main street name(s), side street name(s), signal pole numbers, vehicle and pedestrian head type(s), detector zone designations, volume density and phase recall requirements, flash sequence. All field wires within the cabinet shall be labeled to coincide with those shown on the intersection diagram.

907-632.04--Method of Measurement. Traffic Signal Cabinet Assembly will be measured as a unit per each.

Remove and Replace Existing Traffic Signal Cabinet Assembly will be measured as unit per each.

Modify Existing Traffic Signal Cabinet will be measured as a unit per each.

Solid State Traffic Actuated Controller, of the type specified in the project plans, will be measured as a unit per each.

Signal Software License, of the type specified in the project plans, will be measured as a unit per each.

Malfunction Management Unit, of the type specified in the project plans, will be measured as a unit per each.

Card Rack, of the type specified in the project plans, will be measured as a unit per each.

GPS Clock, as specified in the project plans, will be measured as a unit per each.

Power Service Pedestal, as specified in the project plans, will be measured as a unit per each.

All pay items shall be inclusive of all materials, work, system integration, testing and incidentals necessary for a complete and operable unit in place and accepted. All removal, turn on, and acceptance of equipment, devices, traffic signals, and traffic signal assemblies shall follow Section 631 - Traffic Signal Systems-General prior to payment.

907-632.05--Basis of Payment. Traffic Signal Cabinet Assembly, measured as prescribed above, will be paid for at the contract unit price per each for each type(s) specified in the contract, which price shall be full compensation for furnishing, installing, configuring, wiring, testing, and mounting foundation construction, cabinets, relays, terminals, circuit breakers, modules, coordination and time base control programs, connectors wiring, overlap equipment, load switches, power cables, power supplies, controller mechanism and housing, MMU2, mounting material, all other materials, and all equipment, labor, tools, and incidentals necessary to complete the work.

Remove and Replace Existing Traffic Signal Cabinet Assembly, measured as prescribed above, will be paid for at the contract unit price per each for each type(s) specified in the contract, which price shall be full compensation for furnishing, installing, configuring, wiring, testing, cabinets, relays, terminals, circuit breakers, modules, coordination and time base control programs, connectors wiring, overlap equipment, load switches, power cables, power supplies, controller mechanism and housing, MMU2, mounting material, all other materials, removal, disposal, transfer, storage, and/or resetting of components that are existing, all other components included in the traffic signal cabinet, and all equipment, labor, tools, and incidentals necessary to complete the work.

Modify Existing Traffic Signal Cabinet, measured as prescribed above, will be paid for at the

contract unit price per each, which price shall be full compensation for furnishing, installing, configuring, and mounting all components, wiring, and devices; rewiring, reconfiguring, removal, disposal, transfer, storage, and/or resetting of existing components and devices, installing or changing coordination and time base control programs in the traffic signal cabinet assemblies, testing, final cleanup, all equipment, labor, tools, and incidentals necessary to complete the work.

Solid State Traffic Actuated Controller, measured as prescribed above, will be paid for at the contract unit price per each for each type(s) specified in the contract, which price shall be full compensation for all labor, equipment, tools, materials inclusive of the controller mechanism(s) and housing(s), all power cables, power supplies, wiring, factory and manufacturing inspection, attachment hardware, testing, storage, packaging, shipping, warranty, and all work, equipment, and appurtenances, and all incidentals necessary to provide a fully functional traffic controller ready for use. It shall also include all documentation including operations and maintenance manuals and other material necessary to document the operation of the traffic controller.

Signal Software Licenses, measured as prescribed above, will be paid for at the contract unit price per each for each type(s) specified in the contract, which price shall be full compensation for all labor, equipment, tools, materials inclusive of furnishing, installing and configuring the Signal Software, all power cables, power supplies, wiring, factory and manufacturing inspection, testing, storage, packaging, shipping, warranty, appurtenances, and all incidentals necessary to provide fully functional Signal Software ready for use. It shall also include all documentation including operations and maintenance manuals and other material necessary to document the operation of the Signal Software.

Malfunction Management Unit, measured as prescribed above, will be paid for at the contract unit price per each for each type(s) specified in the contract, which price shall be full compensation for all labor, equipment, tools, materials inclusive of furnishing, installing and configuring the Malfunction Management Unit (MMU2), all power cables, power supplies, wiring, attachment hardware, factory and manufacturing inspection, testing, storage, packaging, shipping, warranty, and all work, equipment, and appurtenances, and all incidentals necessary to provide a fully functional Malfunction Management Unit (MMU2) ready for use. It shall also include all documentation including operations and maintenance manuals and other material necessary to document the operation of the Malfunction Management Unit (MMU2).

Card Rack, measured as prescribed above, will be paid for at the contract unit price per each for each type(s) specified in the contract, which price shall be full compensation for all labor, equipment, tools, materials inclusive of furnishing, installing and configuring the Card Rack, all power cables, power supplies, wiring, attachment hardware, factory and manufacturing inspection, testing, storage, packaging, shipping, warranty, and all work, equipment, and appurtenances, and all incidentals necessary to provide a fully functional Card Rack ready for use. It shall also include all documentation including operations and maintenance manuals and other material necessary to document the operation of the Card Rack.

GPS Clock, measured as prescribed above, will be paid for at the contract unit price per each for each type(s) specified in the contract, which price shall be full compensation for all labor, equipment, tools, materials inclusive of furnishing, installing and configuring the Global

Positioning System (GPS) Clock(s), all power cables, power supplies, wiring, attachment hardware, factory and manufacturing inspection, testing, storage, packaging, shipping, warranty, and all incidentals necessary to provide a fully functional GPS Clock ready for use. It shall also include all documentation including operations and maintenance manuals and other material necessary to document the operation of the GPS Clock.

Power Service Pedestal, measured as prescribed above, will be paid for at the contract unit price per each for each type(s) specified in the contract, which price shall be full compensation for furnishing, installing, configuring, wiring, testing, and mounting foundation construction, cabinets, circuit breakers, connectors wiring, mounting material, all other materials, and all equipment, labor, tools, and incidentals necessary to complete the work.

Payment will be made under:

- 907-632-A: Solid State Traffic Signal Cabinet Assembly,
Type __ Cabinet, Type __ Controller - per each
- 907-632-B: Remove and Replace Existing Traffic Signal Cabinet Assembly,
Type __ Cabinet, Type __ Controller - per each
- 907-632-C: Modify Existing Traffic Signal Cabinet Assembly - per each
- 907-632-D: Solid State Traffic Actuated Controller, Type _____ - per each
- 907-632-E: Single-user Workstation Signal Software License - per each
- 907-632-F: Single-user Server Signal Software License - per each
- 907-632-G: Malfunction Management Unit - per each
- 907-632-H: Card Rack, ____ Position - per each
- 907-632-I: GPS Clock - per each
- 907-632-J: Power Service Pedestal - per each

MISSISSIPPI DEPARTMENT OF TRANSPORTATION

SPECIAL PROVISION NO. 907-641-4

CODE: (IS)

DATE: 03/05/2024

SUBJECT: Radar Vehicle Detection

Section 641, Radar Detection Systems, of the 2017 Edition of the Mississippi Standard Specifications for Road and Bridge Construction is hereby amended as follows.

Delete Section 641 on pages 584 through 594 and substitute the following.

SECTION 907-641 – RADAR VEHICLE DETECTION

907-641.01--Description. This work shall consist of providing all labor, materials, equipment, and incidentals necessary to furnish, install, test, train and operate Radar Vehicle Detection, including Signal Radar Vehicle Detection (SRVD) and Intelligent Transportation Systems (ITS) Radar Vehicle Detection (IRVD). These systems will provide roadway monitoring capabilities via electromagnetic microwave radar signals through the air. The signals bounce off vehicles in their paths and the signal is returned to the detector. The returned signals are processed to determine traffic parameters.

907-641.01.1--Signal Radar Vehicle Detection. SRVD shall provide traffic parameters necessary to the traffic signal controller operation for vehicle detection. All SRVD shall be supplied from the same manufacturer per construction project.

Type 1 SRVD shall be used for basic vehicle detection at signalized intersections as described below in this specification.

Type 2 SRVD shall have all the functionality of the Type 1 SRVD with additional features described below in this specification. Type 2 SRVD shall utilize a matrix of radar signals for two-dimensional coverage and shall track vehicles through each type of detection's specified Area of Coverage. The Type 2 SRVD shall report real-time detection of both moving and stopped vehicles.

907-641.01.2--ITS Radar Vehicle Detection. IRVD shall provide data, including, but not limited to speeds, volume, lane occupancy and classification.

907-641.02--Materials.

907-641.02.1--Radar Design. The IRVD and the SRVD stop bar microwave shall operate in the 24.0 to 24.25 GHz frequency band. The advance radar has the option to either be in the 24 GHz band or in the 10.5 GHz band. Neither stop bar nor advanced radar shall interfere with any existing or proposed traffic signal control and Intelligent Transportation System (ITS) equipment. Should frequencies of other ITS equipment be in the same band, or conflict with detection, the Contractor shall move and space the less critical ITS device, as designated by the Engineer so as

not to interfere with vehicle detection.

The radar units shall operate in all weather conditions and comply with the applicable standards stated in the NEMA TS 2-2003 standard for shock, vibration, and temperature. All units shall be rated for up to 95% relative humidity, non-condensing.

The radar units shall be FCC certified under CFR 47, part 15.

907-641.02.1.1--Signal Radar Vehicle Detection (SRVD) Processor. The SRVD Processor shall be a module that provides power and communication to the radar sensors and/or signal controller through contact closure devices, Ethernet and/or the SDLC port of the signal Controller.

Type 1 SRVD Processors shall include all power cables, jumpers and terminal blocks needed to connect up to four (4) radar sensors to the signal cabinet. The SRVD Processor shall have a 10/100 Ethernet port to allow connection to the local network. Any variation of necessary communications ports or sensor connecting terminals shall be approved by the Engineer.

Type 2 SRVD Processors shall include all power cables, jumpers and terminal blocks needed to connect up to six (6) radar sensors to the signal cabinet. The SRVD Processor shall have a 10/100 Ethernet port to allow connection to the local network. Any variation of necessary communications ports or sensor connecting terminals shall be approved by the Engineer.

The SRVD Processor shall operate in the harsh conditions of a signal cabinet and comply with the applicable standards stated in the NEMA TS 2-2003 standard for shock, vibration, and temperature.

907-641.02.1.2--ITS Radar Vehicle Detection (IRVD) Processor. The IRVD Processor shall be a module that provides power and communication to the radar sensors and/or signal controller through contact closure devices, Ethernet and/or the SDLC port of the signal Controller.

Type 1 IRVD Processors shall include all power cables, jumpers and terminal blocks needed to connect up to four (4) radar sensors to the signal cabinet. The IRVD Processor shall have a 10/100 Ethernet port to allow connection to the local network. Any variation of necessary communications ports or sensor connecting terminals shall be approved by the Engineer.

Type 2 IRVD Processors shall include all power cables, jumpers and terminal blocks needed to connect up to six (6) radar sensors to the signal cabinet. The IRVD Processor shall have a 10/100 Ethernet port to allow connection to the local network. Any variation of necessary communications ports or sensor connecting terminals shall be approved by the Engineer.

The IRVD Processor shall operate in the harsh conditions of a signal cabinet and comply with the applicable standards stated in the NEMA TS 2-2003 standard for shock, vibration, and temperature.

907-641.02.2--Area of Coverage--SRVD.

907-641.02.2.1--Stop Bar Radar Vehicle Detection. Type 1 SRVD stop bar radar sensor shall track vehicles through a field of view that extends out a minimum of 100 feet.

The Type 1 SRVD stop bar radar sensor shall be able to detect and report presence in lanes located within a minimum 100-foot from the face of the detector. Any variance of the detectable area shall be approved by the Engineer.

The Type 1 SRVD stop bar radar sensor shall be able to detect up to four (4) lanes with eight (8) or sixteen (16) individual zones as indicated in the plans.

Type 2 SRVD stop bar radar sensor shall have all the functionality of the Type 1 SRVD stop bar sensor with the addition of the following:

- Type 2 SRVD stop bar radar sensor shall detect true presence of vehicles whether in motion or still without using Locking or Latching Algorithms.
- Type 2 SRVD stop bar radar sensor shall report presence in lanes with a minimum 90-degree arc from the face of the detector.
- Type 2 SRVD stop bar radar sensor shall be able to detect a minimum of ten (10) lanes.

907-641.02.2.2--Advanced Radar Vehicle Detection. The Type 1 SRVD advanced radar sensor shall be able to detect and report vehicle information such as range and speed when mounted within 50 feet of the center of the lanes of interest. Variance of this distance shall be approved by the Engineer per the application.

The Type 1 SRVD advanced radar sensor shall be forward fired and be able to detect and report vehicle information when mounted at heights above the road surface, as per [manufacturer](#) recommendations.

The Type 1 SRVD advanced radar sensor shall be able to detect and report vehicles on the roadway up to 600 feet from the detector.

The Type 2 SRVD advanced radar sensor shall have all the functionality of the Type 1 SRVD advanced with the following additions:

- Type 2 SRVD advanced radar sensor shall be able to detect and report heavy vehicles on the roadway up to 900 feet from the detector.
- Type 2 SRVD advanced radar sensor shall be able to detect Estimated Time of Arrival (ETA) for vehicles. The advanced radar sensors shall support user configurable upper and lower ETA filters for each zone. The sensors shall support the configuring of ETA filters in increments of 0.1 seconds.

907-641.02.3--Area of Coverage-IRVD. The IRVD's field of view shall cover an area with a minimum detection range of six (6) feet from the IRVD and a maximum detection range of 250 feet from the IRVD.

907-641.02.4--Detection Zones--SRVD.

907-641.02.4.1--Stop Bar Radar Vehicle Detection. The stop bar radar sensors shall be able to detect and report presence for vehicles at the stop bar.

The sensors shall be able to detect and report presence in up to eight (8) or sixteen (16) individual zones as indicated in the plans. The number of lanes used and detection zones shall be set up and selected from the Graphical User Interface and manually configured via software provided with the detection unit. The detection zones shall also have the ability to be auto configured by the software tool. A minimum of one (1) separate detection zone per lane is required.

Count zones shall also be able to be set up in the stop bar radar detection unit as a 'spot' type of radar detection zone. The software configuration tool included with the sensor shall allow all zones to be set up as required by the plans.

907-641.02.4.2--Advanced Radar Vehicle Detection. The advanced radar sensors shall be able to simultaneously detect and report information from a minimum of 25 vehicles on the roadway when they are serially sequenced between the near and far boundaries. The number of lanes and detection zones shall be set-up and selected from the Graphical User Interface.

The advanced radar sensors shall detect range, speed, and vehicle Estimated Time of Arrival (ETA) to the stop bar for vehicles or clusters of vehicles moving in the user- selected direction of travel. The detector shall also detect occupancy or density of the detection zones.

The advanced radar sensors shall provide vehicle call and extend data on up to eight (8) channels that can connect to contact closure modules compliant with NEMA TS 1, NEMA TS 2, and 170/2070 controller cabinets.

907-641.02.5--Detection Zones--IRVD. The minimum number of detection zones defined shall range from twelve (12) to 22, for simultaneous detection, as indicated in the plans. The range resolution of each zone shall be no greater than 1.3 feet, and the zone width shall be user defined within a range of six (6) to twenty (20) feet for the area of coverage limits described above.

907-641.02.6--Capabilities--SRVD. Sensors shall not require roadway modification for placement. The advanced detection should provide easy integration with the stop bar detection and vice versa into the same intersection to form one (1) method/system of detection.

The radar sensors shall distinguish and omit wrong way traffic from activating an assigned detector output.

907-641.02.6.1--Stop Bar Radar Vehicle Detection. The stop bar radar unit shall be suitable for mounting on roadside poles or mast arms and provide the following:

- 1) Presence indication of moving or stopped vehicles in its detection zones, provided by contact closure to existing controllers.
- 2) Assign a minimum of four (4) detector outputs per radar unit and capable of using two (2) or four (4)-channel interface modules to the detector rack for contact closure activation.

- 3) A cabinet interface module for multiple radar units may be provided in lieu of individual two (2) and four (4)-channel contact closure interface modules, and as shown in the plans.
- 4) Maintain a detection accuracy of 95% for each detection zone set-up on the graphical user interface.

907-641.02.6.2--Advanced Radar Vehicle Detection. The advance radar unit shall be suitable for mounting on signal pole uprights, span wire or mast arms and provide the following activation within the signal cabinet:

- 1) Assign a minimum of four (4) detector outputs per radar unit and capable of using two (2) or four (4)-channel interface modules to the detector rack for contact closure activation.
- 2) A cabinet interface module for multiple radar units may be provided in lieu of individual two (2) and four (4)-channel contact closure interface modules, and as shown in the plans.
- 3) Maintain a detection accuracy of 95% for each detection zone setup on the graphical user interface.

The advanced radar sensors shall turn on an alert output when the user defined zone output combinational logical is satisfied.

The advanced radar sensors shall turn on normal channel output when any of the channel's alerts is on and the channel's delay and extend time constraints are satisfied.

907-641.02.7--Capabilities--IRVD. The IRVD shall detect true presence of vehicles whether in motion or still without using Locking or Latching Algorithms. It shall be suitable for mounting on roadside poles or on overhead structure and provide the following:

- 1) Presence indication of moving or stopped vehicles in its detection zones shall be provided by contact closure to existing controllers.
- 2) Traffic data, periodically accumulated over user defined time intervals in a 10 to 600 second range, shall be transmitted to the TMC via the communications network.
- 3) Traffic data shall be available simultaneously with detection zone contact closures and serial communications.
- 4) Side-fired configuration data shall include the following in each of a minimum of 12 detection zones (lanes): Volume, lane occupancy, and average speed, as well as vehicle classification by length in up to six (6) user-defined classes.
- 5) IRVD in forward-looking configuration shall monitor traffic in one lane and be capable providing the following data: Volume, occupancy, average speed and travel direction in the lane.
- 6) The unit shall be furnished with the required software for data collection, processing, configuration and set-up and data logging and retrieval. An operator shall be able to use the software to set detector count periods, sensitivities and other operational features and parameters. The software shall be capable of providing both manual and automatic setup and calibration.

907-641.02.7.1--Measurement Accuracy. The following error levels shall be achievable and demonstrated during testing:

Parameter	Error Percentage
Volume	8%
Average Speed	10% or 5 mph
Lane Occupancy	20%

907-641.02.8--Environmental Conditions and Protection. The radar unit shall maintain accurate performance in all weather conditions, including rain, freezing rain, snow, wind, dust, fog, and changes in temperature and light, including direct light on sensor at dawn and dusk. All radar sensors shall not require cleaning or adjusting to maintain performance. Except as stated otherwise herein, the equipment shall meet all its specified requirements during and after subjecting to any combination of the NEMA TS 2-2003 standard and the following:

- 1) Ambient temperature range of -40°F to +165°F
- 2) Relative humidity from 5 to 95%, non-condensing
- 3) Rain and other precipitation up to 1.0 inch/hour
- 4) Power surge protection devices (SPD) shall be included with the radar sensors and shall meet Subsection 722.12 requirements for 24 VDC and signal/data line surge protection for Ethernet, RS-485, RS-422 and RS-232 data lines.

907-641.02.9--Mechanical. The radar sensors shall not exceed five pounds (5 lbs.) in weight. All external parts of the radar sensors shall be ultraviolet-resistant, corrosion resistant, and protected from fungus growth and moisture deterioration.

The radar sensors shall be classified as watertight according to the NEMA 250 Standard. The enclosure shall conform to test criteria set forth in the NEMA 250 standard for type 4X enclosures.

Each of the radar sensors shall be able to withstand a drop of up to five (5) feet without compromising its functional and structural integrity. The sensor shall not require adjustments to maintain performance unless roadway geometry changes.

The radar sensors shall be mounted directly onto a mounting assembly fastened to a pole or other solid structure. The assembly shall provide the necessary degrees of rotation to ensure proper installation. The assembly shall be constructed of weather-resistant materials and shall be able to support a 20-pound load.

907-641.02.10--Electrical. The radar sensors shall consume less than 10 W and shall operate with a DC input between 12 VDC and 28 VDC for IRVD and 9 VDC and 32 VDC for SRVD, or POE. POE injectors shall be approved by the Engineer.

Surge Protection Devices (SPD) shall be provided to protect the equipment from surges in the radar sensors 24 VDC power supply and the signal line RS232, RS 485, or Ethernet communications wiring. Surge suppression shall be UL 1449 listed and meet all requirements of Subsection 722.12 for surge protection devices.

907-641.02.11--Radar Design. The radar units shall be designed to provide detection over a large area and to discriminate lanes. The circuitry shall be void of any manual tuning elements that could lead to human error and degraded performance over time. The radar shall not rely on temperature compensation circuitry to maintain transmit frequency stability.

The bandwidth of the transmit signal of the radar sensor shall not vary by more than one percent (1%) under all specified operating conditions and over the expected life of the sensor. The stop bar radar sensor shall provide at least four (4) RF channels so that multiple units can be mounted in the same vicinity without causing interference between them.

907-641.02.12--Communication Ports. The radar sensor shall have Ethernet, RS-485, or RS-232 ports for communication from the unit to the cabinet. The IRVD shall be upgradable (optional) to include integral 10/100 Base-T Ethernet supporting TCP, UDP, IP, ARP, ICMP.

Within the cabinet, all remote communications to Ethernet switches shall be IP Ethernet with RJ-45 connections. For SRVD, any external device needed to convert serial to IP Ethernet within the cabinet for remote communications shall be provided with the radar sensor unit at no additional cost.

The radar sensor shall support the upload of new firmware into the unit's non-volatile memory. The sensor shall support user defined or automatic configuration of the com ports.

907-641.02.13--Radar Detection Cabling. All Radar Detection cable shall be paid per the unit cost of the pay item for Radar Detection Cable, as shown on the plans or details. The manufacturer is responsible for obtaining plan sets and ensuring cable lengths are properly measured and accounted for in the bid price for each sensor unit and as shown on the plans.

The cable shall have a single continuous run with no splices, unless inside a manufacturer supplied junction box. The cable shall be terminated only on the two (2) farthest ends of the cable. The cable shall meet the requirements of the manufacturer.

907-641.02.14--Electrical Isolation and Surge Protection. All communication and power lines shall be installed using surge protection devices (SPD), as stated in specification Subsection 722.12.

907-641.02.15--Configuration--SRVD. The radar sensor can either have an on screen interactive or automatic configuration setup. The auto setup shall automatically define traffic lanes, stop bars, and detection zones without requiring user intervention. The auto-configuration process shall automatically define traffic lanes or detection zones by detecting the relative position of vehicles with the sensor's field of view.

The radar sensor shall also allow the ability of the user to manually adjust the sensor configuration. The graphical interface shall operate on a MS WindowsTM based software. The software shall automatically negotiate the baud rate, the correct serial communication port, operate over a TCP/IP connection, support dial-up modem connectivity, give the operator the ability to save/back up the sensor configuration to a file or load/restore the configuration from a file, and provide a

virtual connection option so that the software can be used without connecting to an actual sensor.

907-641.02.15.1--Stop Bar Radar Vehicle Detection. The stop bar sensor shall support the configuring of lanes, stop bars, and detection zones in 1-foot increments and as stated in these specifications for lane detection.

907-641.02.15.2--Advanced Radar Vehicle Detection. The advance radar sensor can either have an on screen interactive or automatic setup. The auto setup shall have a method for automatically configuring the sensitivity of detection between 5-foot and 7.5-foot increments. The advanced radar sensor shall support the configuring of zones in at least 5-foot increments.

The advanced radar sensor shall support user configurable high-speed and low-speed detection filters for each zone. These speed filters shall be configured in 1-mph increments.

907-641.02.16--Configuration--IRVD. The radar sensor can either have an on screen interactive or automatic configuration setup. The auto setup shall automatically define traffic lanes, stop bars, and detection zones without requiring user intervention. The auto-configuration process shall automatically define traffic lanes or detection zones by detecting the relative position of vehicles with the sensor's field of view.

The radar sensor shall also allow the ability of the user to manually adjust the sensor configuration. The graphical interface shall operate on a MS WindowsTM based software. The software shall automatically negotiate the baud rate, the correct serial communication port, operate over a TCP/IP connection, support dial-up modem connectivity, give the operator the ability to save/back up the sensor configuration to a file or load/restore the configuration from a file, and provide a virtual connection option so that the software can be used without connecting to an actual sensor.

907-641.02.16.1--Stop Bar Radar Vehicle Detection. The stop bar sensor shall support the configuring of lanes, stop bars, and detection zones in 1-foot increments and as stated in these specifications for lane detection.

907-641.02.16.2--Advanced Radar Vehicle Detection. The advanced radar sensor can either have an on screen interactive or automatic setup. The auto setup shall have a method for automatically configuring the sensitivity of detection between 5-foot and 7.5-foot increments. The advanced radar sensor shall support the configuring of zones in at least 5-foot increments.

The advanced radar sensor shall support user configurable high-speed and low-speed detection filters for each zone. These speed filters shall be configured in 1-mph increments.

907-641.03--Construction Requirements. Radar Detection System shall be constructed to withstand and operate in sustained winds of up to 90 mph and a 30% gust factor. For projects that are in areas with higher wind standard, the higher standard shall be used.

907-641.03.1--SRVD Installation Requirements. The stop bar and advanced radar sensors shall be mounted as shown in the plans or per the manufacturer's recommendations on poles or structures. Mounting brackets shall be provided with the radar sensor and shall be attached to

the pole, structure, or mast arm with approved stainless-steel bands.

The Contractor shall install detector units on a pole, structure, span wire or mast arm at the manufacturers recommended height above the road surface or as shown in the plans so that the masking of vehicles is minimized and that all detection zones are contained within the specified elevation angle as suggested by the manufacturer.

Unused conductors in the cable shall be ground or terminated in the cabinet in accordance with the manufacturer's recommendations. Terminated conductors shall be individually doubled back and taped, then loosely bundled and secured if not specifically called out in the manufacturer's recommendations. If required by the plans and installation methods, impedance termination and testing of multi-drop runs shall be required per RS485 multi-drop standards.

907-641.03.1.1--SRVD Processor. Where required, the Contractor shall install any contact closure modules and processors needed to connect the sensor(s) to the signal controller within the signal cabinet environment shown in the plans. Sensors (up to 6) shall be connected to the cabinet interface module and the processor shall be connected to the signal controller per the manufacturer's requirements for the particular signal cabinet environment shown in the plans at no additional cost, or as approved by the Engineer.

907-641.03.2--IRVD Installation Requirements. All equipment shall be installed according to the manufacturer's recommendations, the plans and as follows:

- 1) The IRVD shall be mounted in side-fired or front facing configuration on poles as shown in the plans, using mounting brackets. The brackets shall be attached with approved 3/4-inch-wide stainless steel bands.
- 2) The Contractor shall install the detector unit on a pole at the manufacture's recommended height above the road surface so that the masking of vehicles is minimized and that all detection zones are contained within the specified elevation angle as suggested by the manufacturer.
- 3) When installing a detector near metal structures, such as building, bridges, or sign supports, the sensor shall be mounted and aimed so that the detection zone is not under and does not pass through any structure to avoid distortion and reflection.
- 4) The IRVD mode of operation, detection zones and other calibration and set up will be performed using a MS Windows™ based software and a Notebook PC. The software shall allow verification of correct setup and diagnostics. It shall include facilities for saving verification data and collected data as well as saving and retrieving sensor setup from disk file.
- 5) Unused conductors in the ITS Radar Vehicle Detector Cable shall be grounded or terminated in the cabinet in accordance with the manufacturer's recommendations. Terminated conductors shall be individually doubled back and taped, then loosely bundled and secured.
- 6) The Contractor shall provide the Department with a written inventory of items received and the condition in which they were received. Inventory shall be inclusive of make, model, and serial numbers, MAC address, and installation GPS coordinates. All equipment shall be installed according to the manufacturer's recommendations or as directed by the Department.

- 7) Any new, additional, or updated drivers required for the existing ATMS software to communicate and control new IRVD installed by Contractor shall be the responsibility of the Contractor.

907-641.03.2.1--IRVD Processor. Where required, the Contractor shall install any contact closure modules and processors needed to connect the sensor(s) to the signal controller within the signal cabinet environment shown in the plans. Sensors (up to 6) shall be connected to the cabinet interface module and the processor shall be connected to the signal controller per the manufacturer's requirements for the particular signal cabinet environment shown in the plans at no additional cost, or as approved by the Engineer.

907-641.03.3--Radar Sensor Test Requirements. When requested by the Project Engineer and/or the Project Engineer's representative, the Contractor shall conduct a Project Testing Program as required below. All costs associated with the Project Testing Program shall be included in overall contract prices; no separate payment will be made for any testing.

The Contractor shall be responsible for planning, coordinating, conducting, and documenting all aspects of the Project Testing Program. The Project Engineer and/or the Project Engineer's representative are only responsible for attending and observing each test and reviewing and approving the Contractor's test results documentation. The Project Engineer and/or the Project Engineer's representative reserve the right to attend and observe all tests.

Each test shall fully demonstrate that the equipment being tested is in full compliance with all project requirements.

Test procedures shall be submitted and approved for each test as part of the project submittals at the request of the Engineer. Test procedures shall include every action necessary to fully demonstrate that the equipment being tested is clearly and definitively in full compliance with all project requirements. Test procedures shall contain documentation regarding the equipment configurations and programming.

No testing shall be scheduled until approval of all project submittals and approval of the test procedures for the given test.

The Contractor shall provide all ancillary equipment and materials as required in the approved test procedures.

The Contractor shall request in writing the Project Engineer's approval for each test occurrence a minimum of 14 days prior to the requested test date. Test requests shall include the test to be performed and the equipment to be tested. The Project Engineer reserves the right to reschedule test request if needed.

All tests shall be documented in writing by the Contractor in accordance with the test procedure and submitted to the Project Engineer within seven (7) days of the test. Any given test session is considered incomplete until the Project Engineer has approved the documentation for that test session.

All tests deemed by the Project Engineer to be unsatisfactorily completed shall be repeated by the Contractor. In the written request for each test occurrence that is a repeat of a previous test, the Contractor shall summarize the diagnosis and correction of each aspect of the previous test that was deemed unsatisfactory. The test procedures for a repeated test occurrence shall meet all the requirements of the original test procedures, including review and approval by the Project Engineer.

The satisfactory completion of any test shall not relieve the Contractor of responsibility to provide a completely acceptable and operating system that meets all requirements of this project.

Test shall include verification of detection for each lane of traffic or zone per site.

907-641.03.4--Warranty. The Signal Radar Detection sensors shall be warranted to be free of manufacturer defects in materials and workmanship for a period of one (1) year from the date of Final Acceptance. Equipment covered by the manufacturer's warranties shall have the registration of that component placed in the Department's name prior to Final Inspection. The Contractor shall be responsible for ensuring that the vendors and/or manufacturers supplying the components and providing the equipment warranties recognize the Department as the original purchaser and owner/end user of the component from new. During the warranty period, the supplier shall repair or replace with new or refurbished material, at no additional cost to the State, any product containing a warranty defect, provided the product is returned postage-paid by the Department to the supplier's factory or authorized warranty site. Products repaired or replaced under warranty by the supplier shall be returned prepaid by the supplier.

During the warranty period, technical support shall be available from the supplier via telephone within four hours of the time a call is made by the Department, and this support shall be available from factory certified personnel. During the warranty period, updates, and corrections to control unit software shall be made available to the Department by the supplier at no additional cost.

907-641.03.5--MDOT Employee Training. The supplier of the radar detection sensors shall, at a minimum, provide an 8-hour operations and maintenance training class with suitable documentation for up to eight (8) persons selected by the Department, if shown and quantified in the plans. The training shall be at the discretion and approved by the Engineer. The training must include both classroom style training and hands-on training in the field of the maintenance and troubleshooting procedures required for the system. The training should also consist of a hands-on demonstration of all software configuration and functionality where applicable. The operations and maintenance class shall be scheduled at a mutually acceptable time and location.

907-641.03.6--Maintenance and Technical Support. The supplier shall maintain an adequate inventory of parts to support maintenance and repair of the radar detection sensor(s). The manufacturer of the radar detection system must provide and have a parts support system capable of providing parts for a period of five (5) years from the date of system acceptance. Spare parts shall be available for delivery within 30 days of placement of an acceptable order at the supplier's then current pricing and terms of sale of said spare parts.

The suppliers shall maintain an ongoing program of technical support for the Radar Detection System. This technical support shall be available via telephone or via personnel sent to the installation site upon placement of an acceptable order at the supplier's then current pricing and terms of sale of said technical support services.

907-641.04--Method of Measurement. Radar Vehicle Detection Sensors, of the type specified, will be measured as a unit per each.

Radar Vehicle Detection Processor, of the type specified, will be measured as a unit per each.

Radar Vehicle Detection Cable will be measured by the linear foot, measured horizontally along the conduit, messenger cable or mast arm and vertically along the pole.

Radar Vehicle Detection Training will be measured per lump sum.

907-641.05--Basis of Payment. Radar Vehicle Detection Sensor, of the type specified, measured as prescribed above, will be paid for at the contract unit price bid per each, which price shall be full compensation for furnishing all materials, construction installation, connecting, testing, for all equipment, tools, labor, and incidentals required to complete the work. Work shall include furnishing, installing, system integration, testing and training (if required) of complete radar sensor system that includes the unit, cabling between the unit and the cabinet, surge protection devices, communication converters (if required), all conduit, risers and weatherhead between the radar sensors and the cabinet, interconnection wiring, power supply, connections to support structures (includes all incidental components, attachment hardware, mounting brackets, mounting arms, bolts, or any other items to mount the radar sensor as intended), satisfactory completion of testing and training requirements and all work, equipment and appurtenances as required to effect the full operation including remote and local control of the radar site complete in place and ready to use. The price bid shall also include all system documentation including shop drawings, operations, and maintenance manuals, wiring diagrams, block diagrams and other material necessary to document the operation of the radar sensor.

Radar Vehicle Detection Processor, of the type specified, measured as prescribed above, will be paid for at the contract unit price bid per each, which price shall be full compensation for furnishing all materials, construction installation, connecting, testing, for all equipment, tools, labor, and incidentals required to complete the work. Work shall include furnishing, installing, system integration, testing and training (if required) of the processor, that includes the unit, cabling between the unit and the signal controller, surge protection devices, communication converters (if required), and power supply. The price bid shall also include all system documentation including shop drawings, operations, and maintenance manuals, wiring diagrams, block diagrams and other material necessary to document the operation of the processor.

Radar Vehicle Detection Cable will be paid at the contract unit price per linear foot, which price shall be full compensation for all labor, materials, equipment tools, furnishing, installing, system integration, connections, testing, and all incidentals necessary to complete the work.

Radar Vehicle Detection Training, measured as prescribed above, will be paid for as a lump sum

unit price.

Payment will be made under:

- 907-641-A: Signal Stop Bar Radar Vehicle Detection Sensor, Type ____ - per each
- 907-641-B: Signal Advanced Radar Vehicle Detection Sensor, Type ____ - per each
- 907-641-C: ITS Radar Vehicle Detection Sensor - per each
- 907-641-D: Radar Vehicle Detection Cable - per linear foot
- 907-641-E: Radar Vehicle Detection Training - lump sum
- 907-641-F: Signal Radar Vehicle Detection Processor, Type ____ - per each
- 907-641-G: ITS Radar Vehicle Detection Processor, Type ____ - per each

MISSISSIPPI DEPARTMENT OF TRANSPORTATION

SPECIAL PROVISION NO. 907-700-1

CODE: (IS)

DATE: 10/25/2022

SUBJECT: Materials and Tests

Section 700, Materials and Tests, of the 2017 Edition of the Mississippi Standard Specifications for Road and Bridge Construction is hereby amended as follows.

After Subsection 700.01 on page 713, add the following.

907-700.01.1--Buy America Materials Sourcing Requirements for Construction Materials.

As related to the requirements in Subsection 907-106.14, Construction Materials shall include an article or material that is or consists primarily of non-ferrous metals; plastic and polymer-based products (including polyvinylchloride, composite building materials, and polymers used in fiber optic cables); glass (including optic glass); lumber; or drywall. Construction Materials which are exempt from the requirements in Subsection 907-106.14 include the following: cement or cementitious materials; aggregates such as stone, sand, or gravel; or aggregate binding agents or additives.

For Construction Materials, both the final manufacturing process and the manufacturing stage immediately preceding the final manufacturing process shall occur domestically.

907-700.01.2--Compliance Requirements. Prior to incorporation into the work, the Contractor shall furnish the Project Engineer with certificates of compliance documenting conformance to the requirements of Subsection 907-106.14.

The certificates shall be on the Supplier's/Manufacturer's letterhead, containing the following:

- Project number
- Name of manufacturer and address of manufacture location
- Material description
- Batch number / Heat number / Lot number
- Bill of lading number
- Date received
- "I certify each material listed on this certificate to be permanently incorporated in this project has been manufactured domestically."
- Signature of an authorized representative of the Supplier/Manufacturer

MISSISSIPPI DEPARTMENT OF TRANSPORTATION

SUPPLEMENT TO SPECIAL PROVISION NO. 907-701-4

DATE: 11/05/2024

SUBJECT: Hydraulic Cement

907-701.04--Blended Hydraulic Cement.

907-701.04.1--Types of Blended Hydraulic Cement. After the last paragraph of Subsection 907-701.04.1 on page 1, add the following.

Blended cement Types IL meeting the “HE” high early strength requirement listed in AASHTO M 240, Table 3 shall have the “(HE)” suffix added to the type designation.

MISSISSIPPI DEPARTMENT OF TRANSPORTATION

SPECIAL PROVISION NO. 907-701-4

CODE: (IS)

DATE: 11/21/2023

SUBJECT: Hydraulic Cement

Section 701, Hydraulic Cement, of the 2017 Edition of the Mississippi Standard Specifications for Road and Bridge Construction is hereby amended as follows.

907-701.01--General. In the first sentence of the second paragraph of Subsection 701.01 on page 718, change “mills” to “plants.”

In the second sentence of the sixth paragraph of Subsection 701.01 on pages 718 and 719, change “shall” to “will.”

907-701.02--Portland Cement.

907-701.02.1--General. Delete Subsections 701.02.1.1, 701.02.1.2, 701.02.2, 701.02.2.1, and 701.02.2.2 on pages 719 and 720, and substitute the following.

907-701.02.1.1--Types of Portland Cement. Portland cement shall be either Type I, Type II, or Type III conforming to AASHTO M85 or Type III (MS). Type III (MS) is defined as a Type III cement conforming to AASHTO M85 having a maximum tricalcium aluminate (C₃A) content of 8%.

907-701.02.2--Blank.

907-701.02.2.1--Blank.

907-701.02.2.2--Blank.

Delete Subsection 701.04 on pages 720 and 721, and substitute the following.

907-701.04--Blended Hydraulic Cement.

907-701.04.1--Types of Blended Hydraulic Cement. Blended hydraulic cements (blended cements) shall be of the following types and conform to AASHTO M 240:

- Type IL – Portland-limestone cement
- Type IP – Portland-pozzolan cement
- Type IS – Portland blast-furnace slag cement

Blended cement Types IL, IP, and IS meeting the “MS” sulfate resistance requirement listed in AASHTO M 240, Table 3 shall have the “(MS)” suffix added to the type designation.

MISSISSIPPI DEPARTMENT OF TRANSPORTATION

SPECIAL PROVISION NO. 907-702-4

CODE: (IS)

DATE: 09/11/2018

SUBJECT: Bituminous Materials

Section 702, Bituminous Materials, of the 2017 Edition of the Mississippi Standard Specifications for Road and Bridge Construction is hereby amended as follows.

907-702.04--Sampling. Delete the sentence in Subsection 702.04 on page 722, and substitute the following.

Sampling of bituminous materials shall be as set out in AASHTO R 66.

907-702.07--Emulsified Asphalt. Delete the last sentence in Subsection 702.07 on page 724, and substitute the following.

Asphalt for fog seal shall conform to the requirements of Subsection 907-702.12, Table V.

907-702.12--Tables. Delete Table V in Subsection 702.12 on page 729, and substitute the following.

**TABLE V
SPECIFICATION FOR FOG SEAL**

Test Requirements	LD-7		CHPF-1		Test Method
	Min.	Max.	Min.	Max.	
Viscosity, Saybolt Furol, @ 25°C, Sec.	10	100	-	100	AASHTO T 72
Storage Stability Test, 24 hr, %	-	1	-	1	AASHTO T 59
Settlement, 5 day, %	-	5	-	-	AASHTO T 59
Oil Distillate, %	-	1	-	-	AASHTO T 59
Sieve Test, % *	-	0.3	-	0.1	AASHTO T 59
Residue by Distillation, %	40	-	40	-	AASHTO T 59
Test on Residue from Distillation					
Penetration @ 25°C, 100g, 5 sec	-	20	40	90	AASHTO T 49
Softening Point, °C	65	-	-	-	ASTM D 36
Solubility in trichloroethylene, %	97.5	-	-	-	AASHTO T 44
Elastic Recovery @ 25°C, %	-	-	40	-	AASHTO T 301
Original DSR @ 82° (G*/Sinδ, 10 rad/sec)	1	-	-	-	AASHTO T 111

* The Sieve Test result is tested for reporting purposes only and may be waived if no application problems are present in the field.

MISSISSIPPI DEPARTMENT OF TRANSPORTATION

SPECIAL PROVISION NO. 907-703-2

CODE: (SP)

DATE: 11/29/2022

SUBJECT: Gradation

Section 703, Aggregates, of the 2017 Edition of the Mississippi Standard Specifications for Road and Bridge Construction is hereby amended as follows.

907-703.03--Coarse Aggregates for Hydraulic Cement Concrete.

907-703.03.2--Detail Requirements.

907-703.03.2.4--Gradation. In the table in Subsection 703.03.2.4 on page 734, add 100 for the percent passing by weight on the 1½-inch sieve for Size No. 67 aggregates.

Delete Note 2 under the table in Subsection 703.03.2.4 on page 734, and substitute the following.

Note ² – 100 percent shall pass the 1-inch sieve for Size 67 used in Class F and Class FX concrete.

MISSISSIPPI DEPARTMENT OF TRANSPORTATION

SPECIAL PROVISION NO. 907-705-1

CODE: (IS)

DATE: 06/13/2018

SUBJECT: Stone Riprap

Section 705, Stone Blanket Protection and Filter Blanket Materials, of the 2017 Edition of the Mississippi Standard Specifications for Road and Bridge Construction is hereby amended as follows.

907-705.04--Stone Riprap. Delete the last sentence of the first paragraph of Subsection 705.04 on page 750, and substitute the following.

Quality requirements for rock to be furnished under these specifications will come from a pre-approved source and be visually approved prior to use.

MISSISSIPPI DEPARTMENT OF TRANSPORTATION

SPECIAL PROVISION NO. 907-707-3

CODE: (IS)

DATE: 10/27/2021

SUBJECT: Joint Materials

Section 707, Joint Materials, of the 2017 Edition of the Mississippi Standard Specifications for Road and Bridge Construction is hereby amended as follows.

907-707.02--Joint Filler.

907-707.02.2--Preformed Sponge, Rubber, Cork and Closed-Cell Polypropylene Foam Joint Fillers for concrete Paving and Structural Constructions. Delete the two paragraphs of Subsection 707.02.2 on page 755, and substitute the following.

Preformed joint filler shall conform to AASHTO M 153 for sponge, rubber, and cork and tested according to ASTM D545. The type required will be indicated on the plans.

Closed-cell polypropylene foam shall conform to the requirements in ASTM D8139 and tested in accordance with ASTM D545.

907-707.02.3--Wood. Delete paragraph (b) of Subsection 707.02.3 on page 755, and substitute the following:

- (b) Dimensions shall be as shown on the plans. Dimensions shown on the plans are “dressed” sizes in accordance with Table 3 of the American Softwood Lumber Standard, SP-20. At the discretion of the Engineer, a 3/4-inch dressed board may be used in lieu of a 1-inch dressed board. A tolerance of plus or minus 1/16 inch thickness and plus or minus 1/8 inch width will be permitted. For slip-form paving a tolerance of minus 1/4 inch on each end in length will be permitted.

907-707.06--Flexible Plastic Gasket for Joining Conduit. Delete the third paragraph of Subsection 707.06 on page 756, and substitute the following.

The Department may require the performance test described in ASTM C 990.

MISSISSIPPI DEPARTMENT OF TRANSPORTATION

SPECIAL PROVISION NO. 907-711-2

CODE: (IS)

DATE: 09/11/2018

SUBJECT: Plain Steel Wire

Section 711, Reinforcement and Wire Rope, of the 2017 Edition of the Mississippi Standard Specifications for Road and Bridge Construction is hereby amended as follows.

907-711.02--Deformed and Plain Carbon-Steel Bars for Concrete Reinforcing.

907-711.02.3--Steel Welded and Non-Welded Wire Reinforcement, Plain and Deformed, for Concrete.

907-711.02.3.1--Plain Steel Wire. Delete the sentence in Subsection 711.02.3.1 on pages 780 and 781, and substitute the following.

Plain steel wire and plain steel welded wire shall conform to the requirements of AASHTO M 336.

MISSISSIPPI DEPARTMENT OF TRANSPORTATION

SPECIAL PROVISION NO. 907-712-1

CODE: (SP)

DATE: 12/07/2021

SUBJECT: Fence and Guardrail

Section 712, Fence and Guardrail, of the 2017 Edition of the Mississippi Standard Specifications for Road and Bridge Construction is hereby amended as follows.

907-712.01--General. After the sentence in Subsection 712.01 on page 785, add the following.

All materials' inspection, testing, and certification will be performed in accordance with the requirements of the current version of the Department's *Materials Division Inspection, Testing, and Certification Manual*.

Delete Subsections 712.02 and 712.03 on page 785, and substitute the following.

907-712.02--Barbed Wire. Barbed wire shall conform to the requirements of AASHTO M 280. In the coastal counties of Hancock, Harrison, and Jackson, either Coating Type Z Class 3 or Coating Type A shall be furnished. In all other areas of the State, either Coating Type Z Class 1, Coating Type Z Class 3, Coating Type ZA Class 60, or Coating Type A shall be furnished.

907-712.03--Metallic-Coated, Steel Woven Wire Fence Fabric. Woven wire fencing (i.e., "hog wire") shall conform to the requirements of AASHTO M 279. In the coastal counties of Hancock, Harrison, and Jackson, either Coating Type Z Class 3 or Coating Type A shall be furnished. In all other areas of the State, either Coating Type Z Class 1, Coating Type Z Class 3, Coating Type ZA Class 60, or Coating Type A shall be furnished.

907-712.04--Chain Link Fence. Delete Subsections 712.04.1 thru 712.04.7 on pages 785 & 786, and substitute the following.

907-712.04.1--Fabric. In the coastal counties of Hancock, Harrison, and Jackson, either Type I Class D, Type II, Type III, or Type IV fabrics shall be furnished. In all other areas of the State, either Type I Class C, Type I Class D, Type II, Type III, or Type IV fabrics shall be furnished.

907-712.04.2--Tie Wire. Tie wire shall be of the same material as the fencing wire being used, shall be of good commercial quality, and shall meet the requirements of AASHTO M 181. Either Type I, Type II, Type III, or Type IV tie wire shall be furnished.

907-712.04.3--Tension Wire. Tension wire shall be of the same material as the fencing wire being used, shall be of good commercial quality, and shall meet the requirements of AASHTO M 181. In the coastal counties of Hancock, Harrison, and Jackson, either Type I Class 3, Type II, Type III, or Type IV tension shall be furnished. In all other areas of the State, either Type II, Type III, Type IV, or Type I Classes 1, 2, or 3 tension wires shall be furnished.

907-712.04.4--Posts Rails, Gate Frames, and Expansion Sleeves. Posts, rails, gate frames, and expansion sleeves shall conform to the requirements for posts in Subsection 712.05.2, unless otherwise designated in the contract.

907-712.04.5--Miscellaneous Fittings and Hardware. Miscellaneous fittings and hardware shall conform to the requirements of Subsection 712.16.

907-712.05--Fence Posts and Braces.

907-712.05.1--Treated Timber Posts and Braces.

907-712.05.1.1--General. Delete the third, fourth, fifth, and sixth paragraphs of Subsection 712.05.1.1 on page 787, and substitute the following.

All wood posts and braces shall be treated in accordance with Subsections 718.03 and 718.04.

907-712.05.1.2--Round Posts. Delete the last sentence of the last paragraph of Subsection 712.05.1.2 on page 788.

907-712.05.1.3--Sawed Posts. Delete the last sentence of the paragraph of Subsection 712.05.1.3 on page 788.

907-712.05.1.4--Sawed Braces. Delete the last sentence of the paragraph of Subsection 712.05.1.4 on page 788.

Delete Subsection 712.05.2 on page 788, and substitute the following.

907-712.05.2--Metal Posts.

907-712.05.2.1--Round Steel Pipe. Round steel pipe shall meet the requirements of AASHTO M 181, either Grade 1 (i.e., meeting the requirements in ASTM F 1083) or Grade 2 (i.e., meeting the requirements of ASTM F 1043).

Round steel pipe shall be sized in accordance with NPS (nominal pipe size) designations as shown on Plans, and not according to the outer or inner pipe diameter.

907-712.05.2.2--Steel Fence Post and Assemblies, Hot-Wrought. Steel posts with the following section shapes, Tee, channel or U, and Y-Bar shall meet the requirements of AASHTO M 281, galvanized in accordance with the requirements of AASHTO M 111, unless otherwise specified in the contract. Acceptance of these steel posts shall be by certification from the manufacturer, producer, supplier, or fabricator, as applicable.

907-712.05.2.3--Blank.

907-712.05.2.4--Steel H-Beam Posts. Steel H-Beam posts shall be produced from structural quality weldable steel having a minimum yield strength of 45,000 psi and shall be galvanized in accordance with ASTM A 123. Steel H-Beam line posts shall be 2.250 inches by 1.625 inches and shall weigh 3.43 pounds per foot. A tolerance of plus or minus 5.0 percent is allowed for

weight per foot. A tolerance of plus or minus 1.0 percent is allowed for dimensions.

907-712.05.2.5--Aluminum-Alloy Posts and Assemblies. Round aluminum-alloy posts shall meet the requirements of ASTM B 241, Alloy 6061, T6. Aluminum-Alloy H-Beam posts shall meet the requirements of ASTM B 221, Alloy 6061, T6.

907-712.05.2.6--Formed Steel Section Posts. Formed steel section posts, "C" sections, shall be formed from sheet steel conforming to ASTM A 1011, Grade 45, and shall be galvanized in accordance with ASTM A 123.

907-712.06--Guard and Guardrail Posts.

907-712.06.2--Treated Wood Posts.

907-712.06.2.1--Square Posts. Delete the paragraph in Subsection 712.06.2.1 on page 789, and substitute the following.

All square posts shall be inspected for conformance with Section 712.05, except that the posts may be rough and shall be within $\pm 3/8$ " of the dimensions shown on the plans.

907-712.06.2.2--Round Posts. Delete the paragraph in Subsection 712.06.2.2 on page 789, and substitute the following.

All round posts shall be inspected for conformance with Section 712.05, except that the posts shall be of the shape and dimensions shown on the plans.

907-712.06.5--Treated Wood Blocks for Use with Metal Guardrail Posts. Delete the paragraphs of Subsection 712.06.5 on pages 789 & 790, and substitute the following.

Treated wood blocks for use with metal guardrail posts shall be within $\pm 3/8$ " of the size and dimensions shown on the plans, except that a minus tolerance shall not be allowed for the slotted width in which the metal post must fit.

Delete Subsection 712.16 on page 791, and substitute the following.

907-712.16--Hardware. All ferrous metal hardware for fencing such as bolts, nuts, washers, and metal straps shall be as specified on the plans and galvanizing shall not be less than 1.0 ounce per square foot of uncoated area. Aluminum coated hardware shall be coated with aluminum meeting the requirements of AASHTO M 181 for aluminum coating and at the rate of not less than 0.4 ounces per square foot of uncoated area.

Aluminum alloy hardware shall conform to the requirements of ASTM B 221 for extruded aluminum alloy 6063, T6. The finished members shall be of uniform quality.

Aluminum-zinc coated hardware shall be coated with an aluminum-zinc alloy meeting the chemical requirements and weight of coating specified for aluminum-zinc alloy coated metal gates.

MISSISSIPPI DEPARTMENT OF TRANSPORTATION

SPECIAL PROVISION NO. 907-714-3

CODE: (SP)

DATE: 08/31/2021

SUBJECT: Miscellaneous Materials

Section 714, Miscellaneous Materials, of the 2017 Edition of the Mississippi Standard Specifications for Road and Bridge Construction is hereby amended as follows.

907-714.01--Water.

907-714.01.1--General. Delete the last sentence of the second paragraph in Subsection 714.01.1 on page 794.

907-714.01.2--Water for Use in Concrete. Delete Subsection 714.01.2 on page 794, and substitute the following:

Water from municipal sources is permitted be used as mixing water in concrete, mortar, and grout without Department testing. Water from non-municipal water sources used in mixing of concrete, mortar, and grout which does not meet the requirements in Subsection 714.01.1 shall be tested for conformance as required in AASHTO M157, Table 1 and Table 2.

907-714.01.3--Water for Use in Chemically Stabilized Based. Delete the first sentence of first paragraph in Subsection 714.01.3 on page 794, and substitute the following:

Water used in the construction of bases that contain cement, lime, or other chemical additive shall be as set out in Subsection 714.01.1. Water from municipal sources is permitted to be used without testing for conformance to the requirements below. If water is not from a municipal source, it shall not contain impurities in excess of the following limits:

Delete Subsection 714.01.6 on page 795, and substitute the following.

907-714.01.6--Blank.

907-714.05--Fly Ash.

907-714.05.1--General. Delete the first sentence of the fifth paragraph in Subsection 714.05.1 on page 797.

907-714.13--Geotextiles.

907-714.13.11--Tables. Delete Table 1 in Subsection 714.13.11 on page 813, and substitute the following.

Table 1 - Geotextiles

Type Designation	I ¹ Sediment Control	II ¹ Control	III Drainage	IV Paving	V Separation & Drainage		VI Separation, Stabilization & Reinforcement		VIII High Strength	IX High Strength	Test Method
					Woven	Non-Woven	Woven	Non-Woven			
Grab Strength (lb)	50	90	110	90	200	280	180	450	280	280	ASTM D 4632
Elongation (%)	----	50% max @ 45 lb	20% min	50% min @ break	50% min	50% max	50% min	50% max	50% min	50% min	ASTM D 4632
Seam Strength (lb)	----	----	70	----	180	240	160	400	240	240	ASTM D 4632
Puncture Strength (lb)	----	----	40	----	80	110	75	180	115	115	ASTM D 6241
Trapezoidal Tear (lb)	----	----	40	----	80	100	70	150	100	100	ASTM D 4533
Asphalt Retention (gal/yd ²)	----	----	----	0.2	----	----	----	----	----	----	ASTM D 6140
Permittivity (sec ⁻¹) min	0.05	0.05	0.5	----	0.2	0.2	0.2	0.2	0.2	0.2	ASTM D 4491
AOS Woven (mm) max	0.60	0.60	0.6	----	0.6	0.43	----	0.43	----	----	ASTM D 4751
AOS Non-Woven (mm) max	0.84	0.84	0.43	----	0.43	----	0.43	----	0.43	0.43	----
Tensile Strength after UV (% Retained)	70% @ 500 hr	70% @ 500 hr	50% @ 500 hr	----	50% @ 500 hr	50% @ 500 hr	50% @ 500 hr	50% @ 500 hr	50% @ 500 hr	50% @ 500 hr	ASTM D 4355
Melting Point °(F)	----	----	----	325	----	----	----	----	----	----	ASTM D 276
Minimum Ultimate Tensile Strength ³ (lb/in)	----	----	----	----	----	----	----	----	660	2000	ASTM D 4595

Notes: 1 - All property values, with the exception of apparent opening size (AOS), represent minimum average roll values in the weakest principal direction. Values for AOS represent the maximum average roll values, 2 - Values not identified in this table should meet manufacturer certification for the use and application, 3 - Machine direction

Delete Subsection 714.15 on pages 816 and 817 and substitute the following.

907-714.15--Geogrids.

907-714.15.1--General. A geogrid is defined as a geosynthetic formed by a regular network of connected elements with apertures greater than 0.25 inch to allow interlocking with surrounding soil, rock, and other surrounding materials to function primarily as reinforcement.

Geogrid shall be manufactured from an expanded strain hardened monolithic polymer sheet composed of one or more synthetic polymers and shall be mildew resistant and inert to biological degradation and naturally encountered chemicals, alkalis and acids. The geogrid shall contain stabilizers and/or inhibitors, or a resistance finish or covering to make it resistant to deterioration from direct sunlight, ultraviolet rays, and heat.

Geogrid manufacturers shall participate in and be in compliance with the American Association of State Highway Transportation Officials (AASHTO) National Transportation Product Evaluation Program's (NTPEP) Geosynthetics audit program. Geogrid shall meet the requirements of Table II for the application and type shown on the plans and shall be selected from the Department's Approved Lists.

907-714.15.1.1--Geogrid for Retaining Walls and Reinforced Soil Slopes. Geogrid for retaining walls and reinforced soil slopes shall be creep tested in accordance with AASHTO R69 and meet Long Term Design Load, Minimum Ultimate Tensile Strength, and open area criteria listed in Table II. Manufacturers shall perform at least one long-term creep test for no less than 10,000 hours in accordance to ASTM D 5262 for each polymer or composition of polymers from which the geogrid is produced. The long-term design load that shall be reported for design use, shall be that load at which no more than 10% strain occurs over a 100-year design life of the geogrid, as calculated in accordance with AASHTO R69. Long-term design loads shall be reported unfactored, and the AASHTO strength reduction factors (Durability and Installation, and safety factors) will be considered by the Department's Geotechnical Branch on a site specific design basis.

907-714.15.1.2--Geogrid for Subgrade Stabilization. Geogrid for subgrade stabilization shall meet Minimum Ultimate Tensile Strength and open area criteria listed in Table II.

907-714.15.2--Marking, Shipment, and Storage. Each roll or container of geogrid shall be visibly labeled with the name of the manufacturer, trade name of the product, lot number, and quantity of material. In addition, each roll or container shall be clearly tagged to show the type designation that corresponds to that required by the plans. During shipment and storage the geogrid shall be protected from direct sunlight, and temperatures above 120°F or below 0°F. The geogrid shall either be wrapped and maintained in a heavy duty protective covering or stored in a safe enclosed area to protect from damage during prolonged storage.

907-714.15.3--Manufacturer Certification. The Contractor shall furnish the Engineer three copies of the manufacturer's certified test reports indicating that the geogrid furnished conforms to the requirements of the specifications and is of the same composition as the originally approved

by the Department.

907-714.15.4--Acceptance Sampling and Testing. Final acceptance of each shipment will be based upon results of tests performed by the Department on verification samples submitted from the project, as compared to the manufacturer's certified test reports. The Engineer will select one roll or container at random from each shipment for sampling. As sample extending full width of the randomly selected roll or container and being at least five (5) square yards in area will be obtained and submitted by the Engineer. All material samples shall be provided at no cost to the State.

**TABLE II
GEOGRIDS**

Physical Properties	Type Designation						Test Method
	I	II	III	IV	V	VI	
Long Term Design Load ¹ , pounds per foot, Machine Direction	250	500	750	1500	2500	3500	AASHTO R69, ASTM D5262
Minimum Ultimate Tensile Strength ² , pounds per foot, Machine Direction	500	1000	1500	3000	5000	7000	ASTM D6637
Open Area, percent	70	70	50	50	50	50	Direct Measurement

¹ Minimum design criteria requirement.

² Minimum Average Roll Value (MARV).

MISSISSIPPI DEPARTMENT OF TRANSPORTATION

SPECIAL PROVISION NO. 907-718-1

CODE: (SP)

DATE: 12/07/2021

SUBJECT: Timber and Dimension Lumber

Section 718, Timber and Dimension Lumber, of the 2017 Edition of the Mississippi Standard Specifications for Road and Bridge Construction is hereby amended as follows.

Delete the Subsections in Section 718 on pages 836 thru 838, and substitute the following.

907-718.01--General. All timber and dimension lumber shall be Southern pine and shall conform in all respects to applicable requirements of AASHTO M 168. The Department reserves the right to sample and to test all materials at any time; all inspection, testing, and certification of materials will be performed in accordance with the requirements of the current version of the Department's *Materials Division Inspection, Testing, and Certification Manual*.

Timber and dimension lumber shall be furnished in the sizes shown on the plans or as specified. Unless otherwise specified, timber and dimension lumber shall be No. 1, or better, graded according to the latest American Lumber Standards.

Only one type of preservative shall be used for the treatment of materials for any one class of construction on a project, unless otherwise specified.

Where treated timber and dimensional lumber is to be used in non-highway construction or use, such as decking, handrails in walking trails, or in any manner where general public exposure by touch is possible, the treatment requirements will be as per project plans and/or approved by the State Materials Engineer.

907-718.02--Untreated Timber and Dimension Lumber. Untreated timber and dimension lumber shall conform to the requirements of AASHTO M 168.

907-718.03--Treated Timber and Dimension Lumber. Timber and dimension lumber to be treated shall meet the requirements herein specified and shall be treated as specified. Treated timber or dimensional lumber will not be accepted for use unless it has been inspected by an authorized representative of the Department and found to be satisfactory after treatment.

907-718.03.1--Blank.

907-718.03.2--Treatment.

907-718.03.2.1--General. All materials shall be treated in accordance with AASHTO M 133 unless otherwise directed by the Environmental Protection Agency (EPA).

907-718.03.2.2--Blank.

907-718.03.2.3--Inspection. Treated timber and dimension lumber shall be inspected by an authorized representative of the Department before being incorporated into the work. Treatment reports shall be provided to the Department for each lot of material supplied.

907-718.03.3--Blank.

907-718.03.4--Storage of Treated Material. All material treated for stock shall be stacked as compactly as possible on a well-drained surface. Material shall be supported on sills spaced as necessary, not to exceed 10 foot intervals and shall have at least one foot of air space beneath the stacks.

All materials treated with preservatives for use in buildings and applications where painting is required shall be dried after treatment. The treated wood shall be dried in accordance with American Lumber Standards.

907-718.04--Preservative. Preservatives shall be as specified in AASHTO M 133 unless otherwise directed by the Environmental Protection Agency (EPA).

MISSISSIPPI DEPARTMENT OF TRANSPORTATION

SPECIAL PROVISION NO. 907-720-3

CODE: (IS)

DATE: 07/09/2024

SUBJECT: Pavement Marking Materials

Section 720, Pavement Marking Materials, of the 2017 Edition of the Mississippi Standard Specifications for Road and Bridge Construction is hereby amended as follows.

Delete Section 720 on pages 840 thru 854, and substitute the following.

SECTION 720 - PAVEMENT MARKING MATERIALS

907-720.01--General. The Department reserves the right to perform sampling and testing of any materials at any time. Upon request of the Engineer, samples of the material shall be furnished.

907-720.02--Color Requirements. All pavement markings except raised pavement markers are required to meet the color requirements of ASTM D6628.

907-720.03--Optics. Optics used in thermoplastic pavement markings shall consist of a double-drop system of glass beads or advanced optics.

907-720.03.1--Glass Beads. The manufacturer shall furnish the Engineer with a certified test report indicating that the glass beads meet AASHTO M 247. AASHTO Type 4 beads shall be applied to the newly placed stripe first, followed by the application of AASHTO Type 1 beads. Type 1 and 4 glass beads shall be transparent, clean, colorless glass, smooth and spherically shaped, free from milkiness, pits, or excessive air bubbles. Type 1 and 4 glass beads shall be coated with a bead coating that is compatible with the traffic marking material to which the glass beads will be applied and will provide adequate moisture proofing, increased adhesion, and optimum embedment of the glass beads.

907-720.03.1.1--Acceptance Procedure. The Contractor shall furnish the Engineer with a copy of the manufacturer's certified test reports for the lot(s) of materials from which the shipment originated. The test report shall show all the test results for the material properties and characteristics as specified herein. The test report shall state that the material represented by the test results meets all the requirements of the contract. It shall be the Contractor's responsibility to furnish the manufacturer's test report to the Engineer for each shipment of material to the project.

Acceptance sampling and testing will be in accordance with the Materials Division Inspection, Testing, and Certification Manual (Materials Manual). Samples of the material shall be furnished and shall be provided at no cost to the State.

907-720.03.2--Advanced Optics. Advanced optics are materials that do not meet the specific requirements of AASHTO M 247 but produce a final drop-on optics system that meets or exceeds

the reflectivity requirements in Special Provision 907-626. Advanced optics shall be a double-drop system that is pre-approved and listed on the Department's Approved Products List.

907-720.03.2.1--Acceptance Procedure. The Contractor shall furnish the Engineer with a copy of the manufacturer's certified test reports for the lot(s) of materials from which the shipment originated. The test report shall show all the test results for the material properties and characteristics as specified herein. The test report shall state that the material represented by the test results meets all the requirements of the contract. It shall be the Contractor's responsibility to furnish the manufacturer's test report to the Engineer for each shipment of material to the project.

Acceptance sampling and testing may be conducted at the request of the Engineer. Samples of the material shall be furnished and shall be provided at no cost to the State.

907-720.04--Thermoplastic Marking Material.

907-720.04.1--General. Thermoplastic marking material shall meet the color requirements of Subsection 907-720.02.

There shall be no obvious change in the color of the material if held at its plastic temperature for a period of four (4) hours nor by reason of four (4) re-heatings to its plastic temperature.

The pavement markings shall maintain its original dimension and placement. The material shall not be slippery when wet and it shall not lift from the pavement in freezing weather.

907-720.04.2--Extruded Thermoplastic Material. Extruded thermoplastic pavement marking material shall meet the requirements of AASHTO M 249, and shall meet the requirements of 907-720.04 with the following exceptions:

- Blue - ADA thermoplastic marking material shall meet the requirements of Subsection 907-720.04.2 with the exception that the color shall be Blue – ADA, and the Contractor may use hot applied thermoplastic materials meeting the satisfaction of the Engineer.

907-720.04.3--Spray-Applied Thermoplastic Material. Spray-applied thermoplastic pavement marking material shall meet the requirements of AASHTO M 249 and shall meet the requirements of 907-720.04.

907-720.04.4--Pre-formed Thermoplastic Material. Heat-fused, pre-formed thermoplastic pavement marking material shall meet the color requirements of 907-720.02.

907-720.04.5--Acceptance Procedure. The Contractor shall furnish the Engineer with a copy of the manufacturer's certified test reports for the lot(s) of materials from which the shipment originated. The test report shall show all the test results for the material properties and characteristics as specified herein. The test report shall state that the material represented by the test results meets all the requirements of the contract. It shall be the Contractor's responsibility to furnish the manufacturer's test report to the Engineer for each shipment of material to the project.

907-720.05--Pavement Marking Tape.

907-720.05.1--General. Pavement marking tape shall be listed on the Department's Approved Lists.

907-720.05.2--Cold Plastic Pavement Markings (Permanent Pavement Marking Tape). Pavement marking tape for use in roadway applications shall be designated on the Department's Approved Lists as permanent.

The prefabricated markings described shall consist of white or yellow pigmented plastic films with reflective optics uniformly distributed throughout their entire cross-sectional area, and be capable of being affixed by either a pressure sensitive pre-coated adhesive or a liquid contact cement. The markings shall be provided complete in a form that will facilitate rapid application and protect the markings in shipment and storage. The manufacturer shall identify proper solvents and/or adhesives to be applied at the time of application, all equipment necessary for proper application, and recommendations for application that will assure an effective performance life.

Prefabricated legends and symbols shall conform to the applicable shapes and sizes as outlined in the current "Manual on Uniform Traffic Control Devices."

907-720.05.2.1--Specific Requirements. Unless otherwise indicated on the plans, the patterned material without adhesive shall have a minimum caliper of 0.065 inch at the thickest portion of the patterned cross-section and a minimum caliper of 0.020 inch at the thinnest portion of the cross-section. The material shall be a pliant polymer film with 50±15% of the surface are raised and presenting a near vertical face angle of 0° to 60° to traffic from any direction. The channels between the raised areas shall be substantially free of exposed optics or particles.

The size and quality of the optics will be such that performance requirements of Subsection 907-720.02 for the retroreflective pliant polymer film shall be met. The pigments shall be selected and blended to provide a marking film that is white or yellow conforming to the performance requirements of Subsection 907-720.02 through the expected life of the film.

907-720.05.2.2--Conformability and Resealing. The marking shall be capable of conforming to pavement contours, breaks, faults, etc. through the action of traffic at normal pavement temperatures.

The marking shall have resealing characteristics that allows it to be capable of fusing with itself and previously applied marking of the same composition under normal conditions of use. The marking shall be capable of use for patching worn areas of the same type in accordance with manufacturer's instructions.

907-720.05.2.3--Tensile Strength and Elongation. The material shall have a minimum tensile strength of 40 pounds per square inch of cross section when tested according to ASTM D 638. A 6-inch x 1-inch x 0.06-inch sample shall be tested at a temperature between 70°F and 80°F using a jaw speed of 12 inches per minute.

The material shall have a minimum elongation of 75% at break when tested according to ASTM D 638 using a jaw speed of 12 inches per minute.

907-720.05.2.4--Skid Resistance. The surface of the material shall provide a minimum skid resistance value of 45 BPN when tested according to ASTM E 303 except values will be taken at downweb and at a 45-degree angle from downweb. These two values will then be averaged to find the skid resistance of the patterned surface.

907-720.05.2.5--Effective Performance Life and Warranty. When applied according to the recommendations of the manufacturer the pavement marking tape shall provide a neat and durable marking that will not flow or distort due to temperature if the pavement surface remains stable. The film shall be weather resistant and through normal traffic wear shall show no appreciable fading, lifting, or shrinkage throughout the useful life of the marking, nor shall it show significant tearing, roll back, or other signs of poor adhesion.

All manufacturer's standard warranties and guarantees on pavement marking tape, which are provided as customary trade practice, shall be delivered to the Engineer at the final inspection. All warranties and guarantees shall be made out to the Department.

907-720.05.2.6--Acceptance Procedure. The Contractor shall furnish the Engineer with a copy of the manufacturer's certified test reports for the lot(s) of materials from which the shipment originated. The test report shall show all the test results for the material properties and characteristics as specified herein. The test report shall state that the material represented by the test results meets all the requirements of the contract. It shall be the Contractor's responsibility to furnish the manufacturer's test report to the Engineer for each shipment of material to the project.

Acceptance sampling and testing will be in accordance with the Materials Division Inspection, Testing, and Certification Manual (Materials Manual). Samples of the material shall be furnished and shall be provided at no cost to the State.

907-720.05.3--Preformed Pavement Markings for Construction Zones. Preformed pavement markings for construction zones shall be designated Department's Approved Lists as temporary. Retroreflective preformed pavement markings for construction zones shall be as specified on the plans or in the contract documents.

The markings shall be provided in specified widths and shapes. Preformed words and symbols shall conform to the applicable shapes and sizes as outlined in the current "Manual on Uniform Traffic Control Devices for Streets and Highways," or as modified.

The materials shall be packaged in accordance with accepted commercial standards and when stored indoors in a cool dry place, shall be suitable for use one year after date of purchase.

907-720.05.3.1--Specific Requirements. Preformed markings shall consist of retroreflective materials on a conformable backing and shall meet the performance requirements of Subsection 907-720.02. The markings shall consist of a mixture of high-quality polymeric materials, pigments, and optics with a reflective layer of optics bonded to the top surface. The markings shall

be pre-coated with a pressure sensitive adhesive capable of adhering to pavement in accordance with the manufacturer's instructions without the use of heat, solvents, or other additional adhesives. The markings and/or adhesive shall not require any curing time after application. A coated non-metallic medium shall be incorporated with the pressure sensitive adhesive to facilitate removal.

907-720.05.3.2--Acceptance Procedure. The Contractor shall furnish the Engineer with a copy of the manufacturer's certified test reports for the lot(s) of materials from which the shipment originated. The test report shall show all the test results for the material properties and characteristics as specified herein. The test report shall state that the material represented by the test results meets all the requirements of the contract. It shall be the Contractor's responsibility to furnish the manufacturer's test report to the Engineer for each shipment of material to the project.

907-720.06--Raised Pavement Markers.

907-720.06.1--General. Pavement markers shall be listed on the Department's Approved Lists and shall conform to ASTM D 4280.

907-720.06.2--Packaging. Shipments shall be made in containers acceptable to common carriers and packaged in such a manner as to ensure delivery in perfect condition. All damaged shipments shall be replaced by the Contractor. Each package shall be clearly marked as to the name of the manufacturer, type, quantity enclosed, lot number, and date of manufacture.

907-720.06.3--Non-Reflective Pavement Markers. Non-reflective pavement markers are occasionally referred to as "jiggle markers". Non-reflective markers consisting of a heat-fired, vitreous, ceramic base, and a heat-fired, opaque, glazed surface are permitted for use; the bottom of the marker shall not be glazed. Ceramic markers shall be produced from any suitable combination of intimately mixed clays, shales, talcs, flints, feldspars, or other inorganic material. Ceramic markers shall be thoroughly and evenly matured, and all non-reflective pavement markers shall be free from defects which affect appearance or serviceability.

Ceramic non-reflective markers shall conform to the following finish and testing requirements in Table 2 below.

Table 2

Ceramic Non-Reflective Marker Requirements	
Glaze Thickness	0.005 inch, minimum
Mohs Hardness	6, minimum
Autoclave	Glaze shall not spall, craze, or peel.
Compressive Strength	750 psi, minimum
Water Absorption	2.0%, maximum

907-720.06.4--Acceptance Procedure. The Contractor shall furnish the Engineer with a copy of the manufacturer's certified test reports for the lot(s) of materials from which the shipment originated. The test report shall show all the test results for the material properties and characteristics as specified herein. The test report shall state that the material represented by the test results meets all the requirements of the contract. It shall be the Contractor's responsibility to

furnish the manufacturer's test report to the Engineer for each shipment of material to the project.

907-720.07--Adhesive for Pavement Markers.

907-720.07.1--General. The adhesive shall be listed on the Department’s Approved Lists and shall be an asphaltic material suitable for bonding pavement markers to surfaces when the road surface and marker temperatures are in the range of 50°F to 160°F. The composition of the adhesive must be such that its properties will not deteriorate when heated to and applied at temperatures up to 425°F. Samples may be submitted in the form of an adhesive testing package from each batch or material obtained from a package shipped to the project.

907-720.07.2--Packaging and Labeling. The adhesive shall be packaged in self-releasing cardboard containers that will stack properly. The label shall show the manufacturer, quantity, and lot or batch number. "Adhesive for Pavement Markers" or "Adhesive for Traffic Markers" shall be printed in bold lettering on the label.

907-720.07.3--Bituminous Adhesive. The asphaltic adhesive material shall be flexible type.

907-720.07.3.1--Flexible Bituminous Adhesive. Flexible bituminous adhesive shall be designated on the Department’s Approved Lists as flexible and shall comply with requirements of Table 3 below.

Table 3

Flexible Bituminous Adhesive Properties			
	Min	Max	Test Method
Penetration @ 77°F	-	25	ASTM D 5
Softening Point, °F	200	-	ASTM D 36
Brookfield Viscosity @ 400°F, cp.	-	10,000	ASTM D 3236
Ductility @ 77°F, 5 cm/min	15	-	ASTM D 113
Ductility @ 39.2°F, 1 cm/min	5	-	ASTM D 113
Asphalt Compatibility	Pass		ASTM D 5329
Flexibility @ 20°F	Pass		Per Subsection

907-720.07.4--Acceptance Procedure. The Contractor shall furnish the Engineer with a copy of the manufacturer's certified test reports for the lot(s) of materials from which the shipment originated. The test report shall show all the test results for the material properties and characteristics as specified herein. The test report shall state that the material represented by the test results meets all the requirements of the contract. It shall be the Contractor's responsibility to furnish the manufacturer's test report to the Engineer for each shipment of material to the project.

Acceptance sampling and testing will be in accordance with the Materials Division Inspection, Testing, and Certification Manual (Materials Manual). Samples of the material shall be furnished and shall be provided at no cost to the State.

MISSISSIPPI DEPARTMENT OF TRANSPORTATION

SPECIAL PROVISION NO. 907-721-4

CODE: (IS)

DATE: 04/19/2022

SUBJECT: Materials for Signing

Section 721, Materials for Signing, of the 2017 Edition of the Mississippi Standard Specifications for Road and Bridge Construction is hereby amended as follows.

907-721.06--Reflective Sheeting.

907-721.06.2--Performance Requirements. Delete Table 4 and Table 5 in Subsection 721.06.2 on pages 860 & 861, and substitute the following.

**MINIMUM COEFFICIENTS OF RETROREFLECTION
Candela per foot candle per square foot (cd/ft²)
Per ASTM Designation D4956**

**TABLE 4
Type IX Sheeting**

Observation Angle	Entrance Angle	White	Yellow	Green	Red	Blue	Fluorescent Yellow/Green	Fluorescent Yellow	Fluorescent Orange
0.2°	-4.0°	380	285	38	76	17	300	230	115
0.2°	+30.0°	215	162	22	43	10	170	130	65
0.5°	-4.0°	240	180	24	48	11	190	145	72
0.5°	+30.0°	135	100	14	27	6.0	110	81	41
1.0°	-4.0°	80	60	8.0	16	3.6	64	48	24
1.0°	+30.0°	45	34	4.5	9.0	2.0	36	27	14

**TABLE 5
Type XI Sheeting**

Observation Angle	Entrance Angle	White	Yellow	Green	Red	Blue	Brown	Fluorescent Yellow/Green	Fluorescent Yellow	Fluorescent Orange
0.2°	-4.0°	580	435	58	87	26	17	460	350	175
0.2°	+30.0°	220	165	22	33	10	7.0	180	130	66
0.5°	-4.0°	420	315	42	63	19	13	340	250	125
0.5°	+30.0°	150	110	15	23	7.0	5.0	120	90	45
1.0°	-4.0°	120	90	12	18	5.0	4.0	96	72	36
1.0°	+30.0°	45	34	5.0	7.0	2.0	1.0	36	27	14

After Subsection 721.10 on page 864, add the following.

907-721.11--Digital Applied Printing. The following addresses the requirements for digitally printed finished retroreflective traffic control signs on flat sheet aluminum and digitally printed traffic sign faces intended to be applied to a sign substrate.

907-721.11.1--Digitally Printed Ink Systems. Traffic signs must be produced using components, and processes that comply with the retroreflective sheeting manufacturer’s recommendations.

Digital printed ink systems used to print traffic signs must meet and comply with daytime and nighttime chromaticity (color standards) as recognized in ASTM D4956 “Standard Specification for Retroreflective Sheeting for Traffic Control.”

Digital printed ink systems must meet 70% of the initial retroreflectivity specifications of each respective reflective film color as found in ASTM D4956 “Standard Specification for Retroreflective Sheeting for Traffic Control.”

Prior to fabrication and preferably at the preconstruction meeting, the Contractor shall advise the Project Engineer in writing as to which signs on the project will be digitally printed and which ones will be screen printed. The Contractor shall submit to the Project Engineer certifications for all digitally printed signs, which will be forwarded to the State Traffic Engineer for review.

907-721.11.2--Protective Overlay Film. Permanent traffic signs printed with digital ink systems will be fabricated with a full sign protective overlay film designed to provide a smooth surface needed for retroreflectivity, and to protect the sign from fading and UV degradation. The overlamine shall comply with the retroreflective sheeting manufacturer’s recommendations to ensure proper adhesion and transparency and will also meet the reflective film durability as identified in Table 1.

**Table 1
Retroreflective Film Minimum Durability Requirements**

ASTM D4956 Type	Full Sign Replacement Term (years)	Sheeting Replacement Term (years)
IV	7	10
VIII	7	10
IX	7	12
XI	7	12

Temporary signs used in work zones printed with black ink only will not require a protective overlay film as long as the finished sign is warranted for a minimum outdoor durability of three years by the sheeting manufacturer.

907-721.11.3--Inspection. During fabrication, the Contractor shall provide sufficient testing and quality control throughout fabrication to insure good workmanship. Once the material has been received, it may be subject to random testing to ensure compliance with all requirements. If any test samples do not conform to the requirements, the entire order may be returned at the vendor’s expense.

907-721.11.4--Traffic Sign Performance Warranty Provisions. Based on the ASTM Type of sheeting specified, traffic control signs shall be warranted for the duration shown in Table 1. The Contractor shall supply a copy of the warranty document with complete details of terms and conditions upon request of the Department.

907-721.11.5--Certified Digital Sign Fabricator. Sign fabricators using digital imaging methods to produce regulated traffic signs must be certified by the reflective sheeting manufacturer whose materials are used to produce the delivered signs.

Certified sign fabricators must undergo an audit process by the sheeting manufacturer to ensure they have the proper equipment, manufacturing capabilities, manufacturing application processes and the materials required to fulfill the sheeting manufacturer's warranty obligations. Sign fabricators must recertify annually with reflective sheeting manufacturers or utilize a 3rd party certifier approved by the reflective sheeting manufacturer.

The Contractor shall submit proof of Sign Fabricator Certification as issued by the retroreflective sign sheeting manufacturer to the Project Engineer upon delivery of the signs, or with the Shop Drawings.

MISSISSIPPI DEPARTMENT OF TRANSPORTATION

SPECIAL PROVISION NO. 907-722-1

CODE: (IS)

DATE: 11/15/2017

SUBJECT: **Materials for Traffic Signal Installation**

Section 722, Materials for Traffic Signal Installation, of the 2017 Edition of the Mississippi Standard Specifications for Road and Bridge Construction is hereby amended as follow.

907-722.02.3--Design Strength Requirements. Delete Subsection 722.02.3 on pages 864 thru 866, and substitute the following.

Unless specified otherwise in the plans, poles shall meet the requirements of the AASHTO *Standard Specifications for Structural Supports for Highway Signs, Luminaires, and Traffic Signals*, as specified in the plans with all interim supplements. All components of the assemblies shall be designed to the following:

- Importance Factor: 1.0; 50 year mean recurrence interval
- Basic Wind Speed (3 second gust): As shown on the project plans
- Minimum Gust Effect Factor: 1.14
- Fatigue Category: II
- Ice Loading: As shown on the project plans
- Natural Wind Gust Pressure Loads: Included
- Truck Induced Gust Pressure Loads: Not included
- Galloping: Not included

907-722.02.5--Mast Arms for Traffic Signal and Equipment Poles. Delete the first four sentences of the third paragraph of Subsection 722.02.5 on page 867, and substitute the following.

Anchor base plates must meet the minimum requirements of ASTM A36 or ASTM A709 Grade 36 or ASTM A572 Grade 50 and must be welded to the shaft by either telescoped with two continuous arc welds or by back up ring using full penetration welds.. Flange plate shall telescope the large end of the arm and be welded by either two (2) continuous arc welds, one (1) being on the outside of the plate, adjacent to the shaft, and the other one (1) on the inside at the end of the tubular cross section or by back up ring using full penetration welds. The thru-bolt flange plate or tapped flange plate supporting the mast arm shall be welded to the pole near the top and supported side plate tangent to the pole and gusset plates both top and bottom. The thru-bolt or tapped flange plate must be sufficient to develop the full capacity of the connecting bolts.

907-722.03--Electric Cable. Delete the paragraphs for Loop Detector Wire and Loop Detector Lead-in Cable in Subsection 722.03 on page 869.

Delete the first sentence of “Communication Cable” in Subsection 722.03 on page 870, and substitute the following.

Communication cables shall be as per the manufacturer's recommendation.

907-722.05.4--Type III or Type IV Rigid Non-Metallic Conduit. After the last sentence of Subsection 722.05.4 on page 871, add the following.

Schedule 40 conduit shall be used unless otherwise noted in the plans.

Delete the title of Subsection 722.13.3 on page 876, and substitute the following.

907-722.13.3--Power Service Pedestal.

Delete the first paragraph of Subsection 722.13.3 on page 876, and substitute the following.

The pedestal shall be of NEMA Type 3R rainproof construction and shall be UL Listed as "Enclosed Industrial Control Equipment" (UL 508A). External construction shall comply with UL50 requirements and shall be unpainted aluminum.

Nominal size of the pedestal shall be 48"H x 16"W x 16"D.

Pedestal shall have a voltage rating or 120v/240v single phase with an Amperage rating of 800A.

After the first sentence of the seventh paragraph of Subsection 722.13.3 on page 876, add the following.

An outdoor rated heavy duty combination lock shall be provided to lock the customer compartment door.

907-722.14.1.3--Optical System. Delete the sixteenth paragraph of Subsection 722.14.1.3 on page 879, and substitute the following.

The signal module on-board circuitry shall include voltage surge protection to withstand high-repetition noise transients and low-repetition high-energy transients as stated in Section 2.1.6, NEMA Standard TS 2, 1992.

Delete the last sentence of the seventeenth paragraph of Subsection 722.14.1.3 on page 879, and substitute the following.

Load switches shall be compatible with NEMA TS 1 or later, or Model 170-1989 or later.

Delete Subsection 722.14.5 on page 882, and substitute the following.

907-722.14.5--Blank.

Delete Subsections 722.14.7 and 722.14.8 on page 882.

SECTION 905 - PROPOSAL

Date _____

Mississippi Transportation Commission
Jackson, Mississippi

Sirs: The following proposal is made on behalf of _____
_____ of _____

for constructing the following designated project(s) within the time(s) hereinafter specified.

The plans are composed of drawings and blue prints on file in the offices of the Mississippi Department of Transportation, Jackson, Mississippi.

The Specifications are the current Standard Specifications of the Mississippi Department of Transportation approved by the Federal Highway Administration, except where superseded or amended by the plans, Special Provisions and Notice(s) to Bidders attached hereto and made a part thereof.

I (We) certify that I (we) possess a copy of said Standard and any Supplemental Specifications.

Evidence of my (our) authority to submit the Proposal is hereby furnished. The proposal is made without collusion on the part of any person, firm or corporation. I (We) certify that I (we) have carefully examined the Plans, the Specifications, including the Special Provisions and Notice(s) to Bidders, herein, and have personally examined the site of the work. On the basis of the Specifications, Special Provisions, Notice(s) to Bidders, and Plans, I (we) propose to furnish all necessary machinery, tools, apparatus and other means of construction and do all the work and furnish all the materials in the manner specified. I (We) understand that the quantities mentioned herein are approximate only and are subject to either increase or decrease, and hereby propose to perform any increased or decreased quantities of work at the unit prices bid, in accordance with the above.

I (We) acknowledge that this proposal will be found irregular and/or non-responsive unless a certified check, cashier's check, or Proposal Guaranty Bond in the amount as required in the Advertisement (or, by law) is submitted electronically with the proposal or is delivered to the Contract Administration Engineer prior to the bid opening time specified in the advertisement.

INSTRUCTION TO BIDDERS: Alternate and Optional Items on Bid Schedule.

1. Two or more items entered opposite a single unit quantity WITHOUT DEFINITE DESIGNATION AS "ALTERNATE ITEMS" are considered as "OPTIONAL ITEMS". Bidders may or may not indicate on bids the Optional Item proposed to be furnished or performed WITHOUT PREJUDICE IN REGARD TO IRREGULARITY OF BIDS.
2. Items classified on the bid schedule as "ALTERNATE ITEMS" and/or "ALTERNATE TYPES OF CONSTRUCTION" must be preselected and indicated on bids. However, "Alternate Types of Construction" may include Optional Items to be treated as set out in Paragraph 1, above.
3. Optional items not preselected and indicated on the bid schedule MUST be designated in accordance with Subsection 102.06 prior to or at the time of execution of the contract.
4. Optional and Alternate items designated must be used throughout the project.

I (We) further propose to perform all "force account or extra work" that may be required of me (us) on the basis provided in the Specifications and to give such work my (our) personal attention in order to see that it is economically performed.

I (We) further propose to execute the attached contract agreement (Section 902) as soon as the work is awarded to me (us), and to begin and complete the work within the time limit(s) provided for in the Specifications and Advertisement. I (We) also propose to execute the attached contract bond (Section 903) in an amount not less than one hundred (100) percent of the total of my (our) part, but also to guarantee the excellence of both workmanship and materials until the work is finally accepted.

I (We) shall submit electronically with our proposal or deliver prior to the bid opening time a certified check, cashier's check or bid bond for **five percent (5%) of total bid** and hereby agree that in case of my (our) failure to execute the contract and furnish bond within Ten (10) days after notice of award, the amount of this check (bid bond) will be forfeited to the State of Mississippi as liquidated damages arising out of my (our) failure to execute the contract as proposed. It is understood that in case I am (we are) not awarded the work, the check will be returned as provided in the Specifications.

SECTION 905 -- PROPOSAL (CONTINUED)

I (We) hereby certify by digital signature and electronic submission via Bid Express of the Section 905 proposal below, that all certifications, disclosures and affidavits incorporated herein are deemed to be duly executed in the aggregate, fully enforceable and binding upon delivery of the bid proposal. I (We) further acknowledge that this certification shall not extend to the bid bond or alternate security which must be separately executed for the benefit of the Commission. This signature does not cure deficiencies in any required certifications, disclosures and/or affidavits. I (We) also acknowledge the right of the Commission to require full and final execution on any certification, disclosure or affidavit contained in the proposal at the Commission's election upon award. Failure to so execute at the Commission's request within the time allowed in the Standard Specifications for execution of all contract documents will result in forfeiture of the bid bond or alternate security.

Respectfully Submitted,

DATE _____

Contractor

BY _____
Signature

TITLE _____

ADDRESS _____

CITY, STATE, ZIP _____

PHONE _____

FAX _____

E-MAIL _____

(To be filled in if a corporation)

Our corporation is chartered under the Laws of the State of _____ and the names, titles and business addresses of the executives are as follows:

President Address

Secretary Address

Treasurer Address

The following is my (our) itemized proposal.

Mill & Overlay approximately 7 miles of US 278 from the east side of the ICGRR Overpass to east of Terza Road, known as Federal Aid Project Nos NHPP-0070-03(026) / 108710301 & NHPP-0070-03(028) / 109439301 in Panola County.

Line no.	Item Code	Adj Code	Quantity	Units	Description[Fixed Unit Price]
Roadway Items					
0010	201-D002		7	Acre	Random Clearing
0020	202-B007		860	Square Yard	Removal of Asphalt Pavement, All Depths
0030	202-B068		38	Square Yard	Removal of Concrete Pavement Punchouts, 9" Depth
0040	202-B069		2,902	Square Yard	Removal of Concrete Pavement w/ Variable Depth Overlay
0050	202-B117		64	Each	Removal of Delineator, All Types
0060	202-B158		3,345	Linear Feet	Removal of Guard Rail, Including Rails, Posts and Terminal Ends
0070	202-B240		3,460	Linear Feet	Removal of Traffic Stripe
0080	203-G001	(E)	165	Cubic Yard	Excess Excavation, FM, AH
0090	304-B004	(GT)	10,025	Ton	Granular Material, Class 5, Group D
0100	406-D001		583,000	Square Yard	Fine Milling of Bituminous Pavement, All Depths
0110	407-A001	(A2)	58,300	Gallon	Asphalt for Tack Coat
0120	413-D003		1,939	Linear Feet	Cleaning and Filling Joints in PCC Pavement
0130	423-A001		46	Mile	Rumble Strips, Ground In
0140	501-D001		36	Linear Feet	Expansion Joints, With Dowels
0150	503-A003	(C)	38	Square Yard	9" and Variable Reinforced Concrete Pavement, Broom Finish
0160	503-C010		8,192	Linear Feet	Saw Cut, Full Depth
0170	503-E002		80	Each	Tie Bars, No. 5 Deformed Drilled and Epoxied or Grouted
0180	606-B002		2,675	Linear Feet	Guard Rail, Class A, Type 1, 'W' Beam
0190	606-C001		5	Each	Guard Rail, Cable Anchor Type 1, Metal Post
0200	606-D022		8	Each	Guard Rail, Bridge End Section, Type I
0210	606-E005		9	Each	Guard Rail, Terminal End Section, Flared
0220	606-E007		4	Each	Guard Rail, Terminal End Section, Non-Flared
0230	618-B001		20	Square Feet	Additional Construction Signs (\$10.00)
0240	619-A1001		65	Mile	Temporary Traffic Stripe, Continuous White
0250	619-A2001		61	Mile	Temporary Traffic Stripe, Continuous Yellow
0260	619-A3001		55	Mile	Temporary Traffic Stripe, Skip White
0270	619-A4002		5	Mile	Temporary Traffic Stripe, Skip Yellow
0280	619-A5001		48,047	Linear Feet	Temporary Traffic Stripe, Detail
0290	619-A6002		7,452	Linear Feet	Temporary Traffic Stripe, Legend
0300	620-A001		1	Lump Sum	Mobilization
0310	630-F002		116	Each	Delineators, Flexible Post Mounted, Crossover, Type I, Yellow
0320	630-F006		38	Each	Delineators, Guard Rail, White
0330	630-F007		59	Each	Delineators, Guard Rail, Yellow
0340	907-403-A006	(BA1)	2,475	Ton	19-mm, ST, Asphalt Pavement
0350	907-403-A013	(BA1)	5,300	Ton	9.5-mm, HT, Asphalt Pavement

Line no.	Item Code	Adj Code	Quantity	Units	Description[Fixed Unit Price]
0360	907-403-A015	(BA1)	6,775	Ton	9.5-mm, ST, Asphalt Pavement
0370	907-403-B010	(BA1)	7,950	Ton	9.5-mm, HT, Asphalt Pavement, Leveling
0380	907-403-D007	(BA1)	38,200	Ton	9.5-mm, HT, Asphalt Pavement, Polymer Modified
0390	907-413-E001		63,417	Linear Feet	Sawing and Sealing Transverse Joints in Asphalt Pavement
0400	907-618-A001		1	Lump Sum	Maintenance of Traffic
0410	907-626-A007		28	Mile	6" Thermoplastic Double Drop Traffic Stripe, Skip White
0420	907-626-C012		33	Mile	6" Thermoplastic Double Drop Edge Stripe, Continuous White
0430	907-626-D003		3	Mile	6" Thermoplastic Double Drop Traffic Stripe, Skip Yellow
0440	907-626-E003		31	Mile	6" Thermoplastic Double Drop Traffic Stripe, Continuous Yellow
0450	907-626-G006		34,505	Linear Feet	Thermoplastic Double Drop Detail Stripe, White
0460	907-626-G007		13,542	Linear Feet	Thermoplastic Double Drop Detail Stripe, Yellow
0470	907-626-H006		4,640	Square Feet	Thermoplastic Double Drop Legend, White
0480	907-626-H007		7,452	Linear Feet	Thermoplastic Double Drop Legend, White
0490	907-627-J001		448	Each	Two-Way Clear Reflective High Performance Raised Markers
0500	907-627-K001		2,474	Each	Red-Clear Reflective High Performance Raised Markers
0510	907-627-L001		2,082	Each	Two-Way Yellow Reflective High Performance Raised Markers
0520	907-632-C001		8	Each	Modify Existing Traffic Signal Cabinet Assembly
0530	907-641-A002		18	Each	Signal Stop Bar Radar Vehicle Detection Sensor, Type 2
0540	907-641-B002		12	Each	Signal Advanced Radar Vehicle Detection Sensor, Type 2
0550	907-641-D001		5,470	Linear Feet	Radar Vehicle Detection Cable
0560	907-641-F002		2	Each	Signal Radar Vehicle Detection Processor, Type 2
ALTERNATE GROUP AA NUMBER 1					
0570	304-F001	(GT)	325	Ton	3/4" and Down Crushed Stone Base
ALTERNATE GROUP AA NUMBER 2					
0580	304-F002	(GT)	325	Ton	Size 610 Crushed Stone Base
ALTERNATE GROUP AA NUMBER 3					
0590	304-F003	(GT)	325	Ton	Size 825B Crushed Stone Base

SECTION 905 - COMBINATION BID PROPOSAL (Continued)

CONDITIONS FOR COMBINATION BID

If a bidder elects to submit a combined bid for two or more of the contracts listed for this month's letting, the bidder must complete and execute these sheets of the proposal in each of the individual proposals to constitute a combination bid. In addition to this requirement, each individual contract shall be completed, executed and submitted in the usual specified manner.

Failure to execute this Combination Bid Proposal in each of the contracts combined will be just cause for each proposal to be received and evaluated as a separate bid.

It is understood that the Mississippi Transportation Commission not only reserves the right to reject any and all proposals, but also the right to award contracts upon the basis of lowest separate bids or combination bids most advantageous to the State.

It is further understood and agreed that the Combination Bid Proposal is for comparison of bids only and that each contract shall operate in every respect as a separate contract in accordance with its proposal and contract documents.

I (We) agree to complete each contract on or before its specified completion date.

COMBINATION BID PROPOSAL

This proposal is tendered as one part of a Combination Bid Proposal utilizing option ___* of Subsection 102.11 on the following contracts:

* Option to be shown as either (a), (b), or (c).

	<u>Project No.</u>	<u>County</u>	<u>Project No.</u>	<u>County</u>
1.	_____	_____	6.	_____
2.	_____	_____	7.	_____
3.	_____	_____	8.	_____
4.	_____	_____	9.	_____
5.	_____	_____	10.	_____

(a) If Combination A has been selected, your Combination Bid is complete.

(b) If Combination B has been selected, then complete the following page.

SECTION 905 - COMBINATION BID PROPOSAL (Continued)

Project Number	Pay Item Number	Unit	Unit Price Reduction	Total Item Reduction	Total Contract Reduction
1.					
2.					
3.					
4.					
5.					
6.					
7.					
8.					

For Informational Purposes Only

SECTION 905 - COMBINATION BID PROPOSAL (Continued)

Project Number	Pay Item Number	Unit	Unit Price Reduction	Total Item Reduction	Total Contract Reduction
9.					
10.					

(c) If Combination C has been selected, then initial and complete ONE of the following.

_____ I (We) desire to be awarded work not to exceed a total monetary value of \$ _____.

_____ I (We) desire to be awarded work not to exceed _____ number of contracts.



**Certification with regard to the Performance of Previous
Contracts or Subcontracts subject to the Equal Opportunity
Clause and the filing of Required Reports**

The Bidder hereby certifies that he has _____, has not _____, participated in a previous contract or subcontract subject to the Equal Opportunity Clause, as required by Executive Orders 10925, 11114, or 11246, and that he has _____, has not _____, filed with the Joint Reporting Committee, the Director of the Office of Federal Contract Compliance, a Federal Government contracting or administering agency, or the former President's Committee on Equal Employment Opportunity, all reports due under the applicable filing requirements.

(COMPANY)

DATE: _____

NOTE: The above certification is required by the Equal Employment Opportunity Regulations of the Secretary of Labor (41 CFR 60-1.7 (b) (1)), and must be submitted by bidders and proposed subcontractors only in connection with contracts and subcontracts which are subject to the Equal Opportunity Clause. Contracts and Subcontracts which are exempt from the Equal Opportunity Clause are set forth in 41 CFR 60-1.5. (Generally only contracts or subcontracts of \$10,000 or under are exempt.)

Currently, Standard Form 100 (EEO-1) is the only report required by the Executive Orders or their implementing regulations.

Proposed prime Contractors and Subcontractors who have participated in a previous contract or subcontract subject to the Executive orders and have not filed the required reports should note that 41 CFR 60-1.7 (b) (1) prevents the award of contracts and subcontracts unless such Contractors submit a report covering the delinquent period or such other period specified by the Federal Highway Administration or by the Director, Office of Federal Contract Compliance, U. S. Department of Labor.

MISSISSIPPI DEPARTMENT OF TRANSPORTATION
CERTIFICATION

I, _____,
(Name of person signing bid)

individually, and in my capacity as _____ of
(Title of person signing bid)

_____ do hereby certify under
(Name of Firm, partnership, or Corporation)

penalty of perjury under the laws of the United States and the State of Mississippi that _____

_____, Bidder
(Name of Firm, Partnership, or Corporation)

on Project No. **NHPP-0070-03(026)/ 108710301000 & NHPP-0070-03(028)/ 109439301000**

in **Panola** County(ies), Mississippi, has not either

directly or indirectly entered into any agreement, participated in any collusion; or otherwise taken any action in restraint of free competitive bidding in connection with this contract; nor have any of its corporate officers or principal owners.

Except as noted hereafter, it is further certified that said legal entity and its corporate officers, principal owners, managers, auditors and others in a position of administering federal funds:

- a) Are not presently debarred, suspended, proposed for debarment, declared ineligible, or voluntarily excluded from covered transactions by any Federal department or agency;
- b) Have not within a three-year period preceding this proposal been convicted of or had a civil judgment rendered against them for commission of fraud or a criminal offense in connection with obtaining, attempting to obtain, or performing a public (Federal, State or local) transaction or contract under a public transaction; violation of Federal or State antitrust statutes or commission of embezzlement, theft, forgery, bribery, falsification or destruction of records, making false statements, or receiving stolen property;
- c) Are not presently indicted for or otherwise criminally or civilly charged by a governmental entity (Federal, State or local) with commission of any of the offenses enumerated in (b) above; and
- d) Have not within a three-year period preceding this application/ proposal had one or more public transactions (Federal, State or local) terminated for cause or default.

Do exceptions exist and are made a part thereof? Yes / No

Any exceptions shall address to whom it applies, initiating agency and dates of such action.

Note: Exceptions will not necessarily result in denial of award but will be considered in determining bidder responsibility. Providing false information may result in criminal prosecution or administrative sanctions.

The bidder further certifies that the certification requirements contained in Section XI of Form FHWA 1273, will be or have been included in all subcontracts, material supply agreements, purchase orders, etc. except those procurement contracts for goods or services that are expected to be less than the Federal procurement small purchase threshold fixed at 10 U.S.C. 2304(g) and 41 U.S.C. 253(g) (currently \$25,000) which are excluded from the certification requirements.

The bidder further certifies, to the best of his or her knowledge and belief, that:

1) No Federal appropriated funds have been paid or will be paid to any person for influencing or attempting to influence an officer or employee of any Federal agency, a Member of Congress, an officer or employee of Congress, or an employee of a Member of Congress in connection with the awarding of any Federal contract, the making of any Federal grant, the making of any Federal loan, the entering into of any cooperative agreement, and the extension, continuation, renewal, amendment, or modification of any Federal contract, grant, loan, or cooperative agreement.

2) If any funds other than Federal appropriated funds have been paid or will be paid to any person for influencing or attempting to influence an officer or employee of any Federal agency, a Member of Congress, an officer or employee of Congress, or an employee of a Member of Congress in connection with this contract, Standard Form-LLL, Disclosure Form to Report Lobbying, in accordance with its instructions will be completed and submitted.

The certification contained in (1) and (2) above is a material representation of fact upon which reliance is placed and a prerequisite imposed by Section 1352, Title 31, U.S. Code prior to entering into this contract. Failure to comply shall be subject to a civil penalty of not less than \$10,000 and not more than \$100,000. The bidder shall include the language of the certification in all subcontracts exceeding \$100,000 and all subcontractors shall certify and disclose accordingly.

All of the foregoing is true and correct.

Executed on _____

Signature

MISSISSIPPI DEPARTMENT OF TRANSPORTATION

SAM.GOV Registration and Unique Entity ID

Bidders are advised that the Prime Contractor must register and maintain a current registration in the **System for Award Management** (<http://sam.gov>) at all times during the project. Upon registration, the Contractor will be assigned a SAM Unique Entity ID.

Bidders are advised that prior to the award of this contract, they MUST be registered in the System for Award Management.

I (We) acknowledge that this contract cannot be awarded if I (We) are not registered in the System for Award Management prior to the award of this contract. _____ (Yes / No)

I (We) have a SAM Unique Entity ID. _____ (Yes / No)

SAM Unique Entity ID: _____

Company Name: _____

Company e-mail address: _____

SECTION 902

CONTRACT FOR _____
LOCATED IN THE COUNTY(IES) OF _____

STATE OF MISSISSIPPI
COUNTY OF HINDS

This Contract is entered into by and between the Mississippi Transportation Commission (the "Commission") and the undersigned contractor (the "Contractor"), as follows:

As consideration for this Contract, the Commission agrees to pay the Contractor the amount(s) set out in the Proposal attached hereto. Said payment will be made in the manner and at the time(s) specified in the Specifications and/or Special Provisions, if any. In exchange for said consideration, the Contractor hereby agrees to accept the prices stated in the Proposal as full compensation for the furnishing of all labor, materials and equipment, and the execution of the scope of work identified for this referenced Project as contemplated in this Contract, and as more fully outlined in the Contract Documents (the "Work"). The Contract Documents consist of the Advertisement, the Notice to Bidders, the Proposal, the Specifications, the Special Provisions, and the approved Plans, all of which are hereby made a part of this Contract and incorporated herein by reference.

The Contractor shall be responsible for all loss or damage arising out of, or in any way in connection with the Work, or from any unforeseen obstructions or difficulties that may be encountered in the prosecution of the Work, and for all risks of every description connected with the Work, with the exception of any items specifically excluded in the Contract Documents. The Contractor shall fully and faithfully complete the Work in a good and workmanlike manner, according to the Contract Documents and any Supplemental Agreements thereto.

The Contractor further agrees that the Work shall be done under the direct supervision of, and to the complete satisfaction of, the Executive Director of the Mississippi Department of Transportation, or his authorized representative(s), and, when federal funds are involved, subject to the inspection and approval of the Federal Highway Administration, or its agents, and/or the agents of any other state or federal agency whose funds are involved. Further, the Work shall be done in accordance with any applicable state and federal laws, and any such rules and regulations issued by the Commission and/or any relevant Federal Agency.

The Contractor agrees that all labor as outlined in the Contract Documents may be secured from a list furnished by the Manager of the Win Job Center nearest the project location, or any successor thereto.

It is agreed and understood that each and every provision of law and clause required by law to be inserted into this Contract shall be deemed to be inserted herein, and this Contract shall be read and enforced as though it were included herein. If through mere mistake or otherwise, any such provision is not inserted, then upon the application of either party hereto, the Contract shall be physically amended to make such insertion.

The Contractor agrees that he has read each and every clause of the Contract Documents, and fully understands the meaning of same, and hereby acknowledges that he will comply with all terms, covenants and agreements therein.

Witness our signatures, this the ____ day of _____, 20__.

Contractor

By: _____
Title: _____

Signed and sealed in the presence of: (name and address of witness)

MISSISSIPPI TRANSPORTATION COMMISSION

Executive Director

Secretary to the Commission

Award authorized by the Mississippi Transportation Commission in session on the ____ day of _____, _____, Minute Book No. _____, Page No. _____.

**SECTION 903
PERFORMANCE BOND**

PERFORMANCE BOND FOR THE FOLLOWING CONTRACT:

Project No.: _____

For the construction of: _____

Contract date: _____ Contract Price: _____

FOR OWNER: MISSISSIPPI TRANSPORTATION COMMISSION, 401 N. WEST STREET, JACKSON, MISSISSIPPI 39201.

CONTRACTOR (full legal name, contact person, phone number and address):

SURETY (legal name, phone number, principal place of business and address *for notice purposes*):

Second Surety (if applicable):

The Contractor and Surety, jointly and severally, bind themselves, their heirs, executors, administrators, successors and assigns, to the Owner for the performance of the Contract, which is incorporated herein by reference, and subject to the following terms:

1. If the Contractor fully and faithfully performs the Contract, the Surety and the Contractor shall have no obligation under this Bond.
2. The Surety's obligation under this Bond shall arise after:
 - (a) the Owner first provides notice to the Contractor and the Surety that termination is imminent, pursuant to the current edition of the Mississippi Standard Specifications for Road and Bridge Construction, which is a part of the Contract; and
 - (b) the Owner declares a Contractor Default, terminates the Contract, and notifies the Surety.
3. Within 20 calendar days as set forth in Section 108.08 of the current edition of the Mississippi Standard Specifications for Road and Bridge Construction, the Surety shall, after discussions with and consent from the Owner, and at the Surety's expense, elect to take one of the following actions:
 - (a) Arrange for the Contractor, with the consent of the Owner, to perform and complete the Contract;
 - (b) Undertake to perform and complete the Contract itself, through its agents or independent contractors;
 - (c) Waive its right to perform and complete, arrange for completion, or obtain a new contractor, and after investigation, determine the amount for which it may be liable to the Owner (subject to the consent of the Owner) and as soon as practicable after the amount is determined, make payment to the Owner.

4. If the Surety does not proceed, within a reasonable time frame, to enact and carry out the election made in Paragraph 3, then the Surety shall be deemed to be in default on this Bond, and the Owner shall be entitled to enforce any remedy available to it under the Contract and applicable law.
5. Subject to the commitment by the Owner to pay the Balance of the Contract Price, the Surety is obligated, without duplication, for
 - (a) the responsibilities of the Contractor for correction of defective work and completion of the Contract;
 - (b) additional legal, design professional and delay costs resulting from the Contractor's Default, and resulting from the actions or failure to act of the Surety under Paragraph 3; and
 - (c) liquidated damages, or if no liquidated damages are specified in the Contract, actual damages caused by delayed performance or non-performance of the Contractor.
6. The Surety hereby waives notice of any change, including changes of time, to the Contract or to related subcontracts, purchase orders and other obligations.
7. The penal sum of the Bond shall be equal to the Contract Price; however, the penal sum may be increased or decreased as the result of any subsequent Supplemental Agreements and/or final contract quantities.
8. Notice to the Surety, the Owner or the Contractor shall be mailed or delivered to the address listed for notice purposes on the first page of this Bond.

CONTRACTOR AS PRINCIPAL

Company: _____

Signature: _____

Name: _____

Title: _____

Address: _____

SURETY

Company: _____

Signature: _____

MS Insurance ID # _____

Name: _____

Title: _____

Address: _____

SURETY (if applicable)

Company: _____

Signature: _____

MS Insurance ID # _____

Name: _____

Title: _____

Address: _____

**SECTION 903
PAYMENT BOND**

PAYMENT BOND FOR THE FOLLOWING CONTRACT:

Project No.: _____

For the construction of: _____

Contract date: _____ Contract Price: _____

**FOR OWNER: MISSISSIPPI TRANSPORTATION COMMISSION, 401 N. WEST STREET,
JACKSON, MISSISSIPPI 39201.**

CONTRACTOR (full legal name, contact person, phone number and address):

SURETY (legal name, phone number, principal place of business and address *for notice purposes*):

Second Surety (if applicable):

The Contractor and Surety, jointly and severally, bind themselves, their heirs, executors, administrators, successors and assigns, to the Owner for payment of labor, materials and equipment furnished for use in the performance of the Contract, which is incorporated herein by reference, subject to the following terms:

1. If the Contractor promptly makes payment of all sums due to any and all subcontractors, sub-subcontractors, suppliers to the Contractor, suppliers to subcontractors and/or laborers who have performed work on the project site, and defends, indemnifies and holds harmless the Owner from claims, demands, liens or suits by any person or entity seeking payment for labor, materials or equipment furnished for use in the performance of the Contract, then the Surety and the Contractor shall have no obligation under this Bond.
2. The Owner shall provide notice to the Surety of any claims, demands, liens or suits against the Owner or the Owner's property that it receives from any person or entity ("Claimants") seeking payment for labor, materials or equipment furnished for use in the performance of the Contract.
3. Upon notice of any claims, demands, liens or suits provided by the Owner or Contractor or given to the Surety by a Claimant, the Surety shall promptly and at the Surety's expense, defend, indemnify and hold harmless the Owner against said claim, demand, lien or suit and shall take the following additional actions:
 - (a) Send an answer to the Claimant, with a copy to the Owner, within sixty (60) days after receipt of the Claim, stating the amounts that are undisputed and the basis for challenging any amounts that are disputed; and
 - (b) Pay or arrange for payment of any undisputed amounts.

4. The Surety shall not be liable to the Owner, Claimants or others for obligations of the Contractor that are unrelated to the Contract. The Owner shall not be liable for the payment of any costs or expenses of any Claimant under this Bond and shall have no obligation under this Bond to make payments to, or give notice on behalf of, Claimants, or otherwise have any obligations to Claimants under this Bond.
5. The Surety hereby waives notice of any change, including changes of time, to the Contract or to related subcontracts, purchase orders and other obligations.
6. The penal sum of the Bond shall be equal to the Contract Price; however, the penal sum may be increased or decreased as the result of any subsequent Supplemental Agreements and/or final contract quantities.

CONTRACTOR AS PRINCIPAL

Company: _____
Signature: _____
Name: _____
Title: _____
Address: _____

SURETY

Company: _____
Signature: _____
Name: _____
Title: _____
Address: _____

MS Insurance ID # _____

SURETY (if applicable)

Company: _____
Signature: _____
Name: _____
Title: _____
Address: _____

MS Insurance ID # _____



BID BOND

KNOW ALL MEN BY THESE PRESENTS, that we _____
Contractor

Address

City, State ZIP

As principal, hereinafter called the Principal, and _____
Surety

a corporation duly organized under the laws of the state of _____

as Surety, hereinafter called the Surety, are held and firmly bound unto State of Mississippi, Jackson, Mississippi

As Obligee, hereinafter called Obligee, in the sum of **Five Per Cent (5%) of Amount Bid**

Dollars(\$ _____)

for the payment of which sum will and truly to be made, the said Principal and said Surety, bind ourselves, our heirs, executors, administrators, successors and assigns, jointly and severally, firmly by these presents.

WHEREAS, the Principal has submitted a bid for **Mill & Overlay approximately 7 miles of US 278 from the east side of the ICGRR Overpass to east of Terza Road, known as Federal Aid Project Nos NHPP-0070-03(026) / 108710301 & NHPP-0070-03(028) / 109439301 in Panola County.**

NOW THEREFORE, the condition of this obligation is such that if the aforesaid Principal shall be awarded the contract, the said Principal will, within the time required, enter into a formal contract and give a good and sufficient bond to secure the performance of the terms and conditions of the contract, then this obligation to be void; otherwise the Principal and Surety will pay unto the Obligee the difference in money between the amount of the bid of the said Principal and the amount for which the Obligee legally contracts with another party to perform the work if the latter amount be in excess of the former, but in no event shall liability hereunder exceed the penal sum hereof.

Signed and sealed this _____ day of _____, 20__

(Principal) (Seal)

(Witness) (Name) By: _____ (Title)

(Surety) (Seal)

(Witness) (Attorney-in-Fact) By: _____

(MS Agent)

Mississippi Insurance ID Number

MISSISSIPPI DEPARTMENT OF TRANSPORTATION
OFFICE OF CIVIL RIGHTS
JACKSON, MISSISSIPPI

LIST OF FIRMS SUBMITTING QUOTES

I/we received quotes from the following firms on:

Letting Date: **February 25, 2025**

Project No: NHPP-0070-03(026)/ 108710301000 & NHPP-0070-03(028)/ 109439301000

County: Panola

Disadvantaged Business Enterprise (DBE) Regulations as stated in 49 CFR 26.11 require the Mississippi Department of Transportation (MDOT) to create and maintain a comprehensive list of all firms quoting/bidding subcontracts on prime contracts and quoting/bidding subcontracts on federally-funded transportation projects. For every firm, we require the following information:

Firm Name: _____
Contact Name/Title: _____
Firm Mailing Address: _____
Phone Number: _____
_____ DBE Firm _____ Non-DBE Firm

Firm Name: _____
Contact Name/Title: _____
Firm Mailing Address: _____
Phone Number: _____
_____ DBE Firm _____ Non-DBE Firm

Firm Name: _____
Contact Name/Title: _____
Firm Mailing Address: _____
Phone Number: _____
_____ DBE Firm _____ Non-DBE Firm

Firm Name: _____
Contact Name/Title: _____
Firm Mailing Address: _____
Phone Number: _____
_____ DBE Firm _____ Non-DBE Firm

Firm Name: _____
Contact Name/Title: _____
Firm Mailing Address: _____
Phone Number: _____
_____ DBE Firm _____ Non-DBE Firm

SUBMITTED BY (Signature)

FIRM NAME

