

MDOT Use Only

Checked _____

Loaded _____

Keyed _____

12 -



SM No. CSP0035010091

PROPOSAL AND CONTRACT DOCUMENTS

FOR THE CONSTRUCTION OF

12

Mill & Overlay approximately 4.2 miles of SR 311 from Landfill Road to Liles Road and approximately 3.5 miles from 0.1 mile south of Audie Todd Road to US 72, known as State Project Nos. SP-0035-01(009) / 109983301 & SP-0035-01(010) / 109984301 in Marshall County.

Project Completion: 112 Working Days

(STATE DELEGATED)

NOTICE

**BIDDERS MUST COMPLETE AN ONLINE REQUEST
FOR PERMISSION TO BID THIS PROJECT.**

Electronic addendum updates will be posted on www.gomdot.com

SECTION 900

OF THE CURRENT 2017 STANDARD SPECIFICATIONS FOR ROAD AND BRIDGE CONSTRUCTION

JACKSON, MISSISSIPPI

**MISSISSIPPI DEPARTMENT OF TRANSPORTATION
TABLE OF CONTENTS**

**PROJECT: SP-0035-01(009)/109983301 - Marshall
SP-0035-01(010)/109984301 - Marshall**

Section 901 - Advertisement

Section 904 - Notice to Bidders

#1	Governing Specification, w/ Supplement
#3	Final Cleanup
#13	Safety Edge
#296	Reduced Speed Limit Signs
#445	Mississippi Agent or Qualified Nonresident Agent
#516	Errata and Modifications to the 2017 Standard Specifications
#1225	Early Notice to Proceed
#1226	Material Storage Under Bridges
#1241	Fuel and Material Adjustments
#1963	Guardrail Pads
#2206	MASH Compliant Devices
#2273	Mississippi Special Fuel Tax Law
#2278	Smoothness Tolerances
#2954	Reflective Sheeting for Signs
#3676	Asphalt Gyratory Compactor Internal Angle Calibration
#4702	App for Traffic Control Report
#5086	Detail of Square Tube Sign Posts
#5551	Federal Bridge Formula
#7597	Contract Time
#7598	Scope of Work
#7624	Standard Drawings w/Supplement

Section 907 - Special Provisions

907-101-1	Definitions and Terms
907-102-2	Bidding Requirements and Conditions
907-103-2	Award and Execution of Contract
907-104-2	Minor Alterations to the Contract
907-105-2	Control of Work
907-108-4	Subletting of Contract
907-108-6	Default and Termination of Contract
907-109-5	Measurement and Payment
907-401-2	Asphalt Pavements - General
907-403-4	Asphalt Pavements
907-407-1	Tack Coat
907-605-1	Underdrains
907-618-4	Additional Signing Requirements, w/Supplement
907-618-12	Traffic Control Management
907-619-6	Temporary Portable Rumble Strips
907-626-12	Thermoplastic Traffic Markings
907-627-1	Raised Pavement Markings
907-701-4	Hydraulic Cement, w/ Supplement

PROJECT: SP-0035-01(009)/109983301 - Marshall
SP-0035-01(010)/109984301 - Marshall

907-702-4	Bituminous Materials
907-703-2	Gradation
907-705-1	Stone Riprap
907-707-3	Joint Materials
907-711-2	Plain Steel Wire
907-712-1	Fence and Guardrail
907-714-4	Miscellaneous Materials
907-718-1	Timber and Dimension Lumber
907-720-4	Pavement Marking Materials
907-721-4	Materials for Signing

Section 905 - Proposal, Proposal Bid Items, Combination Bid Proposal
State Board of Contractors Requirement
State Certification Regarding Non-Collusion, Debarment and Suspensions
Section 902 - Contract Form
Section 903 - Contract Bond Forms

Progress Schedule

(REVISIONS TO THE ABOVE WILL BE INDICATED ON THE SECOND SHEET
OF SECTION 905 AS ADDENDA)

01/30/2026 12:15 PM

MISSISSIPPI DEPARTMENT OF TRANSPORTATION

SECTION 901 - ADVERTISEMENT

Electronic bids will be received by the Mississippi Transportation Commission at 10:00 o'clock A.M., Tuesday, February 24, 2026, from the Bid Express Service and shortly thereafter publicly read on the Sixth Floor for:

Mill & Overlay approximately 4.2 miles of SR 311 from Landfill Road to Liles Road and approximately 3.5 miles from 0.1 mile south of Audie Todd Road to US 72, known as State Project Nos. SP-0035-01(009) / 109983301 & SP-0035-01(010) / 109984301 in Marshall County.

The attention of bidders is directed to the predetermined minimum wage rate set by the U. S. Department of Labor under the Fair Labor Standards Act.

The specifications are on file in the offices of the Mississippi Department of Transportation.

Contractors may request permission to bid online at <http://shop.mdot.ms.gov> at no cost. Upon approval, Contractors shall be eligible to submit a bid using Bid Express at <http://bidx.com>. Specimen proposals may be viewed and downloaded online at no cost at <http://mdot.ms.gov> or purchased online at <http://shop.mdot.ms.gov> at a cost of Ten Dollars (\$10.00) per proposal plus a small convenience fee. Cash or checks will not be accepted as payment.

Bid bond, signed or countersigned by a Mississippi Agent or Qualified Nonresident Agent, with Power of Attorney attached, a Cashier's check or Certified Check for five (5%) percent of bid, payable to STATE OF MISSISSIPPI, must accompany each proposal.

The attention of bidders is directed to the provisions of Subsection 102.07 pertaining to irregular proposals and rejection of bids.

BRAD WHITE
EXECUTIVE DIRECTOR

MISSISSIPPI DEPARTMENT OF TRANSPORTATION

SUPPLEMENT TO NOTICE TO BIDDERS NO. 1

DATE: 06/08/2021

SUBJECT: Governing Specifications

Change the web address at the end of the first paragraph to the following.

<https://shop.mdot.ms.gov/default.aspx?StoreIndex=1>

MISSISSIPPI DEPARTMENT OF TRANSPORTATION

SECTION 904 - NOTICE TO BIDDERS NO. 1

CODE: (IS)

DATE: 03/01/2017

SUBJECT: Governing Specifications

The current (2017) Edition of the Standard Specifications for Road and Bridge Construction adopted by the Mississippi Transportation Commission is made a part hereof fully and completely as if it were attached hereto, except where superseded by special provisions, or amended by revisions of the Specifications contained within this proposal. Copies of the specification book may be purchased from the MDOT Construction Division, or online at shopmdot/default.aspx?StoreIndex=1.

A reference in any contract document to controlling requirements in another portion of the contract documents shall be understood to apply equally to any revision or amendment thereof included in the contract.

In the event the plans or proposal contain references to the 2004 Edition of the Standard Specifications for Road and Bridge Construction, it is to be understood that such references shall mean the comparable provisions of the 2017 Edition of the Standard Specifications.

MISSISSIPPI DEPARTMENT OF TRANSPORTATION

SECTION 904 - NOTICE TO BIDDERS NO. 3

CODE: (SP)

DATE: 01/17/2017

SUBJECT: Final Clean-Up

Immediately prior to final inspection for release of maintenance, the Contractor shall pick up, load, transport and properly dispose of all litter from the entire highway right-of-way that is within the termini of the project.

Litter shall include, but not be limited to, solid wastes such as glass, paper products, tires, wood products, metal, synthetic materials and other miscellaneous debris.

Litter removal is considered incidental to other items of work and will not be measured for separate payment.

MISSISSIPPI DEPARTMENT OF TRANSPORTATION

SECTION 904 - NOTICE TO BIDDERS NO. 13

CODE: (IS)

DATE: 03/01/2017

SUBJECT: Safety Edge

Bidders are hereby advised that the Shoulder Wedge (Safety Edge) specified in Section 401, Asphalt Pavements, shall only apply to the top two (2) lifts of asphalt. Open Graded Friction Courses (OGFC) are not to be considered a lift as it pertains to safety edge. Attached is a drawing showing the safety edge. Note that the shoulder dimensions in the bottom two drawings will be less than three feet (3').

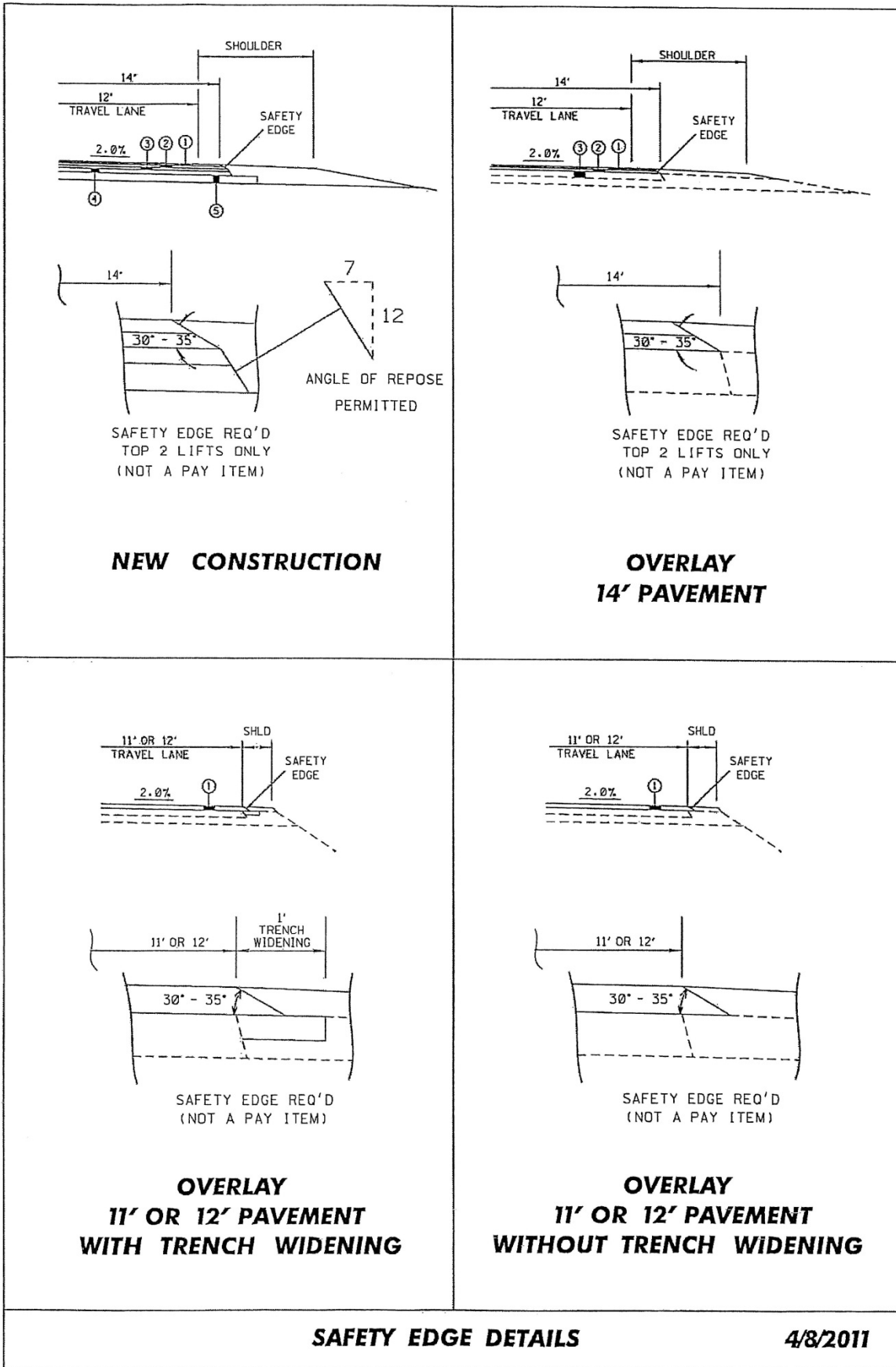

MISSISSIPPI DEPARTMENT OF TRANSPORTATION

SECTION 904 - NOTICE TO BIDDERS NO. 296

CODE: (SP)

DATE: 07/25/2017

SUBJECT: Reduced Speed Limit Signs

Bidders are advised that when the plans or contract documents require the speed limit on a project to be reduced, the Contractor shall begin work within 48 hours of installing the reduced speed limit signs. Should the Contractor not start work or have no plans to start work within 48 hours of installing the signs, the reduced speed limit signs shall be covered and existing speed limit signs uncovered.

MISSISSIPPI DEPARTMENT OF TRANSPORTATION

SECTION 904 - NOTICE TO BIDDERS NO. 445

CODE: (SP)

DATE: 10/10/2017

SUBJECT: Mississippi Agent or Qualified Nonresident Agent

Bidders are hereby advised of the requirements of Subsections 102.08, 103.05.2, and 107.14.2.1 of the *2017 Standard Specifications for Road and Bridge Construction* as it refers to bonding agents. Proposal guaranties, bonds, and liability insurance policies must be signed by a **Mississippi Agent or Qualified Nonresident Agent.**

MISSISSIPPI DEPARTMENT OF TRANSPORTATION

SECTION 904 - NOTICE TO BIDDERS NO. 516

CODE: (IS)

DATE: 11/28/2017

SUBJECT: Errata and Modifications to the 2017 Standard Specifications

<u>Page</u>	<u>Subsection</u>	<u>Change</u>
16	102.06	In the seventh full paragraph, change “Engineer” to “Director.”
33	105.05.1	In the sixth sentence, change “Contract Administration Engineer” to “Contract Administration Director.”
34	105.05.2.1	In subparagraph 2, change “SWPPP, ECP” to “SWPPP and the ECP”
35	105.05.2.2	In subparagraphs 2, add “ and” to the end of the sentence. In subparagraph 3, remove “, and” and add “.”.
90	109.04.2	In the last paragraph of subparagraph (a), place a period “.” at the end of the sentence.
93	109.04.2	In the last paragraph of subparagraph (g), place a period “.” at the end of the sentence. Also, in the first paragraph of subparagraph (h), place a period “.” at the end of the sentence.
97	109.07	Under ADJUSTMENT CODE, subparagraph (A1), change “HMA mixture” to “Asphalt mixtures.”
98	109.11	In the third sentence, change “Engineer” to “Director.”
219	308.04	In the last sentence of the last paragraph, change “Contractor’s decision” to “Engineer’s decision.”
300	405.02.5.9	In the first sentence of the second paragraph, change “Hot Mix Asphalt” to “Asphalt Mixtures.”
502	630.01.1	In the first paragraph, change “AASHTO” to “AASHTO’s LRFD”.
636	646.05	Change “each” to “per each” for the pay item units of payment.
640	656.02.6.2	In item 7), change “down stream” to “downstream”.
688	630.03.2	Change the subsection number from “630.03.2” to “680.03.2.”

725 702.08.3 In the second sentence of the first paragraph, change “hot-mix” to “asphalt.”

954 804.02.13.1.6 In the definition for “M” in the % Reduction formulas, change “paragraph 7.3” to “paragraph 5.3.”

MISSISSIPPI DEPARTMENT OF TRANSPORTATION

SECTION 904 - NOTICE TO BIDDERS NO. 1225

CODE: (SP)

DATE: 11/13/2018

SUBJECT: Early Notice to Proceed

Bidders are advised that if an early notice to proceed is allowed by the Department and the Contractor experiences problems or delays between the early notice to proceed date and the original notice to proceed date, this shall not be justification for any monetary compensation or an extension of contract time.

MISSISSIPPI DEPARTMENT OF TRANSPORTATION

SECTION 904 - NOTICE TO BIDDERS NO. 1226

CODE: (IS)

DATE: 11/16/2018

SUBJECT: Material Storage Under Bridges

Bidders are advised that Subsection 106.08 of the Standard Specifications allows the Contractor to store materials and equipment on portions of the right-of-way. However, the Contractor will not be allowed to store or stockpile materials under bridges without written permission from the Project Engineer. The Contractor shall submit a detailed request of all proposed materials to be stored under bridges to the Engineer a minimum of 14 calendar days prior to anticipated storage. This detail shall include, but not limited to, bridge location, material type, material quantity, and duration of storage. The Project Engineer and any other needed Division will review this information and determine whether to grant approval. The Contractor shall not store any material under any bridge without written approval from the Project Engineer.

MISSISSIPPI DEPARTMENT OF TRANSPORTATION

SECTION 904 - NOTICE TO BIDDERS NO. 1241

CODE: (IS)

DATE: 11/27/2018

SUBJECT: Fuel and Material Adjustments

Bidder's attention is brought to the last paragraph of Subsection 109.07 of the Standard Specifications which states that no fuel or material adjustment will be made after the completion of contract time. Any fuels consumed or materials incorporated into the work during the monthly estimate period falling wholly after the expiration of contract time will not be subject a fuel or material adjustment.

MISSISSIPPI DEPARTMENT OF TRANSPORTATION

SECTION 904 - NOTICE TO BIDDERS NO. 1963

CODE: (SP)

DATE: 9/23/2019

SUBJECT: Guardrail Pads

Bidders are hereby advised that prior to construction of the guardrail pads, the Contractor shall coordinate with the guardrail Subcontractor to determine the guardrail pad dimensions necessary to meet MASH compliance.

MISSISSIPPI DEPARTMENT OF TRANSPORTATION

SECTION 904 - NOTICE TO BIDDERS NO. 2206

CODE: (IS)

DATE: 01/14/2020

SUBJECT: MASH Compliant Devices

Bidders are hereby advised that compliance associated with the requirements of meeting either the National Cooperative Highway Research Program (NCHRP) Report 350 or the Manual for Assessing Safety Hardware (MASH) for installations of certain traffic control devices and permanent safety hardware devices (guardrails, guardrail terminals, permanent portable barriers, cast-in-place barriers, all other permanent longitudinal barriers, crash cushions, cable barriers, cable barrier terminals, bridge rails, bridge rail transitions, all other terminals, sign supports, and all other breakaway hardware) as listed throughout the Standard Specifications and/or the Standard Drawings, or both, is now replaced with the requirements of meeting the 2016 version of MASH after December 31, 2019. This change applies to new permanent installations and to full replacements of existing installations.

At the preconstruction conference or prior to starting any work on the project, the Contractor shall submit a letter stating that the traffic control devices and permanent safety hardware devices as outlined within the paragraph above that are to be used on the project are certified to meet MASH 2016.

When a MASH 2016-compliant device does not exist for the new permanent installations and/or full replacement installations of permanent safety hardware devices, as listed above, a MASH 2009-compliant or a NCHRP 350-compliant device may be proposed by the Contractor for the project. A written request for such instances must be submitted by the Contractor either at the preconstruction conference or prior to starting any work on the project. The Contractor shall submit the following items to the Project Engineer: (1) a detailed list of the proposed devices and locations thereof; and (2) certification letters indicating that the proposed devices are compliant with either MASH 2009 or NCHRP 350.

When a MASH 2016-compliant device does not exist for the temporary work zone traffic control devices (Category 1, Category 2, and Category 3 devices), a MASH 2009-compliant or a NCHRP 350-compliant device may be proposed by the Contractor for the project. Temporary work zone traffic control devices (Category 1, Category 2, and Category 3 devices) that are MASH 2009-compliant or NCHRP 350-compliant that have been in use prior to December 31, 2019, and that have a remaining service life may be proposed for use throughout their normal service life on the project by the Contractor. For either of these scenarios for temporary work zone traffic control devices, a written request must be submitted by the Contractor either at the preconstruction conference or prior to starting any work on the project. The Contractor shall submit the following items to the Project Engineer: (1) a detailed list of the proposed devices and locations thereof; and (2) certification letters indicating that the proposed devices are compliant with either MASH 2009 or NCHRP 350.

Work will only be allowed to proceed after the Department has granted written concurrence(s) with the proposed request(s) as listed above.

MISSISSIPPI DEPARTMENT OF TRANSPORTATION

SECTION 904 - NOTICE TO BIDDERS NO. 2273

CODE: (SP)

DATE: 02/12/2020

SUBJECT: Mississippi Special Fuel Tax Law

Bidder's attention is brought to the second paragraph of Subsection 107.02 of the Standard Specifications which states that all Contractors and Subcontractors must comply with all requirements contained in the Mississippi Special Fuel Tax Law, Section 27-55-501, *et seq.* Attached are two Fact Sheets provided by the Mississippi Department of Revenue (MDOR) with additional information.

Gasoline and Dyed Diesel Used for Non-Highway Purposes

Mississippi provides a reduced rate for gasoline and dyed diesel used for non-highway purposes. The reduced rates are 6.44 cents per gallon and 5.75 cents per gallon of gasoline or dyed diesel. These fuels are generally taxed at 18 cents per gallon if for on road use.

Gasoline Used for Non-Highway Purposes

You may be entitled to a refund of 11.56 cents per gallon (making this an equivalent to a tax rate of 6.44 cents per gallon) if you desire to purchase gasoline to be used off road. The gasoline must be used for agricultural, maritime, industrial, manufacturing, domestic or non-highway purposes only.

Examples of non-highway include gasoline used in boats, golf carts, machinery used for manufacturing or farm equipment used exclusively in plowing, planting or harvesting farm products.

Refund Gasoline User

The refund is based on the amount of gallons used. Before a refund is issued, you are required to...

1. Obtain a refund gasoline user's permit and a certificate for refund booklet from the Department of Revenue;
2. Have a storage tank marked "REFUND GASOLINE"; and,
3. Purchase the gasoline from someone who holds a refund gasoline dealer's permit.

No refund will be allowed for gasoline used in motor vehicles owned or operated by a government entity or used in Mississippi government contracts.

Refund Gasoline Dealer

You must obtain a refund gasoline dealer's permit from the Department of Revenue before selling refund gasoline. At no time should the gasoline be delivered to a tank that is not properly marked. The gasoline must be dyed a distinctive mahogany color at the time of delivery.

The Department of Revenue may waive the dye requirement if the dye may cause damage to the equipment. The refund gasoline user is required to obtain the waiver from the Department of Revenue.

Dyed Diesel Used for Non-Highway Purposes

Unlike gasoline, you are not required to apply for a refund if you desire to purchase dyed diesel to be used off road. Mississippi provides a reduced rate of 5.75 cents per gallon on dyed diesel used off road. Diesel used on road is subjected to 18 cents per gallon. Dyed diesel used in motor vehicles owned or operated by a government entity or used in Mississippi government contracts will be subjected to 18 cents per gallon.

Dyed Diesel Used on the Highway

Any person who purchases, receives, acquires or uses dyed diesel for highway use will be liable to pay 18 cents per gallon and subject to a penalty in the amount of \$1000.

Identifying Dyed Diesel

Storage facilities for dyed diesel must be plainly marked "NONHIGHWAY DIESEL FUEL" or "NONHIGHWAY KEROSENE". Retailers are also required to mark all pumps or dispensing equipment.



Special Fuel Used on Government Contracts

State and Local Government Contracts

Special fuel purchased, acquired or used in performing contracts with the State of Mississippi, counties, municipalities or any political subdivision is taxed at a rate of 18 cents per gallon. Special fuel includes but is not limited to the following:

- Dyed diesel fuel;
- Kerosene;
- Undyed diesel fuel; and,
- Fuel oil.

State and local government contracts include construction, reconstruction and maintenance or repairs of projects such as roads, bridges, water systems, sewer systems, buildings, drainage canals and recreational facilities. The Department of Revenue may require contractors to remit the excise tax directly to the state in lieu of paying the tax to a distributor.

Special Fuel Direct Pay Permit

Contractors that remit the excise tax to the state will be issued a Special Fuel Direct Pay Permit. This permit relieves the distributor from collecting the tax and requires the contractor to file a monthly special fuel return. The distributor should include the contractor’s permit number on all invoices that are related to tax-free sales.

The contractor is required to furnish a surety or cash bond guaranteeing the payment of the excise tax prior to receiving the Special Fuel Direct Pay Permit. The Department of Revenue may accept a contractors tax bond if the bond covers the excise tax levied on special fuel.

Special Fuel Distributors

If the contractor does not have a Special Fuel Direct Pay Permit, distributors are required to collect the 18 cents excise tax and remit the tax to the Department of Revenue. The additional 12.25 cents levied on special fuel (excluding undyed diesel) should be reported on schedules 5F and 5G of the special fuel return.

Environmental Protection Fee

Special fuel distributors are required to collect the environmental protection fee even if the contractor has a Special Fuel Direct Pay Permit. The fee is levied at 4/10^{ths} of a cent per gallon. The fee is suspended or reinstated when the trust fund has exceeded or fallen below the obligatory balance.

Penalties

Any person who knowingly and willfully purchases untaxed fuel for use in equipment utilized on a road or highway construction site in this state is guilty of a misdemeanor and, upon conviction, shall be fined not less than \$1,000 or more than \$100,000, or imprisoned in the county jail for not more than one year, or both.



MISSISSIPPI DEPARTMENT OF TRANSPORTATION

SECTION 904- NOTICE TO BIDDERS NO. 2278

CODE: (SP)

DATE: 03/04/2020

SUBJECT: Smoothness Tolerances

Bidders are hereby advised that the smoothness tolerances for this project shall meet the requirements of a Category C project according to Subsection 403.03.2.1. Bidders are responsible for the collection of a preliminary smoothness profile prior to any work being performed.

MISSISSIPPI DEPARTMENT OF TRANSPORTATION

SECTION 904 - NOTICE TO BIDDERS NO. 2954

CODE: (IS)

DATE: 12/01/2020

SUBJECT: Reflective Sheeting for Signs

Bidders are hereby advised that the retroreflective sign sheeting used for signs on this project shall be as listed below and shall meet the requirements of Subsection 721.06.

Temporary Construction Signs

Temporary traffic control (orange) sign sheeting shall be a minimum Type IX Fluorescent Orange sheeting as shown in Special Provision 907-721.

Permanent Signs

Permanent signs, except signs on traffic signal poles/mast arms, shall be as follows:

- Brown background sheeting on guide signs shall be a minimum Type VIII sheeting,
- Green and blue background sheeting on guide signs shall be a minimum Type IX sheeting, and
- All white, yellow, red, fluorescent yellow, and fluorescent yellow/green sheeting shall be Type XI sheeting.

MISSISSIPPI DEPARTMENT OF TRANSPORTATION

SECTION 904 - NOTICE TO BIDDERS NO. 3676

CODE: (SP)

DATE: 09/21/2021

SUBJECT: Asphalt Gyrotory Compactor Internal Angle Calibration

Bidders are advised that by March 1, 2022, all asphalt gyrotory compactors shall be calibrated to an internal angle of $1.16^{\circ} \pm 0.02^{\circ}$. This requirement will be reflected in updates made to MT-78, MT-80, and MT-83. This calibration requirement also extends to all QC/QA testing.

MISSISSIPPI DEPARTMENT OF TRANSPORTATION

SECTION 904 - NOTICE TO BIDDERS NO. 4702

CODE: (SP)

DATE: 11/22/2022

SUBJECT: App for Traffic Control Reports

Bidders are advised that the Department has created a smart phone App for completing and submitting traffic control reports (Form CSD-762) required on this project. The Contractor who monitors traffic control activities and completes traffic control reports will be required to download and use this App when completing and submitting traffic control reports. The reports will then be readily available to all persons who need access to the forms. The App is free and is available for downloading at the following location.

<https://extacctmgmt.mdot.state.ms.us/>

MISSISSIPPI DEPARTMENT OF TRANSPORTATION

SECTION 904 - NOTICE TO BIDDERS NO. 5086

CODE: (SP)

DATE: 05/02/2023

SUBJECT: Detail of Square Tube Sign Posts

Bidders are advised that the following drawings shall be used in the manufacture and installation of square tube sign posts, unless otherwise directed by the Engineer.

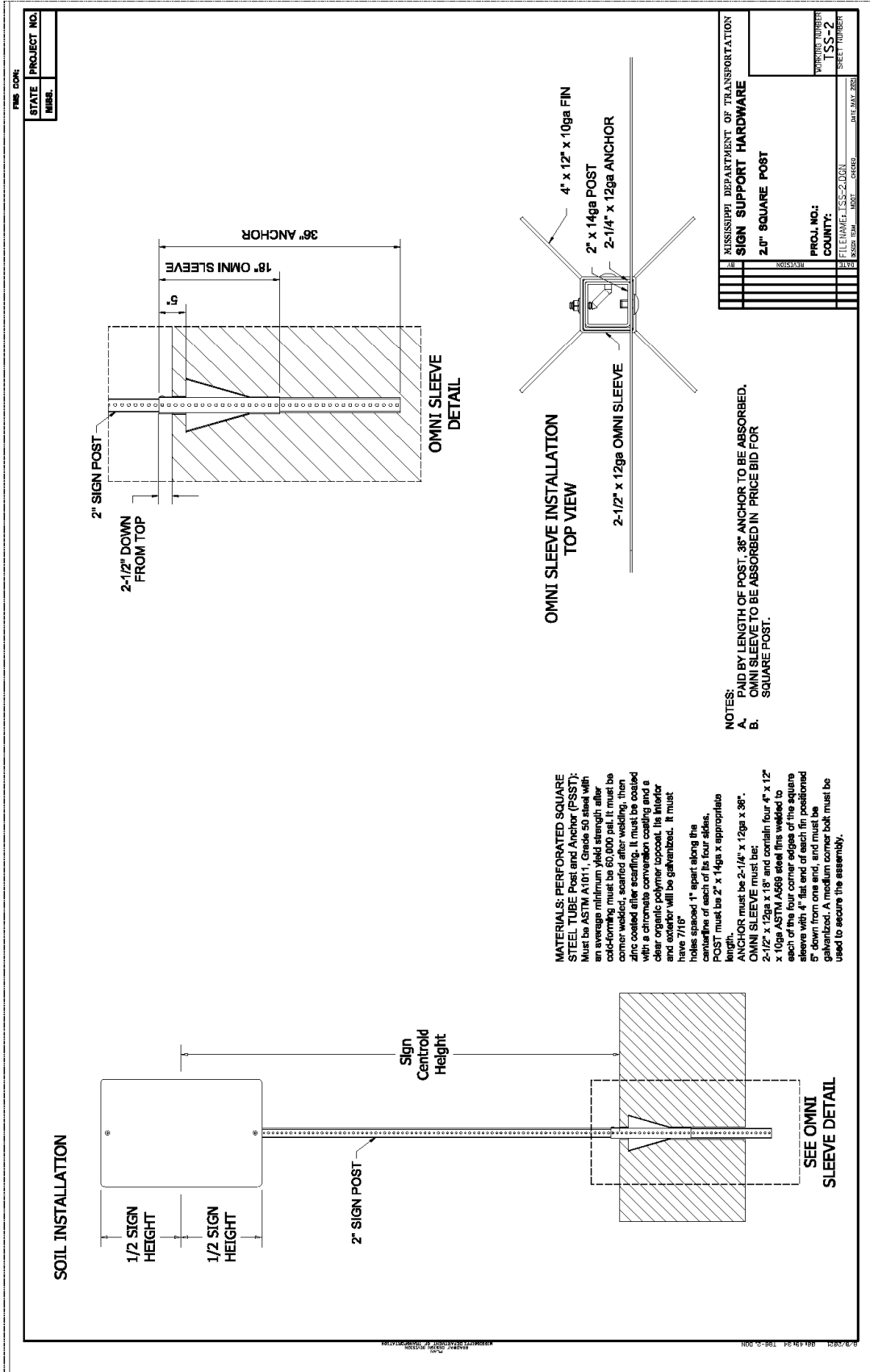

MISSISSIPPI DEPARTMENT OF TRANSPORTATION

SECTION 904 - NOTICE TO BIDDERS NO. 5551

CODE: (IS)

DATE: 12/06/2023

SUBJECT: Federal Bridge Formula

Bidders are hereby advised that the latest revision of Federal Highway Administration Publication No. FHWA-HOP-06-105, **BRIDGE FORMULA WEIGHTS**, dated August 2006, is made a part of this contract when applicable.

Prior to the preconstruction conference, the Contractor shall advise the Engineer, in writing, what materials, if any, will be delivered to the jobsite via Interstate route(s).

Copies of the **BRIDGE FORMULA WEIGHTS** publication may be obtained by contacting:

Federal Highway Administration
400 7th Street, SW
Washington, DC 20590
(202) 366-2212

or

https://ops.fhwa.dot.gov/freight/publications/brdg_frm_wghts/

MISSISSIPPI DEPARTMENT OF TRANSPORTATION

SECTION 904 - NOTICE TO BIDDERS NO. 7597

CODE: (SP)

DATE: 01/27/2026

SUBJECT: Contract Time

**PROJECT: SP-0035-01(009) / 109983301 & SP-0035-01(010) / 109984301
Marshall County**

The completion of work to be performed by the Contractor for this project will not be a specified date but shall be when all allowable working days are assessed, or any extension thereto as provided in Subsection 108.06. It is anticipated that the Notice of Award will be issued no later than **March 10, 2026** and the date for Notice to Proceed / Beginning of Contract Time will be **April 09, 2026**.

Should the Contractor request a Notice to Proceed earlier than **April 09, 2026** and it is agreeable with the Department for an early Notice to Proceed, the requested date will become the new Notice to Proceed date. Regardless of whether or not an early Notice to Proceed is granted, contract time will start at the original Notice to Proceed date.

All requests for an early Notice to Proceed shall be sent to the Project Engineer who will forward it to the Contract Administration Division.

112 Working Days have been allowed for the completion of work on this project.

MISSISSIPPI DEPARTMENT OF TRANSPORTATION

SECTION 904 - NOTICE TO BIDDERS NO. 7598

CODE: (SP)

DATE: 01/06/2025

SUBJECT: SCOPE OF WORK

**PROJECT: SP-0035-01(009) / 109983301 & SP-0035-01(010) / 109984301
Marshall County**

The contract documents do not include an official set of construction plans but may, by reference; include some Standard Drawings when so specified in a Notice to Bidders entitled, "Standard Drawings".

The work to be accomplished using the Pay Items and corresponding specifications set forth in this contract, which is an overlay of SR 311; 109983-301000, beginning at Landfill Road (Sta. 67+20) and going northerly for approximately 4.2 miles to Liles Road (Sta. 286+00) and 109984-301000, beginning at 0.1 miles south of Audie Todd Road (Sta. 498+40) and going northerly for approximately 3.5 miles to US 72 (Sta. 681+41).

It shall be the responsibility of the contractor to protect the roadway and all existing structures, such as bridges and curbs, from damage occurring as a result of the contractor's operations. Damages to existing features caused by the contractor's operations shall be repaired or replaced at no cost to the Mississippi Department of Transportation.

At bridge ends and at the end of workday, a taper of one (1) vertical inch for each three (3) horizontal foot shall be provided.

The contractor shall make a utility location request to 811 prior to any excavation, except for trench widening or pavement removal/repair.

In order to expedite the safe movement of traffic and to protect each phase of the work as it is performed, a firm sequence of operations is essential. The work shall begin and continually prosecuted.

The work shall consist of the following:

1. Random clearing shall be performed from the beginning of the project to the end of the project limits of the mainline as directed by the Engineer. Following the MDOT Tree Management Policy, right-of-way shall be cleared from the edge of pavement or to the right-of-way line. Overhanging vegetation shall be trimmed to a minimum height of thirty feet (30') above the ground elevation at the edge of the clearing limits. It is the intent of this Contract for vegetation and trees, to be fully removed from the project site. This work shall be paid for under pay item 201-D: Random Clearing, per station. Each side of the roadway will be measured separately. Clearing within two feet (2') of fences, utilities, and other obstructions as directed by the Project Engineer within the ROW is to be omitted in order to avoid damages.

If roadside foreslopes are steeper than 3:1 or include other roadway features that would make tree removal infeasible, risk assessment should be conducted by the Project Engineer and Highway Safety Division.

NOTE: No magnolia trees within the ROW limits are to be removed without prior approval from the Project Engineer.

NOTE: Due care should be taken to prevent damage in areas within the ROW that are outside the clearing limits as shown in the table. Any disturbed areas not shown above will not be measured for separate payment and shall be reestablished at no additional cost to the Department.

NOTE: Herbicide shall be used for sprout control of cut stumps. Paint or spray freshly cut stump surface thoroughly covering cambium area next to bark until the herbicide runs down around the root collar. Treat stump as soon as practical after cutting for more effective control but no later than day of cutting except when spraying must be postponed due to inclement weather. Pine stumps and all other stumps larger than 15 inches in diameter do not require spraying for control of sprouting. Permissible herbicides are 2,4-D (amine); picloram +2,4-D; ammonium sulfamate; and dicamba. Specific requirements such as mixing, diluting, rate, application, use restrictions, safety precautions, etc. will be in accordance with the manufacturer's printed container label.

NOTE: Re-spraying will be required when the herbicide is washed off by rain within eight hours of application or diluted to such an extent that it is rendered ineffective.

NOTE: Grinding of all stumps will be required to be flush with the ground.

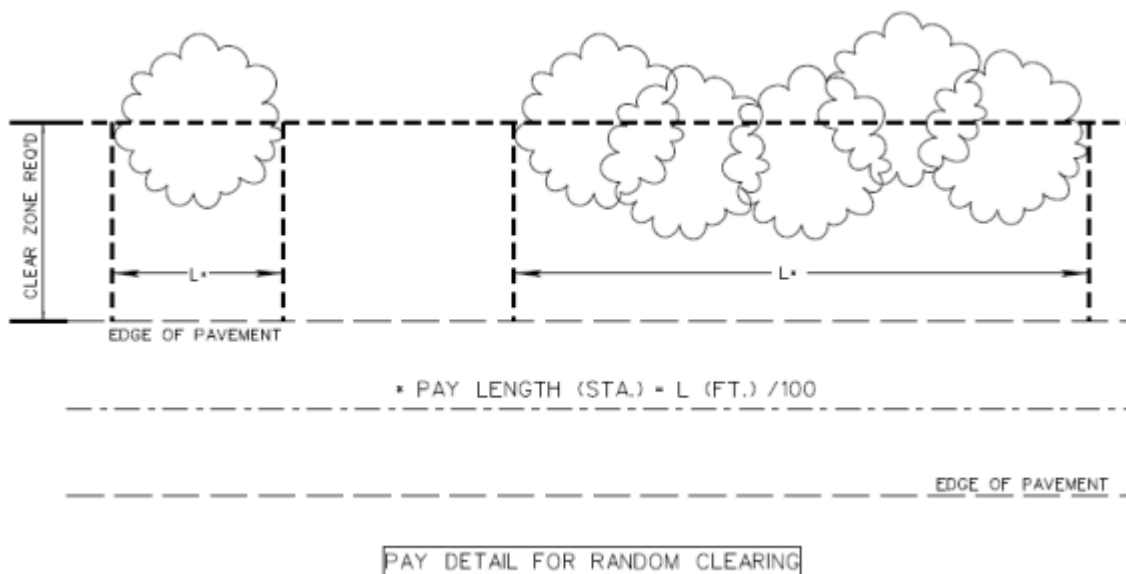

2. Repair failed areas on SR 311 as needed using the following pay items:

- 202-B, Removal of Asphalt Pavement, All Depths
- 203-G, Excess Excavation – for material below the pavement structure
- 907-403-A, 19mm, ST, Asphalt Pavement
- 503-C, Saw Cut, Full Depth

FMS #	Station Start	Station End	Location	Length (ft)	Asphalt Width (ft)	Asphalt Area (SY)	Saw Cuts (LF)
109983	150+60	151+13		53	6	36	65
	166+20	166+36		16	6	11	28
109983 TOTALS						47	93

109984	540+20	540+30	L	10	6	7	22
	580+00	581+19	R	119	6	79	131
	589+00	589+28	L	28	6	19	40
	589+20	589+41	R	21	6	14	33
	590+00	590+53	L	53	6	35	65
	597+50	598+90	R	140	6	93	152
	599+20	599+54	R	34	6	23	46
	607+80	608+20	R	40	6	27	52
	608+80	609+14	L	34	6	23	46
	612+80	613+05	R	25	6	17	37
	616+20	617+13	R	93	6	62	105
	617+00	617+46	L	46	6	31	58
	621+60	622+13	L	53	6	35	65
	622+25	622+35	L & Center	10	14	16	48
	622+50	624+14	R	164	6	109	176
623+60	624+10	L	50	6	33	62	
625+75	626+90	L & Center	115	11	141	137	
109984 TOTALS						763	1275

PROJECT TOTALS	810	1368
-----------------------	------------	-------------

NOTE: Failed areas are estimated as one (1) foot of depth and backfilled with one (1) foot (maximum of 3 ½” lifts) of 19-mm, ST Asphalt. The removal to one (1) foot is paid under the Removal of Asphalt Pavement, All Depths. The asphalt shall be placed per the Project Engineer’s instructions. Saw cuts will be required and will be paid for separately.

NOTE: Any extra excavation below one (1) foot depth required, as determined by the Project Engineer, will be paid for as Excess Excavation.

NOTE: Failed areas are to be backfilled the same day as excavation.

2. Cold milling of the existing asphalt pavement at local road tie-ins and bridge ends to a depth of one and one-half (1 1/2") inches and variable in order to provide a smooth transition will be required. The entire roadway section will not be milled.

The cold milling material obtained shall become the property of the contractor. Payment for Cold Milling of Pavement will be made under Pay Item No. 406-A, per square yard, and shall include all cost associated with the milling operation.

NOTE: During this operation and prior to placement of the asphalt, due care shall be required to keep surface water from ponding on the roadway surface; continuous monitoring of the project may be required.

NOTE: During this operation and prior to placement of the asphalt, contractor shall repair and maintain all potholes.

3. The Contractor shall excavate three inches (3") deep and two feet (2') wide at the pavement edges for trench widening. The overall pavement width shall be 26' wide.

NOTE: Prior to this excavation, sufficient granular material shall be in place to provide an acceptable trench widening operation.

NOTE: Any material removed from the excavation operation of trench widening that cannot be reasonably used as part of the final shoulder shall be removed; and this material shall be moved simultaneously with the trench widening operation. The cost of this work will not be measured for separate payment, and all costs should be included in the cost bid for trench widening. Neither shall this material be allowed to remain rolled up on the existing shoulder or blade down the existing slope.

NOTE: The Contractor shall take due care to only remove the amount of trench widening that can be replaced before the end of each day in order to not leave an open trench overnight.

4. Three inches (3") of 19-mm, ST, Trench Widening asphalt shall be placed in the previously excavated trench.
5. A quantity for 9.5mm, ST, Asphalt Pavement, Leveling has been set up for curve corrections as directed by the Project Engineer. A quantity of 50 tons/mile of 9.5mm, ST, Asphalt, Leveling has been set up to be used at the discretion of the Project Engineer.

NOTE: Daily placement of Granular Material Class 5, Group D, on the shoulders shall be placed to ensure the drop off meets minimum requirements, before opening back up to traffic.

6. The contractor shall place one and one-half inches (1.5") of 9.5mm, ST, Asphalt Pavement for the surface course on the previously leveled mainline.

- 7. Placement of Granular Material Class 5, Group D on the shoulders as directed to raise the existing shoulders to the new surface course grade.

NOTE: Shoulders shall be bladed, shaped and compacted throughout the length of the project regardless of whether granular material is required.

NOTE: Granular material not required for the final shape of the shoulders may require removal under the pay item for excess excavation and may include small amounts of asphalt.

NOTE: Due care shall be taken during this operation to blade material to the roadway and away from the ditch line. Material inadvertently bladed to the roadway vegetation shall be removed at no cost to the Mississippi Department of Transportation.

- 8. Placement of Temporary Traffic Stripe daily as per Special Provisions Nos. 907-618.
- 9. Remove and replace guardrails as per the attached table. Existing guardrail is not located in asphalt and will be driven in the Granular Material.

BR #	Guardrail Removal (LF)	Guardrail Installation W-Beam (LF)	Terminal End Section, Flared (EA)	Bridge End Section (Type F)	Guard Rail, Bridge Connector, Per Plans (EA)	Delineators White (EA)
11.8	600	350	4	4	2	22

NOTE: The contractor shall be responsible for verifying the bridge end sections prior to installation.

- 10. Install a six (6) inch rumble strip for rumble stripe.
- 11. Place permanent pavement markings as required (Thermoplastic Striping, Reflective High Performance Raised Markers). The existing stripe on the bridge shall be removed and replaced. The length of the bridge is 120 feet.
- 12. All existing post-mounted standard roadside signs estimated in the attached table shall be replaced. The Contractor shall deliver the removed signs to the Marshall County Maintenance Lot located at 185 Heritage Drive, Holly Springs. All signs and hardware shall be removed from post prior to delivery. The Contractor is required to verify the sign quantity prior to ordering materials. All hardware and footings required for the erection of new signs and posts shall be absorbed in other items of work.

Sign Quantity - 109983			
Pay Item	Description	Unit	Quantity
202-B	Removal of Sign, Including Post and Footing	EA	24
630-A	Standard Roadside Signs, Sheet Aluminum, 0.080" Thickness	SF	79.1035
630-A	Standard Roadside Signs, Sheet Aluminum, .1" Thickness	SF	145.38
630-A	Standard Roadside Signs, Sheet Aluminum, 0.125" Thickness	SF	9.00
630-C	Square Tube Post, 2.0 lb/ft	LF	315
630-C	Square Tube Post, 4.0 lb/ft	LF	15

Sign Quantity - 109984			
Pay Item	Description	Unit	Quantity
202-B	Removal of Sign, Including Post and Footing	EA	45
630-A	Standard Roadside Signs, Sheet Aluminum, 0.080" Thickness	SF	77.314
630-A	Standard Roadside Signs, Sheet Aluminum, .1" Thickness	SF	103.23
630-A	Standard Roadside Signs, Sheet Aluminum, 0.125" Thickness	SF	45
630-C	Square Tube Post, 2.0 lb/ft	LF	465
630-G	Type 3 Object Markers, OM-3R or OM-3L	EA	22

NOTE: Any Existing Pipe Post will remain in place for the new signs to be attached as shown in the Sign Table attached to the Scope of Work.

NOTE: The Contractor will not be allowed to use rivets for attaching signs to posts. Contractor shall utilize a bolt, washer, and nut for connections as approved by the Project Engineer.

The contractor shall provide all signs and traffic handling devices necessary to safely maintain traffic around or through the work areas.

The Engineer may direct the use of additional cones at County roads or intersections within lane closures and will be absorbed in Maintenance of Traffic.

Incidental work such as removing vegetation, shaping and compaction of shoulder, necessary and incidental grading of roadway ditches, and other incidental work that is necessary to complete the work will not be measured for separate payment and the cost will be included in the bid items provided.

Prior to grinding rumble strips, the Contractor shall mark the beginning and ending of these rumble strips. Temporary paint shall not be used solely as a final location of begin and end of rumble strip.

STATE	PROJECT NO.
MISS.	

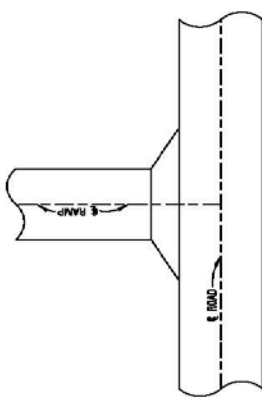

PLAN VIEW OF RAMP

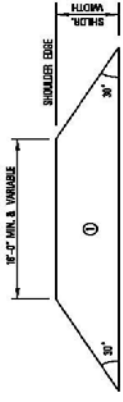

DETAIL OF PAVED APRON

① 1'-1/2" ± VARIABLE DEPTH ASPHALT PAVEMENT REQUIRED

MISSISSIPPI DEPARTMENT OF TRANSPORTATION	
MISCELLANEOUS DETAIL	
DATE	NOV 19 1968
DESIGNED BY	MOB 1
CHECKED BY	MOB 1
PROJECT NO.	7598
SHEET NUMBER	447



109984-301000

Location (Sta. #)	Lane Location	Sign Code	Sign Description	630-G004 Type 3 Object Markers	630-F006 Delimiters, Guard Rail, White	Size	630-A001 0.08" (SF)	630-A005 0.1" (SF)	630-A003 0.125" (SF)	630-C005 Square Tube Posts, 2.0 lb/ft	202-B215 Removal U-Channel	Notes
503+80	Left	R1-1	Stop Sign			36" Octagon		7.46		15	1	Audie Todd Rd
511+00	Right Lane	R1-1	Stop Sign			36" Octagon		7.46		15	1	Belle Meade Rd
516+30	Right	W1-2L	Curve (Left)			36" X 36"			9	15	1	
539+20	Left	W1-2R	Curve (Right)			36" X 36"			9	15	1	
551+10	Right	W2-2	Side Road (left)			30" X 30"	6.25			15	1	Carey Chapel Rd
557+80	Left	R1-1	Stop Sign			36" Octagon		7.46		15	1	Object Markers
559+30	Both			4							2	Chapel Hill Dr (new)
562+40	Right	R1-1	Stop Sign			36" Octagon		7.46		15	1	Object Markers
564+00	Left	W2-2	Side Road (right)			36" X 36"		6.25		15	1	Object Markers
571+80	Right			1							1	Object Markers
572+10	Right			1							1	Object Markers
579+30	Right	R1-1	Stop Sign			36" Octagon		7.46		15	1	Cold Water Bend
581+20	Right	W1-2R	Curve (Right)			36" X 36"			9	15	1	
590+20	Both			4							2	Object Markers
592+60	Left	R1-1	Stop Sign			36" Octagon		7.46		15	1	Object Markers
597+95	Left	W1-2L	Curve (Left)			36" X 36"			9	15	1	Jessita Cove
600+80	Both			4							2	Object Markers
609+00	Right	R1-1	Stop Sign			36" Octagon		7.46		15	1	Eagle Hill Dr
617+20	Right	R1-1	Stop Sign			36" Octagon		7.46		15	1	Memphis Ave
624+50	Right	W8-13	Bridge less before road			36" X 36"	9			15	1	
631+60	Right				7							South Side Guard Rail
632+60	Left				4							South Side Guard Rail
633+60	Both			2							2	South Bridge End Object Markers
634+80	Both			2							2	North Bridge End Object Markers
635+80	Right				4							North Side Guard Rail
636+80	Left				7							North Side Guard Rail
642+10	Both			4							2	Object Markers
643+20	Left	W8-13	Bridge less before road			36" X 36"	9			15	1	
643+60	Right	R1-1	Stop Sign			36" Octagon		7.46		15	1	Cold Creek Dr (new)
655+00	Right	R2-1	Speed Limit (35)			24" X 30"	5			15	1	
655+60	Left	R2-1	Speed Limit (55)			24" X 30"	5			15	1	
657+00		R2-1	Speed Limit (25)			24" X 30"	5			30	2	REPLACE POSTS ONLY
662+80	Right	S4-2P	When Children Are Present (white/black)			24" X 12"	2			15	1	All on one post
668+80	Left	S4-3P	School (yellow/black)			24" X 9"	1.5					
669+40	Right	R1-1	Stop Sign			36" Octagon		7.46		15	1	Comer Ave
671+40	Right	W3-1	Stop Ahead			36" Octagon		7.46	9	15	1	Boswell Rd
672+50	Left	R1-1	Stop Sign			36" X 36"				15	1	Mt Pleasant Rd
672+50	Right	R1-1	Stop Sign			36" Octagon		7.46		15	1	Janie Catherine Ave
676+00	Right	M1-6	72 (Black Border)			24" X 24"	4.00			15	1	All on one post
677+00	Left	M2-1	JCT			21" X 15"	2.19			15	1	
677+50	Right	R2-1	Speed Limit 35			24" X 30"	5			30	2	Memphis Walnut sign. Just replacing the posts not the sign
678+20	Left	M3-3	SOUTH (black/white)			24" X 12"	2.00			15	1	REUSE Weight Limit sign
		M1-6	311 (Black Border)			30" X 24"	5.00					
		M3-2	EAST (black/white)			24" X 12"	2					
		M1-6	72 (Black Border)			24" X 24"	4.00					
679+20	Right	M6-1L	Arrow Left (black/white)			21" X 15"	2.19					All on one post - no post in need of replacement
		M3-4	WEST (black/white)			24" X 12"	2.00					
		M1-6	72 (Black Border)			24" X 24"	4.00					
		M6-2R	Arrow Right (diagonal)			21" X 15"	2.19					
Totals				22	22		77.314	103.23	45	465	45	

109984-301000

ROW Widths					
Right of CL	Left of CL	Start Sta #	End Sta #	Total Length	
50	50	70+00	110+00	4000	
70	50	110+00	122+00	1200	
50	50	122+00	169+00	4700	
80	50	169+00	174+00	500	
50	50	174+00	228+00	5400	
60	60	228+00	246+00	1800	
80	60	246+00	249+00	300	
70	60	249+00	259+00	1000	
70	70	259+00	268+00	900	
70	50	268+00	269+00	100	
50	50	269+00	272+00	300	
70	70	272+00	279+00	700	
60	60	279+00	289+00	1000	

Random Clearing					
Starting Station	Ending Station	Length (ft)	No. of Stations	Location	
72+40	76+60	420	4.2	Right	
82+80	100+00	1720	17.2	Right	
103+00	106+40	340	3.4	Right	
132+00	142+40	1040	10.4	Right	
143+60	144+20	60	0.6	Right	
150+40	175+60	2520	25.2	Right	
180+00	180+60	60	0.6	Right	
185+00	188+00	300	3.0	Right	
189+40	257+00	6760	67.6	Right	
266+00	267+00	100	1.0	Right	
271+20	274+00	280	2.8	Right	
274+70	286+00	1130	11.3	Right	
72+00	97+80	2580	25.8	Left	
100+00	130+20	3020	30.2	Left	
132+00	155+80	2380	23.8	Left	
157+00	157+40	40	0.4	Left	
158+60	162+70	410	4.1	Left	
163+80	165+00	120	1.2	Left	
165+80	168+00	220	2.2	Left	
168+40	169+90	150	1.5	Left	
171+00	172+60	160	1.6	Left	
174+00	180+40	640	6.4	Left	
184+80	190+00	520	5.2	Left	
192+00	206+40	1440	14.4	Left	
207+20	217+80	1060	10.6	Left	
223+40	226+00	260	2.6	Left	
228+00	244+60	1660	16.6	Left	
245+20	266+20	2100	21.0	Left	
267+40	269+80	240	2.4	Left	
271+90	277+80	590	5.9	Left	
281+40	283+60	220	2.2	Left	
285+00	286+00	100	1.0	Left	
Total			326.4		

109983-301000

ROW Widths					
Right of CL	Left of CL	Start Sta #	End Sta #	Total Length	
50	50	498+40	536+00	3760.00	
70	90	536+00	545+00	900.00	
70	70	545+00	546+00	100.00	
80	70	546+00	555+00	900.00	
50	50	555+00	559+00	400.00	
60	50	559+00	567+00	800.00	
50	50	567+00	621+00	5400.00	
70	50	621+00	625+00	400.00	
70	70	625+00	634+00	900.00	
60	50	634+00	656+56	2256.00	
50	50	656+56	665+00	844.00	
50	50	665+00	681+41	1641.00	

Random Clearing					
Starting Station	Ending Station	Length (ft)	No. of Stations	Location	
499+40	504+80	540	5.4	Right	
507+80	510+00	220	2.2	Right	
511+40	516+60	520	5.2	Right	
517+20	521+80	460	4.6	Right	
522+20	528+00	580	5.8	Right	
534+00	544+00	1000	10.0	Right	
551+00	552+50	150	1.5	Right	
572+20	572+40	20	0.2	Right	
585+20	585+40	20	0.2	Right	
587+00	592+80	580	5.8	Right	
594+00	594+40	40	0.4	Right	
594+80	602+00	720	7.2	Right	
605+80	608+60	280	2.8	Right	
609+00	616+60	760	7.6	Right	
622+00	633+80	1180	11.8	Right	
635+00	642+80	780	7.8	Right	
646+00	665+00	1900	19.0	Right	
498+40	499+00	60	0.6	Left	
503+20	504+00	80	0.8	Left	
516+60	519+00	240	2.4	Left	
519+80	520+20	40	0.4	Left	
528+80	532+60	380	3.8	Left	
536+60	547+20	1060	10.6	Left	
547+80	551+60	380	3.8	Left	
552+20	554+00	180	1.8	Left	
558+80	571+60	1280	12.8	Left	
577+20	592+40	1520	15.2	Left	
593+00	593+40	40	0.4	Left	
594+00	595+00	100	1.0	Left	
599+00	605+80	680	6.8	Left	
609+40	613+60	420	4.2	Left	
614+80	622+60	780	7.8	Left	
625+00	627+20	220	2.2	Left	
630+20	634+00	380	3.8	Left	
657+40	667+00	960	9.6	Left	
Total			185.5		

109984-301000

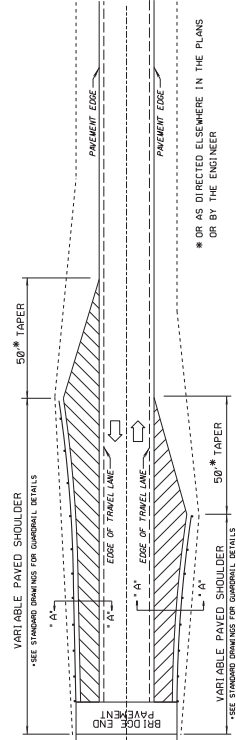

TYPICAL DETAIL OF PAVED SHOULDERS AT BRIDGE ENDS
 (2 - WAY TRAFFIC)
 SEE SECTION 'A' - 'A'

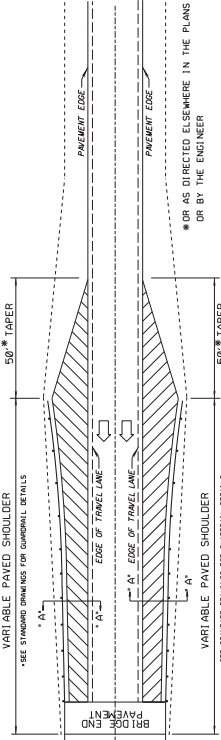

TYPICAL DETAIL OF PAVED SHOULDERS AT BRIDGE ENDS
 (1 - WAY TRAFFIC)
 SEE SECTION 'A' - 'A'

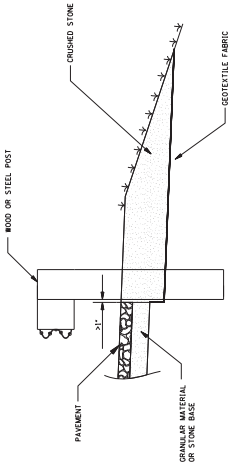

SECTION A-A

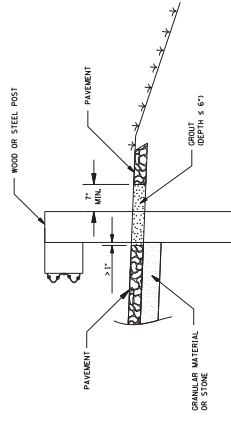

SECTION A-A

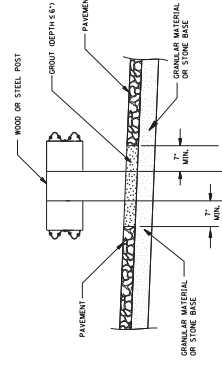

SECTION B-B

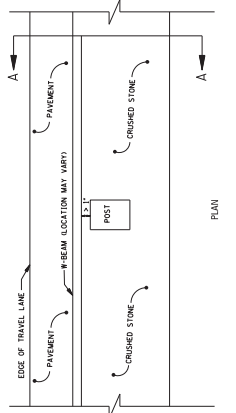

PAVEMENT LEAVE-OUT AREA FOR GUARDRAIL POSTS
 SINGLE-FACED GUARDRAIL (CRUSHED STONE OPTION)

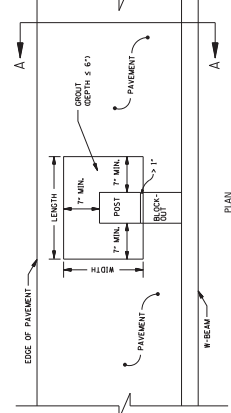

PAVEMENT LEAVE-OUT AREA FOR GUARDRAIL POSTS
 SINGLE-FACED GUARDRAIL (GROUT OPTION)

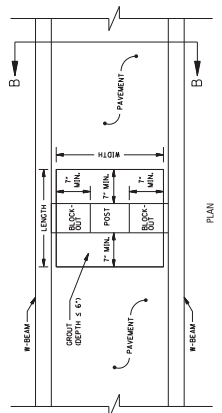

PAVEMENT LEAVE-OUT AREA FOR GUARDRAIL POSTS
 DOUBLE-FACED GUARDRAIL

POST	MIN. PAV'T LEAVE-OUT AREA	
	SINGLE-FACED	DOUBLE-FACED
LENGTH	15	15
WIDTH	15	15
WOOD	24	24
STEEL	18	18

- GENERAL NOTES FOR CRUSHED STONE OPTION
- GUARDRAIL POSTS SHALL NOT BE COMPLETELY SURROUNDED BY PAVEMENT. THE AREA BEHIND AND LATERAL OF THE POST SHALL BE FILLED WITH A MINIMUM 28 DAY COMPRESSIVE STRENGTH OF 120 PSLI.
 - GROUT SHALL BE INSTALLED AT A DEPTH EQUAL TO THE SURROUNDING PAVEMENT IS GREATER THAN 6". IF DIFFERENCE SHALL BE FILLED IN WITH SHOULDER GRANULAR MATERIAL.
 - STANDARD EMBEMENT DEPTH SHALL BE ABSORBED IN THE COST OF OTHER ITEMS BID.
 - PAVEMENT LEAVE-OUT AREAS ARE REQUIRED FOR STEEL AND WOOD POSTS.
 - STANDARD EMBEMENT DEPTH SHALL APPLY MEASURED FROM THE TOP OF THE PROJECTED PAVEMENT SURFACE.
- GENERAL NOTES FOR GROUT OPTION
- GUARDRAIL POSTS SHALL NOT BE COMPLETELY SURROUNDED BY PAVEMENT. THE AREA BEHIND AND LATERAL OF THE POST SHALL BE FILLED WITH A MINIMUM 28 DAY COMPRESSIVE STRENGTH OF 120 PSLI.
 - GROUT SHALL BE INSTALLED AT A DEPTH EQUAL TO THE SURROUNDING PAVEMENT IS GREATER THAN 6". IF DIFFERENCE SHALL BE FILLED IN WITH SHOULDER GRANULAR MATERIAL.
 - STANDARD EMBEMENT DEPTH SHALL BE ABSORBED IN THE COST OF OTHER ITEMS BID.
 - PAVEMENT LEAVE-OUT AREAS ARE REQUIRED FOR STEEL AND WOOD POSTS.
 - STANDARD EMBEMENT DEPTH SHALL APPLY MEASURED FROM THE TOP OF THE PROJECTED PAVEMENT SURFACE.

NOTE: THE ALTERNATIVES SHOWN HEREIN APPLY TO ALL GUARDRAIL CONSTRUCTION WHERE MON STRIPS ARE AVOIDED.

PRELIMINARY
NOT FOR
CONSTRUCTION



MISSISSIPPI DEPARTMENT OF TRANSPORTATION

DESIGNED BY: DISTRICT 2
CHECKED BY:
DATE:

FMS CON: 109984/301000
PROJECT NO.: SP-0035-01-10
COUNTY: MARSHALL

Notice to Bidders No. 7558--567
DETAIL OF BRIDGE CONNECTOR

WV No. BGR-C-1
SHEET NO. 1

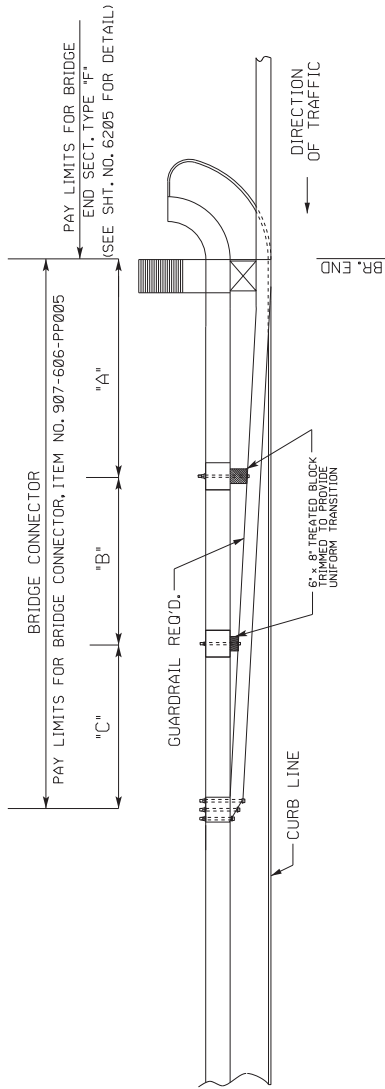

PLAN VIEW

Bridge #	NB	SB	A	B	C	RT	LT
118	6'-4"	6'-1"	6'-1"	6'-2"	6'-2"		
118	6'-3 1/2"	6'-3 1/2"	6'-3 1/2"	6'	6'		

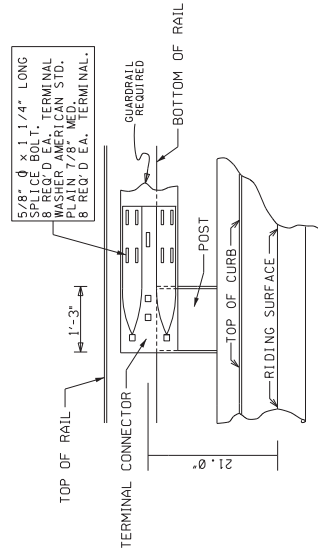
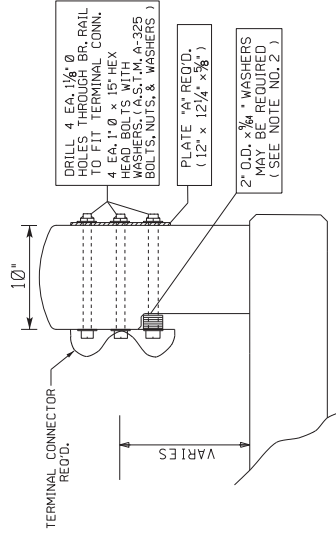
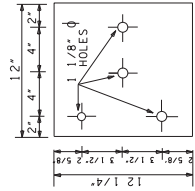

- NOTE
- (1) GUARDRAIL MAY BE CUT AT ONE END OF BRIDGE CONNECTOR AND HOLES FIELD DRILLED TO MATCH POST LOCATIONS, HOLES AND CUT END OF RAIL TO BE FIELD PAINTED AS DIRECTED BY THE PROJECT ENGINEER.
 - (2) 7 WASHERS EACH, FOR SPACERS, MAY BE REQUIRED, ACCORDING TO THE VARIATIONS OF HEIGHT OF GUARDRAIL FROM THE TOP OF CURB.
 - (3) CONTRACTOR IS TO FIELD VERIFY POST SPACING FOR BRIDGE CONNECTIONS.

STATE	PROJECT NO.
MISS	SP-0035-01(009)/SP-0035-01(010)

SUMMARY OF QUANTITIES (SHEET 1)

PAY ITEM NO.	PAY ITEM	UNIT	MARSHALL : 109983-301000	
			Prelim	Final
201-D001	Random Clearing	STA	327	
202-B007	Removal of Asphalt Pavement, All Depths	SY	47	
202-B215	Removal of Sign Including Post & Footing	EA	24	
203-G001	Excess Excavation, FM, AH	CY	20	
304-B004	Granular Material, Class 5, Group D	TON	1,600	
907-403-A006	19-mm, ST, Asphalt Pavement	TON	50	
907-403-A015	9.5-mm, ST, Asphalt Pavement	TON	5,750	
907-403-B012	9.5-mm, ST, Asphalt Pavement, Leveling	TON	1,700	
907-403-C003	19-mm, ST, Asphalt Pavement, Trench Widening	TON	1,800	
406-A002	Cold Milling of Bituminous Pavement, All Depths	SY	635	
407-A001	Asphalt for Tack Coat	GAL	6,800	
423-A001	Rumble Strips, Ground In	MI	9	
503-C010	Saw Cut, Full Depth	LF	93	
907-618-A001	Maintenance of Traffic	LS	1	
618-B001	Additional Construction Signs	SF	1	
619-A1001	Temporary Traffic Stripe, Continuous White	MI	9	
619-A2001	Temporary Traffic Stripe, Continuous Yellow	MI	5	
619-A4002	Temporary Traffic Stripe, Skip Yellow	MI	3	
619-A5001	Temporary Traffic Stripe, Detail	LF	300	
619-A6002	Temporary Traffic Stripe, Legend	LF	100	
907-619-B001	Temporary Portable Rumble Strips	LF	66	
420-A001	Mobilization	LS	1	
907-626-C014	6" Thermoplastic Edge Stripe, Continuous White	MI	9	
907-626-D005	6" Thermoplastic Traffic Stripe, Skip Yellow	MI	3	
907-626-E005	6" Thermoplastic Traffic Stripe, Continuous Yellow	MI	5	
907-626-G004	Thermoplastic Detail Stripe, White	LF	300	
907-626-G005	Thermoplastic Detail Stripe, Yellow	LF	1,024	
907-626-H009	Thermoplastic Legend, White	SF	118	
907-626-H010	Thermoplastic Legend, White	LF	100	
907-627-J001	Two-Way Clear Reflective High Performance Raised Markers	EA	1,208	
907-627-L001	Two-Way Yellow Reflective High Performance Raised Markers	EA	574	
630-A001	Standard Roadside Signs, Sheet Aluminum, 0.080" Thickness	SF	80	
630-A003	Standard Roadside Signs, Sheet Aluminum, 0.125" Thickness	SF	9	
630-A005	Standard Roadside Signs, Sheet Aluminum, 0.1" Thickness	SF	146	
630-C001	Square Tube Posts, 4.0 lb/ft	LF	15	
630-C005	Square Tube Posts, 2.0 lb/ft	LF	315	

MISSISSIPPI DEPARTMENT OF TRANSPORTATION	
SUMMARY OF QUANTITIES	
PROJ NO: SP-0035-01(009)	Working Number: SQ-1
COUNTY: MARSHALL	Sheet Number
FILENAME: 109983-109984 - SQS	1
Design Team	Checked
Date	

STATE	PROJECT NO.
MISS	SP-0035-01(009)/SP-0035-01(010)

SUMMARY OF QUANTITIES (SHEET 2)

PAY ITEM NO.	PAY ITEM	UNIT	MARSHALL : 109984-301000	
			Prelim	Final
201-D001	Random Clearing	STA	186	
202-B007	Removal of Asphalt Pavement, All Depths	SY	763	
202-B158	Removal of Guard Rail, Including Rails, Posts and Terminal Ends	LF	600	
202-B215	Removal of Sign Including Post & Footing	EA	45	
202-B240	Removal of Traffic Stripe	LF	360	
203-G001	Excess Excavation, FM, AH	CY	255	
304-B004	Granular Material, Class 5, Group D	TON	1,200	
907-403-A006	19-mm, ST, Asphalt Pavement	TON	500	
907-403-A015	9.5-mm, ST, Asphalt Pavement	TON	5,000	
907-403-B012	9.5-mm, ST, Asphalt Pavement, Leveling	TON	825	
907-403-C003	19-mm, ST, Asphalt Pavement, Trench Widening	TON	1,500	
406-A002	Cold Milling of Bituminous Pavement, All Depths	SY	1,628	
407-A001	Asphalt for Tack Coat	GAL	5,417	
423-A001	Rumble Strips, Ground In	MI	7	
503-C010	Saw Cut, Full Depth	LF	1,275	
606-B002	Guard Rail, Class A, Type 1, 'W' Beam	LF	350	
606-D015	Guard Rail, Bridge End Section, Type F	EA	4	
606-E005	Guard Rail, Terminal End Section, Flared	EA	4	
907-606-PP005	Guard Rail, Bridge Connector, Per Plans	EA	2	
907-618-A001	Maintenance of Traffic	LS	1	
618-B001	Additional Construction Signs	SF	1	
619-A1001	Temporary Traffic Stripe, Continuous White	MI	7	
619-A2001	Temporary Traffic Stripe, Continuous Yellow	MI	4	
619-A4002	Temporary Traffic Stripe, Skip Yellow	MI	3	
619-A5001	Temporary Traffic Stripe, Detail	LF	1,440	
619-A6002	Temporary Traffic Stripe, Legend	LF	928	
907-619-B001	Temporary Portable Rumble Strips	LF	66	
620-A001	Mobilization	LS	1	
907-626-C014	6" Thermoplastic Edge Stripe, Continuous White	MI	7	
907-626-D005	6" Thermoplastic Traffic Stripe, Skip Yellow	MI	3	
907-626-E005	6" Thermoplastic Traffic Stripe, Continuous Yellow	MI	4	
907-626-G004	Thermoplastic Detail Stripes, White	LF	1,440	
907-626-H010	Thermoplastic Legend, White	LF	928	
907-627-J001	Two-Way Clear Reflective High Performance Raised Markers	EA	1,084	
907-627-L001	Two-Way Yellow Reflective High Performance Raised Markers	EA	470	
630-A001	Standard Roadside Signs, Sheet Aluminum, 0.080" Thickness	SF	78	
630-A003	Standard Roadside Signs, Sheet Aluminum, 0.125" Thickness	SF	45	
630-A005	Standard Roadside Signs, Sheet Aluminum, 0.1" Thickness	SF	104	
630-C005	Square Tube Posts, 2.0 lb/ft	LF	465	
630-F006	Delimiters, Guard Rail, White	EA	22	
630-G004	Type 3 Object Markers, OM-3R or OM-3L	EA	22	

MISSISSIPPI DEPARTMENT OF TRANSPORTATION	
SUMMARY OF QUANTITIES	
Revision	
PROJ NO: SP-0035-01(010)	Working Number: SQ-2
COUNTY: MARSHALL	Sheet Number: 2
FILENAME: 109983-109984 - SQS	Checked Date
Design Team	

STATE	PROJECT NO.
MISS	SP-0035-01(009)/SP-0035-01(010)

SUMMARY OF QUANTITIES (SHEET 3)

PAY ITEM NO.	PAY ITEM	UNIT	Total Amount	
			Prelim	Final
201-D001	Random Clearing	STA	513	
202-B007	Removal of Asphalt Pavement, All Depths	SY	810	
202-B158	Removal of Guard Rail, Including Rails, Posts and Terminal Ends	LF	600	
202-B215	Removal of Sign Including Post & Footing	EA	69	
202-B240	Removal of Traffic Stripe	LF	360	
203-G001	Excess Excavation, FM, AH	CY	275	
304-B004	Granular Material, Class 5, Group D	TON	2,800	
907-403-A006	19-mm, ST, Asphalt Pavement	TON	550	
907-403-A015	9.5-mm, ST, Asphalt Pavement	TON	10,750	
907-403-B012	9.5-mm, ST, Asphalt Pavement, Leveling	TON	2,525	
907-403-C003	19-mm, ST, Asphalt Pavement, Trench Widening	TON	3,300	
406-A002	Cold Milling of Bituminous Pavement, All Depths	SY	2,263	
407-A001	Asphalt for Tack Coat	GAL	12,217	
423-A001	Rumble Strips, Ground In	MI	16	
503-C010	Saw Cut, Full Depth	LF	1,368	
606-B002	Guard Rail, Class A, Type 1, 'W' Beam	LF	350	
606-D015	Guard Rail, Bridge End Section, Type F	EA	4	
606-E005	Guard Rail, Terminal End Section, Flared	EA	4	
907-606-PP005	Guard Rail, Bridge Connector, Per Plans	EA	2	
907-618-A001	Maintenance of Traffic	LS	1	
618-B001	Additional Construction Signs	SF	2	
619-A1001	Temporary Traffic Stripe, Continuous White	MI	16	
619-A2001	Temporary Traffic Stripe, Continuous Yellow	MI	9	
619-A4002	Temporary Traffic Stripe, Skip Yellow	MI	6	
619-A5001	Temporary Traffic Stripe, Detail	LF	1,740	
619-A6002	Temporary Traffic Stripe, Legend	LF	1,028	
907-619-B001	Temporary Portable Rumble Strips	LF	132	
620-A001	Mobilization	LS	1	
907-626-C014	6" Thermoplastic Edge Stripe, Continuous White	MI	16	
907-626-D005	6" Thermoplastic Traffic Stripe, Skip Yellow	MI	6	
907-626-E005	6" Thermoplastic Traffic Stripe, Continuous Yellow	MI	9	
907-626-G004	Thermoplastic Detail Stripe, White	LF	1,740	
907-626-G005	Thermoplastic Detail Stripe, Yellow	LF	1,024	
907-626-H009	Thermoplastic Legend, White	SF	118	
907-626-H010	Thermoplastic Legend, White	LF	1,028	
907-627-J001	Two-Way Clear Reflective High Performance Raised Markers	EA	2,292	
907-627-L001	Two-Way Yellow Reflective High Performance Raised Markers	EA	1,044	
630-A001	Standard Roadside Signs, Sheet Aluminum, 0.080" Thickness	SF	158	
630-A003	Standard Roadside Signs, Sheet Aluminum, 0.125" Thickness	SF	54	
630-A005	Standard Roadside Signs, Sheet Aluminum, 0.1" Thickness	SF	250	
630-C001	Square Tube Posts, 4.0 lb/ft	LF	15	
630-C005	Square Tube Posts, 2.0 lb/ft	LF	780	
630-F006	Delineators, Guard Rail, White	EA	22	
630-G004	Type 3 Object Markers, OM-3R or OM-3L	EA	22	

MISSISSIPPI DEPARTMENT OF TRANSPORTATION	
SUMMARY OF QUANTITIES - PROJECT TOTALS	
Working Number	SQ-3
Sheet Number	3
PROJ NO: SP-0035-01(009)/SP-0035-01(010)	
FMS: 109983-301000/109984-301000	
FILENAME: 109983-109984 - SQS	
Design Team	Checked
Date	

MISSISSIPPI DEPARTMENT OF TRANSPORTATION

| **SUPPLEMENT TO NOTICE TO BIDDERS NO. 7624**

| **DATE:** **01/23/2026**

After the last drawing on page 33, add the following.

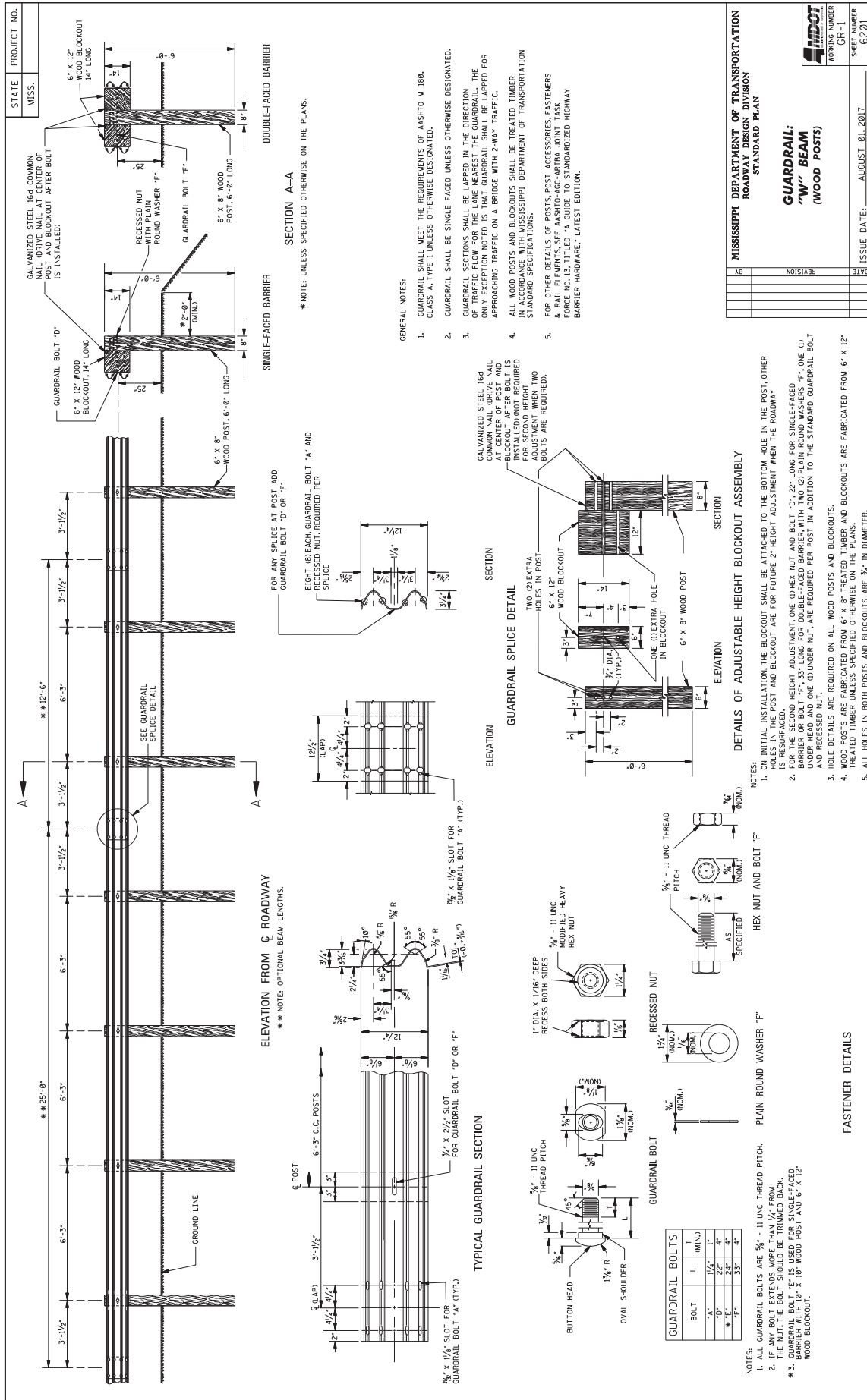

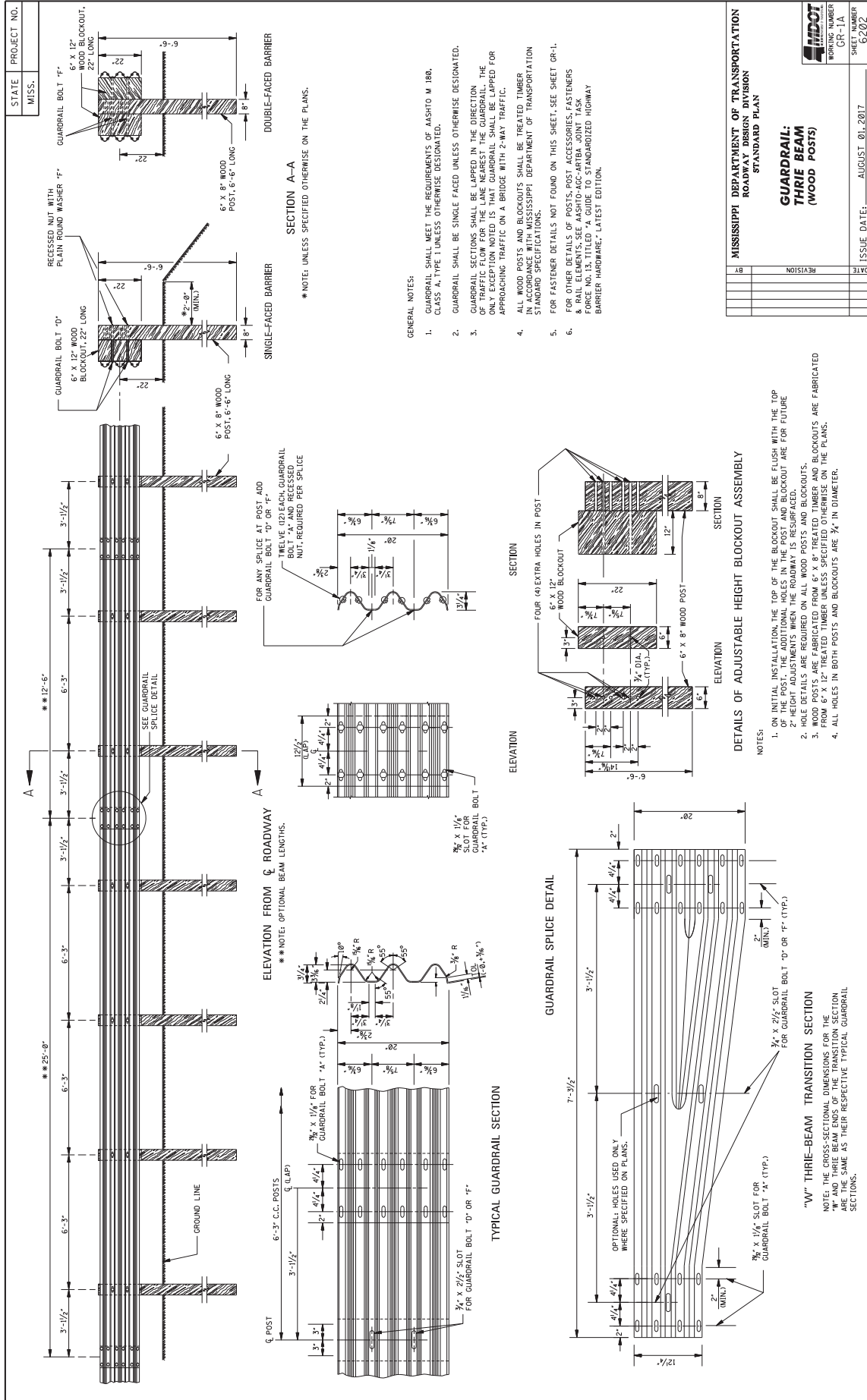

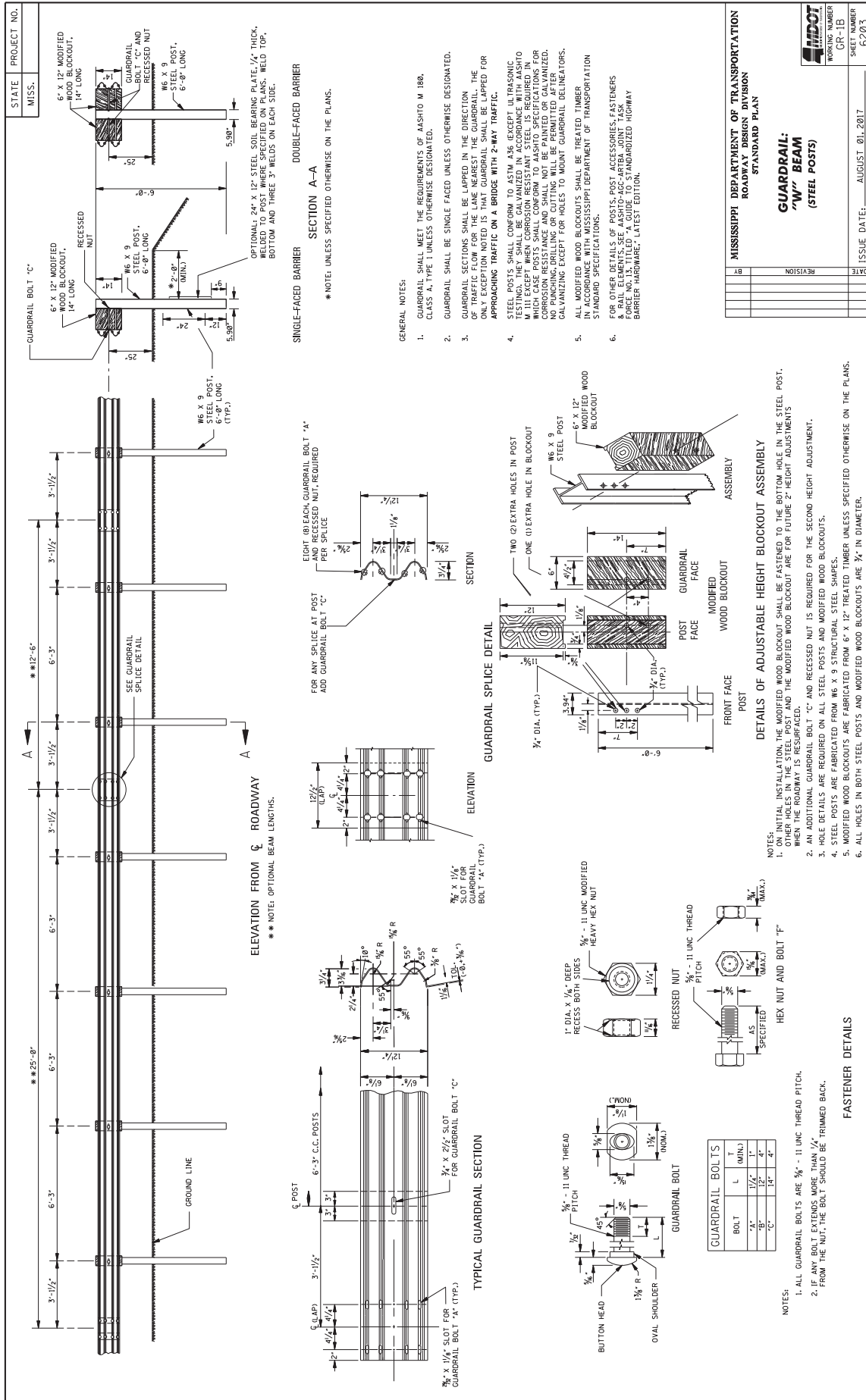

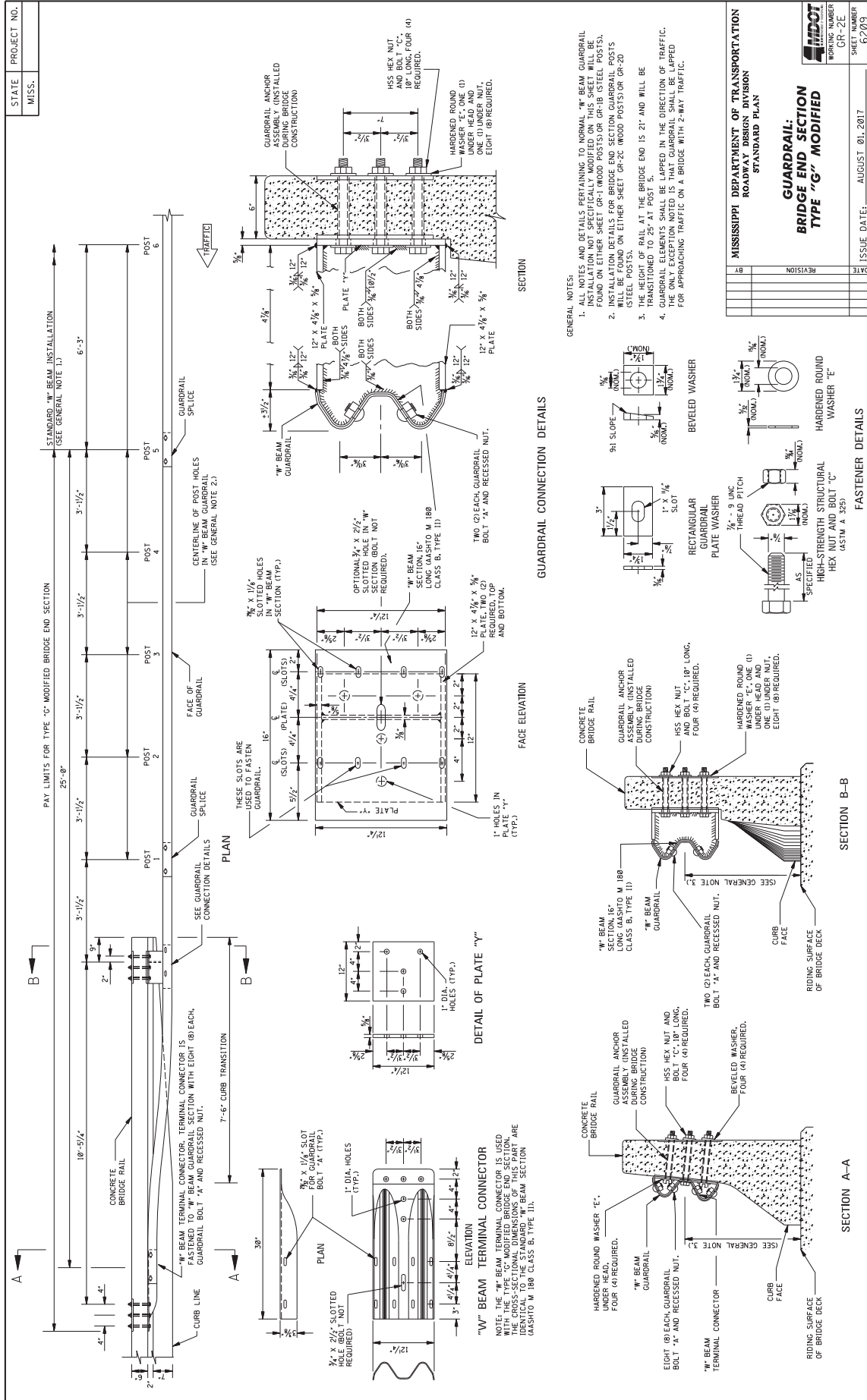

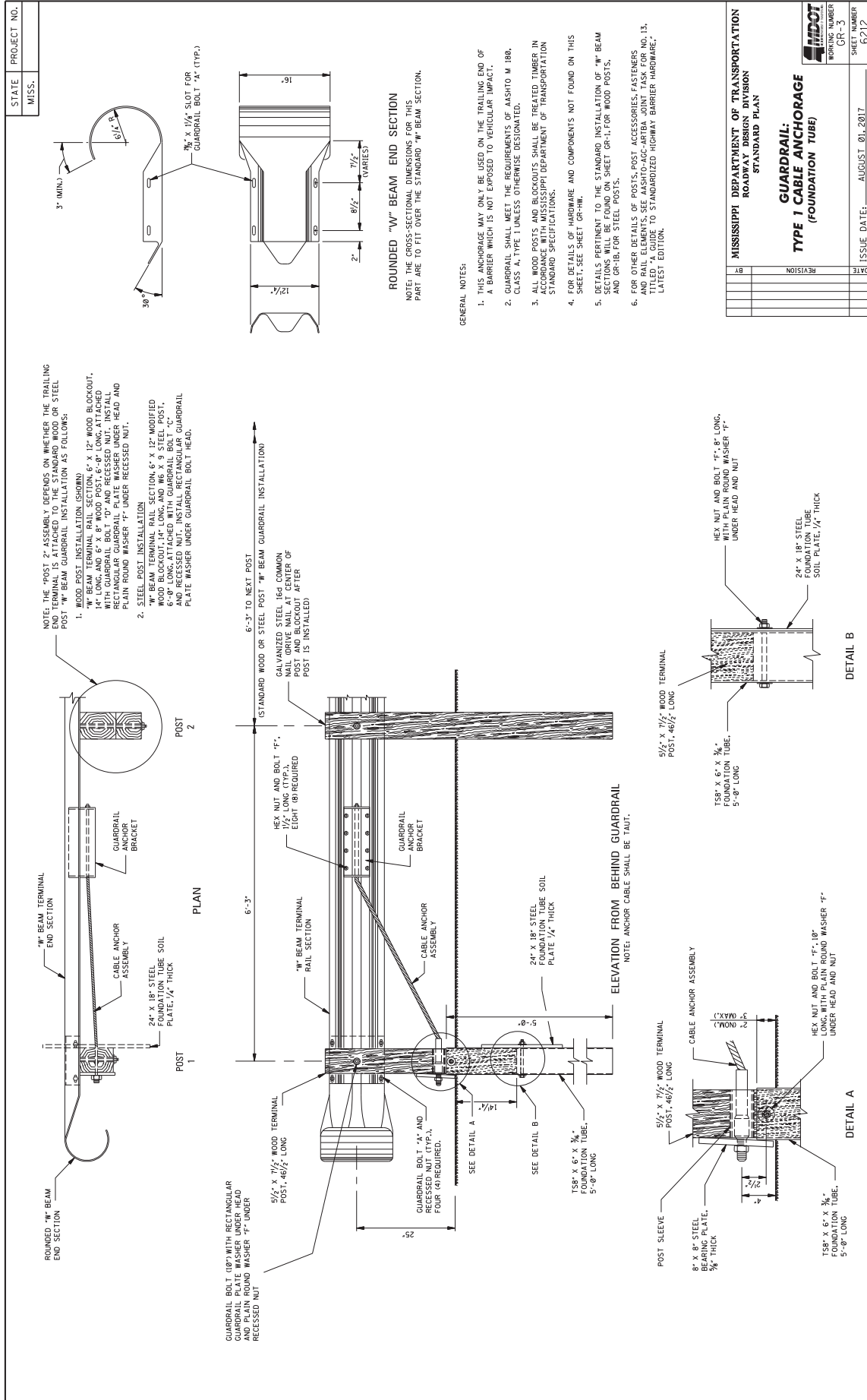

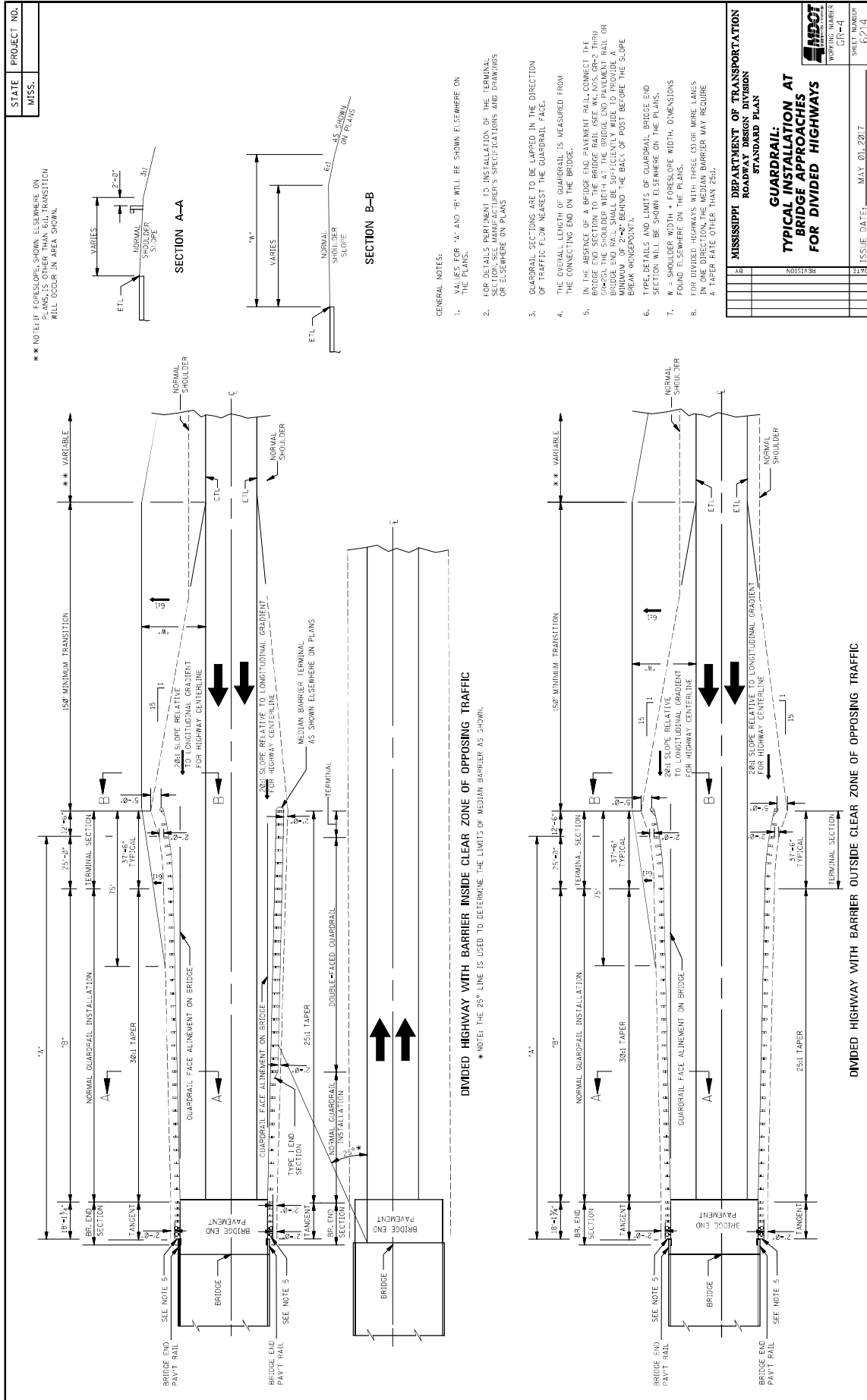

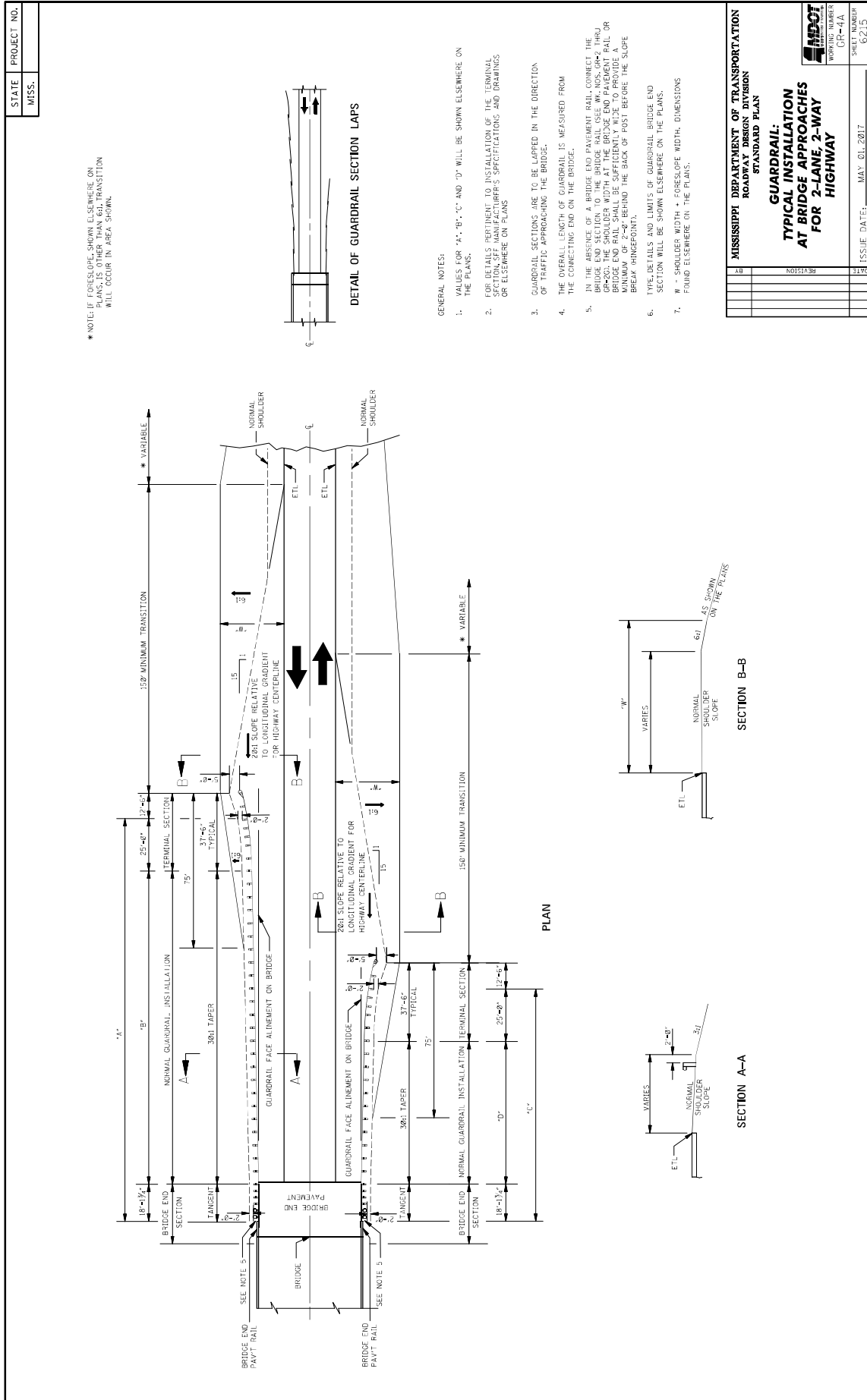

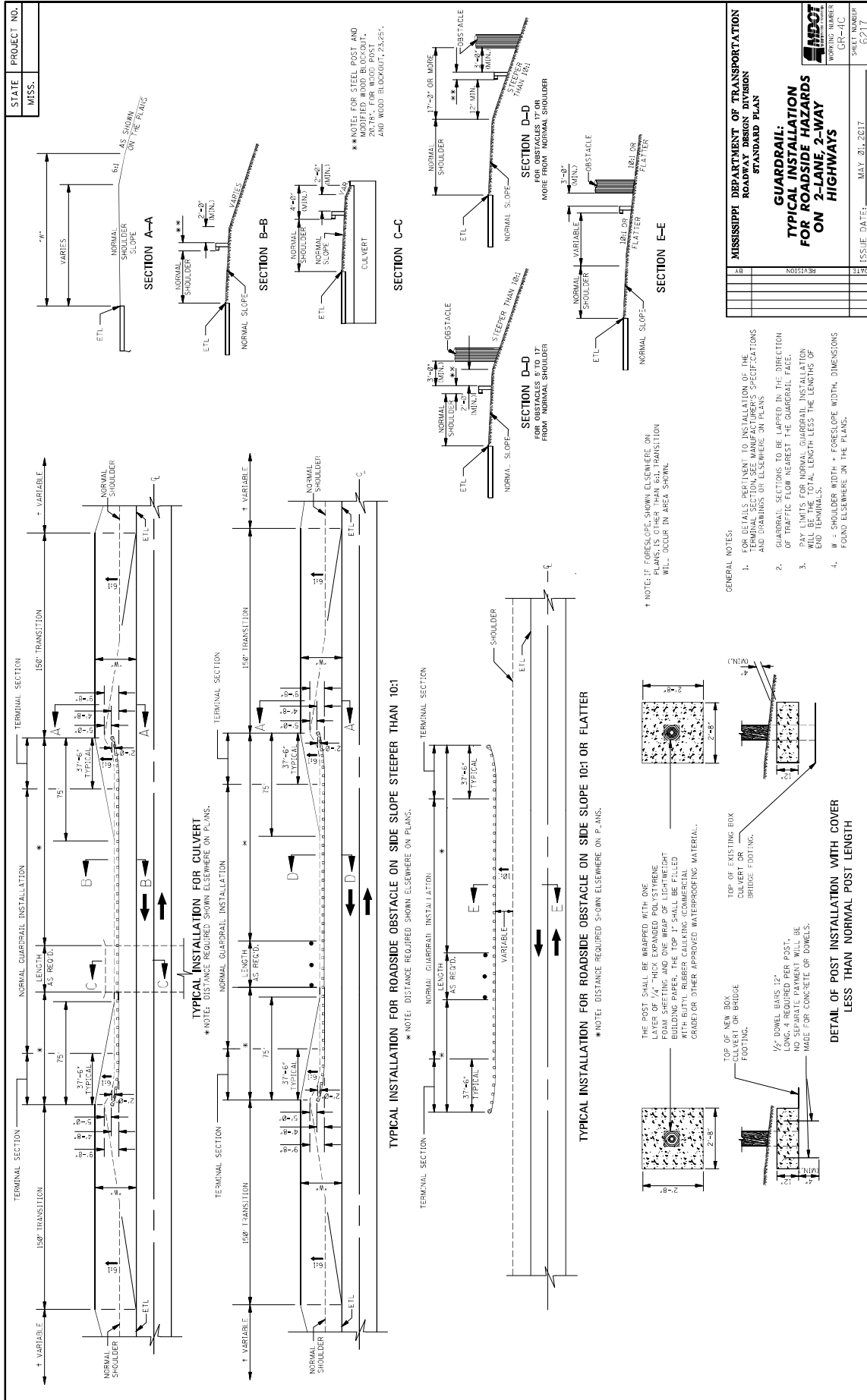

STATE	PROJECT NO.	
MISS.		

"M" BEAM TERMINAL CONNECTOR PLATE

NOTES:
 1. THE "M" BEAM TERMINAL CONNECTOR SHALL BE AASHTO M 188 CORRUGATED SHEET STEEL CLASS B, TYPE 1.
 2. SPLICE-BOLT SLOTS MAY ALSO BE ORIENTED AT 50° (ON THE PLATE) INSTEAD OF 0° AS SHOWN.

STEEL TUBE ANCHOR

NOTE: TERMINAL POST SHALL BE ABLE TO SLIDE INTO THE TUBE. THE ACTUAL INSIDE DIMENSIONS OF THIS GALVANIZED TUBE CANNOT BE LESS THAN 7/2" X 5/2".

TERMINAL POST FOR FOUNDATION TUBE INSTALLATION

NOTE: TERMINAL POST SHALL BE MADE OF S4S TIMBER WITH 2 STRESS GRADE OF 1200 LBS/IN².

BEARING PLATE

SOIL PLATE

NOTE: 2 REQUIRED

GUARDRAIL BOLT

END PLATE

PLAIN ROUND WASHER

ANCHOR PLATE ASSEMBLY DETAILS

CABLE ANCHOR ASSEMBLY

BREAKAWAY TERMINAL POST SLEEVE

SHELF ANGLE BRACKET

FASTENER DETAILS

BOLT	L	T (MIN.)	C (NOM.)
1/2"	12"	4"	1/4"
3/4"	14"	4"	3/8"
1"	22"	4"	1/2"
1 1/4"	33"	4"	3/4"
1 1/2"	42"	4"	7/8"
2"	53"	4"	1"
2 1/2"	62"	4"	1 1/8"
3"	72"	4"	1 1/4"

NOTES:
 1. ALL GUARDRAIL BOLTS ARE 1/4" - 11 UNC THREAD PITCH.
 2. IF ANY BOLT EXTENDS MORE THAN 1/4" FROM THE NUT, THE BOLT SHOULD BE TRIMMED BACK.

WASHER	A (NOM.)	B (NOM.)	C (NOM.)
1/4"	1 1/8"	1 1/4"	1/8"
3/8"	1 3/8"	1 3/4"	3/16"
1/2"	1 5/8"	1 7/8"	1/4"
3/4"	1 7/8"	2"	3/8"
1"	2 1/8"	2 1/4"	1/2"
1 1/4"	2 3/8"	2 3/4"	5/8"
1 1/2"	2 5/8"	2 7/8"	3/4"
2"	3 1/8"	3 1/4"	7/8"
2 1/2"	3 3/8"	3 3/4"	1"
3"	3 5/8"	3 7/8"	1 1/8"

ANCHOR PLATE

STATE	PROJECT NO.				
MISS.					

DETAIL OF TYPE 3 OBJECT MARKER

NOTE: COLORS - BLACK AND YELLOW. STRIPING SLANT DOWNWARD TO THE RIGHT FOR LEFT SIDE OF BRIDGE END. SEE DETAIL BELOW.

REAR VIEW OF TYPE 3 OBJECT MARKER OR DISTANCE REFERENCE SIGN ASSEMBLY

NOTE: TYPE 3 OBJECT MARKER AND DISTANCE REFERENCE SIGNS SHALL BE FASTENED TO U-SECTION POSTS WITH 3/8" DIA. BLIND FASTENERS OF THE COLLAR TYPE.

DELINEATOR MOUNTING ON OUTSIDE SHOULDER ALONG MAIN FACILITY OR RAMP

SINGLE OR DOUBLE AS REQUIRED

DELINEATOR MOUNTING ON INTERCHANGE LOOPS WITH UNMOUNTABLE CURB ON INSIDE

SINGLE OR DOUBLE AS REQUIRED

DELINEATOR MOUNTING ON OUTSIDE SHOULDER WITH MOUNTABLE CURB ALONG MAIN FACILITY OR RAMP

SINGLE OR DOUBLE AS REQUIRED

DELINEATOR MOUNTING ON INTERCHANGE LOOPS WITH UNMOUNTABLE CURB ON INSIDE

SINGLE OR DOUBLE AS REQUIRED

DETAIL OF SINGLE WHITE DELINEATOR

DETAIL OF DOUBLE WHITE OR DOUBLE YELLOW DELINEATOR

REAR VIEW OF DELINEATOR ASSEMBLY

DETAIL OF SINGLE YELLOW DELINEATOR

DETAIL OF DOUBLE WHITE OR DOUBLE YELLOW DELINEATOR

REAR VIEW OF DELINEATOR ASSEMBLY

DELINEATORS: OBJECT MARKERS D10-1, D10-1A, D10-2, D10-2A, D10-3, D10-3A, D10-4, AND D10-5 ARE MOUNTED TO THIS FACE AS SHOWN.

MOUNTING DETAIL

GENERAL NOTES:

- DELINEATORS AND TYPE 3 OBJECT MARKER SHALL BE RETROREFLECTIVE SHEETING ON 0.080" THICK ALUMINUM SHEET OR 14 GAGE GALVANIZED SHEET STEEL.
- DELINEATOR, TYPE 3 OBJECT MARKER AND DISTANCE REFERENCE SIGN POSTS SHALL BE GALVANIZED STEEL. THE POSTS SHALL BE FABRICATED BEFORE THE METAL IS GALVANIZED.
- WEIGHT WITHOUT GROUND PLATES:
 - A. DELINEATOR POST 7'-0" - 2.0 lb/ft TO 2.5 lb/ft
 - B. DELINEATOR MARKER ASSEMBLY 3'-0" - 2.5 lb/ft TO 3.0 lb/ft
 - C. DISTANCE REFERENCE SIGN POST 9'-0" - 11'-0" - 3.0 lb/ft TO 3.5 lb/ft
- UNIT PRICE OF DELINEATORS AND TYPE 3 OBJECT MARKERS SHALL INCLUDE COST OF POST. DISTANCE REFERENCE SIGN POST WILL BE PAID PER FOOT. ROLLED SECTION.
- RADIUS IN BENDS OF POST CROSS SECTION NOT TO EXCEED 3/8" FOR HOT GROUND PLATE NOT REQUIRED ON U-SECTION POST.

DELINEATORS: OBJECT MARKERS D10-1, D10-1A, D10-2, D10-2A, D10-3, D10-3A, D10-4, AND D10-5 ARE MOUNTED TO THIS FACE AS SHOWN.

MOUNTING DETAIL

GENERAL NOTES:

- DELINEATORS AND TYPE 3 OBJECT MARKER SHALL BE RETROREFLECTIVE SHEETING ON 0.080" THICK ALUMINUM SHEET OR 14 GAGE GALVANIZED SHEET STEEL.
- DELINEATOR, TYPE 3 OBJECT MARKER AND DISTANCE REFERENCE SIGN POSTS SHALL BE GALVANIZED STEEL. THE POSTS SHALL BE FABRICATED BEFORE THE METAL IS GALVANIZED.
- WEIGHT WITHOUT GROUND PLATES:
 - A. DELINEATOR POST 7'-0" - 2.0 lb/ft TO 2.5 lb/ft
 - B. DELINEATOR MARKER ASSEMBLY 3'-0" - 2.5 lb/ft TO 3.0 lb/ft
 - C. DISTANCE REFERENCE SIGN POST 9'-0" - 11'-0" - 3.0 lb/ft TO 3.5 lb/ft
- UNIT PRICE OF DELINEATORS AND TYPE 3 OBJECT MARKERS SHALL INCLUDE COST OF POST. DISTANCE REFERENCE SIGN POST WILL BE PAID PER FOOT. ROLLED SECTION.
- RADIUS IN BENDS OF POST CROSS SECTION NOT TO EXCEED 3/8" FOR HOT GROUND PLATE NOT REQUIRED ON U-SECTION POST.

DELINEATORS: OBJECT MARKERS D10-1, D10-1A, D10-2, D10-2A, D10-3, D10-3A, D10-4, AND D10-5 ARE MOUNTED TO THIS FACE AS SHOWN.

MOUNTING DETAIL

GENERAL NOTES:

- DELINEATORS AND TYPE 3 OBJECT MARKER SHALL BE RETROREFLECTIVE SHEETING ON 0.080" THICK ALUMINUM SHEET OR 14 GAGE GALVANIZED SHEET STEEL.
- DELINEATOR, TYPE 3 OBJECT MARKER AND DISTANCE REFERENCE SIGN POSTS SHALL BE GALVANIZED STEEL. THE POSTS SHALL BE FABRICATED BEFORE THE METAL IS GALVANIZED.
- WEIGHT WITHOUT GROUND PLATES:
 - A. DELINEATOR POST 7'-0" - 2.0 lb/ft TO 2.5 lb/ft
 - B. DELINEATOR MARKER ASSEMBLY 3'-0" - 2.5 lb/ft TO 3.0 lb/ft
 - C. DISTANCE REFERENCE SIGN POST 9'-0" - 11'-0" - 3.0 lb/ft TO 3.5 lb/ft
- UNIT PRICE OF DELINEATORS AND TYPE 3 OBJECT MARKERS SHALL INCLUDE COST OF POST. DISTANCE REFERENCE SIGN POST WILL BE PAID PER FOOT. ROLLED SECTION.
- RADIUS IN BENDS OF POST CROSS SECTION NOT TO EXCEED 3/8" FOR HOT GROUND PLATE NOT REQUIRED ON U-SECTION POST.

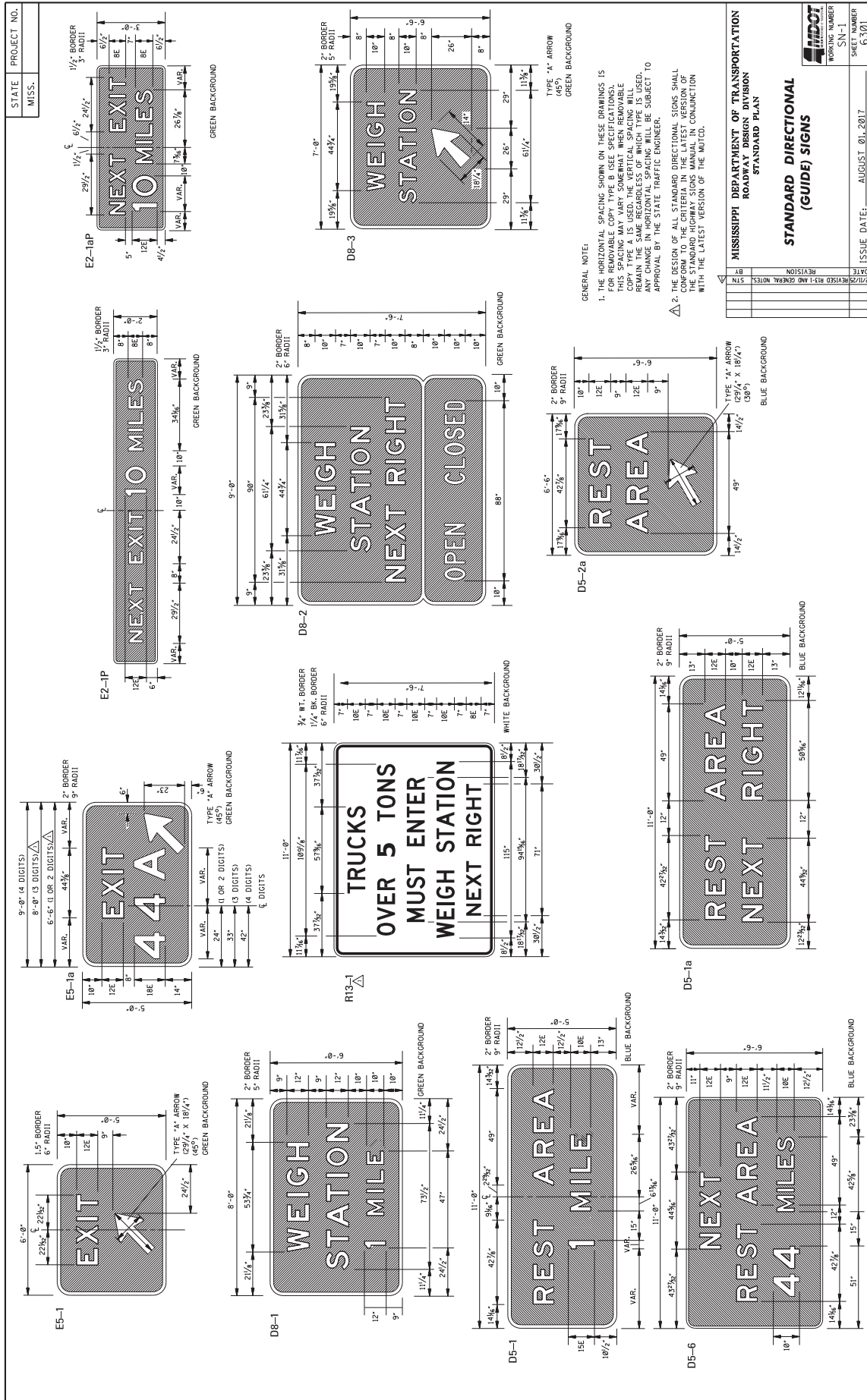

STATE

PROJECT NO.

MISS.

MISS.

GENERAL NOTES:

1. U.S. AND MISSISSIPPI SHIELDS DO NOT HAVE AN OUTSIDE BORDER.
2. INTERSTATE, U.S. AND MISSISSIPPI SHIELDS SHALL BE USED ONLY ON GUIDE SIGNS. SEE OTHER DRAWINGS FOR SHIELDS TO BE USED INDEPENDENTLY AS ROUTE MARKERS.
3. ON INTERSTATE SHIELDS, THE LEGEND AND BACKGROUND SHALL BE RETROREFLECTIVE.
4. ON U.S. AND MISSISSIPPI SHIELDS, THE BACKGROUND SHALL BE RETROREFLECTIVE.
5. IN SOME CASES, NUMERALS CANNOT BE ACCOMMODATED WITHIN THE SHIELD. IN THESE SITUATIONS, THE STANDARD SERIES "D" NUMERALS MAY BE REDUCED TO SERIES "C" NUMERALS OR AS SMALLER HEIGHT COMMONLY AVAILABLE.
6. THE DESIGN OF ALL ROUTE SHIELDS SHALL CONFORM TO THE CRITERIA IN THE LATEST VERSION OF THE MUTCD. THE DESIGN OF ALL "EXIT ONLY" PANELS SHALL CONFORM WITH THE LATEST VERSION OF THE MUTCD.
7. FOR OVERHEAD SIGN INSTALLATIONS USE M-1.

M1-1A

12" NUMERALS	18" NUMERALS	24" NUMERALS	24" NUMERALS
2 DIGITS	3 DIGITS	2 DIGITS	3 DIGITS
A 24"	30"	36"	45"
B 24"	24"	36"	48"
C 15"	17"	25 1/2"	30"
D 5"	5"	7 1/2"	10"
E 5"	5"	7 1/2"	10"
F 1/2"	2 1/4"	3 1/4"	4 1/4"
G 1/2"	2 1/4"	3 1/4"	4 1/4"
H 100	100	150	200
I 100	100	150	200
J 100	100	150	200
K 100	100	150	200
L 100	100	150	200
M 100	100	150	200
N 15 3/4"	21 3/8"	24 1/2"	34 3/8"
O 10 3/4"	15 3/8"	16 1/4"	21 1/2"

M1-4

12" NUMERALS	18" NUMERALS	24" NUMERALS	24" NUMERALS
2 DIGITS	3 DIGITS	2 DIGITS	3 DIGITS
A 24"	30"	36"	45"
B 24"	30"	36"	45"
C 5"	5"	7 1/2"	10"
D 7"	10"	10 1/2"	14"
E 5"	5"	7 1/2"	10"
F 2"	2"	3"	4"
G 2"	2"	3"	4"
H 1"	4"	1 1/2"	2"
I 9 1/2"	9 1/2"	8 1/2"	11"
J 12"	12"	18"	24"
K 6 1/2"	6 1/2"	9 3/4"	13"

M1-5

DIMENSIONS (INCHES)				
A	B	C	D	E
12-DIGITS	24"	30"	36"	45"
12-DIGITS	36"	36"	36"	36"
12-DIGITS	48"	48"	48"	48"
3-DIGITS	30"	24"	6"	12"
3-DIGITS	45"	36"	9"	18"
3-DIGITS	60"	48"	12"	24"
3-DIGITS	60"	48"	12"	24"

GENERAL NOTES:

1. THESE ARE OVERHEAD SIGNS FABRICATED ON 8 MIL THICK SIGN SHEET. THESE SIGNS SHALL BE SET TO CORRECTIONAL PAID FOR AS SEPARATE SIGNS BUT SHALL BE CONSIDERED AS PART OF THE MAJOR SIGNS TO WHICH THEY ARE AFFIXED.
2. LETTER SIZE: 12" SERIES "D" COLOR: LEGEND - BLACK; BACKGROUND - HI-INTENSITY YELLOW (RETROREFLECTIVE TYPE AS SPECIFIED IN THE PLANS)
3. THE DESIGN OF ALL "EXIT ONLY" PANELS SHALL CONFORM TO THE CRITERIA IN THE LATEST VERSION OF THE MUTCD. THE DESIGN OF ALL "EXIT ONLY" PANELS SHALL CONFORM WITH THE LATEST VERSION OF THE MUTCD.

E11-1a

E11-1b

E11-1c

MISSISSIPPI DEPARTMENT OF TRANSPORTATION
ROADWAY DESIGN DIVISION
STANDARD PLAN

ROUTE SHIELDS AND "EXIT ONLY" PANELS

DATE

REVISION

REVISED TEXT AND DETAILS

SYMBOL

ISSUE DATE: AUGUST 01, 2017
SHEET NUMBER: SN-2
TOTAL SHEETS: 6302

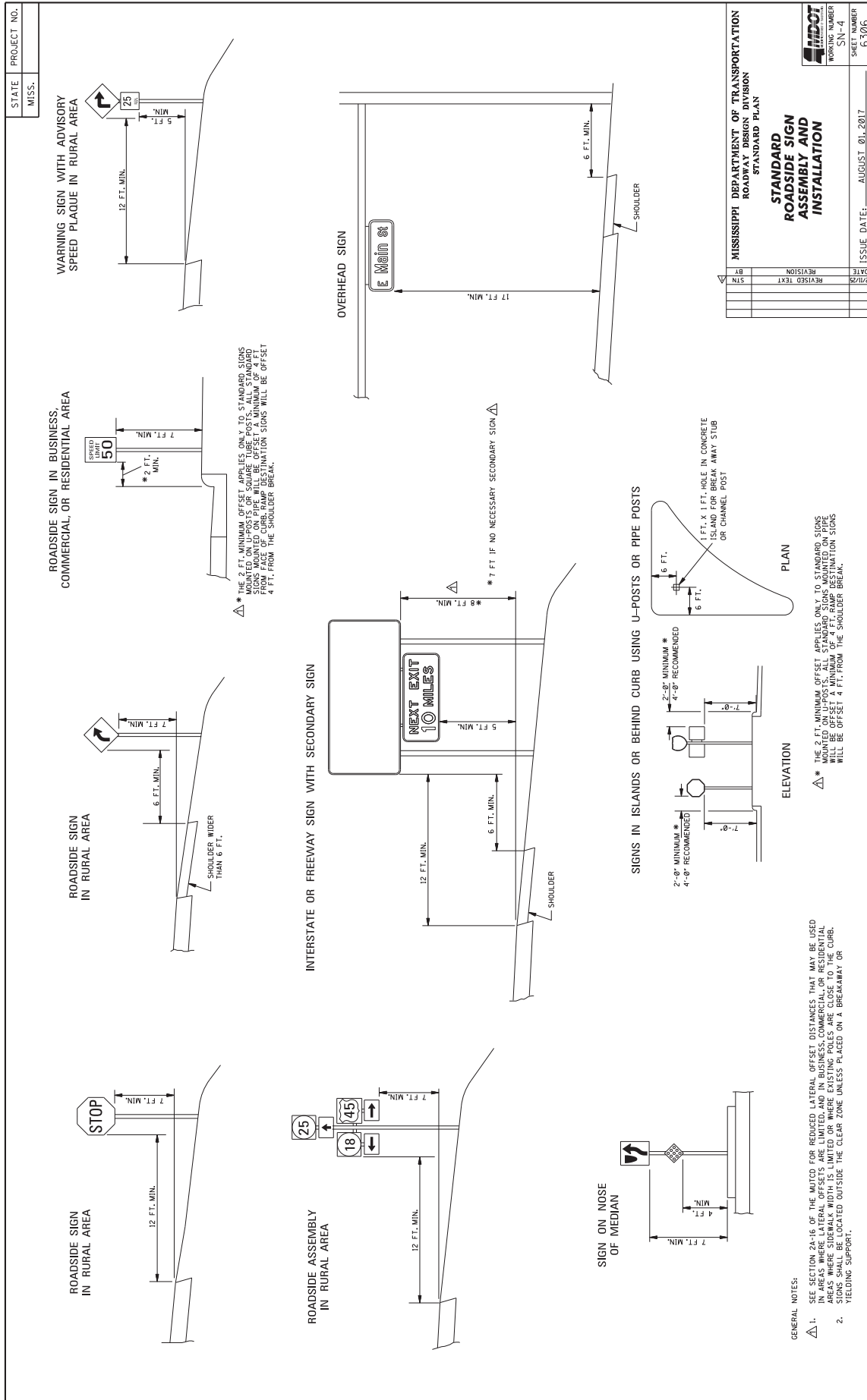

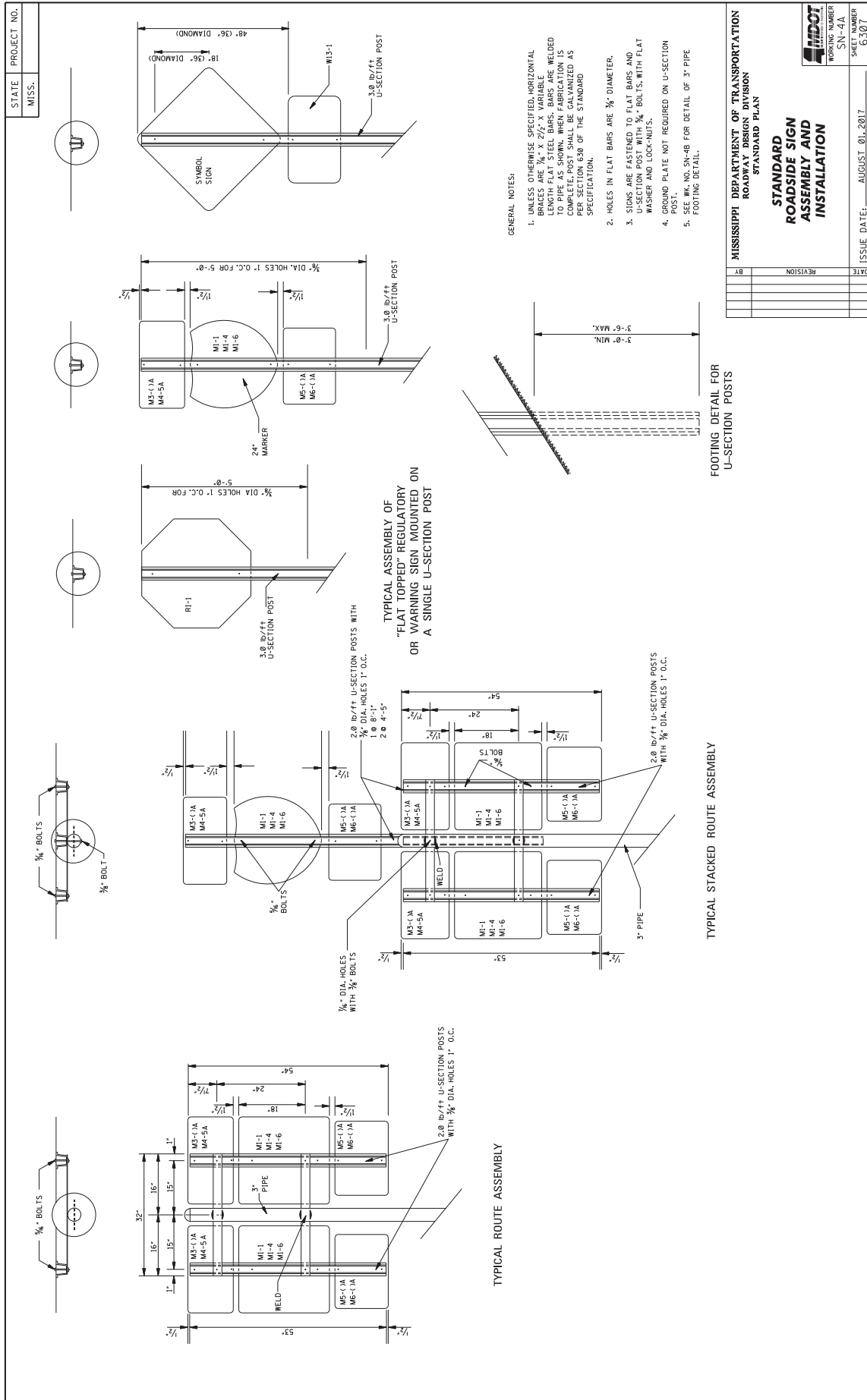

STATE PROJECT NO.
MISS.

MISSISSIPPI DEPARTMENT OF TRANSPORTATION ROADWAY DESIGN DIVISION STANDARD PLAN	
STANDARD ROADSIDE SIGN ASSEMBLY AND INSTALLATION	
WORKING NUMBER SN-4/A	SHEET NUMBER G307
DATE AUGUST 01, 2017	ISSUE DATE
REVISION	BR

- GENERAL NOTES:
- UNLESS OTHERWISE SPECIFIED, HORIZONTAL BRACES ARE 1/4" X 2 1/2" X VARIABLE LENGTH FLAT STEEL BARS. BARS ARE WELDED TO U-SECTION POSTS. COMPLETE POST SHALL BE GALVANIZED AS PER SECTION 630 OF THE STANDARD SPECIFICATION.
 - HOLES IN FLAT BARS ARE 3/8" DIAMETER.
 - SIGNS ARE FASTENED TO FLAT BARS AND U-SECTION POST WITH 3/8" BOLTS WITH FLAT WASHER AND LOCK-NUTS.
 - GROUND PLATE NOT REQUIRED ON U-SECTION POST.
 - SEE WK. NO. SN-4B FOR DETAIL OF 3" PIPE FOOTING DETAIL.

TYPICAL ASSEMBLY OF
"FLAT TOPPED" REGULATORY
OR WARNING SIGN MOUNTED ON
A SINGLE U-SECTION POST

FOOTING DETAIL FOR
U-SECTION POSTS

TYPICAL STACKED ROUTE ASSEMBLY

TYPICAL ROUTE ASSEMBLY

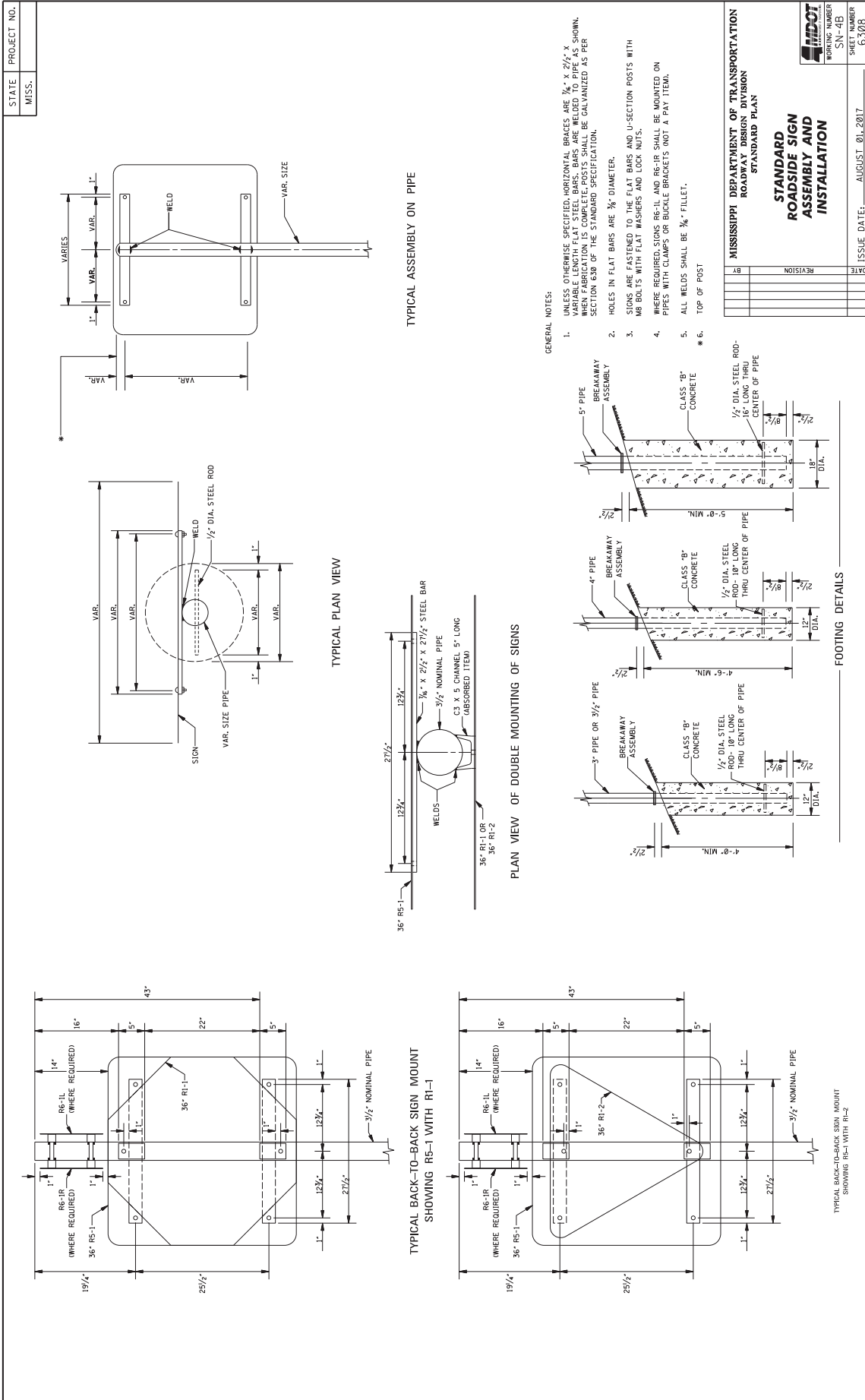

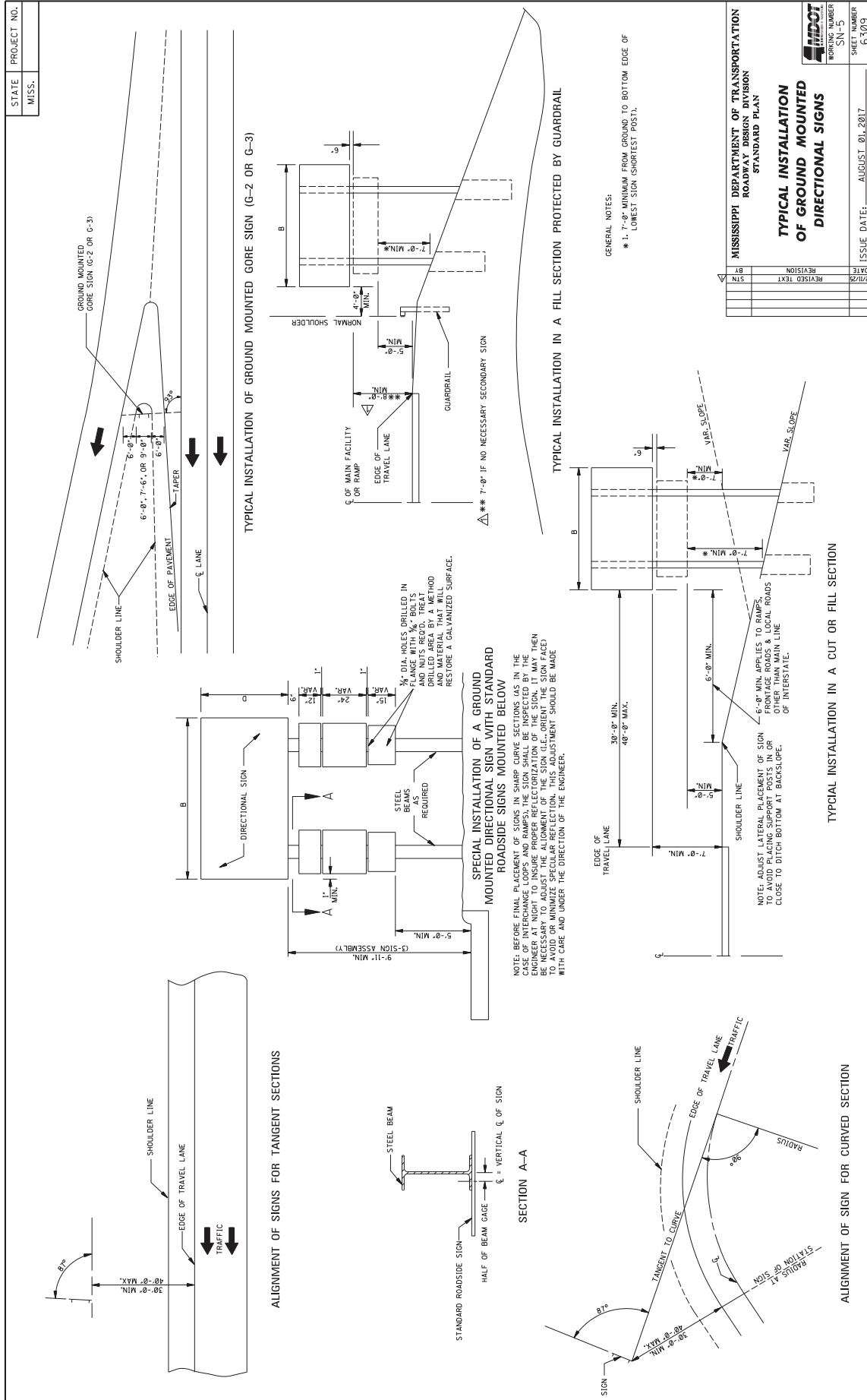

STATE	PROJECT NO.
MISS.	

GENERAL NOTES FOR WORKING SHEETS SN-6, SN-6A AND SN-6B:

1. EROZING: ALL FOOTINGS SHALL BE CLASS 'B' CONCRETE. POST STUDS SHALL BE SET IN CONCRETE FOOTING AT REQUIRED GRADE AND ALIGNMENT WITH CARE SO THAT MINIMUM SHIMMING WILL BE REQUIRED.
2. BASE CONNECTION PROCEDURE: ASSEMBLE POST TO STUD WITH BOLTS AND WITH A FLAT WASHER ON EACH BOLT BETWEEN PLATES. SHIM AS REQUIRED TO PLUMB POST. TIGHTEN ALL BOLTS TO THE MAXIMUM POSSIBLE WITH A 12" TO 15" WRENCH TO BEB WASHERS AND SHIMS AND TO CLEAN BOLT THREADS. THEN LOOSEN EACH BOLT TO 1/2 TURN. REPEAT THIS PROCEDURE FOR ALL BOLTS. BRACE AND TIGHTEN BOLTS BY TABLE. BURR THREADS AT JUNCTION WITH NUT USING A CENTER PUNCH. HIGH STRENGTH BOLTS IN BASE CONNECTIONS SHALL BE TIGHTENED TO TORQUE AS SHOWN BY TABLE ON SN-6A. DO NOT OVER TIGHTEN.
3. POST LENGTH: ALL POST LENGTHS SHALL BE VERIFIED AND APPROVED BY THE ENGINEER PRIOR TO FABRICATION. WHERE FIELD CONDITIONS REQUIRE THE POST LENGTH TO VARY MORE THAN 12", IT MAY BE NECESSARY TO CHANGE THE SIZE OR NUMBER OF POSTS. SUCH DETERMINATION WILL BE MADE BY THE STATE TRAFFIC ENGINEER. ANY CHANGE OF SIZE OR NUMBER OF POSTS SHALL NOT BE JUSTIFICATION FOR ANY CONTRACT PRICE ADJUSTMENTS.
4. FABRICATOR NOTE: IMPORTANT - ALL FRICTION FUSE BOLTS SHALL BE TIGHTENED IN SHOP BY A METHOD APPROVED BY THE BRIDGE DESIGN ENGINEER. TIGHTENING SHALL BE TO SUCH A DEGREE AS TO PROVIDE THE MINIMUM TENSION IN EACH BOLT WHEN ALL BOLTS ARE TIGHT, AS SHOWN BY TABLE SN-6A.
5. ALL HOLES IN FUSE PLATES AND HINGE PLATES SHALL BE DRILLED.
6. ALL PLATE CUTS SHOULD BE SAW CUTS. FLAME CUTTING WILL BE PERMITTED PROVIDED ALL EDGES ARE GROUND, METAL PROJECTING BEYOND THE PLANE OF THE PLATE FACE WILL NOT BE ACCEPTABLE.
7. WELDING FOR STEEL SIGN SUPPORTS: WELDING SHALL BE PERFORMED IN SHOP BY ELECTRIC ARC PROCESS.
8. MATERIAL SPECIFICATIONS: THE MATERIALS USED IN THE CONSTRUCTION OF THE GROUND MOUNTED SIGN SUPPORT STRUCTURES, AS LISTED BELOW, SHALL CONFORM WITH THE REQUIREMENTS OF THE DESIGNATED ASTM SPECIFICATION. ALL OTHER MATERIALS, FABRICATION AND ERECTION SHALL BE IN ACCORDANCE WITH THE REQUIREMENTS OF THE SPECIFICATIONS, EXCEPT AS OTHERWISE NOTED ON THE PLANS.

TYPICAL 2-POST INSTALLATION WITHOUT EXIT SIGN

TYPICAL 2 OR 3 POST INSTALLATION WITH SUPPLEMENTARY GUIDE SIGN AND POST BRACING ANGLE LOCATION

* NOTES: PLACE POST BRACING ANGLE AT BOTTOM OF PRIMARY OR SUPPLEMENTARY SIGN WHICHEVER IS LOWER. (SEE 'END ELEVATION OF POST AND FOOTING' ON SN-6A.)

2 POST		2 POST (CONT'D)		3 POST	
B'	C'	B'	C'	B'	C'
4'-6"	1'-0"	14'-0"	8'-0"	20'-0"	14'-0"
4'-6"	2'-6"	15'-0"	9'-0"	20'-0"	14'-3"
5'-0"	3'-0"	15'-6"	9'-3"	21'-0"	14'-9"
5'-6"	3'-6"	16'-0"	9'-6"	21'-6"	15'-0"
6'-0"	4'-0"	16'-6"	10'-0"	22'-0"	15'-6"
7'-0"	5'-0"	17'-6"	10'-6"	23'-0"	16'-0"
7'-6"	5'-6"	18'-0"	10'-9"	23'-6"	16'-6"
8'-0"	6'-0"	18'-6"	11'-0"	24'-0"	16'-9"
8'-6"	6'-6"	19'-0"	11'-6"	24'-6"	17'-3"
9'-0"	7'-0"	19'-6"	12'-0"	25'-0"	17'-6"
10'-0"	7'-0"	20'-6"	12'-3"	26'-0"	18'-3"
10'-6"	7'-6"	21'-0"	12'-6"	26'-6"	18'-6"
11'-0"	7'-0"	21'-6"	13'-0"	27'-0"	19'-0"
11'-6"	7'-6"	22'-0"	13'-3"	27'-6"	19'-3"
12'-0"	7'-6"	22'-6"	13'-6"	28'-0"	19'-6"
12'-6"	7'-6"	23'-0"	13'-9"	28'-6"	20'-0"
13'-0"	7'-9"	23'-6"	14'-0"	29'-0"	20'-3"
13'-6"	8'-0"	24'-0"	14'-6"	29'-6"	20'-6"
14'-0"	8'-6"	24'-6"	15'-0"	30'-0"	21'-0"

DESCRIPTION	MATERIALS PER ASTM DESIGNATION	MATERIALS PER ASTM DESIGNATION	GALVANIZE
POSTS OF STEEL PIPE	A 53 GRADE 'B' (1)	A 53 GRADE 'B' (1)	A 123
BASE CONNECTION PLATES FOR PIPES	A 36	A 36	A 123
POSTS OF STEEL W, B, AND T BEAMS INCLUDING BASE CONNECTION, FUSE AND HINGE PLATES AND FLAT BARS USED IN FABRICATION AND ERECTION OF SIGN SUPPORTS	A 588 OR A 572 GRADE 58	A 572 GRADE 58	A 123
HIGH STRENGTH BOLTS, NUTS AND WASHERS	A 36	A 36	A 123
BOLTS OTHER THAN HIGH STRENGTH	A 307 GRADE 'A'	A 307 GRADE 'A'	A 153

① ALL STEEL SHALL BE GALVANIZED AFTER FABRICATION EXCEPT AS NOTED ON THE PLANS.
 ② PIPES MAY BE WELDED OR SEAMLESS.
 ③ BOLTS, WASHERS, AND NUTS USED FOR FASTENING ALUMINUM SIGN SHEETS AND PANELS SHALL BE ALUMINUM AS PER FOLLOWING TABLE.

DESCRIPTION	ASTM DESIGNATION	ALLOY
BOLTS AND WASHERS	B 208	2024-T4
PANEL BOLT NUTS	B 211	6061-T6
STOP NUTS	B 211	2017-T4

MISSISSIPPI DEPARTMENT OF TRANSPORTATION
 ROADWAY DESIGN DIVISION
 STANDARD PLAN

**BREAKAWAY
 SIGN SUPPORTS**

ISSUE DATE:	AUGUST 01, 2017
WORKING NUMBER	SN-6
SHEET NUMBER	6310

STATE PROJECT NO.
MISS.

GENERAL NOTES (SEE WK. NO. SN-6 FOR ADDITIONAL GENERAL NOTES)

- THE TOP PLATE OF THE TRIANGULAR SLIP BASE SHALL BE THE SAME EXTERIOR DIMENSIONS AS THE BOTTOM PLATE. THE LIFTING CONE SHALL BE WELDED TO THE BOTTOM PLATE ONLY. A HOLE EQUAL TO THE INSIDE DIAMETER OF THE SIGN POST SHALL BE CUT THROUGH THE CENTER OF THE TOP PLATE WITH THE HOLE EDGE BEveled AS DETAIL. TOP & BOTTOM PLATES SHALL BE SYMMETRICAL FOR THE PURPOSE OF ASSEMBLY IN ANY POSITION.
- BASE CONNECTION ASSEMBLY AS FOLLOWS:
 - ASSEMBLE POST TO STUB WITH 3 BOLTS AND WITH 3 FLAT WASHERS PER BOLT.
 - SHIM AS REQUIRED TO PLUMB POST.
 - TIGHTEN ALL BOLTS THE MAXIMUM POSSIBLE WITH A 12" TO 18" TORQUE. USE BRASS KEPTER PLATE, SHIMS AND TO CLEAN THREADS.
 - LOOSEN EACH BOLT IN TURN & RETIGHTEN IN A SYSTEMATIC ORDER TO PRESCRIBED TORQUE. (SEE BASE CONNECTION DETAIL)
 - BURR THREADS AT JUNCTION WITH NUT WITH A CENTER PUNCH TO PREVENT NUT FROM LOOSENING.
- FRICION CAPS TO BE MANUFACTURED FROM HOT ROLLED OR ROLLED SHEET METAL. THE MINIMUM THICKNESS SHALL BE 20 GAUGE SHEET METAL. RIM EDGES SHALL BE REASONABLY STRAIGHT AND SMOOTH. CAPS SHALL BE SIZED AND FORMED IN SUCH A MANNER AS TO PROVIDE A PROTECTIVE PROTECTION AGAINST ENTRANCE OF RAINWATER. CAPS SHALL BE FREE OF SHARP EDGES OR INDEENTATIONS AND THE FINISH SHALL BE THE SAME AS THE POST. CAPS SHALL BE SAME IN SHAPE AND GENERAL APPEARANCE AS APPROVED BY THE ENGINEER.
- STUB PROJECTION SHOULD BE MEASURED OVER A 5'-0" CHORD AS PER AASHTO LRFD SPECIFICATIONS FOR STRUCTURAL SIGNALLS, LATEST EDITION. SEE WK. NO. SN-6 FOR DIAGRAM.
- AS AN ALTERNATIVE THE POST LENGTH OF THE SIGN POST CAN BE MADE UP USING A NOMINAL LENGTH OF GALVANIZED PIPE. APPROVED EQUAL WITH ALL NECESSARY HARDWARE REQUIRED TO SECURE THEM TO THE SIGN POST. A GALVANIZED KEPTER PLATE AND A GALVANIZED FRICION CAP SHALL BE USED TO FASTEN THE SIGN AND ONE SET SCREW TO PREVENT ROTATION. THE MANUFACTURER SHALL PROVIDE SHOP DRAWINGS OF THE COMPLETE ASSEMBLY FOR MDOT APPROVAL.

FRICION CAP DETAIL
NOTE: SEE NOTE 3

SHIM DETAIL
NOTE: DIMENSION 2 @ 0.015" - THICK AND 2 @ 0.025" - THICK SHIMS PER POST SHIM SHALL BE FABRICATED FROM BRASS SHIM STOCK OR STRIP CONFORMING TO ASTM B 36.

POST ELEVATION

MULTI-DIRECTIONAL SIGN POST & STUB POST

U.S. HEX. BOLT DIMENSIONS SEE TABLE FOR SIZE. 3 WASHERS ALSO REQUIRED PER BOLT.

BOLT KEPTER PLATE DETAIL

NOTE: TO BE FABRICATED FROM 28 G. USE GALVANIZED STEEL. TO BE WELDED AS SHOWN IN DETAIL AT UPPER LEFT.

SECTION A-A

NOTE: SEE DATA TABLE FOR DIMENSIONS

BASE CONNECTION DATA TABLE

DIMENSIONS	BOLT TORQUE	T	W	C	D	E	F	G	H	J	K	L	M	N	P	S	U	V	R
PIPE SIZES	3/4" x 2 1/2"	3/8"	3/8"	1"	10 3/8"	2 3/8"	1/2"	1 3/4"	3/2"	1 3/4"	3/2"	1 3/4"	1 1/2"	2 3/8"	6"	9"	2"	4 1/4"	1 1/2"
PIPE SIZES	3/2" x 3"	3/8"	3/8"	1"	10 3/8"	2 3/8"	1/2"	1 3/4"	3/2"	1 3/4"	3/2"	1 3/4"	1 1/2"	2 3/8"	6"	9"	2"	4 1/4"	1 1/2"
PIPE SIZES	4" x 5"	3/8"	3/8"	1"	10 3/8"	2 3/8"	1/2"	1 3/4"	3/2"	1 3/4"	3/2"	1 3/4"	1 1/2"	2 3/8"	6"	9"	2"	4 1/4"	1 1/2"

* NOTE: APPROXIMATE DIMENSIONS

MISSISSIPPI DEPARTMENT OF TRANSPORTATION
ROADWAY DESIGN DIVISION
STANDARD PLAN

BREAKAWAY
SIGN SUPPORTS

ISSUE DATE: AUGUST 01, 2017
SHEET NUMBER: 6312

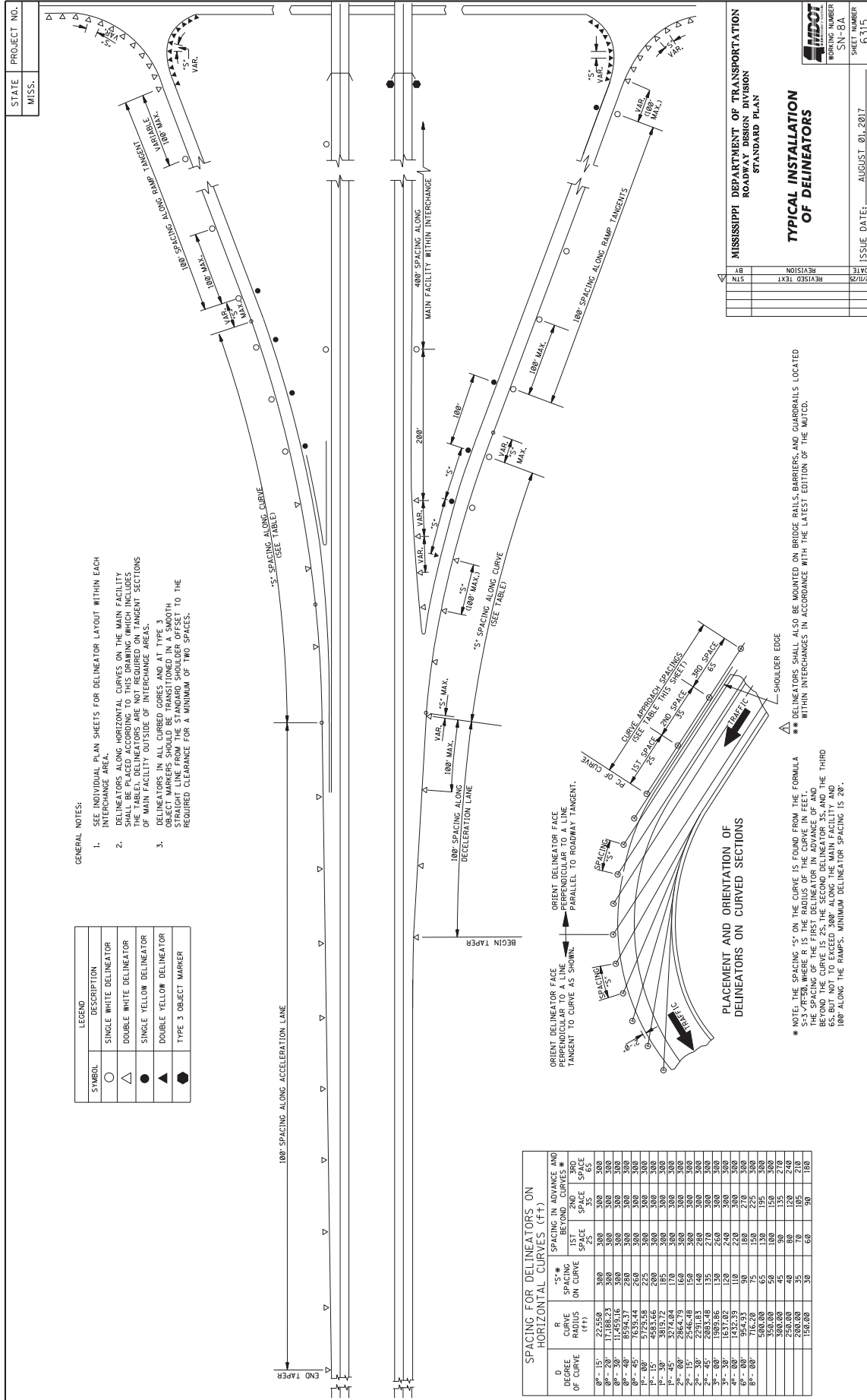

MISSISSIPPI DEPARTMENT OF TRANSPORTATION
ROADWAY DESIGN DIVISION
STANDARD PLAN

TYPICAL INSTALLATION OF DELINEATORS

DATE	REVISION	BY	CHK'D
	REVISED TEXT		

ISSUE DATE: AUGUST 01, 2017
SHEET NUMBER: SN-8A
6315

STATE	PROJECT NO.
MISS.	

GRAPHIC SHOWING SPACINGS OF GUARDRAIL DELINEATORS AT SOME COMMONLY USED BRIDGE APPROACHES

EMBANKMENT OR ROADSIDE OBSTACLE INSTALLATION—LENGTH GREATER THAN 250'
(ONE-WAY TRAFFIC)

EMBANKMENT OR ROADSIDE OBSTACLE INSTALLATION—LENGTH GREATER THAN 250'
(TWO-WAY TRAFFIC)

ROADSIDE OBSTACLE INSTALLATION—LENGTH 250' OR LESS
(ONE-WAY TRAFFIC)

ROADSIDE OBSTACLE INSTALLATION—LENGTH 250' OR LESS
(TWO-WAY TRAFFIC)

BRIDGE APPROACH INSTALLATION
(TWO-WAY TRAFFIC)

BRIDGE APPROACH INSTALLATION
(ONE-WAY TRAFFIC)

DETAIL OF FLEXIBLE GUARDRAIL DELINEATOR

TYPICAL FLEXIBLE POST DELINEATOR GUARDRAIL INSTALLATION

PLAN VIEWS

TYPICAL FLEXIBLE POST DELINEATOR GUARDRAIL INSTALLATION

GENERAL NOTES:

1. THE UNIT PRICE OF DELINEATOR INCLUDES COSTS OF DELINEATOR FACE(S), POST, HARDWARE AND INSTALLATION.
2. DELINEATORS SHALL CONSIST OF RETROREFLECTIVE DEVICES THAT ARE CAPABLE OF CLEARLY RETROREFLECTING LIGHT UNDER NORMAL ATMOSPHERIC CONDITIONS FROM A DISTANCE OF 1000 FEET WHEN ILLUMINATED BY THE HIGH BEAMS OF STANDARD AUTOMOBILE LIGHTS.
3. FOR THE SPACING OF DELINEATORS IN HORIZONTAL CURVES ON ROADWAYS OR BRIDGES, SEE TABLE 30-1, MUTCD 11th EDITION, FOR SPACING REQUIREMENTS.
4. DELINEATORS FOR GUARDRAIL SHALL BE MOUNTED ON FLEXIBLE POSTS AS FOLLOWS:
THE DELINEATOR POSTS WILL BE FROM MOOT'S "APPROVED PRODUCTS LIST" AND WILL BE FASTENED TO GUARDRAIL POST IN ACCORDANCE WITH THE MANUFACTURER'S RECOMMENDATION.

NOTE: ONE-WAY TRAFFIC
ONE-WAY TRAFFIC DELINEATOR SPACING FOR TWO-WAY TRAFFIC SIMILAR. DELINEATOR COLOR WILL BE THE SAME AS THE ADJACENT PAVEMENT EDGE MARKING. THE FIRST THREE (3) MARKERS WILL FACE TRAFFIC IN OFF LANE FOR TWO-WAY TRAFFIC AS SHOWN IN DRAWING FOR OBSTACLE INSTALLATION FOR TWO-WAY TRAFFIC.

MISSISSIPPI DEPARTMENT OF TRANSPORTATION
ROADWAY DESIGN DIVISION
STANDARD PLAN

TYPICAL GUARDRAIL DELINEATION

DATE	REVISION
BY	REVISED TEXT
DATE	BY
DATE	BY
DATE	BY

ISSUE DATE: AUGUST 01, 2017
SHEET NUMBER SN-8C
WORKING NUMBER 6317

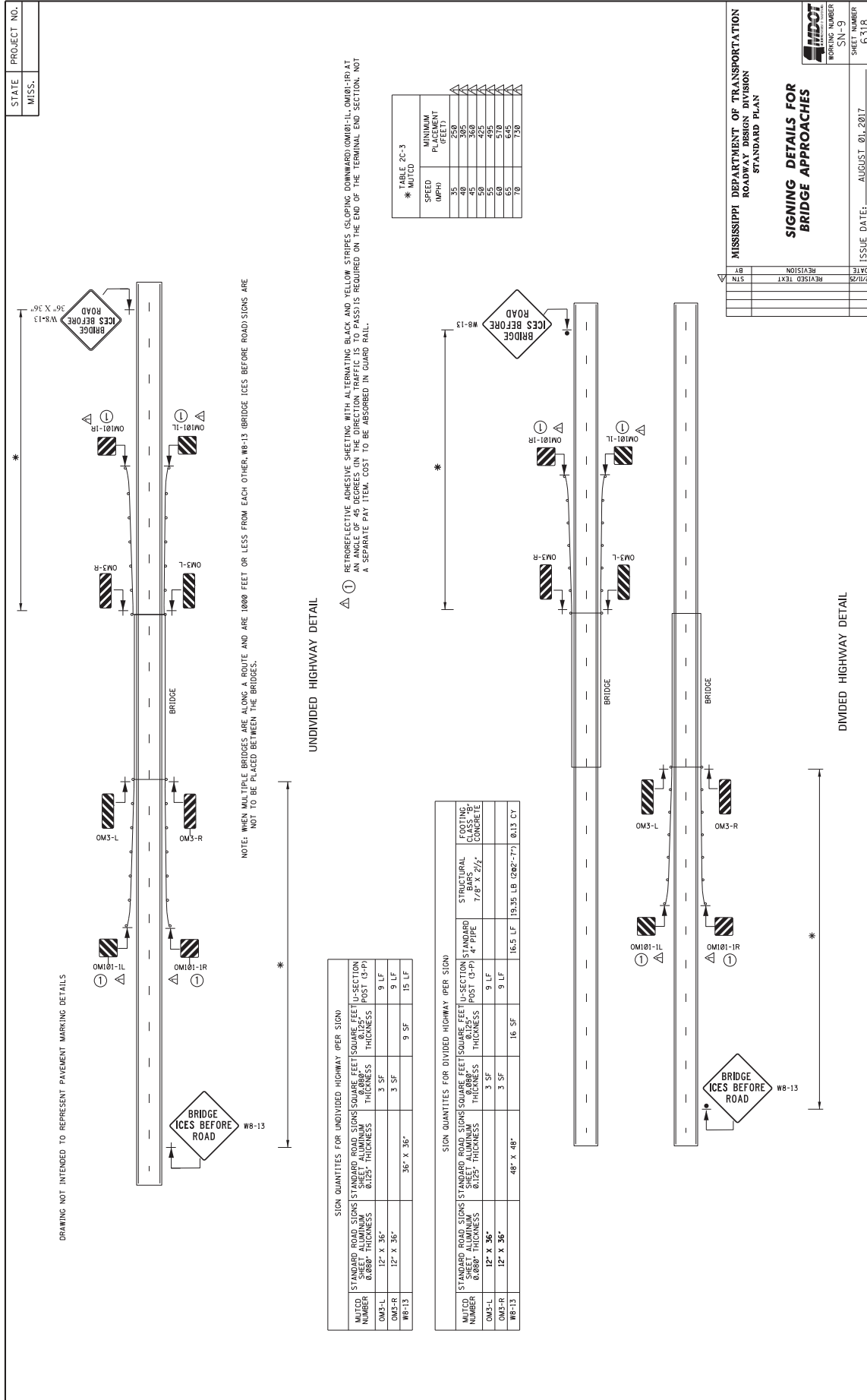

MISSISSIPPI DEPARTMENT OF TRANSPORTATION

SECTION 904 – NOTICE TO BIDDERS NO. 7624

CODE: (SP)

DATE: 01/20/2026

SUBJECT: Standard Drawings

Standard Drawings attached hereto shall govern appropriate items of required work.

Larger copies of Standard Drawings may be purchased from:

MDOT Plans Print Shop
MDOT Shop Complex, Building C, Room 114
2567 North West Street
P.O. Box 1850
Jackson, MS 39215-1850
Telephone: (601) 359-7460
or FAX: (601) 359-7461
or e-mail: plans@mdot.state.ms.us

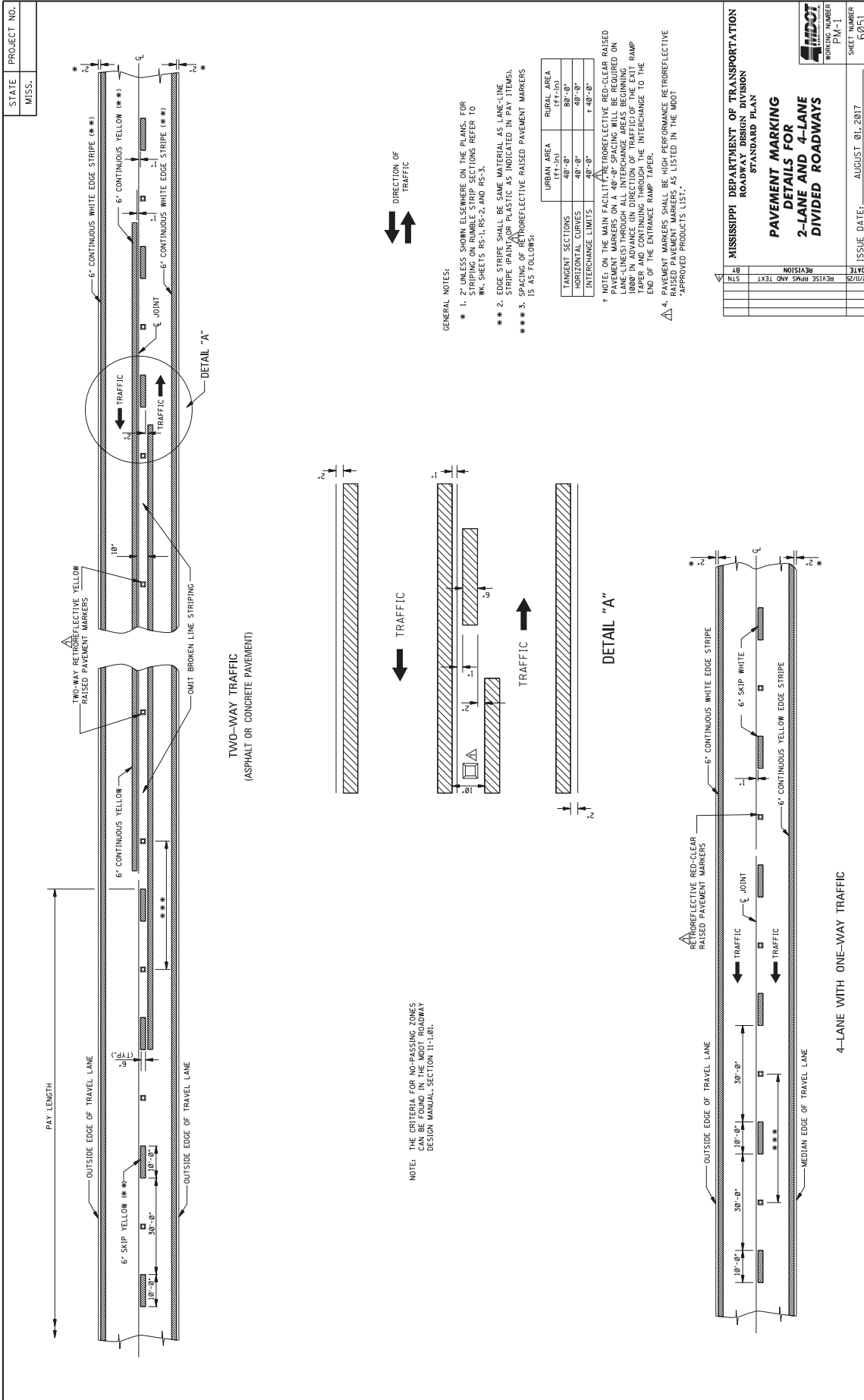

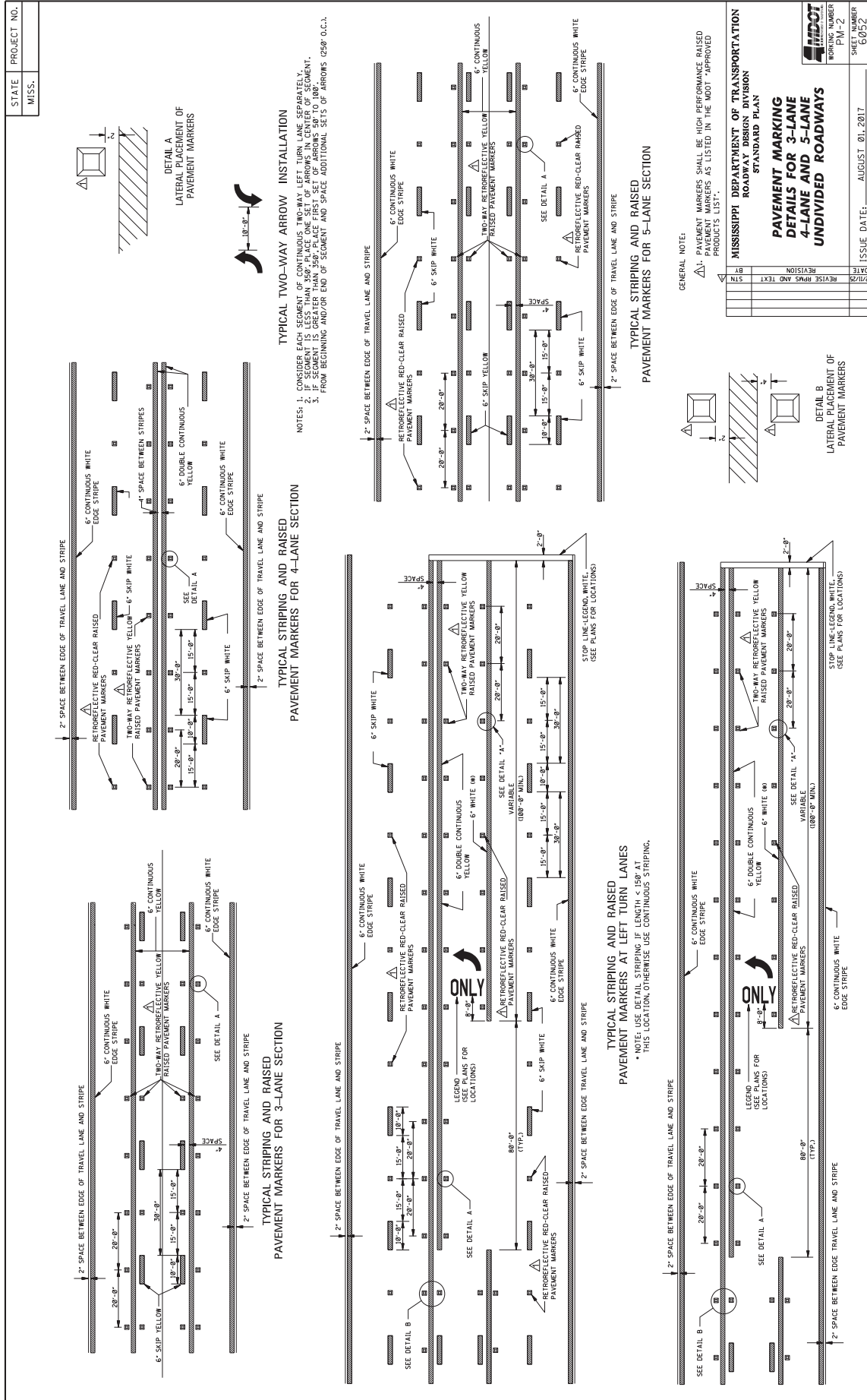

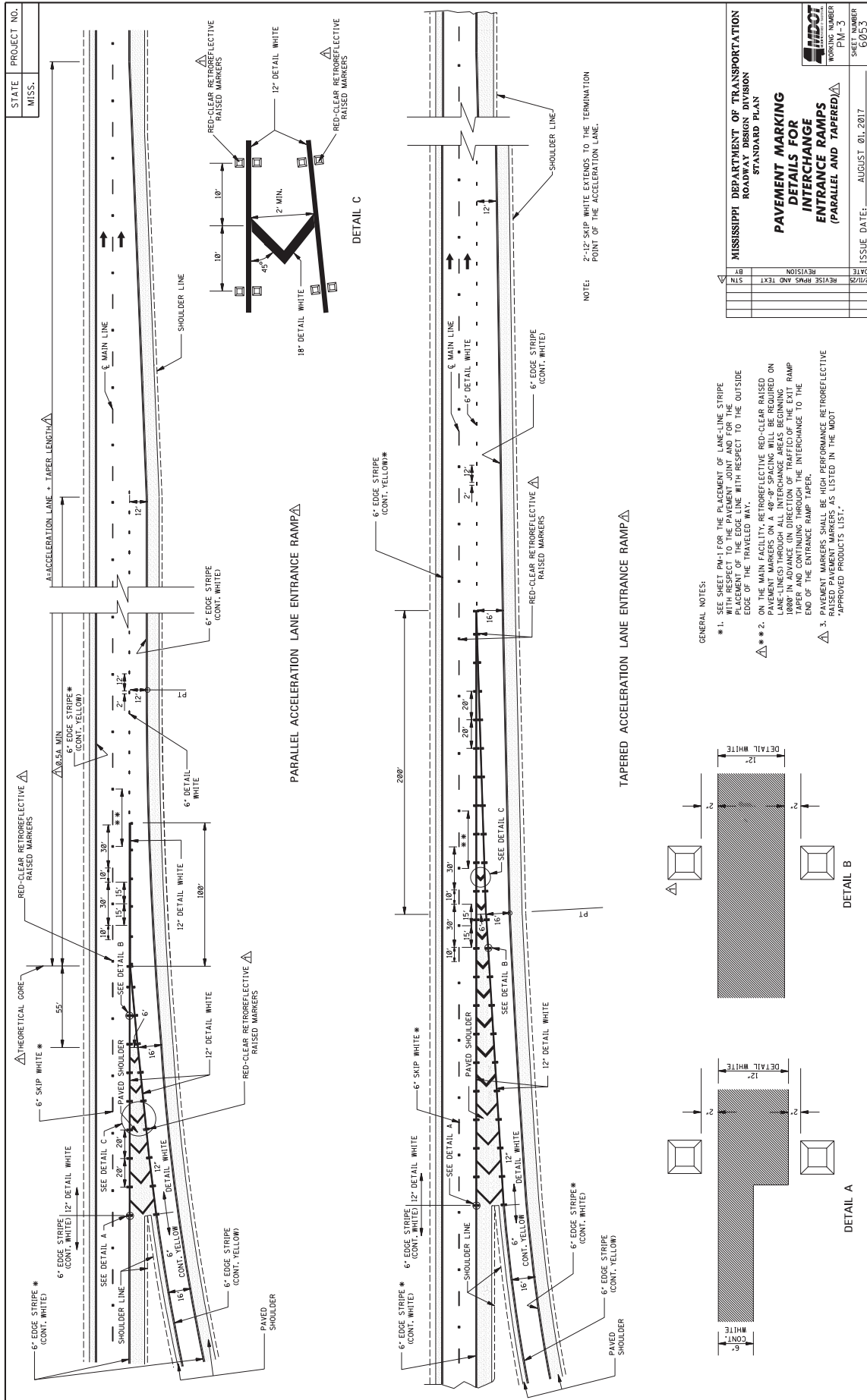

STATE PROJECT NO.
MISS.

DATE	REVISION	BY

MISSISSIPPI DEPARTMENT OF TRANSPORTATION
ROADWAY DESIGN DIVISION
STANDARD PLAN
**PAVEMENT MARKING
DETAILS FOR
INTERCHANGE RAMP
(PARALLEL AND TAPERED)**

ISSUE DATE: AUGUST 01, 2017
SHEET NUMBER: PW-3
WORKING NUMBER: 0033

- GENERAL NOTES:
- # 1. SEE SHEET PW1 FOR THE PLACEMENT OF LANE-LINE STRIPE WITH RESPECT TO THE PAVEMENT JOINT AND FOR THE PLACEMENT OF THE EDGE LINE WITH RESPECT TO THE EDGE OF THE TRAVELED WAY.
 - # 2. ON THE MAIN FACILITY, RETROREFLECTIVE RED-CLEAR RAISED PAVEMENT MARKERS ON A 40'-0" SPACING WILL BE REQUIRED ON 1000' IN ADVANCE IN DIRECTION OF TRAFFIC OF THE EXIT RAMP TAPER AND CONTINUING THROUGH THE INTERCHANGE TO THE END OF THE ENTRANCE RAMP TAPER.
 - # 3. PAVEMENT MARKERS SHALL BE HIGH PERFORMANCE RETROREFLECTIVE RAISED PAVEMENT MARKERS AS LISTED IN THE MDT "APPROVED PRODUCTS LIST".

NOTE: 2'-0" SKIP WHITE EXTENDS TO THE TERMINATION POINT OF THE ACCELERATION LANE.

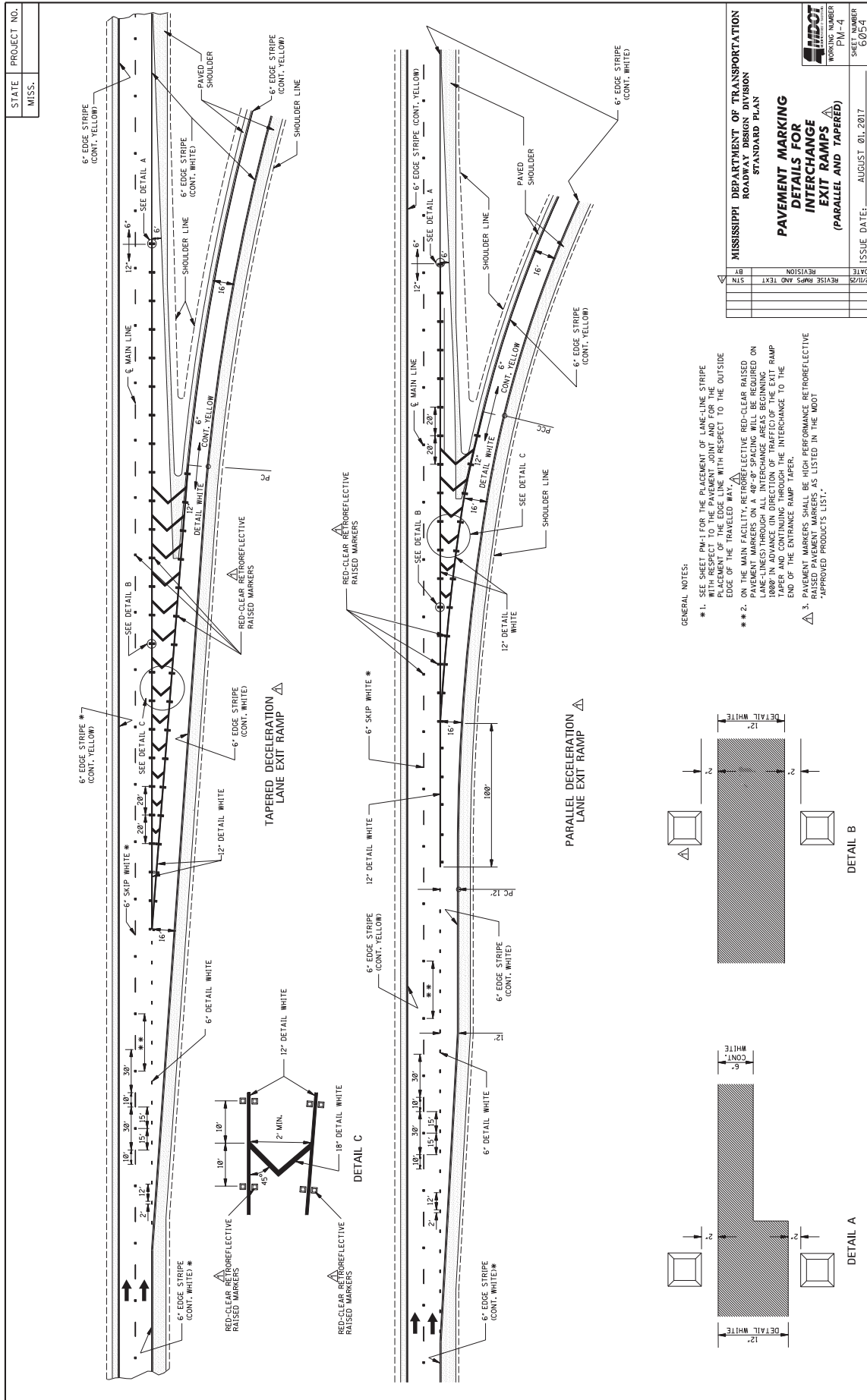

- GENERAL NOTES:
- * 1. SEE SHEET PM-1 FOR THE PLACEMENT OF LANE-LINE STRIPE WITH RESPECT TO THE PAVEMENT JOINT AND FOR THE PLACEMENT OF THE EDGE LINE WITH RESPECT TO THE OUTSIDE EDGE OF THE PAVED SHOULDER.
 - ** 2. FOR THE TAPERED EXIT RAMP, RED-CLEAR RAISED PAVEMENT MARKERS ON K-40-90 SPACING WILL BE REQUIRED ON LANE-LINES THROUGH ALL INTERCHANGE AREAS BEGINNING 1000' IN ADVANCE IN DIRECTION OF TRAFFIC OF THE EXIT RAMP TAPER AND CONTINUING THROUGH THE INTERCHANGE TO THE END OF THE ENTRANCE RAMP TAPER.
 - △ 3. PAVED PAVEMENT MARKERS SHALL BE HIGH PERFORMANCE RETROREFLECTIVE *APPROVED PRODUCTS LIST*.

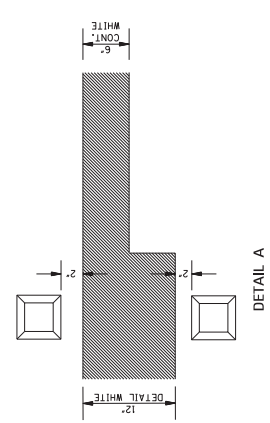
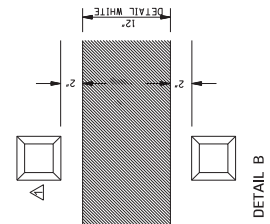

STATE PROJECT NO.		MISS.	
DATE		REVISION	
BY	DATE	BY	DATE
DRAWN		CHECKED	
DESIGNED		APPROVED	

MISSISSIPPI DEPARTMENT OF TRANSPORTATION
 ROADWAY DESIGN DIVISION
 STANDARD PLAN

**PAVEMENT MARKING
 DETAILS FOR
 INTERCHANGE
 EXIT RAMP
 (PARALLEL AND TAPERED)**

ISSUE DATE: AUGUST 01, 2017
 SHEET NUMBER: PM-4
 WORKING NUMBER: 6034

STATE MISS.	PROJECT NO.				
----------------	-------------	--	--	--	--

STOP

8'-4" (width) x 6'-4" (height)

RIGHT

8'-4" (width) x 7'-8" (height)

LEFT

8'-4" (width) x 6'-4" (height)

TRAFFIC

8'-4" (width) x 6'-4" (height)

STOP AHEAD

8'-4" (width) x 8'-0" (height)

SCHOOL

8'-4" (width) x 9'-8" (height)

SIGNAL

8'-4" (width) x 8'-8" (height)

EXIT

8'-4" (width) x 5'-4" (height)

PAVEMENT MARKING

8'-4" (width) x 6'-4" (height)

GENERAL NOTES:

- TWO HORIZONTAL GAPS (CAUSED BY UNAVAILABLE LETTERS) SHALL BE INSTALLED IN EACH LETTER. THE GAPS SHALL BE PERMITTED IN EACH LETTER.
- PAVEMENT MARKING LETTERS, NUMERALS, SYMBOLS, AND ARROWS SHALL BE INSTALLED IN ACCORDANCE WITH THE REQUIREMENTS OF THE "STANDARD HIGHWAY SIGNS" PUBLICATION AS REFERENCED IN SECTION 103.04 (LATEST EDITION) OF THE MUTCD.
- WORD, SYMBOL, AND ARROW MARKINGS SHALL BE WHITE UNLESS OTHERWISE NOTED IN THE PLANS.
- PAVEMENT MARKING LEGENDS ARE AS FOLLOWS:

LEGEND	AREA (FT ²)
STOP	24.6
RIGHT	28.6
LEFT	19.5
TURN	27.3
LANE	27.3
AHEAD	32.3
YIELD	26.8
EXIT	18.5
SIGNAL	32.5
SCHOOL	35.5

PAVEMENT MARKING LEGEND DETAILS

MISSISSIPPI DEPARTMENT OF TRANSPORTATION
ROADWAY DESIGN DIVISION
STANDARD PLAN

ISSUE DATE: AUGUST 01, 2017

DATE	REVISION	BY

WORKING NUMBER: PM-5
SHEET NUMBER: 6035

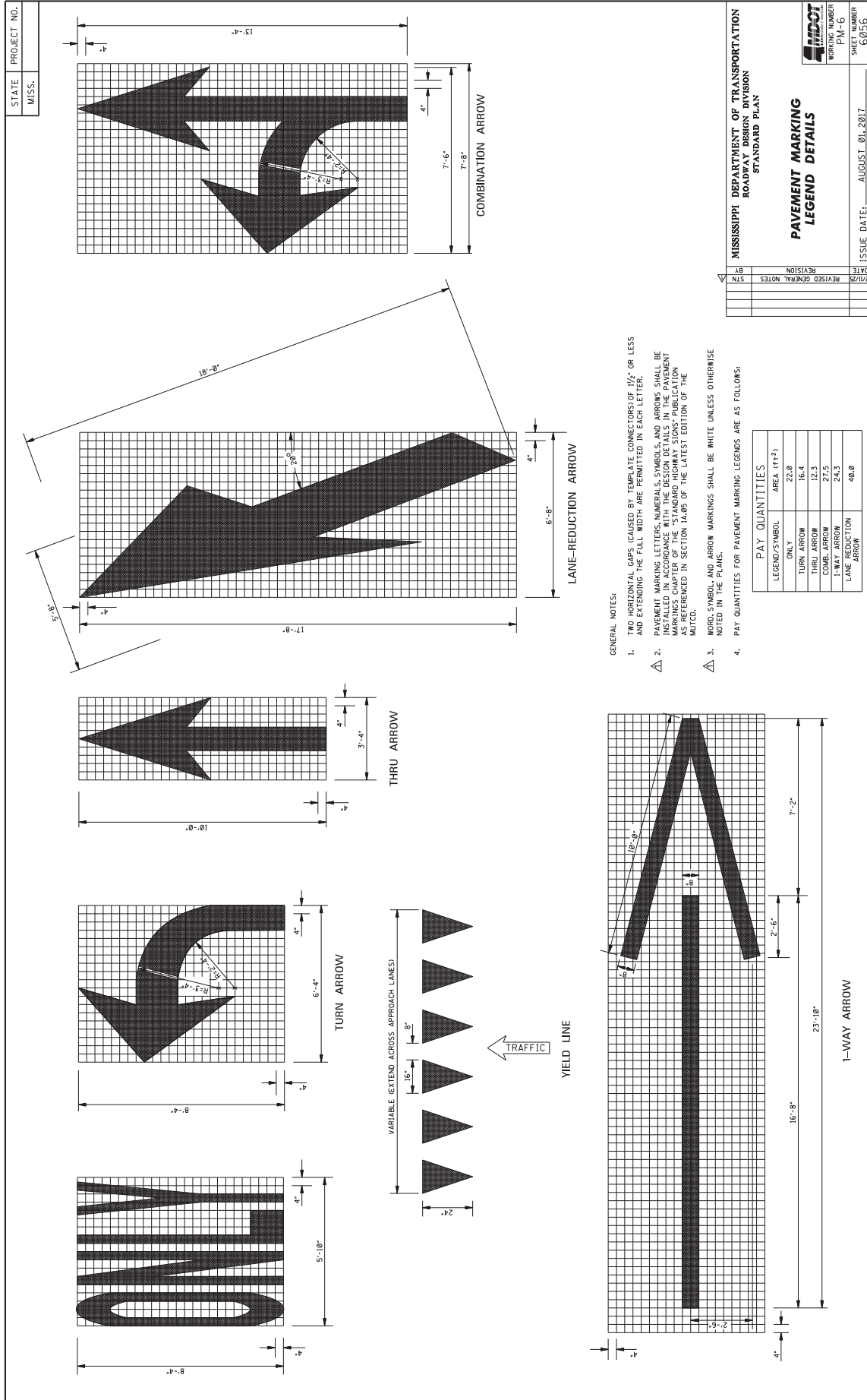

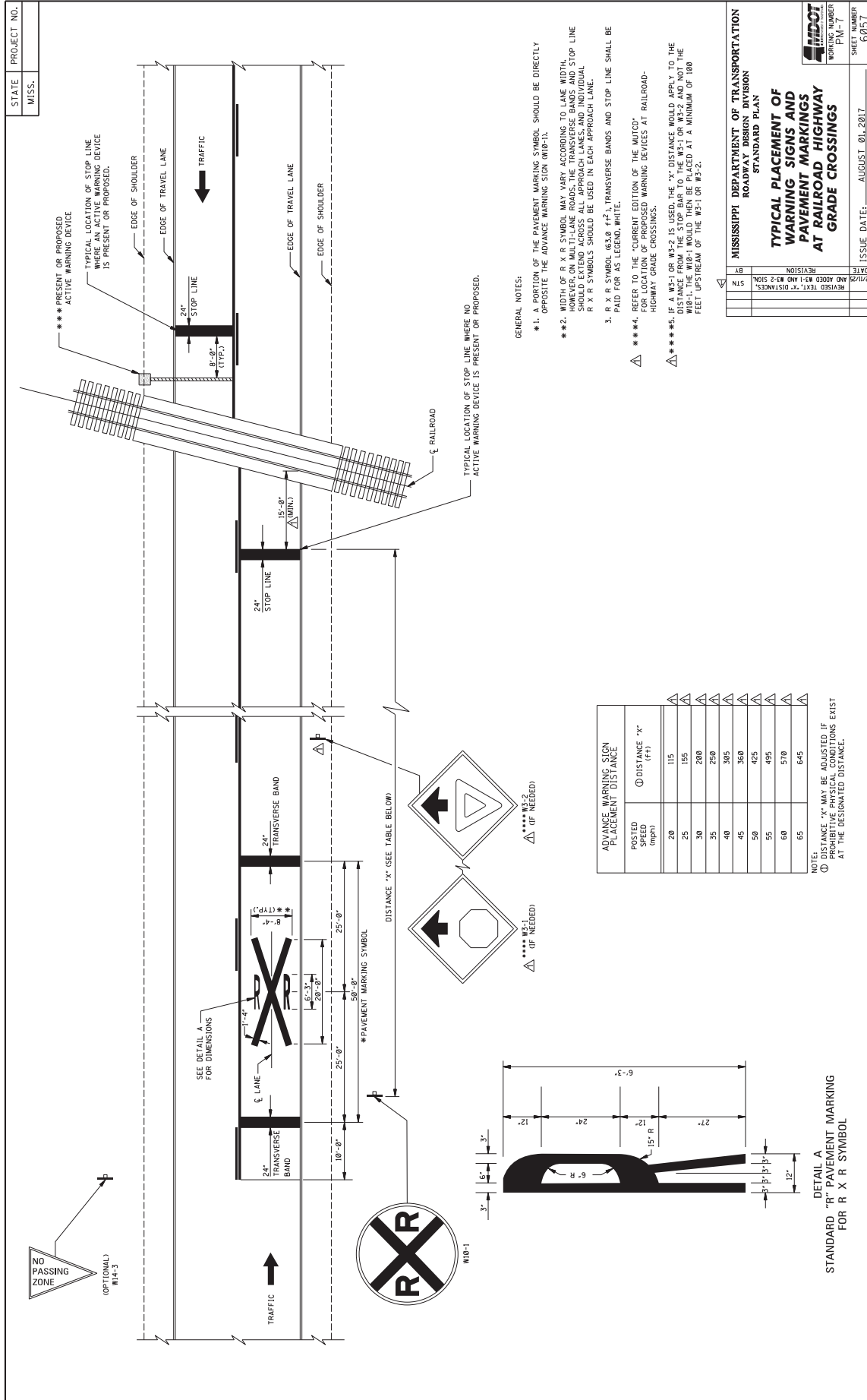

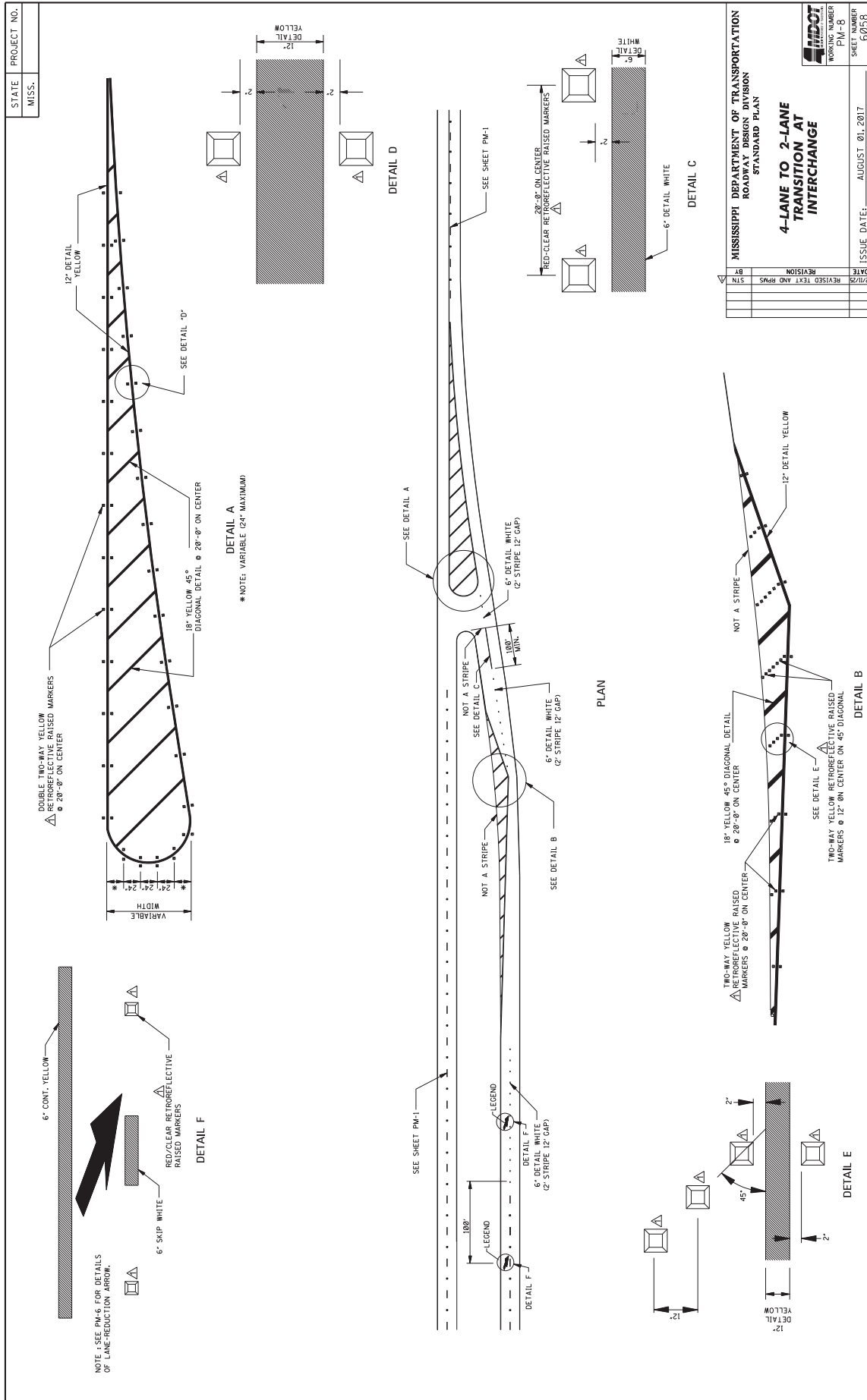

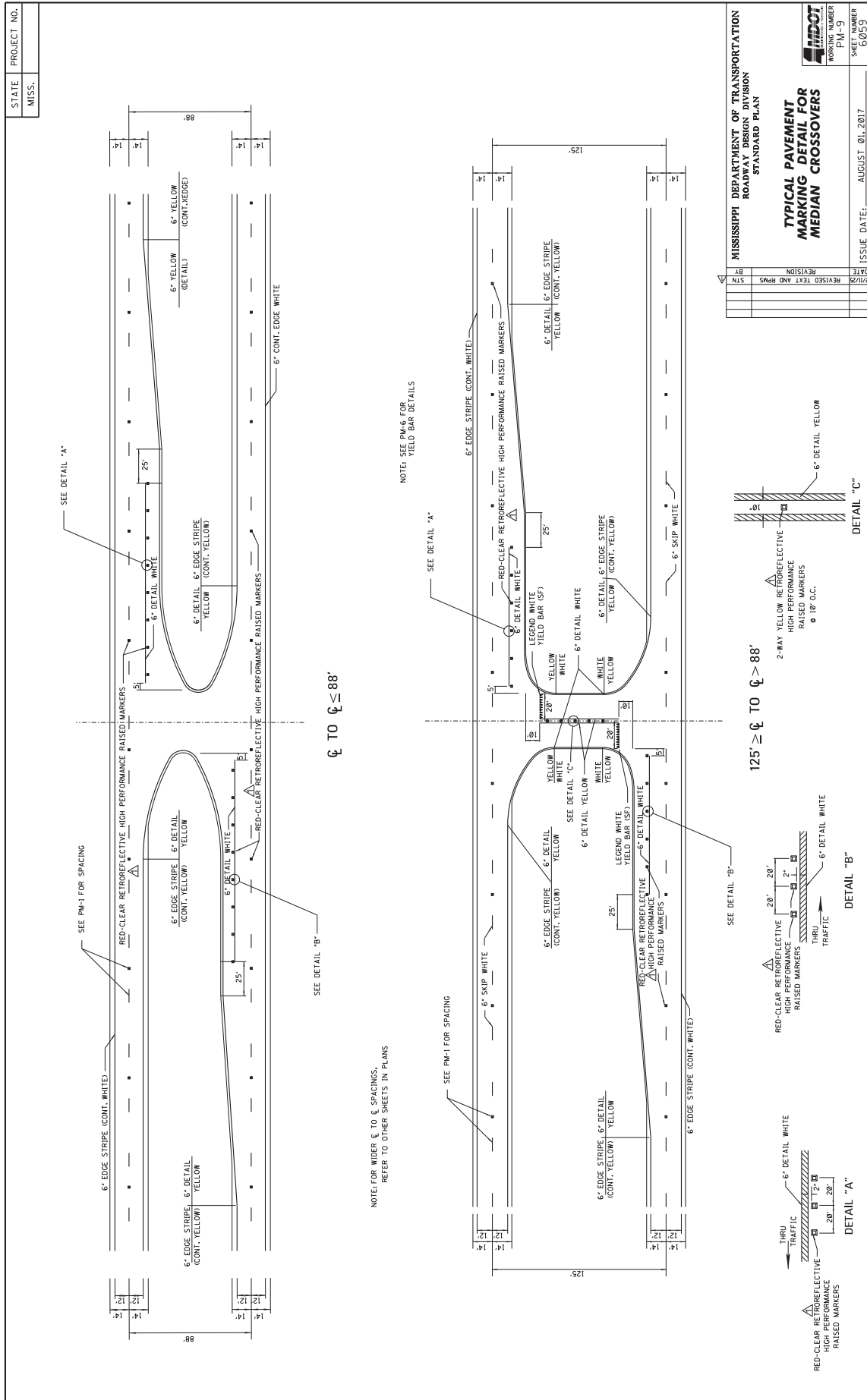

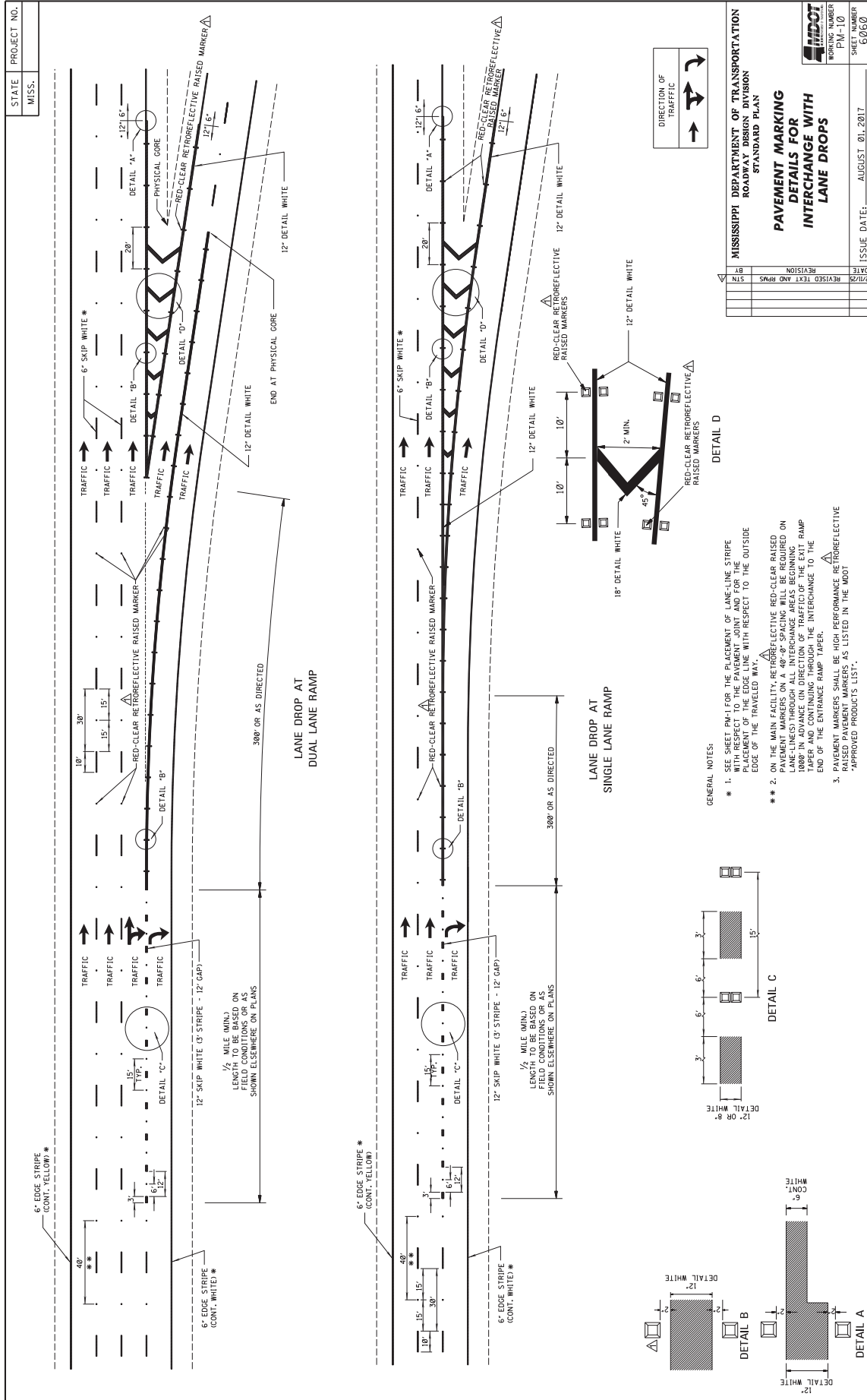

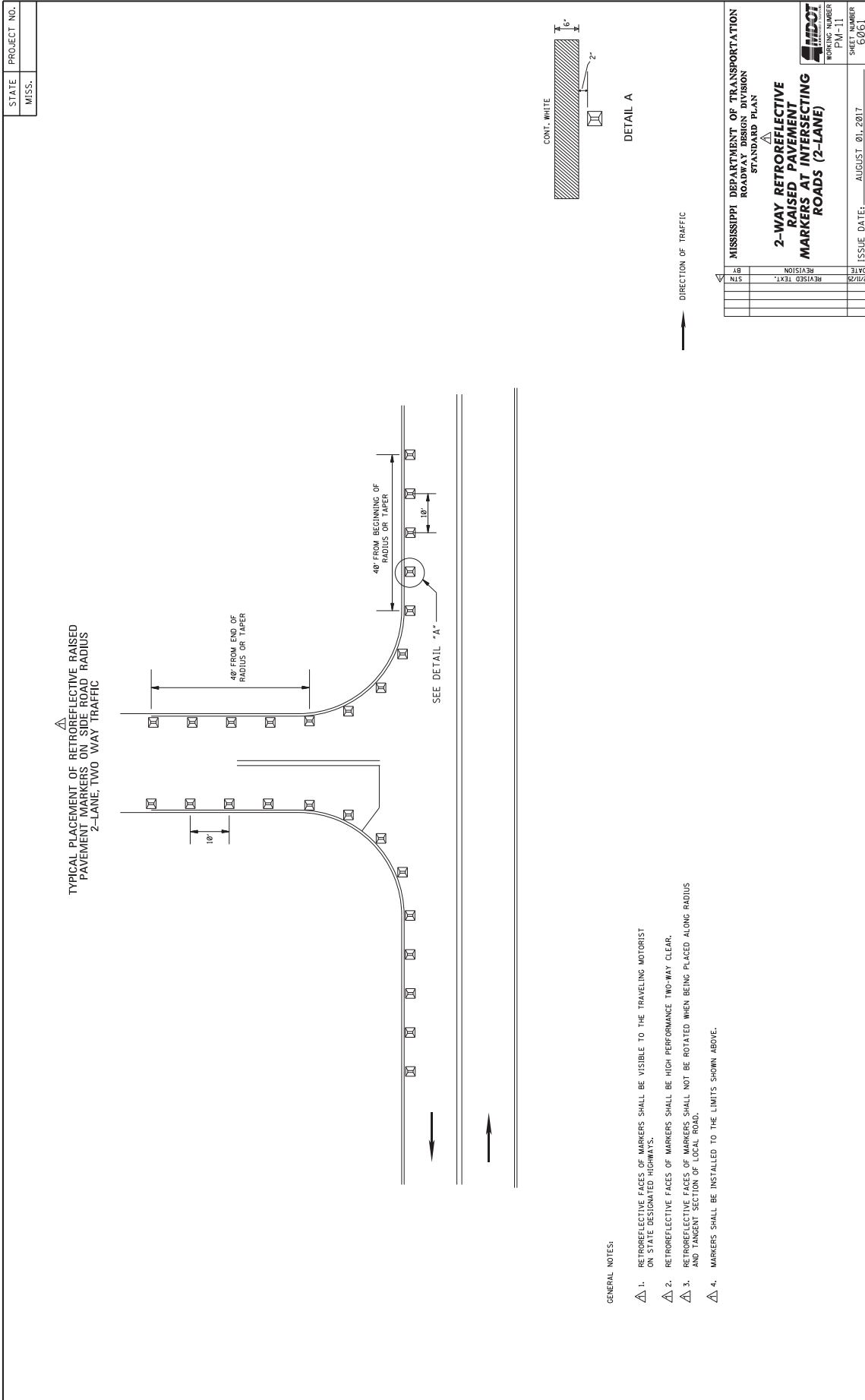

MISSISSIPPI DEPARTMENT OF TRANSPORTATION ROADWAY DESIGN DIVISION STANDARD PLAN	
2-WAY RETROREFLECTIVE RAISED PAVEMENT MARKERS AT INTERSECTING ROADS (2-LANE)	
DATE	REVISION
BY	BY
DATE	REVISION
BY	BY

ISSUE DATE: AUGUST 01, 2017	SHEET NUMBER PW-11
	WORKING NUMBER 6061

STATE	PROJECT NO.
MISS.	

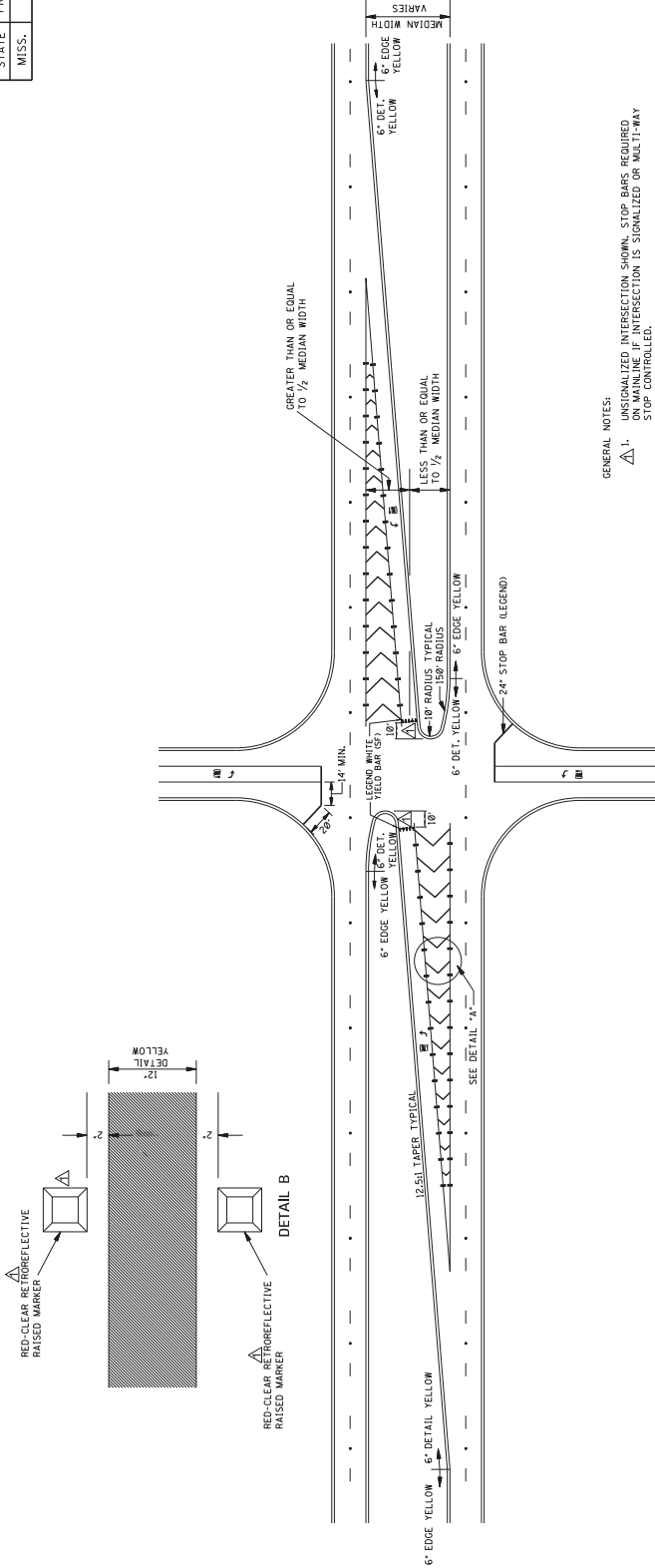

GENERAL NOTES:

1. UNREALIZED INTERSECTION SHOWN. STOP BARS REQUIRED AT UNREALIZED INTERSECTION IS SIGNALIZED OR MULTIPHASE STOP CONTROLLED.
2. SEE M.S. NOS. PM-1, PM-3 and PM-6 FOR OTHER DETAILS.
3. TAPER LENGTH VARIES WITH MEDIAN WIDTH.
4. TAPERED OFFSET LEFT TURN LANE SHOWN. PARALLEL, OFFSET LEFT TURN LANE PAVEMENT MARKINGS ARE SIMILAR.
5. 3-LANE SIDE ROAD SHOWN. SEE PERMANENT PAVEMENT MARKING DETAIL SHEETS FOR SIDE ROAD PAVEMENT MARKING DETAILS.
6. SEE PM-12 FOR INTERSECTING ROAD RAISED PAVEMENT MARKER PLACEMENT.

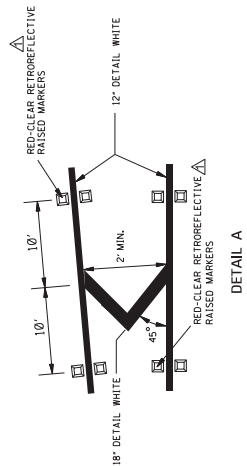
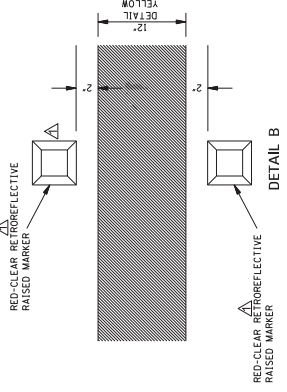

MISSISSIPPI DEPARTMENT OF TRANSPORTATION			SHEET NUMBER PM-13 6063
ROADWAY DESIGN DIVISION			
STANDARD PLAN		OFFSET LEFT TURN LANES	
ISSUE DATE: AUGUST 01, 2017			
DATE	REVISION		
2/12	REVISED TEXT AND RAMP		
	ADDED LEFT TURN		
	SYN		

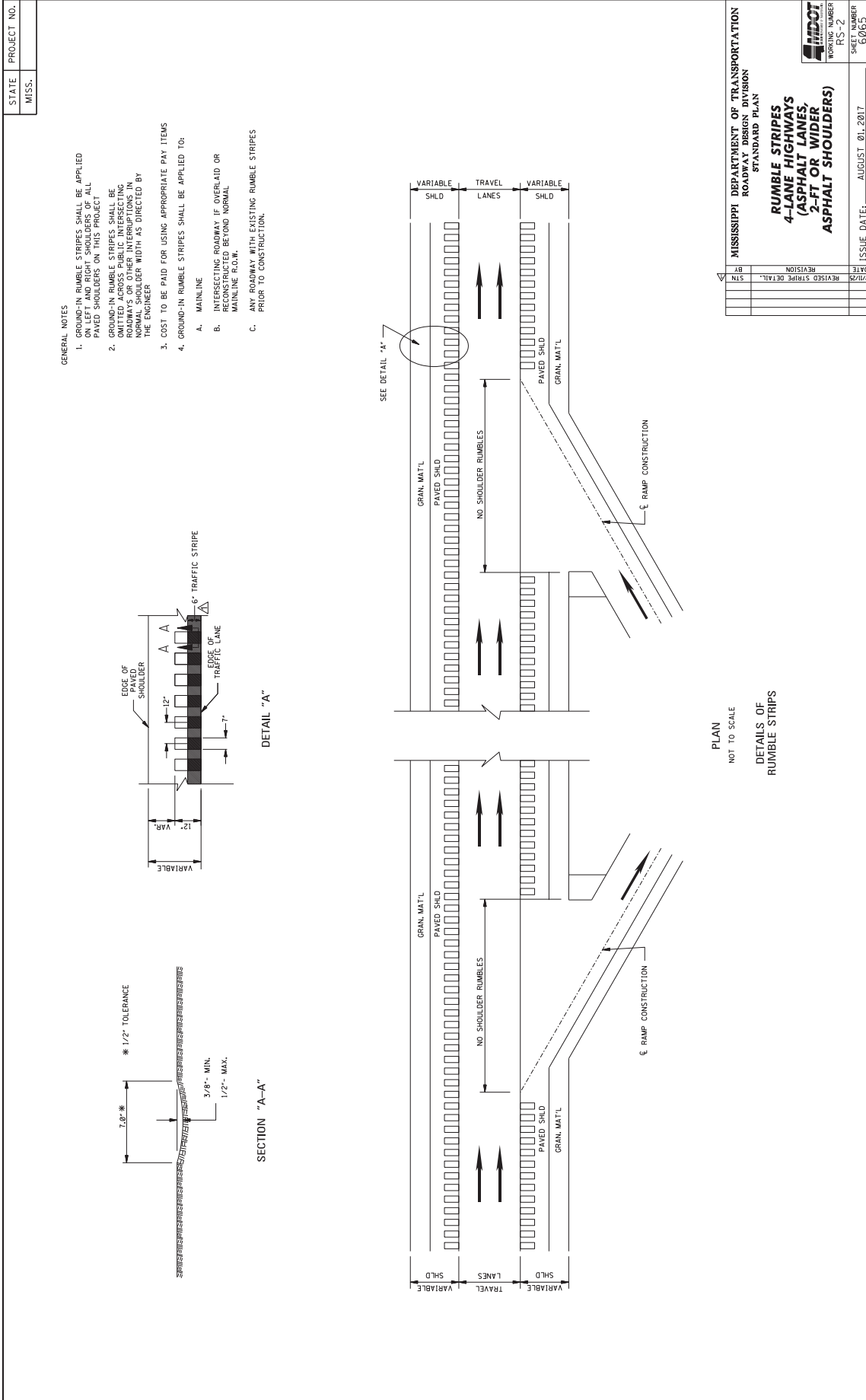

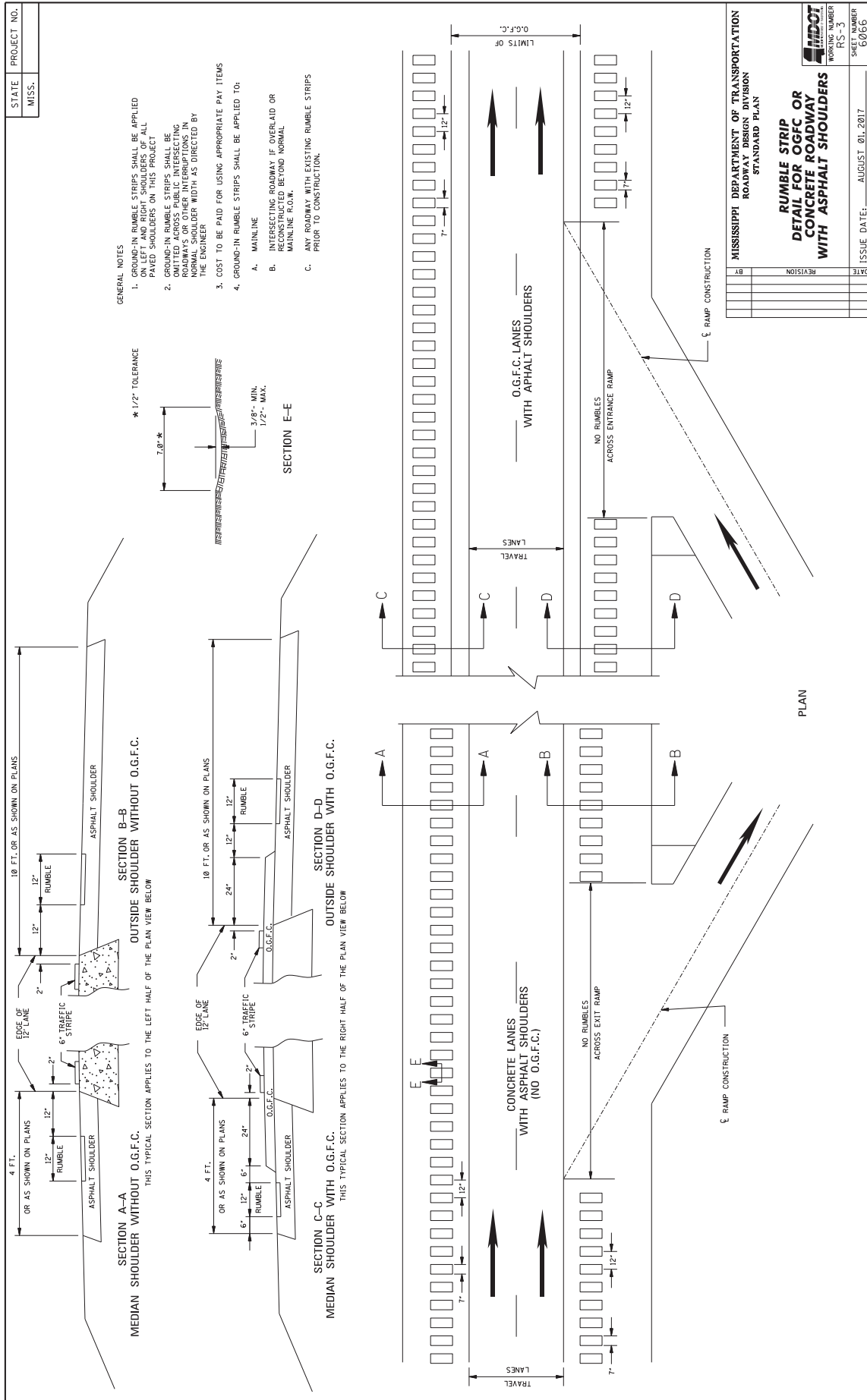

STATE PROJECT NO.
MISS.

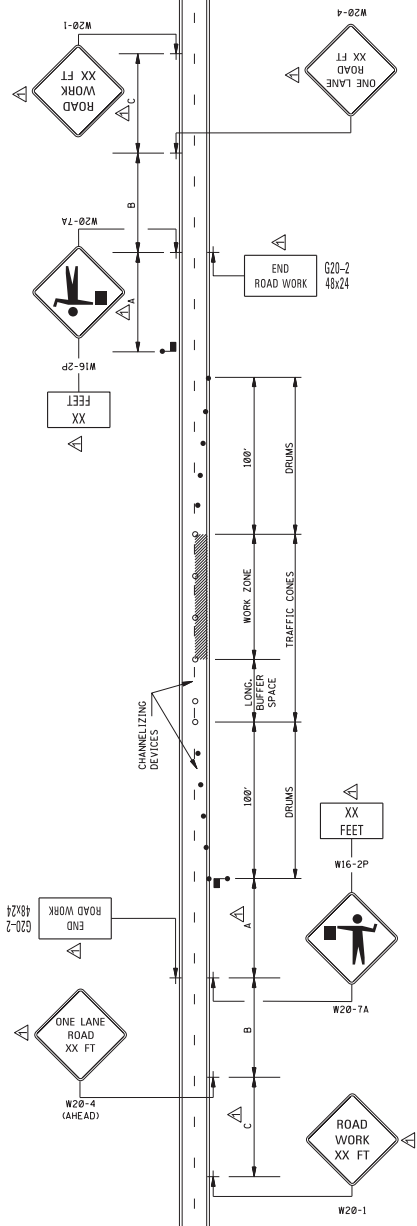

- LEGEND**
- ▲ FLAGGER
 - RETROREFLECTIVE FREE-STANDING PLASTIC DRUMS
 - TRAFFIC CONES (28" HEIGHT MINIMUM)

DISTANCE BETWEEN SIGNS

ROAD TYPE	A	B	C
URBAN (35 MPH OR LESS)	100 FT.	100 FT.	100 FT.
URBAN (40 - 70 MPH)	350 FT.	350 FT.	350 FT.
RURAL	500 FT.	500 FT.	500 FT.
EXPRESSWAY / FREEWAY	1000 FT.	1500 FT.	2640 FT.

- GENERAL NOTES:**
1. THE LOCATION OF CHANNELIZING DEVICES AND THE WORK AREA LAYOUT SHALL BE BASED ON THE CRITERIA IN THE FOLLOWING TABLE. FLAGGER STATIONS SHALL BE LOCATED SUCH THAT THE FLAGGER WILL BE WITHIN THE STOPPING SIGHT DISTANCE COLUMN MAY BE USED AS A MINIMUM FOR THIS DISTANCE.
 2. ALL CHANNELIZING DEVICES SHALL BE A MINIMUM OF 28" IN HEIGHT.
 3. DIAMOND SHARED TRAFFIC CONTROL SIGNS SHALL BE A MINIMUM OF 36" x 36" AND BLACK COPY ON FLUORESCENT ORANGE SHEETING.
 4. WHEN WORK ZONE IS NO LONGER NEEDED, ALL SIGNS SHALL BE COVERED BY CHANNELIZING DEVICES SHALL BE MOVED TO THE SHOULDER EDGE.
 5. ADDITIONAL FLAGGERS MAY BE NEEDED AS DIRECTED BY THE ENGINEER.
 6. WHEN WORK IS REQUIRED AT NIGHT, FLAGGER STATIONS SHALL BE ILLUMINATED EXCEPT IN EMERGENCIES.
 7. CHANNELIZING DEVICE TYPES FOR:
 - A. APPROACH AND EXIT TAPERS- RETROREFLECTIVE PLASTIC DRUMS
 - B. ALONG LANE LINE AND WORK ZONE- TRAFFIC CONES (28" HEIGHT)
 8. ALL TRAFFIC CONTROL ITEMS SHOWN ON THIS SHEET WILL NOT BE MEASURED FOR SEPARATE PAYMENT. THIS WORK SHALL BE INCLUDED IN THE PRICE BID FOR MAINTENANCE OF TRAFFIC.
 9. AN OPTIONAL FLAGGER (W20-7A) WORD MESSAGE IS SHOWN IN THE STANDARD HIGHWAY SIGNS PUBLICATION.

POSTED SPEED AND/OR DESIGN SPEED ANTICIPATED OPERATING SPEED (mph)	MAXIMUM CHANNELIZING DEVICE SPACING (ft)	LONGITUDINAL BUFFER SPACE (ft)	STOPPING SIGHT DISTANCE
25	20	50	155
30	20	60	200
35	20	70	250
40	20	80	305
45	20	90	360
50	20	100	425
55	20	110	495
60	20	120	570
65	20	130	645

* NOTE: BUFFER SPACE MAY BE ADJUSTED AS NEEDED ACCORDING TO ROADWAY GEOMETRY TO MEET SIGHT DISTANCE REQUIREMENTS, AS DIRECTED BY THE ENGINEER.

MISSISSIPPI DEPARTMENT OF TRANSPORTATION
ROADWAY DESIGN DIVISION
STANDARD PLAN

**TRAFFIC CONTROL PLAN
WITH FLAGGER
(ONE-LANE CLOSURE OF
TWO-WAY TRAFFIC)**

ISSUE DATE: AUGUST 01, 2017
SHEET NUMBER: 6351
WORKING NUMBER: TCP-1

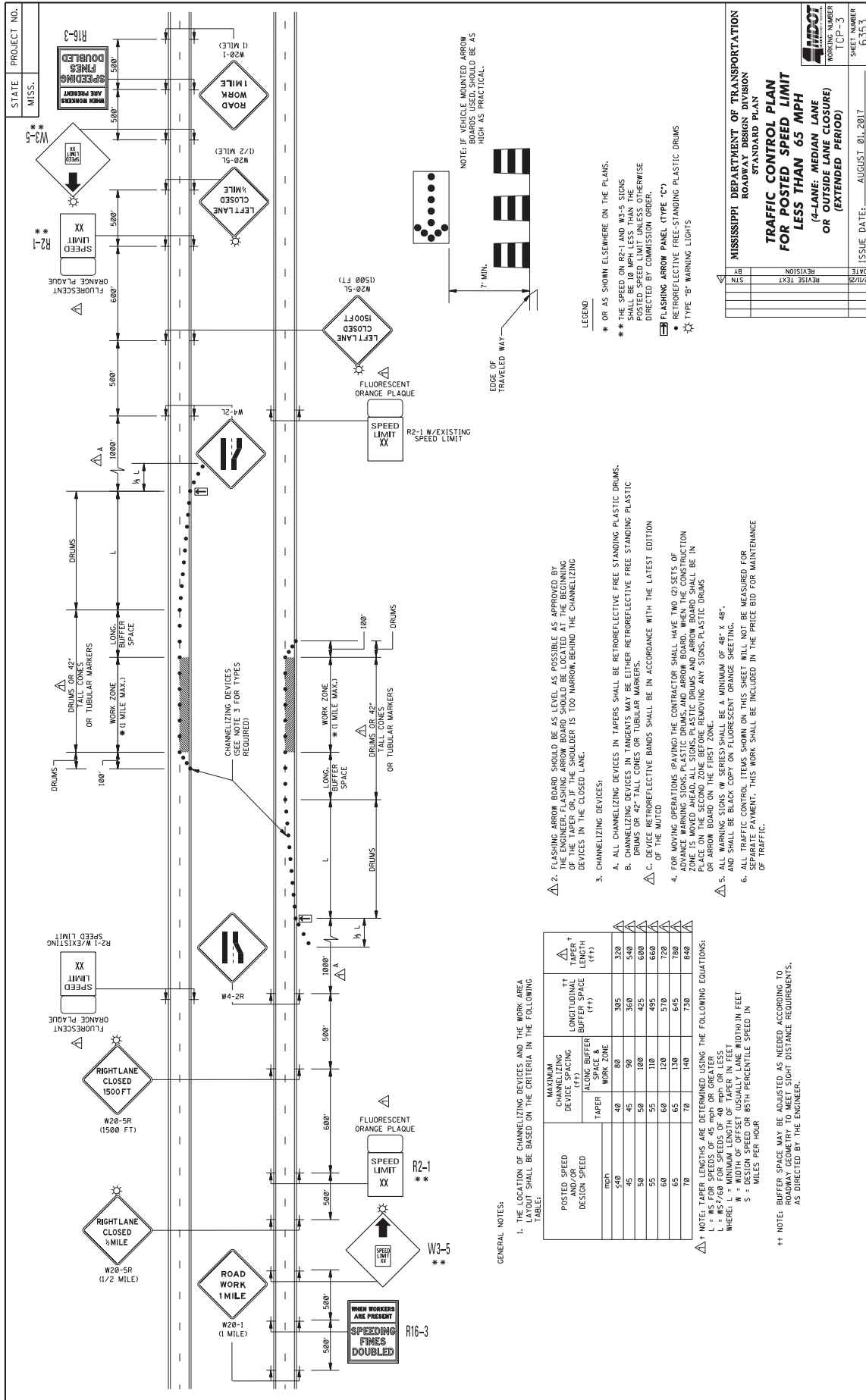

1. THE LOCATION OF CHANNELIZING DEVICES AND THE WORK AREA LAYOUT SHALL BE BASED ON THE CRITERIA IN THE FOLLOWING TABLE:

POSTED SPEED AND/OR DESIGN SPEED	MAXIMUM CHANNELIZING DEVICES SPACING (ft)		LONGITUDINAL BUFFER SPACE (ft)	MINIMUM TAPER LENGTH (ft)
	TAPER	WORK ZONE		
40	40	80	305	320
45	45	90	360	540
50	50	100	425	600
55	55	110	495	660
60	60	120	570	720
65	65	130	645	780
70	70	140	730	840

†† NOTE: BUFFER SPACE MAY BE ADJUSTED AS NEEDED ACCORDING TO ROADWAY GEOMETRY TO MEET SIGHT DISTANCE REQUIREMENTS, AS DIRECTED BY THE ENGINEER.

NOTE: TAPER LENGTHS ARE DETERMINED USING THE FOLLOWING EQUATIONS:
 L = WS FOR SPEEDS OF 45 mph OR GREATER
 L = WS/60 FOR SPEEDS OF 40 mph OR LESS
 WHERE: W = WIDTH OF OFFSET (USUALLY LANE WIDTH) IN FEET
 S = DESIGN SPEED OR 85TH PERCENTILE SPEED IN MILES PER HOUR

GENERAL NOTES:
 1. THE LOCATION OF CHANNELIZING DEVICES AND THE WORK AREA LAYOUT SHALL BE BASED ON THE CRITERIA IN THE FOLLOWING TABLE:

2. FLASHING ARROW BOARD SHOULD BE AS LEVEL AS POSSIBLE AS APPROVED BY THE ENGINEER. FLASHING ARROW BOARD SHOULD BE LOCATED AT THE BEGINNING OF THE WORK AREA. BUFFER SHOULD BE 100' WIDE BEHIND THE CHANNELIZING DEVICES IN THE CLOSED LANE.
3. CHANNELIZING DEVICES:
 - A. ALL CHANNELIZING DEVICES IN TAPERS SHALL BE RETROREFLECTIVE FREE STANDING PLASTIC DRUMS.
 - B. CHANNELIZING DEVICES IN TANGENTS MAY BE EITHER RETROREFLECTIVE FREE STANDING PLASTIC DRUMS OR 42" TALL CONES OR TUBULAR MARKERS.
 - C. DEVICE RETROREFLECTIVE BANDS SHALL BE IN ACCORDANCE WITH THE LATEST EDITION OF THE MUTCD
4. FOR MOVING OPERATIONS (PAVING) THE CONTRACTOR SHALL HAVE TWO (2) SETS OF ADVANCE WARNING DEVICES (RETROREFLECTIVE PLASTIC DRUMS, AND TUBULAR MARKERS OR ARROW BOARD) ON THE SECOND ZONE BEFORE REMOVING ANY SIGNS/PLASTIC DRUMS OR ARROW BOARD ON THE FIRST ZONE.
5. ALL WARNING SIGNS (W SERIES) SHALL BE A MINIMUM OF 48" X 48" AND SHALL BE BLACK COPY ON FLUORESCENT ORANGE SHEETING.
6. SEPARATE PAYMENT: THIS WORK SHALL BE INCLUDED IN THE PRICE BID FOR MAINTENANCE OF TRAFFIC.

LEGEND
 * OR AS SHOWN ELSEWHERE ON THE PLANS.
 ** THE SPEED ON R2-1 AND R2-5 SIGNS SHALL BE 10 MPH LESS THAN THE POSTED SPEED LIMIT UNLESS OTHERWISE DIRECTED BY COMMISSION ORDER.
 [Symbol] FLASHING ARROW PANEL (TYPE 'C')
 [Symbol] RETROREFLECTIVE FREE-STANDING PLASTIC DRUMS
 [Symbol] TYPE 'B' WARNING LIGHTS

STATE PROJECT NO.
 MISS.

W20-5R (1500 FT)
 RIGHT LANE CLOSED 1500 FT
 W20-5L (1/2 MILE)
 LEFT LANE CLOSED 1/2 MILE
 W20-1 (1 MILE)
 ROAD WORK 1 MILE
 W20-5L (1500 FT)
 LEFT LANE CLOSED 1500 FT
 W4-2L
 W4-2R
 W20-5R (1500 FT)
 RIGHT LANE CLOSED 1500 FT
 W20-5L (1/2 MILE)
 LEFT LANE CLOSED 1/2 MILE
 W20-1 (1 MILE)
 ROAD WORK 1 MILE
 R2-1
 SPEED LIMIT XX
 W3-5
 WHEN WORKERS ARE PRESENT SPEEDING FINES DOUBLED
 R16-3

MISSISSIPPI DEPARTMENT OF TRANSPORTATION
 ROADWAY DESIGN DIVISION
 STANDARD PLAN
**TRAFFIC CONTROL PLAN
 FOR POSTED SPEED LIMIT
 LESS THAN 65 MPH
 (4-LANE MEDIAN LANE
 OR OUTSIDE LANE CLOSURE
 OR EXTENDED PERIOD)**
 WORKING NUMBER
 TCC-3
 SHEET NUMBER
 6353
 ISSUE DATE: AUGUST 01, 2017

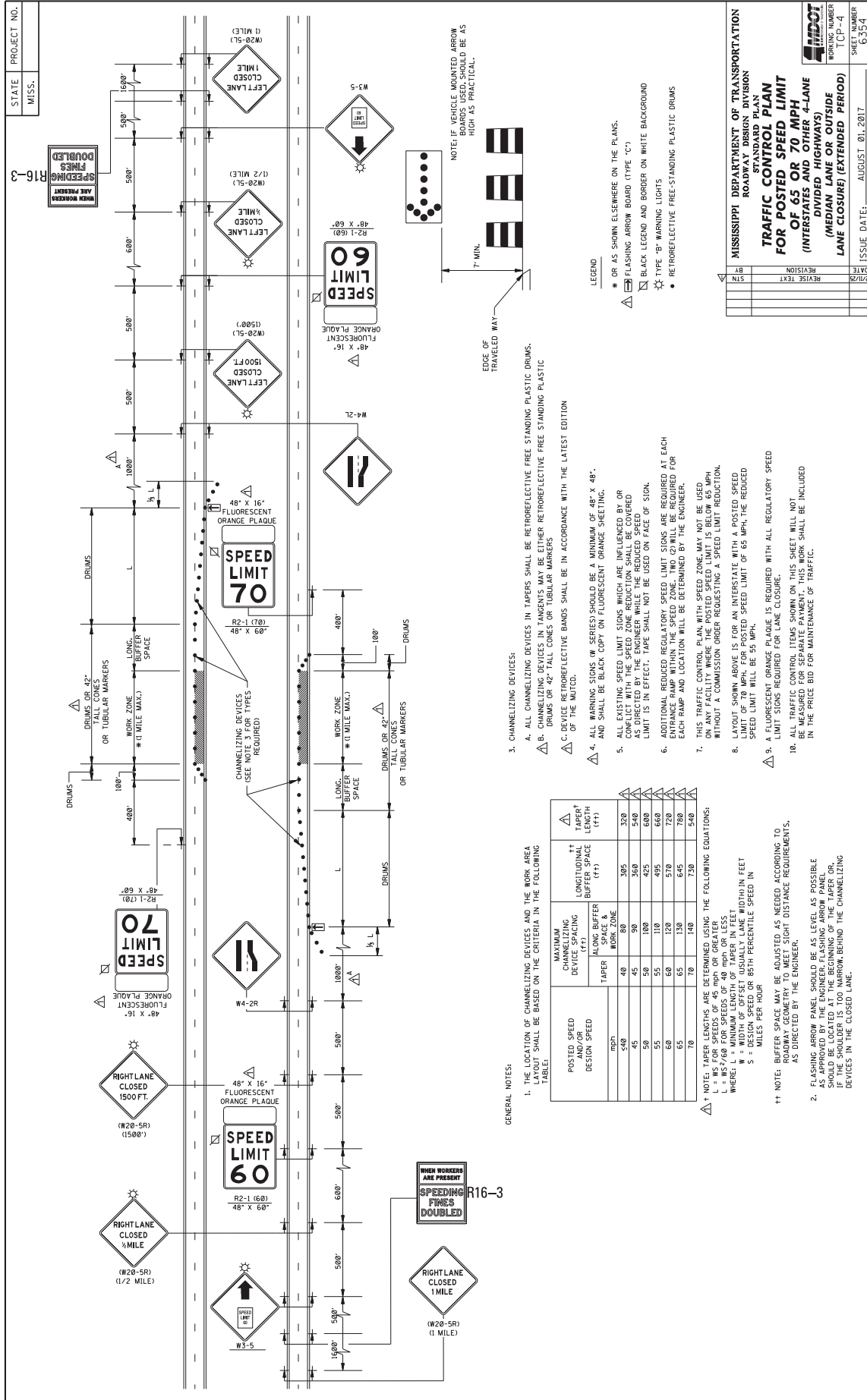

GENERAL NOTES:

1. THE LOCATION OF CHANNELIZING DEVICES AND THE WORK AREA TAPER SHALL BE BASED ON THE CRITERIA IN THE FOLLOWING TABLE:

POSTED SPEED AND/OR DESIGN SPEED mph	MAXIMUM CHANNELIZING DEVICE SPACING		LONGITUDINAL BUFFER SPACE (FT)	TAPER LENGTH (FT)
	ALONG BUFFER SPACE & WORK ZONE	TAPER		
40	40	80	305	320
45	45	90	350	340
50	50	100	400	360
55	55	110	450	380
60	60	120	520	420
65	65	130	645	720
70	70	140	730	540

†† NOTE: TAPER LENGTHS ARE DETERMINED USING THE FOLLOWING EQUATIONS:

L = MS FOR SPEEDS OF 45 MPH OR GREATER
 L = MS²/60 FOR SPEEDS OF 40 MPH OR LESS
 WHERE: L = MINIMUM LENGTH OF TAPER IN FEET
 M = DESIGN SPEED OR 85TH PERCENTILE SPEED IN FEET PER HOUR
 S = DESIGN SPEED OR 85TH PERCENTILE SPEED IN MILES PER HOUR

††† NOTE: BUFFER SPACE MAY BE ADJUSTED AS NEEDED ACCORDING TO ROADWAY GEOMETRY TO MEET SIGHT DISTANCE REQUIREMENTS, AS DIRECTED BY THE ENGINEER.

2. FLASHING ARROW PANEL SHOULD BE AS LEVEL AS POSSIBLE AS APPROVED BY THE ENGINEER. FLASHING ARROW PANEL SHOULD BE LOCATED AT THE BEGINNING OF THE TAPER OR AT THE END OF THE TAPER, BEHIND THE CHANNELIZING DEVICES IN THE CLOSED LANE.

3. CHANNELIZING DEVICES:

- A. ALL CHANNELIZING DEVICES IN TAPERS SHALL BE RETROREFLECTIVE FREE STANDING PLASTIC DRUMS.
- B. CHANNELIZING DEVICES IN TANGENTS MAY BE EITHER RETROREFLECTIVE FREE STANDING PLASTIC DRUMS OR 42" TALL CONES OR TUBULAR MARKERS
- C. DEVICE RETROREFLECTIVE BANDS SHALL BE IN ACCORDANCE WITH THE LATEST EDITION OF THE MUTCD.

4. ALL WARNING STONS (W SERIES) SHOULD BE A MINIMUM OF 48" X 48". AND SHALL BE BLACK COPY ON FLUORESCENT ORANGE SHEETING.

5. ALL EXISTING SPEED LIMIT SIGNS WHICH ARE INFLUENCED BY OR CONFLICT WITH THE SPEED ZONE REDUCTION SHALL BE COVERED AS DIRECTED BY THE ENGINEER WHILE THE REDUCED SPEED LIMIT IS IN EFFECT. TAPE SHALL NOT BE USED ON FACE OF SIGN.

6. ADDITIONAL REDUCED REGULATORY SPEED LIMIT SIGNS ARE REQUIRED AT EACH ENTRANCE RAMP WITHIN THE SPEED ZONE. TWO (2) WILL BE REQUIRED FOR EACH RAMP AND LOCATION WILL BE DETERMINED BY THE ENGINEER.

7. THIS TRAFFIC CONTROL PLAN WITH SPEED ZONE MAY NOT BE USED ON ANY FACILITY WHERE THE POSTED SPEED LIMIT IS BELOW 65 MPH WITHOUT THE APPROVAL OF THE ENGINEER. REQUEST A SPEED LIMIT REDUCTION WITHOUT A COMMISSION ORDER REQUESTING A SPEED LIMIT REDUCTION.

8. LAYOUT SHOWN ABOVE IS FOR AN INTERSTATE WITH A POSTED SPEED LIMIT OF 70 MPH. IF THE POSTED SPEED LIMIT IS 65 MPH, THE REDUCED SPEED LIMIT WILL BE 55 MPH.

9. A FLUORESCENT ORANGE PLAQUE IS REQUIRED WITH ALL REGULATORY SPEED LIMIT SIGNS REQUIRED FOR LANE CLOSURE.

10. ALL TRAFFIC CONTROL TAPERS SHOWN ON THIS SHEET WILL NOT BE MEASURED FOR SEPARATE PAYMENT. THIS WORK SHALL BE INCLUDED IN THE PRICE BID FOR MAINTENANCE OF TRAFFIC.

LEGEND

- * OR AS SHOWN ELSEWHERE ON THE PLANS.
- ◻ FLASHING ARROW BOARD (TYPE "C")
- ◻ BLACK LEGEND AND BORDER ON WHITE BACKGROUND
- ☆ TYPE "B" WARNING LIGHTS
- RETROREFLECTIVE FREE-STANDING PLASTIC DRUMS

NOTE: IF VEHICLE MOUNTED ARROW BOARD IS USED, IT SHOULD BE AS HIGH AS PRACTICAL.

STATE PROJECT NO. MISS. R16-3

WHEN WORKERS ARE PRESENT SPEEDING FINES DOUBLED

MISSISSIPPI DEPARTMENT OF TRANSPORTATION
 ROADWAY DESIGN DIVISION
TRAFFIC CONTROL PLAN FOR POSTED SPEED LIMIT OF 65 OR 70 MPH (INTERSTATES AND OTHER 4-LANE DIVIDED HIGHWAYS) (MEDIAN LANE OR OUTSIDE LANE CLOSURE) (EXTENDED PERIOD)

DATE: AUGUST 01, 2017
 SHEET NUMBER: 6534

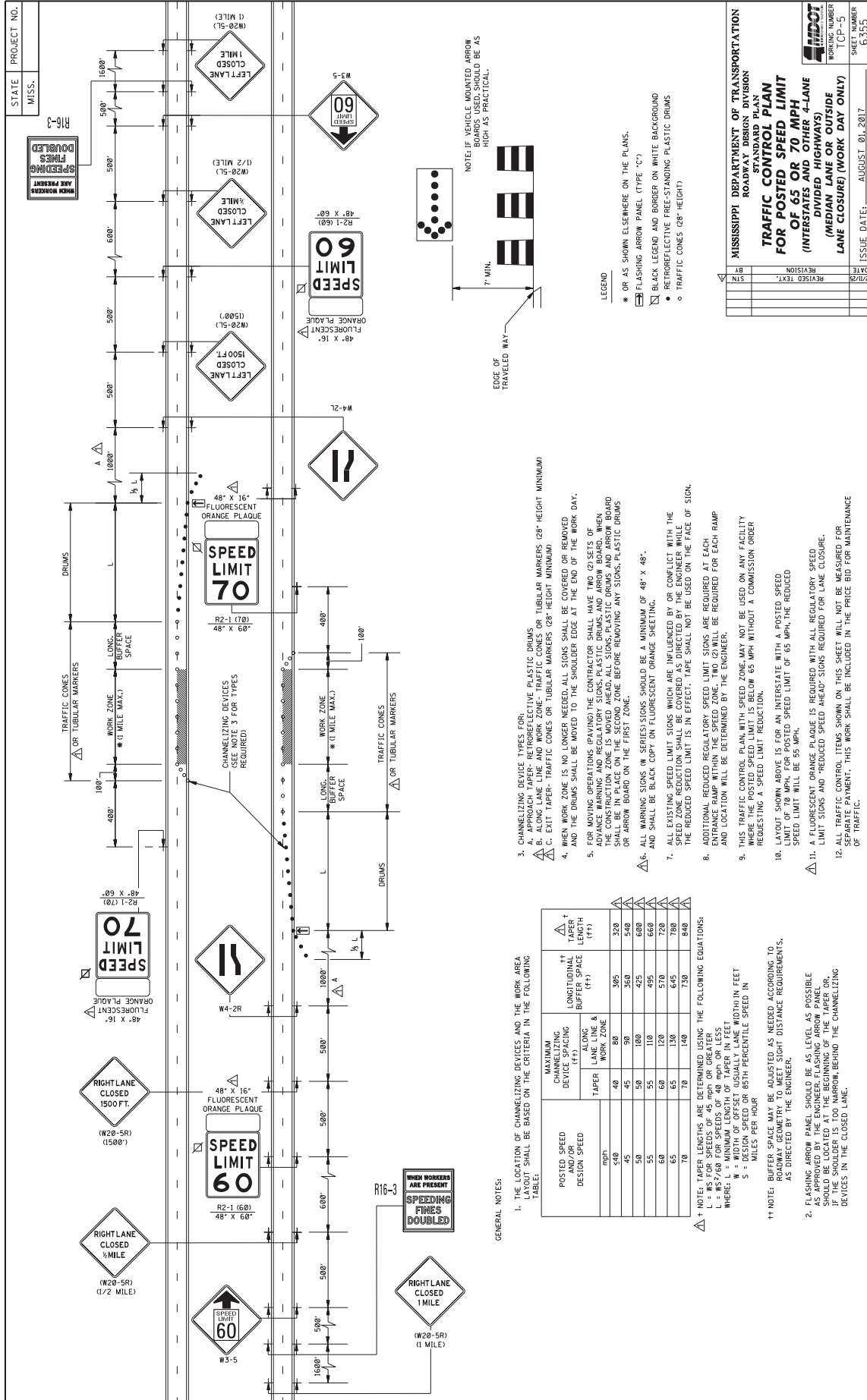

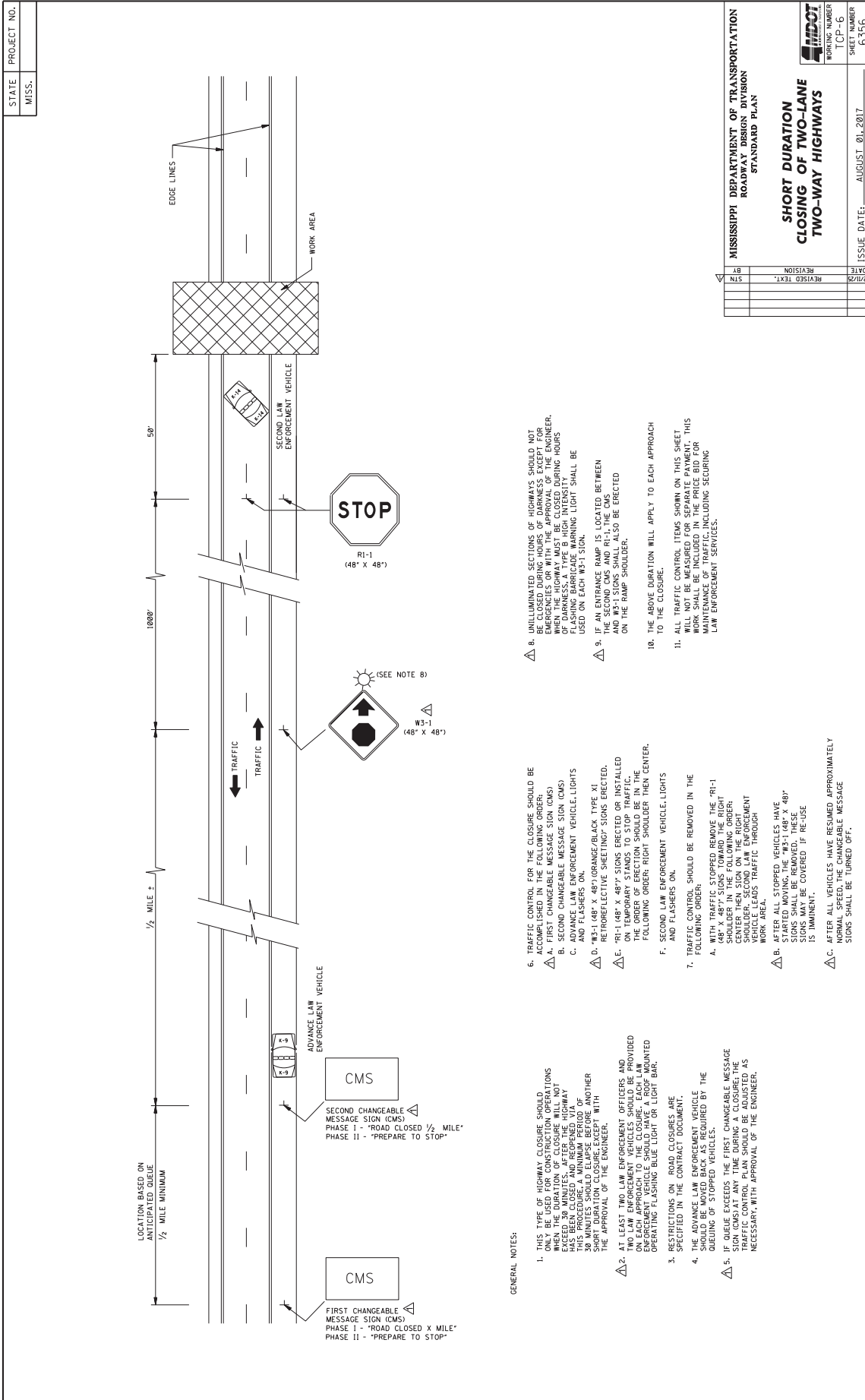

STATE	PROJECT NO.
MISS.	

MISSISSIPPI DEPARTMENT OF TRANSPORTATION ROADWAY DESIGN DIVISION STANDARD PLAN	
SHORT DURATION CLOSING OF TWO-LANE TWO-WAY HIGHWAYS	
WORKING NUMBER	TCP-6
SHEET NUMBER	6356
ISSUE DATE:	AUGUST 01, 2017

- GENERAL NOTES:**
- THIS TYPE OF HIGHWAY CLOSURE SHOULD BE USED ONLY WHEN THE DURATION OF CLOSURE WILL NOT EXCEED 30 MINUTES. AFTER THE HIGHWAY CLOSURE, THE ADVANCE LAW ENFORCEMENT VEHICLE SHOULD ELAPSE BEFORE ANOTHER ADVANCE LAW ENFORCEMENT VEHICLE WITH THE APPROVAL OF THE ENGINEER.
 - AT LEAST TWO LAW ENFORCEMENT OFFICERS AND ONE ADVANCE LAW ENFORCEMENT VEHICLE SHOULD BE PROVIDED ON EACH APPROACH TO THE CLOSURE. EACH LAW ENFORCEMENT VEHICLE SHOULD HAVE A PROTRUDING OPERATING FLASHING BLUE LIGHT ON LIGHT BAR.
 - RESTRICTIONS ON ROAD CLOSURES ARE SPECIFIED IN THE CONTRACT DOCUMENT.
 - THE ADVANCE LAW ENFORCEMENT VEHICLE SHOULD BE POSITIONED AS DETERMINED BY THE QUEUING OF STOPPED VEHICLES.
 - IF QUEUE EXCEEDS THE FIRST CHANGEABLE MESSAGE SIGN (CMS) AT ANY TIME DURING A CLOSURE, THE TRAFFIC CONTROL PLAN SHOULD BE ADJUSTED AS NECESSARY, WITH APPROVAL OF THE ENGINEER.
 - TRAFFIC CONTROL FOR THE CLOSURE SHOULD BE ACCOMPLISHED IN THE FOLLOWING ORDER:
 - FIRST CHANGEABLE MESSAGE SIGN (CMS)
 - SECOND CHANGEABLE MESSAGE SIGN (CMS)
 - ADVANCE LAW ENFORCEMENT VEHICLE, LIGHTS ON
 - "R1-1 (48" X 48") STOP SIGN, TYPE XI, RETROREFLECTIVE SHEETING" SIGNS ERECTED.
 - "R1-1 (48" X 48") SIGNS ERECTED OR INSTALLED ON TEMPORARY STANDS TO STOP TRAFFIC. THE ORDER OF ERECTION SHOULD BE IN THE FOLLOWING ORDER: RIGHT SHOULDER THEN CENTER, AND FLASHERS ON.
 - SECOND LAW ENFORCEMENT VEHICLE, LIGHTS ON.
 - TRAFFIC CONTROL SHOULD BE REMOVED IN THE FOLLOWING ORDER:
 - WITH TRAFFIC STOPPED REMOVE THE "R1-1 (48" X 48") SIGNS TOWARD THE RIGHT SHOULDER THEN SIGN ON THE RIGHT SHOULDER. SECOND LAW ENFORCEMENT VEHICLE LEADS TRAFFIC THROUGH WORK AREA.
 - AFTER ALL STOPPED VEHICLES HAVE STARTED MOVING, THE "R1-1 (48" X 48") SIGNS SHALL BE COVERED. THESE SIGNS SHALL BE COVERED IF RE-USE IS IMMINENT.
 - AFTER ALL VEHICLES HAVE RESUMED APPROXIMATELY NORMAL SPEED, THE CHANGEABLE MESSAGE SIGNS SHALL BE TURNED OFF.
 - UNILLUMINATED SECTIONS OF HIGHWAYS SHOULD NOT BE CLOSED DURING HOURS OF DARKNESS EXCEPT FOR EMERGENCY REPAIRS. THE APPROVAL OF THE ENGINEER, WHEN THE CLOSURE MUST BE CLOSING DURING HOURS OF DARKNESS, A TYPE B HIGH INTENSITY FLASHING BARRICADE WARNING LIGHT SHALL BE USED ON EACH W5-1 SIGN.
 - IF AN ENTRANCE RAMP IS LOCATED BETWEEN THE WORK AREA AND THE RAMP SHOULDER, AND W5-1 SIGNS SHALL ALSO BE ERECTED ON THE RAMP SHOULDER.
 - THE ABOVE DURATION WILL APPLY TO EACH APPROACH TO THE CLOSURE.
 - ALL TRAFFIC CONTROL ITEMS SHOWN ON THIS SHEET WILL NOT BE MEASURED FOR SEPARATE PAYMENT. THIS WORK SHALL BE INCLUDED IN THE PRICE BID FOR MAINTENANCE AND REPAIRS, INCLUDING SECURING LAW ENFORCEMENT SERVICES.

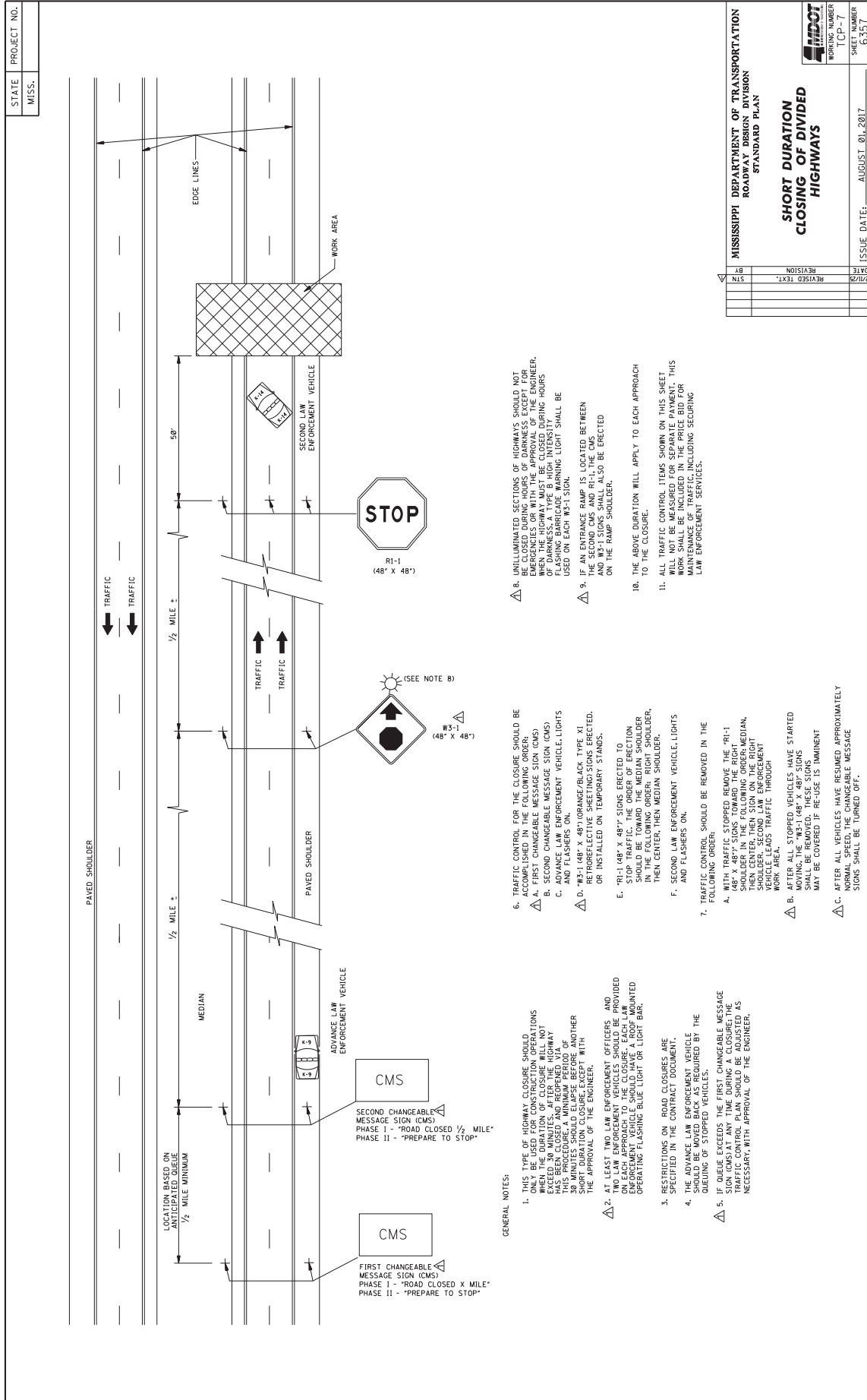

STATE	PROJECT NO.
MISS.	

MISSISSIPPI DEPARTMENT OF TRANSPORTATION ROADWAY DESIGN DIVISION STANDARD PLAN	
SHORT DURATION CLOSING OF DIVIDED HIGHWAYS	
DATE	ISSUE DATE: AUGUST 01, 2017
REVISION	WORKING NUMBER
STN.	TCP--7
	SHEET NUMBER
	6357

- 8. UNLIMITED SECTIONS OF HIGHWAYS SHOULD NOT BE CLOSED FOR SHORT DURATION CLOSURES DURING EMERGENCIES OR WITH THE APPROVAL OF THE ENGINEER. WHEN THE HIGHWAY MUST BE CLOSED DURING HOURS OF EMERGENCY, FLASHING BARRICADE WARNING LIGHTS SHALL BE USED ON EACH W3-1 SIGN.
- 9. IF AN ENTRANCE RAMP IS LOCATED BETWEEN THE SECOND CMS AND RI-1, THE CMS AND W3-1 SIGNS SHALL ALSO BE ERCTED ON THE RAMP SHOULDER.
- 10. THE ABOVE DURATION WILL APPLY TO EACH APPROACH TO THE CLOSURE.
- 11. ALL TRAFFIC CONTROL ITEMS SHOWN ON THIS SHEET WILL NOT BE MEASURED OR SEPARATE PAID FOR. THIS WORK SHALL BE INCLUDED IN THE BIDDING PRICE FOR MAINTENANCE OF TRAFFIC, INCLUDING SECURING LAW ENFORCEMENT SERVICES.

- 6. TRAFFIC CONTROL FOR THE CLOSURE SHOULD BE ACCOMPLISHED USING THE FOLLOWING ORDER:
 - A. FIRST CHANGEABLE MESSAGE SIGN (CMS)
 - B. SECOND CHANGEABLE MESSAGE SIGN (CMS)
 - C. ADVANCE LAW ENFORCEMENT VEHICLE, LIGHTS AND FLASHERS ON.
 - D. W3-1 48" X 48" ORANGE/BLACK TYPE XI RETROREFLECTIVE SHEETING SIGNS ERCTED, OR INSTALLED ON TEMPORARY STANDS.
 - E. RI-1 48" X 48" SIGNS ERCTED TO STOP TRAFFIC. THE ORDER OF ERECTION SHOULD BE TOWARD THE MEDIAN SHOULDER IN THE FOLLOWING ORDER: RIGHT SHOULDER, THEN CENTER, THEN MEDIAN SHOULDER.
 - F. SECOND LAW ENFORCEMENT VEHICLE, LIGHTS AND FLASHERS ON.
- 7. TRAFFIC CONTROL SHOULD BE REMOVED IN THE FOLLOWING ORDER:
 - A. WITH TRAFFIC STOPPED REMOVE THE RI-1 48" X 48" SIGNS TOWARD THE RIGHT SHOULDER, THEN CENTER, THEN SIGN ON THE RIGHT SHOULDER. SECOND LAW ENFORCEMENT VEHICLE LEADS TRAFFIC THROUGH WORK AREA.
 - B. AFTER ALL STOPPED VEHICLES HAVE STARTED MOVING, THE W3-1 48" X 48" SIGNS SHALL BE REMOVED. THESE SIGNS MAY BE COVERED IF RE-USE IS IMMINENT.
 - C. AFTER ALL VEHICLES HAVE RESUMED APPROXIMATELY NORMAL SPEED, THE CHANGEABLE MESSAGE SIGNS SHALL BE TURNED OFF.

- GENERAL NOTES:
- 1. THIS TYPE OF HIGHWAY CLOSURE SHOULD ONLY BE USED FOR CONSTRUCTION OPERATIONS WHEN THE DURATION OF CLOSURE WILL NOT EXCEED 15 MINUTES. THIS TYPE OF HIGHWAY CLOSURE HAS BEEN CLOSED AND REOPENED VIA THIS PROCEDURE A MINIMUM PERIOD OF 15 MINUTES. THE DURATION OF CLOSURE IS SUBJECT TO THE APPROVAL OF THE ENGINEER.
 - 2. AT LEAST TWO LAW ENFORCEMENT OFFICERS AND TWO LAW ENFORCEMENT VEHICLES SHOULD BE PROVIDED ON EACH APPROACH TO THE CLOSURE. EACH LAW ENFORCEMENT VEHICLE SHOULD BE EQUIPPED WITH OPERATING FLASHING BLUE LIGHT OR LIGHT BAR.
 - 3. RESTRICTIONS ON ROAD CLOSURES ARE SPECIFIED IN THE CONTRACT DOCUMENT.
 - 4. THE ADVANCE LAW ENFORCEMENT VEHICLE SHOULD BE MOVED BACK AS REQUIRED BY THE DURING OF STOPPED VEHICLES.
 - 5. THE ORDER OF ERECTION OF CHANGEABLE MESSAGE SIGN, CMS, AT LEAST ONE TRAFFIC CONTROL PLAN SHOULD BE ADJUSTED AS NECESSARY, WITH APPROVAL OF THE ENGINEER.

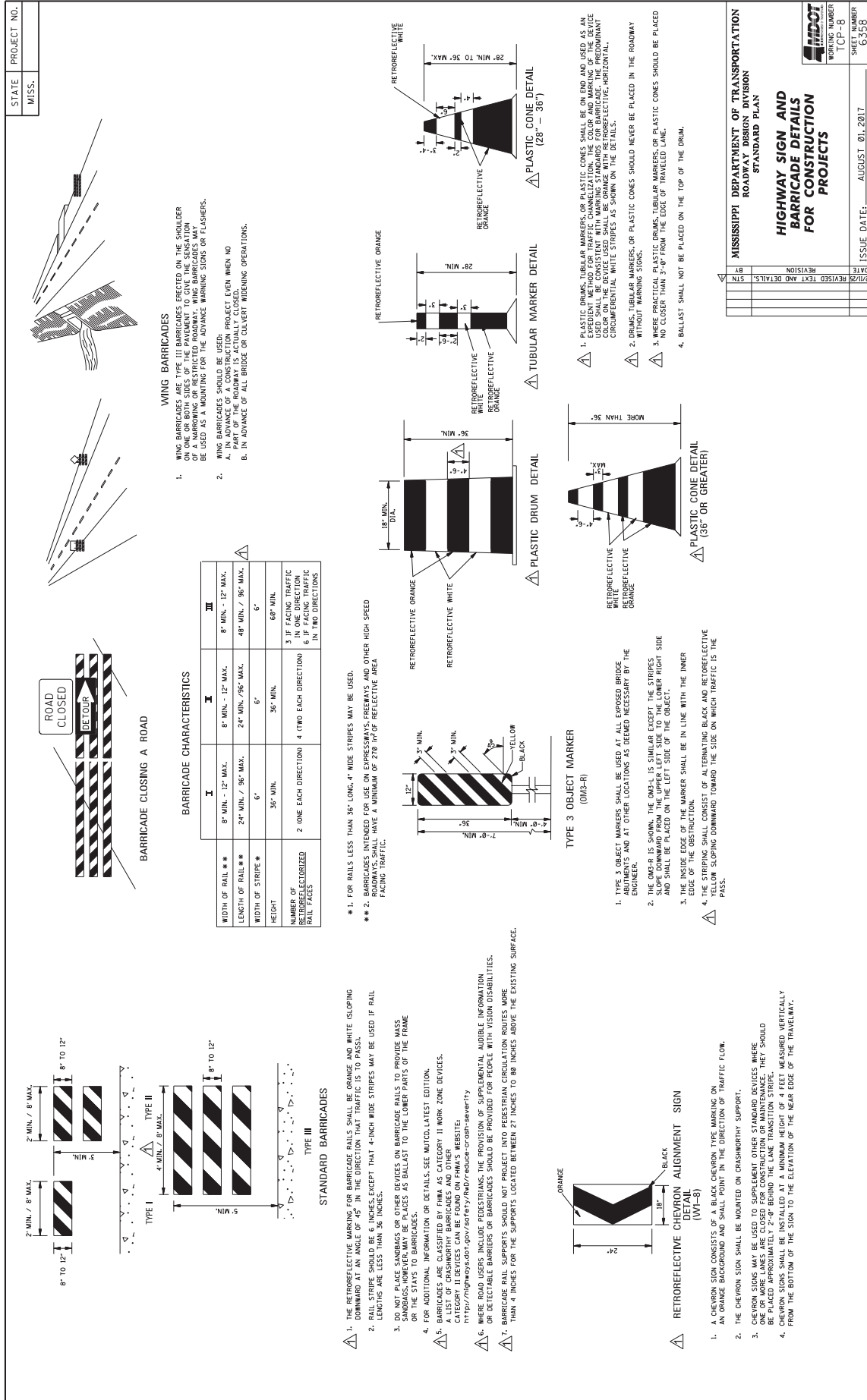

STATE	PROJECT NO.
MISS.	

MOBILE OPERATIONS ON MULTILANE ROAD

MOBILE OPERATIONS ON MULTILANE ROAD

MOBILE OPERATIONS ON TWO-LANE ROAD

MOBILE OPERATIONS ON TWO-LANE ROAD

NOTES FOR MULTILANE LANE OPERATION:

1. SHADOW AND WORK VEHICLES SHALL DISPLAY HIGH-INTENSITY FLASHING ARROWS. A TRUCK-MOUNTED FLASHING ARROW BOARD SHALL BE USED WHEN A FREEWAY LANE IS CLOSED. WHEN MORE THAN ONE FREEWAY LANE IS CLOSED, A SEPARATE ARROW BOARD SHALL BE USED FOR EACH CLOSED LANE.
2. SHADOW VEHICLE 2 SHOULD BE EQUIPPED WITH AN ARROW BOARD AND TRUCK-MOUNTED ATTENUATOR.
3. SHADOW VEHICLE 1 SHOULD BE EQUIPPED WITH AN ARROW BOARD AND TRUCK-MOUNTED ATTENUATOR (TMA).
4. SHADOW VEHICLE 2 SHOULD TRAVEL AT A VARYING DISTANCE FROM THE WORK OPERATION SO AS TO PROVIDE ADEQUATE SIGHT DISTANCE FOR TRAFFIC APPROACHING FROM THE REAR.
5. THE SPACING BETWEEN THE WORK VEHICLES AND THE SHADOW VEHICLES, AND BETWEEN EACH SHADOW VEHICLE, SHOULD BE MINIMIZED TO DETERMINE ROAD USERS FROM DRIVING IN BETWEEN.
6. ON HIGH-SPEED ROADWAYS, A THIRD SHADOW VEHICLE (NOT SHOWN) MAY BE USED WITH SHADOW VEHICLE 1 IN THE CLOSED LANE, SHADOW VEHICLE 2 STRADDLING THE EDGE LINE, AND SHADOW VEHICLE 3 ON THE SHOULDER.
7. ARROW BOARD SHALL BE AS A MINIMUM TYPE B, 60" x 36" IN ACCORDANCE WITH THE CRITERIA PRESENTED IN THE MUTCD.
8. WORK SHOULD NORMALLY BE DONE DURING OFF-PEAK HOURS.

NOTES FOR TWO-LANE OPERATION:

1. WHERE PRACTICAL AND WHEN NEEDED, THE WORK AND SHADOW VEHICLES SHOULD PULL OVER PERIODICALLY TO ALLOW TRAFFIC TO PASS. IF THIS CAN NOT BE DONE FREQUENTLY AS AN ALTERNATIVE, A "DO NOT PASS" SIGN MAY BE PLACED ON THE REAR OF THE VEHICLE BLOCKING THE LANE.
2. THE DISTANCE BETWEEN THE WORK AND SHADOW VEHICLES MAY VARY ACCORDING TO TERRAIN, PAINT DRYING TIME, AND OTHER FACTORS. SHADOW VEHICLES ARE USED TO WARN TRAFFIC OF THE OPERATION AHEAD. WHENEVER ADEQUATE SIGHT DISTANCE IS MAINTAINED, SHADOW VEHICLES SHOULD MAINTAIN THE MINIMUM DISTANCE AND PROCEED AT THE SAME SPEED AS THE WORK VEHICLE. THE SHADOW VEHICLE SHOULD SLOW DOWN IN ADVANCE OF VERTICAL OR HORIZONTAL CURVES THAT RESTRICT SIGHT DISTANCE.
3. ADDITIONAL SHADOW VEHICLES TO WARN AND REDUCE THE SPEED OF ONCOMING OR OPPOSING TRAFFIC MAY BE USED. POLICE PATROL CARS MAY BE USED FOR THIS PURPOSE.
4. A TRUCK-MOUNTED ATTENUATOR (TMA) SHOULD BE USED ON THE SHADOW VEHICLE AND MAY BE USED ON THE WORK VEHICLE.
5. THE WORK VEHICLE SHALL BE EQUIPPED WITH BEACONS, AND THE SHADOW VEHICLES SHOULD BE EQUIPPED WITH BEACONS. SHADOW AND WORK LIGHTS MOUNTED ON THE REAR, ADJACENT TO THE SIGN, SHADOW AND WORK VEHICLES SHALL DISPLAY FLASHING OR ROTATING BEACONS BOTH FORWARD AND TO THE REAR.
6. VEHICLE-MOUNTED SIGNS SHOULD BE MOUNTED WITH THE BOTTOM OF THE SIGN LOCATED AT A MINIMUM HEIGHT OF 48" ABOVE THE PAVEMENT AND SHALL NOT BE OBTURED BY EQUIPMENT ON SIGNPOSTS. SIGN LEGENDS SHALL BE COVERED OR TURNED FROM VIEW WHEN WORK IS NOT IN PROGRESS.
7. ARROW BOARD TO BE USED IN CAUTION MODE.
8. ALL TRAFFIC CONTROL ITEMS SHOWN ON THIS SHEET WILL NOT BE MEASURED FOR SEPARATE PAYMENT. THIS WORK SHALL BE INCLUDED IN THE PRICE BID FOR MAINTENANCE OF TRAFFIC.

NOTES FOR TWO-LANE OPERATION:

9. VEHICLE-MOUNTED SIGNS SHOULD BE MOUNTED WITH THE BOTTOM OF THE SIGN LOCATED AT A MINIMUM HEIGHT OF 48" ABOVE THE PAVEMENT AND SHALL NOT BE OBTURED BY EQUIPMENT OR SUPPLIES. SIGN LEGENDS SHALL BE COVERED OR TURNED FROM VIEW WHEN WORK IS NOT IN PROGRESS.
10. WHEN THE WORK VEHICLE OCCUPIES AN INTERIOR LANE (A LANE OTHER THAN THE FAR RIGHT OR FAR LEFT) OF A FREEWAY, SHADOW VEHICLE 1 SHOULD DRIVE FEET OR MORE IN WIDTH SHADOW VEHICLE 2 SHOULD DRIVE ON THE RIGHT-HAND SHOULDER WITH A SIGN INDICATING THAT WORK IS TAKING PLACE IN THE INTERIOR LANE.
11. ON HIGH-SPEED ROADWAYS, A THIRD SHADOW VEHICLE (NOT SHOWN) MAY BE USED WITH SHADOW VEHICLE 1 IN THE CLOSED LANE, SHADOW VEHICLE 2 STRADDLING THE EDGE LINE, AND SHADOW VEHICLE 3 ON THE SHOULDER.
12. WHERE ADEQUATE SHOULDER WIDTH IS NOT AVAILABLE, SHADOW VEHICLE 3 MAY ALSO STRADDLE THE EDGE LINE.
13. ALL TRAFFIC CONTROL ITEMS SHOWN ON THIS SHEET WILL NOT BE MEASURED FOR SEPARATE PAYMENT. THIS WORK SHALL BE INCLUDED IN THE PRICE BID FOR MAINTENANCE OF TRAFFIC.

MISSISSIPPI DEPARTMENT OF TRANSPORTATION ROADWAY DESIGN DIVISION STANDARD PLAN	
TRAFFIC CONTROL PLAN MOBILE OPERATIONS MULTILANE ROADS AND TWO-LANE ROADS	
DATE	ISSUE DATE: AUGUST 01, 2017
BY	BY
DATE	DATE
REVISION	REVISION
TEXT AND DETAILS	TEXT AND DETAILS
SYMBOLS	SYMBOLS
WORKING NUMBER	WORKING NUMBER
TCP-9	TCP-9
SHEET NUMBER	SHEET NUMBER
6359	6359

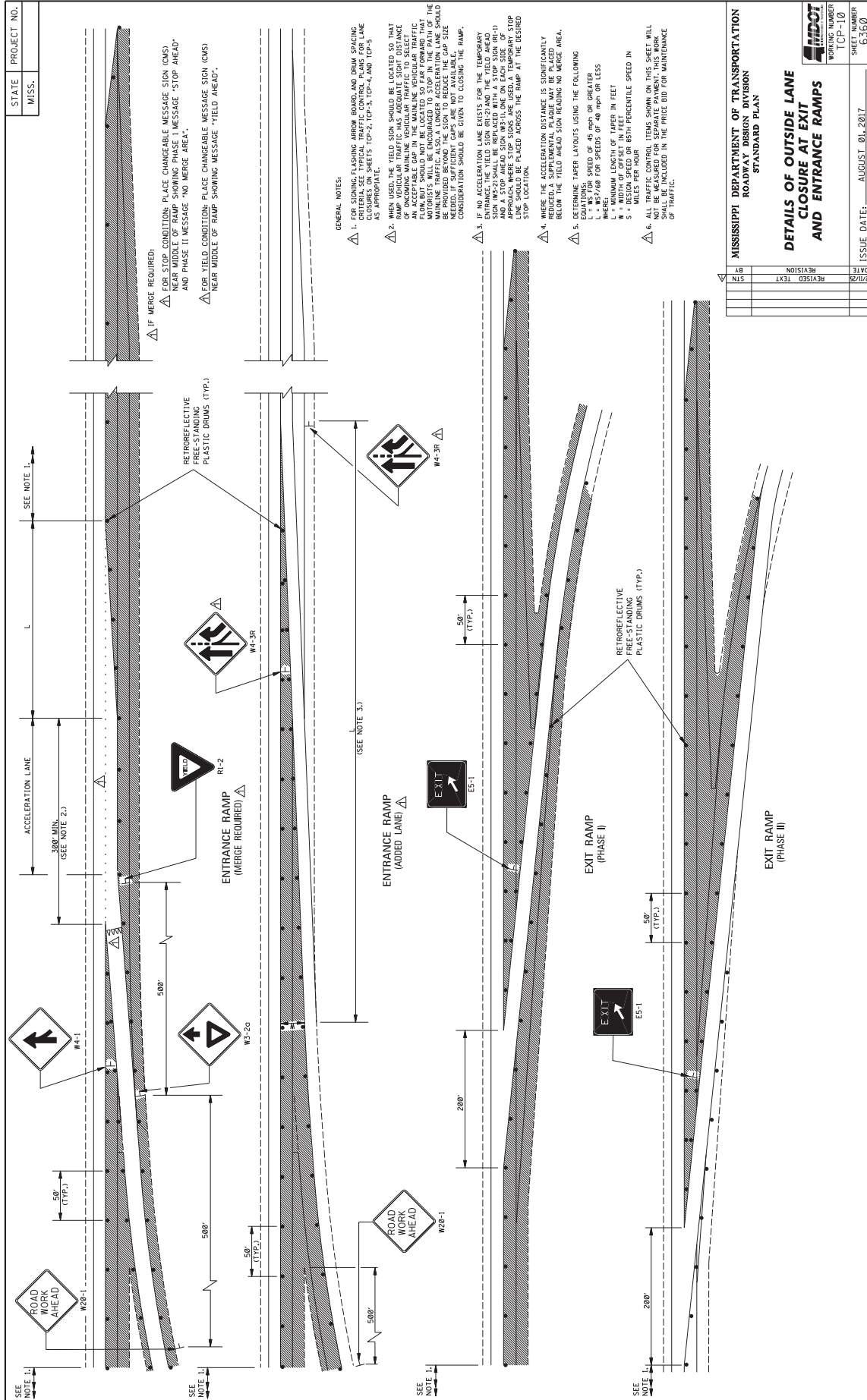

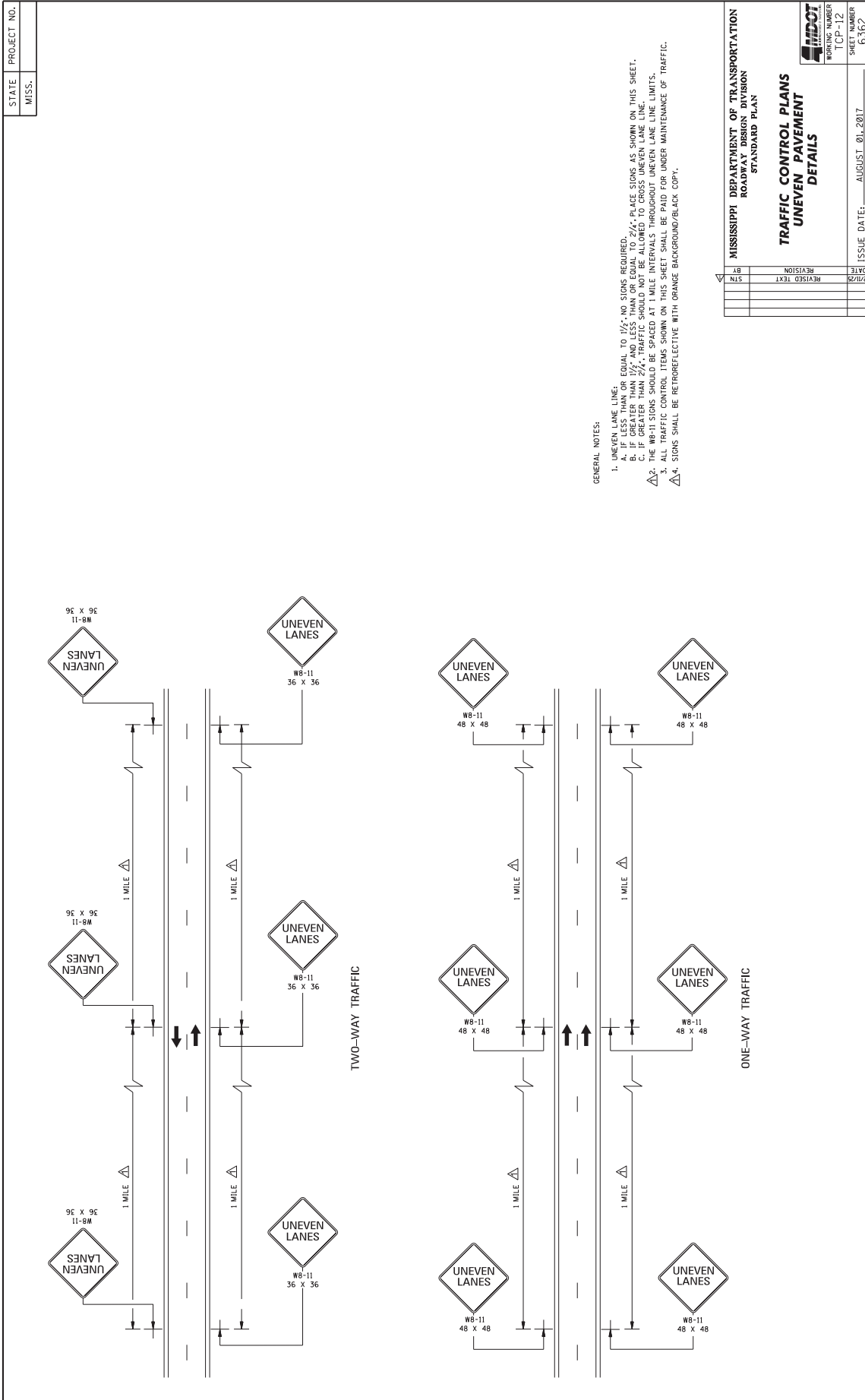

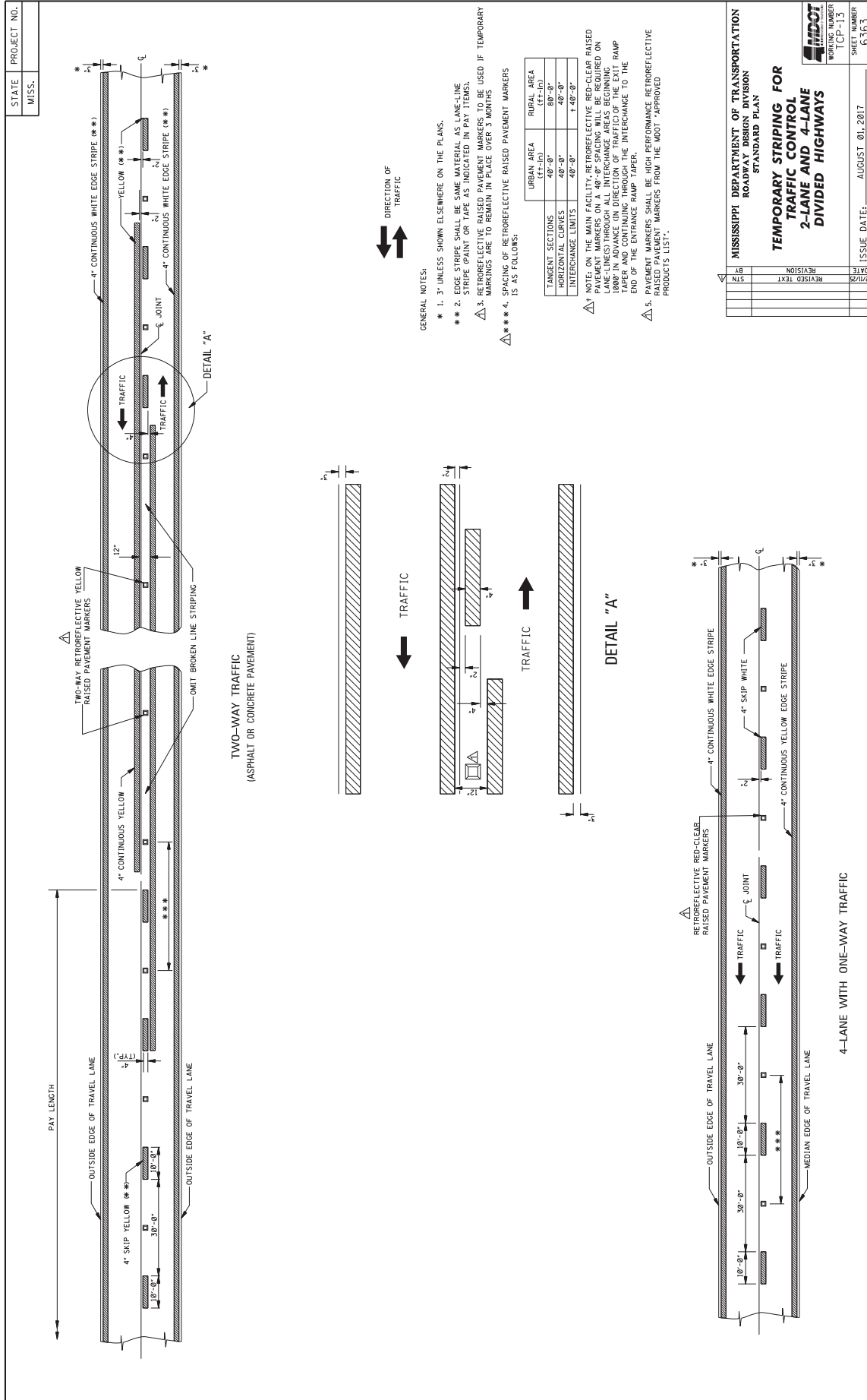

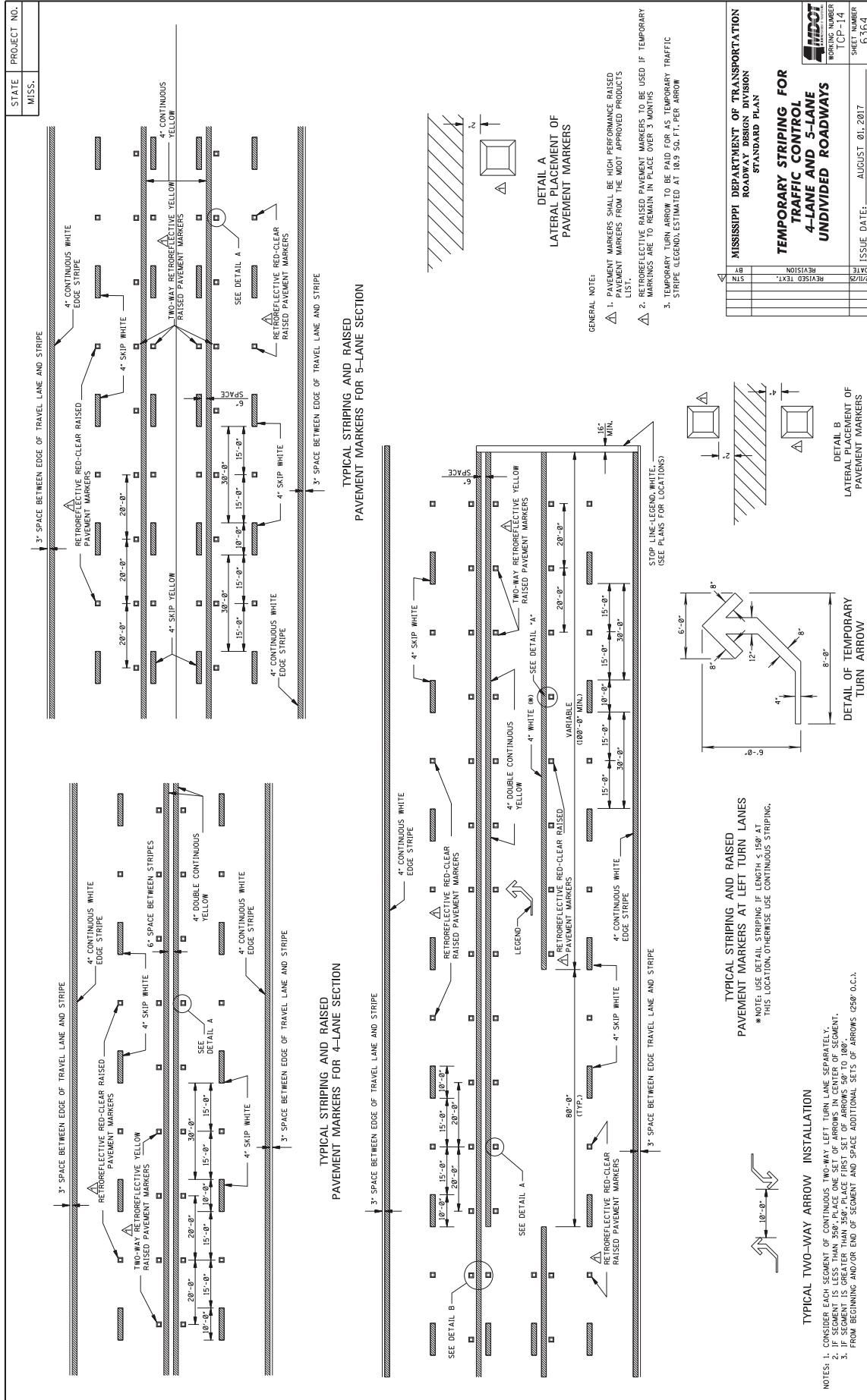

MISSISSIPPI DEPARTMENT OF TRANSPORTATION ROADWAY DESIGN DIVISION STANDARD PLAN	
TEMPORARY STRIPING FOR TRAFFIC CONTROL 4-LANE AND 5-LANE UNDIVIDED ROADWAYS	
DATE	ISSUE DATE: AUGUST 01, 2017
REVISION	SHEET NUMBER 6264
NO.	TCP-14
TEXT	WORKING NUMBER

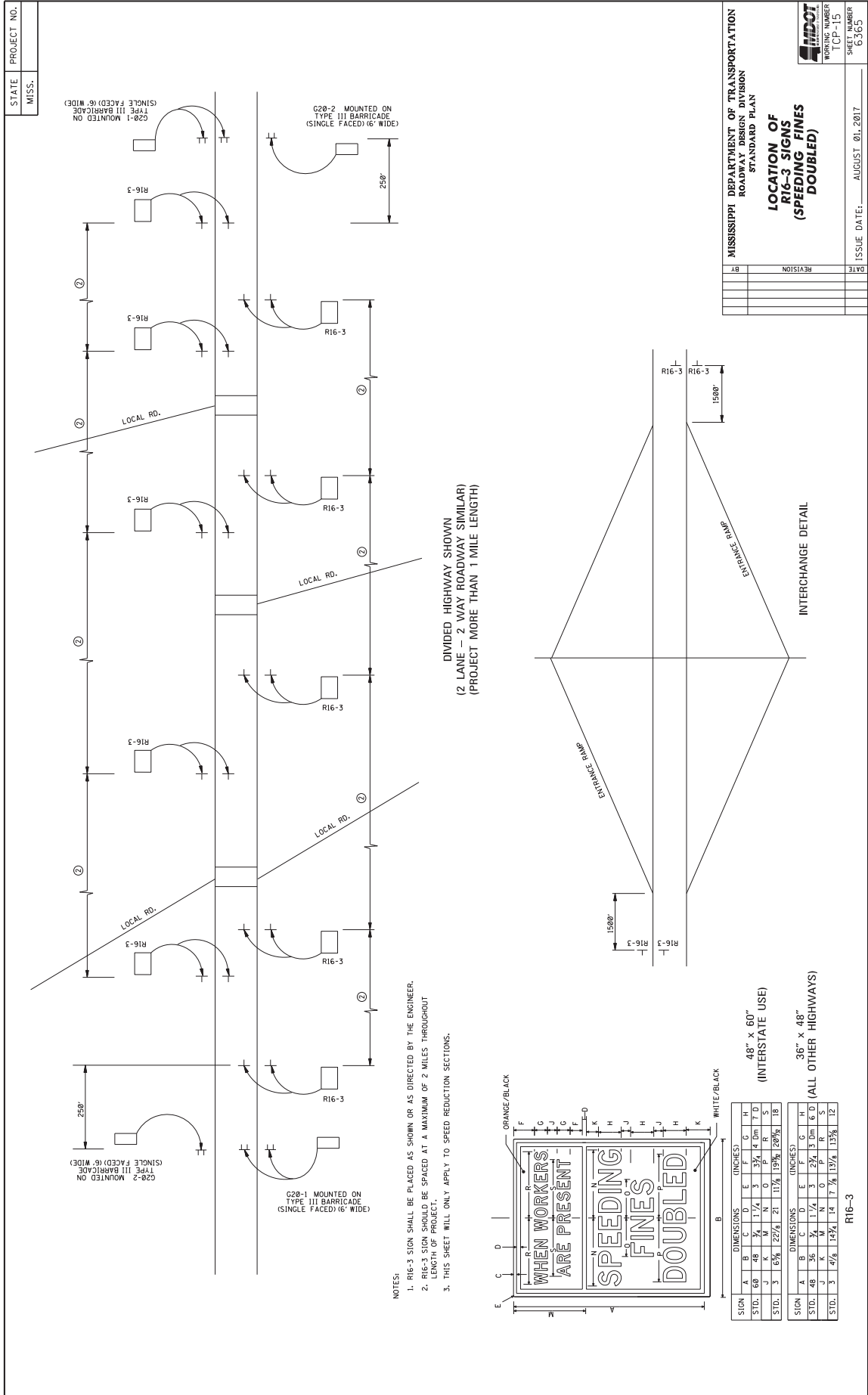

**MISSISSIPPI DEPARTMENT OF TRANSPORTATION
ROADWAY DESIGN DIVISION
STANDARD PLAN**

**LOCATION OF
R16-3 SIGNS
(SPEEDING FINES
DOUBLED)**

ISSUE DATE: AUGUST 01, 2017
SHEET NUMBER: 0363

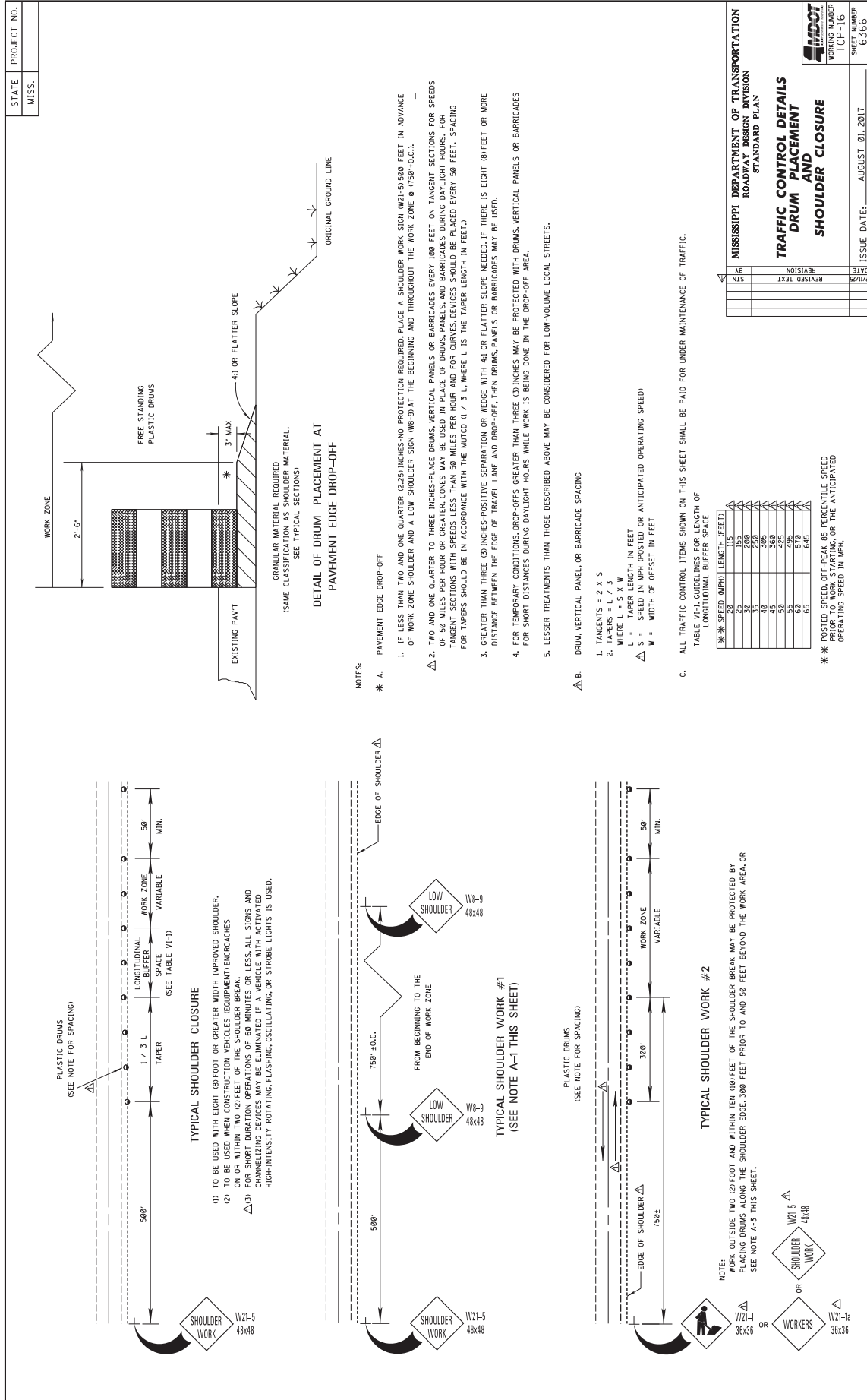

MISSISSIPPI DEPARTMENT OF TRANSPORTATION

SPECIAL PROVISION NO. 907-101-1

CODE: (IS)

DATE: 07/20/2023

SUBJECT: Definitions and Terms

Section 101, Definitions and Terms, of the 2017 Edition of the Mississippi Standard Specifications for Road and Bridge Construction is hereby amended as follows.

907-101.01--Abbreviations. After the abbreviation API on page 1, add the following.

APL Approved Products List

Replace the abbreviation for AWPA on page 1 with the following.

AWPA American Wood Protection Association

907-101.02--Definitions. Delete the sentence after the list of holidays in Subsection 101.02 on page 6 under **holidays, legal**, and substitute the following.

When a legal holiday falls on a Saturday or Sunday, the succeeding Monday, or as proclaimed by the Governor, will be observed as a legal holiday.

Delete the definition for Notice to Proceed in Subsection 101.02 on page 8, and substitute the following.

Notice to Proceed - Written notice to the Contractor to proceed with the contract work.

Delete the definition for “Plans” in Subsection 101.02 on page 8, and substitute the following.

plans - The approved plans, profiles, typical cross-sections, working drawings and supplemental drawings, or exact reproduction thereof, that show the location, character, dimensions, and details of the work to be done. The plans may also include electronic files, referred to on the plans as Electronic Files Identified as Plans, which may include engineering models, spreadsheets, CADD files or other electronic files used to convey design intent. When the contract does not have an official set of plans, reference to the plans shall mean the contract documents.

MISSISSIPPI DEPARTMENT OF TRANSPORTATION

SPECIAL PROVISION NO. 907-102-2

CODE: (IS)

DATE: 11/22/2017

SUBJECT: Bidding Requirements and Conditions

Section 102, Bidding Requirements and Conditions, of the 2017 Edition of the Mississippi Standard Specifications for Road and Bridge Construction is hereby amended as follows.

907-102.01--Prequalification of Bidders. Delete the last sentence of the third paragraph of Subsection 102.01 on page 13, and substitute the following.

The Bidder's Certificate of Responsibility number must be on file with the Department's Contract Administration Division prior to request for permission to bid.

907-102.02--Contents of Proposal Forms. Delete the fourth paragraph in Subsection 102.02 on page 13, and substitute the following.

Prospective bidders must complete an online request for permission to be eligible to bid a project. Upon approval, the bidder will be authorized to submit a bid electronically using Bid Express at <http://bidx.com>.

MISSISSIPPI DEPARTMENT OF TRANSPORTATION

SPECIAL PROVISION NO. 907-103-2

CODE: (SP)

DATE: 06/22/2017

SUBJECT: Award and Execution of Contract

Section 103, Award and Execution of Contract, of the 2017 Edition of the Mississippi Standard Specifications for Road and Bridge Construction is hereby amended as follows.

907-103.01--Consideration of Proposal. Delete the second and third paragraphs of Subsection 103.01 on page 19, and substitute the following.

907-103.01.1--For Projects Constructed Without Federal Funds. Resident Contractors actually domiciled in Mississippi are to be granted preference over nonresidents in awarding of Contracts financed 100% with State funds.

In consideration of proposals that are equal to or in excess of \$50,000 and financed 100% with State funds, a nonresident bidder domiciled in a state having laws granting preference to local Contractors will be considered for such contracts on the same basis as the nonresident bidder's state awards contracts to Mississippi Contractors bidding under similar circumstances. When a nonresident Contractor submits a bid equal to or in excess of \$50,000 on a contract financed 100% with State funds, a copy of the current laws from the state of domicile and an explanation thereof pertaining to treatment of nonresident Contractors shall be attached. If no preferential treatment is provided for Contractors in the state of domicile and contracts are awarded to the lowest responsible bidder, a statement to this effect shall be attached. Should the attachment not accompany the bid when submitted, the Contractor shall have 10 days following the opening of the bids to furnish the required information to the Contract Administration Director for attachment to the bid. Failure to provide the attachment within 10 days will result in the nonresident Contractor's bid being rejected and not considered for award. As used herein, the term "resident Contractor" includes a nonresident person, firm or corporation that has been qualified to do business in this State and has maintained a permanent full-time office in the State of Mississippi for two years prior to the submission of the bid, and the subsidiaries and affiliates of such a person, firm or corporation.

MISSISSIPPI DEPARTMENT OF TRANSPORTATION

SPECIAL PROVISION NO. 907-104-2

CODE: (SP)

DATE: 06/17/2025

SUBJECT: Minor Alteration to the Contract

Section 104, Scope of Work, of the 2017 Edition of the Mississippi Standard Specifications for Road and Bridge Construction is hereby amended as follows:

907-104.02--Alterations of Plans or Character of Work.

907-104.02.3--Minor Alteration to the Contract. In the first paragraph of Subsection 104.02.3 on page 25, change \$10,000.00 to \$25,000.00.

MISSISSIPPI DEPARTMENT OF TRANSPORTATION

SPECIAL PROVISION NO. 907-105-2

CODE: (IS)

DATE: 07/20/2023

SUBJECT: Control of Work

Section 105, Control of Work, of the 2017 Edition of the Mississippi Standard Specifications for Road and Bridge Construction is hereby amended as follows.

907-105.01--Authority of the Engineer. Delete the first sentence of the second paragraph of Subsection 105.01 on page 31, and substitute the following.

The Engineer has the right to suspend the work wholly or in part and to withhold payments because of the Contractor's failure to correct conditions unsafe for workmen or the general public, for failure to carry out provisions of the Contract, or for failure to carry out orders.

907-105.02--Plans and Working Drawings. Delete the first paragraph of Subsection 105.02 on page 31, and substitute the following.

After the contract is executed by the Executive Director, the Contractor will receive, free of charge, two bound copies of the proposal and contract documents (one executed and one blank) two full scale copies of the plans, five half-scale copies of the Plans, and Electronic Files Identified as Plans. The Contractor shall have one copy of the proposal and contract documents and one half-scale copy of the plans available at all times during work activity on the project.

MISSISSIPPI DEPARTMENT OF TRANSPORTATION

SPECIAL PROVISION NO. 907-108-4

CODE: (SP)

DATE: 10/07/2020

SUBJECT: Subletting of Contract

Section 108, Prosecution and Progress, of the 2017 Edition of the Mississippi Standard Specifications for Road and Bridge Construction is hereby amended as follows.

907-108.01--Subletting of Contract.

907-108.01.1--General. Delete the third sentence of the tenth paragraph of Subsection 108.01.1 on the bottom of page 72.

MISSISSIPPI DEPARTMENT OF TRANSPORTATION

SPECIAL PROVISION NO. 907-108-6

CODE: (SP)

DATE: 03/11/2025

SUBJECT: Default and Termination of Contract

Section 108, Prosecution and Progress, of the 2017 Edition of the Mississippi Standard Specifications for Road and Bridge Construction is hereby amended as follows.

907-108.08--Default and Termination of Contract. At the end of the Subsection 108.08 on page 85, add the following.

907-108.08.1--Debarment of Contractor If the Contractor is declared to be in default under this Subsection and the Contract terminated for the reason(s) indicated in Subsections 108.08 (d), (f), or (g) above, the Commission may, in its discretion and in addition to default and termination, declare the Contractor to be debarred from bidding on any other projects for a period of one (1) year from the date of the termination letter. If the debarred Contractor has multiple on-going Contracts with the Commission and receives a one (1) year debarment, the on-going Contract(s) may continue; however, the Contractor will not be allowed to bid another project until one (1) year has passed from date of the termination letter.

MISSISSIPPI DEPARTMENT OF TRANSPORTATION

SPECIAL PROVISION NO. 907-109-5

CODE: (IS)

DATE: 11/14/2023

SUBJECT: Measurement and Payment

Section 109, Measurement and Payment, of the 2017 Edition of the Mississippi Standard Specifications for Road and Bridge Construction is hereby amended as follows.

907-109.01--Measurement of Quantities. Delete the sixth full paragraph of Subsection 109.01 on page 88, and substitute the following.

If appropriate based on the specific circumstances of the project, the Contractor may request that material specified to be measured by the cubic yard or ton be converted to the other measure. The Contractor must submit this request to the Engineer. The Engineer will provide an approval or denial in writing. The decision is in the sole discretion of the Engineer. If approved, factors for this conversion will be determined by the District Materials Engineer and agreed to by the Contractor. The conversion of the materials along with the conversion factor will be incorporated into the Contract by supplemental agreement. The supplemental agreement must be executed before such method of measurement is used.

907-109.04--Extra Work.

907-109.04.1--Supplemental Agreement. Delete the second paragraph of Subsection 109.04.1 on page 90.

907-109.04.2--Force Account Agreement. Delete the last sentence of subparagraph (c) in Subsection 109.04.2 on page 91, and substitute the following.

An amount will be added equal to fifteen percent (15%) of the sum thereof, excluding sales tax.

Delete subparagraph (d) in Subsection 109.04.2 on pages 91 & 92, and substitute the following.

- (d) **Equipment.** Equipment used for force account work shall be of sufficient size and type necessary to perform the required work in an economic and expeditious manner. The Contractor must provide the manufacturer, make, model, year, type of fuel and other necessary information to determine proper hourly payment rates. Subject to advance approval of the Engineer, actual transportation cost for a distance of not more than 200 miles will be reimbursed for equipment not already on the project.

For equipment authorized by the Engineer for use on the force account work, the Engineer will use the equipment rental rates from the “*Rental Rate Blue Book*” as published on the Equipment Watch website www.equipmentwatch.com for the time period the force account work is authorized to determine payment to the Contractor. The maximum allowable rates

are determined as follows:

1. The hourly equipment rate will equal the FHWA total hourly rate. This rate takes into account adjustment factors for age and region.
2. The hourly estimated operating costs have been included in the FHWA total hourly rate.
3. The idle and standby rates shall be as listed in the "*Rental Rate Blue Book*" as reported by *Equipment Watch*.
4. These rates include the basic machine plus any necessary attachments.

Standby rates shall apply when equipment is not in operation and is approved by the Engineer to standby for later use to complete the work. Idle rates shall apply to equipment located on the project and the engine is burning fuel but no ground engaging or other components are actively engaged in meaningful work. In general, idle or standby rates shall apply when equipment is not in use, but will be needed again to complete the work and the cost of moving the equipment will exceed the accumulated standby cost. If the idle standby cost should exceed the equipment moving cost to or from the work site, the Contractor will be entitled to the moving cost only. Idle or standby rates will be used under the following conditions:

1. The equipment is totally dedicated to the force account work and not used intermittently on other work.
2. Idle or standby cost will be considered only after equipment has been operated on force account work.
3. The sum of idle or standby time and operating time shall not exceed eight (8) hours per day or 40 hours in a week.
4. Idle or standby payment will not apply to days not normally considered to be work days such as holidays, weekends, or days of inclement weather when no other work is taking place.

The Department will not pay for idle or standby time when equipment is inoperable, for time spent repairing equipment, or for the time elapsed after the Engineer has advised the Contractor that the equipment is no longer needed. The Department will determine if it will be more cost effective to pay standby time on approved equipment on site or for multiple mobilizations.

If equipment is needed, which is not included in the *Rental Rate Blue Book* as reported by *Equipment Watch*, the Department and Contractor will agree upon reasonable rental rates in writing before the equipment is used.

All equipment shall be subject to approval from day to day in accordance with the requirements of Subsection 108.05.

907-109.06--Partial Payment.

907-109.06.2--Advancement on Materials.

Delete the next to last paragraph of Subsection 109.06.2 on page 95, and substitute the following.

Materials for which an advanced payment has been allowed must be paid for by the Contractor within 30 days of the estimate on which the advanced payment was first allowed and proof of said payment must be verified by the supplier. If proof of payment is not furnished within the allowable 30 days, the advanced payment will be deducted on subsequent current estimates until such time that proof of payment is furnished.

907-109.07--Changes in Material Costs. After the fifth paragraph of Subsection 109.07 on page 96, change the web address to the following.

https://mdot.ms.gov/portal/current_letting

MISSISSIPPI DEPARTMENT OF TRANSPORTATION

SPECIAL PROVISION NO. 907-401-2

CODE: (SP)

DATE: 01/06/2025

SUBJECT: Asphalt Pavement - General

Section 401, Asphalt Pavement - General, of the 2017 Edition of the Mississippi Standard Specifications for Road and Bridge Construction is hereby amended as follows..

907-401.02--Materials.

907-401.02.6--Standards of Acceptance.

907-401.02.6.8--Acceptance Procedure for Pavement Smoothness Using Mean Roughness Index (MRI). Delete the third sentence of the second paragraph of Subsection 401.02.6.8 on page 253, and substitute the following.

The surface shall be tested and corrected to a smoothness index as described herein except those locations or specific projects that are excluded from smoothness testing with an IPS.

Delete the third, fourth and fifth paragraphs of Subsection 401.02.6.8 on pages 253 & 254, and substitute the following.

The smoothness of the surface lift will be determined for traffic lanes, auxiliary lanes, climbing lane and two-way turn lanes. Areas excluded from a smoothness test with the IPS are acceleration and deceleration lanes, tapered sections, transition sections for width, shoulders, crossovers, ramps, side street returns, etc. The roadway pavement on bridge replacement projects having 1,000 feet or less of pavement on each side of the structure will be excluded from a smoothness test. Smoothness testing shall exclude 264 feet from each transverse joint that separates the pavement from a bridge deck, bridge approach slab or existing pavement not constructed under the contract. This can apply to any other exceptions including, but not limited to, railroad crossings and manholes. Segments containing a considerable number of encroachments such as intersections, manholes, curb and gutter sections, etc. may be excluded at the Engineer's discretion.

Once paving has concluded, one final smoothness measurement shall be performed for both pay adjustments and corrective action. Multiple smoothness measurements for pay adjustments and correction can still be performed at the Engineer's discretion. These measurements must be performed at the posted speed limit or 50 miles per hour (± 5 miles per hour), whichever is lower. Measurements will be made in both wheel paths of exterior and interior lanes. The wheel paths shall be designated as being located three feet (3') and nine feet (9') from centerline or longitudinal joint, respectively. Testing will also be required on sections that have been surface corrected. No smoothness testing shall be performed when there is any residual moisture on the

pavement surface. Any additional testing shall meet the requirements of Subsection 907-403.03.2.

The surface lift will be accepted on a continuous interval basis for pavement smoothness. Continuous reporting is based upon all MRI values for a specified running interval. These values are averaged and presented at the midpoint of the specified running interval.

Delete the last sentence of the last paragraph of Subsection 401.02.6.8 on page 254, and substitute the following.

All tests and corrections shall be in accordance with AASHTO R 54, Accepting Pavement Ride Quality When Measured Using Inertial Profiling Systems.

Delete Subsection 401.02.6.9 on pages 254 & 255, and substitute the following.

907-401.02.6.9--Inertial Profiling System.

907-401.02.6.9.1--General. The Inertial Profiling System (IPS), furnished and operated by the Contractor under the supervision of the Engineer or the Engineer’s representative, shall be a dual-line laser on a high speed vehicle meeting the requirements of AASHTO M 328, Standard Specification for Inertial Profiler. Additionally, each IPS should be equipped with a GPS to ensure distance measurement accuracy. The profiler system and operator shall be certified at an MDOT approved regional calibration facility in accordance with AASHTO R 56, Standard Practice for Certification of Inertial Profiler Systems and AASHTO R 57, Operating Inertial Profiler Systems.

907-401.02.6.9.2--Computer Requirements. The computer measurement program must be menu driven, Windows compatible, and able to produce unfiltered profiler runs in the Pavement Profile (*.ppf) file format. The computer shall have the ability to display and print data on site for verification and shall have the ability to save and transfer data via Universal Serial Bus (USB) flash drive, which shall be provided by the Contractor.

All runs must be stored in a directory named in the following format for acceptance by the Project Engineer:

Project_County_Route

All profiler runs must be named in the following format for acceptance by the Project Engineer:

Direction_Lane_BeginStation_EndStation

In addition to manufacturers' software; the latest version of FHWA’s ProVAL software shall be installed on the IPS computer.

907-401.03--Construction Requirements.

907-401.03.1--Specific Requirements.

907-401.03.1.2--Tack Coat. After the first sentence in Subsection 401.03.1.2 on page 256, add the following.

In addition to the products listed on the Department's APL, the Contractor may use one of the following as a tack coat.

- CSS-1
- CSS-1h
- SS-1
- SS-1h

907-401.03.1.4--Density. In the first sentence of the first paragraph of Subsection 401.03.1.4 on page 256, change "preleveling" to "pre-leveling".

907-401.03.9--Material Transfer Equipment. In the third sentence of Subsection 401.03.9 on page 261, change "include:" to "include".

907-401.03.14--Shoulder Wedge. In the second sentence of the first paragraph of Subsection 401.03.14 on page 263, change "cross roads" to "crossroads".

MISSISSIPPI DEPARTMENT OF TRANSPORTATION

SPECIAL PROVISION NO. 907-403-4

CODE: (SP)

DATE: 03/19/2025

SUBJECT: Asphalt Pavements

Section 403, Asphalt Pavements, of the 2017 Edition of the Mississippi Standard Specifications for Road and Bridge Construction is hereby amended as follows:

907-403.03--Construction Requirements.

907-403.03.2--Smoothness Tolerances. In the tenth paragraph of Subsection 403.03.2 on page 283, change “Sections(s)” to “Segment(s)”.

907-403.03.2.1--Smoothness Tolerances for Mean Roughness Index (MRI). After the second paragraph of Subsection 403.03.2.1 on page 283, add the following.

For all projects, smoothness data shall be reported by two MRI methods:

1. A continuous long interval MRI report
2. A continuous 25-foot short interval MRI report

At the bottom of page 283 and top of 284 in Subsection 403.03.2.1, delete the paragraphs for Category, A, Category B, and Category C, and substitute the following.

Category A projects shall have a long interval surface MRI of not more than 60 inches per mile.

Category B projects shall have a long interval surface MRI of not more than 70 inches per mile.

Category C projects shall have the existing surface profiled at no additional cost to the State. These projects shall be measured by a long fixed interval (528-foot) surface MRI and meet the following requirements:

- A 50% improvement in MRI from the existing surface
- or
- 80 inches per mile (whichever value is higher)

Delete the first, second, and third full paragraphs on page 284, and substitute the following.

For all projects, areas of the surface lift with localized roughness greater than 160 inches per mile as determined by the continuous short interval (25’) report will be identified for correction by the Contractor.

When a project has multiple lifts, the intermediate lift shall meet the short interval requirement of 200 inches per mile. Corrective action must be taken on those segments that do not meet this requirement. No unit price adjustment will be applied on the underlying lift.

Delete the table at the bottom of page 284, and substitute the following.

Mean Roughness Index (inches / mile)	Contract Price Adjustment Percent of Asphalt Unit Bid Price
Above 20.0 Over	REMOVE AND REPLACE *
15.1 to 20.0 Over	80
10.1 to 15.0 Over	85
5.1 to 10.0 Over	90
0.1 to 5.0 Over	95
Required Surface MRI	100

* In lieu of removal and replacement, segments may be brought into compliance through corrective action at the discretion of the Project Engineer.

Delete the table and footnote at the top of page 285, and substitute the following.

Mean Roughness Index (inches/mile) Percent Improvement	Contract Price Adjustment Percent of Asphalt Unit Bid Price
Below 30.1 Percent	80 **
30.1 to 35.0 Percent	80
35.1 to 40.0 Percent	85
40.1 to 45.0 Percent	90
45.1 to 50.0 Percent	95
Above 50%	100

** Segments that show less than 30 percent improvement as well as a final surface MRI greater than 100 inches/mile will be subject to removal.

Before the last paragraph on Subsection 403.03.2.1 on page 285, add the following.

Corrective action for all categories must be taken on those segments that exceed the localized roughness or the ‘Remove and Replace’ threshold. All locations must be located and marked by the Contractor and approved by the Project Engineer before corrective action shall take place. The minimum remove and replace length will be 528 feet (0.1 mile). Additional smoothness testing shall be required on segments following corrective action and/or replacement and will be required to meet *at least* the maximum surface MRI short of ‘Remove and Replace’ tolerance.

907-403.05--Basis of Payment.

907-403.05.2--Pay Items. Add the “907” prefix to the list of pay items on page 291.

MISSISSIPPI DEPARTMENT OF TRANSPORTATION

SPECIAL PROVISION NO. 907-407-1

CODE: (SP)

DATE: 01/16/2026

SUBJECT: Tack Coat

Section 407, Tack Coat, of the 2017 Edition of the Mississippi Standard Specifications for Road and Bridge Construction is hereby amended as follows.

907-407.03—Construction Requirements.

907-407.03.3—Application of Bituminous Material.

Delete the second sentence of the first paragraph of Subsection 407.03.3 and substitute the following.

A hand wand will only be allowed for applying tack coat on irregular areas as defined in Subsection 907-401.02.6.4.4.

907-407-05-- Basis of Payment.

Add the “907” prefix to the pay item listed on page 309.

MISSISSIPPI DEPARTMENT OF TRANSPORTATION

SPECIAL PROVISION NO. 907-605-1

CODE: (IS)

DATE: 11/21/2023

SUBJECT: Underdrains

Section 605, Underdrains, of the 2017 Edition of the Mississippi Standard Specifications for Road and Bridge Construction is hereby amended as follows.

907-605.02--Materials.

907-605.02.4--Edge Drain Pipe and Fittings.

907-605.02.4.4--Miscellaneous. Delete the first paragraph of Subsection 605.02.4.4 on page 398, and substitute the following.

Concrete for aprons shall be Class "C" concrete meeting the requirements of Section 907-799.

MISSISSIPPI DEPARTMENT OF TRANSPORTATION

SUPPLEMENT TO SPECIAL PROVISION NO. 907-618-4

DATE: 01/06/2026

PROJECT: SP-0035-01(009) – 109983/301000 – Marshall County

Delete the paragraph in Subsection 907-618.01.2 on page 1, and substitute the following.

For compliance with the traffic control plan, the Contractor will be required to install and maintain traffic control devices at various locations throughout the project. Payment for these devices will be included in the price bid for pay item no. 907-618-A: Maintenance of Traffic per lump sum.

Additional traffic control devices will be required as follows.

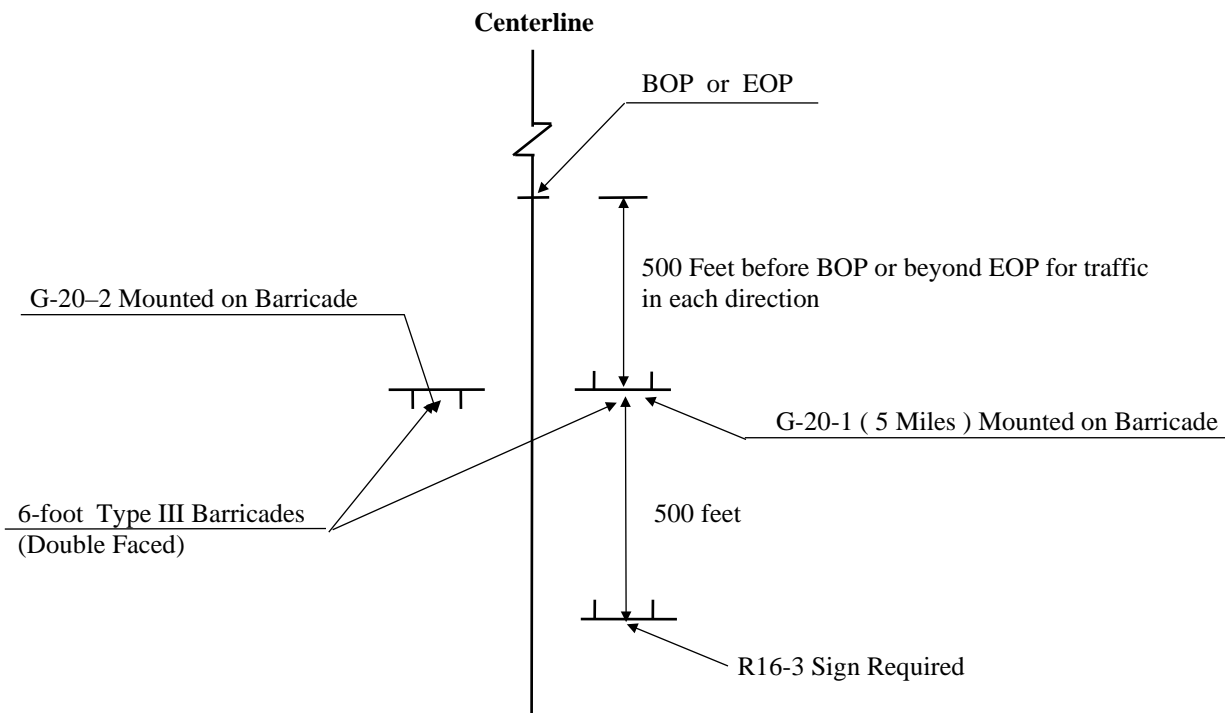

ADDITIONAL TRAFFIC CONTROL SIGNS REQUIRED:

- 34 - W20-1 "AHEAD" signs required. One (1) W20-1 "AHEAD" sign is required at each local road or street entering the project.
- 145 - R4-1 "DO NOT PASS" signs required.
- 17 - R4-2 "PASS WITH CARE" signs required.
- 18 - W14-3 "NO PASSING ZONE" signs required.
- 14 - R16-3 "SPEEDING FINES DOUBLED" signs required.

R4-1 "DO NOT PASS", R4-2 "PASS WITH CARE", and W14-3 "NO PASSING ZONE" signs are required in accordance with Subsection 618.03.3, this drawing, and as specified in the Manual on Uniform Traffic Control Devices.

R16-3 signs shall be spaced in accordance with sheet titled "Location of R16-3 Signs".

All construction signs and barricades shown on this page shall be included in the bid price for pay item 907-618-A, Maintenance of Traffic. Fluorescent orange sheeting shall be used on all construction and traffic control signs except for R16-3, R4-1 and R4-2 signs which shall be black legend and border on white background.

MISSISSIPPI DEPARTMENT OF TRANSPORTATION

SUPPLEMENT TO SPECIAL PROVISION NO. 907-618-4

DATE: 01/06/2026

PROJECT: SP-0035-01(010) – 109984/301000 – Marshall County

Delete the paragraph in Subsection 907-618.01.2 on page 1, and substitute the following.

For compliance with the traffic control plan, the Contractor will be required to install and maintain traffic control devices at various locations throughout the project. Payment for these devices will be included in the price bid for pay item no. 907-618-A: Maintenance of Traffic per lump sum.

Additional traffic control devices will be required as follows.

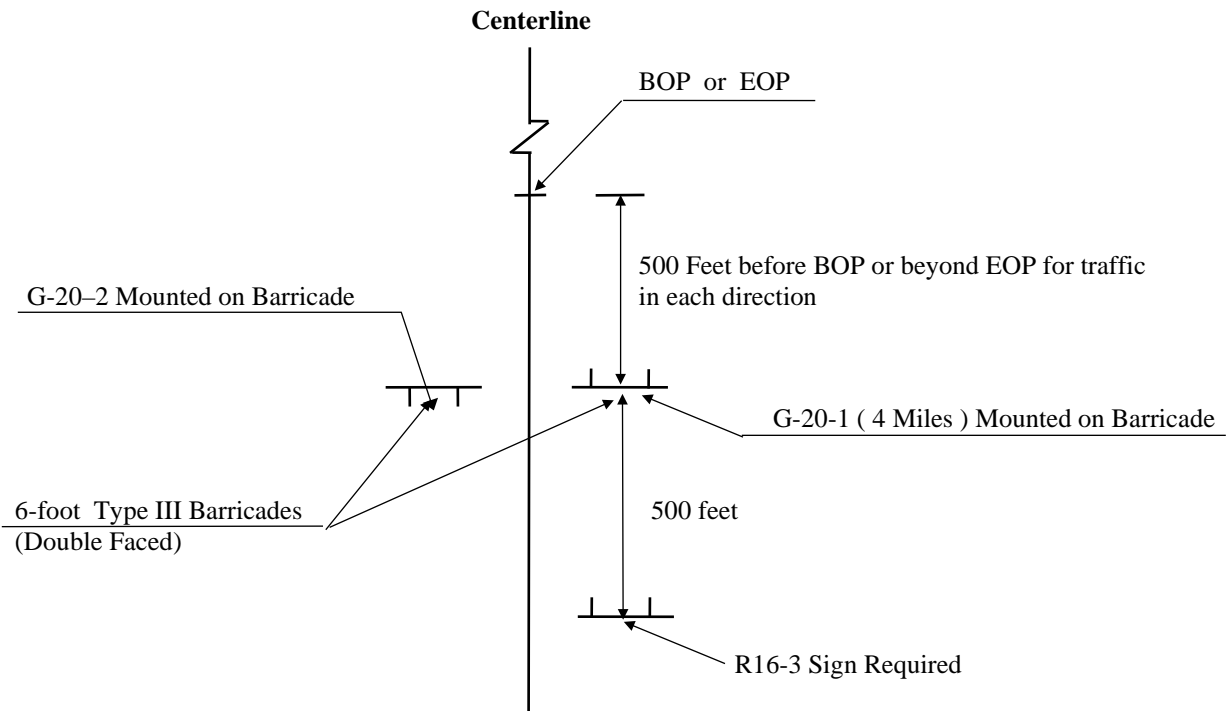

ADDITIONAL TRAFFIC CONTROL SIGNS REQUIRED:

- 34 - W20-1 "AHEAD" signs required. One (1) W20-1 "AHEAD" sign is required at each local road or street entering the project.
- 145 - R4-1 "DO NOT PASS" signs required.
- 17 - R4-2 "PASS WITH CARE" signs required.
- 18 - W14-3 "NO PASSING ZONE" signs required.
- 14 - R16-3 "SPEEDING FINES DOUBLED" signs required.

R4-1 "DO NOT PASS", R4-2 "PASS WITH CARE", and W14-3 "NO PASSING ZONE" signs are required in accordance with Subsection 618.03.3, this drawing, and as specified in the Manual on Uniform Traffic Control Devices.

R16-3 signs shall be spaced in accordance with sheet titled "Location of R16-3 Signs".

All construction signs and barricades shown on this page shall be included in the bid price for pay item 907-618-A, Maintenance of Traffic. Fluorescent orange sheeting shall be used on all construction and traffic control signs except for R16-3, R4-1 and R4-2 signs which shall be black legend and border on white background.

STATE PROJECT NO.
MISS.

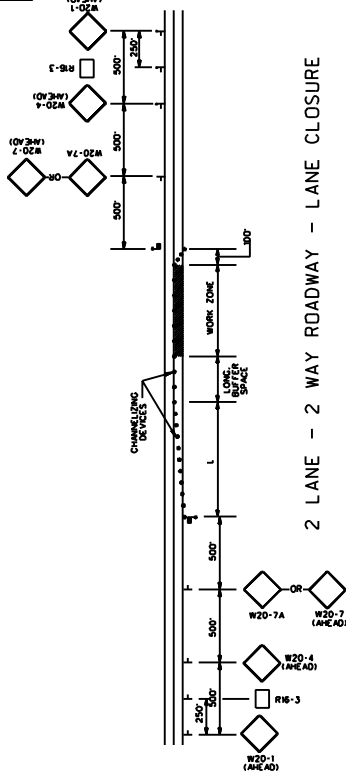

2 LANE - 2 WAY ROADWAY - LANE CLOSURE

DIVIDED HIGHWAY
(PROJECTS LESS THAN 1 MILE LENGTH)

- NOTES
- 1. R16-3 SIGN TO BE PLACED AS SHOWN OR AS DIRECTED BY THE ENGINEER.
 - 2. R16-3 SIGN SHALL BE SPACED AT A MAXIMUM OF 2 MILES THROUGHOUT LENGTH OF PROJECT.

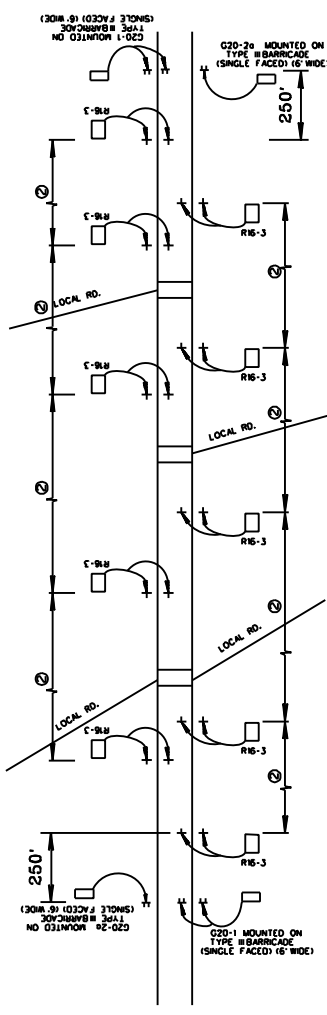

DIVIDED HIGHWAY SHOWN
(2 LANE - 2 WAY ROADWAY SIMILAR)
(PROJECT MORE THAN 1 MILE LENGTH)

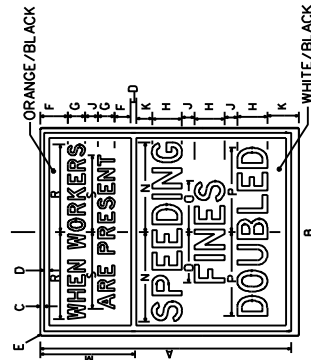
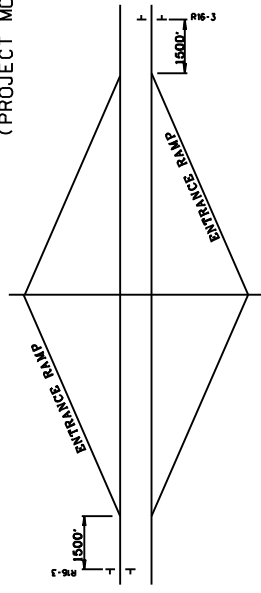

SIZE	DIMENSIONS (INCHES)											
300	A	B	C	D	E	F	G	H	I	J	K	L
300	60	48	3/4	1/4	3/4	1/4	1/4	1/4	1/4	1/4	1/4	1/4
300	J	K	M	N	O	P	R	S				
300	3	6 1/2	2 1/4	2 1/4	1 1/4	1 1/4	1 1/4	1 1/4				

SIZE	DIMENSIONS (INCHES)											
300	A	B	C	D	E	F	G	H	I	J	K	L
300	48	36	3/4	1/4	3/4	1/4	1/4	1/4	1/4	1/4	1/4	1/4
300	J	K	M	N	O	P	R	S				
300	3	6 1/2	2 1/4	2 1/4	1 1/4	1 1/4	1 1/4	1 1/4				

48" x 60" (INTERSTATE USE)

36" x 48" (ALL OTHER HIGHWAYS)

R16-3

MISSISSIPPI DEPARTMENT OF TRANSPORTATION

LOCATION OF R16-3 SIGNS

REVISION	BY	DATE

WORKING NUMBER

SHEET NUMBER

FILE NAME: SPEED_SIGN_DETAIL.DWG

DATE: 02/08/09

CHECKED: _____

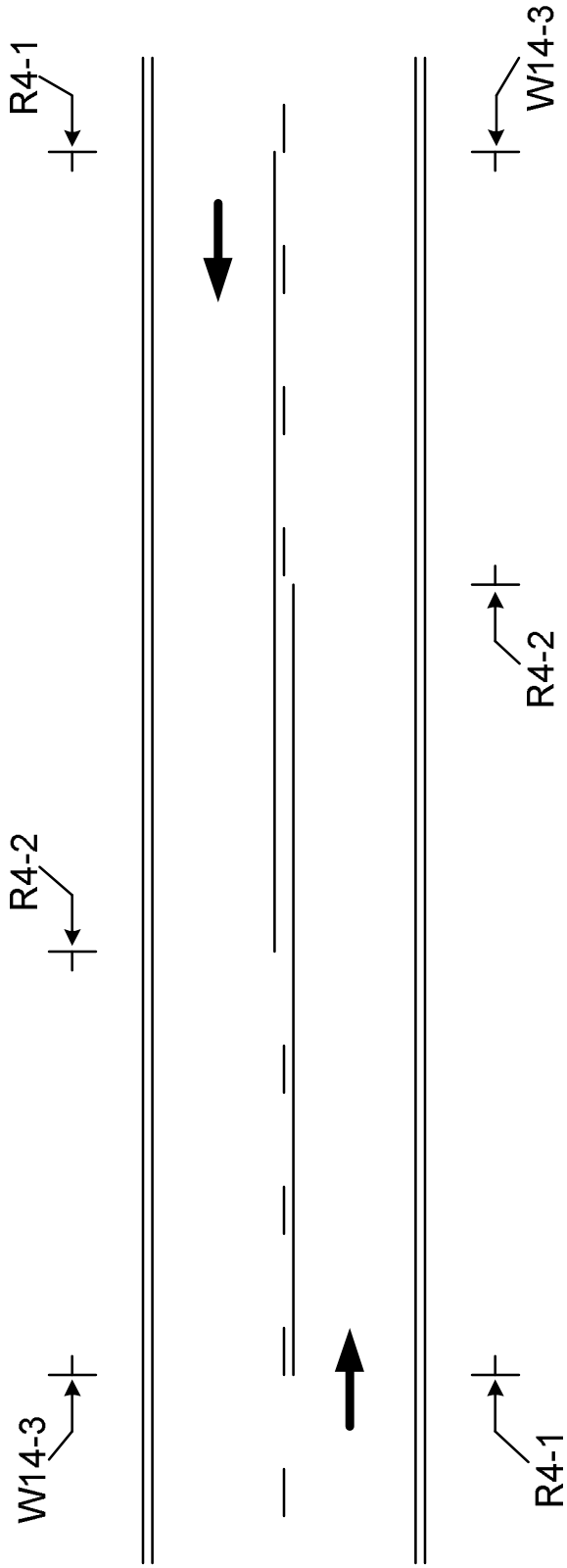

The W14-3, No Passing Zone sign, shall be placed on the left side of the road at the beginning of each no passing zone.

The R4-1, Do Not Pass signs, shall be placed on the right side of the road at the beginning of the no passing zone. Additional R4-1 signs shall be placed right and left in increments of 750 to 1000 feet throughout the length of the no passing zone.

The R4-2, Pass With Care sign, shall be placed on the right side of the road at the end of the no passing zone.

The R4-1, R4-2 and W14-3 signs are to be used when standard pavement markings are not in place. The signs may also be used to emphasize pavement markings.

MISSISSIPPI DEPARTMENT OF TRANSPORTATION

SPECIAL PROVISION NO. 907-618-4

CODE: (SP)

DATE: 02/01/2018

SUBJECT: Additional Signing Requirements

Section 618, Maintenance of Traffic and Traffic Control Plan, of the 2017 Edition of the Mississippi Standard Specifications for Road and Bridge Construction is hereby amended as follows.

907-618.01.2--Traffic Control Plan. At the end of Subsection 618.01.2 on page 441, add the following:

For compliance with the traffic control plan, the Contractor will be required to install and maintain traffic control devices at various locations throughout the project. Payment for these devices will be included in the price bid for pay item no. 618-A, Maintenance of Traffic per lump sum.

MISSISSIPPI DEPARTMENT OF TRANSPORTATION

SPECIAL PROVISION NO. 907-618-12

CODE: (SP)

DATE: 05/03/2024

SUBJECT: Traffic Control Management

Section 618, Maintenance of Traffic and Traffic Control Plan, of the 2017 Edition of the Mississippi Standard Specifications for Road and Bridge Construction is hereby amended as follows.

907-618.01--Description.

907-618.01.2--Traffic Control Management. Delete subparagraph (g) of Subsection 618.01.2 on page 441, and substitute the following.

- g) Perform a minimum of once-a-week inspections from the Notice to Proceed until a Partial or Final Maintenance Release is obtained. Once work begins, daily daytime inspections and weekly nighttime inspections are required on projects with predominantly daytime work, and daily nighttime inspections and weekly daytime inspections are required on projects with predominantly nighttime work. Weekly inspections will be allowed for periods outside of active construction. When lane closures are present or any non-fixed signs or traffic handling devices such as cones or barrels are in place, inspections shall be performed daily whether work is being performed or not.

907-618.05--Basis of Payment. Delete pay item 618-A on page 449 and substitute the following.

907-618-A: Maintenance of Traffic

- lump sum

MISSISSIPPI DEPARTMENT OF TRANSPORTATION

SPECIAL PROVISION NO. 907-619-6

CODE: (SP)

DATE: 03/21/2018

SUBJECT: Temporary Portable Rumble Strips

Section 619, Traffic Control for Construction Zones, of the 2017 Edition of the Mississippi Standard Specifications for Road and Bridge Construction is hereby amended as follows.

907-619.02--Materials. After Subsection 619.02.15 on page 472, add the following.

907-619.02.16--Temporary Portable Rumble Strips. Temporary portable rumble strips shall be RoadQuake manufactured by PSS and meet the following requirements:

- capable of being installed without adhesives or bolts,
- have a minimum weight of 100 pounds,
- have a minimum overall length of 11 feet,
- have a minimum width of 12 inches, and
- have a maximum height of 3/4 inch.

Temporary portable rumble strips shall be installed in accordance with the attached details, or as directed by the Engineer.

907-619.03--Construction Requirements. After Subsection 619.03.11 on page 476, add the following.

907-619.03.16--Temporary Portable Rumble Strips. Temporary portable rumble strips shall be placed at locations shown on the traffic control plans, attached drawing, or as directed by the Engineer. The rumble strips shall be removed when lane closures are removed, relocated when lane closures are relocated, or as directed by the Engineer.

Prior to placement of the rumble strips, the roadway shall be cleaned to be free of dust, sand, and other materials that may cause slippage. The minimum roadway temperature at the time of installation shall be in accordance with manufacturer recommendations.

A minimum of three (3) temporary portable rumble strips shall be arranged in an array. The spacing of temporary portable rumble strips in each array shall be on 15-foot centers. One array of three (3) strips shall be used in each lane. The rumble strips shall be regularly monitored and maintained to ensure they stay in place under traffic.

907-619.04--Method of Measurement. At the end of Subsection 619.04 on page 478, add the following.

Temporary Portable Rumble Strips will be measured for payment by the linear foot only when a pay item for temporary portable rumble strips is included in the contract. Otherwise, temporary portable rumble strips will be included in the cost of pay item 618-A, Maintenance of Traffic. The quantity of temporary portable rumble strips will be the length of rumble strips approved by the Engineer to be in-place on the project at any one time.

907-619.05--Basis of Payment. After the fifth paragraph of Subsection 619.05 on page 478, add the following.

Temporary Portable Rumble Strips measured as prescribed above, will be paid for at the contract unit price per linear foot, which price shall be full compensation for cleaning the roadway surface, installing the rumble strips, maintenance and repair of the strips, cleaning and resetting of the strips, removal and replacement, and for all labor, equipment, tools, and incidentals necessary to complete the work.

After the last pay item listed on page 480, add the following.

907-619-B: Temporary Portable Rumble Strips - per linear foot

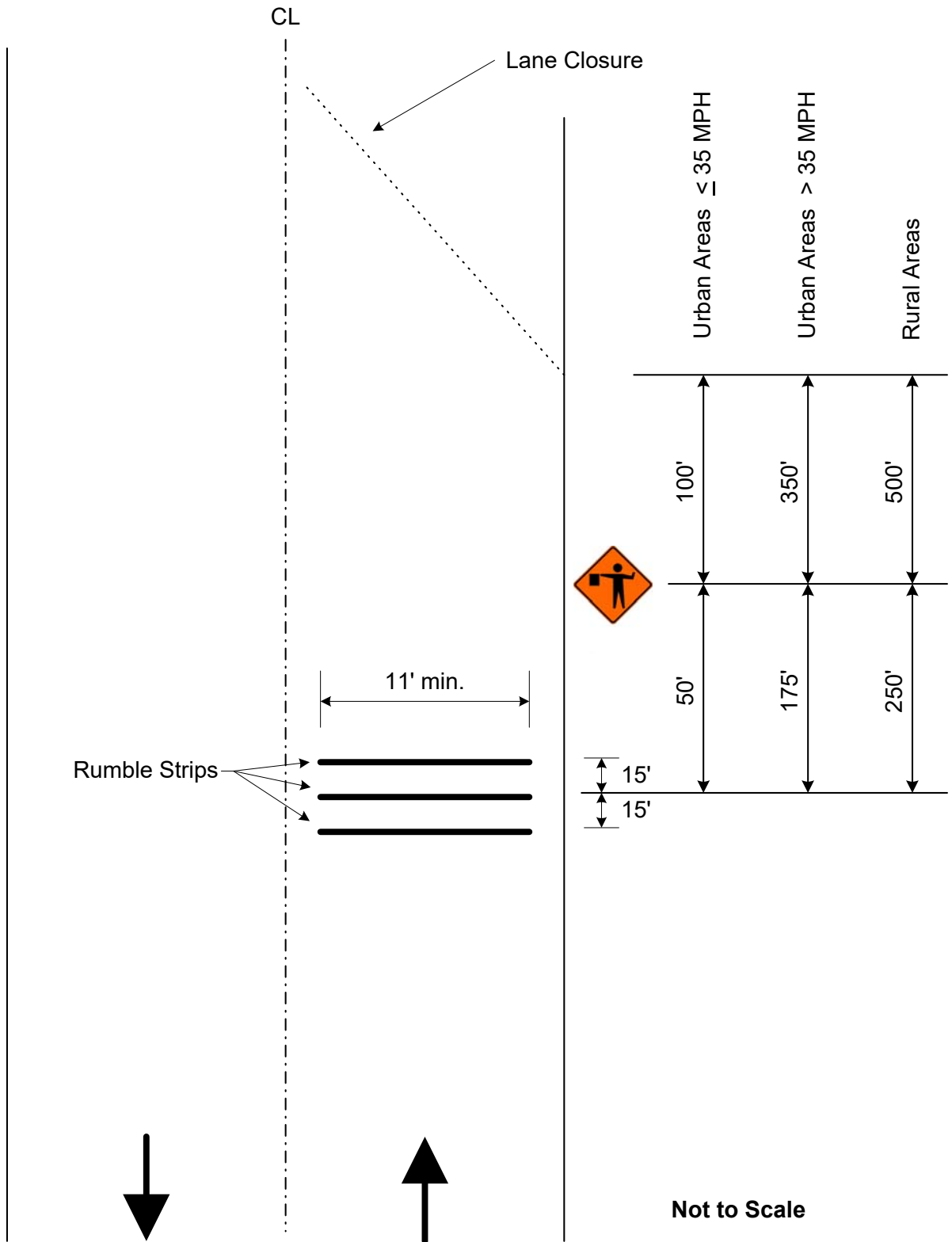

Detail of Temporary Portable Rumble Strips

MISSISSIPPI DEPARTMENT OF TRANSPORTATION

SPECIAL PROVISION NO. 907-626-12

CODE: (IS)

DATE: 06/17/2025

SUBJECT: Thermoplastic Traffic Markings

Section 626, Thermoplastic Traffic Markings, of the 2017 Edition of the Mississippi Standard Specifications for Road and Bridge Construction is hereby amended as follows.

Delete Section 626 on pages 492 thru 496, and substitute the following.

SECTION 626 - THERMOPLASTIC TRAFFIC MARKINGS

907-626.01--Description. This work consists of furnishing materials and placing thermoplastic pavement markings of the type specified in conformity with these specifications and the details shown on the plans or established. All hot-applied thermoplastic pavement markings shall be coated with a double-drop combination of optics.

This work may also consist of placing an audible bump or puck style marking system on the edge line that provides an audible and vibratory warning when driven over. The marking system shall be a road marking system of the dimensions indicated at regular and predetermined intervals.

This work may also consist of placing a profile or raised shape marking system on centerline or edge line that provides audible and vibratory warning when driven over. The marking system shall be a road marking system of the dimensions indicated and at regular and predetermined intervals. When placed on centerline, the markings system shall consist of an extruded black transverse thermoplastic bar of the dimensions indicated at regular and predetermined intervals.

This work may also consist of placing high contrast thermoplastic markings. High contrast thermoplastic markings shall consist of placing thermoplastic pavement markings over a black thermoplastic pavement marking to enhance the marking's visibility.

All pavement marking material, excluding lines over rumble strips, shall be applied using the extrusion/ribbon method. Lines placed over rumble strips shall be applied using the atomization/spray method, [unless the extrusion/ribbon method can be demonstrated to perform adequately and is approved by the Engineer.](#)

Permanent pavement marking tape (permanent cold plastic tape) may be used in lieu of hot applied thermoplastic markings. Substitution will only be allowed for pay items 907-626-A through H. Substituted pavement marking tape shall be of the same color and width as that required for the hot applied thermoplastic. Unless otherwise specified, the markings, whether hot applied or pavement marking tape, shall be of the same type of material for the entire project. Stop bars and crosswalks shall not be substituted with pavement marking tape and shall be alkyd hot-applied thermoplastic markings or heat-fused preformed pavement markings. Material and construction

requirements for substituted pavement marking tape shall meet the requirements of Special Provision 907-628. The layout and spacing for substituted pavement markings will remain as shown in the plans, or in the contract documents, for hot applied thermoplastic markings. Measurement of adhesive substituted pavement markings shall be made in accordance with Special Provision 907-628. Payment for adhesive substituted pavement markings shall be made at the unit price for the appropriate hot applied thermoplastic marking.

When thermoplastic pavement markings are used on bridge decks or concrete surfaces, the surface shall be sealed with an epoxy sealer prior to the application of thermoplastic.

907-626.02--Materials. All pavement marking materials shall meet the requirements of Special Provision 907-720.

907-626.02.1--Audible Bumps. Audible bumps shall have a profile such that the leading and trailing edges are sloped at a sufficient angle to create an audible and vibratory warning.

Audible bumps shall be at least 0.45 inches above the pavement surface at the highest point of the bump. The height shall be measured after the application of drop-on material. The bumps shall have a minimum dimension of two and one-half inches (2½") in both transverse and longitudinal directions. The bumps may have a drainage channel. The width of each drainage channel shall not exceed one-quarter of an inch (¼") at the bottom of the channel.

907-626.02.2--Audible Transverse Bars. The length of transverse bars is the measurement lateral to the direction of travel, also known as transverse width. The width of transverse bars is the measurement parallel to the travel way.

Transverse bars on centerline shall have a length of 10 inches, a width of three inches (3"), and a height of 350 mils. Transverse bars on centerline shall be placed on 2-foot centers through no-passing zones and 5-foot centers through passing zones. Transverse bars on centerline shall be placed in advance of permanent thermoplastic markings.

Transverse bars on edge lines shall have a length of six inches (6"), a width of three inches (3"), and a height of 350 mils. Transverse bars on edge lines shall be placed on 2-foot centers. Tolerance for the longitudinal and transverse measurements shall be one quarter of an inch (¼") and the tolerance for height shall be 50 mils. The above dimensions are based on 6-inch strip application.

Thermoplastic material for edge line transverse bars shall be as specified on the Plans and meet the requirements of Special Provision 907-720 or as specified on the plans. Thermoplastic material for centerline transverse bars shall be black and shall meet the requirements of Special Provision 907-720.

907-626.02.3--High Contrast Markings. High contrast markings shall be black with the pertinent marking color overlaid on top and shall meet the requirements of Special Provision 907-720.

907-626.03--Construction Requirements.

907-626.03.1--Equipment. Equipment for hot application shall be of sufficient size and stability to ensure smooth, uniform, properly aligned markings of the dimensions specified. The equipment shall be suitably equipped for heating and controlling the flow of the material. The equipment shall be constructed to provide continuous mixing and agitation of the material. The conveying parts of the equipment, between the main material reservoir and applicator, shall be so constructed as to prevent accumulation and clogging. The equipment shall be constructed so that all mixing and conveying parts, up to and including the applicator, maintain the material at the plastic temperature. The thermoplastic material shall be dispensed at a temperature recommended by the manufacturer. The applicator shall include a cutoff device remotely controlled to provide clean, square stripe ends and to provide a method for applying skip lines. The thermoplastic reservoir shall be insulated and equipped with an automatic thermostatic control to maintain the proper temperature of the material.

The application equipment shall be capable of automatic placement of intermittent and continuous line patterns in single or double line applications simultaneously. The intermittent timer mechanism shall provide a variable ratio of materials applied and variable cycle length such that accurate placement of new patterns, or replacement of existing patterns can be achieved.

The equipment shall also be capable of applying the top dressing of optics (beads) in a manner that firmly embeds them into the surface of the thermoplastic material for at least one half of the diameter of the larger gradation sizes of the optics. The dispensing equipment shall be equipped with an automatic cut-off control for the application of the optics that is synchronized with the cut-off of the thermoplastic material.

Optics applied to the surface of the completed stripe shall be applied by an automatic dispenser attached to the pavement marking equipment in such a manner that the optics are immediately dispensed upon the completed line. The dispenser shall be equipped with an automatic cutoff control, synchronized with the cutoff of the pavement marking equipment. The double-drop optics as defined in 907-720 shall be automatically applied at a uniform rate to achieve the minimum retroreflectivity requirements of 907-626.

907-626.03.2--Construction Details. The thermoplastic compound shall be screed or ribbon extruded to the pavement surface. Heat-fused, pre-formed pavement markings shall be fusible to asphalt surfaces by means of the normal heat of a propane weed-burner type of torch or other heating device as recommended by the manufacturer. Heat-fused, pre-formed pavement markings shall be instantly highly reflective without the application of additional optics.

Thermoplastic markings shall not be applied to the pavement surface when the pavement surface temperature is less than 55°F. The pavement surface shall be dry, to the satisfaction of the Engineer, before application will be permitted. Unless otherwise specified by the manufacturer, thermoplastic pavement marking material shall be applied to the surface between 400°F and 450°F with a recommended application temperature being 420°F.

Immediately before application, all areas to be marked shall be thoroughly cleaned. Cleaning may be done by rotary brooms, air blast, scrapers, or whatever combination of equipment is necessary to clean the pavement thoroughly without damage to the pavement surface. On areas of pavement

cured with compound, the membrane shall be removed completely by shot blasting, sand blasting or other approved method. Before edge striping, particular care shall be taken to remove all vegetation, loose soil, and the like from the area to be marked. Should other methods fail, the surface shall be wetted with a water jet and scrubbed as necessary to dislodge all foreign material. After washing, the surface shall be allowed to dry thoroughly, and all films of dried mud apparent after surface drying shall be removed before application of markings. Marking shall follow as closely as practicable after the surface has been cleaned and dried, but no markings shall be applied until the surface has been inspected and permission given to proceed. The cost for preparing the surface shall be included in the contract unit prices for the marking items.

Unless otherwise directed by the Engineer, traffic stripes that are conflicting with the thermoplastic stripe shall be removed prior to placement of the thermoplastic material. Removal of pavement markings shall be done by a means that will not gouge the surface of the pavement in a manner that requires patching to ensure the integrity of the pavement. Temporary paint stripe may be left in place when satisfactorily placed in the proper location. Any temporary stripe not covered shall be removed. Payment for removal of stripe, except temporary stripe, will be made under Section 202.

On newly constructed asphalt pavements, any sand, grit, or other surface contaminants shall be removed using compressed air and/or sweeping. Water blasting may be necessary to remove surface contaminants which cannot be removed by the use of compressed air and/or sweeping. This work is considered surface preparation.

The finished lines shall have well defined edges and the thickness of thermoplastic markings above the roadway surface shall be no less than 90 mils for edge lines, center lines, lane lines, barrier lines, and detail stripe including gore markings, and no less than 120 mils for crosswalks, stop lines, and railroad, word and symbol markings. The minimum thickness, as required above, will be measured in the center of the line when gauged. The minimum thickness one-half inch (1/2") from the edges shall not be less than 75% of the thickness required in the center.

Any thermoplastic traffic marking less than the required thickness shall be corrected by recapping at no additional costs to the Department. Although a thickness tolerance of 25 percent from center to edge is allowed, a consistent underrun of any amount in thickness as determined by the Engineer will not be acceptable.

The length and width of lines shall be within a tolerance of ± 3 inches and $\pm 1/8$ inch, respectively. For skip markings, the tolerance for intervals shall not exceed the line length tolerance. On curves, unsightly variations from the normal curvature will not be permitted unless specifically shown on the plans or ordered by the Engineer.

Heat-fused, pre-formed pavement markings shall be supplied with a minimum average thickness of 90 mils before application on the roadway surface.

All newly applied thermoplastic material shall be protected from traffic until the material is sufficiently dry so as not to sustain damage from vehicle tires. Any material so damaged by traffic shall be repaired, and the thermoplastic material tracked onto the pavement shall be removed and

replaced.

907-626.03.3--Reflectivity Requirements. The longitudinal pavement markings shall meet the following retroreflectivity values when measured within 10 to 30 calendar days of placement, after removing loose beads.

Table 1. Minimum Dry Retroreflectivity

Color	All Stripe without Rumble mcd/m ² /lx	Rumble Stripe mcd/m ² /lx
White	375	250
Yellow	225	150

For projects with less than two miles between the BOP and EOP, retroreflectivity measurements will not be required.

907-626.03.3.1--Measuring Devices. Retroreflectivity measurements are required to be taken using a vehicle mounted mobile retroreflectometer using 30-meter geometry with video and mapping capabilities as per AASHTO T-398. The retroreflectometer and operator shall be certified by the manufacturer, authorized representative of the manufacturer, or an MDOT approved program such as the Texas A&M Transportation Institute (TTI) Mobile Retroreflectometer Certification Program. The Contractor shall provide copies of current certifications for the operator(s) and the device(s) to the Engineer.

907-626.03.3.2--Acceptance Procedure. Averages of the mobile measurements shall be provided for every 0.1 miles unless otherwise specified or approved. Take measurements on each section of roadway for each series of markings (i.e., edge line, center skip line, each line of a double line, etc.) and for each direction of traffic flow. Measure each line in both directions for centerlines on two-way roadways (i.e., measure both double solid line in both directions and measure all center skip lines in both directions). Furnish measurements in compliance with the below requirements. Use all equipment in accordance with the manufacturer’s recommendations and directions. Inform the Engineer at least 24 hours before taking any measurements.

A marking meets the retroreflectivity requirements if:

- The combined average retroreflectivity value for a one-mile segment meets the minimum retroreflectivity values specified, and
- Within the one-mile segment, no more than three consecutive 0.1 mile intervals shall have an average retroreflectivity value below the minimum required value.

The one-mile segment will start from the beginning of the data collection and end after a mile worth of measurements have been taken; each subsequent mile of measurements will be a new segment. If the remainder is 0.5 miles or less, it shall be included in the previous mile segment, otherwise the remaining segment of greater than 0.5 mile shall be its own segment. Centerlines with 2 stripes (either solid or broken) will result in 2 miles of data for each mile segment. Each centerline stripe must be tested for compliance as a stand-alone stripe.

The Contractor may elect to restripe with a minimum of 0.060 in. (60 mils) at no cost to the Department each one-mile segment that failed to meet the minimum retroreflectivity requirements.

Measurements shall be retaken within 10 to 30 calendar days after the second application for the mile segment for that series of markings. If the markings do not meet minimum retroreflectivity after the second application, the Engineer may require removal of all existing markings, a new application as initially specified, and a repeat of the application process until minimum retroreflectivity requirements are met.

907-626.03.3.3--Mobile Retroreflectivity Data Collection. Mobile Retroreflectivity Data Collection (MRDC) shall be conducted on dry pavement only and when the ambient air temperature is greater than 40°F. Data shall be submitted to the Engineer no later than 3 working days after the day the data is collected. Submit all raw data collected in addition to all other data submitted. Provide data files in Microsoft Excel format or a format approved by the Engineer. The data file and video must contain the following information.

907-626.03.3.3.1--Data File. Data files shall be provided with the following:

- Date;
- District;
- County;
- Name of mobile retroreflectometer operator;
- Route number with reference markers or other reference information provided by the Engineer to indicate the location of beginning and end data collection points on that roadway;
- Cardinal direction;
- Line type (single solid, single broken, double solid, etc.);
- Line color;
- File name corresponding to video;
- Data for each centerline listed separately;
- Average reading taken for each 0.1-mi. interval (or interval designated by the Engineer);
- Accurate GPS coordinates (within 20 ft.) for each interval;
- Color-coding for each interval indicating passing or failing, unless otherwise directed by the Engineer (passing and failing thresholds provided by the Engineer);
- Graphical representation of the MRDC (y-axis showing retroreflectivity and x-axis showing intervals) corresponding with each data file;
- Distance in miles driven while measuring the pavement markings;
- Event codes (pre-approved by the Engineer) indicating problems with measurement;
- Upper validation threshold (may be included separately with the raw data but must be clearly identified with the data collected using that threshold).

907-626.03.3.3.2--Map. A map shall be provided in an electronic format approved by the Engineer with each MRDC submission that includes the following information:

- Date;
- District number;
- County;

- Color-coded 1-mi. intervals (or interval length designated by the Engineer) for passing and failing retroreflectivity values or retroreflectivity threshold values provided by the Engineer; and
- Percentage of passing and failing intervals, if required by the Engineer.

907-626.03.3.3.3--Video. A high-quality video file shall be provided with the following information:

- Date and corresponding data file name on label;
- District number;
- County;
- Route number with reference markers or other designated reference information to indicate the location of beginning and end collection points on that roadway; and
- Retroreflectivity values presented on the same screen with the following information:
 - Date;
 - Location;
 - Starting and ending mileage;
 - Total miles;
 - Retroreflectivity readings; and
 - Upper validation thresholds (may be included separately with the raw data but must be clearly identified with the data collected using that threshold).

907-626.03.4--Reflectivity Verification Testing. The Engineer or a third party may perform retroreflectivity verification testing on any project. At a minimum, each Contractor performing work for the Department will be verified on an annual basis. The Contractor-submitted retroreflectivity data will be compared to the verification test data to determine acceptability of the Contractor's mobile retroreflectometer data. Comparison of the data will result in one of the two scenarios below:

- Contractor's Data is Validated – If the difference between Contractor's and Engineer/third party data is 20% or less, then the Contractor's data is validated. The Contractor's data will be used for acceptance.
- Contractor's Data is not Validated – If the difference between the Contractor's and Engineer/third party data is more than 20%, then the Contractor's data is not validated. The Engineer/third party data will be used for acceptance and the Contractor will be required to take corrective action prior to additional Contractor data collection and may require re-certification of the mobile retroreflectometer.

907-626.04--Method of Measurement. Thermoplastic stripe completed in accordance with the plans and specifications will be measured by the mile or by the linear foot, as indicated, from end-to-end of individual stripes. In the case of skip lines the measurement will include skip intervals. The length used to measure centerline, lane lines, and edge stripes will be the horizontal length computed along the roadway.

Detail traffic stripe will be measured by the linear foot from end-to-end of individual stripes. Measurements will be made along the surface of each stripe and will exclude skip intervals where

strips are specified. Stripes more than six inches (6") in width will be converted to equivalent lengths of 6-inch stripe.

Hot-applied legend, which is to include railroad markings, pedestrian crosswalks, and stop lines, will be measured by the square foot or linear foot. Pay areas of individual letters and symbols will usually be shown on the plans and measured by the square foot. Transverse railroad bands, pedestrian crosswalks and stop lines will generally be measured by the linear foot, in which case, stripes more than six inches (6") in width will be converted to equivalent lengths of 6-inch widths.

Pre-formed legend which is to include railroad markings and pedestrian crosswalks will be measured and paid for by each.

The length measured for thermoplastic audible bump edge stripe will not include the permanent thermoplastic edge stripe. Permanent thermoplastic edge stripe will be measured for payment under a separate pay item.

Thermoplastic audible bar centerline skip stripe will be measured by the linear foot or mile. Measurements will be made along the surface from end-to-end of the stripe and will include skip intervals. The length used to measure audible bar centerline stripe will be the horizontal length computed along the roadway. The length measured for thermoplastic audible bar centerline skip stripe will not include the permanent centerline continuous or skip stripe. Permanent centerline continuous and skip stripe will be measured for payment under separate pay items.

Thermoplastic audible bar edge stripe will be measured by the linear foot or mile. Measurements will be made along the surface from end-to-end of the stripe. The length used to measure thermoplastic audible bar edge stripe will be the horizontal length computed along the roadway. The length measured for thermoplastic audible bar edge stripe will not include the permanent thermoplastic edge stripe. Permanent thermoplastic edge stripe will be measured for payment under a separate pay item.

907-626.05--Basis of Payment. Thermoplastic traffic markings will be paid for at the contract unit price per mile, linear foot, square foot or each as applicable. Any deductions for non-satisfactory material test results will be made after final testing has been performed.

Payment will be made under:

- 907-626-A: 6" Thermoplastic Traffic Stripe, Skip White - per linear foot or mile
- 907-626-B: 6" Thermoplastic Traffic Stripe, Continuous White - per linear foot or mile
- 907-626-C: 6" Thermoplastic Edge Stripe, Continuous White - per linear foot or mile
- 907-626-D: 6" Thermoplastic Traffic Stripe, Skip Yellow - per linear foot or mile
- 907-626-E: 6" Thermoplastic Traffic Stripe, Continuous Yellow - per linear foot or mile

907-626-F:	6" Thermoplastic Edge Stripe, Continuous Yellow	- per linear foot or mile
907-626-G:	Thermoplastic Detail Stripe, Color *	- per linear foot
907-626-H:	Thermoplastic Legend, Color *	- per linear foot, square foot, or per each
907-626-Q:	Thermoplastic Audible Bump Edge Stripe	-per linear foot or mile
907-626-R:	Thermoplastic Detail Audible *** Stripe, Color **,	-per mile
907-626-AA:	6" High Contrast Thermoplastic Traffic Stripe, Skip White	- per linear foot or mile
907-626-BB:	6" High Contrast Thermoplastic Traffic Stripe, Continuous White	- per linear foot or mile
907-626-CC:	6" High Contrast Thermoplastic Edge Stripe, Continuous White	- per linear foot or mile
907-626-DD:	6" High Contrast Thermoplastic Traffic Stripe, Skip Yellow	- per linear foot or mile
907-626-EE:	6" High Contrast Thermoplastic Traffic Stripe, Continuous Yellow	- per linear foot or mile
907-626-FF:	6" High Contrast Thermoplastic Edge Stripe, Continuous Yellow	- per linear foot or mile
907-626-GG:	High Contrast Thermoplastic Detail Stripe, Color *	- per linear foot
907-626-HH:	High Contrast Thermoplastic Legend, Color *	- per linear foot, square foot, or each

- * Indicate Blue - ADA if applicable
- ** Indicate White or Black
- *** Indicate Centerline - Passing Zone, Centerline - No-Passing Zone, or Edge Line

MISSISSIPPI DEPARTMENT OF TRANSPORTATION

SPECIAL PROVISION NO. 907-627-1

CODE: (IS)

DATE: 06/24/2024

SUBJECT: Raised Pavement Markers

Section 627, Raised Pavement Markers, of the 2017 Edition of the Mississippi Standard Specifications for Road and Bridge Construction is hereby amended as follows:

Delete Subsection 627.02 on page 496, and substitute the following.

907-627.02--Materials. Pavement and jiggle markers of the types specified shall conform to the applicable requirements of Subsection 907-720.06 and shall be listed on the Department's APL.

Type B through G High Performance reflective markers shall be listed on the Department's APL for high performance raised pavement markers.

The bituminous adhesive for pavement markers shall meet the requirements of Subsection 907-720.07.3.

907-627.05--Basis of Payment. Add the "907" prefix to the pay items listed on page 498.

MISSISSIPPI DEPARTMENT OF TRANSPORTATION

SUPPLEMENT TO SPECIAL PROVISION NO. 907-701-4

DATE: 11/05/2024

SUBJECT: Hydraulic Cement

907-701.04--Blended Hydraulic Cement.

907-701.04.1--Types of Blended Hydraulic Cement. After the last paragraph of Subsection 907-701.04.1 on page 1, add the following.

Blended cement Types IL meeting the “HE” high early strength requirement listed in AASHTO M 240, Table 3 shall have the “(HE)” suffix added to the type designation.

MISSISSIPPI DEPARTMENT OF TRANSPORTATION

SPECIAL PROVISION NO. 907-701-4

CODE: (IS)

DATE: 11/21/2023

SUBJECT: Hydraulic Cement

Section 701, Hydraulic Cement, of the 2017 Edition of the Mississippi Standard Specifications for Road and Bridge Construction is hereby amended as follows.

907-701.01--General. In the first sentence of the second paragraph of Subsection 701.01 on page 718, change “mills” to “plants.”

In the second sentence of the sixth paragraph of Subsection 701.01 on pages 718 and 719, change “shall” to “will.”

907-701.02--Portland Cement.

907-701.02.1--General. Delete Subsections 701.02.1.1, 701.02.1.2, 701.02.2, 701.02.2.1, and 701.02.2.2 on pages 719 and 720, and substitute the following.

907-701.02.1.1--Types of Portland Cement. Portland cement shall be either Type I, Type II, or Type III conforming to AASHTO M85 or Type III (MS). Type III (MS) is defined as a Type III cement conforming to AASHTO M85 having a maximum tricalcium aluminate (C₃A) content of 8%.

907-701.02.2--Blank.

907-701.02.2.1--Blank.

907-701.02.2.2--Blank.

Delete Subsection 701.04 on pages 720 and 721, and substitute the following.

907-701.04--Blended Hydraulic Cement.

907-701.04.1--Types of Blended Hydraulic Cement. Blended hydraulic cements (blended cements) shall be of the following types and conform to AASHTO M 240:

- Type IL – Portland-limestone cement
- Type IP – Portland-pozzolan cement
- Type IS – Portland blast-furnace slag cement

Blended cement Types IL, IP, and IS meeting the “MS” sulfate resistance requirement listed in AASHTO M 240, Table 3 shall have the “(MS)” suffix added to the type designation.

MISSISSIPPI DEPARTMENT OF TRANSPORTATION

SPECIAL PROVISION NO. 907-702-4

CODE: (IS)

DATE: 09/11/2018

SUBJECT: Bituminous Materials

Section 702, Bituminous Materials, of the 2017 Edition of the Mississippi Standard Specifications for Road and Bridge Construction is hereby amended as follows.

907-702.04--Sampling. Delete the sentence in Subsection 702.04 on page 722, and substitute the following.

Sampling of bituminous materials shall be as set out in AASHTO R 66.

907-702.07--Emulsified Asphalt. Delete the last sentence in Subsection 702.07 on page 724, and substitute the following.

Asphalt for fog seal shall conform to the requirements of Subsection 907-702.12, Table V.

907-702.12--Tables. Delete Table V in Subsection 702.12 on page 729, and substitute the following.

**TABLE V
SPECIFICATION FOR FOG SEAL**

Test Requirements	LD-7		CHPF-1		Test Method
	Min.	Max.	Min.	Max.	
Viscosity, Saybolt Furol, @ 25°C, Sec.	10	100	-	100	AASHTO T 72
Storage Stability Test, 24 hr, %	-	1	-	1	AASHTO T 59
Settlement, 5 day, %	-	5	-	-	AASHTO T 59
Oil Distillate, %	-	1	-	-	AASHTO T 59
Sieve Test, % *	-	0.3	-	0.1	AASHTO T 59
Residue by Distillation, %	40	-	40	-	AASHTO T 59
Test on Residue from Distillation					
Penetration @ 25°C, 100g, 5 sec	-	20	40	90	AASHTO T 49
Softening Point, °C	65	-	-	-	ASTM D 36
Solubility in trichloroethylene, %	97.5	-	-	-	AASHTO T 44
Elastic Recovery @ 25°C, %	-	-	40	-	AASHTO T 301
Original DSR @ 82° (G*/Sinδ, 10 rad/sec)	1	-	-	-	AASHTO T 111

* The Sieve Test result is tested for reporting purposes only and may be waived if no application problems are present in the field.

MISSISSIPPI DEPARTMENT OF TRANSPORTATION

SPECIAL PROVISION NO. 907-703-2

CODE: (SP)

DATE: 11/29/2022

SUBJECT: Gradation

Section 703, Aggregates, of the 2017 Edition of the Mississippi Standard Specifications for Road and Bridge Construction is hereby amended as follows.

907-703.03--Coarse Aggregates for Hydraulic Cement Concrete.

907-703.03.2--Detail Requirements.

907-703.03.2.4--Gradation. In the table in Subsection 703.03.2.4 on page 734, add 100 for the percent passing by weight on the 1½-inch sieve for Size No. 67 aggregates.

Delete Note 2 under the table in Subsection 703.03.2.4 on page 734, and substitute the following.

Note ² – 100 percent shall pass the 1-inch sieve for Size 67 used in Class F and Class FX concrete.

MISSISSIPPI DEPARTMENT OF TRANSPORTATION

SPECIAL PROVISION NO. 907-705-1

CODE: (IS)

DATE: 06/13/2018

SUBJECT: Stone Riprap

Section 705, Stone Blanket Protection and Filter Blanket Materials, of the 2017 Edition of the Mississippi Standard Specifications for Road and Bridge Construction is hereby amended as follows.

907-705.04--Stone Riprap. Delete the last sentence of the first paragraph of Subsection 705.04 on page 750, and substitute the following.

Quality requirements for rock to be furnished under these specifications will come from a pre-approved source and be visually approved prior to use.

MISSISSIPPI DEPARTMENT OF TRANSPORTATION

SPECIAL PROVISION NO. 907-707-3

CODE: (IS)

DATE: 10/27/2021

SUBJECT: Joint Materials

Section 707, Joint Materials, of the 2017 Edition of the Mississippi Standard Specifications for Road and Bridge Construction is hereby amended as follows.

907-707.02--Joint Filler.

907-707.02.2--Preformed Sponge, Rubber, Cork and Closed-Cell Polypropylene Foam Joint Fillers for concrete Paving and Structural Constructions. Delete the two paragraphs of Subsection 707.02.2 on page 755, and substitute the following.

Preformed joint filler shall conform to AASHTO M 153 for sponge, rubber, and cork and tested according to ASTM D545. The type required will be indicated on the plans.

Closed-cell polypropylene foam shall conform to the requirements in ASTM D8139 and tested in accordance with ASTM D545.

907-707.02.3--Wood. Delete paragraph (b) of Subsection 707.02.3 on page 755, and substitute the following:

- (b) Dimensions shall be as shown on the plans. Dimensions shown on the plans are “dressed” sizes in accordance with Table 3 of the American Softwood Lumber Standard, SP-20. At the discretion of the Engineer, a 3/4-inch dressed board may be used in lieu of a 1-inch dressed board. A tolerance of plus or minus 1/16 inch thickness and plus or minus 1/8 inch width will be permitted. For slip-form paving a tolerance of minus 1/4 inch on each end in length will be permitted.

907-707.06--Flexible Plastic Gasket for Joining Conduit. Delete the third paragraph of Subsection 707.06 on page 756, and substitute the following.

The Department may require the performance test described in ASTM C 990.

MISSISSIPPI DEPARTMENT OF TRANSPORTATION

SPECIAL PROVISION NO. 907-711-2

CODE: (IS)

DATE: 09/11/2018

SUBJECT: Plain Steel Wire

Section 711, Reinforcement and Wire Rope, of the 2017 Edition of the Mississippi Standard Specifications for Road and Bridge Construction is hereby amended as follows.

907-711.02--Deformed and Plain Carbon-Steel Bars for Concrete Reinforcing.

907-711.02.3--Steel Welded and Non-Welded Wire Reinforcement, Plain and Deformed, for Concrete.

907-711.02.3.1--Plain Steel Wire. Delete the sentence in Subsection 711.02.3.1 on pages 780 and 781, and substitute the following.

Plain steel wire and plain steel welded wire shall conform to the requirements of AASHTO M 336.

MISSISSIPPI DEPARTMENT OF TRANSPORTATION

SPECIAL PROVISION NO. 907-712-1

CODE: (SP)

DATE: 12/07/2021

SUBJECT: Fence and Guardrail

Section 712, Fence and Guardrail, of the 2017 Edition of the Mississippi Standard Specifications for Road and Bridge Construction is hereby amended as follows.

907-712.01--General. After the sentence in Subsection 712.01 on page 785, add the following.

All materials' inspection, testing, and certification will be performed in accordance with the requirements of the current version of the Department's *Materials Division Inspection, Testing, and Certification Manual*.

Delete Subsections 712.02 and 712.03 on page 785, and substitute the following.

907-712.02--Barbed Wire. Barbed wire shall conform to the requirements of AASHTO M 280. In the coastal counties of Hancock, Harrison, and Jackson, either Coating Type Z Class 3 or Coating Type A shall be furnished. In all other areas of the State, either Coating Type Z Class 1, Coating Type Z Class 3, Coating Type ZA Class 60, or Coating Type A shall be furnished.

907-712.03--Metallic-Coated, Steel Woven Wire Fence Fabric. Woven wire fencing (i.e., "hog wire") shall conform to the requirements of AASHTO M 279. In the coastal counties of Hancock, Harrison, and Jackson, either Coating Type Z Class 3 or Coating Type A shall be furnished. In all other areas of the State, either Coating Type Z Class 1, Coating Type Z Class 3, Coating Type ZA Class 60, or Coating Type A shall be furnished.

907-712.04--Chain Link Fence. Delete Subsections 712.04.1 thru 712.04.7 on pages 785 & 786, and substitute the following.

907-712.04.1--Fabric. In the coastal counties of Hancock, Harrison, and Jackson, either Type I Class D, Type II, Type III, or Type IV fabrics shall be furnished. In all other areas of the State, either Type I Class C, Type I Class D, Type II, Type III, or Type IV fabrics shall be furnished.

907-712.04.2--Tie Wire. Tie wire shall be of the same material as the fencing wire being used, shall be of good commercial quality, and shall meet the requirements of AASHTO M 181. Either Type I, Type II, Type III, or Type IV tie wire shall be furnished.

907-712.04.3--Tension Wire. Tension wire shall be of the same material as the fencing wire being used, shall be of good commercial quality, and shall meet the requirements of AASHTO M 181. In the coastal counties of Hancock, Harrison, and Jackson, either Type I Class 3, Type II, Type III, or Type IV tension shall be furnished. In all other areas of the State, either Type II, Type III, Type IV, or Type I Classes 1, 2, or 3 tension wires shall be furnished.

907-712.04.4--Posts Rails, Gate Frames, and Expansion Sleeves. Posts, rails, gate frames, and expansion sleeves shall conform to the requirements for posts in Subsection 712.05.2, unless otherwise designated in the contract.

907-712.04.5--Miscellaneous Fittings and Hardware. Miscellaneous fittings and hardware shall conform to the requirements of Subsection 712.16.

907-712.05--Fence Posts and Braces.

907-712.05.1--Treated Timber Posts and Braces.

907-712.05.1.1--General. Delete the third, fourth, fifth, and sixth paragraphs of Subsection 712.05.1.1 on page 787, and substitute the following.

All wood posts and braces shall be treated in accordance with Subsections 718.03 and 718.04.

907-712.05.1.2--Round Posts. Delete the last sentence of the last paragraph of Subsection 712.05.1.2 on page 788.

907-712.05.1.3--Sawed Posts. Delete the last sentence of the paragraph of Subsection 712.05.1.3 on page 788.

907-712.05.1.4--Sawed Braces. Delete the last sentence of the paragraph of Subsection 712.05.1.4 on page 788.

Delete Subsection 712.05.2 on page 788, and substitute the following.

907-712.05.2--Metal Posts.

907-712.05.2.1--Round Steel Pipe. Round steel pipe shall meet the requirements of AASHTO M 181, either Grade 1 (i.e., meeting the requirements in ASTM F 1083) or Grade 2 (i.e., meeting the requirements of ASTM F 1043).

Round steel pipe shall be sized in accordance with NPS (nominal pipe size) designations as shown on Plans, and not according to the outer or inner pipe diameter.

907-712.05.2.2--Steel Fence Post and Assemblies, Hot-Wrought. Steel posts with the following section shapes, Tee, channel or U, and Y-Bar shall meet the requirements of AASHTO M 281, galvanized in accordance with the requirements of AASHTO M 111, unless otherwise specified in the contract. Acceptance of these steel posts shall be by certification from the manufacturer, producer, supplier, or fabricator, as applicable.

907-712.05.2.3--Blank.

907-712.05.2.4--Steel H-Beam Posts. Steel H-Beam posts shall be produced from structural quality weldable steel having a minimum yield strength of 45,000 psi and shall be galvanized in accordance with ASTM A 123. Steel H-Beam line posts shall be 2.250 inches by 1.625 inches and shall weigh 3.43 pounds per foot. A tolerance of plus or minus 5.0 percent is allowed for

weight per foot. A tolerance of plus or minus 1.0 percent is allowed for dimensions.

907-712.05.2.5--Aluminum-Alloy Posts and Assemblies. Round aluminum-alloy posts shall meet the requirements of ASTM B 241, Alloy 6061, T6. Aluminum-Alloy H-Beam posts shall meet the requirements of ASTM B 221, Alloy 6061, T6.

907-712.05.2.6--Formed Steel Section Posts. Formed steel section posts, "C" sections, shall be formed from sheet steel conforming to ASTM A 1011, Grade 45, and shall be galvanized in accordance with ASTM A 123.

907-712.06--Guard and Guardrail Posts.

907-712.06.2--Treated Wood Posts.

907-712.06.2.1--Square Posts. Delete the paragraph in Subsection 712.06.2.1 on page 789, and substitute the following.

All square posts shall be inspected for conformance with Section 712.05, except that the posts may be rough and shall be within $\pm 3/8$ " of the dimensions shown on the plans.

907-712.06.2.2--Round Posts. Delete the paragraph in Subsection 712.06.2.2 on page 789, and substitute the following.

All round posts shall be inspected for conformance with Section 712.05, except that the posts shall be of the shape and dimensions shown on the plans.

907-712.06.5--Treated Wood Blocks for Use with Metal Guardrail Posts. Delete the paragraphs of Subsection 712.06.5 on pages 789 & 790, and substitute the following.

Treated wood blocks for use with metal guardrail posts shall be within $\pm 3/8$ " of the size and dimensions shown on the plans, except that a minus tolerance shall not be allowed for the slotted width in which the metal post must fit.

Delete Subsection 712.16 on page 791, and substitute the following.

907-712.16--Hardware. All ferrous metal hardware for fencing such as bolts, nuts, washers, and metal straps shall be as specified on the plans and galvanizing shall not be less than 1.0 ounce per square foot of uncoated area. Aluminum coated hardware shall be coated with aluminum meeting the requirements of AASHTO M 181 for aluminum coating and at the rate of not less than 0.4 ounces per square foot of uncoated area.

Aluminum alloy hardware shall conform to the requirements of ASTM B 221 for extruded aluminum alloy 6063, T6. The finished members shall be of uniform quality.

Aluminum-zinc coated hardware shall be coated with an aluminum-zinc alloy meeting the chemical requirements and weight of coating specified for aluminum-zinc alloy coated metal gates.

MISSISSIPPI DEPARTMENT OF TRANSPORTATION

SPECIAL PROVISION NO. 907-714-4

CODE: (SP)

DATE: 07/28/2025

SUBJECT: Miscellaneous Materials

Section 714, Miscellaneous Materials, of the 2017 Edition of the Mississippi Standard Specifications for Road and Bridge Construction is hereby amended as follows.

907-714.01--Water.

907-714.01.1--General. Delete the last sentence of the second paragraph in Subsection 714.01.1 on page 794.

907-714.01.2--Water for Use in Concrete. Delete Subsection 714.01.2 on page 794, and substitute the following:

Water from municipal sources is permitted be used as mixing water in concrete, mortar, and grout without Department testing. Water from non-municipal water sources used in mixing of concrete, mortar, and grout which does not meet the requirements in Subsection 714.01.1 shall be tested for conformance as required in AASHTO M157, Table 1 and Table 2.

907-714.01.3--Water for Use in Chemically Stabilized Based. Delete the first sentence of first paragraph in Subsection 714.01.3 on page 794, and substitute the following:

Water used in the construction of bases that contain cement, lime, or other chemical additive shall be as set out in Subsection 714.01.1. Water from municipal sources is permitted to be used without testing for conformance to the requirements below. If water is not from a municipal source, it shall not contain impurities in excess of the following limits:

Delete Subsection 714.01.6 on page 795, and substitute the following.

907-714.01.6--Blank.

907-714.05--Fly Ash.

907-714.05.1--General. Delete the first sentence of the fifth paragraph in Subsection 714.05.1 on page 797.

Delete Subsection 714.06 on page 798, and substitute the following.

907-714.06--Slag Cement.

907-714.06.1--General. The slag cement source must be approved for listing in the Department's

APL prior to use. The acceptance of slag cement shall be based on certified test reports, certification of shipment from the supplier, and tests performed on samples obtained after delivery in accordance with the Department's *Materials Division Inspection, Testing, and Certification Manual* and Department SOP.

The Contractor shall provide suitable means for storing and protecting the slag cement against dampness and contamination. Separate storage silos, bins, or containers shall be provided for slag cement. Slag cement that is partially set, caked or contains lumps shall not be used.

The State Materials Engineer shall be notified in writing of the nature, amount and identity of any processing or other additions made to the slag cement during production.

Slag cement from different mills shall not be mixed or used alternately in any one class of construction or structure without written permission from the Engineer; except that this requirement will not be applicable to cement treatment of design soils or bases.

No additional cementitious materials, such as blended hydraulic cement, fly ash, metakaolin, or others, shall be added to or as a replacement for hydraulic cement when used with slag cement in the production of concrete. The replacement of hydraulic cement with slag cement shall be in accordance with the applicable replacement content specified in Subsection 701.02.2.

907-714.06.2--Specific Requirements. Slag cement shall meet the requirements of AASHTO M 302, Grade 100 or 120. Slag cement shall contain no chlorides.

907-714.13--Geotextiles.

907-714.13.11--Tables. Delete Table 1 in Subsection 714.13.11 on page 813, and substitute the following.

Table 1 - Geotextiles

Type Designation	I ¹	II ¹	III	IV	V	VI		VII		VIII	IX
	Sediment Control		Drainage	Paving	Separation & Drainage	Separation, Stabilization & Reinforcement		Separation, Stabilization & Reinforcement		High Strength	
Physical Property ²						Woven	Non-Woven	Woven	Non-Woven		Test Method
Grab Strength (lb)	50	90	110	90	200	280	180	450	280	----	ASTM D 4632
Elongation (%)	----	50% max @ 45 lb	20% min	50% min @ break	50% min	50% max	50% Min	50% max	50% Min	----	ASTM D 4632
Seam Strength (lb)	----	----	70	----	180	240	160	400	240	----	ASTM D 4632
Puncture Strength (lb)	----	----	40	----	80	110	75	180	115	----	ASTM D 6241
Trapezoidal Tear (lb)	----	----	40	----	80	100	70	150	100	----	ASTM D 4533
Asphalt Retention (gal/yd ²)	----	----	----	0.2	----	----	----	----	----	----	ASTM D 6140
Permittivity (sec ⁻¹) min	0.05	0.05	0.5	----	0.2	0.2	0.2	0.2	0.2	----	ASTM D 4491
AOS Woven (mm) max	0.60	0.60	0.6	----	0.6	0.43	----	0.43	----	----	ASTM D 4751
AOS Non-Woven (mm) max	0.84	0.84	0.43	----	0.43	----	0.43	----	0.43	----	
Tensile Strength after UV (% Retained)	70% @ 500 hr	70% @ 500 hr	50% @ 500 hr	----	50% @ 500 hr	50% @ 500 hr	50% @ 500 hr	50% @ 500 hr	50% @ 500 hr	----	ASTM D 4355
Melting Point °(F)	----	----	----	325	----	----	----	----	----	----	ASTM D 276
Minimum Ultimate Tensile Strength ³ (lb/in)	----	----	----	----	----	----	----	----	----	660	ASTM D 4595

Notes: 1- All property values, with the exception of apparent opening size (AOS), represent minimum average roll values in the weakest principal direction. Values for AOS represent the maximum average roll values, 2 - Values not identified in this table should meet manufacturer certification for the use and application, 3- Machine direction

Delete Subsec

907-714.15--Geogrids.

907-714.15.1--General. A geogrid is defined as a geosynthetic formed by a regular network of connected elements with apertures greater than 0.25 inch to allow interlocking with surrounding soil, rock, and other surrounding materials to function primarily as reinforcement.

Geogrid shall be manufactured from an expanded strain hardened monolithic polymer sheet composed of one or more synthetic polymers and shall be mildew resistant and inert to biological degradation and naturally encountered chemicals, alkalis and acids. The geogrid shall contain stabilizers and/or inhibitors, or a resistance finish or covering to make it resistant to deterioration from direct sunlight, ultraviolet rays, and heat.

Geogrid manufacturers shall participate in and be in compliance with the American Association of State Highway Transportation Officials (AASHTO) National Transportation Product Evaluation Program's (NTPEP) Geosynthetics audit program. Geogrid shall meet the requirements of Table II for the application and type shown on the plans and shall be selected from the Department's Approved Lists.

907-714.15.1.1--Geogrid for Retaining Walls and Reinforced Soil Slopes. Geogrid for retaining walls and reinforced soil slopes shall be creep tested in accordance with AASHTO R69 and meet Long Term Design Load, Minimum Ultimate Tensile Strength, and open area criteria listed in Table II. Manufacturers shall perform at least one long-term creep test for no less than 10,000 hours in accordance to ASTM D 5262 for each polymer or composition of polymers from which the geogrid is produced. The long-term design load that shall be reported for design use, shall be that load at which no more than 10% strain occurs over a 100-year design life of the geogrid, as calculated in accordance with AASHTO R69. Long-term design loads shall be reported unfactored, and the AASHTO strength reduction factors (Durability and Installation, and safety factors) will be considered by the Department's Geotechnical Branch on a site specific design basis.

907-714.15.1.2--Geogrid for Subgrade Stabilization. Geogrid for subgrade stabilization shall meet Minimum Ultimate Tensile Strength and open area criteria listed in Table II.

907-714.15.2--Marking, Shipment, and Storage. Each roll or container of geogrid shall be visibly labeled with the name of the manufacturer, trade name of the product, lot number, and quantity of material. In addition, each roll or container shall be clearly tagged to show the type designation that corresponds to that required by the plans. During shipment and storage the geogrid shall be protected from direct sunlight, and temperatures above 120°F or below 0°F. The geogrid shall either be wrapped and maintained in a heavy duty protective covering or stored in a safe enclosed area to protect from damage during prolonged storage.

907-714.15.3--Manufacturer Certification. The Contractor shall furnish the Engineer three copies of the manufacturer's certified test reports indicating that the geogrid furnished conforms to the requirements of the specifications and is of the same composition as the originally approved by the Department.

907-714.15.4--Acceptance Sampling and Testing. Final acceptance of each shipment will be

based upon results of tests performed by the Department on verification samples submitted from the project, as compared to the manufacturer's certified test reports. The Engineer will select one roll or container at random from each shipment for sampling. As sample extending full width of the randomly selected roll or container and being at least five (5) square yards in area will be obtained and submitted by the Engineer. All material samples shall be provided at no cost to the State.

**TABLE II
GEOGRIDS**

Physical Properties	Type Designation						Test Method
	I	II	III	IV	V	VI	
Long Term Design Load ¹ , pounds per foot, Machine Direction	250	500	750	1500	2500	3500	AASHTO R69, ASTM D5262
Minimum Ultimate Tensile Strength ² , pounds per foot, Machine Direction	500	1000	1500	3000	5000	7000	ASTM D6637
Open Area, percent	70	70	50	50	50	50	Direct Measurement

¹ Minimum design criteria requirement.

² Minimum Average Roll Value (MARV).

MISSISSIPPI DEPARTMENT OF TRANSPORTATION

SPECIAL PROVISION NO. 907-718-1

CODE: (SP)

DATE: 12/07/2021

SUBJECT: Timber and Dimension Lumber

Section 718, Timber and Dimension Lumber, of the 2017 Edition of the Mississippi Standard Specifications for Road and Bridge Construction is hereby amended as follows.

Delete the Subsections in Section 718 on pages 836 thru 838, and substitute the following.

907-718.01--General. All timber and dimension lumber shall be Southern pine and shall conform in all respects to applicable requirements of AASHTO M 168. The Department reserves the right to sample and to test all materials at any time; all inspection, testing, and certification of materials will be performed in accordance with the requirements of the current version of the Department's *Materials Division Inspection, Testing, and Certification Manual*.

Timber and dimension lumber shall be furnished in the sizes shown on the plans or as specified. Unless otherwise specified, timber and dimension lumber shall be No. 1, or better, graded according to the latest American Lumber Standards.

Only one type of preservative shall be used for the treatment of materials for any one class of construction on a project, unless otherwise specified.

Where treated timber and dimensional lumber is to be used in non-highway construction or use, such as decking, handrails in walking trails, or in any manner where general public exposure by touch is possible, the treatment requirements will be as per project plans and/or approved by the State Materials Engineer.

907-718.02--Untreated Timber and Dimension Lumber. Untreated timber and dimension lumber shall conform to the requirements of AASHTO M 168.

907-718.03--Treated Timber and Dimension Lumber. Timber and dimension lumber to be treated shall meet the requirements herein specified and shall be treated as specified. Treated timber or dimensional lumber will not be accepted for use unless it has been inspected by an authorized representative of the Department and found to be satisfactory after treatment.

907-718.03.1--Blank.

907-718.03.2--Treatment.

907-718.03.2.1--General. All materials shall be treated in accordance with AASHTO M 133 unless otherwise directed by the Environmental Protection Agency (EPA).

907-718.03.2.2--Blank.

907-718.03.2.3--Inspection. Treated timber and dimension lumber shall be inspected by an authorized representative of the Department before being incorporated into the work. Treatment reports shall be provided to the Department for each lot of material supplied.

907-718.03.3--Blank.

907-718.03.4--Storage of Treated Material. All material treated for stock shall be stacked as compactly as possible on a well-drained surface. Material shall be supported on sills spaced as necessary, not to exceed 10 foot intervals and shall have at least one foot of air space beneath the stacks.

All materials treated with preservatives for use in buildings and applications where painting is required shall be dried after treatment. The treated wood shall be dried in accordance with American Lumber Standards.

907-718.04--Preservative. Preservatives shall be as specified in AASHTO M 133 unless otherwise directed by the Environmental Protection Agency (EPA).

MISSISSIPPI DEPARTMENT OF TRANSPORTATION

SPECIAL PROVISION NO. 907-720-4

CODE: (IS)

DATE: 06/17/2025

SUBJECT: Pavement Marking Materials

Section 720, Pavement Marking Materials, of the 2017 Edition of the Mississippi Standard Specifications for Road and Bridge Construction is hereby amended as follows.

Delete Section 720 on pages 840 thru 854, and substitute the following.

SECTION 720 - PAVEMENT MARKING MATERIALS

907-720.01--General. The Department reserves the right to perform sampling and testing of any materials at any time. Upon request of the Engineer, samples of the material shall be furnished.

907-720.02--Color Requirements. All pavement markings except raised pavement markers are required to meet the color requirements of ASTM D6628.

907-720.03--Optics. Optics used in thermoplastic pavement markings shall consist of a double-drop system of glass beads or advanced optics.

907-720.03.1--Glass Beads. The manufacturer shall furnish the Engineer with a certified test report indicating that the glass beads meet AASHTO M 247. AASHTO Type 4 beads shall be applied to the newly placed stripe first, followed by the application of AASHTO Type 1 or Type 2 beads. Type 1, 2, and 4 glass beads shall be transparent, clean, colorless glass, smooth and spherically shaped, free from milkiness, pits, or excessive air bubbles. Type 1, 2, and 4 glass beads shall be coated with a bead coating that is compatible with the traffic marking material to which the glass beads will be applied and will provide adequate moisture proofing, increased adhesion, and optimum embedment of the glass beads.

907-720.03.1.1—Acceptance Procedure. The Contractor shall furnish the Engineer with a copy of the manufacturer's certified test reports for the lot(s) of materials from which the shipment originated. The test report shall show all the test results for the material properties and characteristics as specified herein. The test report shall state that the material represented by the test results meets all the requirements of the contract. It shall be the Contractor's responsibility to furnish the manufacturer's test report to the Engineer for each shipment of material to the project.

Acceptance sampling and testing will be in accordance with the Materials Division Inspection, Testing, and Certification Manual (Materials Manual).

907-720.03.2--Advanced Optics. Advanced optics are materials that do not meet the specific requirements of AASHTO M 247 but produce a final drop-on optics system that meets or exceeds the reflectivity requirements in Special Provision 907-626. Advanced optics shall be a double-

drop system that is pre-approved and listed on the Department's Approved Products List.

907-720.03.2.1—Acceptance Procedure. The Contractor shall furnish the Engineer with a copy of the manufacturer's certified test reports for the lot(s) of materials from which the shipment originated. The test report shall show all the test results for the material properties and characteristics as specified herein. The test report shall state that the material represented by the test results meets all the requirements of the contract. It shall be the Contractor's responsibility to furnish the manufacturer's test report to the Engineer for each shipment of material to the project.

Acceptance sampling and testing may be conducted at the request of the Engineer.

907-720.04--Thermoplastic Marking Material. Thermoplastic marking material shall meet the color requirements of Subsection 907-720.02.

There shall be no obvious change in the color of the material if held at its plastic temperature for a period of four (4) hours nor by reason of four (4) re-heatings to its plastic temperature.

The pavement markings shall maintain its original dimension and placement. The material shall not be slippery when wet and it shall not lift from the pavement in freezing weather.

907-720.04.1--Extruded Thermoplastic Material. Extruded thermoplastic pavement marking material shall meet the requirements of AASHTO M 249, and shall meet the requirements of 907-720.04 with the following exceptions:

- Blue - ADA thermoplastic marking material shall meet the requirements of Subsection 907-720.04.2 with the exception that the color shall be Blue – ADA, and the Contractor may use hot applied thermoplastic materials meeting the satisfaction of the Engineer.

907-720.04.2--Spray-Applied Thermoplastic Material. Spray-applied thermoplastic pavement marking material shall meet the requirements of AASHTO M 249 and shall meet the requirements of 907-720.04.

907-720.04.3--Pre-formed Thermoplastic Material. Heat-fused, pre-formed thermoplastic pavement marking material shall meet the color requirements of 907-720.02.

907-720.04.4—Acceptance Procedure. The Contractor shall furnish the Engineer with a copy of the manufacturer's certified test reports for the lot(s) of materials from which the shipment originated. The test report shall show all the test results for the material properties and characteristics as specified herein. The test report shall state that the material represented by the test results meets all the requirements of the contract. It shall be the Contractor's responsibility to furnish the manufacturer's test report to the Engineer for each shipment of material to the project.

907-720.05--Pavement Marking Tape. Pavement marking tape shall be listed on the Department's Approved Lists.

907-720.05.1—Cold Plastic Pavement Markings (Permanent Pavement Marking Tape). Pavement marking tape for use in roadway applications shall be designated on the Department's Approved Lists as permanent.

The prefabricated markings described shall consist of white or yellow pigmented plastic films with reflective optics uniformly distributed throughout their entire cross-sectional area, and be capable of being affixed by either a pressure sensitive pre-coated adhesive or a liquid contact cement. The markings shall be provided complete in a form that will facilitate rapid application and protect the markings in shipment and storage. The manufacturer shall identify proper solvents and/or adhesives to be applied at the time of application, all equipment necessary for proper application, and recommendations for application that will assure an effective performance life.

Prefabricated legends and symbols shall conform to the applicable shapes and sizes as outlined in the current "Manual on Uniform Traffic Control Devices."

907-720.05.1.1--Specific Requirements. Unless otherwise indicated on the plans, the patterned material without adhesive shall have a minimum caliper of 0.065 inch at the thickest portion of the patterned cross-section and a minimum caliper of 0.020 inch at the thinnest portion of the cross-section. The material shall be a pliant polymer film with 50±15% of the surface are raised and presenting a near vertical face angle of 0° to 60° to traffic from any direction. The channels between the raised areas shall be substantially free of exposed optics or particles.

The size and quality of the optics will be such that performance requirements of Subsection 907-720.02 for the retroreflective pliant polymer film shall be met. The pigments shall be selected and blended to provide a marking film that is white or yellow conforming to the performance requirements of Subsection 907-720.02 through the expected life of the film.

907-720.05.1.2--Conformability and Resealing. The marking shall be capable of conforming to pavement contours, breaks, faults, etc. through the action of traffic at normal pavement temperatures.

The marking shall have resealing characteristics that allows it to be capable of fusing with itself and previously applied marking of the same composition under normal conditions of use. The marking shall be capable of use for patching worn areas of the same type in accordance with manufacturer's instructions.

907-720.05.1.3--Tensile Strength and Elongation. The material shall have a minimum tensile strength of 40 pounds per square inch of cross section when tested according to ASTM D 638. A 6-inch x 1-inch x 0.06-inch sample shall be tested at a temperature between 70°F and 80°F using a jaw speed of 12 inches per minute.

The material shall have a minimum elongation of 75% at break when tested according to ASTM D 638 using a jaw speed of 12 inches per minute.

907-720.05.1.4--Skid Resistance. The surface of the material shall provide a minimum skid resistance value of 45 BPN when tested according to ASTM E 303 except values will be taken at

downweb and at a 45-degree angle from downweb. These two values will then be averaged to find the skid resistance of the patterned surface.

907-720.05.1.5--Effective Performance Life and Warranty. When applied according to the recommendations of the manufacturer the pavement marking tape shall provide a neat and durable marking that will not flow or distort due to temperature if the pavement surface remains stable. The film shall be weather resistant and through normal traffic wear shall show no appreciable fading, lifting, or shrinkage throughout the useful life of the marking, nor shall it show significant tearing, roll back, or other signs of poor adhesion.

All manufacturer's standard warranties and guarantees on pavement marking tape, which are provided as customary trade practice, shall be delivered to the Engineer at the final inspection. All warranties and guarantees shall be made out to the Department.

907-720.05.1.6—Acceptance Procedure. The Contractor shall furnish the Engineer with a copy of the manufacturer's certified test reports for the lot(s) of materials from which the shipment originated. The test report shall show all the test results for the material properties and characteristics as specified herein. The test report shall state that the material represented by the test results meets all the requirements of the contract. It shall be the Contractor's responsibility to furnish the manufacturer's test report to the Engineer for each shipment of material to the project.

Acceptance sampling and testing will be in accordance with the Materials Division Inspection, Testing, and Certification Manual (Materials Manual). Samples of the material shall be furnished and shall be provided at no cost to the State.

907-720.05.2--Preformed Pavement Markings for Construction Zones. Preformed pavement markings for construction zones shall be designated Department's Approved Lists as temporary. Retroreflective preformed pavement markings for construction zones shall be as specified on the plans or in the contract documents.

The markings shall be provided in specified widths and shapes. Preformed words and symbols shall conform to the applicable shapes and sizes as outlined in the current "Manual on Uniform Traffic Control Devices for Streets and Highways," or as modified.

The materials shall be packaged in accordance with accepted commercial standards and when stored indoors in a cool dry place, shall be suitable for use one year after date of purchase.

907-720.05.2.1--Specific Requirements. Preformed markings shall consist of retroreflective materials on a conformable backing and shall meet the performance requirements of Subsection 907-720.02. The markings shall consist of a mixture of high-quality polymeric materials, pigments, and optics with a reflective layer of optics bonded to the top surface. The markings shall be pre-coated with a pressure sensitive adhesive capable of adhering to pavement in accordance with the manufacturer's instructions without the use of heat, solvents, or other additional adhesives. The markings and/or adhesive shall not require any curing time after application. A coated non-metallic medium shall be incorporated with the pressure sensitive adhesive to facilitate removal.

907-720.05.2.2—Acceptance Procedure. The Contractor shall furnish the Engineer with a copy of the manufacturer's certified test reports for the lot(s) of materials from which the shipment originated. The test report shall show all the test results for the material properties and characteristics as specified herein. The test report shall state that the material represented by the test results meets all the requirements of the contract. It shall be the Contractor's responsibility to furnish the manufacturer's test report to the Engineer for each shipment of material to the project.

907-720.06--Raised Pavement Markers. Pavement markers shall be listed on the Department's Approved Lists and shall conform to ASTM D 4280.

907-720.06.1--Packaging. Shipments shall be made in containers acceptable to common carriers and packaged in such a manner as to ensure delivery in perfect condition. All damaged shipments shall be replaced by the Contractor. Each package shall be clearly marked as to the name of the manufacturer, type, quantity enclosed, lot number, and date of manufacture.

907-720.06.2--Non-Reflective Pavement Markers. Non-reflective pavement markers are occasionally referred to as "jiggle markers". Non-reflective markers consisting of a heat-fired, vitreous, ceramic base, and a heat-fired, opaque, glazed surface are permitted for use; the bottom of the marker shall not be glazed. Ceramic markers shall be produced from any suitable combination of intimately mixed clays, shales, talcs, flints, feldspars, or other inorganic material. Ceramic markers shall be thoroughly and evenly matured, and all non-reflective pavement markers shall be free from defects which affect appearance or serviceability.

Ceramic non-reflective markers shall conform to the following finish and testing requirements in Table 2 below.

Table 2

Ceramic Non-Reflective Marker Requirements	
Glaze Thickness	0.005 inch, minimum
Mohs Hardness	6, minimum
Autoclave	Glaze shall not spall, craze, or peel.
Compressive Strength	750 psi, minimum
Water Absorption	2.0%, maximum

907-720.06.3—Acceptance Procedure. The Contractor shall furnish the Engineer with a copy of the manufacturer's certified test reports for the lot(s) of materials from which the shipment originated. The test report shall show all the test results for the material properties and characteristics as specified herein. The test report shall state that the material represented by the test results meets all the requirements of the contract. It shall be the Contractor's responsibility to furnish the manufacturer's test report to the Engineer for each shipment of material to the project.

907-720.07--Adhesive for Pavement Markers. The adhesive shall be listed on the Department's Approved Lists and shall be an asphaltic material suitable for bonding pavement markers to surfaces when the road surface and marker temperatures are in the range of 50°F to 160°F. The composition of the adhesive must be such that its properties will not deteriorate when heated to and applied at temperatures up to 425°F. Samples may be submitted in the form of an adhesive

testing package from each batch or material obtained from a package shipped to the project.

907-720.07.1--Packaging and Labeling. The adhesive shall be packaged in self-releasing cardboard containers that will stack properly. The label shall show the manufacturer, quantity, and lot or batch number. "Adhesive for Pavement Markers" or "Adhesive for Traffic Markers" shall be printed in bold lettering on the label.

907-720.07.2--Bituminous Adhesive. The asphaltic adhesive material shall be flexible type.

907-720.07.2.1--Flexible Bituminous Adhesive. Flexible bituminous adhesive shall be designated on the Department's Approved Lists as flexible and shall comply with requirements of Table 3 below.

Table 3

Flexible Bituminous Adhesive Properties			
	Min	Max	Test Method
Penetration @ 77°F	-	25	ASTM D 5
Softening Point, °F	200	-	ASTM D 36
Brookfield Viscosity @ 400°F, cp.	-	10,000	ASTM D 3236
Ductility @ 77°F, 5 cm/min	15	-	ASTM D 113
Ductility @ 39.2°F, 1 cm/min	5	-	ASTM D 113
Asphalt Compatibility	Pass		ASTM D 5329
Flexibility @ 20°F	Pass		Per Subsection

907-720.07.3—Acceptance Procedure. The Contractor shall furnish the Engineer with a copy of the manufacturer's certified test reports for the lot(s) of materials from which the shipment originated. The test report shall show all the test results for the material properties and characteristics as specified herein. The test report shall state that the material represented by the test results meets all the requirements of the contract. It shall be the Contractor's responsibility to furnish the manufacturer's test report to the Engineer for each shipment of material to the project.

Acceptance sampling and testing will be in accordance with the Materials Division Inspection, Testing, and Certification Manual (Materials Manual). Samples of the material shall be furnished and shall be provided at no cost to the State.

MISSISSIPPI DEPARTMENT OF TRANSPORTATION

SPECIAL PROVISION NO. 907-721-4

CODE: (IS)

DATE: 04/19/2022

SUBJECT: Materials for Signing

Section 721, Materials for Signing, of the 2017 Edition of the Mississippi Standard Specifications for Road and Bridge Construction is hereby amended as follows.

907-721.06--Reflective Sheeting.

907-721.06.2--Performance Requirements. Delete Table 4 and Table 5 in Subsection 721.06.2 on pages 860 & 861, and substitute the following.

**MINIMUM COEFFICIENTS OF RETROREFLECTION
Candela per foot candle per square foot (cd/ft²)
Per ASTM Designation D4956**

**TABLE 4
Type IX Sheeting**

Observation Angle	Entrance Angle	White	Yellow	Green	Red	Blue	Fluorescent Yellow/Green	Fluorescent Yellow	Fluorescent Orange
0.2°	-4.0°	380	285	38	76	17	300	230	115
0.2°	+30.0°	215	162	22	43	10	170	130	65
0.5°	-4.0°	240	180	24	48	11	190	145	72
0.5°	+30.0°	135	100	14	27	6.0	110	81	41
1.0°	-4.0°	80	60	8.0	16	3.6	64	48	24
1.0°	+30.0°	45	34	4.5	9.0	2.0	36	27	14

**TABLE 5
Type XI Sheeting**

Observation Angle	Entrance Angle	White	Yellow	Green	Red	Blue	Brown	Fluorescent Yellow/Green	Fluorescent Yellow	Fluorescent Orange
0.2°	-4.0°	580	435	58	87	26	17	460	350	175
0.2°	+30.0°	220	165	22	33	10	7.0	180	130	66
0.5°	-4.0°	420	315	42	63	19	13	340	250	125
0.5°	+30.0°	150	110	15	23	7.0	5.0	120	90	45
1.0°	-4.0°	120	90	12	18	5.0	4.0	96	72	36
1.0°	+30.0°	45	34	5.0	7.0	2.0	1.0	36	27	14

After Subsection 721.10 on page 864, add the following.

907-721.11--Digital Applied Printing. The following addresses the requirements for digitally printed finished retroreflective traffic control signs on flat sheet aluminum and digitally printed traffic sign faces intended to be applied to a sign substrate.

907-721.11.1--Digitally Printed Ink Systems. Traffic signs must be produced using components, and processes that comply with the retroreflective sheeting manufacturer’s recommendations.

Digital printed ink systems used to print traffic signs must meet and comply with daytime and nighttime chromaticity (color standards) as recognized in ASTM D4956 “Standard Specification for Retroreflective Sheeting for Traffic Control.”

Digital printed ink systems must meet 70% of the initial retroreflectivity specifications of each respective reflective film color as found in ASTM D4956 “Standard Specification for Retroreflective Sheeting for Traffic Control.”

Prior to fabrication and preferably at the preconstruction meeting, the Contractor shall advise the Project Engineer in writing as to which signs on the project will be digitally printed and which ones will be screen printed. The Contractor shall submit to the Project Engineer certifications for all digitally printed signs, which will be forwarded to the State Traffic Engineer for review.

907-721.11.2--Protective Overlay Film. Permanent traffic signs printed with digital ink systems will be fabricated with a full sign protective overlay film designed to provide a smooth surface needed for retroreflectivity, and to protect the sign from fading and UV degradation. The overlamine shall comply with the retroreflective sheeting manufacturer’s recommendations to ensure proper adhesion and transparency and will also meet the reflective film durability as identified in Table 1.

**Table 1
Retroreflective Film Minimum Durability Requirements**

ASTM D4956 Type	Full Sign Replacement Term (years)	Sheeting Replacement Term (years)
IV	7	10
VIII	7	10
IX	7	12
XI	7	12

Temporary signs used in work zones printed with black ink only will not require a protective overlay film as long as the finished sign is warranted for a minimum outdoor durability of three years by the sheeting manufacturer.

907-721.11.3--Inspection. During fabrication, the Contractor shall provide sufficient testing and quality control throughout fabrication to insure good workmanship. Once the material has been received, it may be subject to random testing to ensure compliance with all requirements. If any test samples do not conform to the requirements, the entire order may be returned at the vendor’s expense.

907-721.11.4--Traffic Sign Performance Warranty Provisions. Based on the ASTM Type of sheeting specified, traffic control signs shall be warranted for the duration shown in Table 1. The Contractor shall supply a copy of the warranty document with complete details of terms and conditions upon request of the Department.

907-721.11.5--Certified Digital Sign Fabricator. Sign fabricators using digital imaging methods to produce regulated traffic signs must be certified by the reflective sheeting manufacturer whose materials are used to produce the delivered signs.

Certified sign fabricators must undergo an audit process by the sheeting manufacturer to ensure they have the proper equipment, manufacturing capabilities, manufacturing application processes and the materials required to fulfill the sheeting manufacturer's warranty obligations. Sign fabricators must recertify annually with reflective sheeting manufacturers or utilize a 3rd party certifier approved by the reflective sheeting manufacturer.

The Contractor shall submit proof of Sign Fabricator Certification as issued by the retroreflective sign sheeting manufacturer to the Project Engineer upon delivery of the signs, or with the Shop Drawings.

SECTION 905 - PROPOSAL

Date _____

Mississippi Transportation Commission
Jackson, Mississippi

Sirs: The following proposal is made on behalf of _____
_____ of _____

for constructing the following designated project(s) within the time(s) hereinafter specified.

The plans are composed of drawings and blue prints on file in the offices of the Mississippi Department of Transportation, Jackson, Mississippi.

The Specifications are the current Standard Specifications of the Mississippi Department of Transportation approved by the Federal Highway Administration, except where superseded or amended by the plans, Special Provisions and Notice(s) to Bidders attached hereto and made a part thereof.

I (We) certify that I (we) possess a copy of said Standard and any Supplemental Specifications.

Evidence of my (our) authority to submit the Proposal is hereby furnished. The proposal is made without collusion on the part of any person, firm or corporation. I (We) certify that I (we) have carefully examined the Plans, the Specifications, including the Special Provisions and Notice(s) to Bidders, herein, and have personally examined the site of the work. On the basis of the Specifications, Special Provisions, Notice(s) to Bidders, and Plans, I (we) propose to furnish all necessary machinery, tools, apparatus and other means of construction and do all the work and furnish all the materials in the manner specified. I (We) understand that the quantities mentioned herein are approximate only and are subject to either increase or decrease, and hereby propose to perform any increased or decreased quantities of work at the unit prices bid, in accordance with the above.

I (We) acknowledge that this proposal will be found irregular and/or non-responsive unless a certified check, cashier's check, or Proposal Guaranty Bond in the amount as required in the Advertisement (or, by law) is submitted electronically with the proposal or is delivered to the Contract Administration Engineer prior to the bid opening time specified in the advertisement.

INSTRUCTION TO BIDDERS: Alternate and Optional Items on Bid Schedule.

1. Two or more items entered opposite a single unit quantity WITHOUT DEFINITE DESIGNATION AS "ALTERNATE ITEMS" are considered as "OPTIONAL ITEMS". Bidders may or may not indicate on bids the Optional Item proposed to be furnished or performed WITHOUT PREJUDICE IN REGARD TO IRREGULARITY OF BIDS.
2. Items classified on the bid schedule as "ALTERNATE ITEMS" and/or "ALTERNATE TYPES OF CONSTRUCTION" must be preselected and indicated on bids. However, "Alternate Types of Construction" may include Optional Items to be treated as set out in Paragraph 1, above.
3. Optional items not preselected and indicated on the bid schedule MUST be designated in accordance with Subsection 102.06 prior to or at the time of execution of the contract.
4. Optional and Alternate items designated must be used throughout the project.

I (We) further propose to perform all "force account or extra work" that may be required of me (us) on the basis provided in the Specifications and to give such work my (our) personal attention in order to see that it is economically performed.

I (We) further propose to execute the attached contract agreement (Section 902) as soon as the work is awarded to me (us), and to begin and complete the work within the time limit(s) provided for in the Specifications and Advertisement. I (We) also propose to execute the attached contract bond (Section 903) in an amount not less than one hundred (100) percent of the total of my (our) part, but also to guarantee the excellence of both workmanship and materials until the work is finally accepted.

I (We) shall submit electronically with our proposal or deliver prior to the bid opening time a certified check, cashier's check or bid bond for **five percent (5%) of total bid** and hereby agree that in case of my (our) failure to execute the contract and furnish bond within Ten (10) days after notice of award, the amount of this check (bid bond) will be forfeited to the State of Mississippi as liquidated damages arising out of my (our) failure to execute the contract as proposed. It is understood that in case I am (we are) not awarded the work, the check will be returned as provided in the Specifications.

SECTION 905 -- PROPOSAL (CONTINUED)

I (We) hereby certify by digital signature and electronic submission via Bid Express of the Section 905 proposal below, that all certifications, disclosures and affidavits incorporated herein are deemed to be duly executed in the aggregate, fully enforceable and binding upon delivery of the bid proposal. I (We) further acknowledge that this certification shall not extend to the bid bond or alternate security which must be separately executed for the benefit of the Commission. This signature does not cure deficiencies in any required certifications, disclosures and/or affidavits. I (We) also acknowledge the right of the Commission to require full and final execution on any certification, disclosure or affidavit contained in the proposal at the Commission's election upon award. Failure to so execute at the Commission's request within the time allowed in the Standard Specifications for execution of all contract documents will result in forfeiture of the bid bond or alternate security.

Respectfully Submitted,

DATE _____

Contractor

BY _____
Signature

TITLE _____

ADDRESS _____

CITY, STATE, ZIP _____

PHONE _____

FAX _____

E-MAIL _____

(To be filled in if a corporation)

Our corporation is chartered under the Laws of the State of _____ and the names, titles and business addresses of the executives are as follows:

President Address

Secretary Address

Treasurer Address

The following is my (our) itemized proposal.

Mill & Overlay approximately 4.2 miles of SR 311 from Landfill Road to Liles Road and approximately 3.5 miles from 0.1 mile south of Audie Todd Road to US 72, known as State Project Nos. SP-0035-01(009) / 109983301 & SP-0035-01(010) / 109984301 in Marshall County.

Line no.	Item Code	Adj Code	Quantity	Units	Description[Fixed Unit Price]
Roadway Items					
0010	201-D001		513	Station	Random Clearing
0020	202-B007		810	Square Yard	Removal of Asphalt Pavement, All Depths
0030	202-B158		600	Linear Feet	Removal of Guard Rail, Including Rails, Posts and Terminal Ends
0040	202-B215		69	Each	Removal of Sign Including Post & Footing
0050	202-B240		360	Linear Feet	Removal of Traffic Stripe
0060	203-G001	(E)	275	Cubic Yard	Excess Excavation, FM, AH
0070	304-B004	(GT)	2,800	Ton	Granular Material, Class 5, Group D
0080	406-A002		2,263	Square Yard	Cold Milling of Bituminous Pavement, All Depths
0090	423-A001		16	Mile	Rumble Strips, Ground In
0100	503-C010		1,368	Linear Feet	Saw Cut, Full Depth
0110	606-B002		350	Linear Feet	Guard Rail, Class A, Type 1, 'W' Beam
0120	606-D015		4	Each	Guard Rail, Bridge End Section, Type F
0130	606-E005		4	Each	Guard Rail, Terminal End Section, Flared
0140	618-B001		2	Square Feet	Additional Construction Signs (\$10.00)
0150	619-A1001		16	Mile	Temporary Traffic Stripe, Continuous White
0160	619-A2001		9	Mile	Temporary Traffic Stripe, Continuous Yellow
0170	619-A4002		6	Mile	Temporary Traffic Stripe, Skip Yellow
0180	619-A5001		1,740	Linear Feet	Temporary Traffic Stripe, Detail
0190	619-A6002		1,028	Linear Feet	Temporary Traffic Stripe, Legend
0200	620-A001		1	Lump Sum	Mobilization
0210	630-A001		158	Square Feet	Standard Roadside Signs, Sheet Aluminum, 0.080" Thickness
0220	630-A003		54	Square Feet	Standard Roadside Signs, Sheet Aluminum, 0.125" Thickness
0230	630-A005		250	Square Feet	Standard Roadside Signs, Sheet Aluminum, 0.1" Thickness
0240	630-C001		15	Linear Feet	Square Tube Posts, 4.0 lb/ft
0250	630-C005		780	Linear Feet	Square Tube Posts, 2.0 lb/ft
0260	630-F006		22	Each	Delineators, Guard Rail, White
0270	630-G004		22	Each	Type 3 Object Markers, OM-3R or OM-3L
0280	907-403-A006	(BA1)	550	Ton	19-mm, ST, Asphalt Pavement
0290	907-403-A015	(BA1)	10,750	Ton	9.5-mm, ST, Asphalt Pavement
0300	907-403-B012	(BA1)	2,525	Ton	9.5-mm, ST, Asphalt Pavement, Leveling
0310	907-403-C003	(BA1)	3,300	Ton	19-mm, ST, Asphalt Pavement, Trench Widening
0320	907-407-A001	(A2)	12,217	Gallon	Asphalt for Tack Coat
0330	907-606-PP005		2	Each	Guard Rail, Bridge Connector, Per Plans
0340	907-618-A001		1	Lump Sum	Maintenance of Traffic
0350	907-619-B001		132	Linear Feet	Temporary Portable Rumble Strips

Line no.	Item Code	Adj Code	Quantity	Units	Description[Fixed Unit Price]
0360	907-626-C014		16	Mile	6" Thermoplastic Edge Stripe, Continuous White
0370	907-626-D005		6	Mile	6" Thermoplastic Traffic Stripe, Skip Yellow
0380	907-626-E005		9	Mile	6" Thermoplastic Traffic Stripe, Continuous Yellow
0390	907-626-G004		1,740	Linear Feet	Thermoplastic Detail Stripe, White
0400	907-626-G005		1,024	Linear Feet	Thermoplastic Detail Stripe, Yellow
0410	907-626-H009		118	Square Feet	Thermoplastic Legend, White
0420	907-626-H010		1,028	Linear Feet	Thermoplastic Legend, White
0430	907-627-J001		2,292	Each	Two-Way Clear Reflective High Performance Raised Markers
0440	907-627-L001		1,044	Each	Two-Way Yellow Reflective High Performance Raised Markers

SECTION 905 - COMBINATION BID PROPOSAL (Continued)

CONDITIONS FOR COMBINATION BID

If a bidder elects to submit a combined bid for two or more of the contracts listed for this month's letting, the bidder must complete and execute these sheets of the proposal in each of the individual proposals to constitute a combination bid. In addition to this requirement, each individual contract shall be completed, executed and submitted in the usual specified manner.

Failure to execute this Combination Bid Proposal in each of the contracts combined will be just cause for each proposal to be received and evaluated as a separate bid.

It is understood that the Mississippi Transportation Commission not only reserves the right to reject any and all proposals, but also the right to award contracts upon the basis of lowest separate bids or combination bids most advantageous to the State.

It is further understood and agreed that the Combination Bid Proposal is for comparison of bids only and that each contract shall operate in every respect as a separate contract in accordance with its proposal and contract documents.

I (We) agree to complete each contract on or before its specified completion date.

COMBINATION BID PROPOSAL

This proposal is tendered as one part of a Combination Bid Proposal utilizing option ___* of Subsection 102.11 on the following contracts:

* Option to be shown as either (a), (b), or (c).

	<u>Project No.</u>	<u>County</u>	<u>Project No.</u>	<u>County</u>
1.	_____	_____	6.	_____
2.	_____	_____	7.	_____
3.	_____	_____	8.	_____
4.	_____	_____	9.	_____
5.	_____	_____	10.	_____

(a) If Combination A has been selected, your Combination Bid is complete.

(b) If Combination B has been selected, then complete the following page.

SECTION 905 - COMBINATION BID PROPOSAL (Continued)

Project Number	Pay Item Number	Unit	Unit Price Reduction	Total Item Reduction	Total Contract Reduction
1.					
2.					
3.					
4.					
5.					
6.					
7.					
8.					

For Informational Purposes Only

SECTION 905 - COMBINATION BID PROPOSAL (Continued)

Project Number	Pay Item Number	Unit	Unit Price Reduction	Total Item Reduction	Total Contract Reduction
9.					
10.					

(c) If Combination C has been selected, then initial and complete ONE of the following.

_____ I (We) desire to be awarded work not to exceed a total monetary value of \$ _____.

_____ I (We) desire to be awarded work not to exceed _____ number of contracts.

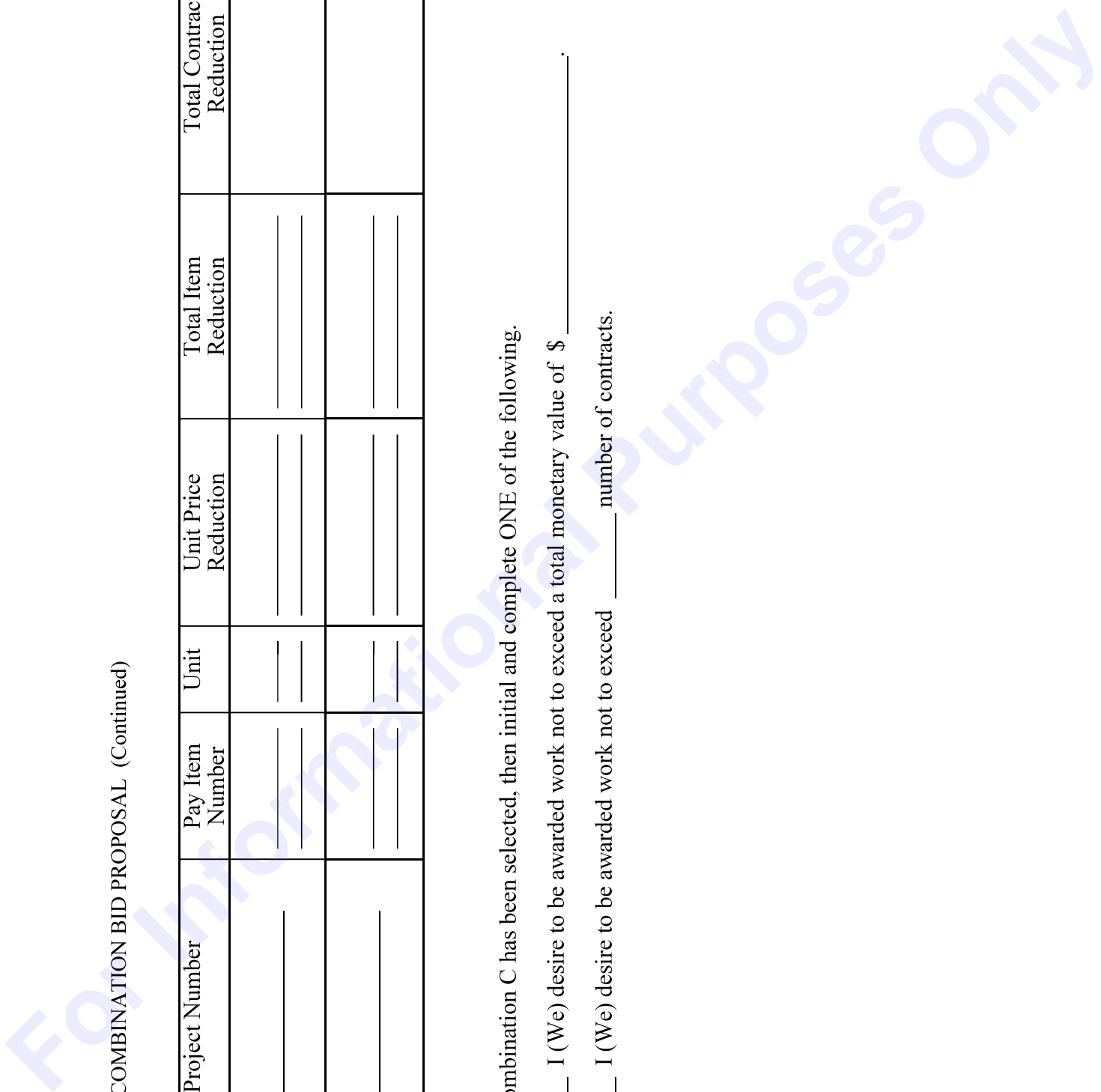

TO: EXECUTIVE DIRECTOR, MISSISSIPPI DEPARTMENT OF TRANSPORTATION
JACKSON, MISSISSIPPI

CERTIFICATE

If awarded this contract, I (we) contemplate that portions of the contract will be sublet. I (we) certify that those subcontracts which are equal to or in excess of fifty thousand dollars (\$50,000.00) will be in accordance with regulations promulgated and adopted by the Mississippi State Board of Contractors on September 8, 2011.

I (we) agree that this notification of intent DOES NOT constitute APPROVAL of the subcontracts.

_____	_____
(Individual or Firm)	(Address)
_____	_____
(Individual or Firm)	(Address)
_____	_____
(Individual or Firm)	(Address)
_____	_____
(Individual or Firm)	(Address)

NOTE: Failure to complete the above DOES NOT preclude subsequent subcontracts. Subsequent subcontracts, if any, equal to or in excess of fifty thousand dollars (\$50,000.00) will be in accordance with regulations promulgated and adopted by the Mississippi State Board of Contractors on September 8, 2011.

Contractor _____

MISSISSIPPI DEPARTMENT OF TRANSPORTATION
CERTIFICATION

I, _____,
(Name of person signing bid)

individually, and in my capacity as _____ of
(Title of person signing bid)

(Name of Firm, partnership, or Corporation)

do hereby certify under penalty of perjury under the laws of the United States and the State of Mississippi

that _____, Bidder
(Name of Firm, Partnership, or Corporation)

on Project No. **SP-0035-01(009)/ 109983301000 & SP-0035-01(010)/ 109984301000**

in **Marshall** County(ies), Mississippi, has not either directly or indirectly entered into any agreement, participated in any collusion; or otherwise taken any action in restraint of free competitive bidding in connection with this contract; nor have any of its corporate officers or principal owners.

Except as noted hereafter, it is further certified that said legal entity and its corporate officers, principal owners, managers, auditors and others in a position of administering federal funds are not currently under suspension, debarment, voluntary exclusion or determination of ineligibility; nor have a debarment pending; nor been suspended, debarred, voluntarily excluded or determined ineligible within the past three years by the Mississippi Transportation Commission, the State of Mississippi, any other State or a federal agency; nor been indicted, convicted or had a civil judgment rendered by a court of competent jurisdiction in any matter involving fraud or official misconduct within the past three years.

Do exceptions exist and are made a part thereof? Yes / No

Any exceptions shall address to whom it applies, initiating agency and dates of such action.

Note: Exceptions will not necessarily result in denial of award but will be considered in determining bidder responsibility. Providing false information may result in criminal prosecution or administrative sanctions.

All of the foregoing is true and correct.

(1/2016 S)

SECTION 902

CONTRACT FOR _____
LOCATED IN THE COUNTY(IES) OF _____

STATE OF MISSISSIPPI
COUNTY OF HINDS

This Contract is entered into by and between the Mississippi Transportation Commission (the "Commission") and the undersigned contractor (the "Contractor"), as follows:

As consideration for this Contract, the Commission agrees to pay the Contractor the amount(s) set out in the Proposal attached hereto. Said payment will be made in the manner and at the time(s) specified in the Specifications and/or Special Provisions, if any. In exchange for said consideration, the Contractor hereby agrees to accept the prices stated in the Proposal as full compensation for the furnishing of all labor, materials and equipment, and the execution of the scope of work identified for this referenced Project as contemplated in this Contract, and as more fully outlined in the Contract Documents (the "Work"). The Contract Documents consist of the Advertisement, the Notice to Bidders, the Proposal, the Specifications, the Special Provisions, and the approved Plans, all of which are hereby made a part of this Contract and incorporated herein by reference.

The Contractor shall be responsible for all loss or damage arising out of, or in any way in connection with the Work, or from any unforeseen obstructions or difficulties that may be encountered in the prosecution of the Work, and for all risks of every description connected with the Work, with the exception of any items specifically excluded in the Contract Documents. The Contractor shall fully and faithfully complete the Work in a good and workmanlike manner, according to the Contract Documents and any Supplemental Agreements thereto.

The Contractor further agrees that the Work shall be done under the direct supervision of, and to the complete satisfaction of, the Executive Director of the Mississippi Department of Transportation, or his authorized representative(s), and, when federal funds are involved, subject to the inspection and approval of the Federal Highway Administration, or its agents, and/or the agents of any other state or federal agency whose funds are involved. Further, the Work shall be done in accordance with any applicable state and federal laws, and any such rules and regulations issued by the Commission and/or any relevant Federal Agency.

The Contractor agrees that all labor as outlined in the Contract Documents may be secured from a list furnished by the Manager of the Win Job Center nearest the project location, or any successor thereto.

It is agreed and understood that each and every provision of law and clause required by law to be inserted into this Contract shall be deemed to be inserted herein, and this Contract shall be read and enforced as though it were included herein. If through mere mistake or otherwise, any such provision is not inserted, then upon the application of either party hereto, the Contract shall be physically amended to make such insertion.

The Contractor agrees that he has read each and every clause of the Contract Documents, and fully understands the meaning of same, and hereby acknowledges that he will comply with all terms, covenants and agreements therein.

Witness our signatures, this the ____ day of _____, 20__.

Contractor

By: _____
Title: _____

Signed and sealed in the presence of: (name and address of witness)

MISSISSIPPI TRANSPORTATION COMMISSION

Executive Director

Secretary to the Commission

Award authorized by the Mississippi Transportation Commission in session on the ____ day of _____, _____, Minute Book No. _____, Page No. _____.

**SECTION 903
PERFORMANCE BOND**

PERFORMANCE BOND FOR THE FOLLOWING CONTRACT:

Project No.: _____

For the construction of: _____

Contract date: _____ Contract Price: _____

FOR OWNER: MISSISSIPPI TRANSPORTATION COMMISSION, 401 N. WEST STREET, JACKSON, MISSISSIPPI 39201.

CONTRACTOR (full legal name, contact person, phone number and address):

SURETY (legal name, phone number, principal place of business and address *for notice purposes*):

Second Surety (if applicable):

The Contractor and Surety, jointly and severally, bind themselves, their heirs, executors, administrators, successors and assigns, to the Owner for the performance of the Contract, which is incorporated herein by reference, and subject to the following terms:

1. If the Contractor fully and faithfully performs the Contract, the Surety and the Contractor shall have no obligation under this Bond.
2. The Surety's obligation under this Bond shall arise after:
 - (a) the Owner first provides notice to the Contractor and the Surety that termination is imminent, pursuant to the current edition of the Mississippi Standard Specifications for Road and Bridge Construction, which is a part of the Contract; and
 - (b) the Owner declares a Contractor Default, terminates the Contract, and notifies the Surety.
3. Within 20 calendar days as set forth in Section 108.08 of the current edition of the Mississippi Standard Specifications for Road and Bridge Construction, the Surety shall, after discussions with and consent from the Owner, and at the Surety's expense, elect to take one of the following actions:
 - (a) Arrange for the Contractor, with the consent of the Owner, to perform and complete the Contract;
 - (b) Undertake to perform and complete the Contract itself, through its agents or independent contractors;
 - (c) Waive its right to perform and complete, arrange for completion, or obtain a new contractor, and after investigation, determine the amount for which it may be liable to the Owner (subject to the consent of the Owner) and as soon as practicable after the amount is determined, make payment to the Owner.

4. If the Surety does not proceed, within a reasonable time frame, to enact and carry out the election made in Paragraph 3, then the Surety shall be deemed to be in default on this Bond, and the Owner shall be entitled to enforce any remedy available to it under the Contract and applicable law.
5. Subject to the commitment by the Owner to pay the Balance of the Contract Price, the Surety is obligated, without duplication, for
 - (a) the responsibilities of the Contractor for correction of defective work and completion of the Contract;
 - (b) additional legal, design professional and delay costs resulting from the Contractor's Default, and resulting from the actions or failure to act of the Surety under Paragraph 3; and
 - (c) liquidated damages, or if no liquidated damages are specified in the Contract, actual damages caused by delayed performance or non-performance of the Contractor.
6. The Surety hereby waives notice of any change, including changes of time, to the Contract or to related subcontracts, purchase orders and other obligations.
7. The penal sum of the Bond shall be equal to the Contract Price; however, the penal sum may be increased or decreased as the result of any subsequent Supplemental Agreements and/or final contract quantities.
8. Notice to the Surety, the Owner or the Contractor shall be mailed or delivered to the address listed for notice purposes on the first page of this Bond.

CONTRACTOR AS PRINCIPAL

Company: _____

Signature: _____

Name: _____

Title: _____

Address: _____

SURETY

Company: _____

Signature: _____

MS Insurance ID # _____

Name: _____

Title: _____

Address: _____

SURETY (if applicable)

Company: _____

Signature: _____

MS Insurance ID # _____

Name: _____

Title: _____

Address: _____

**SECTION 903
PAYMENT BOND**

PAYMENT BOND FOR THE FOLLOWING CONTRACT:

Project No.: _____

For the construction of: _____

Contract date: _____ Contract Price: _____

**FOR OWNER: MISSISSIPPI TRANSPORTATION COMMISSION, 401 N. WEST STREET,
JACKSON, MISSISSIPPI 39201.**

CONTRACTOR (full legal name, contact person, phone number and address):

SURETY (legal name, phone number, principal place of business and address *for notice purposes*):

Second Surety (if applicable):

The Contractor and Surety, jointly and severally, bind themselves, their heirs, executors, administrators, successors and assigns, to the Owner for payment of labor, materials and equipment furnished for use in the performance of the Contract, which is incorporated herein by reference, subject to the following terms:

1. If the Contractor promptly makes payment of all sums due to any and all subcontractors, sub-subcontractors, suppliers to the Contractor, suppliers to subcontractors and/or laborers who have performed work on the project site, and defends, indemnifies and holds harmless the Owner from claims, demands, liens or suits by any person or entity seeking payment for labor, materials or equipment furnished for use in the performance of the Contract, then the Surety and the Contractor shall have no obligation under this Bond.
2. The Owner shall provide notice to the Surety of any claims, demands, liens or suits against the Owner or the Owner's property that it receives from any person or entity ("Claimants") seeking payment for labor, materials or equipment furnished for use in the performance of the Contract.
3. Upon notice of any claims, demands, liens or suits provided by the Owner or Contractor or given to the Surety by a Claimant, the Surety shall promptly and at the Surety's expense, defend, indemnify and hold harmless the Owner against said claim, demand, lien or suit and shall take the following additional actions:
 - (a) Send an answer to the Claimant, with a copy to the Owner, within sixty (60) days after receipt of the Claim, stating the amounts that are undisputed and the basis for challenging any amounts that are disputed; and
 - (b) Pay or arrange for payment of any undisputed amounts.

4. The Surety shall not be liable to the Owner, Claimants or others for obligations of the Contractor that are unrelated to the Contract. The Owner shall not be liable for the payment of any costs or expenses of any Claimant under this Bond and shall have no obligation under this Bond to make payments to, or give notice on behalf of, Claimants, or otherwise have any obligations to Claimants under this Bond.
5. The Surety hereby waives notice of any change, including changes of time, to the Contract or to related subcontracts, purchase orders and other obligations.
6. The penal sum of the Bond shall be equal to the Contract Price; however, the penal sum may be increased or decreased as the result of any subsequent Supplemental Agreements and/or final contract quantities.

CONTRACTOR AS PRINCIPAL

Company: _____
Signature: _____
Name: _____
Title: _____
Address: _____

SURETY

Company: _____
Signature: _____
Name: _____
Title: _____
Address: _____

MS Insurance ID # _____

SURETY (if applicable)

Company: _____
Signature: _____
Name: _____
Title: _____
Address: _____

MS Insurance ID # _____



BID BOND

KNOW ALL MEN BY THESE PRESENTS, that we _____
Contractor

Address

City, State ZIP

As principal, hereinafter called the Principal, and _____
Surety

a corporation duly organized under the laws of the state of _____

as Surety, hereinafter called the Surety, are held and firmly bound unto State of Mississippi, Jackson, Mississippi

As Obligee, hereinafter called Obligee, in the sum of **Five Per Cent (5%) of Amount Bid**

Dollars(\$ _____)

for the payment of which sum will and truly to be made, the said Principal and said Surety, bind ourselves, our heirs, executors, administrators, successors and assigns, jointly and severally, firmly by these presents.

WHEREAS, the Principal has submitted a bid for **Mill & Overlay approximately 4.2 miles of SR 311 from Landfill Road to Liles Road and approximately 3.5 miles from 0.1 mile south of Audie Todd Road to US 72, known as State Project Nos. SP-0035-01(009) / 109983301 & SP-0035-01(010) / 109984301 in Marshall County.**

NOW THEREFORE, the condition of this obligation is such that if the aforesaid Principal shall be awarded the contract, the said Principal will, within the time required, enter into a formal contract and give a good and sufficient bond to secure the performance of the terms and conditions of the contract, then this obligation to be void; otherwise the Principal and Surety will pay unto the Obligee the difference in money between the amount of the bid of the said Principal and the amount for which the Obligee legally contracts with another party to perform the work if the latter amount be in excess of the former, but in no event shall liability hereunder exceed the penal sum hereof.

Signed and sealed this _____ day of _____, 20__

(Principal)

(Seal)

(Witness) (Name) By: _____ (Title)

(Surety) (Seal)

(Witness) (Attorney-in-Fact) By: _____

(MS Agent)

Mississippi Insurance ID Number

