

MDOT Use Only

Checked _____

Loaded _____

Keyed _____

03 -



SM No. CNHPP0010011852

PROPOSAL AND CONTRACT DOCUMENTS

FOR THE CONSTRUCTION OF

03

Widening on I-10 at MS 605 WB Ramp, known as Federal Aid Project No. NHPP-0010-01(185) / 109879301 in Harrison County.

Project Completion: 09/10/2027

(STATE DELEGATED)

NOTICE

**BIDDERS MUST COMPLETE AN ONLINE REQUEST
FOR PERMISSION TO BID THIS PROJECT.**

Electronic addendum updates will be posted on www.gomdot.com

SECTION 900
OF THE CURRENT
2017 STANDARD SPECIFICATIONS
FOR ROAD AND BRIDGE CONSTRUCTION
JACKSON, MISSISSIPPI

MISSISSIPPI DEPARTMENT OF TRANSPORTATION

SECTION 904 - NOTICE TO BIDDERS NO. 7988

DATE: 7/3/2026

SUBJECT: Readvertisement

PROJECT: NHPP-0010-01(185)/ 109879301000 - Harrison County(ies)

The contents of this proposal are the same as when advertised for the May 2026 Letting, except as follows:

Revised Advertisement;

Revised NTB No. 7986;

NTB No. 8191 replaces NTB No. 7578;

Added SP 907-407-1;

Added SP 907-618-11;

Add this Notice to Bidders No. 7988

**MISSISSIPPI DEPARTMENT OF TRANSPORTATION
TABLE OF CONTENTS**

PROJECT: NHPP-0010-01(185)/109879301 - Harrison

RE-ADVERTISEMENT NOTICE TO BIDDERS NO. 7988

Section 901 - Advertisement

Section 904 - Notice to Bidders

#1	Governing Specification, w/ Supplement
#2	Status of ROW, w/ Attachments
#3	Final Cleanup
#13	Safety Edge
#296	Reduced Speed Limit Signs
#445	Mississippi Agent or Qualified Nonresident Agent
#516	Errata and Modifications to the 2017 Standard Specifications
#757	Additional Erosion Control Requirements
#1225	Early Notice to Proceed
#1226	Material Storage Under Bridges
#1241	Fuel and Material Adjustments
#1434	Erosion Control Plan
#1878	Storm Water Discharge Associated with Construction Activities (≥ 1 and < 5 Acres)
#2172	App for Storm Water Reports
#2206	MASH Compliant Devices
#2273	Mississippi Special Fuel Tax Law
#2954	Reflective Sheeting for Signs
#3963	Super Silt Fence
#4113	Unique Entity ID Requirement For Federal Funded Projects
#4702	App for Traffic Control Report
#5086	Detail of Square Tube Sign Posts
#5551	Federal Bridge Formula
#5570	Special Provisions Related to Concrete
#7304	Erosion Control Contract Compliance
#7986	Contract Time
#8191	Obligation Date
906	Required Federal Contract Provisions -- FHWA 1273, w/Supplements

Section 907 - Special Provisions

907-101-1	Definitions and Terms
907-102-2	Bidding Requirements and Conditions
907-104-2	Minor Alterations to the Contract
907-105-2	Control of Work
907-106-5	Control of Materials
907-107-2	Contractor's Erosion Control Plan
907-108-4	Subletting of Contract
907-109-5	Measurement and Payment
907-234-1	Silt Fence

PROJECT: NHPP-0010-01(185)/109879301 - Harrison

907-401-4	Asphalt Pavements - General
907-403-4	Asphalt Pavements
907-407-1	Tack Coat
907-601-1	Structural Concrete
907-618-11	Work Zone Law Enforcement
907-618-12	Traffic Control Management
907-619-5	Traffic Control for Construction Zones
907-626-12	Thermoplastic Traffic Markings
907-627-1	Raised Pavement Markings
907-700-3	Materials and Tests w/Attachment
907-701-4	Hydraulic Cement, w/ Supplement
907-702-4	Bituminous Materials
907-703-2	Gradation
907-705-1	Stone Riprap
907-707-3	Joint Materials
907-711-2	Plain Steel Wire
907-712-1	Fence and Guardrail
907-714-4	Miscellaneous Materials
907-718-1	Timber and Dimension Lumber
907-720-4	Pavement Marking Materials
907-721-4	Materials for Signing
907-799-1	Hydraulic Cement Concrete Mixtures, w/Supplement

Section 905 - Proposal, Proposal Bid Items, Combination Bid Proposal

Certification of Performance - Prior Federal-Aid Contracts

Certification Regarding Non-Collusion, Debarment and Suspension

SAM.GOV Registration and Unique Entity ID

Section 902 - Contract Form

Section 903 - Contract Bond Forms

(REVISIONS TO THE ABOVE WILL BE INDICATED ON THE SECOND SHEET
OF SECTION 905 AS ADDENDA)

07/01/2026 03:38 PM

MISSISSIPPI DEPARTMENT OF TRANSPORTATION

SECTION 901 - ADVERTISEMENT

Electronic bids will be received by the Mississippi Transportation Commission at 10:00 o'clock A.M., Tuesday, July 28, 2026, from the Bid Express Service and shortly thereafter publicly read on the Sixth Floor for:

Widening on I-10 at MS 605 WB Ramp, known as Federal Aid Project No. NHPP-0010-01(185) / 109879301 in Harrison County.

The attention of bidders is directed to the Contract Provisions governing selection and employment of labor. Minimum wage rates have been predetermined by the Secretary of Labor and are subject to Public Law 87-581, Work Hours Act of 1962, as set forth in the Contract Provisions.

Contractors may request permission to bid online at <http://shop.mdot.ms.gov> at no cost. Upon approval, Contractors shall be eligible to submit a bid using Bid Express at <http://bidx.com>. Specimen proposals may be viewed and downloaded online at no cost at <http://mdot.ms.gov> or purchased online at <http://shop.mdot.ms.gov> at a cost of Ten Dollars (\$10.00) per proposal plus a small convenience fee. Cash or checks will not be accepted as payment.

Plans must be purchased online at <https://shop.mdot.ms.gov>. Costs of plans will be on a per sheet basis plus a small convenience fee. If you have any questions, you can contact the MDOT Plans Print Shop at (601) 359-7460, or e-mail at plans@mdot.state.ms.us. Plans will be shipped upon receipt of payment. Cash or checks will not be accepted as payment.

Bid bond, signed or countersigned by a Mississippi Agent or Qualified Nonresident Agent, with Power of Attorney attached, a Cashier's check or Certified Check for five (5%) percent of bid, payable to STATE OF MISSISSIPPI, must accompany each proposal.

The attention of bidders is directed to the provisions of Subsection 102.07 pertaining to irregular proposals and rejection of bids.

BRAD WHITE
EXECUTIVE DIRECTOR

MISSISSIPPI DEPARTMENT OF TRANSPORTATION

SUPPLEMENT TO NOTICE TO BIDDERS NO. 1

DATE: 06/08/2021

SUBJECT: Governing Specifications

Change the web address at the end of the first paragraph to the following.

<https://shop.mdot.ms.gov/default.aspx?StoreIndex=1>

MISSISSIPPI DEPARTMENT OF TRANSPORTATION

SECTION 904 - NOTICE TO BIDDERS NO. 1

CODE: (IS)

DATE: 03/01/2017

SUBJECT: Governing Specifications

The current (2017) Edition of the Standard Specifications for Road and Bridge Construction adopted by the Mississippi Transportation Commission is made a part hereof fully and completely as if it were attached hereto, except where superseded by special provisions, or amended by revisions of the Specifications contained within this proposal. Copies of the specification book may be purchased from the MDOT Construction Division, or online at shopmdot/default.aspx?StoreIndex=1.

A reference in any contract document to controlling requirements in another portion of the contract documents shall be understood to apply equally to any revision or amendment thereof included in the contract.

In the event the plans or proposal contain references to the 2004 Edition of the Standard Specifications for Road and Bridge Construction, it is to be understood that such references shall mean the comparable provisions of the 2017 Edition of the Standard Specifications.

MISSISSIPPI DEPARTMENT OF TRANSPORTATION

SECTION 904 - NOTICE TO BIDDERS NO. 2

CODE: (IS)

DATE: 03/01/2017

SUBJECT: Status of Right-of-Way

Although it is desirable to have acquired all rights-of-way and completed all railroad agreements, utility adjustments and work to be performed by others prior to receiving bids, sometimes it is not considered to be in the public interest to wait until each and every such clearance has been obtained. The bidder is hereby advised of possible unacquired rights-of-way, relocations, railroad agreements and utilities adjustments which have not been completed.

The status of right-of-way acquisition, utility adjustments, encroachments, potentially contaminated sites, railroad facilities, improvements, and asbestos contamination are set forth in the following attachments.

In the event right of entry is not available to ALL parcels of right-of-way and/or all work that is to be accomplished by others on the date set forth in the contract for the Notice to Proceed is not complete, the Department will issue a restricted Notice to Proceed.

STATUS OF RIGHT-OF-WAY
NHPP-0010-01(185)
109879/301000
Harrison County

All rights of way and legal rights of entry have been acquired except:

None.

MISSISSIPPI DEPARTMENT OF TRANSPORTATION

Inter-Departmental Memorandum

TO: Don Drake
Right of Way Division

DATE: January 30, 2026

FROM: Martha Brewer 
District Preconstruction Engineer

SUBJECT OR PROJECT NO: NHPP-0010-01(185)
109879/30100

INFORMATION COPY TO:
File

COUNTY: Harrison

District Status Report

1. **STATUS OF RIGHT OF WAY:** All work to be done within existing ROW.
2. **RIGHT OF WAY CLEARANCE:** There are no encroachments.
3. **STATUS OF AFFECTED RAILROAD OPERATING FACILITIES:** None affected.
4. **STATUS OF REQUIRED UTILITY RELOCATIONS:** No known conflicts.
5. **STATUS OF CONSTRUCTION AGREEMENT:** None Required

ASBESTOS ABATEMENT STATUS REPORT

NHPP-0010-01(185) 109879-301000

Harrison County

February 2, 2026

Reference is made to notices to bidders entitled "Asbestos National Emission Standards for Hazardous Air Pollutants (NESHAP)" and "Removal of Obstructions".

The following pertinent information is furnished concerning asbestos-containing materials (ACMs), if any, found in buildings to be removed by the Contractor.

There is no right-of-way required for this project, and the contractor will not need to remove any buildings.

STATUS OF POTENTIALLY CONTAMINATED SITES REPORT

NHPP-0010-01(185) 109879-301000

Harrison County

February 2, 2026

THERE IS NO RIGHT-OF-WAY REQUIRED FOR THIS PROJECT. NO INITIAL SITE ASSESSMENT WILL BE PERFORMED. IF CONTAMINATION ON THE EXISTING RIGHT-OF-WAY IS DISCOVERED, IT WILL BE HANDLED BY THE DEPARTMENT.

IMPROVEMENTS STATUS REPORT

Improvements to be included in the Notice to Bidders to be removed by the Construction Contractor

FMS Construction Project No: 109879-301000

FMS ROW Project No:

External ROW No: NHPP-0010-01(185))

Parcel No:
Station No:
Property Owner:
Description/Pictures:

MISSISSIPPI DEPARTMENT OF TRANSPORTATION

SECTION 904 - NOTICE TO BIDDERS NO. 3

CODE: (SP)

DATE: 01/17/2017

SUBJECT: Final Clean-Up

Immediately prior to final inspection for release of maintenance, the Contractor shall pick up, load, transport and properly dispose of all litter from the entire highway right-of-way that is within the termini of the project.

Litter shall include, but not be limited to, solid wastes such a glass, paper products, tires, wood products, metal, synthetic materials and other miscellaneous debris.

Litter removal is considered incidental to other items of work and will not be measured for separate payment.

MISSISSIPPI DEPARTMENT OF TRANSPORTATION

SECTION 904 - NOTICE TO BIDDERS NO. 13

CODE: (IS)

DATE: 03/01/2017

SUBJECT: Safety Edge

Bidders are hereby advised that the Shoulder Wedge (Safety Edge) specified in Section 401, Asphalt Pavements, shall only apply to the top two (2) lifts of asphalt. Open Graded Friction Courses (OGFC) are not to be considered a lift as it pertains to safety edge. Attached is a drawing showing the safety edge. Note that the shoulder dimensions in the bottom two drawings will be less than three feet (3').

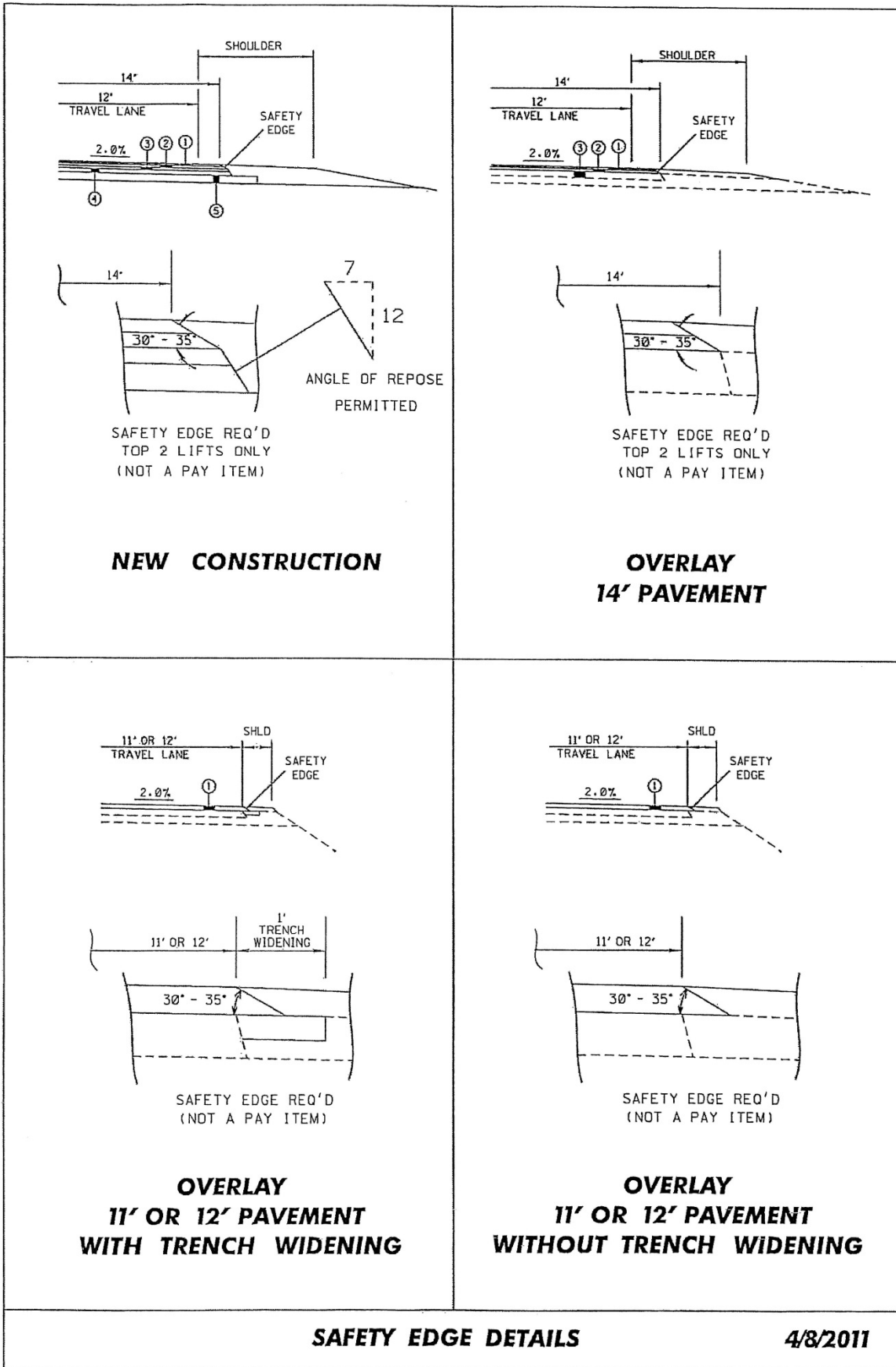

MISSISSIPPI DEPARTMENT OF TRANSPORTATION

SECTION 904 - NOTICE TO BIDDERS NO. 296

CODE: (SP)

DATE: 07/25/2017

SUBJECT: Reduced Speed Limit Signs

Bidders are advised that when the plans or contract documents require the speed limit on a project to be reduced, the Contractor shall begin work within 48 hours of installing the reduced speed limit signs. Should the Contractor not start work or have no plans to start work within 48 hours of installing the signs, the reduced speed limit signs shall be covered and existing speed limit signs uncovered.

MISSISSIPPI DEPARTMENT OF TRANSPORTATION

SECTION 904 - NOTICE TO BIDDERS NO. 445

CODE: (SP)

DATE: 10/10/2017

SUBJECT: Mississippi Agent or Qualified Nonresident Agent

Bidders are hereby advised of the requirements of Subsections 102.08, 103.05.2, and 107.14.2.1 of the *2017 Standard Specifications for Road and Bridge Construction* as it refers to bonding agents. Proposal guaranties, bonds, and liability insurance policies must be signed by a **Mississippi Agent or Qualified Nonresident Agent.**

MISSISSIPPI DEPARTMENT OF TRANSPORTATION

SECTION 904 - NOTICE TO BIDDERS NO. 516

CODE: (IS)

DATE: 11/28/2017

SUBJECT: Errata and Modifications to the 2017 Standard Specifications

<u>Page</u>	<u>Subsection</u>	<u>Change</u>
16	102.06	In the seventh full paragraph, change “Engineer” to “Director.”
33	105.05.1	In the sixth sentence, change “Contract Administration Engineer” to “Contract Administration Director.”
34	105.05.2.1	In subparagraph 2, change “SWPPP, ECP” to “SWPPP and the ECP”
35	105.05.2.2	In subparagraphs 2, add “ and” to the end of the sentence. In subparagraph 3, remove “, and” and add “.”.
90	109.04.2	In the last paragraph of subparagraph (a), place a period “.” at the end of the sentence.
93	109.04.2	In the last paragraph of subparagraph (g), place a period “.” at the end of the sentence. Also, in the first paragraph of subparagraph (h), place a period “.” at the end of the sentence.
97	109.07	Under ADJUSTMENT CODE, subparagraph (A1), change “HMA mixture” to “Asphalt mixtures.”
98	109.11	In the third sentence, change “Engineer” to “Director.”
219	308.04	In the last sentence of the last paragraph, change “Contractor’s decision” to “Engineer’s decision.”
300	405.02.5.9	In the first sentence of the second paragraph, change “Hot Mix Asphalt” to “Asphalt Mixtures.”
502	630.01.1	In the first paragraph, change “AASHTO” to “AASHTO’s LRFD”.
636	646.05	Change “each” to “per each” for the pay item units of payment.
640	656.02.6.2	In item 7), change “down stream” to “downstream”.
688	630.03.2	Change the subsection number from “630.03.2” to “680.03.2.”

- | | | |
|-----|---------------|---|
| 725 | 702.08.3 | In the second sentence of the first paragraph, change “hot-mix” to “asphalt.” |
| 954 | 804.02.13.1.6 | In the definition for “M” in the % Reduction formulas, change “paragraph 7.3” to “paragraph 5.3.” |

MISSISSIPPI DEPARTMENT OF TRANSPORTATION

SECTION 904 - NOTICE TO BIDDERS NO. 757

CODE: (IS)

DATE: 03/20/2018

SUBJECT: Additional Erosion Control Requirements

Bidders are hereby advised of the following requirements that relate to erosion control activities on the project.

THE MAXIMUM TOTAL ACREAGE THAT CAN BE DISTURBED, AT ONE TIME, ON THE PROJECT IS NINETEEN (19) ACRES. THE CONTRACTOR SHALL BE REQUIRED TO STABILIZE DISTURBED AREAS PRIOR TO OPENING UP ADDITIONAL SECTIONS OF THE PROJECT. STABILIZED SHALL BE WHEN THE DISTURBED AREA MEETS ONE OF THE FOLLOWING CRITERIA:

- **THE AREA HAS BEEN SEEDED, EITHER TEMPORARY OR PERMANENT, AND MULCHED ACCORDING TO THE SPECIFICATIONS, OR**
- **A CRUSHED STONE COURSE OR A LIFT OF ASPHALT PAVEMENT HAS BEEN PLACED, OR**
- **THE AREA HAS BEEN CHEMICALLY TREATED USING PORTLAND CEMENT OR LIME-FLY ASH, AND SEALED.**

DISTURBED AREAS INCLUDE THE ROADBED, SLOPES AND REMAINING AREA OUT TO THE ROW LINE.

Clearing and Grubbing: Prior to beginning any clearing and grubbing operations on the project, controls shall be in place to address areas such as drainage structures, wetlands, streams, steep slopes and any other sensitive areas in accordance with the approved Erosion Control Plan or as directed by the Engineer. Clearing and grubbing should be limited to the minimum area necessary to construct the project. Grubbing operations should be minimized in areas outside the construction limits and stumps should be cut off flush with the existing ground elevations. A buffer area of at least fifteen (15) feet or as shown in the Plans shall be in place adjacent to the right-of-way line. The buffer area can either be the existing vegetation that is left undisturbed or re-established by planting new vegetation if clearing and grubbing was required. *As applicable, see the Riparian Buffer Erosion Control sheet(s) in the Plans for clearing and grubbing limits adjacent to stream banks.*

Unclassified Excavation: Cut sections shall be graded in accordance with the typical sections and plan grades. Permanent erosion control BMP's should be placed as soon as possible after the cut material has been moved. Fill sections that are completed shall have permanent erosion control BMP's placed. Fill sections that are not completed shall be either permanently or temporarily seeded until additional material is made available to complete these sections. All unclassified excavation on the project is be required to be moved prior to incorporating any borrow excavation. The Contractor may have to stockpile unclassified excavation in order to comply with the nineteen (19) acre requirement. No additional compensation will be made for stockpiling operations.

Disturbed areas that remain inactive for a period of more than fourteen (14) days shall be temporary grassed and mulched. Temporary grassing and mulching shall only be paid one time for a given area.

MISSISSIPPI DEPARTMENT OF TRANSPORTATION

SECTION 904 - NOTICE TO BIDDERS NO. 1225

CODE: (SP)

DATE: 11/13/2018

SUBJECT: Early Notice to Proceed

Bidders are advised that if an early notice to proceed is allowed by the Department and the Contractor experiences problems or delays between the early notice to proceed date and the original notice to proceed date, this shall not be justification for any monetary compensation or an extension of contract time.

MISSISSIPPI DEPARTMENT OF TRANSPORTATION

SECTION 904 - NOTICE TO BIDDERS NO. 1226

CODE: (IS)

DATE: 11/16/2018

SUBJECT: Material Storage Under Bridges

Bidders are advised that Subsection 106.08 of the Standard Specifications allows the Contractor to store materials and equipment on portions of the right-of-way. However, the Contractor will not be allowed to store or stockpile materials under bridges without written permission from the Project Engineer. The Contractor shall submit a detailed request of all proposed materials to be stored under bridges to the Engineer a minimum of 14 calendar days prior to anticipated storage. This detail shall include, but not limited to, bridge location, material type, material quantity, and duration of storage. The Project Engineer and any other needed Division will review this information and determine whether to grant approval. The Contractor shall not store any material under any bridge without written approval from the Project Engineer.

MISSISSIPPI DEPARTMENT OF TRANSPORTATION

SECTION 904 - NOTICE TO BIDDERS NO. 1241

CODE: (IS)

DATE: 11/27/2018

SUBJECT: Fuel and Material Adjustments

Bidder's attention is brought to the last paragraph of Subsection 109.07 of the Standard Specifications which states that no fuel or material adjustment will be made after the completion of contract time. Any fuels consumed or materials incorporated into the work during the monthly estimate period falling wholly after the expiration of contract time will not be subject a fuel or material adjustment.

MISSISSIPPI DEPARTMENT OF TRANSPORTATION

SECTION 904 - NOTICE TO BIDDERS NO. 1434

CODE: (IS)

DATE: 03/06/2019

SUBJECT: Erosion Control Plan

Bidders are advised that the Best Management Practices (BMPs) shown at sensitive areas on the Erosion Control Sheets in the Plans shall be shown on the Contractor's Erosion Control Plan and shall be used in the field as indicated on the original plans sheets. Should the installation of these BMPs produce an unsatisfactory result, the Contractor shall submit to the Engineer alternate BMPs for approval. Once approved, the Contractor shall revise the Contractor's Erosion Control Plan to include these changes.

MISSISSIPPI DEPARTMENT OF TRANSPORTATION

SECTION 904 - NOTICE TO BIDDERS NO. 1878

CODE: (SP)

DATE: 08/27/2019

SUBJECT: Storm Water Discharge Associated with Construction Activity
(≥ 1 and < 5 Acres)

Construction Storm Water General NPDES Permit MSR 15 to discharge storm water associated with construction activity is required. This project is granted permission to discharge treated storm water into State waters. Copies of said permit and Storm Water Pollution Prevention Plan (SWPPP) are on file with the Department.

Prior to the execution of the contract, the successful bidder shall execute and deliver to the Executive Director an original signed copy of the completed Prime Contractor Certification (Form No. 1).

Failure of the bidder to execute and file the completed Prime Contractor Certification (Form No. 1) shall be just cause for the cancellation of the award.

The executed Prime Contractor Certification (Form No. 1) shall be prima facie evidence that the bidder has examined the permit, is satisfied as to the terms and conditions contained therein, and that the bidder has the primary responsibility for meeting all permit terms and conditions including, but not limited to, the inspection and reporting requirements of the permit. For this project, the Contractor shall furnish, set up and read, as needed, an on-site rain gauge.

The Contractor must furnish the Project Engineer a completed copy of the Small Construction Notice of Intent (SCNOI) along with the Contractor's Erosion Control Plan.

The Contractor shall make inspections in accordance with condition No. S-4, Page 20, and shall furnish the Project Engineer with the results of each weekly inspection as soon as possible following the date of inspection. The weekly inspections must be documented monthly on the Inspection and Certification Form, a copy of which is provided. The Contractor's representative and the Project Engineer shall jointly review and discuss the results of the inspections so that corrective action can be taken. The Project Engineer shall retain copies of the inspection reports.

The Engineer will have the authority to suspend all work and/or withhold payments for failure of the Contractor to carry out provisions of MDEQ's Storm Water Construction General Permit, the erosion control plan, updates to the erosion control plan, and /or proper maintenance of the BMPs.

Securing a permit (s) for storm water discharge associated with the Contractor's activity on any other regulated area the Contractor occupies, shall be the responsibility of the Contractor.

MISSISSIPPI DEPARTMENT OF TRANSPORTATION

SECTION 904 - NOTICE TO BIDDERS NO. 2172

CODE: (SP)

DATE: 01/06/2020

SUBJECT: App for Storm Water Reports

Bidders are advised that the Department has created a smart phone App for completing and submitting storm water reports required on this project. The Contractor who monitors storm water activities and completes storm water reports will be required to download and use this App when completing and submitting storm water reports. The reports will then be readily available to all persons who need access to the forms. The App is free and is available for downloading at the following location.

<https://extacctmgmt.mdot.state.ms.us/>

MISSISSIPPI DEPARTMENT OF TRANSPORTATION

SECTION 904 - NOTICE TO BIDDERS NO. 2206

CODE: (IS)

DATE: 01/14/2020

SUBJECT: MASH Compliant Devices

Bidders are hereby advised that compliance associated with the requirements of meeting either the National Cooperative Highway Research Program (NCHRP) Report 350 or the Manual for Assessing Safety Hardware (MASH) for installations of certain traffic control devices and permanent safety hardware devices (guardrails, guardrail terminals, permanent portable barriers, cast-in-place barriers, all other permanent longitudinal barriers, crash cushions, cable barriers, cable barrier terminals, bridge rails, bridge rail transitions, all other terminals, sign supports, and all other breakaway hardware) as listed throughout the Standard Specifications and/or the Standard Drawings, or both, is now replaced with the requirements of meeting the 2016 version of MASH after December 31, 2019. This change applies to new permanent installations and to full replacements of existing installations.

At the preconstruction conference or prior to starting any work on the project, the Contractor shall submit a letter stating that the traffic control devices and permanent safety hardware devices as outlined within the paragraph above that are to be used on the project are certified to meet MASH 2016.

When a MASH 2016-compliant device does not exist for the new permanent installations and/or full replacement installations of permanent safety hardware devices, as listed above, a MASH 2009-compliant or a NCHRP 350-compliant device may be proposed by the Contractor for the project. A written request for such instances must be submitted by the Contractor either at the preconstruction conference or prior to starting any work on the project. The Contractor shall submit the following items to the Project Engineer: (1) a detailed list of the proposed devices and locations thereof; and (2) certification letters indicating that the proposed devices are compliant with either MASH 2009 or NCHRP 350.

When a MASH 2016-compliant device does not exist for the temporary work zone traffic control devices (Category 1, Category 2, and Category 3 devices), a MASH 2009-compliant or a NCHRP 350-compliant device may be proposed by the Contractor for the project. Temporary work zone traffic control devices (Category 1, Category 2, and Category 3 devices) that are MASH 2009-compliant or NCHRP 350-compliant that have been in use prior to December 31, 2019, and that have a remaining service life may be proposed for use throughout their normal service life on the project by the Contractor. For either of these scenarios for temporary work zone traffic control devices, a written request must be submitted by the Contractor either at the preconstruction conference or prior to starting any work on the project. The Contractor shall submit the following items to the Project Engineer: (1) a detailed list of the proposed devices and locations thereof; and (2) certification letters indicating that the proposed devices are compliant with either MASH 2009 or NCHRP 350.

Work will only be allowed to proceed after the Department has granted written concurrence(s) with the proposed request(s) as listed above.

MISSISSIPPI DEPARTMENT OF TRANSPORTATION

SECTION 904 - NOTICE TO BIDDERS NO. 2273

CODE: (SP)

DATE: 02/12/2020

SUBJECT: Mississippi Special Fuel Tax Law

Bidder's attention is brought to the second paragraph of Subsection 107.02 of the Standard Specifications which states that all Contractors and Subcontractors must comply with all requirements contained in the Mississippi Special Fuel Tax Law, Section 27-55-501, *et seq.* Attached are two Fact Sheets provided by the Mississippi Department of Revenue (MDOR) with additional information.

Gasoline and Dyed Diesel Used for Non-Highway Purposes

Mississippi provides a reduced rate for gasoline and dyed diesel used for non-highway purposes. The reduced rates are 6.44 cents per gallon and 5.75 cents per gallon of gasoline or dyed diesel. These fuels are generally taxed at 18 cents per gallon if for on road use.

Gasoline Used for Non-Highway Purposes

You may be entitled to a refund of 11.56 cents per gallon (making this an equivalent to a tax rate of 6.44 cents per gallon) if you desire to purchase gasoline to be used off road. The gasoline must be used for agricultural, maritime, industrial, manufacturing, domestic or non-highway purposes only.

Examples of non-highway include gasoline used in boats, golf carts, machinery used for manufacturing or farm equipment used exclusively in plowing, planting or harvesting farm products.

Refund Gasoline User

The refund is based on the amount of gallons used. Before a refund is issued, you are required to...

1. Obtain a refund gasoline user's permit and a certificate for refund booklet from the Department of Revenue;
2. Have a storage tank marked "REFUND GASOLINE"; and,
3. Purchase the gasoline from someone who holds a refund gasoline dealer's permit.

No refund will be allowed for gasoline used in motor vehicles owned or operated by a government entity or used in Mississippi government contracts.

Refund Gasoline Dealer

You must obtain a refund gasoline dealer's permit from the Department of Revenue before selling refund gasoline. At no time should the gasoline be delivered to a tank that is not properly marked. The gasoline must be dyed a distinctive mahogany color at the time of delivery.

The Department of Revenue may waive the dye requirement if the dye may cause damage to the equipment. The refund gasoline user is required to obtain the waiver from the Department of Revenue.

Dyed Diesel Used for Non-Highway Purposes

Unlike gasoline, you are not required to apply for a refund if you desire to purchase dyed diesel to be used off road. Mississippi provides a reduced rate of 5.75 cents per gallon on dyed diesel used off road. Diesel used on road is subjected to 18 cents per gallon. Dyed diesel used in motor vehicles owned or operated by a government entity or used in Mississippi government contracts will be subjected to 18 cents per gallon.

Dyed Diesel Used on the Highway

Any person who purchases, receives, acquires or uses dyed diesel for highway use will be liable to pay 18 cents per gallon and subject to a penalty in the amount of \$1000.

Identifying Dyed Diesel

Storage facilities for dyed diesel must be plainly marked "NONHIGHWAY DIESEL FUEL" or "NONHIGHWAY KEROSENE". Retailers are also required to mark all pumps or dispensing equipment.



Special Fuel Used on Government Contracts

State and Local Government Contracts

Special fuel purchased, acquired or used in performing contracts with the State of Mississippi, counties, municipalities or any political subdivision is taxed at a rate of 18 cents per gallon. Special fuel includes but is not limited to the following:

- Dyed diesel fuel;
- Kerosene;
- Undyed diesel fuel; and,
- Fuel oil.

State and local government contracts include construction, reconstruction and maintenance or repairs of projects such as roads, bridges, water systems, sewer systems, buildings, drainage canals and recreational facilities. The Department of Revenue may require contractors to remit the excise tax directly to the state in lieu of paying the tax to a distributor.

Special Fuel Direct Pay Permit

Contractors that remit the excise tax to the state will be issued a Special Fuel Direct Pay Permit. This permit relieves the distributor from collecting the tax and requires the contractor to file a monthly special fuel return. The distributor should include the contractor’s permit number on all invoices that are related to tax-free sales.

The contractor is required to furnish a surety or cash bond guaranteeing the payment of the excise tax prior to receiving the Special Fuel Direct Pay Permit. The Department of Revenue may accept a contractors tax bond if the bond covers the excise tax levied on special fuel.

Special Fuel Distributors

If the contractor does not have a Special Fuel Direct Pay Permit, distributors are required to collect the 18 cents excise tax and remit the tax to the Department of Revenue. The additional 12.25 cents levied on special fuel (excluding undyed diesel) should be reported on schedules 5F and 5G of the special fuel return.

Environmental Protection Fee

Special fuel distributors are required to collect the environmental protection fee even if the contractor has a Special Fuel Direct Pay Permit. The fee is levied at 4/10^{ths} of a cent per gallon. The fee is suspended or reinstated when the trust fund has exceeded or fallen below the obligatory balance.

Penalties

Any person who knowingly and willfully purchases untaxed fuel for use in equipment utilized on a road or highway construction site in this state is guilty of a misdemeanor and, upon conviction, shall be fined not less than \$1,000 or more than \$100,000, or imprisoned in the county jail for not more than one year, or both.



MISSISSIPPI DEPARTMENT OF TRANSPORTATION

SECTION 904 - NOTICE TO BIDDERS NO. 2954

CODE: (IS)

DATE: 12/01/2020

SUBJECT: Reflective Sheeting for Signs

Bidders are hereby advised that the retroreflective sign sheeting used for signs on this project shall be as listed below and shall meet the requirements of Subsection 721.06.

Temporary Construction Signs

Temporary traffic control (orange) sign sheeting shall be a minimum Type IX Fluorescent Orange sheeting as shown in Special Provision 907-721.

Permanent Signs

Permanent signs, except signs on traffic signal poles/mast arms, shall be as follows:

- Brown background sheeting on guide signs shall be a minimum Type VIII sheeting,
- Green and blue background sheeting on guide signs shall be a minimum Type IX sheeting, and
- All white, yellow, red, fluorescent yellow, and fluorescent yellow/green sheeting shall be Type XI sheeting.

MISSISSIPPI DEPARTMENT OF TRANSPORTATION

SECTION 904 - NOTICE TO BIDDERS NO. 3963

CODE: (SP)

DATE: 01/19/2022

SUBJECT: Super Silt Fence

Bidders are hereby advised that Kengro Siltron SIL-M-36 may be used as a substitute material for pay item 907-234-C001, Super Silt Fence, in accordance with Subsection 234.03.1.2 of the Standard Specifications. In the event that the material fails to perform, the Department reserves the right to require Super Silt Fence be installed as per the Standard Drawing at no additional cost to the Department.

<https://www.kengro.com/products/siltron>

MISSISSIPPI DEPARTMENT OF TRANSPORTATION

SECTION 904 - NOTICE TO BIDDERS NO. 4113

CODE: (SP)

DATE: 03/23/2022

SUBJECT: Unique Entity ID (SAM) Requirement for Federal Funded Projects

Bidders are advised that the Prime Contractor must register and maintain a current registration in the System for Award Management (<http://sam.gov>) at all times during this project. Upon registration, the Contractor will be assigned a SAM Unique Entity ID.

Bidders are also advised that prior to the award of this contract, they MUST be registered, active, and have no active exclusions in the System for Award Management.

MISSISSIPPI DEPARTMENT OF TRANSPORTATION

SECTION 904 - NOTICE TO BIDDERS NO. 4702

CODE: (SP)

DATE: 11/22/2022

SUBJECT: App for Traffic Control Reports

Bidders are advised that the Department has created a smart phone App for completing and submitting traffic control reports (Form CSD-762) required on this project. The Contractor who monitors traffic control activities and completes traffic control reports will be required to download and use this App when completing and submitting traffic control reports. The reports will then be readily available to all persons who need access to the forms. The App is free and is available for downloading at the following location.

<https://extacctmgmt.mdot.state.ms.us/>

MISSISSIPPI DEPARTMENT OF TRANSPORTATION

SECTION 904 - NOTICE TO BIDDERS NO. 5086

CODE: (SP)

DATE: 05/02/2023

SUBJECT: Detail of Square Tube Sign Posts

Bidders are advised that the following drawings shall be used in the manufacture and installation of square tube sign posts, unless otherwise directed by the Engineer.

FMS DOW

STATE	PROJECT NO.
MI	

FLAT PANEL SIGN BRACE

6061-T6 ALUMINUM ALLOY;
BRACE SHALL BE 1/8" DEEP BY 1/8" NOMINAL
WALL THICKNESS. BRACE
CENTERS SHALL BE CENTERED
ALONG ENTIRE LENGTH OF THE BRACE. A
MINIMUM OF TWO HORIZONTAL
BRACES MUST BE USED.

SIGN DRIVE RIVET W/WASHER

3/8" ALUMINUM SHELL / STEEL CORE RIVET
WASHER SHALL BE 3/8" DIA. BY 1/8" THICK.
RIVETS SHOULD BE FT INTO
SIGN BRACE TO SECURE ALUMINUM SIGN
BRACE TO SIGN PANEL. RIVETS SHALL
USE 3/16" DIA. GRIP RANGE ALUMINUM FOOT
RIVETS (#46).

EXTRUDED PANEL SIGN CLAMP

FLAT PANEL SIGN CLAMP

POST CAP

SIGN POSTS

example slip base assembly (detailed below)

2-1/2" SQUARE POST RECEIVER

POST LOCKING WEDGE

SURFACE MOUNT BASE

UNIBASE ANCHOR STUB

FLAT PANEL SIGN BRACE

MATERIALS: 1.4" WIDE x 1.06" TYPE 304, #20 FINISHED ALUMINUM SIGN BRACE. INCLUDES STAINLESS STEEL 3/8" x 1/8" x 2" CARRIAGE BOLT AND 3/16" x 1/8" x 1/2" PLANGED NUT. ONE (1) PLANGED NUT REQUIRED FOR EACH BRACE TO POST JUNCTION.

EXTRUDED PANEL SIGN CLAMP

MATERIALS: 1.4" WIDE x 1.06" TYPE 304, #20 FINISHED ALUMINUM SIGN CLAMP. INCLUDES STAINLESS STEEL 3/8" x 1/8" x 2" CARRIAGE BOLT AND 3/16" x 1/8" x 1/2" PLANGED NUT. ONE (1) PLANGED NUT REQUIRED FOR EACH BRACE TO POST JUNCTION.

POST CAP

MADE OF 10GA REGALVANIZED STEEL WITH AN ID CAPABLE OF FITTING OVER THE POST. CAP MUST BE USED WITHOUT ANY FASTENERS. A CAP ALUMINUM FRICTION FIT CAP MAY ALSO BE USED.

SIGN POSTS

2-3/16" 10ga 8" INSERT WHERE REQUIRED

example slip base assembly (detailed below)

1" DIA. 1/4" GRABER & DAUBLE HEX BOLT, GALVANIZED PER ASTM A153 (EACH PART)

1" DIA. 1/4" WASHED INNER & 1/2" DIA. 1/4" WASHED OUTER W/ GALVANIZED PER ASTM A153 (EACH PART)

1/2" SQUARE 1/4" THICK TITAN COATED HARDENED SLIP WASHER (EACH PART)

1/2" 13 GRADE LARGE FLANGE NUT GALVANIZED PER ASTM B966 (EACH PART)

SLIP BASE MATCH PLATE HARDWARE KIT

RECEIVER TO BE CAST FROM DUCTILE IRON PER ASTM A48-12 GALVANIZED PER ASTM A153.

SLIP PLATE DIMENSION

UNIBASE ANCHOR

38" UNIBASE ANCHOR A500 GRADE B TUBE WELDED TO A572 GALVANIZED PER ASTM A153.

AS72 SLIP PLATE WELDED TO A500 GRADE B TUBE WELDED TO A572 MOUNTING PLATE. GALVANIZED PER ASTM A153.

NOTES:

- CONCRETE FOOTING MUST BE 12" DIAMETER x 36" DEEP. BRASS SHIMS MAY BE USED BETWEEN SLIP PLATES TO LEVEL THE UPPER SLIP PLANE.
- SLIP BASE IS FHWA ACCEPTED, MEETING CURRENT AASHTO & NCHRP 350 REQUIREMENTS.
- SIGN BRACE CLAMPS ALLOW SIGN BRACE TO BE ADJUSTED UP, DOWN, LEFT OR RIGHT IN ORDER TO ACHIEVE PERFECT POSITION OF SIGN PANEL.
- USE INSTALLATION INSTRUCTION RT280U-SQ1.
- PRODUCT MUST MEET FHWA'S MADE IN AMERICA CLAUSE.
- PAID BY LENGTH OF POST, 38" STUB TO BE ABSORBED.

SIGN CENTROID	2-1/2" x 10ga POST	2-1/2" x 10ga & 2-3/4" x 10ga HEATED POST	Sign Bracing**
16'	24.82	43.46	18" maximum distance between braces
15'	26.48	46.36	18" maximum distance between braces
14'	28.38	49.66	18" maximum distance between braces
13'	30.56	53.48	18" maximum distance between braces
12'	33.10	57.94	18" maximum distance between braces
11'	36.12	63.20	18" maximum distance between braces

NOTE: Sign area is in square feet.
** based on two legs per sign
** Minimum of two braces per flat panel sign

MISSISSIPPI DEPARTMENT OF TRANSPORTATION

SIGN SUPPORT HARDWARE

2 1/2" SQUARE POST

PROJ. NO.: MISSISSIPPI TSS-1

COUNTY: TSS-1

FILE # 155-1-0001

ISSUE DATE: 08/15/2008

DATE: MAY 2008

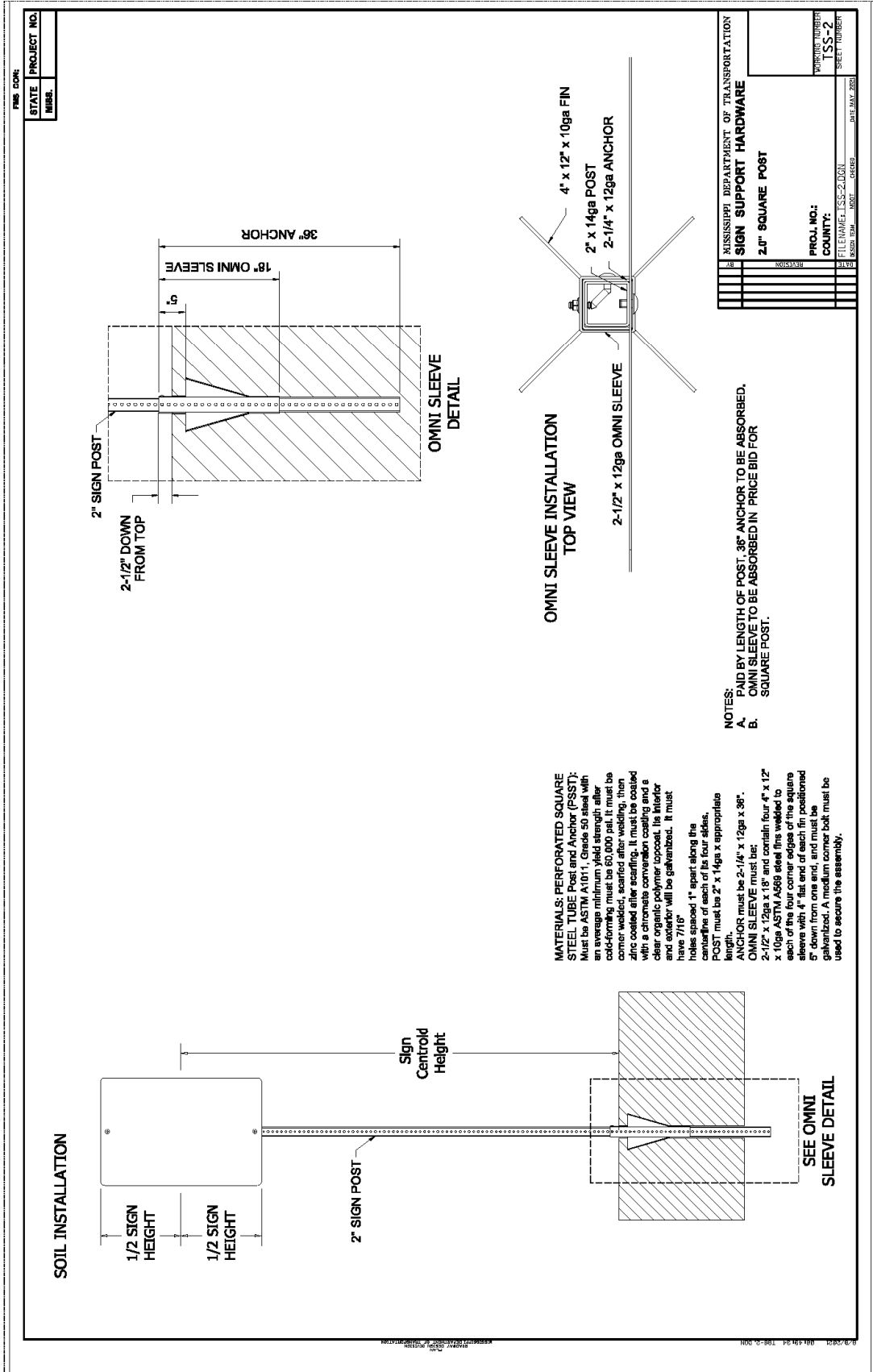

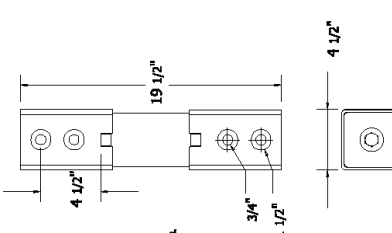
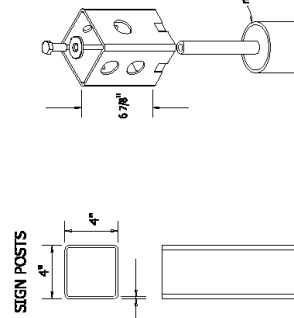
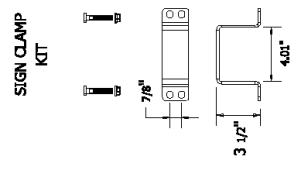
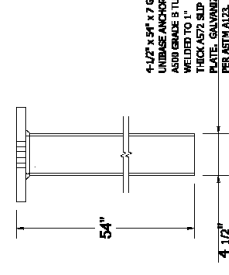
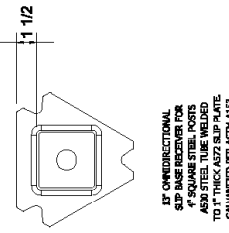
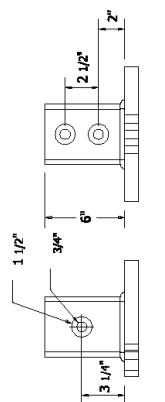
PMS CON. STATE PROJECT NO. MISS.	HINGE ASSEMBLY  <p>HINGE ASSEMBLY (1) 2" DIA. STAINLESS STEEL HEX BOLTS (2) 2" DIA. STAINLESS STEEL HEX NUTS (3) 2" DIA. STAINLESS STEEL WASHERS (4) 2" DIA. STAINLESS STEEL TUBES (5) 1/2" DIA. STAINLESS STEEL TUBES (6) 1/2" DIA. STAINLESS STEEL TUBES (7) 1/2" DIA. STAINLESS STEEL TUBES (8) 1/2" DIA. STAINLESS STEEL TUBES (9) 1/2" DIA. STAINLESS STEEL TUBES (10) 1/2" DIA. STAINLESS STEEL TUBES (11) 1/2" DIA. STAINLESS STEEL TUBES TORQUE TO 100 FT-LBS.</p>	SIGN POSTS  <p>STEEL CONFORMS TO ASTM A500, GRADE C. MUST BE WELDED, BEARDED OUTSIDE AFTER WELDING. GALVANIZED INTERIOR AND EXTERIOR AFTER SCRAPING. MUST BE COATED WITH A CHROMATE CONVERSION COATING AND ORGANIC POLYMER TOPCOAT. POST WEIGHT IS 5.6 LB./FT.</p>	SIGN CLAMP KIT  <p>MATERIALS: 2" WIDE x 3/16" THICK 304, 18-8 FINISHED STAINLESS STEEL BRACKET, 1/2" DIA. STAINLESS STEEL BOLTS AND NUTS, ONE CLAMP BRACKET PER SIGN BRACKET TO POST JUNCTION.</p>	UNIBASE ANCHOR STUB  <p>1-1/2" x 1/2" x 7 GA UNIBASE ANCHOR WELDED TO 1" TUBE THICK A572 SLIP PLATE, GALVANIZED PER ASTM A153.</p>	4" SQUARE POST RECEIVER  <p>1" ONE-DIRECTIONAL SLIP BASE RECEIVER FOR 4" SQUARE POSTS. ADD STEEL TUBE WELDED TO 1" THICK A572 SLIP PLATE, GALVANIZED PER ASTM A153.</p>	4" SQUARE POST RECEIVER 			
HINGE ASSEMBLY (1) 2" DIA. STAINLESS STEEL HEX BOLTS (2) 2" DIA. STAINLESS STEEL HEX NUTS (3) 2" DIA. STAINLESS STEEL WASHERS (4) 2" DIA. STAINLESS STEEL TUBES (5) 1/2" DIA. STAINLESS STEEL TUBES (6) 1/2" DIA. STAINLESS STEEL TUBES (7) 1/2" DIA. STAINLESS STEEL TUBES (8) 1/2" DIA. STAINLESS STEEL TUBES (9) 1/2" DIA. STAINLESS STEEL TUBES (10) 1/2" DIA. STAINLESS STEEL TUBES (11) 1/2" DIA. STAINLESS STEEL TUBES TORQUE TO 100 FT-LBS.		STEEL CONFORMS TO ASTM A500, GRADE C. MUST BE WELDED, BEARDED OUTSIDE AFTER WELDING. GALVANIZED INTERIOR AND EXTERIOR AFTER SCRAPING. MUST BE COATED WITH A CHROMATE CONVERSION COATING AND ORGANIC POLYMER TOPCOAT. POST WEIGHT IS 5.6 LB./FT.		MATERIALS: 2" WIDE x 3/16" THICK 304, 18-8 FINISHED STAINLESS STEEL BRACKET, 1/2" DIA. STAINLESS STEEL BOLTS AND NUTS, ONE CLAMP BRACKET PER SIGN BRACKET TO POST JUNCTION.		1-1/2" x 1/2" x 7 GA UNIBASE ANCHOR WELDED TO 1" TUBE THICK A572 SLIP PLATE, GALVANIZED PER ASTM A153.		1" ONE-DIRECTIONAL SLIP BASE RECEIVER FOR 4" SQUARE POSTS. ADD STEEL TUBE WELDED TO 1" THICK A572 SLIP PLATE, GALVANIZED PER ASTM A153.	
HINGE ASSEMBLY (1) 2" DIA. STAINLESS STEEL HEX BOLTS (2) 2" DIA. STAINLESS STEEL HEX NUTS (3) 2" DIA. STAINLESS STEEL WASHERS (4) 2" DIA. STAINLESS STEEL TUBES (5) 1/2" DIA. STAINLESS STEEL TUBES (6) 1/2" DIA. STAINLESS STEEL TUBES (7) 1/2" DIA. STAINLESS STEEL TUBES (8) 1/2" DIA. STAINLESS STEEL TUBES (9) 1/2" DIA. STAINLESS STEEL TUBES (10) 1/2" DIA. STAINLESS STEEL TUBES (11) 1/2" DIA. STAINLESS STEEL TUBES TORQUE TO 100 FT-LBS.		STEEL CONFORMS TO ASTM A500, GRADE C. MUST BE WELDED, BEARDED OUTSIDE AFTER WELDING. GALVANIZED INTERIOR AND EXTERIOR AFTER SCRAPING. MUST BE COATED WITH A CHROMATE CONVERSION COATING AND ORGANIC POLYMER TOPCOAT. POST WEIGHT IS 5.6 LB./FT.		MATERIALS: 2" WIDE x 3/16" THICK 304, 18-8 FINISHED STAINLESS STEEL BRACKET, 1/2" DIA. STAINLESS STEEL BOLTS AND NUTS, ONE CLAMP BRACKET PER SIGN BRACKET TO POST JUNCTION.		1-1/2" x 1/2" x 7 GA UNIBASE ANCHOR WELDED TO 1" TUBE THICK A572 SLIP PLATE, GALVANIZED PER ASTM A153.		1" ONE-DIRECTIONAL SLIP BASE RECEIVER FOR 4" SQUARE POSTS. ADD STEEL TUBE WELDED TO 1" THICK A572 SLIP PLATE, GALVANIZED PER ASTM A153.	

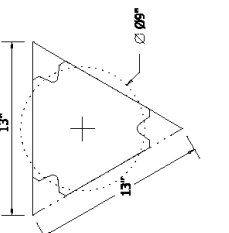
SLIP PLATE DIMENSION

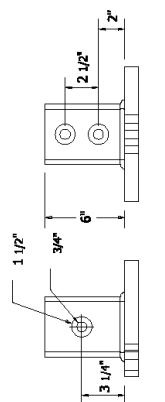
4" SQUARE POST RECEIVER

POST ATTACHMENT HARDWARE KIT WILL CONSIST OF:
 (1) 5/8" x 1 1/2" HEX BOLTS - A325
 (2) 5/8" x 1 1/2" ARMO WASHERS
 (3) 5/8" x 1 1/2" ARMO WASHERS - F488
 (4) 5/8" HEX NUTS - A563D8
 ALL HOT DIP GALVANIZED PER ASTM A153/F2328.

NOTE: 1 POST ATTACHMENT HARDWARE KIT IS USED FOR EACH POST. 2 POST ATTACHMENT HARDWARE KITS ARE USED FOR HINGE ATTACHMENT TO MAIN POST AND TO SIGN POST. TORQUE TO 100 FT-LBS.

4" SQUARE POST (DUAL POST)
 MISSISSIPPI DEPARTMENT OF TRANSPORTATION
 PROJ. NO.:
 COUNTY:
 WORKING NUMBER: TSS-4
 SHEET NUMBER:
 DATE: MAY, 2003

MISSISSIPPI DEPARTMENT OF TRANSPORTATION

SECTION 904 - NOTICE TO BIDDERS NO. 5551

CODE: (IS)

DATE: 12/06/2023

SUBJECT: Federal Bridge Formula

Bidders are hereby advised that the latest revision of Federal Highway Administration Publication No. FHWA-HOP-06-105, **BRIDGE FORMULA WEIGHTS**, dated August 2006, is made a part of this contract when applicable.

Prior to the preconstruction conference, the Contractor shall advise the Engineer, in writing, what materials, if any, will be delivered to the jobsite via Interstate route(s).

Copies of the **BRIDGE FORMULA WEIGHTS** publication may be obtained by contacting:

Federal Highway Administration
400 7th Street, SW
Washington, DC 20590
(202) 366-2212

or

https://ops.fhwa.dot.gov/freight/publications/brdg_frm_wghts/

MISSISSIPPI DEPARTMENT OF TRANSPORTATION

SECTION 904 – NOTICE TO BIDDERS NO. 5570

CODE: (SP)

DATE: 07/28/2025

SUBJECT: Special Provisions Related to Concrete

Bidders are hereby advised that this contract contains one or more of the following **new** Special Provisions related to concrete:

- Special Provision No. 907-501-1, Subject: Concrete Pavement
- Special Provision No. 907-502-1, Subject: Concrete Bridge End Pavement
- Special Provision No. 907-503-1, Subject: Replacement of Concrete Pavement
- Special Provision No. 907-504-4, Subject: Fiber-reinforced Concrete Pavement
- Special Provision No. 907-601-1, Subject: Structural Concrete
- Special Provision No. 907-605-1, Subject: Underdrains
- Special Provision No. 907-701-4, Subject: Hydraulic Cement
- Special Provision No. 907-799-1, Subject: Hydraulic Cement Concrete Mixtures
- Special Provision No. 907-803-6, Subject: Deep Foundations
- Special Provision No. 907-804-13, Subject: Concrete Bridges and Structures
- Special Provision No. 907-804-14, Subject: Bridge Deck Overlay

MISSISSIPPI DEPARTMENT OF TRANSPORTATION

SECTION 904 - NOTICE TO BIDDERS NO. 7304

CODE: (SP)

DATE: 08/25/2025

SUBJECT: Erosion Control Contract Compliance

Bidders are hereby advised that Erosion Control measures will be monitored for contract compliance at the specified intervals as per the Contract Documents. The Contractor will be subject to the following conditions:

If a Contractor is found to be in violation of Notice to Bidders 2172 in excess of the time allotted per the MDEQ General Permit without a Contractor's Inspection, or a second consecutive Stormwater Inspection showing a recurring major/critical deficiency without any Corrective Action report showing that the area had been addressed, said Contractor will be issued a Non-Compliance Assessment per violation until the project is found to be back in compliance with the Contract Documents (Stormwater permit included).

Non-Compliance Assessments will accrue per each reporting period that the Contractor remains in violation of the above referenced items. A deduction, calculated from the Non-Compliance Assessment charges listed in Table I, will be made from money due the Contractor. The charges set out in Table I of non-compliance assessments are based on Penalty amounts developed by MDEQ to encourage Contractor Compliance. The Contractor and the Contractor's Sureties shall be liable for all non-compliance assessments in excess of any money due the Contractor.

Erosion Control Inspection reports are required to be submitted until there is a Full Maintenance Release, documented in writing by the State Construction Engineer. The non-compliance assessments may be returned to the Contractor at the completion of the project if the Contractor is found to have three (3) or fewer documented violations during the life of the project. The Contractor will forfeit any non-compliance assessments if found to have been assessed penalties for more than three (3) documented violations.

Should the Contractor come upon an issue that causes a delay or an inability to submit the required reports, said Contractor has twenty-four (24) hours to report to the MDOT's Project Engineer or MDOT's LPA Division (for LPA Projects) of the issue and get assistance. Lack of willingness to use or learn to use the application will not be accepted as a valid reason for nonuse.

Table I

Non-Compliance Assessments of Construction and Mining Storm Water Permits (Per Documented Violation)

Violation	Original Contract Amount		Type of Stormwater Permit*	
			SCNOI	LCNOI
Failure to complete weekly inspection, failure to address a documented major/critical Deficiency (noted as a recurring deficiency)	\$ < 10,000,000	\$ 10,000,000	\$ 1,000	\$ 2,500
	\$ 10,000,000	\$ 40,000,000	\$ 1,000	\$ 4,000
	\$ 40,000,000	>\$40,000,000	\$ 1,000	\$ 7,000

- Permit defined by project documents.

MISSISSIPPI DEPARTMENT OF TRANSPORTATION

SECTION 904 - NOTICE TO BIDDERS NO. 7986

CODE: (SP)

DATE: 06/29/2026

SUBJECT: Contract Time

PROJECT: NHPP-0010-01(185)/109879301 – Harrison County

The calendar date for completion of work to be performed by the Contractor for this project shall be **September 10, 2027** which date or extended date as provided in Subsection 108.06 shall be the end of contract time. It is anticipated that the Notice of Award will be issued no later than **August 11, 2026** and the effective date of the Notice to Proceed / Beginning of Contract Time will be **September 10, 2026**.

Should the Contractor request a Notice to Proceed earlier than **September 10, 2026** and it is agreeable with the Department for an early Notice to Proceed, the requested date will become the new Notice to Proceed date.

All requests for an early Notice to Proceed shall be sent to the Project Engineer who will forward it to the Contract Administration Division.

MISSISSIPPI DEPARTMENT OF TRANSPORTATION

SECTION 904 - NOTICE TO BIDDERS NO. 8191

CODE: (SP)

DATE: 07/01/2026

SUBJECT: Obligation Date

With respect to the obligation date referenced in Special Provision No. 907-700-3 entitled “Materials and Tests”, bidders are advised that this project will be obligated on or after October 1, 2025 and before October 1, 2026.

State: Mississippi

Construction Types: Highway

Counties: Mississippi Counties of
Harrison

Modification Number	Publication Date
0	01/02/2026
1	05/18/2026

SUMS2010-056 08/04/2014

	Rates	Fringes
TRUCK DRIVER: SEMI/TRAILER TRUCK.....	\$ 14.36	0.00
TRUCK DRIVER: DUMP TRUCK (ALL TYPES).....	\$ 14.32	0.00
TRUCK DRIVER: WATER TRUCK.....	\$ 17.08	0.00
TRUCK DRIVER: MECHANIC.....	\$ 12.31	0.00
TRUCK DRIVER: LOWBOY TRUCK.....	\$ 11.00	0.00
TRUCK DRIVER: FLATBED TRUCK.....	\$ 14.72	0.00
OPERATOR: TRACTOR.....	\$ 12.29	0.00
OPERATOR: SCRAPER.....	\$ 14.00	0.00
OPERATOR: ROLLER (ALL TYPES).....	\$ 14.23	0.00
OPERATOR: PAVER (ASPHALT, AGGREGATE, AND CONCRETE).....	\$ 15.81	0.00
OPERATOR: OILER.....	\$ 12.22	0.00
OPERATOR: MILLING MACHINE.....	\$ 15.44	0.00
OPERATOR: MECHANIC.....	\$ 19.33	0.00
OPERATOR: LOADER.....	\$ 14.38	0.00
OPERATOR: GRADER/BLADE.....	\$ 16.44	0.00
OPERATOR: DISTRIBUTOR.....	\$ 13.87	0.00
OPERATOR: CRANE.....	\$ 15.89	0.00
OPERATOR: CONCRETE SAW.....	\$ 14.96	3.27
OPERATOR: BULLDOZER.....	\$ 15.47	0.00
OPERATOR: BROOM/SWEEPER.....	\$ 14.25	0.00
OPERATOR: BOBCAT/SKID STEER/SKID LOADER.....	\$ 11.86	0.00
OPERATOR: BACKHOE/EXCAVATOR/TRACKHOE.....	\$ 15.62	0.00
OPERATOR: ASPHALT SPREADER.....	\$ 14.83	0.00
LABORER: LABORER-CONES/ BARRICADES/BARRELS - SETTER/MOVER/SWEEPER.....	\$ 13.19	0.00
LABORER: PIPELAYER.....	\$ 15.00	0.00
LABORER: MASON TENDER - CEMENT/CONCRETE.....	\$ 13.14	0.00
LABORER: LUTEMAN.....	\$ 12.88	0.00
LABORER: LANDSCAPE.....	\$ 12.00	0.00
LABORER: GRADE CHECKER.....	\$ 15.63	0.00
LABORER: FLAGGER.....	\$ 11.16	0.00
LABORER: COMMON OR GENERAL.....	\$ 11.00	0.00
LABORER: ASPHALT, INCLUDES RAKER, SHOVELER, SPREADER AND DISTRIBUTOR.....	\$ 12.27	0.00
IRONWORKER, REINFORCING.....	\$ 17.33	0.00

INSTALLER: GUARDRAIL.....	\$ 11.78	0.00
INSTALLER - SIGN.....	\$ 13.41	0.00
HIGHWAY/PARKING LOT STRIPING: TRUCK DRIVER (LINE STRIPING TRUCK).....	\$ 14.75	0.00
ELECTRICIAN.....	\$ 25.57	6.79
CEMENT MASON/CONCRETE FINISHER.....	\$ 15.25	0.00
CARPENTER (FORM WORK ONLY).....	\$ 14.43	0.00

--
WELDERS - Receive rate prescribed for craft performing operation to which welding is incidental.

=====
Note: Executive Order (EO) 13706, Establishing Paid Sick Leave for Federal Contractors applies to all contracts subject to the Davis-Bacon Act for which the contract is awarded (and any solicitation was issued) on or after January 1, 2017. If this contract is covered by the EO, the contractor must provide employees with 1 hour of paid sick leave for every 30 hours they work, up to 56 hours of paid sick leave each year. Employees must be permitted to use paid sick leave for their own illness, injury or other health-related needs, including preventive care; to assist a family member (or person who is like family to the employee) who is ill, injured, or has other health-related needs, including preventive care; or for reasons resulting from, or to assist a family member (or person who is like family to the employee) who is a victim of, domestic violence, sexual assault, or stalking. Additional information on contractor requirements and worker protections under the EO is available at <https://www.dol.gov/agencies/whd/government-contracts>.

Note: Executive Order 13658 generally applies to contracts subject to the Davis-Bacon Act that were awarded on or between January 1, 2015 and January 29, 2022, and that have not been renewed or extended on or after January 30, 2022. Executive Order 13658 does not apply to contracts subject only to the Davis-Bacon Related Acts regardless of when they were awarded. If a contract is subject to Executive Order 13658, the contractor must pay all covered workers at least \$13.65 per hour (or the applicable wage rate listed on this wage determination, if it is higher) for all hours spent performing on the contract from May 11, 2026, through December 31, 2026. The applicable Executive Order minimum wage rate will be adjusted annually. Additional information on contractor requirements and worker protections under Executive Order 13658 is available at www.dol.gov/whd/govcontracts.

Unlisted classifications needed for work not included within the scope of the classifications listed may be added after award only as provided in the labor standards contract clauses (29CFR 5.5 (a) (1) (iii)).

The body of each wage determination lists the classifications and wage rates that have been found to be prevailing for the type(s) of construction and geographic area covered by the wage determination. The classifications are listed in alphabetical order under rate identifiers indicating whether the particular rate is a union rate (current union negotiated rate), a survey rate, a weighted union average rate, a state adopted rate, or a

supplemental classification rate.

Union Rate Identifiers

A four-letter identifier beginning with characters other than ♦SU♦, ♦UAVG♦, ♦SA♦, or ♦SC♦ denotes that a union rate was prevailing for that classification in the survey. Example: PLUM0198-005 07/01/2024. PLUM is an identifier of the union whose collectively bargained rate prevailed in the survey for this classification, which in this example would be Plumbers. 0198 indicates the local union number or district council number where applicable, i.e., Plumbers Local 0198. The next number, 005 in the example, is an internal number used in processing the wage determination. The date, 07/01/2024 in the example, is the effective date of the most current negotiated rate.

Union prevailing wage rates are updated to reflect all changes over time that are reported to WHD in the rates in the collective bargaining agreement (CBA) governing the classification.

Union Average Rate Identifiers

The UAVG identifier indicates that no single rate prevailed for those classifications, but that 100% of the data reported for the classifications reflected union rates. EXAMPLE: UAVG-OH-0010 01/01/2024. UAVG indicates that the rate is a weighted union average rate. OH indicates the State of Ohio. The next number, 0010 in the example, is an internal number used in producing the wage determination. The date, 01/01/2024 in the example, indicates the date the wage determination was updated to reflect the most current union average rate.

A UAVG rate will be updated once a year, usually in January, to reflect a weighted average of the current rates in the collective bargaining agreements on which the rate is based.

Survey Rate Identifiers

The ♦SU♦ identifier indicates that either a single non-union rate prevailed (as defined in 29 CFR 1.2) for this classification in the survey or that the rate was derived by computing a weighted average rate based on all the rates reported in the survey for that classification. As a weighted average rate includes all rates reported in the survey, it may include both union and non-union rates. Example: SUFL2022-007 6/27/2024. SU indicates the rate is a single non-union prevailing rate or a weighted average of survey data for that classification. FL indicates the State of Florida. 2022 is the year of the survey on which these classifications and rates are based. The next number, 007 in the example, is an internal number used in producing the wage determination. The date, 6/27/2024 in the example, indicates the survey completion date for the classifications and rates under that identifier.

♦SU♦ wage rates typically remain in effect until a new survey is conducted. However, the Wage and Hour Division (WHD) has the discretion to update such rates under 29 CFR 1.6(c)(1).

State Adopted Rate Identifiers

The ♦SA♦ identifier indicates that the classifications and prevailing wage rates set by a state (or local) government were adopted under 29 C.F.R 1.3(g)-(h). Example: SAME2023-007 01/03/2024. SA reflects that the rates are state adopted. ME refers to the State of Maine. 2023 is the year during which the state completed the survey on which the listed classifications and rates are based. The next number, 007 in the example, is an internal number used in producing the wage determination. The date, 01/03/2024 in the example, reflects the date on which the classifications and rates under the ♦SA♦ identifier took effect under state law in the state from which the rates were adopted.

WAGE DETERMINATION APPEALS PROCESS

1) Has there been an initial decision in the matter? This can be:

- a) a survey underlying a wage determination
- b) an existing published wage determination
- c) an initial WHD letter setting forth a position on a wage determination matter
- d) an initial conformance (additional classification and rate) determination

On survey related matters, initial contact, including requests for summaries of surveys, should be directed to the WHD Branch of Wage Surveys. Requests can be submitted via email to davisbaconinfo@dol.gov or by mail to:

Branch of Wage Surveys
Wage and Hour Division
U.S. Department of Labor
200 Constitution Avenue, N.W.
Washington, DC 20210

Regarding any other wage determination matter such as conformance decisions, requests for initial decisions should be directed to the WHD Branch of Construction Wage Determinations. Requests can be submitted via email to BCWD-Office@dol.gov or by mail to:

Branch of Construction Wage Determinations
Wage and Hour Division
U.S. Department of Labor
200 Constitution Avenue, N.W.
Washington, DC 20210

2) If an initial decision has been issued, then any interested party (those affected by the action) that disagrees with the decision can request review and reconsideration from the Wage and Hour Administrator (See 29 CFR Part 1.8 and 29 CFR Part 7). Requests for review and reconsideration can be submitted via email to dba.reconsideration@dol.gov or by mail to:

Wage and Hour Administrator
U.S. Department of Labor
200 Constitution Avenue, N.W.
Washington, DC 20210

The request should be accompanied by a full statement of the interested party's position and any information (wage payment data, project description, area practice material, etc.) that the requestor considers relevant to the issue.

3) If the decision of the Administrator is not favorable, an interested party may appeal directly to the Administrative Review Board (formerly the Wage Appeals Board). Write to:

Administrative Review Board
U.S. Department of Labor
200 Constitution Avenue, N.W.
Washington, DC 20210.

=====

END OF GENERAL DECISION

SUPPLEMENT TO FORM FHWA-1273

DATE: 07/26/2022

SUBJECT: Federal Contract Provisions for Subcontracts

Federal Contract Provisions for Subcontracts

All subcontracts shall be in writing and contain all pertinent provisions and requirements of the prime contract.

Each “Request for Permission to Subcontract” (Mississippi Department of Transportation Form CAD-720) shall include a copy of the subcontract. The federal contract provisions (FHWA-1273, SUPPLEMENT TO FORM FHWA-1273, NOTICE OF REQUIREMENT FOR AFFIRMATIVE ACTION TO ENSURE EQUAL EMPLOYMENT OPPORTUNITY (EXECUTIVE ORDER 11246), DAVIS-BACON AND RELATED ACT PROVISIONS (WAGE RATES)) must be physically incorporated as part of the subcontract. A completed Mississippi Department of Transportation Form CAD-521 and Form CAD-725 must be attached to the CAD-720.

**REQUIRED CONTRACT PROVISIONS
FEDERAL-AID CONSTRUCTION CONTRACTS**

- I. General
- II. Nondiscrimination
- III. Non-segregated Facilities
- IV. Davis-Bacon and Related Act Provisions
- V. Contract Work Hours and Safety Standards Act Provisions
- VI. Subletting or Assigning the Contract
- VII. Safety: Accident Prevention
- VIII. False Statements Concerning Highway Projects
- IX. Implementation of Clean Air Act and Federal Water Pollution Control Act
- X. Certification Regarding Debarment, Suspension, Ineligibility and Voluntary Exclusion
- XI. Certification Regarding Use of Contract Funds for Lobbying
- XII. Use of United States-Flag Vessels:

ATTACHMENTS

A. Employment and Materials Preference for Appalachian Development Highway System or Appalachian Local Access Road Contracts (included in Appalachian contracts only)

I. GENERAL

1. Form FHWA-1273 must be physically incorporated in each construction contract funded under title 23, United States Code, as required in 23 CFR 633.102(b) (excluding emergency contracts solely intended for debris removal). The contractor (or subcontractor) must insert this form in each subcontract and further require its inclusion in all lower tier subcontracts (excluding purchase orders, rental agreements and other agreements for supplies or services). 23 CFR 633.102(e).

The applicable requirements of Form FHWA-1273 are incorporated by reference for work done under any purchase order, rental agreement or agreement for other services. The prime contractor shall be responsible for compliance by any subcontractor, lower-tier subcontractor or service provider. 23 CFR 633.102(e).

Form FHWA-1273 must be included in all Federal-aid design-build contracts, in all subcontracts and in lower tier subcontracts (excluding subcontracts for design services, purchase orders, rental agreements and other agreements for supplies or services) in accordance with 23 CFR 633.102. The design-builder shall be responsible for compliance by any subcontractor, lower-tier subcontractor or service provider.

Contracting agencies may reference Form FHWA-1273 in solicitation-for-bids or request-for-proposals documents, however, the Form FHWA-1273 must be physically incorporated (not referenced) in all contracts, subcontracts and lower-tier subcontracts (excluding purchase orders, rental agreements and other agreements for supplies or services related to a construction contract). 23 CFR 633.102(b).

2. Subject to the applicability criteria noted in the following sections, these contract provisions shall apply to all work

performed on the contract by the contractor's own organization and with the assistance of workers under the contractor's immediate superintendence and to all work performed on the contract by piecework, station work, or by subcontract. 23 CFR 633.102(d).

3. A breach of any of the stipulations contained in these Required Contract Provisions may be sufficient grounds for withholding of progress payments, withholding of final payment, termination of the contract, suspension / debarment or any other action determined to be appropriate by the contracting agency and FHWA.

4. Selection of Labor: During the performance of this contract, the contractor shall not use convict labor for any purpose within the limits of a construction project on a Federal-aid highway unless it is labor performed by convicts who are on parole, supervised release, or probation. 23 U.S.C. 114(b). The term Federal-aid highway does not include roadways functionally classified as local roads or rural minor collectors. 23 U.S.C. 101(a).

II. NONDISCRIMINATION (23 CFR 230.107(a); 23 CFR Part 230, Subpart A, Appendix A; EO 11246)

The provisions of this section related to 23 CFR Part 230, Subpart A, Appendix A are applicable to all Federal-aid construction contracts and to all related construction subcontracts of \$10,000 or more. The provisions of 23 CFR Part 230 are not applicable to material supply, engineering, or architectural service contracts.

In addition, the contractor and all subcontractors must comply with the following policies: Executive Order 11246, 41 CFR Part 60, 29 CFR Parts 1625-1627, 23 U.S.C. 140, Section 504 of the Rehabilitation Act of 1973, as amended (29 U.S.C. 794), Title VI of the Civil Rights Act of 1964, as amended (42 U.S.C. 2000d et seq.), and related regulations including 49 CFR Parts 21, 26, and 27; and 23 CFR Parts 200, 230, and 633.

The contractor and all subcontractors must comply with: the requirements of the Equal Opportunity Clause in 41 CFR 60-1.4(b) and, for all construction contracts exceeding \$10,000, the Standard Federal Equal Employment Opportunity Construction Contract Specifications in 41 CFR 60-4.3.

Note: The U.S. Department of Labor has exclusive authority to determine compliance with Executive Order 11246 and the policies of the Secretary of Labor including 41 CFR Part 60, and 29 CFR Parts 1625-1627. The contracting agency and the FHWA have the authority and the responsibility to ensure compliance with 23 U.S.C. 140, Section 504 of the Rehabilitation Act of 1973, as amended (29 U.S.C. 794), and Title VI of the Civil Rights Act of 1964, as amended (42 U.S.C. 2000d et seq.), and related regulations including 49 CFR Parts 21, 26, and 27; and 23 CFR Parts 200, 230, and 633.

The following provision is adopted from 23 CFR Part 230, Subpart A, Appendix A, with appropriate revisions to conform to the U.S. Department of Labor (US DOL) and FHWA requirements.

1. Equal Employment Opportunity: Equal Employment Opportunity (EEO) requirements not to discriminate and to take affirmative action to assure equal opportunity as set forth under laws, executive orders, rules, regulations (see 28 CFR Part 35, 29 CFR Part 1630, 29 CFR Parts 1625-1627, 41 CFR Part 60 and 49 CFR Part 27) and orders of the Secretary of Labor as modified by the provisions prescribed herein, and imposed pursuant to 23 U.S.C. 140, shall constitute the EEO and specific affirmative action standards for the contractor's project activities under this contract. The provisions of the Americans with Disabilities Act of 1990 (42 U.S.C. 12101 et seq.) set forth under 28 CFR Part 35 and 29 CFR Part 1630 are incorporated by reference in this contract. In the execution of this contract, the contractor agrees to comply with the following minimum specific requirement activities of EEO:

a. The contractor will work with the contracting agency and the Federal Government to ensure that it has made every good faith effort to provide equal opportunity with respect to all of its terms and conditions of employment and in their review of activities under the contract. 23 CFR 230.409 (g)(4) & (5).

b. The contractor will accept as its operating policy the following statement:

"It is the policy of this Company to assure that applicants are employed, and that employees are treated during employment, without regard to their race, religion, sex, sexual orientation, gender identity, color, national origin, age or disability. Such action shall include: employment, upgrading, demotion, or transfer; recruitment or recruitment advertising; layoff or termination; rates of pay or other forms of compensation; and selection for training, including apprenticeship, pre-apprenticeship, and/or on-the-job training."

2. EEO Officer: The contractor will designate and make known to the contracting officers an EEO Officer who will have the responsibility for and must be capable of effectively administering and promoting an active EEO program and who must be assigned adequate authority and responsibility to do so.

3. Dissemination of Policy: All members of the contractor's staff who are authorized to hire, supervise, promote, and discharge employees, or who recommend such action or are substantially involved in such action, will be made fully cognizant of and will implement the contractor's EEO policy and contractual responsibilities to provide EEO in each grade and classification of employment. To ensure that the above agreement will be met, the following actions will be taken as a minimum:

a. Periodic meetings of supervisory and personnel office employees will be conducted before the start of work and then not less often than once every six months, at which time the contractor's EEO policy and its implementation will be reviewed and explained. The meetings will be conducted by the EEO Officer or other knowledgeable company official.

b. All new supervisory or personnel office employees will be given a thorough indoctrination by the EEO Officer, covering all major aspects of the contractor's EEO obligations within thirty days following their reporting for duty with the contractor.

c. All personnel who are engaged in direct recruitment for the project will be instructed by the EEO Officer in the contractor's procedures for locating and hiring minorities and women.

d. Notices and posters setting forth the contractor's EEO policy will be placed in areas readily accessible to employees, applicants for employment and potential employees.

e. The contractor's EEO policy and the procedures to implement such policy will be brought to the attention of employees by means of meetings, employee handbooks, or other appropriate means.

4. Recruitment: When advertising for employees, the contractor will include in all advertisements for employees the notation: "An Equal Opportunity Employer." All such advertisements will be placed in publications having a large circulation among minorities and women in the area from which the project work force would normally be derived.

a. The contractor will, unless precluded by a valid bargaining agreement, conduct systematic and direct recruitment through public and private employee referral sources likely to yield qualified minorities and women. To meet this requirement, the contractor will identify sources of potential minority group employees and establish with such identified sources procedures whereby minority and women applicants may be referred to the contractor for employment consideration.

b. In the event the contractor has a valid bargaining agreement providing for exclusive hiring hall referrals, the contractor is expected to observe the provisions of that agreement to the extent that the system meets the contractor's compliance with EEO contract provisions. Where implementation of such an agreement has the effect of discriminating against minorities or women, or obligates the contractor to do the same, such implementation violates Federal nondiscrimination provisions.

c. The contractor will encourage its present employees to refer minorities and women as applicants for employment. Information and procedures with regard to referring such applicants will be discussed with employees.

5. Personnel Actions: Wages, working conditions, and employee benefits shall be established and administered, and personnel actions of every type, including hiring, upgrading, promotion, transfer, demotion, layoff, and termination, shall be taken without regard to race, color, religion, sex, sexual orientation, gender identity, national origin, age or disability. The following procedures shall be followed:

a. The contractor will conduct periodic inspections of project sites to ensure that working conditions and employee facilities do not indicate discriminatory treatment of project site personnel.

b. The contractor will periodically evaluate the spread of wages paid within each classification to determine any evidence of discriminatory wage practices.

c. The contractor will periodically review selected personnel actions in depth to determine whether there is evidence of discrimination. Where evidence is found, the contractor will promptly take corrective action. If the review indicates that the discrimination may extend beyond the actions reviewed, such corrective action shall include all affected persons.

d. The contractor will promptly investigate all complaints of alleged discrimination made to the contractor in connection with its obligations under this contract, will attempt to resolve such complaints, and will take appropriate corrective action

within a reasonable time. If the investigation indicates that the discrimination may affect persons other than the complainant, such corrective action shall include such other persons. Upon completion of each investigation, the contractor will inform every complainant of all of their avenues of appeal.

6. Training and Promotion:

a. The contractor will assist in locating, qualifying, and increasing the skills of minorities and women who are applicants for employment or current employees. Such efforts should be aimed at developing full journey level status employees in the type of trade or job classification involved.

b. Consistent with the contractor's work force requirements and as permissible under Federal and State regulations, the contractor shall make full use of training programs (i.e., apprenticeship and on-the-job training programs for the geographical area of contract performance). In the event a special provision for training is provided under this contract, this subparagraph will be superseded as indicated in the special provision. The contracting agency may reserve training positions for persons who receive welfare assistance in accordance with 23 U.S.C. 140(a).

c. The contractor will advise employees and applicants for employment of available training programs and entrance requirements for each.

d. The contractor will periodically review the training and promotion potential of employees who are minorities and women and will encourage eligible employees to apply for such training and promotion.

7. Unions: If the contractor relies in whole or in part upon unions as a source of employees, the contractor will use good faith efforts to obtain the cooperation of such unions to increase opportunities for minorities and women. 23 CFR 230.409. Actions by the contractor, either directly or through a contractor's association acting as agent, will include the procedures set forth below:

a. The contractor will use good faith efforts to develop, in cooperation with the unions, joint training programs aimed toward qualifying more minorities and women for membership in the unions and increasing the skills of minorities and women so that they may qualify for higher paying employment.

b. The contractor will use good faith efforts to incorporate an EEO clause into each union agreement to the end that such union will be contractually bound to refer applicants without regard to their race, color, religion, sex, sexual orientation, gender identity, national origin, age, or disability.

c. The contractor is to obtain information as to the referral practices and policies of the labor union except that to the extent such information is within the exclusive possession of the labor union and such labor union refuses to furnish such information to the contractor, the contractor shall so certify to the contracting agency and shall set forth what efforts have been made to obtain such information.

d. In the event the union is unable to provide the contractor with a reasonable flow of referrals within the time limit set forth in the collective bargaining agreement, the contractor will, through independent recruitment efforts, fill the employment vacancies without regard to race, color, religion, sex, sexual orientation, gender identity, national origin, age, or disability; making full efforts to obtain qualified and/or qualifiable minorities and women. The failure of a union to provide

sufficient referrals (even though it is obligated to provide exclusive referrals under the terms of a collective bargaining agreement) does not relieve the contractor from the requirements of this paragraph. In the event the union referral practice prevents the contractor from meeting the obligations pursuant to Executive Order 11246, as amended, and these special provisions, such contractor shall immediately notify the contracting agency.

8. Reasonable Accommodation for Applicants / Employees with Disabilities: The contractor must be familiar with the requirements for and comply with the Americans with Disabilities Act and all rules and regulations established thereunder. Employers must provide reasonable accommodation in all employment activities unless to do so would cause an undue hardship.

9. Selection of Subcontractors, Procurement of Materials and Leasing of Equipment: The contractor shall not discriminate on the grounds of race, color, religion, sex, sexual orientation, gender identity, national origin, age, or disability in the selection and retention of subcontractors, including procurement of materials and leases of equipment. The contractor shall take all necessary and reasonable steps to ensure nondiscrimination in the administration of this contract.

a. The contractor shall notify all potential subcontractors, suppliers, and lessors of their EEO obligations under this contract.

b. The contractor will use good faith efforts to ensure subcontractor compliance with their EEO obligations.

10. Assurances Required:

a. The requirements of 49 CFR Part 26 and the State DOT's FHWA-approved Disadvantaged Business Enterprise (DBE) program are incorporated by reference.

b. The contractor, subrecipient or subcontractor shall not discriminate on the basis of race, color, national origin, or sex in the performance of this contract. The contractor shall carry out applicable requirements of 49 CFR part 26 in the award and administration of DOT-assisted contracts. Failure by the contractor to carry out these requirements is a material breach of this contract, which may result in the termination of this contract or such other remedy as the recipient deems appropriate, which may include, but is not limited to:

- (1) Withholding monthly progress payments;
- (2) Assessing sanctions;
- (3) Liquidated damages; and/or
- (4) Disqualifying the contractor from future bidding as non-responsible.

c. The Title VI and nondiscrimination provisions of U.S. DOT Order 1050.2A at Appendixes A and E are incorporated by reference. 49 CFR Part 21.

11. Records and Reports: The contractor shall keep such records as necessary to document compliance with the EEO requirements. Such records shall be retained for a period of three years following the date of the final payment to the contractor for all contract work and shall be available at reasonable times and places for inspection by authorized representatives of the contracting agency and the FHWA.

a. The records kept by the contractor shall document the following:

(1) The number and work hours of minority and non-minority group members and women employed in each work classification on the project;

(2) The progress and efforts being made in cooperation with unions, when applicable, to increase employment opportunities for minorities and women; and

(3) The progress and efforts being made in locating, hiring, training, qualifying, and upgrading minorities and women.

b. The contractors and subcontractors will submit an annual report to the contracting agency each July for the duration of the project indicating the number of minority, women, and non-minority group employees currently engaged in each work classification required by the contract work. This information is to be reported on [Form FHWA-1391](#). The staffing data should represent the project work force on board in all or any part of the last payroll period preceding the end of July. If on-the-job training is being required by special provision, the contractor will be required to collect and report training data. The employment data should reflect the work force on board during all or any part of the last payroll period preceding the end of July.

III. NONSEGREGATED FACILITIES

This provision is applicable to all Federal-aid construction contracts and to all related construction subcontracts of more than \$10,000. 41 CFR 60-1.5.

As prescribed by 41 CFR 60-1.8, the contractor must ensure that facilities provided for employees are provided in such a manner that segregation on the basis of race, color, religion, sex, sexual orientation, gender identity, or national origin cannot result. The contractor may neither require such segregated use by written or oral policies nor tolerate such use by employee custom. The contractor's obligation extends further to ensure that its employees are not assigned to perform their services at any location under the contractor's control where the facilities are segregated. The term "facilities" includes waiting rooms, work areas, restaurants and other eating areas, time clocks, restrooms, washrooms, locker rooms and other storage or dressing areas, parking lots, drinking fountains, recreation or entertainment areas, transportation, and housing provided for employees. The contractor shall provide separate or single-user restrooms and necessary dressing or sleeping areas to assure privacy between sexes.

IV. DAVIS-BACON AND RELATED ACT PROVISIONS

This section is applicable to all Federal-aid construction projects exceeding \$2,000 and to all related subcontracts and lower-tier subcontracts (regardless of subcontract size), in accordance with 29 CFR 5.5. The requirements apply to all projects located within the right-of-way of a roadway that is functionally classified as Federal-aid highway. 23 U.S.C. 113. This excludes roadways functionally classified as local roads or rural minor collectors, which are exempt. 23 U.S.C. 101. Where applicable law requires that projects be treated as a project on a Federal-aid highway, the provisions of this subpart will apply regardless of the location of the project. Examples include: Surface Transportation Block Grant Program projects funded under 23 U.S.C. 133 [excluding recreational trails projects], the Nationally Significant Freight and Highway

Projects funded under 23 U.S.C. 117, and National Highway Freight Program projects funded under 23 U.S.C. 167.

The following provisions are from the U.S. Department of Labor regulations in 29 CFR 5.5 "Contract provisions and related matters" with minor revisions to conform to the FHWA-1273 format and FHWA program requirements.

1. Minimum wages (29 CFR 5.5)

a. *Wage rates and fringe benefits.* All laborers and mechanics employed or working upon the site of the work (or otherwise working in construction or development of the project under a development statute), will be paid unconditionally and not less often than once a week, and without subsequent deduction or rebate on any account (except such payroll deductions as are permitted by regulations issued by the Secretary of Labor under the Copeland Act ([29 CFR part 3](#))), the full amount of basic hourly wages and bona fide fringe benefits (or cash equivalents thereof) due at time of payment computed at rates not less than those contained in the wage determination of the Secretary of Labor which is attached hereto and made a part hereof, regardless of any contractual relationship which may be alleged to exist between the contractor and such laborers and mechanics. As provided in paragraphs (d) and (e) of 29 CFR 5.5, the appropriate wage determinations are effective by operation of law even if they have not been attached to the contract. Contributions made or costs reasonably anticipated for bona fide fringe benefits under the Davis-Bacon Act ([40 U.S.C. 3141\(2\)\(B\)](#)) on behalf of laborers or mechanics are considered wages paid to such laborers or mechanics, subject to the provisions of paragraph 1.e. of this section; also, regular contributions made or costs incurred for more than a weekly period (but not less often than quarterly) under plans, funds, or programs which cover the particular weekly period, are deemed to be constructively made or incurred during such weekly period. Such laborers and mechanics must be paid the appropriate wage rate and fringe benefits on the wage determination for the classification(s) of work actually performed, without regard to skill, except as provided in paragraph 4. of this section. Laborers or mechanics performing work in more than one classification may be compensated at the rate specified for each classification for the time actually worked therein: *Provided*, That the employer's payroll records accurately set forth the time spent in each classification in which work is performed. The wage determination (including any additional classifications and wage rates conformed under paragraph 1.c. of this section) and the Davis-Bacon poster (WH-1321) must be posted at all times by the contractor and its subcontractors at the site of the work in a prominent and accessible place where it can be easily seen by the workers.

b. *Frequently recurring classifications.* (1) In addition to wage and fringe benefit rates that have been determined to be prevailing under the procedures set forth in [29 CFR part 1](#), a wage determination may contain, pursuant to § 1.3(f), wage and fringe benefit rates for classifications of laborers and mechanics for which conformance requests are regularly submitted pursuant to paragraph 1.c. of this section, provided that:

(i) The work performed by the classification is not performed by a classification in the wage determination for which a prevailing wage rate has been determined;

(ii) The classification is used in the area by the construction industry; and

(iii) The wage rate for the classification bears a reasonable relationship to the prevailing wage rates contained in the wage determination.

(2) The Administrator will establish wage rates for such classifications in accordance with paragraph 1.c.(1)(iii) of this section. Work performed in such a classification must be paid at no less than the wage and fringe benefit rate listed on the wage determination for such classification.

c. *Conformance.* (1) The contracting officer must require that any class of laborers or mechanics, including helpers, which is not listed in the wage determination and which is to be employed under the contract be classified in conformance with the wage determination. Conformance of an additional classification and wage rate and fringe benefits is appropriate only when the following criteria have been met:

(i) The work to be performed by the classification requested is not performed by a classification in the wage determination; and

(ii) The classification is used in the area by the construction industry; and

(iii) The proposed wage rate, including any bona fide fringe benefits, bears a reasonable relationship to the wage rates contained in the wage determination.

(2) The conformance process may not be used to split, subdivide, or otherwise avoid application of classifications listed in the wage determination.

(3) If the contractor and the laborers and mechanics to be employed in the classification (if known), or their representatives, and the contracting officer agree on the classification and wage rate (including the amount designated for fringe benefits where appropriate), a report of the action taken will be sent by the contracting officer by email to DBAconformance@dol.gov. The Administrator, or an authorized representative, will approve, modify, or disapprove every additional classification action within 30 days of receipt and so advise the contracting officer or will notify the contracting officer within the 30-day period that additional time is necessary.

(4) In the event the contractor, the laborers or mechanics to be employed in the classification or their representatives, and the contracting officer do not agree on the proposed classification and wage rate (including the amount designated for fringe benefits, where appropriate), the contracting officer will, by email to DBAconformance@dol.gov, refer the questions, including the views of all interested parties and the recommendation of the contracting officer, to the Administrator for determination. The Administrator, or an authorized representative, will issue a determination within 30 days of receipt and so advise the contracting officer or will notify the contracting officer within the 30-day period that additional time is necessary.

(5) The contracting officer must promptly notify the contractor of the action taken by the Wage and Hour Division

under paragraphs 1.c.(3) and (4) of this section. The contractor must furnish a written copy of such determination to each affected worker or it must be posted as a part of the wage determination. The wage rate (including fringe benefits where appropriate) determined pursuant to paragraph 1.c.(3) or (4) of this section must be paid to all workers performing work in the classification under this contract from the first day on which work is performed in the classification.

d. *Fringe benefits not expressed as an hourly rate.* Whenever the minimum wage rate prescribed in the contract for a class of laborers or mechanics includes a fringe benefit which is not expressed as an hourly rate, the contractor may either pay the benefit as stated in the wage determination or may pay another bona fide fringe benefit or an hourly cash equivalent thereof.

e. *Unfunded plans.* If the contractor does not make payments to a trustee or other third person, the contractor may consider as part of the wages of any laborer or mechanic the amount of any costs reasonably anticipated in providing bona fide fringe benefits under a plan or program, *Provided*, That the Secretary of Labor has found, upon the written request of the contractor, in accordance with the criteria set forth in § 5.28, that the applicable standards of the Davis-Bacon Act have been met. The Secretary of Labor may require the contractor to set aside in a separate account assets for the meeting of obligations under the plan or program.

f. *Interest.* In the event of a failure to pay all or part of the wages required by the contract, the contractor will be required to pay interest on any underpayment of wages.

2. Withholding (29 CFR 5.5)

a. *Withholding requirements.* The contracting agency may, upon its own action, or must, upon written request of an authorized representative of the Department of Labor, withhold or cause to be withheld from the contractor so much of the accrued payments or advances as may be considered necessary to satisfy the liabilities of the prime contractor or any subcontractor for the full amount of wages and monetary relief, including interest, required by the clauses set forth in this section for violations of this contract, or to satisfy any such liabilities required by any other Federal contract, or federally assisted contract subject to Davis-Bacon labor standards, that is held by the same prime contractor (as defined in § 5.2). The necessary funds may be withheld from the contractor under this contract, any other Federal contract with the same prime contractor, or any other federally assisted contract that is subject to Davis-Bacon labor standards requirements and is held by the same prime contractor, regardless of whether the other contract was awarded or assisted by the same agency, and such funds may be used to satisfy the contractor liability for which the funds were withheld. In the event of a contractor's failure to pay any laborer or mechanic, including any apprentice or helper working on the site of the work all or part of the wages required by the contract, or upon the contractor's failure to submit the required records as discussed in paragraph 3.d. of this section, the contracting agency may on its own initiative and after written notice to the contractor, take such action as may be necessary to cause the suspension of any further payment, advance, or guarantee of funds until such violations have ceased.

b. *Priority to withheld funds.* The Department has priority to funds withheld or to be withheld in accordance with paragraph

2.a. of this section or Section V, paragraph 3.a., or both, over claims to those funds by:

- (1) A contractor's surety(ies), including without limitation performance bond sureties and payment bond sureties;
- (2) A contracting agency for its procurement costs;
- (3) A trustee(s) (either a court-appointed trustee or a U.S. trustee, or both) in bankruptcy of a contractor, or a contractor's bankruptcy estate;
- (4) A contractor's assignee(s);
- (5) A contractor's successor(s); or
- (6) A claim asserted under the Prompt Payment Act, [31 U.S.C. 3901–3907](#).

3. Records and certified payrolls (29 CFR 5.5)

a. Basic record requirements (1) Length of record retention. All regular payrolls and other basic records must be maintained by the contractor and any subcontractor during the course of the work and preserved for all laborers and mechanics working at the site of the work (or otherwise working in construction or development of the project under a development statute) for a period of at least 3 years after all the work on the prime contract is completed.

(2) Information required. Such records must contain the name; Social Security number; last known address, telephone number, and email address of each such worker; each worker's correct classification(s) of work actually performed; hourly rates of wages paid (including rates of contributions or costs anticipated for bona fide fringe benefits or cash equivalents thereof of the types described in [40 U.S.C. 3141\(2\)\(B\)](#) of the Davis-Bacon Act); daily and weekly number of hours actually worked in total and on each covered contract; deductions made; and actual wages paid.

(3) Additional records relating to fringe benefits. Whenever the Secretary of Labor has found under paragraph 1.e. of this section that the wages of any laborer or mechanic include the amount of any costs reasonably anticipated in providing benefits under a plan or program described in [40 U.S.C. 3141\(2\)\(B\)](#) of the Davis-Bacon Act, the contractor must maintain records which show that the commitment to provide such benefits is enforceable, that the plan or program is financially responsible, and that the plan or program has been communicated in writing to the laborers or mechanics affected, and records which show the costs anticipated or the actual cost incurred in providing such benefits.

(4) Additional records relating to apprenticeship. Contractors with apprentices working under approved programs must maintain written evidence of the registration of apprenticeship programs, the registration of the apprentices, and the ratios and wage rates prescribed in the applicable programs.

b. Certified payroll requirements (1) Frequency and method of submission. The contractor or subcontractor must submit weekly, for each week in which any DBA- or Related Acts-covered work is performed, certified payrolls to the contracting

agency. The prime contractor is responsible for the submission of all certified payrolls by all subcontractors. A contracting agency or prime contractor may permit or require contractors to submit certified payrolls through an electronic system, as long as the electronic system requires a legally valid electronic signature; the system allows the contractor, the contracting agency, and the Department of Labor to access the certified payrolls upon request for at least 3 years after the work on the prime contract has been completed; and the contracting agency or prime contractor permits other methods of submission in situations where the contractor is unable or limited in its ability to use or access the electronic system.

(2) Information required. The certified payrolls submitted must set out accurately and completely all of the information required to be maintained under paragraph 3.a.(2) of this section, except that full Social Security numbers and last known addresses, telephone numbers, and email addresses must not be included on weekly transmittals. Instead, the certified payrolls need only include an individually identifying number for each worker (e.g., the last four digits of the worker's Social Security number). The required weekly certified payroll information may be submitted using Optional Form WH-347 or in any other format desired. Optional Form WH-347 is available for this purpose from the Wage and Hour Division website at <https://www.dol.gov/sites/dolgov/files/WHD/legacy/files/wh347.pdf> or its successor website. It is not a violation of this section for a prime contractor to require a subcontractor to provide full Social Security numbers and last known addresses, telephone numbers, and email addresses to the prime contractor for its own records, without weekly submission by the subcontractor to the contracting agency.

(3) Statement of Compliance. Each certified payroll submitted must be accompanied by a "Statement of Compliance," signed by the contractor or subcontractor, or the contractor's or subcontractor's agent who pays or supervises the payment of the persons working on the contract, and must certify the following:

(i) That the certified payroll for the payroll period contains the information required to be provided under paragraph 3.b. of this section, the appropriate information and basic records are being maintained under paragraph 3.a. of this section, and such information and records are correct and complete;

(ii) That each laborer or mechanic (including each helper and apprentice) working on the contract during the payroll period has been paid the full weekly wages earned, without rebate, either directly or indirectly, and that no deductions have been made either directly or indirectly from the full wages earned, other than permissible deductions as set forth in [29 CFR part 3](#); and

(iii) That each laborer or mechanic has been paid not less than the applicable wage rates and fringe benefits or cash equivalents for the classification(s) of work actually performed, as specified in the applicable wage determination incorporated into the contract.

(4) Use of Optional Form WH-347. The weekly submission of a properly executed certification set forth on the reverse side of Optional Form WH-347 will satisfy the requirement for submission of the "Statement of Compliance" required by paragraph 3.b.(3) of this section.

(5) *Signature*. The signature by the contractor, subcontractor, or the contractor's or subcontractor's agent must be an original handwritten signature or a legally valid electronic signature.

(6) *Falsification*. The falsification of any of the above certifications may subject the contractor or subcontractor to civil or criminal prosecution under [18 U.S.C. 1001](#) and [31 U.S.C. 3729](#).

(7) *Length of certified payroll retention*. The contractor or subcontractor must preserve all certified payrolls during the course of the work and for a period of 3 years after all the work on the prime contract is completed.

c. *Contracts, subcontracts, and related documents*. The contractor or subcontractor must maintain this contract or subcontract and related documents including, without limitation, bids, proposals, amendments, modifications, and extensions. The contractor or subcontractor must preserve these contracts, subcontracts, and related documents during the course of the work and for a period of 3 years after all the work on the prime contract is completed.

d. *Required disclosures and access* (1) *Required record disclosures and access to workers*. The contractor or subcontractor must make the records required under paragraphs 3.a. through 3.c. of this section, and any other documents that the contracting agency, the State DOT, the FHWA, or the Department of Labor deems necessary to determine compliance with the labor standards provisions of any of the applicable statutes referenced by § 5.1, available for inspection, copying, or transcription by authorized representatives of the contracting agency, the State DOT, the FHWA, or the Department of Labor, and must permit such representatives to interview workers during working hours on the job.

(2) *Sanctions for non-compliance with records and worker access requirements*. If the contractor or subcontractor fails to submit the required records or to make them available, or refuses to permit worker interviews during working hours on the job, the Federal agency may, after written notice to the contractor, sponsor, applicant, owner, or other entity, as the case may be, that maintains such records or that employs such workers, take such action as may be necessary to cause the suspension of any further payment, advance, or guarantee of funds. Furthermore, failure to submit the required records upon request or to make such records available, or to permit worker interviews during working hours on the job, may be grounds for debarment action pursuant to § 5.12. In addition, any contractor or other person that fails to submit the required records or make those records available to WHD within the time WHD requests that the records be produced will be precluded from introducing as evidence in an administrative proceeding under [29 CFR part 6](#) any of the required records that were not provided or made available to WHD. WHD will take into consideration a reasonable request from the contractor or person for an extension of the time for submission of records. WHD will determine the reasonableness of the request and may consider, among other things, the location of the records and the volume of production.

(3) *Required information disclosures*. Contractors and subcontractors must maintain the full Social Security number and last known address, telephone number, and email address

of each covered worker, and must provide them upon request to the contracting agency, the State DOT, the FHWA, the contractor, or the Wage and Hour Division of the Department of Labor for purposes of an investigation or other compliance action.

4. Apprentices and equal employment opportunity (29 CFR 5.5)

a. *Apprentices* (1) *Rate of pay*. Apprentices will be permitted to work at less than the predetermined rate for the work they perform when they are employed pursuant to and individually registered in a bona fide apprenticeship program registered with the U.S. Department of Labor, Employment and Training Administration, Office of Apprenticeship (OA), or with a State Apprenticeship Agency recognized by the OA. A person who is not individually registered in the program, but who has been certified by the OA or a State Apprenticeship Agency (where appropriate) to be eligible for probationary employment as an apprentice, will be permitted to work at less than the predetermined rate for the work they perform in the first 90 days of probationary employment as an apprentice in such a program. In the event the OA or a State Apprenticeship Agency recognized by the OA withdraws approval of an apprenticeship program, the contractor will no longer be permitted to use apprentices at less than the applicable predetermined rate for the work performed until an acceptable program is approved.

(2) *Fringe benefits*. Apprentices must be paid fringe benefits in accordance with the provisions of the apprenticeship program. If the apprenticeship program does not specify fringe benefits, apprentices must be paid the full amount of fringe benefits listed on the wage determination for the applicable classification. If the Administrator determines that a different practice prevails for the applicable apprentice classification, fringe benefits must be paid in accordance with that determination.

(3) *Apprenticeship ratio*. The allowable ratio of apprentices to journeyworkers on the job site in any craft classification must not be greater than the ratio permitted to the contractor as to the entire work force under the registered program or the ratio applicable to the locality of the project pursuant to paragraph 4.a.(4) of this section. Any worker listed on a payroll at an apprentice wage rate, who is not registered or otherwise employed as stated in paragraph 4.a.(1) of this section, must be paid not less than the applicable wage rate on the wage determination for the classification of work actually performed. In addition, any apprentice performing work on the job site in excess of the ratio permitted under this section must be paid not less than the applicable wage rate on the wage determination for the work actually performed.

(4) *Reciprocity of ratios and wage rates*. Where a contractor is performing construction on a project in a locality other than the locality in which its program is registered, the ratios and wage rates (expressed in percentages of the journeyworker's hourly rate) applicable within the locality in which the construction is being performed must be observed. If there is no applicable ratio or wage rate for the locality of the project, the ratio and wage rate specified in the contractor's registered program must be observed.

b. *Equal employment opportunity*. The use of apprentices and journeyworkers under this part must be in conformity with

the equal employment opportunity requirements of Executive Order 11246, as amended, and [29 CFR part 30](#).

c. Apprentices and Trainees (programs of the U.S. DOT).

Apprentices and trainees working under apprenticeship and skill training programs which have been certified by the Secretary of Transportation as promoting EEO in connection with Federal-aid highway construction programs are not subject to the requirements of paragraph 4 of this Section IV. 23 CFR 230.111(e)(2). The straight time hourly wage rates for apprentices and trainees under such programs will be established by the particular programs. The ratio of apprentices and trainees to journeyworkers shall not be greater than permitted by the terms of the particular program.

5. Compliance with Copeland Act requirements. The contractor shall comply with the requirements of 29 CFR part 3, which are incorporated by reference in this contract as provided in 29 CFR 5.5.

6. Subcontracts. The contractor or subcontractor must insert FHWA-1273 in any subcontracts, along with the applicable wage determination(s) and such other clauses or contract modifications as the contracting agency may by appropriate instructions require, and a clause requiring the subcontractors to include these clauses and wage determination(s) in any lower tier subcontracts. The prime contractor is responsible for the compliance by any subcontractor or lower tier subcontractor with all the contract clauses in this section. In the event of any violations of these clauses, the prime contractor and any subcontractor(s) responsible will be liable for any unpaid wages and monetary relief, including interest from the date of the underpayment or loss, due to any workers of lower-tier subcontractors, and may be subject to debarment, as appropriate. 29 CFR 5.5.

7. Contract termination: debarment. A breach of the contract clauses in 29 CFR 5.5 may be grounds for termination of the contract, and for debarment as a contractor and a subcontractor as provided in 29 CFR 5.12.

8. Compliance with Davis-Bacon and Related Act requirements. All rulings and interpretations of the Davis-Bacon and Related Acts contained in 29 CFR parts 1, 3, and 5 are herein incorporated by reference in this contract as provided in 29 CFR 5.5.

9. Disputes concerning labor standards. As provided in 29 CFR 5.5, disputes arising out of the labor standards provisions of this contract shall not be subject to the general disputes clause of this contract. Such disputes shall be resolved in accordance with the procedures of the Department of Labor set forth in 29 CFR parts 5, 6, and 7. Disputes within the meaning of this clause include disputes between the contractor (or any of its subcontractors) and the contracting agency, the U.S. Department of Labor, or the employees or their representatives.

10. Certification of eligibility. a. By entering into this contract, the contractor certifies that neither it nor any person or firm who has an interest in the contractor's firm is a person or firm ineligible to be awarded Government contracts by virtue of [40 U.S.C. 3144\(b\)](#) or § 5.12(a).

b. No part of this contract shall be subcontracted to any person or firm ineligible for award of a Government contract by virtue of [40 U.S.C. 3144\(b\)](#) or § 5.12(a).

c. The penalty for making false statements is prescribed in the U.S. Code, Title 18 Crimes and Criminal Procedure, [18 U.S.C. 1001](#).

11. Anti-retaliation. It is unlawful for any person to discharge, demote, intimidate, threaten, restrain, coerce, blacklist, harass, or in any other manner discriminate against, or to cause any person to discharge, demote, intimidate, threaten, restrain, coerce, blacklist, harass, or in any other manner discriminate against, any worker or job applicant for:

a. Notifying any contractor of any conduct which the worker reasonably believes constitutes a violation of the DBA, Related Acts, this part, or [29 CFR part 1](#) or [3](#);

b. Filing any complaint, initiating or causing to be initiated any proceeding, or otherwise asserting or seeking to assert on behalf of themselves or others any right or protection under the DBA, Related Acts, this part, or [29 CFR part 1](#) or [3](#);

c. Cooperating in any investigation or other compliance action, or testifying in any proceeding under the DBA, Related Acts, this part, or [29 CFR part 1](#) or [3](#); or

d. Informing any other person about their rights under the DBA, Related Acts, this part, or [29 CFR part 1](#) or [3](#).

V. CONTRACT WORK HOURS AND SAFETY STANDARDS ACT

Pursuant to 29 CFR 5.5(b), the following clauses apply to any Federal-aid construction contract in an amount in excess of \$100,000 and subject to the overtime provisions of the Contract Work Hours and Safety Standards Act. These clauses shall be inserted in addition to the clauses required by 29 CFR 5.5(a) or 29 CFR 4.6. As used in this paragraph, the terms laborers and mechanics include watchpersons and guards.

1. Overtime requirements. No contractor or subcontractor contracting for any part of the contract work which may require or involve the employment of laborers or mechanics shall require or permit any such laborer or mechanic in any workweek in which he or she is employed on such work to work in excess of forty hours in such workweek unless such laborer or mechanic receives compensation at a rate not less than one and one-half times the basic rate of pay for all hours worked in excess of forty hours in such workweek. 29 CFR 5.5.

2. Violation; liability for unpaid wages; liquidated damages. In the event of any violation of the clause set forth in paragraph 1. of this section the contractor and any subcontractor responsible therefor shall be liable for the unpaid wages and interest from the date of the underpayment. In addition, such contractor and subcontractor shall be liable to the United States (in the case of work done under contract for the District of Columbia or a territory, to such District or to such territory), for liquidated damages. Such liquidated damages shall be computed with respect to each individual laborer or

mechanic, including watchpersons and guards, employed in violation of the clause set forth in paragraph 1. of this section, in the sum currently provided in 29 CFR 5.5(b)(2)* for each calendar day on which such individual was required or permitted to work in excess of the standard workweek of forty hours without payment of the overtime wages required by the clause set forth in paragraph 1. of this section.

* \$31 as of January 15, 2023 (See 88 FR 88 FR 2210) as may be adjusted annually by the Department of Labor, pursuant to the Federal Civil Penalties Inflation Adjustment Act of 1990.

3. Withholding for unpaid wages and liquidated damages

a. *Withholding process.* The FHWA or the contracting agency may, upon its own action, or must, upon written request of an authorized representative of the Department of Labor, withhold or cause to be withheld from the contractor so much of the accrued payments or advances as may be considered necessary to satisfy the liabilities of the prime contractor or any subcontractor for any unpaid wages; monetary relief, including interest; and liquidated damages required by the clauses set forth in this section on this contract, any other Federal contract with the same prime contractor, or any other federally assisted contract subject to the Contract Work Hours and Safety Standards Act that is held by the same prime contractor (as defined in § 5.2). The necessary funds may be withheld from the contractor under this contract, any other Federal contract with the same prime contractor, or any other federally assisted contract that is subject to the Contract Work Hours and Safety Standards Act and is held by the same prime contractor, regardless of whether the other contract was awarded or assisted by the same agency, and such funds may be used to satisfy the contractor liability for which the funds were withheld.

b. *Priority to withheld funds.* The Department has priority to funds withheld or to be withheld in accordance with Section IV paragraph 2.a. or paragraph 3.a. of this section, or both, over claims to those funds by:

- (1) A contractor's surety(ies), including without limitation performance bond sureties and payment bond sureties;
- (2) A contracting agency for its procurement costs;
- (3) A trustee(s) (either a court-appointed trustee or a U.S. trustee, or both) in bankruptcy of a contractor, or a contractor's bankruptcy estate;
- (4) A contractor's assignee(s);
- (5) A contractor's successor(s); or
- (6) A claim asserted under the Prompt Payment Act, [31 U.S.C. 3901](#)–3907.

4. Subcontracts. The contractor or subcontractor must insert in any subcontracts the clauses set forth in paragraphs 1. through 5. of this section and a clause requiring the subcontractors to include these clauses in any lower tier subcontracts. The prime contractor is responsible for compliance by any subcontractor or lower tier subcontractor with the clauses set forth in paragraphs 1. through 5. In the

event of any violations of these clauses, the prime contractor and any subcontractor(s) responsible will be liable for any unpaid wages and monetary relief, including interest from the date of the underpayment or loss, due to any workers of lower-tier subcontractors, and associated liquidated damages and may be subject to debarment, as appropriate.

5. Anti-retaliation. It is unlawful for any person to discharge, demote, intimidate, threaten, restrain, coerce, blacklist, harass, or in any other manner discriminate against, or to cause any person to discharge, demote, intimidate, threaten, restrain, coerce, blacklist, harass, or in any other manner discriminate against, any worker or job applicant for:

a. Notifying any contractor of any conduct which the worker reasonably believes constitutes a violation of the Contract Work Hours and Safety Standards Act (CWHSSA) or its implementing regulations in this part;

b. Filing any complaint, initiating or causing to be initiated any proceeding, or otherwise asserting or seeking to assert on behalf of themselves or others any right or protection under CWHSSA or this part;

c. Cooperating in any investigation or other compliance action, or testifying in any proceeding under CWHSSA or this part; or

d. Informing any other person about their rights under CWHSSA or this part.

VI. SUBLETTING OR ASSIGNING THE CONTRACT

This provision is applicable to all Federal-aid construction contracts on the National Highway System pursuant to 23 CFR 635.116.

1. The contractor shall perform with its own organization contract work amounting to not less than 30 percent (or a greater percentage if specified elsewhere in the contract) of the total original contract price, excluding any specialty items designated by the contracting agency. Specialty items may be performed by subcontract and the amount of any such specialty items performed may be deducted from the total original contract price before computing the amount of work required to be performed by the contractor's own organization (23 CFR 635.116).

a. The term "perform work with its own organization" in paragraph 1 of Section VI refers to workers employed or leased by the prime contractor, and equipment owned or rented by the prime contractor, with or without operators. Such term does not include employees or equipment of a subcontractor or lower tier subcontractor, agents of the prime contractor, or any other assignees. The term may include payments for the costs of hiring leased employees from an employee leasing firm meeting all relevant Federal and State regulatory requirements. Leased employees may only be included in this term if the prime contractor meets all of the following conditions: (based on longstanding interpretation)

- (1) the prime contractor maintains control over the supervision of the day-to-day activities of the leased employees;
- (2) the prime contractor remains responsible for the quality of the work of the leased employees;

- (3) the prime contractor retains all power to accept or exclude individual employees from work on the project; and
- (4) the prime contractor remains ultimately responsible for the payment of predetermined minimum wages, the submission of payrolls, statements of compliance and all other Federal regulatory requirements.

b. "Specialty Items" shall be construed to be limited to work that requires highly specialized knowledge, abilities, or equipment not ordinarily available in the type of contracting organizations qualified and expected to bid or propose on the contract as a whole and in general are to be limited to minor components of the overall contract. 23 CFR 635.102.

2. Pursuant to 23 CFR 635.116(a), the contract amount upon which the requirements set forth in paragraph (1) of Section VI is computed includes the cost of material and manufactured products which are to be purchased or produced by the contractor under the contract provisions.

3. Pursuant to 23 CFR 635.116(c), the contractor shall furnish (a) a competent superintendent or supervisor who is employed by the firm, has full authority to direct performance of the work in accordance with the contract requirements, and is in charge of all construction operations (regardless of who performs the work) and (b) such other of its own organizational resources (supervision, management, and engineering services) as the contracting officer determines is necessary to assure the performance of the contract.

4. No portion of the contract shall be sublet, assigned or otherwise disposed of except with the written consent of the contracting officer, or authorized representative, and such consent when given shall not be construed to relieve the contractor of any responsibility for the fulfillment of the contract. Written consent will be given only after the contracting agency has assured that each subcontract is evidenced in writing and that it contains all pertinent provisions and requirements of the prime contract. (based on long-standing interpretation of 23 CFR 635.116).

5. The 30-percent self-performance requirement of paragraph (1) is not applicable to design-build contracts; however, contracting agencies may establish their own self-performance requirements. 23 CFR 635.116(d).

VII. SAFETY: ACCIDENT PREVENTION

This provision is applicable to all Federal-aid construction contracts and to all related subcontracts.

1. In the performance of this contract the contractor shall comply with all applicable Federal, State, and local laws governing safety, health, and sanitation (23 CFR Part 635). The contractor shall provide all safeguards, safety devices and protective equipment and take any other needed actions as it determines, or as the contracting officer may determine, to be reasonably necessary to protect the life and health of employees on the job and the safety of the public and to protect property in connection with the performance of the work covered by the contract. 23 CFR 635.108.

2. It is a condition of this contract, and shall be made a condition of each subcontract, which the contractor enters into pursuant to this contract, that the contractor and any subcontractor shall not permit any employee, in performance of the contract, to work in surroundings or under conditions which are unsanitary, hazardous or dangerous to his/her health or safety, as determined under construction safety and

health standards (29 CFR Part 1926) promulgated by the Secretary of Labor, in accordance with Section 107 of the Contract Work Hours and Safety Standards Act (40 U.S.C. 3704). 29 CFR 1926.10.

3. Pursuant to 29 CFR 1926.3, it is a condition of this contract that the Secretary of Labor or authorized representative thereof, shall have right of entry to any site of contract performance to inspect or investigate the matter of compliance with the construction safety and health standards and to carry out the duties of the Secretary under Section 107 of the Contract Work Hours and Safety Standards Act (40 U.S.C. 3704).

VIII. FALSE STATEMENTS CONCERNING HIGHWAY PROJECTS

This provision is applicable to all Federal-aid construction contracts and to all related subcontracts.

In order to assure high quality and durable construction in conformity with approved plans and specifications and a high degree of reliability on statements and representations made by engineers, contractors, suppliers, and workers on Federal-aid highway projects, it is essential that all persons concerned with the project perform their functions as carefully, thoroughly, and honestly as possible. Willful falsification, distortion, or misrepresentation with respect to any facts related to the project is a violation of Federal law. To prevent any misunderstanding regarding the seriousness of these and similar acts, Form FHWA-1022 shall be posted on each Federal-aid highway project (23 CFR Part 635) in one or more places where it is readily available to all persons concerned with the project:

18 U.S.C. 1020 reads as follows:

"Whoever, being an officer, agent, or employee of the United States, or of any State or Territory, or whoever, whether a person, association, firm, or corporation, knowingly makes any false statement, false representation, or false report as to the character, quality, quantity, or cost of the material used or to be used, or the quantity or quality of the work performed or to be performed, or the cost thereof in connection with the submission of plans, maps, specifications, contracts, or costs of construction on any highway or related project submitted for approval to the Secretary of Transportation; or

Whoever knowingly makes any false statement, false representation, false report or false claim with respect to the character, quality, quantity, or cost of any work performed or to be performed, or materials furnished or to be furnished, in connection with the construction of any highway or related project approved by the Secretary of Transportation; or

Whoever knowingly makes any false statement or false representation as to material fact in any statement, certificate, or report submitted pursuant to provisions of the Federal-aid Roads Act approved July 11, 1916, (39 Stat. 355), as amended and supplemented;

Shall be fined under this title or imprisoned not more than 5 years or both."

IX. IMPLEMENTATION OF CLEAN AIR ACT AND FEDERAL WATER POLLUTION CONTROL ACT (42 U.S.C. 7606; 2 CFR 200.88; EO 11738)

This provision is applicable to all Federal-aid construction contracts in excess of \$150,000 and to all related subcontracts. 48 CFR 2.101; 2 CFR 200.327.

By submission of this bid/proposal or the execution of this contract or subcontract, as appropriate, the bidder, proposer, Federal-aid construction contractor, subcontractor, supplier, or vendor agrees to comply with all applicable standards, orders or regulations issued pursuant to the Clean Air Act (42 U.S.C. 7401-7671q) and the Federal Water Pollution Control Act, as amended (33 U.S.C. 1251-1387). Violations must be reported to the Federal Highway Administration and the Regional Office of the Environmental Protection Agency. 2 CFR Part 200, Appendix II.

The contractor agrees to include or cause to be included the requirements of this Section in every subcontract, and further agrees to take such action as the contracting agency may direct as a means of enforcing such requirements. 2 CFR 200.327.

X. CERTIFICATION REGARDING DEBARMENT, SUSPENSION, INELIGIBILITY AND VOLUNTARY EXCLUSION

This provision is applicable to all Federal-aid construction contracts, design-build contracts, subcontracts, lower-tier subcontracts, purchase orders, lease agreements, consultant contracts or any other covered transaction requiring FHWA approval or that is estimated to cost \$25,000 or more – as defined in 2 CFR Parts 180 and 1200. 2 CFR 180.220 and 1200.220.

1. Instructions for Certification – First Tier Participants:

- a. By signing and submitting this proposal, the prospective first tier participant is providing the certification set out below.
- b. The inability of a person to provide the certification set out below will not necessarily result in denial of participation in this covered transaction. The prospective first tier participant shall submit an explanation of why it cannot provide the certification set out below. The certification or explanation will be considered in connection with the department or agency's determination whether to enter into this transaction. However, failure of the prospective first tier participant to furnish a certification or an explanation shall disqualify such a person from participation in this transaction. 2 CFR 180.320.
- c. The certification in this clause is a material representation of fact upon which reliance was placed when the contracting agency determined to enter into this transaction. If it is later determined that the prospective participant knowingly rendered an erroneous certification, in addition to other remedies available to the Federal Government, the contracting agency may terminate this transaction for cause of default. 2 CFR 180.325.
- d. The prospective first tier participant shall provide immediate written notice to the contracting agency to whom this proposal is submitted if any time the prospective first tier participant learns that its certification was erroneous when submitted or has become erroneous by reason of changed circumstances. 2 CFR 180.345 and 180.350.

e. The terms "covered transaction," "debarred," "suspended," "ineligible," "participant," "person," "principal," and "voluntarily excluded," as used in this clause, are defined in 2 CFR Parts 180, Subpart I, 180.900-180.1020, and 1200. "First Tier Covered Transactions" refers to any covered transaction between a recipient or subrecipient of Federal funds and a participant (such as the prime or general contract). "Lower Tier Covered Transactions" refers to any covered transaction under a First Tier Covered Transaction (such as subcontracts). "First Tier Participant" refers to the participant who has entered into a covered transaction with a recipient or subrecipient of Federal funds (such as the prime or general contractor). "Lower Tier Participant" refers any participant who has entered into a covered transaction with a First Tier Participant or other Lower Tier Participants (such as subcontractors and suppliers).

f. The prospective first tier participant agrees by submitting this proposal that, should the proposed covered transaction be entered into, it shall not knowingly enter into any lower tier covered transaction with a person who is debarred, suspended, declared ineligible, or voluntarily excluded from participation in this covered transaction, unless authorized by the department or agency entering into this transaction. 2 CFR 180.330.

g. The prospective first tier participant further agrees by submitting this proposal that it will include the clause titled "Certification Regarding Debarment, Suspension, Ineligibility and Voluntary Exclusion-Lower Tier Covered Transactions," provided by the department or contracting agency, entering into this covered transaction, without modification, in all lower tier covered transactions and in all solicitations for lower tier covered transactions exceeding the \$25,000 threshold. 2 CFR 180.220 and 180.300.

h. A participant in a covered transaction may rely upon a certification of a prospective participant in a lower tier covered transaction that is not debarred, suspended, ineligible, or voluntarily excluded from the covered transaction, unless it knows that the certification is erroneous. 2 CFR 180.300; 180.320, and 180.325. A participant is responsible for ensuring that its principals are not suspended, debarred, or otherwise ineligible to participate in covered transactions. 2 CFR 180.335. To verify the eligibility of its principals, as well as the eligibility of any lower tier prospective participants, each participant may, but is not required to, check the System for Award Management website (<https://www.sam.gov/>). 2 CFR 180.300, 180.320, and 180.325.

i. Nothing contained in the foregoing shall be construed to require the establishment of a system of records in order to render in good faith the certification required by this clause. The knowledge and information of the prospective participant is not required to exceed that which is normally possessed by a prudent person in the ordinary course of business dealings.

j. Except for transactions authorized under paragraph (f) of these instructions, if a participant in a covered transaction knowingly enters into a lower tier covered transaction with a person who is suspended, debarred, ineligible, or voluntarily excluded from participation in this transaction, in addition to other remedies available to the Federal Government, the department or agency may terminate this transaction for cause or default. 2 CFR 180.325.

2. Certification Regarding Debarment, Suspension, Ineligibility and Voluntary Exclusion – First Tier Participants:

a. The prospective first tier participant certifies to the best of its knowledge and belief, that it and its principals:

(1) Are not presently debarred, suspended, proposed for debarment, declared ineligible, or voluntarily excluded from participating in covered transactions by any Federal department or agency, 2 CFR 180.335;

(2) Have not within a three-year period preceding this proposal been convicted of or had a civil judgment rendered against them for commission of fraud or a criminal offense in connection with obtaining, attempting to obtain, or performing a public (Federal, State, or local) transaction or contract under a public transaction; violation of Federal or State antitrust statutes or commission of embezzlement, theft, forgery, bribery, falsification or destruction of records, making false statements, or receiving stolen property, 2 CFR 180.800;

(3) Are not presently indicted for or otherwise criminally or civilly charged by a governmental entity (Federal, State or local) with commission of any of the offenses enumerated in paragraph (a)(2) of this certification, 2 CFR 180.700 and 180.800; and

(4) Have not within a three-year period preceding this application/proposal had one or more public transactions (Federal, State or local) terminated for cause or default. 2 CFR 180.335(d).

(5) Are not a corporation that has been convicted of a felony violation under any Federal law within the two-year period preceding this proposal (USDOT Order 4200.6 implementing appropriations act requirements); and

(6) Are not a corporation with any unpaid Federal tax liability that has been assessed, for which all judicial and administrative remedies have been exhausted, or have lapsed, and that is not being paid in a timely manner pursuant to an agreement with the authority responsible for collecting the tax liability (USDOT Order 4200.6 implementing appropriations act requirements).

b. Where the prospective participant is unable to certify to any of the statements in this certification, such prospective participant should attach an explanation to this proposal. 2 CFR 180.335 and 180.340.

3. Instructions for Certification - Lower Tier Participants:

(Applicable to all subcontracts, purchase orders, and other lower tier transactions requiring prior FHWA approval or estimated to cost \$25,000 or more - 2 CFR Parts 180 and 1200). 2 CFR 180.220 and 1200.220.

a. By signing and submitting this proposal, the prospective lower tier participant is providing the certification set out below.

b. The certification in this clause is a material representation of fact upon which reliance was placed when this transaction was entered into. If it is later determined that the prospective lower tier participant knowingly rendered an erroneous certification, in addition to other remedies available to the Federal Government, the department, or agency with which

this transaction originated may pursue available remedies, including suspension and/or debarment.

c. The prospective lower tier participant shall provide immediate written notice to the person to which this proposal is submitted if at any time the prospective lower tier participant learns that its certification was erroneous by reason of changed circumstances. 2 CFR 180.365.

d. The terms "covered transaction," "debarred," "suspended," "ineligible," "participant," "person," "principal," and "voluntarily excluded," as used in this clause, are defined in 2 CFR Parts 180, Subpart I, 180.900 – 180.1020, and 1200. You may contact the person to which this proposal is submitted for assistance in obtaining a copy of those regulations. "First Tier Covered Transactions" refers to any covered transaction between a recipient or subrecipient of Federal funds and a participant (such as the prime or general contract). "Lower Tier Covered Transactions" refers to any covered transaction under a First Tier Covered Transaction (such as subcontracts). "First Tier Participant" refers to the participant who has entered into a covered transaction with a recipient or subrecipient of Federal funds (such as the prime or general contractor). "Lower Tier Participant" refers any participant who has entered into a covered transaction with a First Tier Participant or other Lower Tier Participants (such as subcontractors and suppliers).

e. The prospective lower tier participant agrees by submitting this proposal that, should the proposed covered transaction be entered into, it shall not knowingly enter into any lower tier covered transaction with a person who is debarred, suspended, declared ineligible, or voluntarily excluded from participation in this covered transaction, unless authorized by the department or agency with which this transaction originated. 2 CFR 1200.220 and 1200.332.

f. The prospective lower tier participant further agrees by submitting this proposal that it will include this clause titled "Certification Regarding Debarment, Suspension, Ineligibility and Voluntary Exclusion-Lower Tier Covered Transaction," without modification, in all lower tier covered transactions and in all solicitations for lower tier covered transactions exceeding the \$25,000 threshold. 2 CFR 180.220 and 1200.220.

g. A participant in a covered transaction may rely upon a certification of a prospective participant in a lower tier covered transaction that is not debarred, suspended, ineligible, or voluntarily excluded from the covered transaction, unless it knows that the certification is erroneous. A participant is responsible for ensuring that its principals are not suspended, debarred, or otherwise ineligible to participate in covered transactions. To verify the eligibility of its principals, as well as the eligibility of any lower tier prospective participants, each participant may, but is not required to, check the System for Award Management website (<https://www.sam.gov/>), which is compiled by the General Services Administration. 2 CFR 180.300, 180.320, 180.330, and 180.335.

h. Nothing contained in the foregoing shall be construed to require establishment of a system of records in order to render in good faith the certification required by this clause. The knowledge and information of participant is not required to exceed that which is normally possessed by a prudent person in the ordinary course of business dealings.

i. Except for transactions authorized under paragraph e of these instructions, if a participant in a covered transaction knowingly enters into a lower tier covered transaction with a person who is suspended, debarred, ineligible, or voluntarily

excluded from participation in this transaction, in addition to other remedies available to the Federal Government, the department or agency with which this transaction originated may pursue available remedies, including suspension and/or debarment. 2 CFR 180.325.

4. Certification Regarding Debarment, Suspension, Ineligibility and Voluntary Exclusion--Lower Tier Participants:

a. The prospective lower tier participant certifies, by submission of this proposal, that neither it nor its principals:

(1) is presently debarred, suspended, proposed for debarment, declared ineligible, or voluntarily excluded from participating in covered transactions by any Federal department or agency, 2 CFR 180.355;

(2) is a corporation that has been convicted of a felony violation under any Federal law within the two-year period preceding this proposal (USDOT Order 4200.6 implementing appropriations act requirements); and

(3) is a corporation with any unpaid Federal tax liability that has been assessed, for which all judicial and administrative remedies have been exhausted, or have lapsed, and that is not being paid in a timely manner pursuant to an agreement with the authority responsible for collecting the tax liability. (USDOT Order 4200.6 implementing appropriations act requirements)

b. Where the prospective lower tier participant is unable to certify to any of the statements in this certification, such prospective participant should attach an explanation to this proposal.

XI. CERTIFICATION REGARDING USE OF CONTRACT FUNDS FOR LOBBYING

This provision is applicable to all Federal-aid construction contracts and to all related subcontracts which exceed \$100,000. 49 CFR Part 20, App. A.

1. The prospective participant certifies, by signing and submitting this bid or proposal, to the best of his or her knowledge and belief, that:

a. No Federal appropriated funds have been paid or will be paid, by or on behalf of the undersigned, to any person for influencing or attempting to influence an officer or employee of any Federal agency, a Member of Congress, an officer or employee of Congress, or an employee of a Member of Congress in connection with the awarding of any Federal contract, the making of any Federal grant, the making of any Federal loan, the entering into of any cooperative agreement, and the extension, continuation, renewal, amendment, or modification of any Federal contract, grant, loan, or cooperative agreement.

b. If any funds other than Federal appropriated funds have been paid or will be paid to any person for influencing or attempting to influence an officer or employee of any Federal agency, a Member of Congress, an officer or employee of Congress, or an employee of a Member of Congress in connection with this Federal contract, grant, loan, or

cooperative agreement, the undersigned shall complete and submit Standard Form-LLL, "Disclosure Form to Report Lobbying," in accordance with its instructions.

2. This certification is a material representation of fact upon which reliance was placed when this transaction was made or entered into. Submission of this certification is a prerequisite for making or entering into this transaction imposed by 31 U.S.C. 1352. Any person who fails to file the required certification shall be subject to a civil penalty of not less than \$10,000 and not more than \$100,000 for each such failure.

3. The prospective participant also agrees by submitting its bid or proposal that the participant shall require that the language of this certification be included in all lower tier subcontracts, which exceed \$100,000 and that all such recipients shall certify and disclose accordingly.

XII. USE OF UNITED STATES-FLAG VESSELS:

This provision is applicable to all Federal-aid construction contracts, design-build contracts, subcontracts, lower-tier subcontracts, purchase orders, lease agreements, or any other covered transaction. 46 CFR Part 381.

This requirement applies to material or equipment that is acquired for a specific Federal-aid highway project. 46 CFR 381.7. It is not applicable to goods or materials that come into inventories independent of an FHWA funded-contract.

When oceanic shipments (or shipments across the Great Lakes) are necessary for materials or equipment acquired for a specific Federal-aid construction project, the bidder, proposer, contractor, subcontractor, or vendor agrees:

1. To utilize privately owned United States-flag commercial vessels to ship at least 50 percent of the gross tonnage (computed separately for dry bulk carriers, dry cargo liners, and tankers) involved, whenever shipping any equipment, material, or commodities pursuant to this contract, to the extent such vessels are available at fair and reasonable rates for United States-flag commercial vessels. 46 CFR 381.7.

2. To furnish within 20 days following the date of loading for shipments originating within the United States or within 30 working days following the date of loading for shipments originating outside the United States, a legible copy of a rated, 'on-board' commercial ocean bill-of-lading in English for each shipment of cargo described in paragraph (b)(1) of this section to both the Contracting Officer (through the prime contractor in the case of subcontractor bills-of-lading) and to the Office of Cargo and Commercial Sealift (MAR-620), Maritime Administration, Washington, DC 20590. (MARAD requires copies of the ocean carrier's (master) bills of lading, certified onboard, dated, with rates and charges. These bills of lading may contain business sensitive information and therefore may be submitted directly to MARAD by the Ocean Transportation Intermediary on behalf of the contractor). 46 CFR 381.7.

**ATTACHMENT A - EMPLOYMENT AND MATERIALS
PREFERENCE FOR APPALACHIAN DEVELOPMENT
HIGHWAY SYSTEM OR APPALACHIAN LOCAL ACCESS
ROAD CONTRACTS (23 CFR 633, Subpart B, Appendix B)**

This provision is applicable to all Federal-aid projects funded under the Appalachian Regional Development Act of 1965.

1. During the performance of this contract, the contractor undertaking to do work which is, or reasonably may be, done as on-site work, shall give preference to qualified persons who regularly reside in the labor area as designated by the DOL wherein the contract work is situated, or the subregion, or the Appalachian counties of the State wherein the contract work is situated, except:

a. To the extent that qualified persons regularly residing in the area are not available.

b. For the reasonable needs of the contractor to employ supervisory or specially experienced personnel necessary to assure an efficient execution of the contract work.

c. For the obligation of the contractor to offer employment to present or former employees as the result of a lawful collective bargaining contract, provided that the number of nonresident persons employed under this subparagraph (1c) shall not exceed 20 percent of the total number of employees employed by the contractor on the contract work, except as provided in subparagraph (4) below.

2. The contractor shall place a job order with the State Employment Service indicating (a) the classifications of the laborers, mechanics and other employees required to perform the contract work, (b) the number of employees required in each classification, (c) the date on which the participant estimates such employees will be required, and (d) any other pertinent information required by the State Employment Service to complete the job order form. The job order may be placed with the State Employment Service in writing or by telephone. If during the course of the contract work, the information submitted by the contractor in the original job order is substantially modified, the participant shall promptly notify the State Employment Service.

3. The contractor shall give full consideration to all qualified job applicants referred to him by the State Employment Service. The contractor is not required to grant employment to any job applicants who, in his opinion, are not qualified to perform the classification of work required.

4. If, within one week following the placing of a job order by the contractor with the State Employment Service, the State Employment Service is unable to refer any qualified job applicants to the contractor, or less than the number requested, the State Employment Service will forward a certificate to the contractor indicating the unavailability of applicants. Such certificate shall be made a part of the contractor's permanent project records. Upon receipt of this certificate, the contractor may employ persons who do not normally reside in the labor area to fill positions covered by the certificate, notwithstanding the provisions of subparagraph (1c) above.

5. The provisions of 23 CFR 633.207(e) allow the contracting agency to provide a contractual preference for the use of mineral resource materials native to the Appalachian region.

6. The contractor shall include the provisions of Sections 1 through 4 of this Attachment A in every subcontract for work which is, or reasonably may be, done as on-site work.

**NOTICE OF REQUIREMENTS FOR AFFIRMATIVE
ACTION TO ENSURE EQUAL EMPLOYMENT
OPPORTUNITY (EXECUTIVE ORDER 11246)**

1. The Offeror’s or Bidder’s attention is called to the “Equal Opportunity Clause” and the “Standard Federal Equal Employment Opportunity Construction Contract Specifications” set forth herein.

2. The goal for female participation, expressed in percentage terms for the Contractor’s aggregate workforce in each trade on all construction work, is 6.9%.

Until further notice	Goals for minority participation for each trade (percent)
----------------------	---

SHSA Cities:

Pascagoula - Moss Point -----	16.9
Biloxi - Gulfport -----	19.2
Jackson -----	30.3

SMSA Counties:

Desoto -----	32.3
Hancock, Harrison, Stone-----	19.2
Hinds, Rankin-----	30.3
Jackson -----	16.9

Non-SMSA Counties:

George, Greene-----	26.4
---------------------	------

Alcorn, Benton, Bolivar, Calhoun, Carroll, Chickasaw, Clay, Coahoma, Grenada, Itawamba, Lafayette, Lee, Leflore, Marshall, Monroe, Montgomery, Panola, Pontotoc, Prentiss, Quitman, Sunflower, Tallahatchie, Tate, Tippah, Tishomingo, Tunica, Union, Washington, Webster, Yalobusha -----	26.5
---	------

Attala, Choctaw, Claiborne, Clarke, Copiah, Covington, Franklin, Holmes, Humphreys, Issaquena, Jasper, Jefferson, Jefferson Davis, Jones Kemper, Lauderdale, Lawrence, Leake, Lincoln, Lowndes, Madison, Neshoba, Newton, Noxubee, Oktibbeha, Scott, Sharkey, Simpson, Smith, Warren, Wayne, Winston, Yazoo-----	32.0
---	------

Forrest, Lamar, Marion, Pearl River, Perry, Pike, Walthall-----	27.7
--	------

Adams, Amite, Wilkinson -----	30.4
-------------------------------	------

These goals are applicable to all the Contractor’s construction work (whether or not it is Federal or federally assisted) performed in the covered area. If the contractor performs construction work in a geographical area located outside of the covered area, it shall apply the goals established for such geographical area where the work is actually performed. With regard to this second area, the contractor also is subject to the goals for both its federally involved and nonfederally involved construction.

The Contractor’s compliance with the Executive Order and the regulations in 41 CFR Part 60-4 shall be based on its implementation of the Equal Opportunity clause, specific affirmative action obligations required by the specifications set forth in 41 CFR 60-4.3(a), and its efforts to meet the goals. The hours of minority and female employment and training must be substantially uniform throughout the length of the contract, and in each trade, and the Contractor shall make a good faith effort to employ minorities and women evenly on each of its projects. The transfer of minority or female employees or trainees from Contractor to Contractor or from project to project for the sole purpose of meeting the Contractor’s goals shall be a violation of the contract, the Executive Order and the regulations in 41 CFR Part 60-4.2(d). Compliance with the goals will be measured against the total work hours performed.

3. The Contractor shall provide written notification to the Director of the Office of Federal Contract Compliance Programs within 10 working days of award of any construction subcontract in excess of \$10,000 at any tier for construction work under the contract resulting from this solicitation. The notification shall list the name, address and telephone number of the subcontractor, employer identification number of the subcontractor, estimated dollar amount of the subcontract; estimated starting and completion dates of the subcontract; and the geographical area in which the subcontract is to be performed.

4. As used in this Notice, and in the contract resulting from this solicitation, the “covered area” is to the county and city (if any), stated in the advertisement.

5. The notification required in Paragraph 3 shall be addressed to the following:

Contract Compliance Officer
Mississippi Department of Transportation
P.O. Box 1850
Jackson, Mississippi 39215-1850

(12/04/2018)

MISSISSIPPI DEPARTMENT OF TRANSPORTATION

SPECIAL PROVISION NO. 907-101-1

CODE: (IS)

DATE: 07/20/2023

SUBJECT: Definitions and Terms

Section 101, Definitions and Terms, of the 2017 Edition of the Mississippi Standard Specifications for Road and Bridge Construction is hereby amended as follows.

907-101.01--Abbreviations. After the abbreviation API on page 1, add the following.

APL Approved Products List

Replace the abbreviation for AWPA on page 1 with the following.

AWPA American Wood Protection Association

907-101.02--Definitions. Delete the sentence after the list of holidays in Subsection 101.02 on page 6 under **holidays, legal**, and substitute the following.

When a legal holiday falls on a Saturday or Sunday, the succeeding Monday, or as proclaimed by the Governor, will be observed as a legal holiday.

Delete the definition for Notice to Proceed in Subsection 101.02 on page 8, and substitute the following.

Notice to Proceed - Written notice to the Contractor to proceed with the contract work.

Delete the definition for “Plans” in Subsection 101.02 on page 8, and substitute the following.

plans - The approved plans, profiles, typical cross-sections, working drawings and supplemental drawings, or exact reproduction thereof, that show the location, character, dimensions, and details of the work to be done. The plans may also include electronic files, referred to on the plans as Electronic Files Identified as Plans, which may include engineering models, spreadsheets, CADD files or other electronic files used to convey design intent. When the contract does not have an official set of plans, reference to the plans shall mean the contract documents.

MISSISSIPPI DEPARTMENT OF TRANSPORTATION

SPECIAL PROVISION NO. 907-102-2

CODE: (IS)

DATE: 11/22/2017

SUBJECT: **Bidding Requirements and Conditions**

Section 102, Bidding Requirements and Conditions, of the 2017 Edition of the Mississippi Standard Specifications for Road and Bridge Construction is hereby amended as follows.

907-102.01--Prequalification of Bidders. Delete the last sentence of the third paragraph of Subsection 102.01 on page 13, and substitute the following.

The Bidder's Certificate of Responsibility number must be on file with the Department's Contract Administration Division prior to request for permission to bid.

907-102.02--Contents of Proposal Forms. Delete the fourth paragraph in Subsection 102.02 on page 13, and substitute the following.

Prospective bidders must complete an online request for permission to be eligible to bid a project. Upon approval, the bidder will be authorized to submit a bid electronically using Bid Express at <http://bidx.com>.

MISSISSIPPI DEPARTMENT OF TRANSPORTATION

SPECIAL PROVISION NO. 907-104-2

CODE: (SP)

DATE: 06/17/2025

SUBJECT: Minor Alteration to the Contract

Section 104, Scope of Work, of the 2017 Edition of the Mississippi Standard Specifications for Road and Bridge Construction is hereby amended as follows:

907-104.02--Alterations of Plans or Character of Work.

907-104.02.3--Minor Alteration to the Contract. In the first paragraph of Subsection 104.02.3 on page 25, change \$10,000.00 to \$25,000.00.

MISSISSIPPI DEPARTMENT OF TRANSPORTATION

SPECIAL PROVISION NO. 907-105-2

CODE: (IS)

DATE: 07/20/2023

SUBJECT: Control of Work

Section 105, Control of Work, of the 2017 Edition of the Mississippi Standard Specifications for Road and Bridge Construction is hereby amended as follows.

907-105.01--Authority of the Engineer. Delete the first sentence of the second paragraph of Subsection 105.01 on page 31, and substitute the following.

The Engineer has the right to suspend the work wholly or in part and to withhold payments because of the Contractor's failure to correct conditions unsafe for workmen or the general public, for failure to carry out provisions of the Contract, or for failure to carry out orders.

907-105.02--Plans and Working Drawings. Delete the first paragraph of Subsection 105.02 on page 31, and substitute the following.

After the contract is executed by the Executive Director, the Contractor will receive, free of charge, two bound copies of the proposal and contract documents (one executed and one blank) two full scale copies of the plans, five half-scale copies of the Plans, and Electronic Files Identified as Plans. The Contractor shall have one copy of the proposal and contract documents and one half-scale copy of the plans available at all times during work activity on the project.

MISSISSIPPI DEPARTMENT OF TRANSPORTATION

SPECIAL PROVISION NO. 907-106-5

CODE: (IS)

DATE: 4/20/2026

SUBJECT: Control of Materials

Section 106, Control of Materials, of the 2017 Edition of the Mississippi Standard Specifications for Road and Bridge Construction is hereby amended as follows.

After Subsection 106.13 on page 47, add the following:

907-106.14--Buy America/Build America. Buy America (BABA) Materials Sourcing Requirements for Federal-Aid Projects.

The "Infrastructure Investment and Jobs Act" (the "Act"), or Bipartisan Infrastructure Law (BIL), was enacted on November 15, 2021 (See Public Law No. 117-58, Sections 70901-70953). The [Buy America, Buy America \(BABA\)](#) provisions of the Act expand the previous Buy America requirements beyond what was currently required for steel and iron products.

Articles, materials, or supplies will only be classified under one of the following categories: iron or steel products, construction materials, manufactured products, or excluded materials (as further described in subsection 907-700.01.1). An article, material, or supply shall not be considered to fall under multiple categories. The applicable classification of the article, material, or supply being permanently incorporated into a construction project will be based on the status at the time the article, material, or supply is brought to the project work site.

Any iron or steel products, construction materials, and manufactured products that are permanently incorporated into a construction project, shall be domestically manufactured and compliant with current requirements of the Act, including 2 CFR 184, 2 CFR 200.322, OMB 24-02 Memo and related requirements therein, and with the current requirements within 23 CFR 635.410.

It is the prime Contractor's responsibility to ensure all submittals and/or certifications required by the above listed [Buy America/BABA](#) provisions are submitted to the Project Engineer prior to the article, material, or supply being incorporated into the work.

[Buy America/BABA](#) provisions do not apply to temporarily used articles, materials, or supplies that:

(1) are specified to be removed at the end of the project per the contract provisions, or (2) are specified to remain in place per the contract provisions and are also documented by the Department in the contract provisions to be removed in a subsequent imminent, near-term phased project.

The following categories, as described above, require Domestic Materials Self-Certification Form (as described within Subsection 907-700.01.2) on construction projects:

Iron or Steel Products
Construction Materials
Manufactured Products.

Buy America/**BABA** provisions do not apply to excluded materials.

A non-exclusive list of items that must comply with the above listed Buy America/**BABA** requirements and require the submittal of the Buy America Domestic Materials Self-Certification Form may be viewed at www.goMDOT.com under Business Center → Engineering Standards/Guides/Manuals → Construction Materials.

The list of items referenced above is not all-inclusive. All iron or steel products, construction material, and manufactured products permanently incorporated into the project shall comply with the applicable Buy America/Build America (BABA) requirements, regardless of whether such items are specifically Identified.

MISSISSIPPI DEPARTMENT OF TRANSPORTATION

SPECIAL PROVISION NO. 907-107-2

CODE: (SP)

DATE: 01/31/2018

SUBJECT: Contractor's Erosion Control Plan

Section 107, Legal Relations and Responsibility to Public, of the 2017 Edition of the Mississippi Standard Specifications for Road and Bridge Construction is hereby amended as follows.

907-107.22--Environmental Protection.

907-107.22.1--Contractor's Erosion Control Plan (ECP). After the first sentence of the first paragraph of Subsection 107.22.1 on page 63, add the following.

The ECP shall be submitted electronically to the Project Engineer who will forward it to the appropriate MDOT Divisions.

Delete the example Narrative in Subsection 107.22.1 on page 65, and substitute the following.

EXAMPLE
MISSISSIPPI DEPARTMENT OF TRANSPORTATION
Storm Water Pollution Prevention Plan (SWPPP)
Narrative

General Permit Coverage No: MSR _____
Project Number: _____
County: _____
Route: _____

SITE INFORMATION

This project consists of grading and installing drainage structures necessary to construct approximately 6 miles of parallel lanes on SR 31 between the Hinds County Line and the Rankin County Line.

SEDIMENT AND EROSION CONTROLS

- a) **Vegetative Controls:** Clearing and grubbing areas will be minimized to comply with the buffer zones (minimum of 15 feet along the ROW lines and 5 feet along creeks) as per the contract documents. A combination of temporary and permanent grassing will be used to protect slopes as construction progresses. **Should a disturbed area be left undisturbed for 14 days or more, placement of temporary BMPs (seeding & mulching, silt fences, basins, ditch checks, slope drains, etc.) or permanent erosion control measures (seeding & mulching, riprap, paved ditch, flumes, etc.) will be initiated by the next working day after the land disturbing activities have stopped.**
- b) **Structural Controls:** Gravel construction entrance/exit will be installed near Stations 145+50, 159+50, 164+50 & 172+50. Riprap ditch checks will be constructed at Stations 144+50, 151+75, 162+00 & 166+25. The Concrete washout area will be at Stations 140+25, 152+00 & 168+50.
- c) **Housekeeping Practices:** Structural BMPs will be cleaned out when sediment reaches 1/3 to 1/2 of the height of the BMP. Maintenance and repair of equipment will be performed off-site, material wash out will occur either off-site or within designated wash out areas.
- d) **Post-Construction Control Measures:** As construction is completed, permanent vegetative growth will be established on disturbed soils to improve soil stability and provide a buffer zone for loose material. Paved ditches and flumes will be placed as specified in the ECP to reduce erosion in concentrated flow areas and rip rap will be placed as specified to dissipate flow energy and reduce flow velocity.

IMPLEMENTATION SEQUENCE

Perimeter controls will be installed first. Clearing and grubbing will be performed in 19-acre sections beginning at the BOP and temporary grassing will be installed as needed. Temporary erosion control BMPs will be installed at the drainage structures prior/during construction of the drainage structures. Grading activities will commence at the BOP and proceed towards the EOP, fill slopes will be permanently grassed in stages for fill heights that exceed 5 feet. Base materials will be installed on completed grading sections with the paving to follow.

MAINTENANCE PLAN

All erosion and sediment control practices will be checked for stability and operation following every rainfall but in no case less than once every week. Any needed repairs will be made immediately to maintain all practices as designed. Sediment basins will be cleaned out when the level of sediment reaches 2.0 feet below the top of the riser. Sediment will be removed from the front/upstream end of the BMPs when it becomes about 1/3 to 1/2 height of BMP.

Prime Contractor's Signature

Date

Printed Name

Title

MISSISSIPPI DEPARTMENT OF TRANSPORTATION

SPECIAL PROVISION NO. 907-108-4

CODE: (SP)

DATE: 10/07/2020

SUBJECT: Subletting of Contract

Section 108, Prosecution and Progress, of the 2017 Edition of the Mississippi Standard Specifications for Road and Bridge Construction is hereby amended as follows.

907-108.01--Subletting of Contract.

907-108.01.1--General. Delete the third sentence of the tenth paragraph of Subsection 108.01.1 on the bottom of page 72.

MISSISSIPPI DEPARTMENT OF TRANSPORTATION

SPECIAL PROVISION NO. 907-109-5

CODE: (IS)

DATE: 11/14/2023

SUBJECT: Measurement and Payment

Section 109, Measurement and Payment, of the 2017 Edition of the Mississippi Standard Specifications for Road and Bridge Construction is hereby amended as follows.

907-109.01--Measurement of Quantities. Delete the sixth full paragraph of Subsection 109.01 on page 88, and substitute the following.

If appropriate based on the specific circumstances of the project, the Contractor may request that material specified to be measured by the cubic yard or ton be converted to the other measure. The Contractor must submit this request to the Engineer. The Engineer will provide an approval or denial in writing. The decision is in the sole discretion of the Engineer. If approved, factors for this conversion will be determined by the District Materials Engineer and agreed to by the Contractor. The conversion of the materials along with the conversion factor will be incorporated into the Contract by supplemental agreement. The supplemental agreement must be executed before such method of measurement is used.

907-109.04--Extra Work.

907-109.04.1--Supplemental Agreement. Delete the second paragraph of Subsection 109.04.1 on page 90.

907-109.04.2--Force Account Agreement. Delete the last sentence of subparagraph (c) in Subsection 109.04.2 on page 91, and substitute the following.

An amount will be added equal to fifteen percent (15%) of the sum thereof, excluding sales tax.

Delete subparagraph (d) in Subsection 109.04.2 on pages 91 & 92, and substitute the following.

- (d) **Equipment.** Equipment used for force account work shall be of sufficient size and type necessary to perform the required work in an economic and expeditious manner. The Contractor must provide the manufacturer, make, model, year, type of fuel and other necessary information to determine proper hourly payment rates. Subject to advance approval of the Engineer, actual transportation cost for a distance of not more than 200 miles will be reimbursed for equipment not already on the project.

For equipment authorized by the Engineer for use on the force account work, the Engineer will use the equipment rental rates from the “*Rental Rate Blue Book*” as published on the Equipment Watch website www.equipmentwatch.com for the time period the force account work is authorized to determine payment to the Contractor. The maximum allowable rates

are determined as follows:

1. The hourly equipment rate will equal the FHWA total hourly rate. This rate takes into account adjustment factors for age and region.
2. The hourly estimated operating costs have been included in the FHWA total hourly rate.
3. The idle and standby rates shall be as listed in the "*Rental Rate Blue Book*" as reported by *Equipment Watch*.
4. These rates include the basic machine plus any necessary attachments.

Standby rates shall apply when equipment is not in operation and is approved by the Engineer to standby for later use to complete the work. Idle rates shall apply to equipment located on the project and the engine is burning fuel but no ground engaging or other components are actively engaged in meaningful work. In general, idle or standby rates shall apply when equipment is not in use, but will be needed again to complete the work and the cost of moving the equipment will exceed the accumulated standby cost. If the idle standby cost should exceed the equipment moving cost to or from the work site, the Contractor will be entitled to the moving cost only. Idle or standby rates will be used under the following conditions:

1. The equipment is totally dedicated to the force account work and not used intermittently on other work.
2. Idle or standby cost will be considered only after equipment has been operated on force account work.
3. The sum of idle or standby time and operating time shall not exceed eight (8) hours per day or 40 hours in a week.
4. Idle or standby payment will not apply to days not normally considered to be work days such as holidays, weekends, or days of inclement weather when no other work is taking place.

The Department will not pay for idle or standby time when equipment is inoperable, for time spent repairing equipment, or for the time elapsed after the Engineer has advised the Contractor that the equipment is no longer needed. The Department will determine if it will be more cost effective to pay standby time on approved equipment on site or for multiple mobilizations.

If equipment is needed, which is not included in the *Rental Rate Blue Book* as reported by *Equipment Watch*, the Department and Contractor will agree upon reasonable rental rates in writing before the equipment is used.

All equipment shall be subject to approval from day to day in accordance with the requirements of Subsection 108.05.

907-109.06--Partial Payment.

907-109.06.2--Advancement on Materials.

Delete the next to last paragraph of Subsection 109.06.2 on page 95, and substitute the following.

Materials for which an advanced payment has been allowed must be paid for by the Contractor within 30 days of the estimate on which the advanced payment was first allowed and proof of said payment must be verified by the supplier. If proof of payment is not furnished within the allowable 30 days, the advanced payment will be deducted on subsequent current estimates until such time that proof of payment is furnished.

907-109.07--Changes in Material Costs. After the fifth paragraph of Subsection 109.07 on page 96, change the web address to the following.

https://mdot.ms.gov/portal/current_letting

MISSISSIPPI DEPARTMENT OF TRANSPORTATION

SPECIAL PROVISION NO. 907-234-1

CODE: (SP)

DATE: 10/13/2021

SUBJECT: Silt Fence

Section 234, Silt Fence, of the 2017 Edition of the Mississippi Standard Specifications for Road and Bridge Construction is hereby amended as follows.

907-234.02--Materials. Delete the first paragraph of Subsection 234.02 on page 181, and substitute the following.

Materials used in silt fence and super silt fence may be accepted by certification per Subsection 700.05.1. Geotextile fabric, posts, staples and woven wire backing, when required, shall meet the requirements of Subsection 714.13.

907-234.05--Basis of Payment. Add the “907” prefix to the pay items listed on page 183.

MISSISSIPPI DEPARTMENT OF TRANSPORTATION

SPECIAL PROVISION NO. 907-401-4

CODE: (IS)

DATE: 03/02/2026

SUBJECT: Asphalt Pavement - General

Section 401, Asphalt Pavement - General, of the 2017 Edition of the Mississippi Standard Specifications for Road and Bridge Construction is hereby amended as follows..

907-401.02--Materials.

907-401.02.6--Standards of Acceptance.

907-401.02.6.4—Acceptance Procedure for Density.

Delete the paragraph and Lot Determination table of Subsection 401.02.6.4 and substitute the following:

Each completed lift will be accepted with respect to compaction on a lot to lot basis from density tests performed by the Department. For normal production days, every 350 tons will be considered a lot. When cores are being used for the compaction evaluation, randomly obtain one core from each lot. When the nuclear density gauge is being used for compaction evaluation, obtain two random readings from each lot and average the results. See Chapter 7 of the latest edition of MDOT's Field Manual for Asphalt Mixtures for more details. Additional tests may be required by the Engineer to determine acceptance of work appearing deficient. The Contractor shall furnish and maintain traffic control for all compaction evaluations, including coring, required in satisfying specified density requirements.

907-401.02.6.4.1 –Roadway Density.

Delete the last sentence in section 1 of Subsection 401.02.6.4.1 on page 250 and substitute the following:

For all other leveling, no density shall be required but the pavement shall be rolled to refusal densification as defined in Subsection 907-401.02.6.4.3.

907-401.02.6.4.3—Roll to Refusal Densification.

Roll to refusal densification is defined as the number of roller passes to maximize the in-place unit weight of the mixture. A density gauge shall be used to determine the number of passes to achieve the maximum in-place unit weight.

907-401.02.6.4.4—Irregular Areas.

Irregular areas are defined as a mat where an established rolling pattern cannot be obtained. Irregular areas include areas with a width of less than 8 feet or shorter than 300 feet in length, pre-leveling, wedging [less than fifty percent (50%) of width greater than minimum lift thickness], ramp pads, median crossovers, turnouts, and other areas where an established rolling pattern cannot be obtained.

907-401.02.6.8--Acceptance Procedure for Pavement Smoothness Using Mean Roughness Index (MRI). Delete the third sentence of the second paragraph of Subsection 401.02.6.8 on page 253, and substitute the following.

The surface shall be tested and corrected to a smoothness index as described herein except those locations or specific projects that are excluded from smoothness testing with an IPS.

Delete the third, fourth and fifth paragraphs of Subsection 401.02.6.8 on pages 253 & 254, and substitute the following.

The smoothness of the surface lift will be determined for traffic lanes, auxiliary lanes, climbing lane and two-way turn lanes. Areas excluded from a smoothness test with the IPS are acceleration and deceleration lanes, tapered sections, transition sections for width, shoulders, crossovers, ramps, side street returns, etc. The roadway pavement on bridge replacement projects having 1,000 feet or less of pavement on each side of the structure will be excluded from a smoothness test. Smoothness testing shall exclude 264 feet from each transverse joint that separates the pavement from a bridge deck, bridge approach slab or existing pavement not constructed under the contract. This can apply to any other exceptions including, but not limited to, railroad crossings and manholes. Segments containing a considerable number of encroachments such as intersections, manholes, curb and gutter sections, etc. may be excluded at the Engineer's discretion.

Once paving has concluded, one final smoothness measurement shall be performed for both pay adjustments and corrective action. Multiple smoothness measurements for pay adjustments and correction can still be performed at the Engineer's discretion. These measurements must be performed at the posted speed limit or 50 miles per hour (± 5 miles per hour), whichever is lower. Measurements will be made in both wheel paths of exterior and interior lanes. The wheel paths shall be designated as being located three feet (3') and nine feet (9') from centerline or longitudinal joint, respectively. Testing will also be required on sections that have been surface corrected. No smoothness testing shall be performed when there is any residual moisture on the pavement surface. Any additional testing shall meet the requirements of Subsection 907-403.03.2.

The surface lift will be accepted on a continuous interval basis for pavement smoothness. Continuous reporting is based upon all MRI values for a specified running interval. These values are averaged and presented at the midpoint of the specified running interval.

Delete the last sentence of the last paragraph of Subsection 401.02.6.8 on page 254, and substitute the following.

All tests and corrections shall be in accordance with AASHTO R 54, Accepting Pavement Ride Quality When Measured Using Inertial Profiling Systems.

Delete Subsection 401.02.6.9 on pages 254 & 255, and substitute the following.

907-401.02.6.9--Inertial Profiling System.

907-401.02.6.9.1--General. The Inertial Profiling System (IPS), furnished and operated by the Contractor under the supervision of the Engineer or the Engineer’s representative, shall be a dual-line laser on a high speed vehicle meeting the requirements of AASHTO M 328, Standard Specification for Inertial Profiler. Additionally, each IPS should be equipped with a GPS to ensure distance measurement accuracy. The profiler system and operator shall be certified at an MDOT approved regional calibration facility in accordance with AASHTO R 56, Standard Practice for Certification of Inertial Profiler Systems and AASHTO R 57, Operating Inertial Profiler Systems.

907-401.02.6.9.2--Computer Requirements. The computer measurement program must be menu driven, Windows compatible, and able to produce unfiltered profiler runs in the Pavement Profile (*.ppf) file format. The computer shall have the ability to display and print data on site for verification and shall have the ability to save and transfer data via Universal Serial Bus (USB) flash drive, which shall be provided by the Contractor.

All runs must be stored in a directory named in the following format for acceptance by the Project Engineer:

Project_County_Route

All profiler runs must be named in the following format for acceptance by the Project Engineer:

Direction_Lane_BeginStation_EndStation

In addition to manufacturers' software; the latest version of FHWA’s ProVAL software shall be installed on the IPS computer.

907-401.03--Construction Requirements.

907-401.03.1--Specific Requirements.

907-401.03.1.2--Tack Coat. Delete the fourth sentence of Subsection 401.03.1.2 and substitute the following:

A hand wand will only be allowed for applying tack coat on irregular areas as defined in Subsection 907-401.02.6.4.4 if the distributor bar is not a feasible option.

907-401.03.1.4--Density. Delete the first sentence of the first paragraph of Subsection 401.03.1.4 and substitute the following.

The lot density for all dense graded pavement lifts, except for irregular areas as defined in Subsection 907-401.02.6.4.4, shall not be less than the specified percent (92% or 93%) of the maximum density based upon AASHTO T 209 for the day's production..

Delete the third paragraph of Subsection 401.03.1.4 and substitute the following.

Irregular areas as defined in Subsection 907-401.02.6.4.4 shall be compacted to roll to refusal densification as defined in Subsection 907-401.02.6.4.3.

907-401.03.9--Material Transfer Equipment. In the third sentence of Subsection 401.03.9 on page 261, change "include:" to "include".

907-401.03.14--Shoulder Wedge. In the second sentence of the first paragraph of Subsection 401.03.14 on page 263, change "cross roads" to "crossroads".

MISSISSIPPI DEPARTMENT OF TRANSPORTATION

SPECIAL PROVISION NO. 907-403-4

CODE: (SP)

DATE: 03/19/2025

SUBJECT: Asphalt Pavements

Section 403, Asphalt Pavements, of the 2017 Edition of the Mississippi Standard Specifications for Road and Bridge Construction is hereby amended as follows:

907-403.03--Construction Requirements.

907-403.03.2--Smoothness Tolerances. In the tenth paragraph of Subsection 403.03.2 on page 283, change “Sections(s)” to “Segment(s)”.

907-403.03.2.1--Smoothness Tolerances for Mean Roughness Index (MRI). After the second paragraph of Subsection 403.03.2.1 on page 283, add the following.

For all projects, smoothness data shall be reported by two MRI methods:

1. A continuous long interval MRI report
2. A continuous 25-foot short interval MRI report

At the bottom of page 283 and top of 284 in Subsection 403.03.2.1, delete the paragraphs for Category, A, Category B, and Category C, and substitute the following.

Category A projects shall have a long interval surface MRI of not more than 60 inches per mile.

Category B projects shall have a long interval surface MRI of not more than 70 inches per mile.

Category C projects shall have the existing surface profiled at no additional cost to the State. These projects shall be measured by a long fixed interval (528-foot) surface MRI and meet the following requirements:

- A 50% improvement in MRI from the existing surface
- or
- 80 inches per mile (whichever value is higher)

Delete the first, second, and third full paragraphs on page 284, and substitute the following.

For all projects, areas of the surface lift with localized roughness greater than 160 inches per mile as determined by the continuous short interval (25’) report will be identified for correction by the Contractor.

When a project has multiple lifts, the intermediate lift shall meet the short interval requirement of 200 inches per mile. Corrective action must be taken on those segments that do not meet this requirement. No unit price adjustment will be applied on the underlying lift.

Delete the table at the bottom of page 284, and substitute the following.

Mean Roughness Index (inches / mile)	Contract Price Adjustment Percent of Asphalt Unit Bid Price
Above 20.0 Over	REMOVE AND REPLACE *
15.1 to 20.0 Over	80
10.1 to 15.0 Over	85
5.1 to 10.0 Over	90
0.1 to 5.0 Over	95
Required Surface MRI	100

* In lieu of removal and replacement, segments may be brought into compliance through corrective action at the discretion of the Project Engineer.

Delete the table and footnote at the top of page 285, and substitute the following.

Mean Roughness Index (inches/mile) Percent Improvement	Contract Price Adjustment Percent of Asphalt Unit Bid Price
Below 30.1 Percent	80 **
30.1 to 35.0 Percent	80
35.1 to 40.0 Percent	85
40.1 to 45.0 Percent	90
45.1 to 50.0 Percent	95
Above 50%	100

** Segments that show less than 30 percent improvement as well as a final surface MRI greater than 100 inches/mile will be subject to removal.

Before the last paragraph on Subsection 403.03.2.1 on page 285, add the following.

Corrective action for all categories must be taken on those segments that exceed the localized roughness or the ‘Remove and Replace’ threshold. All locations must be located and marked by the Contractor and approved by the Project Engineer before corrective action shall take place. The minimum remove and replace length will be 528 feet (0.1 mile). Additional smoothness testing shall be required on segments following corrective action and/or replacement and will be required to meet *at least* the maximum surface MRI short of ‘Remove and Replace’ tolerance.

907-403.05--Basis of Payment.

907-403.05.2--Pay Items. Add the “907” prefix to the list of pay items on page 291.

MISSISSIPPI DEPARTMENT OF TRANSPORTATION

SPECIAL PROVISION NO. 907-407-1

CODE: (SP)

DATE: 01/16/2026

SUBJECT: Tack Coat

Section 407, Tack Coat, of the 2017 Edition of the Mississippi Standard Specifications for Road and Bridge Construction is hereby amended as follows.

907-407.03—Construction Requirements.

907-407.03.3—Application of Bituminous Material.

Delete the second sentence of the first paragraph of Subsection 407.03.3 and substitute the following.

A hand wand will only be allowed for applying tack coat on irregular areas as defined in Subsection 907-401.02.6.4.4.

907-407-05-- Basis of Payment.

Add the “907” prefix to the pay item listed on page 309.

MISSISSIPPI DEPARTMENT OF TRANSPORTATION

SPECIAL PROVISION NO. 907-601-1

CODE: (IS)

DATE: 11/21/2023

SUBJECT: Structural Concrete

Section 601, Structural Concrete, of the 2017 Edition of the Mississippi Standard Specifications for Road and Bridge Construction is hereby amended as follows.

907-601.02--Materials.

907-601.02.1--General. Delete the first sentence of Subsection 601.02.1 on page 377, and substitute the following.

Materials for structural concrete and their use, care, and handling shall be in accordance with Subsection 907-804.02.

907-601.02.2--Classification of Concrete. Delete the second sentence of Subsection 601.02.2 on page 377, and substitute the following.

Classes of concrete are identified in Subsection 907-799.01.

907-601.03--Construction Requirements.

Delete Subsection 601.03.1 on page 378 and substitute the following.

907-601.03.1--Blank.

907-601.05--Basis of Payment. Delete the pay items listed at the end of Subsection 601.05, and substitute the following.

907-601-A: Class ___ Structural Concrete - per cubic yard

907-601-B: Class ___ Structural Concrete, Minor Structures - per cubic yard

MISSISSIPPI DEPARTMENT OF TRANSPORTATION

SPECIAL PROVISION NO. 907-618-11

CODE: (SP)

DATE: 03/30/2022

SUBJECT: Work Zone Law Enforcement

Pursuant to House Bill No. 580, Section 618, Maintenance of Traffic and Traffic Control Plan, of the 2017 Edition of the Mississippi Standard Specifications for Road and Bridge Construction is hereby amended as follows.

907-618.01--Description. After Subsection 618.01.4 on page 443, add the following.

907-618.01.6--Work Zone Law Enforcement. On projects that the Commission determines are on high-volume roadways or are otherwise high risk projects, the Commission may include a pay item to provide for reimbursement to the Contractor for enhanced law enforcement safety operations in the work zone.

According to House Bill No. 580, the work zone safety operations, when required by the Commission, shall consist of utilizing a uniformed law enforcement officer equipped with a patrol vehicle with blue flashing lights to enforce traffic laws and provide for an enhanced law enforcement presence in order to facilitate the safe movement of traffic through the work zone and to protect workers within the work zone.

907-618.03--Construction Requirements. After Subsection 618.03.5 on page 447, add the following.

907-618.03.7--Work Zone Law Enforcement. The utilization of work zone law enforcement shall be done at such locations and time periods deemed necessary and appropriate by the Engineer, after discussion with the Contractor. The Contractor shall be responsible for the coordination with the work zone law enforcement agency.

The Contractor shall provide a daily work record of the actual hours of work performed by the law enforcement agency and shall be accompanied by signed invoices from the law enforcement agency, which must be verified by the Engineer.

907-618.04--Method of Measurement. After the last paragraph of Subsection 618.04 on page 449, add the following.

Work zone law enforcement will be measured per hour for every hour verified by the Engineer using an invoice or other acceptable record. Measurement for payment will not be made for work zone law enforcement after expiration of contract time.

907-618.05--Basis of Payment. After the third paragraph of Subsection 618.05 on page 449, add the following.

Work zone law enforcement, measured as prescribed above, will be paid for at the fixed contract unit price per hour, which price shall be full compensation for furnishing and reimbursing work zone law enforcement.

After the last pay item listed on page 450, add the following.

907-618-M2: Work Zone Law Enforcement - per hour

MISSISSIPPI DEPARTMENT OF TRANSPORTATION

SPECIAL PROVISION NO. 907-618-12

CODE: (SP)

DATE: 05/03/2024

SUBJECT: Traffic Control Management

Section 618, Maintenance of Traffic and Traffic Control Plan, of the 2017 Edition of the Mississippi Standard Specifications for Road and Bridge Construction is hereby amended as follows.

907-618.01--Description.

907-618.01.2--Traffic Control Management. Delete subparagraph (g) of Subsection 618.01.2 on page 441, and substitute the following.

- g) Perform a minimum of once-a-week inspections from the Notice to Proceed until a Partial or Final Maintenance Release is obtained. Once work begins, daily daytime inspections and weekly nighttime inspections are required on projects with predominantly daytime work, and daily nighttime inspections and weekly daytime inspections are required on projects with predominantly nighttime work. Weekly inspections will be allowed for periods outside of active construction. When lane closures are present or any non-fixed signs or traffic handling devices such as cones or barrels are in place, inspections shall be performed daily whether work is being performed or not.

907-618.05--Basis of Payment. Delete pay item 618-A on page 449 and substitute the following.

907-618-A: Maintenance of Traffic

- lump sum

MISSISSIPPI DEPARTMENT OF TRANSPORTATION

SPECIAL PROVISION NO. 907-619-5

CODE: (IS)

DATE: 01/17/2018

SUBJECT: Traffic Control for Construction Zones

Section 619, Traffic Control for Construction Zones, of the 2017 Edition of the Mississippi Standard Specifications for Road and Bridge Construction is hereby amended as follows.

907-619.02--Materials.

907-619.02.8--Traffic Signals and Flashers. Delete Subsection 619.02.8.1 on pages 452 thru 455, and substitute the following.

907-619.02.8.1-Portable Traffic Signals. Portable traffic signals shall be trailer or pedestal mounted units that provide for easy, legal transportation and quick setup and deployment. Each unit shall be self-contained. The types of portable traffic signals are as follows.

- Type 1 portable traffic signal shall include two signal heads per trailer with one signal head mounted on an overhead mast arm that can be extended over the travel lane, and the other signal head shall be mounted on the vertical upright of the trailer.
- Type 2 portable traffic signal shall include one signal head that is mounted on the vertical upright of the pedestal/cart or trailer. Pedestal/Cart mounted shall be designated as Type 2A and Trailer mounted shall be designated as Type 2B. Type 2 portable traffic signals shall be tested to MASH Standards or NCHRP Test Level 3 crash testing requirements by an accredited independent test facility, with supporting documentation available upon request.
- Type 3 portable traffic signal shall be the same as Type 1 mentioned above but with enhanced capabilities as mentioned in each applicable section below.

The portable traffic signals shall be MUTCD Compliant and utilize standard ITE signal heads, and adhere to the ITE Specifications and Standards for Vehicle Traffic Control Signal Heads, Light Emitting Diode (LED) Circular Signal Supplement. The units shall be battery powered with a solar charging system, and be equipped with an onboard battery charger capable of being used with a 120V AC power source. Portable traffic signals shall be able to communicate with other portable signals via 900 MHz or other accepted wireless communications. If wireless connectivity is not feasible, hardwired connectivity shall be an acceptable alternative, as approved by the Engineer. Portable Traffic Signals shall include all the major components listed below or be able to perform the functions of these components. The major components of the unit shall include, but are not limited to, the trailer or pedestal/cart, telescoping mast arm (on Type 1 and 3), signal head(s) and back plates, traffic signal controller with operating software, solar charging system with batteries, input and output devices, vehicle detection, flasher units, conflict monitor, relays,

communications system and other equipment required for the safe operation and installation of the unit.

907-619.02.8.1.1--Signal Heads. The signal heads and all applicable components of the portable traffic signal shall meet the physical display and operational requirements of conventional traffic signals as specific in the Manual on Uniform Traffic Control Devices (MUTCD). The signal heads shall be cast aluminum or polycarbonate and shall meet the requirements laid out in the Mississippi Standard Specification for traffic signal heads and associated MDOT material specifications for traffic signal heads. The signal heads shall accommodate standard 12-inch LED indications meeting the ITE Specification “Vehicle Traffic Control Signal Heads” and ITE Specifications and Standards for Vehicle Traffic Control Signal Heads, Light Emitting Diode (LED) Circular Signal Supplement.

For Type 1, Type 2 and Type 3 portable traffic signals, the signal heads shall have the ability to be rotated 180 degrees to face in the opposite direction and shall have the ability to rotate and lock in approximately 10 degree increments to position the signal head for the optimum visibility to motorists.

For Type 1 portable traffic signals, each unit shall contain two signal heads with one signal head mounted on an overhead mast arm that can be extended over the travel lane with a minimum clearance of 17 feet measured from the bottom of the signal head unit to the road surface. The lower signal head shall be mounted to the vertical upright of the trailer at a minimum height of eight feet (8') from the bottom of the signal head unit to the road surface.

For Type 2 portable traffic signals, the signal head shall be mounted to the vertical upright of the trailer at a minimum height of eight feet (8') from the bottom of the signal head unit to the road surface.

For Type 3 portable traffic signals, each unit shall be the same as Type 1 mentioned above but with enhanced capabilities as mentioned below.

907-619.02.8.1.2--Controller and Operating Requirements. The portable traffic signal (Types 1, 2, and 3) shall include a solid state Controller Unit (CU) that is in compliance with NEMA TS 5 Performance Standard. The CU shall have an easy to read front panel backlit display for viewing and programming the configuration settings and CU status. The CU shall be capable of operating the portable traffic signal system in a fixed time, traffic actuated or manual control mode. Multiple portable traffic signals shall have the capability to be interconnected to form a portable traffic signal system. Each portable traffic signal within a connected system shall have the capability to serve as either the master or remote signal. Each portable traffic signal shall include a Conflict Monitor Unit (CMU), or Malfunction Management Unit (MMU) to ensure phase conflicts do not exist during operation.

For Type 1 and Type 2 portable traffic signals, a minimum of five (5) automatic time-of-day timing plans within a 24-hour period should be available in fixed time mode. The CU should have the ability to control a minimum of four (4) traffic phases with programmable cycle time adjustments and user adjustable red, amber, minimum green and maximum green times. The CU shall have

the capability of programming green and red times from 1 to 999 seconds and yellow times up to 15 seconds in one-second increments. The CU shall also have the capability of facilitating standby modes of red, red flash and yellow flash.

For Type 3 portable traffic signals, a minimum of ten (10) automatic time-of-day timing plans within a 24-hour period should be available in fixed time mode. The CU should have the ability to control a minimum of 16 traffic phases with programmable cycle time adjustments and user adjustable red, amber, minimum green and maximum green times. The CU shall have the capability of programming green and red times from 1 to 999 seconds and yellow times up to 15 seconds in one-second increments. The CU shall also have the capability of facilitating standby modes of red, red flash and yellow flash.

The system shall also have the ability to operate in vehicle actuation mode when vehicle detection components are used. The operating system shall have the capability to allow the Portable Traffic Signal to be connected to and controlled by a standard NEMA controller.

The system shall have the capability to be controlled remotely using a hardwired or wireless remote. The wireless radio remote shall be capable of communicating at a clear line of site distance up to ¼ mile from the master.

The CU shall have the capability of interfacing with a Remote Monitoring System (RMS) capable of reporting signal location, battery voltage, and system faults. The RMS shall include a password-protected web site, viewable via an internet connection. In the event of a system fault, the RMS shall provide specific information concerning the cause of the system fault (example: "red lamp on signal number 1 out"). The RMS shall immediately contact previously designated individuals via SMS text messaging or email, upon a fault event.

The active timing program operating the PTS system shall be available and viewable through the RMS website at all times. The RMS shall maintain a history of the operating system in each signal including total operating hours, alerts, and the location of the PTS trailer.

907-619.02.8.1.3--Wireless Communications. The portable traffic signals shall communicate with other portable traffic signals within the signal system via license-free wireless 900 MHZ radio link communications as specified in Subsection 662.02.2 of the radio Interconnect System specification. The radio units shall maintain communications at a minimum distance of one (1) mile. The radio system shall conform to the applicable Federal Communications Commission requirements and all applicable state and local requirements.

The portable traffic signals shall be in direct communication at all times either by wireless or hardware connection to provide for the required conflict monitoring / malfunction management system.

907-619.02.8.1.4--Power Requirements. Each Portable Traffic Signal shall be equipped with a power source consisting of a solar collection array, solar controller and/or charging unit and batteries sufficient to operate the signal system. The number and size of batteries shall be sufficient to operate the Type 1 and Type 3 signals for a minimum of 30 days and Type 2A signals for

minimum of five (5) days, and Type 2B signals for minimum of 15 days without additional charging or assist from the solar array. An on-board battery charger shall be compatible with both the solar array and with a 120V AC power source.

For Type 1 signals, the solar panel array shall provide for a minimum of 440 watts of solar collection capability.

For Type 2A signals, the solar panel array shall provide for a minimum of 90 watts of solar collection capability.

For Type 2B signals, the solar panel array shall provide for a minimum of 110 watts of solar collection capability.

For Type 3 signals, the solar panel array shall provide for a minimum of 480 watts of solar collection capability and shall include a tilt and rotate system to optimally position the panels.

All instrumentation for the electrical system and battery compartment shall be contained in a lockable weatherproof enclosure. Solar panels shall be secured to the mounting brackets for theft prevention.

907-619.02.8.1.5--Trailer and Lift System. The trailer or pedestal/cart and all mounted components shall conform to the wind loading requirements as follows: 100 mph minimum for Type 1 portable traffic signals, 55 mph minimum for Type 2A portable traffic signals, 75 mph minimum for Type 2B portable traffic signals, and 90 mph minimum for Type 3 portable traffic signals as described in the AASHTO *Standard Specifications for Highway Signs, Luminaries and Traffic Signals*, as specified in the plans including all interims and updates. At the request of the Engineer, proof of conformance to these wind load ratings shall be verified by a third-party. No additional loose ballast shall be used to meet these wind load requirements. The trailer shall be made of structural steel and shall include four (4) leveling/stabilizer jacks capable of lifting the trailer a minimum of six inches (6”).

The trailer or pedestal shall be equipped with a mechanical, hydraulic or electric lift system sufficient for one person to be able to raise and lower the vertical upright and/or horizontal mast arm to and from the operating position.

For Type 1, 2B, and Type 3 signals, the trailer shall be equipped to provide legal and safe transport on the public highway system at speeds up to 55 mph.

All exterior metal surfaces, except signal heads and back plates, shall be powder-coat painted highway safety orange.

907-619.02.9--Impact Attenuators. Delete the sentence in the first paragraph of Subsection 619.02.9 on page 455, and substitute the following.

Impact attenuators must be listed on the Department's APL.

907-619.02.11--Snap-Back Delineators. Delete the sentence in the paragraph of Subsection 619.02.11 on page 456, and substitute the following.

Snap-back delineators shall be selected from the list of surface mounted flexible delineator posts as shown on the Department's APL.

907-619.02.14--Changeable Message Sign.

907-619.02.14.5--PCMS Controller and Storage Cabinets. Delete the fifth sentence in the first paragraph of Subsection 619.02.14.5 on pages 462 and 463, and substitute the following.

The controller cabinet shall be illuminated.

907-619.05--Basis of Payment. Add the following to the list of pay items ending on page 480.

907-619-E3: Changeable Message Sign ***** - per each

907-619-H2: Traffic Signal, Portable, Type ____ - per each

MISSISSIPPI DEPARTMENT OF TRANSPORTATION

SPECIAL PROVISION NO. 907-626-12

CODE: (IS)

DATE: 06/17/2025

SUBJECT: Thermoplastic Traffic Markings

Section 626, Thermoplastic Traffic Markings, of the 2017 Edition of the Mississippi Standard Specifications for Road and Bridge Construction is hereby amended as follows.

Delete Section 626 on pages 492 thru 496, and substitute the following.

SECTION 626 - THERMOPLASTIC TRAFFIC MARKINGS

907-626.01--Description. This work consists of furnishing materials and placing thermoplastic pavement markings of the type specified in conformity with these specifications and the details shown on the plans or established. All hot-applied thermoplastic pavement markings shall be coated with a double-drop combination of optics.

This work may also consist of placing an audible bump or puck style marking system on the edge line that provides an audible and vibratory warning when driven over. The marking system shall be a road marking system of the dimensions indicated at regular and predetermined intervals.

This work may also consist of placing a profile or raised shape marking system on centerline or edge line that provides audible and vibratory warning when driven over. The marking system shall be a road marking system of the dimensions indicated and at regular and predetermined intervals. When placed on centerline, the markings system shall consist of an extruded black transverse thermoplastic bar of the dimensions indicated at regular and predetermined intervals.

This work may also consist of placing high contrast thermoplastic markings. High contrast thermoplastic markings shall consist of placing thermoplastic pavement markings over a black thermoplastic pavement marking to enhance the marking's visibility.

All pavement marking material, excluding lines over rumble strips, shall be applied using the extrusion/ribbon method. Lines placed over rumble strips shall be applied using the atomization/spray method, [unless the extrusion/ribbon method can be demonstrated to perform adequately and is approved by the Engineer.](#)

Permanent pavement marking tape (permanent cold plastic tape) may be used in lieu of hot applied thermoplastic markings. Substitution will only be allowed for pay items 907-626-A through H. Substituted pavement marking tape shall be of the same color and width as that required for the hot applied thermoplastic. Unless otherwise specified, the markings, whether hot applied or pavement marking tape, shall be of the same type of material for the entire project. Stop bars and crosswalks shall not be substituted with pavement marking tape and shall be alkyd hot-applied thermoplastic markings or heat-fused preformed pavement markings. Material and construction

requirements for substituted pavement marking tape shall meet the requirements of Special Provision 907-628. The layout and spacing for substituted pavement markings will remain as shown in the plans, or in the contract documents, for hot applied thermoplastic markings. Measurement of adhesive substituted pavement markings shall be made in accordance with Special Provision 907-628. Payment for adhesive substituted pavement markings shall be made at the unit price for the appropriate hot applied thermoplastic marking.

When thermoplastic pavement markings are used on bridge decks or concrete surfaces, the surface shall be sealed with an epoxy sealer prior to the application of thermoplastic.

907-626.02--Materials. All pavement marking materials shall meet the requirements of Special Provision 907-720.

907-626.02.1--Audible Bumps. Audible bumps shall have a profile such that the leading and trailing edges are sloped at a sufficient angle to create an audible and vibratory warning.

Audible bumps shall be at least 0.45 inches above the pavement surface at the highest point of the bump. The height shall be measured after the application of drop-on material. The bumps shall have a minimum dimension of two and one-half inches (2½") in both transverse and longitudinal directions. The bumps may have a drainage channel. The width of each drainage channel shall not exceed one-quarter of an inch (¼") at the bottom of the channel.

907-626.02.2--Audible Transverse Bars. The length of transverse bars is the measurement lateral to the direction of travel, also known as transverse width. The width of transverse bars is the measurement parallel to the travel way.

Transverse bars on centerline shall have a length of 10 inches, a width of three inches (3"), and a height of 350 mils. Transverse bars on centerline shall be placed on 2-foot centers through no-passing zones and 5-foot centers through passing zones. Transverse bars on centerline shall be placed in advance of permanent thermoplastic markings.

Transverse bars on edge lines shall have a length of six inches (6"), a width of three inches (3"), and a height of 350 mils. Transverse bars on edge lines shall be placed on 2-foot centers. Tolerance for the longitudinal and transverse measurements shall be one quarter of an inch (¼") and the tolerance for height shall be 50 mils. The above dimensions are based on 6-inch strip application.

Thermoplastic material for edge line transverse bars shall be as specified on the Plans and meet the requirements of Special Provision 907-720 or as specified on the plans. Thermoplastic material for centerline transverse bars shall be black and shall meet the requirements of Special Provision 907-720.

907-626.02.3--High Contrast Markings. High contrast markings shall be black with the pertinent marking color overlaid on top and shall meet the requirements of Special Provision 907-720.

907-626.03--Construction Requirements.

907-626.03.1--Equipment. Equipment for hot application shall be of sufficient size and stability to ensure smooth, uniform, properly aligned markings of the dimensions specified. The equipment shall be suitably equipped for heating and controlling the flow of the material. The equipment shall be constructed to provide continuous mixing and agitation of the material. The conveying parts of the equipment, between the main material reservoir and applicator, shall be so constructed as to prevent accumulation and clogging. The equipment shall be constructed so that all mixing and conveying parts, up to and including the applicator, maintain the material at the plastic temperature. The thermoplastic material shall be dispensed at a temperature recommended by the manufacturer. The applicator shall include a cutoff device remotely controlled to provide clean, square stripe ends and to provide a method for applying skip lines. The thermoplastic reservoir shall be insulated and equipped with an automatic thermostatic control to maintain the proper temperature of the material.

The application equipment shall be capable of automatic placement of intermittent and continuous line patterns in single or double line applications simultaneously. The intermittent timer mechanism shall provide a variable ratio of materials applied and variable cycle length such that accurate placement of new patterns, or replacement of existing patterns can be achieved.

The equipment shall also be capable of applying the top dressing of optics (beads) in a manner that firmly embeds them into the surface of the thermoplastic material for at least one half of the diameter of the larger gradation sizes of the optics. The dispensing equipment shall be equipped with an automatic cut-off control for the application of the optics that is synchronized with the cut-off of the thermoplastic material.

Optics applied to the surface of the completed stripe shall be applied by an automatic dispenser attached to the pavement marking equipment in such a manner that the optics are immediately dispensed upon the completed line. The dispenser shall be equipped with an automatic cutoff control, synchronized with the cutoff of the pavement marking equipment. The double-drop optics as defined in 907-720 shall be automatically applied at a uniform rate to achieve the minimum retroreflectivity requirements of 907-626.

907-626.03.2--Construction Details. The thermoplastic compound shall be screed or ribbon extruded to the pavement surface. Heat-fused, pre-formed pavement markings shall be fusible to asphalt surfaces by means of the normal heat of a propane weed-burner type of torch or other heating device as recommended by the manufacturer. Heat-fused, pre-formed pavement markings shall be instantly highly reflective without the application of additional optics.

Thermoplastic markings shall not be applied to the pavement surface when the pavement surface temperature is less than 55°F. The pavement surface shall be dry, to the satisfaction of the Engineer, before application will be permitted. Unless otherwise specified by the manufacturer, thermoplastic pavement marking material shall be applied to the surface between 400°F and 450°F with a recommended application temperature being 420°F.

Immediately before application, all areas to be marked shall be thoroughly cleaned. Cleaning may be done by rotary brooms, air blast, scrapers, or whatever combination of equipment is necessary to clean the pavement thoroughly without damage to the pavement surface. On areas of pavement

cured with compound, the membrane shall be removed completely by shot blasting, sand blasting or other approved method. Before edge striping, particular care shall be taken to remove all vegetation, loose soil, and the like from the area to be marked. Should other methods fail, the surface shall be wetted with a water jet and scrubbed as necessary to dislodge all foreign material. After washing, the surface shall be allowed to dry thoroughly, and all films of dried mud apparent after surface drying shall be removed before application of markings. Marking shall follow as closely as practicable after the surface has been cleaned and dried, but no markings shall be applied until the surface has been inspected and permission given to proceed. The cost for preparing the surface shall be included in the contract unit prices for the marking items.

Unless otherwise directed by the Engineer, traffic stripes that are conflicting with the thermoplastic stripe shall be removed prior to placement of the thermoplastic material. Removal of pavement markings shall be done by a means that will not gouge the surface of the pavement in a manner that requires patching to ensure the integrity of the pavement. Temporary paint stripe may be left in place when satisfactorily placed in the proper location. Any temporary stripe not covered shall be removed. Payment for removal of stripe, except temporary stripe, will be made under Section 202.

On newly constructed asphalt pavements, any sand, grit, or other surface contaminants shall be removed using compressed air and/or sweeping. Water blasting may be necessary to remove surface contaminants which cannot be removed by the use of compressed air and/or sweeping. This work is considered surface preparation.

The finished lines shall have well defined edges and the thickness of thermoplastic markings above the roadway surface shall be no less than 90 mils for edge lines, center lines, lane lines, barrier lines, and detail stripe including gore markings, and no less than 120 mils for crosswalks, stop lines, and railroad, word and symbol markings. The minimum thickness, as required above, will be measured in the center of the line when gauged. The minimum thickness one-half inch (1/2") from the edges shall not be less than 75% of the thickness required in the center.

Any thermoplastic traffic marking less than the required thickness shall be corrected by recapping at no additional costs to the Department. Although a thickness tolerance of 25 percent from center to edge is allowed, a consistent underrun of any amount in thickness as determined by the Engineer will not be acceptable.

The length and width of lines shall be within a tolerance of ± 3 inches and $\pm 1/8$ inch, respectively. For skip markings, the tolerance for intervals shall not exceed the line length tolerance. On curves, unsightly variations from the normal curvature will not be permitted unless specifically shown on the plans or ordered by the Engineer.

Heat-fused, pre-formed pavement markings shall be supplied with a minimum average thickness of 90 mils before application on the roadway surface.

All newly applied thermoplastic material shall be protected from traffic until the material is sufficiently dry so as not to sustain damage from vehicle tires. Any material so damaged by traffic shall be repaired, and the thermoplastic material tracked onto the pavement shall be removed and

replaced.

907-626.03.3--Reflectivity Requirements. The longitudinal pavement markings shall meet the following retroreflectivity values when measured within 10 to 30 calendar days of placement, after removing loose beads.

Table 1. Minimum Dry Retroreflectivity

Color	All Stripe without Rumble mcd/m ² /lx	Rumble Stripe mcd/m ² /lx
White	375	250
Yellow	225	150

For projects with less than two miles between the BOP and EOP, retroreflectivity measurements will not be required.

907-626.03.3.1--Measuring Devices. Retroreflectivity measurements are required to be taken using a vehicle mounted mobile retroreflectometer using 30-meter geometry with video and mapping capabilities as per AASHTO T-398. The retroreflectometer and operator shall be certified by the manufacturer, authorized representative of the manufacturer, or an MDOT approved program such as the Texas A&M Transportation Institute (TTI) Mobile Retroreflectometer Certification Program. The Contractor shall provide copies of current certifications for the operator(s) and the device(s) to the Engineer.

907-626.03.3.2--Acceptance Procedure. Averages of the mobile measurements shall be provided for every 0.1 miles unless otherwise specified or approved. Take measurements on each section of roadway for each series of markings (i.e., edge line, center skip line, each line of a double line, etc.) and for each direction of traffic flow. Measure each line in both directions for centerlines on two-way roadways (i.e., measure both double solid line in both directions and measure all center skip lines in both directions). Furnish measurements in compliance with the below requirements. Use all equipment in accordance with the manufacturer’s recommendations and directions. Inform the Engineer at least 24 hours before taking any measurements.

A marking meets the retroreflectivity requirements if:

- The combined average retroreflectivity value for a one-mile segment meets the minimum retroreflectivity values specified, and
- Within the one-mile segment, no more than three consecutive 0.1 mile intervals shall have an average retroreflectivity value below the minimum required value.

The one-mile segment will start from the beginning of the data collection and end after a mile worth of measurements have been taken; each subsequent mile of measurements will be a new segment. If the remainder is 0.5 miles or less, it shall be included in the previous mile segment, otherwise the remaining segment of greater than 0.5 mile shall be its own segment. Centerlines with 2 stripes (either solid or broken) will result in 2 miles of data for each mile segment. Each centerline stripe must be tested for compliance as a stand-alone stripe.

The Contractor may elect to restripe with a minimum of 0.060 in. (60 mils) at no cost to the Department each one-mile segment that failed to meet the minimum retroreflectivity requirements.

Measurements shall be retaken within 10 to 30 calendar days after the second application for the mile segment for that series of markings. If the markings do not meet minimum retroreflectivity after the second application, the Engineer may require removal of all existing markings, a new application as initially specified, and a repeat of the application process until minimum retroreflectivity requirements are met.

907-626.03.3.3--Mobile Retroreflectivity Data Collection. Mobile Retroreflectivity Data Collection (MRDC) shall be conducted on dry pavement only and when the ambient air temperature is greater than 40°F. Data shall be submitted to the Engineer no later than 3 working days after the day the data is collected. Submit all raw data collected in addition to all other data submitted. Provide data files in Microsoft Excel format or a format approved by the Engineer. The data file and video must contain the following information.

907-626.03.3.3.1--Data File. Data files shall be provided with the following:

- Date;
- District;
- County;
- Name of mobile retroreflectometer operator;
- Route number with reference markers or other reference information provided by the Engineer to indicate the location of beginning and end data collection points on that roadway;
- Cardinal direction;
- Line type (single solid, single broken, double solid, etc.);
- Line color;
- File name corresponding to video;
- Data for each centerline listed separately;
- Average reading taken for each 0.1-mi. interval (or interval designated by the Engineer);
- Accurate GPS coordinates (within 20 ft.) for each interval;
- Color-coding for each interval indicating passing or failing, unless otherwise directed by the Engineer (passing and failing thresholds provided by the Engineer);
- Graphical representation of the MRDC (y-axis showing retroreflectivity and x-axis showing intervals) corresponding with each data file;
- Distance in miles driven while measuring the pavement markings;
- Event codes (pre-approved by the Engineer) indicating problems with measurement;
- Upper validation threshold (may be included separately with the raw data but must be clearly identified with the data collected using that threshold).

907-626.03.3.3.2--Map. A map shall be provided in an electronic format approved by the Engineer with each MRDC submission that includes the following information:

- Date;
- District number;
- County;

- Color-coded 1-mi. intervals (or interval length designated by the Engineer) for passing and failing retroreflectivity values or retroreflectivity threshold values provided by the Engineer; and
- Percentage of passing and failing intervals, if required by the Engineer.

907-626.03.3.3.3--Video. A high-quality video file shall be provided with the following information:

- Date and corresponding data file name on label;
- District number;
- County;
- Route number with reference markers or other designated reference information to indicate the location of beginning and end collection points on that roadway; and
- Retroreflectivity values presented on the same screen with the following information:
 - Date;
 - Location;
 - Starting and ending mileage;
 - Total miles;
 - Retroreflectivity readings; and
 - Upper validation thresholds (may be included separately with the raw data but must be clearly identified with the data collected using that threshold).

907-626.03.4--Reflectivity Verification Testing. The Engineer or a third party may perform retroreflectivity verification testing on any project. At a minimum, each Contractor performing work for the Department will be verified on an annual basis. The Contractor-submitted retroreflectivity data will be compared to the verification test data to determine acceptability of the Contractor's mobile retroreflectometer data. Comparison of the data will result in one of the two scenarios below:

- Contractor's Data is Validated – If the difference between Contractor's and Engineer/third party data is 20% or less, then the Contractor's data is validated. The Contractor's data will be used for acceptance.
- Contractor's Data is not Validated – If the difference between the Contractor's and Engineer/third party data is more than 20%, then the Contractor's data is not validated. The Engineer/third party data will be used for acceptance and the Contractor will be required to take corrective action prior to additional Contractor data collection and may require re-certification of the mobile retroreflectometer.

907-626.04--Method of Measurement. Thermoplastic stripe completed in accordance with the plans and specifications will be measured by the mile or by the linear foot, as indicated, from end-to-end of individual stripes. In the case of skip lines the measurement will include skip intervals. The length used to measure centerline, lane lines, and edge stripes will be the horizontal length computed along the roadway.

Detail traffic stripe will be measured by the linear foot from end-to-end of individual stripes. Measurements will be made along the surface of each stripe and will exclude skip intervals where

strips are specified. Stripes more than six inches (6") in width will be converted to equivalent lengths of 6-inch stripe.

Hot-applied legend, which is to include railroad markings, pedestrian crosswalks, and stop lines, will be measured by the square foot or linear foot. Pay areas of individual letters and symbols will usually be shown on the plans and measured by the square foot. Transverse railroad bands, pedestrian crosswalks and stop lines will generally be measured by the linear foot, in which case, stripes more than six inches (6") in width will be converted to equivalent lengths of 6-inch widths.

Pre-formed legend which is to include railroad markings and pedestrian crosswalks will be measured and paid for by each.

The length measured for thermoplastic audible bump edge stripe will not include the permanent thermoplastic edge stripe. Permanent thermoplastic edge stripe will be measured for payment under a separate pay item.

Thermoplastic audible bar centerline skip stripe will be measured by the linear foot or mile. Measurements will be made along the surface from end-to-end of the stripe and will include skip intervals. The length used to measure audible bar centerline stripe will be the horizontal length computed along the roadway. The length measured for thermoplastic audible bar centerline skip stripe will not include the permanent centerline continuous or skip stripe. Permanent centerline continuous and skip stripe will be measured for payment under separate pay items.

Thermoplastic audible bar edge stripe will be measured by the linear foot or mile. Measurements will be made along the surface from end-to-end of the stripe. The length used to measure thermoplastic audible bar edge stripe will be the horizontal length computed along the roadway. The length measured for thermoplastic audible bar edge stripe will not include the permanent thermoplastic edge stripe. Permanent thermoplastic edge stripe will be measured for payment under a separate pay item.

907-626.05--Basis of Payment. Thermoplastic traffic markings will be paid for at the contract unit price per mile, linear foot, square foot or each as applicable. Any deductions for non-satisfactory material test results will be made after final testing has been performed.

Payment will be made under:

- 907-626-A: 6" Thermoplastic Traffic Stripe, Skip White - per linear foot or mile
- 907-626-B: 6" Thermoplastic Traffic Stripe, Continuous White - per linear foot or mile
- 907-626-C: 6" Thermoplastic Edge Stripe, Continuous White - per linear foot or mile
- 907-626-D: 6" Thermoplastic Traffic Stripe, Skip Yellow - per linear foot or mile
- 907-626-E: 6" Thermoplastic Traffic Stripe, Continuous Yellow - per linear foot or mile

907-626-F:	6" Thermoplastic Edge Stripe, Continuous Yellow	- per linear foot or mile
907-626-G:	Thermoplastic Detail Stripe, Color *	- per linear foot
907-626-H:	Thermoplastic Legend, Color *	- per linear foot, square foot, or per each
907-626-Q:	Thermoplastic Audible Bump Edge Stripe	-per linear foot or mile
907-626-R:	Thermoplastic Detail Audible *** Stripe, Color **,	-per mile
907-626-AA:	6" High Contrast Thermoplastic Traffic Stripe, Skip White	- per linear foot or mile
907-626-BB:	6" High Contrast Thermoplastic Traffic Stripe, Continuous White	- per linear foot or mile
907-626-CC:	6" High Contrast Thermoplastic Edge Stripe, Continuous White	- per linear foot or mile
907-626-DD:	6" High Contrast Thermoplastic Traffic Stripe, Skip Yellow	- per linear foot or mile
907-626-EE:	6" High Contrast Thermoplastic Traffic Stripe, Continuous Yellow	- per linear foot or mile
907-626-FF:	6" High Contrast Thermoplastic Edge Stripe, Continuous Yellow	- per linear foot or mile
907-626-GG:	High Contrast Thermoplastic Detail Stripe, Color *	- per linear foot
907-626-HH:	High Contrast Thermoplastic Legend, Color *	- per linear foot, square foot, or each

- * Indicate Blue - ADA if applicable
- ** Indicate White or Black
- *** Indicate Centerline - Passing Zone, Centerline - No-Passing Zone, or Edge Line

MISSISSIPPI DEPARTMENT OF TRANSPORTATION

SPECIAL PROVISION NO. 907-627-1

CODE: (IS)

DATE: 06/24/2024

SUBJECT: Raised Pavement Markers

Section 627, Raised Pavement Markers, of the 2017 Edition of the Mississippi Standard Specifications for Road and Bridge Construction is hereby amended as follows:

Delete Subsection 627.02 on page 496, and substitute the following.

907-627.02--Materials. Pavement and jiggle markers of the types specified shall conform to the applicable requirements of Subsection 907-720.06 and shall be listed on the Department's APL.

Type B through G High Performance reflective markers shall be listed on the Department's APL for high performance raised pavement markers.

The bituminous adhesive for pavement markers shall meet the requirements of Subsection 907-720.07.3.

907-627.05--Basis of Payment. Add the "907" prefix to the pay items listed on page 498.

MISSISSIPPI DEPARTMENT OF TRANSPORTATION

SPECIAL PROVISION NO. 907-700-3

CODE: (IS)

DATE: 4/20/2026

SUBJECT: **Materials and Tests**

Section 700, Materials and Tests, of the 2017 Edition of the Mississippi Standard Specifications for Road and Bridge Construction is hereby amended as follows.

Delete fourth, fifth, sixth, and seventh paragraph of Subsection 700.01 on page 713, and add the following.

907-700.01.1--Buy America/Build America. Buy America (BABA) Requirements.

Iron or Steel Products. Iron or steel or wire products (including prestressed cables and strands) are products that consist wholly or predominantly of iron or steel or a combination of both.

Predominantly of iron or steel or a combination of both means that the cost of the iron and steel content exceeds 50 percent of the total cost of all components. The cost of iron and steel is the cost of the iron or steel mill products (such as bar, billet, slab, wire, plate, or sheet), castings, or forgings utilized in the manufacture of the product and a good faith estimate of the cost of the iron and steel components.

Iron or steel or wire products, as described above, that are permanently incorporated into a construction project must be produced domestically. All manufacturing processes for iron or steel or wire products, from the initial melting stage through the application of coatings, that are permanently incorporated into a construction project, must occur domestically. However, pig iron and processed, pelletized, and reduced iron ore manufactured outside of the United States may be used in the domestic manufacturing process for iron and/or steel and/or wire products. Coating includes all processes that protect or enhance the value of the material to which the coating is applied.

Construction Materials. Construction materials are articles, materials, or supplies that consist of only one of the items listed (non-ferrous metals, plastic and polymer-based products, glass, fiber-optic cables (including drop cables), optical fibers, lumber, drywall, and engineered woods). Minor additions of articles, materials, supplies, or binding agents to a construction material do not change the categorization of the construction material. All manufacturing processes for the listed construction materials, from the initial processes as described within 2 CFR 184.6 to the final processes as described within 2 CFR 184.6, that are permanently incorporated into a construction project, must occur domestically.

Manufactured Products. Manufactured products are articles, materials, or supplies that have been processed into a specific form or shape; or when combined with other articles, materials, or supplies create a product with different properties than the individual articles, materials, or supplies. An item that is classified as an iron or steel product, a construction material, or an excluded material is not a manufactured product. However, an article, material, or supply classified as a manufactured product

may include components that are iron or steel products, excluded materials, or other product categories as specified by law or in [2 CFR part 184](#). Mixtures of excluded materials delivered to a work site without final form for incorporation into a project are not a manufactured product. For construction projects obligated on or after October 1, 2025, the manufactured product must be manufactured domestically. For construction projects obligated on or after October 1, 2026, the manufactured product must be manufactured domestically and the cost of the components of the manufactured product that are mined, produced, or manufactured domestically is greater than 55 percent of the total cost of all components of the manufactured product.

Excluded Materials. Excluded materials, as listed in Section 70917(c) of the Build America, Buy America (**BABA**) Act, are cement and cementitious materials; aggregates such as stone, sand, or gravel; or aggregate binding agents or additives. However, an article, material, or supply classified as a manufactured product may include components that are iron or steel products, excluded materials, or other product categories as specified by law or in 2 CFR part 184. Mixtures of excluded materials delivered to a work site without final form for incorporation into a project are not a manufactured product.

Domestically shall be understood to mean all States of the United States, District of Columbia, Puerto Rico, American Samoa, Guam, and Virgin Islands and any other place subject to the jurisdiction of the United States.

907-700.01.2—Certificate of Compliance Requirements. Prior to incorporation into the work, the Contractor shall furnish the Project Engineer with a Domestic Materials Self-Certification Form documenting conformance to the requirements of Subsection 907-106.14. Attached hereto is the Domestic Materials Self-Certification Form that shall be furnished by the Contractor to the Project Engineer.

Domestic Materials Self-Certification Form

This certification is for a manufacturer/supplier to certify the below articles, materials, or supplies are in compliance with the applicable domestic material content procurement preferences found in the Buy America Act requirements (23 CFR 635.410) and the Build America, Buy America Act (BABA) requirements (2 CFR part 184). The individual completing this form takes full responsibility for the information included in the form. State agencies have the authority to request additional details related to the information provided in the form. All forms shall be submitted via AASHTO DataMine for delivery to authorized governmental users through the Industry Document Repository. The manufacturer/supplier is required to include updates to process changes within 10 days of the change occurring via uploading a revised form into DataMine.

PART 1: COMPANY CONTACT INFORMATION

Company/Producer/Manufacturer Name:

Supplier Representative Name:

Contact Email Address:

Contact Phone Number:

Date Form is Being Submitted: mm/dd/yyyy

PART 2: DETAILS OF THE ARTICLE, MATERIAL, OR SUPPLY:

Using Table 1 below, provide the classification of the article, material, or supply as one of the following: (1) iron or steel product; (2) construction material (3) manufactured product; or (4) excluded materials including Section 70917(c) materials.

Classification	
Producer of the Article, Material, or Supply:	
Product/Model/Part/Material:	
Manufacturing Address:	
Manufacturing City:	
Manufacturing State:	
Manufacturing Zip Code:	
DataMine # (if applicable):	
Federal/State/Local Project number(s):	
Pay Code Number (PCN):	
Project Item code:	
Project Item Description:	
Quantity Certified:	

TABLE 1: Material Classifications

(1) Iron or Steel Product	
Wholly or predominantly Iron or Steel, or a combination of both (23 CFR 635.410(b)(1)(ii))	Certification requires predominantly of iron or steel or a combination of both means that the cost of the iron and steel content exceeds 50 percent of the total cost of all its components. The cost of iron and steel is the cost of the iron or steel mill products (such as bar, billet, slab, wire, plate, or sheet), castings, or forgings utilized in the manufacture of the product and a good faith estimate of the cost of iron or steel components.
(2) Construction Material	
Non-Ferrous Metals (2 CFR 184.6(a)(1))	Certification requires all manufacturing processes, from initial smelting or melting through final shaping, coating, and assembly, occurred in the United States.
Plastic and Polymer based products (including polyvinyl chloride, composite building materials, and polymers used in fiber optic cables) (2 CFR 184.6(a)(2))	Certification requires all manufacturing processes, from initial combination of constituent plastic or polymer-based inputs, or where applicable, constituent composite materials, until the item is in its final form, occurred in the United States.
Glass (including optic glass) (2 CFR 184.6(a)(3))	Certification requires all manufacturing processes, from initial batching and melting of raw materials through annealing, cooling, and cutting, occurred in the United States.
Fiber Optic Cable (including drop cable) (2 CFR 184.6(a)(4))	Certification requires all manufacturing processes, from the initial ribboning (if applicable), through buffering, fiber stranding and jacking, occurred in the United States. All manufacturing processes also include the standards for glass and optical fiber, but not for non-ferrous metals, plastics and polymer-based products, or any others.
Optical Fiber (2 CFR 184.6(a)(5))	Certification requires all manufacturing processes, from the initial preform fabrication stage through the completion of the draw, occurred in the United States
Lumber (2 CFR 184.6(a)(6))	Certification requires all manufacturing processes, from initial debarking through treatment and planing, occurred in the United States.
Drywall (2 CFR 184.6(a)(7))	Certification requires all manufacturing processes, from initial blending of mined or synthetic gypsum plaster and additives through cutting and drying of sandwiched panels, occurred in the United States.
Engineered Wood (2 CFR 184.6(a)(8))	Certification requires all manufacturing processes, from initial combination of constituent materials until the wood product is in its final form, occurred in the United States.
(3) Manufactured Product	
Manufactured Products other than Precast Concrete Products and Intelligent Transportation Systems and Other Electronic Hardware Systems Installed on the Highway ROW or Other Real Property (23 CFR 635.410(c)(1)(vii)) and 23 CFR 635.410(c)(1)(iv)	<ul style="list-style-type: none"> • Certification requires for projects obligated before October 1, 2025, no certification is required (excludes EV chargers). • Certification requires for projects obligated on or after October 1, 2025, certification requires the final manufacturing process occurred in the United States (excludes EV chargers). • Certification requires for projects obligated on or after October 1, 2026, and all EV chargers, certification requires the final manufacturing process occurred in the United States and the cost of the components that are mined,

	produced, or manufactured in the United States is greater than 55 percent of the total cost of all components of the manufactured product.
Precast Concrete Products (23 CFR 635.410(c)(2)(i))	Classified as a manufactured product must comply with both the wholly or predominantly iron or steel or a combination of both product and manufactured product certification requirements as stated above.
Intelligent Transportation Systems and Other Electronic Hardware Systems Installed on the Highway ROW or Other Real Property (23 CFR 635.410(c)(2)(ii))	Classified as a manufactured product must comply with both the wholly or predominantly iron or steel or a combination of both product certification requirements for any iron or steel enclosures as well as the manufacturing certification requirements as stated above.
(4) Excluded Materials	
Excluded Materials Including Section 70917(c) Materials (23 CFR 635.410(c)(1)(ii))	No certification is required for excluded materials including Section 70917(c) materials. Section 70917(c) materials means cement and cementitious materials; aggregates such as stone, sand, or gravel; or aggregate binding agents or additives.

PART 3: DECLARATION OF SUBMITTAL

Do the articles, materials, or supplies submitted in this form comply with applicable domestic materials content procurement preferences found in the Buy America Act requirements (23 CFR 635.410) and the Build America, Buy America Act requirements (2 CFR part 184) (Y/N)? _____

PART 4: CERTIFICATION (Read and check all boxes before signing)

Note: State Departments of Transportation may have different language requirements for this section.

- I certify that the description above is a true and accurate description of the article, material, or supply provided, and that the undersigned is in a position to legally bind the Company/Organization represented in this form.
- I certify that the iron or steel product, construction material, or manufactured product complies with the applicable Buy America or BABA requirements.

Signature: _____ Date: mm/dd/yyyy

Printed Name:
Title:
Company/Organization:
Company/Organization address:

MISSISSIPPI DEPARTMENT OF TRANSPORTATION

SUPPLEMENT TO SPECIAL PROVISION NO. 907-701-4

DATE: 11/05/2024

SUBJECT: Hydraulic Cement

907-701.04--Blended Hydraulic Cement.

907-701.04.1--Types of Blended Hydraulic Cement. After the last paragraph of Subsection 907-701.04.1 on page 1, add the following.

Blended cement Types IL meeting the “HE” high early strength requirement listed in AASHTO M 240, Table 3 shall have the “(HE)” suffix added to the type designation.

MISSISSIPPI DEPARTMENT OF TRANSPORTATION

SPECIAL PROVISION NO. 907-701-4

CODE: (IS)

DATE: 11/21/2023

SUBJECT: Hydraulic Cement

Section 701, Hydraulic Cement, of the 2017 Edition of the Mississippi Standard Specifications for Road and Bridge Construction is hereby amended as follows.

907-701.01--General. In the first sentence of the second paragraph of Subsection 701.01 on page 718, change “mills” to “plants.”

In the second sentence of the sixth paragraph of Subsection 701.01 on pages 718 and 719, change “shall” to “will.”

907-701.02--Portland Cement.

907-701.02.1--General. Delete Subsections 701.02.1.1, 701.02.1.2, 701.02.2, 701.02.2.1, and 701.02.2.2 on pages 719 and 720, and substitute the following.

907-701.02.1.1--Types of Portland Cement. Portland cement shall be either Type I, Type II, or Type III conforming to AASHTO M85 or Type III (MS). Type III (MS) is defined as a Type III cement conforming to AASHTO M85 having a maximum tricalcium aluminate (C₃A) content of 8%.

907-701.02.2--Blank.

907-701.02.2.1--Blank.

907-701.02.2.2--Blank.

Delete Subsection 701.04 on pages 720 and 721, and substitute the following.

907-701.04--Blended Hydraulic Cement.

907-701.04.1--Types of Blended Hydraulic Cement. Blended hydraulic cements (blended cements) shall be of the following types and conform to AASHTO M 240:

- Type IL – Portland-limestone cement
- Type IP – Portland-pozzolan cement
- Type IS – Portland blast-furnace slag cement

Blended cement Types IL, IP, and IS meeting the “MS” sulfate resistance requirement listed in AASHTO M 240, Table 3 shall have the “(MS)” suffix added to the type designation.

MISSISSIPPI DEPARTMENT OF TRANSPORTATION

SPECIAL PROVISION NO. 907-702-4

CODE: (IS)

DATE: 09/11/2018

SUBJECT: Bituminous Materials

Section 702, Bituminous Materials, of the 2017 Edition of the Mississippi Standard Specifications for Road and Bridge Construction is hereby amended as follows.

907-702.04--Sampling. Delete the sentence in Subsection 702.04 on page 722, and substitute the following.

Sampling of bituminous materials shall be as set out in AASHTO R 66.

907-702.07--Emulsified Asphalt. Delete the last sentence in Subsection 702.07 on page 724, and substitute the following.

Asphalt for fog seal shall conform to the requirements of Subsection 907-702.12, Table V.

907-702.12--Tables. Delete Table V in Subsection 702.12 on page 729, and substitute the following.

**TABLE V
SPECIFICATION FOR FOG SEAL**

Test Requirements	LD-7		CHPF-1		Test Method
	Min.	Max.	Min.	Max.	
Viscosity, Saybolt Furol, @ 25°C, Sec.	10	100	-	100	AASHTO T 72
Storage Stability Test, 24 hr, %	-	1	-	1	AASHTO T 59
Settlement, 5 day, %	-	5	-	-	AASHTO T 59
Oil Distillate, %	-	1	-	-	AASHTO T 59
Sieve Test, % *	-	0.3	-	0.1	AASHTO T 59
Residue by Distillation, %	40	-	40	-	AASHTO T 59
Test on Residue from Distillation					
Penetration @ 25°C, 100g, 5 sec	-	20	40	90	AASHTO T 49
Softening Point, °C	65	-	-	-	ASTM D 36
Solubility in trichloroethylene, %	97.5	-	-	-	AASHTO T 44
Elastic Recovery @ 25°C, %	-	-	40	-	AASHTO T 301
Original DSR @ 82° (G*/Sinδ, 10 rad/sec)	1	-	-	-	AASHTO T 111

* The Sieve Test result is tested for reporting purposes only and may be waived if no application problems are present in the field.

MISSISSIPPI DEPARTMENT OF TRANSPORTATION

SPECIAL PROVISION NO. 907-703-2

CODE: (SP)

DATE: 11/29/2022

SUBJECT: Gradation

Section 703, Aggregates, of the 2017 Edition of the Mississippi Standard Specifications for Road and Bridge Construction is hereby amended as follows.

907-703.03--Coarse Aggregates for Hydraulic Cement Concrete.

907-703.03.2--Detail Requirements.

907-703.03.2.4--Gradation. In the table in Subsection 703.03.2.4 on page 734, add 100 for the percent passing by weight on the 1½-inch sieve for Size No. 67 aggregates.

Delete Note 2 under the table in Subsection 703.03.2.4 on page 734, and substitute the following.

Note ² – 100 percent shall pass the 1-inch sieve for Size 67 used in Class F and Class FX concrete.

MISSISSIPPI DEPARTMENT OF TRANSPORTATION

SPECIAL PROVISION NO. 907-705-1

CODE: (IS)

DATE: 06/13/2018

SUBJECT: Stone Riprap

Section 705, Stone Blanket Protection and Filter Blanket Materials, of the 2017 Edition of the Mississippi Standard Specifications for Road and Bridge Construction is hereby amended as follows.

907-705.04--Stone Riprap. Delete the last sentence of the first paragraph of Subsection 705.04 on page 750, and substitute the following.

Quality requirements for rock to be furnished under these specifications will come from a pre-approved source and be visually approved prior to use.

MISSISSIPPI DEPARTMENT OF TRANSPORTATION

SPECIAL PROVISION NO. 907-707-3

CODE: (IS)

DATE: 10/27/2021

SUBJECT: Joint Materials

Section 707, Joint Materials, of the 2017 Edition of the Mississippi Standard Specifications for Road and Bridge Construction is hereby amended as follows.

907-707.02--Joint Filler.

907-707.02.2--Preformed Sponge, Rubber, Cork and Closed-Cell Polypropylene Foam Joint Fillers for concrete Paving and Structural Constructions. Delete the two paragraphs of Subsection 707.02.2 on page 755, and substitute the following.

Preformed joint filler shall conform to AASHTO M 153 for sponge, rubber, and cork and tested according to ASTM D545. The type required will be indicated on the plans.

Closed-cell polypropylene foam shall conform to the requirements in ASTM D8139 and tested in accordance with ASTM D545.

907-707.02.3--Wood. Delete paragraph (b) of Subsection 707.02.3 on page 755, and substitute the following:

- (b) Dimensions shall be as shown on the plans. Dimensions shown on the plans are “dressed” sizes in accordance with Table 3 of the American Softwood Lumber Standard, SP-20. At the discretion of the Engineer, a 3/4-inch dressed board may be used in lieu of a 1-inch dressed board. A tolerance of plus or minus 1/16 inch thickness and plus or minus 1/8 inch width will be permitted. For slip-form paving a tolerance of minus 1/4 inch on each end in length will be permitted.

907-707.06--Flexible Plastic Gasket for Joining Conduit. Delete the third paragraph of Subsection 707.06 on page 756, and substitute the following.

The Department may require the performance test described in ASTM C 990.

MISSISSIPPI DEPARTMENT OF TRANSPORTATION

SPECIAL PROVISION NO. 907-711-2

CODE: (IS)

DATE: 09/11/2018

SUBJECT: Plain Steel Wire

Section 711, Reinforcement and Wire Rope, of the 2017 Edition of the Mississippi Standard Specifications for Road and Bridge Construction is hereby amended as follows.

907-711.02--Deformed and Plain Carbon-Steel Bars for Concrete Reinforcing.

907-711.02.3--Steel Welded and Non-Welded Wire Reinforcement, Plain and Deformed, for Concrete.

907-711.02.3.1--Plain Steel Wire. Delete the sentence in Subsection 711.02.3.1 on pages 780 and 781, and substitute the following.

Plain steel wire and plain steel welded wire shall conform to the requirements of AASHTO M 336.

MISSISSIPPI DEPARTMENT OF TRANSPORTATION

SPECIAL PROVISION NO. 907-712-1

CODE: (SP)

DATE: 12/07/2021

SUBJECT: Fence and Guardrail

Section 712, Fence and Guardrail, of the 2017 Edition of the Mississippi Standard Specifications for Road and Bridge Construction is hereby amended as follows.

907-712.01--General. After the sentence in Subsection 712.01 on page 785, add the following.

All materials' inspection, testing, and certification will be performed in accordance with the requirements of the current version of the Department's *Materials Division Inspection, Testing, and Certification Manual*.

Delete Subsections 712.02 and 712.03 on page 785, and substitute the following.

907-712.02--Barbed Wire. Barbed wire shall conform to the requirements of AASHTO M 280. In the coastal counties of Hancock, Harrison, and Jackson, either Coating Type Z Class 3 or Coating Type A shall be furnished. In all other areas of the State, either Coating Type Z Class 1, Coating Type Z Class 3, Coating Type ZA Class 60, or Coating Type A shall be furnished.

907-712.03--Metallic-Coated, Steel Woven Wire Fence Fabric. Woven wire fencing (i.e., "hog wire") shall conform to the requirements of AASHTO M 279. In the coastal counties of Hancock, Harrison, and Jackson, either Coating Type Z Class 3 or Coating Type A shall be furnished. In all other areas of the State, either Coating Type Z Class 1, Coating Type Z Class 3, Coating Type ZA Class 60, or Coating Type A shall be furnished.

907-712.04--Chain Link Fence. Delete Subsections 712.04.1 thru 712.04.7 on pages 785 & 786, and substitute the following.

907-712.04.1--Fabric. In the coastal counties of Hancock, Harrison, and Jackson, either Type I Class D, Type II, Type III, or Type IV fabrics shall be furnished. In all other areas of the State, either Type I Class C, Type I Class D, Type II, Type III, or Type IV fabrics shall be furnished.

907-712.04.2--Tie Wire. Tie wire shall be of the same material as the fencing wire being used, shall be of good commercial quality, and shall meet the requirements of AASHTO M 181. Either Type I, Type II, Type III, or Type IV tie wire shall be furnished.

907-712.04.3--Tension Wire. Tension wire shall be of the same material as the fencing wire being used, shall be of good commercial quality, and shall meet the requirements of AASHTO M 181. In the coastal counties of Hancock, Harrison, and Jackson, either Type I Class 3, Type II, Type III, or Type IV tension shall be furnished. In all other areas of the State, either Type II, Type III, Type IV, or Type I Classes 1, 2, or 3 tension wires shall be furnished.

907-712.04.4--Posts Rails, Gate Frames, and Expansion Sleeves. Posts, rails, gate frames, and expansion sleeves shall conform to the requirements for posts in Subsection 712.05.2, unless otherwise designated in the contract.

907-712.04.5--Miscellaneous Fittings and Hardware. Miscellaneous fittings and hardware shall conform to the requirements of Subsection 712.16.

907-712.05--Fence Posts and Braces.

907-712.05.1--Treated Timber Posts and Braces.

907-712.05.1.1--General. Delete the third, fourth, fifth, and sixth paragraphs of Subsection 712.05.1.1 on page 787, and substitute the following.

All wood posts and braces shall be treated in accordance with Subsections 718.03 and 718.04.

907-712.05.1.2--Round Posts. Delete the last sentence of the last paragraph of Subsection 712.05.1.2 on page 788.

907-712.05.1.3--Sawed Posts. Delete the last sentence of the paragraph of Subsection 712.05.1.3 on page 788.

907-712.05.1.4--Sawed Braces. Delete the last sentence of the paragraph of Subsection 712.05.1.4 on page 788.

Delete Subsection 712.05.2 on page 788, and substitute the following.

907-712.05.2--Metal Posts.

907-712.05.2.1--Round Steel Pipe. Round steel pipe shall meet the requirements of AASHTO M 181, either Grade 1 (i.e., meeting the requirements in ASTM F 1083) or Grade 2 (i.e., meeting the requirements of ASTM F 1043).

Round steel pipe shall be sized in accordance with NPS (nominal pipe size) designations as shown on Plans, and not according to the outer or inner pipe diameter.

907-712.05.2.2--Steel Fence Post and Assemblies, Hot-Wrought. Steel posts with the following section shapes, Tee, channel or U, and Y-Bar shall meet the requirements of AASHTO M 281, galvanized in accordance with the requirements of AASHTO M 111, unless otherwise specified in the contract. Acceptance of these steel posts shall be by certification from the manufacturer, producer, supplier, or fabricator, as applicable.

907-712.05.2.3--Blank.

907-712.05.2.4--Steel H-Beam Posts. Steel H-Beam posts shall be produced from structural quality weldable steel having a minimum yield strength of 45,000 psi and shall be galvanized in accordance with ASTM A 123. Steel H-Beam line posts shall be 2.250 inches by 1.625 inches and shall weigh 3.43 pounds per foot. A tolerance of plus or minus 5.0 percent is allowed for

weight per foot. A tolerance of plus or minus 1.0 percent is allowed for dimensions.

907-712.05.2.5--Aluminum-Alloy Posts and Assemblies. Round aluminum-alloy posts shall meet the requirements of ASTM B 241, Alloy 6061, T6. Aluminum-Alloy H-Beam posts shall meet the requirements of ASTM B 221, Alloy 6061, T6.

907-712.05.2.6--Formed Steel Section Posts. Formed steel section posts, "C" sections, shall be formed from sheet steel conforming to ASTM A 1011, Grade 45, and shall be galvanized in accordance with ASTM A 123.

907-712.06--Guard and Guardrail Posts.

907-712.06.2--Treated Wood Posts.

907-712.06.2.1--Square Posts. Delete the paragraph in Subsection 712.06.2.1 on page 789, and substitute the following.

All square posts shall be inspected for conformance with Section 712.05, except that the posts may be rough and shall be within $\pm 3/8$ " of the dimensions shown on the plans.

907-712.06.2.2--Round Posts. Delete the paragraph in Subsection 712.06.2.2 on page 789, and substitute the following.

All round posts shall be inspected for conformance with Section 712.05, except that the posts shall be of the shape and dimensions shown on the plans.

907-712.06.5--Treated Wood Blocks for Use with Metal Guardrail Posts. Delete the paragraphs of Subsection 712.06.5 on pages 789 & 790, and substitute the following.

Treated wood blocks for use with metal guardrail posts shall be within $\pm 3/8$ " of the size and dimensions shown on the plans, except that a minus tolerance shall not be allowed for the slotted width in which the metal post must fit.

Delete Subsection 712.16 on page 791, and substitute the following.

907-712.16--Hardware. All ferrous metal hardware for fencing such as bolts, nuts, washers, and metal straps shall be as specified on the plans and galvanizing shall not be less than 1.0 ounce per square foot of uncoated area. Aluminum coated hardware shall be coated with aluminum meeting the requirements of AASHTO M 181 for aluminum coating and at the rate of not less than 0.4 ounces per square foot of uncoated area.

Aluminum alloy hardware shall conform to the requirements of ASTM B 221 for extruded aluminum alloy 6063, T6. The finished members shall be of uniform quality.

Aluminum-zinc coated hardware shall be coated with an aluminum-zinc alloy meeting the chemical requirements and weight of coating specified for aluminum-zinc alloy coated metal gates.

MISSISSIPPI DEPARTMENT OF TRANSPORTATION

SPECIAL PROVISION NO. 907-714-4

CODE: (SP)

DATE: 07/28/2025

SUBJECT: Miscellaneous Materials

Section 714, Miscellaneous Materials, of the 2017 Edition of the Mississippi Standard Specifications for Road and Bridge Construction is hereby amended as follows.

907-714.01--Water.

907-714.01.1--General. Delete the last sentence of the second paragraph in Subsection 714.01.1 on page 794.

907-714.01.2--Water for Use in Concrete. Delete Subsection 714.01.2 on page 794, and substitute the following:

Water from municipal sources is permitted be used as mixing water in concrete, mortar, and grout without Department testing. Water from non-municipal water sources used in mixing of concrete, mortar, and grout which does not meet the requirements in Subsection 714.01.1 shall be tested for conformance as required in AASHTO M157, Table 1 and Table 2.

907-714.01.3--Water for Use in Chemically Stabilized Based. Delete the first sentence of first paragraph in Subsection 714.01.3 on page 794, and substitute the following:

Water used in the construction of bases that contain cement, lime, or other chemical additive shall be as set out in Subsection 714.01.1. Water from municipal sources is permitted to be used without testing for conformance to the requirements below. If water is not from a municipal source, it shall not contain impurities in excess of the following limits:

Delete Subsection 714.01.6 on page 795, and substitute the following.

907-714.01.6--Blank.

907-714.05--Fly Ash.

907-714.05.1--General. Delete the first sentence of the fifth paragraph in Subsection 714.05.1 on page 797.

Delete Subsection 714.06 on page 798, and substitute the following.

907-714.06--Slag Cement.

907-714.06.1--General. The slag cement source must be approved for listing in the Department's

APL prior to use. The acceptance of slag cement shall be based on certified test reports, certification of shipment from the supplier, and tests performed on samples obtained after delivery in accordance with the Department's *Materials Division Inspection, Testing, and Certification Manual* and Department SOP.

The Contractor shall provide suitable means for storing and protecting the slag cement against dampness and contamination. Separate storage silos, bins, or containers shall be provided for slag cement. Slag cement that is partially set, caked or contains lumps shall not be used.

The State Materials Engineer shall be notified in writing of the nature, amount and identity of any processing or other additions made to the slag cement during production.

Slag cement from different mills shall not be mixed or used alternately in any one class of construction or structure without written permission from the Engineer; except that this requirement will not be applicable to cement treatment of design soils or bases.

No additional cementitious materials, such as blended hydraulic cement, fly ash, metakaolin, or others, shall be added to or as a replacement for hydraulic cement when used with slag cement in the production of concrete. The replacement of hydraulic cement with slag cement shall be in accordance with the applicable replacement content specified in Subsection 701.02.2.

907-714.06.2--Specific Requirements. Slag cement shall meet the requirements of AASHTO M 302, Grade 100 or 120. Slag cement shall contain no chlorides.

907-714.13--Geotextiles.

907-714.13.11--Tables. Delete Table 1 in Subsection 714.13.11 on page 813, and substitute the following.

Table 1 - Geotextiles

Type Designation	I ¹	II ¹	III	IV	V	VI		VII		VIII	IX
	Sediment Control		Drainage	Paving	Separation & Drainage	Separation, Stabilization & Reinforcement		Woven	Non-Woven	High Strength	Test Method
Grab Strength (lb)	50	90	110	90	200	280	180	450	280	----	ASTM D 4632
Elongation (%)	----	50% max @ 45 lb	20% min	50% min @ break	50% min	50% max	50% Min	50% max	50% Min	----	ASTM D 4632
Seam Strength (lb)	----	----	70	----	180	240	160	400	240	----	ASTM D 4632
Puncture Strength (lb)	----	----	40	----	80	110	75	180	115	----	ASTM D 6241
Trapezoidal Tear (lb)	----	----	40	----	80	100	70	150	100	----	ASTM D 4533
Asphalt Retention (gal/yd ²)	----	----	----	0.2	----	----	----	----	----	----	ASTM D 6140
Permittivity (sec ⁻¹) min	0.05	0.05	0.5	----	0.2	0.2	0.2	0.2	0.2	----	ASTM D 4491
AOS Woven (mm) max	0.60	0.60	0.6	----	0.6	0.43	----	0.43	----	----	ASTM D 4751
AOS Non-Woven (mm) max	0.84	0.84	0.43	----	0.43	----	0.43	----	0.43	----	----
Tensile Strength after UV (% Retained)	70% @ 500 hr	70% @ 500 hr	50% @ 500 hr	----	50% @ 500 hr	50% @ 500 hr	50% @ 500 hr	50% @ 500 hr	50% @ 500 hr	----	ASTM D 4355
Melting Point °(F)	----	----	----	325	----	----	----	----	----	----	ASTM D 276
Minimum Ultimate Tensile Strength ³ (lb/in)	----	----	----	----	----	----	----	----	----	660	2000
											ASTM D 4595

Notes: 1- All property values, with the exception of apparent opening size (AOS), represent minimum average roll values in the weakest principal direction. Values for AOS represent the maximum average roll values, 2 - Values not identified in this table should meet manufacturer certification for the use and application, 3- Machine direction

Delete Subsec

907-714.15--Geogrids.

907-714.15.1--General. A geogrid is defined as a geosynthetic formed by a regular network of connected elements with apertures greater than 0.25 inch to allow interlocking with surrounding soil, rock, and other surrounding materials to function primarily as reinforcement.

Geogrid shall be manufactured from an expanded strain hardened monolithic polymer sheet composed of one or more synthetic polymers and shall be mildew resistant and inert to biological degradation and naturally encountered chemicals, alkalis and acids. The geogrid shall contain stabilizers and/or inhibitors, or a resistance finish or covering to make it resistant to deterioration from direct sunlight, ultraviolet rays, and heat.

Geogrid manufacturers shall participate in and be in compliance with the American Association of State Highway Transportation Officials (AASHTO) National Transportation Product Evaluation Program's (NTPEP) Geosynthetics audit program. Geogrid shall meet the requirements of Table II for the application and type shown on the plans and shall be selected from the Department's Approved Lists.

907-714.15.1.1--Geogrid for Retaining Walls and Reinforced Soil Slopes. Geogrid for retaining walls and reinforced soil slopes shall be creep tested in accordance with AASHTO R69 and meet Long Term Design Load, Minimum Ultimate Tensile Strength, and open area criteria listed in Table II. Manufacturers shall perform at least one long-term creep test for no less than 10,000 hours in accordance to ASTM D 5262 for each polymer or composition of polymers from which the geogrid is produced. The long-term design load that shall be reported for design use, shall be that load at which no more than 10% strain occurs over a 100-year design life of the geogrid, as calculated in accordance with AASHTO R69. Long-term design loads shall be reported unfactored, and the AASHTO strength reduction factors (Durability and Installation, and safety factors) will be considered by the Department's Geotechnical Branch on a site specific design basis.

907-714.15.1.2--Geogrid for Subgrade Stabilization. Geogrid for subgrade stabilization shall meet Minimum Ultimate Tensile Strength and open area criteria listed in Table II.

907-714.15.2--Marking, Shipment, and Storage. Each roll or container of geogrid shall be visibly labeled with the name of the manufacturer, trade name of the product, lot number, and quantity of material. In addition, each roll or container shall be clearly tagged to show the type designation that corresponds to that required by the plans. During shipment and storage the geogrid shall be protected from direct sunlight, and temperatures above 120°F or below 0°F. The geogrid shall either be wrapped and maintained in a heavy duty protective covering or stored in a safe enclosed area to protect from damage during prolonged storage.

907-714.15.3--Manufacturer Certification. The Contractor shall furnish the Engineer three copies of the manufacturer's certified test reports indicating that the geogrid furnished conforms to the requirements of the specifications and is of the same composition as the originally approved by the Department.

907-714.15.4--Acceptance Sampling and Testing. Final acceptance of each shipment will be

based upon results of tests performed by the Department on verification samples submitted from the project, as compared to the manufacturer's certified test reports. The Engineer will select one roll or container at random from each shipment for sampling. As sample extending full width of the randomly selected roll or container and being at least five (5) square yards in area will be obtained and submitted by the Engineer. All material samples shall be provided at no cost to the State.

**TABLE II
GEOGRIDS**

Physical Properties	Type Designation						Test Method
	I	II	III	IV	V	VI	
Long Term Design Load ¹ , pounds per foot, Machine Direction	250	500	750	1500	2500	3500	AASHTO R69, ASTM D5262
Minimum Ultimate Tensile Strength ² , pounds per foot, Machine Direction	500	1000	1500	3000	5000	7000	ASTM D6637
Open Area, percent	70	70	50	50	50	50	Direct Measurement

¹ Minimum design criteria requirement.

² Minimum Average Roll Value (MARV).

MISSISSIPPI DEPARTMENT OF TRANSPORTATION

SPECIAL PROVISION NO. 907-718-1

CODE: (SP)

DATE: 12/07/2021

SUBJECT: Timber and Dimension Lumber

Section 718, Timber and Dimension Lumber, of the 2017 Edition of the Mississippi Standard Specifications for Road and Bridge Construction is hereby amended as follows.

Delete the Subsections in Section 718 on pages 836 thru 838, and substitute the following.

907-718.01--General. All timber and dimension lumber shall be Southern pine and shall conform in all respects to applicable requirements of AASHTO M 168. The Department reserves the right to sample and to test all materials at any time; all inspection, testing, and certification of materials will be performed in accordance with the requirements of the current version of the Department's *Materials Division Inspection, Testing, and Certification Manual*.

Timber and dimension lumber shall be furnished in the sizes shown on the plans or as specified. Unless otherwise specified, timber and dimension lumber shall be No. 1, or better, graded according to the latest American Lumber Standards.

Only one type of preservative shall be used for the treatment of materials for any one class of construction on a project, unless otherwise specified.

Where treated timber and dimensional lumber is to be used in non-highway construction or use, such as decking, handrails in walking trails, or in any manner where general public exposure by touch is possible, the treatment requirements will be as per project plans and/or approved by the State Materials Engineer.

907-718.02--Untreated Timber and Dimension Lumber. Untreated timber and dimension lumber shall conform to the requirements of AASHTO M 168.

907-718.03--Treated Timber and Dimension Lumber. Timber and dimension lumber to be treated shall meet the requirements herein specified and shall be treated as specified. Treated timber or dimensional lumber will not be accepted for use unless it has been inspected by an authorized representative of the Department and found to be satisfactory after treatment.

907-718.03.1--Blank.

907-718.03.2--Treatment.

907-718.03.2.1--General. All materials shall be treated in accordance with AASHTO M 133 unless otherwise directed by the Environmental Protection Agency (EPA).

907-718.03.2.2--Blank.

907-718.03.2.3--Inspection. Treated timber and dimension lumber shall be inspected by an authorized representative of the Department before being incorporated into the work. Treatment reports shall be provided to the Department for each lot of material supplied.

907-718.03.3--Blank.

907-718.03.4--Storage of Treated Material. All material treated for stock shall be stacked as compactly as possible on a well-drained surface. Material shall be supported on sills spaced as necessary, not to exceed 10 foot intervals and shall have at least one foot of air space beneath the stacks.

All materials treated with preservatives for use in buildings and applications where painting is required shall be dried after treatment. The treated wood shall be dried in accordance with American Lumber Standards.

907-718.04--Preservative. Preservatives shall be as specified in AASHTO M 133 unless otherwise directed by the Environmental Protection Agency (EPA).

MISSISSIPPI DEPARTMENT OF TRANSPORTATION

SPECIAL PROVISION NO. 907-720-4

CODE: (IS)

DATE: 06/17/2025

SUBJECT: Pavement Marking Materials

Section 720, Pavement Marking Materials, of the 2017 Edition of the Mississippi Standard Specifications for Road and Bridge Construction is hereby amended as follows.

Delete Section 720 on pages 840 thru 854, and substitute the following.

SECTION 720 - PAVEMENT MARKING MATERIALS

907-720.01--General. The Department reserves the right to perform sampling and testing of any materials at any time. Upon request of the Engineer, samples of the material shall be furnished.

907-720.02--Color Requirements. All pavement markings except raised pavement markers are required to meet the color requirements of ASTM D6628.

907-720.03--Optics. Optics used in thermoplastic pavement markings shall consist of a double-drop system of glass beads or advanced optics.

907-720.03.1--Glass Beads. The manufacturer shall furnish the Engineer with a certified test report indicating that the glass beads meet AASHTO M 247. AASHTO Type 4 beads shall be applied to the newly placed stripe first, followed by the application of AASHTO Type 1 or Type 2 beads. Type 1, 2, and 4 glass beads shall be transparent, clean, colorless glass, smooth and spherically shaped, free from milkiness, pits, or excessive air bubbles. Type 1, 2, and 4 glass beads shall be coated with a bead coating that is compatible with the traffic marking material to which the glass beads will be applied and will provide adequate moisture proofing, increased adhesion, and optimum embedment of the glass beads.

907-720.03.1.1—Acceptance Procedure. The Contractor shall furnish the Engineer with a copy of the manufacturer's certified test reports for the lot(s) of materials from which the shipment originated. The test report shall show all the test results for the material properties and characteristics as specified herein. The test report shall state that the material represented by the test results meets all the requirements of the contract. It shall be the Contractor's responsibility to furnish the manufacturer's test report to the Engineer for each shipment of material to the project.

Acceptance sampling and testing will be in accordance with the Materials Division Inspection, Testing, and Certification Manual (Materials Manual).

907-720.03.2--Advanced Optics. Advanced optics are materials that do not meet the specific requirements of AASHTO M 247 but produce a final drop-on optics system that meets or exceeds the reflectivity requirements in Special Provision 907-626. Advanced optics shall be a double-

drop system that is pre-approved and listed on the Department's Approved Products List.

907-720.03.2.1—Acceptance Procedure. The Contractor shall furnish the Engineer with a copy of the manufacturer's certified test reports for the lot(s) of materials from which the shipment originated. The test report shall show all the test results for the material properties and characteristics as specified herein. The test report shall state that the material represented by the test results meets all the requirements of the contract. It shall be the Contractor's responsibility to furnish the manufacturer's test report to the Engineer for each shipment of material to the project.

Acceptance sampling and testing may be conducted at the request of the Engineer.

907-720.04--Thermoplastic Marking Material. Thermoplastic marking material shall meet the color requirements of Subsection 907-720.02.

There shall be no obvious change in the color of the material if held at its plastic temperature for a period of four (4) hours nor by reason of four (4) re-heatings to its plastic temperature.

The pavement markings shall maintain its original dimension and placement. The material shall not be slippery when wet and it shall not lift from the pavement in freezing weather.

907-720.04.1--Extruded Thermoplastic Material. Extruded thermoplastic pavement marking material shall meet the requirements of AASHTO M 249, and shall meet the requirements of 907-720.04 with the following exceptions:

- Blue - ADA thermoplastic marking material shall meet the requirements of Subsection 907-720.04.2 with the exception that the color shall be Blue – ADA, and the Contractor may use hot applied thermoplastic materials meeting the satisfaction of the Engineer.

907-720.04.2--Spray-Applied Thermoplastic Material. Spray-applied thermoplastic pavement marking material shall meet the requirements of AASHTO M 249 and shall meet the requirements of 907-720.04.

907-720.04.3--Pre-formed Thermoplastic Material. Heat-fused, pre-formed thermoplastic pavement marking material shall meet the color requirements of 907-720.02.

907-720.04.4—Acceptance Procedure. The Contractor shall furnish the Engineer with a copy of the manufacturer's certified test reports for the lot(s) of materials from which the shipment originated. The test report shall show all the test results for the material properties and characteristics as specified herein. The test report shall state that the material represented by the test results meets all the requirements of the contract. It shall be the Contractor's responsibility to furnish the manufacturer's test report to the Engineer for each shipment of material to the project.

907-720.05--Pavement Marking Tape. Pavement marking tape shall be listed on the Department's Approved Lists.

907-720.05.1—Cold Plastic Pavement Markings (Permanent Pavement Marking Tape). Pavement marking tape for use in roadway applications shall be designated on the Department's Approved Lists as permanent.

The prefabricated markings described shall consist of white or yellow pigmented plastic films with reflective optics uniformly distributed throughout their entire cross-sectional area, and be capable of being affixed by either a pressure sensitive pre-coated adhesive or a liquid contact cement. The markings shall be provided complete in a form that will facilitate rapid application and protect the markings in shipment and storage. The manufacturer shall identify proper solvents and/or adhesives to be applied at the time of application, all equipment necessary for proper application, and recommendations for application that will assure an effective performance life.

Prefabricated legends and symbols shall conform to the applicable shapes and sizes as outlined in the current "Manual on Uniform Traffic Control Devices."

907-720.05.1.1--Specific Requirements. Unless otherwise indicated on the plans, the patterned material without adhesive shall have a minimum caliper of 0.065 inch at the thickest portion of the patterned cross-section and a minimum caliper of 0.020 inch at the thinnest portion of the cross-section. The material shall be a pliant polymer film with 50±15% of the surface are raised and presenting a near vertical face angle of 0° to 60° to traffic from any direction. The channels between the raised areas shall be substantially free of exposed optics or particles.

The size and quality of the optics will be such that performance requirements of Subsection 907-720.02 for the retroreflective pliant polymer film shall be met. The pigments shall be selected and blended to provide a marking film that is white or yellow conforming to the performance requirements of Subsection 907-720.02 through the expected life of the film.

907-720.05.1.2--Conformability and Resealing. The marking shall be capable of conforming to pavement contours, breaks, faults, etc. through the action of traffic at normal pavement temperatures.

The marking shall have resealing characteristics that allows it to be capable of fusing with itself and previously applied marking of the same composition under normal conditions of use. The marking shall be capable of use for patching worn areas of the same type in accordance with manufacturer's instructions.

907-720.05.1.3--Tensile Strength and Elongation. The material shall have a minimum tensile strength of 40 pounds per square inch of cross section when tested according to ASTM D 638. A 6-inch x 1-inch x 0.06-inch sample shall be tested at a temperature between 70°F and 80°F using a jaw speed of 12 inches per minute.

The material shall have a minimum elongation of 75% at break when tested according to ASTM D 638 using a jaw speed of 12 inches per minute.

907-720.05.1.4--Skid Resistance. The surface of the material shall provide a minimum skid resistance value of 45 BPN when tested according to ASTM E 303 except values will be taken at

downweb and at a 45-degree angle from downweb. These two values will then be averaged to find the skid resistance of the patterned surface.

907-720.05.1.5--Effective Performance Life and Warranty. When applied according to the recommendations of the manufacturer the pavement marking tape shall provide a neat and durable marking that will not flow or distort due to temperature if the pavement surface remains stable. The film shall be weather resistant and through normal traffic wear shall show no appreciable fading, lifting, or shrinkage throughout the useful life of the marking, nor shall it show significant tearing, roll back, or other signs of poor adhesion.

All manufacturer's standard warranties and guarantees on pavement marking tape, which are provided as customary trade practice, shall be delivered to the Engineer at the final inspection. All warranties and guarantees shall be made out to the Department.

907-720.05.1.6—Acceptance Procedure. The Contractor shall furnish the Engineer with a copy of the manufacturer's certified test reports for the lot(s) of materials from which the shipment originated. The test report shall show all the test results for the material properties and characteristics as specified herein. The test report shall state that the material represented by the test results meets all the requirements of the contract. It shall be the Contractor's responsibility to furnish the manufacturer's test report to the Engineer for each shipment of material to the project.

Acceptance sampling and testing will be in accordance with the Materials Division Inspection, Testing, and Certification Manual (Materials Manual). Samples of the material shall be furnished and shall be provided at no cost to the State.

907-720.05.2--Preformed Pavement Markings for Construction Zones. Preformed pavement markings for construction zones shall be designated Department's Approved Lists as temporary. Retroreflective preformed pavement markings for construction zones shall be as specified on the plans or in the contract documents.

The markings shall be provided in specified widths and shapes. Preformed words and symbols shall conform to the applicable shapes and sizes as outlined in the current "Manual on Uniform Traffic Control Devices for Streets and Highways," or as modified.

The materials shall be packaged in accordance with accepted commercial standards and when stored indoors in a cool dry place, shall be suitable for use one year after date of purchase.

907-720.05.2.1--Specific Requirements. Preformed markings shall consist of retroreflective materials on a conformable backing and shall meet the performance requirements of Subsection 907-720.02. The markings shall consist of a mixture of high-quality polymeric materials, pigments, and optics with a reflective layer of optics bonded to the top surface. The markings shall be pre-coated with a pressure sensitive adhesive capable of adhering to pavement in accordance with the manufacturer's instructions without the use of heat, solvents, or other additional adhesives. The markings and/or adhesive shall not require any curing time after application. A coated non-metallic medium shall be incorporated with the pressure sensitive adhesive to facilitate removal.

907-720.05.2.2—Acceptance Procedure. The Contractor shall furnish the Engineer with a copy of the manufacturer's certified test reports for the lot(s) of materials from which the shipment originated. The test report shall show all the test results for the material properties and characteristics as specified herein. The test report shall state that the material represented by the test results meets all the requirements of the contract. It shall be the Contractor's responsibility to furnish the manufacturer's test report to the Engineer for each shipment of material to the project.

907-720.06--Raised Pavement Markers. Pavement markers shall be listed on the Department's Approved Lists and shall conform to ASTM D 4280.

907-720.06.1--Packaging. Shipments shall be made in containers acceptable to common carriers and packaged in such a manner as to ensure delivery in perfect condition. All damaged shipments shall be replaced by the Contractor. Each package shall be clearly marked as to the name of the manufacturer, type, quantity enclosed, lot number, and date of manufacture.

907-720.06.2--Non-Reflective Pavement Markers. Non-reflective pavement markers are occasionally referred to as "jiggle markers". Non-reflective markers consisting of a heat-fired, vitreous, ceramic base, and a heat-fired, opaque, glazed surface are permitted for use; the bottom of the marker shall not be glazed. Ceramic markers shall be produced from any suitable combination of intimately mixed clays, shales, talcs, flints, feldspars, or other inorganic material. Ceramic markers shall be thoroughly and evenly matured, and all non-reflective pavement markers shall be free from defects which affect appearance or serviceability.

Ceramic non-reflective markers shall conform to the following finish and testing requirements in Table 2 below.

Table 2

Ceramic Non-Reflective Marker Requirements	
Glaze Thickness	0.005 inch, minimum
Mohs Hardness	6, minimum
Autoclave	Glaze shall not spall, craze, or peel.
Compressive Strength	750 psi, minimum
Water Absorption	2.0%, maximum

907-720.06.3—Acceptance Procedure. The Contractor shall furnish the Engineer with a copy of the manufacturer's certified test reports for the lot(s) of materials from which the shipment originated. The test report shall show all the test results for the material properties and characteristics as specified herein. The test report shall state that the material represented by the test results meets all the requirements of the contract. It shall be the Contractor's responsibility to furnish the manufacturer's test report to the Engineer for each shipment of material to the project.

907-720.07--Adhesive for Pavement Markers. The adhesive shall be listed on the Department's Approved Lists and shall be an asphaltic material suitable for bonding pavement markers to surfaces when the road surface and marker temperatures are in the range of 50°F to 160°F. The composition of the adhesive must be such that its properties will not deteriorate when heated to and applied at temperatures up to 425°F. Samples may be submitted in the form of an adhesive

testing package from each batch or material obtained from a package shipped to the project.

907-720.07.1--Packaging and Labeling. The adhesive shall be packaged in self-releasing cardboard containers that will stack properly. The label shall show the manufacturer, quantity, and lot or batch number. "Adhesive for Pavement Markers" or "Adhesive for Traffic Markers" shall be printed in bold lettering on the label.

907-720.07.2--Bituminous Adhesive. The asphaltic adhesive material shall be flexible type.

907-720.07.2.1--Flexible Bituminous Adhesive. Flexible bituminous adhesive shall be designated on the Department's Approved Lists as flexible and shall comply with requirements of Table 3 below.

Table 3

Flexible Bituminous Adhesive Properties			
	Min	Max	Test Method
Penetration @ 77°F	-	25	ASTM D 5
Softening Point, °F	200	-	ASTM D 36
Brookfield Viscosity @ 400°F, cp.	-	10,000	ASTM D 3236
Ductility @ 77°F, 5 cm/min	15	-	ASTM D 113
Ductility @ 39.2°F, 1 cm/min	5	-	ASTM D 113
Asphalt Compatibility	Pass		ASTM D 5329
Flexibility @ 20°F	Pass		Per Subsection

907-720.07.3—Acceptance Procedure. The Contractor shall furnish the Engineer with a copy of the manufacturer's certified test reports for the lot(s) of materials from which the shipment originated. The test report shall show all the test results for the material properties and characteristics as specified herein. The test report shall state that the material represented by the test results meets all the requirements of the contract. It shall be the Contractor's responsibility to furnish the manufacturer's test report to the Engineer for each shipment of material to the project.

Acceptance sampling and testing will be in accordance with the Materials Division Inspection, Testing, and Certification Manual (Materials Manual). Samples of the material shall be furnished and shall be provided at no cost to the State.

MISSISSIPPI DEPARTMENT OF TRANSPORTATION

SPECIAL PROVISION NO. 907-721-4

CODE: (IS)

DATE: 04/19/2022

SUBJECT: Materials for Signing

Section 721, Materials for Signing, of the 2017 Edition of the Mississippi Standard Specifications for Road and Bridge Construction is hereby amended as follows.

907-721.06--Reflective Sheeting.

907-721.06.2--Performance Requirements. Delete Table 4 and Table 5 in Subsection 721.06.2 on pages 860 & 861, and substitute the following.

**MINIMUM COEFFICIENTS OF RETROREFLECTION
Candela per foot candle per square foot (cd/ft²)
Per ASTM Designation D4956**

**TABLE 4
Type IX Sheeting**

Observation Angle	Entrance Angle	White	Yellow	Green	Red	Blue	Fluorescent Yellow/Green	Fluorescent Yellow	Fluorescent Orange
0.2°	-4.0°	380	285	38	76	17	300	230	115
0.2°	+30.0°	215	162	22	43	10	170	130	65
0.5°	-4.0°	240	180	24	48	11	190	145	72
0.5°	+30.0°	135	100	14	27	6.0	110	81	41
1.0°	-4.0°	80	60	8.0	16	3.6	64	48	24
1.0°	+30.0°	45	34	4.5	9.0	2.0	36	27	14

**TABLE 5
Type XI Sheeting**

Observation Angle	Entrance Angle	White	Yellow	Green	Red	Blue	Brown	Fluorescent Yellow/Green	Fluorescent Yellow	Fluorescent Orange
0.2°	-4.0°	580	435	58	87	26	17	460	350	175
0.2°	+30.0°	220	165	22	33	10	7.0	180	130	66
0.5°	-4.0°	420	315	42	63	19	13	340	250	125
0.5°	+30.0°	150	110	15	23	7.0	5.0	120	90	45
1.0°	-4.0°	120	90	12	18	5.0	4.0	96	72	36
1.0°	+30.0°	45	34	5.0	7.0	2.0	1.0	36	27	14

After Subsection 721.10 on page 864, add the following.

907-721.11--Digital Applied Printing. The following addresses the requirements for digitally printed finished retroreflective traffic control signs on flat sheet aluminum and digitally printed traffic sign faces intended to be applied to a sign substrate.

907-721.11.1--Digitally Printed Ink Systems. Traffic signs must be produced using components, and processes that comply with the retroreflective sheeting manufacturer’s recommendations.

Digital printed ink systems used to print traffic signs must meet and comply with daytime and nighttime chromaticity (color standards) as recognized in ASTM D4956 “Standard Specification for Retroreflective Sheeting for Traffic Control.”

Digital printed ink systems must meet 70% of the initial retroreflectivity specifications of each respective reflective film color as found in ASTM D4956 “Standard Specification for Retroreflective Sheeting for Traffic Control.”

Prior to fabrication and preferably at the preconstruction meeting, the Contractor shall advise the Project Engineer in writing as to which signs on the project will be digitally printed and which ones will be screen printed. The Contractor shall submit to the Project Engineer certifications for all digitally printed signs, which will be forwarded to the State Traffic Engineer for review.

907-721.11.2--Protective Overlay Film. Permanent traffic signs printed with digital ink systems will be fabricated with a full sign protective overlay film designed to provide a smooth surface needed for retroreflectivity, and to protect the sign from fading and UV degradation. The overlamine shall comply with the retroreflective sheeting manufacturer’s recommendations to ensure proper adhesion and transparency and will also meet the reflective film durability as identified in Table 1.

**Table 1
Retroreflective Film Minimum Durability Requirements**

ASTM D4956 Type	Full Sign Replacement Term (years)	Sheeting Replacement Term (years)
IV	7	10
VIII	7	10
IX	7	12
XI	7	12

Temporary signs used in work zones printed with black ink only will not require a protective overlay film as long as the finished sign is warranted for a minimum outdoor durability of three years by the sheeting manufacturer.

907-721.11.3--Inspection. During fabrication, the Contractor shall provide sufficient testing and quality control throughout fabrication to insure good workmanship. Once the material has been received, it may be subject to random testing to ensure compliance with all requirements. If any test samples do not conform to the requirements, the entire order may be returned at the vendor’s expense.

907-721.11.4--Traffic Sign Performance Warranty Provisions. Based on the ASTM Type of sheeting specified, traffic control signs shall be warranted for the duration shown in Table 1. The Contractor shall supply a copy of the warranty document with complete details of terms and conditions upon request of the Department.

907-721.11.5--Certified Digital Sign Fabricator. Sign fabricators using digital imaging methods to produce regulated traffic signs must be certified by the reflective sheeting manufacturer whose materials are used to produce the delivered signs.

Certified sign fabricators must undergo an audit process by the sheeting manufacturer to ensure they have the proper equipment, manufacturing capabilities, manufacturing application processes and the materials required to fulfill the sheeting manufacturer's warranty obligations. Sign fabricators must recertify annually with reflective sheeting manufacturers or utilize a 3rd party certifier approved by the reflective sheeting manufacturer.

The Contractor shall submit proof of Sign Fabricator Certification as issued by the retroreflective sign sheeting manufacturer to the Project Engineer upon delivery of the signs, or with the Shop Drawings.

MISSISSIPPI DEPARTMENT OF TRANSPORTATION

SUPPLEMENT TO SPECIAL PROVISION NO. 907-799-1

DATE: 07/28/2025

SUBJECT: Hydraulic Cement Concrete Mixtures

907-799.01.1--Materials. Delete *Ground Granulated Blast Furnace Slag (GGBFS)* from the list in Subsection 907-799.01.1 on page 1, and substitute the following.

Slag Cement 714.06

Delete the title for Subsection 907-799.02 on page 1, and substitute the following.

907-799.01.2--Classification and Uses of Concrete.

Delete numbers 9 through 15 in the classes and general use list on pages 1 & 2, and substitute the following.

- 9) Class F (SCC) – Self Consolidating Concrete for prestressed members.
- 10) Class DS – Concrete for drilled shafts.
- 11) Class FX – Extra Strength concrete for prestressed members, as shown on plans.
- 12) Class FX (SCC) – Extra Strength Self Consolidating concrete for prestressed members, as shown on plans.
- 13) Class PA – Concrete paving.
- 14) Class PO – Concrete for repair of concrete paving.
- 15) Class PP – Concrete for special design requirements.
- 16) Class S – For all seal concrete deposited under water.
- 17) Class WT – Fiber-reinforced concrete pavement.

907-799.02--Hydraulic Cement Concrete Mixture Design. Add the following to Table 1 on page 3.

F ⁸ (SCC)	67	0.40	5000	28[-4] ¹²	See Note ⁴
FX ⁸ (SCC)	67	As per mixture design	As shown on plans	28[-4] ¹²	See Note ⁴

Delete Note 8 of Table 1 on page 4, and substitute the following.

⁸ Type III, Type IL (HE), or Type III (MS) cement may be used in these Classes of concrete.
¹² Refers to slump flow in inches. It shall be acquired by ASTM C1611.

907-799.02.1.1--Portland Cement. Delete the paragraph in Subsection 907-799.02.1.1 on page 4, and substitute the following.

Portland cement (cement) shall be either Type I or Type II. Type III, Type IL (HE), or Type III (MS), may be used for the production of precast or precast-prestressed concrete members or Classes of concrete with Note 8 in Table 1.

907-799.02.2--Replacement of Portland Cement or Blended Cement. Delete Table X on page 5, and substitute the following.

**Table X
Replacement Ranges of Portland Cements and Blended Cements by Fly Ash or Slag Cement**

Portland Cement or Blended Cement Type	Fly Ash Replacement Range (%)	Slag Cement Replacement Range (%)
Types I, II, III, and III (MS)	20 – 25	45 – 50
Types IL, IL (MS), and IL (HE)	20 – 35	35 – 40
Types IS and IS (MS)	20 – 25	20 - 25
Types IP and IP (MS)	No replacement combination allowed	

907-799.02.4--Exposure to Soluble Sulfates or Seawater. Delete Table R on page 6, and substitute the following.

**Table R
Cementitious Materials Combinations for Soluble Sulfate Conditions or Seawater**

	Exposure to Moderate Sulfates or Exposure to Seawater	Exposure to Severe Sulfates
Water-soluble sulfate (SO₄) in soil, % by mass	0.10 – 0.20	0.20 – 2.00
Sulfate (SO₄) in water, ppm	150 – 1,500	1,500 – 10,000
Portland Cement or Blended Cement Types	Replacement Ranges by SCMs (%)	
Type I or Type III	24.5 – 25.0% Class F fly ash, or 49.5 – 50.0% Slag cement, or 19.5 – 20.0% Metakaolin	49.5 – 50.0% Slag cement
Type II or Type III (MS)	See Note 1	24.5 – 25.0% Class F fly ash, or 49.5 – 50.0% Slag cement, or 19.5 – 20.0% Metakaolin
Type IL or IL (HE)	24.5 – 35.0% Class F fly ash, or 49.5 – 50.0% Slag cement, or 19.5 – 20.0% Metakaolin	49.5 – 50.0% Slag cement

Type IL (MS)	See Note 1	24.5 – 35.0% Class F fly ash, or 49.5 – 50.0% Slag cement, or 19.5 – 20.0% Metakaolin
Type IS	24.5 – 25.0% Class F fly ash, or 24.5 – 25.0% Slag cement, or 19.5 – 20.0% Metakaolin	24.5 – 25.0% Class F fly ash, or 24.5 – 25.0% Slag cement, or 19.5 – 20.0% Metakaolin
Type IS (MS)	See Note 1	24.5 – 25.0% Class F fly ash, or 24.5 – 25.0% Slag cement, or 19.5 – 20.0% Metakaolin
Type IP (MS)	No replacement combination allowed	Type not allowed

¹ Class F fly ash or slag cement may be added as a replacement for cement as allowed in Subsection 907-799.02.2.

907-799.03--Proportioning of Hydraulic Cement Concrete Mixture Design.

907-799.03.1--Proportioning on the Basis of Previous Field Experience of Trial Mixtures.

Delete subparagraph (c) on page 7, and substitute the following.

- (c) Consists of 10 consecutive tests, an average of three cylinders per test, tested at 28 days. For concrete categorized as a self-consolidating concrete (SCC) mixture, the test data for the plastic concrete shall include the slump flow data, instead of the slump data, and at least one test to determine the static segregation. For all mixture designs, for each of these tests on the plastic concrete the test data shall meet the acceptance criteria of Subsection 907-804.02.13.1.

907-799.03.2--Proportioning on the Basis of Laboratory Trial Mixtures. Add the following to the list of restrictions on page 8.

- (g) For concrete categorized as a SCC mixture, the mixture shall be designed to produce a slump flow within ±2 inches of the maximum permitted and a maximum static segregation of 15.0 percent. The concrete shall not be rodded or vibrated during casting the test specimens.
- (h) For concrete categorized as a SCC mixture, test specimens shall be made in accordance with the above listed specifications with the exception that the concrete shall not be rodded or vibrated during casting the test specimens.

907-799.05--Field Verification of Concrete Mixture Design. Delete the second and third paragraphs on page 9, and substitute with the following.

The Contractor’s Certified Quality Control Technicians shall test each concrete mixture design upon the first placement of the mix. Aggregates and concrete tests during the first placement shall be as follows.

Aggregates

Bulk Specific Gravity

Moisture

Gradation

Concrete

Water Content

Slump or Slump Flow

Air Content

Unit Weight

Yield

Static Segregation

For all Classes of concrete, the mixture shall be verified to yield within 2.0% of the correct volume when all the mix water is added to the batch, either by the batch plant or as ice used to control mixture acceptance temperature. For concrete categorized as a SCC mixture, the mixture shall produce a slump flow within minus four inches (4") of the maximum permitted and a static segregation less than 15.0%.

MISSISSIPPI DEPARTMENT OF TRANSPORTATION

SPECIAL PROVISION NO. 907-799-1

CODE: (IS)

DATE: 11/21/2023

SUBJECT: Hydraulic Cement Concrete Mixtures

Section 907-799, Hydraulic Cement Concrete Mixtures, is hereby added to and made part of the 2017 Edition of the Mississippi Standard Specifications for Road and Bridge Construction as follows.

SECTION 907-799 - HYDRAULIC CEMENT CONCRETE MIXTURES

907-799.01--General.

907-799.01.1--Materials. The materials for hydraulic cement concrete mixtures shall meet the requirements of the following Subsections:

Portland Cement	701.01 and 701.02
Blended Cement	701.01 and 701.04
Fine Aggregate	703.02
Coarse Aggregate	703.03
Lightweight Aggregate	703.19.02
Synthetic Structural Fiber	711.04
Admixtures	713.02
Water	714.01.1 and 714.01.2
Fly Ash	714.05
Ground Granulated Blast Furnace Slag (GGBFS)	714.06
Metakaolin	907-714.09.01

907-799.02--Classification and Uses of Concrete. The classes and general uses of hydraulic cement concrete (concrete) mixtures are as follows:

- 1) Class AA - Concrete for bridge construction and concrete exposed to seawater.
- 2) Class B - General use, heavily reinforced sections, cast-in-place concrete piles, and conventional concrete piles.
- 3) Class BD - Concrete for bridge decks.
- 4) Class BDx - Extra strength concrete for bridge decks.
- 5) Class BDO - Concrete for bridge deck overlay.
- 6) Class C - Massive sections or lightly reinforced sections.
- 7) Class D - Massive unreinforced sections and riprap.
- 8) Class F - Concrete for prestressed members.
- 9) Class DS - Concrete for drilled shafts.
- 10) Class FX - Extra strength concrete for prestressed members, as shown on plans.
- 11) Class PA - Concrete paving.

- 12) Class PO - Concrete for repair of concrete paving.
- 13) Class PP - Concrete for special design requirements.
- 14) Class S - For all seal concrete deposited under water.
- 15) Class WT - Fiber-reinforced concrete pavement.

907-799.02--Hydraulic Cement Concrete Mixture Design. At least 10 working days prior to production of concrete, the Contractor shall submit to the Engineer proposed concrete mixture designs complying with the Department's *Concrete Manual*. Materials shall be from approved sources meeting the requirements of the Standard Specifications. Proportions for the mixture designs shall be for the class concrete required by the plans and shall meet the requirements of the "Master Proportion Table for Hydraulic Cement Concrete Designs" listed in Table 1. The concrete producer shall assign a permanent unique mixture number to each mixture design. Each mixture design shall be field verified as required in Subsection 907-799.03.3. Acceptable field verification data shall be required for final approval of a mixture design.

All concrete mixture designs will be reviewed by the Materials Division prior to use. Concrete mixture designs disapproved will be returned to the Contractor with a statement explaining the disapproval.

If the maturity method is used to estimate the compressive strength for applications such as early opening to traffic or form removal, the Contractor shall also submit compressive strength/maturity documentation developed in accordance with Subsection 804.03.15 for the mixture prior to production of concrete.

If the Contractor chooses to cure the concrete in accordance with the requirements listed under **Length of Time Defined by Development of Compressive Strength** in Subsection 804.03.17, the compressive strength/maturity relationship shall be developed for the mixture design for a minimum of 28 days following the requirements of Subsection 804.03.15. The compressive strength/maturity relationship information shall be submitted with the mixture design information.

Table 1
MASTER PROPORTION TABLE FOR HYDRAULIC CEMENT CONCRETE DESIGNS

Class	Required Coarse Aggregate Size No.⁷	Maximum w/cm Ratio	Specified Compressive Strength (f'_c) psi	Maximum Permitted Slump inches⁵	Total Air Content (%)
AA	57 or 67	0.45	4000	8	3.0-6.0
B	57 or 67	0.50	3500	8	3.0-6.0
BD^{2,3}	57 or 67	0.45 ¹	4000	5	3.0-6.0 5.0 8.0
BDX^{2,3}	57 or 67	0.45 ¹	4500	5	3.0-6.0 5.0 8.0
BDO^{3,6,8,11}	7, 8, or 78	As per mixture design	2500	6	3.0-6.0
C	57 or 67	0.55	3000	8	3.0-6.0
D	57 or 67	0.70	2000	8	3.0-6.0
DS	67	0.45	4000	8±1	See Note ⁴
F⁸	67	0.40	5000	8	See Note ⁴
FX⁸	67	As per mixture design	As shown on plans	8	See Note ⁴
PA	467 or 57 ⁹	0.48	3500	3	3.0-6.0
PO^{8,11}	57 or 67	As per mixture design	3500	8	3.0-6.0
PP	57 or 67	0.45	Per Plans	8	3.0-6.0
S	57 or 67	0.45	3000	8	3.0-6.0
WT^{3,8,10,11}	57 or 67	0.40	3500	4	3.0-6.0

¹ For Class BD concrete for bridge decks, the minimum water/cementitious material ratio shall be 0.43 and the maximum cementitious material content shall be 550 pounds per cubic yard.

For Class BDX concrete for bridge decks, the minimum water/cementitious material ratio shall be 0.42 and the maximum cementitious material content shall be 564 pounds per cubic yard.

² For bridge decks constructed following the requirements of Subsection 804.03.19.7.3, Subsection 804.03.14.2, and Subsection 804.03.17.2, then the Class BD or Class BDX mixture design shall contain lightweight aggregate (LWA) and have an internal curing water content of 8.0 lbs per 100 lbs of total cementitious materials in the mixture design; mixture designs not containing LWA and the required minimum internal curing water content shall not be used.

³ An approved synthetic structural fiber shall be incorporated into the mixture at 1.25 times the approved dosage rate. For each additional pound of fibers per cubic yard added in excess

of the requirement stated above, an additional inch of slump will be allowed up to a maximum permitted slump of eight (8) inches.

- ⁴ Entrained air is not required for Class F, FX, and DS concrete unless exposed to seawater. For concrete not exposed to seawater, the total air content shall not exceed 6.0%. For concrete exposed to seawater, the total air content shall be 3.0-6.0%.
- ⁵ Except as noted for Class DS concrete, the design slump selected by the Contractor for the mixture design may be less than the maximum permitted slump. The design slump is the maximum acceptance slump for field acceptance in accordance with Subsection 907-804.02.13.1.2. Except as noted for Class DS concrete, minus slump requirements shall meet those set forth in Table 3 of AASHTO M157.
- ⁶ For Class BDO the mixture design shall include a minimum 564 pounds per cubic yard of cementitious material with a minimum 15 percent fly ash replacement. The specified strength shall be achieved prior to Opening To Traffic.
- ⁷ Other small coarse aggregate sizes meeting the requirements of Subsection 703.03.2.4 may be used in conjunction with the coarse aggregate sizes listed. Lightweight aggregate (LWA) meeting the requirements of Subsection 703.19.2 may also be used as a partial replacement for fine aggregate.
- ⁸ Type III or Type III (MS) portland cement may be used in these Classes of concrete.
- ⁹ The oven-dry coarse aggregate volume per cubic yard of concrete shall be a minimum of 72%.
- ¹⁰ The coarse aggregate size requirements shall meet the requirements of Subsection 907-799.02.4.2.
- ¹¹ Non-chloride based accelerating admixtures may be used in these Classes of concrete.

907-799.02.1--Allowable Hydraulic Cement Types.

907-799.02.1.1--Portland Cement. Portland cement (cement) shall be either Type I or Type II. Type III or Type III (MS) may be used for the production of precast or precast-prestressed concrete members or Classes of concrete with Note 8 in Table 1.

907-799.02.1.2--Blended Cement. Blended hydraulic cements (blended cements) shall be of the following types and conform to Subsection 701.04:

- Type IL – Portland-limestone cement
- Type IP – Portland-pozzolan cement
- Type IS – Portland blast-furnace slag cement

Blended cement Types IL, IP, and IS meeting the “MS” sulfate resistance requirements listed in AASHTO M 240, Table 3 may also be used.

907-799.02.2--Replacement of Portland Cement or Blended Cement. Replacement of portland cement or blended cement shall be on a weight basis. At least 50% by weight of total cementitious material per cubic yard shall be portland cement.

Except as noted for concrete exposed to soluble sulfates or sea water in Subsection 907-799.02.4, the maximum replacement limits of portland cement or blended cement by weight by fly ash and

slag cement shall be in accordance with Table X provided the 50% by weight of total cementitious material per cubic yard of portland cement is maintained.

Table X
Replacement Ranges of Portland cements and Blended cements
by Fly Ash or Slag Cement

Portland cement or Blended cement type	Fly ash replacement range (%)	Slag cement replacement range (%)
Types I, II, III, and III (MS)	20 - 25	45 - 50
Types IL and IL (MS)	20 - 35	35 - 40
Types IS and IS (MS)	20 - 25	20 - 25
Types IP and IP (MS)	No replacement combination allowed	

Replacement contents below the range minimum in Table X may be used in concrete, but the concrete does not qualify for any special considerations, such as the maximum acceptance temperature for concrete in Subsection 804.02.13.1.5. Special considerations shall only apply for replacement of both portland cement and blended cement by either fly ash or slag cement.

907-799.02.3--Alkali Content. The total alkali content for all classes of concrete shall not exceed 4.0 lb per cubic yard based on the alkali contribution from the portland cement. The maximum cement alkali content reported on the cement mill certificate shall be used in this determination. An example calculation can be found in the Department's *Concrete Manual*.

907-799.02.4--Exposure to Soluble Sulfates or Seawater. When portland cement or blended cement concrete is exposed to moderate or severe soluble sulfate conditions or to seawater listed, cement types and replacement of cement by Class F fly ash, slag cement, or metakaolin shall be as follows in Table R.

Class C fly ash shall not be used as a replacement for cement in any of the sulfate exposure conditions listed below. Type IP blended cement shall not be used in any of the sulfate exposure conditions listed below.

Table R
Cementitious Materials Combinations for Soluble Sulfate Conditions or Seawater

	Exposure to Moderate Sulfates or Exposure to Seawater	Exposure to Severe Sulfates
Water-soluble sulfate (SO₄) in soil, % by mass	0.10 - 0.20	0.20 - 2.00
Sulfate (SO₄) in water, ppm	150 - 1,500	1,500 - 10,000
Portland cement or Blended cement types	Replacement Ranges by SCMs (%)	
Type I or Type III	24.5 - 25.0% Class F fly ash, or 49.5 - 50.0% Slag cement, or 19.5 - 20.0% Metakaolin	49.5 - 50.0% Slag cement
Type II or Type III (MS)	See Note 1	24.5 - 25.0% Class F fly ash, or 49.5 - 50.0% Slag cement, or 19.5 - 20.0% Metakaolin
Type II	24.5 - 35.0% Class F fly ash, or 49.5 - 50.0% Slag cement, or 19.5 - 20.0% Metakaolin	49.5 - 50.0% Slag cement
Type II (MS)	See Note 1	24.5 - 35.0% Class F fly ash, or 49.5 - 50.0% Slag cement, or 19.5 - 20.0% Metakaolin
Type IS	24.5 - 25.0% Class F fly ash, or 24.5 - 25.0% Slag cement, or 19.5 - 20.0% Metakaolin	24.5 - 25.0% Class F fly ash, or 24.5 - 25.0% Slag cement, or 19.5 - 20.0% Metakaolin
Type IS (MS)	See Note 1	24.5 - 25.0% Class F fly ash, or 24.5 - 25.0% Slag cement, or 19.5 - 20.0% Metakaolin
Type IP (MS)	No replacement combination allowed	Type not allowed

¹ Class F fly ash or slag cement may be added as a replacement for cement as allowed in Subsection 907-799.02.2.

907-799.02.5--Chemical Admixtures. At least one water-reducing admixture or water-reducing/set-retarding admixture shall be used in all classes of concrete in accordance with the manufacturer's recommended dosage range. Admixtures providing a specific performance characteristic other than those of water reduction or set retardation may be used in accordance with the manufacturer's recommended dosage range. Accelerating admixtures shall not be used unless approved by the State Materials Engineer and as applied to Classes by Note 11 in Table 1. Any combinations of admixtures shall be approved by the Engineer before their use.

907-799.02.6--Aggregates.

907-799.02.6.1--Lightweight Aggregate Requirements for Bridge Decks. For bridge decks constructed following the requirements of Subsection 804.03.19.7.3, Subsection 804.03.14.2 and Subsection 804.03.17.2, then the Class BD or Class BDX mixture design shall contain LWA meeting the requirements of Subsection 703.19.2 and have an internal curing water content of 8.0 lbs. per 100 lbs. of total cementitious materials in the mixture design; mixture designs not containing LWA and the required minimum internal curing water content shall not be used.

907-799.02.6.2--Class WT Concrete. Class WT concrete used in fiber-reinforced concrete pavements with a design thickness greater than or equal to 4 inches, size 57 coarse aggregate shall be used. Class WT concrete used in fiber-reinforced concrete pavements with a design thickness less than 4 inches, size 67 coarse aggregate shall be used.

907-799.03--Proportioning of Hydraulic Cement Concrete Mixture Design. Proportioning of hydraulic cement concrete shall be based on an existing mixture of which the producer has field experience and documentation or based on a recently batched laboratory mixture tested according to the required specifications.

907-799.03.1--Proportioning on the Basis of Previous Field Experience of Trial Mixtures.

Where a concrete production facility has a record, based on at least 10 consecutive strength tests from at least 10 different batches within the past 12 months from a mixture not previously used on Department projects, the standard deviation shall be calculated. The record of tests from which the standard deviation is calculated shall:

- (a) Represent similar materials and conditions to those expected. Changes in materials and proportions within the test record shall not have been more closely restricted than those for the proposed work.
- (b) Represent concrete produced to meet a specified strength.
- (c) Consist of 10 consecutive tests, average of three cylinders per test, tested at 28 days. For all mixture designs, for each of these tests on the plastic concrete the test data shall meet the acceptance criteria of Subsection 804.02.13.1.

The standard deviation, *s*, shall be calculated as:

$$s = \left[\sum (X_i - \bar{X})^2 \div (N - 1) \right]^{1/2}$$

where:

- X_i* = the strength result of an individual test
- \bar{X} = the average of individual tests in the series
- N* = number of tests in the series

When the concrete production facility does not have a record of tests for calculation of standard deviation, as required in the above formula, the requirements of Subsection 907-799.03.2 shall govern.

The required average compressive strength (f'_{cr}) used as the basis for selection of concrete proportions shall conform to the inequality listed below, while using a standard deviation, s , calculated as shown above.

$$\bar{X} \geq f'_{cr}$$

where:

$$f'_{cr} = f'_c + 1.43s$$

where:

- f'_c = specified compressive strength of concrete, psi
- f'_{cr} = required average compressive strength of concrete, psi
- s = standard deviation, psi

1.43 represents the Lower Quality Index necessary to assure that 93% of compressive strength tests are above f'_c .

907-799.03.2--Proportioning on the Basis of Laboratory Trial Mixtures. When an acceptable record of field test results is not available, concrete proportions shall be established based on laboratory trial mixtures meeting the following restrictions:

- (a) The combination of materials shall be those intended for use in the proposed work.
- (b) Trial mixtures having proportions and consistencies suitable for the proposed work shall be made using the ACI 211.1 as a guide to proportion the mixture design.
- (c) Trial mixtures shall be designed to produce a slump within $\pm\frac{3}{4}$ inch of the design slump allowed, and for air-entrained concrete, ± 0.5 percent of the maximum permitted air content in Table 1 in Subsection 907-799.02. The temperature of freshly mixed concrete in trial mixtures shall be reported.
- (d) For each proposed mixture, at least three compressive test cylinders shall be made and cured in accordance with AASHTO R 39. Each change of water-cement ratio shall be considered a new mixture. The cylinders shall be tested for strength in accordance with AASHTO T 22 and shall be tested at 28 days.
- (e) The required average strength of laboratory trial mixes shall exceed f'_c by 1200 psi for concrete mixture designs less than 5000 psi and by 1400 psi for concrete mixture designs of 5000 psi or more.
- (f) The laboratory trial batch mixtures shall have been made within the previous 12 months before being submitted for approval and shall not have been previously used on Department projects.

907-799.04--Documentation of Average Strength. Documentation that the proposed concrete proportions will produce an average strength equal to or greater than the required average shall consist of the strength test records from field tests or results from laboratory trial mixtures.

907-799.05--Field Verification of Concrete Mixture Design. Unless otherwise noted within this Subsection, and except for Class PO, concrete mixture designs will only be tentatively approved pending field verification submission. All concrete placed using a mixture design which has not been acceptably field verified will not be paid for by the Department until field verification is submitted and approved as having been found to meet the requirements in this Subsection and those in the Department's *Concrete Manual*. The requirements for yield, slump, or total air content shall be successfully met within the first three (3) production days. Mixture designs may be transferred to other projects without additional field verification testing if the most recent field verification testing was conducted within the past twelve (12) months. All concrete mixtures will have a complete field verification performed and submitted to the Department's Materials Division every 12 months.

The Contractor's Certified Quality Control Technicians shall test each concrete mixture design upon the first placement of the mixture. Aggregates and concrete tests during the first placement shall be as follows.

<u>Aggregates</u>	<u>Concrete</u>
Bulk Specific Gravity	Water Content
Moisture	Slump
Gradation	Air Content
	Unit Weight
	Yield

For all Classes of concrete, the mixture shall be verified to yield within 2.0% of the correct volume when all the mix water is added to the batch, either by the batch plant or as ice used to control mixture acceptance temperature.

For all Classes of concrete other than DS, F, and FX, the mixture shall produce a slump within a minus 1½-inch tolerance of the design for mixtures with a design slump of three inches (3") or less or within a minus 2½-inch tolerance of the design for mixtures with a design slump of greater than three inches (3"), and producing a total air content within the allowable air content range in Table 3.

For Class DS, the slump range shall be 8 inches ±1 inch. For Class DS exposed to seawater, the total air content shall be within the allowable air content range in Table 3. For Class DS not exposed to seawater the total air content shall be within the requirements in Table 3.

For Classes F and FX, the slump shall be within a minus 1½-inch tolerance of the design for mixtures with a design slump of three inches (3") or less or within a minus 2½-inch tolerance of the design for mixtures with a design slump of greater than three inches (3"). For Classes F and FX exposed to seawater, the total air content shall be within the allowable air content range in Table 3. For Classes F and FX not exposed to seawater the total air content shall be within the requirements in Table 3.

The mixture shall be adjusted and retested, if necessary, on subsequent placements until the above-mentioned properties are met.

If the requirements for yield, slump, or total air content are not met within the first three (3) production days, subsequent field verification testing shall not be permitted on Department projects, and the mixture design shall not be used until the requirements listed above are met. Any mixture design adjustments, changes in the mixture proportions, are to be made by a Class III Certified Technician representing the Contractor. After the mixture design has been verified and adjustments made, verification test results will be reviewed by the Engineer.

907-799.05.1--Field Verification and Slump Loss of Class DS Concrete Mixture Designs.

Prior to placement of Class DS concrete mixture, the Contractor shall provide test results of a slump loss test using approved methods to demonstrate that the mixture meets the four-hour requirement in Subsection 803.03.2.7.1. The Contractor shall notify the Department 48 hours prior to performing the slump loss test. These tests shall be conducted successfully by an approved testing laboratory during the installation of the trial shaft, with personnel from the Department present. As an alternative, the slump loss test can be performed prior to the installation of the trial shaft.

The slump loss test shall be conducted at temperatures and conditions similar to those expected at the job site at the time of the installation of the trial shaft. The sample for the slump loss test shall be from a minimum batch size of four (4) cubic yards of concrete. If the temperature between a successful slump loss test and the installation of the production shaft exceeds 10°F above the concrete temperature, another successful slump loss test shall be performed on the first truckload of concrete as part of the installation of the trial shaft. The requirement to limit the time between the previous slump loss test and an installation of the trial shaft also applies to Class DS concrete mixture designs being transferred from another project. During any shaft installation a slump loss test shall be conducted by the Contractor at the direction of the Engineer from the concrete at the site for verification of slump loss requirements using a sample from a minimum batch size of four cubic yards of concrete.

907-799.05.2--Field Verification of Class BDO and Class WT Concrete Mixture Designs.

Prior to mixture design submittal, the Contractor shall perform a field verification on Class BDO and Class WT concrete mixture designs and submit the field verification data and batch ticket information as part of the mixture submittal.

In addition to the requirements in Subsection 907-799.03.3, this documentation must indicate that the mixture achieves the requirements in Table 1 for:

- the compressive strengths required for acceptance within 28 days;
- the compressive strengths required for early opening to traffic within the time specified by the Engineer; and
- if the maturity method is to be used to estimate the compressive strength for early opening to traffic, the strength/maturity relationship shall be verified within 10% of the predicted compressive strength value determined by the maturity curve following the requirements of AASHTO T325 during the field verification.

907-799.06--Adjustments of Mixtures. The mixture design may be adjusted by the Class III Certified Technician representing the Contractor in accordance with the allowable revisions listed in paragraph 5.7 of the Department's *Concrete Manual*. Written notification shall be submitted to the Engineer a minimum of seven (7) days prior to any source or brand of material change, aggregate size change, allowable material type change, or decrease in any cementitious material content. Any adjustments of the concrete mixture design shall necessitate repeat of field verification procedure as described in Subsection 907-799.05 and approval by the Engineer.

SECTION 905 - PROPOSAL

Date _____

Mississippi Transportation Commission
Jackson, Mississippi

Sirs: The following proposal is made on behalf of _____
_____ of _____

for constructing the following designated project(s) within the time(s) hereinafter specified.

The plans are composed of drawings and blue prints on file in the offices of the Mississippi Department of Transportation, Jackson, Mississippi.

The Specifications are the current Standard Specifications of the Mississippi Department of Transportation approved by the Federal Highway Administration, except where superseded or amended by the plans, Special Provisions and Notice(s) to Bidders attached hereto and made a part thereof.

I (We) certify that I (we) possess a copy of said Standard and any Supplemental Specifications.

Evidence of my (our) authority to submit the Proposal is hereby furnished. The proposal is made without collusion on the part of any person, firm or corporation. I (We) certify that I (we) have carefully examined the Plans, the Specifications, including the Special Provisions and Notice(s) to Bidders, herein, and have personally examined the site of the work. On the basis of the Specifications, Special Provisions, Notice(s) to Bidders, and Plans, I (we) propose to furnish all necessary machinery, tools, apparatus and other means of construction and do all the work and furnish all the materials in the manner specified. I (We) understand that the quantities mentioned herein are approximate only and are subject to either increase or decrease, and hereby propose to perform any increased or decreased quantities of work at the unit prices bid, in accordance with the above.

I (We) acknowledge that this proposal will be found irregular and/or non-responsive unless a certified check, cashier's check, or Proposal Guaranty Bond in the amount as required in the Advertisement (or, by law) is submitted electronically with the proposal or is delivered to the Contract Administration Engineer prior to the bid opening time specified in the advertisement.

INSTRUCTION TO BIDDERS: Alternate and Optional Items on Bid Schedule.

1. Two or more items entered opposite a single unit quantity WITHOUT DEFINITE DESIGNATION AS "ALTERNATE ITEMS" are considered as "OPTIONAL ITEMS". Bidders may or may not indicate on bids the Optional Item proposed to be furnished or performed WITHOUT PREJUDICE IN REGARD TO IRREGULARITY OF BIDS.
2. Items classified on the bid schedule as "ALTERNATE ITEMS" and/or "ALTERNATE TYPES OF CONSTRUCTION" must be preselected and indicated on bids. However, "Alternate Types of Construction" may include Optional Items to be treated as set out in Paragraph 1, above.
3. Optional items not preselected and indicated on the bid schedule MUST be designated in accordance with Subsection 102.06 prior to or at the time of execution of the contract.
4. Optional and Alternate items designated must be used throughout the project.

I (We) further propose to perform all "force account or extra work" that may be required of me (us) on the basis provided in the Specifications and to give such work my (our) personal attention in order to see that it is economically performed.

I (We) further propose to execute the attached contract agreement (Section 902) as soon as the work is awarded to me (us), and to begin and complete the work within the time limit(s) provided for in the Specifications and Advertisement. I (We) also propose to execute the attached contract bond (Section 903) in an amount not less than one hundred (100) percent of the total of my (our) part, but also to guarantee the excellence of both workmanship and materials until the work is finally accepted.

I (We) shall submit electronically with our proposal or deliver prior to the bid opening time a certified check, cashier's check or bid bond for **five percent (5%) of total bid** and hereby agree that in case of my (our) failure to execute the contract and furnish bond within Ten (10) days after notice of award, the amount of this check (bid bond) will be forfeited to the State of Mississippi as liquidated damages arising out of my (our) failure to execute the contract as proposed. It is understood that in case I am (we are) not awarded the work, the check will be returned as provided in the Specifications.

SECTION 905 -- PROPOSAL (CONTINUED)

I (We) hereby certify by digital signature and electronic submission via Bid Express of the Section 905 proposal below, that all certifications, disclosures and affidavits incorporated herein are deemed to be duly executed in the aggregate, fully enforceable and binding upon delivery of the bid proposal. I (We) further acknowledge that this certification shall not extend to the bid bond or alternate security which must be separately executed for the benefit of the Commission. This signature does not cure deficiencies in any required certifications, disclosures and/or affidavits. I (We) also acknowledge the right of the Commission to require full and final execution on any certification, disclosure or affidavit contained in the proposal at the Commission's election upon award. Failure to so execute at the Commission's request within the time allowed in the Standard Specifications for execution of all contract documents will result in forfeiture of the bid bond or alternate security.

Respectfully Submitted,

DATE _____

Contractor

BY _____
Signature

TITLE _____

ADDRESS _____

CITY, STATE, ZIP _____

PHONE _____

FAX _____

E-MAIL _____

(To be filled in if a corporation)

Our corporation is chartered under the Laws of the State of _____ and the names, titles and business addresses of the executives are as follows:

_____ President	_____ Address
_____ Secretary	_____ Address
_____ Treasurer	_____ Address

The following is my (our) itemized proposal.

Widening on I-10 at MS 605 WB Ramp, known as Federal Aid Project No. NHPP-0010-01(185) / 109879301 in Harrison County.

Line no.	Item Code	Adj Code	Quantity	Units	Description[Fixed Unit Price]
Roadway Items					
0010	202-B063		23	Square Yard	Removal of Concrete Paved Ditch
0020	202-B117		3	Each	Removal of Delineator, All Types
0030	202-B136		115	Linear Feet	Removal of Guard Rail
0040	202-B188		930	Square Yard	Removal of Pavement, All Types and Depths
0050	202-B215		8	Each	Removal of Sign Including Post & Footing
0060	203-A001	(E)	137	Cubic Yard	Unclassified Excavation, FM, AH
0070	203-EX017	(E)	649	Cubic Yard	Borrow Excavation, AH, FME, Class B7
0080	209-A005		3,647	Square Yard	Geotextile Stabilization, Type V, Non-Woven
0090	211-B001	(E)	633	Cubic Yard	Topsoil for Slope Treatment, Contractor Furnished Guardrail
0100	213-C001		1	Ton	Superphosphate Shoulder
0110	215-A001		4	Ton	Vegetative Materials for Mulch
0120	216-A001		133	Square Yard	Solid Sodding
0130	219-A001		3	Thousand Gallon	Watering (\$20.00)
0140	220-A001		1	Acre	Insect Pest Control (\$30.00)
0150	221-A001	(S)	23	Cubic Yard	Concrete Paved Ditch
0160	225-A001		2	Acre	Grassing
0170	225-B001		1	Ton	Agricultural Limestone
0180	226-A001		2	Acre	Temporary Grassing
0190	237-A002		300	Linear Feet	Wattles, 20"
0200	246-B001		30	Each	Rockbags
0210	406-D001		4,968	Square Yard	Fine Milling of Bituminous Pavement, All Depths
0220	503-C010		1,165	Linear Feet	Saw Cut, Full Depth
0230	602-A001	(S)	1,780	Pounds	Reinforcing Steel
0240	619-A1002		5,488	Linear Feet	Temporary Traffic Stripe, Continuous White
0250	619-A2002		1,568	Linear Feet	Temporary Traffic Stripe, Continuous Yellow
0260	619-A5001		3,730	Linear Feet	Temporary Traffic Stripe, Detail
0270	619-A6001		174	Square Feet	Temporary Traffic Stripe, Legend
0280	619-A6002		176	Linear Feet	Temporary Traffic Stripe, Legend
0290	619-D1001		8	Square Feet	Standard Roadside Construction Signs, Less than 10 Square Feet
0300	619-D2001		96	Square Feet	Standard Roadside Construction Signs, 10 Square Feet or More
0310	619-F1001		1,300	Linear Feet	Concrete Median Barrier, Precast
0320	619-F2001		1,300	Linear Feet	Remove and Reset Concrete Median Barrier, Precast
0330	619-G4005		12	Linear Feet	Barricades, Type III, Single Faced
0340	619-G5001		20	Each	Free Standing Plastic Drums
0350	619-J1005		1	Each	Impact Attenuator, 70 MPH

Line no.	Item Code	Adj Code	Quantity	Units	Description[Fixed Unit Price]
0360	619-J2005		1	Each	Impact Attenuator, 70 MPH, Replacement Package
0370	619-J3001		2	Each	Remove and Reset Impact Attenuator
0380	620-A001		1	Lump Sum	Mobilization
0390	630-A001		69	Square Feet	Standard Roadside Signs, Sheet Aluminum, 0.080" Thickness
0400	630-A003		36	Square Feet	Standard Roadside Signs, Sheet Aluminum, 0.125" Thickness
0410	630-B002		502	Square Feet	Interstate Directional Signs, Bolted Extruded Aluminum Panels, Ground Mounted
0420	630-C001		169	Linear Feet	Square Tube Posts, 4.0 lb/ft
0430	630-C002		24	Linear Feet	Steel U-Section Posts, 2.0 lb/ft
0440	630-C1001		81	Linear Feet	Square Post Inner Sleeve
0450	630-D005		79	Linear Feet	Structural Steel Beams, W12 x 26
0460	630-D009		75	Linear Feet	Structural Steel Beams, W8 x 18
0470	630-E002		74	Pounds	Structural Steel Angles & Bars, 3" x 3" x 1/4" Angles
0480	630-E003		142	Pounds	Structural Steel Angles & Bars, 4" x 4" x 5/16" Angles
0490	630-E004		276	Pounds	Structural Steel Angles & Bars, 7/16" x 2 1/2" Flat Bar
0500	630-F010		23	Each	Delineators, Post Mounted, Double White
0510	630-F011		1	Each	Delineators, Post Mounted, Double Yellow
0520	630-F012		5	Each	Delineators, Post Mounted, Single White
0530	630-F013		4	Each	Delineators, Post Mounted, Single Yellow
0540	699-A001		1	Lump Sum	Roadway Construction Stakes
0550	907-234-A001		2,500	Linear Feet	Temporary Silt Fence
0560	907-403-A006	(BA1)	839	Ton	19-mm, ST, Asphalt Pavement
0570	907-403-D001	(BA1)	335	Ton	12.5-mm, HT, Asphalt Pavement, Polymer Modified
0580	907-403-D003	(BA1)	839	Ton	19-mm, HT, Asphalt Pavement, Polymer Modified
0590	907-403-D007	(BA1)	703	Ton	9.5-mm, HT, Asphalt Pavement, Polymer Modified
0600	907-407-A001	(A2)	1,329	Gallon	Asphalt for Tack Coat
0610	907-601-B001	(S)	12	Cubic Yard	Class "B" Structural Concrete, Minor Structures
0620	907-618-A001		1	Lump Sum	Maintenance of Traffic
0630	907-618-M2001		300	Hours	Work Zone Law Enforcement (\$60.00)
0640	907-619-E3001		1	Each	Changeable Message Sign
0650	907-626-B005		1,124	Linear Feet	6" Thermoplastic Traffic Stripe, Continuous White
0660	907-626-C013		1,620	Linear Feet	6" Thermoplastic Edge Stripe, Continuous White
0670	907-626-F006		795	Linear Feet	6" Thermoplastic Edge Stripe, Continuous Yellow
0680	907-626-G004		2,159	Linear Feet	Thermoplastic Detail Stripe, White
0690	907-626-H009		241	Square Feet	Thermoplastic Legend, White
0700	907-626-H010		88	Linear Feet	Thermoplastic Legend, White
0710	907-627-K001		107	Each	Red-Clear Reflective High Performance Raised Markers

ALTERNATE GROUP AA NUMBER 1

Line no.	Item Code	Adj Code	Quantity	Units	Description[Fixed Unit Price]
0720	304-F001	(GT)	1,316	Ton	3/4" and Down Crushed Stone Base
ALTERNATE GROUP AA NUMBER 2					
0730	304-F002	(GT)	1,316	Ton	Size 610 Crushed Stone Base
ALTERNATE GROUP AA NUMBER 3					
0740	304-F003	(GT)	1,316	Ton	Size 825B Crushed Stone Base

For Informational Purposes Only

SECTION 905 - COMBINATION BID PROPOSAL (Continued)

CONDITIONS FOR COMBINATION BID

If a bidder elects to submit a combined bid for two or more of the contracts listed for this month's letting, the bidder must complete and execute these sheets of the proposal in each of the individual proposals to constitute a combination bid. In addition to this requirement, each individual contract shall be completed, executed and submitted in the usual specified manner.

Failure to execute this Combination Bid Proposal in each of the contracts combined will be just cause for each proposal to be received and evaluated as a separate bid.

It is understood that the Mississippi Transportation Commission not only reserves the right to reject any and all proposals, but also the right to award contracts upon the basis of lowest separate bids or combination bids most advantageous to the State.

It is further understood and agreed that the Combination Bid Proposal is for comparison of bids only and that each contract shall operate in every respect as a separate contract in accordance with its proposal and contract documents.

I (We) agree to complete each contract on or before its specified completion date.

COMBINATION BID PROPOSAL

This proposal is tendered as one part of a Combination Bid Proposal utilizing option ___* of Subsection 102.11 on the following contracts:

* Option to be shown as either (a), (b), or (c).

	<u>Project No.</u>	<u>County</u>	<u>Project No.</u>	<u>County</u>
1.	_____	_____	6.	_____
2.	_____	_____	7.	_____
3.	_____	_____	8.	_____
4.	_____	_____	9.	_____
5.	_____	_____	10.	_____

(a) If Combination A has been selected, your Combination Bid is complete.

(b) If Combination B has been selected, then complete the following page.

SECTION 905 - COMBINATION BID PROPOSAL (Continued)

Project Number	Pay Item Number	Unit	Unit Price Reduction	Total Item Reduction	Total Contract Reduction
1.					
2.					
3.					
4.					
5.					
6.					
7.					
8.					

For Informational Purposes Only

SECTION 905 - COMBINATION BID PROPOSAL (Continued)

Project Number	Pay Item Number	Unit	Unit Price Reduction	Total Item Reduction	Total Contract Reduction
9.					
10.					

(c) If Combination C has been selected, then initial and complete ONE of the following.

_____ I (We) desire to be awarded work not to exceed a total monetary value of \$ _____.

_____ I (We) desire to be awarded work not to exceed _____ number of contracts.

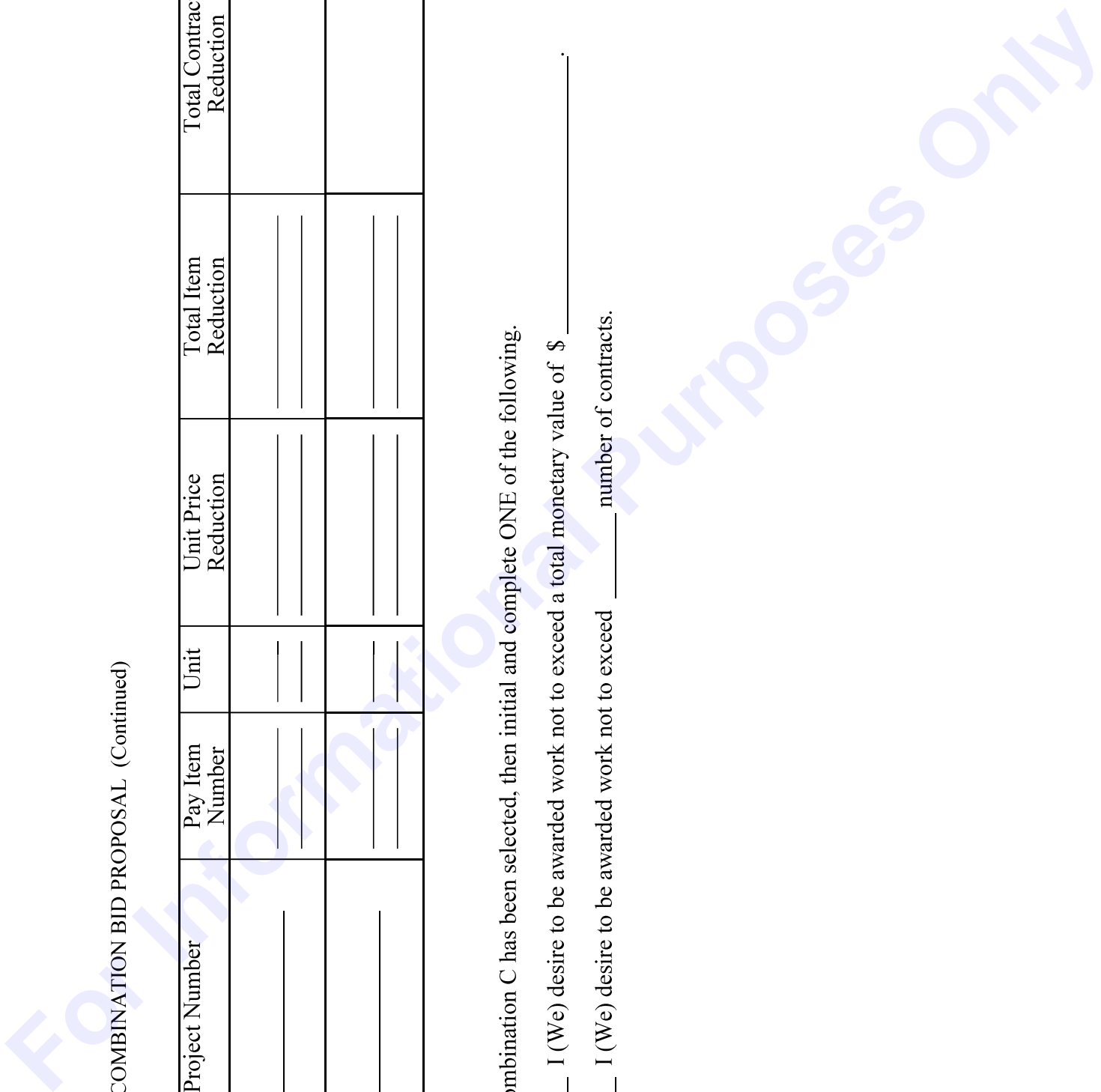

**Certification with regard to the Performance of Previous
Contracts or Subcontracts subject to the Equal Opportunity
Clause and the filing of Required Reports**

The Bidder hereby certifies that he has _____, has not _____, participated in a previous contract or subcontract subject to the Equal Opportunity Clause, as required by Executive Orders 10925, 11114, or 11246, and that he has _____, has not _____, filed with the Joint Reporting Committee, the Director of the Office of Federal Contract Compliance, a Federal Government contracting or administering agency, or the former President's Committee on Equal Employment Opportunity, all reports due under the applicable filing requirements.

(COMPANY)

DATE: _____

NOTE: The above certification is required by the Equal Employment Opportunity Regulations of the Secretary of Labor (41 CFR 60-1.7 (b) (1)), and must be submitted by bidders and proposed subcontractors only in connection with contracts and subcontracts which are subject to the Equal Opportunity Clause. Contracts and Subcontracts which are exempt from the Equal Opportunity Clause are set forth in 41 CFR 60-1.5. (Generally only contracts or subcontracts of \$10,000 or under are exempt.)

Currently, Standard Form 100 (EEO-1) is the only report required by the Executive Orders or their implementing regulations.

Proposed prime Contractors and Subcontractors who have participated in a previous contract or subcontract subject to the Executive orders and have not filed the required reports should note that 41 CFR 60-1.7 (b) (1) prevents the award of contracts and subcontracts unless such Contractors submit a report covering the delinquent period or such other period specified by the Federal Highway Administration or by the Director, Office of Federal Contract Compliance, U. S. Department of Labor.

MISSISSIPPI DEPARTMENT OF TRANSPORTATION
CERTIFICATION

I, _____,
(Name of person signing bid)

individually, and in my capacity as _____ of
(Title of person signing bid)

_____ do hereby certify under
(Name of Firm, partnership, or Corporation)

penalty of perjury under the laws of the United States and the State of Mississippi that _____

_____, Bidder
(Name of Firm, Partnership, or Corporation)

on Project No. **NHPP-0010-01(185)/ 109879301000**

in **Harrison** County(ies), Mississippi, has not either

directly or indirectly entered into any agreement, participated in any collusion; or otherwise taken any action in restraint of free competitive bidding in connection with this contract; nor have any of its corporate officers or principal owners.

Except as noted hereafter, it is further certified that said legal entity and its corporate officers, principal owners, managers, auditors and others in a position of administering federal funds:

- a) Are not presently debarred, suspended, proposed for debarment, declared ineligible, or voluntarily excluded from covered transactions by any Federal department or agency;
- b) Have not within a three-year period preceding this proposal been convicted of or had a civil judgment rendered against them for commission of fraud or a criminal offense in connection with obtaining, attempting to obtain, or performing a public (Federal, State or local) transaction or contract under a public transaction; violation of Federal or State antitrust statutes or commission of embezzlement, theft, forgery, bribery, falsification or destruction of records, making false statements, or receiving stolen property;
- c) Are not presently indicted for or otherwise criminally or civilly charged by a governmental entity (Federal, State or local) with commission of any of the offenses enumerated in (b) above; and
- d) Have not within a three-year period preceding this application/ proposal had one or more public transactions (Federal, State or local) terminated for cause or default.

Do exceptions exist and are made a part thereof? Yes / No

Any exceptions shall address to whom it applies, initiating agency and dates of such action.

Note: Exceptions will not necessarily result in denial of award but will be considered in determining bidder responsibility. Providing false information may result in criminal prosecution or administrative sanctions.

The bidder further certifies that the certification requirements contained in Section XI of Form FHWA 1273, will be or have been included in all subcontracts, material supply agreements, purchase orders, etc. except those procurement contracts for goods or services that are expected to be less than the Federal procurement small purchase threshold fixed at 10 U.S.C. 2304(g) and 41 U.S.C. 253(g) (currently \$25,000) which are excluded from the certification requirements.

The bidder further certifies, to the best of his or her knowledge and belief, that:

1) No Federal appropriated funds have been paid or will be paid to any person for influencing or attempting to influence an officer or employee of any Federal agency, a Member of Congress, an officer or employee of Congress, or an employee of a Member of Congress in connection with the awarding of any Federal contract, the making of any Federal grant, the making of any Federal loan, the entering into of any cooperative agreement, and the extension, continuation, renewal, amendment, or modification of any Federal contract, grant, loan, or cooperative agreement.

2) If any funds other than Federal appropriated funds have been paid or will be paid to any person for influencing or attempting to influence an officer or employee of any Federal agency, a Member of Congress, an officer or employee of Congress, or an employee of a Member of Congress in connection with this contract, Standard Form-LLL, Disclosure Form to Report Lobbying, in accordance with its instructions will be completed and submitted.

The certification contained in (1) and (2) above is a material representation of fact upon which reliance is placed and a prerequisite imposed by Section 1352, Title 31, U.S. Code prior to entering into this contract. Failure to comply shall be subject to a civil penalty of not less than \$10,000 and not more than \$100,000. The bidder shall include the language of the certification in all subcontracts exceeding \$100,000 and all subcontractors shall certify and disclose accordingly.

All of the foregoing is true and correct.

Executed on _____

Signature

MISSISSIPPI DEPARTMENT OF TRANSPORTATION

SAM.GOV Registration and Unique Entity ID

Bidders are advised that the Prime Contractor must register and maintain a current registration in the **System for Award Management** (<http://sam.gov>) at all times during the project. Upon registration, the Contractor will be assigned a SAM Unique Entity ID.

Bidders are advised that prior to the award of this contract, they MUST be registered in the System for Award Management.

I (We) acknowledge that this contract cannot be awarded if I (We) are not registered in the System for Award Management prior to the award of this contract. _____ (Yes / No)

I (We) have a SAM Unique Entity ID. _____ (Yes / No)

SAM Unique Entity ID: _____

Company Name: _____

Company e-mail address: _____

SECTION 902

CONTRACT FOR _____
LOCATED IN THE COUNTY(IES) OF _____

STATE OF MISSISSIPPI
COUNTY OF HINDS

This Contract is entered into by and between the Mississippi Transportation Commission (the "Commission") and the undersigned contractor (the "Contractor"), as follows:

As consideration for this Contract, the Commission agrees to pay the Contractor the amount(s) set out in the Proposal attached hereto. Said payment will be made in the manner and at the time(s) specified in the Specifications and/or Special Provisions, if any. In exchange for said consideration, the Contractor hereby agrees to accept the prices stated in the Proposal as full compensation for the furnishing of all labor, materials and equipment, and the execution of the scope of work identified for this referenced Project as contemplated in this Contract, and as more fully outlined in the Contract Documents (the "Work"). The Contract Documents consist of the Advertisement, the Notice to Bidders, the Proposal, the Specifications, the Special Provisions, and the approved Plans, all of which are hereby made a part of this Contract and incorporated herein by reference.

The Contractor shall be responsible for all loss or damage arising out of, or in any way in connection with the Work, or from any unforeseen obstructions or difficulties that may be encountered in the prosecution of the Work, and for all risks of every description connected with the Work, with the exception of any items specifically excluded in the Contract Documents. The Contractor shall fully and faithfully complete the Work in a good and workmanlike manner, according to the Contract Documents and any Supplemental Agreements thereto.

The Contractor further agrees that the Work shall be done under the direct supervision of, and to the complete satisfaction of, the Executive Director of the Mississippi Department of Transportation, or his authorized representative(s), and, when federal funds are involved, subject to the inspection and approval of the Federal Highway Administration, or its agents, and/or the agents of any other state or federal agency whose funds are involved. Further, the Work shall be done in accordance with any applicable state and federal laws, and any such rules and regulations issued by the Commission and/or any relevant Federal Agency.

The Contractor agrees that all labor as outlined in the Contract Documents may be secured from a list furnished by the Manager of the Win Job Center nearest the project location, or any successor thereto.

It is agreed and understood that each and every provision of law and clause required by law to be inserted into this Contract shall be deemed to be inserted herein, and this Contract shall be read and enforced as though it were included herein. If through mere mistake or otherwise, any such provision is not inserted, then upon the application of either party hereto, the Contract shall be physically amended to make such insertion.

The Contractor agrees that he has read each and every clause of the Contract Documents, and fully understands the meaning of same, and hereby acknowledges that he will comply with all terms, covenants and agreements therein.

Witness our signatures, this the ____ day of _____, 20__.

Contractor

By: _____
Title: _____

Signed and sealed in the presence of: (name and address of witness)

MISSISSIPPI TRANSPORTATION COMMISSION

Executive Director

Secretary to the Commission

Award authorized by the Mississippi Transportation Commission in session on the ____ day of _____, _____, Minute Book No. _____, Page No. _____.

**SECTION 903
PERFORMANCE BOND**

PERFORMANCE BOND FOR THE FOLLOWING CONTRACT:

Project No.: _____

For the construction of: _____

Contract date: _____ Contract Price: _____

FOR OWNER: MISSISSIPPI TRANSPORTATION COMMISSION, 401 N. WEST STREET, JACKSON, MISSISSIPPI 39201.

CONTRACTOR (full legal name, contact person, phone number and address):

SURETY (legal name, phone number, principal place of business and address *for notice purposes*):

Second Surety (if applicable):

The Contractor and Surety, jointly and severally, bind themselves, their heirs, executors, administrators, successors and assigns, to the Owner for the performance of the Contract, which is incorporated herein by reference, and subject to the following terms:

1. If the Contractor fully and faithfully performs the Contract, the Surety and the Contractor shall have no obligation under this Bond.
2. The Surety's obligation under this Bond shall arise after:
 - (a) the Owner first provides notice to the Contractor and the Surety that termination is imminent, pursuant to the current edition of the Mississippi Standard Specifications for Road and Bridge Construction, which is a part of the Contract; and
 - (b) the Owner declares a Contractor Default, terminates the Contract, and notifies the Surety.
3. Within 20 calendar days as set forth in Section 108.08 of the current edition of the Mississippi Standard Specifications for Road and Bridge Construction, the Surety shall, after discussions with and consent from the Owner, and at the Surety's expense, elect to take one of the following actions:
 - (a) Arrange for the Contractor, with the consent of the Owner, to perform and complete the Contract;
 - (b) Undertake to perform and complete the Contract itself, through its agents or independent contractors;
 - (c) Waive its right to perform and complete, arrange for completion, or obtain a new contractor, and after investigation, determine the amount for which it may be liable to the Owner (subject to the consent of the Owner) and as soon as practicable after the amount is determined, make payment to the Owner.

4. If the Surety does not proceed, within a reasonable time frame, to enact and carry out the election made in Paragraph 3, then the Surety shall be deemed to be in default on this Bond, and the Owner shall be entitled to enforce any remedy available to it under the Contract and applicable law.
5. Subject to the commitment by the Owner to pay the Balance of the Contract Price, the Surety is obligated, without duplication, for
 - (a) the responsibilities of the Contractor for correction of defective work and completion of the Contract;
 - (b) additional legal, design professional and delay costs resulting from the Contractor's Default, and resulting from the actions or failure to act of the Surety under Paragraph 3; and
 - (c) liquidated damages, or if no liquidated damages are specified in the Contract, actual damages caused by delayed performance or non-performance of the Contractor.
6. The Surety hereby waives notice of any change, including changes of time, to the Contract or to related subcontracts, purchase orders and other obligations.
7. The penal sum of the Bond shall be equal to the Contract Price; however, the penal sum may be increased or decreased as the result of any subsequent Supplemental Agreements and/or final contract quantities.
8. Notice to the Surety, the Owner or the Contractor shall be mailed or delivered to the address listed for notice purposes on the first page of this Bond.

CONTRACTOR AS PRINCIPAL

Company: _____

Signature: _____

Name: _____

Title: _____

Address: _____

SURETY

Company: _____

Signature: _____

MS Insurance ID # _____

Name: _____

Title: _____

Address: _____

SURETY (if applicable)

Company: _____

Signature: _____

MS Insurance ID # _____

Name: _____

Title: _____

Address: _____

**SECTION 903
PAYMENT BOND**

PAYMENT BOND FOR THE FOLLOWING CONTRACT:

Project No.: _____

For the construction of: _____

Contract date: _____ Contract Price: _____

**FOR OWNER: MISSISSIPPI TRANSPORTATION COMMISSION, 401 N. WEST STREET,
JACKSON, MISSISSIPPI 39201.**

CONTRACTOR (full legal name, contact person, phone number and address):

SURETY (legal name, phone number, principal place of business and address *for notice purposes*):

Second Surety (if applicable):

The Contractor and Surety, jointly and severally, bind themselves, their heirs, executors, administrators, successors and assigns, to the Owner for payment of labor, materials and equipment furnished for use in the performance of the Contract, which is incorporated herein by reference, subject to the following terms:

1. If the Contractor promptly makes payment of all sums due to any and all subcontractors, sub-subcontractors, suppliers to the Contractor, suppliers to subcontractors and/or laborers who have performed work on the project site, and defends, indemnifies and holds harmless the Owner from claims, demands, liens or suits by any person or entity seeking payment for labor, materials or equipment furnished for use in the performance of the Contract, then the Surety and the Contractor shall have no obligation under this Bond.
2. The Owner shall provide notice to the Surety of any claims, demands, liens or suits against the Owner or the Owner's property that it receives from any person or entity ("Claimants") seeking payment for labor, materials or equipment furnished for use in the performance of the Contract.
3. Upon notice of any claims, demands, liens or suits provided by the Owner or Contractor or given to the Surety by a Claimant, the Surety shall promptly and at the Surety's expense, defend, indemnify and hold harmless the Owner against said claim, demand, lien or suit and shall take the following additional actions:
 - (a) Send an answer to the Claimant, with a copy to the Owner, within sixty (60) days after receipt of the Claim, stating the amounts that are undisputed and the basis for challenging any amounts that are disputed; and
 - (b) Pay or arrange for payment of any undisputed amounts.

4. The Surety shall not be liable to the Owner, Claimants or others for obligations of the Contractor that are unrelated to the Contract. The Owner shall not be liable for the payment of any costs or expenses of any Claimant under this Bond and shall have no obligation under this Bond to make payments to, or give notice on behalf of, Claimants, or otherwise have any obligations to Claimants under this Bond.
5. The Surety hereby waives notice of any change, including changes of time, to the Contract or to related subcontracts, purchase orders and other obligations.
6. The penal sum of the Bond shall be equal to the Contract Price; however, the penal sum may be increased or decreased as the result of any subsequent Supplemental Agreements and/or final contract quantities.

CONTRACTOR AS PRINCIPAL

Company: _____
Signature: _____
Name: _____
Title: _____
Address: _____

SURETY

Company: _____
Signature: _____
Name: _____
Title: _____
Address: _____

MS Insurance ID # _____

SURETY (if applicable)

Company: _____
Signature: _____
Name: _____
Title: _____
Address: _____

MS Insurance ID # _____



BID BOND

KNOW ALL MEN BY THESE PRESENTS, that we _____
Contractor

Address

City, State ZIP

As principal, hereinafter called the Principal, and _____
Surety

a corporation duly organized under the laws of the state of _____

as Surety, hereinafter called the Surety, are held and firmly bound unto State of Mississippi, Jackson, Mississippi

As Obligee, hereinafter called Obligee, in the sum of **Five Per Cent (5%) of Amount Bid**

Dollars(\$ _____)

for the payment of which sum will and truly to be made, the said Principal and said Surety, bind ourselves, our heirs, executors, administrators, successors and assigns, jointly and severally, firmly by these presents.

WHEREAS, the Principal has submitted a bid for **Widening on I-10 at MS 605 WB Ramp, known as Federal Aid Project No. NHPP-0010-01(185) / 109879301 in Harrison County.**

NOW THEREFORE, the condition of this obligation is such that if the aforesaid Principal shall be awarded the contract, the said Principal will, within the time required, enter into a formal contract and give a good and sufficient bond to secure the performance of the terms and conditions of the contract, then this obligation to be void; otherwise the Principal and Surety will pay unto the Obligee the difference in money between the amount of the bid of the said Principal and the amount for which the Obligee legally contracts with another party to perform the work if the latter amount be in excess of the former, but in no event shall liability hereunder exceed the penal sum hereof.

Signed and sealed this _____ day of _____, 20__

(Principal) (Seal)

(Witness) (Name) By: _____ (Title)

(Surety) (Seal)

(Witness) (Attorney-in-Fact) By: _____

(MS Agent)

Mississippi Insurance ID Number