

Mississippi Department of Transportation

REQUEST FOR PROPOSALS

A DESIGN-BUILD PROJECT

Improvements to Interstate 55
Lincoln and Copiah Counties, Mississippi

Project Numbers

DB/IM-0055-02(228)/105444-305

DB/IM-0055-02(228)/105444-306

August 31, 2012

TABLE OF CONTENTS

	Page Number
I. PURPOSE OF REQUEST FOR PROPOSALS	1
II. OVERVIEW	1
Project Goals	1
Project Information	1
Current Project Cost Estimate	4
Proposal Stipend	4
III. GENERAL INSTRUCTIONS	4
Pre-Proposal Meeting	4
Questions.....	4
Proposal Submittal	5
IV. PROJECT SCOPE	6
V. PROPOSAL DEVELOPMENT	6
Volume 1 – Technical Proposal	7
Volume 2 – Contract Price Proposal	9
VI. ESCROW PROPOSAL DOCUMENTS	10
VII. EVALUATION OF PROPOSALS	10
VIII. CRITERIA FOR SCORING	10
Compliance with the RFP Requirements	11
Management Approach	11
Technical Solutions	11
Quality Management Plan	11
Schedule	11
Selection of Contractor	12
IX. GENERAL INFORMATION	13
X. MILESTONE SCHEDULE	13

The Following are Contract Documents and are available on the Project Web Site (www.GoMDOT.com):

- Section 904
- Section 906
- Section 907
- Technical Requirements
- Section 905
- Section 902 and Exhibits
- Section 903

I. PURPOSE OF REQUEST FOR PROPOSALS

The purpose of this Request for Proposals (“RFP”) is to select a Proposer to perform the Project services described in this RFP. “Proposer,” as used here, includes a firm or firms, partnership, joint venture, or other legal entity, which has been requested by the Mississippi Transportation Commission (“Commission”) to submit a Proposal in response to this RFP. The “CONTRACTOR”, as used here, is defined as the selected Proposer with whom the Contract is executed.

The Commission is requesting a Contract Price, Best-Value Proposal. It is not the intention of the Commission to receive complete detailed Project analysis and design prior to the selection of a Proposer and the later execution of a Contract. Rather, the response to this RFP shall provide sufficient information to be evaluated in accordance with the specified process and criteria. The Proposal shall be specific enough on assumptions used in its preparation so as to provide the basis for determining a final Contract.

II. OVERVIEW

Project Goals

The following are the Commission’s goals for the Project:

- Anticipated issuance of Notice to Proceed for the Contract is as specified in Section X, Milestone Schedule;
- The Final Completion Date shall be as described in the Contractor’s Schedule Certificate.
- Design and construction of a Project of the highest quality that has reasonably maintainable, easily inspectable, long lasting bridges and roadways;
- A safe Project for all parties involved and the public;
- A Project that is sensitive to the environment and the community;
- A Project that is designed and built to maximize the amount of scope identified in the RFP without the Contract Price exceeding ten million dollars (\$10,000,000.00).

Project Information

The bridges on I-55 in Lincoln and Copiah Counties, as defined in the Section 904 – NTP No. 2618-D3-1 DB and the Contractor’s Schedule Certificate will be widened, repaired or reconstructed to meet the current MDOT Standards. This work may include repairs to the bridge end pavement and roadway pavement at I-55 over Tyson Road, clearing and site improvements at the SR 27 interchange, widening of the bridges at all other bridge sites listed below, bearing replacement as necessary, minor existing structural repairs as necessary, bridge joint repairs and lowering of the undercrossing roadway at SR 27, SR 28 and Gallman Road to meet the vertical clearance requirements.

Construction of the Project will be within Mississippi Department of Transportation (MDOT) right-of-way. The Commission intends to secure the Categorical Exclusion for the construction of the Project and the Stormwater Permit. Any additional permits required will be the responsibility of the Proposer.

Project services shall include but are not limited to:

- Design Services – complete development of construction plans
- Quality Control (QC) of design
- Construction Services necessary to build and ensure high quality workmanship of the designed facility
- Utility Coordination

The project shall include the following bridge sites:

1. I-55 NB and I-55 SB over County Line Road(Mile Marker 74.3)
 - Widen both bridges to meet the project requirements.
 - Project Limits - 100 feet in advance of the existing or proposed guardrail to a distance of 100 feet beyond the end of the bridge.
2. I-55 NB and I-55 SB over SR 27 (Mile Marker 72.0)
 - Widen both bridges to meet the project requirements.
 - Lower SR 27 Roadway to meet the 16.5 foot vertical clearance requirement at the I-55 Bridges.
 - Lower the embankment material in the gore area between I-55 SB and I-55 SB Entrance Ramp.
 - Clear the trees in the gore area between I-55 NB and the I-55 NB Entrance Ramp.
 - Project Limits – The area within the ROW as defined by I-55 Station 1205+00 to I-55 Station 1230+00 and SR 27 Station 315+00 to SR 27 Station 324+00.
3. I-55 NB and I-55 SB over Clear Creek Road (Mile Marker 66.1)
 - Widen both bridges to meet the project requirements.
 - Project Limits - 100 feet in advance of the existing or proposed guardrail to a distance of 100 feet beyond the end of the bridge.
4. I-55 NB and I-55 SB over Gallman Road (Mile Marker 65.5)
 - Widen both bridges to meet the project requirements.
 - Lower Gallman Road to meet the 16.5 foot vertical clearance requirement at the I-55 Bridges.
 - Project Limits – On I-55, 100 feet in advance of the existing or proposed guardrail to a distance of 100 feet beyond the end of the bridge. On Gallman Road, from Station 11+00 to Station 26+00 on the as-built plans.

The Contractor may include the following bridge sites in the following order:

1. I-55 NB and I-55 SB over SR 28 (Mile Marker 61.8)
 - Widen both bridges to meet the project requirements.
 - Lower SR 28 Roadway to meet the 16.5 foot vertical clearance requirement at the I-55 Bridges.
 - Project Limits – On I-55, 100 feet in advance of the existing or proposed guardrail to a distance of 100 feet beyond the end of the bridge. On SR 28, from Station 123+50 to Station 133+00 on the as-built plans.
2. I-55 NB over Tyson Road (Mile Marker 55.8) (Pavement Repairs)
 - Replace the approach bridge end pavement to be flush with the bridge deck, replace the deteriorated roadway pavement at the exit end of the bridge.
 - Project Limits - 50 feet in advance of the existing bridge to a distance of 150 feet beyond the end of the bridge.
3. I-55 NB and I-55 SB over US 84 (Mile Marker 37.5)
 - Widen both bridges to meet the project requirements.
 - Project Limits - 100 feet in advance of the existing or proposed guardrail to a distance of 100 feet beyond the end of the bridge.

Note: Bridge site at US 84 will be included in the project only if it is not included in the Pike and Lincoln Counties Design-Build Project Nos. DBIM-0055-02(226)/105444-303 and DBIM-0055-02(226)/105444-304.

The Proposers will be required to determine the maximum number of bridge site locations to be widened, as described in Section 904 – NTP No. 2618-D3-1 DB for as many of the bridge locations that can be widened or replaced up to a maximum lump sum proposal price of \$10 Million.

The Commission may utilize a separate Firm to provide MDOT with Project Management Assistance. MDOT will be responsible for the Construction Inspection and Job Acceptance Testing in accordance with the Mississippi Standard Specification for Roadway and Bridge Construction; however, the Proposer's Design Engineering Firm will be responsible for Design Quality Control. The Contractor will be responsible to provide the Pile Dynamic Analysis (PDA) and pile driving criteria and to provide the quality control testing for asphalt and concrete.

The Project has been approved as a Categorical Exclusion (CE). As Built plans of the bridges are provided to the Proposers. The Proposer shall be responsible for completing all necessary investigations, permits and design.

The submittal of a Proposal in response to this RFP, with all required signatures, shall constitute the Proposer's agreement to enter into a contract with the Commission for the completion of the Project under the terms set forth in the Contract. The terms of the Contract are not negotiable.

The Commission values a partnering approach on projects and as such this Project will require regular Partnering Sessions.

The contract for this Project contains a Disadvantaged Business Enterprise (DBE) goal of ten percent (10%) of the Contract Price. The Proposer shall submit a DBE committal sheet (OCR-485) and a Disadvantaged Business Enterprise List (OCR-481) with their Submittal of Contract Price Proposal (Volume 2).

Current Project Cost Estimate

The maximum Contract Price is \$10 Million for this Project. If the maximum proposed Contract Price is exceeded, the Proposal shall be considered non-responsive.

Proposal Stipend

A stipend in the amount of \$30,000.00 will be paid to each responsive Proposer not selected as the successful Proposer. Upon acceptance of payment of the stipend, the responsive Proposer agrees that the entire Proposal shall become the exclusive property of the Commission.

III. GENERAL INSTRUCTIONS

Pre-Proposal Meeting

A mandatory Pre-Proposal meeting is scheduled for the date as specified in Section X, Milestone Schedules, in the auditorium on the first floor of the MDOT Building, 401 North West Street, Jackson, MS 39201. Shortlisted Proposers are required to have a representative at the Pre-Proposal meeting in order for their Proposal to be considered. The purpose of the meeting is to review the information provided in the RFP and to receive questions from the Proposers.

Questions

Proposers are encouraged to submit written questions at least two days prior to the mandatory Pre-Proposal Meeting. At the mandatory Pre-Proposal Meeting questions will be received from all representatives of the shortlisted Proposers. Written or verbal questions will be accepted at the meeting.

Only the Project Director may submit questions or request clarifications relating to the RFP after the Pre-Proposal Meeting. These inquiries must be in writing and must be received by the Commission on the date and time as specified in Section X, Milestone Schedule.

RFP questions shall be directed in writing to:

Mr. Mark McConnell, P.E.
Mississippi Department of Transportation

Post Office Box 1850
Jackson, Mississippi 39215-1850

Or by e-mail to: I55CopiahBridgeWidening@mdot.state.ms.us The list of questions received and MDOT's written responses to these questions and any applicable addenda will be posted on the MDOT web page (www.gomdot.com). Proposers are encouraged to check the website often for posting of new information. Proposer shall be solely responsible for checking the website for updates and addenda.

Proposers shall not rely on any responses about the RFP except written responses to questions submitted in writing in accordance with the RFP. No requests for additional information or clarification to any other MDOT office, consultant, or employee will be considered. The Commission will not be responsible for and the Proposer shall not rely on any oral or other exchange of information that occurs outside of the official process for written questions and answers specified herein.

Proposal Submittal

Volume 1 – Technical Proposals must be received by the date and time specified in Section X, Milestone Schedule.

Deliver **ten (10)** copies of the Volume 1 Proposal, sequentially numbered on the lower right hand cover sheet from 1 to 10, and one (1) CD containing the proposals in one (1) to five (5) PDF files to:

Mr. B.B. House, P.E.
Contract Administration Engineer
Mississippi Department of Transportation
401 North West Street
P.O. Box 1850
Jackson, Mississippi 39215-1850
Phone: (601) 359-7730
Fax: (601) 359-7732

Volume 2 – Contract Price Proposal must be received by the date and time specified in Section X, Milestone Schedule.

All Responders/Proposers must visibly mark as “CONFIDENTIAL” each part of their submission that they consider to contain confidential and/or proprietary information. All submittals will be subject to disclosure in accordance with the Mississippi Public Records Act, Miss. Code Ann. § 25-61-1, *et seq.*

IV. PROJECT SCOPE

The Project Scope shall be defined in Section 904 – NTP No. 2618-D3-1 DB (Project Scope). The Proposer shall define the number of bridges included in the Project Scope as indicated on the Contractor's Schedule Certificate.

The Proposer shall submit a proposed schedule and preliminary construction work plan demonstrating how major portions of the Work will be completed, the number of crews anticipated, shifts, and length of work week only for the Work proposed to be completed. The Proposed schedule shall include a realistic date for the Final Completion of proposed Contract Work. The Proposer will be required to certify its proposed schedule and demonstrate how it is achievable and realistic for performance of the Work.

The proposed number of calendar days submitted by the Proposer on the form labeled *Contractor's Schedule Certificate* shall be used as the basis for the assessment of Liquidated Damages included in the Contract.

V. PROPOSAL DEVELOPMENT

The Commission is requesting a Contract Price, Best-Value Proposal that includes a Project schedule commitment for the scope of Work included in this RFP. The price and schedule shall be guaranteed by the Proposer for a minimum of 60 days after the date identified for submission of Contract Price Proposals in Section X, Responses to the RFP, shall:

- Describe the Proposal in sufficient detail that the Commission may determine its cost of bridge locations proposed, scope and intent.
- Describe any assumptions used in developing cost and schedule components of the Proposal.
- Provide a breakdown of Project costs and assumptions used in determination by work phase (design, construction, Project management, and construction management).
- Identify the proposed schedule for implementing the Project, including the total number of calendar days from Notice to Proceed necessary to complete the Project.
- Describe assurances of timely completion of the Project.
- Describe how Project quality will be achieved.

The Proposer is solely responsible for submitting a Proposal that meets the Requirements of the RFP. Assumptions that are not in compliance with the RFP will not relieve the Proposer of the Requirements of the RFP. The submitted Proposal is evaluated for general conformance with the RFP requirements for the purpose of selecting the Best-Value Proposal. While the Proposal becomes a part of the Contract documents, the Contractor's Release for Construction (RFC) plans and designs must meet all the RFP Technical Requirements.

In order that evaluation can be accomplished efficiently, the Proposal shall be prepared in separate volumes, as applicable, in the following sequence:

Volume 1 – Technical Proposal (Marked and Sealed Separately)

The document should not be longer than 50 single-sided double-spaced 8.5 inch by 11 inch pages typed on one side only, excluding appendices. Proposals should use cross-referencing to reduce repetition in explaining the proposed Project. MDOT reserves the right to reject any proposal that is deemed illegible and reserves the right to evaluate only the first 50 pages submitted with the Technical Proposal.

The Technical Proposal will contain the following information:

1. **Executive Summary**
2. **Project Scope** – Describe in detail the proposed horizontal alignment and profile including details that demonstrate Project concepts and understanding. Proposers shall submit plan sheets showing for each bridge site proposed to be completed; bridge plan and elevation, bridge sections, foundation layout and other such details in a separate appendix to the Technical Proposal. Roadway plan and profile drawings shall be included for sites that require roadway adjustment. The Plan Sheets, which can be 11 inch by 17 inch in size, will not count toward the page limitation.

Proposers shall indicate the total number of bridge sites that will be completed on the Contractor's Schedule Certificate, which shall be submitted with Volume 1.

3. **Management Approach** – Describe the overall approach to the Project including a construction staging plan. Management approach shall demonstrate a plan for mobilizing key personnel, equipment and materials and how the Proposer intends to ensure that these are available to meet the Project schedule. Proposer shall identify anticipated major risks and present a plan to manage those risks. Proposer shall demonstrate a plan to manage document control and sound, proven management techniques for design management, construction management, and the integration of both for this Design-Build Project. Proposer shall describe activities that will address environmental concerns. Proposer shall describe the week to week management of the project and which members of the Proposer team will attend the weekly and monthly coordination meetings.
4. **Preliminary Construction Work Plan** – Provide preliminary plan for accomplishing the proposed Work including the crews, shifts, workweeks for constructing the work, including roadway, foundation, substructure, and superstructure. Material and equipment resources shall be addressed. Describe how the overall project will be phased and the plan to construct the proposed improvements.

5. **Key Individuals** – Proposer shall include a copy of the organization chart provided in the Statement of Qualifications and shall state that there are no modifications to Key Individuals as submitted in the Statement of Qualifications. If personnel changes are anticipated, then Proposer shall resubmit all Key Individual information as defined in the Request for Qualifications (RFQ) and shall present a justification for the change. Any modification will require prior MDOT approval.

Modifications to the Proposer’s Team or Key Individuals and other personnel listed in the Proposer Statement of Qualifications are discouraged. MDOT will not approve requests for modification without justification. Examples of justification include death of a team member, changes in employment status, bankruptcy, inability to perform, organizational conflict of interest, or other such significant cause. In order to secure MDOT’s approval prior to the award of the contract, a written request shall be forwarded to the person and address as shown in the Section III, General Instructions, Proposal Submittal of this RFP. The request shall include: a) the nature of the desired change, b) the reason for the desired change, and c) a statement of how the desired change will meet the required qualifications for the position/responsibility. No such modification will be made without prior MDOT approval.

6. **Organizational Conflict of Interest** - The Proposer’s attention is directed to 23 CFR Section 636 Subpart A and in particular to Subsection 636.116 regarding organizational conflicts of interest. Subsection 636.103 defines “organizational conflict of interest” as follows:

Organizational conflict of interest means that because of other activities or relationships with other persons, a person is unable or potentially unable to render impartial assistance or advice to the owner, or the person’s objectivity in performing the contract work is or might be otherwise impaired, or a person has an unfair competitive advantage.

Proposer shall provide information concerning potential organizational conflicts of interest and disclose all relevant facts concerning any past, present or currently planned interests which may present an organizational conflict of interest. Proposer shall state how its interests or those of its chief executives, directors, Key Individuals for this Project, or any proposed consultant, contractor or subcontractor may result, or could be viewed as, an organizational conflict of interest.

The Proposer is prohibited from receiving any advice or discussing any aspect relating to the Project or the procurement of the Project with any person or entity with an organizational conflict of interest, including, but not limited to URS Corporation, and any affiliates of URS Corporation. Such persons and entities are prohibited from participating in a Proposer organization relating to the Project.

The Proposer agrees that, if after award, an organizational conflict of interest is discovered, the Proposer must make an immediate and full written disclosure to MDOT that includes a description of the action that the Proposer has taken or proposes to take to avoid or mitigate such conflicts. If an organizational conflict of interest is determined to exist, MDOT may, at its discretion, cancel the Design-Build contract for the Project. If the Proposer was aware of an organizational conflict of interest prior to the award of the contract and did not disclose the conflict to MDOT, then MDOT may terminate the contract for default.

7. **Technical Solutions** – Proposer shall describe technical solutions that offer advantages to MDOT. Such technical solutions may include items which ease construction, address schedule or budget saving techniques, improve long term durability with the proposed pavement type and design thicknesses, improve long term maintenance, or other. The proposed method for maintenance of traffic at SR 27, SR 28 and Gallman Road during the reconstruction of the roadways should be presented. Plan sheets (11" X 17") may be helpful for the reviewer to fully understand the proposed plan.
8. **Quality Management Plan** – Proposer shall demonstrate the approach to quality management including design and construction quality management and the integration of both for this Design-Build Project. Proposer shall demonstrate controls that will be put in place to ensure overall quality of the design and how the Proposer will monitor conformance to the plans and material testing (asphalt and concrete). Proposer shall provide how the team will resolve issues of non-conformance with the design, construction or material testing and who will be responsible for addressing quality issues for the Proposer.
9. **Schedule Summary** – Proposer shall submit a summary schedule demonstrating how the Contractor plans to complete the Project within its prescribed schedule for completion. The summary schedule shall include dates for planned start and finish of design, procurement of major items, mobilization, foundation installation, superstructure installation, the total number of calendar days from the Notice to Proceed to Final Completion. The proposed number of calendar days for Final Completion shall be as shown on the Contractor's Schedule Certificate.
10. **Required Forms and Certifications** – The Proposer shall provide the following completed document:
 1. Contractor's Schedule Certificate.

These form shall be placed at the beginning of Volume 1. These forms will not be counted against the page limitation.

Volume 2 – Contract Price Proposal (Marked and Sealed Separately as per 907.102.09)

This Contract Price Proposal shall contain the following information:

1. All pages of Section 905 including acknowledgment of addenda and bid sheets completed and signed.
2. A certified check, cashier's check or Proposer's Bid Bond payable to the State of Mississippi in the principle amount of 5% of the bid that includes the project number, executed by the Proposer and signed or countersigned by a qualified Mississippi agent or qualified nonresident agent for the Surety with Power of Attorney attached.
3. An executed Equal Opportunity Clause Certification.
4. A signed Form Disadvantaged Business Enterprise List (OCR-481).
5. A signed list of all Firms submitting quotes (OCR-485).
6. The Certification regarding Non-Collusion, Debarment and Suspension, etc. executed in duplicate.

The information obtained under this RFP of the successful Proposer shall become the exclusive property of the Commission without restriction or limitation on its use. The Commission shall have unrestricted authority to publish, disclose, distribute, or otherwise use in whole or in part any reports, data, or other materials prepared under this RFP by the successful Proposer. The Commission shall retain ownership of all plans, specifications, and related documents.

VI. ESCROW PROPOSAL DOCUMENTS

Proposer is required to escrow all Proposal documents in accordance with Special Provision 907-103.06 within two (2) business days of Notification of Award. Failure to escrow documents in the allotted time may result in rescission of the award and/or forfeiture of the Proposer's bid bond.

VII. EVALUATION OF PROPOSALS

A Proposal Review Committee ("Committee") will be appointed to evaluate the Technical Proposals on behalf of the Commission. The Committee will be comprised of five MDOT employees. In addition, MDOT will assemble a group of advisory members, that shall include the Federal Highway Administration (FHWA), and others with various areas of expertise.

VIII. CRITERIA FOR SCORING

The Commission has developed criteria for use in evaluating and scoring the Proposals. The Committee will use these criteria to develop a numerical score of each Proposal. Scoring will be based on a point system. The Committee will evaluate the Proposals based on meeting the technical evaluation criteria as shown below.

The maximum points for each evaluation criteria will be as follows:

- Compliance with the RFP Requirements – 20
- Management Approach - 25

- Technical Solutions - 25
- Quality Management Plan – 10
- Schedule – 20

The Committee will consider the following minimum criteria:

Compliance with the RFP Requirements

- How well has the Proposer complied with the design criteria?
- Overall presentation and quality of Proposal – Are the format instructions stated within the RFP met, and how well is the Proposal presented in a quality format and in a logical presentation of information?

Management Approach

- What is the overall Project Management Organization? How will this organization be responsive to the Commission, MDOT and public concerns/issues?
- Is the overall Project Management Plan clear and concise, not overly cumbersome and easily implementable? Has this plan been used effectively elsewhere?
- How well does the Proposal address partnering and its implementation?
- How has the Proposer addressed the phasing of the project and how does this plan reduce impacts to the roadway users?
- How will the Proposer manage the coordination with MDOT?

Technical Solutions

- Are the solutions proposed to design/construct the widened or replaced bridge and approaches based on sound principals and easily implementable?
- How well has maintenance and durability been considered in the proposed design?
- How has the Proposer considered innovative solutions for technical consideration and how effective could these innovations be?
- How has the Proposer proposed to minimize traffic disruptions to the public on SR 27, SR 28 and Gallman Road?

Quality Management Plan

- What Project controls will be put in place to ensure overall Project quality (both design and construction) and how effective will these controls be?
- What assurances have been provided to verify Project quality and how effective will these assurances be?
- How effectively will non-conformance aspects of the Project be handled?

Schedule

- Does the Proposer specify the number of calendar days to complete the Project and describe how it effectively will achieve its proposed completion?
- How well does the Proposal contain adequate assurances that the entire Project will be completed on the schedule provided by the Proposer?

- How effectively does the Proposer clearly describe the plan for delivery of the Work?
 - How well does the Contractor demonstrate adequate resources to accomplish the Work in accordance with the Proposed Schedule?
 - How well does the Contractor specifically outline the sources for delivery of materials including the piling, beams, concrete and rebar?
 - How effective are any innovative solution proposed for the construction schedule?

The individual Technical Score by each reviewer will be the summation of the Technical Scores achieved for each of the above selection criteria. The Proposer's Total Technical Score (maximum of 100 points) will be the summation of the individual Technical Scores from each reviewer divided by the number of reviewers.

SELECTION OF CONTRACTOR

The Proposal Review Committee will score the Proposals according to the evaluation criteria. Upon approval of MDOT Executive Director and immediately prior to the opening of Volume 2, MDOT will notify each Proposer of all Technical Scores. MDOT will then publicly open each of the Contract Price Proposals, all in accordance with the Milestone Schedule.

The Best Value Proposal shall be determined by the following formula:

$$\text{Best Value Proposal} = \frac{(\text{Part A} + \text{Part B} - \text{Part C})}{[1 + (\text{Technical Score} / 100)]}$$

Where:

Part A = Contract Price Proposal.

Part B = (Number of calendar days from the Notice to Proceed up to and including Final Completion set forth by the Proposer) x \$3,500.

Part C = (Number of Bridge sites on I-55 to be improved minus) x \$2,000,000.

In the event of a tie for the Best Value Proposal as determined by the above formula, the Proposer with the lowest Contract Price Proposal will be selected.

The Commission intends to award and offer a Contract to the Proposer submitting the Best Value Proposal with the lowest score as determined above. However, if the parties are unable to execute a contract, MDOT may offer a contract to the Proposer that submitted the Best Value Proposal with the next lowest score, and so on, until an agreement is reached.

IX. GENERAL INFORMATION

The Commission reserves the right to terminate evaluation of one or more of the Proposals if it is determined to be in its best interest.

The Commission reserves the right, at its sole discretion, to proceed no further with this RFP process, and/or to re-advertise in another public solicitation.

The Commission reserves the right to reject any and all Proposals and/or to discontinue contract execution with any party at any time prior to final contract execution.

The Commission reserves the right to request or obtain additional information about any and all Proposals.

Except for the stipend defined in Section II, the Commission assumes no liability and will not reimburse cost incurred by firms, whether selected or not, in developing Proposals or in contract execution.

Modification to the Proposer's Team or key individuals within Teams is discouraged. MDOT will not approve requests for modification of the Proposer's Team without justification. After award, in order to secure MDOT approval, the procedures as defined in the Technical Requirements Section 2.4 shall be followed.

The Best Value Proposer shall submit an additional 20 sets of Volume #1 proposals within 10 days after contract award.

The successful Proposer will be required to furnish a Section 903 Performance and Payment Bond, Certificates of Insurance and W9 no later than 10 days after Contract Award.

MILESTONE SCHEDULE

- Issue RFP for selected Proposers August 31, 2012
- Mandatory Pre-Proposal Meeting September 12, 2012
10 AM Central Time
- Deadline for Proposers to submit written questions October 11, 2012
4 PM Central Time
- Target Date for MDOT to post to website last responses to written questions and to issue Addenda October 18, 2012
- Submittal of Technical Proposals (Volume 1) November 2, 2012
4 PM Central Time
- Submittal of Contract Price Proposals (Volume 2) November 13, 2012

- Notification of Award
- Notice to Proceed

10 AM Central Time
November 27, 2012
(Anticipated)
December 11, 2012
(Anticipated)

MISSISSIPPI DEPARTMENT OF TRANSPORTATION

SECTION 904 - NOTICE TO PROPOSERS NO. 1 DB

CODE: (SP)

DATE: 03/10/2009

SUBJECT: Governing Specifications

The current (2004) Edition of the Standard Specifications for Road and Bridge Construction adopted by the Mississippi Transportation Commission is made a part hereof fully and completely as if it were attached hereto, except where superseded by special provisions, or amended by revisions of the Specifications contained herein. Copies of the specification book may be purchased from the MDOT Construction Division.

A reference in any Contract Document to controlling requirements in another portion of the Contract Documents shall be understood to apply equally to any revision or amendment thereof included in the Contract.

In the event the plans or Proposal contain references to the 1990 Edition of the Standard Specifications for Road and Bridge Construction, it is to be understood that such references shall mean the comparable provisions of the 2004 Edition of the Standard Specifications.

MISSISSIPPI DEPARTMENT OF TRANSPORTATION

SECTION 904 - NOTICE TO PROPOSERS NO. 3 DB

CODE: (SP)

DATE: 03/10/09

SUBJECT: Final Clean-Up

Immediately prior to final inspection for release of maintenance, the Contractor shall pick up, load, transport and properly dispose of all litter from the entire highway right-of-way in those areas used in the construction of and maintenance of traffic of individual sites within the termini of the Project.

Litter shall include, but not be limited to, solid wastes such a glass, paper products, tires, wood products, metal, synthetic materials and other miscellaneous debris.

MISSISSIPPI DEPARTMENT OF TRANSPORTATION

SECTION 904 - NOTICE TO PROPOSERS NO. 640 DB

CODE: (SP)

DATE: 03/10/2009

SUBJECT: Fiber Reinforced Concrete

Proposers are hereby advised that synthetic structural fibers meeting the requirements of Subsection 907-711.04 may be used in lieu of wire mesh in some items of construction. Substitution of fibers for wire mesh will be allowed in the construction of paved ditches, paved flumes, paved inlet apron, driveways, guard rail anchors and pile encasements. Substitution in any other items of work must be approved by the State Construction Engineer prior to use.

SUPPLEMENT TO NOTICE TO PROPOSERS NO. 696 DB

DATE: 07/25/2012

The goal is 10 percent for the Disadvantaged Business Enterprise. The best value Proposer is required to submit Form OCR-481 for all DBEs.

Form OCR-481 is available at

<http://sp.gomdot.com/Civil%20Rights/Civil%20Rights%20Forms/DBE/MDOT%20Projects/OCR-481%20-%20Disadvantage%20Business%20Enterprise%20List.pdf>

or by calling 601-359-7466.

All OCR-481s must be included in the Submittal of Contract Price Proposal (Volume 2).

For answers to questions, contact the MDOT Office of Civil Rights at (601) 359-7466.

MISSISSIPPI DEPARTMENT OF TRANSPORTATION

SECTION 904 - NOTICE TO PROPOSERS NO. 696 DB

CODE: (SP)

DATE: 07/09/2012

SUBJECT: Disadvantaged Business Enterprises In Federal-Aid Highway Construction

This Contract is subject to the "Safe, Accountable, Flexible, Efficient Transportation Equity Act, A Legacy For Users (SAFETEA-LU)" and applicable requirements of "Part 26, Title 49, Code of Federal Regulations." Portions of the Act are set forth in this Notice as applicable to compliance by the Contractor and all of the Act, and the MDOT DBE Program, is incorporated by reference herein.

The Department has developed a Disadvantaged Business Enterprise Program that is applicable to this Contract and is made a part thereof by reference.

Copies of the program may be obtained from:

Office of Civil Rights
Mississippi Department of Transportation
P. O. Box 1850
Jackson, Mississippi 39215-1850

POLICY

It is the policy of the Mississippi Department of Transportation to provide a level playing field, to foster equal opportunity in all federally assisted contracts, to improve the flexibility of the DBE Program, to reduce the burdens on small businesses, and to achieve that amount of participation that would be obtained in a non-discriminatory market place. In doing so, it is the policy of MDOT that there will be no discrimination in the award and performance of federally assisted contracts on the basis of race, color, sex, age, religion, national origin, or any handicap.

ASSURANCES THAT CONTRACTORS MUST TAKE:

MDOT will require that each contract which MDOT signs with a sub recipient or a Contractor, and each subcontract the Prime Contractor signs with a Subcontractor, includes the following assurances:

“The Contractor, sub recipient or Subcontractor shall not discriminate on the basis of race, color, national origin, or sex in the performance of this Contract. The Contractor shall carry out applicable requirements of 49 CFR 26 in the award and administration of federally assisted contracts. Failure by the Contractor to carry out these requirements is a material breach of this Contract, which may result in the termination of this Contract or such other remedy as MDOT deems appropriate.”

August 31, 2012

Project Nos. DB/IM-0055-02(228)/105444-305
DB/IM-0055-02(228)/105444-306

DEFINITIONS

For purposes of this provision the following definitions will apply:

"Disadvantaged Business" means a small business concern: (a) which is at least 51 percent owned by one or more socially and economically disadvantaged individual(s) or in the case of any publicly owned business, at least 51 percent of the stock of which is owned by one or more socially and economically disadvantaged individual(s); and (b) whose management and daily business operations are controlled by one or more of the socially and economically disadvantaged individual(s) who own it. It is important to note that the business owners themselves must control the operations of the business. Absentee ownership or title ownership by an individual who does not take an active role in controlling the business is not consistent with eligibility as a DBE under CFR 49 Part 26.71.

CONTRACTOR'S OBLIGATION

The Contractor and all Subcontractors shall take all necessary and reasonable steps to ensure that DBE firms can compete for and participate in the performance of a portion of the Work in this Contract and shall not discriminate on the basis of race, color, national origin, religion or sex. Failure on the part of the Contractor to carry out the DBE requirements of this Contract constitutes a breach of Contract and after proper notification the Department may terminate the Contract or take other appropriate action as determined by the Department.

When a contract requires a zero percent (0%) DBE goal, the Contractor still has the responsibility to take all necessary and reasonable steps to ensure that DBE firms can compete for and participate in the performance of the Work in the contract. In this case, all work performed by a certified DBE firm is considered to be a "race neutral" measure and the Department will receive DBE credit towards the overall State goals when the DBE firm is paid for their work. If the Prime Contractor is a certified DBE firm, the Department can receive DBE credit only for the work performed by the Prime Contractor's work force or any Work subcontracted to another DBE firm. Work performance by a non-DBE Subcontractor is not eligible for DBE credit.

CONTRACT GOAL

The goal for participation by DBEs is established for this Contract in the attached Supplement. The Contractor shall exercise all necessary and reasonable steps to ensure that participation is equal to or exceeds the Contract goal.

The percentage of the Contract that is proposed for DBEs shall be so stated on the last bid sheet of the Proposal.

The apparent best value responsive Proposer shall submit to the Office of Civil Rights Form OCR-481, signed by the Prime Contractor and the DBE Subcontractors in the Submittal of Contract Price Proposal (Volume 2).

FORMS ARE AVAILABLE FROM THE OFFICE OF CIVIL RIGHTS

The OCR-481 Form must contain the following information:

The name and address of each certified DBE Contractor / Supplier;

The Reference Number, percent of Work and the dollar amount of each item. If a portion of an item is subcontracted, a breakdown of that item including quantities and unit price must be attached, detailing what part of the item the DBE firm is to perform and who will perform the remainder of the item.

If the DBE Commitment shown on the last proposal sheet of the Proposal does not equal or exceed the Contract goal, the Proposer must submit, with the Proposal, information to satisfy the Department that adequate good faith efforts have been made to meet the Contract goal.

Failure of the best value Proposer to furnish acceptable proof of good faith efforts, submitted with the Proposal, shall be just cause for rejection of the Proposal. Award may then be made to the next best value responsive Proposer or the Work may be re-advertised.

The following factors are illustrative of matters the Department will consider in judging whether or not the Proposer has made adequate good faith effort to satisfy the Contract goal.

1. Whether the Proposer attended the pre-proposal meeting that was scheduled by the Department to inform DBEs of subcontracting opportunities;
2. whether the Proposer advertised in general circulation, trade association, and minority-focus media concerning the subcontracting opportunities;
3. whether the Proposer provided written notice to a reasonable number of specific DBEs that their interest in the Contract is being solicited;
4. whether the Proposer followed up initial solicitations of interest by contacting DBEs to determine with certainty whether they were interested;
5. whether the Proposer selected portions of the Work to be performed by DBEs in order to increase the likelihood of meeting the Contract goal;
6. whether the Proposer provided interested DBEs with adequate information about the plans, specifications and requirements of the Contract;
7. whether the Proposer negotiated in good faith with interested DBEs and did not reject them as unqualified without sound reasons based on a thorough investigation of their capabilities; and
8. whether the Proposer made efforts to assist interested DBEs in obtaining any

required bonding or insurance.

DIRECTORY

A list of "Certified DBE Contractors" which have been certified as such by the Mississippi Department of Transportation and other Unified Certification Partners (UCP) can be found at the following link.

<http://sp.gomdot.com/Civil%20Rights/Pages/DBE.aspx>

REPLACEMENT

If a DBE Subcontractor cannot perform satisfactorily, and this causes the OCR-481 commitment to fall below the Contract goal, the Contractor shall take all necessary reasonable steps to replace the DBE with another certified DBE Subcontractor or submit information to satisfy the Mississippi Department of Transportation that adequate good faith efforts have been made to replace the DBE. The replacement DBE must be a DBE who was on the Department's list of "Certified DBE Contractors" when the job was awarded, and who is still active. All DBE replacements must be approved by the Department.

Under no circumstances shall the Prime or any Subcontractor perform the DBE's work (as shown on the OCR-481) without prior written approval from the Department. See "Sanctions" at the end of this document for penalties for performing DBE's work.

When a Contractor proposes to substitute/replace/terminate a DBE that was originally named on the OCR-481, the Contractor must obtain a release, in writing, from the named DBE explaining why the DBE Subcontractor cannot perform the work. A copy of the original DBE's release must be attached to the Contractor's written request to substitute/replace/terminate along with appropriate Subcontract Forms for the substitute/replacement/terminated Subcontractor, all of which must be submitted to the DBE Coordinator and approved, in advance, by MDOT.

GOOD FAITH EFFORTS

To demonstrate good faith efforts to replace any DBE that is unable to perform successfully, the Contractor must document steps taken to subcontract with another certified DBE Contractor. Such documentation shall include no less than the following:

- (a) Proof of written notification to certified DBE Contractors by certified mail that their interest is solicited in subcontracting the Work defaulted by the previous DBE or in subcontracting other items of work in the Contract.
- (b) Efforts to negotiate with certified DBE Contractors for specific items shall include as a minimum:
 - a. The name, address, and telephone number of each DBE contacted;

- b. A description of the information provided about the plans and specifications for those portions of the Work to be subcontracted; and
- c. A statement of why agreements were not reached.
- (c) For each DBE contacted that was rejected as unqualified, the reasons for such conclusion.
- (d) Efforts made to assist each DBE that needed assistance in obtaining bonding or insurance required by the Contractor.

Failure of the Contractor to demonstrate good faith efforts to replace a DBE Subcontractor that cannot perform as intended with another DBE Subcontractor, when required, shall be a breach of Contract and may be just cause to be disqualified from further bidding for a period of up to 12 months after notification by certified mail.

PARTICIPATION / DBE CREDIT

Participation shall be counted toward meeting the goal in this Contract as follows:

1. If the Prime Contractor is a certified DBE firm, only the value of the Work actually performed by the DBE Prime can be counted towards the Project goal, along with any Work subcontracted to a certified DBE firm.
2. If the Contractor is not a DBE, the Work subcontracted to a certified DBE Contractor will be counted toward the goal.
3. The Contractor may count toward the goal a portion of the total dollar value of a contract with a joint venture eligible under the standards of this provision equal to the percentage of the DBE partner in the joint venture.
4. Expenditures to DBEs that perform a commercially useful function may be counted toward the goal. A business is considered to perform a commercially useful function when it is responsible for the execution of a distinct element of the Work and carries out its responsibilities by actually performing, managing, and supervising the work involved.
5. The Contractor may count 100% of the expenditures for materials and supplies obtained from certified DBE suppliers and manufacturers that produce goods from raw materials or substantially alters them for resale provided the suppliers and manufacturers assume the actual and contractual responsibility for the provision of the materials and supplies. The Contractor may count 60 percent of the expenditures to suppliers that are not manufacturers, provided the supplier performs a commercially useful function in the supply process. Within 30 days after receipt of the materials, the Contractor shall furnish to the DBE Coordinator

invoices from the certified supplier to verify the DBE goal.

6. Any Work that a certified DBE firm subcontracts or sub-subcontracts to a non-DBE firm will not count towards the DBE goal.
7. Only the dollars actually paid to the DBE firm may be counted towards the DBE goal.

AWARD

Award of this Contract to the best value Proposer will be contingent upon the following conditions:

1. Concurrence from Federal Highway Administration, when applicable.
2. Proposer must submit to the Office of Civil Rights for approval, Form OCR-481 (DBE Commitment) with the Submittal of Contract Price Proposal (Volume 2) to satisfy the Department and that adequate good faith efforts have been made to meet the Contract goal.
3. Proposer must submit **with the Submittal of Contract Price Proposal (Volume 2)** a list of all firms that submitted quotes for material supplies or items to be subcontracted. This information must be submitted on form OCR-485 in the back of the Contract Proposal.

Prior to the start of any work, the Proposer must notify the Project Engineer, in writing, of the name of the designated "DBE Liaison Officer" for this Project. This notification must be posted on the bulletin board at the Project site.

DEFAULT

The Contract goal established by MDOT in this Proposal must be met to fulfill the terms of the Contract. The Contractor may list DBE Subcontractors and items that exceed MDOT's Contract Goal, but should unforeseen problems arise that would prevent a DBE from completing its total commitment percentage, the Contractor will meet the terms of the Contract as long as it meets or exceeds MDOT's Contract Goal. For additional information, refer to "Replacement" section of this Notice.

DBE REPORTS

1. OCR-481: Refer to "CONTRACT GOAL" section of this Notice to Proposers for information regarding this form.
2. OCR-482: At the conclusion of the Project the Contractor will submit to the Project Engineer for verification of quantities and further handling Form OCR-

482 whereby the Contractor certifies to the amounts of payments made to each Contractor / Supplier. The Project Engineer shall submit the completed Form OCR-482 to the DBE Coordinator (Office of Civil Rights). Final acceptance of the Project is dependent upon Contract Administration Division's receipt of completed Form OCR-482 which they will receive from the Office of Civil Rights.

3. OCR-483: The Project Engineer/Inspector will complete Form OCR-483, the Commercially Useful Function (CUF) Performance Report, in accordance with MDOT S.O.P. No. OCR-03-09-01-483. Evaluations reported on this form are used to determine whether or not the DBE firm is performing a CUF. The Prime Contractor should take corrective action when the report contains any negative evaluations. DBE credit may be disallowed and/or other sanctions imposed if it is determined the DBE firm is not performing a CUF. This form should also be completed and returned to the DBE Coordinator (Office of Civil Rights).
4. OCR-484: Each month, the Contractor will submit to the Project Engineer OCR-484 certifying payments to all Subcontractors.
5. OCR-485: The Proposer must submit **with the Submittal of Contract Price Proposal (Volume 2)** a list of all firms that submitted quotes for material supplies or items to be subcontracted.
6. OCR-487: Only used by Prime Contractors that are certified DBE firms. This form is used in determining the exact percentage of DBE credit for the specified project. It should be returned to MDOT with the OCR-481 form, or can also be returned with the Permission to Subcontract Forms (CAD-720 or CAD-725).

SANCTIONS

The Department has the option to enforce any of the following penalties for failure of the Prime Contractor to fulfill the DBE goal as stated on the OCR-481 form or any violations of the DBE program guidelines:

1. Disallow credit towards the DBE goal
2. Withhold progress estimate payments
3. Deduct from the final estimate an amount equal to the unmet portion of the DBE goal
4. Recover an amount equal to the unmet Contract goal
5. Debar the Contractor involved from bidding on Mississippi Department of Transportation projects.

6. Deduct from the Contractor's final estimate all or any combination of the following.

<u>Offense</u>	<u>Percentage of the monetary amount disallowed from (1) above</u>	<u>Lump Sum</u>
# 1	10%	\$ 5,000 or both
# 2	20%	\$ 10,000 or both
# 3	40%	\$ 20,000 & debarment

MISSISSIPPI DEPARTMENT OF TRANSPORTATION

SECTION 904 - NOTICE TO PROPOSERS NO. 786 DB

CODE: (SP)

DATE: 03/10/2009

SUBJECT: Cost Adjustment Factors

This Contract DOES NOT have an adjustment code for adjustments in the cost of fuel or materials. Therefore, NO adjustment for changes in the cost of fuel or materials will be allowed on items of work in this Project.

MISSISSIPPI DEPARTMENT OF TRANSPORTATION

SECTION 904 - NOTICE TO PROPOSERS NO. 824 DB

CODE: (SP)

DATE: 07/09/2012

SUBJECT: Lane Closure Restrictions

Proposers are hereby advised that:

1. All interstate roadways and ramps are to remain open to traffic at all times unless otherwise approved by MDOT.
2. **Temporary lane closures shall NOT be permitted during mandatory hurricane evacuation orders. Also no lane closures will be permitted on the following holidays or the day preceding them: New Year's Day, Independence Day, Labor Day, Thanksgiving, and Christmas Day. In the event one of the aforementioned holidays falls during the weekend or on a Monday, no lane closure will be allowed during that weekend or the Friday immediately preceding said holiday.**
3. Continuous maintenance of one-lane traffic within the construction work zone shall be limited to a maximum length work zone of one mile.
4. Continuous maintenance of two-lane traffic shall be maintained except as shown in Item (3) above. Work zones in the same lane shall be spaced no closer than two miles, and adjacent lane work zones shall be no closer than three miles.
5. Work requiring a temporary lane closure shall begin within the limits of the closure within one hour of the closure set-up. The Contractor will be assessed a lane rental fee of \$500.00 per closure for each full or partial five minute period should failure to begin work within the allotted time occur.
6. Barrels may be used to delineate pavement drop-offs if used according to MDOT's Special Design Drawing TCP-SC.
7. Portable Changeable Message Signs shall be required on I-55 for advance motorist warning of road work a minimum of two miles ahead of the Work on I-55. These Changeable Message Signs are to remain in place until traffic is placed in its final phase location. These Changeable Message Signs may be used to alert motorist of changing traffic conditions.
8. If lane closures are located within 6 miles of each other, placement of an advance portable changeable message sign is required only in advance of the first closure site.
9. The Portable Changeable Message Sign(s) shall comply with Part VI of the Manual on Uniform Traffic Control Devices (MUTCD) and Special Provision No. 907-619 DB Changeable Message Signs, with exclusion of cellular programming capabilities.
10. If the lane closure restrictions listed in Section 17.4 of the Technical Requirements are violated, no excuses will be accepted by the Department and the Contractor will be charged a fee of **\$500.00** for each full or partial five minute period until the roadway is back in compliance with the lane closure restriction requirement.

August 31, 2012

Project Nos. DB/IM-0055-02(228)/105444-305
DB/IM-0055-02(228)/105444-306

MISSISSIPPI DEPARTMENT OF TRANSPORTATION

SECTION 904 - NOTICE TO PROPOSERS NO. 845 DB

CODE: (SP)

DATE: 03/10/2009

SUBJECT: Removal and Disposal of any Structures Having lead, Lead-Based Paint and/or Asbestos

Removal and disposal of any structures, having lead, lead-based paint, and/or asbestos shall be in accordance with MDEQ & EPA guidelines. The removed materials shall be handled and deposited in a suitable upland site designated for such material(s).

MISSISSIPPI DEPARTMENT OF TRANSPORTATION

SECTION 904 - NOTICE TO PROPOSERS NO. 883 DB

CODE: (SP)

DATE: 03/10/2009

SUBJECT: Payroll Requirements

Proposers are hereby advised that the Contractor and Subcontractor(s) are required to submit payroll information to the Project Engineers on a weekly basis.

On Federal-Aid Projects, CAD-880, CAD-881 and certified payroll submissions are required each week the Contractor or a Subcontractor performs work on the Project. This is addressed in Section V, page 6 of Form FHWA-1273.

On State-Funded Projects, CAD-880 is required each week the Contractor or a Subcontractor performs work on the Project.

When no work is performed on either Federal-Aid or State-Funded Projects, the Contractor should only submit CAD-880 showing no work activities.

The Contractor shall make all efforts necessary to submit this information to the Project Engineer in a timely manner. The Engineer will have the authority to suspend the Work wholly or in part and to withhold payments because of the Contractor's failure to submit the required information. Submission of forms and payrolls shall be current through the first full week of the month for the estimate period in order for the Project Engineer to process an estimate.

Proposers are advised to review the requirements regarding payroll submissions in Section 110 of the Standard Specifications.

MISSISSIPPI DEPARTMENT OF TRANSPORTATION

SECTION 904 - NOTICE TO PROPOSERS NO. 1405 DB

CODE: (SP)

DATE: 03/10/2009

SUBJECT: Errata And Modifications To The 2004 Standard Specifications

<u>Page</u>	<u>Subsection</u>	<u>Change</u>
101	201.01	In the second sentence of the first paragraph, change “salvable” to “salvageable”.
107	202.04	In the fourth sentence of the fourth paragraph, change “yard” to “feet”.
107	202.05	In the list of units measurements for 202-B, add “square foot”.
132	211.03.4	In the second sentence of the second paragraph, change “planted” to “plated”.
192	306.02.4	In the first line of the first paragraph, delete the word “be”.
200	307.03.7	In the fourth sentence of the second paragraph, change “lime-fly ash” to “treated”.
236	401.01	Change the header from “Section 403” to “Section 401”.
242	401.02.3.2	In the first sentence of the third full paragraph, add “1/8” in the blank before the inch mark.
250	401.02.6.3	In the second sentence of the first paragraph on page 250, change “rutting over ”” to “rutting over 1/8” ”.
253	401.02.6.4.2	In the paragraph preceding the table, change “91.0” to “89.0”.
259	401.03.1.4	In the first paragraph, change “92.0 percent” to “the specified percentage (92.0 or 93.0)”.
269	403.03.2	In the table at the top of page 269, change the PI requirement from “=” to “≤”.
278	404.04	In the second sentence, change the subsection from “401.04” to “403.04”.
283	409.02.2	Change “PG 64-22” to “PG 67-22”.

294	413.02	In the first sentence of the second paragraph, change “707.02.1.3” to “Subsection 707.02.1.3”.
340	511.04	In the second sentence of the second paragraph, change “412” to “512”.
349	601.03.3	In the first sentence, change “804.03.2” to “804.03.5”.
355	603.02	Change the subsection reference for Joint mortar from “707.03” to “714.11”.
369	604.04	In the first sentence, change “601.04” to “Subsection 601.04”.
427	619.04	Delete the second paragraph.
442	625.04	In the third paragraph, change “626.04” to “Subsection 626.04”.
444	626.03.1.2	Delete the third sentence of the first paragraph.
464	631.02	Change the subsection reference for Water from “714.01.0” to “714.01.1”.
570	682.03	Change the subsection number from “682-03” to “682.03”.
575	683.10.4	Change the subsection number from “683.10.4” to “683.04”.
575	683.10.5	Change the subsection number from “683.10.5” to “683.05”.
596	701.02	In the table under the column titled “Cementations material required”, change Class F, FA” to “Class F FA,”.
603	702.11	In the first sentence, change “702.12” to “Subsection 702.12”.
612	703.04.2	In the fifth paragraph, delete “Subsection 703.11 and”.
616	703.07.2	In the Percentage By Weight Passing Square Mesh Sieves table, change the No. 10 requirement for Class 7 material from “30 - 10” to “30 - 100”.
618	703.13.1	In the first sentence of the first paragraph, change “703.09” to “703.06”.
618	703.13.2	In the first sentence, change “703.09” to “703.06”.
671	712.06.2.2	In the first sentence, change “712.05.1” to “Subsection 712.05.1”.

689	714.11.2	In the first sentence, change “412” to “512”.
709	715.09.5	In the first sentence of the first paragraph, change “guage” to “gauge”.
717	717.02.3.4	In the top line of the tension table, change “1 1/2” to “1 1/8” and change “1 1/8” to “1 1/2”.
741	720.05.2.2	In the last sentence of this subsection, change “720.05.2.1” to “Subsection 720.05.2.1”.
827	803.03.2.3.7.5.2	In the first sentence of the second paragraph, change “803.03.5.4” to “803.03.2.3.4”.
833	803.03.2.6	In the first sentence, change “803.03.7” to “803.03.2.5”.
854	804.02.11	In the last sentence of the first paragraph, change “automatically” to “automatic”.
859	804.02.13.1.3	In the last sentence, change Subsection “804.02.12.1” to “804.02.12”.
879	804.03.19.3.2	In the first sentence of the third paragraph, change “listed on of Approved” to “listed on the Approved”.
879	804.03.19.3.2	In the last sentence of the last paragraph, change “804.03.19.3.1” to “Subsection 804.03.19.3.1”.
962	814.02.3	In the first sentence, change “710.03” to “Subsection 710.03”.
976	820.03.2.1	In the first sentence, change “803.02.6” to “803.03.1.7”.
976	820.03.2.2	In the first sentence, change “803.03.9.6” to “803.03.1.9.2”.
985	Index	Change the subsection reference for Petroleum Asphalt Cement from “702.5” to “702.05”.
985	Index	Change the subsection reference for the Definition of Asphaltic Cement or Petroleum Asphalt from “700.2” to “700.02”.
985	Index	Change the subsection reference for Automatic Batchers from “501.03.2.4” to “804.02.10.4”.
986	Index	Delete “501.03.2” as a subsection reference for Batching Plant & Equipment.

- 988 Index Change the subsection reference for the Central Mixed Concrete from “501.03.3.2” to “804.02.11”.
- 988 Index Change the subsection reference for the Concrete Batching Plant & Equipment from “501.03.2” to “804.02.11”.
- 999 Index Delete “501.03.3.3” as a subsection reference for Truck Mixers.
- 1001 Index Change the subsection reference for Edge Drain Pipes from “605.3.5” to “605.03.5”.
- 1002 Index Change the subsection reference for Metal Posts from “713.05.2” to “712.05.2”.
- 1007 Index Change the subsection reference for Coarse Aggregate of Cement Concrete Table from “703.3” to “703.03”.
- 1007 Index Change the subsection reference for Composite Gradation for Mechanically Stabilized Courses Table from “703.8” to “703.08”.
- 1009 Index Delete “501.03.3.3” as a subsection reference for Truck Mixers and Truck Agitators.
- 1010 Index Delete reference to “Working Day, Definition of”.

MISSISSIPPI DEPARTMENT OF TRANSPORTATION

SECTION 904 - NOTICE TO PROPOSERS NO. 1808 DB

CODE: (IS)

DATE: 09/09/2008

SUBJECT: Safety Apparel

Bidders are advised that the Code of Federal Regulations CFR 23 Part 634 final rule was adopted November 24, 2006 with an effective date of November 24, 2008. This rule requires that **"All workers within the right-of-way of a Federal-Aid Highway who are exposed either to traffic (vehicles using the highway for the purposes of travel) or to construction equipment within the work area shall wear high-visibility safety apparel"**. High-visibility safety apparel is defined in the CFR as **"personnel protective safety clothing that is intended to provide conspicuity during both daytime and nighttime usage, and that meets the Performance Class 2 or 3 requirements of the ANSI/ISEA 107-2004 publication entitled American National Standard for High-Visibility Safety Apparel and Headwear"**. All workers on Mississippi State Highway right-of-way shall comply with this Federal Regulation. Workers are defined by the CFR as **"people on foot whose duties place them within the right-of way of a Federal-Aid Highway, such as highway construction and maintenance forces, survey crews, utility crews, responders to incidents within the highway right-of-way, and law enforcement personnel when directing traffic, investigating crashes, and handling lane closures, obstructed roadways, and disasters within the right-of-way of a Federal-Aid Highway"**.

You can access this final rule at the following link:

<http://a257.g.akamaitech.net/7/257/2422/01jan20061800/edocket.access.gpo.gov/2006/pdf/E6-19910.pdf>

MISSISSIPPI DEPARTMENT OF TRANSPORTATION

SECTION 904 - NOTICE TO PROPOSERS NO. 1928 DB

CODE: (SP)

DATE: 03/10/2009

SUBJECT: Federal Bridge Formula

Proposers are hereby advised that Federal Highway Administration Publication No. FHWA-MC-94-007, **BRIDGE FORMULA WEIGHTS**, dated January 1994, is made a part of this Contract when applicable.

Prior to the preconstruction conference, the Contractor shall advise the Engineer, in writing, what materials, if any, will be delivered to the jobsite via Interstate route(s).

Copies of the **BRIDGE FORMULA WEIGHTS** publication may be obtained by contacting:

Federal Highway Administration
400 7th Street, SW
Washington, DC 20590
(202) 366-2212

or

http://ops.fhwa.dot.gov/freight/sw/brdgcalc/calc_page.htm

MISSISSIPPI DEPARTMENT OF TRANSPORTATION

SECTION 904 - NOTICE TO PROPOSERS NO. 2239 DB

CODE: (SP)

DATE: 01/06/2009

SUBJECT: Department of Labor Ruling

On December 19, 2008 the U.S. Department of Labor issued a final rule revising their regulations in 29 CFR Parts 3 and 5. This rule takes effect for all Federal funded contracts awarded after January 19, 2009.

The primary change in the rule is a provision that requires Contractors to limit the amount of personal information on the weekly payroll submissions. Personal addresses and full social security numbers may no longer be used. Contractors must use an " . . . individually identifying number for each employee (e.g., the last four digits of the employee's social security number)." Form FHWA-1273 - "Required Contract Provisions Federal-aid Construction Contracts" will eventually be revised to reflect this change.

Until the revision is made to FHWA-1273, bidders are advised to disregard any requirement in FHWA-1273 regarding the use of personal addresses and full social security numbers, such as in Section V, Paragraph 2b.

Bidders are also advised that the requirement for maintaining and submitting form FHWA-47, as referenced in FHWA-1273 Section VI, is no longer required on construction projects.

MISSISSIPPI DEPARTMENT OF TRANSPORTATION

SECTION 904 - NOTICE TO PROPOSERS NO. 2382 DB

CODE: (SP)

DATE: 03/29/2010

SUBJECT: Status of Right of Way and Utility Adjustments

Although it is desirable to have completed all utility adjustments and work to be performed by others prior to receiving Proposals, sometimes it is not considered to be in the public interest to wait until each and every such clearance has been obtained. The Proposer is hereby advised of possible utilities which have not been discovered and/or relocated.

The status of encroachments and utility adjustments are set forth in following attachments.

Mark C. McConnell
Deputy Executive Director/
Chief Engineer

Charles R. Carr
Director
Office of Intermodal Planning



Jackie Duckworth
Deputy Executive Director/
Administration

Willie Huff
Director
Office of Enforcement

Melinda L. McGrath
Executive Director

P. O. Box 1850 / Jackson, Mississippi 39215-1850 / Telephone (601) 359-7001 / FAX (601) 359-7110 / www.GoMDOT.com

August 30, 2012

Mr. Andrew Hughes
Division Administrator
FHWA—Mississippi Division
100 West Capitol Street, Suite 1062
Jackson MS 39269

RE: DB/IN-0055-02(228)
105444-305000
105444-306000
I-55, Copiah & Lincoln

Dear Mr. Hughes:

RIGHT OF WAY CERTIFICATION

This project will be constructed on existing highway right of way as delineated on plans for previous State and Federal Aid projects on file in offices of the Department of Transportation in Jackson, Mississippi. Since no additional right of way is required, there are no relocations, improvements or potentially contaminated sites involved in this project.

This project is to be let with the design/build delivery model. The impact of the project on utilities is not known at this time. The contractor will be responsible for coordination of adjustments with affected utilities.

Attachments to this certificate are:

Status of Right of Way
Status of Potentially Contaminated Sites
Status of Buildings
Encroachment Certification
Status of Utilities

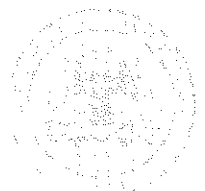

Mr. Andrew Hughes
August 30, 2012
Page 2

RIGHT OF WAY DIVISION

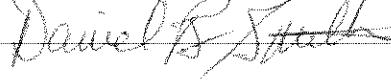

Daniel B. Smith

Pc: Chief Engineer
Contract Administration
Construction Division
District Three & District Seven
Project Engineer
Facility & Records Management

STATUS OF RIGHT OF WAY

DB/IN-0055-02(228)

105444-305000

105444-306000

I-55, Copenh & Lincoln

All right of way has been acquired and legal right of entry has been obtained and possession has been obtained **except** as indicated on the following files:

None.

STATUS OF POTENTIALLY CONTAMINATED SITES

DB/IM-0055-02(228)

105444-305000

Copiah County

August 30, 2012

THERE IS NO RIGHT OF WAY REQUIRED FOR THIS PROJECT. NO INITIAL SITE ASSESSMENT WILL BE PERFORMED. IF CONTAMINATION ON EXISTING RIGHT OF WAY IS DISCOVERED, IT WILL BE HANDLED BY THE DEPARTMENT.

STATUS OF POTENTIALLY CONTAMINATED SITES

DB/IM-0055-02(228)

105444-306000

Lincoln County

August 30, 2012

THERE IS NO RIGHT OF WAY REQUIRED FOR THIS PROJECT. NO INITIAL SITE ASSESSMENT WILL BE PERFORMED. IF CONTAMINATION ON EXISTING RIGHT OF WAY IS DISCOVERED, IT WILL BE HANDLED BY THE DEPARTMENT.

ASBESTOS CONTAMINATION STATUS OF BUILDINGS
TO BE REMOVED BY THE CONTRACTOR
DB/IM-0055-02(228)
105444-305000
Copiah County
August 30, 2012

Reference is made to notices to bidders entitled "Asbestos National Emission Standards for Hazardous Air Pollutants (NESHAP)" and "Removal of Obstructions".

The following pertinent information is furnished concerning asbestos containing materials (ACMs), if any, found in buildings to be removed by the Contractor.

There is no Right of Way required for this project. There are no buildings to be removed by the contractor.

ASBESTOS CONTAMINATION STATUS OF BUILDINGS
TO BE REMOVED BY THE CONTRACTOR
DB/IM-0055-02(228)
105444-306000
Lincoln County
August 30, 2012

Reference is made to notices to bidders entitled "Asbestos National Emission Standards for Hazardous Air Pollutants (NESHAP)" and "Removal of Obstructions".

The following pertinent information is furnished concerning asbestos containing materials (ACMs), if any, found in buildings to be removed by the Contractor.

There is no Right of Way required for this project. There are no buildings to be removed by the contractor.

Mark C. McConnell
Deputy Executive Director/
Chief Engineer

Jackie Duckworth
Deputy Executive Director/
Administration



Dick Hall
Central District Commissioner

J. Kevin Magee
District 3 Engineer

David Foster
District 5 Engineer

84-01

Melinda L. McGrath
Executive Director

P. O. Box 630 / Yazoo City, Mississippi 39194-0630 / Telephone (662) 746-2513 / FAX (662) 746-3672 / GoMDOT.com

Memorandum

Date: August 30, 2012
To: Right of Way Division
Dan Smith
From: Pre-Construction Engineer District Three
Valentino DeVellis *vr*
Re: Project No: DB/IM-0055-02(228)
FMS: 105444/305000
I-55 in Copiah County
Bridge Widening

ENCROACHMENT CERTIFICATION

This is to certify that the above captioned project has been inspected, and no encroachments were found.

VD:vd

pc: Will Ross (District Three)
Meredith Pierce (District Three)
Leroy Crisco (Construction Division)
Shane Martin (Construction Division)
File

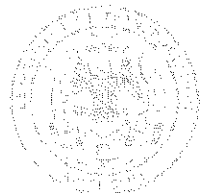

MISSISSIPPI DEPARTMENT OF TRANSPORTATION
Inter-Departmental Memorandum

TO: Ms. Clara Woods
Right-of-Way Division (84-01)

DATE: 3/28/2012

FROM: Gregory L. Wilkinson *GLW*
District Seven Preconstruction (17-01)

SUBJECT OR PROJECT NO: DB/IM-0055-02(226)/105444304000
DB/IM-0055-02(226)/105444303000

INFORMATION COPY TO:

COUNTY: Lincoln & Pike

Preconstruction File
Central File
District Seven (Mr. White & Mr. Morris)
District Seven (Ms. Willis)
Construction Division (Mr. Martin)

I have inspected this project and find no obvious encroachments within the project limits.

If any other information is required, please advise.

RECEIVED

MAR 30 2012

Mark C. McConnell
Deputy Executive Director/
Chief Engineer

Jackie Duckworth
Deputy Executive Director/
Administration



Dick Hall
Central District Commissioner

J. Kevin Magee
District 3 Engineer

David Foster
District 5 Engineer

84-01

Melinda L. McGrath
Executive Director

P. O. Box 630 / Yazoo City, Mississippi 39194-0630 / Telephone (662) 746-2513 / FAX (662) 746-3672 / GoMDOT.com

Memorandum

Date: August 30, 2012

To: Right of Way Division
Dan Smith

From: Pre-Construction Engineer District Three
Valentino DeVellis *VD*

Re: Project No: DB/IM-0055-02(228)
FMS: 105444/305000
I-55 in Copiah County
Bridge Widening

UTILITY STATUS REPORT

This is to certify that the above captioned project has been inspected, and there are potential utilities located at each site.

Utilities that may be within project limits:

AT&T
Entergy Mississippi
Copiah New Zion Water Association
Franklin Telephone Company
Contact Network Inc

VD:vd

pc: Will Ross (District Three)
Meredith Pierce (District Three)
Leroy Crisco (Construction Division)
Shane Martin (Construction Division)
File



MISSISSIPPI DEPARTMENT OF TRANSPORTATION
Inter-Departmental Memorandum

TO: Mr. Dan Smith
Right-of-Way Division (84-01)

DATE: 8/31/2012

FROM: Gregory L. Wilkinson *GLW*
District Seven Preconstruction (17-01)

SUBJECT OR PROJECT NO: DB/IM-0055-02(228)/105444306000

INFORMATION COPY TO:

COUNTY: Lincoln

Preconstruction File
Central File
District Seven (Mr. White & Mr. Morris)
District Seven (Ms. Willis)
Construction Division (Mr. Martin)

This letter is to certify that all of the work will be performed within the existing right-of-way and there are no known utility conflicts on the Lincoln County site for the above referenced project.

Utilities that may be within the project limits on US 84 site:

AT&T 601-833-0765
Entergy 601-925-6506
City of Brookhaven (Water) 601-833-1791
Center Point Energy (Gas) 601-936-0222

If any other information is required, please advise.

MISSISSIPPI DEPARTMENT OF TRANSPORTATION

SECTION 904 - NOTICE TO PROPOSERS NO. 2596 DB

CODE: (SP)

DATE: 07/25/2012

SUBJECT: DBE Forms, Participation and Payment

Bidders are hereby advised that the participation of a DBE Firm can not be counted towards the Prime Contractor's DBE goal until the amount being counted towards the goal has been paid to the DBE.

Bidders are also advised that Form OCR-481 will be completed by **ALL BIDDERS** submitting a bid proposal and **must be signed and included in the Contract Price Proposal Volume 2.** Failure to include Form OCR-481 in the bid proposal package will cause the Contractor's bid to be considered **irregular.**

Form OCR-482 has been developed to comply with this requirement. Bidders are hereby advised that at the end of the job, the Prime Contractor will submit this form to the Project Engineer before the final estimate is paid and the project is closed out. This form certifies payments to all **DBE Subcontractors over the life of the contract.**

Form OCR-484 has also been developed to comply with this requirement. Bidders are hereby advised that each month, the Prime Contractors will submit this form to the Project Engineer no later than the last day of each month. This form certifies payments to all Subcontractors and shows all firms even if the Prime Contractor has paid no monies to the firm during that estimate period (negative report). The Project Engineer will attach this form to the monthly estimate before forwarding the estimate to the Contract Administration Division for processing.

Bidders are also advised that Forms OCR-481 and OCR-485 will be completed by **ALL BIDDERS** submitting a bid proposal and **must be signed and included in the Submittal of Contract Price Proposal (Volume 2).** Failure to include Form OCR-485 in the bid proposal package will cause the Contractor's bid to be considered **irregular.**

DBE Forms, including Forms OCR-481, OCR-482, OCR-484 and OCR-485, can be obtained from the Office of Civil Rights Division, MDOT Administration Building, 401 North West Street, Jackson, MS, or at www.gomdot.com under *Business, Disadvantaged Enterprise, DBE Forms, DBE, MDOT Projects.*

MISSISSIPPI DEPARTMENT OF TRANSPORTATION

SECTION 904 - NOTICE TO PROPOSERS NO. 2618-D3-1 DB

DATE: 07/09/2012

SUBJECT: Project Scope

PROJECT: Design-Build Improvements to Interstate 55 in Lincoln and Covich Counties
Project Nos. DB/IM-0055-02(228)/105444305 and
DB/IM-0055-02(228)/105444306

Work on the project shall consist of bridge sites on I-55 in Lincoln and Covich Counties that will be widened, repaired or reconstructed to meet the current MDOT Standards.

The project shall include the following bridge sites:

1. I-55 NB and I-55 SB over County Line Road(Mile Marker 74.3)
 - Widen both bridges to meet the project requirements.
 - Project Limits - 100 feet in advance of the existing or proposed guardrail to a distance of 100 feet beyond the end of the bridge.
2. I-55 NB and I-55 SB over SR 27 (Mile Marker 72.0)
 - Widen both bridges to meet the project requirements.
 - Lower SR 27 Roadway to meet the 16.5 foot vertical clearance requirement at the I-55 Bridges.
 - Lower the embankment material in the gore area between I-55 SB and I-55 SB Entrance Ramp.
 - Clear the trees in the gore area between I-55 NB and the I-55 NB Entrance Ramp.
 - Project Limits – The area within the ROW as defined by I-55 Station 1205+00 to I-55 Station 1230+00 and SR 27 Station 315+00 to SR 27 Station 324+00.
3. I-55 NB and I-55 SB over Clear Creek Road (Mile Marker 66.1)
 - Widen both bridges to meet the project requirements.
 - Project Limits - 100 feet in advance of the existing or proposed guardrail to a distance of 100 feet beyond the end of the bridge.
4. I-55 NB and I-55 SB over Gallman Road (Mile Marker 65.5)
 - Widen both bridges to meet the project requirements.
 - Lower Gallman Road to meet the 16.5 foot vertical clearance requirement at the I-55 Bridges.
 - Construct slope paving in front of the abutments for the full width of the completed bridge. Project Limits – On I-55, 100 feet in advance of the existing or proposed guardrail to a distance of 100 feet beyond the end of the bridge. On Gallman Road, from Station 11+00 to Station 26+00 on the as-built plans.

The Contractor may include the following bridge sites in the following order:

1. I-55 NB and I-55 SB over SR 28 (Mile Marker 61.8)
 - Widen both bridges to meet the project requirements.
 - Lower SR 28 Roadway to meet the 16.5 foot vertical clearance requirement at the I-55 Bridges.
 - Project Limits – On I-55, 100 feet in advance of the existing or proposed guardrail to a distance of 100 feet beyond the end of the bridge. On SR 28, from Station 123+50 to Station 133+00 on the as-built plans.
2. I-55 NB over Tyson Road (Mile Marker 55.8) (Pavement Repairs)
 - Replace the approach bridge end pavement to be flush with the bridge deck, replace the deteriorated roadway pavement at the exit end of the bridge as detailed below.
 - Project Limits - 50 feet in advance of the existing bridge to a distance of 150 feet beyond the end of the bridge.
3. I-55 NB and I-55 SB over US 84 (Mile Marker 37.5)
 - Widen both bridges to meet the project requirements.
 - Project Limits - 100 feet in advance of the existing or proposed guardrail to a distance of 100 feet beyond the end of the bridge.

Note: Bridge site at US 84 will be included in the project only if it is not included in the Pike and Lincoln Counties Design-Build Project Nos. DBIM-0055-02(226)/105444-303 and DBIM-0055-02(226)/105444-304.

The pavement repair north of the Tyson Road Bridge shall consist of removing 41 feet of CRCP in the right traffic lane. The removal starts 2 feet south of the existing concrete repair and extends north. The replacement concrete shall be CRCP with a thickness equal to the existing pavement. An expansion joint shall be reconstructed at the same location as the existing expansion joint. The new concrete shall be overlaid with asphalt to match the existing overlay. The shoulder on the right side of the right lane at the exit end of the bridge shall be removed to a minimum width of 18 inches and replaced with 9 mm HMA. The minimum depth of removal shall be 4 inches. The length of the removal shall be from the end of the bridge to north end of the right lane pavement replacement.

The Project shall include those bridges and associated roadway work listed above as detailed on the Contractor's Schedule Certificate, made a part of this Project by reference.

Work within the Project limits includes, but is not limited to:

- Removal and disposal of necessary portions of the existing bridge to accomplish the improvements.
- Bridge widening.
- Roadway modifications.
- Clearing of trees for improved site distance.
- Lowering of Embankment for improved site distance.

- Concrete and asphalt paving.
- Remove existing joint armor and repairing joints on existing bridges.
- Remove existing non-integral bearing assemblies and replace with new elastomeric bearing pads on the I-55 NB and I-55 SB over US 84 (Mile Marker 37.5)
- Remove excess debris and clean entire surface of caps at all interior and end bent locations.
- Lane widening shall match existing pavement structure. If existing structure includes an asphalt overlay, the paving bracket shall be designed to accommodate the full concrete pavement depth and a 1.5 inch asphalt overlay.
- The new shoulder shall be a minimum of 6 inches of Class 6, Group D granular material (base) and a minimum of 5.75 inches of Warm or Hot Mix Asphalt.
- Installation and maintenance of temporary erosion control.
- Install necessary embankment material.
- Install new guardrail approaching the bridge, as required by design.
- Within the Project limits and those areas disturbed by the Contractor:
 - Restripe the shoulder lines.
 - Restripe the centerline to match existing centerline spacing.
 - Install new raised pavement markers.
- Perform grassing per the Mississippi Standard Specifications for Road and Bridge Construction.
- Traffic Control.

Construction of the Project will be within Mississippi Department of Transportation (MDOT) Right of Way. The Commission intends to secure the Categorical Exclusion for the construction of the Project. Any additional permits required will be the responsibility of the Proposer.

Project Services shall include but are not limited to:

- Design Services – complete development of construction plans and permitting
- Quality Control (QC) of design
- Construction Services necessary to build and ensure high quality workmanship of the designed facility

The Project will include as many of the above listed bridge sites that can be widened including the associated roadway improvements up to a maximum lump sum proposal price of \$10 Million. The Proposer is required to determine the maximum number of bridge sites to be widened in pairs (i.e. both the northbound and the southbound bridge at each location), in the order presented above.

The scope of work for this Project will include, but is not limited to, the following Design and Construction work items:

Design:

- Preliminary and Final Roadway Design and Plan Preparation
- Preliminary and Final Bridge Superstructure and Substructure Design and Plan Preparation

- Erosion Control Plan
- Traffic Control Plan
- Environmental Coordination
- Roadway and Bridge Drainage Design
- Geotechnical Design
- QC for Design
- Surveying

Design shall meet all appropriate AASHTO *Policy on Geometric Design of Highways and Streets* (latest edition), AASHTO *Standard Specifications for the Design of Highway Bridges* (latest edition), AASHTO LRFD Bridge Design Specifications (6th Edition), *Manual on Uniform Traffic Control Devices* (latest edition) (MUTCD) and MDOT design criteria as modified by the RFP. Microstation and Geopak shall be used in the preparation of CADD files.

Construction:

- Demolition of parts of the existing bridges with debris removal and disposal
- All necessary roadway and bridge work items
- Surveying
- Drainage
- Environmental coordination
- Erosion and sediment control work items
- Traffic control
- Project management
- Construction management
- QC for Construction, including inspection and testing of asphalt and concrete
- PDA testing for piling

Construction shall comply with the MDOT *Standard Specifications for Road And Bridge Construction 2004 Edition* as modified by the RFP to accommodate specific Design/Build requirements, *Manual on Uniform Traffic Control Devices* (latest edition), MDOT Standard Drawings, any Special Provisions, Notice to Bidders, current MDOT publications including, but not limited to, the Materials Division Inspection, Certification, and Testing Manual, and existing AASHTO, ASTM, or MDOT Test Methods.

Design and Construction Responsibilities

The Contractor warrants that it will perform all services in accordance with the standards of care and diligence normally practiced by recognized engineering and construction firms in performing services and obligations of a similar nature. The Contractor warrants that the Project shall be fit for its intended purpose and that all materials and equipment furnished shall be of good quality and new unless otherwise authorized by the Commission and that the construction shall conform to the Contract requirements.

The Contractor, consistent with applicable state licensing laws, shall provide the necessary design Work. The design professionals employed by Contractor or procured from qualified design consultants shall be licensed by the State of Mississippi. The Work, includes, but is not

limited to, surveys, roadway design, traffic control, geotechnical work, hydraulic analyses, storm water management, erosion control, superstructure and substructure design for the preparation of the required drawings, false work, shoring, specifications and other contract documents necessary to permit the Contractor to complete the Project in accordance with the Contract.

The Contractor shall be fully and solely responsible for the accuracy of the design and compliance with specifications, standards and design criteria. The Contractor shall construct the Project in accordance with all applicable Federal, State and local Laws and the Contract.

The Contractor shall perform quality control services as defined in the Technical Requirements, Section 3.2 Construction Testing Requirements.

The Contractor shall provide the necessary supervision, labor, inspection, testing for asphalt and concrete only, material, equipment, machinery, temporary utilities and other temporary facilities to permit performance of all earthwork, drainage, foundation work, all traffic control, substructure and superstructure work, excavation, erosion and sediment control work, field layout work, design and construction management and all other work necessary to complete construction of the Project in accordance with the Contract. Contractor shall perform all construction activities efficiently and with the requisite expertise, skill and competence to satisfy the requirements of the Contract. Contractor at all times shall exercise control over the means, methods, sequences and techniques of construction. Contractor's operations and construction methods shall comply with all applicable Federal, State and local Regulations including but not limited to worker safety, protection and health and protection of the environment and applicable permit requirements.

Control of Work

The Contractor shall be solely responsible for determining the appropriate means, methods and scheduling necessary to complete the Work in a timely manner and in accordance with all Contract requirements. MDOT and FHWA will have the right to review and inspect the Work at any time.

1. Contract Interpretations

The Engineer will decide all questions which may arise as to the quality and acceptability of materials, the Work and the progress of the Work; all questions which may arise as to the interpretation of the specifications; and all questions as to the fulfillment of the Contract.

The Engineer will have the authority, but not the responsibility to suspend the Work, wholly or in part, because of the Contractor's failure to correct conditions unsafe for workers or the general public, for failure to carry out provisions of the Contract, or for failure to carry out orders. The Engineer may also suspend Work for periods deemed necessary due to unsuitable weather conditions, for any conditions considered unsuitable for the prosecution of the Work, or for any other condition or reason deemed to be in the public interest. The Engineer may authorize, in writing, the continued prosecution of

Work activities past their specified seasonal limits when it is determined that the quality of the Work will not be reduced and the public interest will be best served. The Engineer will have authority to enforce and make effective all decisions and orders relating to the Contract.

2. Governmental Approvals and Permits

The Contractor is responsible for obtaining all Governmental Approvals and permits, except those specifically designated as MDOT obtained permits, necessary to construct the Project. Copies of all correspondence and permits shall be forwarded to MDOT within seven (7) days after the correspondence is received. The Contractor shall integrate design practices to avoid and/or minimize potential Work impacts to wetlands and waters of the US. The Contractor shall bear the cost and responsibility of resolving any deviations among the Project Right-of-Way limits, drawings or other information included in the permits that would violate the intent or spirit of the permits. Any proposed changes within the permitted areas shall be coordinated with MDOT and the appropriate agency, and performed to MDOT's satisfaction.

3. Plans for Construction

Prior to the start of construction of any phase or portion of Work, the Contractor shall have plans stamped by MDOT as "Released for Construction" for that phase or portion of Work.

MISSISSIPPI DEPARTMENT OF TRANSPORTATION

SECTION 904 - NOTICE TO PROPOSERS NO. 2818 DB

CODE: (SP)

DATE: 10/01/2009

SUBJECT: Non-Quality Control / Quality Assurance Concrete

Bidders are advised that the following pay items will not be accepted based on the Quality Control / Quality Assurance (QC/QA) requirements of Section 804 of the specifications. The acceptance of these pay items will be based on sampling and testing at the project site by MDOT forces. The Contractor is required to submit mix designs to accomplish this work in accordance with Section 804 and perform normal Quality Control functions at the concrete plant. Acceptance will be in accordance with the requirements of 907-601, Structural Concrete, and TMD-20-04-00-000. At the discretion of the Engineer, the Contractor may request that the concrete be accepted based on QC/QA requirements.

<u>Pay Item</u>	<u>Description</u>
221	Paved Ditches
601	Minor Structures - manholes, inlets, catch basins, junction boxes, pipe headwalls, and pipe collars.
606	Guardrail Anchors
607	Fence Post Footings
608	Sidewalks
609	Curb and Gutter
614	Driveways
616	Median and Island Pavement
630	Sign Footings, except Overhead Sign Supports

MISSISSIPPI DEPARTMENT OF TRANSPORTATION

SECTION 904 - NOTICE TO PROPOSERS NO. 2937 DB

CODE: (SP)

DATE: 01/11/2010

SUBJECT: Reduced Speed Limit Signs

Bidders are advised that all black and white speed limits signs that are used to reduce the speed limit through construction zones shall be covered or removed during times when the Contractor is not performing work. If the Contractor has a routine daytime operation and is not working at night, the signs shall be covered or removed during the nighttime when there is no work activity.

MISSISSIPPI DEPARTMENT OF TRANSPORTATION

SECTION 904 - NOTICE TO PROPOSERS NO. 3131 DB

CODE: (SP)

DATE: 06/24/2010

SUBJECT: Temporary Traffic Paint

Bidders are hereby advised that the temporary traffic paint for this project can be waterborne paint as specified in the 2004 Mississippi Standard Specifications For Road and Bridge Construction or fast dry solvent traffic paint meeting the requirements set out in 907-710-1 (Fast Dry Solvent Traffic Paint).

Payment for all temporary traffic paint shall be paid under the appropriate 619 pay items.

When using fast dry solvent traffic stripe, no paint can be sprayed or placed on the ground during set-up or clean-up.

MISSISSIPPI DEPARTMENT OF TRANSPORTATION

SECTION 904 - NOTICE TO PROPOSERS NO. 3242 DB

CODE: (SP)

DATE: 09/21/2010

SUBJECT: Warm Mix Asphalt

Bidders are advised that MDOT approved products and processes for the production of Warm Mix Asphalt is available at the following MDOT website.

<http://www.gomdot.com/Divisions/Highways/Resources/MPL/Home.aspx>

MISSISSIPPI DEPARTMENT OF TRANSPORTATION

SECTION 904 - NOTICE TO PROPOSERS NO. 3414 DB

CODE: (SP)

DATE: 02/16/2011

SUBJECT: DUNS Requirement for Federal Funded Projects

Bidders are advised that the Prime Contractor must maintain current registrations in the Central Contractor Registration (<http://www.ccr.gov>) at all times during this project. A Dun and Bradstreet Data Universal Numbering System (DUNS) Number (<http://www.dnb.com>) is one of the requirements for registration in the Central Contractor Registration.

Bidders are also advised that the following information needs to be completed and included in the bid documents:

DUNS: _____

Company Name: _____

Company e-mail address: _____

By: _____

MISSISSIPPI DEPARTMENT OF TRANSPORTATION

SECTION 904 - NOTICE TO PROPOSERS NO. 3512 DB

CODE: (SP)

DATE: 04/26/2011

SUBJECT: Wage Rates

Bidders are advised that when a contract consists of work in two or more counties, workers shall be paid the higher wage rate listed in the contract regardless of the county in which work is being performed.

MISSISSIPPI DEPARTMENT OF TRANSPORTATION

SECTION 904 - NOTICE TO PROPOSERS NO. 3581 DB

CODE: (SP)

DATE: 6/10/2011

**SUBJECT: Storm Water Discharge Associated with Construction Activity
(≥ 5 Acres)**

PROJECT:

A Construction Storm Water General NPDES Permit to discharge storm water associated with construction activity is required.

The Department has acquired Certificate of Permit Coverage MSR-106233 under the Mississippi Department of Environmental Quality's (MDEQ) Storm Water Large Construction General Permit. Projects issued a certificate of permit coverage are granted permission to discharge treated storm water associated with construction activity into State waters. Copies of said permit, completed Large Construction Notice of Intent (LCNOI), and Storm Water Pollution Prevention Plan (SWPPP) are on file with the Department.

Prior to the execution of the contract, the successful bidder shall execute and deliver to the Executive Director an original signed copy of the completed Prime Contractor Certification Forms.

Failure of the bidder to execute and file the completed Prime Contractor Certification Forms shall be just cause for the cancellation of the award.

The executed Prime Contractor Certification Forms shall be prima facie evidence that the bidder has examined the permit, is satisfied as to the terms and conditions contained therein, and that the bidder has the primary responsibility for meeting all permit terms including, but not limited to, the inspection and reporting requirements. For this project, the Contractor shall furnish, set up and read, as needed, an on-site rain gauge.

The Contractor shall make inspections in accordance with condition No. S-4, page 22, and shall furnish the Project Engineer with the results of each weekly inspection as soon as possible following the date of inspection. A copy of the inspection form is provided with the packet. The weekly inspections must be documented monthly on the Inspection and Certification Form. The Contractor's representative and the Project Engineer shall jointly review and discuss the results of the inspections so that corrective action can be taken. The Project Engineer shall retain copies of the inspection reports.

The Engineer will have the authority to suspend all work and/or withhold payments for failure of the Contractor to carry out provisions of MDEQ's Storm Water Construction General Permit, the erosion control plan, updates to the erosion control plan, and /or proper maintenance of the BMPs

August 31, 2012

Project Nos. DB/IM-0055-02(228)/105444-305
DB/IM-0055-02(228)/105444-306

Upon successful completion of all permanent erosion and sediment controls, accepted and documented by the full maintenance release, the MDOT Construction Division shall submit a completed Request for Termination (RFT) of Coverage to the Office of Pollution Control.

Securing a permit (s) for storm water discharge associated with the Contractor's activity on any other regulated area the Contractor occupies, shall be the responsibility of the Contractor.

MISSISSIPPI DEPARTMENT OF TRANSPORTATION

SECTION 904 - NOTICE TO PROPOSERS NO. 3612 DB

CODE: (SP)

DATE: 08/10/2011

SUBJECT: Additional Erosion Control Requirements

Bidders are hereby advised of the following requirements that relate to erosion control activities on the project.

THE MAXIMUM TOTAL ACREAGE THAT CAN BE DISTURBED, AT ONE TIME, ON THE PROJECT IS NINETEEN (19) ACRES. THE CONTRACTOR SHALL BE REQUIRED TO STABILIZE DISTURBED AREAS PRIOR TO OPENING UP ADDITIONAL SECTIONS OF THE PROJECT. STABILIZED SHALL BE WHEN THE DISTURBED AREA MEETS ONE OF THE FOLLOWING CRITERIA:

- **THE AREA HAS BEEN GRASSED, EITHER TEMPORARY OR PERMANENT, AND MULCHED ACCORDING TO THE SPECIFICATIONS,OR**
- **A CRUSHED STONE COURSE OR A LIFT OF ASPHALT PAVEMENT HAS BEEN PLACED, OR**
- **THE AREA HAS BEEN CHEMICALLY TREATED USING PORTLAND CEMENT OR LIME-FLY ASH, AND SEALED.**

DISTURBED AREAS INCLUDE THE ROADBED, SLOPES AND REMAINING AREA OUT TO THE ROW LINE.

Clearing and Grubbing: Prior to beginning any clearing and grubbing operations on the project, controls shall be in place to address areas such as drainage structures, wetlands, streams, steep slopes and any other sensitive areas as directed by the Engineer. Clearing and grubbing should be limited to the minimum area necessary to construct the project. Grubbing operations should be minimized in areas outside the construction limits and stumps should be cut off flush with the existing ground elevations. A buffer area of at least fifteen (15) feet shall be in place adjacent to the right-of-way line and at least five (5) feet adjacent to stream banks. The buffer area can either be the existing vegetation that is left undisturbed or re-established by planting new vegetation if clearing and grubbing was required.

Unclassified Excavation: Cut sections shall be graded in accordance with the typical sections and plan grades. Permanent erosion control BMP's should be placed as soon as possible after the cut material has been moved. Fill sections that are completed shall have permanent erosion control BMP's placed. Fill sections that are not completed will be either permanently or temporarily grassed until additional material is made available to complete these sections. All unclassified excavation on the project will still be required to be moved prior to incorporating any borrow excavation on the project. The contractor may have to stockpile unclassified excavation in order to comply with the nineteen (19) acre requirement. No additional compensation will be made for stockpiling operations.

Disturbed areas that remain inactive for a period of more than fourteen (14) days shall be temporary grassed and mulched. Temporary grassing and mulching shall only be paid one time for a given area.

MISSISSIPPI DEPARTMENT OF TRANSPORTATION

SECTION 904 - NOTICE TO PROPOSERS NO. 3655 DB

CODE: (SP)

DATE: 10/04/2011

SUBJECT: Type III Barricade Rails

Bidders are advised that the use of 2-inch nominal thickness timber for rails on Type III barricades has not been approved by NCHRP as a crashworthy device. Therefore, the use of 2-inch nominal thickness timbers will not be allowed for rails on Type III Barricades. Timber rails for Type III Barricades shall be as follows.

- For barricades up to four feet (4') wide, the maximum thickness of timber rails shall be one inch (1") and the material shall be pine timber or 3/4-inch ACX plywood.
- For barricades more than four feet (4') wide, timber rails shall be constructed of 3/4-inch ACX plywood.

A list of crashworthy Type III Barricades can be found at the below FHWA website.

http://safety.fhwa.dot.gov/roadway_dept/policy_guide/road_hardware/wzd/

MISSISSIPPI DEPARTMENT OF TRANSPORTATION

SECTION 904 - NOTICE TO PROPOSERS NO. 6000 DB

CODE: (SP)

DATE: 05/03/2012

SUBJECT: Maintenance of Cable-Barrier Rail System

Proposers are advised that a cable-barrier rail system currently exists in the median of Interstate 55 within the limits of the proposed project. Proposers should take effort to protect and maintain the existing cable-barrier rail system as long as there is traffic on both sides of the Interstate median.

During periods where traffic is only on one side of the median, the cable-barrier system may be dis-assembled to allow for construction of median cross-over ramps. Proposer should consult with the MDOT Project Engineer and should follow all manufacturer's recommendations for dis-assembly of the cable-barrier system.

In addition, where median cross-over ramps are proposed, the Proposer shall remove the cable-barrier concrete footing strip in the area of the cross-over ramp. Proposer shall re-install a cable-barrier concrete footing strip after the cross-over ramp is removed and the entire area is restored to its current condition. The Proposer shall follow all manufacturer's recommendations for re-assembly of the cable-barrier system including installation of posts and re-tensioning of the cables.

During periods when the overall construction is ongoing and the traffic is on both sides of the median, the Proposer shall maintain the integrity of the cable-barrier system through either re-assembly of the cable-barrier system in accordance with manufacturer's recommendation or by providing a barrier system with equivalent crash characteristics.

SUPPLEMENT TO FORM FHWA-1273**DATE: 6/15/94****SUBJECT: Final Certificate and Contract Provisions for Subcontracts**

All subcontracts shall be in writing and contain all pertinent provisions and requirements of the prime Contract.

Each "Request for Permission to Subcontract" (Mississippi Department of Transportation Form CAD-720) shall include a copy of subcontract for review by the Mississippi Department of Transportation. The federal contract provisions may be omitted from the subcontract copy submitted for review provided the Contractor certifies that the provisions will be physically incorporated into the agreement furnished to the Subcontractor.

In lieu of submitting a copy of the subcontract for review, the Contractor may certify that the subcontract agreement is in writing and that it contains all the requirements and pertinent provisions of the prime contract.

Each Subcontractor will be required to provide a copy of the subcontract agreement for contract compliance reviews, along with physical evidence (copy of FHWA-1273) that requirements and pertinent provisions have been provided for review and adherence.

General Decision Number: MS120180 08/03/2012 MS180

Superseded General Decision Number: MS20100223

State: Mississippi

Construction Type: Highway

Counties: Copiah, Hinds and Rankin Counties in Mississippi.

HIGHWAY CONSTRUCTION PROJECTS (excluding tunnels, building structures in rest area projects & railroad construction; bascule, suspension & spandrel arch bridges designed for commercial navigation, bridges involving marine construction; and other major bridges).

Modification Number Publication Date

0	01/06/2012
1	08/03/2012

* ELEC0480-007 07/01/2012

August 31, 2012

Project Nos. DB/IM-0055-02(228)/105444-305
DB/IM-0055-02(228)/105444-306

SECTION 906

	Rates	Fringes
ELECTRICIAN	\$ 23.10	3% + 7.43

SUMS2008-141 09/04/2008

	Rates	Fringes
CEMENT MASON/CONCRETE FINISHER...	\$ 12.85	0.39
LABORER: Common or General.....	\$ 8.25	0.00
LABORER: Pipelayer.....	\$ 10.17	0.00
OPERATOR: Backhoe	\$ 13.38	0.00
OPERATOR: Broom	\$ 8.00	0.00
OPERATOR: Bulldozer.....	\$ 9.00	0.00
OPERATOR: Grader/Blade.....	\$ 11.67	0.00
OPERATOR: Mechanic.....	\$ 13.00	0.00
OPERATOR: Piledriver.....	\$ 12.50	1.23
OPERATOR: Roller	\$ 10.00	0.00
OPERATOR: Scraper	\$ 10.00	0.00
TRUCK DRIVER	\$ 10.00	0.00

WELDERS - Receive rate prescribed for craft performing operation to which welding is incidental.
=====

Unlisted classifications needed for work not included within the scope of the classifications listed may be added after award only as provided in the labor standards contract clauses (29CFR 5.5 (a) (1) (ii)).

The body of each wage determination lists the classification and wage rates that have been found to be prevailing for the cited type(s) of construction in the area covered by the wage determination. The classifications are listed in alphabetical order of "identifiers" that indicate whether the particular rate is union or non-union.

Union Identifiers

An identifier enclosed in dotted lines beginning with characters other than "SU" denotes that the union classification and rate have found to be prevailing for that classification. Example: PLUM0198-005 07/01/2011. The first four letters, PLUM, indicate the international union and the four-digit number, 0198, that follows indicates the local union number or district council number where applicable, i.e., Plumbers Local 0198. The next number, 005 in the example, is an internal number used in processing the wage determination. The date, 07/01/2011, following these characters is the effective date of the most current negotiated rate/collective bargaining agreement which would be July 1, 2011 in the above example.

Union prevailing wage rates will be updated to reflect any changes in the collective bargaining agreements governing the rate.

Non-Union Identifiers

Classifications listed under an "SU" identifier were derived from survey data by computing average rates and are not union rates; however, the data used in computing these rates may include both union and non-union data. Example: SULA2004-007 5/13/2010. SU indicates the rates are not union rates, LA indicates the State of Louisiana; 2004 is the year of the survey; and 007 is an internal number used in producing the wage determination. A 1993 or later date, 5/13/2010, indicates the classifications and rates under that identifier were issued as a General Wage Determination on that date.

Survey wage rates will remain in effect and will not change until a new survey is conducted.

WAGE DETERMINATION APPEALS PROCESS

1.) Has there been an initial decision in the matter? This can be:

- * an existing published wage determination
- * a survey underlying a wage determination
- * a Wage and Hour Division letter setting forth a position on a wage determination matter
- * a conformance (additional classification and rate) ruling

On survey related matters, initial contact, including requests for summaries of surveys, should be with the Wage and Hour Regional Office for the area in which the survey was conducted because those Regional Offices have responsibility for the Davis-Bacon survey program. If the response from this initial contact is not satisfactory, then the process described in 2.) and 3.) should be followed.

With regard to any other matter not yet ripe for the formal process described here, initial contact should be with the Branch of Construction Wage Determinations. Write to:

Branch of Construction Wage Determinations
Wage and Hour Division
U.S. Department of Labor
200 Constitution Avenue, N.W.
Washington, DC 20210

2.) If the answer to the question in 1.) is yes, then an interested party (those affected by the action) can request review and reconsideration from the Wage and Hour Administrator (See 29 CFR Part 1.8 and 29 CFR Part 7). Write to:

Wage and Hour Administrator
U.S. Department of Labor
200 Constitution Avenue, N.W.
Washington, DC 20210

The request should be accompanied by a full statement of the interested party's position and by any information (wage payment data, project description, area practice material, etc.) that the requestor considers relevant to the issue.

3.) If the decision of the Administrator is not favorable, an interested party may appeal directly to the Administrative Review Board (formerly the Wage Appeals Board). Write to:

Administrative Review Board
U.S. Department of Labor
200 Constitution Avenue, N.W.
Washington, DC 20210

4.) All decisions by the Administrative Review Board are final.

=====
END OF GENERAL DECISION

General Decision Number: MS120160 08/03/2012 MS160

Superseded General Decision Number: MS20100203

State: Mississippi

Construction Type: Highway

Counties: Amite, Covington, Issaquena, Jefferson Davis, Lawrence, Lincoln, Marion, Sharkey, Walthall and Warren Counties in Mississippi.

HIGHWAY CONSTRUCTION PROJECTS (excluding tunnels, building structures in rest area projects & railroad construction; bascule, suspension & spandrel arch bridges designed for commercial navigation, bridges involving marine construction; and other major bridges).

Modification Number Publication Date

0 01/06/2012

1 08/03/2012

* ELEC0480-008 07/01/2012

Amite, Covington, Issaquena, Lawrence, Lincoln, Sharkey, Walthall, and Warren Counties

	Rates	Fringes
ELECTRICIAN	\$ 23.10	3%+7.43

ELEC0903-010 06/01/2011

Jefferson Davis and Marion Counties

	Rates	Fringes
ELECTRICIAN	\$ 23.60	12%+4.40

SUMS2008-121 09/04/2008

	Rates	Fringes
CARPENTER, Includes Form Work	\$ 11.42	0.12
CEMENT MASON/CONCRETE FINISHER	\$ 10.82	0.00
IRONWORKER, REINFORCING.....	\$ 11.30	0.00
LABORER: Common or General.....	\$ 8.64	0.00

SECTION 906

LABORER: Pipelayer.....	\$ 9.68	0.00
OPERATOR: Backhoe/Excavator	\$ 11.32	0.00
OPERATOR: Broom	\$ 10.17	0.00
OPERATOR: Bulldozer.....	\$ 10.77	0.00
OPERATOR: Crane.....	\$ 14.57	0.00
OPERATOR: Grader/Blade.....	\$ 12.46	0.00
OPERATOR: Loader	\$ 10.15	0.00
OPERATOR: Mechanic.....	\$ 12.04	0.00
OPERATOR: Oiler	\$ 12.33	0.48
OPERATOR: Roller	\$ 9.31	0.00
OPERATOR: Scraper	\$ 10.00	0.00
OPERATOR: Tractor.....	\$ 7.79	0.00
OPERATOR: Asphalt Paver and Asphalt Spreader.....	\$ 10.00	0.00
TRUCK DRIVER	\$ 9.22	0.00

WELDERS - Receive rate prescribed for craft performing operation to which welding is incidental.

=====

Unlisted classifications needed for work not included within the scope of the classifications listed may be added after award only as provided in the labor standards contract clauses (29CFR 5.5 (a) (1) (ii)).

The body of each wage determination lists the classification and wage rates that have been found to be prevailing for the cited type(s) of construction in the area covered by the wage determination. The classifications are listed in alphabetical order of "identifiers" that indicate whether the particular rate is union or non-union.

Union Identifiers

An identifier enclosed in dotted lines beginning with characters other than "SU" denotes that the union classification and rate have found to be prevailing for that classification. Example: PLUM0198-005 07/01/2011. The first four letters, PLUM, indicate the international union and the four-digit number, 0198, that follows indicates the local union number or district council number where applicable, i.e., Plumbers Local 0198. The next number, 005 in the example, is an internal number used in processing the wage determination. The date, 07/01/2011, following these characters is the effective date of the most current negotiated rate/collective bargaining agreement which would be

July 1, 2011 in the above example.

Union prevailing wage rates will be updated to reflect any changes in the collective bargaining agreements governing the rate.

Non-Union Identifiers

Classifications listed under an "SU" identifier were derived from survey data by computing average rates and are not union rates; however, the data used in computing these rates may include both union and non-union data. Example: SULA2004-007 5/13/2010. SU indicates the rates are not union rates, LA indicates the State of Louisiana; 2004 is the year of the survey; and 007 is an internal number used in producing the wage determination. A 1993 or later date, 5/13/2010, indicates the classifications and rates under that identifier were issued as a General Wage Determination on that date. Survey wage rates will remain in effect and will not change until a new survey is conducted.

WAGE DETERMINATION APPEALS PROCESS

1.) Has there been an initial decision in the matter? This can be:

- * an existing published wage determination
- * a survey underlying a wage determination
- * a Wage and Hour Division letter setting forth a position on a wage determination matter
- * a conformance (additional classification and rate) ruling

On survey related matters, initial contact, including requests for summaries of surveys, should be with the Wage and Hour Regional Office for the area in which the survey was conducted because those Regional Offices have responsibility for the Davis-Bacon survey program. If the response from this initial contact is not satisfactory, then the process described in 2.) and 3.) should be followed.

With regard to any other matter not yet ripe for the formal process described here, initial contact should be with the Branch of Construction Wage Determinations. Write to:

Branch of Construction Wage Determinations
Wage and Hour Division
U.S. Department of Labor
200 Constitution Avenue, N.W.
Washington, DC 20210

2.) If the answer to the question in 1.) is yes, then an interested party (those affected by the action) can request review and reconsideration from the Wage and Hour Administrator (See 29 CFR Part 1.8 and 29 CFR Part 7). Write to:

Wage and Hour Administrator
U.S. Department of Labor
200 Constitution Avenue, N.W.
Washington, DC 20210

The request should be accompanied by a full statement of the interested party's position and by any information (wage payment data, project description, area practice material, etc.) that the requestor considers relevant to the issue.

3.) If the decision of the Administrator is not favorable, an interested party may appeal directly to the Administrative Review Board (formerly the Wage Appeals Board). Write to:

Administrative Review Board
U.S. Department of Labor
200 Constitution Avenue, N.W.
Washington, DC 20210

4.) All decisions by the Administrative Review Board are final.

=====

END OF GENERAL DECISION

**REQUIRED CONTRACT PROVISIONS
FEDERAL-AID CONSTRUCTION CONTRACTS**

FHWA-1273 Electronic version -- March 10, 1994

	Page
I. General -----	1
II. Nondiscrimination -----	1
III. Nonsegregated Facilities -----	3
IV. Payment of Predetermined Minimum Wage -----	3
V. Statements and Payrolls-----	6
VI. Record of Materials, Supplies, and Labor -----	6
VII. Subletting or Assigning the Contract-----	7
VIII. Safety: Accident Prevention-----	7
IX. False Statements Concerning Highway Projects -----	7
X. Implementation of Clean Air Act and Federal Water Pollution Control Act -----	8
XI. Certification Regarding Debarment, Suspension, Ineligibility, and Voluntary Exclusion-----	8
XII. Certification Regarding Use of Contract Funds for Lobbying-----	9

6. Selection of Labor: During the performance of this contract, the contractor shall not:

a. discriminate against labor from any other State, possession, or territory of the United States (except for employment preference for Appalachian contracts, when applicable, as specified in Attachment A), or

b. employ convict labor for any purpose within the limits of the project unless it is labor performed by convicts who are on parole, supervised release, or probation.

II. NONDISCRIMINATION

(Applicable to all Federal-aid construction contracts and to all related subcontracts of \$10,000 or more.)

1. Equal Employment Opportunity: Equal employment opportunity (EEO) requirements not to discriminate and to take affirmative action to assure equal opportunity as set forth under laws, executive orders, rules, regulations (28 CFR 35, 29 CFR 1630 and 41 CFR 60) and orders of the Secretary of Labor as modified by the provisions prescribed herein, and imposed pursuant to 23 U.S.C. 140 shall constitute the EEO and specific affirmative action standards for the contractor's project activities under this contract. The Equal Opportunity Construction Contract Specifications set forth under 41 CFR 60-4.3 and the provisions of the American Disabilities Act of 1990 (42 U.S.C. 12101 et seq.) set forth under 28 CFR 35 and 29 CFR 1630 are incorporated by reference in this contract. In the execution of this contract, the contractor agrees to comply with the following minimum specific requirement activities of EEO:

a. The contractor will work with the State highway agency (SHA) and the Federal Government in carrying out EEO obligations and in their review of his/her activities under the contract.

b. The contractor will accept as his operating policy the following statement:

"It is the policy of this Company to assure that applicants are employed, and that employees are treated during employment, without regard to their race, religion, sex, color, national origin, age or disability. Such action shall include: employment, upgrading, demotion, or transfer; recruitment or recruitment advertising; layoff or termination; rates of pay or other forms of compensation; and selection for training, including apprenticeship, preapprenticeship, and/or on-the-job training."

2. EEO Officer: The contractor will designate and make known to the SHA contracting officers an EEO Officer who will have the responsibility for and must be capable of effectively administering and promoting an active contractor program of EEO and who must be assigned adequate authority and responsibility to do so.

3. Dissemination of Policy: All members of the contractor's staff who are authorized to hire, supervise, promote, and discharge employees, or who recommend such action, or who are substantially involved in such action, will be made fully cognizant of, and will implement, the contractor's EEO policy and contractual responsibilities to provide EEO in each grade and classification of employment.

ATTACHMENTS

- A. Employment Preference for Appalachian Contracts (included in Appalachian contracts only)

I. GENERAL

1. These contract provisions shall apply to all work performed on the contract by the contractor's own organization and with the assistance of workers under the contractor's immediate superintendence and to all work performed on the contract by piecework, station work, or by subcontract.

2. Except as otherwise provided for in each section, the contractor shall insert in each subcontract all of the stipulations contained in these Required Contract Provisions, and further require their inclusion in any lower tier subcontract or purchase order that may in turn be made. The Required Contract Provisions shall not be incorporated by reference in any case. The prime contractor shall be responsible for compliance by any subcontractor or lower tier subcontractor with these Required Contract Provisions.

3. A breach of any of the stipulations contained in these Required Contract Provisions shall be sufficient grounds for termination of the contract.

4. A breach of the following clauses of the Required Contract Provisions may also be grounds for debarment as provided in 29 CFR 5.12:

- Section I, paragraph 2;
- Section IV, paragraphs 1, 2, 3, 4, and 7;
- Section V, paragraphs 1 and 2a through 2g.

5. Disputes arising out of the labor standards provisions of Section IV (except paragraph 5) and Section V of these Required Contract Provisions shall not be subject to the general disputes clause of this contract. Such disputes shall be resolved in accordance with the procedures of the U.S. Department of Labor (DOL) as set forth in 29 CFR 5, 6, and 7. Disputes within the meaning of this clause include disputes between the contractor (or any of its subcontractors) and the contracting agency, the DOL, or the contractor's employees or their representatives.

To ensure that the above agreement will be met, the following actions will be taken as a minimum:

a. Periodic meetings of supervisory and personnel office employees will be conducted before the start of work and then not less often than once every six months, at which time the contractor's EEO policy and its implementation will be reviewed and explained. The meetings will be conducted by the EEO Officer.

b. All new supervisory or personnel office employees will be given a thorough indoctrination by the EEO Officer, covering all major aspects of the contractor's EEO obligations within thirty days following their reporting to duty with the contractor.

c. All personnel who are engaged in direct recruitment for the project will be instructed by the EEO Officer in the contractor's procedures for locating and hiring minority group employees.

d. Notices and posters setting forth the contractor's EEO policy will be placed in areas readily accessible to employees, applicants for employment and potential employees.

e. The contractor's EEO policy and the procedures to implement such policy will be brought to the attention of employees by means of meetings, employee handbooks, or other appropriate means.

4. Recruitment: When advertising for employees, the contractor will include in all advertisements for employees the notation: "An Equal Opportunity Employer." All such advertisements will be placed in publications having a large circulation among minority groups in the area from which the project work force would normally be derived.

a. The contractor will, unless precluded by a valid bargaining agreement, conduct systematic and direct recruitment through public and private employee referral sources likely to yield qualified minority group applicants. To meet this requirement, the contractor will identify sources of potential minority group employees, and establish with such identified sources procedures whereby minority group applicants may be referred to the contractor for employment consideration.

b. In the event the contractor has a valid bargaining agreement providing for exclusive hiring hall referrals, he is expected to observe the provisions of that agreement to the extent that the system permits the contractor's compliance with EEO contract provisions. (The DOL has held that where implementation of such agreements have the effect of discriminating against minorities or women, or obligates the contractor to do the same, such implementation violates Executive Order 11246, as amended.)

c. The contractor will encourage his present employees to refer minority group applicants for employment. Information and procedures with regard to referring minority group applicants will be discussed with employees.

5. Personnel Actions: Wages, working conditions, and employee benefits shall be established and administered, and personnel actions of every type, including hiring, upgrading, promotion, transfer, demotion, layoff, and termination, shall be taken without regard to race, color, religion, sex, national origin, age or disability. The following procedures shall be followed:

a. The contractor will conduct periodic inspections of project sites to insure that working conditions and employee facilities do not indicate discriminatory treatment of project site personnel.

b. The contractor will periodically evaluate the spread of wages paid within each classification to determine any evidence of discriminatory wage practices.

c. The contractor will periodically review selected personnel actions in depth to determine whether there is evidence of discrimination. Where evidence is found, the contractor will promptly take corrective action. If the review indicates that the discrimination may extend beyond the actions reviewed, such corrective action shall include all affected persons.

d. The contractor will promptly investigate all complaints of alleged discrimination made to the contractor in connection with his obligations under this contract, will attempt to resolve such complaints, and will take appropriate corrective action within a reasonable time. If the investigation indicates that the discrimination may affect persons other than the complainant, such corrective action shall include such other persons. Upon completion of each investigation, the contractor will inform every complainant of all of his avenues of appeal.

6. Training and Promotion:

a. The contractor will assist in locating, qualifying, and increasing the skills of minority group and women employees, and applicants for employment.

b. Consistent with the contractor's work force requirements and as permissible under Federal and State regulations, the contractor shall make full use of training programs, i.e., apprenticeship, and on-the-job training programs for the geographical area of contract performance. Where feasible, 25 percent of apprentices or trainees in each occupation shall be in their first year of apprenticeship or training. In the event a special provision for training is provided under this contract, this subparagraph will be superseded as indicated in the special provision.

c. The contractor will advise employees and applicants for employment of available training programs and entrance requirements for each.

d. The contractor will periodically review the training and promotion potential of minority group and women employees and will encourage eligible employees to apply for such training and promotion.

7. Unions: If the contractor relies in whole or in part upon unions as a source of employees, the contractor will use his/her best efforts to obtain the cooperation of such unions to increase opportunities for minority groups and women within the unions, and to effect referrals by such unions of minority and female employees. Actions by the contractor either directly or through a contractor's association acting as agent will include the procedures set forth below:

a. The contractor will use best efforts to develop, in cooperation with the unions, joint training programs aimed toward qualifying more minority group members and women for membership in the unions and increasing the skills of minority group employees and women so that they may qualify for higher paying employment.

b. The contractor will use best efforts to incorporate an EEO clause into each union agreement to the end that such union will be contractually bound to refer applicants without regard to their race, color, religion, sex, national origin, age or disability.

c. The contractor is to obtain information as to the referral practices and policies of the labor union except that to the extent such information is within the exclusive possession of the labor union and such labor union refuses to furnish such information to the contractor, the contractor shall so certify to the SHA and shall set forth what efforts have been made to obtain such information.

d. In the event the union is unable to provide the contractor with a reasonable flow of minority and women referrals within the time limit set forth in the collective bargaining agreement, the contractor will, through independent recruitment efforts, fill the employment vacancies without regard to race, color, religion, sex, national origin, age or disability; making full efforts to obtain qualified and/or qualifiable minority group persons and women. (The DOL has held that it shall be no excuse that the union with which the contractor has a collective bargaining agreement providing for exclusive referral failed to refer minority employees.) In the event the union referral practice prevents the contractor from meeting the obligations pursuant to Executive Order 11246, as amended, and these special provisions, such contractor shall immediately notify the SHA.

8. Selection of Subcontractors, Procurement of Materials and Leasing of Equipment: The contractor shall not discriminate on the grounds of race, color, religion, sex, national origin, age or disability in the selection and retention of subcontractors, including procurement of materials and leases of equipment.

a. The contractor shall notify all potential subcontractors and suppliers of his/her EEO obligations under this contract.

b. Disadvantaged business enterprises (DBE), as defined in 49 CFR 23, shall have equal opportunity to compete for and perform subcontracts which the contractor enters into pursuant to this contract. The contractor will use his best efforts to solicit bids from and to utilize DBE subcontractors or subcontractors with meaningful minority group and female representation among their employees. Contractors shall obtain lists of DBE construction firms from SHA personnel.

c. The contractor will use his best efforts to ensure subcontractor compliance with their EEO obligations.

9. Records and Reports: The contractor shall keep such records as necessary to document compliance with the EEO requirements. Such records shall be retained for a period of three years following completion of the contract work and shall be available at reasonable times and places for inspection by authorized representatives of the SHA and the FHWA.

a. The records kept by the contractor shall document the following:

(1) The number of minority and non-minority group members and women employed in each work classification on the project;

(2) The progress and efforts being made in cooperation with unions, when applicable, to increase employment opportunities for minorities and women;

(3) The progress and efforts being made in locating, hiring, training, qualifying, and upgrading minority and female employees; and

(4) The progress and efforts being made in securing the services of DBE subcontractors or subcontractors with meaningful minority and female representation among their employees.

b. The contractors will submit an annual report to the SHA each July for the duration of the project, indicating the number of minority, women, and non-minority group employees currently engaged in each work classification required by the contract work. This information is to be reported on Form FHWA-1391. If on-the-job training is being required by special provision, the contractor will be required to collect and report training data.

III. NONSEGREGATED FACILITIES

(Applicable to all Federal-aid construction contracts and to all related subcontracts of \$10,000 or more.)

a. By submission of this bid, the execution of this contract or subcontract, or the consummation of this material supply agreement or purchase order, as appropriate, the bidder, Federal-aid construction contractor, subcontractor, material supplier, or vendor, as appropriate, certifies that the firm does not maintain or provide for its employees any segregated facilities at any of its establishments, and that the firm does not permit its employees to perform their services at any location, under its control, where segregated facilities are maintained. The firm agrees that a breach of this certification is a violation of the EEO provisions of this contract. The firm further certifies that no employee will be denied access to adequate facilities on the basis of sex or disability.

b. As used in this certification, the term "segregated facilities" means any waiting rooms, work areas, restrooms and washrooms, restaurants and other eating areas, timeclocks, locker rooms, and other storage or dressing areas, parking lots, drinking fountains, recreation or entertainment areas, transportation, and housing facilities provided for employees which are segregated by explicit directive, or are, in fact, segregated on the basis of race, color, religion, national origin, age or disability, because of habit, local custom, or otherwise. The only exception will be for the disabled when the demands for accessibility override (e.g. disabled parking).

c. The contractor agrees that it has obtained or will obtain identical certification from proposed subcontractors or material suppliers prior to award of subcontracts or consummation of material supply agreements of \$10,000 or more and that it will retain such certifications in its files.

IV. PAYMENT OF PREDETERMINED MINIMUM WAGE

(Applicable to all Federal-aid construction contracts exceeding \$2,000 and to all related subcontracts, except for projects located on roadways classified as local roads or rural minor collectors, which are exempt.)

1. General:

a. All mechanics and laborers employed or working upon the site of the work will be paid unconditionally and not less often than once a week and without subsequent deduction or rebate on any account [except such payroll deductions as are permitted by regulations (29 CFR 3) issued by the Secretary of Labor under the

Copeland Act (40 U.S.C. 276c)] the full amounts of wages and bona fide fringe benefits (or cash equivalents thereof) due at time of payment. The payment shall be computed at wage rates not less than those contained in the wage determination of the Secretary of Labor (hereinafter "the wage determination") which is attached hereto and made a part hereof, regardless of any contractual relationship which may be alleged to exist between the contractor or its subcontractors and such laborers and mechanics. The wage determination (including any additional classifications and wage rates conformed under paragraph 2 of this Section IV and the DOL poster (WH-1321) or Form FHWA-1495) shall be posted at all times by the contractor and its subcontractors at the site of the work in a prominent and accessible place where it can be easily seen by the workers. For the purpose of this Section, contributions made or costs reasonably anticipated for bona fide fringe benefits under Section 1(b)(2) of the Davis-Bacon Act (40 U.S.C. 276a) on behalf of laborers or mechanics are considered wages paid to such laborers or mechanics, subject to the provisions of Section IV, paragraph 3b, hereof. Also, for the purpose of this Section, regular contributions made or costs incurred for more than a weekly period (but not less often than quarterly) under plans, funds, or programs, which cover the particular weekly period, are deemed to be constructively made or incurred during such weekly period. Such laborers and mechanics shall be paid the appropriate wage rate and fringe benefits on the wage determination for the classification of work actually performed, without regard to skill, except as provided in paragraphs 4 and 5 of this Section IV.

b. Laborers or mechanics performing work in more than one classification may be compensated at the rate specified for each classification for the time actually worked therein, provided, that the employer's payroll records accurately set forth the time spent in each classification in which work is performed.

c. All rulings and interpretations of the Davis-Bacon Act and related acts contained in 29 CFR 1, 3, and 5 are herein incorporated by reference in this contract.

2. Classification:

a. The SHA contracting officer shall require that any class of laborers or mechanics employed under the contract, which is not listed in the wage determination, shall be classified in conformance with the wage determination.

b. The contracting officer shall approve an additional classification, wage rate and fringe benefits only when the following criteria have been met:

(1) the work to be performed by the additional classification requested is not performed by a classification in the wage determination;

(2) the additional classification is utilized in the area by the construction industry;

(3) the proposed wage rate, including any bona fide fringe benefits, bears a reasonable relationship to the wage rates contained in the wage determination; and

(4) with respect to helpers, when such a classification prevails in the area in which the work is performed.

c. If the contractor or subcontractors, as appropriate, the laborers and mechanics (if known) to be employed in the additional classification or their representatives, and the contracting officer

agree on the classification and wage rate (including the amount designated for fringe benefits where appropriate), a report of the action taken shall be sent by the contracting officer to the DOL, Administrator of the Wage and Hour Division, Employment Standards Administration, Washington, D.C. 20210. The Wage and Hour Administrator, or an authorized representative, will approve, modify, or disapprove every additional classification action within 30 days of receipt and so advise the contracting officer or will notify the contracting officer within the 30-day period that additional time is necessary.

d. In the event the contractor or subcontractors, as appropriate, the laborers or mechanics to be employed in the additional classification or their representatives, and the contracting officer do not agree on the proposed classification and wage rate (including the amount designated for fringe benefits, where appropriate), the contracting officer shall refer the questions, including the views of all interested parties and the recommendation of the contracting officer, to the Wage and Hour Administrator for determination. Said Administrator, or an authorized representative, will issue a determination within 30 days of receipt and so advise the contracting officer or will notify the contracting officer within the 30-day period that additional time is necessary.

e. The wage rate (including fringe benefits where appropriate) determined pursuant to paragraph 2c or 2d of this Section IV shall be paid to all workers performing work in the additional classification from the first day on which work is performed in the classification.

3. Payment of Fringe Benefits:

a. Whenever the minimum wage rate prescribed in the contract for a class of laborers or mechanics includes a fringe benefit which is not expressed as an hourly rate, the contractor or subcontractors, as appropriate, shall either pay the benefit as stated in the wage determination or shall pay another bona fide fringe benefit or an hourly case equivalent thereof.

b. If the contractor or subcontractor, as appropriate, does not make payments to a trustee or other third person, he/she may consider as a part of the wages of any laborer or mechanic the amount of any costs reasonably anticipated in providing bona fide fringe benefits under a plan or program, provided, that the Secretary of Labor has found, upon the written request of the contractor, that the applicable standards of the Davis-Bacon Act have been met. The Secretary of Labor may require the contractor to set aside in a separate account assets for the meeting of obligations under the plan or program.

4. Apprentices and Trainees (Programs of the U.S. DOL) and Helpers:

a. Apprentices:

(1) Apprentices will be permitted to work at less than the predetermined rate for the work they performed when they are employed pursuant to and individually registered in a bona fide apprenticeship program registered with the DOL, Employment and Training Administration, Bureau of Apprenticeship and Training, or with a State apprenticeship agency recognized by the Bureau, or if a person is employed in his/her first 90 days of probationary employment as an apprentice in such an apprenticeship program, who is not individually registered in the program, but who has been certified by the Bureau of Apprenticeship and Training or a State

apprenticeship agency (where appropriate) to be eligible for probationary employment as an apprentice.

(2) The allowable ratio of apprentices to journeyman-level employees on the job site in any craft classification shall not be greater than the ratio permitted to the contractor as to the entire work force under the registered program. Any employee listed on a payroll at an apprentice wage rate, who is not registered or otherwise employed as stated above, shall be paid not less than the applicable wage rate listed in the wage determination for the classification of work actually performed. In addition, any apprentice performing work on the job site in excess of the ratio permitted under the registered program shall be paid not less than the applicable wage rate on the wage determination for the work actually performed. Where a contractor or subcontractor is performing construction on a project in a locality other than that in which its program is registered, the ratios and wage rates (expressed in percentages of the journeyman-level hourly rate) specified in the contractor's or subcontractor's registered program shall be observed.

(3) Every apprentice must be paid at not less than the rate specified in the registered program for the apprentice's level of progress, expressed as a percentage of the journeyman-level hourly rate specified in the applicable wage determination. Apprentices shall be paid fringe benefits in accordance with the provisions of the apprenticeship program. If the apprenticeship program does not specify fringe benefits, apprentices must be paid the full amount of fringe benefits listed on the wage determination for the applicable classification. If the Administrator for the Wage and Hour Division determines that a different practice prevails for the applicable apprentice classification, fringes shall be paid in accordance with that determination.

(4) In the event the Bureau of Apprenticeship and Training, or a State apprenticeship agency recognized by the Bureau, withdraws approval of an apprenticeship program, the contractor or subcontractor will no longer be permitted to utilize apprentices at less than the applicable predetermined rate for the comparable work performed by regular employees until an acceptable program is approved.

b. Trainees:

(1) Except as provided in 29 CFR 5.16, trainees will not be permitted to work at less than the predetermined rate for the work performed unless they are employed pursuant to and individually registered in a program which has received prior approval, evidenced by formal certification by the DOL, Employment and Training Administration.

(2) The ratio of trainees to journeyman-level employees on the job site shall not be greater than permitted under the plan approved by the Employment and Training Administration. Any employee listed on the payroll at a trainee rate who is not registered and participating in a training plan approved by the Employment and Training Administration shall be paid not less than the applicable wage rate on the wage determination for the classification of work actually performed. In addition, any trainee performing work on the job site in excess of the ratio permitted under the registered program shall be paid not less than the applicable wage rate on the wage determination for the work actually performed.

(3) Every trainee must be paid at not less than the rate specified in the approved program for his/her level of progress,

expressed as a percentage of the journeyman-level hourly rate specified in the applicable wage determination. Trainees shall be paid fringe benefits in accordance with the provisions of the trainee program. If the trainee program does not mention fringe benefits, trainees shall be paid the full amount of fringe benefits listed on the wage determination unless the Administrator of the Wage and Hour Division determines that there is an apprenticeship program associated with the corresponding journeyman-level wage rate on the wage determination which provides for less than full fringe benefits for apprentices, in which case such trainees shall receive the same fringe benefits as apprentices.

(4) In the event the Employment and Training Administration withdraws approval of a training program, the contractor or subcontractor will no longer be permitted to utilize trainees at less than the applicable predetermined rate for the work performed until an acceptable program is approved.

c. Helpers:

Helpers will be permitted to work on a project if the helper classification is specified and defined on the applicable wage determination or is approved pursuant to the conformance procedure set forth in Section IV.2. Any worker listed on a payroll at a helper wage rate, who is not a helper under a approved definition, shall be paid not less than the applicable wage rate on the wage determination for the classification of work actually performed.

5. **Apprentices and Trainees (Programs of the U.S. DOT):**

Apprentices and trainees working under apprenticeship and skill training programs which have been certified by the Secretary of Transportation as promoting EEO in connection with Federal-aid highway construction programs are not subject to the requirements of paragraph 4 of this Section IV. The straight time hourly wage rates for apprentices and trainees under such programs will be established by the particular programs. The ratio of apprentices and trainees to journeymen shall not be greater than permitted by the terms of the particular program.

6. **Withholding:**

The SHA shall upon its own action or upon written request of an authorized representative of the DOL withhold, or cause to be withheld, from the contractor or subcontractor under this contract or any other Federal contract with the same prime contractor, or any other Federally-assisted contract subject to Davis-Bacon prevailing wage requirements which is held by the same prime contractor, as much of the accrued payments or advances as may be considered necessary to pay laborers and mechanics, including apprentices, trainees, and helpers, employed by the contractor or any subcontractor the full amount of wages required by the contract. In the event of failure to pay any laborer or mechanic, including any apprentice, trainee, or helper, employed or working on the site of the work, all or part of the wages required by the contract, the SHA contracting officer may, after written notice to the contractor, take such action as may be necessary to cause the suspension of any further payment, advance, or guarantee of funds until such violations have ceased.

7. **Overtime Requirements:**

No contractor or subcontractor contracting for any part of the contract work which may require or involve the employment of laborers, mechanics, watchmen, or guards (including apprentices, trainees, and helpers described in paragraphs 4 and 5 above) shall

require or permit any laborer, mechanic, watchman, or guard in any workweek in which he/she is employed on such work, to work in excess of 40 hours in such workweek unless such laborer, mechanic, watchman, or guard receives compensation at a rate not less than one-and-one-half times his/her basic rate of pay for all hours worked in excess of 40 hours in such workweek.

8. Violation:

Liability for Unpaid Wages; Liquidated Damages: In the event of any violation of the clause set forth in paragraph 7 above, the contractor and any subcontractor responsible thereof shall be liable to the affected employee for his/her unpaid wages. In addition, such contractor and subcontractor shall be liable to the United States (in the case of work done under contract for the District of Columbia or a territory, to such District or to such territory) for liquidated damages. Such liquidated damages shall be computed with respect to each individual laborer, mechanic, watchman, or guard employed in violation of the clause set forth in paragraph 7, in the sum of \$10 for each calendar day on which such employee was required or permitted to work in excess of the standard work week of 40 hours without payment of the overtime wages required by the clause set forth in paragraph 7.

9. Withholding for Unpaid Wages and Liquidated Damages:

The SHA shall upon its own action or upon written request of any authorized representative of the DOL withhold, or cause to be withheld, from any monies payable on account of work performed by the contractor or subcontractor under any such contract or any other Federal contract with the same prime contractor, or any other Federally-assisted contract subject to the Contract Work Hours and Safety Standards Act, which is held by the same prime contractor, such sums as may be determined to be necessary to satisfy any liabilities of such contractor or subcontractor for unpaid wages and liquidated damages as provided in the clause set forth in paragraph 8 above.

V. STATEMENTS AND PAYROLLS

(Applicable to all Federal-aid construction contracts exceeding \$2,000 and to all related subcontracts, except for projects located on roadways classified as local roads or rural collectors, which are exempt.)

1. Compliance with Copeland Regulations (29 CFR 3):

The contractor shall comply with the Copeland Regulations of the Secretary of Labor which are herein incorporated by reference.

2. Payrolls and Payroll Records:

a. Payrolls and basic records relating thereto shall be maintained by the contractor and each subcontractor during the course of the work and preserved for a period of 3 years from the date of completion of the contract for all laborers, mechanics, apprentices, trainees, watchmen, helpers, and guards working at the site of the work.

b. The payroll records shall contain the name, social security number, and address of each such employee; his or her correct classification; hourly rates of wages paid (including rates of contributions or costs anticipated for bona fide fringe benefits or cash equivalent thereof the types described in Section 1(b)(2)(B) of the Davis Bacon Act); daily and weekly number of hours worked; deductions made; and actual wages paid. In addition, for Appala-

chian contracts, the payroll records shall contain a notation indicating whether the employee does, or does not, normally reside in the labor area as defined in Attachment A, paragraph 1. Whenever the Secretary of Labor, pursuant to Section IV, paragraph 3b, has found that the wages of any laborer or mechanic include the amount of any costs reasonably anticipated in providing benefits under a plan or program described in Section 1(b)(2)(B) of the Davis Bacon Act, the contractor and each subcontractor shall maintain records which show that the commitment to provide such benefits is enforceable, that the plan or program is financially responsible, that the plan or program has been communicated in writing to the laborers or mechanics affected, and show the cost anticipated or the actual cost incurred in providing benefits. Contractors or subcontractors employing apprentices or trainees under approved programs shall maintain written evidence of the registration of apprentices and trainees, and ratios and wage rates prescribed in the applicable programs.

c. Each contractor and subcontractor shall furnish, each week in which any contract work is performed, to the SHA resident engineer a payroll of wages paid each of its employees (including apprentices, trainees, and helpers, described in Section IV, paragraphs 4 and 5, and watchmen and guards engaged on work during the preceding weekly payroll period). The payroll submitted required to be maintained under paragraph 2b of this Section V. This information may be submitted in any form desired. Optional Form WH-347 is available for this purpose and may be purchased from the Superintendent of Documents (Federal stock number 029-005-0014-1), U.S. Government Printing Office, Washington, D.C. 20402. The prime contractor is responsible for the submission of copies of payrolls by all subcontractors.

d. Each payroll submitted shall be accompanied by a "Statement of Compliance," signed by the contractor or subcontractor or his/her agent who pays or supervises the payment of the persons employed under the contract and shall certify the following:

(1) that the payroll for the payroll period contains the information required to be maintained under paragraph 2b of this Section V and that such information is correct and complete;

(2) that such laborer or mechanic (including each helper, apprentice, and trainee) employed on the contract during the payroll period has been paid the full weekly wages earned, without rebate, either directly or indirectly, and that no deductions have been made either directly or indirectly from the full wages earned, other than permissible deductions as set forth in the Regulations, 29 CFR 3;

(3) that each laborer or mechanic has been paid not less than the applicable wage rate and fringe benefits or cash equivalent for the classification of worked performed, as specified in the applicable wage determination incorporated into the contract.

e. The weekly submission of a properly executed certification set forth on the reverse side of Optional Form WH-347 shall satisfy the requirement for submission of the "Statement of Compliance" required by paragraph 2d of this Section V.

f. The falsification of any of the above certifications may subject the contractor to civil or criminal prosecution under 18 U.S.C. 1001 and 31 U.S.C. 231.

g. The contractor or subcontractor shall make the records required under paragraph 2b of this Section V available for

inspection, copying, or transcription by authorized representatives of the SHA, the FHWA, or the DOL, and shall permit such representatives to interview employees during working hours on the job. If the contractor or subcontractor fails to submit the required records or to make them available, the SHA, the FHWA, the DOL, or all may, after written notice to the contractor, sponsor, applicant, or owner, take such actions as may be necessary to cause the suspension of any further payment, advance, or guarantee of funds. Furthermore, failure to submit the required records upon request or to make such records available may be grounds for debarment action pursuant to 29 CFR 5.12.

VI. RECORD OF MATERIALS, SUPPLIES, AND LABOR

1. On all Federal-aid contracts on the National Highway System, except those which provide solely for the installation of protective devices at railroad grade crossings, those which are constructed on a force account or direct labor basis, highway beautification contracts, and contracts for which the total final construction cost for roadway and bridge is less than \$1,000,000 (23 CFR 635) the contractor shall:

a. Become familiar with the list of specific materials and supplies contained in Form FHWA-47, "Statement of Materials and Labor Used by Contractor of Highway Construction Involving Federal Funds," prior to the commencement of work under this contract.

b. Maintain a record of the total cost of all materials and supplies purchased for and incorporated in the work, and also of the quantities of those specific materials and supplies listed on Form FHWA-47, and in the units shown on Form FHWA-47.

c. Furnish, upon the completion of the contract, to the SHA resident engineer on Form FHWA-47 together with the data required in paragraph 1b relative to materials and supplies, a final labor summary of all contract work indicating the total hours worked and the total amount earned.

2. At the prime contractor's option, either a single report covering all contract work or separate reports for the contractor and for each subcontract shall be submitted.

VII. SUBLETTING OR ASSIGNING THE CONTRACT

1. The contractor shall perform with its own organization contract work amounting to not less than 30 percent (or a greater percentage if specified elsewhere in the contract) of the total original contract price, excluding any specialty items designated by the State. Specialty items may be performed by subcontract and the amount of any such specialty items performed may be deducted from the total original contract price before computing the amount of work required to be performed by the contractor's own organization (23 CFR 635).

a. "Its own organization" shall be construed to include only workers employed and paid directly by the prime contractor and equipment owned or rented by the prime contractor, with or without operators. Such term does not include employees or equipment of a subcontractor, assignee, or agent of the prime contractor.

b. "Specialty Items" shall be construed to be limited to work that requires highly specialized knowledge, abilities, or equipment not ordinarily available in the type of contracting organizations qualified and expected to bid on the contract as a whole and in

general are to be limited to minor components of the overall contract.

2. The contract amount upon which the requirements set forth in paragraph 1 of Section VII is computed includes the cost of material and manufactured products which are to be purchased or produced by the contractor under the contract provisions.

3. The contractor shall furnish (a) a competent superintendent or supervisor who is employed by the firm, has full authority to direct performance of the work in accordance with the contract requirements, and is in charge of all construction operations (regardless of who performs the work) and (b) such other of its own organizational resources (supervision, management, and engineering services) as the SHA contracting officer determines is necessary to assure the performance of the contract.

4. No portion of the contract shall be sublet, assigned or otherwise disposed of except with the written consent of the SHA contracting officer, or authorized representative, and such consent when given shall not be construed to relieve the contractor of any responsibility for the fulfillment of the contract. Written consent will be given only after the SHA has assured that each subcontract is evidenced in writing and that it contains all pertinent provisions and requirements of the prime contract.

VIII. SAFETY: ACCIDENT PREVENTION

1. In the performance of this contract the contractor shall comply with all applicable Federal, State, and local laws governing safety, health, and sanitation (23 CFR 635). The contractor shall provide all safeguards, safety devices and protective equipment and take any other needed actions as it determines, or as the SHA contracting officer may determine, to be reasonably necessary to protect the life and health of employees on the job and the safety of the public and to protect property in connection with the performance of the work covered by the contract.

2. It is a condition of this contract, and shall be made a condition of each subcontract, which the contractor enters into pursuant to this contract, that the contractor and any subcontractor shall not permit any employee, in performance of the contract, to work in surroundings or under conditions which are unsanitary, hazardous or dangerous to his/her health or safety, as determined under construction safety and health standards (29 CFR 1926) promulgated by the Secretary of Labor, in accordance with Section 107 of the Contract Work Hours and Safety Standards Act (40 U.S.C. 333).

3. Pursuant to 29 CFR 1926.3, it is a condition of this contract that the Secretary of Labor or authorized representative thereof, shall have right of entry to any site of contract performance to inspect or investigate the matter of compliance with the construction safety and health standards and to carry out the duties of the Secretary under Section 107 of the Contract Work Hours and Safety Standards Act (40 U.S.C. 333).

IX. FALSE STATEMENTS CONCERNING HIGHWAY PROJECTS

In order to assure high quality and durable construction in conformity with approved plans and specifications and a high degree of reliability on statements and representations made by engineers, contractors, suppliers, and workers on Federal-aid highway projects, it is essential that all persons concerned with the project perform their functions as carefully, thoroughly, and

honestly as possible. Willful falsification, distortion, or misrepresentation with respect to any facts related to the project is a violation of Federal law. To prevent any misunderstanding regarding the seriousness of these and similar acts, the following notice shall be posted on each Federal-aid highway project (23 CFR 635) in one or more places where it is readily available to all persons concerned with the project:

NOTICE TO ALL PERSONNEL ENGAGED ON FEDERAL-AID HIGHWAY PROJECTS

18 U.S.C. 1020 reads as follows:

"Whoever, being an officer, agent, or employee of the United States, or of any State or Territory, or whoever, whether a person, association, firm, or corporation, knowingly makes any false statement, false representation, or false report as to the character, quality, quantity, or cost of the material used or to be used, or the quantity or quality of the work performed or to be performed, or the cost thereof in connection with the submission of plans, maps, specifications, contracts, or costs of construction on any highway or related project submitted for approval to the Secretary of Transportation; or

Whoever knowingly makes any false statement, false representation, false report or false claim with respect to the character, quality, quantity, or cost of any work performed or to be performed, or materials furnished or to be furnished, in connection with the construction of any highway or related project approved by the Secretary of Transportation; or

Whoever knowingly makes any false statement or false representation as to material fact in any statement, certificate, or report submitted pursuant to provisions of the Federal-aid Roads Act approved July 1, 1916, (39 Stat. 355), as amended and supplemented;

Shall be fined not more than \$10,000 or imprisoned not more than 5 years or both."

X. IMPLEMENTATION OF CLEAN AIR ACT AND FEDERAL WATER POLLUTION CONTROL ACT

(Applicable to all Federal-aid construction contracts and to all related subcontracts of \$100,000 or more.)

By submission of this bid or the execution of this contract, or subcontract, as appropriate, the bidder, Federal-aid construction contractor, or subcontractor, as appropriate, will be deemed to have stipulated as follows:

1. That any facility that is or will be utilized in the performance of this contract, unless such contract is exempt under the Clean Air Act, as amended (42 U.S.C. 1857 et seq., as amended by Pub.L. 91-604), and under the Federal Water Pollution Control Act, as amended (33 U.S.C. 1251 et seq., as amended by Pub.L. 92-500), Executive Order 11738, and regulations in implementation thereof (40 CFR 15) is not listed, on the date of contract award, on the U.S. Environmental Protection Agency (EPA) List of Violating Facilities pursuant to 40 CFR 15.20.

2. That the firm agrees to comply and remain in compliance with all the requirements of Section 114 of the Clean Air Act and Section 308 of the Federal Water Pollution Control Act and all regulations and guidelines listed thereunder.

3. That the firm shall promptly notify the SHA of the receipt of any communication from the Director, Office of Federal Activities, EPA, indicating that a facility that is or will be utilized for the contract is under consideration to be listed on the EPA List of Violating Facilities.

4. That the firm agrees to include or cause to be included the requirements of paragraph 1 through 4 of this Section X in every nonexempt subcontract, and further agrees to take such action as the government may direct as a means of enforcing such requirements.

XI. CERTIFICATION REGARDING DEBARMENT, SUSPENSION, INELIGIBILITY AND VOLUNTARY EXCLUSION

1. Instructions for Certification - Primary Covered Transactions:

(Applicable to all Federal-aid contracts - 49 CFR 29)

a. By signing and submitting this proposal, the prospective primary participant is providing the certification set out below.

b. The inability of a person to provide the certification set out below will not necessarily result in denial of participation in this covered transaction. The prospective participant shall submit an explanation of why it cannot provide the certification set out below. The certification or explanation will be considered in connection with the department or agency's determination whether to enter into this transaction. However, failure of the prospective primary participant to furnish a certification or an explanation shall disqualify such a person from participation in this transaction.

c. The certification in this clause is a material representation of fact upon which reliance was placed when the department or agency determined to enter into this transaction. If it is later determined that the prospective primary participant knowingly rendered an erroneous certification, in addition to other remedies available to the Federal Government, the department or agency may terminate this transaction for cause of default.

d. The prospective primary participant shall provide immediate written notice to the department or agency to whom this proposal is submitted if any time the prospective primary participant learns that its certification was erroneous when submitted or has become erroneous by reason of changed circumstances.

e. The terms "covered transaction," "debarred," "suspended," "ineligible," "lower tier covered transaction," "participant," "person," "primary covered transaction," "principal," "proposal," and "voluntarily excluded," as used in this clause, have the meanings set out in the Definitions and Coverage sections of rules implementing Executive Order 12549. You may contact the department or agency to which this proposal is submitted for assistance in obtaining a copy of those regulations.

f. The prospective primary participant agrees by submitting this proposal that, should the proposed covered transaction be entered into, it shall not knowingly enter into any lower tier covered transaction with a person who is debarred, suspended, declared ineligible, or voluntarily excluded from participation in this covered transaction, unless authorized by the department or agency entering into this transaction.

g. The prospective primary participant further agrees by submitting this proposal that it will include the clause titled "Certification Regarding Debarment, Suspension, Ineligibility and Voluntary Exclusion-Lower Tier Covered Transaction," provided by the department or agency entering into this covered transaction, without modification, in all lower tier covered transactions and in all solicitations for lower tier covered transactions.

h. A participant in a covered transaction may rely upon a certification of a prospective participant in a lower tier covered transaction that is not debarred, suspended, ineligible, or voluntarily excluded from the covered transaction, unless it knows that the certification is erroneous. A participant may decide the method and frequency by which it determines the eligibility of its principals. Each participant may, but is not required to, check the nonprocurement portion of the "Lists of Parties Excluded From Federal Procurement or Nonprocurement Programs" (Nonprocurement List) which is compiled by the General Services Administration.

i. Nothing contained in the foregoing shall be construed to require establishment of a system of records in order to render in good faith the certification required by this clause. The knowledge and information of participant is not required to exceed that which is normally possessed by a prudent person in the ordinary course of business dealings.

j. Except for transactions authorized under paragraph f of these instructions, if a participant in a covered transaction knowingly enters into a lower tier covered transaction with a person who is suspended, debarred, ineligible, or voluntarily excluded from participation in this transaction, in addition to other remedies available to the Federal Government, the department or agency may terminate this transaction for cause or default.

* * * * *

Certification Regarding Debarment, Suspension, Ineligibility and Voluntary Exclusion--Primary Covered Transactions

1. The prospective primary participant certifies to the best of its knowledge and belief, that it and its principals:

a. Are not presently debarred, suspended, proposed for debarment, declared ineligible, or voluntarily excluded from covered transactions by any Federal department or agency;

b. Have not within a 3-year period preceding this proposal been convicted of or had a civil judgement rendered against them for commission of fraud or a criminal offense in connection with obtaining, attempting to obtain, or performing a public (Federal, State or local) transaction or contract under a public transaction; violation of Federal or State antitrust statutes or commission of embezzlement, theft, forgery, bribery, falsification or destruction of records, making false statements, or receiving stolen property;

c. Are not presently indicted for or otherwise criminally or civilly charged by a governmental entity (Federal, State or local) with commission of any of the offenses enumerated in paragraph 1b of this certification; and

d. Have not within a 3-year period preceding this application/proposal had one or more public transactions (Federal, State or local) terminated for cause or default.

2. Where the prospective primary participant is unable to certify to any of the statements in this certification, such prospective participant shall attach an explanation to this proposal.

* * * * *

2. Instructions for Certification - Lower Tier Covered Transactions:

(Applicable to all subcontracts, purchase orders and other lower tier transactions of \$25,000 or more - 49 CFR 29)

a. By signing and submitting this proposal, the prospective lower tier is providing the certification set out below.

b. The certification in this clause is a material representation of fact upon which reliance was placed when this transaction was entered into. If it is later determined that the prospective lower tier participant knowingly rendered an erroneous certification, in addition to other remedies available to the Federal Government, the department, or agency with which this transaction originated may pursue available remedies, including suspension and/or debarment.

c. The prospective lower tier participant shall provide immediate written notice to the person to which this proposal is submitted if at any time the prospective lower tier participant learns that its certification was erroneous by reason of changed circumstances.

d. The terms "covered transaction," "debarred," "suspended," "ineligible," "primary covered transaction," "participant," "person," "principal," "proposal," and "voluntarily excluded," as used in this clause, have the meanings set out in the Definitions and Coverage sections of rules implementing Executive Order 12549. You may contact the person to which this proposal is submitted for assistance in obtaining a copy of those regulations.

e. The prospective lower tier participant agrees by submitting this proposal that, should the proposed covered transaction be entered into, it shall not knowingly enter into any lower tier covered transaction with a person who is debarred, suspended, declared ineligible, or voluntarily excluded from participation in this covered transaction, unless authorized by the department or agency with which this transaction originated.

f. The prospective lower tier participant further agrees by submitting this proposal that it will include this clause titled "Certification Regarding Debarment, Suspension, Ineligibility and Voluntary Exclusion-Lower Tier Covered Transaction," without modification, in all lower tier covered transactions and in all solicitations for lower tier covered transactions.

g. A participant in a covered transaction may rely upon a certification of a prospective participant in a lower tier covered transaction that is not debarred, suspended, ineligible, or voluntarily excluded from the covered transaction, unless it knows that the certification is erroneous. A participant may decide the method and frequency by which it determines the eligibility of its principals. Each participant may, but is not required to, check the Nonprocurement List.

h. Nothing contained in the foregoing shall be construed to require establishment of a system of records in order to render in good faith the certification required by this clause. The knowledge and information of participant is not required to exceed that which is

normally possessed by a prudent person in the ordinary course of business dealings.

i. Except for transactions authorized under paragraph e of these instructions, if a participant in a covered transaction knowingly enters into a lower tier covered transaction with a person who is suspended, debarred, ineligible, or voluntarily excluded from participation in this transaction, in addition to other remedies available to the Federal Government, the department or agency with which this transaction originated may pursue available remedies, including suspension and/or debarment.

Certification Regarding Debarment, Suspension, Ineligibility and Voluntary Exclusion--Lower Tier Covered Transactions:

1. The prospective lower tier participant certifies, by submission of this proposal, that neither it nor its principals is presently debarred, suspended, proposed for debarment, declared ineligible, or voluntarily excluded from participation in this transaction by any Federal department or agency.

2. Where the prospective lower tier participant is unable to certify to any of the statements in this certification, such prospective participant shall attach an explanation to this proposal.

XII. CERTIFICATION REGARDING USE OF CONTRACT FUNDS FOR LOBBYING

(Applicable to all Federal-aid construction contracts and to all related subcontracts which exceed \$100,000 - 49 CFR 20)

1. The prospective participant certifies, by signing and submitting this bid or proposal, to the best of his or her knowledge and belief, that:

a. No Federal appropriated funds have been paid or will be paid, by or on behalf of the undersigned, to any person for influencing or attempting to influence an officer or employee of any Federal agency, a Member of Congress, an officer or employee of Congress, or an employee of a Member of Congress in connection with the awarding of any Federal contract, the making of any Federal grant, the making of any Federal loan, the entering into of any cooperative agreement, and the extension, continuation, renewal, amendment, or modification of any Federal contract, grant, loan, or cooperative agreement.

b. If any funds other than Federal appropriated funds have been paid or will be paid to any person for influencing or attempting to influence an officer or employee of any Federal agency, a Member of Congress, an officer or employee of Congress, or an employee of a Member of Congress in connection with this Federal contract, grant, loan, or cooperative agreement, the undersigned shall complete and submit Standard Form-LLL, "Disclosure Form to Report Lobbying," in accordance with its instructions.

2. This certification is a material representation of fact upon which reliance was placed when this transaction was made or entered into. Submission of this certification is a prerequisite for making or entering into this transaction imposed by 31 U.S.C. 1352. Any person who fails to file the required certification shall be subject to a civil penalty of not less than \$10,000 and not more than \$100,000 for each such failure.

3. The prospective participant also agrees by submitting his or her bid or proposal that he or she shall require that the language of this certification be included in all lower tier subcontracts, which exceed \$100,000 and that all such recipients shall certify and disclose accordingly.

NOTICE OF REQUIREMENTS FOR AFFIRMATIVE ACTION TO ENSURE EQUAL EMPLOYMENT OPPORTUNITY (EXECUTIVE ORDER 11246)

1. The Offeror’s or Bidder’s attention is called to the “Equal Opportunity Clause” and the “Standard Federal Equal Employment Opportunity Construction Contract Specifications” set forth herein.

2. The goals and timetables for minority and female participation, expressed in percentage terms for the Contractor’s aggregate workforce in each trade on all construction work in the covered area, are as follows:

Timetables	Goals for female participation in each trade (percent)
From April 1, 1978 until March 31, 1979	3.1
From April 1, 1979 until March 31, 1980	5.1
From April 1, 1980 until March 31, 1981	6.9
Until further notice	Goals for minority participation for each trade (percent)
SHSA Cities:	
Pascagoula - Moss Point-----	16.9
Biloxi - Gulfport-----	19.2
Jackson-----	30.3
SMSA Counties:	
Desoto-----	32.3
Hancock, Harrison, Stone-----	19.2
Hinds, Rankin-----	30.3
Jackson-----	16.9
Non-SMSA Counties:	
George, Greene-----	26.4
Alcorn, Benton, Bolivar, Calhoun, Carroll, Chickasaw, Clay, Coahoma, Grenada, Itawamba, Lafayette, Lee, Leflore, Marshall, Monroe, Montgomery, Panola, Pontotoc, Prentiss, Quitman, Sunflower, Tallahatchie, Tate, Tippah, Tishomingo, Tunica, Union, Washington, Webster, Yalobusha-----	26.5
Attala, Choctaw, Claiborne, Clarke, Copiah, Covington, Franklin, Holmes, Humphreys, Issaquena, Jasper, Jefferson, Jefferson Davis, Jones Kemper, Lauderdale, Lawrence, Leake, Lincoln, Lowndes, Madison, Neshoba, Newton, Noxubee, Oktibbeha, Scott, Sharkey, Simpson, Smith, Warren, Wayne, Winston, Yazoo-----	32.0
Forrest, Lamar, Marion, Pearl River, Perry, Pike, Walthall-----	27.7
Adams, Amite, Wilkinson-----	30.4

These goals are applicable to all the Contractor’s construction work (whether or not it is Federal or federally assisted) performed in the covered area. If the contractor performs construction work in a geographical area located outside of the covered area, it shall apply the goals established for such geographical area where the work is actually performed. With regard to this second area, the contractor also is subject to the goals for both its federally involved and nonfederally involved construction.

The Contractor’s compliance with the Executive Order and the regulations in CFR Part 60-4 shall be based on its implementation of the Equal Opportunity clause, specific affirmative action obligations required by the specifications set forth in 41 CFR 60-4.3(a), and its efforts to meet the goals. The hours of minority and female employment and training must be substantially uniform throughout the length of the contract, and in each trade, and the Contractor shall make a good faith effort to employ minorities and women evenly on each of its projects. The transfer of minority or female employees or trainees from Contractor to Contractor or from project to project for the sole purpose of meeting the Contractor’s goals shall be a violation of the contract, the Executive Order and the regulations in 41 CFR Part 60-4. Compliance with the goals will be measured against the total work hours performed.

3. The Contractor shall provide written notification to the Director of the Office of Federal Contract Compliance Programs within 10 working days of award of any construction subcontract in excess of \$10,000 at any tier for construction work under the contract resulting from this solicitation. The notification shall list the name, address and telephone number of the subcontractor, employer identification number of the subcontractor, estimated dollar amount of the subcontract; estimated starting and completion dates of the subcontract; and the geographical area in which the subcontract is to be performed.

4. As used in this Notice, and in the contract resulting from this solicitation, the “covered area” is to the county and city (if any), stated in the advertisement.

5. The notification required in Paragraph 3 shall be addressed to the following:

Contract Compliance Officer
Mississippi Department of Transportation
P.O. Box 1850
Jackson, Mississippi 39215-1850

MISSISSIPPI DEPARTMENT OF TRANSPORTATION

SPECIAL PROVISION NO. 907-101 DB

CODE: (SP)

DATE: 03/10/2009

SUBJECT: Definitions and Terms

Section 101, Definitions and Terms, of the 2004 Edition of the Mississippi Standard Specifications for Road and Bridge Construction is hereby amended as follows:

907-101.01--Abbreviations. Add the following to the list of abbreviations in Subsection 101.01 starting on page 1:

BV	Best Value
CPM	Critical Path Method
MCIA	Mississippi Concrete Industries Association
PPS	Project Payment Schedule
QA	Quality Assurance
QC	Quality Control
RCSR	Review Comment Summary and Resolution
RFC	Release for Construction
RFI	Request for Information
RFQ	Request for Qualifications
RFR	Request for Revision
SOQ	Statement of Qualifications
SOV	Statement of Values
VE	Value Engineering

907-101.02--Definitions. Add the following, or amend the following, to the list of definitions in Subsection 101.02 starting on page 3:

Best Value Proposal – means the Proposal provided by a Proposer that the Commission determines is (a) responsive to the RFP and (b) presents the best value for the Commission and MDOT as determined by the **Criteria for Scoring** of the RFP.

Bid – Bid is understood to mean Proposal throughout all documents.

Bidder – Bidder is understood to mean Proposer throughout all documents.

Daily Diaries - Daily reports, generated by MDOT required for reporting on weather, manpower, equipment, material deliveries, work activities, progress, problems, and whatever else is required by the Contract.

Contract – The written agreement between MDOT and the Contractor setting forth the obligations of the parties thereunder, including but not limited to, the performance of the Work, and the basis of payment. The Contract shall be composed of those documents described in

Section 902, I. (Contract Documents).

Engineer - The Chief Engineer of MDOT, acting directly or through a duly authorized representative(s).

Engineer of Record – Shall be a member of the Contractor’s design team and shall be a licensed Professional Engineer who has responsibility for a specific area of design and shall sign and seal plan sets that have been developed under his/her direct supervision. Engineer of Record shall be responsible for addressing the Contractor’s Request for Information (RFI’s) as per Section 2.2.6 of the Technical Specifications.

Final Completion Date – The date on which all Work specified in the Contract is complete, which is derived from adding the calendar days bid by the Contractor to the date of the Notice to Proceed.

Governmental Approval - Any authorization, consent, approval, action, license, lease, permit, certification, exemption, filing or registration by or with any Governmental Person.

Governmental Person - Any federal, state, local or foreign government, any political subdivision or any governmental, quasi-governmental, judicial, public or statutory instrumentality, administrative agency, authority, body or entity, excluding MDOT unless the context requires otherwise.

Inspector - MDOT’s authorized representative assigned to make detailed inspections of Contract performance.

Laboratory - The testing laboratory of MDOT or any other testing laboratory which may be designated by MDOT.

MDOT duly authorized representative -Those individuals or firms with specific authority to act for and on behalf of MDOT.

Milestone - An activity that represents a significant point in time, and may be used to indicate the start or end of a series of related activities and/or Contract accomplishment. A milestone has zero original and remaining duration, and does not increase the Contract time.

Project Documents - All written instruments associated with the Project including SOQ, RFP, Proposal, Agreement, Exhibits, referenced materials, design, and all documents produced to administer the Project including, but not limited to, all correspondence, changes, RFRs, RCSR, Request for Information, Submittals, etc.

Project Management Services - All planning, monitoring, controlling and reporting for Project activities and design including but not limited to, personnel, facilities, materials, computer systems and training for management of the Project as determined adequate by MDOT.

Project Payment Schedule – See Subsection 907-108.03.1.4.1 of the Special Provisions.

Project Scope - All responsibilities and tasks included in the RFP necessary to complete the

Project and satisfy all requirements in the Contract including all associated work developed from the design, minor MDOT revisions, changed conditions, and contingencies that may be necessary for the Contractor to complete The Work not mentioned or included in the RFP.

Proposal – The offer of a Proposer, on the prescribed form, to perform the Work at the price and time quoted.

Proposal Date – Is the date designated in the RFP for submission of the Proposal to MDOT.

Proposal Form – The approved form on which the Department requires Proposals to be prepared and submitted for the Work.

Proposal Guaranty – A certified check, cashier’s check, or Proposal bond furnished with the Proposal to guarantee that the Proposer will enter into a Contract for the Work and furnish acceptable bond if the Contractor’s Proposal is accepted.

Proposer - Includes a firm or firms, consortia, partnerships, joint ventures and other legal entity, which has been requested by the Mississippi Department of Transportation to submit a Proposal.

Review Comment Summary and Resolution (RCSR) – A written instrument to facilitate the disposition of reviewer comments of Contractor submittals.

Release for Construction - The written act of MDOT advising the Contractor it is allowed to proceed with construction, installation, manufacture or procurement according to the documents so released by MDOT, provided, however, Contractor shall none the less meet all requirements of this Contract.

Request for Information (RFI) - An RFI or information request is submitted by the Contractor to MDOT or duly appointed representative when information is needed concerning the Work. RFIs are answered by the appropriate party and returned to the Contractor with a response.

Request for Revision (RFR) - A written instrument for the Contractor to request a change to the Project scope identified in the RFP or the design developed during each Phase of the Project by the Contractor.

Resident or Project Engineer - The Engineer assigned by the Chief Engineer and bonded to the State to have the responsibility and authority for on-the-job administration.

Site – Shall mean any area within the Right-of-Way and additional areas that may designated in the Contract.

Stipend - Allowance paid for unsuccessful responsive Proposers.

Work –All design, engineering, quality control, procurement, construction, labor, supervision, testing for asphalt and concrete, training and other services, equipment and materials provided or to be furnished and provided by Contractor necessary to achieve Final Acceptance of the Project in regard to which Notice To Proceed have been issued and all requirements in accordance with

all the requirements of this Contract.

Working Drawings - Stress sheets, shop drawings, erection plans, falsework plans, framework plans, cofferdam plans, bending diagrams for reinforcing steel, or any other supplementary plans or similar data which the Contractor is required to submit.

Value Engineering – Proposed change to the Project Scope or design by MDOT or the Contractor that will reduce cost, increase quality and/or expedite the schedule.

907-101.03--Presumption. Delete Subsection 101.03 on page 13 and substitute the following.

907-101.03 – Blank.

MISSISSIPPI DEPARTMENT OF TRANSPORTATION

SPECIAL PROVISION NO. 907-102 DB

CODE: (SP)

DATE: 09/13/2011

SUBJECT: Bidding Requirements and Conditions

Section 102, Bidding Requirements and Conditions, of the 2004 Edition of the Mississippi Standard Specifications for Road and Bridge Construction is hereby deleted in toto and replaced as follows:

907-102.001-Blank.

907-102.01--Prequalification of Proposers. Prospective Proposers will be required to file with the Department a list of persons authorized to bind the company in all matters. Other information may be required from time to time before issuing Proposals.

The attention of prospective Proposers is directed to all fees and taxes required for the privilege of doing business within the State of Mississippi.

When two or more persons, firms or corporations are submitting a joint venture, each of the persons, firms or corporations may be required to comply with the above prequalification requirements.

907-102.02--Contents of Proposal Forms. The Proposal will identify the Project, state the location, describe the Work, and state the time in which the Work must be completed. The Proposal will also include special provisions and requirements which are not contained in the Standard Specifications or required modifications thereto.

All papers bound with, attached to, or designated for addition or substitution in the Proposal are considered a part thereof and must not be detached or altered when the Proposal is submitted. All documents designated in the Proposal shall be considered a part as if attached to and included in the Proposal.

907-102.03--Issuance of Proposal. The Department reserves the right to refuse to issue a Proposal to a prospective Proposer for the following reasons:

- (a) Lack of competency and adequate machinery, plant, or other equipment, as revealed by the information obtained as provided in Subsection 907-102.01 or other determinations made by the Department.
- (b) Uncompleted work which, in the judgment of the Department, might hinder or prevent the prompt completion of additional work if awarded.
- (c) Failure to pay, or satisfactorily settle, all bills due for labor and material on former contracts in force at the time of issuance of Proposals.

- (d) Unsatisfactory performance on previous contracts.
- (e) Failure to promptly reimburse the Department for any overpayment that might have occurred.
- (f) Debarment of a prospective Proposer or any of its corporate officers or principal owners by the Mississippi Transportation Commission.

907-102.04--Interpretation of Quantities. Determination of the quantities for the Work entailed by the Project Scope is the responsibility of the Contractor. Quantities are needed to determine the frequency of materials sampling and testing for quality control. Quantities are also needed for the Schedule of Values. All subsections within the MDOT Standard Specifications that establish the Method of Measurement and Basis of Payment for work performed is deleted. The single lump sum Contract Price submitted by the Contractor in response to the RFP shall constitute full and complete compensation for all Work.

907-102.05--Examination of Specifications, Special Provisions, Notices to Proposers and Site of Work. The Proposer is required to examine carefully the site of the proposed Work, the Request for Proposal (RFP), specifications, special provisions, notices to Proposers and contract forms before submitting a Proposal.

MDOT has made available or provided to the Contractor information that MDOT acquired prior to the date of this Contract in the course of planning for the construction of the Project, which information is hereinafter collectively called “Informational Documents.”

MDOT hereby specifically disclaims any implication that it has made any such representation or warranty either express or implied, as to any matter whatsoever, by virtue of the fact that it is making the Informational Documents available to Contractor. Further, MDOT is not representing that the Informational Documents are exhaustive, complete, accurate or sufficient for design or construction of the Project. Contractor agrees that it has full responsibility for the design and construction of the Project and Contractor specifically acknowledges and agrees that the Informational Documents are preliminary and conceptual in nature.

The submission of a Proposal shall be considered prima facie evidence that the Proposer has made such an examination and is satisfied as to the conditions to be encountered in performing the Work at the Project site and as to the requirements of the Informational Documents, standard specifications, Request for Proposal, special provisions, Contract, and the Federal, State, and local laws which will in any way affect the execution of the Work. All Contracts are subject to the provisions of Sections 65-1-89 and 65- 1-91, Miss. Code Ann. (1972).

907-102.06--Preparation of Proposal. Proposals are to be prepared in accordance with the requirements set forth in the Request for Proposal issued by the Department. All the figures shall be in ink or typed. It is the responsibility of every Proposer to check for any addendum or modification to the Contract document(s). It shall be the Proposer’s responsibility to be sure they

are in receipt of all addenda, meeting information, and/or questions and answers provided at, or subsequent to, the pre-Proposal meeting, if any are issued.

Each Proposal issued will contain duplicate Certification regarding debarment, suspension, and other responsibility matters to be completed by the Proposer. The Certification must be sworn to and shall be under penalty of perjury and Proposers are cautioned to read and understand its contents in entirety before execution. The Contractor shall provide immediate written notice to the Contract Administration Engineer at any time, prior to or after award, that it is known a certification was erroneous when executed or has become erroneous by reason of changed circumstances.

Failure on the part of the Proposer to execute the Certification will result in the Proposal being considered nonresponsive.

The Proposer's Proposal must be signed with ink by the individual, by one or more members of the partnership, by one or more members or officers of each firm representing a joint venture, or by one or more officers of a corporation; or by an agent of the Contractor legally qualified to bind the Contractor and acceptable to the State. If the Proposal is made by an individual, the individual's name and address must be shown; by a partnership, the name and address of each partnership member must be shown; as a joint venture, the name and address of each member or officer of the firms represented by the joint venture must be shown; by a corporation, the name of the corporation and the business address of its corporate officials must be shown.

The address stated on the Proposal shall be the Proposer's permanent address until changed by written notice to the Executive Director. All notices provided for in the Contract shall be considered as delivered to the Contractor when mailed or delivered to such address.

907-102.07--Irregular Proposals. Proposals will be considered irregular and may be rejected for any of the following reasons:

- (a) If the Proposal is on a form other than that furnished by the Department, or if the form is altered or any part thereof is detached, except as allowed in Subsection 907-102.06.
- (b) If there are unauthorized additions, conditional or alternate Proposals or irregularities of any kind which may tend to make the Proposal incomplete, indefinite, or ambiguous as to its meaning.
- (c) If the Proposer adds any provisions reserving the right to accept or reject an award, or to enter into a Contract pursuant to an award.
- (d) If the Proposal, does not contain acknowledgement of receipt and addition to the Proposal and Contract documents of all addenda issued prior to opening of Proposals.
- (e) Failure to execute required affidavits, certificates, etc., and furnish Proposal guaranty.
- (f) The Mississippi Transportation Commission reserves the right to reject any or all Proposals, to waive technicalities or irregularities, or to advertise for new Proposals, and the decision of

the Commission to reject any Proposal shall not be cause for any liability or damage against the Commission, the Department, any of its officers, duly appointed representatives or employees.

907-102.08--Proposal Guaranty. No Volume 2 Proposal will be considered unless accompanied by certified check, cashier's check or bond, made payable to the State of Mississippi, in an amount of not less than five percent of the total amount of the Proposal offered. Proposal bond shall not be conditioned in any way to modify the minimum five percent (5%) required. Proposals that fail to include a Proposal Guaranty shall be deemed nonresponsive and will be rejected by MDOT. The guaranty shall be evidence of good faith that, if awarded the Contract, the Proposer will execute the Contract and give Contract bond as stipulated in Subsection 907-103.05 and as required by law. The Proposal Guaranty amount should not include the dollar amount determined for the Contract Time (Part B).

If a bond is offered as guaranty, the bond must be on a form approved by the Executive Director, made by a Surety acceptable to the Executive Director and signed or countersigned by a Mississippi agent or qualified nonresident agent and the Proposer. Such bid bond shall also conform to the requirements and conditions stipulated in Subsection 907-103.05.2 as applicable.

907-102.08.1--Bonding. The successful Proposer shall provide MDOT with the following bond within ten (10) calendar days of being awarded the Project:

- (a) A Performance Bond, or bonds in a sum equal to the full amount of the Contract. In the event of award of a joint Proposal, each individual, partnership, firm or corporation shall assume jointly the full obligations under the Contract and Contract bond. The form of the bond(s) shall be that provided by or acceptable to the Department. The bond(s) shall be negotiated for, procured from and the premium paid to a qualified Mississippi agent or qualified nonresident agent of the Surety. The bond shall be signed or countersigned by a Mississippi agent or qualified nonresident agent and also bear the signature of an "attorney-in-fact" of the surety. Reference is made to Section 31-5-51 *et seq* of the Mississippi Code of 1972, Annotated, and other State statutes applicable thereto.

Bond(s) must be issued by a Surety with the Best's rating of at least "A" or better and Financial Size Category of VIII or better by A.M. Best Co. The Surety shall be registered with the Mississippi State Insurance Commissioner.

907-102.09--Delivery of Proposals. Unless otherwise specified, Volume 2 Proposals shall be submitted sealed in a special envelope furnished by the Department. The blank spaces on the envelope shall be filled in correctly to clearly indicate its contents. When an envelope other than the special one furnished by the Department is used, it shall be of the same general size and shape and be similarly marked to clearly indicate its contents. Proposal Forms are nontransferable and no name or names of interested parties may be shown other than those to whom the Proposal was issued. When sent by mail, the sealed Proposals shall be mailed to the Department at the address and in care of the official in whose office the Proposals are to be received. All Proposals shall be submitted prior to the time and place specified in the Request for Proposals (RFP). Proposals received after the time set forth in the RFP will be returned to the Proposer unopened.

907-102.10—Blank

Delete Subsections 102.11 and 102.12 on pages 20 and 21 and substitute the following:

907-102.11—Blank

907-102.12—Blank

Delete Subsection 102.13 on page 21 and substitute the following:

907-102.13--Disqualification of Proposers. In addition to those matters set forth in Section 102.07 regarding Irregular Proposals, either of the following reasons may be considered as being sufficient for the disqualification of a Proposer and the rejection of the Proposer's submitted Proposal or Proposals:

- (a) More than one Proposal for the same work from an individual, partnership, firm or corporation under the same or different name(s).
- (b) Evidence of collusion among Proposers. Participants in such collusion will receive no recognition as Proposers for any future work of the Department until reinstated as a qualified Proposer.

MISSISSIPPI DEPARTMENT OF TRANSPORTATION

SPECIAL PROVISION NO. 907-103 DB

CODE: (SP)

DATE: 09/13/2011

SUBJECT: Award and Execution of Contract

Section 103, Award and Execution of Contract, of the 2004 Edition of the Mississippi Standard Specifications for Road and Bridge Construction is hereby deleted in toto and replaced as follows:

SECTION 907-103—AWARD AND EXECUTION OF CONTRACT

907-103.01--Consideration of Proposals. After the Proposals are opened and read, they will be compared on the basis of the criteria set for in the Request for Proposal (RFP).

907-103.02--Award of Contract. The award of a Contract, if awarded, will be made within 60 calendar days after the opening of Proposals to the Proposer with the Best Value Proposal and whose Proposal complies with all the requirements prescribed. The award of contracts involving the expenditure of Federal funds is contingent upon concurrence of the FHWA. The successful Proposer will be notified of the award by letter mailed to the address shown on the Proposal.

907-103.03--Cancellation of Award. The Department reserves the right to cancel the award of a contract any time prior to the execution by all parties without liability against the Commission, Department, or any of its officers or employees.

907-103.04--Return of Proposal Guaranty. The retained Proposal Guaranty of the Proposers will be returned in accordance with the following:

- i. If a contract is executed with the Best Value Proposer, then the remaining Proposers will receive their Proposal Guaranty within 10 days.
- ii. If the Best Value Proposer fails to execute a contract, then the Proposal Guaranty will be forfeited in accordance with Section 103.08.
- iii. If the Commission elects to negotiate a contract with the next responsive Best Value Proposer(s), then the same procedure as defined above will be followed.

In the event no award is made within 30 days after the opening of the Proposals, the Executive Director may permit the Proposer to replace the certified check or cashier's check with a satisfactory Proposer's bond.

Should no award be made within 60 calendar days, all Proposals will be rejected and all guaranties returned unless the Best Value Proposer, at the request of the Commission, agrees in writing to a longer delay.

907-103.05--Contract Bonds.

907-103.05.1--Requirement of Contract Bonds. Prior to the execution of the contract, the successful Proposer shall execute and deliver to the Executive Director a performance and payment bond(s), in a sum equal to the full amount of the contract as a guaranty for complete and full performance of the contract and the protection of the claimants and the Department for materials and equipment and full payment of wages in accordance with Section 65-1-85 Miss. Code Ann. (1972 as amended). In the event of award of a joint bid, each individual, partnership, firm or corporation shall assume jointly the full obligations under the contract and the contract bond(s).

907-103.05.2--Form of Bonds. The form of bond(s) shall be that provided by or acceptable to the Department. These bonds shall be executed by a Mississippi agent or qualified nonresident agent and shall be accompanied by a certification as to authorization of the attorney-in-fact to commit the Surety company. A power of attorney exhibiting the Surety's original seal supporting the Mississippi agent or the qualified nonresident agent's signature shall be furnished with each bond. The Surety company shall be currently authorized and licensed in good standing to conduct business in the State of Mississippi with a minimum rating by A.M. Best of (A-) in the latest printing "Best's Key Rating Guide" to write individual bonds up to ten percent of the policy holders' surplus or listed on the current list of "Companies Holding Certificates of Authority as Acceptable Sureties on Federal Bonds and as Acceptable Reinsuring Companies" as published by the United States Department of the Treasury, Financial Management Service, Circular 570 (latest revision as published and supplemented on the Financial Management Service Web site and in the Federal Register) within the underwriting limits listed for that Surety. All required signatures on the bond(s) and certifications shall be original signatures, in ink, and not mechanical reproductions or facsimiles. The Mississippi agent or qualified nonresident agent shall be in good standing and currently licensed by the Insurance Commissioner of the State of Mississippi to represent the Surety company(ies) executing the bonds.

Surety bonds shall continue to be acceptable to the Commission throughout the life of the Contract and shall not be canceled by the Surety without the consent of the Department. In the event the Surety fails or becomes financially insolvent, the Contractor shall file a new Bond in the amount designated by the Executive Director within thirty (30) days of such failure, insolvency, or bankruptcy. Subsequent to award of Contract, the Commission or the Department may require additional security for any supplemental agreements executed under the contract or replacement security in the event of the surety(ies) loss of the ratings required above. Suits concerning bonds shall be filed in the State of Mississippi and adjudicated under its laws without reference to conflict of laws principles.

907-103.06—Escrow Proposal Documents. The purpose of this specification is to preserve the Proposer's Proposal documents for the use by MDOT in the resolution of any claim or dispute between MDOT and the Contractor either during or after construction. Within two (2) business days following submittal of the Volume 2 Proposal documents, the Contractor shall have delivered into escrow the original of all documents used in preparation of its Volume 2 Proposal for the Project (the "Escrowed Proposal Documents" or "EPD").

Upon execution of the Contract, the unsuccessful Proposers will be notified by the Commission in writing the escrowing of Proposal documents will no longer be required.

The EPD of the successful Proposer will be held in escrow until all of the following have occurred: (a) 180 days have elapsed from the date of the final Contract voucher certification, (b) all disputes regarding this Contract have been settled, and (c) final payment on this Contract has been made by MDOT and accepted by the Contractor.

The EPD shall be available during business hours for joint review by representatives of the Contractor, FHWA and MDOT in connection with the resolution of disputes. The EPD are, and shall always remain, the property of the Contractor, subject to MDOT's right to review the EPD as provided herein. Copies of the EPD shall be provided to the courts of the State of Mississippi and other dispute resolvers upon request of MDOT. The Contractor shall have the right to seek a protective order governing the disclosure of the EPD to parties other than MDOT. The Contractor represents and warrants that the EPD delivered into escrow prior to execution hereof constitute all of the information used in preparation of its Proposal and agrees that no other Proposal preparation information will be considered in resolving disputes or claims related thereto, including in any judicial proceeding to resolve such disputes or claims. The Contractor also agrees that the EPD are not part of this Contract and that nothing in the EPD shall change or modify this Contract.

The Contractor represents and warrants that:

- (a) the EPD clearly itemize the estimated costs of performing the Work required by the Contract provisions, all work is separated into sub-items as required to present a complete and detailed estimate of all costs, crews, equipment, quantities, and rates of production are detailed;
- (b) estimates of costs are divided into Contractor's usual cost categories such as direct labor, repair labor, equipment ownership and operation, expendable materials, permanent materials and subcontract costs as appropriate, plant and equipment and indirect costs are detailed in the Contractor's usual format, and the Contractor's allocation of plant equipment, indirect costs, contingencies, markup and other items such as overhead and profit to each direct cost item shall be clearly identified;
- (c) the EPD include all assumptions, quantity takeoffs, rates of production and progress calculations, quotes for Subcontractors and suppliers, memoranda, narratives and all other information used by the Contractor to arrive at the Contract Price.

It is not intended that the Contractor perform any significant extra work in the preparation of the EPD prior to delivery thereof into escrow. However, the Contractor represents and warrants that the EPD provided prior to execution of this Contract were personally examined prior to delivery to escrow by authorized officers of the Contractor and that they meet the requirements of herein and are adequate to enable a complete understanding and interpretation of how the Contractor arrived at its Proposal. Prior to execution of this Contract representatives of MDOT and the Contractor shall jointly review the EPD to determine whether it is complete, and shall organize the EPD and label each page so that it is obvious that the page is a part of the EPD and so as to enable a person reviewing a page out of context to determine where it can be found within the EPD. The representatives shall also complete an index listing each document included in the EPD and briefly describe the document and its location in the EPD. This index and document description shall be kept with the EPD. In the event that, following the initial organization, MDOT determines that the EPD is incomplete, MDOT may request the Contractor to supply data

to make the EPD complete. The Contractor shall provide all such data within three business days of the request, and at that time it will be date stamped, labeled to identify it as supplementary EPD information, and added to the EPD. The Contractor shall have no right to add documents to the EPD except upon MDOT's request.

The EPD shall at all times be treated as proprietary and confidential information and shall be used only for purposes described in herein. Failure or refusal to provide Proposal documentation shall delay execution of the Contract or may be cause for forfeit.

The cost of the escrow will be borne by the Contractor. The Contractor will provide escrow instructions to the selected repository of EPD's or banking institution located in Jackson, Mississippi, consistent with this specification.

907-103.07--Execution and Approval of Contract. The Best Value Proposer to whom the Contract has been awarded shall sign and file with the Executive Director, the Contract and all documents required by the Contract within 10 days after the Contract has been awarded. The Contract may require certain documents be submitted at an earlier date, in which case, those documents shall be submitted within the time frame specified. No Contract is in effect until it is executed by all parties.

907-103.08--Failure to Execute Contract. Failure of the Proposer to execute the Contract and file acceptable performance and payment bonds and/or other required documents within 10 days shall be just cause for the cancellation of the award and forfeiture of the Proposal Guaranty which shall become the property of the Department, not as a penalty but in liquidation of damages sustained. Award may then be made to the next responsive Best Value Proposer, or the Work may be re-advertised at the discretion of the Department.

MISSISSIPPI DEPARTMENT OF TRANSPORTATION

SPECIAL PROVISION NO. 907-104 DB

CODE: (SP)

DATE: 09/13/2011

SUBJECT: Scope of Work

Section 104, Scope of Work, of the 2004 Edition of the Mississippi Standard Specifications for Road and Bridge Construction is hereby amended as follows:

Delete Subsection 104.01 on page 24 and substitute the following:

907-104.01--Intent of Contract. The intent of the Contract is to provide for the execution, design, construction, and completion in every detail of the Work described, and to compensate the Contractor for all acceptable work performed in accordance with the provisions of the Contract. The Contractor shall furnish all labor, materials, equipment, supplies, transportation, supervision, quality control, methods and procedures necessary to complete the Work in accordance with the terms of the Contract.

907-104.01.1--Partnering Process

COVENANT OF GOOD FAITH AND FAIR DEALING:

This Contract imposes an obligation of good faith and fair dealing in its performance and enforcement.

The Contractor and the Department, with a positive commitment to honesty and integrity, agree to the following mutual duties:

- A. Each will function within the laws and statutes applicable to their duties and responsibilities.
- B. Each will assist in the other's performance.
- C. Each will avoid hindering the other's performance.
- D. Each will proceed to fulfill its obligations diligently.
- E. Each will cooperate in the common endeavor of the Contract.

VOLUNTARY PARTNERING:

The Mississippi Department of Transportation encourages the foundation of a cohesive partnership with the Contractor and its principal subcontractors and suppliers. This partnership will be structured to draw on the strengths of each organization to identify and achieve reciprocal goals. The objectives are effective and efficient Contract performance and completion within budget, on schedule, and in accordance with the Contract.

This partnership will be bilateral in make-up, and participation will be totally voluntary. Any cost associated with effectuating this partnering will be agreed to by both parties and will be shared equally.

To implement this partnering initiative prior to starting of the Work in accordance with the requirements of Subsection 907-108.02 Notice to Proceed and prior to the pre-construction conference, the Contractor's management personnel and MDOT's District Engineer, will initiate a partnering development seminar/team building workshop. The Contractor working with the assistance of the District and the State Construction Engineer will make arrangements to determine attendees for the workshop, agenda of the workshop, duration, and location. Persons required to be in attendance will be the MDOT key project personnel including MDOT's duly authorized representative, the Contractor's Key Individuals of both the prime and principal subcontractors and suppliers. The Contractor's design engineers, MDOT design engineers and FHWA will be also be invited to attend as necessary. The Contractor and MDOT will also be required to have Regional/District and Corporate/State level managers on the Project team.

Follow-up workshops may be held periodically throughout the duration of the Contract as agreed by the Contractor and MDOT.

The establishment of a partnership charter on this Project will not change the legal relationship of the parties to the Contract nor relieve either party from any of the terms of the Contract.

Delete Subsections 104.02, 104.02.1, 104.02.2, and 104.02.3 beginning on page 24 and substitute the following:

907-104.02--Alterations of Plans or Character of Work. Except as may be necessary to satisfactorily complete the Contract, no alterations of the plans or the nature of the Work will involve work beyond the termini of the contemplated construction without modification of the Contract and approval by all parties concerned.

The Department reserves the right to make, in writing, at any time during the Work, such alterations in the Work as are necessary to satisfactorily complete the Project. Such changes and alterations shall neither invalidate the Contract nor release the Surety, and the Contractor agrees to perform the Work as altered.

Wherever in the Specifications a supplemental agreement is provided for, such supplemental agreement must be approved by the Commission and spread upon its minutes prior to execution by the Executive Director.

907-104.02.1—Blank.

907-104.02. 2—Blank

907-104.02. 3—Blank

Delete Subsection 104.03 on page 27 and substitute the following:

907-104.03--Extra Work. If the Engineer determines that authorized extra work changes the Project Scope of the original Contract, an adjustment will be made to the Contract.

The basis for any allowable price adjustment will be a negotiated amount or, in lieu of negotiations or other agreement, an amount based on the sum of actual labor, material, equipment, insurance, bond, tax, etc. costs computed in accordance with Section 902 Subsection III Contract Price/Contract Payments, B.1.

The basis for any allowable time adjustment will be the amount of time that the change in Project Scope affects completion of critical activities of the critical path method (CPM) in Subsection 907-108.03.1.

Delete Subsection 104.04 beginning on page 27 and substitute the following:

907-104.04--Maintenance of Traffic. Unless otherwise provided, the road under construction and all other roads and entrances to adjacent property within the Project Right of Way will be kept open to through and local traffic.

The Contractor shall keep the portion of the Project being used by public traffic in satisfactory condition for traffic to be adequately accommodated. The Contractor shall also provide and maintain in a safe condition temporary approaches or crossings and intersections with trails, roads, streets, businesses, parking lots, residences, garages, and farms.

On any facility on which traffic is maintained, mowing shall be performed as necessary as determined by the Engineer to provide reasonable appearance and safety to the traveling public. Mowing shall be performed at the direction and satisfaction of the Engineer, and shall include those areas from the edge of the pavement to a minimum of five feet beyond the shoulder line.

The Contractor shall be bound by the provisions of this subsection and other applicable provisions of the Contract with regard to the safe and convenient passage of traffic.

In the case of a project for improvements or construction alongside an existing roadway on which traffic is required to be maintained, no equipment, vehicles or materials will be permitted to park or be stored within the clear/safety zone of the roadway unless it is behind a lane or shoulder closure. Unless working under an approved nighttime operation, the Contractor shall not perform any work within the clear/safety zone of the roadway between sunset and sunrise.

The Contractor shall not obstruct any traffic facility or connection thereto which is officially opened to public or private traffic or required under the Contract to be maintained except as permitted in writing by the Engineer on the basis that other suitable provisions have been made.

The Contractor will be required to restore and/or maintain traffic caused by snow, ice, major flooding, landslide or phenomenon of nature such as an earthquake, hurricane, tornado, etc. If the Engineer orders such special maintenance of traffic for the benefit of the traveling public, the ordered work shall be accomplished as provided in Subsection 907-104.03.

Unsatisfactory maintenance of traffic shall be subject to the procedures provided in Subsection 907- 105.15.

Delete Subsection 104.05 beginning on page 29 and substitute the following:

907-104.05--Removal and Disposal of All Materials from the Project. The Contractor shall remove and dispose of all existing structures and obstructions in accordance with the provisions of Section 202 and the Special Provisions.

All existing structures and obstructions or residual portions of structures and obstructions not designated to remain are to be removed and disposed of by the Contractor.

When materials are to be removed and disposed of at locations provided by the Contractor, the Contractor shall furnish the Engineer a copy of a release from each property owner for the servitude of the land. The Contractor shall also furnish the Engineer a certified letter stating that the area of disposal is not in a wetland or in Waters of the U.S. The State, the Commission, the Department, or any of its officers, duly appointed representatives or employees will have no ownership or liability whatsoever for materials or matter removed thus from the right-of-way.

All removals by the Contractors are to be made in accordance with the provisions of Section 201, Section 202 and Section 203.

Delete Subsection 104.06 on page 30 and substitute the following:

907-104.06--Use of Materials Found in the Work. It is understood that the title to all materials found within the Project Right of Way or easements remains with State.

However, the Engineer may permit the Contractor to use stone, gravel, sand and other suitable materials found within the grading limits that may be useful in fulfillment of the Contract requirements. The excavation material, so removed and needed for use in embankments, backfills, approaches, or otherwise in the Work, shall be replaced by the Contractor with other material acceptable to the Engineer all at no cost to MDOT.

Delete Subsection 104.08 beginning on page 31 and substitute the following:

907-104.08--Value Engineering Incentive. Value Engineering Incentive applies to any cost reduction proposal initiated and developed by the Contractor for the purpose of refining the Contract documents or to significantly improve the quality of the final product. This subsection does not apply unless a proposal is identified by the Contractor at the time of submission as a Value Engineering Incentive Proposal. The Department shall be the sole judge of the acceptability of any such proposal and of the estimated net savings in design and construction costs from adoption of all or any part of such proposal.

Cost reduction proposals approved by the Department are to be implemented by a supplemental agreement to the Contract and must result in savings without impairing any essential functions and characteristics such as safety, service life, reliability, economy of operations, ease of maintenance, aesthetics and necessary standard design features. As a minimum, the Contractor shall submit the following information with each proposal:

- a) A statement that the proposal is submitted as a Value Engineering Incentive Proposal;

- b) Description of the proposal;
- c) Narrative on the Contract requirements which will require modification including a recommendation for each change;
- d) Estimated cost reductions;
- e) Prediction of any effects on other costs to the Department;
- f) Recommended implementation timeframe with supporting data for maximizing cost reduction during the remainder of the Contract; and
- g) A statement as to the anticipated effect on the project completion date.

The Commission, the Department or any of its officers, duly appointed representatives or employees will not be liable for any delay in acting upon a proposal. The decision of the Engineer as to acceptance of any such proposal will be final and shall not be subject to Subsection 105.17. The Department may accept the proposal, in whole or in part, by executing a supplemental agreement that will specifically state that, it is executed pursuant to these provisions. Such agreement will incorporate the necessary changes or additions to the Contract documents to permit the proposal or accepted part thereof to be put into effect. If conditional, it will include conditions upon which the Department's approval is based. The agreement will also set forth the estimated net savings attributable to the proposal and will further provide that the Contractor be paid fifty percent (50%) of said savings. For those Value Engineering proposals submitted by the Department, the Contractor will be paid fifty percent (50%) of the savings. The cost to the Department in evaluating the proposal will be considered in determining the estimated net savings. The Contractor's share of the savings shall constitute full compensation for the Value Engineering Incentive Proposal.

Approval of the proposal and performance of the work thereof shall not change the Contract completion date unless specifically provided for in the supplemental agreement implementing the proposal.

The Contractor may request that the Department not use or disclose the information submitted with a proposal and such request may be honored for the extent allowed by law. Such restriction must be in writing and submitted with the proposal. If the proposal is accepted, this restriction shall be void and the Department may use, duplicate or disclose any data necessary to utilize such proposal. The executed supplemental agreement implementing the proposal will become public information in the files of the Department.

MISSISSIPPI DEPARTMENT OF TRANSPORTATION

SPECIAL PROVISION NO. 907-105 DB

CODE: (SP)

DATE: 08/08/12

SUBJECT: Control of Work

Section 105, Control of Work, of the 2004 Edition of the Mississippi Standard Specifications for Road and Bridge Construction is hereby amended as follows:

Delete Subsection 105.01 beginning on page 32 and substitute the following:

907-105.01--Authority of the Engineer. The Engineer will decide all questions which may arise as to the quality and acceptability of materials, the Work and the progress of the Work; all questions which may arise as to the interpretation of the plans and specifications; and all questions as to the fulfillment of the Contract.

The Engineer will have the authority to suspend the Work wholly or in part and to withhold payments because of the Contractor's failure to correct conditions unsafe for the general public, for failure to carry out provisions of the Contract, or for failure to carry out orders. The Engineer may authorize, in writing, the continued prosecution of Work activities past their specified seasonal limits when it is determined that the quality of the Work will not be reduced and the public interest will be best served.

The Engineer will have authority to enforce and make effective all decisions and orders relating to the Contract.

Delete Subsection 105.02 on page 33 and substitute the following:

907-105.02--Plans, Shop Drawings, and Working Drawings. The Contractor shall have one copy of the Proposal and Contract documents and one half-scale copy of the plans available at all times during Work activity on the Project.

Plans will generally show details of the Work to be performed and a summary of the estimated quantities. The plans will be supplemented by shop drawings or working drawings as necessary to adequately control the Work. Shop drawings or working drawings shall be furnished by the Contractor as required for the completion of the Work. Shop drawings or working drawings shall not be considered as plan changes and any conflicts on shop drawings or working drawings, shall not supersede the requirements of the Released for Construction (RFC'd) plans and specifications. If required, the Contractor shall furnish to the Engineer the original tracings of shop drawings or working plans in the format desired by the Engineer.

The contract price shall include the cost of furnishing all shop drawings or working drawings including all revised drawings that may be required in the event design details of the plans are changed.

Delete Subsection 105.03 beginning on page 33 and substitute the following:

907-105.03--Conformity with plans and Specifications. All work performed and all materials furnished shall be in reasonably close conformity with the lines, grades, cross-sections, dimensions, material requirements and other construction requirements shown on the plans or required by the specifications.

In the event the Engineer finds the materials or the finished product in which the materials are used not within reasonably close conformity with the plans and specifications the Contractor's Lead Design Engineer shall submit a recommendation to the Engineer as to whether the Work should be accepted and remain in place or removed and replaced. If the Engineer allows the Work to remain in place, an appropriate adjustment in the contract price for the work or materials will be made in accordance with the contract.

When the materials, the finished product or the work are not in reasonably close conformity with the plans and specifications and have resulted in an inferior, unsatisfactory or unacceptable product, the work or materials shall be removed and replaced or otherwise corrected by the Contractor.

When work is of a temporary nature and its use is expected to be of short duration, the Engineer may allow minor deviations, not more than five percent (5%), from specified test values. Any such allowance will not relieve the Contractor from responsibility for maintenance of the work.

Delete Subsection 105.04 beginning on page 34 and substitute the following:

907-105.04--Coordination of Specifications, Supplemental Specifications, Special Provisions and Request for Proposal (RFP). The Standard Specifications, special provisions, Notice to Proposers, Request for Proposal, Contractor's Proposals and all other supplemental documents are essential parts of the Contract, and a requirement occurring in one Contract Document is as binding as though occurring in all. They are intended to be complementary and provide for a complete Work. In case of discrepancy, calculated dimensions will govern over scaled dimensions. In case of conflict, the order of precedence of Contract documents shall be according to SECTION 902 Subsection I. CONTRACT DOCUMENTS.

Any reference in the Contract documents to a particular Section or Subsection shall mean that Section or Subsection of the Mississippi Standard Specifications for Road and Bridge Construction, or that Section or Subsection as modified by the Contract.

The Contractor shall not take advantage of any apparent error or omission in the Contract requirements. When the Contractor discovers an error or omission, the Engineer shall be immediately notified. The Contractor will then make corrections utilizing the RFR process described in the Technical Requirements Section 2.2.6 and interpretations deemed necessary for fulfilling the intent of the Contract.

Delete Subsection 105.05 on page 35 and substitute the following:

907-105.05--Cooperation by Contractor. The Contractor shall give the Work the attention

necessary to expedite its progress, and shall cooperate with the Department, its duly authorized representatives and other Contractors in every possible way.

The Contractor shall have a competent and experienced full time resident Project Director who is capable of reading and understanding the plans and specifications for the particular work being performed. The Project Director shall receive instructions from the Engineer or duly authorized representative. Upon issuance of the Notice of Award, the Contractor or duly appointed agent authorized to bind the Contractor shall file with the Engineer the name and address of the Project Director who will supervise the Work. The Engineer shall be immediately notified in writing when a change is requested in the Contract's Project Director or Project Director's address. The Project Director shall not be changed without MDOT's approval. The Project Director shall have full authority to execute orders or directives of the Engineer without delay and to promptly supply materials, equipment, labor and incidentals as may be required. Such Project Director shall be furnished irrespective of the amount of work sublet.

The Project Director shall advise the Engineer of an intended absence from the Work and designate a person to be in charge of the Work during such absence.

The Contractor shall also designate a responsible person, whose primary duty shall be to monitor and maintain the effectiveness of the erosion control plan, including NPDES permit requirements. This person must be a Certified Erosion Control Person defined as a person certified in erosion control by an organization approved by MDOT. Prior to or at the pre-construction conference the Contractor shall designate to the Engineer in writing the Certified Erosion Control Person. The designated Certified Erosion Control Person shall be assigned to only one (1) project, unless the Contractor has adjoining projects or another project in close proximity. If either of these cases exist the Contractor may request in writing that the State Construction Engineer approve the use of one (1) Certified Erosion Control Person for both projects. The Contractor may request in writing that the Engineer authorize a substitute Certified Erosion Control Person to act in the absence of the Certified Erosion Control Person. The substitute must also be a Certified Erosion Control Person. A copy of the Certified Erosion Control Person's and the substitutes', if used, certification must be included in the Contractor's Protection Plan as outlined in Subsection 907-107.22.1. The Engineer shall be furnished with the telephone numbers where the Contractor's responsible person and a substitute, authorized to act in the absence of the responsible person, may be reached at all times when not on the Project.

Delete Subsection 105.06 on pages 35 and 36 and substitute the following:

907-105.06--Blank.

Delete Subsection 105.07 beginning on page 36 and substitute the following:

907-105.07--Cooperation Between Contractors. MDOT reserves the right to award contracts for work on or near work covered by other contracts. Each contractor will be expected to cooperate with the other contractor(s) and MDOT in every reasonable manner.

MDOT will make a determination as to the practicality of prosecuting an existing contract before an additional award is made for work in the same area. Insofar as is practicable, MDOT will give

notice of the intent to award subsequent contracts in the same area. Failure to do so, however, shall not prejudice the rights of Commission to award additional contracts and shall not constitute grounds for claims against the State, Commission, MDOT or any of its officers or employees.

When separate contracts are let for work, any part or all of which is within the same limits, each contractor's work shall be conducted so as to cause the least interference with work being performed by the other contractor(s).

When contracts are awarded to separate Contractors for concurrent construction within a common area, the Contractors, in conference with the Engineer, shall establish a written joint schedule of operations. Such schedule will set out approximate dates and sequences for work to be performed with due regard to needs and contract time imitations of each contract. The Engineer may allow modification of the schedule when mutual benefit to the Contractors and the Engineer will result. Any modification of the joint schedule shall be in writing, mutually agreeable, and signed by the Contractors. Failure of either Contractor to abide by the terms of the joint schedule or modified schedule will be justification for termination of the Contract under the provision of Subsection 907-108.08.

Each Contractor's work shall be arranged such that the placement and disposal of the materials and equipment being used shall not interfere with the operations of the other Contractor. Each contractor shall join their work with that of others in an acceptable manner and perform it in the sequence of the established schedule. Each Contractor involved shall assume all liability, financial and otherwise, in connection with each contract and shall protect and save harmless Commission, MDOT or any of its officers, duly authorized representatives, or employees from all damages or claims that may arise because of inconvenience, delay or loss experienced because of the presence and operations of the other Contractor(s) working within the same Contract limits.

Delete Subsection 105.08 beginning on page 37 and substitute the following:

907-105.08--Construction Stakes, Lines and Grades. The Contractor will set construction stakes establishing lines, slopes, and profile grades in road work and establish all centerline and benchmarks for bridge work. The Contractor will also provide all necessary information relating to lines, slopes, and grades. These stakes and benchmarks shall constitute the field control by which the Contractor shall establish and maintain all necessary controls and perform the Work. Any corrective work caused by inaccurate field controls established by the Contractor will be performed in a manner satisfactory to the Engineer and at no additional cost to MDOT.

Delete Subsection 105.09 on page 38 and substitute the following.

907-105.09-- Blank.

Delete Subsection 105.10 on page 38 and substitute the following:

907-105.10--Duties of the Inspector. Inspectors assigned by the Engineer or duly authorized representative will be authorized to inspect all work and materials for compliance with the

Contract requirements. The inspection may extend to all parts of the Work and to the preparation, fabrication or manufacture of the materials. The inspector will not be authorized to alter or waive the provisions of the Contract, to issue instructions contrary to the Contract requirements or to act as foreman for the Contractor.

Delete Subsection 105.11 beginning on page 38 and substitute the following:

907-105.11--Inspection of Work. All materials and each part or detail of the Work are subject to inspection by the Engineer. The Engineer shall be allowed access to all of the Work and shall be furnished with such information and assistance by the Contractor as necessary to make a complete and detailed inspection.

Prior to acceptance of the work, the Contractor shall remove and/or uncover such portions of the work as directed by the Engineer. After examination, the Contractor shall restore said portions of the work. If the work exposed or examined was acceptable, the uncovering and/or removing and the restoring of the work will be paid as Extra Work. If the work so exposed or examined was unacceptable, the cost of uncovering and/or removing and the restoring of the work will be the Contractor's responsibility. Additional time will not be allowed for any uncovering and/or removing and restoring of the work.

When any unit of government, political subdivision, Railroad Corporation or other public service is to pay a portion of the cost of the Work, its respective representative shall have the right to inspect the work. Such inspection shall in no way make said agency or corporation a party to this Contract and shall in no way interfere with the rights of either party of the Contract. Further, no inspection of the work by the Engineer or any other MDOT representative shall relieve Contractor of its responsibilities under this Contract.

Delete Subsection 105.12 on page 39 and substitute the following.

907-105.12--Removal of Unacceptable and Unauthorized Work. Unless otherwise determined acceptable under the provisions of Subsection 105.03, all work which does not conform to the requirements of the contract will be considered as nonconforming work.

Nonconforming Work, whether the result of poor workmanship, defective materials, damage through carelessness or any other cause, found prior to final acceptance of the Work shall be removed and replaced in an acceptable manner, without any additional cost to the Commission.

Delete Subsection 105.14 beginning on page 39 and substitute the following:

907-105.14--Maintenance during Construction. The Contractor shall maintain the Work until released from maintenance. This maintenance shall constitute continuous and effective work prosecuted day by day with adequate equipment, forces and material to the end that the roadway, structures and all other features of the Work are kept in satisfactory condition at all times. Traffic shall be continuously, safely and conveniently maintained as required under the Technical Requirements.

In the case of a contract for the placing of a course upon a course or subgrade previously

constructed, the Contractor shall maintain the previous course or subgrade during all construction operations.

All cost for maintenance of the Work shall be the responsibility of the Contractor.

Delete Subsections 105.16 and 105.16.1 beginning on page 40 and substitute the following.

907-105.16--Acceptance.

907-105.16.1--Partial Acceptance. When the Contractor has completed a unit of the Work such as an interchange, a structure, a portion of the road or pavement or one Project of a multi-project contract, the Contractor may request the Engineer to make a final inspection of that unit; or the Executive Director may order a final inspection of the unit if it is in the public's interest. If the Engineer finds upon inspection that the unit has been completed in compliance with the Contract, save that of growth and coverage and coverage of growth establishment, and it is a complete facility which can be made available to the public or made available for the prosecution of work under another contract, the Executive Director may conditionally accept the unit.

In the event items of Work covered by such release are found to be defective or deficient as evidenced by unsatisfactory test reports of materials incorporated in the Work or other engineering determination, the release shall terminate upon written notification to the Contractor. The Contractor shall make all corrections, restorations, constructions or re-constructions deemed necessary and shall resume all contractual responsibilities until all corrective measures have been made in accordance with the terms of the Contract.

Partial acceptance does not constitute final acceptance of the Work, or any part thereof, nor in any way void or alter any of the terms of the Contract.

Relief from "certain contractual responsibilities" as indicated herein may, or may not, include:

- (a) Further maintenance of the defined limits of the partially accepted Work.
- (b) Further public liability for the defined limits of the partially accepted Work.

MISSISSIPPI DEPARTMENT OF TRANSPORTATION

SPECIAL PROVISION NO. 907-106 DB

CODE: (SP)

DATE: 09/13/2011

SUBJECT: Control of Materials

Section 106, Control of Materials, of the 2004 Edition of the Mississippi Standard Specifications for Road and Bridge Construction is hereby amended as follows:

907-106.01—Source of Supply and Quality Requirements.

907-106.01.1—General. At the end of the first paragraph of Subsection 106.01.1 on page 44, add the following:

The Contractor is responsible for the quality control of all phases of the Work entailed by the Contract requirements including design, construction and materials incorporated. The Contractor shall provide and maintain quality control procedures and processes to continually assess the quality of all work and to verify that the quality of work performed meets the criteria and levels of performance stipulated by the Contract.

The Engineer is responsible for determining the acceptability of all phases of Work entailed by the Contract requirements utilizing MDOT's acceptance procedures.

907-106.02--Local Material Sources

Delete Subsections 106.02.1 on page 45 and substitute the following:

907-106.02.1-- Blank.

Delete Subsections 106.02.2 and 106.02.3 on page 45 and substitute the following:

907-106.02.2--Contractor Furnished Sources. The Contractor shall provide sources of materials meeting the requirements of the Contract and shall bear all costs involved in the inspection, sampling and testing for quality of all materials.

MDOT will assume the cost of acceptance sampling and testing during production and use of the materials.

907-106.02.3--All Sources. All pits and quarry sites are subject to approval from the Mississippi Department of Environmental Quality, Office of Geology, as set forth in Subsection 107.23. All pit operations including hauling shall comply with the applicable provisions of Subsection 107.22. Unless otherwise permitted, all pits shall be drained upon completion.

Delete Subsection 106.03 beginning on page 45 and substitute the following:

907-106.03--Samples, Tests, and Cited Specifications. All materials used in the Work shall conform to the general requirements of Section 700 and the specific requirements for each item of work described therein. Cited specifications of AASHTO, ASTM or Federal Specifications for materials or test methods shall be understood to mean approved pre-published or published "Standards" of ASTM, AASHTO, Federal Specifications, or amended Federal Specifications denoted by a numbered amendment, current on the date of advertisement for RFP.

Unless otherwise provided, all inspection, sampling and testing for quality control of materials shall be performed in accordance with Subsection 700.03 by the Contractor. The work shall be considered incomplete until all materials used in the Work have been accepted. Any work performed prior to approval of materials will be the sole responsibility of the Contractor.

MDOT reserves the right to retest all materials even though they have been tested and approved earlier and to reject all retested materials that do not meet the requirements of the Contract. Prior inspection, test and approval of material used as a component of another item of work shall in no way imply acceptance if the work in which the material is incorporated fails to meet the requirements of the Contract.

Test reports will be furnished by both parties to the Contract upon request.

Delete Subsection 106.05 on page 46 and substitute the following:

907-106.05--Plant Inspection. The Engineer may make additional quality assurance inspections at the source of material produced by a third party. In the event such plant inspection is undertaken the following conditions shall be met:

- (a) The Engineer shall have the cooperation and assistance of the Contractor and the producer.
- (b) The Engineer shall have full entry of the plant as may concern the manufacture or production of the materials.
- (c) When specified, the Contractor shall provide an approved laboratory unit conforming to the applicable requirements of Section 907-621.

Delete Subsection 106.07 on page 47 and substitute the following:

907-106.07--Foreign Materials.

907-106.07.1--Use of Domestic Steel Products. When steel or iron is used it shall be in compliance with Section 165 of the Surface Transportation Assistance Act of 1982, the applicable provisions of Title 23 CFR, Section 635.410, as amended, entitled "Buy America Requirements."

Pig Iron and processed, pelletized, and reduced iron ore manufactured outside of the United States may be used in the domestic manufacturing process for steel and/or iron materials used in Federal-aid highway construction projects.

Except as specifically prohibited in these specifications or other Contract Documents, consideration may be given by MDOT to the use of certain materials manufactured or produced outside of the United States provided the materials are delivered to approved locations within the State. The Contractor shall perform any required sampling and testing which the State is not equipped to perform.

All testing shall generally be performed within the United States' Mainland and be subject to witnessing by the Engineer. Certain materials or processes may necessitate the testing be performed or witnessed at the foreign source by State personnel. When the Engineer authorizes inspection at a foreign site, the Contractor shall reimburse the State for all expenses incurred outside the United States by the State's representatives.

For materials requiring mill test reports, the State Materials Engineer will determine that in-plant quality controls are adequate to assure delivery of uniform material in accordance with Contract requirements, and the State Materials Engineer's determination of the adequacy of in-plant quality controls with respect to mill test reports and certificates of compliance shall be final.

No structural materials will be accepted which cannot be properly identified with mill test reports and certificates of compliance even though in-plant quality control procedures have been established to the satisfaction of the State Materials Engineer.

Delete Subsection 106.10 on page 47 and substitute the following:

907-106.10--Unacceptable Materials. All materials not conforming to the requirements of the specifications at the time they are incorporated in the Work shall be rejected and removed immediately unless otherwise instructed by the Engineer.

907-106.10.1--Acceptance or Rejection of Materials. Following the application of the appropriate MDOT acceptance criteria, the decision of the Engineer will be final as to the acceptance or rejection of the materials.

907-106.10.2--Disposition of Materials. All material evaluated by MDOT as unsatisfactory for the use intended shall be reworked or removed and replaced and resubmitted for acceptance. Rejected materials that have been resubmitted for acceptance shall not be used until the Engineer has given written approval. When the MDOT evaluation indicates the material may satisfactorily remain in place, acceptance will be at an adjusted price as stated in the Specifications or as directed by the Engineer.

Delete Subsection 106.11 on page 48 and substitute the following:

907-106.11—Blank.

Delete Subsection 106.12 on page 48 and substitute the following:

907-106.12--Substitute Materials. The Contractor may request MDOT to approve the use of substitute materials for specific uses provided the requested material is on MDOT's "List of Approved Sources of Materials" or the "List of Approved Substitute Materials". Contractors proposing to use substitute materials will be responsible for determining if the material has

gained MDOT approval. When an approved substitute material is to be used, the Contractor will furnish a certification from the manufacturer that the product is the same material as approved by MDOT and that no alterations have been made. Material will be sampled and tested by MDOT as necessary for acceptance. Approved lists may be obtained from the State Materials Engineer.

MISSISSIPPI DEPARTMENT OF TRANSPORTATION

SPECIAL PROVISION NO. 907-107 DB

CODE: (SP)

DATE: 07/27/2012

SUBJECT: Legal Relations and Responsibility to Public

Section 107, Legal Relations and Responsibility to Public, of the 2004 Edition of the Mississippi Standard Specifications for Road and Bridge Construction is hereby amended as follows:

Delete in toto Subsection 107.02 on page 49 and substitute the following:

907-107.02--Permits, Licenses and Taxes. The Contractor or any Subcontractor shall have the duty to determine any and all permits and licenses required and to procure all permits and licenses, pay all charges, fees and taxes and issue all notices necessary and incidental to the due and lawful prosecution of the work. At any time during the life of this contract, the Department may audit the Contractor's or Subcontractor's compliance with the requirements of this section.

The Contractor or any Subcontractor is advised that the "Mississippi Special Fuel Tax Law", Section 27- 55-501, et seq. and the Mississippi Use Tax Law, Section 27-67-1, et seq., and their requirements and penalties, apply to any contract or subcontract for construction, reconstruction, maintenance or repairs, for contracts or subcontracts entered into with the State of Mississippi, any political subdivision of the State of Mississippi, or any Department, Agency, Institute of the State of Mississippi or any political subdivision thereof.

The Contractor or any Subcontractor will be subject to one or more audits by the Department during the life of this contract to make certain that all applicable fuel taxes, as outlined in Section 27-55-501, et seq., and any sales and/or use taxes, as outlined in Section 27-67-1, et seq. are being paid in compliance with the law. The Department will notify the Mississippi State Tax Commission of the names and addresses of any Contractors or Subcontractors.

Delete Subsection 107.09 on page 56 and substitute the following:

907-107.09--Construction Over or Adjacent to Navigable Waters and Wetlands. All work on, over or adjacent to navigable waters or wetlands shall be conducted in accordance with permits issued by the appropriate Governmental Approvals.

The Contractor will obtain permits for work over navigable waters and wetlands, and closely examine the provisions of such permits relative to spoil disposal and water quality considerations and the necessary construction of retention basins, settling ponds, temporary navigation lights, etc.

The Contractor shall conform with all provisions and conditions of the permits. Should temporary construction be proposed for the Contractor's convenience in the areas set out in the permits, the Contractor shall apply for and furnish a copy of the required permits to the Engineer

before proceeding with the temporary construction. The coordination of obtaining or modifying any permits shall be the Contractor's responsibility.

907-107.14.2--Liability Insurance. Delete in toto Subsection 107.14.2 beginning on page 60 and substitute:

907-107.14.2.1--General. The Contractor shall carry Contractor's liability, including subcontractors and contractual, with limits not less than: \$500,000 each occurrence; \$1,000,000 aggregate; automobile liability - \$500,000 combined single limit - each accident; Workers' Compensation and Employers' Liability - Statutory & \$100,000 each accident; \$100,000 each employee; \$500,000 policy limit. Each policy shall be signed or countersigned by a Mississippi Agent or qualified nonresident agent of the insurance company.

The Contractor shall have certificates furnished to the Department from the insurance companies providing the required coverage. The certificates shall be on the form furnished by the Department and will show the types and limits of coverage.

907-107.14.2.2--Railroad Protective. The following provisions are applicable to all work performed under a contract on, over or under the rights-of-way of each railroad shown on the plans.

The Contractor shall assume all liability for any and all damages to work, employees, servants, equipment and materials caused by railroad traffic.

Prior to starting any work on railroad property, the Contractor shall furnish satisfactory evidence to the Department that insurance of the forms and amounts set out herein in paragraphs (a) and (b) has been obtained. Also, the Contractor shall furnish similar evidence to the Railroad Company that insurance has been obtained in accordance with the Standard Provisions for General Liability Policies and the Railroad Protective Liability Form as published in the Code of Federal Regulations, 23 CFR 646, Subpart A. evidence to the Railroad Company shall be in the form of a Certificate of Insurance for coverages required in paragraph (b), and the original policy of the Railroad Protective Liability Insurance for coverage required in paragraph (a).

All insurance herein specified shall be carried until the contract is satisfactorily complete as evidenced by a release of maintenance from the Department.

The Railroad Company shall be given at least 30 days notice prior to cancellation of the Railroad Protective Liability Insurance policy.

For work within the limits set out in Subsection 107.18 and this subsection, the Contractor shall provide insurance for bodily injury liability, property damage liability and physical damage to property with coverages and limits no less than shown in paragraphs (a) and (b). Bodily injury shall mean bodily injury, sickness, or disease, including death at anytime resulting therefrom. Property damage shall mean damages because of physical injury to or destruction of property, including loss of use of any property due to such injury or destruction. Physical damage shall

mean direct and accidental loss of or damage to rolling stock and their contents, mechanical construction equipment or motive power equipment.

(a) **Railroad Protective Liability Insurance** shall be purchased on behalf of the Railroad Company with limits of \$2,000,000 each occurrence; \$6,000,000 aggregate applying separately to each annual period for lines without passenger trains. If the line carries passenger train(s), railroad protective liability insurance shall be purchased on behalf of the Railroad Company with limits of \$5,000,000 each occurrence; \$10,000,000 aggregate applying separately to each annual period.

Coverage shall be limited to damage suffered by the railroad on account of occurrences arising out of the work of the Contractor on or about the railroad right-of-way, independent of the railroad's general supervision or control, except as noted in paragraph 4 below.

Coverage shall include:

- (1) death of or bodily injury to passengers of the railroad and employees of the railroad not covered by State workmen's compensation laws,
- (2) personal property owned by or in the care, custody or control of the railroads,
- (3) the Contractor, or any of the Contractor's agents or employees who suffer bodily injury or death as a result of acts of the railroad or its agents, regardless of the negligence of the railroads, and
- (4) negligence of only the following classes of railroad employees:
 - i. any supervisory employee of the railroad at the job site
 - ii. any employee of the railroad while operating, attached to, or engaged on, work trains or other railroad equipment at the job site which are assigned exclusively to the Contractor, or
 - iii. any employee of the railroad not within (i) or (ii) above who is specifically loaned or assigned to the work of the Contractor for prevention of accidents or protection or property, the cost of whose services is borne specifically by the Contractor or Governmental authority.

(b) **Regular Contractor's Liability**, including subcontractors, XCU and railroad contractual with limits of \$1,000,000 each occurrence; \$2,000,000 aggregate. **Automobile** with limits of \$1,000,000 combined single limit any one accident; **Workers' Compensation and Employer's Liability** - statutory and \$100,000 each accident; \$100,000 each employee; \$500,000 policy limit. **Excess/Umbrella Liability** \$5,000,000 each occurrence; \$5,000,000 aggregate. All coverage to be issued in the name of the Contractor shall be so written as to furnish protection to the Contractor respecting the Contractor's operations in performing work covered by the contract. Coverage shall include protection from damages arising out of bodily injury or death and damage or destruction of property which may be suffered by persons other than the Contractor's own employees.

In addition, the Contractor shall provide for and on behalf of each subcontractor by means of a separate and individual liability and property damage policy to cover like liability imposed upon

the subcontractor as a result of the subcontractor's operations in the same amounts as contained above; or, in the alternative each subcontractor shall provide same.

907-107.15--Third Party Beneficiary Clause. In the first sentence of the first paragraph of Subsection 107.15 on page 61, change “create the public” to “create in the public”.

Delete Subsection 107.17 beginning on page 62 and substitute the following:

907-107.17--Contractor's Responsibility for Work. Until release of maintenance in accordance with Subsection 907-105.16, the Contractor shall have the charge and care thereof and shall take every precaution against injury or damage by action of the elements or from any other cause, whether arising from the execution or the non-execution of the Work. The Contractor shall rebuild, repair, restore and make good, in accordance with the requirements of the Contract, all injuries or damages to the Work occasioned by any of the above causes before release of maintenance and shall bear the expense thereof.

All repairs of damage to items of construction, caused by the traveling public on a Project or section(s) of a Project open to traffic, shall be the responsibility of the Contractor.

In case of suspension of Work from any cause whatsoever, the Contractor shall be responsible for the Work and shall take the precautions necessary to prevent damage to the Work, provide for normal drainage, erect necessary temporary structures, signs or other facilities; shall maintain the Work in such a manner as to fully carry out the responsibility for maintaining traffic as required under the Contract; shall properly and continuously maintain in an acceptable growing condition all living material in newly established plantings, seedings, and soddings furnished under the Contract, and shall take adequate precautions to protect new tree growth and other vegetative growth against injury. All such protection and maintenance shall be performed by the Contractor without additional cost to the Engineer.

Delete in toto Subsection 107.22.1 on pages 65 and 66, and substitute the following:

907-107.22.1--Contractor's Erosion Control Plan. At the preconstruction conference or prior to starting any work on the project, the Contractor shall submit to the Project Engineer for concurrence a comprehensive erosion and siltation control plan utilizing temporary measures and permanent erosion control features to provide acceptable controls during all stages of construction.

The Contractor shall schedule 60 calendar days for the submittal and concurrence of the Contractor's erosion control plan, MDOT's review of the plan, and any revisions that may be necessary. The original contract time shall not be adjusted unless delays are caused solely by the Department for the submission, review, and concurrence of the Contractor's erosion control plan.

As a minimum, the plan shall include the following:

1. Erosion Control Plan (ECP) sheets or the plan profile sheets, 11” x 17” or larger, of all areas within the rights-of-way from the Beginning of the Project (BOP) to the End of the Project (EOP) showing the location of all temporary erosion control devices. Erosion

control devices should be identified by exact type, temporary or permanent, configuration, and placement of each item to prevent erosion and siltation. A narrative of the Contractor's temporary erosion control plan shall be submitted in a format similar to the form attached to this special provision, but must include the heading and sub-heading information. As a minimum, the narrative shall include the following:

- A detailed description, including locations (station numbers) of the Contractor's proposed sequence of operations including, but not limited to, clearing and grubbing, excavation, drainage, and structures.
 - A detailed description, including locations, and best management practices (BMP) that will be used to prevent siltation and erosion from occurring during the Contractor's proposed sequence of operations.
2. A copy of the certification for the Contractor's Certified Erosion Control Person whose primary duty shall be monitoring and maintaining the effectiveness of the erosion control plan, BMPs, and compliance with the NPDES permit requirements.
 3. A plan for the disposal of waste materials on the project right-of-way which shall include but not be limited to the following:
 - containment and disposal of materials resulting from the cleaning (washing out) of concrete trucks that are delivering concrete to the project site.
 - containment and disposal of fuel / petroleum materials at staging areas on the project.
 -

The erosion and siltation control plan shall be maintained on the project site at all times, updated as work progresses to show changes due to revisions in the sequences of construction operations, replacement of inadequate BMPs, and the maintenance of BMPs. Work shall not be started until an Erosion Control Plan has been concurred with by the MDOT. The Engineer will have the authority to suspend all work and/or withhold payments for failure of the Contractor to carry out provisions of MDEQ's Storm Water Construction General Permit, the Erosion Control Plan, updates to the Erosion Control Plan, and /or proper maintenance of the BMPs.

907-107.22.2--Clearing and Grubbing, Haul Roads, Waste Areas, Plant Sites or Other Areas Occupied by the Contractor. Delete the fourth paragraph of Subsection 107.22.2 on page 66 and substitute the following:

Unless otherwise determined by the Engineer from a study of overall job conditions, the exposed surface area of erodible material at any one time for each of the separate operations of this subsection shall not exceed 19 acres without prior approval by the Engineer.

Delete Subsection 107.22.4 beginning on page 67 and substitute the following:

907-107.22.4--Structures, Grading, and Other Construction. The Contractor shall perform all Work required under the Contract in such manner and with such protective features to control and contain siltation within the limits of the Work.

Performance in the designated or directed sequence and the providing of all erosion protection shall be considered the Contractor's responsibility.

The Contractor shall prevent or minimize undesirable siltation in connection with excavation, construction and backfill of structures. Such temporary measures as are indicated herein for

clearing and grubbing or other measures such as covering of excavated materials, lining channels, constructing bulkheads or other effective measures shall be employed.

The Engineer will limit the areas of excavation, borrow, and embankment operations commensurate with the Contractor's capability and progress in keeping the finish grading, seeding, mulching, and other such permanent erosion control measures current. Should seasonal limitations make such coordination unrealistic, temporary erosion control measures shall be used to the extent feasible and justified. The exposed surface area of erodible material at any one time for each grading operation shall not exceed 19 acres without prior approval by the Engineer.

The Engineer may increase or decrease the areas of erodible material to be exposed at any one time by clearing and grubbing, excavation, borrow and fill operations as determined by analysis of the conditions of the Project.

It is the intent of these specifications that the Work shall proceed in a manner and sequence to ensure the earliest possible establishment of permanent erosion control items.

Delete Subsection 107.22.5 on page 68 and substitute the following:

907-107.22.5--Special Temporary Erosion Control. The Contractor shall perform all designated temporary and all emergency erosion control work such as fast growing grasses or other designated temporary features for problem areas during grading, paving or other construction work as directed by the Engineer. The Work shall be performed at the time and in the manner deemed to provide the most effective deterrent to siltation.

EXAMPLE

MISSISSIPPI DEPARTMENT OF TRANSPORTATION
Storm Water Pollution Prevention Plan (SWPPP)
Narrative

General Permit Coverage No: MSR _____
Project Number: _____
County: _____
Route: _____

SITE INFORMATION

This project consists of grading and installing drainage structures necessary to construct approximately 6 miles of parallel lanes on SR 31 between the Hinds County Line and the Rankin County Line.

SEDIMENT AND EROSION CONTROLS

VEGETATIVE CONTROLS: Clearing and grubbing areas will be minimized to comply with the buffer zones (minimum of 15 feet along the ROW lines and 5 feet along creeks) as per the contract documents. A combination of temporary and permanent grassing will be used to protect slopes as construction progresses. **Should a disturbed area be left undisturbed for 14 days or more, temporary or permanent vegetation will be placed within 7 calendar days.**

STRUCTURAL CONTROLS: Gravel construction entrance/exit will be installed near Stations 145+50, 159+50, 164+50 & 172+50. Riprap ditch checks will be constructed at Stations 144+50, 151+75, 162+00 & 166+25. The Concrete washout area will be at Stations 140+25, 152+00 & 168+50.

HOUSEKEEPING PRACTICES: Structural BMP's will be cleaned out when sediment reaches 1/3 to 1/2 of the height of the BMP. Maintenance and repair of equipment will be performed off-site, material wash out will occur either off-site or within designated wash out areas.

POST-CONSTRUCTION CONTROL MEASURES: As construction is completed, permanent vegetative growth will be established on disturbed soils to improve soil stability and provide a buffer zone for loose material. Paved ditches and flumes will be placed as specified in the ECP to reduce erosion in concentrated flow areas and rip rap will be placed as specified to dissipate flow energy and reduce flow velocity.

IMPLEMENTATION SEQUENCE

Perimeter controls will be installed first. Clearing and grubbing will be performed in 19-acre sections beginning at the BOP and temporary grassing will be installed as needed. Temporary erosion control BMP's will be installed at the drainage structures prior/during construction of the drainage structures. Grading activities will commence at the BOP and proceed towards the EOP, fill slopes will be permanently grassed in stages for fill heights that exceed 5 feet. Base materials will be installed on completed grading sections with the paving to follow.

MAINTENANCE PLAN

All erosion and sediment control practices will be checked for stability and operation following every rainfall but in no case less than once every week. Any needed repairs will be made immediately to maintain all practices as designed. Sediment basins will be cleaned out when the level of sediment reaches 2.0 feet below the top of the riser. Sediment will be removed from behind BMP's when it becomes about 1/3 to 1/2 height of BMP.

Prime Contractor's Signature

Date

Printed Name

Title

MISSISSIPPI DEPARTMENT OF TRANSPORTATION

SPECIAL PROVISION NO. 907-108 DB

CODE: (SP)

DATE: 09/13/2011

SUBJECT: Prosecution and Progress

Section 108, Prosecution and Progress, of the 2004 Edition of the Mississippi Standard Specifications for Road and Bridge Construction is hereby amended as follows:

907-108.01--Subletting of Contract. Delete Subsection 108.01.1 beginning on page 72 and substitute the following:

907-108.01--General. The total value of all work performed by the Contractor's own organization shall be no less than 40 percent of the Contract Price. The Contractor shall not assign, subcontract, sublet or transfer any or all of its interest in this Contract, except the furnishing of necessary materials, without prior written approval of the Executive Director. Consent by the Executive Director to any subcontract shall not relieve Contractor from any of its obligations hereunder, and Contractor is required to maintain final management responsibility with regard to any such subcontract.

The Contractor's "own organization" shall be construed to include workmen employed and paid directly, owned or rented equipment and trucks that are classed as owner-operator.

The simple expediency of carrying the workmen of one Contractor on the prime Contractor's or approved subcontractor's payroll to avoid subcontracting will not be permitted.

If evidence and investigation establish that a violation of the subcontract requirement is being attempted through subterfuge whereby one Contractor's equipment is leased to the prime Contractor or the workmen of one Contractor are placed on the payroll of the prime Contractor, the Executive Director will take such action as deemed appropriate under the provisions of the Contract. This provision does not include the lease or use of equipment from a corporation or company wholly owned by the prime Contractor.

Subcontracting does not release the Contractor of bond and Contract liability and shall not be construed to imply that a contract exists between the Department and a third party.

The Contractor must pay subcontractor(s) for satisfactory performance of their contracts no later than 15 calendar days from receipt of payment from the Department. Within 15 calendar days after receiving payment from the Department for work satisfactorily performed, the Contractor shall make prompt payment to all subcontractors or material suppliers for all monies due.

Delete Subsection 108.02 beginning on page 74 and substitute the following:

907-108.02--Notice to Proceed. The Contractor shall not begin construction on any feature of the Work before a Notice to Proceed is issued.

If the Department delays the issuance of the Notice to Proceed for reasons beyond the August 31, 2012

Contractor's control, the beginning of Contract time shall be adjusted equal to the number of calendar days of the delay. Contract time shall **NOT** be adjusted for delays caused by the Contractor. The Notice to Proceed and the beginning of Contract time shall be the same date.

Delete Subsection 108.03.1 in toto beginning on page 75 and substitute the following:

907-108.03.1—Prosecution and Progress. Delete Subsection 108.03.1 beginning on page 75 and substitute the following:

907-108.03.1--Critical Path Method (CPM) Progress Schedules.

907-108.03.1.1--Definitions. The following definitions pertaining to construction schedules shall apply with respect to all scheduling provisions set forth in the Contract:

1. **Activity:** Any task, or portion of a project, that takes time to complete.
2. **Baseline Schedule:** The initial CPM schedule representing the Contractor's original work plan, as accepted by the Engineer.
3. **Controlling Operation:** The activity within that series of activities defined as the Critical Path, which, if delayed or prolonged, will delay the time of completion of the Contract.
4. **Critical Path:** The series of activities that determines the earliest completion of the Project (i.e., the Forecast Completion Date) in accordance with the terms and conditions of the Contract.
5. **Critical Path Method:** A mathematical calculation that determines the earliest completion of the Project in accordance with the terms and conditions of the Contract and that includes a graphic representation of the sequence of activities showing the interrelationships and interdependencies of the elements composing a project.
6. **Current Contract Completion Date:** The date for completion of the Contract based on the fixed completion date as specified for full and final completion of the Work in the Contract documents.
7. **Differential Completion Time:** The difference in time between the Current Contract Completion Date and the Contractor's scheduled early Forecast Completion Date as shown on the Baseline Schedule, or schedule updates and revisions thereto.
8. **Final Completion:** Completion of all Contract Work to the extent that the Project is open to the safe, convenient, and unimpeded use of the traveling public as determined solely by the Engineer.
9. **Float:** The amount of time between the early start date and the late start date, or the early finish date and the late finish date, of any activity or group of activities in the network. See Free Float and Total Float.
10. **Fragnet:** A section or fragment of the network diagram comprised of a group of activities.

11. **Free Float:** The amount of time an activity can be delayed without delaying the Early Start of a successor activity.
12. **Hammock Activity:** A non-critical activity added to the network to span an existing group of activities for summarizing purposes.
13. **Milestone:** An activity that represents a significant point in time, and may be used to indicate the start or end of a series of related activities and/or Contract accomplishment. A milestone has zero original and remaining duration, and does not increase the Contract time.
14. **Revision:** A change in the schedule that modifies logic, revises the current Contract completion date, adds or deletes activities, or alters activities, sequences, descriptions, calendars, actual dates, or durations.
15. **Tabular Listing:** A report showing schedule activities, their relationships, durations, scheduled and actual dates, float, budgeted cost, and all log notes where comments are inserted for an activity.
16. **Total Float:** The amount of time that an activity may be delayed without affecting the total duration of the Project.
17. **Update:** The modification of the most current Contractor's CPM progress schedule through a regular and periodic (at least monthly) review to incorporate actual progress to date by activity. Update shall indicate changes to the activity's percent complete, actual start and actual finish dates.
18. **Recovery Schedule:** A revised Baseline Schedule requested by the Engineer demonstrating how the Contractor will expedite progress to recover delays that are the responsibility of the Contractor.

907-108.03.1.2--Scheduling Conference. The Contractor shall schedule and conduct a Scheduling Conference. Mandatory attendees shall include the Contractor's Project Director, Construction Scheduler, Quality Assurance Scheduler and the Engineer. This conference shall be scheduled within 15 calendar days after award of the Contract. At this meeting, the requirements of the Special Provisions regarding scheduling will be reviewed with the Contractor.

At the Scheduling Conference, the Contractor shall furnish an Interim Baseline Schedule as discussed in Subsection 108.03.1.4 and be prepared to discuss both its proposed methodologies for fulfilling the scheduling requirements and its sequence of operations. In this meeting, the Contractor shall also supply to the Engineer a copy of the Contractor's proposed activity code dictionary that will be utilized in the sorting of the activities into phases of work, areas of work, types of work, etc. The Contractor shall be prepared to discuss requirements for all off-site material testing and submittals applicable to the Contract, discuss their respective preparation, and review durations.

907-108.03.1.3--Blank

907-108.03.1.4--Interim Baseline Schedule. This interim schedule shall provide a detailed breakdown of the activities to be performed in the initial 90 calendar days of work plus a generalized breakdown of activities for the balance of the Work that includes meeting the Contract completion dates. The Contractor shall maintain and submit monthly an updated 90 calendar day Interim Baseline Schedule until submission and Engineer's acceptance of the Baseline Schedule.

The Engineer will be allowed 10 calendar days to review the Interim Baseline Schedule and to provide comments. The Interim Baseline Schedule does not require the Engineer's acceptance, but all comments from the Engineer with respect to the Interim Baseline Schedule are to be incorporated within the Baseline Schedule. Re-submittal of the Interim Baseline Schedule is not required. Late review of the Interim Baseline Schedule by the Engineer shall not restrain the Contractor's submittal of the Baseline Schedule.

907-108.03.1.4.1 Project Payment Schedule (PPS). The PPS is a variation of the schedules set forth in 108.03.1.4 and 108.03.1.5 that outlines the estimated payment amounts per pay period over the life of the Project. The PPS sets forth the budgeted cost, beginning date, ending date, and percent complete for each Schedule activity. Estimated pay amounts for each activity can then be developed by multiplying the percent complete for the particular activity at the end of each pay period times the budgeted cost for that same activity. The schedules shall include consideration for payments in connection with the procurement, fabrication and delivery of needed materials.

The PPS schedule shall meet all schedule requirements set forth in Subsection 108.03.1.6.

907-108.03.1.5--Baseline Schedule. Within 60 calendar days of the Contract award date, the Contractor shall submit to the Engineer a Baseline Schedule, which shall incorporate any and all comments provided by the Engineer regarding the Interim Baseline Schedule. The Baseline Schedule shall have a data date of the effective date of the Notice to Proceed and shall not include any work prior to that date. A Baseline Schedule Narrative as described in Subsection 108.03.1.9.1 and a revised PPS to reflect all changes shall accompany the Baseline Schedule.

The Baseline Schedule shall depict how the Contractor plans to complete the Work of the Contract and shall show all those activities that define the Critical Path. The Baseline Schedule shall provide for the adequate planning of the Project, as well as the Engineer's monitoring and evaluation of progress and analysis of time impacts. The Contractor shall not attribute any negative float to any activity depicted on the Baseline Schedule. The Engineer will be allowed 10 calendar days to review and accept the Contractor's submittal of the Baseline Schedule. Should the Engineer reject the Contractor's submittal of the Baseline Schedule, the Contractor shall resubmit a revised schedule within 15 calendar days of receipt of the Engineer's review comments, at which time a new 15 calendar day review period by the Engineer will begin.

907-108.03.1.6--General Requirements Regarding Schedules. All schedules submitted by the Contractor shall comply with the following requirements.

All schedules shall be created, updated and provided in the most current version of Primavera Project Planner (P3) and shall comply with (1) any and all interim target dates and/or milestones specified by the Contract; (2) all constraints, restraints or sequences specified by the Contract; and (3) the number of days set forth in the Contract for completion of the Work

All schedules shall follow these scheduling requirements: 1) No constraints shall be included except on milestone, finish and start activities, 2) Negative lags shall not be used at any time, 3) Each activity shall have at least one predecessor and one successor, 4) All submittal, procurement and fabrication activities shall be included, 5) Highlight the critical path (<10 days float) on all applicable reports, and 6) Include milestone activities for completion of all applicable investigations, foundation design, bridge superstructure design, demolition/removal of portions of existing bridge(s), roadway, lane shifts, and full use of the bridge by the traveling public.

All schedules shall indicate the interdependence of activities (how the start of a given activity depends on the completion of preceding activities) and the sequence of work (how failure to complete a given activity may restrain the start of following activities).

Activities with duration times in excess of 15 calendar days, except for non-construction activities, shall be kept to a minimum and be subject to review by the Engineer.

All schedules shall include any coordination and cooperation requirements, construction restrictions or other requirements of the Contract. All schedules shall include sufficient work calendars to identify specific activities requiring multiple shifts/day, multiple crews/shift, extended workweeks, or work at times other than what may be considered regular days or hours.

All schedules shall include activities for all work required by the Contract, including detailed activities for preliminary and final design work plus associated review requirements, permit processes, utilities coordination, demolition, construction, quality control, subcontractors, vendors, and suppliers. In addition, all schedules shall include, as a minimum, activities for the procurement, fabrication, required testing time frames, delivery of critical or special materials and equipment, as well as all submittal activities required by the Contract.

The activities are to be described by location, phase, and sequence so that the work is readily identifiable and the progress of each activity can be measured. Activity duration shall be logical and consistent with the Contract documents and shall be based on realistic and available resources of the Contractor.

All schedules submitted to the Engineer shall be depicted graphically by network diagrams. The Contractor's network diagrams shall be time-scaled to show a continuous flow of information from left to right. The critical path shall be clearly and graphically identified on the network diagrams. All network diagrams prepared by the Contractor shall be organized in a logical fashion. The activities shown on the diagrams shall be sorted and grouped per work structure, with the Work covered by each Project Payment Schedule Item separately designated by distinct schedule activities.

The Contractor's coding for each activity shall be in accordance with the activity code dictionary supplied to the Engineer at the Scheduling Conference. The Engineer has the authority to require the Contractor to utilize additional filters, layouts or activity codes to be able to further categorize, group or summarize the activities. Furthermore, the network diagrams shall indicate all submittals and off-site material testing required by the Contract, and the submittals shall be sub-grouped by category.

All schedules shall also identify, at a minimum, the following activities:

- Identification of all subcontractor work and interfaces as separate activities, including activity description and responsibility coding that identifies the type of utility and the name of the subcontractor involved.
- Identification of Punchlist and final clean up activities (not to exceed 30 calendar days total) required by the Contractor to complete the Work

For each activity in the network, the Contractor shall determine the Contract value of the work activity. Administrative activities, MDOT activities and milestones shall have an assigned cost of zero. The summation of the costs of all activities shall be equal to the Contract price for the Project. These costs are to be incorporated into the Primavera schedule and the anticipated daily earnings computed for both early and late starts. These earnings are to be graphically displayed in a time-cost chart ("S" curve).

Float shall not be considered as time for the exclusive use of or benefit of either MDOT or the Contractor but shall be considered as a jointly owned, expiring resource available to the Project and shall not be used to the financial detriment of either party.

In connection with the submittal of the Baseline Schedule and all updates thereto, the Contractor is required and shall require all of its subcontractors to submit in writing a statement certifying that the subcontractor has concurred with the schedule and that the subcontractor's related schedule has been incorporated accurately, including the duration of activities.

The Engineer's acceptance of a Contractor schedule shall not constitute a change of any portion of the Contract. Failure of the Contractor to include any element of Work required by the Contract in its schedules shall not relieve the Contractor from completing the Work within the time limit specified for completion of the Contract. If the Contractor fails to define any element of Work, activity or logic, and the omission or error is discovered by either the Contractor or the Engineer, it shall be corrected by the Contractor in regard to the next monthly update or revision of the schedule. No additional time or cost to the Contract will be allowed for this correction.

Should the Baseline Schedule or any update thereto show variances from the scheduling requirements of the Contract, the Contractor shall make specific mention of the variations in the letter of transmittal, in order that, if accepted, proper adjustments to the Project schedule can be made. Notwithstanding the foregoing, the Contractor will not be relieved of the responsibility for completing all Work required by the Contract.

In the event that the Baseline Schedule, or any updates or revisions, show completion occurring prior to the Completion Date and/or interim milestones, the Contractor must demonstrate to the Engineer that the schedule is reasonable, practical and achievable. Moreover, it is expressly understood and agreed that (1) the Contractor shall have no claim for delay, disruption, hindrance, or other impact based on any early completion indicated in the Contractor's schedule(s); (2) a delay is critical if and only if to the extent that the delay extends the completion of the entire Work to a date that is beyond the contractually specified date for full completion of the Work, regardless of the Contractor's planned early completion; and (3) the Contract price includes full compensation for all time-related costs associated with the

Contractor working at the Project site for the full duration of the time set forth in the Contract, even if the Contractor represents that the Contractor plans to fully finish the Work in less than the time established by the Contract for full completion of the Work.

The Contractor shall not incorporate any changes or delays to the Work in the Baseline Schedule and in all schedules submitted thereafter without the Engineer's approval.

The submittal of all schedules shall also be accompanied by computer-generated mathematical analysis tabular reports for all activities included in the network diagrams. The tabular reports (8 1/2" x 11" size) shall consist of a report detailing the following or as directed by the Engineer:

- 1) Activity number and description
- 2) Activity Codes Line
- 3) Original, and remaining durations
- 4) Earliest start date (by calendar date)
- 5) Earliest finish date (by calendar date)
- 6) Actual start date (by calendar date)
- 7) Actual finish date (by calendar date)
- 8) Latest start date (by calendar date)
- 9) Latest finish date (by calendar date)
- 10) Identify activity calendar ID
- 11) Total Float and Free Float, in calendar days
- 12) Percentage of activity complete and remaining duration for incomplete activities
- 13) Detailed Predecessor
- 14) Detailed Successor
- 15) Cost associated with each activity
- 16) Budgeted Cost

Unless otherwise specifically noted elsewhere herein, network diagrams and the tabular reports shall be submitted to the Engineer in the following quantities:

- a) 2 sets of the network diagrams on "E" size (36" x 48") sheets
- b) 4 sets of the network diagrams on reduced-size (11" x 17") sheets

- c) 4 copies of all tabular reports (8 1/2" x 11" size)
- d) 4 copies of the "S" curve
- e) 2 copies of electronic files of the Primavera data and the schedule narrative report on CD-ROM or other media as directed by the Engineer.

907-108.03.1.7--Quarterly Progress Meetings. The Engineer and the Contractor shall hold quarterly progress meetings. In the event that the Contractor falls behind schedule, the Engineer may request that the meetings are held more frequently. The quarterly meetings will be held to discuss, among other things, (1) the near-term schedule activities; (2) the current status of As-Built documentation, RFI's, Contractor Daily Reports, Quality Control, submittals, correspondence, and Contract Change Orders; and (3) Jobsite safety, cleanup, traffic control, and coordination issues. Furthermore, the meeting shall address any long-term schedule issues and discussion of any relevant technical issues. The Contractor shall develop a look-ahead schedule identifying the previous month; current month and a month look ahead. The Contractor's look-ahead schedules shall provide sufficient detail to address all activities to be performed and to identify issues requiring action or input by MDOT. At least seven (7) calendar days prior to the quarterly progress meetings, the Contractor shall furnish the look-ahead schedule in hard copy and electronic format to the Engineer for review.

No later than seven (7) calendar days prior to the quarterly progress meeting, the Contractor shall furnish a list of critical items relating to the look-ahead schedule. During the meeting the parties will jointly determine whether additional items need to be listed, the priority of items, the parties responsible for resolving the critical item and the scheduled resolution date. Nothing herein shall be construed to excuse the Contractor's obligation to timely provide either a notice of delay or a notice of potential claim.

The Contractor shall keep minutes of the meeting and distribute a draft of the minutes to all participants for review and comments within two (2) working days of the meeting. The final minutes of the previous quarterly meeting must be distributed at least seven (7) calendar days prior to the next meeting. The list of critical items shall be updated and distributed with the quarterly meeting minutes.

907-108.03.1.8--Monthly Update Schedules. The Contractor shall regularly update the accepted Baseline Schedule to reflect the current status of the Project. On the day following the application for payment cut-off date, the Contractor shall submit a Monthly Update Schedule to the Engineer. The update shall include all information available and status of the Project as of the payment application cut-off date, or such other date as established by the Engineer. All Monthly Update Schedules described below shall comply with the requirements indicated above.

All Monthly Update Schedules shall incorporate all changes previously approved by the Engineer.

Each Monthly Update Schedule shall reflect all as-built activities performed as of the data date of the update schedule. The Monthly Update Schedule shall include the period from the last update to the data date and for the remainder of the Project. The current period's activities shall be reported as they actually took place. In the updated schedule, the Contractor shall indicate the

actual dates that activities were started and/or completed. Ongoing activities shall have an indication of the percent complete and the remaining duration to complete such activities.

Portions of the schedule on which activities are complete need not be reprinted and submitted in subsequent updates. However, the electronic file of the submitted Monthly Update Schedule and the related reports shall constitute a clear record of the actual progress of the Work from the data date of the Notice to Proceed to the effective date of the update, as well as the projected future Work up to final completion of the Project.

The Monthly Update Schedule, and any other relevant information available, will be used to determine the effect of any contemplated or actual changes or delays to the Work.

907-108.03.1.9--Schedule Narrative Reports. The Contractor shall also prepare Schedule Narrative Reports, which are to be submitted to the Engineer concurrently with each CPM submittal.

907-108.03.1.9.1—Interim Baseline and Baseline Narrative Report. These Narrative Reports shall describe, in a narrative fashion, the logic of the schedule. Each shall identify the critical path and other areas of schedule delay risk. The narratives shall include a listing of all decision/approval points in the schedule.

907-108.03.1.9.2--Progress Narrative Reports. The Progress Narrative Report shall describe the physical progress of work performed by the Contractor during the report period. In addition, the report shall indicate the Contractor's plans for continuing the Work during the forthcoming report period, actions planned to correct any negative float, and any delays or problems and their estimated impact on the Contract completion date for the Project. In addition, the Contractor shall include for consideration by the Engineer alternatives for possible schedule recovery to mitigate any potential delay. The report shall follow the outline set forth below:

1. Contractor's Transmittal Letter
2. Work completed during the report period
3. Description of the current critical path of the schedule
4. List of any and all delayed activities, reasons for delay and steps taken to mitigate the delay
5. Status of the Contract Completion Date
 - (a.) On schedule
 - (b.) Ahead of schedule and number of calendar days
 - (c.) Behind schedule and number of calendar days
6. Listing of any changes to the schedule activities or logic

Narrative reports containing non-factual, subjective statements, judgments or opinions, which appear to assign responsibility or to make conclusions as to excusability, responsibility, or compensability for delays shall be cause for rejection of the narrative report.

On a monthly basis, and on a date to be determined by the Engineer, the Contractor shall meet with the Engineer to review the Monthly Update Schedule and the Schedule Narrative Report. The Engineer will be allowed 7 calendar days after the meeting to review and accept or reject the Monthly Update Schedule and the Schedule Narrative Report. Rejected schedules and/or reports shall be revised and resubmitted to the Engineer within 10 calendar days, at which time a new 7 calendar day review period by the Engineer will begin. All efforts shall be made between the Engineer and the Contractor to complete the review and the approval process prior to the cut-off date for the next update schedule. To expedite the process, a second meeting between the Engineer and the Contractor shall be held, as determined to be necessary by the Engineer.

907-108.03.1.10--Schedule Revisions.

907-108.03.1.10.1—Contractor Proposed Revisions. Once the Baseline Schedule is accepted by the Engineer, the Contractor shall not make any revisions to the schedule except as set forth in 108.03.1.10.2.

The above provision shall not be construed as a limitation on the Contractor's obligation to accurately reflect the as-built progress of the Work with respect to each Monthly Update Schedule. It is expressly understood and agreed that the term "revisions", as used herein shall refer to changes to the schedule with respect to work that will be prospectively performed up to completion of the Project.

907-108.03.1.10.2--Engineer Required Revisions. Within 15 calendar days of the Engineer's request, the Contractor shall submit a revised schedule whenever the Engineer determines that there is a major change in the Project scope that affects the Critical Path

If Contractor falls 15 calendar days behind on any critical path activity shown on the Baseline Schedule or it becomes apparent that the Work may not be completed as scheduled or that milestone dates may not be achieved as scheduled, Contractor shall prepare and submit a proposed revised Recovery Schedule demonstrating Contractor's proposed plan to regain lost schedule progress and to achieve Substantial Completion and all Work related thereto and Final Acceptance. After the Engineer accepts the recovery schedule, it will become a part of the Baseline Schedule. The proposed revised Recovery Schedule shall include a narrative demonstrating the resources to be employed and work activities necessary to meet the proposed revision. All costs (including any additional labor costs) to analyze, revise and to incorporate any schedule modification shall be the responsibility of the Contractor. Contractor will prepare and submit the recovery schedule within 10 calendar days after the submittal of the monthly Baseline Schedule update. The Engineer and its representatives shall review the recovery schedule and submit written comments to Contractor within ten (10) calendar days of receipt of the recovery schedule submittal

907-108.03.1.11--Measurement and Payment. An amount equal to 25 percent of the total estimated value of the Work performed during each period may be withheld if the Contractor fails to submit any of the acceptable schedules. This includes Monthly Updates and Schedule

Narrative Reports, and/or failure of said schedules to conform to the requirements of this section, as determined by the Engineer.

Thereafter, on subsequent successive payment application periods, the percentage withheld may be increased at the rate of 25 percent per payment application period in which the non-conformance with this specification continues. Monies withheld for this non-conformance will be released for payment on the next monthly payment application for partial payment following the date the schedule information is brought back into compliance with this specification.

907-108.03.2—Preconstruction Conference. Prior to commencement of the Work, a preconstruction conference shall be held for the purpose of discussing with the Contractor essential matters pertaining to the prosecution and satisfactory completion of the Project. The Contractor, with the assistance of the Engineer, shall schedule the preconstruction conference.

Delete Subsection 108.03.3 on page 76 and substitute the following:

907-108.03.3—Commencement and Execution of Work. The work shall begin as set out in the Contract Documents or the approved progress schedule and shall be prosecuted at a rate necessary to insure its completion within the contract time specified by the Contractor.

All work covered by supplemental agreement shall not commence until the supplemental agreement has been executed by all parties.

Delete Section 108.04 beginning on page 77 in toto and substitute the following:

907-108.04— Blank.

Delete Section 108.06 beginning on page 79 in toto and substitute the following:

907-108.06.1.3--Extension of Time. The Contract Time may not be extended unless there is a delay to the Project caused by an event listed below.

- (a) Force Majeure as that term is defined in Section 902 Subsection VI.
- (b) MDOT initiated scope changes, directives or authorized extra work.
- (c) Acts or omissions by MDOT or its duly appointed representative that unreasonably interfere with the Contractor's performance and cause delay of Work on the critical path of the Project.
- (d) Changes in a legal requirement or regulation that becomes effective subsequent to the date of this Contract.
- (e) Discovery of hazardous materials as set forth in Section 902 Subsection V not discoverable from a reasonable investigation and analysis of the site prior to the Proposal Date.

- (f) Discovery of archeological or paleontological sites not previously identified as set forth in Subsection 5.5 of the Technical Requirements not discoverable from a reasonable investigation and analysis of the site prior to the Proposal Date.

Other than as noted above, the Contract Time shall not be increased for Contract time adjustments or claimed delay damages. Requests for time extensions shall be made in writing to MDOT within 20 calendar days of the event causing the delay. Requests shall include a schedule analysis fragnet demonstrating the delay is the critical path.

Delete Subsection 108.07 on page 85 in toto and substitute the following:

907-108.07— Failure to Complete the Work on Time. The assessment of liquidated damages shall not be considered a penalty; any damages assessed a reasonable estimate of fair compensation for the damage of delay that may reasonably be anticipated from the Contractor's failure to complete the Project within the Contractor specified time constraints.

If the Contractor fails to complete all items of Work by the Contractor's specified Final Completion Date, the Commission will assess liquidated damages (\$3500/day) per calendar day until the date all items of Work are completed.

The assessments of liquidated damages shall be deducted by the Commission from monies due the Contractor, if sufficient monies are available. Otherwise, the Contractor shall pay to the Commission the liquidated damage assessments within fifteen (15) business days of notice that payment is due.

907-108.08-- Default and Termination of Contract. At the end of Subsection 108.08 on page 87, add the following:

Upon termination for default, all Project Documents, as defined in Technical Requirements Section 2.3, shall be surrendered forthwith by Contractor to MDOT. MDOT will be authorized to use the Design documents for the sole purpose of promoting, completing, using, maintaining, upgrading or adding to the Project. This authorization includes allowing design professionals to make changes, corrections, or additions to the Design documents for these purposes.

Delete Subsection 108.09 beginning on page 87 in toto and substitute the following:

907-108.09--Termination of Contract for Reasons Other Than Default. MDOT reserves the right to cancel the Work upon ten (10) calendar days written notice to Contractor. Should the Work be so canceled by MDOT for convenience, Contractor shall be paid for the value of the Work, based upon the Project Payment Schedule, performed to the date of cancellation and demobilization together with any cancellation charges by vendors and subcontractors. The Contractor shall also be entitled to the cost of securing the Work, provided such cost is approved by MDOT. In no event, however, shall the total payment to Contractor pursuant to such a cancellation exceed the Contract Price.

Termination of all or a portion of the Contract shall not relieve Contractor of any responsibility it would otherwise have for the Work completed, or any claims arising from that work.

Upon such termination, all Project Documents, as defined in Technical Requirements Section

2.3, shall be surrendered forthwith by Contractor to MDOT. MDOT will be authorized to use the Design documents for the sole purpose of promoting, completing, using, maintaining, upgrading or adding to the Project. This authorization includes allowing design professionals to make changes, corrections, or additions to the Design documents for these purposes.

Delete Subsection 108.10 on page 88 and substitute the following:

907-108.10--Termination of Contractor's Responsibility. The construction phase of this Contract will be considered complete when all Work has been satisfactorily completed, the final inspection made, the Work accepted by the Executive Director and the final estimate paid. When the Executive Director writes the formal letter of acceptance, the Contractor will be released from further obligation except as set forth under the warranty provisions of the Contract or as provided by law.

MISSISSIPPI DEPARTMENT OF TRANSPORTATION

SPECIAL PROVISION NO. 907-109 DB

CODE: (SP)

DATE: 09/13/2011

SUBJECT: Measurement and Payment

Section 109, Measurement and Payment, of the 2004 Edition of the Mississippi Standard Specifications for Road and Bridge Construction is hereby amended as follows:

Delete Subsection 109.01 beginning on page 88 and substitute the following:

907-109.01—Measurement of Quantities. Measurement and calculations of quantities are for testing frequencies only and for this reason the units of measurement and method of measurement shall be consistent with units of measurements and methods of measurements noted in the Standard Specifications.

Delete the second paragraph of Subsection 109.02 on page 91.

Delete Subsection 109.03 on page 91 and substitute the following:

907-109.03--Blank

Delete Subsection 109.04 beginning on page 91 and substitute the following:

907-109.04--Extra and Force Account Work. Allowable Contract adjustments in accordance with the requirements and provisions of Subsection 907-104.03 will be paid for at the unit prices or lump sum price stipulated in the agreement authorizing the Work, or the Executive Director may require the Contractor to do such work on a force account basis to be compensated in the following manner:

(a) **Labor.** The Contractor will receive the rate of wage or scale agreed upon in writing for each hour that the foreman in direct charge of the specific operations and labor are actually engaged in such work. An amount will be added equal to 19 percent of the sum thereof.

(b) **Bond, Insurance and Tax.** For property damage, liability, and workmen's compensation insurance premiums, unemployment insurance contributions and social security taxes on the force account work, the Contractor will be reimbursed actual cost only. The Contractor shall furnish satisfactory evidence of the rate or rates paid for the bond, insurance and tax.

(c) **Materials.** The Contractor will receive the actual cost of the materials, including transportation charges if paid by the Contractor, exclusive of machinery rentals as hereinafter set forth, plus 19 percent.

(d) **Equipment.** For any machinery or special equipment, other than small tools,

authorized by the Engineer, the Contractor will receive the rates agreed upon in writing. In the event an agreement cannot be reached for a particular piece of equipment, the book entitled "Rental Rate Blue Book For Construction Equipment" as published by Equipment Watch® and is current at the time the force account work is authorized will be used to determine equipment ownership and operating expense rates. These rates do not include allowances for operating labor, mobilization or demobilization costs, overhead or profit, and do not represent rental charges for those in the business of renting equipment. Operating labor and overhead cost will be allowed. Subject to advance approval of the Engineer, actual transportation cost for a distance of not more than 200 miles will be reimbursed for equipment not already on the Project. The cost of transportation after completion of the force account work will be reimbursed except it cannot exceed the allowance for moving the equipment to the Work.

The hourly use rates are computed on the basis of a 40-hour workweek. When the Contractor works more than 40 hours per week, the cost for "Cost of Facilities Capital" (CFC) will be excluded from the hourly rate for those hours in excess of 40 hours per week.

No more than eight hours of standby will be paid during a 24-hour day, nor more than 40 hours per week. Standby time will not be allowed unless the equipment has been in idle status in excess of 16 hours during a 24-hour day. Likewise, standby will not be allowed during periods when the equipment would have otherwise been in idle status or when equipment could reasonably have been used on other parts of the Project. Actual operating time during a week will be credited against the 40 hours maximum standby allowance.

All equipment shall be subject to approval from day to day in accordance with the requirements of Subsection 907-108.05.

(e) **Miscellaneous.** No allowance will be made for general superintendence, the use of small tools, or other costs for which no specific allowance is herein provided.

(f) **Compensation.** No extra work on a force account basis will be paid unless unit prices for labor, materials and equipment rentals have been agreed upon in writing, or as otherwise provided for equipment in paragraph (d), before work is started. The unit prices paid shall not exceed the quoted unit price for each item stipulated in the agreement.

The Contractor, or the Contractor's authorized representative, and the Engineer shall compare records of extra work done on a force account basis at the end of each day. Copies of these records shall be made upon the form provided for this purpose and shall be certified to by the Contractor and the Engineer. The Contractor shall furnish to the Engineer itemized statements of the cost of all force account work. The statements shall include a true copy of the payroll and the original receipt of bills and invoices for the material used and the freight charges paid. Where materials used are not specifically purchased for use on extra work but taken from the Contractor's stock, the Contractor may submit an affidavit of the quantity, price and freight on these

materials.

Statements covering force account work for each specific agreement shall be submitted promptly at the end of the month in which the work was actually completed. Failure to timely submit such information shall constitute a waiver if any claim for monetary damage.

Delete Subsection 109.05 on page 93 and substitute the following:

907-109.05--Eliminated Items. The Department shall have the right to eliminate portions of the Contract relating to any of the engineering services or any of the construction services set forth therein. When the Contractor is notified of the elimination of portions of the Contract work, the Department will reimburse the Contractor for actual work done and all costs incurred prior to the notification.

When a major item is eliminated, the Contractor will be reimbursed for substantiated unrecovered overhead costs but not to exceed five percent of the original contract value of the item as shown in the Escrow Proposal Documents. The Contractor shall not be entitled to nor shall the Commission, the Department, or any of its officers or employees be subjected to any liability or damages.

The Contractor upon request will be paid substantiated actual costs for materials, which are in excess of those used and paid for in the completed work that were mobilized prior to notification of elimination or reduction of a major item. Materials which otherwise would have been required prior to such notification and which are on the order that cannot be cancelled may be included in the material to be paid for by the Department. No payment will be allowed for materials in excess of the quantity required under the Contract

Points of delivery for the reimbursed materials shall be agreeable to the Department. The Contractor shall make delivery at such a point and the additional transportation cost, if any, will be reimbursed by the Department.

Mobilization of material as indicated in this provision shall be understood to be materials which qualify for partial payment under the provisions of Subsection 907-109.06 and cannot be reasonably used by the Contractor in other work under contract.

At the option of the Department, living or perishable plant material, seeds, other materials and warehouse items mobilized for the work may be purchased by the Department.

All mobilized materials for which payment is made shall become the property of the Department, and the Contractor shall furnish the Engineer satisfactory title or approved evidence of ownership.

907-109.06--Partial Payments.

Delete Subsection 907-109.06.1 beginning on page 93 and substitute the following:

907-109.06.1--General. The Contractor shall submit a Project Payment Schedule (PPS) for the contracted Work a minimum of 30 days prior to its initial application for partial payment. This schedule will provide a breakdown of values for the contracted Work aggregating the Contract price, and will be the basis for partial payments. The breakdown will demonstrate reasonable, identifiable, and measurable components of the Work. The sum of all values listed for each element shall be equal to the Contract price proposed for that element as set forth in the Contractor's Project Payment Schedule. The Work shall be subdivided into component parts in sufficient detail to serve as the basis for progress payments and price adjustments, positive and negative. Prices will include a pro rata amount of overhead and profit applicable to each item. The Department may reject the Project Payment Schedule if it fails to provide reasonable detail, any prices are excessively unbalanced, or fails to account for the entire Contract fixed price.

The Contractor shall submit to the Engineer an application for each payment, the cut-off date for receiving submittal shall be the 20th of each month, unless changed by MDOT. A Construction Certificate (Attachment to SP 907-109.06.1) must be attached to each payment application. The Contractor shall include, in each application for payment, a schedule of the percentages of the various parts of the Work completed that, the quantities placed during the current pay period, a running total of all quantities placed to date, OCR-484 and all Contractor Payrolls. The Contractor shall also submit test reports and/or Manufacturer Certificates for materials not tested by the Department with each payment request. Applications for payment shall not be submitted more frequently than once per month. The applications for payment shall be submitted in a format acceptable to MDOT.

The Engineer shall approve all payments based upon the Contractor's compliance with the Project Payment Schedule, the Contract, Construction Certificate and the documented progress of Work. MDOT will make partial payments on the Contract monthly as Work progresses. In the event a submitted application for payment is completed incorrectly, contains defects or improprieties, or there is a good faith dispute, MDOT will so notify the Contractor within two (2) business days stating the reason or reasons the application for payment is defective or improper or the reasons for the dispute. The Contractor shall have two (2) business days in which to submit the corrected application for payment. If the corrected application is not submitted within two (2) business days, payment will be made on the following month's application for payment.

Delete Subsection 109.07 beginning on page 95 and substitute the following:

907-109.07--Blank.

Delete Subsection 109.11 beginning on page 98 and substitute the following:

907-109.11--Acceptance and Final Payment. When the Executive Director has notified the Contractor of final acceptance pursuant to Subsection 907-105.16.2 a final application for payment showing the value of the work will be prepared by the Contractor. The amount of this payment, less all previous payments and deductions required under the Contract, will be paid to the Contractor as soon as practicable. Final payment will not be made until written consent of the Contractor and the Surety has been delivered to the Contract Administration Engineer of the Department. It shall be the Contractor's responsibility to have the Surety provide the consent. Delays in final payment because of non-receipt of Surety's consent shall not be cause for the payment of interest under the provisions of Section 31-5-27 of the Mississippi Code, 1972,

Annotated, for the period of time occasioned by such delay.

Acceptance by the Contractor of final payment shall operate as and shall be a release to the Commission from all claims or liability under the Contract and any act or neglect of the Commission relating to or connected with the Contract.

Attachment to Special Provision 907-109.06.1

CONSTRUCTION CERTIFICATE

TO: Mississippi Department of Transportation

FROM: _____

INVOICE REFERENCE NUMBER: _____

PAY PERIOD COVERED BY REFERENCED INVOICE: _____

PROJECT NUMBER:

This Construction Certificate is made by (“Contractor”), in accordance with the Design/Build Contract, by and between the Contractor and the Mississippi Transportation Commission and in compliance with the requirements of that Contract.

Capitalized terms used in this Construction Certificate shall have the meanings and definitions given them in the Contract.

This Construction Certificate is submitted in connection with Contractor’s invoice referenced above and in order to induce Commission to make to Contractor a progress payment, pursuant to Special Provision No. 907-109.06.1 of the Contract Special provisions. To this end, Contractor hereby certifies, represents, warrants and covenants as follows:

1. Other than as set forth in writing and attached hereto and marked “Exhibit 1”, Contractor is aware of no claim, dispute, circumstance or fact which Contractor asserts gives rise to a Supplemental Agreement for extension of time or addition to or increase in the Contract Price. If there are no such claims, disputes, circumstances or facts of which Contractor is aware, Exhibit 1 shall state “None.” If no such claims, disputes, circumstances or facts are set forth on Exhibit 1, any such claim, dispute, circumstance or fact of which Contractor is aware is hereby waived by Contractor.
2. Pursuant to Special Provision No. 907-108.03.1.9.2 Progress Narrative Report of the Contract Special provisions, attached hereto and marked “Exhibit 2” is a description, in detail sufficient for independent verification, of the Work that has been performed and is being invoiced.
3. Pursuant to Special Provision No. 907-109.06.2 Advancement on Materials of the Contract Special Provisions, attached hereto and marked “Exhibit 3” is a description, in detail sufficient for independent verification, of all newly stored, Stored Materials and all adjustments for Stored Materials incorporated into the

Project in the then immediately preceding progress payment.

4. Pursuant to Special Provision No. 907-109.6.2 Advancement on Materials of the Contract Special Provisions, Contractor certifies that all such Stored Materials to which Contractor holds title and which are described in Exhibit 3 hereto were either obtained and properly stored or removed from storage and incorporated into the Work in the immediately preceding payment period; Exhibit 3 states which such Stored Materials were obtained and properly stored and which such Stored Materials were removed from storage and incorporated into the Work.
5. Pursuant to Section V Quality Control/Quality Assurance (QC/QA) of the Contract, Contractor certifies that the Work invoiced in connection with this Design and Construction Certificate and all Work invoiced to date has been performed in a prudent manner and in compliance with the requirements of the Contract, including the Performance Criteria that all amounts have been paid by the Contractor for Work for which Previous Certificates for Payment were issued and payments received from the Owner.
6. Contractor certifies that Contractor has complied with the requirements of Section III.C.1 Periodic Progress Payment Application on page 18 of the Contract, and that all necessary materials to perform the Work have been provided by Contractor or its Subcontractors or Vendors in accordance with the provisions of the Contract, and that Contractor holds title to all such materials included in the invoice in accordance with Section III.C.1 of the Contract.
7. The undersigned is duly authorized and empowered by Contractor to execute this Construction Certificate.

By: _____
[Type or print name of authorized agent]

Date: _____

Its: _____
[Type or print title of authorized agent]

Signature of authorized agent: _____

MISSISSIPPI DEPARTMENT OF TRANSPORTATION

SPECIAL PROVISION NO. 907-110 DB

CODE: (SP)

DATE: 04/02/2010

SUBJECT: Wage Rates

Section 110, Required Contract Provisions, of the 2004 Edition of the Mississippi Standard Specifications for Road and Bridge Construction is hereby amended as follows:

907-110.02--Application. Delete Subsection 110.02.2 on page 100 and substitute the following.

907-110.02.2--Wage Rates. All persons employed or working upon the site of the work will be paid at wage rates not less than those contained in the wage determination decision of the Secretary of Labor in effect 10 days prior to taking bids.

Bidders are advised that regardless of the wage rates listed in the Supplement to FHWA 1273 in the contract, minimum federal wage rates must be paid.

MISSISSIPPI DEPARTMENT OF TRANSPORTATION

SPECIAL PROVISION NO. 907-215 DB

CODE: (SP)

DATE: 11/02/2011

SUBJECT: **Hydraulically Applied Mulch**

Section 215, Mulching, of the 2004 Edition of the Mississippi Standard Specifications for Road and Bridge Construction is hereby amended as follows.

907-215.01--Description. After the sentence of Subsection 215.01 on page 140, add the following.

Mulching may be accomplished by hydraulically applying the mulch in accordance with these specifications.

907-215.02--Materials. After the last paragraph of 215.02 on page 141, add the following.

When hydraulically applied mulch (hydromulch) is used, the fibers shall be produced from wood, straw, cellulose, natural fibers, or recycled fibers which are free of non-biodegradable substances. The fiber shall disperse into a uniform slurry when mixed with water. Fibers shall be colored green, or other approved contrasting color, and shall not stain concrete or other surfaces. The use of tackifiers or activators will be allowed.

Hydromulch shall be listed on the Department's "Approved Sources of Materials".

907-215.03--Construction Requirements. After Subsection 215.03.4 on page 142, add the following.

907-215.03.5--Hydromulch. Hydromulch shall be applied in accordance with the installation instructions and recommendations of the manufacturer. Hydro mulch shall be uniformly applied at the application rate indicated on the plans, or as directed by the Engineer.

Delete Subsection 215.04 and 215.05 beginning on page 142 and substitute the following:

907-215.04—Blank.

907-215.05—Blank.

MISSISSIPPI DEPARTMENT OF TRANSPORTATION

SPECIAL PROVISION NO. 907-225 DB

CODE: (SP)

DATE: 02/23/2012

SUBJECT: Grassing

Section 907-225, Grassing, of the 2004 Edition of the Mississippi Standard Specifications for Road and Bridge Construction is hereby amended as follows:

Delete in toto Section 225 on pages 158 thru 163, and substitute the following.

SECTION 907-225--GRASSING

907-225-01--Description. This work consists of furnishing, transporting, placing, plant establishment, and all work, including ground preparation, fertilizing, seeding, and mulching, necessary to produce a satisfactory and acceptable growth of grass.

At the Contractor's option, seeds and mulch may be incorporated using a hydraulically applied method under certain limitations. Under no circumstances shall fertilizer be incorporated hydraulically.

907-225.02--Materials.

907-225.02.1--Fertilizers. Fertilizers for purposes of this specification shall be understood to include standard manufactured products consisting of single or combination ingredients and agricultural limestone.

All fertilizer shall comply with the State fertilizer laws, Subsection 715.02, and the requirements of this specification.

907-225.02.2--Seeds. Seeds shall meet the requirements of Subsection 715.03, subject to the provisions of this subsection. The Contractor shall acquire seed from persons registered with the Mississippi Department of Agriculture and Commerce.

Except for the germination requirements, bags of seeds properly labeled or tagged according to law and indicating characteristics meeting or exceeding the requirements of Subsection 715.03 will be acceptable for planting.

The Contractor should provide adequate dry storage facilities for seeds, and shall furnish access to the storage for sampling stored seed.

907-225.02.3--Mulch.

907-225.02.3.1--Vegetative Mulch. The vegetative materials for mulch shall meet the requirements of Subsection 215.02.

907-225.02.3.2--Hydraulically Applied Mulch (Hydromulch). Fibers for hydromulch shall be produced from wood, straw, cellulose, natural fibers, or recycled fibers which are free of non-biodegradable substances. The fiber shall disperse into a uniform slurry when mixed with water. Fibers shall be colored green, or other approved contrasting color, and shall not stain concrete or other surfaces. The use of tackifiers or activators will be allowed.

Hydromulch shall be listed on the Department's "Approved Sources of Materials".

907-225.02.3.2.1--Wood Fiber Mulch. Wood fiber mulch shall be made from wood chip particles manufactured particularly for discharging uniformly on the ground surface when dispersed by a hydraulic water sprayer. It shall remain in uniform suspension in water under agitation and blend with grass seed and fertilizer to form a homogeneous slurry. The fibers shall intertwine physically to form a strong moisture-holding mat on the ground surface and allow rainfall to percolate the underlying soil. The fiber material shall be heat processed so as to contain no germination or growth-inhibiting factors. The mulch shall be dyed an appropriate color to facilitate the application of material using non-toxic dye.

907-225.02.3.2.2--Cellulose Fiber Mulch. Cellulose fiber mulch consist of recycled paper stock products which are shredded into small pieces particular for application by hydraulic seeding equipment. It shall mix readily and uniformly under agitation with water and blend with grass seed and fertilizer to form a homogeneous slurry. When applied to the ground surface, the material shall form a strong moisture-holding mat, allow rainfall to percolate the underlying soil, and remain in place until the grass root system is established. The material shall contain no growth inhibiting characteristic or organisms. The mulch shall be dyed an appropriate color to facilitate the application of material using non-toxic dye.

907-225.02.3.2.3--Wood/Cellulose Fiber Mulch. Wood/cellulose fiber mix hydroseeding mulch shall consist of a combination of the above wood and cellulose fibers at a ratio recommended by the manufacturer of the products.

907-225.02.3.2.4--Straw Mulch. Straw mulch shall consist of a natural straw fiber. This material shall be a minimum 90% straw and essentially free from plastic materials or other non-bio degradable substances. The material shall be disperse into a uniform mulch slurry when mixed with water.

907-225.02.3.2.5--Tackifier. The tackifier will serve the purpose of an adhesive to form a bond between the soil, fiber, and seed particles. It will also allow the soil to retain moisture. The tackifier shall be of the organic or synthetic variety.

907-225.03--Construction Requirements.

907-225.03.1--Ground Preparation. Ground preparation, light or standard, consists of plowing, loosening, and pulverizing the soil to form suitable beds for erosion control items in reasonably close conformity with the established lines and grades without appreciable humps or depressions. When grassing an area that has been previously planted with temporary grassing, a standard

ground preparation will be required. The previously planted grasses shall be disked, tilled, plowed, etc. to assure that the existing temporary grasses are thoroughly mixed into the soil.

Any equipment used for ground preparation shall be approved units suitable to perform the work and subject to the requirements of Subsection 108.05.

The Contractor shall take full advantage of weather and soil conditions, and no attempt shall be made to prepare soil when it is wet or in a condition which will not allow the soil to be properly tilled.

Light ground preparation should be used on areas where seeding is required to improve the coverage of partially vegetated areas.

Standard ground preparation should be used on areas designated to be solid sodded and unvegetated areas designated to be seeded.

Aerating, moistening, or otherwise bringing the soil to a suitable condition for ground preparation shall be considered as incidental to the work and will not be measured for separate payment.

907-225.03.1.1--Light Ground Preparation. Light ground preparation consists of scratching the surface with a close-tooth harrow, disk-harrow, or similar equipment. The depth of scratching should be at least three-quarters inch but not deep enough to damage existing grasses of the type being planted.

907-225.03.1.2--Standard Ground Preparation. Standard ground preparation consists of plowing or disk-harrowing and thoroughly pulverizing the areas immediately before the application of erosion control (vegetative) items. Unless otherwise specified, the pulverized and prepared seedbed should be at least four inches deep and shall be reasonably free of large clods, earthballs, boulders, stumps, roots and other objectionable matter. Incorporation of fertilizer and ground preparation may be performed simultaneously.

907-225.03.2--Fertilizing. Fertilizing consists of furnishing, transporting, spreading, and incorporating fertilizers. The Contractor shall furnish all equipment necessary to properly handle, store, uniformly spread, and incorporate the specified application of fertilizer.

Unless otherwise specified in the contract, the Contractor shall incorporate bag fertilizer at a rate of 1000 pounds per acre of 13-13-13 commercial fertilizer. The equivalent rate of other type fertilizers will be allowed if the equivalent percentages of Nitrogen, Phosphorus and Potassium are obtained. The Contractor shall incorporate agricultural limestone at a rate of 5000 pounds per acre. Fertilization shall be applied uniformly on the areas to be planted or seeded and uniformly incorporated into the soil.

Fertilizers should be applied on individual areas of not more than three acres.

All fertilizer should be incorporated within 24 hours following spreading.

907-225.03.3--Seeding. Seeding consists of furnishing and planting seeds in a prepared seedbed, covering the seeds, and providing plant establishment on all areas seeded.

Prior to planting the seeds, ground preparation and fertilizing shall be satisfactorily performed.

The required type of seeds, minimum rates of application, and planting dates of seeds are shown in the vegetation schedule in the plans.

When a vegetation schedule is not shown in the plans, the following types of seed and application rates shall be used, unless otherwise approved by the Engineer.

Bermudagrass	20 pounds per acre
Bahiagrass	25 pounds per acre
Tall Fescue	15 pounds per acre
Crimson Clover	20 pounds per acre

It is the Contractor's responsibility to apply an ample amount of each type of seed to produce a satisfactory growth of grass and of the seed type required. At the completion of the project, a satisfactory growth of grass will be required. Reference Section 210 for satisfactory growth and coverage of dormant seed.

Seeding should not be done during windy weather or when the ground is frozen, extremely wet, or in a condition which will not allow the soil to be properly tilled.

907-225.03.3.1--Conventional Application. Legume seeds should be treated in accordance with Subsection 715.03.4 immediately before sowing. Seeds should be uniformly sown over the entire area with mechanical seeders. Seeds of different sizes may necessitate separate sowing. When legume seeds become dry, they should be re-inoculated.

All seeds should be covered lightly with soil by raking, rolling, or other approved methods, and the area compacted with a cultipacker.

Mulching should be performed as soon as practicable after seeding.

907-225.03.3.2--Hydroseeding Application. Seeds may be applied using the hydroseeding method except during the months of June, July, August, and September. During these months, the seeding shall be incorporated in accordance with the above Conventional Application method.

The seed(s) shall be combined into a distribution tank with all required ingredients on the project site. The application of the seed(s) and all ingredients shall be performed in one operation.

Mulching should be performed simultaneously with or as soon as practicable after seeding.

907-225.03.3.3--Plant Establishment. The Contractor should provide plant establishment on all areas seeded until release of maintenance. At the completion of the project, a satisfactory growth

of grass will be required. The Contractor should reference Subsection 210 for satisfactory growth and coverage of dormant seed.

Plant establishment should be provided for a minimum period of 45 calendar days after completion of seeding. In the event satisfactory growth and coverage has not been attained by the end of the 45-day period, plant establishment should be continued until a satisfactory growth and coverage is provided for at least one kind of plant as referenced in Section 210. The Contractor shall perform plant establishment on all areas of temporary seeding until the Engineer determines that the temporary seeding has served its purpose.

Plant establishment shall consist of preserving, protecting, watering, reseeding, mowing, and other work necessary to keep the seeded areas in satisfactory condition.

Areas requiring reseeding should be prepared and seeded and all other work performed as if the reseeding was the initial seeding. The types and application rates of fertilizer will be at the discretion of the Contractor.

907-225.03.3.4--Growth and Coverage. It shall be the Contractor's responsibility to provide satisfactory growth and coverage of grasses, legumes, or combination produced from the specified seeding.

Growth and coverage on seeded areas will be considered to be in reasonably close conformity with the intent of the contract when the type of vegetation specified, exclusive of that from seeds not expected to have germinated and shows growth at that time, has reached a point of maturity where stems or runners overlap adjacent similar growth in each direction over the entire area.

907-225.03.4--Mulching. Mulching consists of furnishing, transporting, and placing mulch on slopes, shoulders, medians, and other designated areas. Unless otherwise noted in the contract or directed by the Engineer, the Contractor has the option to place mulch by the conventional method or by the hydraulic method.

907-225.03.4.1--Vegetative Mulch.

907-225.03.4.1.1--Equipment. Mulching equipment should be capable of maintaining a constant air stream which will blow or eject controlled quantities of mulch in a uniform pattern.

Mulch stabilizers should consist of dull blades or disks without camber and approximately 20 inches in diameter. The disks should be notched, should be spaced at approximately 8-inch intervals, and should be equipped with scrapers. The stabilizer should weigh approximately 1000 to 1200 pounds, should have a working width of no more than eight feet, and should be equipped with a ballast compartment, so that weight can be increased.

907-225.03.4.1.2--Placement of Vegetative Mulch. Mulching should be placed uniformly on designated areas within 24 hours following seeding unless weather conditions are such that mulching cannot be performed. Placement should begin on the windward side of areas and from tops of slopes. In its final position, the mulch should be loose enough to allow air to circulate but compact enough to partially shade the ground and reduce erosion.

The baled material should be loosened and broken thoroughly before it is fed into the machine to avoid placement of unbroken clumps.

907-225.03.4.1.3--Anchoring Mulch. The mulch should be anchored by using a mulch stabilizer when not hydraulically applied. If a mulch stabilizer is used, the mulch should be punched into the soil for a minimum depth of one inch.

When mulch stabilizers are used, anchoring the mulch should be performed along the contour of the ground surface.

907-225.03.4.2--Hydromulch. Hydromulch shall be applied in accordance with the installation instructions and recommendations of the manufacturer. Hydromulch shall be uniformly applied at the manufacturer's recommended application rate. In no case shall the application rate be less than one (1) ton per acre.

907-225.03.4.3--Protection and Maintenance. The Contractor should maintain and protect mulched areas until the Release of Maintenance of the project. The Contractor should take every precaution to prevent unnecessary foot and vehicular traffic.

The Contractor should mow, remove or destroy any undesirable growth on all areas mulched as soon as any undesirable growth appears. This will prevent competition with the desired plants and to prevent reseeding of undesirable growth.

907-225.03.5--Hydro Equipment. The equipment for hydraulically applying seed and mulch shall have a built-in agitation system with an operating capacity sufficient to agitate, suspend, and homogeneously mix slurry of the specified amount of fiber, seed, and water. The slurry distribution lines shall be large enough to prevent stoppage. The discharge line shall be equipped with a set of hydraulic spray nozzles, which will provide even distribution of the slurry on the various areas to be seeded.

The mixture shall all be combined into the slurry tank for distribution of all ingredients in one operation as specified herein. The materials shall be combined in a manner recommended by the manufacturer. The slurry mixture shall be so regulated that the amounts and rates of application shall result in a uniform application of all materials at rates not less than the amounts specified. Using the color of the mulch as a guide, the equipment operator shall spray the prepared seedbed with a uniform visible coat. The slurry shall be applied in a sweeping motion, in an arched stream, so as to fall like rain, allowing the mulch to build upon each other until an even coat is achieved.

Delete Subsection 225.04 and 225.05 beginning on page 163 and substitute the following:

907-225.04—Blank.

907-225.05--Blank.

MISSISSIPPI DEPARTMENT OF TRANSPORTATION

SPECIAL PROVISION NO. 907-226 DB

CODE: (SP)

DATE: 05/13/2011

SUBJECT: Temporary Grassing

Section 907-226, Temporary Grassing, is hereby added to and made part of the 2004 Edition of the Mississippi Standard Specifications for Road and Bridge Construction as follows:

SECTION 907-226 -- TEMPORARY GRASSING

907-226.01--Description. This work consists of furnishing, transporting, placing, plant establishment and all work necessary to produce rapid-growing grasses, grains or legumes to provide an initial, temporary cover of grass. This work includes ground preparation, fertilizing, seeding and mulching necessary to establish a satisfactory growth of temporary grass. The Contractor may elect to place temporary grassing using the hydroseeding method as set out in Special Provision No. 907-227, as modified by this special provision.

The Engineer or the plans will designate areas to be temporarily grassed. Any other areas the Contractor desires to grass will be measured for payment only if agreed upon by the Engineer.

907-226.02--Materials.

907-226.02.1--Fertilizers. Fertilizers for purposes of these specifications shall be understood to include standard manufactured products consisting of a combination of ingredients.

All fertilizer shall comply with the State fertilizer laws and Subsection 715.02.

Agricultural limestone will not be requirement for temporary grassing.

907-226.02.2--Seeds. Seeds shall meet the requirements of Subsection 715.03, subject to the provisions of this subsection. The Contractor shall acquire seed from persons registered with the Mississippi Department of Agriculture and Commerce.

Except for the germination requirements, bags of seeds properly labeled or tagged according to law and indicating characteristics meeting or exceeding the requirements of Subsection 715.03 will be acceptable for planting.

The Contractor should provide adequate dry storage facilities for seeds, and shall furnish access to the storage for sampling stored seed.

907-226.02.3--Mulching. The vegetative materials for mulch shall meet the requirements of Subsection 715.05.

When used, bituminous material for mulch shall be Emulsified Asphalt, Grade SS-1, meeting the requirement of Subsection 702.07.

907-226.03--Construction Requirements. The rates of application shall not exceed the rates shown on the temporary vegetation schedule, unless otherwise approved by the Engineer. Any unauthorized overage due to increased application rates will not be measured for payment.

907-226.03.1--Ground Preparation. Any equipment used for ground preparation shall be approved units suitable to perform the work and subject to the requirements of Subsection 108.05.

Light ground preparation should be used on areas where seeding is required.

Light ground preparation consists of scratching the surface with a close-tooth harrow, disk-harrow, or similar equipment. The depth of scratching should be at least three-quarters inch but not deep enough to damage existing grasses of the type being planted.

Aerating, moistening, or otherwise bringing the soil to a suitable condition for ground preparation shall be considered as incidental to the work and will not be measured for separate payment.

907-226.03.2--Fertilizing. The Contractor shall furnish all equipment necessary to properly handle, store, uniformly spread, and incorporate the specified application of fertilizer.

The Contractor shall incorporate fertilizer at a rate of 500 pounds per acre of 13-13-13 commercial fertilizer. The equivalent rate of other type fertilizers will be allowed if the equivalent percentages of Nitrogen, Phosphorus and Potassium are obtained. Fertilization shall be applied uniformly on the areas to be seeded and uniformly incorporated into the soil.

Fertilizer should be applied on individual areas of not more than three acres.

All fertilizer should be incorporated within 24 hours following spreading.

907-226.03.3--Seeding.

907-226.03.3.1--General. Prior to planting the seeds, ground preparation and fertilizing should have been satisfactorily performed.

The required type of seeds, recommended rates of application and recommended planting dates of seeds are shown in the vegetation schedule in the plans.

When a temporary vegetation schedule is not shown in the plans, the following types of seed and application rates should be used.

Spring & Summer

Browntop Millet ----- 20 pounds per acre - April 1 to August 31

Fall & Winter

Rye Grass ----- 25 pounds per acre - September 1 to March 31

Oats ----- 90 pounds per acre - September 1 to December 15

It is the Contractor's responsibility to apply an ample amount of each type of seed to produce a satisfactory growth of grass and of the seed type required.

Legume seeds should be treated in accordance with Subsection 715.03.4 immediately before sowing. Seeds should be uniformly sown over the entire area with mechanical seeders. Seeds of different sizes may necessitate separate sowing. When legume seeds become dry, they should be reinoculated.

Seeding should not be done during windy weather or when the ground is frozen, extremely wet, or in an untillable condition.

All seeds should be covered lightly with soil by raking, rolling, or other approved methods, and the area compacted with a cultipacker.

907-226.03.3.2--Plant Establishment. Plant establishment shall consist of preserving, protecting, watering, reseeding, and other work necessary to keep the seeded areas in satisfactory condition.

Areas requiring reseeding should be prepared and seeded and all other work performed as if the reseeding was the initial seeding. The types and application rates of fertilizer will be at the discretion of the Contractor. No additional measurement and payment will be made for reseeding when payment was made for the initial seeding.

907-226.03.3.3--Growth and Coverage. It shall be the Contractor's responsibility to provide satisfactory growth and coverage of grasses, legumes, or combination produced from the specified seeding.

Growth and coverage on seeded areas will be considered to be in reasonably close conformity with the intent of the contract when the type of vegetation specified, exclusive of that from seeds not expected to have germinated and shows growth at that time, has reached a point of maturity where stems or runners overlap adjacent similar growth in each direction over the entire area.

907-226.03.4--Mulching.

907-226.03.4.1--Equipment. Mulching equipment should be capable of maintaining a constant air stream which will blow or eject controlled quantities of mulch in a uniform pattern. If asphalt is used, a jet or spray nozzle for applying uniform, controlled amounts of asphalt to the vegetative material as it is ejected should be located at or near the discharge spout.

Mulch stabilizers should consist of dull blades or disks without camber and approximately 20 inches in diameter. The disks should be notched, should be spaced at approximately 8-inch intervals, and should be equipped with scrapers. The stabilizer should weigh approximately 1000 to 1200 pounds, should have a working width of no more than eight feet, and should be equipped with a ballast compartment, so that weight can be increased.

907-226.03.4.2--Placement of Vegetative Mulch. If required, mulching should be placed uniformly on designated areas within 24 hours following seeding unless weather conditions are such that mulching cannot be performed. Placement should begin on the windward side of areas and from tops of slopes. In its final position, the mulch should be loose enough to allow air to circulate but compact enough to partially shade the ground and reduce erosion.

The baled material should be loosened and broken thoroughly before it is fed into the machine to avoid placement of unbroken clumps.

907-226.03.4.3--Rates of Application and Anchoring Mulch. The recommended rate of application of vegetative mulch shall be as shown in the vegetation schedule in the plans. The mulch should be anchored by either the use of a mulch stabilizer or by tacking with bituminous material. If a mulch stabilizer is used, the mulch should be punched into the soil for a minimum depth of one inch. If bituminous material is used, the rate of application should be 150 gallons per acre.

Where steep slopes or other conditions are such that anchoring cannot be performed satisfactory with a mulch stabilizer, the Contractor may elect to use bituminous material applied at the time or immediately following the mulch placement.

When mulch stabilizers are used, anchoring the mulch should be performed along the contour of the ground surface.

907-226.03.4.4--Protection and Maintenance. The Contractor should take every precaution to prevent unnecessary foot and vehicular traffic.

MISSISSIPPI DEPARTMENT OF TRANSPORTATION

SPECIAL PROVISION NO. 907-227 DB

CODE: (SP)

DATE: 01/25/2012

SUBJECT: Hydroseeding

Section 907-227, Hydroseeding, is hereby added to and made part of the 2004 Edition of the Mississippi Standard Specifications for Road and Bridge Construction as follows:

SECTION 907-227--HYDROSEEDING

907-227.01--Description. This work consists of furnishing, transporting, placing, plant establishment and all work necessary to produce a satisfactory and acceptable growth of grass. The seeds, fertilizers, tackifier, and mulch shall be incorporated using the hydroseeding process. These items shall be combined into a mixture and force-applied to the areas to be grassed.

907-227.02--Materials. The Contractor shall, prior to application, furnish the Engineer with invoices of all materials used in the grassing operation.

907-227.02.1--Fertilizers. Fertilizers for purposes of these specifications shall be understood to include standard manufactured products consisting of single or combination ingredients.

All fertilizers shall comply with the State fertilizer laws and Subsection 715.02.

907-227.02.2--Seeds. Seeds shall meet the requirements of Subsection 715.03, subject to the provisions of this subsection. The Contractor shall acquire seed from persons registered with the Mississippi Department of Agriculture and Commerce.

Except for the germination requirements, bags of seeds properly labeled or tagged according to law and indicating characteristics meeting or exceeding the requirements of Subsection 715.03 will be acceptable for planting.

The Contractor should provide adequate dry storage facilities for seeds, and shall furnish access to the storage for sampling stored seed.

907-227.02.3--Mulching. The rate of application of fiber mulch shall be as recommended by the manufacture of the fibers mulch.

907-227.02.3.1--Wood Fiber Mulch. Wood fiber mulch shall be made from wood chip particles manufactured particularly for discharging uniformly on the ground surface when dispersed by a hydraulic water sprayer. It shall remain in uniform suspension in water under agitation and blend with grass seed and fertilizer to form a homogeneous slurry. The fibers shall intertwine physically to form a strong moisture-holding mat on the ground surface and allow rainfall to percolate the underlying soil. The fiber material shall be heat processed so as to

contain no germination or growth-inhibiting factors. The mulch shall be dyed an appropriate color to facilitate the application of material using non-toxic dye.

907-227.02.3.2--Cellulose Fiber Mulch. Cellulose fiber mulch consist of recycled paper stock products which are shredded into small pieces particular for application by hydraulic seeding equipment. It shall mix readily and uniformly under agitation with water and blend with grass seed and fertilizer to form a homogeneous slurry. When applied to the ground surface, the material shall form a strong moisture-holding mat, allow rainfall to percolate the underlying soil, and remain in place until the grass root system is established. The material shall contain no growth inhibiting characteristic or organisms. The mulch shall be dyed an appropriate color to facilitate the application of material using non-toxic dye.

907-227.02.3.3--Wood/Cellulose Fiber Mulch. Wood/cellulose fiber mix hydroseeding mulch shall consist of a combination of the above wood and cellulose fibers at a ratio recommended by the manufacturer of the products.

907-227.02.3.4--Straw Mulch. Straw mulch shall consist of a natural straw fiber. This material shall be a minimum 90% straw and essentially free from plastic materials or other non-bio degradable substances. The material shall be dispersed into a uniform mulch slurry when mixed with water.

907-227.02.3.5--Tackifier. The tackifier will serve the purpose of an adhesive to form a bond between the soil, fiber, and seed particles. It will also allow the soil to retain moisture.

The tackifier shall be of the organic or synthetic variety.

907-227.03--Construction Requirements.

907-227.03.1--Ground Preparation. Light ground preparation consists of plowing, loosening, and pulverizing the soil to form suitable beds for seeding items in reasonably close conformity with the established lines and grades without appreciable humps or depressions. Unless otherwise specified, the pulverized and prepared seedbed should be at least four inches deep and shall be reasonably free of large clods, earth balls, boulders, stumps, roots and other objectionable matter. The Engineer may eliminate or alter the requirements for ground preparation due to site conditions.

907-227.03.2--Fertilizing. The Contractor shall furnish all equipment necessary to properly handle, store, uniformly spread, and incorporate the specified application of fertilizer.

The Contractor shall incorporate bag fertilizer at a rate of 1000 pounds per acre of 13-13-13 commercial fertilizer. The equivalent rate of other type fertilizers will be allowed if the equivalent percentages of Nitrogen, Phosphorus and Potassium are obtained. Any changes in the type or rate of application of the fertilizers shall be approved by the Engineer prior to being incorporated.

Agricultural limestone will be incorporated into the area and paid for in accordance with Section 213 of the Standard Specifications.

907-227.03.3--Seeding.

907-227.03.3.1--General. The Contractor shall use the vegetation schedule in the plan for the correct types of seed and application rates, unless otherwise noted or approved by the Engineer.

When a vegetation schedule for permanent grass is not shown in the plans, the following types of seed and application rates shall be used, unless otherwise approved by the Engineer.

Bermudagrass -----	20 pounds per acre
Bahiagrass -----	25 pounds per acre
Tall Fescue -----	15 pounds per acre
Crimson Clover -----	20 pounds per acre

At the completion of the project, a satisfactory growth of grass will be required. The Contractor should reference Subsection 210 for satisfactory growth and coverage of dormant seed.

907-227.03.3.2--Plant Establishment. The Contractor should provide plant establishment on all areas seeded until release of maintenance. Plant establishment shall consist of preserving, protecting, watering, reseeding, mowing, and other work necessary to keep the seeded areas in satisfactory condition.

Plant establishment should be provided for a minimum period of 45 calendar days after completion of seeding. In the event satisfactory growth and coverage has not been attained by the end of the 45-day period, plant establishment should be continued until a satisfactory growth and coverage is provided for at least one kind of plant. The Contractor should reference Section 210 of the Standard Specifications for more information.

907-227.03.3.3--Growth and Coverage. It shall be the Contractor's responsibility to provide satisfactory growth and coverage of grasses, legumes, or combination produced from the specified seeding.

Growth and coverage on seeded areas will be considered to be in reasonably close conformity with the intent of the contract when the type of vegetation specified, exclusive of that from seeds not expected to have germinated and shows growth at that time, has reached a point of maturity where stems or runners overlap adjacent similar growth in each direction over the entire area.

Final acceptance of the project will not be made until a satisfactory growth of grass has been acknowledged by the Engineer.

907-227.03.4--Mulching. At the Contractor's option, mulch may be wood fiber, cellulose fiber, a mixture of wood and cellulose fibers, or straw fiber. The mulch shall be applied at the rate recommended by the manufacturer in a mixture of water, seed and fertilizer. Any changes in the rate of application of the mulch shall be approved by the Engineer prior to its use.

907-227.03.5--Equipment. Hydraulic equipment shall be used for the application of fertilizers, seeds and slurry of the prepared mulch. This equipment shall have a built-in agitation system

with an operating capacity sufficient to agitate, suspend, and homogeneously mix slurry of the specified amount of fiber, fertilizer, seed and water. The slurry distribution lines shall be large enough to prevent stoppage. The discharge line shall be equipped with a set of hydraulic spray nozzles, which will provide even distribution of the slurry on the various areas to be seeded.

The seed, fertilizer, mulch and water shall all be combined into the slurry tank for distribution of all ingredients in one operation as specified herein. The materials shall be combined in a manner recommended by the manufacturer. The slurry mixture shall be so regulated that the amounts and rates of application shall result in a uniform application of all materials at rates not less than the amounts specified. Using the color of the mulch as a guide, the equipment operator shall spray the prepared seedbed with a uniform visible coat. The slurry shall be applied in a sweeping motion, in an arched stream, so as to fall like rain, allowing the mulch to build upon each other until an even coat is achieved.

907-227.03.6--Protection and Maintenance. The Contractor should maintain and protect seeded areas until release of maintenance of the project. The Contractor should take every precaution to prevent unnecessary foot and vehicular traffic.

The Contractor should mow or otherwise remove or destroy any undesirable growth on all areas mulched to prevent competition with the desired plants and to prevent reseeding of undesirable growth.

MISSISSIPPI DEPARTMENT OF TRANSPORTATION

SPECIAL PROVISION NO. 907-234 DB

CODE: (SP)

DATE: 09/23/2010

SUBJECT: Siltation Barriers

Section 234, Silt Fence, of the 2004 Edition of the Mississippi Standard Specifications for Road and Bridge Construction is hereby amended as follows.

907-234.01--Description. Delete the first paragraph of Subsection 234.01 on page 177 and substitute the following:

This work consists of furnishing, constructing and maintaining a water permeable filter type fence, inlet siltation guard or turbidity barrier for the purpose of removing suspended soil particles from the water passing through it in accordance with the requirements shown on the plans, directed by the Engineer and these specifications. Fence, inlet siltation guards and turbidity barriers measured and paid as temporary shall be removed when no longer needed or permanent devices are installed.

Delete the first sentence of the second paragraph of Subsection 234.01 on page 177 and substitute the following:

It is understood that measurement and payment for silt fence, inlet siltation guards, and turbidity barriers will be made when a pay item is included in the proposal.

907-234.02--Materials. After the first paragraph of Subsection 234.02 on page 177, add the following:

Inlet siltation guards shall be listed on the Department's "Approved Sources of Materials".

Turbidity barriers shall be one of the following, or an approved equal.

1. SiltMax Turbidity Barrier by Dawg, Inc., 1-800-935-3294, www.dawginc.com
2. Turbidity Barrier by IWT Cargo-Guard, Inc., 1-609-971-8810, www.iwtcargoguard.com
3. Turbidity Curtain by Abasco, LLC, 1-281-214-0300, www.abasco.net

Chain link fence and hardware for super silt fence shall meet the requirements of Section 607, as applicable. Geotextile for super silt fence shall meet the requirements of Subsection 714.13 for a Type II Woven fabric.

907-234.03--Construction Requirements. After the last paragraph of Subsection 234.03.1 on page 178, add the following:

Super Silt Fence. Super silt fence shall be constructed in accordance with the plans and these specifications.

All posts shall be installed/driven so that at least 34 inches of the post will protrude above the ground. The chain link wire and geotextile shall be stretched taut and securely fastened to the posts as shown on the plans. The bottom edge of the fence and geotextile shall be buried at least eight inches below ground surface to prevent undermining. When splicing of the geotextile is necessary, the fabric shall be overlapped approximately 18 inches.

907-234.03.1.1--Placement of Inlet Siltation Guards and Turbidity Barriers. The inlet siltation guards and turbidity barriers shall be constructed at the locations shown on the erosion control plans. Inlet siltation guards and turbidity barriers shall be installed in accordance with the erosion control drawings in the plans. A copy of the manufacturer's instructions for placement of inlet siltation guards and turbidity barriers shall be provided to the Engineer prior to construction.

907-234.03.2--Maintenance and Removal. At the end of the first paragraph of Subsection 234.03.2 on page 178, add the following:

The Contractor shall maintain the inlet siltation guards. The geotextile shall be removed and replaced when deteriorated to such extent that it reduces the effectiveness of the guard. Replacement geotextile shall be the same type and manufacture as the original. Excessive accumulations against the guard shall be removed and disposed of at a location approved by the Engineer.

The Contractor shall maintain the turbidity barriers. Excessive accumulations against the turbidity barrier shall be removed and disposed of at a location approved by the Engineer.

Delete the second paragraph of Subsection 234.03.2 on page 178 and substitute the following:

Unless otherwise directed, all temporary silt fences, inlet guards and turbidity barriers shall be removed. Upon removal, the Contractor shall remove and dispose of any excess silt accumulations, shape the area to the line, grade, and cross section shown on the plans and vegetate all bare areas in accordance with the contract requirements. The temporary fence, inlet guard materials and turbidity barriers will remain the property of the Contractor and may be used at other locations provided the materials are acceptable to the Engineer.

After Subsection 234.03.2 on page 178, insert the following:

907-234.03.3--Resetting Inlet Siltation Guards and Turbidity Barriers. When inlet siltation guards and turbidity barriers are no longer needed at one location, they may be removed and reset at other needed locations. The Engineer may allow the resetting of siltation guards and turbidity barriers upon an inspection and determination that the siltation guards (frame and geotextile) and turbidity barriers are adequate for their intended purpose. When they have to be stored until needed at another location, payment for resetting will not be made until they are reset at their needed location.

Delete Subsection 234.04 and 234.05 beginning on page 179 and substitute the following:

907-234.04—Blank.

907-234.05—Blank.

MISSISSIPPI DEPARTMENT OF TRANSPORTATION

SPECIAL PROVISION NO. 907-237 DB

CODE: (SP)

DATE: 03/13/2012

SUBJECT: Wattles

Section 907-237, Wattles, is hereby added to and made a part of the 2004 Edition of the Mississippi Standard Specifications for Road and Bridge Construction as follows.

SECTION 907-237 - WATTLES

907-237.01--Description. This work consists of furnishing, constructing and maintaining wattles for the retention of soil around inlets, swale areas, small ditches, sediment basins and other areas as necessary. Also, the work includes removing and disposing of the wattles and silt accumulations.

Measurement and payment for wattles will be made only when a pay item is included in the bid schedule of the proposal. The quantity is estimated for bidding purposes only and will be dependent upon actual conditions which occur during construction of the project.

907-237.02--Materials. Wattles used around inlets shall have a diameter of twelve inches (12") and a length adequate to meet field conditions. Wattles used at other locations shall have a diameter of twenty inches (20") and a length adequate to meet field conditions. The minimum diameter for the above wattle sizes shall be one inch (1") less than the specified diameter.

The stakes used in securing the wattles in place shall be placed approximately three feet (3') apart throughout the length of the wattle. Stakes shall be wooden and of adequate size to stabilize the wattles to the satisfaction of the Engineer.

In addition to the requirements of this specifications, wattles shall be listed on the Department's "Approved Sources of Materials".

907-237.03--Construction Requirements.

907-237.03.1--General. The wattles shall be constructed at the locations and according to the requirements shown on the erosion control plan.

907-237.03.2--Maintenance and Removal. The Contractor shall maintain the wattles and remove and dispose of silt accumulations.

When the wattles are no longer needed, they shall be removed and the Contractor shall dispose of silt accumulations and treat the disturbed areas in accordance with the contract requirements.

MISSISSIPPI DEPARTMENT OF TRANSPORTATION

SPECIAL PROVISION NO. 907-245 DB

CODE: (SP)

DATE: 03/23/2010

SUBJECT: Triangular Silt Dike

Section 907-245, Triangular Silt Dike, is hereby added to and made a part of the 2004 Edition of the Mississippi Standard Specifications for Road and Bridge Construction as follows.

SECTION 907-245 -- TRIANGULAR SILT DIKE

907-245.01--Description. This work consists of furnishing, installing, maintaining and removing temporary triangular silt dikes. The dike consists of a triangular-shaped inner material made of foam rubber or urethane foam. The outer cover is a woven geotextile fabric placed around the inner material with aprons that extend from both sides of the triangle. The dike aprons are entrenched at the upstream side and anchored to the ground at downstream end using staples. This device can be used on surfaces that do not allow for trenching by securing the aprons with sand or gravel bags. The device can be easily removed for maintenance and is considered to be reusable.

907-245.02--Materials. Triangular silt dikes shall be triangular in shape, having a height of at least ten inches (10") in the center. The triangular-shaped inner material shall be foam rubber or urethane foam. The outer cover shall be a woven geotextile fabric placed around the inner triangular plane and allowed to extend beyond both sides of the triangle for two feet to form an apron.

907-245.03--Construction Requirements. The flexibility of the materials in triangular silt dikes allows them to conform to various channel configurations.

The dikes shall be attached to the ground with wire staples. The staples shall be No. 11 gauge wire and be at least six inches long. As a minimum, the staples shall be placed as recommended by the manufacture.

The geotextile filter material shall be attached to the triangular frame by using wire ties or staples. The ties shall be placed evenly 12-inch centers.

Prior to placement of the triangular silt dikes, the Contractor shall make sure the surface on which the dike is to be placed is flat. The triangular silt dikes shall be placed in ditch, keeping excess fabric extended up and downstream of the dam. Excess material shall be trenched into the ground on the upstream end and stapled on the downstream end. A minimum 6-inch overlap between end sections shall be required should the width require multiple triangular silt dikes to be installed. The overlapped end sections shall be connected with wire wraps or staples every 12 inches on center.

The Contractor shall be required to remove and dispose of all sediment that is accumulated adjacent to the dike.

MISSISSIPPI DEPARTMENT OF TRANSPORTATION

SPECIAL PROVISION NO. 907-246 DB

CODE: (SP)

DATE: 11/08/2010

SUBJECT: Sandbags and Rockbags

Section 907-246, Sandbags and Rockbags, is hereby added to and made a part of the 2004 Edition of the Mississippi Standard Specifications for Road and Bridge Construction as follows.

SECTION 907-246 -- SANDBAGS AND ROCKBAGS

907-246.01--Description. This item of work shall consist of the furnishing, installing, and maintaining sandbags and rockbags for the purpose of temporary erosion control by intercepting and slowing the flow of sediment-laden runoff water, or for use as a temporary dam.

907-246.02--Materials. The filler material for sandbags shall consist of a fine aggregate meeting the requirements of Subsection 703.02. The filler material for rockbags shall consist of a size 57 aggregate meeting the requirements of Subsection 703.03.

The bag material shall be woven polypropylene, polyethylene or polyamide fabric with a minimum unit weight of four (4) ounces per square yard. The bags shall be a minimum of 21 inches in length, 12 inches in width, and four (4) in thickness when filled.

907-246.03--Construction Requirements. Sandbags and rockbags shall be used to construct a berm/dam which will intercept sediment-laden storm water runoff from disturbed areas, create a retention pond, detain sediment, and release water in sheet flow. Sand or rock shall be placed in the bag so that at least the top six (6) inches of the bag is unfilled to allow for proper tying of the open end. Any subsequent rows of bags shall be offset one-half the length of the preceding row to provide a layered brick-type arrangement.

The sandbag and rockbag berm/dam installation shall be maintained in good condition by the Contractor. All necessary work and materials to maintain the integrity of the installation shall be provided until earthwork construction is complete and permanent erosion-control features are in place. The maintenance of the bags will not be paid for separately and will be included in the cost for sandbags or rockbags.

MISSISSIPPI DEPARTMENT OF TRANSPORTATION

SPECIAL PROVISION NO. 907-247 DB

CODE: (SP)

DATE: 01/11/2010

SUBJECT: Temporary Stream Diversion

Section 907-247, Temporary Stream Diversion, is hereby added to and made a part of the 2004 Edition of the Mississippi Standard Specifications for Road and Bridge Construction as follows.

SECTION 907-247 -- TEMPORARY STREAM DIVERSION

907-247-.01--Description. Temporary stream diversion shall consist of excavating, stockpiling excavated material, and constructing a stream diversion at a new/existing drainage structure. It shall also include preparation of the diversion stream's bottom and slopes in accordance with the erosion control drawings.

907-247.02--Materials. Geotextiles of the type specified shall meet the requirements of Subsection 714.13. Riprap of the size specified shall meet the requirements of Section 705.

907-247.03--Construction Requirements. Temporary stream diversion(s) will be constructed in accordance with the erosion control drawings.

During the excavation of the stream diversion, all excavated material shall be stockpiled and used to backfill the stream diversion when no longer needed. The stockpiled material shall be treated so the sediment runoff from the stockpile shall not contaminate surrounding areas or enter the nearby streams. If the Contractor elects not to stockpile and maintain suitable excavated material, other suitable material will be used to backfill the stream diversion at no additional costs to the State. Any excavated material that the Engineer deems to be unsatisfactory, will be removed from the project and replaced with suitable material when the stream diversion is backfilled.

MISSISSIPPI DEPARTMENT OF TRANSPORTATION

SPECIAL PROVISION NO. 907-249 DB

CODE: (SP)

DATE: 03/01/2011

SUBJECT: Riprap for Erosion Control

Section 907-249, Riprap for Erosion Control, is hereby added to and made a part of the 2004 Edition of the Mississippi Standard Specifications for Road and Bridge Construction as follows.

SECTION 907-249 -- RIPRAP FOR EROSION CONTROL

907-249.01--Description. Riprap for erosion control consists of furnishing and installing riprap for the purpose of temporary erosion control by intercepting and slowing the flow of sediment-laden runoff water, or for use as a temporary dam. It also includes the maintenance and removal of riprap when no longer needed.

Remove and reset riprap consists of the removal and relocation of riprap to other locations shown on the plans, directed by the Engineer, or indicated on the Contractor's Erosion Control Plan.

Riprap shall be installed in accordance with the specifications in reasonably close conformity with the locations and dimensions shown on the plans or established.

907-249.02--Materials. Stones for riprap shall be Size 100 meeting the requirements of Subsection 705.04.

907-249.03--Construction Requirements. Riprap shall be used to construct a berm/dam which will intercept sediment-laden storm water runoff from disturbed areas, create a retention pond, detain sediment, and release water in sheet flow.

The riprap installation shall be maintained in good condition by the Contractor. All necessary work and materials to maintain the integrity of the installation shall be provided until earthwork construction is complete and permanent erosion-control features are in place. The maintenance of the riprap will not be paid for separately and will be included in the cost for riprap for erosion control.

When required, existing riprap may need to be removed and reset at other locations. These locations may be for additional temporary erosion control or may be placed in permanent locations designated by the Engineer.

MISSISSIPPI DEPARTMENT OF TRANSPORTATION

SPECIAL PROVISION NO. 907-304 DB

CODE: (SP)

DATE: 09/13/2011

SUBJECT: Granular Courses

Section 907-304, Granular Courses, of the 2004 Edition of the Mississippi Standard Specifications for Road and Bridge Construction is hereby amended as follows:

907-304.02--Materials. After the first paragraph of Subsection 304.02.1 on page 183, add the following:

When the contract includes pay item 907-304-E, Granular Material, LVM, RAP, it shall be milled recycled asphalt pavement and shall be visually inspected by the Engineer to insure it is free from chunks and deleterious materials.

Crushed concrete meeting the requirements of Subsection 907-703.04.4 may be used in lieu of other crushed courses specified in the contract.

907-304.03--Construction Requirements.

907-304.03.5--Shaping, Compacting and Finishing. Delete the sixth paragraph of Subsection 304.03.5 on page 185.

Delete the first table in Subsection 304.03.5 on page 186 and substitute the following:

Granular Material Class	Lot Average	Individual Test
7,8,9 or 10	97.0	93.0
5 or 6	99.0	95.0
3 or 4	100.0	96.0
1 or 2	102.0	98.0
Crushed Courses*	99.0	95.0

* When placed on filter fabric on untreated subgrade, the individual tests and the average of the five (5) tests shall equal or exceed the following values:

Lot Average	Individual Test
96.0	92.0

Before the last paragraph of Subsection 304.03.5 on page 186, add the following:

Unless otherwise specified, density for granular material, RAP, shall be achieved by two passes of an approved roller and density tests will not be required.

Delete Subsections 304.04 and 304.05 on pages 186 and 187 and substitute the following:

907-304.04--Blank.

907-304.05--Blank.

MISSISSIPPI DEPARTMENT OF TRANSPORTATION

SPECIAL PROVISION NO. 907-307 DB

CODE: (SP)

DATE: 09/13/2011

SUBJECT: Lime Treated Courses

Section 307, Lime Treated Courses, of the 2004 Edition of the Mississippi Standard Specifications for Road and Bridge Construction is hereby amended as follows:

907-307.02--Materials.

907-307.02.4--Curing Seals. After "EA-1," in the first sentence of Subsection 307.02.4 on page 195, add "AE-P,".

907-307.02.5--Soil-Lime Design. Delete the first paragraph of Subsection 307.02.5 on page 195 and substitute the following:

The design of soil-lime courses shall be performed by the Contractor's Laboratory and reviewed by MDOT's Central Laboratory. At least 45 days prior to the proposed use of a lime course, the Contractor shall make available materials proposed for use in the mixture for sampling and testing by MDOT as the Engineer may consider necessary for the verification of a mix design.

Changes in source of lime shall not be made without approval. Approval will be based on verification of a mix design.

907-307.03--Construction Requirements.

907-307.03.2--Equipment. Delete the second paragraph of Subsection 307.03.2 on pages 196 & 197.

Delete Subsections 307.04 and 307.05 on pages 201 and 202 and substitute the following:

907-307.04--Blank.

907-307.05--Blank.

MISSISSIPPI DEPARTMENT OF TRANSPORTATION

SPECIAL PROVISION NO. 907-308 DB

CODE: (SP)

DATE: 09/13/2011

SUBJECT: Portland Cement Treated Courses

Section 308, Portland Cement Treated Courses, of the 2004 Edition of the Mississippi Standard Specifications for Road and Bridge Construction is hereby amended as follows:

907-308.02.4--Curing Seals. After “EA-1,” in the first sentence of Subsection 308.02.4 on page 204, add “AE-P.”

907-308.02.5—Soil-Cement Design. Delete in toto and substitute the following:

The design of soil-cement courses shall be performed by the Contractor’s Laboratory and reviewed by MDOT’s Central Laboratory. At least 21 days prior to the proposed use of a cement course, the Contractor shall make available materials proposed for use in the mixture for sampling and testing by MDOT as the Engineer may consider necessary for the verification of a mix design.

907-308.03.2--Equipment.

907-308.03.2.1--General. Delete the second paragraph of Subsection 308.03.2.1 on page 206.

Delete Subsection 308.03.7.2 on page 209 and substitute the following:

907-308.03.7.2--Weather Limitations. No cement or cement treated material shall be applied or placed when the temperature is below 45°F nor when the Engineer determines, based on the latest information available from the National Weather Service, that the forecast temperature will fall below 45°F within the next five (5) days in the area in which the Project is located. No cement or cement treated material shall be placed on a frozen foundation or mixed with frozen material.

907-308.03.9.2--Density. Delete the second paragraph of Subsection 308.03.9.2 on page 213 and substitute the following:

Soil Cement Treatment of Subgrade. The lot will be divided into five (5) approximately equal sublots with one (1) density test taken at random in each subplot. The average of the five (5) density tests shall equal or exceed 96.0% with no single density test below 94.0%. Sublots with a density below 94.0% shall be corrected and retested for acceptance.

Each lot of work found not to meet the density requirement of 96.0% of maximum density shall be evaluated by the Lead Design Engineer for suitability.

Soil Cement Treatment of Base. The lot will be divided into five (5) approximately equal

sublots with one (1) density test taken at random in each subplot. The average of the five (5) density tests shall equal or exceed 97.0% with no single density test below 95.0%. Sublots with a density below 95.0% shall be corrected and retested for acceptance.

Each lot of work found not to meet the density requirement of 97.0% of maximum density shall be evaluated by the Lead Design Engineer for suitability.

Soil Cement Treatment of Irregular Areas. Density of irregular areas shall be rolled to highest stability. Irregular areas shall be defined as preleveling, wedging [less than 50% of width greater than minimum lift thickness], ramp pads, irregular shoulder areas, median crossovers, turnouts, and other areas where an established rolling pattern cannot be obtained.

907-308.03.10--Protection and Curing. Delete the second paragraph of Subsection 308.03.10 on page 213 and substitute the following:

When the treated course is the subgrade, a subsequent course shall not be placed on the sealed course for at least seven (7) calendar days. During this seven (7)-day period, the treated course shall not be subjected to any type of traffic and equipment.

When the treated course is the base, the Contractor shall use the mix design (seven (7)-day or 14-day) as specified on the Mix Design. Depending on the specified mix design, a subsequent course shall not be placed on the sealed course for at least seven (7) or 14 calendar days. During this period, the treated course shall not be subjected to any type of traffic and equipment.

Delete Subsections 308.04 and 308.05 on pages 214 and 215 and substitute the following:

907-308.04--Blank.

907-308.05--Blank.

MISSISSIPPI DEPARTMENT OF TRANSPORTATION

SPECIAL PROVISION NO. 907-311 DB

CODE: (SP)

DATE: 09/13/2011

SUBJECT: Lime-Fly Ash Treated Courses

Section 311, Lime-Fly Ash Treated Courses, of the 2004 Edition of the Mississippi Standard Specifications for Road and Bridge Construction is hereby amended as follows:

907-311.02--Materials.

907-311.02.1—Soil-Lime-Fly Ash Design. Delete the first paragraph of Subsection 311.02.1 on page 223 and substitute the following:

The design of soil-lime-fly ash courses shall be performed by the Contractor's Laboratory and reviewed by MDOT's Central Laboratory. At least 45 days prior to the proposed use of a lime-fly ash course, the Contractor shall make available materials proposed for use in the mixture for sampling and testing by MDOT as the Engineer may consider necessary for the verification of a mix design.

907-311.02.2--Curing Seals. After "EA-1," in the first sentence of 311.02.2 on page 223, add "AE-P,".

907-311.03--Construction Requirements. Delete Subsection 311.03.2 on pages 223 & 224, and substitute the following:

907-311.03.2--Equipment. Equipment necessary for the proper prosecution of the Work shall meet the applicable requirements of Subsection 907-308.03.2.

Delete Subsection 311.03.7 on page 225, and substitute the following:

907-311.03.7--Shaping, Compacting, and Finishing.

907-311.03.7.1--General. The mixed material shall be shaped as required immediately after mixing, or delivery to the roadbed in the case of central plant mixed material. Initial compaction shall begin immediately, and machining and compacting shall continue until the entire depth and width of the course is compacted to the required density within two (2) hours of the time of beginning mixing. Compaction shall be by equipment and methods which do not result in lamination.

Areas inaccessible to rollers shall be compacted to the required density by other approved methods.

The addition of thin layers of treated material in order to conform to cross sectional or grade requirements will not be permitted.

Compaction by vibration shall not be performed after the lime fly-ash has taken its initial set. Vibratory compaction of a section shall be completed within one (1) hour.

During compaction, a spike-tooth harrow or other suitable equipment shall be used as required to prevent lamination.

The surface shall then be reshaped to the required lines, grades, and cross section, and if necessary shall be lightly scarified to remove imprints left by the compacting or shaping equipment. The surface shall then be sprinkled as necessary and thoroughly rolled with a pneumatic roller, and if the mixture contains plus No. 4 aggregate, at least one complete coverage of the section shall be made with a steel-wheel tandem roller.

Surface compaction and finishing for the entire section shall be performed in a manner that will produce a smooth, closely knit surface, free from laminations, construction cracks, ridges, or loose material, and conforming to the crown, grade, and lines stipulated within four (4) hours after the beginning of mixing.

Upon completion of compaction, testing will be performed in accordance with Subsections 700.03 and 700.04.

907-311.03.7.2--Density. Determination of acceptance of compaction of treated courses for required density will be performed on a lot to lot basis. Each lot will be each 2,500 linear feet per layer placed. At the discretion of the Engineer, a residual portion of a lot completed during a day's operation may be considered a separate lot or may be included in the previous or subsequent lot, except that any day's operation of less than one full lot will be considered a lot.

The lot will be divided into five (5) approximately equal sublots with one (1) density test taken at random in each subplot. The average of the five (5) density tests shall equal or exceed 98.0% with no single density test below 94.0%. Sublots with a density below 94.0% shall be corrected and retested for acceptance.

For treated materials other than for design soils and bases, the required density will be set out elsewhere in the Contract.

907-311.03.7.3--Width, Thickness, and Surface Requirements. For the purpose of determining reasonable conformity with the designated width of a treated course, it shall be understood that the width of a treated course shall not vary from the designated edge lines by more than plus or minus one (1) inch.

For the purpose of determining reasonable conformance with the designated thickness of a treated course, it shall be understood that the depth of the treated course shall not vary from designated thickness by more than minus one-half (1/2) inch or plus one (1) inch.

The finished surface of a treated course shall conform to the requirements shown on the plans, within the tolerances allowable under Section 321.

Delete Subsections 311.04 and 311.05 beginning on page 225 and substitute the following:

907-311.04--Blank.

907-311.05--Blank.

MISSISSIPPI DEPARTMENT OF TRANSPORTATION

SPECIAL PROVISION NO. 907-401 DB

CODE: (SP)

DATE: 09/13/2011

SUBJECT: Hot Mix Asphalt (HMA)

Section 401, Hot Mix Asphalt (HMA) - General, of the 2004 Edition of the Mississippi Standard Specifications for Road and Bridge Construction is hereby amended as follows:

Delete the first sentence of Subsection 401.02.5.7 on page 246 and substitute the following:

A request for a JMF adjustment signed by a CAT-II may be made to the Engineer by the Contractor.

Delete Subsection 401.02.5.8 beginning on page 247 in toto and substitute the following:

907-401.02.5.8--Actions and Adjustments. Based on the process control test results for any property in question, the following actions shall be taken or adjustments made when appropriate:

- (a) When the running average trends toward the warning limits, the Contractor shall consider taking corrective action. The corrective action, if any, shall be documented. All tests shall be part of the Contract files and shall be included in the running average calculations.
- (b) The Contractor shall notify the Engineer whenever the running average exceeds the warning limits.
- (c) If two consecutive running averages exceed the warning limit, the Contractor shall stop production and make adjustments. Production shall only be restarted after notifying the Engineer of the adjustments made.
- (d) If the adjustment made under (c) improves the process such that the running average after four additional tests is within the warning limits, the Contractor may continue production.
- (e) If the adjustment made under (c) does not improve the process and the running average after four additional tests stays in the warning band, the mixture will be considered unsatisfactory. Unsatisfactory mixtures shall be removed and replaced starting from the stop point to the point when the running average is back within the warning limits unless the mixture is deemed acceptable by the Engineer.
- (f) Failure to stop production and make adjustments when required shall subject all mixture produced from the stop point to the point when the running average is back within the warning limits to be considered unsatisfactory.
- (g) If the running average exceeds the JMF limits, the Contractor shall stop production and make adjustments. Production shall only be restarted after notifying the Engineer of the adjustments made.

- (h) All materials for which the running average exceeds the JMF limits will be considered unacceptable and shall be removed and replaced by the Contractor. The Engineer will determine the quantity of material to be replaced based on a review of the individual testing data which make up the running average in question and an inspection of the completed pavement.
- (i) Single test results shall be compared to 1.7 times the warning and JMF limits. If the test results verified by QA testing, within allowable differences in Subsection 907-401.02.6.2, exceed these limits, the quantity of material represented by the test(s) shall be removed and replaced unless deemed acceptable by the Engineer. Single test limits will be used when insufficient tonnage is produced to require four (4) Contractor's tests.
- (j) The above corrective action will also apply for a mixture when the Contractor's testing data has been proven incorrect. The Contractor's data will be considered incorrect when; 1) the Contractor's tests and the Engineer's tests do not agree within the allowable differences given in Subsection 907-401.02.6.2 and the difference can not be resolved, or 2) the Engineer's tests indicates that production is outside the JMF limits and the results have been verified by the Materials Division. The Engineer's data will be used in place of the Contractor's data.

Delete in toto Subsection 401.02.6.2 on pages 248 and 249, and substitute:

907-401.02.6.2--Assurance Program for Mixture Quality. The Engineer will conduct a quality assurance program. The quality assurance program will be accomplished as follows:

- 1) Conducting verification tests.
- 2) Validate Contractor test results.
- 3) Periodically observing Contractor quality control sampling and testing.
- 4) Monitoring required quality control charts and test results.
- 5) Sampling and testing materials at any time and at any point in the production or laydown process.

The rounding of all test results will be in accordance with Subsection 700.04.

The Engineer will conduct verification tests on samples taken by the Contractor under the direct supervision of the Engineer at a time specified by the Engineer. The frequency will be equal to or greater than ten percent (10%) of the tests required for Contractor quality control and the data will be provided to the Contractor within two (2) asphalt mixture production days after the sample has been obtained by the Engineer. At least one (1) sample shall be tested from the first two (2) days of production. All testing and data analysis shall be performed by a Certified Asphalt Technician-I (CAT-I) or by an assistant under the direct supervision of the CAT-I. Certification shall be in accordance with MDOT *HMA Technician Certification Program* chapter in the Materials Division Inspection, Testing, and Certification Manual. MDOT shall post a chart giving the names and telephone numbers for the personnel responsible for the assurance program.

The Engineer shall be allowed to inspect Contractor testing equipment and equipment calibration

records to confirm both calibration and condition. The Contractor shall calibrate and correlate all testing equipment in accordance with the latest versions of MDOT's Test Methods and AASHTO Designation: R 18.

Random differences between the Engineer's verification tests and the current running average of four (4) quality control tests at the time of obtaining the verification sample will be considered acceptable if within the following limits:

Item	Allowable Differences
Sieve - % Passing	
3/8-inch and above	6.0
No. 4	5.0
No. 8	4.0
No. 16, for 4.75 mm mixtures ONLY	3.5
No. 30	3.5
No. 200	2.0
AC Content	0.4
Specimen Bulk SG, Gmb @ N_{Design}	0.030
Maximum SG, Gmm	0.020

If four (4) quality control tests have not been tested prior to the time of the first verification test, the verification test results will be compared to the average of the preceding quality control tests. If the verification test is the first material tested on each Phase of the Project or if a significant process adjustment was made just prior to the verification test, the verification test results will be compared to the average of four (4) subsequent quality control test results. For all other cases after a significant process adjustment, the verification test results will be compared to the average of the preceding quality control tests (taken after the adjustment) as in the case of a new project start-up when four (4) quality control tests are not available.

In the event that; 1) the comparison of the Contractor's running average quality control data and Engineer's quality assurance verification test results are outside the allowable differences in the above table, or 2) if a bias exists between the results, such that one of the results is predominately higher or lower than the other, and the Engineer's results fail to meet the JMF control limits, the Engineer will investigate the reason immediately. As soon as the need for an investigation becomes known, the Engineer will increase the quality assurance sampling rate to the same frequency required for Contractor testing. The additional samples obtained by the Engineer may be used as part of the investigation process or for routine quality assurance verification tests. The Engineer's investigation may include testing of the remaining quality control split samples, review and observation of the Contractor's testing procedures and equipment, and a comparison of split sample test results by the Contractor quality control laboratory, MDOT quality assurance laboratory and the Materials Division laboratory. The procedures outlined in the latest edition of MDOT's Field Manual for HMA may be used as a guide for the investigation. In the event that the Contractor's results are determined to be incorrect, the Engineer's results will be used for the quality control data.

The Engineer will periodically witness the sampling and testing being performed by the Contractor. The Engineer, both verbally and in writing, will promptly notify the Contractor of any observed deficiencies. When differences exist between the Contractor and the Engineer which cannot be resolved, a decision will be made by the State Materials Engineer, acting as the referee. The Contractor will be promptly notified in writing of the decision. If the deficiencies are not corrected, the Engineer will stop production until corrective action is taken.

907-401.02.6.4.1--Roadway Density. Delete subparagraphs 1., 2., and 3. on page 251 and substitute the following:

1. For all leveling lifts, when full lane width and with a thickness as specified in the table in Subsection 401.02.4, the required density shall be 92.0 percent of maximum density.
2. For all single lift overlays, with or without leveling and/or milling, the required lot density shall be 92.0 percent of maximum density.
3. For all multiple lift overlays of two (2) or more lifts excluding leveling lifts, the required lot density of the bottom lift shall be 92.0 percent of maximum density. The required lot density for all subsequent lifts shall be 93.0 percent of maximum density.
4. For all pavements on new construction, the required lot density for all lifts shall be 93.0 percent of maximum density.

Delete the second full paragraph on page 251 and substitute the following:

When it is determined that the density for a lot(s) is below the required density (92% or 93%) but not lower than 90% or 91% of the maximum density, respectively, the Engineer shall evaluate the lot(s) in question and make a determination as to whether the lot(s) may remain in place, or direct the Contractor to remove and replace the lot(s).

907-401.03.1.2--Tack Coat. Delete the three (3) sentences of Subsection 401.03.1.2 on page 259, and substitute the following:

Tack coat shall be applied to previously placed HMA and between lifts, unless otherwise directed by the Engineer. Tack coat shall be applied with a distributor spray bar. A hand wand will only be allowed for applying tack coat on ramp pads, irregular shoulder areas, median crossovers, turnouts, or other irregular areas. Bituminous materials and application rates for tack coat shall be as specified in Table 410-A on page 293. Construction requirements shall be in accordance with Subsection 907-407.03 of the Standard Specifications.

907-401.03.1.4--Density. Delete the first sentence of the first paragraph of Subsection 401.03.1.4 on page 259 and substitute the following:

The lot density for all dense graded pavement lifts, except as provided below for preleveling, wedging [less than 50% of width greater than minimum lift thickness], ramp pads, irregular shoulder areas, median crossovers, turnouts, or other areas where the established rolling pattern cannot be performed, shall not be less than the specified percent (92% or 93.0%) of the

maximum density based on AASHTO Designation: T 209 for the day's production. For all leveling lifts, when full lane width and with a thickness as specified in the table in Subsection 401.02.4, the required lot density shall be 92.0% of maximum density.

907-401.03.9--Material Transfer Equipment. Delete the paragraph in Subsection 401.03.9 on page 264 and substitute the following:

Excluding the areas mentioned below, the material transferred from the hauling unit when placing the top lift, or the top two (2) lifts of a multi-lift HMA pavement with density requirements, shall be remixed prior to being placed in the paver hopper or insert by using an approved Materials Transfer Device. Information on approved devices can be obtained from the State Construction Engineer. Areas excluded from this requirement include: leveling courses, temporary work of short duration, detours, bridge replacement projects having less than 1,000 feet of pavement on each side of the structure, acceleration and deceleration lanes less than 1,000 feet in length, tapered sections, transition sections for width, shoulders less than ten (10) feet in width, crossovers, ramps, side street returns and other areas designated by the Engineer.

MISSISSIPPI DEPARTMENT OF TRANSPORTATION

SPECIAL PROVISION NO. 907-401-4 DB

CODE: (SP)

DATE: 09/13/2011

SUBJECT: Warm Mix Asphalt (WMA)

Section 401, Hot Mix Asphalt (HMA) - General, of the 2004 Edition of the Mississippi Standard Specifications for Road and Bridge Construction as amended by this special provision is applicable to Warm Mix Asphalt Only.

907-401.01--Description. Delete the first and second paragraphs of Subsection 401.01 on page 236, and substitute the following:

These specifications include general requirements for all types of WMA.

This work consists of the construction of one or more lifts of WMA in accordance with these specifications and the specific requirements for the mixture to be produced and in reasonably close conformity with the lines, grades, thicknesses and typical sections shown on the plans or established by the Engineer.

907-401.02--Materials. Delete Subsection 401.02.2 on page 239, and substitute the following:

907-401.02.2--WMA Products and Processes. The Department will maintain a list of qualified WMA products and processes. No product or process shall be used unless it appears on this list. The Contractor may propose other products or processes for approval by the Product Evaluation Committee. Documentation shall be provided to demonstrate laboratory performance, field performance, and construction experience.

907-401.03--Construction Requirements.

907-401.03.1.1--Weather Limitations. Delete the second sentence of the first paragraph and the Temperature Limitation Table in Subsection 401.03.1.1 on page 258, and substitute the following:

The air and pavement temperature at the time of placement shall equal or exceed 40°F, regardless of compacted lift thickness.

907-401.03.1.2--Tack Coat. Delete the first sentence of the first paragraph of Subsection 401.03.1.2 on page 259 and substitute the following:

Tack coat shall be applied to previously placed WMA and between lifts, unless otherwise directed by the Engineer.

907-401.03.8--Preparation of Mixture. Delete the sentence in Subsection 401.03.8 on page 264, and substitute the following:

The temperature of the WMA mixture, when discharged from the mixer, shall not exceed 280°.

MISSISSIPPI DEPARTMENT OF TRANSPORTATION

SPECIAL PROVISION NO. 907-403 DB

CODE: (SP)

DATE: 09/13/2011

SUBJECT: Hot Mix Asphalt Pavement (HMA)

Section 403, Hot Mix Asphalt Pavement, of the 2004 Edition of the Mississippi Standard Specifications for Road and Bridge Construction is hereby amended as follows:

907-403.03--Construction Requirements.

907-403.03.2--Smoothness Tolerances. Delete the third full paragraph on page 268.

Delete the fifth full paragraph on page 268 and substitute the following:

When approved by the Engineer a short ski or shoe may be substituted for a long ski on the second paving operation working in tandem.

During the finishing and compacting of pavement lifts, it shall be the responsibility of the Contractor to check the surface and joints for progress toward conformance to surface requirements set forth herein. Variations from surface requirements exceeding the allowable tolerances shall be corrected.

Delete the last paragraph on page 268, the table at the top of page 269 and the first three paragraphs on page 269.

Delete Subsection 403.03.3 in toto and substitute the following:

907-403.03.3--Thickness Requirements. Hot Mix asphalt overlay lifts shall be constructed as nearly in accordance with the thickness shown on the plans as the underlying pavement and foundation will permit. Periodic and cumulative yield tests will be made to determine practicable conformity to the thickness of each lift. The Engineer may order modifications in placement thicknesses to prevent unwarranted variations in plan quantities.

When the paver is operating off an established grade line, no thickness determination will be required for the various lifts of pavement. It is understood that the tolerances from design grade will control the thickness requirements.

When grade stakes are eliminated as outlined in Subsection 907-403.03.2(d) and where resulting in the placement of two (2) or more lifts, acceptance will be determined on a lot to lot basis by cores taken from the completed pavement. Lots will be coincidental with acceptance lots for the surface lift as provided in Subsection 907-401.02.6.4, except that only lots resulting from the placement of mainline surface lift will be used for thickness assessment. One (1) core will be obtained at random from each lot. Irregular areas will not be cored.

When the average thickness of all the cores from the lots representing a day's production (excluding any discarded by the Engineer for justifiable reason) is within 3/8 of an inch of the total pavement thickness shown on the plans, excluding lift(s) placed using an established grade line, corrective action will not be required.

When the average thickness of all the cores from the lots representing a day's production is deficient in thickness by more than 3/8 of an inch of the total pavement thickness shown on the plans, excluding lift(s) placed using an established grade line, the deficiency shall be documented as Nonconforming Work. The thickness of the overlay shall be equal to the thickness deficiency but no less than the minimum single lift laying thickness for the specified mixture.

The cores shall be cut and removed by the Contractor in the presence of the Engineer's representative and turned over to the Engineer's representative for further handling. The Contractor shall fill each core hole with surface lift mixture and compact to the satisfaction of the Engineer within 24 hours after coring.

Delete Subsection 403.03.4 beginning on page 270 in toto and substitute the following:

907-403.03.4—Blank.

907-403.03.5--Overlays or Widening and Overlays. In addition to the requirements of Subsection 907-403.03.1 through 907-403.03.3, the following requirements will be applicable when an existing pavement is to be overlaid or widened and overlaid.

907-403.03.5.1--Blank.

907-403.03.5.2—Blank.

Delete Subsection 403.03.5.4 on page 273 in toto and substitute the following:

907-403.03.5.4--Patching. Existing pavement which has failed or unsatisfactorily stabilized shall be removed as directed.

Backfill shall consist of hot mix asphalt or a combination of compacted layers of granular material and hot mix asphalt. Unless otherwise specified, the Engineer will make this determination based on depth and field conditions.

Delete Subsection 403.03.5.5 beginning on page 273 in toto and substitute the following:

907-403.03.5.5--Preliminary Leveling. All irregularities of the existing pavement that result in a thickness greater than approximately two and one-half inches (2 ½") for the first overall leveling lift shall be corrected by skin patching, feather edging or a wedge lift and shall be approved by the Engineer in advance of placing the first overall lift.

Delete Subsections 403.04, 403.05, 403.05.1 and 403.05.2 beginning on page 274 and substitute the following:

907-403.04—Blank.

907-403.05—Blank.

907-403.05.1—Blank.

907-403.05.2—Blank.

MISSISSIPPI DEPARTMENT OF TRANSPORTATION

SPECIAL PROVISION NO. 907-403-9 DB

CODE: (SP)

DATE: 09/13/2011

SUBJECT: Warm Mix Asphalt (WMA)

Section 403, Hot Bituminous Pavement, of the 2004 Edition of the Mississippi Standard Specifications for Road and Bridge Construction is hereby amended as follows:

907-403.01--Description. Delete the first sentence of Subsection 403.01 on page 266, and substitute the following:

This work consists of constructing one or more lifts of HMA or WMA pavement meeting the requirements of Section 401 on a prepared surface in accordance with the requirements of this section and in reasonably close conformity with the lines, grade, thicknesses, and typical cross sections shown on the plans or established by the Engineer.

907-403.05—Blank.

MISSISSIPPI DEPARTMENT OF TRANSPORTATION

SPECIAL PROVISION NO. 907-407 DB

CODE: (SP)

DATE: 03/10/2009

SUBJECT: Tack Coat

Section 407, Tack Coat, of the 2004 Edition of the Mississippi Standard Specifications for Road and Bridge Construction is hereby amended as follows:

907-407.02.1--Bituminous Material. Delete the second sentence of the first paragraph of Subsection 407.02.1 on page 281, and substitute the following:

When not specified, the materials shall be as specified in Table 410-A on page 293.

907-407.03.3--Application of Bituminous Material. Delete the first paragraph of Subsection 407.03.3 on page 281, and substitute the following.

Tack coat shall be applied with a distributor spray bar. A hand wand will only be allowed for applying tack coat on ramp pads, irregular shoulder areas, median crossovers, turnouts, or other irregular areas. Bituminous materials and application rates for tack coat shall be as specified in Table 410-A on page 293. Tack coat shall not be applied during wet or cold weather, after sunset, or to a wet surface. Emulsions shall be allowed to "break" prior to superimposed construction.

907-407.05--Blank.

MISSISSIPPI DEPARTMENT OF TRANSPORTATION

SPECIAL PROVISION NO. 907-413 DB

CODE: (SP)

DATE: 05/09/2008

SUBJECT: Sawing and Sealing Transverse Joints in Asphalt Pavement

Section 413, Cleaning and Sealing Joints and Cracks, of the 2004 Edition of the Mississippi Standard Specifications for Road and Bridge Construction is hereby amended as follows.

907-413.03--Construction Requirements.

907-413.03.3-- Sawing and Sealing Transverse Joints in Asphalt Pavement.

907-413.03.3.1--General. Delete the first paragraph of Subsection 413.03.3.1 on page 296 and substitute the following:

The Contractor's operation shall be conducted so that saw cutting of transverse joints, cleaning, and sealing is a continuous operation. The entire sawing and sealing operation shall be completed within seven (7) days after the placement of the final wearing course, unless the approved traffic control plan or sequence of operations provide otherwise. Traffic shall not be allowed on sawed unsealed joints in the final wearing course.

When intermediate lifts must be exposed to traffic for over seven (7) days, the Contractor shall be required to make an interim 1/8-inch wide saw cut which is one third (1/3) as deep as the hot mix asphalt layer. This interim saw cut does not require sealing. Costs of this interim cut(s) is to be absorbed by the pay item for sawing and sealing transverse joints in asphalt pavement.

907-413.05—Blank.

MISSISSIPPI DEPARTMENT OF TRANSPORTATION

SPECIAL PROVISION NO. 907-502 DB

CODE: (SP)

DATE: 03/10/2009

SUBJECT: Portland Cement Concrete Bridge End Pavement

Delete the last sentence of the second full paragraph of Subsection 502.03.1 on page 329.

Delete Subsection 502.04 and substitute the following:

907-502.04—Blank.

Delete Subsection 502.05 and substitute the following:

907-502.05—Blank.

MISSISSIPPI DEPARTMENT OF TRANSPORTATION

SPECIAL PROVISION 907-510-1 DB

CODE: (SP)

DATE: 09/23/2009

SUBJECT: Partial Depth Repair of Concrete

PROJECT:

Section 510, Repair of Concrete Pavement, 2004 Edition of the Mississippi Standard Specifications for Road and Bridge Construction is deleted in toto and replaced as follows:

SECTION 907-510 – PARTIAL DEPTH REPAIR OF CONCRETE

907-510.01--Description. This work consists of surface preparation (including cleaning) and placement of partial depth repair of concrete in spalled areas of concrete pavement or concrete bridge decks, or other areas directed by the Engineer of Record, in accordance with these specifications and in reasonably close conformity with the lines and grades of the existing pavement or bridge deck, or as specified on the Plans.

907-510.02--Materials.

907-510.02.1--General. Concrete produced and controlled from this specification will be accepted upon proper certification of concrete production through verification by job site acceptance criteria performed by the Contractor’s Construction Quality Control.

The materials for partial depth repair of concrete, when sampled and tested in accordance with 700.03, shall meet the requirements of the following Subsections:

Portland Cement	701.01 and 701.02
Fine Aggregate	703.02
Coarse Aggregate	703.03
Joint Material	707.01, 707.02, and 707.07
Reinforcing Steel	711.02
Structural Synthetic Fibers	711.04
Liquid Membrane Compound	713.01.02
Admixtures	713.02
Fly Ash	714.05
Water	714.01.1 and 714.01.2

907-510.02.2--Mixture Design. The concrete mixture shall be designed by a technician holding a current MDOT Certified Class III certification representing the Contractor to meet the requirements set out in the following:

Minimum Cementitious Content	658 lb/cy
Minimum Fly Ash Replacement Required	15%

Coarse Aggregate Size	#7 or #8
Coarse Aggregate Type	see Subsection 907-510.02.2.1
Synthetic Structural Fibers	see Subsection 907-510.02.2.2
Total Air Content	3 - 6%
Maximum Slump	6 inches
Required Compressive Strength	2500 psi in time required by the Plans

Either a Type F or Type G water reducing chemical admixture shall be used in the concrete mixture. No other water reducing chemical admixtures shall be used in the mixture.

907-510.02.2.1--Coarse Aggregate Requirements. The coarse aggregate for areas of concrete repair which will be milled to obtain the final grade requirements shall be limestone. All other areas may use either limestone or gravel as the coarse aggregate.

907-510.02.2.2--Synthetic Structural Fiber Requirements. Concrete mixture used on bridge decks or for other single areas of concrete repair 25 square feet or greater shall contain synthetic structural fibers added in accordance with the requirements of Subsection 711.04 based on the dosage required for the applicable synthetic structural fiber per the Department's Approved Products List.

907-510.02.2.3--Basis of Proportioning. The Contractor shall establish the proportions based on a laboratory trial mixture in accordance with the requirements of Subsection 804.02.10.1.2 with the following exception: the minimum required average strength of the laboratory trail mixture listed in Subsection 804.02.10.1.2.e shall not be required.

907-510.02.3--Batching and Mixing.

907-510.02.3.1--Job Site Batching and Mixing. For concrete mixture batched and mixed at the job site, the mixing equipment shall meet the requirements for a power-driven, revolving drum, tilting concrete mixer or other in accordance with AASHTO Designation: R39. Hand mixing shall not be allowed.

Measuring of materials shall be in individual buckets of convenient size for each separate material with sufficient number of buckets such that all the materials for an individual batch can be obtained for a single batch at one time. The amount of material required in each bucket shall be determined by weight using a scale meeting the requirements of AASHTO Designation: R39. Once the amount of material has been determined for each bucket, each bucket may be marked to indicate much of an individual material to add to the bucket for additional batches. Weighing of materials for each bucket may be discontinued for subsequent batches provided each bucket is approximately filled to the mark.

Mixing shall meet the requirements of AASHTO Designation: R39. All the aggregates, cementitious materials, and the required amount of water reducing admixture shall be added to the mixer. Particular attention shall be given to the incremental addition of water to ensure the desired slump is obtained for each batch.

907-510.02.3.2--Other Batching and Mixing. Concrete mixture not batched and mixed at the

job site shall be batched, mixed, and transported in according with the requirements of Subsection 804.02.11.

907-510.02.4--Sampling & Testing. Sampling and testing of plastic concrete will be performed by the Contractor's Construction Quality Control having the applicable certifications in Table 2 in Section 804 and in accordance with the applicable test methods listed in Table 1 in Section 804 at the following sampling and testing frequency.

The slump, temperature, and total air content will be determined on the first batch each production day and other subsequent batches until requirements for these plastic properties are met. Slump, temperature, and total air content shall be determined at a minimum frequency of once per each 300 square feet of concrete repair, or fraction thereof, but more often if the slump, temperature, or total air content are in question on subsequent batches. Once a batch has been determined to meet the requirements for slump, temperature, and total air content, additional testing on the batch is not required.

At least two concrete test cylinders for acceptance will be cast per day per section of lane for which an individual lane closure is affected and concrete is replaced. The slump, temperature, and total air content will be determined for the concrete test cylinders. The concrete test cylinders will be made from approximately the last batch of concrete produced each day.

Compressive strength cylinders for opening to traffic shall be cast and tested by the Contractor in accordance with Subsection 907-510.03.6.

907-510.02.5--Basis of Acceptance. The slump of plastic concrete mixture shall meet the requirements of Subsection 907-510.02.2 with the minus slump limits of AASHTO Designation: M157.

Sampling shall meet the requirements of AASHTO Designation: T141. For additional information concerning sampling concrete, see the Department's *Concrete Field Manual*.

The total air content of the plastic concrete mixture shall meet the requirements of Subsection 907-510.02.2.

The maximum plastic concrete acceptance temperature shall be 90°F. Plastic concrete with a temperature exceeding 90°F shall be rejected and not used in Department work. The minimum acceptance temperature shall meet the requirements of Subsection 804.02.16.1 for Cold Weather Concreting.

A check test shall be made on another portion of the obtained sample before rejection of any batch.

The compressive strength shall meet the requirements of Subsection 907-510.02.2.

907-510.03--Construction Requirements.

907-510.03.1--Surface Preparation. All spall areas one inch in diameter or larger shall be

cleaned and prepared for receiving the concrete. The Contractor shall remove all loose, cracked or deteriorated concrete from the spalled areas as directed by the Engineer using a mason or shop hammer and if necessary, a jack hammer not larger than 40 pounds.

With the approval of the Engineer, the Contractor may use a concrete saw conforming to the requirements of Subsection 501.03.6.1 and/or a cold milling machine.

Hydrodemolition shall be used when called for on the Plans and as given in the Specification.

If the deteriorated concrete reaches a depth at or, as determined by the Engineer, just above reinforcing steel, the concrete shall be removed to a depth such that at least the top half of the reinforcing steel is fully exposed in the spall area. Care shall be taken not to damage the reinforcing steel during removal of concrete. Any damage to the reinforcing steel as a result of the Contractor's operations shall be corrected to the satisfaction of the Engineer at no additional cost to the Department.

For concrete pavements, if it is determined by the Engineer that the depth of the deteriorated concrete is greater than one-half the slab thickness, the concrete shall be repaired using the requirements of Section 503.

907-510.03.2--Joint Preparation for Pavements. Spall areas through which there is a joint or full-depth crack shall have the joint or full-depth crack maintained by a compressible insert form, such as Styrofoam, fiber board meeting the requirements of Subsection 707.02.4, or corrugated cardboard. The compressible insert form shall prevent bonding between the adjacent slabs in the spall area.

The compressible insert form shall be capable of maintaining the general line of the joint or full-depth crack during placement of concrete mixture. The thickness of the compressible insert form shall be the width of the existing joint or full-depth crack. The length and height of the compressible insert form shall extend beyond both sides of the repair area at least three (3) inches and into the joint or full-depth crack at least one (1) inch.

At no time shall the concrete mixture be permitted to flow into or across the joint or full-depth crack.

907-510.03.3-- Placing of Concrete. The repair shall begin as soon as practical following the removal concrete and cleaning of the spalled area. Any additional repairs shall be performed prior to or concurrent with the placement of the concrete mixture.

During placement, the concrete shall be thoroughly consolidated by internal vibration through the use of a spud-type vibrator or, if allowed by the Engineer, externally through the use of a vibrating screed. The concrete shall be screeded longitudinally unless otherwise permitted by the Engineer. The screed shall be metal of a type normally used on bridge deck placements. Finishing may be performed by either machine or hand methods. The repaired area shall be checked longitudinally and transversely in order to meet a 1/8 inch in 10 feet smoothness requirement unless it will be ground or milled to obtain the final grade.

After the screeding and floating has been completed and while the concrete is still plastic, the surface of the concrete shall be tested with a 10-foot straightedge. For this purpose the Contractor shall furnish and use an accurate 10-foot straightedge swung from handles three feet longer than one-half the width of the slab. The straightedge shall be held in contact with the surface in successive positions parallel to the road centerline and the whole area gone over from one side of the slab to the other as necessary. Advance along the road shall be in successive stages of not more than one-half the length of the straightedge. All depressions found shall be immediately filled with freshly mixed concrete, struck off, consolidated, and refinished. High areas shall be cut down and refinished. Special attention shall be given to assure that the surface across joints meets any requirements for smoothness. Straightedge testing and surface corrections shall continue until the entire surface is found to be free from observable departures from the straightedge, and the surface conforms to the required grade and cross section.

After the concrete mixture has been placed, an additional amount of the grout from the concrete mixture shall be used to fill and repair any "saw cut run-outs" where a saw cut extends past the repaired spall area.

907-510.03.4--Application of Liquid Membrane. Within 10 minutes of finishing the concrete mixture in each repaired spall area, the Contractor shall apply a coating of liquid membrane compound in accordance with Subsection 713.01.2 to the entire surface of the repaired spall area. The minimum rate of application of the liquid membrane shall be no less than the minimum recommended by the liquid membrane producer and no less than one gallon per 200 square feet of concrete surface.

As a rule of thumb, the color of a pavement covered with the required amount of curing compound should be indistinguishable from a sheet of commercially available standard "letter" size white copier paper placed on top of it when viewed from a distance of about five (5) feet away horizontally if standing on the same grade as the pavement.

907-510.03.5--Sealing Joints. Previously existing joints shall be resealed. Sealing shall be in accordance with the requirements of Subsection 510.03.22 and its subsequent paragraphs.

907-510.03.6--Opening to Traffic. Upon approval of the Engineer, the traffic lane shall be opened within 72 hours and may be opened when a 2500 psi compressive strength is obtained as verified by cylinder break. Eight test cylinders for verifying strength requirements shall be made and cured under the same conditions as the placement. Two test cylinders shall be tested and the results averaged to represent a test break. Traffic shall not be allowed on the repaired concrete until the required 2500 psi strength is attained. The area shall be cleared of equipment and waste materials prior to opening to traffic.

Delete Subsection 510.04 and 510.05 on page 338 and substitute the following:

907-510.04—Blank.

907-510.05—Blank.

MISSISSIPPI DEPARTMENT OF TRANSPORTATION

SPECIAL PROVISION NO. 907-601 DB

CODE: (SP)

DATE: 03/10/2009

SUBJECT: Structural Concrete

Division 600, Incidental Construction, of the 2004 Edition of the Mississippi Standard Specifications for Road and Bridge Construction is hereby amended as follows:

After the heading **DIVISION 600 - INCIDENTAL CONSTRUCTION**, add the following:

Unless otherwise specified, all testing of Portland cement concrete in Division 600 shall be in accordance with the requirements of Subsection 907-601.02.1.

907-601.02--Materials.

907-601.02.1--General. Delete the second and third sentence of the first paragraph of Subsection 601.02.1 on page 348, and substitute the following:

Sampling and testing will be in accordance with TMD-20-04-00-000 or TMD-20-05-00-000, as applicable.

907-601.03.6.3--Removal of Falsework, Forms, and Housing. Delete the first paragraph, the table and second paragraph of Subsection 601.03.6.3 on pages 349 and 350, and substitute the following:

The removal of falsework, forms, and the discontinuance of heating, shall be in accordance with the provisions and requirements of Subsection 907-804.03.15, except that the concrete shall conform to the following compressive strength requirements:

Wingwall and Wall Forms not Under Stress	1000 psi
Wall Forms under Stress	2200 psi
Backfill and Cover clear	2400 psi

In lieu of using concrete strength cylinders to determine when falsework, forms, and housings can be removed, an approved maturity meter may be used to determine concrete strengths by inserting probes into concrete placed in a structure. The minimum number of maturity meter probes required for each structural component shall be in accordance with Subsection 907-804.03.15. Procedures for using the maturity meter and developing the strength/maturity relationship shall follow the requirements of Subsection 907-804.03.15. Technicians using the maturity meter or calculating strength/maturity graphs shall meet the requirements of Subsection 907-804.03.15.

Delete Subsections 601.04 and 601.05 on pages 351 and 352 and substitute the following:

907-601.04--Blank.

907-601.05--Blank.

MISSISSIPPI DEPARTMENT OF TRANSPORTATION

SPECIAL PROVISION NO. 907-603 DB

CODE: (IS)

DATE: 05/12/2008

SUBJECT: Culverts and Storm Drains

Section 603, Culverts and Storm Drains, of the 2004 Edition of the Mississippi Standard Specifications for Road and Bridge Construction is hereby amended as follows.

907-603.03--Construction Requirements.

907-603.03.2--Bedding. After the first paragraph of the Subsection 603.03.2 on page 356, add the following:

Non-rigid pipe used in cross drains and storm drains shall have a Class B bedding. Non-rigid pipe used in side drains shall have a Class C bedding. No separate measurement will be made for pipe bedding. Costs associated with pipe bedding shall be included in the cost of the pipe.

907-603.03.4--Joining Conduit.

907-603.03.4.1--Storm Drainage. Delete the first sentence of the seventh paragraph of Subsection 603.03.4.1 on page 358, and substitute the following:

Flexible steel conduits shall be firmly joined by coupling bands.

907-603.03.7--Backfilling. After the first paragraph of the Subsection 603.03.7 on page 360, add the following:

Backfill of non-rigid corrugated polyethylene and poly (vinyl chloride) (PVC) pipe used in cross drains and storm drains shall be performed using one of the following methods:

1. Flowable fill meeting the requirements of Section 631 of the Standard Specifications. If flowable fill is used, care shall be taken to prevent the pipe from “floating”.
2. Crushed stone aggregate meeting the requirements of Subsection 703.04.3 of the Standard Specification.

No separate measurement will be made for backfilling pipe. Costs associated with backfilling pipe will be included in the cost of the pipe.

907-603.05—Blank.

MISSISSIPPI DEPARTMENT OF TRANSPORTATION

SPECIAL PROVISION NO. 907-605 DB

CODE: (SP)

DATE: 03/10/2009

SUBJECT: Underdrains

Section 605, Underdrains, of the 2004 Edition of the Mississippi Standard Specifications for Road and Bridge Construction is hereby amended as follows:

907-605.03--Construction Requirements.

907-605.03.5--Edge Drain Installation. Delete the seventh paragraph of Subsection 605.03.5 on page 376 and substitute the following:

When corrugated polyethylene drainage tubing is used, joints shall be made with snap-on or split couplings, corrugated to engage the pipe corrugations, and shall engage a minimum of four (4) corrugations, two (2) on each side of the pipe joint.

Delete Subsections 605.04 and 605.05 beginning on page 377 and substitute the following:

907-605.04--Blank.

907-605.05--Blank.

MISSISSIPPI DEPARTMENT OF TRANSPORTATION

SPECIAL PROVISION NO. 907-626 DB

CODE: (SP)

DATE: 03/10/2009

SUBJECT: Double Drop Thermoplastic Markings

Section 626, Thermoplastic Traffic Markings, of the 2004 Edition of the Mississippi Standard Specifications for Road and Bridge Construction is hereby amended as follows:

907-626.03.1.1--Equipment. After the second paragraph of Subsection 626.03.1.1 on page 444, add the following:

When edge lines are placed over rumble strips, the equipment must be able to apply the markings using the atomization method instead of extrusion / ribbon method.

907-626.03.1.2--Construction Details. After the second sentence of the first full paragraph of Subsection 626.03.1.2 on page 445, add the following:

When edge lines are placed on rumble strips, the thickness of the edge line shall be 90 mils.

After the last sentence of the third full paragraph of Subsection 626.03.1.2 on page 445, add the following:

When double drop thermoplastic stripe is called for in the Contract, additional beads by the drop-on method shall be applied as follows:

1. Class A glass beads at a rate of not less than three (3) pounds of beads per 100 feet of six-inch (6") stripe.
2. Class B glass beads at a rate of not less than three (3) pounds of beads per 100 feet of six-inch (6") stripe.

The Class B glass beads shall be applied to the newly placed stripe first; followed by the application of the Class A glass beads.

Delete Subsections 626.04 and 626.05 on pages 445 and 446 and substitute the following:

907-626.04--Blank.

907-626.05--Blank.

MISSISSIPPI DEPARTMENT OF TRANSPORTATION

SPECIAL PROVISION NO. 907-630 DB

CODE: (SP)

DATE: 03/06/2009

SUBJECT: Changeable Message Signs

Section 630, Traffic Signs and Delineators, of the 2004 Edition of the Mississippi Standard Specifications for Road and Bridge Construction is hereby amended as follows:

907-630.01--Description. After the last paragraph of Subsection 630.01 on page 454, add the following:

This work shall also include furnishing, and testing an electronic Portable Changeable Message Sign (PCMS) assembly. The Contractor shall supply a complete operating Light Emitting Diode (LED) sign including the sign housing, sign controller unit (SCU), trailer, solar panels, batteries, battery charger, all cabling, and hardware associated with a complete integrated unit as specified below.

907-630.02--General Material Requirements. After Subsection 630.02.12 on page 458, add the following.

907-630.02.13--Portable Changeable Message Sign.

907-630.02.13.1--General. The sign display shall be a LED, full matrix sign. If more than one portable changeable message sign is required and specified, they shall all be of the same model and from the same manufacturer. All parts and materials used to construct the portable changeable message signs shall be new and interchangeable.

The PCMS shall be a trailer-mounted, solar powered, portable changeable message sign.

Each PCMS shall include the following main components:

- a) Sign Housing
- b) LED Modules
- c) LED Drivers
- d) Battery Bank
- e) Sign Controller
- f) Trailer
- g) AC Charger
- h) Solar Panel
- i) Solar Panel Charger

The LED display shall be full matrix sign with a minimum of 28-pixel rows x 50-pixel columns. The pixel spacing shall be such that three (3) lines of text (5 columns x 7 rows, 8 characters) shall each have a nominal height of 18 inches.

The PCMS shall include a remote communications interface as specified herein. The PCMS shall be provided with a local serial and USB connection within the sign control cabinet so that a laptop computer using the remote software can communicate directly with the sign CPU.

This Special Provision incorporates normative references to other standards as outlined in Section 1 of the NEMA TS-4 standard and as listed below.

NEMA TS4-2004, Hardware Standards for Dynamic Message Signs (DMS) with NTCIP Requirements. All NEMA TS-4 requirements that are applicable to portable signs shall be used.

NTCIP Standards.

If a conflict between the standards referenced and this Special Provision, this Special Provision shall govern.

The definitions of the terms used within this Special Provision are as defined in Section 1 of the NEMA TS-4 standard.

If required in the contract, the PCMS shall include a speed radar unit as specified herein.

907-630.02.13.2--Environmental Requirements. The PCMS Manufacturer shall submit documentation that demonstrates conformance to the mandatory items listed under the Environmental section of the Conformance Table in Section 11.5 in the NEMA TS-4 standard.

Exception to the Environmental section of the NEMA TS-4 standard requiring 3rd party conformance testing is that the PCMS Manufacturer may submit a Conformance Statement or a minimum of three (3) references from different governmental entities using similar portable signs to show compliance with mandatory conformance items.

907-630.02.13.3--Mechanical Construction. Each PCMS shall meet the following minimum requirements.

Weather-Tight Enclosure. The entire sign and trailer assembly, including each component / equipment exposed to weather, shall be fully protected. It shall withstand the effects of sand, dirt, dust, moisture, hose-directed water, ice, snow and UV radiation (UVA and UVB). It shall withstand the effects of high wind loading and blowing rain as specified herein with all outriggers and/or leveling jacks in place. The sign and all components shall be watertight. Space shall be provided for manuals to be stored in a weatherproof environment.

Wind Loading. Wind loading requirements for the portable sign housing and trailer assembly shall be as specified in Section 3.3.2.1.2 of the NEMA TS-4 standard.

Welding. All welding on all major structural components (aluminum or steel) shall be performed by certified welders and in accordance to SAE/AWS D8.8 American Welding Society.

Protective Coatings. Protective coatings or processes, such as anodizing, e-coating, powder coat painting, plating, etc., shall be incorporated to protect all sign, cabinet, and trailer metal surfaces from corrosion. Any non-protected metallic fasteners shall be made of stainless steel or aluminum. All components shall be similar material, or be isolated to reduce galvanic reactions.

Temperature and Humidity. Each PCMS shall be designed to operate continuously in extreme ambient temperature ranges and at high humidity levels.

Operating ambient temperature range of the portable sign and trailer assembly shall be -29°F to +165°F. Storage temperature range shall be from -40°F to +185°F. The portable sign shall be capable of continued operation within the operating temperature ranges specified without the need for active systems (i.e., fans). Operating relative humidity level of the portable sign shall be up to 95% non-condensing.

Sign Face. Sign face material shall be protected by a non-glaring polycarbonate material of at least ¼-inch thickness. It shall be replaceable and manufactured of material rated for outside use and resistant to UV degradation (exposure to the sun).

All electronics and pixels shall be protected from damage due to moisture.

Sign Housing Construction. The portable sign housing, including its front face panels, shall be designed to conform to the requirements of minimum NEMA Type 3R, as described in the latest edition of NEMA 250.

It shall be comply with latest structural AASHTO requirements.

It shall be constructed of aluminum sheeting which shall not be less than 1/8-inch thick with all seams continuously welded by the inert gas process.

The front of the sign housing shall have a flat black matte finish.

Weep holes shall be provided in the housing to allow moisture from condensation to escape.

The sign housing and cabinets shall be designed to keep insects out.

The sign housing shall be constructed in such a manner as to prohibit stray light from reducing legibility.

All sides of the sign housing shall have a maintenance-free finish.

Alignment of the sign housing shall be capable of being horizontally adjusted to position the sign a full 360 degrees. It shall be capable of rotating and locking at any selected horizontal angle up to 360 degrees. A sight alignment tube/device shall be mounted to horizontally position the sign display. A positive brake assembly with lockable control arm shall be provided to position the sign display in the desired position.

It shall allow easy access to all components contained within the display housing without the removal of any external parts. Door locks shall be rigidly mounted. Gasketing shall be provided on all door openings and shall be dust-tight, permanently bonded to the door metal, and shall not stick to the mating metal surface. A gasket channel shall be provided to support the gasket on the door.

Trailer. Each PCMS trailer shall meet all requirements for trailers as outlined in Section 3.3.3 of the latest NEMA TS-4 standard as well as the following minimum requirements.

All trailers shall meet the requirements of FMVSS, Part 571 and SAE J684 for transport safety including, but not limited to the use of brakes, safety chains, coupling device, and lights. PCMS manufacturer shall provide instructions stating procedures necessary to insure safe transport.

The structural frame shall be capable of supporting the gross vehicle weight (GVW) load of the trailer corresponding to the axle and tire ratings that shall be in accordance with FMVSS, Part 571.

The tires shall be radial ST “Special Trailer” rated. The wheels shall be 15-inch steel wheels with five lug bolts per wheel. Each trailer wheel shall be equipped with one locking lug nut. A minimum of four keys for the locking lug nuts shall be supplied for each trailer.

The trailer shall be provided with a minimum of four outriggers or leveling jacks. One outrigger or leveling jack shall be mounted near each corner of the trailer. The length of the leveling jacks shall be such that when the trailer is level, all four jacks and the tongue jack can be lowered into the vertical position. The jacks shall be screw type jacks with a minimum 25-inch lift. Each jack shall include a swivel mechanism that allows the jacks to be swing up to a horizontal position for towing. The swivel mechanism shall secure the jack in both vertical and horizontal positions through a lock pin.

The trailer shall also be provided with a trailer stand mounted on the tongue of the trailer. The stand shall be corrosion resistant. It shall include a 6-inch wheel that allows horizontal positioning of the trailer. The stand shall be welded, not bolted, to the tongue of the trailer.

The trailer shall be provided with legal tail/brake lights, signals, and license plate mounting bracket. The trailer shall be supplied with an electrical harness assembly for connection to the tow vehicle and shall be terminated in a connector type to be specified by the Engineer.

The trailer shall be provided with a 2-inch “hammer blow coupler” style hitch in accordance with SAE J684 and interchangeable with a 2½-inch Pintle coupler / ring meeting SAE J847.

The trailer spring leafs shall be rated at a minimum of 3500 pounds.

The trailer shall be equipped with a sign display lift and control console. The lift shall be electric, hydraulic lift, or combination of both with manual backup lift. The lift shall be capable of lifting the display a minimum of seven feet (7’) above the roadway surface. A mast safety pin shall be provided to prevent the sign display from falling in the event of an electric or hydraulic system failure.

The trailer shall have a minimum of 6,000-pound capacity hydraulic surge brake system along with a breakaway latch.

Illumination shall be provided as an integral part of the sign or trailer assembly to change the sign controller data in darkness.

The trailer shall contain batteries and photovoltaic (solar) panels as specified herein.

Photovoltaic (Solar) Panel System. Each PCMS shall include solar panels. A solar bank shall be assembled using multiple solar panels. All photovoltaic panels shall be listed in accordance with UL 1703, or equivalent. The solar cell bank shall have a minimum capacity of 240 watts. The solar cell bank shall be mounted on a frame capable of being tilted at a minimum of one direction up to 61 degrees with zero degrees being horizontal. Solar cells shall be laminated between ethylene vinyl acetate and tempered glass. The solar panel shall incorporate an extruded aluminum frame. The solar battery charge controller shall include the following three state charger modes.

- Bulk
- Absorption
- Float

Battery Requirements. Each PCMS shall include batteries for primary energy storage on trailers. The battery bank capacity shall be a minimum of 900 amp/hours at 12VDC at 20-hour rate of discharge. The batteries shall be heavy duty deep cycle type rated for 80% discharge. A battery power disconnect shall be provided.

Battery enclosures shall be vented to prevent the accumulation of explosive gases. The battery cabinets must be lockable with a standard padlock.

AC Charging System. Each PCMS shall have an AC battery charging sub-system. The system shall be UL listed and operate from a standard 120VAC generator meeting all NEC requirements for portable equipment.

The solar battery charger shall include the following three state charger modes.

- Bulk
- Absorption
- Float

The AC battery charger shall have sufficient capacity to charge the battery bank from 80% discharged to fully charge in 24-hours, and operate the sign simultaneously. The AC battery charger shall be equipped with a male plug-in and a 50-foot long extension cord constructed of a minimum 12-gauge wire for this purpose.

907-630.02.13.4--Controller to Sign Interface. Each PCMS shall meet all applicable controller to sign interface requirements as outline in Section 4 of the NEMA TS-4 standard.

907-630.02.13.5--Display Properties. Each PCMS shall have a cone of vision (viewing angle) from the center (reference axis) shall be a minimum 15° with the half-power viewing angle defined such that at a given distance from the LED, luminous intensity measured at any point at an angle of 7.5 degrees from the LED's center axis is no less than half the luminous intensity measured directly on the LED's center axis.

The minimum word legibility requirements shall be 1232 feet or greater under daytime light conditions and within the cone of visions as specified. Legibility is defined as the ability to discern the content of a display using a “word message”. The minimum word legibility requirement shall be documented either by a MDOT approved independent testing laboratory or by participation in the NTPEP test program.

The minimum visibility requirements shall be 3000 feet or greater under daytime light conditions and within the cone of vision as specified. Visibility is defined as the ability to recognize that a display exists. The minimum visibility requirement shall be documented either by a MDOT approved independent testing laboratory or by participation in the NTPEP test program.

The PCMS shall be capable of displaying standard fonts and font alphabets as specified in Sections 5.6.1 and 5.6.2.3 of the NEMA TS-4 standard and adhere to NTCIP 1203. The PCMS shall also support moving arrows.

Any NTPEP test results shall be for the PCMS model being used and shall be within the last three completed test cycles.

907-630.02.13.6--Optical Components. The pixels for the PCMS shall be manufactured using Light Emitting Diodes (LED). Changes to displays shall be performed by turning the LEDs in a pixel either on or off. The discrete, LED shall be an untinted, non-diffused, solid-state lamp that uses Aluminum Indium Gallium Phosphide (AlInGap) technology manufactured by Avago Technologies (formerly Agilent Technologies), Toshiba Corporation, Nichia Corporation, or functional equivalent. Horizontal and vertical spacing between modules shall be such that the horizontal and vertical pitch between all pixels is equal. A failure of one pixel shall not effect the operation of any other pixel.

All LEDs used to create a display in a single portable sign shall have a nominally rated LED life of 100,000 hours of operation under field conditions. This shall include a operating temperatures between -29°F to +165°F. LED life shall be defined as the time it takes for the LED light output to degrade to half of the LED's initial light output. Current through an LED shall be limited to the manufacturer's recommendation under any conditions. Each LED character module shall be rated for use over the environmental range specified herein, including heat absorption due to sunlight. The LEDs shall be protected from the outside environmental conditions, including moisture, snow, ice, wind, dust, dirt, and UV rays (UVA and UVB). All LEDs shall be mounted so that they present a uniform and legible display.

Pixels shall be replaceable in modular groupings (modules). All modules within a sign shall be the same size and interchangeable. The replacement of any module shall be possible with no

more than simple non-vendor-specific hand tools, such as screw drivers or wrenches, without any physical modification to the module.

907-630.02.13.7--PCMS Controller and Storage Cabinets. All PCMS controller and storage cabinets shall be minimum NEMA 3R rated and be completely encased and lockable with a standard padlock as specified herein. A separate lockable storage cabinet shall be provided to house various accessories. The controller cabinet shall be manufactured to withstand all types of adverse weather conditions and shall be designed and installed to keep insects out. All components inside the controller cabinet shall be accessible without disconnecting any unassociated wires or components. The controller cabinet shall be illuminated. The keyboard terminal and control panel shall be housed. Lighted keys and terminal displays are acceptable.

All controls in the controller cabinet shall be labeled. The cabinet shall have a voltmeter gauge to indicate the current battery charge status. It shall have an amp gauge to indicate the current/charging status. It will be acceptable to have a display via digital readout on a control console or panel.

907-630.02.13.8--Electronics and Electrical. Each PCMS shall meet all applicable electronics and electrical requirements as outlined in Section 8 of the NEMA TS-4 standard.

Sign Controller. The PCMS shall include a local sign controller with firmware. The local control interface shall have a keyboard capable of allowing full programming and control of the PCMS locally. It shall have a separate serial RS-232 or USB connection to allow a laptop computer using the remote control software to communicate directly with the sign controller.

Local and remote interfaces shall be password protected to safeguard against unauthorized use.

It shall perform and report the following minimum sign diagnostics both through the local interface and Remote Control Subsystem.

- LED brightness controls
- Sign status
- Communications status
- Battery voltage
- Photocell ambient light level.

It shall automatically report a low battery alarm to a remote user through the Remote Control Subsystem. It shall have an alarm for the controller door open and over temperature.

It shall store and display both textual and graphical symbols. It shall store a minimum of 20 pre-programmed messages and graphics. It shall display preprogrammed (by manufacturer) Manual on Uniform Traffic Control Devices (MUTCD) symbolic messages and standard arrows. It shall schedule predetermined sequences of messages based on a programmed time and date. Each sequence shall display up to four (4) programmed messages (text and/or graphics). It shall display conventional one, two, or three-line messages for display with a choice of a minimum of three font sizes. Character width shall be proportional to the letter type. The one line message

font size shall be capable of displaying messages in full size to utilize the maximum area of display.

It shall allow for automatic and manual controls to adjust the brightness of the LEDs. Automatic control shall be capable of varying the LED brightness by sensing the ambient light level using photocells. Manual brightness control shall be password protected to safeguard against unauthorized use.

It shall display a preprogrammed default message or no message at all, after a power recovery from a power failure. The sign shall shut down its LED display if internal cabinet temperatures reach a level that is determined unsafe by the manufacturer.

All communications and power cabling shall be either shielded or routed within conduit to minimize potential EMI/RFI effects.

Remote Control Subsystem. The PCMS shall be supplied with all the hardware and software necessary to control the PCMS from a remote central station.

It shall have a cellular phone and/or modem capable of communication using a MDOT provided cellular service provider. The Contractor shall coordinate with MDOT for cellular service provider. The Contractor shall be responsible for establishing cellular service and providing activated phone number(s) as directed and approved by the MDOT. The Contractor shall pay for cellular service for this project until the Final Maintenance Release as documented by the State Construction Engineer at which time it will be turned over to MDOT.

The cellular service type shall be CDMA/1xRTT or GSM/GPRS, as directed by MDOT.

It shall be capable of supporting connection and remote control, programming and diagnostics via the Internet.

The subsystem shall have all necessary hardware such as external antenna, communications cables, and controller interface and NTCIP Sign controller software. The central station software meeting the following minimum requirements:

- Windows XP compatible
- Capable of running on any desktop or laptop.
- Capable of controlling all PCMS functions through windows and GUIs (Graphical User Interface)
- NTCIP compatible as specified herein.

Communications. In addition to any protocols that may be available from the PCMS Manufacturer, each sign controller shall support NTCIP as follows.

- NTCIP Protocol and Command Sets. This specification references several standards through their NTCIP designated names and numbers. Each NTCIP Component covered by these project specifications shall implement the most recent version of the standard that is

available as of project advertisement date, including any and all prepared Amendments to these standards as of the same date.

Profile Implementation Conformance Specifications (PICS) for each NTCIP standard required shall be submitted for review and approval to the Department.

- RS-232 Interface. Communication interfaces using RS-232 shall conform, with the following minimum requirements.

1101 – NTCIP Simple Transportation Management Framework (STMF)

1203 - NTCIP Object Definition for Portable Dynamic Message Signs

2301 - NTCIP AP-STMF

2201 - NTCIP TP-Transportation Transport Profile

2103 – NTCIP SPPPP/RS232

2104 - NTCIP SP-PMPP/RS232

- Subnet Level. For each communication interface, the NTCIP Components may support additional Subnet Profiles at the manufacturer's option. At any time, only one Subnet Profile shall be active on a given communication interface. The NTCIP Component shall be configurable to allow the field technician to activate the desired Subnet Profile.
- Transport Level. For each communication interface, the communication interface may support additional Transport Profiles at the manufacturer's option. Response data-grams shall use the same Transport Profile used in the request. Each communication interface shall support the receipt of data-grams conforming to any of the identified Transport Profiles at any time.
- Application Level. For each communication interface, all interfaces shall comply with NTCIP 1101 and shall meet the requirements for Conformance Level 1 (NOTE -See Amendment to standard). Optionally, the NTCIP Component may support SNMP traps. A communication interface may support additional Application Profiles at the manufacturer's option. Responses shall use the same Application Profile used by the request. Each communication interface shall support the receipt of Application data packets at any time allowed by the subject standards.

Information Level. For all communication interfaces, the information level protocol shall provide Full, Standardized Object Range Support of all objects required by these procurement specifications unless otherwise indicated below. The maximum Response Time for any object or group of objects shall be 200 milliseconds. All communication interfaces shall implement all mandatory objects of all mandatory Conformance Groups as defined in NTCIP 1203 and their respective Amendments. Table 1 indicates the modified object requirements for these mandatory objects. Table 2 shows the required minimum support of messages that are to be stored in permanent memory. The sign shall blank if a command to display a message contains an invalid Message CRC value for the desired message. Table 3 specifies the support of the required MULTI tags and their ranges.

It shall also implement all mandatory objects of the following optional conformance groups of NTCIP 1201.

- Time Management Conformal Group
- Report Conformal Group. Table 4 indicates the modified object requirements.
- Implement all objects of the Font Configuration Conformance Group, as defined in NTCIP 1203. Table 5 indicates the modified object requirements for this conformance group.
- Implement all objects of the PCMS Configuration Conformance Group, as defined in NTCIP 1203.
- Implement all objects of the Multi Configuration Conformance Group, as defined in NTCIP 1203. Table 6 indicates the modified object requirements for this conformance group.
- Implement all objects of the Multi Error Configuration, as defined in NTCIP 1203.
- Implement all objects of the Illumination/Brightness.
- Sign Status, as defined in NTCIP 1203.
- Status Error, as defined in NTCIP 1203.
- Pixel Error Status, as defined in NTCIP 1203.
- The sign display shall be capable of displaying preprogrammed Manual on Uniform Traffic Control Devices (MUTCD) symbolic messages and standard arrows. Since the display of graphics is currently not defined within the NTCIP Standards or their amendments, the vendor shall propose, and provide detailed documentation (i.e., interface protocol description level), how the specified graphical shapes can be displayed.
- Implement the optional objects listed in Table 7.

Table 1
Modified Object Ranges for Mandatory Objects

Object	Reference	Project Requirement
ModuleTableEntry	NTCIP 1201 Clause 2.2.3	Shall contain at least one row with moduleType equal to 3 (software). The moduleMake shall specify the name of the manufacturer, the moduleModel shall specify the manufacturer's name of the component and the modelVersion shall indicate the model version number of the component.
MaxGroupAddresses	NTCIP 1201 Clause 2.7.1	Shall be at least 1
CommunityNamesMax	NTCIP 1201 Clause 2.8.2	Shall be at least 3
PCMSNumPermanentMsg	NTCIP 1203 Clause 2.6.1.1.1.1	Shall be at least 20*
PCMSMaxChangeableMsg	NTCIP 1203 Clause 2.6.1.1.1.3	Shall be at least 50. Each message shall support at least 4 pages per message.
PCMSFreeChangeableMemory	NTCIP 1203 Clause 2.6.1.1.1.4	Shall be at least 70 when no messages are stored.
PCMSMessageMultiString	NTCIP 1203 Clause 2.6.1.1.1.8.3	The PCMS shall support any valid MULTI string containing any subset of those MULTI tags listed in Table 4.
PCMSControlMode	NTCIP 1203 Clause 2.7.1.1.1.1	Shall support at least the following modes: <ul style="list-style-type: none"> ▪ local ▪ external ▪ central ▪ centralOverride

Table 2
Content of Permanent Messages

Perm. Msg. Num.	Section 12 Description
1	Permanent Message #1 shall blank the display (i.e., command the sign to use PCMSMessageType 7). It shall have a run-time priority of 50.

Table 3
Required MULTI Tags

Code	Feature
f1	Field 1 - time (12hr)
f2	Field 2 - time (24hr)
f8	Field 8 - day of month
f9	Field 9 – month
f10	Field 10 - 2 digit year
f11	Field 11 - 4 digit year
Fl (and /fl)	flashing text on a line by line basis with flash rates controllable in 0.5 second increments.
Fo	Font
J12	justification - line – left
J13	justification - line – center
J14	justification - line – right
J15	justification - line – full
Jp2	justification - page – top
Jp3	justification - page - middle
Jp4	justification - page - bottom
Nl	New line
Np	New page, up to 2 instances in a message (i.e., up to 4 pages/frames in a message counting first page)
Pt	page times controllable in 0.5 second increments.

**Table 4
Modified Object Ranges for the Report Conformance Group**

Object	Reference	Project Requirement
maxEventLogConfigs	NTCIP 1201 Clause 2.5.1	Shall be at least 50
eventConfigurationMode	NTCIP 1201 Clause 2.4.3.1	The NTCIP Component shall support the following Event Configuration Modes: <ul style="list-style-type: none"> ▪ onChange ▪ greaterThanValue ▪ smallerThanValue
maxEventLogSize	NTCIP 1201 Clause 2.5.3	Shall be at least 200
maxEventClasses	NTCIP 1201 Clause 2.5.5	Shall be at least 16

**Table 5
Modified Object Ranges for the Font Configuration Conformance Group**

Object	Reference	Project Requirement
numfont	NTCIP 1203 Clause 2.4.1.1.1.1	Shall be at least 3*
maxFontCharacters	NTCIP 1203 Clause 2.4.1.1.1.3	Shall be at least 127**

* Upon delivery, the first font shall be a standard 18-inch font. The second font shall be a double-stroke 18-inch font. The third font shall be a 28-inch font.

** Upon delivery, the first three font sets shall be configured in accordance with the ASCII character set for the following characters:

"A" thru "Z" - All upper case letters.

"a" thru "z" - All lower case letters.

"0" thru "9" - All decimal digits.

Space (i.e., ASCII code 0x20).

Punctuation marks shown in brackets [. , ! ? - ' ' " " / ()]

Special characters shown in brackets [# & * + < >]

Table 6
Modified Object Ranges for the MULTI Configuration Conformance Group

Object	Reference	Project Requirement
defaultBackgroundColor	NTCIP 1203 Clause 2.5.1.1.1.1	The PCMS shall support the following background colors: <ul style="list-style-type: none"> ▪ black
defaultForegroundColor	NTCIP 1203 Clause 2.5.1.1.1.2	The PCMS shall support the following foreground colors: <ul style="list-style-type: none"> ▪ amber ▪ orange
defaultJustificationLine	NTCIP 1203 Clause 2.5.1.1.1.6	The PCMS shall support the following line justification: <ul style="list-style-type: none"> ▪ Left ▪ Center ▪ Right ▪ Full
defaultJustificationPage	NTCIP 1203 Clause 2.5.1.1.1.7	The PCMS shall support the following forms of page justification: <ul style="list-style-type: none"> ▪ Top ▪ Middle ▪ Bottom
defaultPageOnTime	NTCIP 1203 Clause 2.5.1.1.1.8	The PCMS shall support the full range of these objects with step sizes no larger than 0.5 seconds
defaultPageOffTime	NTCIP 1203 Clause 2.5.1.1.1.9	The PCMS shall support the full range of these objects with step sizes no larger than 0.5 seconds
defaultCharacterSet	NTCIP 1203 Clause 2.5.1.1.1.10	The PCMS shall support the following character sets: <ul style="list-style-type: none"> ▪ eightBit

**Table 7
Optional Object Requirements**

Object	Reference	Project Requirement
globalSetIDParameter	NTCIP 1201 Clause 2.2.1	
eventConfigLogOID	NTCIP 1201 Clause 2.5.2.7	
eventConfigAction	NTCIP 1201 Clause 2.5.2.8	
eventClassDescription	NTCIP 1201 Clause 2.5.6.4	
defaultFlashOn	NTCIP 1203 Clause 2.5.1.1.1.3	The PCMS shall support the full range of these objects with step sizes no larger than 0.5 seconds
defaultFlashOff	NTCIP 1203 Clause 2.5.1.1.1.4	The PCMS shall support the full range of these objects with step sizes no larger than 0.5 seconds
PCMSSWReset	NTCIP 1203 Clause 2.7.1.1.1.2	
PCMSMessageTimeRemaining	NTCIP 1203 Clause 2.7.1.1.1.4	
PCMSShortPowerRecoveryMessage	NTCIP 1203 Clause 2.7.1.1.1.8	
PCMSLongPowerRecoveryMessage	NTCIP 1203 Clause 2.7.1.1.1.9	
PCMSShortPowerLossTime	NTCIP 1203 Clause 2.7.1.1.1.10	
PCMSResetMessage	NTCIP 1203 Clause 2.7.1.1.1.11	
PCMSCommunicationsLossMessage	NTCIP 1203 Clause 2.7.1.1.1.12	
PCMSTimeCommLoss	NTCIP 1203 Clause 2.7.1.1.1.13	
PCMSEndDurationMessage	NTCIP 1203 Clause 2.7.1.1.1.15	
PCMSMemoryMgmt	NTCIP 1203	The PCMS shall support the following Memory

	Clause 2.7.1.1.1.16	management Modes: <ul style="list-style-type: none"> ▪ normal ▪ clearChangeableMessage ▪ clearVolatileMessages
PCMSMultiOtherErrorDescription	NTCIP 1203 Clause 2.7.1.1.1.20	If the vendor implements any vendor-specific MULTI tags, the PCMS shall be provided with documentation that includes meaningful error messages within this object whenever one of these tags generates an error.
PCMSIllumLightOutputStatus	NTCIP 1203 Clause 2.8.1.1.1.9	
watchdogFailureCount	NTCIP 1203 Clause 2.11.1.1.1.5	
PCMSStatDoorOpen	NTCIP 1203 Clause 2.11.1.1.1.6	
fanFailure	NTCIP 1203 Clause 2.11.2.1.1.8	
fanTestActivation	NTCIP 1203 Clause 2.11.2.1.1.9	
tempMinCtrlCabinet	NTCIP 1203 Clause 2.11.4.1.1.1	
tempMaxCtrlCabinet	NTCIP 1203 Clause 2.11.4.1.1.2	
tempMinSignHousing	NTCIP 1203 Clause 2.11.4.1.1.5	
tempMaxSignHousing	NTCIP 1203 Clause 2.11.4.1.1.6	

NTCIP Compliance Documentation. Software shall be supplied with full documentation, including a CD-ROM containing ASCII versions of the following Management Information Base (MIB) files in Abstract Syntax Notation 1 (ASN.1) format.

The relevant version of each official standard MIB Module referenced by the device functionality shall be included. If the device does not support the full range of any given object within a Standard MIB Module, a manufacturer specific version of the official Standard MIB Module with the supported range indicated in ASN.1 format in the SYNTAX and/or DESCRIPTION fields of the associated OBJECT TYPE macro shall be provided. The filename

of this file shall be identical to the standard MIB Module, except that it will have the extension ".man".

A MIB Module in ASN.1 format containing any and all manufacturer-specific objects supported by the device with accurate and meaningful DESCRIPTION fields and supported ranges indicated in the SYNTAX field of the OBJECT-TYPE macros shall be provided. This includes a MIB containing any other objects supported by the device.

Additionally, the manufacturer shall provide a test procedure that demonstrates how the NTCIP compliance of both, the data dictionaries (NTCIP 1201, 1203, and their amendments) and the communications protocols have been tested. The manufacturer shall allow the use of any and all of this documentation by any party authorized by the Procuring Agency for systems integration purposes at any time initially or in the future, regardless of what parties are involved in the systems integration effort.

907-630.02.13.9–Additional Equipment Requirements. When the contract requires the PCMS to include a speed radar unit, the radar shall operate in the "K" band, in an "approach only" mode. In conjunction with the radar, the sign shall be capable of displaying the vehicle speeds. The unit shall be programmable to allow the interruption of user-defined messages by the vehicle speed display and/or alternate messages whenever a settable speed threshold is exceeded. The radar unit shall be encased in an aluminum enclosure with a polycarbonate lens, and the metal portion shall receive the same protective coating, priming, and painting as the rest of the sign

907-630.02.13.10–System Documentation. For each PCMS, the Contractor shall provide two (2) user manuals. The user manual shall include description and samples for all operational functions, software required to operate the sign on site and remotely, all wiring diagrams, a parts lists, the sign specifications, warranty information, maintenance information and schedule, and a trouble shooting table

Each copy shall be bound and shall contain laminated sheets.

907-630.02.13.11–PCMS Testing. The PCMS manufacturer shall be responsible for providing the test procedures, test fixtures and test instruments for all PCMS tests.

Each PCMS shall pass two levels of testing as follows:

PCMS Inspection. Each PCMS shall be field inspected upon delivery. Each PCMS assembly including trailer and all associated subsystems shall be examined carefully to verify that the materials, design, construction, markings and quality of work comply with the requirements of this Special Provision.

The wiring shall be checked to determine conformance with the requirements of the appropriate subsections in this Special Provision.

Each PCMS shall be operated long enough to permit equipment temperature stabilization, and to check and record an adequate number of performance and functional characteristics to ensure compliance with the requirements of this Special Provision.

30 Day Burn-In Test Period. After field inspection of each PCMS, the PCMS manufacturer shall coordinate a 30-calendar day burn-in test period with the assistance of MDOT staff.

The type of tests to be conducted shall be submitted to and approved by MDOT before burn-in testing starts, and shall consist primarily of exercising all control, monitor and communications functions of the PCMS field equipment by the central equipment. The tests shall utilize the DOT's communications system as specified herein and the signs shall be controlled using the PCMS central control software.

During the 30-day test period, downtime, due to mechanical, electrical and/or other malfunctions, shall not exceed five (5) working days. The MDOT may extend the 30-day burn-in test period by a number of days equal to the downtime in excess of five (5) calendar days.

Approved test data forms shall be completed and turned over to MDOT as the basis for review and rejection or acceptance.

At least 30 working days notice shall be given prior to all tests to permit the MDOT and/or their representative to observe each test.

If any unit fails to pass its test, the unit shall be corrected or the unit replaced and the test successfully repeated.

Final Testing Acceptance. Final PCMS testing acceptance will be defined as when all work and materials provided have been furnished and completely tested by the PCMS Manufacturer, and all parts of the work including required documentation have been approved, inspected, and accepted by MDOT and each PCMS has been operated continuously and successfully for 30 calendar days with no more than five (5) calendar days downtime due to mechanical, electrical and/or other malfunctions, as specified herein.

907-630.02.13.12--Warranty. All warranties and guarantees shall be made out to the Mississippi Department of Transportation. The warranty shall be a minimum of a one-year on-site warranty for the trailer, sign, electronics, software, and all other installed and/or attached appurtenances. The warranty period begins upon final maintenance release of the project as documented by the State Construction Engineer.

During the warranty period, the supplier shall repair or replace with new or refurbished material, at no additional cost to the State, any product containing a warranty defect, provided the product is returned postage-paid by the Department to the supplier's factory or authorized warranty site. Products repaired or replaced under warranty by the supplier shall be returned prepaid by the supplier. During the warranty period, technical support shall be available from the supplier via telephone within four (4) hours of the time a call is made by the Department, and this support shall be available from factory certified personnel. During the warranty period, updates and corrections to control unit software shall be made available to the Department by the supplier at no additional cost.

907-630.02.13.13--PCMS Training. The PCMS Manufacturer shall submit to the MDOT for approval a Training Plan including course agendas, detailed description of functions to be demonstrated and a schedule. The training must include both classroom style training and hands-on training in the field of the maintenance and troubleshooting procedures required for each PCMS component. The training should also consist of operational training including hands-on demonstration of all PCMS software configuration and functionality where applicable. Complete training and class documentation and materials shall be included for up to eight (8) persons selected by the Department. The training class(es) shall be scheduled at a mutually acceptable time and location.

The PCMS Manufacturer must also submit the Trainer's qualifications to the MDOT for approval prior to scheduling any training.

907-630.02.13.14--Maintenance and Technical Support. The supplier shall maintain an adequate inventory of parts to support maintenance and repair of the PCMS. Parts shall be available from an authorized dealer within the State of Mississippi. Spare parts shall be available for delivery within 30 days of placement of an acceptable order at the supplier's then current pricing and terms of sale of said spare parts. All equipment and systems shall be delivered fully assembled ready to operate. Factory or dealer representative shall check equipment on delivery and give equipment superintendent information on operation and service requirements. The suppliers shall maintain an ongoing program of technical support. This technical support shall be available via telephone or via personnel sent to the installation site upon placement of an acceptable order at the supplier's then current pricing and terms of sale of said technical support services.

907-630.03--Construction Requirements. After Subsection 630.03.12 on page 462, add the following:

907-630.03.13--Changeable Message Sign. Each portable changeable message sign shall be installed and continuously operated at the location selected by the Engineer on State right-of-way. **The Contractor shall be responsible for all the parts, materials, equipment, maintenance and incidentals necessary to operate the changeable message sign continuously during the specified project.** The Contractor is advised that selected locations may be outside the planned indicated limits of the project. The Contractor shall perform all work necessary for preparation of the site selected and approved by the Engineer, to insure maximum safety for and sign visibility of the traveling public; and may be required to remove any temporary work at a later date as directed by the Engineer. The Contractor will also place a minimum of two plastic drums in advance of the sign and one beside the sign as long as it is in use. The Contractor may be required to move the sign to a new location if directed by the Engineer.

The Contractor may be permitted to bring electric power from outside the normal right-of-way for operation of the equipment if the Department determines that the installation operation will not be hazardous to the traveling public. The Contractor will be required to secure a permit from the Department prior to any work by the power company on the right-of-way. The entire cost of providing electrical service, power to operate the equipment, and removal of the power source from the right-of-way shall be borne by the Contractor.

The changeable message sign(s) will become the property of the State after the Engineer determines that there is no further need for the sign(s) on the project.

Delete Subsection 630.04 and 630.05 beginning on page 462 and 463 and substitute the following:

907-630.04—Blank.

907-630.05—Blank.

MISSISSIPPI DEPARTMENT OF TRANSPORTATION

SPECIAL PROVISION NO. 907-680 DB

CODE: (SP)

DATE: 08/17/2011

SUBJECT: Portable Construction Lighting

Division 680, Portable Construction Lighting, of the 2004 Edition of the Mississippi Standard Specifications for Road and Bridge Construction is hereby amended as follows:

907-680.02--Materials.

907-680.02.1--Tower Lights. Delete the second and third paragraphs of Subsection 680.02.1 on page 561, and substitute the following:

Tower lights shall be of sufficient wattage and/or quantity to provide an average maintained horizontal luminance in accordance with Subsection 907-680.02.3. In no case shall the main beam of the light be aimed higher than 30° above straight down. The lights should be set as far from traffic as practical and aimed in the direction of, or normal to, the traffic flow.

Delete Subsection 680.02.2 on page 561, and substitute the following:

907-680.02.2--Balloon Lights. All moving equipment used during night time operations shall have a balloon lighting system and flashing amber light on the equipment. In lieu of a flashing amber light, the Contractor may install four square feet of approved reflective material on the equipment in a location that will be seen by the traveling public. This lighting system shall illuminate the work area in each direction of travel of the equipment. Machine balloon lights shall be mercury vapor, metal halide, high pressure sodium or low pressure sodium in conventional roadway enclosed fixtures mounted on supports attached to the construction machine at a height of approximately thirteen (13) feet. The power supply shall be of sufficient capacity to operate the light(s) and shall be securely mounted on the machine. Electrical grounding of generators to frames of machines on which they are mounted shall be done in conformance with the National Electrical Code (NEC).

The light fixtures shall be of sufficient wattage and/or quantity to provide an average maintained horizontal luminance in accordance with Subsection 907-680.02.3.

Balloon lights are in addition to conventional automotive type head lights which are necessary for maneuverability.

Delete Subsection 680.02.3 on pages 561 & 562, and substitute the following:

907-680.02.3--Lighting Levels. The submitted lighting plan shall indicate how the Contractor intends to accomplish the lighting of the work area(s). The lighting system shall provide a minimum of five (5) foot-candles throughout the work area. For stationary operations, the work area shall be defined as the entire area where work is being performed. For mobile operations

the work area shall be defined as 25 feet in front of and behind moving equipment.

907-680.03--Construction Requirements. Delete the first, second, third, and fourth paragraphs of Subsection 680.03 on page 562 and substitute the following:

Tower lights may be used when the night work is confined to a fairly small area and is essentially a stationary operation.

Balloon lights shall be used when the night work is not confined to a small area and is essentially a continuous moving construction operation.

Use of tower lights in lieu of balloon lights will be considered when the number of machines, type of work, or need for inspection justify their use as decided by the Engineer.

The work area where traffic control devices are being set up or repositioned at night shall be illuminated.

If night work requires the use of a flagger, then the flagger must be illuminated by balloon lighting.

Delete Subsection 680.05 beginning on page 563 and substitute the following:

907-680.05—Blank.

MISSISSIPPI DEPARTMENT OF TRANSPORTATION

SPECIAL PROVISION NO. 907-699 DB

CODE: (IS)

DATE: 02/15/2012

SUBJECT: Construction Stakes

Section 699, Construction Stakes, of the 2004 Edition of the Mississippi Standard Specifications for Road and Bridge Construction is hereby amended as follows.

907-699.01--Description. After the first paragraph of Subsection 699.01 on page 585, add the following:

This work may be performed utilizing Automated Machine Guidance technologies and systems in accordance with the standard specifications and contract documents. Automated Machine Guidance (AMG) is defined as the utilization of positioning technologies such as Global Positioning Systems (GPS), Robotic Total Stations, lasers, and sonic systems to automatically guide and adjust construction equipment according to the intended design requirements. The Contractor may use any type of AMG system(s) that result in compliance with the contract documents and applicable Standard Specifications.

Automated Machine Guidance (AMG) is not a mandatory requirement. Automated Machine Guidance (AMG), conventional staking, or a combination of both may be used at the Contractor's option for staking on this project.

907-699.02--Materials. After the last sentence of the first paragraph of Subsection 699.02 on page 585, add the following.

All equipment required to accomplish automated machine guidance shall be provided by the Contractor. The Contractor may use any type of AMG equipment that achieves compliance with the contract documents and applicable Standard Specifications.

907-699.03--Construction Requirements. Delete the first sentence of Subsection 699.03 on page 585 and substitute the following:

The Department will establish, one time only, secondary control points with elevations at distances not to exceed 1500 feet or that minimum distance necessary to maintain inter-visibility.

Delete the third sentence of the fourth paragraph of Subsection 699.03 on page 587, and substitute the following.

The duties performed by said Registrant shall conform to the definitions under the "practice of engineering" and practice of "land surveying" in Mississippi Law and the latest edition of the MDOT Survey Manual. The MDOT Survey Manual can be obtained online at the following address.

After the last paragraph of Subsection 699.03 on page 587, add the following.

907-699.03.1--Automated Machine Guidance.

907-699.03.1.1--Automated Machine Guidance Work Plan. The Contractor shall submit a comprehensive written Automated Machine Guidance Work Plan to the Engineer for review at least 30 days prior to use. The submittal of a AMG Work Plan shall be an indication of the Contractor's intention to utilize AMG instead of conventional methods on the project areas and elements stated in the Work Plan. The Engineer shall review the Automated Machine Guidance Work Plan to ensure that the requirements of this special provision are addressed. The Contractor shall assume total responsibility for the performance of the system utilized in the Work Plan. Any update or alteration of the Automated Machine Guidance Work Plan in the course of the work shall be approved and submitted to MDOT for determination of conformance with requirements of this special provision.

The Automated Machine Guidance Work Plan shall describe how the automated machine guidance technology will be integrated into other technologies employed on the project. This shall include, but not limited to, the following:

1. A description of the manufacturer, model, and software version of the AMG equipment.
2. Information on the Contractor's experience in the use of Automated Machine Guidance system (or Related Technologies) to be used on the project, including formal training and field experience of project staff.
3. A single onsite staff person as the primary contact, and up to one alternate contact person for Automated Machine Guidance technology issues.
4. A definition of the project boundaries and scope of work to be accomplished with the AMG system.
5. A description of how the project proposed secondary control(s) is to be established. It shall also include a list and map detailing control points enveloping the site.
6. A description of site calibration procedures including, but not limited to, equipment calibration and the frequency of calibration as well as how the equipment calibration and information will be documented to MDOT and the Project Engineer. The documentation shall contain a complete record of when and where the tests were performed and the status of each equipment item tested within or out of the ranges of required tolerances.
7. A description of the Contractor's quality control procedures for checking mechanical calibration and maintenance of equipment. It shall also include the frequency and type of checks to be performed.
8. A description of the method and frequency of field verification checks and the submission schedule of results to the Project Engineer.
9. A description of the Contractor's contingency plan in the event of failure/outage of the AMG system.
10. A schedule of Digital Terrain Models (DTM) intended for use on the project. This shall be submitted to the Engineer for review, feedback, and communication.

The Contractor and MDOT will agree on the quantity and schedule of Contractor-provided

training on the utilized AMG system required under Subsection 907-699.03.1.3.

907-699.03.1.2--State's Responsibilities. The District Surveyor will set the primary horizontal and vertical control points in the field for the project as per latest edition of the MDOT Survey Manual. The control points shall be in Mississippi State Plane coordinate system.

MDOT will provide an electronic alignment file and primary control file for the project. This file will be based on the appropriate Mississippi State Plane Coordinate Zone either West or East. These files will be created with the computer software applications MicroStation (CADD software) and GEOPAK (civil engineering software). The data files will be provided in the native formats. The Contractor shall perform necessary conversion of the files for their selected grade control equipment, field verify the data for accuracy, and immediately report any errors to MDOT.

MDOT will provide design data, if available, in an electronic format to the Contractor. These files will be created with the computer software applications MicroStation (CADD software) and GEOPAK (civil engineering software). The data files will be provided in the native formats as specified in the Data Format section of this specification. No guarantee is made to the data accuracy or completeness, or that the data systems used by MDOT will be directly compatible with the systems used by the Contractor. Information shown on the paper plans marked with the seal (official plans as advertised) shall govern.

The Engineer will perform spot checks as necessary of the Contractor's machine control grading results, surveying calculations, records, field procedures, and actual staking. If the Engineer determines that the work is not being performed in accordance with the Specifications, the Engineer shall order the Contractor to re-construct the work to the requirements of the contract documents at no additional cost to the Department.

907-699.03.1.3--Contractor's Responsibilities The Contractor shall provide formal training, if requested, on the use of the Automated Machine Guidance Equipment and the Contractor's systems to MDOT project personnel prior to the start of construction activities utilizing AMG. This training is for providing MDOT project personnel with an understanding of the equipment, software, and electronic data being used by the Contractor.

The Contractor shall use the alignment and control data provided by MDOT.

The Contractor shall bear all costs, including but not limited to the cost of actual reconstruction work that may be incurred due to errors in application of Automated Machine Guidance techniques or manipulation of MDOT design data in Digital Terrain Models (DTM).

The Contractor shall be responsible for converting the information on the plans and/or electronic data file provided by MDOT into a format compatible with the Contractor's AMG system.

The Contractor shall establish secondary control points at locations along the length of the project and outside the project limits and/or where work is performed beyond the project limits as required by the Automated Machine Guidance system utilized. The Contractor shall establish this secondary control using survey procedures as outlined in the latest edition of the MDOT

Survey Manual. A copy of all new control point information shall be provided to the Engineer prior to construction activities. The Contractor shall be responsible for all errors resulting from their efforts and shall correct deficiencies to the satisfaction of the Engineer and at no additional cost to the State.

The Contractor shall preserve all reference points and monuments that are established by the District Surveyor outside the construction limits. If the Contractor fails to preserve these items, they shall be re-established by the Contractor to their original quality at no additional cost to the State.

The Contractor shall set grade stakes at the top of the finished sub-grade and base course at all hinge points on the typical sections at 2000-foot maximum intervals on mainline, critical points such as, but not limited to, PC's, PT's, beginning and ending super elevation transition sections, middle of the curve, and at least two locations on each of the side roads and ramps, and at the beginning and end of each cross slope transition where Automated Machine Guidance is used. These grade stakes shall be established using conventional survey methods for use by the Engineer to check the accuracy of the construction.

The Contractor shall meet the same accuracy requirements as detailed in the Mississippi Standard Specifications for Road and Bridge Construction. Grade stakes shall be established as per Section 699 of the Mississippi Standard Specifications for Road and Bridge Construction for use by the Engineer to check the accuracy of the construction.

The Contractor shall be responsible for implementing the AMG system using the Mississippi State Plane Coordinate System. No localization methods will be accepted.

907-699.03.1.4--Data Format. It is the Contractor's responsibility to produce the Digital Terrain Model(s) and/or 3D line work needed for Automated Machine Guidance. MDOT does not produce this data in its design process. MDOT does provide CADD files created in the design process to the Contractor. The CADD files provided by MDOT are provided in the native software application formats in which they are created with no conversions, and their use in developing 3D data for machine guidance is at the discretion of the Contractor. The CADD files that may be available are listed below. Cross-Sections are one of the items provided but are not necessarily created at critical design locations. Therefore their use in Digital Terrain Models (DTM) for AMG is limited.

1. Project Control - Microstation DGN file and ASCII file
2. Existing Topographic Data - Microstation DGN file(s)
3. Preliminary Surveyed Ground Surface - GeoPak TIN, if available
4. Horizontal and Vertical alignment information - GeoPak GPK file and/or Microstation DGN file(s)
5. 2D Design line work (edge of pavement, shoulder, etc.) - Microstation DGN file(s)
6. Cross sections - Microstation DGN file(s), GeoPak format
7. Superelevation - Microstation DGN file(s), GeoPak format
8. Form Grades - Microstation DGN file(s)
9. Design Drainage - Microstation DGN file(s)

It is expressly understood and agreed that MDOT assumes no responsibility in respect to the sufficiency or accuracy of these CADD files. These files are provided for convenience only and the contract plans are the legal document for constructing the project.

Delete Subsection 699.04 and 699.05 beginning on page 587 and 588 and substitute the following:

907-699.04—Blank.

907-699.05—Blank.

MISSISSIPPI DEPARTMENT OF TRANSPORTATION

SPECIAL PROVISION NO. 907-701 DB

CODE: (SP)

DATE: 11/09/2010

SUBJECT: Hydraulic Cement

Section 701, Hydraulic Cement, of the 2004 Edition of the Mississippi Standard Specifications for Road and Bridge Construction is hereby amended as follows:

Delete Subsection 701.01 on pages 595 & 596, and substitute the following:

907-701.01--General. The following requirements shall be applicable to hydraulic cement:

Only hydraulic cements conforming to Section 701 shall be used. Hydraulic cements shall not be listed or designated as meeting more than one AASHTO or Department type.

Different brands of hydraulic cement, or the same brand of hydraulic cement from different mills, shall not be mixed or used alternately in any one class of construction or structure, without written permission from the Engineer; except that this requirement will not be applicable to hydraulic cement treatment of design soils, or bases.

The Contractor shall provide suitable means for storing and protecting the hydraulic cement against dampness. Hydraulic cement, which for any reason, has become partially set or which contains lumps of caked hydraulic cement will be rejected. Hydraulic cement salvaged from discarded or used bags shall not be used.

The temperature of bulk hydraulic cement shall not be greater than 165°F at the time of incorporation in the mix.

Acceptance of hydraulic cement will be based on the certification program as described in the Department's Materials Division Inspection, Testing, and Certification Manual and job control sampling and testing as established by Department SOP.

Retests of hydraulic cement may be made for soundness and expansion within 28 days of test failure and, if the hydraulic cement passes, it may be accepted. Hydraulic cement shall not be rejected due to failure to meet the fineness requirements if upon retests after drying at 212°F for one hour, it meets such requirements.

Delete Subsection 701.02 on page 596, and substitute the following:

907-701.02--Portland Cement.

907-701.02.1--General.

907-701.02.1.1--Types of Portland Cement. Portland cement (cement) shall be either Type I or Type II conforming to AASHTO Designation: M85 or Type I(MS), as defined by the description below Table 1. Type III cement conforming to AASHTO Designation: M85 or Type III(MS), as defined by the description below Table 1, may be used for the production of precast or precast-prestressed concrete members.

907-701.02.1.2--Alkali Content. All cement types in this Subsection shall meet the Equivalent alkali content requirement for low-alkali cements listed in AASHTO Designation: M85, Table 2.

907-701.02.2--Replacement by Other Cementitious Materials. The maximum replacement of cement by weight is 25% for fly ash or 50% for ground granulated blast furnace slag (GGBFS). The minimum tolerance for replacement shall be 5% below the maximum replacement content. Replacement contents below this minimum tolerance by fly ash or GGBFS may be used, but shall not be given any special considerations, like the maximum acceptance temperature for Portland cement concrete containing pozzolans. Special considerations shall only apply for replacement of cement by fly ash or GGBFS.

907-701.02.2.1--Portland Cement Concrete Exposed to Soluble Sulfate Conditions or Seawater. When Portland cement concrete is exposed to moderate or severe soluble sulfate conditions, or to seawater, cement types and replacement of cement by Class F fly ash, GGBFS, or silica fume shall be as follows in Table 1.

Table 1- Cementitious Materials for Soluble Sulfate Conditions

Sulfate Exposure	Water-soluble sulfate (SO ₄) in soil, % by mass	Sulfate (SO ₄) in water, ppm	Cementitious material required*
Moderate and Seawater	0.10 - 0.20	150 - 1,500	Type II **, ***, **** cement, or Type I cement with one of the following replacements of cement by weight: 25% Class F fly ash, 50% GGBFS, or 8% silica fume
Severe	0.20 - 2.00	1,500 - 10,000	Type I cement with a replacement by weight of 50% GGBFS, or Type II ** cement with one of the following replacements of cement by weight: 25% Class F fly ash, 50% GGBFS, or 8% silica fume

- * The values listed in this table for replacement of Portland cement by the cementitious materials listed are maximums and shall not be exceeded. The minimum tolerance for replacement shall be 0.5% below the maximum replacement content. Replacement contents below this minimum tolerance by the cementitious materials listed in this table do not meet the requirements for the exposure conditions listed and shall not be allowed.
- ** Type I cement conforming to AASHTO Designation: M85 with a maximum 8% tricalcium aluminate (C₃A) may be used in lieu of Type II cement; this cement is given the designation “Type I(MS)”. Type III cement conforming to AASHTO Designation: M85 with a maximum 8% tricalcium aluminate (C₃A) may be used in lieu of Type II cement as allowed in Subsection 907-701.02.1; this cement is given the designation “Type III(MS)”.
- *** Blended cement meeting the sulfate resistance requirements of Subsection 907-701.04 may be used in lieu of Type II as allowed in Subsection 907-701.04. No additional cementitious materials shall be added to or as a replacement for blended cement.
- **** Class F fly ash or GGBFS may be added as a replacement for cement as allowed in Subsection 907-701.02.2.

Class C fly ash shall not be used as a replacement for cement in any of the sulfate exposure conditions listed above.

907-701.02.2.2--Cement for Soil Stabilization Exposed to Soluble Sulfate Conditions or Seawater. When Portland cement for use in soil stabilization is exposed to moderate or severe soluble sulfate conditions, or to seawater, cement types and replacement of cement by Class F fly ash or GGBFS shall meet the requirements of Subsection 907-701.02.2.1. Neither metakaolin nor silica fume shall be used to bring the cementitious materials into compliance with the requirements of Table 1.

Delete Subsection 701.03 on page 596, and substitute the following:

907-701.03--Masonry Cement. Masonry cement shall conform to ASTM Designation: C 91 and shall only be used in masonry applications.

Delete Subsection 701.04 on page 596, and substitute the following:

907-701.04--Blended Hydraulic Cement.

907-701.04.1--General.

907-701.04.1.1--Types of Blended Cement. Blended hydraulic cements (blended cements) shall be of the following types and conform to AASHTO Designation: M 240:

- Type I(SM) – Slag-modified Portland cement
- Type IS – Portland blast-furnace slag cement
- Type I(PM) – Pozzolan-modified Portland cement
- Type IP – Portland-pozzolan cement

Blended cement for use in Portland cement concrete or soil stabilization exposed to the moderate soluble sulfate condition or exposure to seawater as defined in Table 1 shall meet the Sulfate resistance requirement listed in AASHTO Designation: M 240, Table 2 and the “(MS)” suffix shall be added to the type designation.

907-701.04.1.2--Alkali Content. All blended cement types in this Subsection shall meet the Mortar expansion requirements listed in AASHTO Designation: M 240, Table 2.

907-701.04.2--Replacement by Other Cementitious Materials. No additional cementitious materials, such as Portland cement, performance hydraulic cement, fly ash, GGBFS, metakaolin, or others, shall be added to or as a replacement for blended cement.

907-701.04.3--Exposure to Soluble Sulfate Conditions or Seawater. When Portland cement concrete or blended cement for soil stabilization is exposed to moderate soluble sulfate conditions or to seawater, where the moderate soluble sulfate condition is defined in Table 1, the blended cement shall meet the sulfate resistance requirement listed in AASHTO Designation: M 240, Table 2.

When Portland cement concrete or blended cement for soil stabilization is exposed to severe soluble sulfate conditions, where the severe soluble sulfate condition is defined in Table 1, blended cements shall not be used.

MISSISSIPPI DEPARTMENT OF TRANSPORTATION

SPECIAL PROVISION NO. 907-703 DB

CODE: (SP)

DATE: 09/13/2011

SUBJECT: Aggregates

Section 703, Aggregates, of the 2004 Edition of the Mississippi Standard Specifications for Road and Bridge Construction is hereby amended as follows:

907-703.03.2.4--Gradation. Delete the last sentence of the last paragraph of Subsection 703.03.2.4 on page 611.

907-703.04--Aggregate for Crushed Stone Courses.

907-703.04.1--Coarse Aggregate. Delete the first sentence of the first paragraph of Subsection 703.04.1 on page 611, and substitute the following:

Coarse aggregate, defined as material retained on No. 8 sieve, shall be either crushed stone, slag, granite, shell, gravel, concrete, or combination thereof.

907-703.04.2--Fine Aggregate. Delete the first sentence of the first paragraph of Subsection 703.04.2 on page 612, and substitute the following:

Fine aggregate, defined as material passing no. 8 sieve, shall be material resulting from the crushing of stone, slag, gravel, concrete, or combination thereof.

907-703.04.3--Gradation. Add the following to the "TABLE OF SIZES AND GRADATION OF CRUSHED STONE AGGREGATE" in Subsection 703.04.3 on page 613.

Sieve Size	Percent Passing By Weight	
	Size No. 825	Crushed Stone
2 inch	100	
1 1/2 inch	90 - 100	100
1 inch	75 - 98	90 - 100
3/4 inch		
1/2 inch	60 - 85	62 - 90
3/8 inch		
No. 4	40 - 65	30 - 65
No. 8	28 - 54	
No. 10		15 - 40
No. 16	19 - 42	

No. 40		
No. 50	9 - 27	
No. 200	4 - 18	3 - 16

After the “TABLE OF SIZES AND GRADATION OF CRUSHED STONE AGGREGATE” in Subsection 703.04.3 on page 613, add the following:

907-703.04.4--Crushed Concrete. Crushed reclaimed concrete shall also be allowed as a crushed aggregate course provided it meets the requirements of Subsection 703.04 and the following.

Crushed Concrete

Sieve Size	Percent Passing By Weight
2 inch	
1 1/2 inch	100
1 inch	90 - 100
3/4 inch	
1/2 inch	60 - 85
3/8 inch	
No. 4	40 - 65
No. 8	28 - 54
No. 10	
No. 16	19 - 42
No. 40	
No. 50	9 - 27
No. 200	2 - 18

907-703.06--Aggregates for Hot Mix Asphalt.

907-703.06.1.2--Fine Aggregates. Delete the last sentence of Subsection 703.06.1.2 on page 614.

MISSISSIPPI DEPARTMENT OF TRANSPORTATION

SPECIAL PROVISION NO. 907-707 DB

CODE: (SP)

DATE: 10/25/2011

SUBJECT: Joint Materials

Section 707, Joint Materials, of the 2004 Edition of the Mississippi Standard Specifications for Road and Bridge Construction is hereby amended as follows:

907-707.02.1.3--Concrete Joint Sealer Compound - Hot-Poured Elastic Type. In the first paragraph of Subsection 707.02.1.3 on page 633, delete "AASHTO Designation: M 173" and replace with "AASHTO Designation: M 324 for Type I Joint and Crack Sealant".

Delete in toto Subsection 707.02.1.5 on pages 634 and 635 and substitute:

907-707.02.1.5--Backer Rod for Use with Hot and Cold Poured Joint Sealer. The backer rod shall be a closed-cell foam rod made from polyethylene, polyolefin or similar type material, and shall conform to ASTM Designation: D 5249 with the exception that water absorption shall be determined by ASTM Designation: C 1016, Procedure A. The backer rod shall either be a Type I, for use with either hot or cold poured joint sealers, or a Type 3, for use with cold poured joint sealers only. Open-cell foam rods or open-cell foam rods covered with an impermeable sheath or skin shall not be allowed.

The Contractor shall furnish a three linear foot sample of each shipment and three copies of the manufacturer's certification that the backer rod meets the requirements of this specification.

MISSISSIPPI DEPARTMENT OF TRANSPORTATION

SPECIAL PROVISION NO. 907-710 DB

CODE: (SP)

DATE: 06/24/10

SUBJECT: Fast Dry Solvent Traffic Paint

Section 710, Paint, of the 2004 Edition of the Mississippi Standard Specifications for Road and Bridge Construction is amended as follows:

After Subsection 710.05 on Page 661, add the following:

907-710.06--Fast Dry Solvent Traffic Paint. Fast dry solvent traffic paints intended for use under this specification shall include products that are single packaged and ready mixed. Upon curing, these materials shall produce an adherent, reflective pavement marking capable of resisting deformation by traffic. The manufacturer shall have the option of formulating the material according to their own specifications. However, the requirements delineated in this specification, Section 619 and Section 710 shall apply regardless of the formulation used. The material shall be free from all skins, dirt and foreign objects.

907-710.06.1--Composition.

907-710.06.1.1--Percent Pigment. The percent pigment by weight shall be not less than 51% nor more than 58% when tested in accordance with ASTM D 3723.

907-710.06.1.2--Viscosity. The consistency of the paint shall be not less than 75 nor more than 95 Krebs Units (KU) when tested in accordance with ASTM D 562.

907-710.06.1.3--Weight per Gallon. The paint shall weigh a minimum 11.8 pounds per gallon and the weight of the production batches shall not vary more than +/- 0.5 pounds per gallon from the weight of the qualification samples when tested in accordance with ASTM D 1475.

907-710.06.1.4--Total Solids. The percent of total solids shall not be less than 70% by weight when tested in accordance with ASTM D 2369.

907-710.06.1.5--Dry Time (No pick-up). The paint shall dry to a no tracking condition in a maximum of 10 minutes.

907-710.06.1.6--Volatile Organic Content. The volatile organic content (VOC) shall contain a maximum of 1.25 pounds of volatile organic matter per gallon of total non-volatile paint material when tested in accordance with ASTM D 3960.

907-710.06.1.7--Bleeding. The paint shall have a minimum bleeding ratio of 0.95 when tested in accordance with Federal Specification TT-P-115D.

907-710.06.1.8--Color. The initial daytime chromaticity for yellow materials shall fall within the box created by the following coordinates:

Initial Daytime Chromaticity Coordinates (Corner Points)

	1	2	3	4
x	0.53	0.51	0.455	0.472
y	0.456	0.485	0.444	0.4

The initial daytime chromaticity of white materials shall fall within the box created by the following coordinates:

Initial Daytime Chromaticity Coordinates (Corner Points)

	1	2	3	4
x	0.355	0.305	0.285	0.355
y	0.355	0.305	0.325	0.375

907-710.06.2--Environmental Requirements. All yellow materials using lead chromate pigments shall meet the criteria of non-hazardous waste as defined by 40 CFR 261.24 when tested in accordance with EPA Test Method 1311, Toxicity Characteristics Leaching Procedures (TCLP). The striping and marking material, upon preparation and installation, shall not exude fumes which are toxic, or detrimental to persons or property. All material using lead free pigments shall NOT contain either lead or other Resource Conservation and Recovery Act (RCCA) materials in excess of the standard defined by EPA Method 3050 and 6010.

907-710.06.3--Acceptance Procedures. Acceptance of all fast dry solvent based traffic paint will be based on the Manufacturer's Certification and Certified Test Results. The Contractor shall furnish the Engineer with three copies of the manufacturer's certification stating that each lot of material in a shipment complies with the requirements of this contract. In addition, the Contractor shall provide Certified Test Reports for all tests required by this specification. The test results shall be representative of the material contained with the shipment.

MISSISSIPPI DEPARTMENT OF TRANSPORTATION

SPECIAL PROVISION NO. 907-711 DB

CODE: (IS)

DATE: 06/26/2009

SUBJECT: Synthetic Structural Fiber Reinforcement

Section 711, Reinforcement and Wire Rope, of the 2004 Edition of the Mississippi Standard Specifications for Road and Bridge Construction is hereby amended as follows:

After Subsection 711.03.4.3 on page 665, add the following:

907-711.04--Synthetic Structural Fiber. The synthetic structural fibers shall be approved for listing in the Department's "Approved Sources of Materials" prior to use. The synthetic structural fibers shall be added to the concrete and mixed in accordance with the manufacturer's recommended methods.

907-711.04.1--Material Properties. The fibers shall meet the requirements of ASTM Designation: C 1116, Section 4.1.3. The fibers shall be made of polypropylene, polypropylene/polyethylene blend, nylon, or polyvinyl alcohol (PVA).

907-711.04.2--Minimum Dosage Rate. The dosage rate shall be such that the average residual strength ratio ($R_{150,3.0}$) of fiber reinforced concrete beams is a minimum of 20.0 percent when the beams are tested in accordance with ASTM Designation: C 1609. The dosage rate for fibers shall be determined by the following.

The fiber manufacturer shall have the fibers tested by an acceptable, independent laboratory acceptable to the Department and regularly inspected by the Cement and Concrete Reference Laboratory of the National Institutes of Standards and Technology and approved to perform ASTM Designations: C 39, C 78, and C192.

The laboratory shall test the fibers following the requirements of ASTM Designation: C 1609 in a minimum of three (3) test specimens cast from the same batch of concrete, molded in 6 x 6 x 20-inch standard beam molds meeting the requirements of ASTM Designation: C 31. The beams shall be tested on an 18-inch span. The tests for $R_{150,3.0}$ shall be performed when the average compressive strength of concrete used to cast the beams is between 3500 and 4500 psi. The tests for compressive strength shall follow the requirements of ASTM Designation: C 39. The average compressive strength shall be determined from a minimum of two (2) compressive strength cylinders.

The value for $R_{150,3}$ shall be determined using the following equation:

$$R_{150,3.0} = \frac{f_{150,3.0}}{f_1} \times 100$$

The residual flexural strength ($f_{150,3.0}$) shall be determined using the following equation:

$$f_{150,3.0} = \frac{P_{150,3.0} \times L}{b \times d^2}$$

where:

$f_{150,3.0}$ is the residual flexural strength at the midspan deflection of $L/150$, (psi),

$P_{150,3.0}$ is the residual load capacity at the midspan deflection of $L/150$, (lbf),

L is the span, (in),

b is the width of the specimen at the fracture, (in), and

d is the depth of the specimen at the fracture, (in).

For a 6 x 6 x 20-inch beam, the $P_{150,3.0}$ shall be measured at a midspan deflection of 0.12 inch.

Additionally, $R_{150,3.0}$, $f_{150,3.0}$, and $P_{150,3.0}$ may also be referred to as R_{150}^{150} , f_{150}^{150} , and P_{150}^{150} respectively.

At the dosage rate required to achieve the minimum $R_{150,3}$, the mixture shall both be workable and the fibers shall not form clumps.

The manufacturer shall submit to the State Materials Engineer certified test reports from the independent laboratory showing the test results of each test specimen.

907-711.04.3--Job Control Requirements. The synthetic structural fibers shall be one from the Department's "Approved Sources of Materials."

At the required dosage rate, the mixture shall both be workable and the fibers shall not form clumps to the satisfaction of the Engineer. If the mixture is determined by the Engineer to not be workable or have clumps of fibers, the mixture may be rejected.

MISSISSIPPI DEPARTMENT OF TRANSPORTATION

SUPPLEMENT TO SPECIAL PROVISION NO. 907-713 DB

DATE: 04/04/2012

SUBJECT: Admixtures for Concrete

After the last sentence of the first paragraph of Subsection 907-713.02 on page 1, add the following.

Admixtures providing a specific performance characteristic(s) other than those of water reduction or set retardation shall meet the minimum requirements for Type S. For admixtures meeting the requirements for Type S, the manufacturer shall provide data to substantiate the specific performance characteristic(s) to the satisfaction of the State Materials Engineer.

MISSISSIPPI DEPARTMENT OF TRANSPORTATION

SPECIAL PROVISION NO. 907-713 DB

CODE: (SP)

DATE: 11/09/2010

SUBJECT: Admixtures for Concrete

Section 713, Concrete Curing Materials and Admixtures, of the 2004 Edition of the Mississippi Standard Specifications for Road and Bridge Construction is hereby amended as follows:

After the second paragraph of Subsection 713.01.2 on page 676, add the following.

Type 1-D compound may be used on bridge rails, median barriers, and other structures requiring a spray finish. When Type 1-D compound is used, it will be the Contractor's responsibility to assure that the compound has dissipated from the structure prior to applying the spray finish and that the spray finish adheres soundly to the structure.

Delete Subsection 713.02 on pages 676 & 677, and substitute the following:

907-713.02--Admixtures for Concrete. Air-entraining admixtures used in Portland cement concrete shall comply with AASHTO Designation: M 154. Set-retarding, accelerating, and/or water-reducing admixtures shall comply with AASHTO Designation: M 194. Water-reducing admixture shall meet the minimum requirements for Type A. Set-retarding admixtures shall meet the minimum requirements for Type D.

In order to obtain approval of an admixture, the State Materials Engineer shall have been furnished certified test reports, made by an acceptable independent laboratory regularly inspected by the Cement and Concrete Reference Laboratory of the National Institutes of Standards and Technology, which show that the admixture meets all the requirements of the applicable AASHTO Standard Specification.

The Department reserves the right to sample, for check tests, any shipment or lot of admixture delivered to a project.

The Department reserves the right to require tests of the material to be furnished, using the specific cement and aggregates proposed for use on the project, as suggested in AASHTO Designation: M 154 and outlined in AASHTO Designation: M 194.

After an admixture has been approved, the Contractor shall submit to the State Materials Engineer, with each new lot of material shipped, a certification from the manufacturer in accordance with the requirements of Subsection 700.05.1 and stating the material is of the same composition as originally approved and has not been changed or altered in any way. The requirement in Subsection 700.05.1(b) is not required on the certification from the manufacturer.

Admixtures containing chlorides will not be permitted.

Failure to maintain compliance with any requirement of these specifications shall be cause for rejection of any previously approved source or brand of admixture.

Admixtures shall only be used in accordance with the manufacturer's recommended dosage range as set forth in the manufacturer's approval request correspondence. When an admixture is used in Portland cement concrete, it shall be the responsibility of the Contractor to produce satisfactory results.

907-713.02.1--Source Approval. In order to obtain approval of an admixture, the Producer/Suppliers shall submit to the State Materials Engineer the following for review: certified test reports, made by an acceptable independent laboratory regularly inspected by the Cement and Concrete Reference Laboratory of the National Institutes of Standards and Technology, which show that the admixture meets all the requirements of the applicable AASHTO or Department Specification for the specific type and the dosage range for the specific type of admixture.

907-713.02.2--Specific Requirements. Admixtures containing chlorides will not be permitted.

907-713.02.3--Acceptance. The Department reserves the right to sample, for check tests, any shipment or lot of admixture delivered to a project.

The Department reserves the right to require tests of the material to be furnished, using the specific cement and aggregates proposed for use on the project, as suggested in AASHTO Designation: M 154 and outlined in AASHTO Designation: M 194.

Failure to maintain compliance with any requirement of these specifications shall be cause for rejection of any previously approved source or brand of admixture.

With each new lot of material shipped the Contractor shall submit to the State Materials Engineer, a notarized certification from the manufacturer showing that the material complies with the requirements of the applicable AASHTO or Department Specification.

When an admixture is used, it shall be the responsibility of the Contractor to produce satisfactory results.

MISSISSIPPI DEPARTMENT OF TRANSPORTATION

SPECIAL PROVISION NO. 907-714 DB

CODE: (SP)

DATE: 11/09/2010

SUBJECT: Miscellaneous Materials

Section 714, Miscellaneous Materials, of the 2004 Edition of the Mississippi Standard Specifications for Road and Bridge Construction is hereby amended as follows:

907-714.05--Fly Ash. Delete Subsections 714.05.1 & 714.05.2 on pages 680 & 681, and substitute the following:

907-714.05.1--General. The fly ash source must be approved for listing in the Department's "Approved Sources of Materials" prior to use. The acceptance of fly ash shall be based on certified test reports, certification of shipment from the supplier, and tests performed on samples obtained after delivery in accordance with the Department's Materials Division Inspection, Testing, and Certification Manual and Department SOP.

Different classes of fly ash or different sources of the same class shall not be mixed or used in the construction of a structure or unit of a structure without written permission from the Engineer.

The Contractor shall provide suitable means for storing and protecting the fly ash from dampness. Separate storage silos, bins, or containers shall be provided for fly ash. Fly ash which has become partially set or contains lumps of caked fly ash shall not be used.

The temperature of the bulk fly ash shall not be greater than 165°F at the time of incorporation into the work.

All classes of fly ash shall meet the supplementary option chemical requirement for available alkalis listed in AASHTO Designation: M 295, Table 2. Class F fly ash shall have a calcium oxide (CaO) content of less than 6.0%. Class C fly ash shall have a CaO content of greater than or equal to 6.0%.

The replacement of Portland cement with fly ash shall be in accordance with the applicable replacement content specified in Subsection 907-701.02.2.

In addition to these requirements, fly ash shall meet the following specific requirements for the intended use.

907-714.05.2--Fly Ash for Use in Concrete. When used with Portland cement in the production of concrete or grout, the fly ash shall meet the requirements of AASHTO Designation: M 295, Class C or F, with the following exception:

The loss on ignition shall not exceed 6.0 percent.

No additional cementitious materials, such as blended hydraulic cement, GGBFS, metakaolin, or others, shall be added to or as a replacement for Portland cement when used with fly ash.

907-714.06--Ground Granulated Blast Furnace Slag (GGBFS). Delete Subsection 714.06.1 on page 681, and substitute the following:

907-714.06.1--General. The GGBFS source must be approved for listing in the Department's "Approved Sources of Materials" prior to use. The acceptance of GGBFS shall be based on certified test reports, certification of shipment from the supplier, and tests performed on samples obtained after delivery in accordance with the Department's Materials Division Inspection, Testing, and Certification Manual and Department SOP.

The Contractor shall provide suitable means for storing and protecting the GGBFS against dampness and contamination. Separate storage silos, bins, or containers shall be provided for GGBFS. GGBFS which has become partially set, caked or contains lumps shall not be used.

The State Materials Engineer shall be notified in writing of the nature, amount and identity of any processing or other additions made to the GGBFS during production.

GGBFS from different mills shall not be mixed or used alternately in any one class of construction or structure without written permission from the Engineer; except that this requirement will not be applicable to cement treatment of design soils or bases.

No additional cementitious materials, such as blended hydraulic cement, fly ash, metakaolin, or others, shall be added to or as a replacement for Portland cement when used with GGBFS in the production of concrete. The replacement of Portland cement with GGBFS shall be in accordance with the applicable replacement content specified in Subsection 907-701.02.2.

Delete Subsection 714.07 on page 682, and substitute the following:

907-714.07--Additional Cementitious Materials.

907-714.07.1--Metakaolin.

907-714.07.1.1--General. Metakaolin shall only be used as a supplementary cementitious material in Portland cement concrete for compliance with the requirements for cementitious materials exposed to soluble sulfate conditions. Metakaolin from different sources shall not be mixed or used alternately in any one class of construction or structure without written permission from the Engineer. No additional cementitious materials, such as blended hydraulic cement, fly ash, GGBFS, or others, shall be added to or as a replacement for Portland cement when used with metakaolin in the production of concrete.

The State Materials Engineer shall be notified in writing of the nature, amount and identity of any processing, or other additions made to the metakaolin during production.

907-714.07.1.2--Source Approval. The approval of each metakaolin source shall be on a case by case basis as determined by the State Materials Engineer. In order to obtain approval of a metakaolin source, the Producer/Suppliers shall submit to the State Materials Engineer the

following for review: certified test reports, made by an acceptable, independent laboratory regularly inspected by the Cement and Concrete Reference Laboratory of the National Institutes of Standards and Technology, which show that the metakaolin meets all the requirements of AASHTO Designation: M295, including the Effectiveness in contributing to sulfate resistance, Procedure A, listed in AASHTO Designation: M295, Table 4 for Supplementary Optional Physical Requirements, and other requirements listed herein.

In order to demonstrate effectiveness in contributing to sulfate resistance, included in this test data shall be results of metakaolin from the proposed source tested in accordance with ASTM Designation: C 1012. There shall be two sets of test specimens per the following:

- a. One set of test specimens shall be prepared using a Type I Portland cement meeting the requirements of AASHTO Designation: M85 and having a tricalcium aluminate (C_3A) content of more than 8.0%,
- b. One set of test specimens shall be prepared using a Type II Portland cement meeting the requirements of AASHTO Designation: M85.
- c. The proposed metakaolin shall be incorporated at the rate of 10% cement replacement in each set of test specimens and shall meet both of the acceptance criteria listed below for source approval.

The requirement for acceptance of the test sample using Type I Portland cement is an expansion of 0.10% or less at the end of six months. The requirement for acceptance of the test sample using Type II Portland cement is an expansion of 0.05% or less at the end of six months.

907-714.07.1.3--Storage. The Contractor shall provide suitable means for storing and protecting the metakaolin against dampness and contamination. Metakaolin which has become partially set, caked, or contains lumps shall not be used.

907-714.07.1.4--Specific Requirements. Metakaolin shall meet the requirements of AASHTO Designation: M 295, Class N with the following modifications:

1. The sum of $SiO_2 + Al_2O_3 + Fe_2O_3$ shall be at least 85%. The Material Safety Data Sheet shall indicate that the amount of crystalline silica, as measured by National Institute of Occupation Safety and Health (NIOSH) 7500 method, after removal of the mica interference, is less than 1.0%.
2. The loss on ignition shall be less than 3.0%.
3. The available alkalies, as equivalent Na_2O , shall not exceed 1.0%.
4. The amount of material retained on a No. 325 mesh sieve shall not exceed 1.0%.
5. The strength activity index at seven (7) days shall be at least 85%.

907-714.07.1.5--Acceptance. With each new lot of material shipped the Contractor shall submit to the State Materials Engineer a certified test report from the manufacturer showing that the material meets the requirements AASHTO Designation: M295, Class N and the requirements of this Subsection.

The Department reserves the right to sample, for check tests, any shipment or lot of metakaolin delivered to a project.

907-714.07.2--Silica Fume.

907-714.07.2.1--General. Silica fume shall only be used as a supplementary cementitious material in Portland cement concrete for compliance with the requirements for cementitious materials exposed to soluble sulfate conditions. Silica fume from different sources shall not be mixed or used alternately in any one class of construction or structure without written permission from the Engineer. No additional cementitious materials, such as blended hydraulic cement, performance hydraulic cement, fly ash, GGBFS, or others, shall be added to or as a replacement for Portland cement when used with silica fume in the production of concrete.

The State Materials Engineer shall be notified in writing of the nature, amount and identity of any processing, or other additions made to the silica fume during production.

907-714.07.2.2--Source Approval. The approval of each silica fume source shall be on a case by case basis as determined by the State Materials Engineer. In order to obtain approval of a silica fume source, the Producer/Suppliers shall submit to the State Materials Engineer the following for review: certified test reports, made by an acceptable, independent laboratory regularly inspected by the Cement and Concrete Reference Laboratory of the National Institutes of Standards and Technology, which show that the silica fume meets all the requirements of AASHTO Designation: M307, Table 3, including the Sulfate resistance expansion, listed in the table for Optional Physical Requirements, and other requirements listed herein.

In order to demonstrate effectiveness in contributing to sulfate resistance, included in this test data shall be results of silica fume from the proposed source tested in accordance with ASTM Designation: C 1012. There shall be two sets of test specimens per the following:

- a. One set of test specimens shall be prepared using a Type I Portland cement meeting the requirements of AASHTO Designation: M85 and having a tricalcium aluminate (C_3A) content of more than 8.0%,
- b. One set of test specimens shall be prepared using a Type II Portland cement meeting the requirements of AASHTO Designation: M85.
- c. The proposed silica fume shall be incorporated at the rate of 8% cement replacement in each set of test specimens and shall meet both of the acceptance criteria listed below for source approval.

The requirement for acceptance of the test sample using Type I Portland cement is an expansion of 0.10% or less at the end of six months. The requirement for acceptance of the test sample using Type II Portland cement is an expansion of 0.05% or less at the end of six months.

907-714.07.2.3--Storage. The Contractor shall provide suitable means for storing and protecting the silica fume against dampness and contamination. Silica fume which has become partially set, caked, or contains lumps shall not be used.

907-714.07.2.4--Acceptance. With each new lot of material shipped, the Contractor shall submit to the State Materials Engineer a certified test report from the manufacturer showing that the material meets the Chemical and Physical Requirements of AASHTO Designation: M307.

The Department reserves the right to sample, for check tests, any shipment or lot of silica fume

delivered to a project.

Delete Subsection 714.11.6 on pages 690 and 691, and substitute the following:

907-714.11.6--Rapid Setting Cementitious Patching Compounds for Concrete Repair.

Rapid setting concrete patching compounds must be approved for listing in the Department's "Approved Sources of Materials" prior to use. Upon approval, a product must be recertified every four (4) years to remain on the "Approved Sources of Materials" list. Each product shall be pre-measured and packaged dry by the manufacturer. All liquid solutions included by the manufacturer as components of the packaged material shall be packaged in a watertight container. The manufacturer may include aggregates in the packaged material or recommend the addition of Contractor furnished aggregates.

The type, size and quantity of aggregates, if any, to be added at the job site shall be in accordance with the manufacturer's recommendations and shall meet the requirements of Subsection 703.02 for fine aggregate and Subsection 703.03 for coarse aggregate. Required mixing water to be added at the job site shall meet the requirements of Subsection 714.01.2.

Only those bonding agents, if any, recommended by the manufacturer of the grout or patching compounds may be used for increasing the bond to old concrete or mortar surfaces.

Patching compounds containing soluble chlorides will not be permitted when in contact with steel.

Site preparation, proportioning of materials, mixing, placing and curing shall be performed in accordance with the manufacturer's recommendation for the specific type of application, and the Contractor shall furnish a copy of these recommendations to the Engineer.

Rapid setting cementitious concrete patching compounds, including components to be added at the job site, shall conform to the following physical requirements:

Non-shrink cementitious grouts shall not be permitted for use.

Compressive strength shall equal or exceed 3000 psi in 24 hours in accordance with ASTM C 928 for Type R2 concrete or mortar.

Bond strength shall equal or exceed 1000 psi in 24 hours in accordance with ASTM C 928 for Type R2 concrete or mortar.

The material shall have a maximum length change of $\pm 0.15\%$ in accordance with ASTM C 928 for Type R2 concrete or mortar.

The Contractor shall furnish to the Engineer three copies of the manufacturer's certified test report(s) showing results of all required tests and certification that the material meets the specifications when mixed and placed in accordance with the manufacturer's instructions. When the mixture is to be placed in contact with steel, the certification shall further state that the

packaged material contains no chlorides. Certified test report(s) and certification shall be furnished for each lot in a shipment.

The proportioning of materials must be approved by the State Materials Engineer and any subsequent change in proportioning must also be approved. A sample of each component shall be submitted to the Engineer along with the quantity or percentage of each to be blended. At least 45 days must be allowed for initial approval.

The proportioning of materials for subsequent lots may be approved by the State Materials Engineer upon receipt of certification from the manufacturer that the new lot of material is the same composition as that originally approved by the Department and that the material has not been changed or altered in any way.

907-714.11.7--Commercial Grout for Anchoring Doweled Tie Bars in Concrete. Before Subsection 714.11.7.1 on page 691, add the following:

Approved Non-“Fast Set” Epoxy anchor systems as specified below may be used for the repair of concrete pavements that do not involve permanent sustained tension applications or overhead applications.

“*Fast Set Epoxy*” may not be used for any Adhesive Anchor Applications. Adhesive Anchor Systems (Fast Set epoxy or otherwise) shall not be used for permanent sustained tension applications or overhead applications. “Fast Set Epoxy” refers to an epoxy produced by the Sika Corporation called Sikadur AnchorFix-3 and repackaged for sale under a variety of names/companies listed at the Federal Highway Administration web site at the following link:

<http://www.fhwa.dot.gov/Bridge/adhesives.cfm>

907-714.11.7.4--Acceptance Procedure. After the last sentence of the first paragraph of Subsection 714.11.4 on page 691, add the following:

Upon approval, a product must be recertified every four (4) years to remain on the “Approved Sources of Materials” list.

907-714.11.8--Epoxy Joint Repair System.

907-714.11.8.1--General. After the last sentence of the first paragraph of Subsection 714.11.8.1 on page 692, add the following:

Upon approval, a product must be recertified every four (4) years to remain on the “Approved Sources of Materials” list.

MISSISSIPPI DEPARTMENT OF TRANSPORTATION

SPECIAL PROVISION NO. 907-715 DB

CODE: (SP)

DATE: 03/10/2009

SUBJECT: Roadside Development Materials

Section 715, Roadside Development Materials, of the 2004 Edition of the Mississippi Standard Specifications for Road and Bridge Construction is hereby amended as follows:

907-715-02.2.1--Agricultural Limestone. Delete the first sentence of Subsection 715-02.2.1 on page 704 and substitute the following.

Agricultural limestone shall be either a hard-rock limestone material or a marl or chalk agricultural liming material as addressed in the latest amendment to the Mississippi Agricultural Liming Material Act of 1993, published by the Mississippi Department of Agriculture and Commerce.

907-715.02.2.1.1--Screening Requirements. Delete the first sentence of Subsection 715.02.2.1.1 on page 704.

Delete Subsection 715.02.2.1.2 on page 704 and substitute the following:

907-715-02.2.1.2--Calcium Carbonate Equivalent. Marl or chalk liming material shall not have less than 70% calcium and magnesium carbonate calculated as calcium carbonate equivalent when expressed on a dry weight basis.

907-715-02.2.1.3--Neutralizing Values. Hard-rock limestone material shall have a minimum Relative Neutralizing Value (RNV) of 63.0%, which is determined as follows:

$$\% \text{ RNV} = \text{CCE} \times (\% \text{ passing } \#10 \text{ mesh} + \% \text{ passing } \#50 \text{ mesh})/2$$

Where: CCE = Calcium Carbonate Equivalent

907-715.03--Seed.

907-715.03.2--Germination and Purity Requirements. Add the following to Table B on page 705.

Name (Kind)	Name (Variety)	Percent Germination	Percent Purity
GRASSES			
Rye Grass	Annual	80	98

MISSISSIPPI DEPARTMENT OF TRANSPORTATION

SPECIAL PROVISION NO. 907-720 DB

CODE: (IS)

DATE: 3/17/2008

SUBJECT: Pavement Markings Materials

Section 720, Pavement Marking Materials, of the 2004 Edition of the Mississippi Standard Specifications for Road and Bridge Construction is hereby amended as follows:

907-720.02--Thermoplastic Pavement Markings. Delete the first paragraph of Subsection 720.02 on page 730 and substitute the following:

The thermoplastic material shall be lead free and conform to AASHTO Designation: M 249 except the glass beads shall be moisture resistant coated.

After the first sentence of the second paragraph of Subsection 720.02 on page 730, add the following:

In addition, the certification for the thermoplastic material shall state that the material is lead free.

MISSISSIPPI DEPARTMENT OF TRANSPORTATION

SPECIAL PROVISION NO. 907-803 DB

CODE: (SP)

DATE: 03/10/2009

SUBJECT: Maturity Meters in Drilled Shafts

Section 803, Deep Foundations, of the 2004 Edition of the Mississippi Standard Specifications for Road and Bridge Construction is hereby amended as follows:

907-803.03--Construction Requirements.

907-803.03.2--Drilled Shafts.

907-803.03.2.3.1.1--Protection of Existing Structures. Delete the fifth sentence of the first paragraph of Subsection 803.03.2.3.1.1 on page 820, and substitute the following:

Advancing an uncased drilled shaft excavation or the use of a vibratory hammer to install casings within 30 feet of a newly constructed shaft will not be permitted unless the concrete in that shaft has attained a compressive strength of 2,500 psi, as determined by cylinder tests, or maturity meter probe when maturity meter readings indicate that the required concrete strength is achieved.

After the first paragraph of Subsection 803.03.2.3.1.1 on page 820, add the following:

If a maturity meter probe is used, it shall be located in the last concrete placed. Procedures for using the maturity meter and developing the strength/maturity relationship shall follow the requirements of AASHTO Designation: T 325 and ASTM Designation: C 1074 specifications. Technicians using the maturity meter or calculating strength/maturity graphs shall be required to have at least two (2) hours of training prior to using the maturity equipment.

907-803.03.2.7--Concrete Placement.

907-803.03.2.7.1--General. Delete the last sentence of the fifth paragraph of Subsection 803.03.2.7.1 on pages 834.

907-803.03.2.8.1--Static Load Tests. Delete the first sentence of the first paragraph of Subsection 803.03.2.8.1 on pages 836 & 837, and substitute the following:

Static load testing shall not begin until the concrete has attained a compressive strength of 3,000 psi as determined from cylinder tests, or maturity meter probe in accordance with Subsection 803.03.2.3.1.1. If a maturity meter probe is used, it shall be located in the last concrete placed.

Delete Subsections 803.04 and 803.05 beginning on page 840 and substitute the following:

907-803.04--Blank.

907-803.05--Blank.

MISSISSIPPI DEPARTMENT OF TRANSPORTATION

SUPPLEMENT TO SPECIAL PROVISION NO. 907-804-13

DATE: 06/05/2012

SUBJECT: Concrete Bridges And Structures

After the second paragraph of Subsection 907-804.02.10 on page 2, add the following.

After the first paragraph of Subsection 804.02.10 on page 850, add the following.

If the Contractor chooses to cure the concrete in accordance with the requirements listed under **Length of Time Defined by Development of Compressive Strength** in Subsection 907-804.03.17, the compressive strength/maturity relationship shall be developed for the mixture design for a minimum of 28 days following the requirements of Subsection 907-804.03.15. The compressive strength/maturity relationship information shall be submitted with the mixture design information.

In the ** Note of Subsection 907-804.02.10 on page 2, delete “metakaolin” from the list of other cementitious materials.

After the first sentence of the last paragraph of Subsection 907-804.02.10 on page 3, add the following.

Mixture designs containing accelerating admixtures will not be approved. Admixtures providing a specific performance characteristic other than those of water reduction or set retardation may be used in accordance with the manufacturer’s recommended dosage range.

After Subsection 907-804.02.10.1.1 on page 3, add the following.

907-804.02.10.1.2--Proportioning on the Basis of Laboratory Trial Mixtures. Delete subparagraph d) of Subsection 804.02.10.1.2 on pages 852 & 853, and substitute the following.

- d) For each proposed mixture, at least three compressive test cylinders shall be made and cured in accordance with AASHTO Designation: T 126. Each change of water-cementitious ratio shall be considered a new mixture. The cylinders shall be tested for strength in accordance with AASHTO Designation: T 22 and shall be tested at 28 days.

After Subsection 907-804.02.10.3 on page 4, add the following.

After Subsection 804.02.10.3 on page 853, add the following.

907-804.02.10.3.1--Slump Retention of Class DS Concrete Mixture Designs. Prior to concrete placement, the Contractor shall provide test results of a slump loss test using approved methods to demonstrate that the mixture meets the four hour requirement in Subsection 907-

803.02.7.1. These tests shall be conducted successfully by an approved testing laboratory within 30 days prior to installation of the trial shaft, with personnel from the Department's Central Laboratory present. The slump loss test shall be conducted at temperatures and conditions similar to those expected at the job site at the time of the installation of the trial shaft. The sample for the slump loss test shall be from a minimum batch size of four cubic yards of concrete. If the time between the previous successful slump loss test and the installation of the trial shaft exceeds 30 days, another successful slump loss test shall be performed on the first truckload of concrete as part of the installation of the trial shaft. This requirement limiting the time between the previous slump loss test and an installation of the trial shaft also applies to Class DS concrete mixture designs being transferred from another project. During any shaft installation a slump loss test shall be conducted by the Contractor at the direction of the Engineer from the concrete at the site for verification of slump loss requirements using a sample from a minimum batch size of four cubic yards of concrete.

Before Subsection 907-804.02.12.3 on page 5, add the following.

907-804.02.12.1.1--Elements of Plan. After item 3) in Subsection 804.02.12.1.1 on page 855, add the following.

4) Job Site Batch Adjustments by Addition of Chemical Admixtures:

The Plan shall address if the Contractor intends to adjust either the slump and/or total air content of a batch on the job site by adding chemical admixture(s) to a batch. The Contractor shall include the names of the personnel designated to perform this batch adjustment, the equipment used to add the chemical admixture(s), and the procedure by which the batch adjustment will be accomplished. Only the Contractor's designated personnel shall adjust a batch. Only calibrated dispensing equipment shall be used to add chemical admixture(s) to a batch. Only the procedure described in section of the Plan shall be utilized.

If the maximum permitted slump or total air content is exceeded after the addition of admixtures at the job site, the concrete shall be rejected.

If the Contractor elects to utilize Job Site Batch Adjustments by Addition of Chemical Admixture within Item 2, Procedures for Corrective Actions for Non Compliance of Specifications, to adjust batches which do not meet the minimum specification requirements for slump and/or total air content, no more than three batches on any one project shall be allowed to be adjusted.

5) Construction of Concrete Bridge Decks, including the following:

- the description of the equipment used for placing concrete on the bridge deck in accordance with Subsection 907-804.03.6 and, as applicable, Subsections 907-804.03.7 and 907-804.03.8 including any accessories added to the pump to ensure the entrained air in the concrete mixture remains entrained during pumping and depositing of the concrete mixture,

- the description of and the number of pieces of equipment used to consolidate the concrete in accordance with Subsection 907-804.03.6.2,
- the description of the equipment used to finish the bridge deck in accordance with Subsection 907-804.03.19.7,
- the plan for ensuring a continuous rate of finishing the bridge deck without delaying the application of curing materials within the time specified in Subsection 907-804.03.17, including ensuring a continuous supply of concrete throughout the placement with an adequate quantity of concrete to complete the deck and filling diaphragms and end walls in advance of deck placement,
- the plan for applying the curing materials within the time specified in Subsection 907-804.03.17,
- the description of the powered fogging equipment in accordance with Subsection 907-804.03.17,
- a sample of the documentation used as the daily inspection report for ensuring maintenance of the continuous wet curing in accordance with Subsection 907-804.03.17, as required,
- the description of the equipment used to apply the liquid membrane, including but not limited to, the nozzles, pumping/pressurization equipment, and liquid membrane tanks, in accordance with Subsection 907-804.03.17,
- the method for determining the rate of applied liquid membrane meets the application rate requirements in accordance with Subsection 907-804.03.17,
- a sample of the documentation used for the application rate verification of the liquid membrane in accordance with Subsection 907-804.03.17.

After Subsection 907-804.03.6.2 on page 7, add the following.

907-804.03.8--Pumping Concrete. Delete the second paragraph of Subsection 804.03.8 on page 866, and substitute the following.

Where concrete mixture is conveyed and placed by mechanically applied pressure (pumping), the equipment shall be suitable in kind and adequate in capacity for the work. The Contractor shall select concrete mixture proportions such that the concrete mixture is pumpable and placeable with the selected equipment.

The pumping equipment shall be thoroughly cleaned prior to concrete placement. Excess form release agent shall be removed from the concrete pump hopper. The Contractor shall prime the pump at no additional cost to the Department by pumping and discarding enough concrete mixture to produce a uniform mixture exiting the pump. At least 0.25 cubic yard of concrete mixture shall be pumped and discarded to prime the pump. This shall be accomplished by using the pump to fill a commercially-available six (6) cubic foot wheelbarrow to overflowing or filling a commercially-available eight (8) cubic foot wheel barrow to level. Only concrete mixture shall be added directly into the concrete pump hopper after placement has commenced. If anything other than concrete mixture is added to the concrete pump hopper, all concrete mixture in the concrete pump hopper and pump line shall be discarded and the pump re-primed at no additional cost to the Department.

The discharge end of the pump shall be of such a configuration that the concrete does not move

in the pump line under its own weight. The intent of this requirement is to ensure that entrained air in the concrete mixture remains entrained during pumping and depositing the concrete mixture. This shall be accomplished with one or both of the following:

- a minimum 10-foot flexible hose attached to the discharge end of a steel reducer having a minimum length of three (3) feet and a minimum reduction in area of 20% which is attached to the discharge end of the pump line, or
- a flexible reducing hose to the discharge end of the pumpline with a minimum reduction in area of 20% over a minimum 10-foot hose length.

Regardless of the configuration chosen, the Contractor shall ensure that the concrete is pumped and does not free-fall more than five (5) feet within the entire length of pump line and after discharge from the end of pump line.

The Contractor shall not have any type of metal elbow, metal pipe, or other metal fitting within five (5) feet of any person during discharge of concrete mixture.

Boom pumps shall have a current Concrete Pump Manufacturers Association’s ASME/ANSI B30.27 certification. Equipment added to the boom and pump line shall meet the pump manufacturer’s specifications and shall not exceed the manufacturer’s maximum recommended weight limit for equipment added to the boom and pump line.

The operation of the pump shall be such that a continuous stream of concrete without air pockets is produced. When pumping is completed, the concrete remaining in the pipe line, if it is to be used, shall be ejected in such a manner that there will be no contamination of the concrete or separation of the ingredients. After this operation, the entire equipment shall be thoroughly cleaned.

Delete Table 6 of Subsection 907-804.03.15 on page 8, and substitute the following.

Table 6
Minimum Compressive Strength Requirements for Form Removal

Forms:

Columns	1000 psi
Side of Beams	1000 psi
Walls not under pressure	1000 psi
Other Parts	1000 psi

Centering:

Under Beams	2400 psi
Under Bent Caps	2000 psi

Limitation for Placing Beams on:

Pile Bents, pile under beam	2000 psi
Frame Bents, two or more columns	2200 psi
Frame Bents, single column	2400 psi

Forms for bridge deck slabs overhead and bridge deck slabs between beams shall be removed with the approval of the Engineer, between two weeks and four weeks after the removal of the wet burlap applied in accordance with Subsection 907-804.03.17.1, or application of liquid membrane applied in accordance with Subsection 907-804.03.17.2.

Delete the second paragraph of Subsection 907-804.03.16.1 on page 9, and substitute the following.

At the option of the Contractor with the approval of the Engineer, when concrete is placed during cold weather and there is a probability that the ambient temperatures will be lower than 40°F, an approved maturity meter may be used to determine concrete strengths by inserting probes into concrete placed in a structure. The minimum number of maturity meter probes required for each structural component shall be in accordance with Table 7. An approved insulating blanketing material shall be used to protect the work when ambient temperatures are less than 40°F and shall remain in place until the required concrete strength in Table 6 is achieved. Within 30 minutes of removal of the insulating blanketing material in any area, the Contractor shall have curing of the concrete established in accordance with the requirements in Subsection 907-804.03.17. Procedures for using the maturity meter and developing the strength/maturity relationship shall follow the requirements of AASHTO Designation: T 325 and ASTM Designation: C 1074 specifications. Technicians using the maturity meter or calculating strength/maturity graphs shall be required to have at least two hours of training prior to using the maturity equipment.

Before Subsection 907-804.03.19 on page 9, add the following.

907-804.03.17--Curing Concrete. Delete Subsection 804.03.17 on pages 874 & 875, and substitute the following.

Curing is defined as all actions taken to ensure the moisture and temperature conditions of freshly placed concrete exist so the concrete may develop its potential properties. Curing shall take place from the time of placement until its potential properties have developed. The Contractor shall use the guidance in ACI 308R-01 to:

- a) cure the concrete in such a manner as to prevent premature moisture loss from the concrete,
- b) supply additional moisture to the concrete as required in order to ensure sufficient moisture within the concrete, and
- c) maintain a concrete temperature beneficial to the concrete.

Curing in accordance with the requirements in either Subsection 907-804.03.17.1 or Subsection 907-804.03.17.2 shall be completely established within 20 minutes after finishing, except as noted for bridge decks. Finishing is complete when the pan drag, burlap drag, or other is complete.

The length of time for curing shall be maintained in accordance with either of the following:

1. Prescribed Length of Time:

- a) Curing following the requirements of Subsection 804.03.17.1 shall continue uninterrupted for at least 14 days.
- b) Curing following the requirements of Subsection 804.03.17.2 shall continue uninterrupted for at least 10 days.

OR

2. Length of Time Defined by Development of Compressive Strength:

Curing following the application requirements of Subsection 907-804.03.17.1 or Subsection 907-804.03.17.2 shall continue uninterrupted for each day's production until the compressive strength of the concrete exceeds 75% of the 28-day compressive strength submitted as the Basis of Proportioning per Subsection 907-804.02.10.1. Therefore, if an area is being cured in accordance with Subsection 907-804.03.17.1, the curing by wet burlap shall continue until the concrete in that area has attained a minimum of 75% of the 28-day compressive strength submitted as the Basis of Proportioning per Subsection 907-804.02.10.1. Likewise, if an area is being cured in accordance with Subsection 907-804.03.17.2, the curing by liquid membrane shall continue until the concrete in that area has attained a minimum of 75% of the 28-day compressive strength submitted as the Basis of Proportioning per Subsection 907-804.02.10.1.

The compressive strength of the concrete may be determined by the use of maturity meter in accordance with Subsection 907-804.03.15.

907-804.03.17.1--Water With Waterproof Cover. All burlap shall be completely saturated and wet prior to placing it on the concrete. The burlap shall have been fully soaked in water for a minimum of 12 hours prior to placement on the concrete.

For bridge decks, the Contractor shall apply one (1) layer of saturated burlap within 20 minutes of the initial strike-off for bridges without a skew and 25 minutes of the initial strike-off for bridges with a skew. For all other concrete, the Contractor shall apply one (1) layer of saturated burlap within 20 minutes of completing finishing.

Following the first layer of burlap, the Contractor shall apply a second layer of saturated burlap within five (5) minutes of applying the first layer. The concrete surface shall not be allowed to dry after strike-off or at any time during the curing period.

The Contractor shall maintain the burlap in a fully wet condition using powered fogging equipment capable of producing a fog spray of atomized droplets of water until the concrete has gained sufficient strength to allow foot traffic without the foot traffic marring the surface of the concrete. Burlap shall not be maintained in the fully wet condition using equipment which does not produce a fog spray of atomized droplets of water or by use of manually pressurized sprayers. For bridge decks, once the concrete has gained sufficient strength to allow foot traffic which does not mar the surface of the concrete, soaker hoses shall be placed on the burlap. The soaker hoses shall then be supplied with running water continuously to maintain continuous saturation of all burlap and the entire concrete surface.

If there is a delay in the placement of the first layer of saturated burlap outside the time limit, the struck-off and finished concrete shall be kept wet by use of the powered fogging equipment used to keep the burlap wet.

White polyethylene sheets shall be placed on top of the wet burlap and, as applicable, soaker hoses covering the entire concrete surface as soon as practical and not more than 12 hours after the placement of the concrete. White polyethylene sheets of the widest practical width shall be used, overlapping adjacent sheets a minimum of six inches (6") and tightly sealed with an adhesive like pressure sensitive tape, mastic, glue, or other approved methods to form a complete waterproof cover of the entire concrete surface. White polyethylene sheets which overlap a minimum of two feet (2') may be held in place using means other than an adhesive. The white polyethylene sheets shall be secured so that wind will not displace them. The Contractor shall immediately repair the broken or damaged portions or replace sections that have lost their waterproof qualities.

If burlap and/or white polyethylene sheets are temporarily removed for any reason during the curing period, the Contractor shall keep the entire exposed area continuously wet. The saturated burlap and white polyethylene sheets shall be replaced, resuming the specified curing conditions, as soon as possible.

The Contractor shall inspect the concrete surface once every 8 hours for the entirety of the curing period, so that all areas remain wet for the entire curing period and all curing requirements are satisfied and document the inspection in accordance with Subsection 907-804.03.17.1.1.

At the end of the curing period, one coating of liquid membrane shall be applied following the requirements of Subsection 907-804.03.17.1.2. The purpose of the coating of liquid membrane is to allow for slow drying of the concrete. The application of liquid membrane to any area shall be complete within 30 minutes of the beginning of removal of the white polyethylene sheets, soaker hoses, and burlap from this area.

907-804.03.17.1.1--Documentation. The Contractor shall provide the Engineer with a daily inspection report that includes:

- documentation that identifies any deficiencies found (including location of deficiency);
- documentation of corrective measures taken;
- a statement of certification that all areas are wet and all curing material is in place on the entire bridge deck;
- documentation showing the time and date of all inspections and the inspector's signature;
- documentation of any temporary removal of curing materials including location, date and time, length of time curing was removed, and means taken to ensure exposed area was kept continuously wet.

907-804.03.17.1.2--Liquid Membrane. At the end of the 14-day wet curing period the wet burlap and polyethylene sheets shall be removed and within 30 minutes, the Contractor shall apply white liquid membrane to the deck. The liquid membrane shall be thoroughly mixed within the time recommended by the liquid membrane producer but no more than an hour before use. If the use of liquid membrane results in a streaked or blotched appearance, the method shall be stopped and water curing applied until the cause of defective appearance is corrected.

The liquid membrane shall be applied when no free water remains on the surface but while the surface is still wet. The liquid membrane shall be applied according to the manufacturer's instructions with a minimum spreading rate per coat of one (1) gallon per 200 square feet of concrete surface. If the concrete is dry or becomes dry, the Contractor shall thoroughly wet it with water applied as a fog spray by means of approved equipment.

The application of liquid membrane shall be accomplished by the use of power applied spray equipment using nozzles and other equipment recommended by the liquid membrane producer. Manually pressurized or manual pump-up type sprayers shall not be used to apply the first application of liquid membrane.

As a visual guide, the color of concrete covered with the required amount of liquid membrane should be indistinguishable from a sheet of commercially available standard "letter" size white copier paper placed on top of it when viewed from a distance of about five feet (5') away horizontally if standing on the same grade as the concrete. The appearance of the concrete does not supersede applying the minimum spreading rate.

The coating shall be protected against marring for at least seven (7) days after the application of the curing compound. The coating on bridge decks shall receive extra attention and may require additional protection as required by the Engineer. All membrane marred or otherwise disturbed shall be given an additional coating. Manually pressurized or manual pump-up type sprayers may be used for giving marred areas the required additional application of liquid membrane. Should the surface coating be subjected repeatedly to injury, the Engineer may require that the water curing method be applied at once.

The 7-day period during which the liquid membrane is applied and protected shall not be reduced even if the period of wet curing is extended past the required 14 days.

907-804.03.17.1.2.1--Liquid Membrane Documentation. The Contractor shall make available to the Engineer an application rate verification method and any information necessary during application of the liquid membrane to verify that the rate of application meets the prescribed rate for the various surfaces of the concrete, including, but not limited to, the top surface of the bridge deck and exposed sides of the bridge deck after any forms are removed. The Contractor shall submit this application verification method to the Engineer in accordance with Subsection 907-804.02.12.1.1.

One method of verifying the rate of application is as follows:

1. Determine the volume of liquid membrane in the container. For a container with a uniform cross-sectional area, for example a 55-gallon drum, determine the area of the cross-section. Determine the height of the surface of the liquid membrane from the bottom of the container. This may be accomplished by inserting a sufficiently long, clean dip-stick parallel with the axis of the container into the liquid membrane until the inserted end of the dip-stick contacts the bottom of the container. On removing the dip-stick, measure the length from the end which was inserted to the point on the dip-stick where the liquid

- membrane ceases to coat the dip-stick. Multiply the area of the cross-section by the height of the level of liquid membrane, maintaining consistent units, to determine the volume.
2. Perform step 1 prior to beginning applying the liquid membrane to establish the initial volume.
 3. During the period of application, perform step 1 each 100 square feet of bridge deck.
 4. In order to meet the required application rate of one (1) gallon per 200 square feet, the amount in the container shall be at least 0.5 gallon less than the previous volume in the previous 100 square feet. Other changes in volume may apply depending on the manufacturer's recommended application rate.
 5. Additional applications to an area shall be applied until the required rate is satisfied. Areas which are not visually satisfactory to the Engineer shall have additional liquid membrane applied as directed by the Engineer.

The amount of liquid membrane applied shall be determined each day using the application verification method. This information shall be submitted to the Engineer within 24 hours of applying the liquid membrane.

907-804.03.17.2--Liquid Membrane Method. Surfaces on which curing is to be by liquid membrane shall be given the required surface finish prior to the application of liquid membrane. Concrete surfaces cured by liquid membrane shall receive two applications of white liquid membrane. Neither application shall be made from a position supported by or in contact with the freshly placed concrete. Both applications shall be applied perpendicularly to the surface of the concrete.

When using liquid membrane, the liquid membrane shall be thoroughly mixed within the time recommended by the liquid membrane producer but no more than an hour before use. If the use of liquid membrane results in a streaked or blotched appearance, the method shall be stopped and water curing applied until the cause of defective appearance is corrected.

The application of liquid membrane shall be accomplished by the use of power applied spray equipment using nozzles and other equipment recommended by the liquid membrane producer. Manually pressurized or manual pump-up type sprayers shall not be used to apply the first two applications of liquid membrane.

The liquid membrane shall be applied when no free water remains on the surface but while the surface is still wet. The liquid membrane shall be applied according to the manufacturer's instructions with a minimum spreading rate per coat of one (1) gallon per 200 square feet of concrete surface. If the concrete is dry or becomes dry, the Contractor shall thoroughly wet it with water applied as a fog spray by means of approved equipment.

The first application of the liquid membrane shall be made as the work progresses. For bridge decks, the first application shall be completed in each area of the deck within 20 minutes of initial strike-off for bridges with no skew and within 25 minutes of initial strike-off for bridges with skew. For all other concrete, the first application of the liquid membrane shall be completed within 20 minutes of finishing.

The second application shall be applied within 30 minutes after the first application. The liquid

membrane shall be uniformly applied to all exposed concrete surfaces.

As a visual guide, the color of concrete covered with the required amount of liquid membrane should be indistinguishable from a sheet of commercially available standard “letter” size white copier paper placed on top of it when viewed from a distance of about five feet (5’) away horizontally if standing on the same grade as the concrete. The appearance of the concrete does not supersede applying the minimum spreading rate.

The Contractor shall make available to the Engineer an application rate verification in accordance with Subsection 907-804.03.17.1.2.1.

The coating shall be protected against marring for at least 10 days after the application of the curing compound. The coating on bridge decks shall receive extra attention and may require additional protection as required by the Engineer. All membrane marred or otherwise disturbed shall be given an additional coating. Manually pressurized or manual pump-up type sprayers may be used for giving marred areas the required additional application of liquid membrane. Should the surface coating be subjected repeatedly to injury, the Engineer may require that the water curing method be applied at once.

Delete Subsection 907-804.19.7 on page 9, and substitute the following.

907-804.03.19.7--Finishing Bridge Decks.

907-804.03.19.7.1--General. Delete the third paragraph of Subsection 804.03.19.7.1 on page 884, and substitute the following.

Except when indicated otherwise on the plans, the finish of the bridge deck shall be either a belt finish, a broom finish, or one of the following drag methods: pan, double pan, burlap, or pan and burlap. Manual finishing of the bridge deck shall be performed only in areas inaccessible by the finishing equipment mounted to the strike-off screed, but shall not hinder the requirements for curing in accordance with Subsection 907-804.03.17.1. The surface texture specified and surface requirements shall be in accordance with the applicable requirements of Subsections 501.03.17 and 501.03.18 modified only as the Engineer deems necessary for bridge deck construction operations.

At no time shall water on the surface of the concrete from bleeding, fogging, curing, or other sources be worked into the concrete or used as an aid for finishing.

Regardless of the method of finishing selected, requirements for curing per Subsection 907-804.03.17 shall be completed within the specified time limits. If the requirements in Subsection 907-804.03.17 are not completed within the specific time limits, the Contractor shall cease operations, revise his operations up to and including acquiring new or additional equipment or additional personnel in order to satisfy the requirements in Subsection 907-804.03.17, and, on approval from the Engineer, resume operations

907-804.03.19.7.2--Longitudinal Method. Before the first paragraph of Subsection 804.03.19.7.2 on page 884, add the following.

The longitudinal method may be used for repairs to bridge decks or bridge widening projects. For bridge widening projects, the time for establishing curing in accordance with Subsections 907-804.03.17 shall be increased to within 30 minutes for bridges without skew and within 35 minutes for bridges with skew.

907-804.03.19.7.3--Transverse Method. Delete the first sentence of the second paragraph of Subsection 804.03.19.7.3 on page 885, and substitute the following.

The machine shall be so constructed and operated as to produce a bridge deck of uniform density with minimum manipulation of the fresh concrete and achieved in the shortest possible time.

Delete the fourth paragraph of Subsection 804.03.19.7.3 on page 885, and substitute the following.

At least one dry run shall be made the length of each pour with a "tell-tale" device attached to the screed carriage to assure the specified clearance to the reinforcing steel.

Delete the last sentence of the fifth paragraph of Subsection 804.03.19.7.3 on page 885, and substitute the following.

The screed shall be mechanically actuated to deliver the screeding action and for travel in a longitudinal direction at a uniform rate along the bridge deck.

Delete the last paragraph of Subsection 804.03.19.7.3 on page 886, and substitute the following.

Other finishing requirements shall be in accordance with the general requirements in Subsection 907-804.03.19.7.1 and as specified on the plans.

Regardless of the finish, the requirements for curing per Subsection 907-804.03.17 shall be completed within the specified time limits.

After Subsection 907-804.03.19.7.4 on page 9, add the following.

Delete the title of Subsection 804.03.19.7.4.1.3 on page 888, and substitute the following.

907-804.03.19.7.4.1.3--Final Surface Texture.

907-804.03.20--Opening Bridges.

907-804.03.20.2--Construction Traffic. Delete the paragraph in Subsection 804.03.20.2 on page 889, and substitute the following:

Unless otherwise specified, the concrete bridge decks shall be closed to construction traffic for the time required for curing in Subsection 907-804.03.17 and until the required compressive strength for the concrete is obtained.

MISSISSIPPI DEPARTMENT OF TRANSPORTATION

SPECIAL PROVISION NO. 907-804 DB

CODE: (SP)

DATE: 11/09/2010

SUBJECT: Concrete Bridges And Structures

Section 804, Concrete Bridges And Structures, of the 2004 Edition of the Mississippi Standard Specifications for Road and Bridge Construction is hereby amended as follows:

907-804.02-- Materials.

907-804.02.1--General. Delete the third and fourth sentences of the first paragraph of Subsection 804.02.1 on page 846, and substitute the following:

For projects with 1000 cubic yards and more, quality control and acceptance shall be achieved through statistical evaluation of test results. For projects of more than 200 but less than 1000 cubic yards, quality control and acceptance shall be achieved by individual test results.

Add the following materials to the list of materials in Subsection 804.02.1 on page 847.

Blended Cement..... 907-701.01 and 907-701.04
 Ground Granulated Blast Furnace Slag (GGBFS)..... 907-714.06
 Silica Fume 907-714.07.2

907-804.02.8--Laboratory Accreditation. In Table 1 of Subsection 804.02.8 on page 849, substitute AASHTO: R 39 - Making and Curing Concrete Test Specimens in the Laboratory for AASHTO: T 126 - Making and Curing Concrete Test Specimens in the Laboratory.

907-804.02.9--Testing Personnel. Delete Table 2 in this subsection and replace it with the following.

Table 2

Concrete Technician's Tasks	Test Method Required	Certification Required**
Sampling or Testing of Plastic Concrete	AASHTO Designation: T 23, T 119, T 121, T 141, T 152, T 196, and ASTM Designation: C 1064	MDOT Class I certification
Compressive Strength Testing of Concrete Cylinders	AASHTO Designation: T 22 and T 231	MDOT Concrete Strength Testing Technician certification
Sampling of Aggregates	AASHTO Designation: T 2	Work under the supervision of an MDOT Class II certified technician
Testing of Aggregates	AASHTO Designation: T 19,	MDOT Class II certification

	T 27, T 84, T 85, T 248, and T 255	
Proportioning of Concrete Mixtures*	AASHTO Designation: M 157 and R 39	MDOT Class III
Interpretation and Application of Maturity Meter Readings	AASHTO Designation: T 325 and ASTM Designation: C 1074	MDOT Class III or Two hours maturity method training

* Technicians making concrete test specimens for meeting the requirements of Subsection 804.02.10.1.2 shall be MDOT Class I certified and under the direct supervision of an MDOT Class III certified technician.

** MDOT Class I certification encompasses the same test procedures and specifications as ACI Concrete Field Testing Technician Grade I. MDOT Class II certification encompasses the same test procedures and specifications as ACI Aggregate Testing Technician - Level 1. MDOT Concrete Strength Testing Technician encompasses the same test procedures and specifications as ACI Concrete Strength Testing certification.

For specifics about the requirements for each level of certification, please refer to the latest edition of the Department's *Concrete Field Manual*. Technicians holding current MDOT Class I, MDOT Class II and/or MDOT Class III certifications shall be acceptable until those certifications expire. Upon a current certification expiration, recertification with the certifications listed in Table 2 shall be required. Technicians currently performing either specific gravity testing of aggregates or compressive strength tests shall be required to either:

- have the required MDOT certification listed in Table 2, or
- have a current MDOT Class III certification or work under the direct supervision of current MDOT Class III technician, and have demonstrated the specific gravity and/or compressive strength test during the inspection of laboratory equipment by the Materials Division, Concrete Section.

907-804.02.10--Portland Cement Concrete Mix Design. Delete the first sentence of the first paragraph of Subsection 804.02.10 on page 850 and substitute the following:

At least 30 days prior to production of concrete, the Contractor shall submit to the Engineer proposed concrete mixture designs complying with the Department's *Concrete Field Manual*.

Delete the Notes under Table 3 of Subsection 804.02.10 on pages 850 & 851, and substitute the following:

- * Maximum size aggregate shall conform to the concrete mix design for the specified aggregate.
- ** The replacement limits of Portland cement by weight by other cementitious materials (such as fly ash, GGBFS, metakaolin, silica fume, or others) shall be in accordance with the values in Subsection 907-701.02. Other hydraulic cements may be used in accordance with the specifications listed in Section 701.
- *** The slump may be increased up to eight (8) inches with:
 - an approved water-reducing admixture,

- an approved water-reducing/set-retarding admixture, or
 - a combination of an approved water-reducing admixture and an approved set-retarding admixture, in accordance with 907-713.02. Minus slump requirements shall meet those set forth in Table 3 of AASHTO Designation: M157.
- **** Entrained air is not required except for concrete exposed to seawater. For concrete exposed to seawater, the total air content shall be 3.0 % to 6.0%. For concrete not exposed to seawater, the total air content shall not exceed 6.0%.
- ***** Class DS Concrete for drilled shafts shall have an 8±1-inch slump.

Delete the last paragraph of Subsection 804.02.10 on page 851 and substitute the following:

At least one water-reducing admixture shall be used in all classes of concrete in accordance with the manufacturer's recommended dosage range. Any combinations of admixtures shall be approved by the Engineer before their use.

907-804.02.10.1.1--Proportioning on the Basis of Previous Field Experience of Trial Mixtures. Delete the first sentence of the first paragraph of Subsection 804.02.10.1.1 on page 851, and substitute the following:

Where a concrete production facility has a record, based on at least 10 consecutive strength tests from at least 10 different batches within the past 12 months from a mixture not previously used on Department projects, the standard deviation shall be calculated.

907-804.02.10.3--Field Verification of Concrete Mix Design. Delete the first sentence of the third paragraph of Subsection 804.02.10.3 on page 853 and substitute the following:

For all Classes of concrete, the mixture shall be verified to yield within 2.0% of the correct volume when all the mix water is added to the batch.

For all Classes of concrete other than DS, F, and FX, the mixture shall produce a slump within a minus 1½-inch tolerance of the maximum permitted for mixtures with a maximum permitted slump of three inches (3") or less or within a minus 2½-inch tolerance of the maximum permitted for mixtures with a maximum permitted slump of greater than three inches (3"), and producing a total air content within a minus 1½ percent tolerance of the maximum allowable air content in Table 3.

For Class DS, the slump shall be within the requirements in Note ***** below Table 3. For Class DS exposed to seawater, the total air content shall be within a minus 1½ percent tolerance of the maximum allowable air content in Note ***** below Table 3. For Class DS not exposed to seawater the total air content shall be within the requirements in Note **** below Table 3.

For Classes F and FX, the slump shall be within a minus 1½-inch tolerance of the maximum permitted for mixtures with a maximum permitted slump of three inches (3") or less or within a minus 2½-inch tolerance of the maximum permitted for mixtures with a maximum permitted slump of greater than three inches (3"). For Classes F and FX exposed to seawater, the total air content shall be within a minus 1½ percent tolerance of the maximum allowable air content in

Note **** below Table 3. For Classes F and FX not exposed to seawater the total air content shall be within the requirements in Note **** below Table 3.

Delete the third sentence of the third paragraph of Subsection 804.02.10.3 on page 853, and substitute the following:

If the requirements of yield, slump, or total air content are not met within three (3) production days after the first placement, subsequent field verification testing shall not be permitted on department projects, and the mix design shall not be used until the requirements listed above are met

907-804.02.10.4--Adjustments of Mixture Proportions. Delete the paragraph in Subsection 804.02.10.4 on page 854, and substitute the following:

The mixture may be adjusted by the Class III Certified Technician representing the Contractor in accordance with the allowable revisions listed in the Department's Concrete Field Manual, paragraph 5.7. Written notification shall be submitted to the Engineer a minimum of seven (7) days prior to any source or brand of material change, aggregate size change, allowable material type change, or decrease in any cementitious material content. Any adjustments of the concrete mixture design shall necessitate repeat of field verification procedure as described in Subsection 804.02.10.3 and approval by the Engineer.

907-804.02.11--Concrete Batch Plants. Delete the first three paragraphs of Subsection 804.02.11 on page 854, and substitute the following:

The concrete batch plant shall meet the requirements of the National Ready Mixed Concrete Association *Quality Control Manual, Section 3, Plant Certification Checklist* as outlined in the latest edition of the Department's *Concrete Field Manual*. The Contractor shall submit a copy of the approved checklist along with proof of calibration of batching equipment, i.e., scales, water meter, and admixture dispenser, to the Engineer 30 days prior to the production of concrete.

For projects with 1000 cubic yards and more, the concrete batch plant shall meet the requirements for an automatic system capable of recording batch weights. It shall also have automatic moisture compensation for the fine aggregate. For projects of more than 200 but less than 1000 cubic yards the plant can be equipped for manual batching with a fine aggregate moisture meter visible to the plant operator.

The concrete batch plant shall have available adequate facilities to cool concrete during hot weather.

Mixer trucks to be used on the project are to be listed in the checklist and shall meet the requirements of the checklist.

907-804.02.12--Contractor's Quality Control. Delete the fourth paragraph of Subsection 804.02.12 on page 854 & 855, and substitute the following:

The Contractor's Quality Control program shall encompass the requirements of AASHTO Designation: M 157 into concrete production and control, equipment requirements, testing, and batch ticket information. The requirement of AASHTO Designation: M 157, Section 11.7 shall

be followed except, on arrival to the job site, a maximum of 1½ gallons per cubic yard is allowed to be added. Water shall not be added at a later time. If the maximum permitted slump is exceeded after the addition of water at the job site, the concrete shall be rejected.

907-804.02.12.3--Documentation. After the second sentence of the second paragraph of Subsection 804.02.12.3 on page 856, add the following:

Batch tickets and gradation data shall be documented in accordance with Department requirements. Batch tickets shall contain all the information in AASHTO Designation: M157, Section 16 including the additional information in Subsection 16.2 with the following exception: the information listed in paragraphs 16.2.7 and 16.2.8 is not required. Batch tickets shall also contain the concrete producer's permanent unique mix number assigned to the concrete mix design.

907-804.02.12.5--Non-Conforming Materials. In Table 4 of Subsection 804.02.12.5 on page 857, delete “/ FM” from the requirements on line B.3.a.

In Table 4 of Subsection 804.02.12.5 on page 857, replace “One set (two cylinders) for 0-100 yd³ inclusive” with “A minimum of one set (two cylinders) for each 100 yd³,”

907-804.02.13--Quality Assurance Sampling and Testing. Delete subparagraph c) in Subsection 804.02.13 on page 858 and substitute the following:

- c) For concrete, the Contractor's QC and Department's QA testing of concrete compressive strengths compare when using the data comparison computer program with an alpha value of 0.01 for projects with 1000 cubic yards and more; or, strength comparisons are within 990 psi for projects of more than 200 but less than 1000 cubic yards.

In Table 5 of Subsection 804.02.13 on page 858, delete “and FM” from the requirements on line A.3.

Delete Subsection 907-804.02.13.1 beginning on page 859 and substitute the following:

907-804.02.13.1--Basis of Acceptance.

907-804.02.13.1.1--Sampling. Sampling of concrete mixture shall be performed in accordance with the latest edition of the Department's *Concrete Field Manual*.

907-804.02.13.1.2--Slump. Slump of plastic concrete shall meet the requirements of Table 3: MASTER PROPORTION TABLE FOR STRUCTURAL CONCRETE DESIGN. A check test shall be made on another portion of the sample before rejection of any load.

907-804.02.13.1.3--Air. Total air content of concrete shall be within the specified range for the class of concrete listed in Table 3: MASTER PROPORTION TABLE FOR STRUCTURAL CONCRETE DESIGN. A check test shall be made on another portion of the sample before rejection of any load.

907-804.02.13.1.4--Yield. If the yield of the concrete mix design is more than plus or minus 3% of the designed volume, the mix shall be adjusted by a Class III Certified Technician representing the Contractor to yield the correct volume plus or minus three percent ($\pm 3\%$). If batching of the proportions of the mix design varies outside the batching tolerance range of the originally approved proportions by more than the tolerances allowed in Subsection 804.02.12.1, the new proportions shall be field verified per Subsection 804.02.10.3.

907-804.02.13.1.5--Temperature. Cold weather concreting shall follow the requirements of Subsection 907-804.03.16.1. Hot weather concreting shall follow the requirements of Subsection 804.03.16.2 with a maximum temperature of 95°F for Class DS concrete or for concrete mixes containing cementitious materials meeting the requirements of Subsection 907-701.02.2 as a replacement of Portland cement. For other concrete mixes, the maximum concrete temperature shall be 90°F. Concrete with a temperature more than the maximum allowable temperature shall be rejected and not used in Department work.

907-804.02.13.1.6--Compressive Strength. Laboratory cured concrete compressive strength tests shall conform to the specified strength (f'_c) listed in the specifications. Concrete represented by compressive strength test below the specified strength (f'_c) may be removed and replaced by the Contractor. If the Contractor elects not to remove the material, it will be evaluated by the Department as to the adequacy for the use intended. All concrete evaluated as unsatisfactory for the intended use shall be removed and replaced by the Contractor at no additional cost to the Department. For concrete allowed to remain in place, reduction in payment will be as follows:

Projects with 1000 Cubic Yards and More. When the evaluation indicates that the work may remain in place, a statistical analysis will be made of the QC and QA concrete test results. If this statistical analysis indicates at least 93% of the material would be expected to have a compressive strength equal to or greater than the specified strength (f'_c) and 99.87% of the material would be expected to have a compressive strength at least one standard deviation above the allowable design stress (f_c), the work will be accepted. If the statistical analysis indicates that either of the two criteria are not met, the Engineer will provide for an adjustment in pay as follows for the material represented by the test result.

Total Pay on Material in Question = Unit Price - (Unit Price x % Reduction)

$$\% \text{ Reduction} = \frac{(f'_c - X)}{f'_c - (f_c + s)} \times 100$$

where:

- f'_c = Specified 28-day compressive strength, psi
- X = Individual compressive strength below f'_c , psi
- s = standard deviation, psi*
- f_c = allowable design stress, psi

* Standard deviation used in the above reduction of pay formula shall be calculated from the applicable preceding compressive strengths test results plus the individual compressive

strength below f'_c . If below f'_c strengths occur during the project's first ten compressive strength tests, the standard deviation shall be calculated from the first ten compressive strength tests results.

Projects of More Than 200 but Less Than 1000 Cubic Yards. When the evaluation indicates that the work may remain in place, a percent reduction in pay will be assessed based on a comparison of the deficient 28-day test result to the specified strength. The Engineer will provide for an adjustment in pay as follows for the material represented by the test result.

Total Pay on Material in Question = Unit Price - (Unit Price x % Reduction)

$$\% \text{ Reduction} = \frac{(f'_c - X)}{f'_c} \times 100$$

where:

f'_c = Specified 28-day compressive strength, psi

X = Individual compressive strength below f'_c , psi

907-804.03--Construction Requirements.

907-804.03.6--Handling and Placing Concrete.

907-804.03.6.2--Consolidation. After the last sentence of Subsection 804.03.6.2 on page 864, add the following:

If the Department determines that there is an excessive number of projections, swells, ridges, depressions, waves, voids, holes, honeycombs or other defects in the completed structure, removal of the entire structure may be required as set out in Subsection 105.12.

907-804.03.15--Removal of Falsework, Forms, and Housing. Delete the first sentence of the second paragraph of Subsection 804.03.15 on page 871, and substitute the following:

Concrete in the last pour of a continuous superstructure shall have attained a compressive strength of 2,400 psi, as determined by cylinder tests or maturity meter probe, prior to striking any falsework.

Delete the first sentence of the third paragraph of Subsection 804.03.15 on page 871, and substitute the following:

At the Contractor's option and with the approval of the Engineer, the time for removal of forms may be determined by cylinder tests, in accordance with the requirements listed in Table 6, in which case the Contractor shall furnish facilities for testing the cylinders.

Delete the fourth and fifth paragraphs of Subsection 804.03.15 on pages 871 & 872, and substitute the following:

The cylinders shall be cured under conditions which are not more favorable than those existing for the portions of the structure which they represent.

Delete the table in Subsection 804.03.15 on page 872, and substitute the following:

Table 6
Minimum Compressive Strength Requirements for Form Removal

Forms:

Columns	1000 psi
Side of Beams	1000 psi
Walls not under pressure	1000 psi
Floor Slabs, overhead	2000 psi
Floor Slabs, between beams	2000 psi
Slab Spans	2400 psi
Other Parts	1000 psi

Centering:

Under Beams	2400 psi
Under Bent Caps	2000 psi

Limitation for Placing Beams on:

Pile Bents, pile under beam	2000 psi
Frame Bents, two or more columns	2200 psi
Frame Bents, single column	2400 psi

In lieu of using concrete strength cylinders to determine when falsework, forms, and housings can be removed, an approved maturity meter may be used to determine concrete strengths by inserting probes into concrete placed in a structure. The minimum number of maturity meter probes required for each structural component shall be in accordance with Table 7. Falsework, forms, and housings may be removed when maturity meter readings indicate that the required concrete strength is achieved. Procedures for using the maturity meter and developing the strength/maturity relationship shall follow the requirements of AASHTO Designation: T 325 and ASTM Designation: C 1074 specifications. Technicians using the maturity meter or calculating strength/maturity graphs shall be required to have at least two hours of training prior to using the maturity equipment.

Table 7
Requirements for use of Maturity Meter Probes

Structure Component	Quantity of Concrete	No. of Probes
Slabs, beams, walls, & miscellaneous items	0 - 30 yd ³	2
	> 30 to 60 yd ³	3
	> 60 to 90 yd ³	4
	> 90 yd ³	5
Footings, Columns & Caps	0 - 13 yd ³	2
	> 13 yd ³	3
Pavement, Pavement Overlays	1200 yd ²	2
Pavement Repairs	Per repair or 900 yd ² Whichever is smaller	2

907-804.03.16--Cold or Hot Weather Concreting.

907-804.03.16.1--Cold Weather Concreting. After the third paragraph of Subsection 804.03.16.1 on page 873, add the following:

In lieu of the protection and curing of concrete in cold weather, at the option of the Contractor with the approval of the Engineer, when concrete is placed during cold weather and there is a probability of ambient temperatures lower than 40°F, an approved maturity meter may be used to determine concrete strengths by inserting probes into concrete placed in a structure. The minimum number of maturity meter probes required for each structural component shall be in accordance with Table 7. An approved insulating blanketing material shall be used to protect the work when ambient temperatures are less than 40°F and shall remain in place until the required concrete strength in Table 6 is achieved. Procedures for using the maturity meter and developing the strength/maturity relationship shall follow the requirements of AASHTO Designation: T 325 and ASTM Designation: C 1074 specifications. Technicians using the maturity meter or calculating strength/maturity graphs shall be required to have at least two hours of training prior to using the maturity equipment.

Rename the Table in Subsection 804.03.16.1 on page 874 from “Table 6” to “Table 8”.

907-804.03.19--Finishing Concrete Surfaces.

907-804.03.19.7--Finishing Bridge Floors.

907-804.03.19.7.4--Acceptance Procedure for Bridge Deck Smoothness. After the first sentence of the second paragraph of Subsection 804.03.19.7.4 on page 886, add the following:

Auxiliary lanes, tapers, shoulders and other areas that are not checked with the profilograph, shall meet a 1/8 inch in 10-foot straightedge check made transversely and longitudinally across the deck or slab.

Delete Subsections 804.04 and 804.05 beginning on page 897 and substitute the following:

907-804.04—Blank.

907-804.05—Blank.

TABLE OF CONTENTS

1.0 INTRODUCTION1-1

1.1 PROJECT DESCRIPTION 1-1

1.2 PLAN SET DEVELOPMENT 1-1

2.0 DESIGN AND CONSTRUCTION RESPONSIBILITIES2-1

2.1 DESIGN CRITERIA 2-1

2.2 DESIGN REVIEW..... 2-1

2.2.1 *Design Review Requirements* 2-1

2.2.2 *Preliminary Design Phase (Minimum 30% Plans)* 2-1

2.2.3 *Optional Design Review*..... 2-2

2.2.4 *Final Design Review Phases (100% Plans)*..... 2-2

2.2.5 *Released for Construction Documents.* 2-2

2.2.6 *Request for Information (RFI) Process.* 2-3

2.2.7 *Request for Revision (RFR) Process*..... 2-3

2.2.8 *As-Built Drawings and Records.* 2-3

2.3 PROJECT MANAGEMENT 2-4

2.4 KEY PERSONNEL..... 2-5

2.5 DELIVERABLES..... 2-6

3.0 QUALITY CONTROL/QUALITY ASSURANCE (QC/QA) 1

3.1 DESIGN QUALITY CONTROL REQUIREMENTS 1

3.2 CONSTRUCTION TESTING REQUIREMENTS 1

3.3 MDOT’S CONSTRUCTION JOB ACCEPTANCE..... 1

3.4 MDOT INSPECTION AND TESTING 2

3.5 CONTRACTOR’S OBLIGATION..... 2

3.6 DELIVERABLES..... 2

4.0 NOT USED.....4-1

5.0 ENVIRONMENTAL COMPLIANCE.....5-1

5.1 COMPLIANCE WITH ENVIRONMENTAL COMMITMENTS 5-1

5.2 DESIGN PHASE 5-1

5.3 PRECONSTRUCTION CONFERENCE(S) 5-1

5.4 CONSTRUCTION PHASE(S) 5-1

5.5 PROTECTION OF ARCHEOLOGICAL AND PALEONTOLOGICAL REMAINS AND MATERIALS 5-2

5.6 WETLANDS AND WATER QUALITY MITIGATION 5-2

5.7 REGULATORY COMPLIANCE..... 5-3

5.8 HAZARDOUS MATERIAL 5-3

5.8.1 *Contractor Responsibilities* 5-3

5.8.2 *Commission Responsibilities*..... 5-3

5.8.3 *Resuming Work*..... 5-3

5.8.4 *Contractor’s Hazardous Materials*..... 5-3

5.9 DELIVERABLES..... 5-3

6.0 NOT USED.....6-1

7.0 UTILITIES.....7-1

7.1 COMMISSION’S RESPONSIBILITIES 7-1

TABLE OF CONTENTS

7.2 CONTRACTOR’S RESPONSIBILITY 7-1

7.3 RESOLUTION OF CONFLICTS 7-1

7.4 UTILITY AVOIDANCE AND LOSSES 7-1

7.5 PARALLEL SERVICE 7-1

7.6 COORDINATION 7-2

7.7 DOCUMENTATION 7-2

7.8 CERTIFICATION..... 7-2

7.9 UTILITY AS-BUILTS 7-2

7.10 DELIVERABLES..... 7-2

8.0 RIGHT-OF-WAY8-1

8.1 NEW RIGHT-OF-WAY 8-1

9.0 SURVEY9-1

9.1 PROJECT SURVEY COORDINATION 9-1

9.2 CONTRACTOR SUPPLIED SURVEY..... 9-1

9.3 PRESERVATION OF SURVEY CONTROL MONUMENTS..... 9-1

9.4 PERMISSION TO ENTER PROPERTY 9-1

9.5 RIGHT OF WAY MARKER 9-1

9.6 DELIVERABLES..... 9-1

10.0 GEOTECHNICAL.....10-1

10.1 GEOTECHNICAL DESIGN CRITERIA 10-1

 10.1.1 *New Structures*..... 10-1

 10.1.2 *Widened Structures*..... 10-1

10.2 GROUND IMPROVEMENT 10-2

10.3 GEOTECHNICAL PLANNING REPORT..... 10-2

10.4 GEOTECHNICAL EXPLORATION 10-3

 10.4.1 *General*..... 10-3

 10.4.2 *Bridge Foundations*..... 10-3

 10.4.3 *Retaining Walls*..... 10-3

 10.4.4 *High Volume Change Soils*..... 10-3

 10.4.5 *Embankments* 10-4

 10.4.6 *Cut Slopes* 10-4

 10.4.7 *Laboratory Testing*..... 10-4

 10.4.8 *Geotechnical Report* 10-4

10.5 DEEP FOUNDATION VERIFICATION..... 10-5

 10.5.1 *Driven Piles*..... 10-5

 10.5.2 *Drilled Shafts* 10-5

 10.5.3 *Deliverables*..... 10-6

11.0 SIGNING, PAVEMENT MARKING.....11-1

11.1 SIGNING 11-1

11.2 PAVEMENT MARKING..... 11-1

 11.2.1 *Permanent Pavement Marking* 11-1

 11.2.2 *Temporary Pavement Marking* 11-1

12.0 DRAINAGE.....12-1

12.1 DRAINAGE CRITERIA 12-1

TABLE OF CONTENTS

12.2 COORDINATION WITH OTHER AGENCIES..... 12-1

12.3 BRIDGES OVER WATERWAYS..... 12-1

12.4 DELIVERABLES..... 12-1

13.0 ROADWAYS AND PAVEMENTS13-1

13.1 ROADWAY DESIGN CRITERIA..... 13-1

13.2 HORIZONTAL ALIGNMENT 13-1

13.3 VERTICAL ALIGNMENT..... 13-1

13.4 RAMP LOCATION **ERROR! BOOKMARK NOT DEFINED.**

13.5 RAMP INTERSECTION ALIGNMENT..... **ERROR! BOOKMARK NOT DEFINED.**

13.6 EARTHWORK AND GRADING..... 13-1

13.7 PAVEMENT DESIGN LIFE..... 13-1

13.8 PAVEMENT SELECTION 13-2

13.9 ROADWAY SAFETY..... 13-3

 13.9.1 Notes for Table 13-9-1..... 13-3

13.10 DELIVERABLES..... 13-4

14.0 NOT USED.....14-1

15.0 WIDENED STRUCTURES15-1

15.1 DESIGN METHODOLOGY 15-1

15.2 LOADS AND FORCES..... 15-1

 15.2.1 Live Loads 15-1

 15.2.2 Thermal Movement 15-1

15.3 GENERAL REQUIREMENTS FOR BRIDGES..... 15-1

 15.3.1 Bridge Superstructures..... 15-1

 15.3.2 Bridge Substructures..... 15-2

 15.3.3 Debris Removal..... 15-2

15.4 BRIDGE DESIGN CRITERIA..... 15-3

 15.4.1 Concrete Design..... 15-3

 15.4.2 Structural Steel Design..... 15-5

 15.4.3 Structural Steel Fabrication Requirements..... 15-6

 15.4.4 Deep Foundation Design..... 15-8

 15.4.5 Bearings..... 15-8

 15.4.6 Bridge Railings..... 15-9

 15.4.7 Expansion Joints..... 15-9

 15.4.8 Bridge Drainage..... 15-9

 15.4.9 Cranes on Existing Bridges..... 15-9

 15.4.10 Load Rating..... 15-10

 15.4.11 Temporary Concrete Traffic Barriers..... 15-10

15.5 DELIVERABLES..... 15-10

16.0 NEW STRUCTURES..... ERROR! BOOKMARK NOT DEFINED.

16.1 DESIGN METHODOLOGY **ERROR! BOOKMARK NOT DEFINED.**

16.2 LOADS AND FORCES..... **ERROR! BOOKMARK NOT DEFINED.**

 16.2.1 Live Loads *Error! Bookmark not defined.*

 16.2.2 Thermal Movement *Error! Bookmark not defined.*

16.3 GENERAL REQUIREMENTS FOR BRIDGES..... **ERROR! BOOKMARK NOT DEFINED.**

 16.3.1 Bridge Superstructures..... *Error! Bookmark not defined.*

TABLE OF CONTENTS

16.3.2 Bridge Substructures..... *Error! Bookmark not defined.*

16.4 BRIDGE DESIGN CRITERIA..... **ERROR! BOOKMARK NOT DEFINED.**

 16.4.1 Concrete Design..... *Error! Bookmark not defined.*

 16.4.2 Structural Steel Design..... *Error! Bookmark not defined.*

 16.4.3 Paint System..... *Error! Bookmark not defined.*

 16.4.4 Structural Steel Fabrication Requirements..... *Error! Bookmark not defined.*

 16.4.5 Deep Foundation Design..... *Error! Bookmark not defined.*

 16.4.6 Bearings..... *Error! Bookmark not defined.*

 16.4.7 Bridge Railings..... *Error! Bookmark not defined.*

 16.4.8 Expansion Joints..... *Error! Bookmark not defined.*

 16.4.9 Bridge Drainage..... *Error! Bookmark not defined.*

 16.4.10 Load Rating..... *Error! Bookmark not defined.*

16.5 DELIVERABLES..... **ERROR! BOOKMARK NOT DEFINED.**

17.0 MAINTENANCE OF TRAFFIC DURING CONSTRUCTION17-2

 17.1 TRAFFIC CONTROL PLANS..... 17-2

 17.2 CONSTRUCTION REQUIREMENTS..... 17-2

 17.3 PROTECTIVE BARRIERS FOR THE CONSTRUCTION ZONE SHALL BE ANCHORED TO THE EXISTING BRIDGE DECKS
 PER SECTION 15.4.11. EMERGENCY EVENTS 17-3

 17.4 BEARING REPLACEMENT..... 17-3

 17.5 DELIVERABLES..... 17-3

18.0 TECHNICAL STANDARDS, DATA, REPORTS18-1

SECTION 1.0 - INTRODUCTION**1.0 INTRODUCTION**

These Technical Requirements for Design and Construction provide the technical requirements for the Project. Initially capitalized terms used herein shall have the meaning as set forth in Special Provision No. 907-101 DB or Subsection 101.02 of Mississippi Standard Specifications for Road and Bridge Construction

Wherever in this document there is a reference to FHWA, AASHTO or other technical standards it is intended to refer to the list of contract required technical documents listed in Section 18.

1.1 Project Description

The Project Scope is defined as indicated in Section 904 – NTP No. 2618-D3-1 DB and on the Contractor's Schedule Certificate.

1.2 Plan Set Development

The development of the construction drawings for the Project shall follow MDOT's standard format for construction plans. The Released for Construction drawings each shall be prepared so that the Released for Construction drawings will form a portion of the overall Project set of drawings.

SECTION 2.0 – DESIGN AND CONSTRUCTION RESPONSIBILITIES

2.0 DESIGN AND CONSTRUCTION RESPONSIBILITIES

2.1 Design Criteria

It shall be the responsibility of the Contractor to design the Project using English units in accordance with the design criteria contained in these Technical Requirements.

The Contractor shall provide a completed set of construction plans with each sheet signed and sealed by a Professional Engineer licensed by the State.

Construction plans will be developed in Microstation Version 8.1 or later and GeoPak or as agreed to by MDOT and the Contractor.

2.2 Design Review

2.2.1 Design Review Requirements

Contractor shall submit the number of copies shown in Table 2.2-1 for preliminary and final design. Each submittal by the Contractor shall also contain PDF of all drawing and PDF copies of all reports and other submittal items. PDF drawings shall be black and white (22 inches X 36 inches) and 300 DPI. Cross sections shall be submitted with final design submittal.

Table 2.2-1
Required Quantities—Construction Plan Sets

Commission Use	Number of Plan Sets
½ scale (11” x 17”) plans	20
Specifications	20
Reports	6
Calculations	6

Responses to MDOT’s comments shall be returned within 14 Calendar days after the comments have been provided.

2.2.2 Preliminary Design Phase (Minimum 30% Plans)

The Contractor will prepare and submit a single preliminary design submittal for each location. Preliminary design shall include roadway plan and profile, bridge layouts (foundation plan, elevation view, and typical cross section), drainage, erosion control, major signs, pavement marking, and traffic control plans. Pavement marking plans may be omitted if the lane lines are provided on the roadway plan sheets. MDOT will review preliminary design submittals within twenty-one (21) days of the submittal. MDOT will provide any review comments.

The Contractor shall submit a certification that the submittal complies with the Design Quality Control Plan.

**SECTION 2.0 – DESIGN AND CONSTRUCTION
RESPONSIBILITIES**

The Contractor shall schedule a meeting to be held after the review period with MDOT to review the comments. The Contractor shall incorporate the comments into the final design submittal to MDOT's satisfaction, unless an explanation satisfactory to MDOT is provided explaining why a comment has not been addressed in the final design.

2.2.3 Optional Design Review

At the request of the Contractor, MDOT will provide optional design reviews on design packages. MDOT, as appropriate, will review optional design Submittals within fourteen (14) days. MDOT will provide any review comments.

The Contractor may schedule a meeting with MDOT to be held after the review period to review the comments. The Contractor shall incorporate the comments into the plans and specifications to MDOT's satisfaction, unless an explanation satisfactory to MDOT is provided explaining why a comment has not been addressed in the final design

2.2.4 Final Design Review Phases (100% Plans).

After completion of the preliminary design, the final design may be broken down into packages (i.e. roadway, portions of bridges, drainage, etc.) as determined by the Contractor. Following completion of the design of a package, the Contractor shall prepare and submit a final design submittal for each package for review by MDOT. MDOT, as appropriate, will review the final design submittals within twenty-one (21) days. MDOT will provide any review comments.

The Contractor shall schedule a meeting to be held after the review period with MDOT to review the comments. The Contractor shall incorporate the comments into the plans and specifications to MDOT's satisfaction, unless an explanation satisfactory to MDOT is provided explaining why a comment has not been addressed in the final design

The final design submittal and any resubmittals required shall include drawings, details, specifications, computations, and supporting data to establish fully the intent of all construction to be accomplished. Final design submittals for bridges shall include the bridge load ratings and independent check calculations. All material shall be prepared under the supervision of and stamped by an engineer(s), surveyor(s), or architect, as appropriate, licensed to practice in the State of Mississippi.

The Contractor shall submit a certification that the submittal complies with the Design Quality Control Plan.

2.2.5 Released for Construction Documents.

Following the incorporation of MDOT's comments from the final design review phase, the Contractor shall prepare and submit a Release for Construction (RFC) submittal to MDOT for MDOT's final review and Released for Construction stamp. Two (2) full size reproducible sets, two (2) half scale sets of plans, two (2) sets of Project specifications, two (2) sets of all reports and quantities for civil construction shall be submitted to MDOT. The Contractor shall have a Professional Engineer licensed in the State, stamp and sign each sheet of the plans. MDOT shall either stamp the plans and specifications "Released for Construction" and return one (1) full size reproducible set to the Contractor or return comments within seven (7) days. Once plans/specifications are Released for Construction, the Contractor shall provide twenty (20) copies of half scale sets of plans to MDOT within seven (7) days.

SECTION 2.0 – DESIGN AND CONSTRUCTION RESPONSIBILITIES

The Contractor shall submit a certification that the submittal complies with the Design Quality Control Plan.

MDOT’s stamping of drawings as “Released for Construction” does not substantiate the adequacy or acceptability of the design or relieve the Contractor of its obligation to comply with all provisions of the Contract.

2.2.6 Request for Information (RFI) Process.

Any questions concerning clarification of the plans or specifications, substitutions or alternate concepts shall be submitted to the Engineer of Record for response with a copy to the MDOT Project Engineer. The Engineer of Record is responsible for providing the response to the Contractor. If the substitution or alternate concept is not acceptable to MDOT, then MDOT is responsible for providing a comment to the Engineer of Record and Contractor within 3 working days of receipt of the completed RFI (hard copy) and associated documents (if any). MDOT will provide either the response or a schedule of when a response will be completed. If MDOT does not have an objection, and the Engineer of Record provides a clarification to the RFI then the Engineer of Record shall provide a response to the RFI and return the completed RFI to the Contractor. The Contractor will then submit the RFI to MDOT.

If the Engineer of Record agrees to a substitution or alternate concept then the RFI becomes a Request for Revision and follows the process detailed below.

The RFI shall use the attached form or similar document.

2.2.7 Request for Revision (RFR) Process.

Any revisions to the plans and specifications desired by Contractor or to correct deficiencies in the construction documents after the Submittal has been Released for Construction will require a Request for Revision (RFR). The Contractor shall submit a Request for Revision to MDOT. These shall be resubmitted to MDOT for review and re-release according to Section 2.2.5.

All Requests for Revision shall include the following: justification narrative, copies of pertinent correspondence, jurisdictional sign-off as necessary, any additional governmental approvals, index of impacted agencies with review comments and/or acknowledgements, preliminary drawings, engineering calculations and specifications, as necessary.

MDOT may accept or reject any Request for Revision. If MDOT accepts an RFR, the Contractor shall finalize all pertinent documentation, including final design drawings and specifications for final review and Release for Construction.

In no event shall the RFR process be used to change the Contract scope.

2.2.8 As-Built Drawings and Records.

1. Contractor Responsibilities. In addition to those documents set forth above, the Contractor shall provide to MDOT thirty (30) days after completion of a portion of the Project a complete set of record plans. Record drawings consist of the final design documents listed as follows: design plan CADD (Microstation) drawings, Geopak files and PDF files that incorporate all changes, including any adjustments, plan and profiles

SECTION 2.0 – DESIGN AND CONSTRUCTION RESPONSIBILITIES

of relocated utilities, additions and deletions that occurred during construction. The Contractor shall certify that the record drawings are a true and correct representation of the Work as constructed.

2. Plan Revision Box. Information regarding major revisions to the plans shall be noted in a revision box on the plans. The information listed in the revision box shall include: the initiator of the revision, date, and a brief explanation of the nature of the revision.
3. Contents. In addition to the revisions that incorporated changes during construction, the record drawings shall include the following information gathered during construction:
 - a. The final profile of each bridge constructed. The profile shall include the elevation along the centerline and a line three feet inboard of each gutter line. Points on the profile shall be taken at no greater than 25-foot intervals and shall include the beginning and end of each span.
 - b. If any structure has pile foundations, information concerning the pile driving operation shall be listed to include pile and driving equipment data, final pile bearing, elevation of pile tip when plan bearing was obtained, final pile tip elevation, penetration into the ground, and pile driving analysis or wave evaluation analysis program data. This information shall be entered on each footing or bent sheet, or be included as a new sheet inserted immediately following the pertinent footing or bent sheet.
 - c. If any structure has drilled shaft foundations, information concerning the installation of the shaft shall be listed to include the drilled shaft report. This information shall be entered on each footing or bent sheet, or be included as a new sheet inserted immediately following the pertinent footing or bent sheet.
 - d. The verification of the final location of all existing and relocated utility lines and electrical conduit lines & structures that are within the Project Right-of-Way.
 - e. The final location of all pipes, culverts, and drainage structures.
 - f. All shop drawings in hard copy and PDF format.
4. Submission Requirements. Record drawings shall be submitted as follows:
 - a. One half-scale (Roadway and Bridge) (18" x 12") bond paper copy
 - b. One copy on compact disc in PDF format set up to print full size.
 - c. Microstation CADD (roadway and bridge) drawings shall conform to MDOT standard levels and symbology used to develop the design drawings for the Project.

2.3 Project Management

The Contractor shall be responsible for ensuring that the Project is constructed in conformance with the Contract, all referenced documents and specifications, and applicable Laws.

SECTION 2.0 – DESIGN AND CONSTRUCTION RESPONSIBILITIES

The Contractor shall provide Project management services sufficient to supervise the activities of its subcontractors. The Contractor shall provide a sufficient number of persons on Site to provide for the construction management of the Project.

The Contractor shall attend meetings when requested by MDOT. The meetings shall include the Contractors Project Director or his designee, the Construction Manager and the project superintendent. The meeting will not be requested more than once weekly during the construction period.

All meeting between MDOT and the Contractor shall have meeting minutes prepared by the Contractor. The meeting minutes shall be completed and sent to MDOT for concurrence within 5 days of the meeting.

Without relieving the Contractor of any of its responsibilities under the Contract, the Project Director or an approved designee must be present on Site, or within close proximity, fulltime as the Work is performed, have full authority to make the final decisions on behalf of the Contractor and have responsibility for communicating these decisions directly to MDOT.

Without relieving the Contractor of any of its responsibilities under the Contract, MDOT will provide representatives assigned to the Project to monitor the Project progress and provide necessary coordination between MDOT and the Contractor. MDOT and Federal Highway Administration (FHWA) representatives will have full and complete access to the Project, the Work in progress, the Daily Diaries, and to other technical documents and Project records associated with design, construction, materials, quality control, materials installation, and testing. MDOT representatives shall be given seventy-two (72) hours advance notice and have the opportunity to participate in any meetings that may be held concerning the Project or the relationship between the Contractor and their consultants and subcontractors when such meetings are associated with technical matters, progress, or quality of the Project. As used in this paragraph, “notice” shall require actual written notice to the Engineer.

All correspondence to MDOT from the Contractor shall be accompanied by a transmittal using a sequential document number. Each transmittal will be addressed to the Engineer and will list the Project name and Project number. This will be followed by a subject reference that will be used as the document name. All correspondence is to be signed by the Project Director. Any other form of correspondence will not be considered as binding. Emails to various team members will also be entered into document control, but will not be considered as official correspondence for purposes of direction unless backed up with a signed hard copy.

The Contractor shall provide a monthly status report with the monthly pay estimate, on all design submittals, Requests for Information and Requests for Revision.

2.4 Key Personnel

The Contractor shall maintain a directory of Key Personnel and contact numbers and shall provide at least one copy to MDOT and maintain a copy on-site. Key Personnel will include:

1. Project Director – The Project Director shall be the primary person in charge of and responsible for delivery of the Project in accordance with the contract requirements. The Project Director or an approved designee must be present on site fulltime as the work is performed, have full authority to make the final decisions on behalf of the Contractor and have responsibility for communicating these decisions directly to MDOT.

**SECTION 2.0 – DESIGN AND CONSTRUCTION
RESPONSIBILITIES**

2. Lead Design Engineer – The Lead Design Engineer shall be a licensed Professional Engineer and in charge of and responsible for all aspects of the design of the Project (road, bridge, hydrology, and geotechnical).
3. Construction Manager – The Construction Manager reports directly to the Project Director and shall be responsible for the overall coordination of the Project including design and construction.
4. Environmental Manager – The Environmental Manager shall be responsible for adherence to all environmental requirements and commitments, including but not limited to erosion control inspections as required by the National Pollutant Discharge Elimination System (NPDES), the terms of the Categorical Exclusion, if any, and other environmental rules and regulations.

The Contractor shall not change or substitute any such Key Personnel except due to retirement, death, disability, incapacity or voluntary or involuntary termination of employment, or as otherwise approved by MDOT.

In order to obtain MDOT approval of a change to Key Personnel, a written request shall be delivered to MDOT’s Authorized Representative. The request shall include:

1. The nature of the desired change;
2. The reason for the desired change;
3. A statement of how the desired change will meet the required qualifications for the position/responsibility; and
4. A description of how the modification is proposed to be made.

No such modification will be made without prior written approval from MDOT.

2.5 Deliverables

At a minimum, the Contractor shall submit the following to MDOT:

SECTION 2.0 – DESIGN AND CONSTRUCTION RESPONSIBILITIES

Deliverable	Review and Comment	Schedule	Reference Section
Preliminary Design Submittal	✓	At the end of Preliminary Design	2.2.2
Final Design Submittal	✓	As Needed	2.2.4
Release for Construction Submittal	✓	Prior to Construction	2.2.5
Request for Information		As Needed	2.2.6
Request for Revisions	✓	As Needed	2.2.7
Governmental Approvals and Permits		Seven (7) days after any correspondence is sent or received	II.D.2 of Section 902
Monthly Status Report	✓	Monthly	2.3

**SECTION 3.0 - QUALITY CONTROL/
QUALITY ASSURANCE (QC/QA)**

3.0 QUALITY CONTROL/QUALITY ASSURANCE (QC/QA)

The Contractor shall prepare and submit a Design Quality Control Plan and a Construction Quality Control Plan.

3.1 Design Quality Control Requirements

The Contractor shall prepare and submit for MDOT’s review and approval a Design Quality Control Plan (DQCP) for the Work. The DQCP shall be submitted to MDOT within seven (7) days from issuance of Notice to Proceed (NTP). The DQCP shall contain complete procedures for the implementation of the DQCP. The DQCP shall include the requirements specified below. No submittal for design review shall be made to MDOT until the applicable sections of the DQCP have been approved by MDOT.

1. Design Quality Control Manager: The Design Quality Control Manager’s responsibilities shall be limited to administering contracts with the independent firms, managing and ensuring Contractor compliance with the DQCP, resolution of quality related issues and certifying submittals comply with the Design Quality Control Plan. Note: These responsibilities cannot be delegated to another person.
2. Documentation: The Contractor shall maintain records of all independent checking of calculations and independent plan checking performed. These records shall be under the physical control of the Design Quality Control Manager in a form acceptable to MDOT. Bridge design and checking shall be completed in accordance with MDOT’s policies.
3. Reporting Functions: The Design Quality Control Manager shall furnish to MDOT a monthly quality report. This monthly report shall include, as a minimum:
 - Summary of QC activities during the month; and
 - Quality problems and resolutions.

3.2 Construction Testing Requirements

The Contractor is required to conduct Quality Control sampling and testing in accordance with Mississippi Standard Specifications for Road and Bridge Construction Section 401.02.5 Contractor’s Quality Management Program and Section 804.02.012 Contractor’s Quality Control, and MDOT Special Provisions for all portions of the Work. All test results shall be provided to MDOT within three (3) working days of the completed test. The cost of these activities will be borne by the Contractor.

The Contractor shall also provide the PDA monitoring and analysis for the all piles as required by Section 10.5

3.3 MDOT’s Construction Job Acceptance

MDOT will perform or cause to be performed Job Acceptance Testing and Inspection.

All materials and every part of the Work shall be subject to MDOT’s Job Acceptance inspection and testing, as well as independent assurance testing by MDOT. MDOT, FHWA and all duly Authorized

**SECTION 3.0 - QUALITY CONTROL/
QUALITY ASSURANCE (QC/QA)**

Representatives shall be allowed access to all parts of the Work and shall be furnished with information and assistance by the Contractor, as required, to make complete and detailed inspections and to do any testing that such representatives deem appropriate.

All sampling and testing will be in accordance with existing AASHTO, ASTM, or test methods used by MDOT. The Contractor shall cooperate with MDOT to allow the necessary testing to be conducted prior to proceeding to the next operation.

In addition, MDOT may perform additional tests to ensure that proper sampling and testing procedures are being followed and that testing equipment is functioning properly. This testing may consist of observing Contractor and MDOT personnel, as well as taking split samples for the purposes of comparison testing.

Sampling frequency shall be as defined in the MDOT Standard Operating Procedure TMD 20-04-00-0000.

3.4 MDOT Inspection and Testing

All materials and every part of the Work shall be subject to MDOT’s Job Acceptance inspection and testing, as well as independent assurance testing by MDOT. MDOT, FHWA and all duly Authorized Representatives shall be allowed access to all parts of the Work and shall be furnished with information and assistance by the Contractor, as required, to make complete and detailed inspections and to do any testing that such representatives deem appropriate. All inspections and all tests conducted by MDOT and/or its duly authorized representatives that meet the acceptance standards constitute acceptance of the materials or Work tested or inspected.

3.5 Contractor’s Obligation

MDOT’s testing in no way relieves the Contractor of its obligation to comply with the Contract requirements. All materials incorporated into the Project shall meet or exceed Contract requirements and specifications. Further, any testing by MDOT will not relieve Contractor of any of its warranty obligations.

3.6 Deliverables

At a minimum, the Contractor shall submit the following to MDOT for review or comments:

Deliverable	Review and Approve	Schedule	Reference Section
Design Quality Control Plan	✓	Seven (7) days following NTP	3.1
Monthly Design and Construction Quality Reports		Monthly	3.2

SECTION 4.0 – NOT USED

4.0 Not Used

SECTION 5.0 – ENVIRONMENTAL COMPLIANCE

5.0 ENVIRONMENTAL COMPLIANCE**5.1 Compliance with Environmental Commitments**

The Contractor shall comply with all environmental commitments and requirements in the NEPA Approval including, but not limited to, the following:

1. The provisions of all environmental permits applicable to the Project, including any restrictions and agreements specifically agreed to or entered into by MDOT in obtaining permits for the Project.
2. Those stipulations and conditions under which the MTC and/or MDOT received the NEPA Approval and any modifications resulting from the re-evaluation of the document.
3. Applicable Laws and regulations relating to potential or actual Hazardous Material that may be encountered in the course of carrying out the Contract.
4. Carrying out all necessary social, economic and environmental studies required by regulatory authorities in the course of the construction.
5. Updating or extending approved permits obtained by the Contractor.

5.2 Design Phase

All plans and designs are to be prepared in accordance with all of the environmental commitments/requirements outlined in the Special Provisions and Notice to Bidders of this Contract and all environmental commitments in the NEPA Approval. The Lead Design Engineer shall assure MDOT that all plans and designs have been prepared in accordance with all of the environmental commitments/requirements by certified letter at the RFC submittal.

5.3 Preconstruction Conference(s)

The Contractor shall conduct one (or more, if appropriate) pre-construction conference(s) prior to any construction activity to discuss environmental and permitting issues, which conference shall include all subcontractors, and to the extent feasible, representatives from the U.S. Army Corp of Engineers, the Mississippi Department of Natural Resources, the Mississippi Department of Environmental Quality, the FHWA, the Contractor, MDOT, and others as deemed necessary.

5.4 Construction Phase(s)

The Contractor shall be responsible for compliance with all of the environmental commitments/requirements outlined in the Special Provisions and Notice to Proposers as provided in environmental commitments contained within the NEPA Approval. The commitments/requirements shall be complied with during all phases of the construction activities. Upon completion of the Construction Work, the Contractor shall certify that all construction activities have complied with all of the environmental commitments/requirements. MDOT will have the authority to suspend all Work for non-compliance with the environmental commitments/requirements.

SECTION 5.0 – ENVIRONMENTAL COMPLIANCE

5.5 Protection of Archeological and Paleontological Remains and Materials

1. If archeological or paleontological remains are uncovered, the Contractor shall immediately halt operation in the area of the discovery and notify MDOT.
2. Archeological remains consist of any materials made or altered by man which remain from historic or prehistoric times (*i.e.* older than 50 years). Examples include old pottery fragments, metal, wood, arrowheads, stone implements or tools, human burials, historic docks, structures or not recent (*i.e.* older than 100 years) vessel ruins. Paleontological remains consist of old animal remains, original or fossilized, such as teeth, tusks, bone, or entire skeletons.
3. MDOT will have the authority to suspend the Work for the purpose of preserving, documenting, and recovering the remains and materials of archeological and paleontological importance for the State. The Contractor shall carry out all instructions of MDOT for the protection of archeological or paleontological remains, including steps to protect the Site from vandalism and unauthorized investigations, from accidental damage and from dangers such as heavy rainfall or runoff.

5.6 Wetlands and Water Quality Mitigation

1. The Contractor shall fulfill the terms and conditions of both the Clean Water Act Section 404 permit and the Section 401 Water Quality Certification, as required by the U.S. Army Corps of Engineers and the Mississippi Department of Natural Resources, respectively. The Contractor shall be responsible for all stream and/or wetland mitigation required to fulfill the permitting requirements.
2. The Contractor shall maintain the natural low flow characteristics of all stream crossings, including temporary crossings as required in the approved permits.
3. The Contractor shall provide the following list of deliverable items when applicable:
 - Wetland and stream mitigation engineering drawings;
 - Constructed wetland and stream mitigation that meets standards of regulating agencies;
 - Certificate of completed mitigation.
4. If the Contractor's work extends outside of the Categorical Exclusion obtained by MDOT the Contractor shall provide:
 - Copy of permit applications;
 - Copy of approved permits; and
 - Certificate of completed mitigation.

SECTION 5.0 – ENVIRONMENTAL COMPLIANCE

5.7 Regulatory Compliance

The Contractor shall be responsible for all fines and penalties that may be assessed by an agency with jurisdiction in connection with the Contractor's failure to comply with applicable Environmental Laws or Environmental Approvals. Further, it shall be the Contractor's responsibility to correct, at its own expense, any violations caused by the Contractor. Immediately upon receiving a written notice of violation or similar notification, the Contractor shall notify MDOT and provide all correspondence and details of the resolution of these warnings and/or violations.

5.8 Hazardous Material

5.8.1 Contractor Responsibilities

The Contractor is responsible for handling, storage, remediation, or disposal of any materials, wastes, substances and chemicals deemed to be hazardous under applicable state or federal law, (hereinafter "Hazardous Substances") encountered at the site which were known or should have been known at the time of submission of the remediation plan or introduced to the site by the Contractor or any of its agents. Upon encountering any Hazardous Substances, the Contractor shall stop Work immediately in the affected area and duly notify MDOT and, if required by state or federal law, all government or quasi-government entities with jurisdiction over the Project or site.

5.8.2 Commission Responsibilities

Upon receiving notice of unidentified Hazardous Substances, the Commission will take necessary measures required to ensure that the Hazardous Substances are remediated or rendered harmless. Such necessary measures will include the Commission either (i) retaining qualified independent firm or (ii) negotiating a supplemental agreement with the Contractor.

5.8.3 Resuming Work

The Contractor shall resume Work at the affected area of the Project only after written notice from MDOT in the case of Hazardous Substances unidentified in the remediation plan that the (i) Hazardous Substances have been removed or rendered harmless and (ii) all necessary approvals have been obtained from all government and quasi-government entities having jurisdiction over the Project.

5.8.4 Contractor's Hazardous Materials

The Contractor is responsible for Hazardous Materials actually brought to the Project by Contractor, Contractor's design consultants, subcontractors and suppliers or anyone for whose acts they may be or are liable. The Contractor is responsible for negligent or willful acts by the Contractor, Contractor's design consultants, subcontractors and suppliers or anyone for whose acts they may be responsible or are liable relating to Hazardous Substances found at the site.

5.9 Deliverables

The Contractor shall provide the following list of deliverable items:

Deliverables	Review and	Schedule	Reference
--------------	------------	----------	-----------

SECTION 5.0 – ENVIRONMENTAL COMPLIANCE

	Comment		Section
Wetland and stream mitigation engineering drawings	✓	With final design plan submittal	5.6
Copy of Permit Applications		When Permit is submitted	5.6
Copy of Approved Permits		When Permit is approved	5.6
Certification of Completed Mitigation		When Certificate is received	5.6

SECTION 6.0 – NOT USED

6.0 Not Used

SECTION 7.0 – UTILITIES

7.0 UTILITIES**7.1 Commission’s Responsibilities**

The Commission has no utility relocation responsibility for this Contract.

7.2 Contractor’s Responsibility

As part of the Project Scope, the Contractor shall have the responsibility of coordinating the Project construction with all utilities that may be affected as listed in Notice to Proposers 2382 DB. The Contractor shall be responsible for identifying the utility affected, coordinating an appropriate relocation, and shall use either the utility’s own forces to complete the work or shall complete the work utilizing a contractor approved by the utility. The Contractor will be responsible for management and coordination of any utility relocation, including the submission of new or revised permit application(s). Contractor shall include the cost of utility management in his lump sum Contract Price.

Should the Contractor encounter a utility not listed in Notice to Proposers 2382 DB, the Contractor shall notify Commission in writing immediately. The contractor shall then prepare a cost estimate in the form of utility agreement and submit the cost estimates to MDOT for review and approval by MDOT prior to work commencing on any relocation. Relocation of any utility not listed in Notice to Proposers 2382 DB shall be considered Extra Work. For those utilities requiring relocation, the Contractor shall conform with Commission’s “A Policy for Accommodating Utilities on Highway Rights of Way” and the Code of Federal Regulations, Title 23, Chapter 1, Subchapter G, part 645, subparts A and B.

7.3 Resolution of Conflicts

The resolution of any conflicts between utility companies and the construction of the Project shall be the responsibility of the Contractor. No additional compensation (time or dollars) will be allowed for any delays, inconveniences, damage sustained by Contractor or its subcontractors due to interference from utilities or the operation of relocating utilities for those utilities listed in Notice to Proposers 2382 DB. If the Contractor experiences delays with the Utility companies, MDOT shall be promptly notified and will cooperate and assist with reasonable requests from the Contractor in resolving the disputes between the parties.

7.4 Utility Avoidance and Losses

The Contractor shall design the Project to avoid conflicts with utilities where possible, and minimize impacts where conflicts cannot be avoided. Contractor will be responsible for all wastewater discharges and for water loss that occur in association with construction within the right-of-way during the term of the Contract.

7.5 Parallel Service

Contractor will maintain parallel service throughout any utility relocation construction. Contractor will ensure that major service interruptions are avoided.

SECTION 7.0 – UTILITIES**7.6 Coordination**

The Contractor shall initiate early coordination with all affected utilities and provide the utility companies with design plans for their use in developing Relocation Sketches as soon as the plans have reached a level of completeness adequate to allow the companies to fully understand the Project impacts. If a party other than the utility company prepares Relocation Sketches, there shall be a concurrence box on the plans where the utility company signs and accepts the Relocation Sketches as shown.

7.7 Documentation

The Contractor shall be responsible for collecting and submitting to Commission the following from each utility company that is located within the Project limits:

1. New or revised permit application(s) for relocation;
2. Relocation Sketches;
3. Utility Agreements including cost estimate and relocation plans for all affected utilities in accordance with the terms of the executed MOA's;
4. Letters of "no conflict" where the company's facilities will not be impacted by the Project.

The Contractor shall assemble the information included in the Utility Agreements and Relocation Sketches in a final and complete form and in such a manner that MDOT may approve the submittals with minimal review. The Contractor shall ensure that there are no conflicts with the proposed highway improvements, or between each of the utility companies' relocation plans. The Contractor shall not begin their relocation work until authorized in writing by MDOT.

7.8 Certification

At the time the Contractor notifies MDOT that the Project has reached Final Completion, the Contractor shall certify to MDOT that 1) all utilities have been identified 2) that the utilities have been relocated as necessary, and 3) any related claims have been satisfied or will be satisfied by the Contractor

7.9 Utility As-Builts

The Contractor shall accurately show the final location plan and profile of all utilities on the as-built drawings for the Project.

7.10 Deliverables

The Contractor shall provide the following list of deliverable items:

SECTION 7.0 – UTILITIES

Deliverables	Review and Comment	Schedule	Reference Section
Permit Application(s), Utility Relocation Sketches and Utility Agreements	✓	As available	7.7
Utility Certification		Final Completion	7.8
As-Built Drawings	✓		7.9

SECTION 8.0 – RIGHT-OF-WAY

8.0 RIGHT-OF-WAY

8.1 New Right-of-Way

The Project shall be designed and constructed within the existing right-of-way.

SECTION 9.0 – SURVEY

9.0 SURVEY

9.1 Project Survey Coordination

The Contractor shall designate a licensed Professional Surveyor as the responsible person in charge of all Contractor survey activities on the Project. The Contractor shall comply with the most recent and applicable Laws.

9.2 Contractor Supplied Survey

The Contractor shall survey the Project utilizing standard surveying practices as required to prepare preliminary plans, and final plans, and construct in accordance with applicable standards. The Contractor shall use the same survey line as the original plans.

9.3 Preservation of Survey Control Monuments

The Contractor shall preserve all survey control monuments and any governmental defined land corners located on or within MDOT right-of-way. The Contractor shall notify MDOT as soon as it becomes known that a monument is in a position that will interfere with new construction or with Contractor operations.

9.4 Permission to Enter Property

The Contractor shall notify property owners before entering any private property and each property owner shall be contacted by the Contractor and asked to sign the MDOT Survey Notification form. An explanation of the purpose, nature, and approximate duration of the proposed work may be given to the property owner, but personnel should refrain from outlining any plans or policies that might be misconstrued. If the landowner lives out of state or can not be physically contacted, the form should be mailed to the property owner. Contractor shall record all contacts carefully and accurately for future use. At a minimum, the record shall include the names of persons contacted, identifying them as owners or tenants, the date and time of conversation, telephone numbers and a summary of the conversation.

9.5 Right of Way Marker

The Contractor shall locate and preserve all Right-of-Way markers.

9.6 Deliverables

At a minimum, the Contractor shall submit the following to MDOT for review and comment:

Deliverable	Review and Comment	Schedule	Reference Section
None			

SECTION 10.0 – GEOTECHNICAL

10.0 GEOTECHNICAL

The Contractor shall determine the need for geotechnical information and conduct investigations as necessary to complete the analyses, design and construction.

10.1 Geotechnical Design Criteria

10.1.1 New Structures

Design criteria for structures shall follow the AASHTO LRFD Bridge Design Specifications. For the purpose of completing the geotechnical design of structures for this project, a Site as referred to in section 10.5 of the current LRFD Bridge Design Specifications shall be defined as a single bridge (or retaining wall) location. Deep foundations shall be designed for axial compression, dragdown, uplift, and lateral loading of single piles (shafts) and/or pile (shaft) groups. Drilled shafts shall be designed based upon either an on-site full scale static or special instrumented load test. Failure criteria for the static load test are provided in ASTM D1143. All embankments along the alignment shall be designed using the following criteria for global stability of approach embankments or retaining walls. All miscellaneous foundations such as overhead signs, traffic signal and light poles shall be designed in accordance with the Standard Specification for Highway Bridges 17th Edition.

Bridge approach embankments supported by deep foundations shall be limited to 2 inches of settlement remaining at 180 days after abutment foundation construction. Limiting settlements (total and differential) for retaining walls shall follow the AASHTO LRFD Bridge Design Specifications.

Geotechnical seismic design of structures shall follow AASHTO LRFD Bridge Design Specifications. This design should include, but is not limited to: Seismic site classification and corresponding recommended response spectra for both period and displacement, assessment of liquefaction potential and proposed remediation techniques where liquefaction potential exists, pseudo-static slope stability analyses for all slopes, development of foundation stiffness matrices or other methods for modeling foundation stiffness as a component of the superstructure/substructure system.

Table 10.1-1 - Embankment Slopes

<i>Failure Mode/Design Criteria</i>	<i>Long Term</i>
Global Stability :Embankment slopes and Retaining Walls	1.50

10.1.2 Widened Structures

Design criteria for minimum Factors of Safety are provided in the following tables. Geotechnical design criteria have been provided for the following typical transportation structures: Bridge Foundation (Table 10.1-2), and Bridge Approach Embankment (Table 10.1-3). All embankments along the alignment shall be designed using the following criteria for global stability of approach embankments or retaining walls. Drilled shafts shall be designed based upon a static load test. Failure criteria for static load test are provided in ASTM D1143. All miscellaneous foundation such as overhead signs and light poles shall be designed in accordance with the criteria provided in Bridge/Foundation (Table 10.1-2).

SECTION 10.0 – GEOTECHNICAL

Table 10.1-2 - Bridge Foundations

<i>Deep Foundations</i>	Static
Driven Piles with Wave Equation Minimum Factor of Safety	2.75
Driven Piles with Dynamic Testing (PDA) Minimum Factor of Safety	2.50
Driven Piles with Static Load Test Minimum Factor of Safety	2.00
Drilled Shafts (Less than 48 inches in diameter) Minimum Factor of Safety	2.00
Drilled Shafts (48 inches in diameter or greater) Minimum Factor of Safety	1.50

Table 10.1-3 - Bridge Approach Embankment

<i>Failure Mode/Design Criteria</i>	Static
External Stability: Bridge side and end slopes - Minimum Factor of Safety	1.50

10.2 Ground Improvement

If ground improvement is necessary to meet the design criteria, the design methodology and construction specifications shall be in accordance with FHWA Publication No. SA-98-086R, Ground Improvement Technical Summaries, Volumes I and II. Prior to commencing ground improvement operations, the Contractor shall submit the type of ground improvement technique, the anticipated results from the improvement and the methodology for verifying the results from the improvement to MDOT for review and acceptance. A summary report of the field-testing shall be submitted documenting the effects from the ground improvement techniques and indicating if the ground improvement techniques have successfully achieved the anticipated results. The Contractor is solely responsible for the performance of the ground improvement techniques.

10.3 Geotechnical Planning Report

The Contractor shall prepare a Geotechnical Planning Report for the Project, including all Phases, and submit the Geotechnical Planning Report to MDOT within thirty (30) working days from NTP1 for review and written comment. The Geotechnical Planning Report shall include a detailed method statement describing the general philosophy and methods of design and construction and the rationale for selection of the proposed construction methods for all geotechnical and foundation aspects of the Project. The method statement shall indicate how material and design details are chosen to match selected construction methods and details, soil conditions, and groundwater environment for the Site. The Geotechnical Planning Report shall specify the method for verification of bearing capacity of the deep foundation elements at each Site.

The Geotechnical Planning Report shall define the engineering and design approach that will be followed in order to develop technically and environmentally acceptable and durable foundations, cut and fill slopes, retaining structures, pavement subgrades, and all geotechnical designs for the project. The Geotechnical Planning Report shall discuss all aspects of the required geotechnical effort and design analysis.

SECTION 10.0 – GEOTECHNICAL

The Geotechnical Planning Report shall outline the anticipated testing requirements, tests and frequency that will be necessary to implement during construction in order control the material placement on the project.

MDOT will review the Geotechnical Planning Report within twenty-one (21) days of the submittal and will provide any review comments.

10.4 Geotechnical Exploration

10.4.1 *General*

The frequency, spacing, and depth of soil test borings will depend on the anticipated variation in subsurface conditions and the type of structure to be designed. The soil borings and laboratory data included in Exhibit 1 of Section 902 are for information only. The Contractor assumes all liability/responsibility for the interpretation and use of this data for this Project. The Contractor shall obtain soil test borings needed to meet the requirements detailed in the Geotechnical Planning Report. The Contractor shall locate (station and offset and GPS coordinates) and establish ground or mud line elevation at all soil test borings taken by the Contractor. The Contractor is solely responsible for the adequacy of the geotechnical information for this Project. An electronic copy of the final boring logs completed at the time of the preliminary design submittal, shall be submitted with the preliminary Geotechnical Report to MDOT in PDF or Microstation format.

10.4.2 *Bridge Foundations*

Borings shall extend to depths sufficient to define the subsurface profile for structures, subgrades and embankments, and geotechnical features. All soil test borings taken for deep foundations shall extend below the anticipated pile or drilled shaft tip elevation a minimum of twenty (20) feet. The Contractor shall test for sulfates as part of their geotechnical investigation. Where moderate to severe sulfates are found, pile concrete shall meet the current requirements in 907- 701.02.2.1.

10.4.3 *Retaining Walls*

All retaining walls shall have one soil test boring performed at least every seventy-five (75) feet along the wall line, if the wall is within 500 feet of bridge abutments. Retaining walls more than 500 feet from the bridge abutment shall have one soil test boring performed at least every 200 feet along the wall line. All soil test borings performed by the Contractor shall extend to a depth of at least twice the height of the wall. Continuous flight auger borings are not acceptable. Undisturbed samples will be required for testing to determine the required strength design parameters and the expected differential settlement along the length of the retaining wall.

10.4.4 *High Volume Change Soils*

A high volume change soil is defined as a soil having a volume change of 60 percent or higher when determined in accordance with AASHTO T 92 using the formula. $VC = (w_1 - S) R$ High volume change material having a volume change of 60 percent or higher shall be removed from the project.

SECTION 10.0 – GEOTECHNICAL

10.4.5 Embankments

The subgrade soils along all roadway alignments shall be evaluated by soil test borings completed by the Contractor. Slope stability analysis of all embankments, with an embankment height of 10 feet or more, shall be completed by the Contractor. Sufficient soil test borings shall be obtained to identify the existing geotechnical conditions at each site to complete the analysis.

The subgrade soils along the all roadway alignments shall be evaluated by soils test borings performed in accordance with MDOT SOP #TMD-20-14-00-000.

All borrow excavation material shall meet the requirements of Class B1-B9 as specified in the Mississippi Standard Specifications for Road and Bridge Construction, Section 703.21.

10.4.6 Cut Slopes

All cuts slopes over 10 feet in height shall be analyzed for slope stability by the Contractor. Sufficient soil test borings shall be obtained to identify the existing geotechnical conditions at each site to complete the analysis.

Cut slopes shall be constructed with a 6:1 slope when the existing material has a volume change of 60 percent or greater.

Existing material with a volume change greater that 60 percent shall be over excavated to three feet from the roadway surface and replaced with one of the two types of materials listed below.

1. Granular Material, Class 1 through Class 10, E
2. Borrow Excavation, Classes B5-6, B6-6, B9-6, B15 or B16

The base course of the design soils may be constructed with Granular Material, Class 1 through Class 10, Group D or E.

10.4.7 Laboratory Testing

The Contractor shall perform laboratory soils tests of sufficient numbers and type to classify and ascertain the shear strength, conditions of stability, and consolidation characteristics of the material encountered.

10.4.8 Geotechnical Report

The Contractor shall prepare a preliminary and final geotechnical report for all bridges, retaining walls, roadway subgrades and embankments, concrete culverts and any other structures constructed for this Project, including the Initial Phase and any subsequent Phase. The preliminary geotechnical report shall provide the preliminary recommendations for the design of the selected foundation types, reproductions of the field boring logs and a generalized soil profile along the alignment. The final geotechnical report shall summarize subsurface soils, foundation design recommendations, laboratory testing results; provide a reproduction of the field boring logs and a generalized soil profile containing the location of all soil borings. In addition, the report shall indicate any special treatments of subgrades to be performed before paving. Each report shall be submitted to MDOT along with the final or preliminary plan submittal. The review of the report will be performed in accordance with the structure submittal plan review process. In August 31, 2012

SECTION 10.0 – GEOTECHNICAL

addition, after construction of the foundations is complete, the Contractor shall provide a supplement to the report containing the actual field conditions encountered and as-built foundation data and information.

10.5 Deep Foundation Verification

10.5.1 *Driven Piles*

The Contractor shall verify the capacity of piles at each Site to substantiate the requirements of the contract. Bridge pairs on the interstate system (NB and SB or EB and WB) will be considered a site. The Contractor shall provide positive demonstration that each pile has the required bearing capacity. At a minimum one abutment pile and one interior pile, but not less than 2% of the production piles for each individual bridge, shall be dynamically tested to determine the capacity and to set the driving criteria for the remaining piles. Dynamic testing requires signal matching and determination of nominal resistance shall be made from a restrike. The first pile driven at an abutment or interior bent shall be the verification pile. The Contractor shall submit the pile verification results including driving criteria within two (2) days after the completed driving of the verification test pile. The pile driving criteria shall be accepted by MDOT prior to driving production piles.

Pile driving criteria shall include calculations showing that the driving stresses will not exceed the allowable stresses. Driving criteria shall include the maximum stroke of the hammer and the pile cushion material.

10.5.2 *Drilled Shafts*

The Contractor shall verify the design capacity of the drilled shafts at each Site by means of a full-scale load test. The load test(s) shall be conducted in representative soil conditions where unit side friction capacities are measured in each soil layer which was encountered during design of the production shafts at the Site. The unit end bearing capacity shall be measured in the soil layer where the deepest shaft at the Site will be founded. The load test shall be conducted using shaft(s) constructed in a manner and of dimensions and materials identical to those planned for the production shafts. For bridges where shafts of multiple diameters are to be used, a single full-scale load test may represent production shafts with diameters within 6 inches of the test shaft diameter.

Each test shaft and production shaft shall be tested to determine verticality, diameter and volume prior to concrete placement using an acoustic measuring device such as the SoniCaliper Testing System (SCTS). Caliper testing occurs between the completion of excavation and final clean out and the installation of the reinforcing steel cage prior to concreting. At a minimum, caliper readings shall be taken every 5 feet in uncased portions, every 1 foot within 5 feet of the bottom of casing, and every 20 feet in the casing. If telescoping casing is used, take readings every 1 foot for 5 feet above and below each casing transition.

The Contractor shall prepare inspection logs documenting each shaft construction activity, including casing installation, excavation, shaft bottom inspection, reinforcement installation and concrete placement. The logs shall fully document the work performed with frequent reference to date, time and casing/excavation elevation. In addition, the Contractor shall prepare and submit the logs documenting any subsurface investigation borings or rock core holes performed for the Contract at drilled shaft foundation locations.

Records for temporary or permanent casing shall include at least the following information: diameter and wall thickness of the casing; dimensions of any casing reinforcement; top and bottom elevations for the

SECTION 10.0 – GEOTECHNICAL

casing; method and equipment used for casing installation; any problems encountered during casing installation; and the name of the inspector.

The shaft excavation log shall contain at least the following information: identification number, location, and surface elevation of the shaft; description and approximate top and bottom elevation of each soil or rock material encountered; seepage or groundwater conditions; type and dimensions of tools and equipment used, and any changes to the tools and equipment; type of slurry used, if any, and the results of the slurry tests; any problems encountered; elevation of any changes in the shaft diameter; and the name of the inspector and any changes in the inspector.

Concrete placement records shall include at least the following information: concrete mix used; time of start and end of concrete placement; volume and start/end time for each truck load laced; concrete test results; concrete surface elevation and corresponding tremie tip elevation periodically during concrete placement; concrete yield curve (volume versus concrete elevation, actual and theoretical); and the name of the inspector.

A full set of shaft inspection logs for an individual drilled shaft shall be submitted within 2 days of the completion of concrete placement at the shaft.

10.5.3 Deliverables

At a minimum, the Contractor shall submit the following to MDOT for review and comment:

Deliverable	Review and Comment	Schedule	Reference Section
Geotechnical Planning Report	✓	Thirty (30) days after NTP1	10.3
Preliminary Geotechnical Report	✓	Submit with Final Design Documents	10.4.8
Deep Foundation Verification Including Pile Driving Criteria	✓	Two (2) days after installation	10.5

SECTION 11.0 – SIGNING, PAVEMENT AND MARKING

11.0 SIGNING, PAVEMENT MARKING**11.1 Signing**

Signage shall be designed and constructed by Contractor to include all regulatory, warning, route marker, guide and information signs, and trailblazer signs.

All regulatory, warning, route marker, guide and information signs, mounting requirements and vertical and horizontal clearances shall conform to the MUTCD and MDOT Standard Plans, and the requirements specified herein. Design and placement of signs shall consider future roadway widening.

All signs placed within Project Right-of-Way shall conform to all MDOT design policy, criteria, standards and specifications.

Sign posts and structures shall be designed and constructed in accordance with MDOT design policy, specifications and standards, and AASHTO Standard Specifications for Structural Supports for Highway Signs, Luminaries and Traffic Signals. Sign structures shall be constructed utilizing structural steel.

The Contractor's design shall address modifications to permanent signing outside the Project Right-of-Way that are made inaccurate, ineffective, confusing or unnecessary by the Project. Figure 11.1.1 provides a concept interchange signing plan.

All existing sign panels that require modification shall be replaced with new sign panels and supports.

11.2 Pavement Marking***11.2.1 Permanent Pavement Marking***

Pavement markings shall be designed in accordance with the MUTCD and MDOT Standard Drawings. The permanent pavement marking system on MDOT owned roadways shall be according to Table 11.2.1

11.2.2 Temporary Pavement Marking

Temporary Pavement markings shall be designed in accordance with the MUTCD and MDOT Standard Drawings. Type 1 Pavement Marking Tape shall be used for all temporary pavement markings on final pavement surfaces of the project.

SECTION 11.0 – SIGNING, PAVEMENT AND MARKING

1/4/2010

MDOT Pavement Marking Policy

	ASPHALT			OPEN GRADED FRICTION COURSE			CONCRETE		
	ADT < 2000	ADT 2000 - 30k	ADT > 30k	ADT < 2000	ADT 2000 - 30k	ADT > 30k	ADT < 2000	ADT 2000 - 30k	ADT > 30k
EDGE LINES	Rumble Stripe Paint (waterborne or high build) or Thermoplastic	Rumble Stripe Thermoplastic	Rumble Stripe Thermoplastic (90 mils) (Double-Drop)	Paint (waterborne or high build) or Thermoplastic	Thermoplastic	Thermoplastic (90 mils) (Double-Drop)	Paint (waterborne or high build), Thermoplastic, High Performance Cold Plastic Tape or Inverted Profile Thermoplastic or approved equal	Thermoplastic (90 mils)(Double-Drop), High Performance Cold Plastic Tape or Inverted Profile Thermoplastic or approved equal	Thermoplastic (90 mils)(Double-Drop), High Performance Cold Plastic Tape or Inverted Profile Thermoplastic or approved equal
CENTERLINES & LANELINES	Paint (waterborne or high build) or Thermoplastic & RPM's	Thermoplastic & RPM's	Thermoplastic (90 mils) (Double-Drop) & RPM's	Paint (waterborne or high build) or Thermoplastic & RPM's	Thermoplastic & RPM's	Thermoplastic (90 mils) (Double-Drop) & RPM's	Paint(waterborne or high build), Thermoplastic, High Performance Cold Plastic Tape or Inverted Profile Thermoplastic or approved equal & RPM's	Thermoplastic (90 mils)(Double-Drop)High Performance Cold Plastic Tape or Inverted Profile Thermoplastic or approved equal & RPM's	Thermoplastic (90 mils)(Double-Drop)High Performance Cold Plastic Tape or Inverted Profile Thermoplastic or approved equal & RPM's
SYMBOLS	Paint (waterborne or high build) or Thermoplastic	Thermoplastic	Thermoplastic (120 mils)	Paint (waterborne or high build) or Thermoplastic	Thermoplastic	Thermoplastic (120 mils)	Paint (waterborne or high build), Thermoplastic, High Performance Cold Plastic Tape	Thermoplastic (120 mils)(Double-Drop), High Performance Cold Plastic Tape	Thermoplastic (120 mils)(Double-Drop), High Performance Cold Plastic Tape

NOTES:

- 1) Rumble Strips are required on the shoulders of new concrete pavement and open graded friction courses.
- 2) Rumble Stripe and Rumble Strips may be omitted from residential or business areas within the corporate limits of a city, or where curb and gutter is present.
- 3) In places where two (2) foot paved shoulders cannot be provided, Rumble Stripes and Rumble Strips will not be required.
- 4) The District has the option to require the Double-Drop Bead system on routes with ADT < 30k.
- 5) If lane widths are less than 11 feet, rumble stripe is not required.
- 6) The use of any product that is not listed above shall require Chief Engineer approval, otherwise options are at the discretion of the District Engineer.
- 7) For concrete-bridges and pavements, a minimum of two (2) products shall be competitively bid against each other if thermoplastic or paint is not used.

 Date _____
 Larry L. Bui
 Executive Director

 Date 1/19/10
 Andrew Hughes
 FHWA Division Administrator

SECTION 12.0 – DRAINAGE

12.0 DRAINAGE

12.1 Drainage Criteria

The Project shall include all Work for the design and construction of drainage facilities including temporary and permanent erosion control measures. Project design will be in compliance with the MDOT Roadway Design Manual, Chapter 7, incorporated in Section 17. All pipe culverts shall meet the requirements of MDOT Pipe Culvert Material Design Criteria.

The existing hydraulic opening of the bridge site shall not be reduced as a result of the new construction.

Bridge deck drainage shall be based on the FHWA Publication, Design of Bridge Deck Drainage, Hydraulic Engineering Circular No. 21 (HEC-21).

12.2 Coordination with Other Agencies

The Contractor shall coordinate all drainage issues with affected regulatory agencies that have interest or jurisdiction over the Project.

The Contractor shall copy MDOT on all correspondence, promptly advise of any direct contact and give advance notice of any meetings and/or hearings with affected regulatory agencies.

12.3 Bridges Over Waterways

For bridge widening projects, all pier locations adjacent to the channel and substructures in the widened portion shall be skewed and placed parallel to the channel. If the substructures must be placed in the channel, then they must be parallel to flow direction of flood flow.

For bridges over waterways, the low chord elevation of the exterior girder shall be above the highest of the following elevations:

1. Four (4) inches below the existing low chord elevation,
2. The High Water Elevation shown on the existing bridge plans,
3. The 100 year water surface elevation as shown in the FEMA Flood Insurance Study for FEMA regulatory floodways.

Unless specified otherwise, slope protection for the abutments and piers shall match the type and thickness of the existing protection as a minimum.

12.4 Deliverables

The Contractor shall provide the following list of deliverable items:

Deliverables	Review and Comment	Schedule	Reference Section
None			

SECTION 13.0 – ROADWAYS AND PAVEMENTS

13.0 ROADWAYS AND PAVEMENTS**13.1 Roadway Design Criteria**

Project design will be in compliance with the MDOT Roadway Design Manual, freeway conditions, rolling terrain and rural setting. The design of roadways will be in accordance with Table 13.7-1. Table 2-7B of the MDOT Roadway Design Manual shall be revised as detailed in Table 13.7-1

13.2 Horizontal Alignment

The horizontal alignment shall follow the existing alignment.

13.3 Vertical Alignment

Vertical alignment for I-55 shall match the existing alignment. Vertical alignment for SR 27, SR 28 and Gallman Road shall be adjusted as necessary.

13.4 Earthwork and Grading

Roadway earthwork and grading design and construction will conform to the typical sections and the following specific requirements:

The minimum embankment slopes, outside of the clear zone, will be constructed using normal 3:1 slopes unless flatter slopes are determined to be necessary from the geotechnical investigation performed in accordance with MDOT SOP TMD-20-14-00-000. Embankments will be constructed with suitable material acquired from either onsite excavation or hauled from offsite borrow pits or a combination of both. Embankment material shall be placed and compacted in accordance with the contract documents.

Safety barriers shall be used to protect motorists from obstructions.

The Contractor shall perform excavation (and undercut, if necessary) of the roadway, side slopes, ditches and channels, structures, and all other items necessary for the construction of this Project. Excavation shall include all materials above the subgrade (and undercut, if required) and the disposal of all materials not suitable for re-use in construction.

The Contractor shall be responsible for locating and obtaining all borrow material required for this Project, including all approvals, permits, and fees required for obtaining and hauling the borrow material.

Grading of excavated areas, embankments and other areas disturbed by construction shall meet all erosion and sedimentation control requirements.

13.5 Pavement Design Life

All pavements shall be designed based on equivalent 18,000-pound single-axle loads.

Pavement design shall be based on the following:

SECTION 13.0 – ROADWAYS AND PAVEMENTS

Location	Design of 18 KIP ESALS From Base Year Asphalt Pavement	HMA Type
SR 27	3,700,000	HT top 2 lifts w/polymers
SR 28	2,600,000	MT
Gallman Road and Ramps	500,000	ST

13.6 Pavement Selection

The pavement structure design shall be based on subgrade data developed through Contractor's geotechnical investigation.

The pavement shall be designed, constructed and maintained with adequate surface drainage to prevent pavement structure problems.

The minimum pavement thickness shall be as follows:

Minimum Pavement Thickness

Location	Minimum Asphalt Thickness
SR 27	7 1/2inches
SR 28	7 inches
Gallman Road and Ramps	5 inches

SECTION 13.0 – ROADWAYS AND PAVEMENTS

13.7 Roadway Safety

All roadway guardrail and roadside barriers shall be designed according to design speed using current MDOT standards and shall meet requirements for NCHRP 350 TL-3. All roadway pavement sections on the Project shall incorporate rumble strips along the inside and outside shoulders.

Table 13.7-1 Typical Roadway Section Criteria

	Interstates (Mainline)	SR 27 and SR 28	Gallman Road	One Lane Ramps
Functional Classification	Freeway	Rural Arterial	Local Road	N/A
Design Speed	70 mph	65 mph	30 mph	50 MPH
Control of Access	Full (type 1)	(Type 3)	Type 3	Full (Type 1)
Number of Through Lanes	4	2 each way	2	1
Lane Width	12 ft.	12 ft.	12	16 ft.
Outside Shoulder Width, Usable	12 ft.	8	4	10 ft.
Outside Shoulder Width, Surfaced	10 ft.	N/A	1	8 ft.
Median Shoulder Width, Usable	8 ft.	N/A	N/A	6 ft.
Median Shoulder Width, Surfaced	4 ft.	N/A	N/A	3 ft.
Auxiliary Lane Width	12 ft.	12 ft.	9 ft.	
Auxiliary Lane Shoulder Width	10 ft. surfaced 12 ft. useable	8 ft.	N/A	
Median Type	Depressed	N/A	N/A	
Median Minimum Width	64 ft.	N/A	N/A	
Cross Slope Travel Lane	2%	2%	2%	2%
Cross Slope Shoulder	4 %	4%	4%	4%
Total (Final) Bridge Minimum Width	T.W. +12ft (out)+6ft (Med)	44 ft.		
Minimum Clear Span				
Roadside Clear Zone (Obstruction)	30 ft.	See Note 4	10 ft.	See Note 7
Cut Foreslope (Within Clear Zone)	6:1	6:1	3:1	4:1
Depth of Ditch	4 ft.	3 ft.	3 ft.	4 ft.
Cut Backslope	3:1	3:1	1:1	3:1
Safety Slope (Within clear Zone)	6:1	6:1		6:1
Fill Slope (Outside Clear Zone)	3:1	3:1	3:1	3:1
Stopping Sight Distance (AASHTO)	730 ft.	645 ft.	185 ft.	360 ft.
Maximum Horizontal Curve	1630 ft.	1348 ft.	231 ft.	694 ft.
Superelevation Rate	See table 3-4 A ($e_{max}=0.10$)	See table 3-4 A ($e_{max}=0.10$)	SA-3E-1	See Note 10
Maximum Grade	3%	4%	18%	6.5%
Vertical Curve K Factor (Crest) (MDOT)	290	230	26	110
Vertical Curve K Factor (Sag) (AASHTO)	181	157	33	96

13.7.1 Notes for Table 13-7-1

1. The minimum vertical clearance for all bridge over highways and streets shall be 16’ – 6” or maintain the existing vertical clearance except for I-55 over County Line Road and I-55 over Clear Creek Road where the existing vertical clearance shall be maintained.

SECTION 13.0 – ROADWAYS AND PAVEMENTS

2. The minimum vertical clearance over railroads shall be 23’ – 6” or more if required by the railroad.
3. Horizontal Sight Distances- See Subsection 3.50 in the MDOT Roadway Design Manual for applicable criteria.
4. T.W. refers to the travel way or the total lane width.
5. Approach Roadway width is defined by the total lane width plus the total useable shoulder.
6. Horizontal clearances at railroads shall meet the requirements of AREMA and the Railroad Company.
7. Clear zone to be based upon speed, side slope and traffic volume.
8. Where auxiliary lanes are used along the mainline, clear zone is measured for the outside edge of the auxiliary lane.
9. The bridge end approach slabs shall be constructed and widened in accordance with the current MDOT Roadway Design Standard Drawings. Use Special Design Sheet BE-1A.
10. The superelevation rate for new curves shall be designed with $e_{max} = 0.06$. Existing curves with as superelevation of 0.10 are acceptable.
11. Vertical curve K factors do not apply near the ramp tie-in where the profiles are controlled by the cross slope of the tie-in roadway.

13.8 Deliverables

At a minimum, the Contractor shall submit the following to MDOT for review or comment:

Deliverable	Review and Comment	Schedule	Reference Section
Preliminary Plans (30%) and Cross Sections	✓	According to Contractor’s Schedule	2.2.2
Final Plans (100%) and Cross Sections	✓	Prior to Request For Release for Construction	2.2.4
Release for Construction Plans and Cross Sections	✓	According to Contractor’s Schedule	2.2.5
As Built Drawings	✓	30 days after Completion of Construction	2.2.8

SECTION 14.0 – NOT USED

14.0 NOT USED

SECTION 15.0 – WIDENED STRUCTURES

15.0 WIDENED STRUCTURES

15.1 Design Methodology

All structural components of the widened bridges shall be designed by the AASHTO *Standard Specifications for the Design of Highway Bridges* methodology.

15.2 Loads and Forces

The structures contained in this Project shall be proportioned for loads and forces in accordance with the latest edition of AASHTO *Standard Specifications for the Design of Highway Bridges*.

15.2.1 Live Loads

Live loads shall be calculated in accordance with AASHTO Standard Specifications for the Design of Highway Bridges. Vehicular live loading on the roadway of bridges or incidental structures shall be HS20-44.

15.2.2 Thermal Movement

Thermal forces shall be calculated in accordance with AASHTO Article 3.16, as specified for moderate climate regions.

1. Normal Temperature at the time of erection: 60° F
2. Design Temperature Ranges:

Steel Structures:

Rise: 50° F

Fall: 50° F

Concrete Structures:

Rise: 50° F

Fall: 50° F

3. Bridge deck joints shall be open and match the size and location of the existing bridge joints.

15.3 General Requirements for Bridges

15.3.1 Bridge Superstructures

1. All bridges on this Project shall have cast-in-place reinforced concrete bridge decks supported by precast-prestressed concrete girders, precast-prestressed post-tensioned concrete girders, or steel plate girders. In no case shall the exterior girders have less carrying capacity than an interior girder.

SECTION 15.0 – WIDENED STRUCTURES

2. Continuity at the substructure locations of the widened portion of the bridge shall match the continuity of the existing bridge.
3. Bridge superstructures that have continuity over piers shall have the same number of girders in each span of the continuous section.
4. Stay-in-place deck forms or precast concrete deck panels shall not be used.
5. Bridge deck cross slope shall match the existing bridge cross slope.
6. The existing bridge deck may be removed only up to the outside face of the top flange of the exterior girder or the exterior web of a box girder. At the removal line the existing concrete bridge shall be saw cut to a depth of 1 inch below the top of deck to provide a neat construction joint surface.
7. No fracture critical members, connections, or pin and link type connections are allowed.
8. Structures shall have members and details that utilize redundant load paths.
9. All steel plate girder spans shall be curved to match the horizontal curvature of the alignment. Precast-prestressed concrete girder spans shall not be utilized when the horizontal curvature of the alignment results in an offset of 10-inches or more in a span measured between the chord as defined by the straight girder and the curve.
10. All girders shall be braced immediately after erection.

15.3.2 Bridge Substructures

Bridge substructures (including abutments) shall be reinforced concrete components supported by foundations using the same type and size of the existing substructure element. The bridge across Tangipahoa River may utilize pile and cap configurations at bents 4 and 5. New bridge piers and foundations shall be designed to resist all loads generated by the additional bridge width. This width shall be measured from the outside edge of the existing girder or web. Bridge pier caps shall be physically connected to the existing bridge when the existing superstructure is not integral with the bridge pier. For bridges where the existing superstructure is integral with the bridge pier the new diaphragm shall not be connected to the existing bridge.

Bridges at interchanges shall be constructed with cast-in-place concrete columns.

See Section 15.4.4 for pier configuration requirements.

15.3.3 Debris Removal

All portions of the bridge(s) to be removed shall be removed to a minimum of 1 foot below natural ground and shall become the property of the Contractor and removed from the site.

SECTION 15.0 – WIDENED STRUCTURES

15.4 Bridge Design Criteria**15.4.1 Concrete Design***15.4.1.1. Reinforced Concrete*

All concrete shall be designed and produced in accordance with Mississippi Standard Specifications for Road and Bridge Construction Section 804 Table 3. Cement used in concrete shall meet the requirements of Section 701 of the Mississippi Standard Specifications for Road and Bridge Construction.

Cast-in-Place Concrete:

Class AA

$f'_c = 4,000$ psi

Drilled Shaft Concrete:

Class DS

$f'_c = 4,000$ psi

15.4.1.2. Reinforcing Steel

1. Cast-in-place concrete shall be reinforced only with deformed bars conforming to AASHTO M31 (ASTM A 615) or A 706. Reinforcement to be welded shall conform to ASTM A 706. Reinforcing steel shall be Grade 60.
2. Cast-in-Place Concrete Clear Cover -
 - i. Drilled Shafts – 6” to the main reinforcing steel
 - ii. Footings – Bottom Mat – 4”
 - iii. Footings – Top Mat – 3”
 - iv. Pedestals and Columns – 3”
 - v. All other reinforcing steel per AASHTO
3. At the deck, abutments, and pier cap the existing reinforcing steel shall be made continuous by the use of lap splices or mechanical couplers. Mechanical couplers, if used, shall be epoxy coated.
4. Mechanical couplers may not be used in any case in which the resulting clear cover over the newly installed coupler is less than 1 inch.
5. Existing bridge decks that have a clear cover of less than 1 inch shall use a non-contact lap splice.

15.4.1.3. Prestressing Steel

Prestressing Steel shall conform to AASHTO M 203 (ASTM A 416). Prestressing Strand shall be weldless in accordance with AASHTO 203, subsection 8.1.4.

SECTION 15.0 – WIDENED STRUCTURES

15.4.1.4. Allowable Stress, Deflection and Strength Considerations

1. Reinforced concrete structures shall be designed by the Load Factor Design Method in accordance with AASHTO Article 8.16, Serviceability Requirements.
2. Flexural members shall be checked for serviceability in accordance with AASHTO Article 8.16.8.
3. The live load deflection of the new structure shall be within ¼ inch of the existing bridge. The bridge calculations shall provide the live load deflections for the new and existing bridge

15.4.1.5. Special Requirements for Bridge Decks

1. The minimum bridge deck thickness shall match the existing bridge deck thickness. The cantilever overhang portions of the bridge deck shall have a minimum thickness of nine and one-fourth (9 1/4) inches.
2. Final surface texture of concrete bridge decks and bridge end pavement shall have the same finish as the existing bridge deck.

15.4.1.6. Prestressed Concrete

In the event the existing spans are continuous prestressed concrete beam spans, then the new prestressed concrete girders shall be designed as simple spans and made continuous for live load.

All concrete shall be designed and produced in accordance with Mississippi Standard Specifications for Road and Bridge Construction Section 804 Table 3. Cement used in concrete shall meet the requirements of Section 701 of the Mississippi Standard Specifications for Road and Bridge Construction.

Prestressed Concrete	
Class Fx range	
From a minimum of	f'c = 5,000 psi
To a maximum of	f'c = 6,000 psi

15.4.1.7. Miscellaneous Requirements and Restrictions

1. For prestressed concrete girder spans, cast-in-place concrete diaphragm(s) shall be designed and constructed to match the existing bridge diaphragm locations. The diaphragm shall be a minimum thickness of nine (9) inches and match the depth of the existing diaphragms.
5. For prestressed concrete girder spans, cast-in-place concrete diaphragm shall be located at all intermediate piers that are within the deck live load continuity. The intermediate pier diaphragms shall match the size of the existing diaphragms.
6. Cast-in-place Concrete diaphragms at the ends of prestressed concrete girders where there is a break in deck continuity shall match the size of the existing diaphragms.
7. External Post-tensioning will not be permitted.

SECTION 15.0 – WIDENED STRUCTURES

8. All substructure caps shall have shear keys located on the cap just outside the exterior girders and shall have a minimum height of twelve (12) inches above the bottom of the exterior girder. The minimum length as measured transversely along the cap shall be twelve (12) inches and the minimum width shall be three (3) feet or two-thirds (2/3) of the cap width, whichever is greater. There shall be a one (1) inch gap between the shear key and either the face of the exterior girder or any bearing device, pad or plate supporting the exterior girder.
9. Prestressed concrete piles shall be a minimum of 7 days old prior to driving.

15.4.2 Structural Steel Design

Steel structures shall be designed in accordance with AASHTO Standard Specifications for the Design of Highway Bridges.

15.4.2.1. Materials

Structural steel for primary members shall conform to the requirements of AASHTO M 270 Grade 36, Grade 50 or Grade HPS 70W. Structural steel for secondary members shall conform to the requirements of AASHTO M 270 Grade 36 or Grade 50. Steel with a design yield strength greater than seventy (70) ksi will not be permitted. High strength bolts shall be ASTM A 325, designed for values as specified in AASHTO Subsection 6.13.2.8 with Class B contact surfaces. All field connections shall use 7/8” minimum diameter bolts. Direct tension indicators (DTIs) shall be the only acceptable method for verifying proper bolt installation.

15.4.2.2. Design and Details

1. Girders shall be I-shaped and shall be designed to act compositely with the deck slab in the positive moment region and with the reinforcing steel in the negative moment region.
2. All bolted connections shall be designed as slip critical connections having Class B contact surfaces.
3. Electroslag welding will not be permitted.

15.4.2.3. Fasteners for Steel Bridge Girders

1. High Strength Bolts shall meet the requirement of ASTM. A 325, Type 1, and shall be hot dip galvanized in accordance with the requirements of ASTM A 153, Class C Coating or galvanized by the mechanical process in accordance with the requirements of ASTM B 695, Class 50 Coating. Maximum hardness for high strength bolts shall be 33 Rockwell C (RC).
2. Nuts for high strength bolts shall be heavy hex and meet the requirements of ASTM A 563, Grade DH galvanized.
3. Hardened steel washers shall meet the requirements of ASTM F 436, galvanized.
4. Direct tension indicators shall meet the requirements of ASTM F 959 and shall be galvanized by the mechanical process meeting the requirements of ASTM B 695, Class 50 Coating.

SECTION 15.0 – WIDENED STRUCTURES

5. Nuts for high strength bolts shall be tapped oversize the minimum amount required for proper assembly and lubricated with an acceptable lubricant containing a dye of any color that contrasts with the color of galvanizing.
6. High strength bolts, nuts, or direct tension indicators shall not be reused after tightening.
7. Mill test reports, certified test reports, and certificates of compliance are required for high strength bolts, nuts, hardened washers and direct tension indicators.

15.4.2.4. *Paint System*

All structural steel, except for expansion joints, and rail plates shall be painted in accordance with Section 814 of the Mississippi Standard Specifications for Road and Bridge Construction.

15.4.3 *Structural Steel Fabrication Requirements*

All steel plates, angles, bars, rolled shapes, finger joints and pot bearings incorporated into a bridge structure shall meet the following requirements:

All girder web plates, flange plates and splice plates shall meet the Longitudinal Charpy-V-Notch Toughness Test. The Supplementary Bend Test as described in Section 717 of the Mississippi Standard Specifications for Road and Bridge Construction is not required. Miscellaneous steel less than 1/4 inch thick shall be identified on the shop drawings. Web and flange material heat numbers shall be stenciled on each girder using low stress die stamps. The heat numbers shall be stamped on the side of the web in the upper left hand corner.

All welding shall be completed by the electric arc process and shall conform to the ANSI/AASHTO/AWS D1.5 BRIDGE WELDING CODE, and as directed herein. Certification for all welders to be used on this Project shall be submitted to the Contractor’s Construction Quality Control Manager and MDOT Bridge Engineer for review. Welding machines shall have operating, properly calibrated current meters with attached calibration stickers. Run-off tabs of adequate length shall be used to help prevent weld defects at weld edges. Material surfaces for flange to web fillet welds shall be ground prior to fit-up for welding to remove all mill scale. This area includes the flange, near and far side web and the web edge.

Welded shop splices in webs and flanges are conditionally permissible and shall be submitted to the Contractor’s Lead Design Engineer for approval of type and location. Welded web and flange shop splices shall not occur at concurrent locations and shall be offset a minimum of five (5) feet along the girder. Welded shop splices are prohibited in the following regions in each span:

1. Top Flange Plates in the Negative Moment Region: the region of prohibition shall begin at the centerline bearing and shall extend along the span to the lesser of twenty-five (25) feet or one tenth of the span length. In no case shall this region be less than fifteen (15) feet in length.
2. Bottom Flange Plates in the Positive Moment Region: the region of prohibition shall be the lesser of forty (40) feet or on tenth of the span length. This region shall be centered about the point of maximum positive moment. In no case shall this region be less than twenty (20) feet in length.
3. Web Plates: the region of prohibition at each end of the span shall begin at centerline bearing and shall extend along the span to the greater of fifteen (15) feet or one tenth of

SECTION 15.0 – WIDENED STRUCTURES

the span length as measured from the centerline of bearing. This region need not be greater than twenty- five (25) feet in length.

With the exception of surface condition repairs to correct undercut or overlap conditions, repairs to groove welds require an approved welding repair procedure that includes supporting documentation, size and location of the repair, Non Destructive Evaluation (NDE) reports and the Fabricator's Non-Conformance Report. Approval by the Contractor's Quality Control Manager and review by the MDOT Bridge Engineer is required prior to performing these repairs. Repairs to base metal (including flame cut edges with excessive gouges) require an approved welding repair procedure that includes supporting documentation, size and location of the repair, NDE reports and the Fabricator's Non-Conformance Report. Approval by the Contractor's Construction Quality Control Manager and review by the MDOT Bridge Engineer is required prior to performing these repairs.

The Fabricator shall have a Certified Welding Inspector (CWI) on each work shift where welding or other significant work is performed. Quality Control inspections for acceptance shall precede Quality Assurance inspections. Quality Control shop inspection records shall be made available to MDOT QA Shop Inspection Personnel.

Camber shall be checked and recorded by the Fabricator at all points shown in the approved shop drawings.

Prior to fabrication, the Fabricator and its subcontractor(s) shall determine specific inspection procedures that include techniques and acceptance standards for NDE applications for unusual or nonstandard weld geometries

Radiography of weld transitions shall be performed by placing the film on the flat side of the transition. A floating center punch shall be placed on the base metal adjacent to the weld and shall be visible on each radiographic film in the area of interest.

Prior to fabrication, the Fabricator shall have Shop Drawings approved by the Contractor's Lead Design Engineer. Also prior to fabrication, the Fabricator shall submit Welding Procedures, a Procedure for Storage and Handling of Welding Electrodes, Wire And Flux and A Flux Recovery Procedure (if applicable) to the Contractor's Lead Design Engineer for approval and for review by the MDOT Bridge Engineer. The Construction Quality Control Manager shall schedule a Pre-Fabrication Conference at each fabrication location. The Fabricator's facilities will be inspected by the Contractor's Construction Quality Control Manager, MDOT Bridge Engineer and MDOT QA Shop Inspection personnel during the Pre-Fabrication Conference. No fabrication shall begin prior to this inspection.

Prior to fabrication, the Fabricator and/or subcontractor shall submit their NDE procedures to the Contractor's Construction Quality Control Manager and MDOT Bridge Engineer for review. The NDE procedure shall include a written practice, a method procedure for each inspection process and personnel certifications.

Breaks in fabrication shall require at least two weeks advance notification to the Contractor's Quality Control Manager and MDOT Bridge Engineer prior to restarting work.

Progressive girder assembly using a minimum three girder laydown is permissible while shop assembling girders. Drilling of material for splice connections shall occur with all items in their proper location, including splice and shim plates. Parts shall be firmly drawn together prior to drilling.

SECTION 15.0 – WIDENED STRUCTURES

The Fabricator shall furnish MDOT QA Shop Inspection Personnel with at least 140 square feet of floor space. Additional space shall be provided as required by MDOT Bridge Engineer. The office shall contain desks, chairs, file cabinets, telephone with long distance access, electric lights, power outlets, shelves and tables. The office shall be provided with adequate heating, ventilation and air conditioning. The office shall have access to convenient sanitary facilities with running water. The office shall be in good repair, located where there is not excessive noise and shall be used for MDOT QA Shop Inspection Personnel only. Convenient and adequate parking shall be provided.

The Fabricator shall provide MDOT QA Shop Inspection Personnel convenient access to a fax machine and a copy machine. Changes in office location or facilities shall be made only upon approval of MDOT Bridge Engineer.

15.4.4 *Deep Foundation Design*

All bridge foundations (including abutments) shall be constructed with deep foundations consisting of piles, drilled shafts or footings supported by piles or drilled shafts.

Piers for bridges over rivers, streams or creeks shall have pile foundations.

Piers for bridges at grade separations shall consist of cap and columns with either piles and pile cap (footing) or drilled shafts. The minimum size of the column shall be 36 inches in diameter. The minimum number of piles supporting the pile cap (footing) shall be four (4).

Top of footings shall be no higher than the top of existing footings.

Piles or drilled shafts shall be tipped no higher than the existing pile or shaft tip elevations. Footings on bridges at grade separations shall have a minimum of two (2) feet of cover.

Deep foundations are required to extend a minimum of fifteen (15) feet below any compacted fill.

All piling shall be prestressed concrete or H-pile. For water crossing, steel H-piles, if used, shall be encased from the bottom of the pile cap to a minimum of five (5) feet below natural ground.

15.4.5 *Bearings*

Elastomeric bearings shall be designed in accordance with AASHTO Division I, Section 14. Natural rubber in elastomeric bearings will not be allowed. Replacement elastomeric bearings shall have the same compressed height as the existing bearing. Any new bearings for a given span (including replacement bearings), shall utilize the same design at all locations in that span.

All bearings shall be designed and detailed to be replaceable by jacking while maintaining traffic.

Traffic shall be stopped during raising and lowering of the bridge to replace the bearings (see Section 16.4). At a minimum, jacking the bridge shall be accomplished by jacking an entire end of a span.

Bearings at integral abutments are excluded from the bearing replacement requirements.

SECTION 15.0 – WIDENED STRUCTURES

15.4.6 *Bridge Railings*

All barriers shall be 32” tall, New Jersey Shape concrete barrier which meets NCHRP Report 350 TL-4 criteria. The surface of the bridge rails shall be given a spray finish in accordance with Mississippi Standard Specifications for Road and Bridge Construction, Section 804.03.19.3.2 Spray Finishes.

15.4.7 *Expansion Joints*

Expansion joints shall be provided to accommodate the movement of the bridge. Existing bridge joint armoring, if present, shall be removed, the joints saw cut to remove cracked and broken concrete, repaired with an Epoxy Mortar, and sealed with a silicone sealant.

Finger Joints shall be used when the movement rating of the expansion joints is greater than two (2) inches. The design and construction of the finger joint shall be similar to the joint plans shown at the end of this Section 15. Modular joints shall not be used. Expansion finger joints and rail plates shall be galvanized in accordance with ASTM A 123.

For normal geometry conditions, cellular or modular joints shall not be used. When present, curvature of the structure shall be considered in the design of the expansion joint. If it can be shown that expansion finger joints are not feasible for use due to excessive horizontal curvature of the structure, other joint types may be considered, when approved by MDOT.

15.4.8 *Bridge Drainage*

1. Bridge deck drainage shall be provided as necessary to keep the ten (10) year event for a five (5) minute interval from spreading into the travel lanes. Rainfall intensity – Duration – Frequency Curves are provided in MDOT Roadway Design Manual Figure 7-4f. Bridge deck drainage design shall be in accordance with FHWA Circular No.21, “Design of Bridge Deck Drainage” (HEC-21).
2. Bridge deck drainage shall be contained on the bridge deck prior to passing through the bridge deck drains. Bridge deck drainage shall not be allowed to pass through the railing.
3. Bridge deck drains shall extend below the bottom flange of steel girders. Where drainage scuppers and drain pipes are used, pipes shall be located inside of the exterior girder.
4. Bridge deck drains for precast-prestressed concrete girder spans may utilize drain holes with a minimum opening of three (3) inches by eight (8) inches. Drain holes shall be located adjacent to the bridge barrier.
5. No bridge deck drainage shall drain onto the railroad right-of-way or onto a roadway, sidewalk, and shoulder.

15.4.9 *Cranes on Existing Bridges*

Cranes may be placed on existing bridges provided that the Lead Design Engineer has determined that the existing structure can safely support the proposed crane at an inventory rating. Crane mats shall be placed over the portion of the bridge deck that the crane will cross or set up on. Contractor shall submit stamped calculations and supporting documentation to MDOT demonstrating that the existing bridge can safely carry the crane load.

SECTION 15.0 – WIDENED STRUCTURES

Any damage to the bridge or bridge deck shall be immediately repaired by the Contractor.

15.4.10 Load Rating

The Contractor shall load rate the widened portion of all bridges. The load ratings shall be in accordance with the requirements below. A report for each Structure shall be submitted detailing the ratings for all axle configurations identified. Calculations shall be supplied to MDOT in an acceptable format.

HS20-44 Truck shall be used for the operating and inventory levels.

The following trucks shall be use to rate operating level. The axle weight for each truck and spacing is provided below:

HS-SHORT

8 kip -- 12 ft -- 20 kip -- 4 ft -- 20 kip -- 10 ft -- 16 kip -- 4 ft --14 kip
total weight = 80 kip

HS-LONG

8 kip -- 12 ft -- 20 kip -- 4 ft -- 20 kip -- 22 ft -- 16 kip -- 4 ft --14 kip
total weight = 80 kip

CONCRETE TRUCK

10 kip -- 12 ft -- 25 kip -- 4 ft -- 25 kip
total weight = 60 kip

TANDEM AXLE

20 kip -- 4 ft -- 20 kip
total weight = 40 kip

The bridge ratings shall be summarized in a table at the start of the calculations showing the critical point in the bridge for each truck.

15.4.11 Temporary Concrete Traffic Barriers

Temporary concrete traffic barriers which meet the NCHRP Report 350 TL-3 criteria shall be used on the bridge deck to separate the work area from the traffic. When the temporary concrete traffic barriers are to be placed less than eight (8) ft. from an open edge of bridge deck, the barriers shall be safely attached to the bridge deck. The bridge deck attachments shall be designed to carry the TL-3 loading. When the temporary concrete traffic barriers are removed from the bridge deck, the attachments shall be completely removed and the deck repaired with a non-shrink grout. Design calculations and plan sheets shall be submitted to MDOT for review in the Final Design Review Phase (Section 2.2.4).

15.5 Deliverables

At a minimum the Contractor shall submit the following to MDOT:

SECTION 15.0 – WIDENED STRUCTURES

Deliverable	Review and Comment	Schedule	Reference Section
Preliminary Design	✓	According to Contractor's Schedule	2.2.2
Final Design	✓	Prior to RFC Submittal	2.2.4
RFC Documents	✓	Prior to Construction of the designed portion of Project	2.2.5
As-Built Drawings and Records	✓	30 days following Construction of the designed portion of Project	2.2.8
Jacking Plans for Bearing Pad Replacement with Calculations	✓	30 days prior to installation of the replacement bearing pads	15.4.5
Rating of Widened Portion of each Bridge	✓	30 days following Construction of the designed portion of Project	15.4.10
Temporary Concrete Traffic Barrier Details and Calculations	✓	At the Final Design Review Phase	15.4.11

**SECTION 17.0 – MAINTENANCE OF
TRAFFIC DURING CONSTRUCTION**

16.0 Not Used

SECTION 17.0 – MAINTENANCE OF TRAFFIC DURING CONSTRUCTION

17.0 MAINTENANCE OF TRAFFIC DURING CONSTRUCTION

The Contractor shall develop and submit a Maintenance of Traffic (MOT) Plan for MDOT approval at least 30 Days prior to beginning the first phase or stage of construction at each location. The MOT Plan shall identify the Contractor’s strategy to provide for the safe and efficient movement of people, goods and services through and around each location while minimizing impacts to local residents, business and commuters; its approach to developing detailed Traffic Control Plans (TCP); Contractor shall describe the MOT Plan with reasonable and measurable tasks and milestones..

17.1 Traffic Control Plans

The Contractor shall develop and submit Traffic Control Plans for each stage of construction on each Project Bridge that shows the Contractor’s proposed construction staging and proposed traffic control devices consistent with the MOT Plan. The TCP shall be submitted for approval to MDOT three (3) days prior to construction of the Work shown in the TCP. Major revision to a TCP shall also be submitted to MDOT for its approval. The TCPs shall include, at a minimum, the following:

1. A detailed diagram showing the location of all traffic control devices.
2. An access maintenance plan for all properties requiring access during construction. The plan shall also indicate the areas where equipment will be stored and vehicles parked if within the Project Right-of-Way.
3. A plan for maintaining and controlling pedestrian, bicycle and other non-vehicular traffic.

17.2 Construction Requirements

1. The Contractor shall maintain two (2) eleven (11) foot lanes on I-55 at all times from July 1 through November 1 and at all times north of SR 27 and the bridge site at SR 27.
2. South of SR 27, the Contractor shall maintain one (1) twelve (12) foot lane on the existing structures at all times from November 2 to June 30. During period of work when one lane on the interstate is permitted, November 2 to June 30, the minimum unobstructed travel way width shall be 17’ – 0” unless otherwise permitted by MDOT. Exceptions may be granted for the erection of bridge girders and setting of protective barriers for the construction zones.
3. The Contractor shall notify MDOT of any lane closures necessary to perform work at each location prior to instituting or changing such traffic control measures. This notification shall be submitted at least 48 hours prior to the construction. Total road closures will not be permitted
4. The Contractor shall notify MDOT of any vertical clearance reduction that provides less than 16.5’ clearance, any load capacity reductions, or any width reduction that results in a restriction of less than 20’ wide a minimum of 20 days prior to such restriction.
5. The Contractor shall provide a paved surface for all detours or bypasses.

SECTION 17.0 – MAINTENANCE OF TRAFFIC DURING CONSTRUCTION

- 6. The Contractor’s placement of construction equipment, materials and vehicles shall comply with MUTCD.

17.3 Protective barriers for the construction zone shall be anchored to the existing bridge decks per Section 15.4.11. Emergency Events

The Interstate system is a vital link in the evacuation of residents along the coast in the event of a Hurricane. In the event of a hurricane, the Contractor shall assist MDOT in maintaining an open highway system. This assistance will be paid for under a Supplemental Agreement.

17.4 Bearing Replacement

The Interstate system may be closed between the hours of 8 PM and 6 AM to raise and lower the bridge to replace the bearings. The closure period shall be limited to fifteen (15) minute intervals. The Contractor shall provide appropriate advanced warning to the traveling public such that they may either continue on the Interstate or exit the Interstate. No detour route will be required.

The Contractor shall obtain approval in writing from the MDOT Project Engineer of all Interstate closures prior to providing advanced warning to the public.

The Contractor shall provide seven (7) days advanced warning of the closures to the public.

17.5 Deliverables

At a minimum, the Contractor shall submit the following to MDOT for review or comment:

Deliverable	Review and Comment	Schedule	Reference Section
Maintenance of Traffic Plan	✓	30 Days prior to start of construction	17
Traffic Control Plans	✓	At least 3 days prior to construction of the Work shown in the TCP submittal	17.1

SECTION 18.0 – TECHNICAL STANDARDS, DATA, REPORTS

18.0 Technical Standards, Data, Reports

The following standards, data, or reports are Contract Documents. These standards apply unless otherwise described in Sections 1-17 of the Technical Requirements. In case of conflict, the order of precedence of these documents shall be as listed in the order presented below.

Availability Legend:

- IS = Industry standard, not provided by MDOT
- PR = Provided by MDOT
- GoMDOT = Provided by MDOT via Internet
- W = Available via the Internet, not provided by MDOT

Originator	Title	Availability
MDOT	Standard Specifications for Road and Bridge Construction, 2004 Edition	GoMDOT
MDOT	Stormwater Management Program	PR
MDOT	Field Manual for Concrete	GoMDOT
MDOT	Field Manual for Hot Mix Asphalt (HMA)	GoMDOT
MDOT	Pipe Culvert Material Design Criteria	GoMDOT
MDOT	Roadway Design Manual, 2001 Version	GoMDOT
MDOT	CADD Standards	GoMDOT
MDOT	Roadway Design Memos	GoMDOT
MDOT	Special Design Sheets	GoMDOT
MDOT	Roadway Design Standard Drawings	GoMDOT
AASHTO	All Standards/Manuals	IS
ADA	ADA Accessibility Guidelines	IS
American Railway Engineering and Maintenance of Right-of-Way Association (AREMA)	Manual for Railway Engineering	IS

SECTION 18.0 – TECHNICAL STANDARDS, DATA, REPORTS

Originator	Title	Availability
ASTM	Standards	IS
Electronics Industries Alliance (EIA)	Standards	IS
FHWA	All Standards/Manuals	IS
Illuminating Engineering Society of North America	Roadway Lighting, ANSI Approved RP-8-00	IS
ISO	ISO 9000	IS
ISO	ISO 9001	IS
National Electrical Manufacturers Association (NEMA)	Standards	IS
National Fire Protection Agency (NFPA)	Life Safety Code	IS
National Fire Protection Agency (NFPA)	National Electric Code	IS
National Transportation Communications for ITS Protocol Standards (NTCIP)	Standards	IS
Telecommunications Industries Association (TIA)	All standards and publications	IS
Transportation Research Board	Highway Capacity Manual	IS
US Army Corp of Engineers	Publications	www.usace.army.mil/publications

SECTION 905

Date _____

Mississippi Transportation Commission
Jackson, Mississippi

Sirs: The following Proposal is made on behalf of _____
_____ of _____

for constructing the following designated Project(s) within the time(s) hereinafter specified.

The Specifications are the current Standard Specifications of the Mississippi Department of Transportation approved by the Federal Highway Administration, except where superseded or amended by the Special Provisions and Notice(s) to Proposers attached hereto and made a part thereof.

I (We) certify that I (we) possess a copy of said Standard and Supplemental Specifications.

Evidence of my (our) authority to submit the Proposal is hereby furnished. The Proposal is made without collusion on the part of any person, firm or corporation. I (We) certify that I (we) have carefully examined the Specifications, including the Special Provisions and Notice(s) to Proposers, herein, and have personally examined the site of the Work. On the basis of the Specifications, Special Provisions, Notice(s) to Proposers and Contract Documents, I (we) will furnish all necessary items to successfully complete the Project.

Attached hereto is a certified check, cashier's check or Proposal Guaranty Bond in the amount as required in the Advertisement (or, by law).

I (We) further propose to perform all "force account or extra work" that may be required of me (us) on the basis provided in the Specifications and to give such work my (our) personal attention in order to see that it is economically performed.

I (We) further propose to execute the attached Contract as soon as the Work is awarded to me (us), and to begin and complete the Work within the time limit(s) provided for in the Specifications and Advertisement. I (We) also propose to execute the attached Contract bond in an amount not less than one hundred (100) percent of the total of my (our) part, but also to guarantee the excellence of both workmanship and materials until the Work is finally accepted.

SECTION 905

I (We) enclose a certified check, cashier's check or bid bond for **five percent (5%) of total price proposed** and hereby agree that in case of my (our) failure to execute the contract and furnish bond within Ten (10) days after notice of award, the amount of this check (proposal guarantee bond) will be forfeited to the State of Mississippi as liquidated damages arising out of my (our) failure to execute the contract as proposed. It is understood that in case I am (we are) not awarded the work, the check will be returned as provided in the Specifications.

Proposer acknowledges receipt of and has added to and made a part of the Proposal and Contract documents the following addendum (addenda):

ADDENDUM NO. ___ DATED _____	ADDENDUM NO. ___ DATED _____
ADDENDUM NO. ___ DATED _____	ADDENDUM NO. ___ DATED _____
ADDENDUM NO. ___ DATED _____	ADDENDUM NO. ___ DATED _____
ADDENDUM NO. ___ DATED _____	ADDENDUM NO. ___ DATED _____

TOTAL ADDENDA: _____
 (Must agree with total addenda issued prior to opening of bids)

Number Description

Respectfully Submitted,

DATE _____

 Contractor

BY _____
 Signature

TITLE _____

ADDRESS _____

CITY, STATE, ZIP _____

PHONE _____

FAX _____

EMAIL _____

(To be filled in if a corporation)

Our corporation is chartered under the Laws of the State of _____

and the names, titles and business addresses of the executives are as follows:

_____ President	_____ Address
--------------------	------------------

_____ Secretary	_____ Address
--------------------	------------------

_____ Treasurer	_____ Address
--------------------	------------------

SECTION 905

SECTION 905
PROPOSAL (Sheet 2-1)

DB/IM-0055-02(228)/105444-305
DB/IM-0055-02(228)/105444-306
Lincoln and Copiah Counties

Design Build for the Improvements on Interstate 55 in Lincoln and Copiah Counties will be widened or replaced to improve the bridges to the current roadway standards, as per Section 904 – NTP No. 2618-D3-1 DB (Project Scope). The Work shall include:

1. I-55 NB and I-55 SB over County Line Road(Mile Marker 74.3) (Bridge Widening)
2. I-55 NB and I-55 SB over SR 27 (Mile Marker 72.0) (Bridge Widening / SR 27 Roadway Adjustment)
3. I-55 NB and I-55 SB over Clear Creek Road (Mile Marker 66.1) (Bridge Widening)
4. I-55 NB and I-55 SB over Gallman Road (Mile Marker 65.5) (Bridge Widening / Gallman Road Adjustment)

The Project shall include any additional bridges, if any, as specified in Volume 1, on Contractor’s Schedule Certificate.

I (We) agree to complete the entire Project with the specified contract time specified in Contractor’s Schedule Certificate.

***** SPECIAL NOTICE TO BIDDERS ******

BIDS WILL NOT BE CONSIDERED UNLESS BOTH UNIT PRICES AND ITEM TOTALS ARE ENTERED
BIDS WILL NOT BE CONSIDERED UNLESS THE BID CERTIFICATE LOCATED AT THE END OF THE BID SHEETS IS SIGNED

BID SCHEDULE

REF NO	PAY ITEM NO.	ADJ CODE	APPROX QUANTITY	UNIT	DESCRIPTION	UNIT PRICE		ITEM TOTAL	
						DOLLAR	CENT	DOLLAR	CENT
			1	Lump Sum	Design-Build for Improvements to Interstate 55 in Lincoln and Copiah Counties, Mississippi; at locations indicated in Volume 1 on the Contractor’s Schedule Certificate	\$XXXXXXXXXXXX	XX	\$	00

TOTAL BID.....CONTRACT PRICE (NOT TO EXCEED \$10,000,000.00).....\$_____

COMPLETE ITEM NOS. 1, 2, AND/OR 3 AS APPROPRIATE. SEE NOTICE TO BIDDERS NO. 696 AND SUPPLEMENT.

1. I/We agree that no less than _____ percent shall be expended with small business concerns owned and controlled by socially and economically disadvantaged individuals (DBE and WBE).
2. Classification of Bidder: Small Business (DBE) _____ Small Business (WBE) _____
3. A joint venture with a Small Business (DBE/WBE): Yes _____
4. All requirements of the RFP have been included in the Total Bid.

***** SIGNATURE STATEMENT *****

BIDDER ACKNOWLEDGES THAT HE/SHE HAS CHECKED ALL ITEMS IN THIS PROPOSAL FOR ACCURACY AND CERTIFIED THAT THE FIGURES SHOWN THEREIN CONSTITUTE THEIR OFFICIAL BID.

PROPOSER'S SIGNATURE

PROPOSER'S COMPANY

PROPOSER'S TAX ID NUMBER/DUNS NUMBER

SECTION 905

**Certification with regard to the Performance of Previous
Contracts or Subcontracts subject to the Equal Opportunity
Clause and the filing of Required Reports**

The Proposer _____, proposed Subproposers _____, hereby certifies that it/they/he has _____, has not _____, participated in a previous contract or subcontract subject to the Equal Opportunity Clause, as required by Executive Orders 10925, 11114, or 11246, and that it has _____, has not _____, filed with the Joint Reporting Committee, the Director of the Office of Federal Contract Compliance, a Federal Government contracting or administering agency, or the former President's Committee on Equal Employment Opportunity, all reports due under the applicable filing requirements.

(COMPANY)

BY _____

(TITLE)

DATE: _____

NOTE: The above certification is required by the Equal Employment Opportunity Regulations of the Secretary of Labor (41 CFR 60-1.7 (b) (1)), and must be submitted by bidders and proposed subcontractors only in connection with contracts and subcontracts which are subject to the Equal Opportunity Clause. Contracts and Subcontracts which are exempt from the Equal Opportunity Clause are set forth in 41 CFR 60-1.5. (Generally only contracts or subcontracts of \$10,000 or under are exempt.)

Currently, Standard Form 100 (EEO-1) is the only report required by the Executive Orders or their implementing regulations.

Proposed prime Contractors and Subcontractors who have participated in a previous contract or subcontract subject to the Executive orders and have not filed the required reports should note that 41 CFR 60-1.7 (b) (1) prevents the award of contracts and subcontracts unless such Contractors submit a report covering the delinquent period or such other period specified by the Federal Highway Administration or by the Director, Office of Federal Contract Compliance, U. S. Department of Labor.

SECTION 905

OCR-485
REV. 10/02

**MISSISSIPPI DEPARTMENT OF TRANSPORTATION
OFFICE OF CIVIL RIGHTS
JACKSON, MISSISSIPPI**

LIST OF FIRMS SUBMITTING QUOTES

I/we received quotes from the following firms on Project No: _____
County: _____

Disadvantaged Business Enterprise (DBE) Regulations as stated in 49 CFR 26.11 require the Mississippi Department of Transportation (MDOT) to create and maintain a comprehensive list of all firms quoting/bidding subcontracts on prime contracts and quoting/bidding subcontracts on federally-funded transportation projects. For every firm, we require the following information:

Firm Name: _____
Contact Name/Title: _____
Firm Mailing Address _____
Phone Number: _____
_____ DBE Firm _____ Non-DBE Firm

Firm Name: _____
Contact Name/Title: _____
Firm Mailing Address _____
Phone Number: _____
_____ DBE Firm _____ Non-DBE Firm

Firm Name: _____
Contact Name/Title: _____
Firm Mailing Address _____
Phone Number: _____
_____ DBE Firm _____ Non-DBE Firm

Firm Name: _____
Contact Name/Title: _____
Firm Mailing Address _____
Phone Number: _____
_____ DBE Firm _____ Non-DBE Firm

Firm Name: _____
Contact Name/Title: _____
Firm Mailing Address _____
Phone Number: _____
_____ DBE Firm _____ Non-DBE Firm

SUBMITTED BY (Signature)

FIRM NAME

Submit this form to Contract Administration as a part of your proposal package. If this form is not included as part of the proposal packet, your proposal will be deemed irregular. For further information about this form, call Mississippi DOT's Office of Civil Rights at (601) 359-7466; FAX (601) 576-4504. Please make copies of this form when needed and also add those copies to the proposal package.

SECTION 905

MISSISSIPPI DEPARTMENT OF TRANSPORTATION

DEBARMENT

CERTIFICATION
(Execute in duplicate)

State of Mississippi

County of _____

I, _____,
(Name of person signing certification)

individually, and in my capacity as _____ of
(Title)

_____ do hereby certify under
(Name of Firm, Partnership, or Corporation)

penalty of perjury under the laws of the United States and the State of Mississippi that _____

_____, Proposer
(Name of Firm, Partnership, or Corporation)

on Project No. _____,

in _____ County(ies), Mississippi, has not either directly or indirectly entered into any agreement, participated in any collusion; or otherwise taken any action in restraint of free competitive proposing in connection with this contract; nor have any of its corporate officers or principal owners.

Except as noted hereafter, it is further certified that said legal entity and its corporate officers, principal owners, managers, auditors and others in a position of administering federal funds:

- a) Are not presently debarred, suspended, proposed for debarment, declared ineligible, or voluntarily excluded from covered transactions by any Federal department or agency;
- b) Have not within a three-year period preceding this Proposal been convicted of or had a civil judgment rendered against them for commission of fraud or a criminal offense in connection with obtaining, attempting to obtain, or performing a public (Federal, State or local) transaction or contract under a public transaction; violation of Federal or State antitrust statutes or commission of embezzlement, theft, forgery, bribery, falsification or destruction of records, making false statements, or receiving stolen property;
- c) Are not presently indicted for or otherwise criminally or civilly charged by a governmental entity (Federal, State or local) with commission of any of the offenses enumerated in (b) above; and
- d) Have not within a three-year period preceding this application/ Proposal had one or more public transactions (Federal, State or local) terminated for cause or default.

SECTION 905

Initial here "_____" if exceptions are attached and made a part thereof. Any exceptions shall address to whom it applies, initiating agency and dates of such action.

Note: Exceptions will not necessarily result in denial of award but will be considered in determining Proposer responsibility. Providing false information may result in criminal prosecution or administrative sanctions.

The Proposer further certifies that the certification requirements contained in Section XI of Form FHWA 1273, will be or have been included in all subcontracts, material supply agreements, purchase orders, etc. except those procurement contracts for goods or services that are expected to be less than the Federal procurement small purchase threshold fixed at 10 U.S.C. 2304(g) and 41 U.S.C. 253(g) (currently \$25,000) which are excluded from the certification requirements.

The Proposer further certifies, to the best of his or her knowledge and belief, that:

- 1) No Federal appropriated funds have been paid or will be paid to any person for influencing or attempting to influence an officer or employee of any Federal agency, a Member of Congress, an officer or employee of Congress, or an employee of a Member of Congress in connection with the awarding of any Federal contract, the making of any Federal grant, the making of any Federal loan, the entering into of any cooperative agreement, and the extension, continuation, renewal, amendment, or modification of any Federal contract, grant, loan, or cooperative agreement.
- 2) If any funds other than Federal appropriated funds have been paid or will be paid to any person for influencing or attempting to influence an officer or employee of any Federal agency, a Member of Congress, an officer or employee of Congress, or an employee of a Member of Congress in connection with this contract, Standard Form-LLL, "Disclosure Form to Report Lobbying," in accordance with its instructions will be completed and submitted.

The certification contained in (1) and (2) above is a material representation of fact upon which reliance is placed and a prerequisite imposed by Section 1352, Title 31, U.S. Code prior to entering into this contract. Failure to comply shall be subject to a civil penalty of not less than \$10,000 and not more than \$100,000. The bidder shall include the language of the certification in all subcontracts exceeding \$100,000 and all subcontractors shall certify and disclose accordingly.

All of the foregoing and attachments (when indicated) is true and correct.

Executed on _____

Signature

(11/23/92F)

SECTION 905

MISSISSIPPI DEPARTMENT OF TRANSPORTATION

DEBARMENT

CERTIFICATION
(Execute in duplicate)

State of Mississippi

County of _____

I, _____,
(Name of person signing certification)

individually, and in my capacity as _____ of
(Title)

_____ do hereby certify under
(Name of Firm, Partnership, or Corporation)

penalty of perjury under the laws of the United States and the State of Mississippi that _____

_____, Proposer
(Name of Firm, Partnership, or Corporation)

on Project No. _____,

in _____ County(ies), Mississippi, has not either directly or indirectly entered into any agreement, participated in any collusion; or otherwise taken any action in restraint of free competitive proposing in connection with this contract; nor have any of its corporate officers or principal owners.

Except as noted hereafter, it is further certified that said legal entity and its corporate officers, principal owners, managers, auditors and others in a position of administering federal funds:

- a) Are not presently debarred, suspended, proposed for debarment, declared ineligible, or voluntarily excluded from covered transactions by any Federal department or agency;
- b) Have not within a three-year period preceding this Proposal been convicted of or had a civil judgment rendered against them for commission of fraud or a criminal offense in connection with obtaining, attempting to obtain, or performing a public (Federal, State or local) transaction or contract under a public transaction; violation of Federal or State antitrust statutes or commission of embezzlement, theft, forgery, bribery, falsification or destruction of records, making false statements, or receiving stolen property;
- c) Are not presently indicted for or otherwise criminally or civilly charged by a governmental entity (Federal, State or local) with commission of any of the offenses enumerated in (b) above; and
- d) Have not within a three-year period preceding this application/ Proposal had one or more public transactions (Federal, State or local) terminated for cause or default.

SECTION 905

Initial here "_____" if exceptions are attached and made a part thereof. Any exceptions shall address to whom it applies, initiating agency and dates of such action.

Note: Exceptions will not necessarily result in denial of award but will be considered in determining Proposer responsibility. Providing false information may result in criminal prosecution or administrative sanctions.

The Proposer further certifies that the certification requirements contained in Section XI of Form FHWA 1273, will be or have been included in all subcontracts, material supply agreements, purchase orders, etc. except those procurement contracts for goods or services that are expected to be less than the Federal procurement small purchase threshold fixed at 10 U.S.C. 2304(g) and 41 U.S.C. 253(g) (currently \$25,000) which are excluded from the certification requirements.

The Proposer further certifies, to the best of his or her knowledge and belief, that:

- 1) No Federal appropriated funds have been paid or will be paid to any person for influencing or attempting to influence an officer or employee of any Federal agency, a Member of Congress, an officer or employee of Congress, or an employee of a Member of Congress in connection with the awarding of any Federal contract, the making of any Federal grant, the making of any Federal loan, the entering into of any cooperative agreement, and the extension, continuation, renewal, amendment, or modification of any Federal contract, grant, loan, or cooperative agreement.
- 2) If any funds other than Federal appropriated funds have been paid or will be paid to any person for influencing or attempting to influence an officer or employee of any Federal agency, a Member of Congress, an officer or employee of Congress, or an employee of a Member of Congress in connection with this contract, Standard Form-LLL, "Disclosure Form to Report Lobbying," in accordance with its instructions will be completed and submitted.

The certification contained in (1) and (2) above is a material representation of fact upon which reliance is placed and a prerequisite imposed by Section 1352, Title 31, U.S. Code prior to entering into this contract. Failure to comply shall be subject to a civil penalty of not less than \$10,000 and not more than \$100,000. The bidder shall include the language of the certification in all subcontracts exceeding \$100,000 and all subcontractors shall certify and disclose accordingly.

All of the foregoing and attachments (when indicated) is true and correct.

Executed on _____

Signature

(11/23/92F)

CONTRACTOR'S SCHEDULE CERTIFICATE

State of Mississippi

Counties of Lincoln and Copiah

_____, hereinafter denoted as CONTRACTOR, does hereby certify that it has or will obtain, the labor, material and equipment resources needed and shall perform the Work described in the Project Scope on or before the dates specified below:

Final Completion Date: Calendar Days _____ from Notice to Proceed

The Contractor does hereby propose to complete the widening of the following bridge sites and all associated Work:

1. I-55 NB and I-55 SB over County Line Road(Mile Marker 74.3) (Bridge Widening)
2. I-55 NB and I-55 SB over SR 27 (Mile Marker 72.0) (Bridge Widening / SR 27 Roadway Adjustment)
3. I-55 NB and I-55 SB over Clear Creek Road (Mile Marker 66.1) (Bridge Widening)
4. I-55 NB and I-55 SB over Gallman Road (Mile Marker 65.5) (Bridge Widening / Gallman Road Adjustment)

The Contractor does hereby propose to complete the following bridge sites (northbound and southbound) and all associated Work, which must be bid in consecutive order as shown below (put an "x" to indicate choice):

	Included as part of this Proposal	Not included in this Proposal
1. I-55 NB and I-55 SB over SR 28 (Mile Marker 61.8) (Bridge Widening / SR 28 Roadway Adjustment)		
2. I-55 NB over Tyson Road (Mile Marker 55.8) (Pavement Repairs)		
3. I-55 NB and I-55 SB over US 84 (Mile Marker 37.5) (Bridge Widening)		

Further, CONTRACTOR hereby agrees that attainment or non-attainment of the Completion Days stated above shall be the measure of performance for the assessment of liquidated damages.

Witness our signature this the _____ day of _____, 201__.

Contractor

August 31, 2012

Project Nos. DB/IM-0055-02(228)/105444-305
DB/IM-0055-02(228)/105444-306

SECTION 902

TABLE OF CONTENTS

Page Number

I. CONTRACT DOCUMENTS 2

II. PROJECT SCOPE 2

 A. Project Scope of Work2

III. CONTRACT PRICE/CONTRACT PAYMENTS 3

 A. Contract Price.....3

 B. Contract Price Adjustments3

 C. Contract Payments4

IV. CONTRACT COMPLETION DATE AND LIQUIDATED DAMAGES 5

 A. Contract Completion Date5

 B. Failure to Complete on Time and Liquidated Damages5

V. FORCE MAJEURE 5

VI. INDEMNITY 5

VII. RECORD RETENTION..... 6

VIII. OWNERSHIP OF DOCUMENTS..... 6

IX. RELATIONSHIP OF THE PARTIES 6

X. ORGANIZATIONAL CONFLICTS OF INTEREST 7

XI. GENERAL PROVISIONS 7

 A. Laws7

 B. Headings and Titles.....7

 C. Severability8

 D. Written Notices8

 E. Understanding8

 F. Failure to Enforce8

 G. Contract Rights9

XII. AUTHORITY 9

CERTIFICATION OF CONTRACTOR 10

CERTIFICATION OF DIRECTOR..... 11

SECTION 902

CONTRACT FOR DB/IM-0055-02(228)/105444-305 and DB/IM-0055-02(228)/105444-306
LOCATED IN THE COUNTIES OF LINCOLN AND COPIAH
STATE OF MISSISSIPPI,
COUNTY OF HINDS

THIS CONTRACT IS EXECUTED BY AND BETWEEN THE MISSISSIPPI TRANSPORTATION COMMISSION, A BODY CORPORATE OF THE STATE OF MISSISSIPPI, (“COMMISSION”) AND THE UNDERSIGNED CONTRACTOR, AN ENTITY DULY AUTHORIZED TO DO BUSINESS IN THE STATE OF MISSISSIPPI, (“CONTRACTOR”) EFFECTIVE AS OF THE DATE OF LATEST EXECUTION BELOW.

WITNESSETH:

THAT WHEREAS, the people of the State of Mississippi will benefit from the construction of the said Improvements on I-55, in Lincoln and Copiah Counties, Mississippi (hereinafter referred to as “the Project”), due to increased safety and use of the widened shoulders by emergency vehicles, especially during hurricane evacuations; and

WHEREAS, the Commission, desires the completion of this strategic Project, as it is in the best interest of the people of the State of Mississippi; and

WHEREAS, the Commission, working with the people, the federal government, and other agencies of the State of Mississippi, has devised an innovative plan to allow the commencement and completion of the Project in a timely and cost-effective manner; and

WHEREAS, the Commission is authorized under the provision of Section 65-1-85, Miss. Code Ann. (1972) to utilize the design/build method of procurement to design and construct the Project; and

WHEREAS, after a competitive process, Contractor has been selected to participate in this venture by designing and building the Project; and

WHEREAS, the Commission desires to avail itself of and rely upon Contractor’s expertise and proven track record in designing and constructing such projects, on time and within budget; and

WHEREAS, the Contractor wishes to provide that expertise and to participate in this venture for the good of the people of the State of Mississippi;

NOW THEREFORE, for and in consideration of the mutual promises and covenants hereinafter set forth, the Commission and the Contractor mutually agree as follows:

I. CONTRACT DOCUMENTS

The Contract shall be composed of all items (listed A through M) below, and any amendments thereto. Each of these documents below are an essential part of the Contract. The documents are intended to be complementary and are intended to be read as a complete Contract. In case of conflict, ambiguity or inconsistency the order of precedence, from highest to lowest, of the Contract documents shall be:

- A. Section 902
- B. Exhibits to Section 902
 - Exhibit 1 – As-Built Plans of Project features prior to Contract, by MDOT
 - Exhibit 2 – Environmental Document (Categorical Exclusion) and Permits
 - Exhibit 3 – Typical Existing Bridge Joint Rehabilitation
 - Exhibit 4 – Erosion Control Standards
- C. Section 904
 - Supplements to Notice to Proposers
 - Notice to Proposers
- D. Section 905
- E. Section 906
 - Supplement to Form FHWA-1273
 - Minimum Hourly Wage Rates
 - Federal-Aid Construction Contracts (Form FHWA-1273)
 - Notice of Requirements for Affirmative Action to Ensure Equal Employment Opportunity (Executive Order 11246)
- F. Section 907
 - Supplements to Special Provisions
 - Special Provisions
- G. Contractor's Proposal – Contractor's Technical Proposal – Volume 1 – (Only those items that are a higher standard than the Technical Requirements.)
- H. Technical Requirements for Design and Construction
- I. Final Design Documents (provided by Contractor)
- J. Section 903
 - Contract Bond
- K. Contractors Proposal Volume 1 (Except those items that are a higher standard than the Technical Requirements.)
- L. Request for Proposals and Addenda, if any
- M. Proposer's (Contractor's) Statement of Qualifications

II. PROJECT SCOPE

- A. Project Scope of Work

Contractor shall furnish all services, labor, materials, equipment, supplies, tools, transportation, and coordination required to perform all preliminary and final engineering, surveying, geotechnical services, scheduling, permitting, procurement, construction, design quality control, material testing for asphalt and concrete, traffic control, and any other services necessary to perform the Project.

The Project Scope shall be as defined in Section 904 – NTP No. 2618-D3-1 DB and the Contractor’s Schedule Certificate.

III. CONTRACT PRICE/CONTRACT PAYMENTS

A. Contract Price

The “Contract Price” shall be the amount shown on Section 905 sheet 2-2.

In consideration for the Contract Price, Contractor shall perform all of its responsibilities under the Contract. The Contract Price shall include all Work identified in the Project Scope of Work.

B. Contract Price Adjustments

1. Allowable adjustments

The Contract Price may only be adjusted due to any of the following occurrences:

- (a) Commission approved Scope changes, value engineering proposals, directives or authorized extra work.
- (b) Acts or omissions by Commission or its duly appointed representative that unreasonably interfere with the Contractor’s performance and cause delay of Work on the critical path of the Project.
- (c) Changes in a legal requirement or regulation that becomes effective subsequent to the date of this Contract.
- (d) Discovery of Hazardous Materials not discoverable from a reasonable investigation and analysis of the site prior to the submission of the Proposal or as allowed in Section V below.
- (e) Discovery of archeological or paleontological sites, as noted in Subsection 203.03.1 of the Standard Specifications that was not discoverable from a reasonable investigation and analysis of the Site prior to the Proposal Date.

Other than as provided above, the Contract Price shall not be increased for Contract price adjustments or claimed delay damages. The basis for any allowable price adjustment will be a negotiated amount or by Force Account in accordance with Section 109.04 of the Contract.

2. Changes

- (a) A “Change” shall be any deviation or variation from the Project Scope, the Design Criteria or the Construction Criteria of the Project as originally set forth in this Contract. No Change shall be implemented prior to execution of an appropriate Supplemental Agreement. A “Change” may be an “Additive Change” or a “Deductive Change”.
- (b) MDOT may initiate a Change by advising Contractor in writing of the change. Within seven (7) days, Contractor shall prepare and forward to MDOT an

estimate of cost or savings, and the impact to the schedule resulting from the change. An independent cost estimate may or may not be performed by the Commission's duly authorized representative. Parties to the Contract will then negotiate in good faith partnering efforts to agree on scope and cost impacts. MDOT will advise the Contractor in writing of its approval or disapproval of the change. If the Commission approves the change, the Contractor shall perform the Services as changed.

3. Construction Change Directive

A Construction Change Directive is a written order from MDOT directing a change prior to agreement with the Contractor on adjustment, if any, to the Contract Price or Contract Time.

4. Direct Costs for Construction Change Directive

For the purpose of a Contract Price Adjustment, "Direct Costs" shall be defined as:

- (a) costs of labor, including social security, unemployment insurance, fringe benefits required by agreement or custom, and workers' compensation insurance;
- (b) costs of labor for QC, surveying and erosion control or fees paid for this Work directly attributable to the change or event;
- (c) costs of materials, supplies, and equipment, including cost of transportation, whether incorporated or consumed;
- (d) depreciated time value of machinery and equipment owned by Contractor or any affiliated or related entity exclusive of hand tools;
- (e) actual costs paid for rental of machinery and equipment exclusive of hand tools;
- (f) costs of premiums for all bonds and insurance, permit fees, and sales, use or similar taxes;
- (g) additional costs of supervision and field office personnel directly attributable to the change or event; and
- (h) Costs incurred or fees paid for design work related to the change or event.

C. Contract Payments

Mobilization shall not exceed 5% of the Contract Price.

MDOT will make Contract Payments in accordance with Subsection 907-109.06 and 907-109.11 of the Technical Standards, Supplements to Special Provisions, and Special Provisions.

IV. CONTRACT COMPLETION DATE AND LIQUIDATED DAMAGES

A. Contract Completion Date

The Contractor shall complete the Project by the date shown on the Contractor's Schedule Certificate, Final Completion Date.

B. Failure to Complete on Time and Liquidated Damages

The Commission will assess liquidated damages against the Contractor for each calendar day beyond the Final Completion Date. The assessment of liquidated damages shall not be considered a penalty; any damages assessed represent a reasonable estimate of fair compensation for the damage of delay that may reasonably be anticipated from the Contractor's failure to complete the Project within the Final Completion Date. If the Contractor fails to complete all items of Work by the Final Completion Date, the Commission will assess liquidated damages of \$3,500 per calendar day until the date all items of Work are completed. The assessment of liquidated damages shall be deducted by the Commission from monies due the Contractor, if sufficient monies are available. Otherwise, the Contractor shall pay to the Commission the liquidated damages assessments within fifteen (15) calendar days of notice that payment is due.

V. FORCE MAJEURE

Delays or failures of performance shall not constitute breach of the Contract if and to the extent such delays or failures of performance are caused by severe and not reasonably foreseeable occurrences beyond the control of the Commission or the Contractor, including, but not limited to: Acts of God or the public enemy; expropriation or confiscation of facilities; compliance with any order of any governmental authority other than the Commission or a party in privity with it; Acts of War; rebellion or sabotage or damages resulting there from; fires, floods, hurricanes, explosions, or accidents that require stoppage of the entire Work, riots or nationwide strikes or other concerted acts of workman, whether direct or indirect, encountering rare or endangered species or any similar causes, which are not within the control of the Commission or the Contractor respectively, and which by the exercise of reasonable diligence, the Commission or the Contractor are unable to prevent. Any expense attributable to such occurrence shall not entitle the Contractor to an adjustment in the Contract Price. Dates by which performance obligations are scheduled to be met will be extended for a period of time equal to the critical path time lost due to any delay so caused.

VI. INDEMNITY

The Contractor shall indemnify and hold harmless the Commission and all its officers, agents and employees from any claim, loss, damage, cost, charge or expense arising out of any negligent act, actions, neglect or omission by the Contractor, its agents employees, or subcontractors during the performance of this Contract, whether direct or indirect, and whether to any person or property for which the Commission or said parties may be subject, except that neither the Contractor nor any of its agents or sub-contractors will be liable under this provision for damages arising out of the injury or damage to persons or property solely caused or resulting from the negligence of the Commission or any of its officers, agents or employees.

The Contractor's obligation to indemnify, defend, and pay for the defense, or at the Commission's option, to participate and associate with the Commission in the defense and trial or arbitration of any damage claim, lien or suit and related settlement negotiations shall be initiated by the Commission's notice of claim for indemnification to the Contractor. The Contractor's evaluation of liability, or its inability to evaluate liability, shall not excuse Contractor's duty to defend. Only an adjudication or judgment after the highest appeal is exhausted specifically finding the Commission entirely responsible shall excuse performance of this provision by the Contractor. In such case, the Commission shall pay all costs and fees related to this obligation and its enforcement. Should there be a finding of dual or multiple liability, costs and fees shall be apportioned accordingly.

In conjunction herewith, the Commission agrees to notify the Contractor as soon as practicable after receipt or notice of any claim involving Contractor. These indemnities shall not be limited by reason of the listing of any insurance coverage or warranties elsewhere herein.

VII. RECORD RETENTION

The Contractor shall maintain all documents for a period of three (3) years after Payment of Final Voucher.

During the three (3) year retention period, the Commission, the FHWA or duly authorized representatives thereof will be granted access to those documents upon reasonable notice. At any time during the period, the Commission will have the option of taking custody of the documents. The Contractor shall obtain a written release from MDOT prior to destroying the records after the three (3) year retention period.

VIII. OWNERSHIP OF DOCUMENTS

Drawings, specifications, test data, inspection reports, QC documents, daily diaries, record drawings, shop drawings, engineering reports, survey control data, safety records and any other documents, including those in electronic form, prepared by Contractor or Contractor's consultants for the Project are "Project Documents". MDOT shall be the owner of the Project Documents. Upon the Effective Date of this Contract, MDOT grants Contractor and Contractor's consultants permission to reproduce and use the Project Documents for purposes of using, maintaining, upgrading, or adding to the Project. The Contractor shall provide hard copies and electronic copies to MDOT before Final Acceptance.

IX. RELATIONSHIP OF THE PARTIES

The relationship of the Contractor to the Commission is that of an independent contractor, and said Contractor, in accordance with its status as an independent contractor, covenants and agrees that it will conduct itself consistent with such status, that it will neither hold itself out as, nor claim to be, an officer or employee of the Commission by reason hereof. The Contractor will not by reason hereof, make any claim, demand or application or for any right or privilege applicable to an officer or employee of the Commission, including but not limited to workers' compensation coverage, unemployment insurance benefits, social security coverage, retirement membership or credit, or any form of tax withholding whatsoever.

The Commission executes all directives and orders through the Mississippi Department of Transportation. All notices, communications and correspondence between the Commission and the Contractor shall be directed to the Project Director and Commission designated agents shown in Section XI.

The term MDOT and Commission as used in the Contract may be interchanged as appropriate.

X. ORGANIZATIONAL CONFLICTS OF INTEREST

The Contractor's attention is directed to 23 CFR Section 636 Subpart A and in particular to Subsection 636.116 regarding organization conflicts of interest. Subsection 636.103 defines "organizational conflict of interest" as follows:

Organizational conflict of interest means that because of other activities or relationships with other persons, a person is unable or potentially unable to render impartial assistance or advice to the owner, or the person's objectivity in performing the contract work is or might be otherwise impaired, or a person has an unfair competitive advantage.

Contractor shall provide information concerning potential organizational conflicts of interest and disclose all relevant facts concerning any past, present or currently planned interests which may present an organizational conflict of interest. Contractor shall state how its interests or those of its chief executives, directors, key individuals for this Project, or any proposed consultant, contractor or subcontractor may result, or could be viewed as, an organizational conflict of interest.

The Contractor is prohibited from receiving any advice or discussing any aspect relating to the Project or the procurement of the Project with any person or entity with an organizational conflict of interest, including, but not limited to URS Corporation, and any affiliates of URS Corporation. Such persons and entities are prohibited from participating in a Proposer's organization relating to the Project.

The Contractor agrees that, if after award, an organizational conflict of interest is discovered, the Contractor must make an immediate and full written disclosure to MDOT that includes a description of the action that the Contractor has taken or proposes to take to avoid or mitigate such conflicts. If an organizational conflict of interest is determined to exist, MDOT may, at its discretion, cancel the Design-Build contract for the Project. If the Contractor was aware of an organizational conflict of interest prior to the award of the contract and did not disclose the conflict to MDOT, MDOT may terminate the contract for default.

MDOT may disqualify a Contractor if any of its major participants belong to more than one Contractor's organization.

XI. GENERAL PROVISIONS

A. Laws

This Contract shall be governed by and interpreted in accordance with the substantive laws of the State of Mississippi.

B. Headings and Titles

Headings and titles of the various parts of this Contract are for convenience of reference only and shall not be considered in interpreting the text of this Contract. Modifications or amendments to this Contract must be in writing and executed by duly authorized representatives of each party.

C. Severability

To the extent that this Contract may be construed as to any portion to be violative of any State, Federal or local ordinance, statute, law or executive order, now or in the future, the balance hereof shall remain in full force and effect.

D. Written Notices

All deliveries and notices pertaining to this Contract shall be in writing and, if to Commission, will be sufficient when sent registered or certified mail, or faxed with proof of receipt, to MDOT addressed to the MDOT Project/Resident Engineer.

Brad Cupit, PE
Project/Resident Engineer
P.O. Box 49
Hazlehurst MS 39083
Fax: (601) 894-2554

All notices to Contractor shall be sufficient when registered or certified mail, or faxed with proof of receipt, to Contractor addressed as follows:

Project Director

E. Understanding

The Contract Documents set forth the full and complete understanding of the parties as of the Effective Date defined herein, and supersede any and all agreements and representations made or dated prior thereto.

F. Failure to Enforce

In no event shall any failure by either party hereto to fully enforce any provision to this Contract be construed as a waiver by such party of its right to subsequently enforce, assert or rely upon such provision.

G. Contract Rights

Nothing in this Contract is intended to create any Contract rights for any party other than the Commission and Contractor, nor are any third-party beneficiary rights intended to be created hereby.

XII. AUTHORITY

We the undersigned do hereby certify that we have the authority to execute this Contract for and on behalf of the entity listed below.

WITNESS my signature in execution hereof, this the ____ day of _____, 2012.

CONTRACTOR

TITLE: _____

Attest: _____

WITNESS my signature in execution hereof, this the ____ day of _____, 2012.

MISSISSIPPI TRANSPORTATION COMMISSION,
BY AND THROUGH THE DULY AUTHORIZED
EXECUTIVE DIRECTOR OF THE MISSISSIPPI
DEPARTMENT OF TRANSPORTATION

Melinda L. McGrath PE, Executive Director
Mississippi Department of Transportation

Secretary to the Commission

Award authorized by the Mississippi Transportation Commission in session on the ____ day of _____, 20 __, Book _____, Page _____

CERTIFICATION OF CONTRACTOR

I hereby certify that I am the duly authorized representative of the Contractor and that neither I nor the above Contractor has:

- (a) employed or retained for a commission, percentage, brokerage, contingent fee, or other consideration, any firm or person (other than a bona fide employee working solely for me or the above Contractor) to solicit or secure this Contract;
- (b) Agreed, as an express or implied condition for obtaining this Contract, to employ or retain the services of any firm or person in connection with carrying out the Contract, or
- (c) paid, or agreed to pay, to any firm, organization or person (other than a bona fide employee working solely for me or the above Contractor) any fee, contribution, donation, or consideration of any kind for, or in connection with, procuring or carrying out the Contract except as here expressly stated (if any);
- (d) Either directly or indirectly, entered into any agreement, participated in any collusion, or otherwise taken any action, in restraint of free competitive bidding in connection with the submitted Proposal.

I acknowledge that this certificate is to be furnished to the Department, the Federal Highway Administration, and the U. S. Department of Transportation, and is subject to applicable State and Federal laws, both criminal and civil.

By: _____
Contractor

Date: _____

CERTIFICATION OF DIRECTOR

I hereby certify that I am the Executive Director of the Mississippi Department of Transportation (MDOT) of the State of Mississippi and that the above Contractor or its representative has not been required, directly or indirectly, as an express or implied condition in connection with obtaining or carrying out this Contract to:

(a) employ or retain, or agree to employ or retain, any firm or person,

or

(b) pay, or agree to pay, to any firm, person, or organization, any fee, contributions, donations, or consideration of any kind, except as here expressly stated (if any).

I acknowledge that this certificate is to be furnished to the Federal Highway Administration, and U. S. Department of Transportation, and is subject to applicable State and Federal laws, both criminal and civil.

By: _____
Melinda L. McGrath, PE
Executive Director

Date: _____

Exhibit 1
As-Built Plans
Pile Records
(Provided on CD)

Exhibit 2
Categorical Exclusion

**MISSISSIPPI DEPARTMENT OF TRANSPORTATION
ENVIRONMENTAL DIVISION
ENVIRONMENTAL CLASS OF ACTION DETERMINATION**

105444

DISTRICT NO: <u>7</u> PROJECT NO: <u>IM-0055-02(226)</u> SECTION NO: <u>02</u>	F.A. NO: <u>0055</u> HIGHWAY NO: <u>55</u> COUNTY: <u>Pike</u>	7. APPROVED BY: DISTRICT ENGINEER _____ DATE <u>4/27/12</u> PLANNING ENGINEER _____ DATE <u>5/2/2012</u> ROADWAY DESIGN ENGINEER _____ DATE <u>5/8/2012</u> ENVIRONMENTAL ENGINEER / ADMINISTRATOR _____ DATE <u>6/21/12</u>		
I. PROJECT TERMINI: Interstate 55 between the Louisiana/Mississippi State Line and the Pike-Lincoln County Line.		8. FHWA CONCURRENCE: FHWA DIVISION ADMINISTRATOR _____ DATE <u>June 22 '12</u>		
(A.) EXISTING CONDITIONS: Interstate 55 is a hurricane evacuation route in District 7. Some of the existing bridges along Interstate 55 in Pike County are functionally obsolete and do not meet the minimum standards for bridge width.				
(B.) PROPOSED IMPROVEMENTS: To increase the width of the existing bridges on this hurricane evacuation route.				
(C.) PRELIMINARY PURPOSE & NEED: Widen the existing bridges to current standards on Interstate 55 in Pike.				
(D.) NEW ROW REQUIRED: <input type="checkbox"/> YES <input checked="" type="checkbox"/> NO				
2. ENVIRONMENTAL CONSEQUENCES EVALUATION (CHECK ONE) A. LAND USE IMPACTS B. FARMLAND IMPACTS C. SOCIAL IMPACTS D. RELOCATION IMPACTS E. ECONOMIC IMPACTS F. JOINT DEVELOPMENT G. CONSIDERATIONS RELATING TO PEDESTRAINS & BICYCLISTS H. AIR QUALITY IMPACTS I. NOISE IMPACTS J. WATER QUALITY IMPACTS K. PERMITS L. WETLAND/STREAM IMPACTS M. WATER BODY MODIFICATION & WILDLIFE IMPACTS N. FLOODPLAIN IMPACTS O. WILD & SCENIC RIVERS P. COASTAL BARRIERS Q. COASTAL ZONE IMPACTS R. THREATENED OR ENDANGERED SPECIES S. HISTORIC & ARCHAEOLOGICAL PRESERVATION / 4(f) LANDS T. HAZARDOUS WASTE SITES U. VISUAL IMPACTS V. ENERGY W. CONSTRUCTION IMPACTS	SIG.	MIN.	NONE	COMMENTS IDENTIFYING ISSUES WHICH MAKES IMPACT SIGNIFICANT OR MINIMAL During Construction <i>Nationwide Permit EOT</i> During Construction
3. PUBLIC INVOLVEMENT RECOMMENDATIONS: NONE				
4. ACTION REQUIRED: CATEGORICAL EXCLUSION <input checked="" type="checkbox"/> 106 CONSULTATION <input type="checkbox"/> ENDANGERED SPECIES ASSESSMENT <input type="checkbox"/> EA/FONSI <input type="checkbox"/> EIS <input type="checkbox"/> NOISE STUDY <input type="checkbox"/> SHPO LETTER <input type="checkbox"/> 4 (f) STATEMENT <input type="checkbox"/> CLASS DETERMINATION: CATEGORICAL EXCLUSION				
5. WETLANDS/STREAMS FINDING (CEX ONLY): NONE <i>Minimal Impacts to Streams are expected. Approximately 114' of bridge widening (shade/canal), 60' temporary bridging, 80' of culvert extensions. EOT</i>				
6. OTHER REMARKS: FMS NO. 105444/303000.				

MDOT Commitments to Environmental Excellence

Project No: IM-0055-02(226) FMS 105444-303000, 304000

Highway: Interstate 55

Revision Date: _____

County: Pike, Lincoln

Page 1 of _____

1

*Value Engineering Study Recommended Yes No

Commitments/Requirements	Source of Commitment	Responsible Office	Place on Plans	Requires A Special Provision	Status of Commitment/Requirement
<p>Live Oak Trees planted by MDOT possibly dating back to "Lady Bird Johnson" Beautification Act will be avoided to the extent possible.</p> <p>Live Oak Trees that are required to be removed will be replaced in kind.</p>	Environmental Division, FHWA	District 7, Construction	No	Yes	To be handled during Design and Construction
Change in Access Notifications to the Public using standard publication media procedures will occur during construction.	Environmental Division, FHWA	District 7	No	No	To be handled during Construction Activities
Consider various measures to prevent migratory birds from nesting in box culverts.	Environmental Division USFWS	District 7, Environmental, Construction	No	Yes	To be handled during Construction Activities

All practical and standard procedures and measures, including Best Management practices will be implemented to avoid or minimize impacts.

- These commitments should be carried throughout each phase of the project development including Design, Right of Way, Construction, and Maintenance.

*Value Engineering (VE) Studies are recommended for projects on the NHS System and/or an Intermodal Connector with an estimated project costs approaching \$25 Million

Channel Assessment Table

CA #	Site #	Latitude	Longitude	Sta.	Section- Township- Range	Type	Length In Project Area (feet)	Channel Width (feet)	Name	Impact
1	1	31.11971	-90.48375	63+08	3- 2N-7E	P	300	20	Tangipahoa	20ft- Temp. bridge construction 36 ft- Added bridge width
2	2	31.22053	-90.48400	425+00	15- 3N-7E	E	700	5	N/A	20ft- Culvert extension
3	3	31.23338	-90.48186	475+78	10- 3N-7E	P	300	15	Little Tangipahoa River	20ft- Temp. bridge construction 36ft- Added bridge width
4	5	31.32577	-90.47733	814+00	11- 4N-7E	P	300	18	Beaver Creek	20 ft- Temp. bridge construction 36 ft- Additional bridge width rip-rap

CA- Channel Assessment- Channel Assessment point location

Type:

P-Perennial

I-Intermittent

E-Ephemeral

OHWM-Ordinary High Water Mark

Station numbers (Sta.) are approximate

CA Summary	Total Present (ft)	New Bridge Width Shade/ Clear (ft)	Temporary Bridge Width Shade/ clear (ft)	Culvert/ Pipe (ft)	Rip-Rap/ Armor (ft)	Relocate and Fill (ft)	New Channel with rip- rap (ft)
Perennial:	174	114	60				
Intermittent:		0	0	0	0		
Ephemeral:	20	0	0	20	0		
Total (P.I.E.)	194	114	60	20			



Mile Marker	37.5
Location	US 84
Length (ft)	293
Width (ft)	33.23
Year Built	1966
Vertical Cl. (ft)	Bridge "A" 17.66 Bridge "B" 16.42
Superstructure	Box Girder
Substructure	Pier Int. Bents

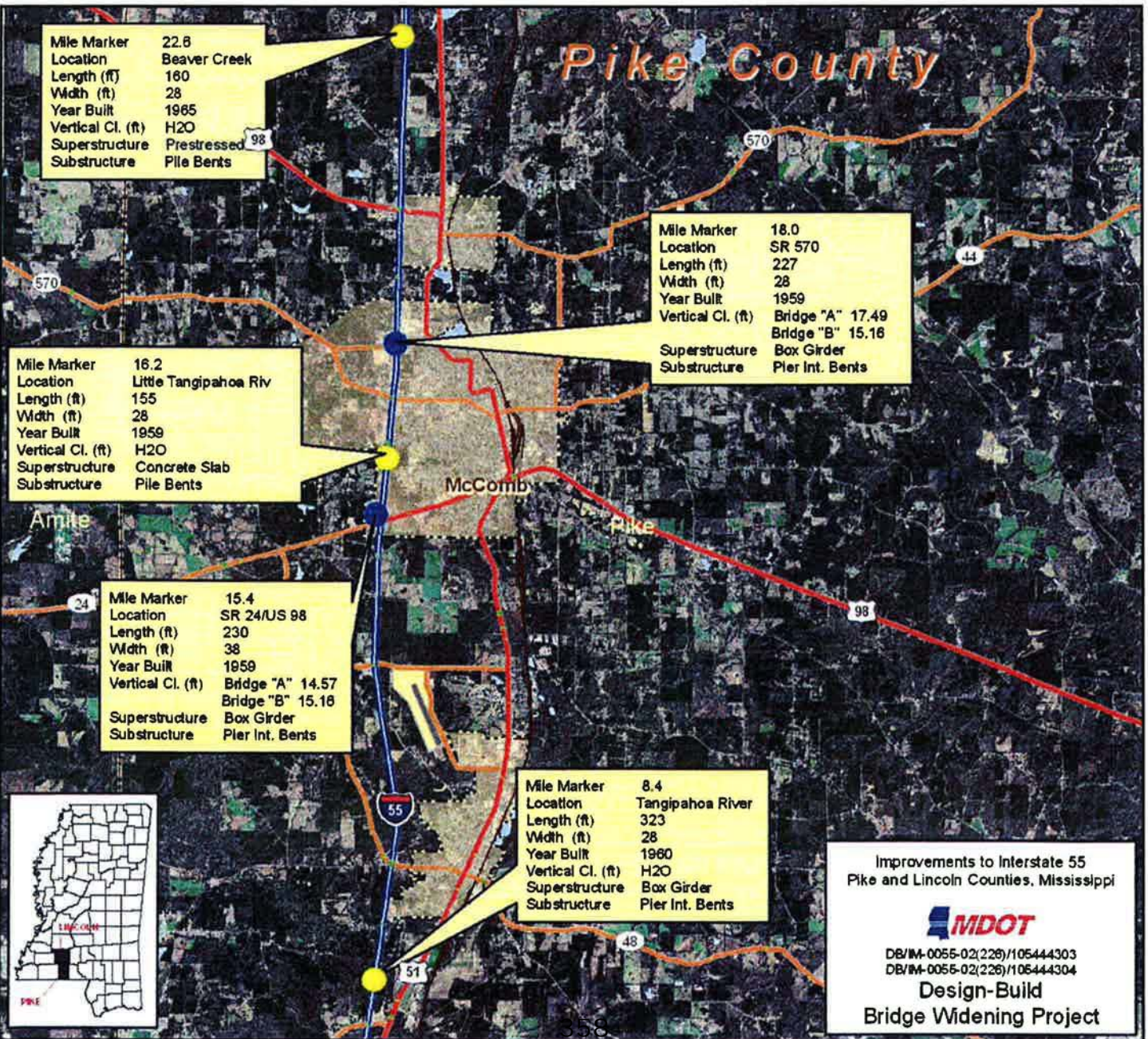

Mile Marker	22.6
Location	Beaver Creek
Length (ft)	160
Width (ft)	28
Year Built	1965
Vertical Cl. (ft)	H2O
Superstructure	Prestressed
Substructure	Pile Bents

Mile Marker	18.0
Location	SR 570
Length (ft)	227
Width (ft)	28
Year Built	1959
Vertical Cl. (ft)	Bridge "A" 17.49 Bridge "B" 15.18
Superstructure	Box Girder
Substructure	Pier Int. Bents

Mile Marker	16.2
Location	Little Tangipahoa Riv
Length (ft)	155
Width (ft)	28
Year Built	1959
Vertical Cl. (ft)	H2O
Superstructure	Concrete Slab
Substructure	Pile Bents

Mile Marker	15.4
Location	SR 24/US 98
Length (ft)	230
Width (ft)	38
Year Built	1959
Vertical Cl. (ft)	Bridge "A" 14.57 Bridge "B" 15.18
Superstructure	Box Girder
Substructure	Pier Int. Bents

Mile Marker	8.4
Location	Tangipahoa River
Length (ft)	323
Width (ft)	28
Year Built	1960
Vertical Cl. (ft)	H2O
Superstructure	Box Girder
Substructure	Pier Int. Bents

Improvements to Interstate 55
 Pike and Lincoln Counties, Mississippi



DB/IM-0055-02(226)/105444303
 DB/IM-0055-02(226)/105444304

Design-Build
 Bridge Widening Project



MISSISSIPPI DEPARTMENT OF TRANSPORTATION

SECTION 904 - NOTICE TO PROPOSERS NO. 3500 DB

CODE: (SP)

DATE: 06/06/2012

SUBJECT: Barn Swallows

Survey of the drainage box culverts at the I-55 and MS 24 Interchange found Barn Swallows (*Hirundo Rustica*) nesting on the walls of the box culvert. These birds are protected by the Migratory Bird Act.

The normal nesting period for the barn swallows is March to June. Variation to this period may occur due to environmental factors.

If active swallow nests become established (eggs or young in the nest), all work that impacts the nests shall be avoided until the chicks have fledged or the nests is unoccupied as determined by a wildlife biologist. The contractor shall prevent construction activity from displacing swallows after they have laid their eggs and before the young have fledged.

If the contractors design requires construction activity that will affect the swallows, measures can be taken by the contractor to prevent the swallows from nesting in the box culverts. Netting or other approved methods to prevent the swallows from building nests at the site is acceptable.

MISSISSIPPI DEPARTMENT OF TRANSPORTATION

SECTION 904 - NOTICE TO PROPOSERS NO. 3501 DB

CODE: (SP)

DATE: 06/06/2012

SUBJECT: Live Oak Trees

Live Oak trees are located within the project limits. Live Oak trees to remain after the project need to be protected from damage during construction. Any live oak trees within 100 feet of the work zone shall have a construction safety fence placed around the trees per the attached drawing.

Live Oak trees that will be affected (fill placed on the root ball, root pruning, limb pruning) will be treated as detailed in the attached drawing.

Live Oak trees that are removed will be replaced on a 1:1 basis. The location of the new trees shall be determined by the Engineer.

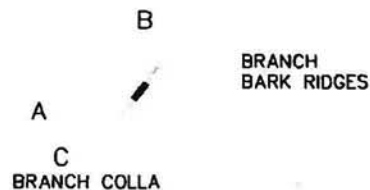

CONSTRUCTION
SAFETY FENCE

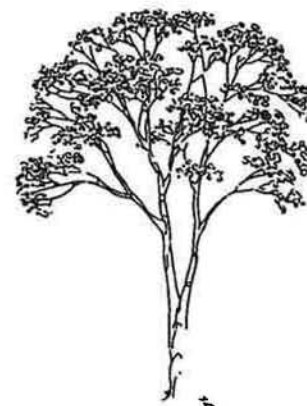

CONSTRUCTION
SAFETY FENCE

PRUNING PRINCIPALS

THE FIRST CUT (A) UNDERCUTS THE LIMB.
THE SECOND CUT (B) REMOVES THE LIMB.
THE FINAL CUT (C) SHOULD BE AT THE BRANCH
COLLAR TO REMOVE THE RESULTANT STUB.

SECTION
N.T.S.

NOTES:

1. CONSTRUCTION SAFETY FENCE TO BE PLACED IN A CIRCLE AROUND TREES WITHIN THE AREA OF CONSTRUCTION OUTSIDE THE OUTER DRIP LINE OF THE TREE.
2. NO EQUIPMENT OR MATERIAL WILL BE STORED INSIDE THE TEMPORARY FENCING OR UNDER THE CANOPY OF ANY TREE.
3. UTILITIES SHOULD BE BORED IN AREAS OF CONCERN TO PREVENT DAMAGE TO ROOTS FROM TRENCHING.
4. ANY NECESSARY ROOT PRUNING SHALL BE PERFORMED WITH A ROTATING DISC ON THE DOWNSWING AND NO DEEPER THAN 4" BELOW THE DISTURBED AREA.
5. CONTRACTOR TO APPLY A SLOW RELEASE 13-13-13 FERTILIZER WITHIN TEMPORARY FENCING.
6. ANY EXPOSED ROOTS WILL BE LOOSELY COVERED WITH A BACKFILL CONSISTING OF 50% SAND AND 50% FINE ORGANIC MATERIAL.
7. ANY PRUNED LIMBS SHALL BE IN ACCORDANCE WITH ANSI A300. PRUNING EQUIPMENT SHALL BE STERILIZED WITH 1 PART BLEACH AND 9 PARTS POTABLE WATER.
8. ALL WORK DESCRIBED ON THIS SHEET WILL NOT BE MEASURED FOR SEPARATE PAY. THIS WORK IS TO BE INCLUDED IN THE PRICE BID FOR CONSTRUCTION SAFETY FENCE.

MISSISSIPPI DEPARTMENT OF TRANSPORTATION	
DETAIL OF TREE PROTECTION	
DB/1M-0855-021(026)	WORKING NUMBER DTP-1
PIKE & LINCOLN	SHEET NUMBER
FILENAME:	
ISSUE TEAM	OTHER

**MISSISSIPPI DEPARTMENT OF TRANSPORTATION
ENVIRONMENTAL DIVISION
ENVIRONMENTAL CLASS OF ACTION DETERMINATION**

DISTRICT NO: <u>7</u> F.A. NO: <u>0055</u> PROJECT NO: <u>IM-0055-01(097)</u> HIGHWAY NO: <u>55</u> SECTION NO: <u>01</u> COUNTY: <u>Lincoln</u>	7. APPROVED BY: DISTRICT ENGINEER DATE PLANNING ENGINEER DATE ROADWAY DESIGN ENGINEER DATE ENVIRONMENTAL ENGINEER / ADMINISTRATOR DATE 8. FHWA CONCURRENCE: FHWA DIVISION ADMINISTRATOR DATE	1. PROJECT TERMINI: Interstate 55 between the Pike-Lincoln County Line and the Pike-Copiah County Line. (A.) EXISTING CONDITIONS: Interstate 55 is a hurricane evacuation route in District 7. Some of the existing bridges along Interstate 55 in Lincoln County are functionally obsolete and do not meet the minimum standards for bridge width. (B.) PROPOSED IMPROVEMENTS: To increase the width of the existing bridges on this hurricane evacuation route. (C.) PRELIMINARY PURPOSE & NEED: Widen the existing bridges to current standards on Interstate 55 in Lincoln.																																																																																																																								
(D.) NEW ROW REQUIRED: <input type="checkbox"/> YES <input checked="" type="checkbox"/> NO	2. ENVIRONMENTAL CONSEQUENCES EVALUATION (CHECK ONE) <table border="1" style="width:100%; border-collapse: collapse; text-align: center;"> <thead> <tr> <th style="width:60%;"></th> <th style="width:10%;">SIG.</th> <th style="width:10%;">MIN.</th> <th style="width:10%;">NONE</th> <th style="width:10%;"></th> </tr> </thead> <tbody> <tr><td>A. LAND USE IMPACTS</td><td></td><td></td><td>X</td><td></td></tr> <tr><td>B. FARMLAND IMPACTS</td><td></td><td></td><td>X</td><td></td></tr> <tr><td>C. SOCIAL IMPACTS</td><td></td><td></td><td>X</td><td></td></tr> <tr><td>D. RELOCATION IMPACTS</td><td></td><td></td><td>X</td><td></td></tr> <tr><td>E. ECONOMIC IMPACTS</td><td></td><td></td><td>X</td><td></td></tr> <tr><td>F. JOINT DEVELOPMENT</td><td></td><td></td><td>X</td><td></td></tr> <tr><td>G. CONSIDERATIONS RELATING TO PEDESTRAINS & BICYCLISTS</td><td></td><td></td><td>X</td><td></td></tr> <tr><td>H. AIR QUALITY IMPACTS</td><td></td><td></td><td>X</td><td></td></tr> <tr><td>I. NOISE IMPACTS</td><td></td><td>X</td><td></td><td>During Construction</td></tr> <tr><td>J. WATER QUALITY IMPACTS</td><td></td><td></td><td>X</td><td></td></tr> <tr><td>K. PERMITS</td><td></td><td></td><td>X</td><td></td></tr> <tr><td>L. WETLAND/STREAM IMPACTS</td><td></td><td>X</td><td>X</td><td>Minimal Wetlands Nationwide #23</td></tr> <tr><td>M. WATER BODY MODIFICATION & WILDLIFE IMPACTS</td><td></td><td></td><td>X</td><td></td></tr> <tr><td>N. FLOODPLAIN IMPACTS</td><td></td><td></td><td>X</td><td></td></tr> <tr><td>O. WILD & SCENIC RIVERS</td><td></td><td></td><td>X</td><td></td></tr> <tr><td>P. COASTAL BARRIERS</td><td></td><td></td><td>X</td><td></td></tr> <tr><td>Q. COASTAL ZONE IMPACTS</td><td></td><td></td><td>X</td><td></td></tr> <tr><td>R. THREATENED OR ENDANGERED SPECIES</td><td></td><td></td><td>X</td><td></td></tr> <tr><td>S. HISTORIC & ARCHAEOLOGICAL PRESERVATION / 4(f) LANDS</td><td></td><td></td><td>X</td><td></td></tr> <tr><td>T. HAZARDOUS WASTE SITES</td><td></td><td></td><td>X</td><td></td></tr> <tr><td>U. VISUAL IMPACTS</td><td></td><td>X</td><td></td><td>During Construction</td></tr> <tr><td>V. ENERGY</td><td></td><td></td><td>X</td><td></td></tr> <tr><td>W. CONSTRUCTION IMPACTS</td><td></td><td></td><td>X</td><td></td></tr> </tbody> </table>			SIG.	MIN.	NONE		A. LAND USE IMPACTS			X		B. FARMLAND IMPACTS			X		C. SOCIAL IMPACTS			X		D. RELOCATION IMPACTS			X		E. ECONOMIC IMPACTS			X		F. JOINT DEVELOPMENT			X		G. CONSIDERATIONS RELATING TO PEDESTRAINS & BICYCLISTS			X		H. AIR QUALITY IMPACTS			X		I. NOISE IMPACTS		X		During Construction	J. WATER QUALITY IMPACTS			X		K. PERMITS			X		L. WETLAND/STREAM IMPACTS		X	X	Minimal Wetlands Nationwide #23	M. WATER BODY MODIFICATION & WILDLIFE IMPACTS			X		N. FLOODPLAIN IMPACTS			X		O. WILD & SCENIC RIVERS			X		P. COASTAL BARRIERS			X		Q. COASTAL ZONE IMPACTS			X		R. THREATENED OR ENDANGERED SPECIES			X		S. HISTORIC & ARCHAEOLOGICAL PRESERVATION / 4(f) LANDS			X		T. HAZARDOUS WASTE SITES			X		U. VISUAL IMPACTS		X		During Construction	V. ENERGY			X		W. CONSTRUCTION IMPACTS			X	
	SIG.	MIN.	NONE																																																																																																																							
A. LAND USE IMPACTS			X																																																																																																																							
B. FARMLAND IMPACTS			X																																																																																																																							
C. SOCIAL IMPACTS			X																																																																																																																							
D. RELOCATION IMPACTS			X																																																																																																																							
E. ECONOMIC IMPACTS			X																																																																																																																							
F. JOINT DEVELOPMENT			X																																																																																																																							
G. CONSIDERATIONS RELATING TO PEDESTRAINS & BICYCLISTS			X																																																																																																																							
H. AIR QUALITY IMPACTS			X																																																																																																																							
I. NOISE IMPACTS		X		During Construction																																																																																																																						
J. WATER QUALITY IMPACTS			X																																																																																																																							
K. PERMITS			X																																																																																																																							
L. WETLAND/STREAM IMPACTS		X	X	Minimal Wetlands Nationwide #23																																																																																																																						
M. WATER BODY MODIFICATION & WILDLIFE IMPACTS			X																																																																																																																							
N. FLOODPLAIN IMPACTS			X																																																																																																																							
O. WILD & SCENIC RIVERS			X																																																																																																																							
P. COASTAL BARRIERS			X																																																																																																																							
Q. COASTAL ZONE IMPACTS			X																																																																																																																							
R. THREATENED OR ENDANGERED SPECIES			X																																																																																																																							
S. HISTORIC & ARCHAEOLOGICAL PRESERVATION / 4(f) LANDS			X																																																																																																																							
T. HAZARDOUS WASTE SITES			X																																																																																																																							
U. VISUAL IMPACTS		X		During Construction																																																																																																																						
V. ENERGY			X																																																																																																																							
W. CONSTRUCTION IMPACTS			X																																																																																																																							
3. PUBLIC INVOLVEMENT RECOMMENDATIONS: NONE																																																																																																																										
4. ACTION REQUIRED: <table border="1" style="width:100%; border-collapse: collapse;"> <tr> <td style="width:33%;">CATEGORICAL EXCLUSION <input checked="" type="checkbox"/></td> <td style="width:33%;">106 CONSULTATION <input type="checkbox"/></td> <td style="width:33%;">ENDANGERED SPECIES ASSESSMENT <input type="checkbox"/></td> </tr> <tr> <td>EA/FONSI <input type="checkbox"/></td> <td>EIS <input type="checkbox"/></td> <td>NOISE STUDY <input type="checkbox"/></td> </tr> <tr> <td colspan="3">SHPO LETTER <input type="checkbox"/></td> </tr> <tr> <td colspan="3">4 (f) STATEMENT <input type="checkbox"/></td> </tr> <tr> <td colspan="3">CLASS DETERMINATION: CATEGORICAL EXCLUSION</td> </tr> </table>			CATEGORICAL EXCLUSION <input checked="" type="checkbox"/>	106 CONSULTATION <input type="checkbox"/>	ENDANGERED SPECIES ASSESSMENT <input type="checkbox"/>	EA/FONSI <input type="checkbox"/>	EIS <input type="checkbox"/>	NOISE STUDY <input type="checkbox"/>	SHPO LETTER <input type="checkbox"/>			4 (f) STATEMENT <input type="checkbox"/>			CLASS DETERMINATION: CATEGORICAL EXCLUSION																																																																																																											
CATEGORICAL EXCLUSION <input checked="" type="checkbox"/>	106 CONSULTATION <input type="checkbox"/>	ENDANGERED SPECIES ASSESSMENT <input type="checkbox"/>																																																																																																																								
EA/FONSI <input type="checkbox"/>	EIS <input type="checkbox"/>	NOISE STUDY <input type="checkbox"/>																																																																																																																								
SHPO LETTER <input type="checkbox"/>																																																																																																																										
4 (f) STATEMENT <input type="checkbox"/>																																																																																																																										
CLASS DETERMINATION: CATEGORICAL EXCLUSION																																																																																																																										
5. WETLANDS/STREAMS FINDING (CEX ONLY): NONE Minimal Wetlands covered under Nationwide #23																																																																																																																										
6. OTHER REMARKS: FMS NO. 105877/301000.																																																																																																																										

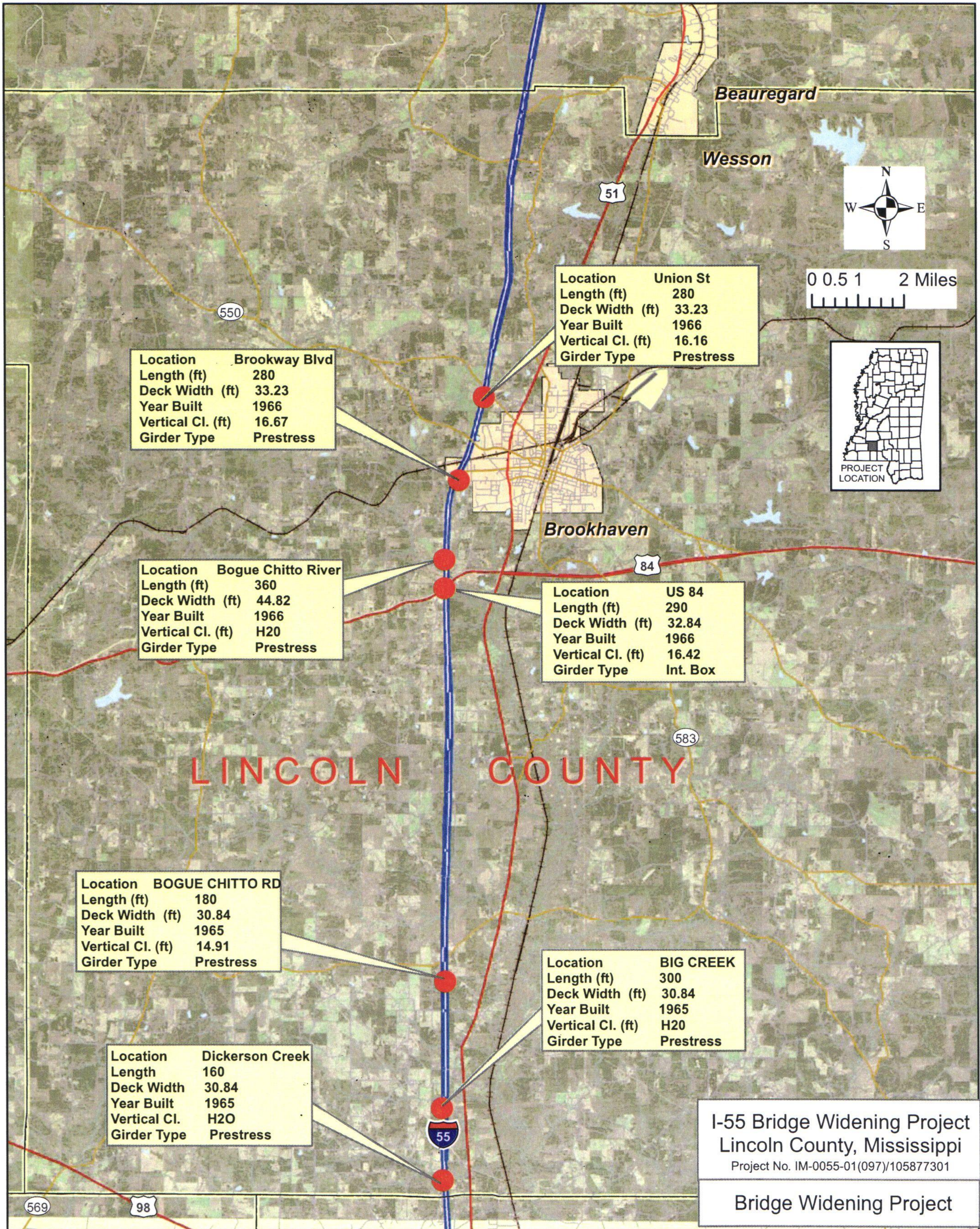

Location	Brookway Blvd
Length (ft)	280
Deck Width (ft)	33.23
Year Built	1966
Vertical Cl. (ft)	16.67
Girder Type	Prestress

Location	Union St
Length (ft)	280
Deck Width (ft)	33.23
Year Built	1966
Vertical Cl. (ft)	16.16
Girder Type	Prestress

Location	Bogue Chitto River
Length (ft)	360
Deck Width (ft)	44.82
Year Built	1966
Vertical Cl. (ft)	H20
Girder Type	Prestress

Location	US 84
Length (ft)	290
Deck Width (ft)	32.84
Year Built	1966
Vertical Cl. (ft)	16.42
Girder Type	Int. Box

Location	BOGUE CHITTO RD
Length (ft)	180
Deck Width (ft)	30.84
Year Built	1965
Vertical Cl. (ft)	14.91
Girder Type	Prestress

Location	BIG CREEK
Length (ft)	300
Deck Width (ft)	30.84
Year Built	1965
Vertical Cl. (ft)	H20
Girder Type	Prestress

Location	Dickerson Creek
Length	160
Deck Width	30.84
Year Built	1965
Vertical Cl.	H20
Girder Type	Prestress

I-55 Bridge Widening Project
 Lincoln County, Mississippi
 Project No. IM-0055-01(097)/105877301

Bridge Widening Project

MISSISSIPPI DEPARTMENT OF TRANSPORTATION

Inter-Departmental Memorandum

TO: Ms. Kim Thurman
Environmental Division (87-01)

DATE: 4/12/2010

FROM: Gregory L. Wilkinson *GLW*
District 7 Preconstruction Engineer (17-01)

SUBJECT OR PROJECT NO: IM-0055-01(097)/105877
I55

INFORMATION COPY TO:

COUNTY: Lincoln

Preconstruction File
Central File
District Seven (Mr. Broome & Mr. Morris)
District Seven (Ms. Willis)
Construction Division (Mr. Hall & Mr. Crisco)

Please find attached the ENV-160, on the above referenced project, for further processing.

If any other information is required, please advise.

Melinda L. McGrath
Deputy Executive Director/
Chief Engineer

Brenda Znachko
Deputy Executive Director/
Administration



Steven K. Edwards
Director
Office of Intermodal Planning

Willie Huff
Director
Office of Enforcement

Larry L. "Butch" Brown
Executive Director

P. O. Box 1850 / Jackson, Mississippi 39215-1850 / Telephone (601) 359-7001 / FAX (601) 359-7110 / GoMDOT.com

Inter-Departmental Memorandum

Date: May 3, 2010

To: Mr. Darrell Broome
District VII Engineer, McComb

From: Mrs. Kim Thurman
Environmental Division Administrator

Subject: Project Number IM-0055-01(197) / 105877-301000
I-55 Widening of Bridges
Lincoln County

We are enclosing the approved Categorical Exclusion for the subject project. If you have any questions or require additional information, please contact Mr. Chad Wallace or myself at telephone number (601) 359-7920.

Attachment

cc: District 7 Asst. Dist. Const. Engineer Preconstruction (with attachments)
Roadway Design Division (with attachments)
Construction Division (Attn: Leroy Crisco with attachments)
Right of Way (Attn: Sharen Willis with attachments)
Bridge Division (with attachments)
Traffic Division (with attachments)
Contract Administration (Attn: Linda Buege with attachments)



Mark C. McConnell
Deputy Executive Director/
Chief Engineer

Charles R. Carr
Director
Office of Intermodal Planning



Jackie Duckworth
Deputy Executive Director/
Administration

Willie Huff
Director
Office of Enforcement

Melinda L. McGrath
Executive Director

P. O. Box 1850 / Jackson, Mississippi 39215-1850 / Telephone (601) 359-7001 / FAX (601) 359-7110 / www.GoMDOT.com

Inter-Departmental Memorandum

Date: August 30, 2012

To: Mr. Kevin Magee
District 3 Engineer, Yazoo City

From: *BT For* Kim D. Thurman
Environmental Division Administrator

Subject: Project Number DB/IM-0055-02(228) 105444/305000
I-55 Design Build – Bridge Widening
Copiah County

We are enclosing the approved Categorical Exclusion for the subject project. If you have any questions or require additional information, please contact Ms. Kim Thurman or Mr. Brad Johnson at telephone number (601) 359-7920.

KDT:DBJ:tbs

Attachment

cc: District 3 Asst. Dist. Construction Engineer Preconstruction (with attachments)
Roadway Design Division (with attachments)
Construction Division (Attn: Leroy Crisco with attachments)
Right of Way (Attn: Meredith Pierce with attachments)
Bridge Division (with attachments)
Traffic Division (with attachments)
Contract Administration (Attn: Linda Buege with attachments)



MDOT Commitments to Environmental Excellence

Project No: DB/IM-0055-02(228) 105444/305000
 Highway: Interstate 55
 Revision Date: 08/30/2012
Various Bridge Locations
 County: Copiah
 Page 1 of 1

*Value Engineering Study Recommended Yes No

Commitments/Requirements	Source of Commitment	Responsible Office	Place on Plans	Requires A Special Provision	Status of Commitment/Requirement
Consider various measures to prevent migratory birds from nesting on bridges and in box culverts	US Fish and Wildlife Service	District 3, Construction	No	Yes	To be handled during Design and Construction
A buffer zone of 30 feet on each side of the intermittent stream shall not be cleared unless the buffer zone enters into the clear zone of the roadway.	Environmental Division, FHWA	District 3, Construction	Yes	Yes	To be handled during Design and Construction

- These commitments should be carried throughout each phase of the project development including Design, Right of Way, Construction, and Maintenance.

*Value Engineering (VE) Studies are recommended for projects on the NHS System and/or an Intermodal Connector with an estimated project costs approaching \$25 Million

**MISSISSIPPI DEPARTMENT OF TRANSPORTATION
ENVIRONMENTAL DIVISION
ENVIRONMENTAL CLASS OF ACTION DETERMINATION**

DISTRICT NO: <u>3</u>	F.A. NO: <u>55</u>	7. APPROVED BY: DISTRICT ENGINEER <u>[Signature]</u> DATE <u>8/30/12</u>		
PROJECT NO: <u>105444/305000</u>	HIGHWAY NO: <u>55</u>	PLANNING ENGINEER <u>[Signature]</u> DATE <u>8/30/2012</u>		
SECTION NO: <u>1</u>	COUNTY: <u>Copiah</u>	ROADWAY DESIGN ENGINEER <u>[Signature]</u> DATE <u>8/30/2012</u>		
1. PROJECT TERMINI: Interstate Bridges in Copiah County <u>60.7 A+B @ SR 28</u> <u>65.0 A+B @ Clear Creek Rd</u> <u>64.4 A+B @ Gallman Rd</u> <u>70.9 A+B @ SR 27</u> <u>73.2 A+B @ Hourly Rd</u>		ENVIRONMENTAL ENGINEER / ADMINISTRATOR <u>[Signature]</u> DATE <u>8/30/2012</u>		
(A.) EXISTING CONDITIONS: Narrow Interstate Bridges		8. FHWA CONCURRENCE: FHWA DIVISION ADMINISTRATOR _____ DATE _____		
(B.) PROPOSED IMPROVEMENTS: Widen Interstate Bridges		Programmatic Agreement		
(C.) PRELIMINARY PURPOSE & NEED: Widen bridges to improve roadway safety				
(D.) NEW ROW REQUIRED: <input type="checkbox"/> YES <input checked="" type="checkbox"/> NO				
2. ENVIRONMENTAL CONSEQUENCES EVALUATION (CHECK ONE)	SIG.	MIN.	NONE	COMMENTS IDENTIFYING ISSUES WHICH MAKES IMPACT SIGNIFICANT OR MINIMAL
A. LAND USE IMPACTS			X	
B. FARMLAND IMPACTS			X	
C. SOCIAL IMPACTS			X	
D. RELOCATION IMPACTS			X	
E. ECONOMIC IMPACTS			X	
F. JOINT DEVELOPMENT			X	
G. CONSIDERATIONS RELATING TO PEDESTRAINS & BICYCLISTS			X	
H. AIR QUALITY IMPACTS			X	
I. NOISE IMPACTS			X	
J. WATER QUALITY IMPACTS			X	
K. PERMITS			X	
L. WETLAND/STREAM IMPACTS		X		Minimal Impacts to streams *
M. WATER BODY MODIFICATION & WILDLIFE IMPACTS			X	
N. FLOODPLAIN IMPACTS			X	
O. WILD & SCENIC RIVERS			X	
P. COASTAL BARRIERS			X	
Q. COASTAL ZONE IMPACTS			X	
R. THREATENED OR ENDANGERED SPECIES			X	
S. HISTORIC & ARCHAEOLOGICAL PRESERVATION / 4(f) LANDS			X	
T. HAZARDOUS WASTE SITES			X	
U. VISUAL IMPACTS			X	
V. ENERGY			X	
W. CONSTRUCTION IMPACTS			X	
3. PUBLIC INVOLVEMENT RECOMMENDATIONS:				
4. ACTION REQUIRED:				
CATEGORICAL EXCLUSION <input checked="" type="checkbox"/>		106 CONSULTATION <input type="checkbox"/>		ENDANGERED SPECIES ASSESSMENT <input type="checkbox"/>
EA/FONSI <input type="checkbox"/>		EIS <input type="checkbox"/>		NOISE STUDY <input type="checkbox"/>
SHPO LETTER <input type="checkbox"/>		4 (f) STATEMENT <input type="checkbox"/>		
CLASS DETERMINATION:				
5. WETLANDS/STREAMS FINDING (CEX ONLY): * Minimal impacts to an ephemeral stream, Nationwide 23 Permit may be required				
6. OTHER REMARKS:				

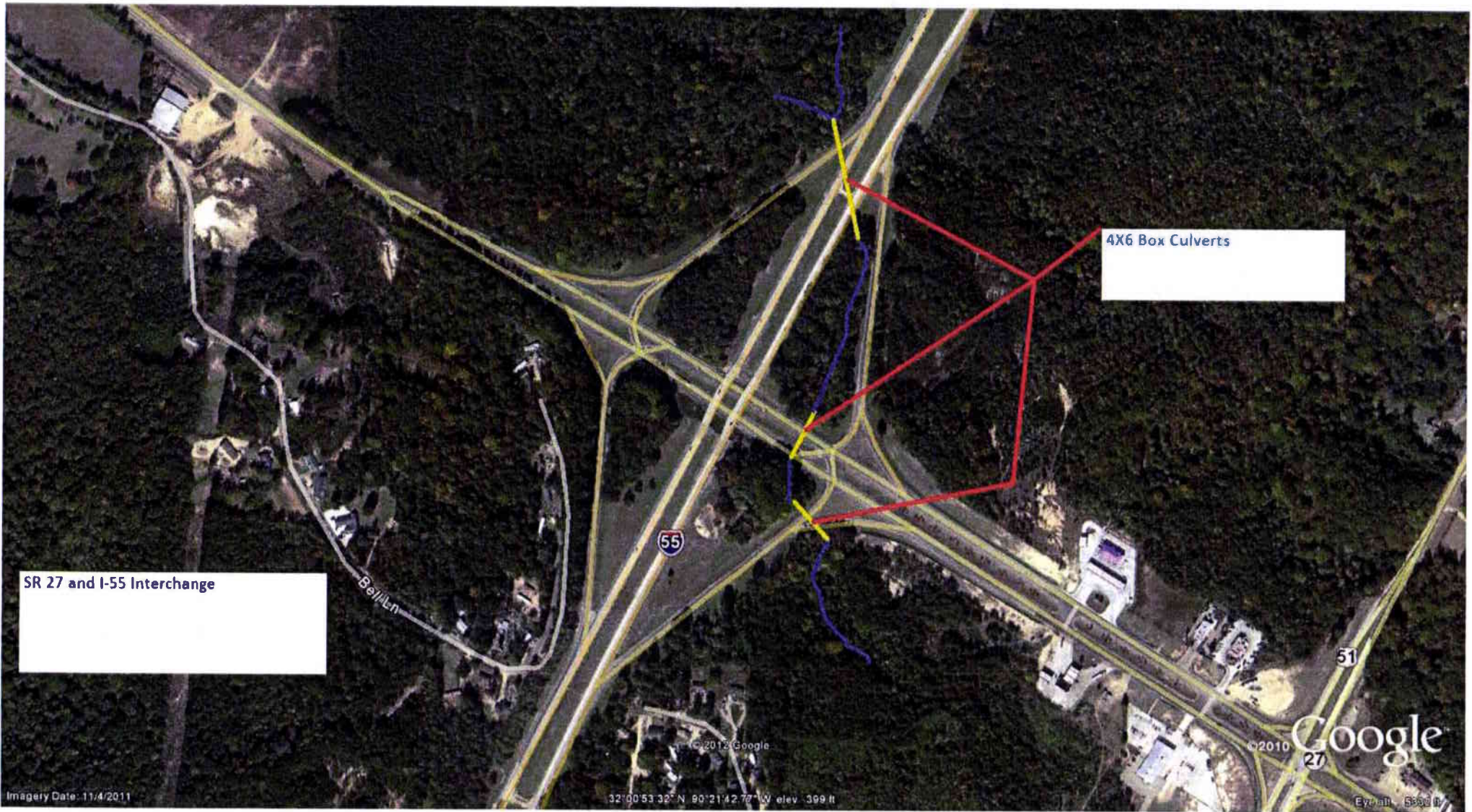

MISSISSIPPI DEPARTMENT OF TRANSPORTATION

SECTION 904 - NOTICE TO PROPOSERS NO. 3500 DB

CODE: (SP)

DATE: 06/06/2012

SUBJECT: Barn Swallows

Survey of the drainage box culverts at the I-55 and MS 24 Interchange found Barn Swallows (*Hirundo Rustica*) nesting on the walls of the box culvert. These birds are protected by the Migratory Bird Act.

The normal nesting period for the barn swallows is March to June. Variation to this period may occur due to environmental factors.

If active swallow nests become established (eggs or young in the nest), all work that impacts the nests shall be avoided until the chicks have fledged or the nests is unoccupied as determined by a wildlife biologist. The contractor shall prevent construction activity from displacing swallows after they have laid their eggs and before the young have fledged.

If the contractors design requires construction activity that will affect the swallows, measures can be taken by the contractor to prevent the swallows from nesting in the box culverts. Netting or other approved methods to prevent the swallows from building nests at the site is acceptable.

Exhibit 3
Typical Existing Bridge Joint Rehabilitation

Exhibit 3
Typical Existing Bridge Joint Rehabilitation

JOINT REPAIR NOTES:

1. The Intent Of The Contract Is To Remove All Joint Armor Existing At The Time The Contract Is Let, Repair Joints With Epoxy Mortar And Seal Joints With A Silicone Joint Sealant. It Is Possible That Between Plan Preparation And Letting Time, Joint Armor Shown To Be Removed May Have Been Removed Earlier By Department Personnel. Also, The Number Of Joints Requiring Sawcutting May Change Due To Temperature Changes. Quantities Shall Be Adjusted Accordingly. Payment For Joint Preparation, Joint Repair And Removal Of Joint Armor Shall Be Paid For As The Length Along The Bridge Deck On Each Side Of The Centerline Of Joint.
3. Sawcutting The Joint Is Required At Existing Joints That Have Less Than 1/2 Inch Of Opening.
4. Silicone Sealed Joints Are Required At All Joints. Payment For Silicone Sealed Joints And Sawcutting The Joints Shall Be Paid For As The Length Along The Centerline Of Joint Only And Not Each Side Of The Joint.
6. Removal Of Existing Joint Sealants Will Not Be Paid For Directly And Therefor Shall Be Considered As An Absorbed Item Of Work.

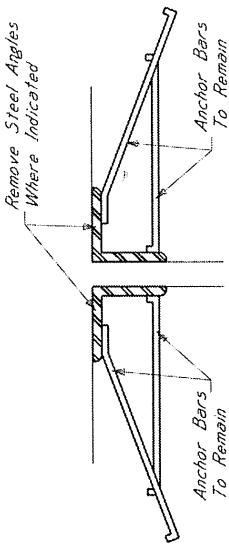

TYPICAL SECTION AT JOINT REPAIR

Showing Existing Joint Armor To Be Removed
Form New Joint With Epoxy Mortar. Tool Finish To 1/4" Radius.

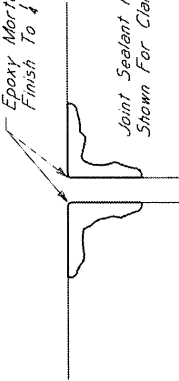

TYPICAL SECTION AT JOINT REPAIR

Showing Joint After Epoxy Mortar Repair

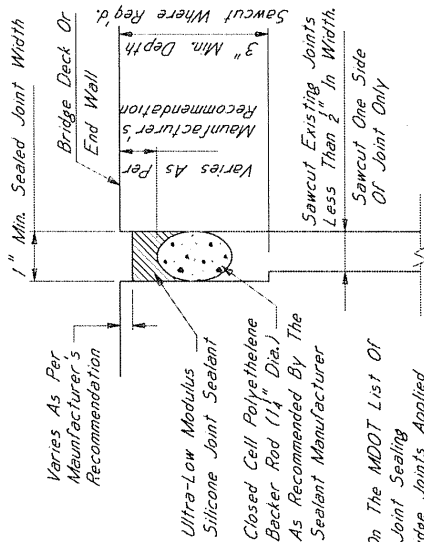

NOTE:

Sealant Shall Be On The MDDT List Of Approved Silicone Joint Sealing Compounds For Bridge Joints Applied According To The Manufacturer's Directions.

TYPICAL SECTION AT SAWCUT & SEALED JOINT

Showing Silicone Sealed Joint After Sawcut And Repair With Epoxy Mortar

EPOXY MORTAR AND POLYMER CONCRETE NOTES:

1. Epoxy Mortar Shall Be "HP-BINDER" As Manufactured By Hunt Process Corporation, P.O. Box 688, Ridgeland, MS 39158, Telephone No. 1601/856-8811, Or Approved Equal And Installed According To The Manufacturer's Recommendations.
2. Polymer Concrete May Be Used In Place Of Epoxy Mortar. Polymer Concrete Shall Be As Manufactured By Polymer Concrete, Inc. P. O. Box 610, Camden, AL 36726, (205)682-4296, Or Approved Equal And Installed According To The Manufacturer's Recommendations.

GENERAL NOTES:

1. Specifications: Mississippi Standard Specifications For Road And Bridge Construction, 1990.
2. No Change Of Plans Will Be Permitted Except By Written Approval Of The Bridge Engineer. Minor Changes Of Detail Of Design Or Construction Procedure May Be Authorized By The Bridge Engineer Provided Such Changes Will Not Be Cause For Contract Price Adjustment.
3. Work For Which No Pay Item Is Provided In The Proposal Will Not Be Paid For Directly And Compensation Therefor Will Be Included In The Prices And Payments For Bid Items.

ESTIMATED QUANTITIES		
PAY ITEM NO.	PAY ITEM	UNIT
808-A	Joint Preparation	Lin. Ft.
907-824-PP	Bridge Repair (Joint Repair) Per Plans	Lin. Ft.
907-824-PP	Bridge Repair (Removal Of Joint Armor) Per Plans	Lin. Ft.
907-824-PP	Bridge Repair (Silicone Sealed Joints) Per Plans	Lin. Ft.
907-824-PP	Bridge Repair (Sawcut Joints) Per Plans	Lin. Ft.

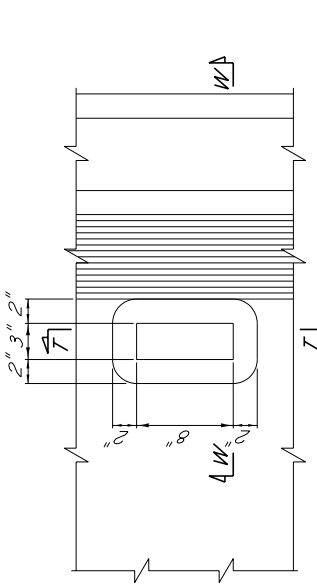

0.02 Ft. Per Ft. Slope

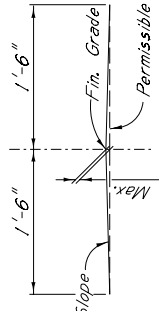

CROWN DETAILS

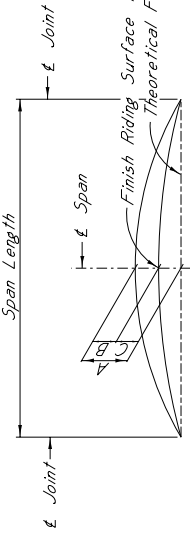

DEFLECTION DIAGRAM

A = Total Recommended Allowance For Deflection.
B = Estimated Deflection Due To Dead Load Of Slab & Rail.
C = A-B = Net Initial Camber In Riding Surface, Which Includes An Allowance For Creep.

NOTE: For Values Of A, B & C, See Beam Detail Sheets.

NOTE: The Deflection Values Shown On The Beam Detail Sheets Were Prepared And Intended For Design And Estimation Purposes Only. It Is The Contractor's Responsibility To Determine Bridge Girder Deflections For Use In Calculating Bridge Deck Form Grades. Prior To Formwork Construction, The Contractor Shall Submit Three (3) Copies Of Deck Form Grades, Bridge Girder Deflections And Bridge Girder Profiles To The Bridge Engineer For Review, Through The Project Engineer. This Submittal Shall Include All Calculations, Assumptions And Parameters Used By The Contractor To Determine Bridge Girder Deflections And Form Grade Elevations And Shall Be Stamped By A Mississippi Registered Professional Engineer.

GENERAL NOTES:

All Concrete In Span And Railing Shall Be Class "AA".
Chamfer All Edges 3/8", Unless Otherwise Noted.
See Layout Sheet For Finishing Of Concrete Surfaces.
Placing Dimensions For Reinforcing Steel To Concrete Surfaces Are Clear Distances.
To Determine The Dimension From Finish Grade To Cap, The Assumption Is Made That The Compressed Thickness Of The Neoprene Pad Is As Shown In Table, And That The Original Camber Of The Beams Will Be Within The Limits Shown On The Beam Detail Sheets. The Bridge Engineer Shall Be Notified If The Cambers Not Within These Limits.

DETAIL "D"

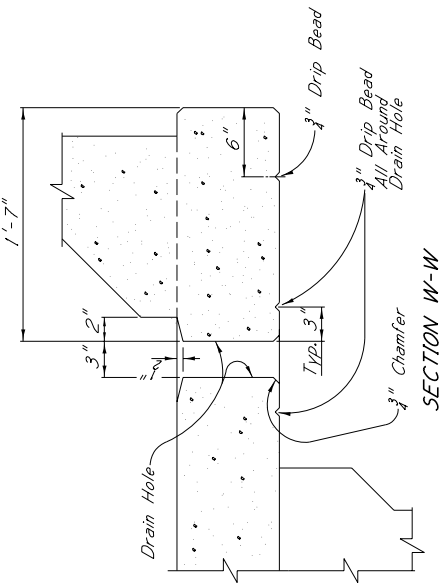

SECTION W-W

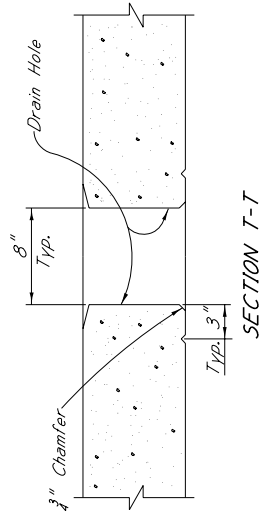

SECTION T-T

NOTE: Drain Holes Shall Be Located To That Bars B & C Will Not Be Cut. If Necessary One Bar A May Be Cut In Field.

DRAIN HOLE DETAILS

Use Where Shown On The Span Detail Sheet.

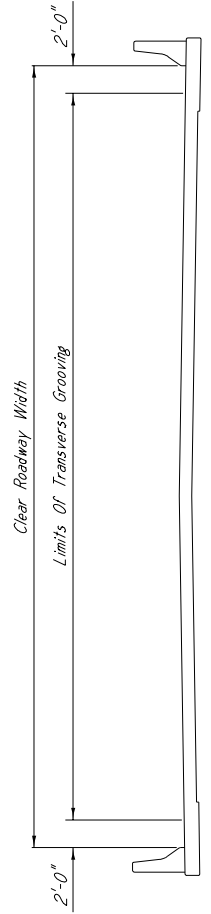

LIMITS OF TRANSVERSE GROOVING

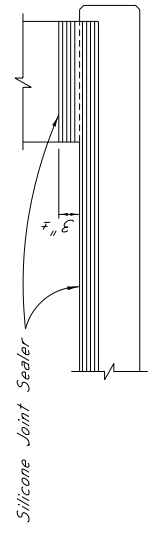

ELEVATION AT END OF SPAN

NEOPRENE PAD THICKNESS TABLE	
PAD THICKNESS	COMPRESSED PAD THICKNESS

NOTE: Joints In Newly Constructed Bridge Decks Shall Be Protected From Damage Until Accepted For Maintenance By The State. Damaged Joints Shall Be Repaired At No Cost To The State.

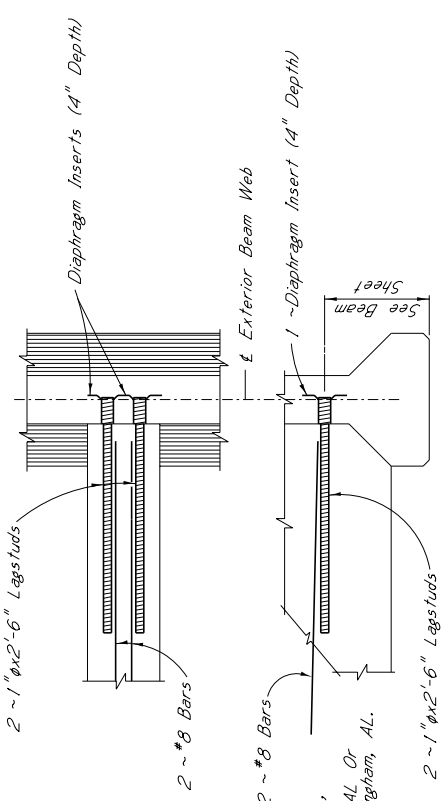

PART SECTION

DIAPHRAGM INSERT AND LAGSTUD DETAILS

NOTE: Continuous Threaded Lagstuds And Diaphragm Inserts Shall Be As Manufactured By The Richmond Screw Anchor Co., Inc., Atlanta, GA; By Meadow Steel Products Co., Inc., Birmingham, AL Or Dayton Superior Co., Inc., Birmingham, AL.

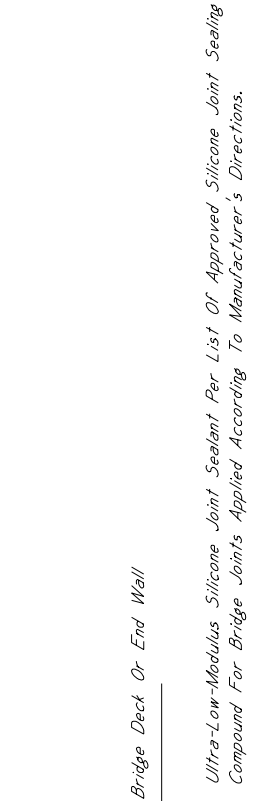

TYPICAL SECTION SILICONE SEALED JOINT

NOTE: The Contractor Should Be Aware That The Joint Opening (Width) Can Change At Temperatures Higher Or Lower Than The 60°F Design Width. Installation Of The Joint Sealer Material Shall Be In Accordance With Manufacturer's Recommendations.

NOTE: Seal All Open Joints As Shown On The Layout Sheet. Width Of Joint Is Shown In End Bent And Span Details. Seal Joint When It Is At Or Near Its Design Width. A Representative Of The Joint Sealant Manufacturer Shall Be Present At The Time Joint Sealing Begins To Ensure That The Contractor Is Properly Schooled In The Installation Of The Joint Material.

REVISIONS	
NO.	DESCRIPTION

DATE	DESIGNED	DATE	WORKING NUMB
	CHECKED		

MISSISSIPPI DEPARTMENT OF TRANSPORTATION
MISCELLANEOUS SPAN DETAILS
PROJECT
COUNTY

Exhibit 4
Erosion Control Plans

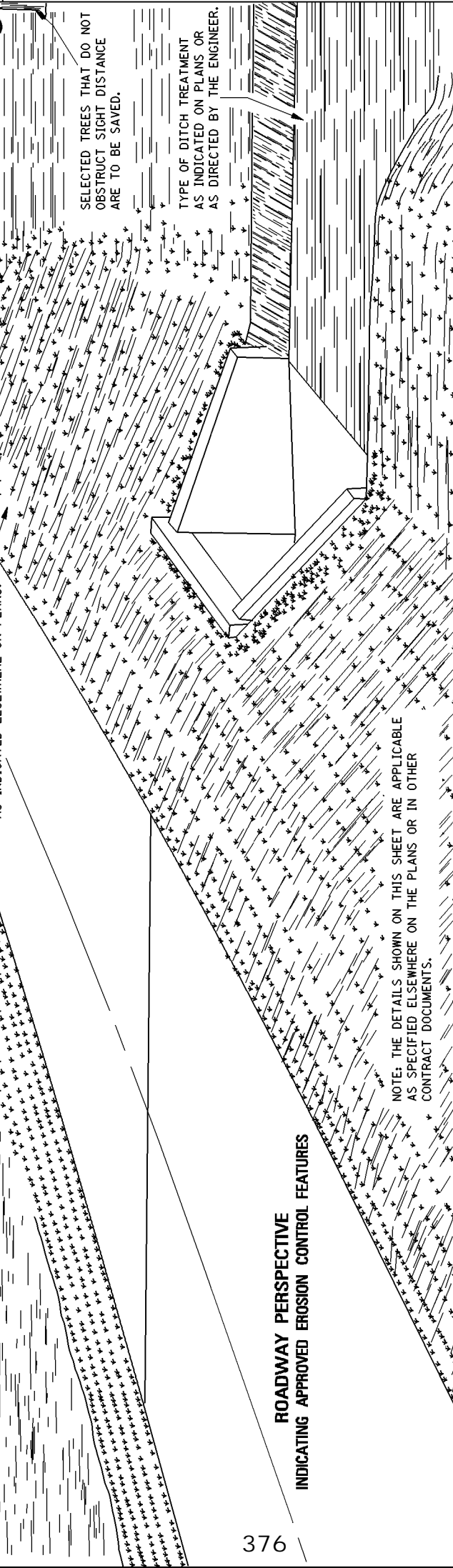
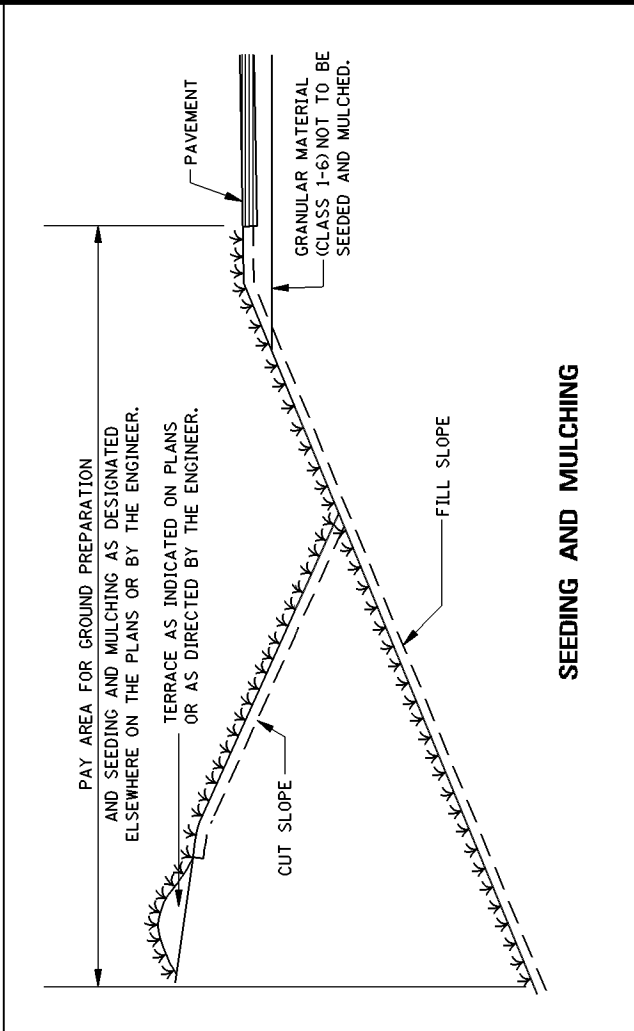
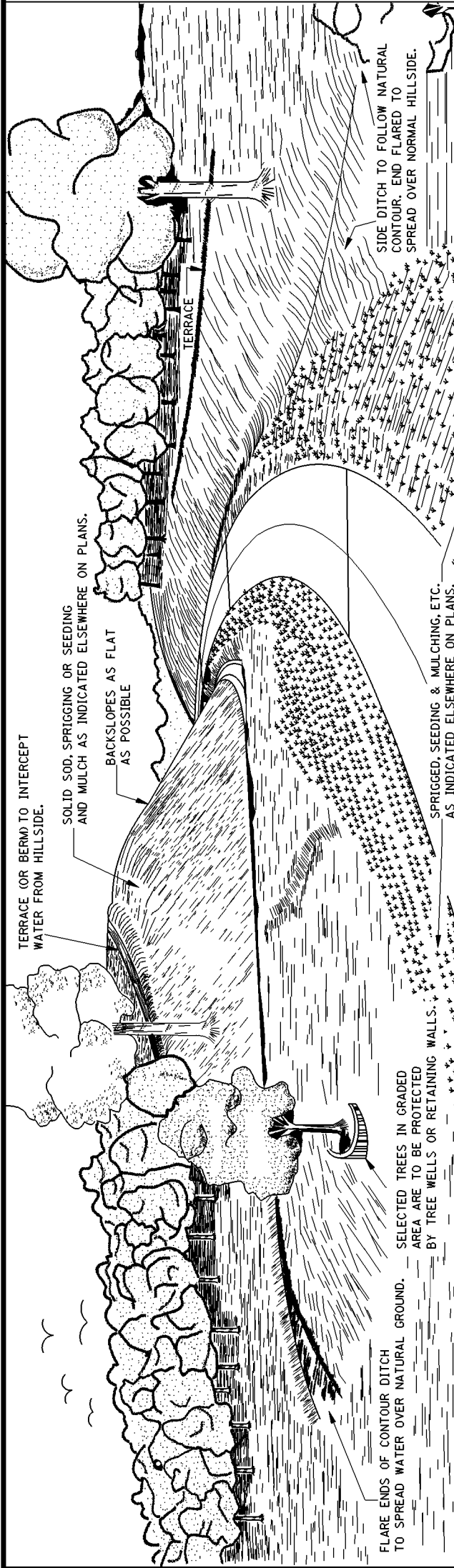
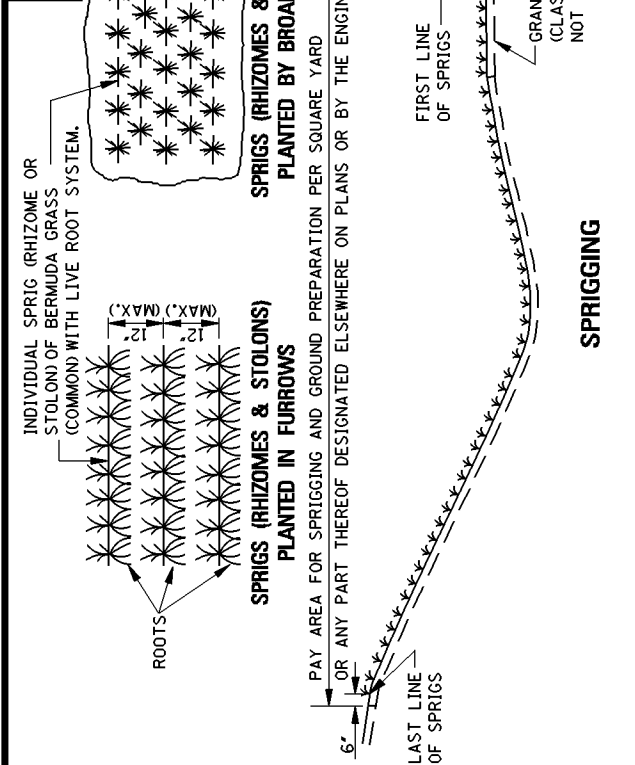

SEEDING AND MULCHING

GENERAL NOTE:
1. LONGITUDINAL AND TRANSVERSE MEASUREMENTS FOR THE PAY AREA SHALL BE TAKEN ALONG THE SLOPES.

DATE	ISSUE DATE: OCTOBER 1, 1998
REVISION	
BY	

MISSISSIPPI DEPARTMENT OF TRANSPORTATION
ROADWAY DESIGN DIVISION
STANDARD PLAN

EROSION CONTROL

WORKING NUMBER EC-1
SHEET NUMBER 140

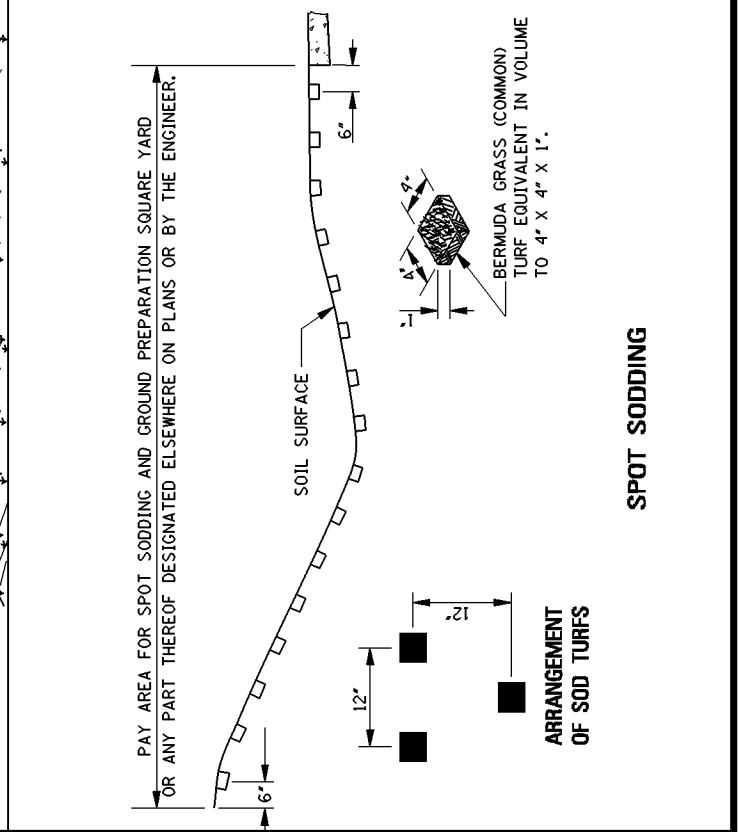
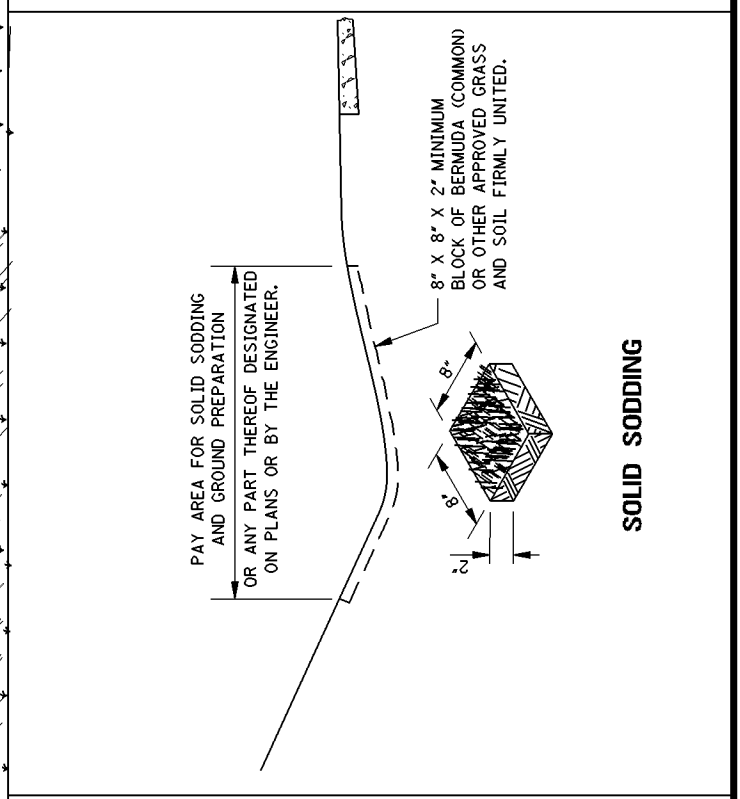
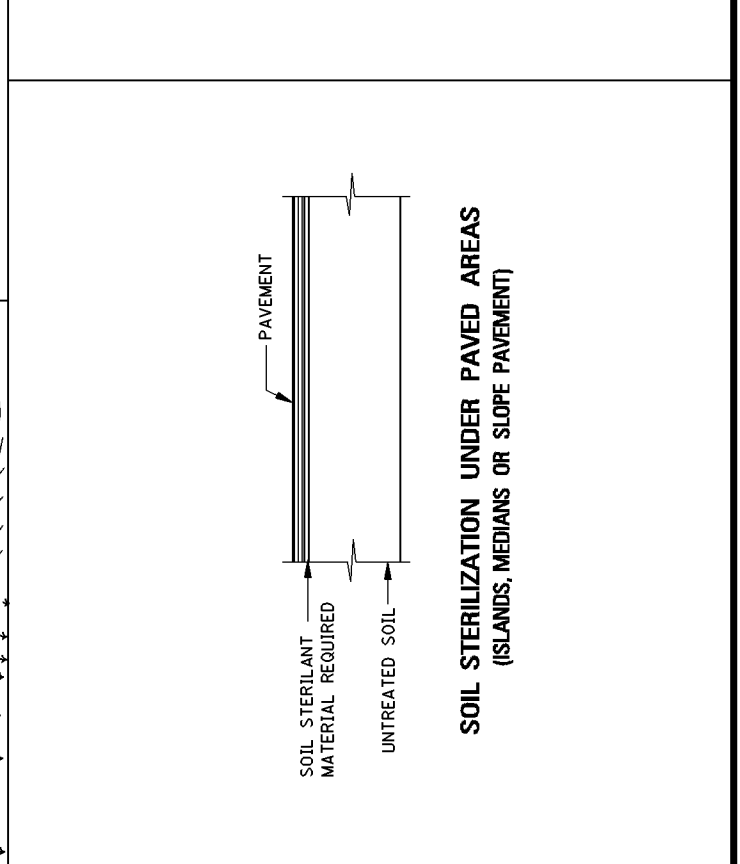

ROADWAY PERSPECTIVE INDICATING APPROVED EROSION CONTROL FEATURES

NOTE: THE DETAILS SHOWN ON THIS SHEET ARE APPLICABLE AS SPECIFIED ELSEWHERE ON THE PLANS OR IN OTHER CONTRACT DOCUMENTS.

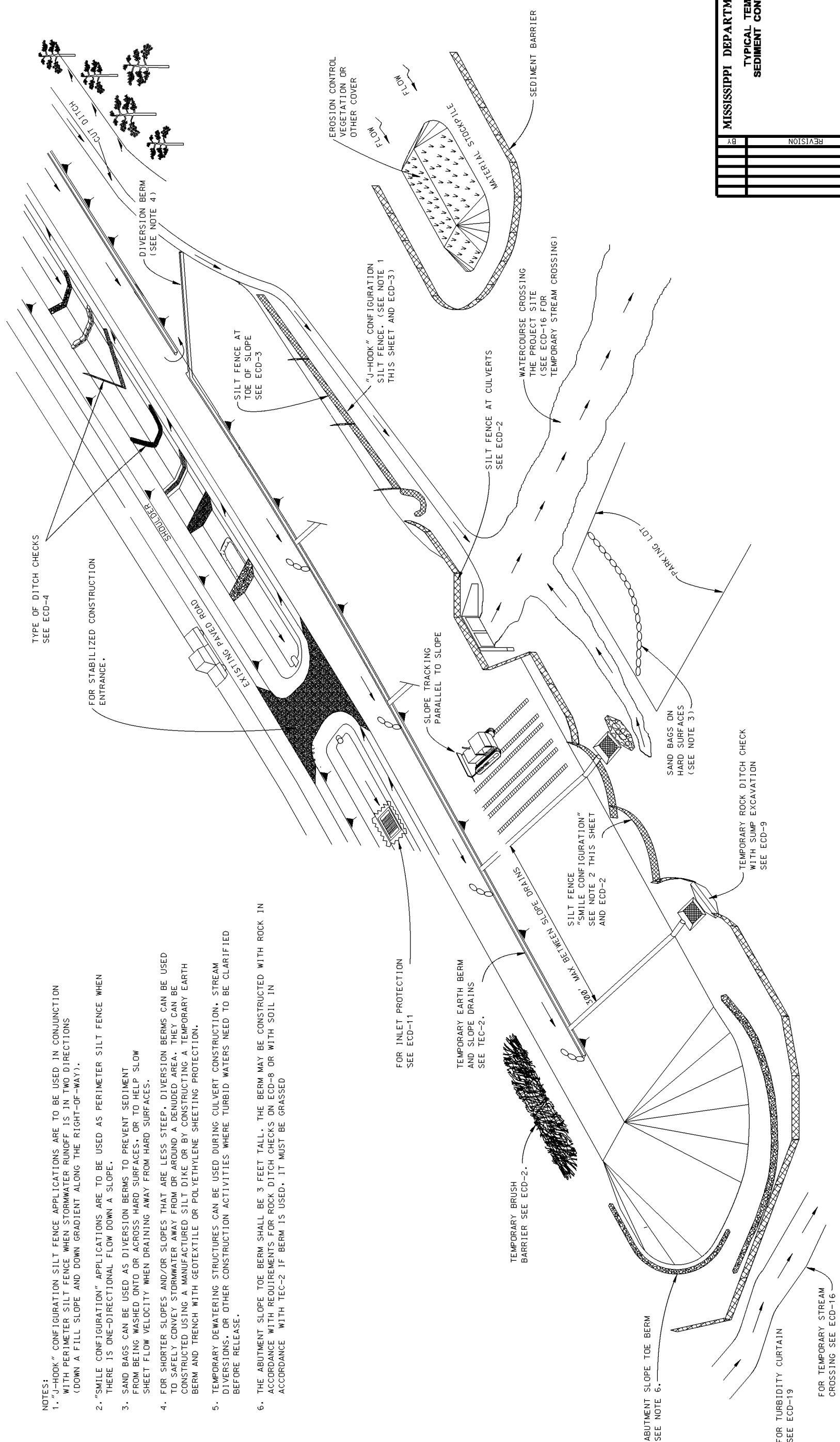

- NOTES:
1. "J-HOOK" CONFIGURATION SILT FENCE APPLICATIONS ARE TO BE USED IN CONJUNCTION WITH PERIMETER SILT FENCE WHEN STORMWATER RUNOFF IS IN TWO DIRECTIONS (DOWN A FILL SLOPE AND DOWN GRADIENT ALONG THE RIGHT-OF-WAY).
 2. "SMILE CONFIGURATION" APPLICATIONS ARE TO BE USED AS PERIMETER SILT FENCE WHEN THERE IS ONE-DIRECTIONAL FLOW DOWN A SLOPE.
 3. SAND BAGS CAN BE USED AS DIVERSION BERMS TO PREVENT SEDIMENT FROM BEING WASHED ONTO OR ACROSS HARD SURFACES, OR TO HELP SLOW SHEET FLOW VELOCITY WHEN DRAINING AWAY FROM HARD SURFACES.
 4. FOR SHORTER SLOPES AND/OR SLOPES THAT ARE LESS STEEP, DIVERSION BERMS CAN BE USED TO SAFELY CONVEY STORMWATER AWAY FROM OR AROUND A DENUDED AREA. THEY CAN BE CONSTRUCTED USING A MANUFACTURED SILT DIKE OR BY CONSTRUCTING A TEMPORARY EARTH BERM AND TRENCH WITH GEOTEXTILE OR POLYETHYLENE SHEETING PROTECTION.
 5. TEMPORARY DEWATERING STRUCTURES CAN BE USED DURING CULVERT CONSTRUCTION. STREAM DIVERSIONS, OR OTHER CONSTRUCTION ACTIVITIES WHERE TURBID WATERS NEED TO BE CLARIFIED BEFORE RELEASE.
 6. THE ABUTMENT SLOPE TOE BERM SHALL BE 3 FEET TALL. THE BERM MAY BE CONSTRUCTED WITH ROCK IN ACCORDANCE WITH REQUIREMENTS FOR ROCK DITCH CHECKS ON ECD-8 OR WITH SOIL IN ACCORDANCE WITH TEC-2 IF BERM IS USED, IT MUST BE GRASSED.

MISSISSIPPI DEPARTMENT OF TRANSPORTATION
TYPICAL TEMPORARY EROSION/
SEDIMENT CONTROL APPLICATIONS

BY	REVISION	DATE

DESIGN TEAM: _____
CHECKED: _____
DATE: _____

WORKING NUMBER: **ECD-1**
SHEET NUMBER: _____
FILENAME: _EROSION_CONTROL\ECD-1.DWG

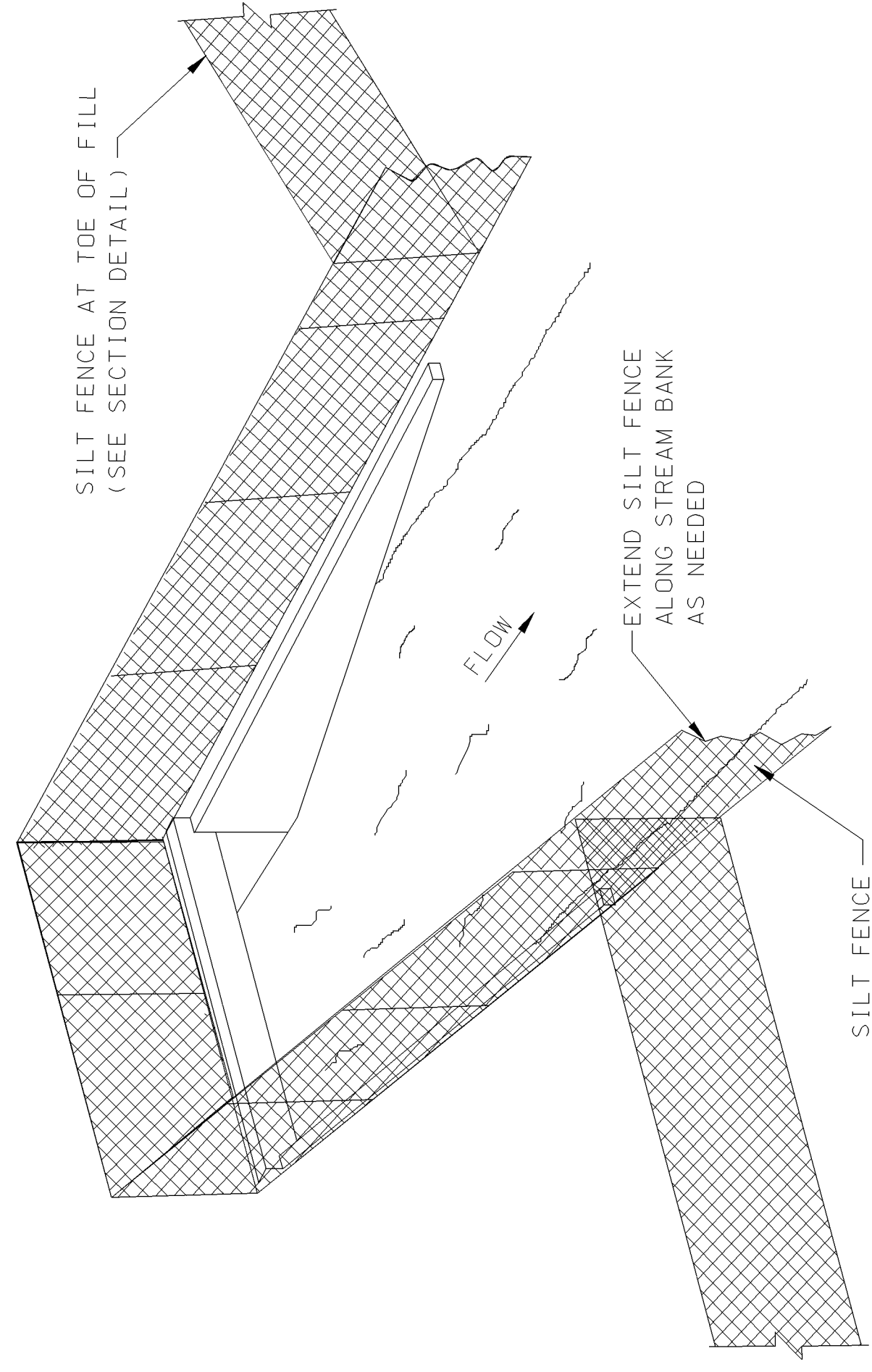

SEDIMENT BARRIER AT CROSS DRAIN

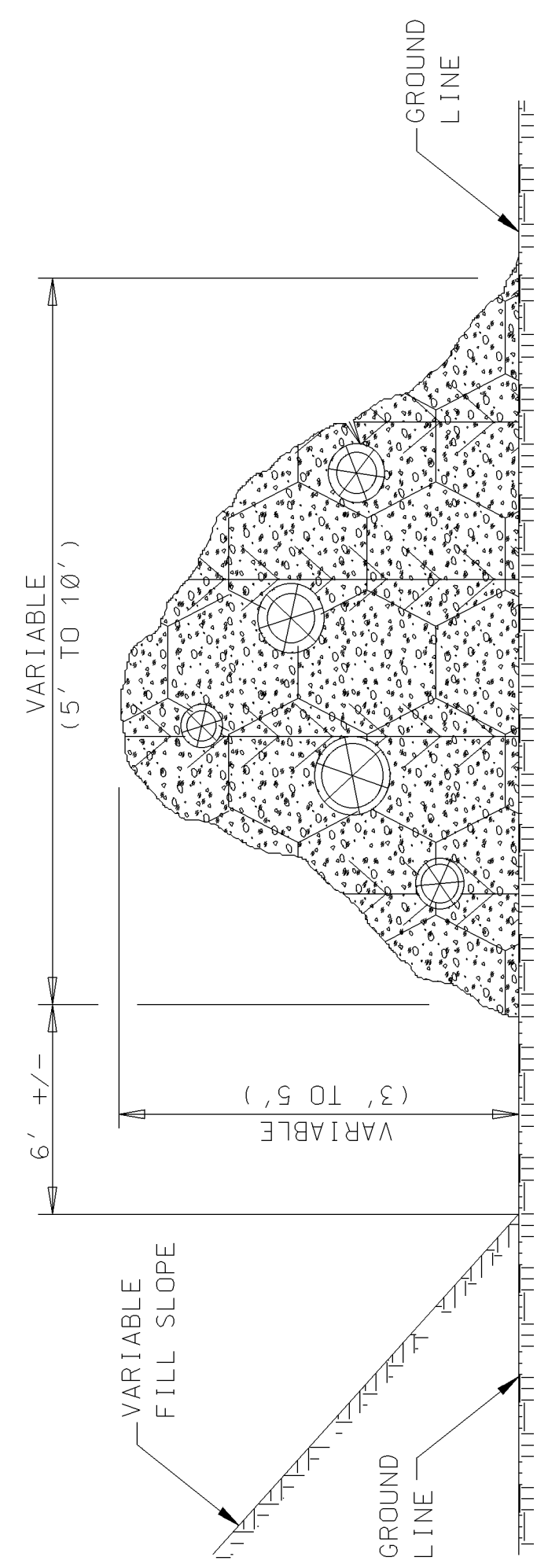

SIDE ELEVATION

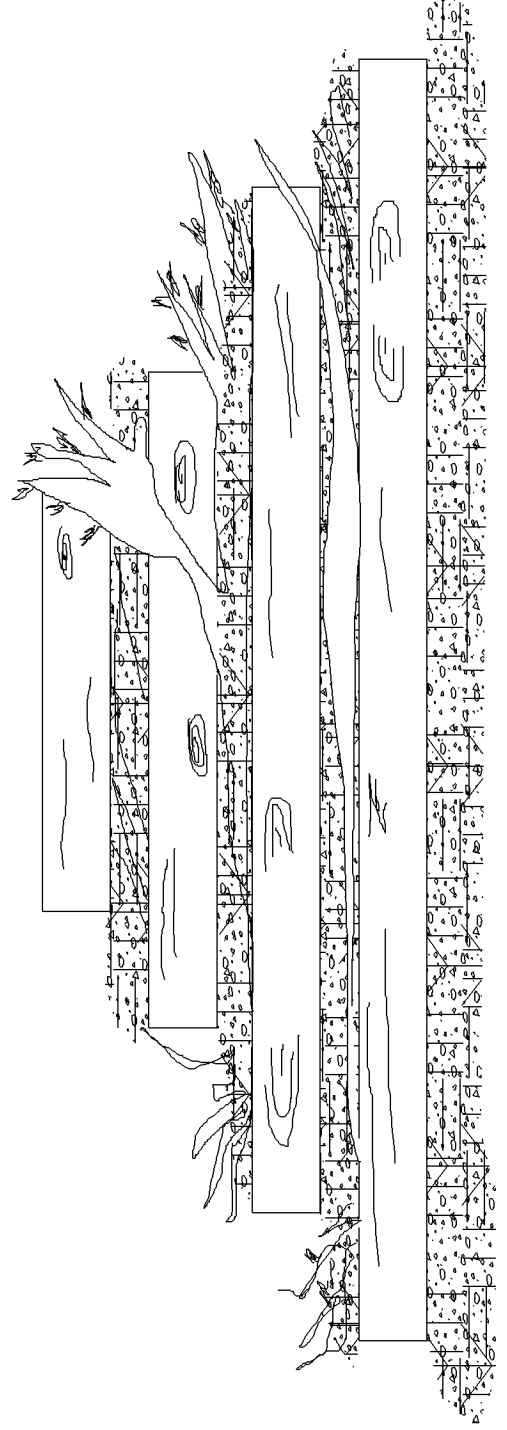

FRONT ELEVATION

TEMPORARY BRUSH BARRIER

- NOTES:
- BRUSH BARRIER MAY BE USED WHERE NATURAL GROUND IS LEVEL OR SLOPING AWAY FROM PROJECT.
 - PLACE BRUSH, LOG AND TREE LAPS APPROXIMATELY PARALLEL TO TOE OF FILL SLOPE WITH SOME OF THE HEAVIER MATERIALS BEING PLACED ON TOP TO PROPERLY SECURE THE BARRIER AS DETAILED AT LOCATIONS SHOWN ON PLANS OR AS DIRECTED OR PERMITTED BY THE ENGINEER.
 - TO ALLOW WATER TO SEEP THROUGH BRUSH BARRIER, INTERMINGLE THE BRUSH, LOG AND TREE LAPS SO AS NOT TO FORM A SOLID DAM.
 - THE BRUSH BARRIER MAY BE CHOKED WITH FILTER FABRIC.
 - TEMPORARY BRUSH BARRIER WILL NOT BE MEASURED FOR SEPARATE PAYMENT

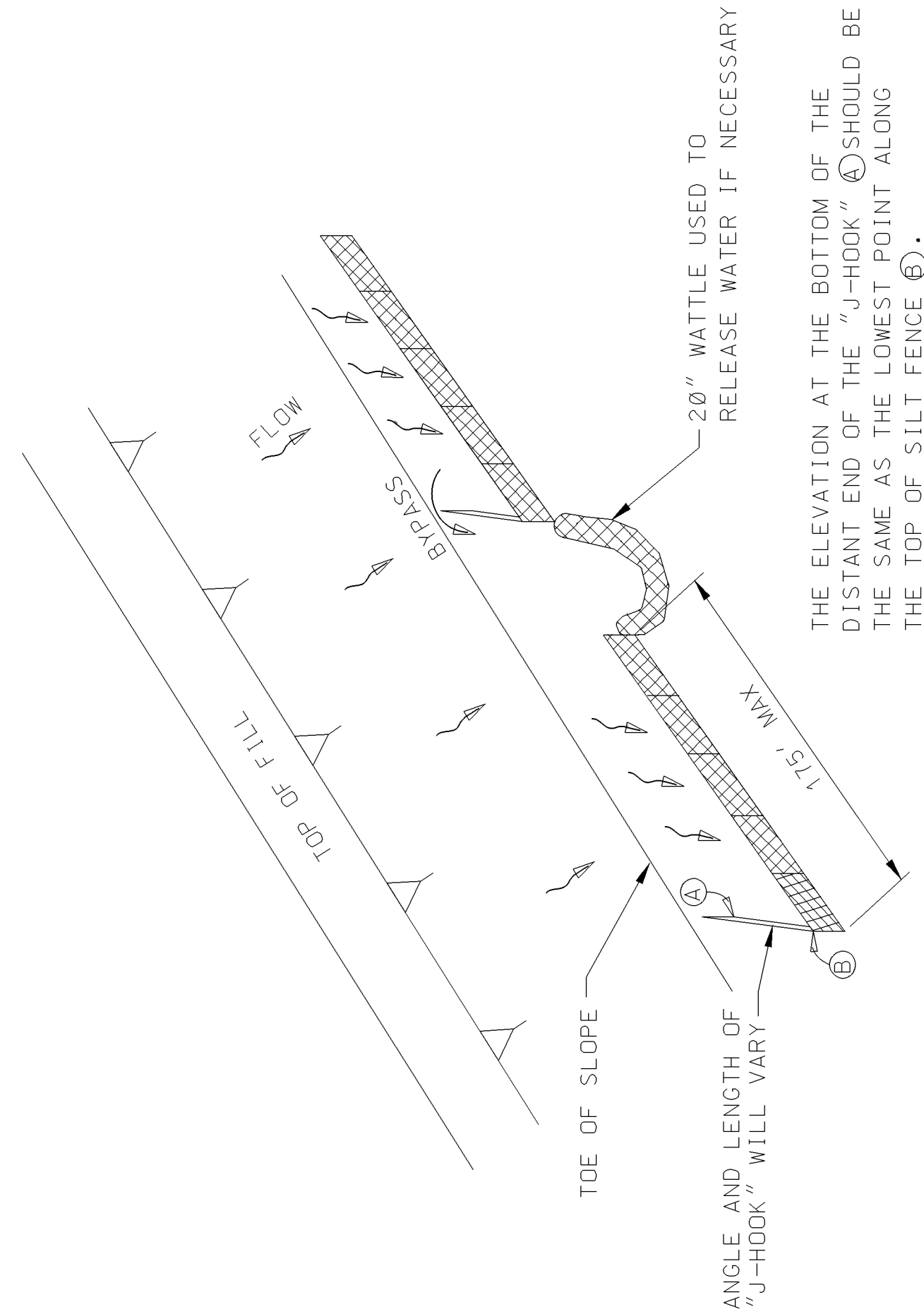

"J-HOOK" SILT FENCE APPLICATION

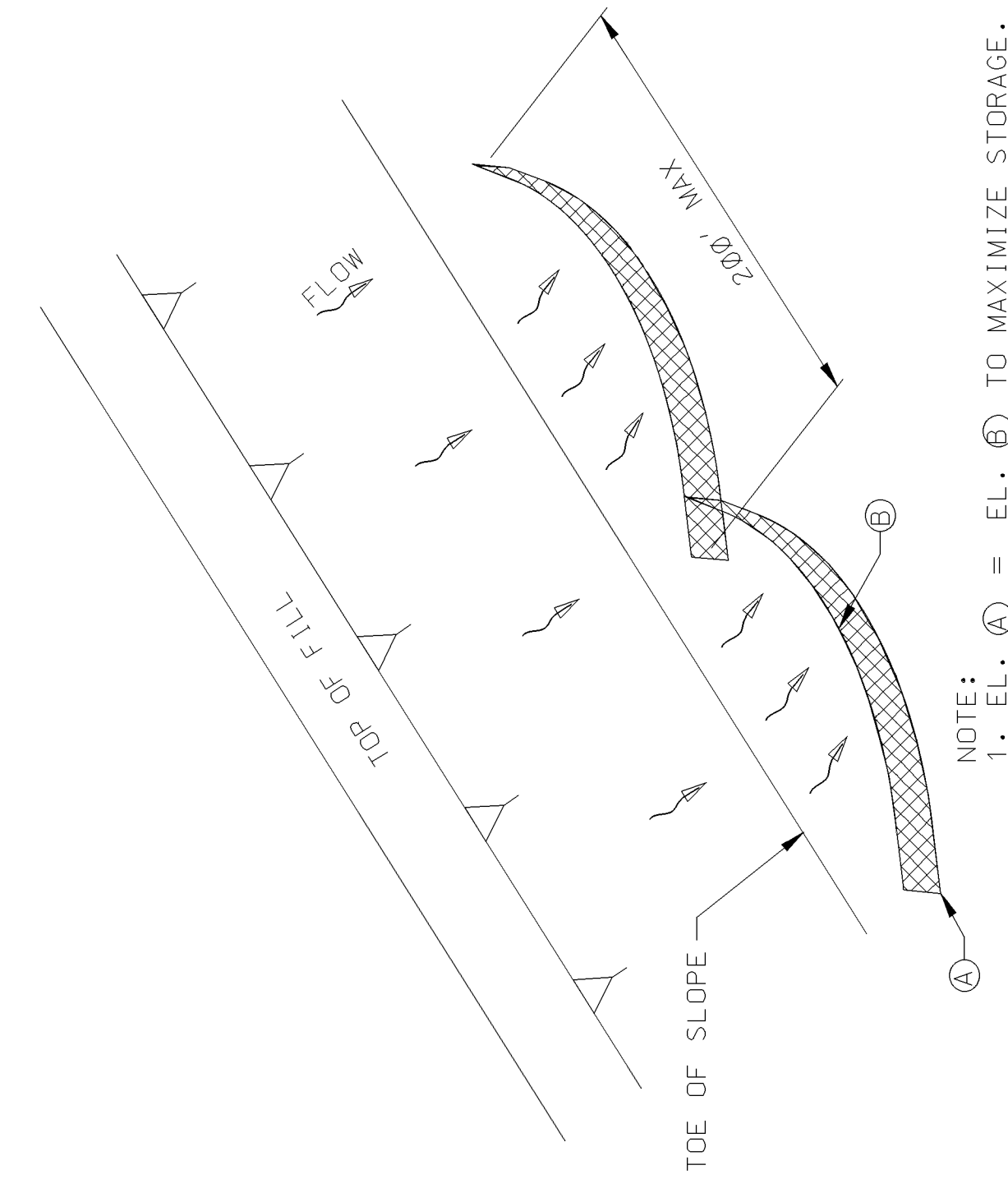

"SMILE-CONFIGURATION" SILT FENCE APPLICATION

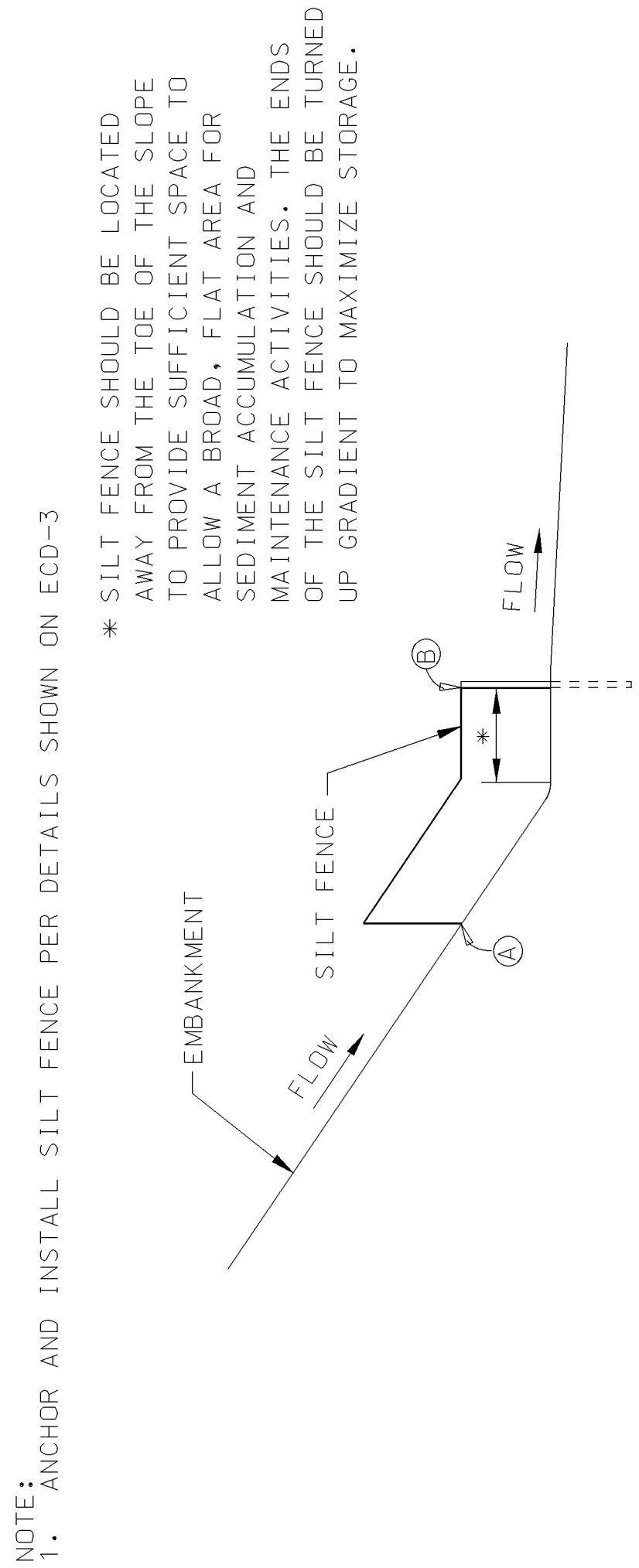

SILT FENCE SECTION AT TOE OF FILL

- NOTE:
- ANCHOR AND INSTALL SILT FENCE PER DETAILS SHOWN ON ECD-3

MISSISSIPPI DEPARTMENT OF TRANSPORTATION		DETAILS OF SEDIMENT BARRIER APPLICATIONS	
BY	REVISION	DATE	DESIGN TEAM

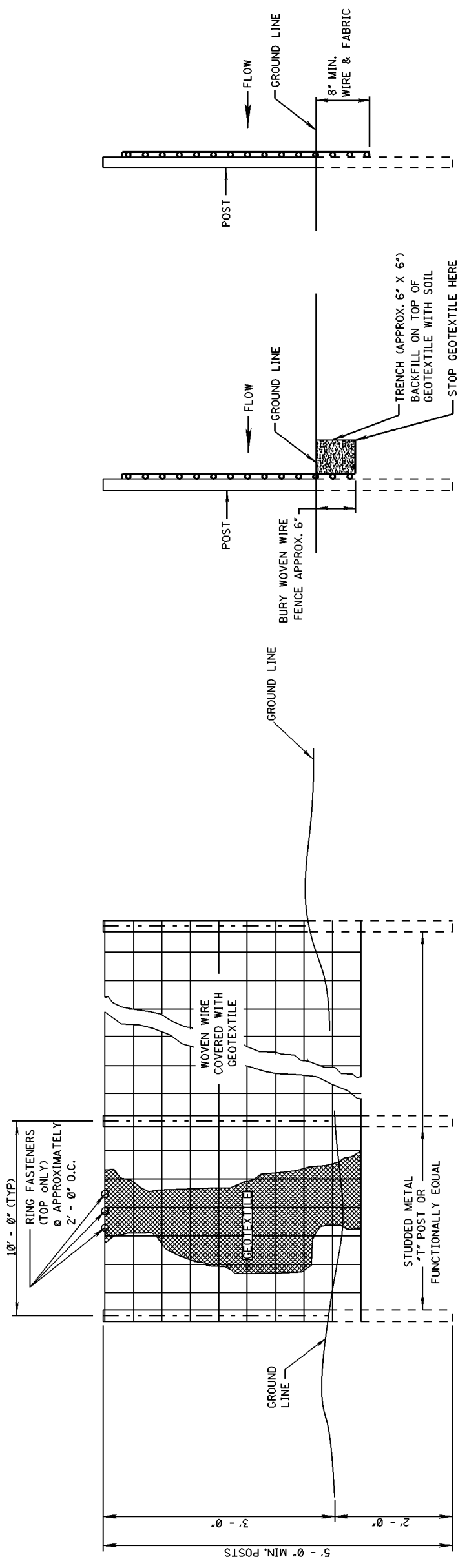

ELEVATION VIEW

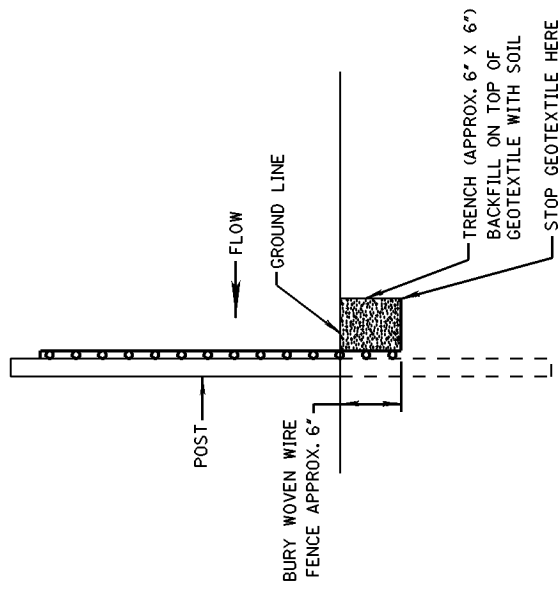

METHOD I

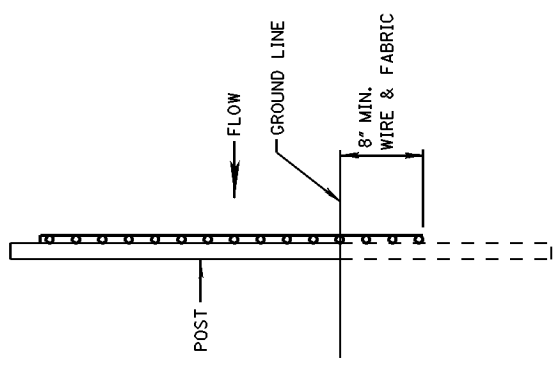

METHOD II
MECHANICAL INSTALLATION

SIDE VIEW

- NOTES:
1. SILT FENCES SHALL BE USED IN AREAS WHERE FLOW IS NOT SEVERE.
 2. SILT FENCES ARE TEMPORARY SEDIMENT CONTROL ITEMS THAT SHALL BE ERECTED OPPOSITE ERODIBLE AREAS SUCH AS NEWLY GRADED FILL SLOPES AND ADJACENT TO STREAMS AND CHANNELS.
 3. SILT FENCE SHOULD BE PLACED WELL INSIDE RIGHT-OF-WAY AND ALONG EDGE OF CLEARING LIMITS. THIS WILL ALLOW ROOM FOR A BACK-UP FENCE IF FIRST FENCE BECOMES FULL.
 4. WHEREVER POSSIBLE SILT FENCE SHALL BE CONSTRUCTED ACROSS A LEVEL AREA IN THE SHAPE OF A SMILE. THIS AIDS IN PONDING OF RUNOFF AND FACILITATES SEDIMENTATION.
 5. THE CONTRACTOR MAY ELECT TO USE EITHER METHOD I OR METHOD II. COST TO BE LINEAR FEET OF SILT FENCE.
 6. METHOD II INSTALLATION SHALL BE ACCOMPLISHED USING AN IMPLEMENT THAT IS MANUFACTURED FOR THE APPLICATION AND PROVIDES A CONFIGURATION MEETING THE REQUIREMENTS OF THE DETAIL.
 7. WIRE SHALL BE MINIMUM OF 32" IN WIDTH AND SHALL HAVE A MINIMUM OF 6 LINE WIRES WITH 12" STAY SPACING.
 8. GEOTEXTILE FABRIC MEETING THE TYPE II MATERIAL REQUIREMENTS AND INSTALLED ACCORDING TO SPECIFICATION MAY BE USED WITHOUT WIRE FENCE.

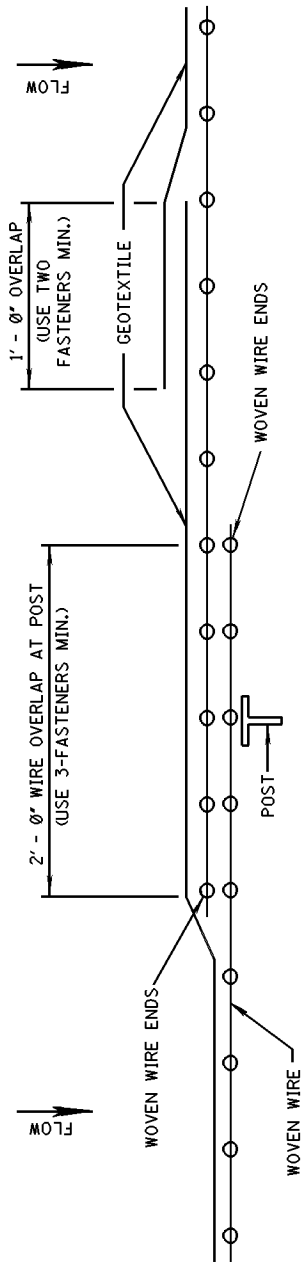

PLAN VIEW
REQUIRED LAPPING

MISSISSIPPI DEPARTMENT OF TRANSPORTATION
**DETAILS OF SILT FENCE
INSTALLATION**

BY	REVISION	DATE

WORKING NUMBER
ECD-3

FILENAME: EROSION_CONTROL\ECD-3.DGN SHEET NUMBER
DESIGN TEAM CHECKED DATE

REFERENCE PROJECT NO.	FISCAL YEAR	SHEET NO.

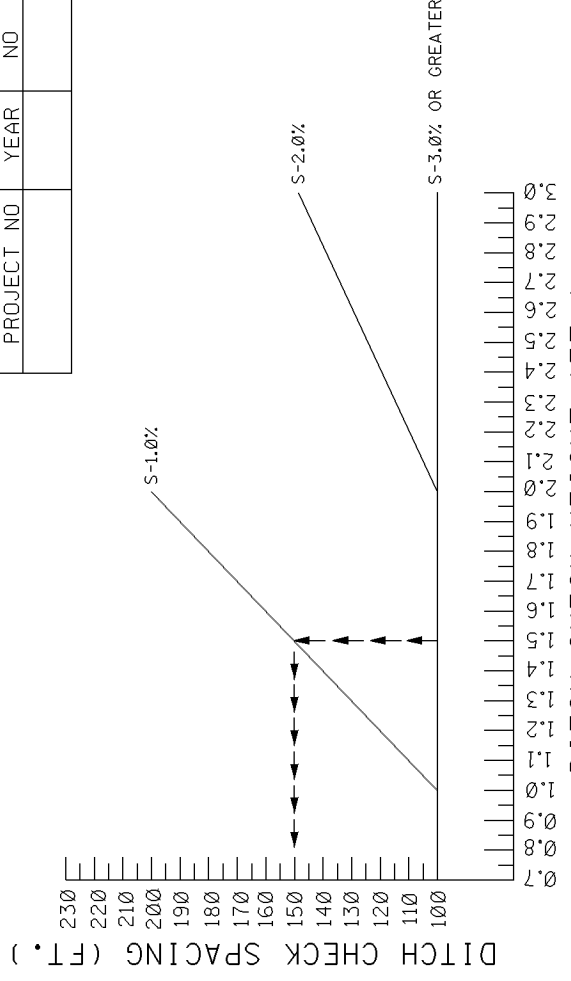

DITCH CHECK SPACING

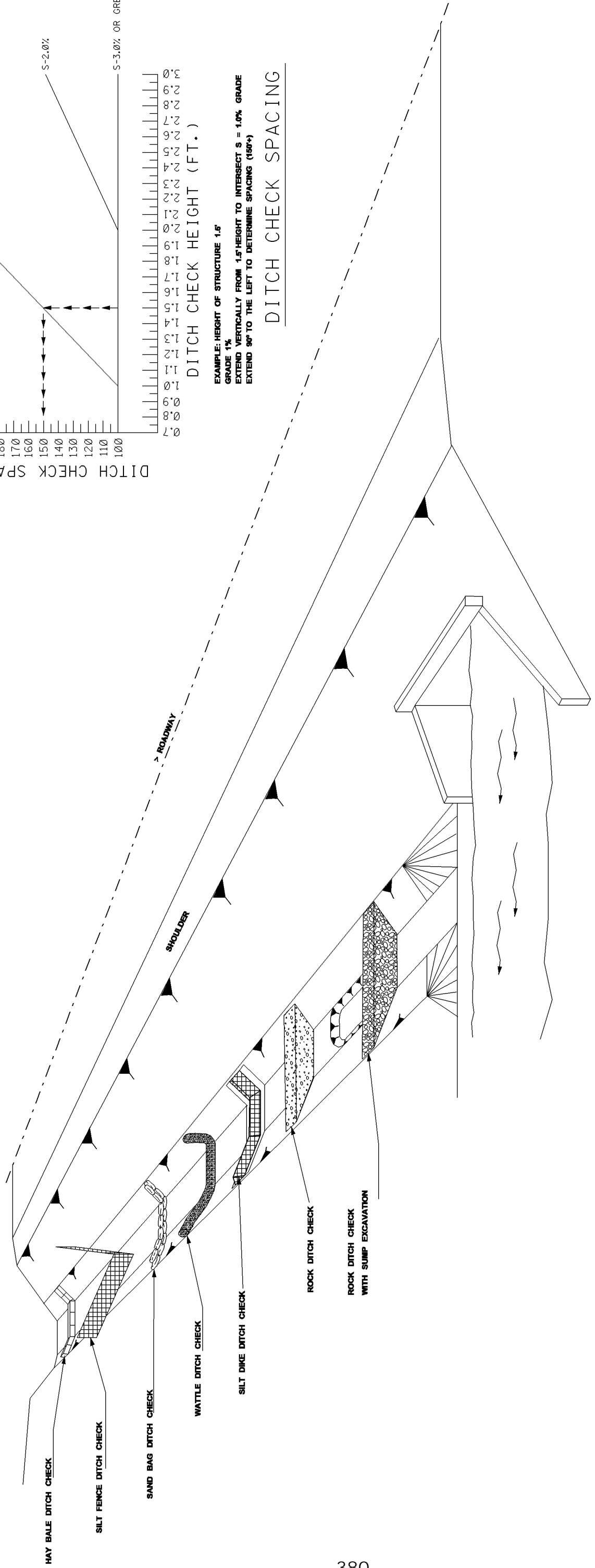

- NOTES:
1. THE DITCH CHECK PERSPECTIVE ILLUSTRATES A TOOL BOX OF TEMPORARY PRACTICES THAT MAY BE USED. DITCH CHECKS ARE INSTALLED TO CONTROL RUNOFF VELOCITY AND THUS REDUCE EROSION AND PROVIDE FOR TRAPPING OF SEDIMENTS.
 2. SELECTION OF THE APPROPRIATE DITCH CHECK SHOULD BE A FUNCTION OF CONSTRUCTION PHASE, DRAINAGE AREA, DITCH GRADIENT, SOIL TYPE ECONOMY AND SAFETY.
 3. DITCH CHECKS CAN BE REMOVED FOR MAINTENANCE AND/OR REPLACEMENT BUT MUST REMAIN IN PLACE UNTIL UPSLOPE AREAS HAVE BEEN PERMANENTLY STABILIZED. MAINTENANCE INCLUDES REMOVAL OF SEDIMENT BEGINNING WHEN SEDIMENT ACCUMULATION REACHES 1/3 THE CAPACITY OR HEIGHT OF THE STRUCTURE AND NEVER ALLOWING FOR SEDIMENT TO ACCUMULATE MORE THAN 1/2 THE VOLUME OR HEIGHT OF THE DITCH CHECK STRUCTURE.
 4. HAY BALES ARE USED TO INTERCEPT LOW VOLUME FLOWS IN LOW TO MODERATE GRADIENT DITCHES.
 5. SILT FENCE DITCH CHECKS ARE USED WHERE IT HAS BEEN DETERMINED THAT HAY BALES CHECKS ARE INADEQUATE. SILT FENCE DITCH CHECKS ARE USED TO INTERCEPT LOW VOLUME FLOWS IN LOW TO MODERATE GRADIENT DITCHES.
 6. SAND BAG DITCH CHECKS ARE USED FOR VELOCITY REDUCTION AND MINIMAL SEDIMENT TRAPPING IN CONCRETE PAVED DITCHES OR IN DITCHES THAT HAVE ROCKY BOTTOMS.
 7. WATTLE DITCH CHECKS ARE APPROPRIATE FOR VELOCITY REDUCTION AND CONTROL OF SEDIMENT TRANSPORT UNDER LOW TO MEDIUM FLOW CONDITIONS.

8. SILT DIKES CAN BE USED IN DITCHES WITH CONCENTRATED FLOWS WITHIN THE CLEAR ZONE WHERE RIPRAP CAN NOT BE USED AS CONSTRUCTION PROGRESSES.
9. ROCK DITCH CHECK WITH SUMP EXCAVATION CAN BE PLACED IN DITCHES TO ASSURE ON-SITE SEDIMENT TRAPPING REQUIREMENTS ARE MET. DITCH CHECK WITH SUMP EXCAVATION IS USED WHEN DITCHES RECEIVE DRAINAGE FROM CUT OR FILL SLOPES OR OTHER CRITICAL AREAS WHERE SOIL EROSION IS EXPECTED. DRAINAGE AREA FOR A TEMPORARY SEDIMENT TRAP SHALL NOT EXCEED 3 ACRES. THEY CAN BE USED IN SERIES TO INCREASE ON-SITE SEDIMENT TRAPPING EFFICIENCY.
10. IN GENERAL, DITCH CHECKS SHOULD NOT BE PLACED IN LIVE STREAMS.
11. CONFIGURATION AND SPACING MAY BE ADJUSTED IF APPROVED BY THE ENGINEER TO ACCOMMODATE TRAVELWAY SAFETY, WATER FLOW, OR SOIL AND INSTALLATION CHALLENGES.

MISSISSIPPI DEPARTMENT OF TRANSPORTATION	
DITCH CHECK STRUCTURES, TYPICAL APPLICATIONS AND DETAILS	
BY	REVISION
DATE	CHECKED
DESIGN TEAM	DATE
FILENAME: EROSION CONTROL.ECD-4.DGN	WORKING NUMBER
	ECD-4
	SHEET NUMBER

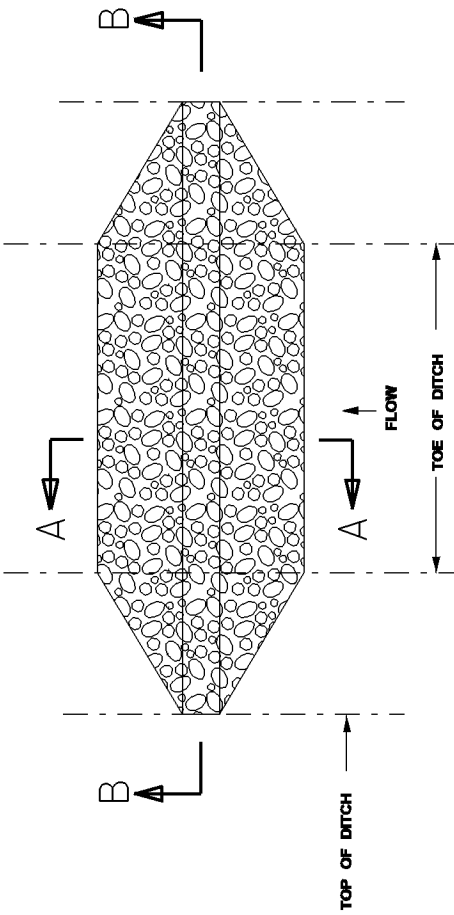

PLAN VIEW
DETAIL FOR TRAPEZOIDAL DITCH

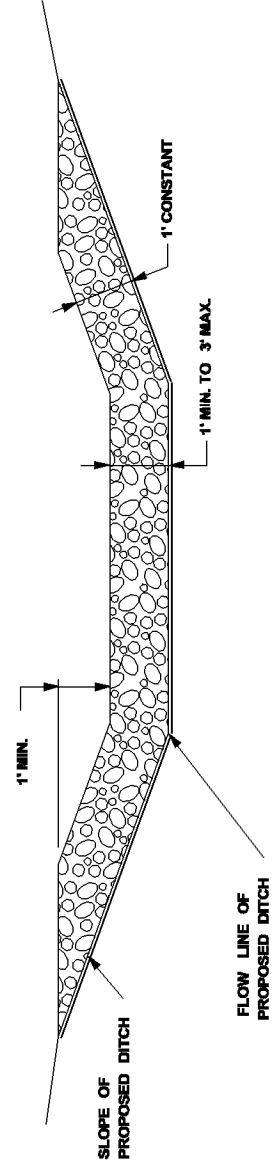

SECTION B-B

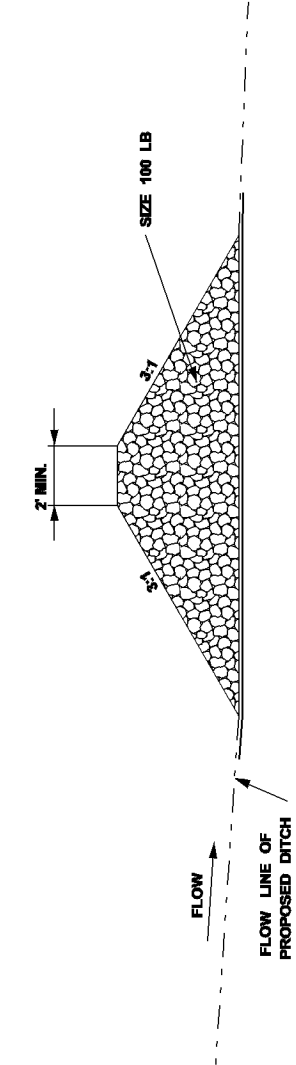

SECTION A-A

TEMPORARY ROCK DITCH CHECKS IN ROADSIDE DITCHES

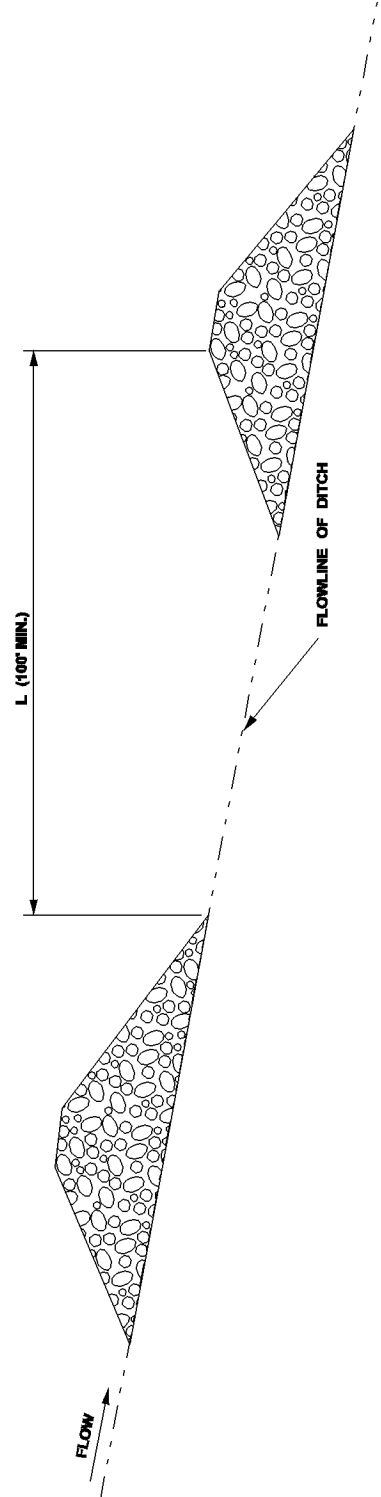

DETAIL FOR SPACING BETWEEN DITCH CHECKS

- NOTES:
1. MINIMUM SPACING FOR ROCK DITCH CHECKS SHALL BE 100 FEET OR EROSION CONTROL PLAN APPROVED BY THE ENGINEER. SEE SPACING GUIDANCE ON ECD-4
 2. ROCK DITCH CHECKS MAY ALSO BE CHOKED WITH FABRIC.
 3. SIZE 300 LB RIP RAP MAY BE USED FOR SPECIFIED APPLICATIONS AS SHOWN ON EROSION CONTROL PLAN

MISSISSIPPI DEPARTMENT OF TRANSPORTATION		WORKING NUMBER
ROCK DITCH CHECK		ECD-8
BY	REVISION	FILENAME: EROSION CONTROL.ECD-8.DGN
		DESIGN TEAM
		CHECKED
		DATE
		SHEET NUMBER

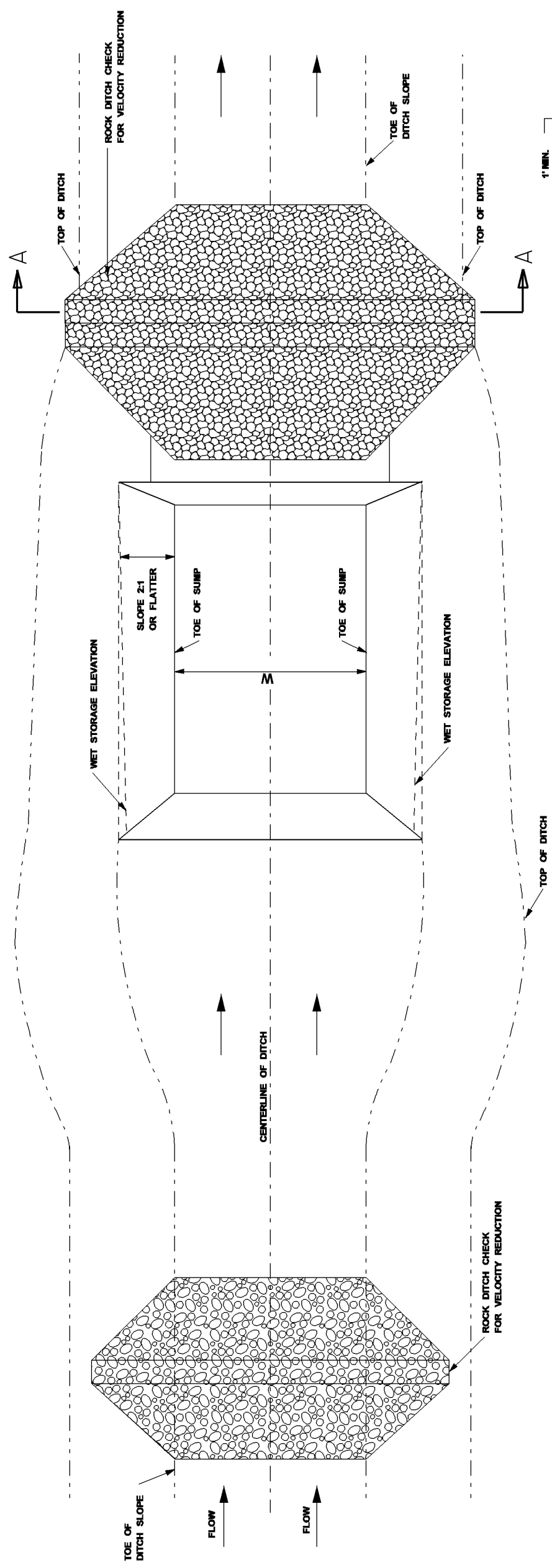

PLAN VIEW

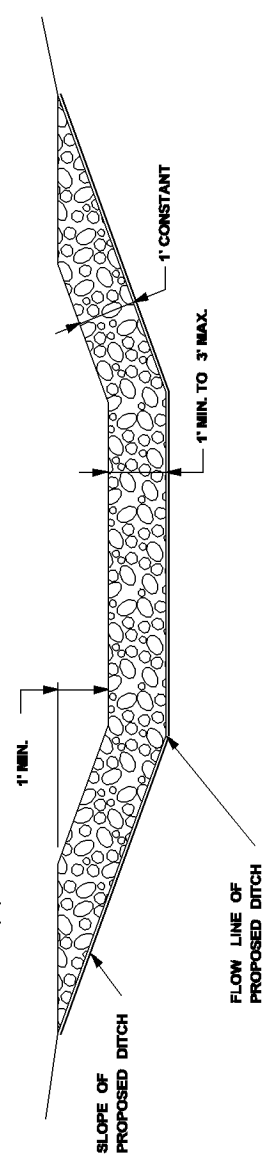

SECTION A-A

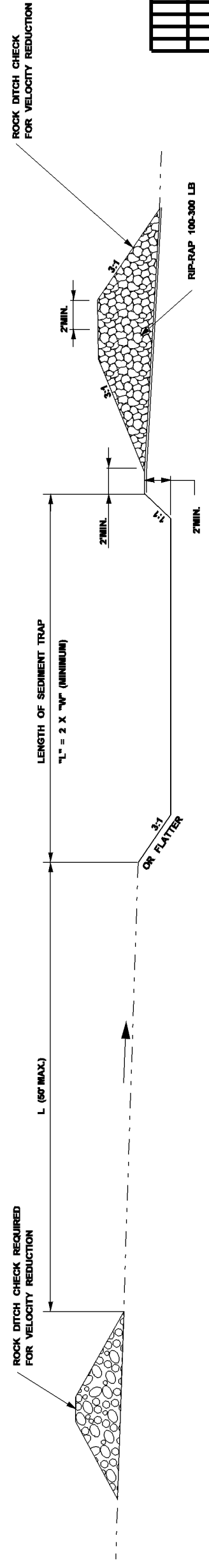

PROFILE VIEW

MISSISSIPPI DEPARTMENT OF TRANSPORTATION		WORKING NUMBER
ROCK DITCH CHECK WITH SUMP EXCAVATION		ECD-9
FILENAME: EROSION CONTROL/ECD-S.DGN	DESIGN TEAM	SHEET NUMBER
DATE	CHECKED	DATE
BY	REVISION	

EXTEND POLYETHYLENE OR FABRIC 3' BEYOND TOE OF RIP-RAP

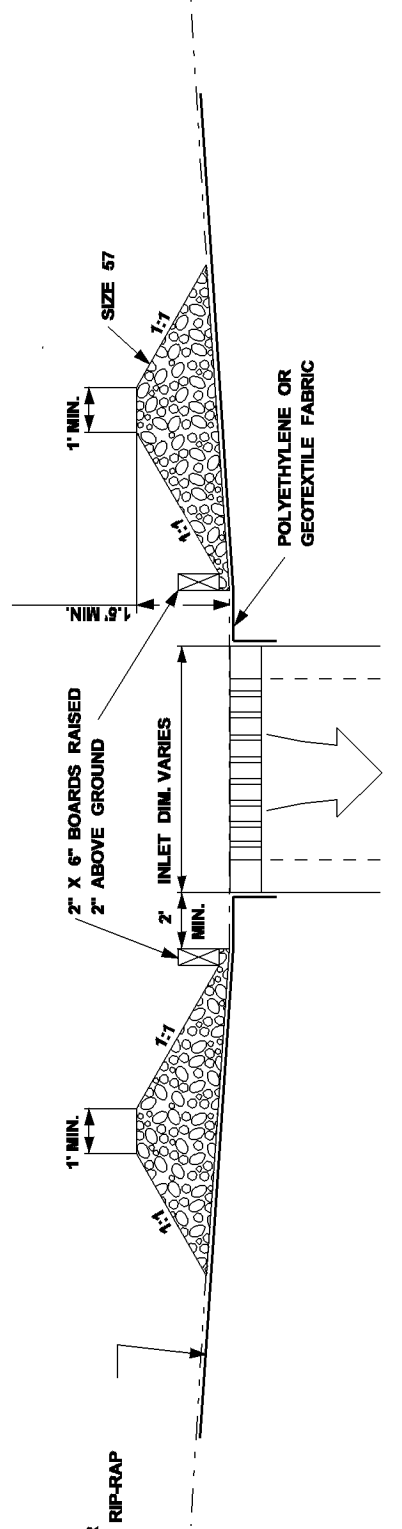

SECTION B-B

- NOTES:
1. THE ELEVATION OF THE TOP OF THE REQUIRED STONE BERM SHALL BE A MINIMUM OF 1.5' ABOVE THE ELEVATION OF THE INLET WORKING POINT AND A MINIMUM OF 6" BELOW THE ELEVATION OF THE OUTSIDE EDGE OF THE INSIDE SHOULDER.
 2. THIS COARSE AGGREGATE INLET PROTECTION SHALL NOT BE UTILIZED DURING STAGE 1 AND STAGE 2 INLET CONSTRUCTION. SEE INLET PROTECTION TYPICAL APPLICATIONS AND DETAILS.)
 3. 2" X 6" BOARDS MAY BE REPLACED WITH WIRE MESH WIOPENINGS LESS THAN 1" X 1". COST IS ABSORBED.

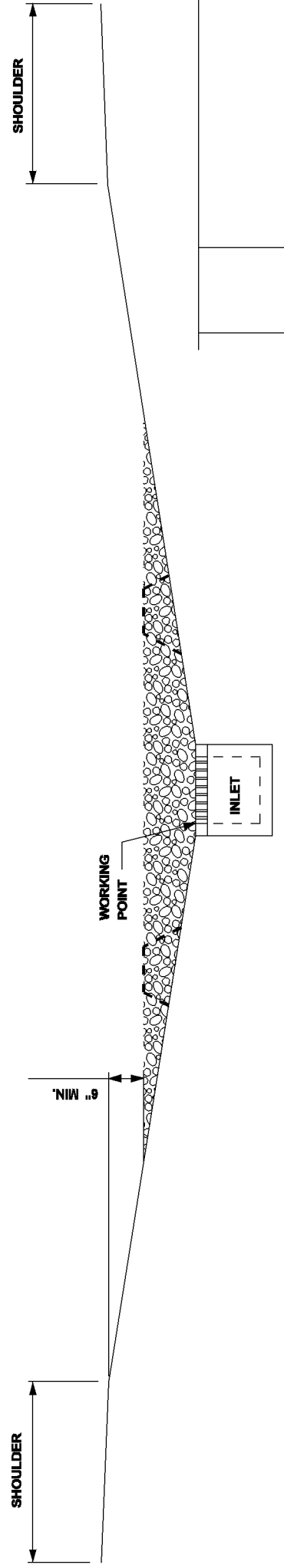

SECTION A-A

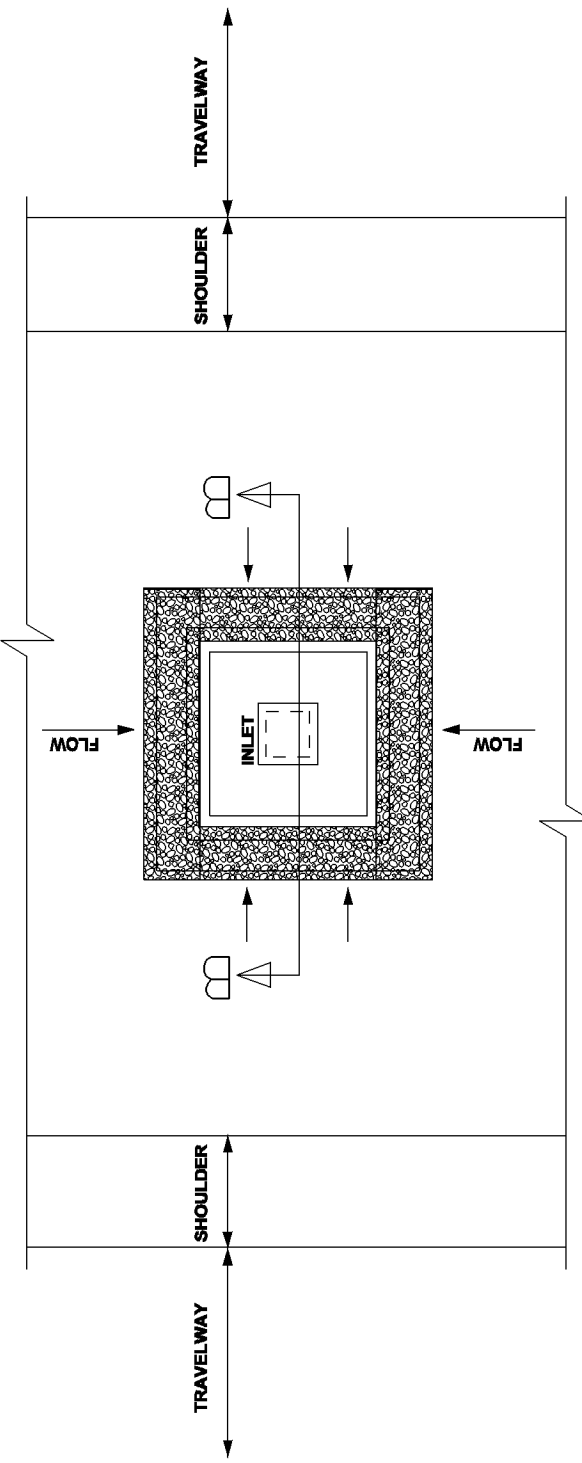

PLAN - IN SAG

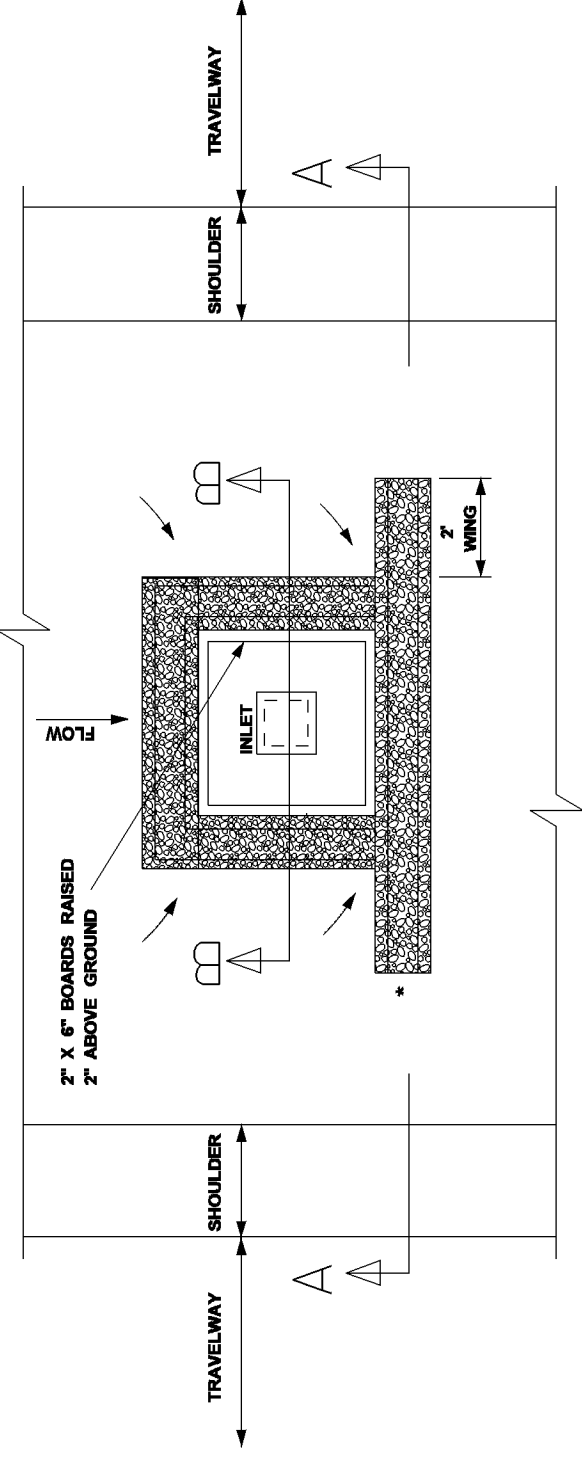

PLAN - ON GRADE

* CONSTRUCT WINGS TO PREVENT BYPASS

MISSISSIPPI DEPARTMENT OF TRANSPORTATION
INLET PROTECTION
DETAILS FOR COARSE AGGREGATE
ON GRADES & SAGS

BY	REVISION	DATE	CHECKED	DESIGN TEAM

WORKING NUMBER
ECD-11
SHEET NUMBER

FILENAME: EROSION_CONTR/ECD-11.DGN
DATE
DESIGN TEAM

NOTE:
SILT FENCE OR SAND BAGS MAY ALSO BE USED FOR THIS APPLICATION.
HAY BALES NOT ACCEPTABLE DURING THIS STAGE.

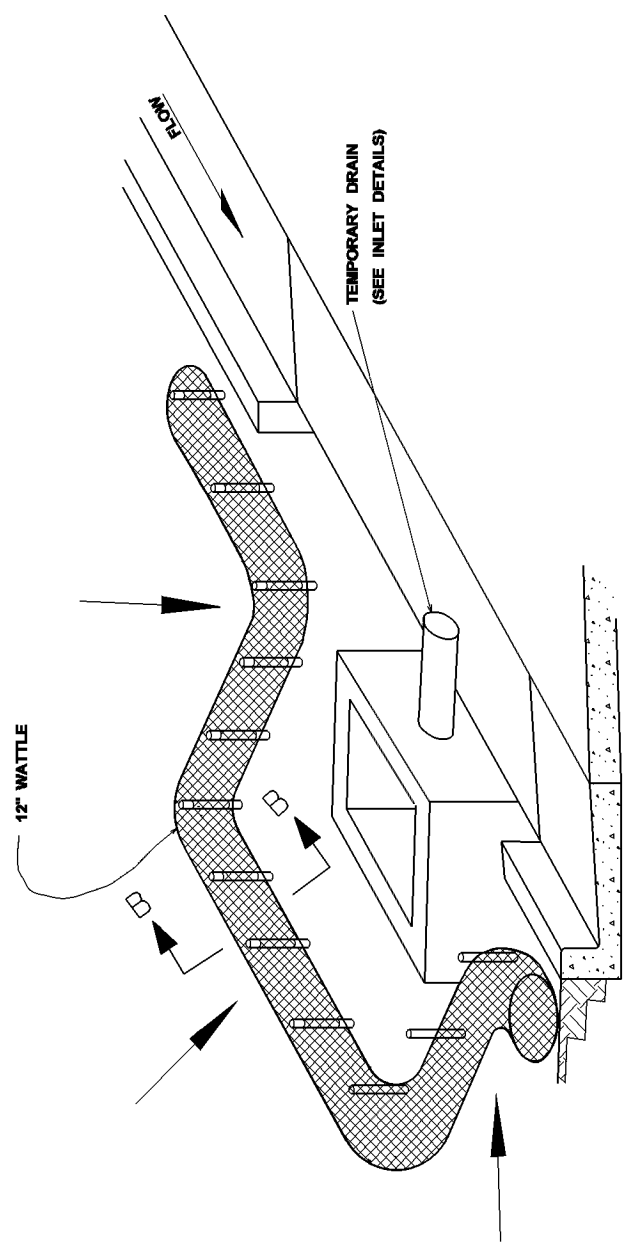

CURB INLET PROTECTION (STAGE 2)
SINGLE OR DOUBLE WING INLET

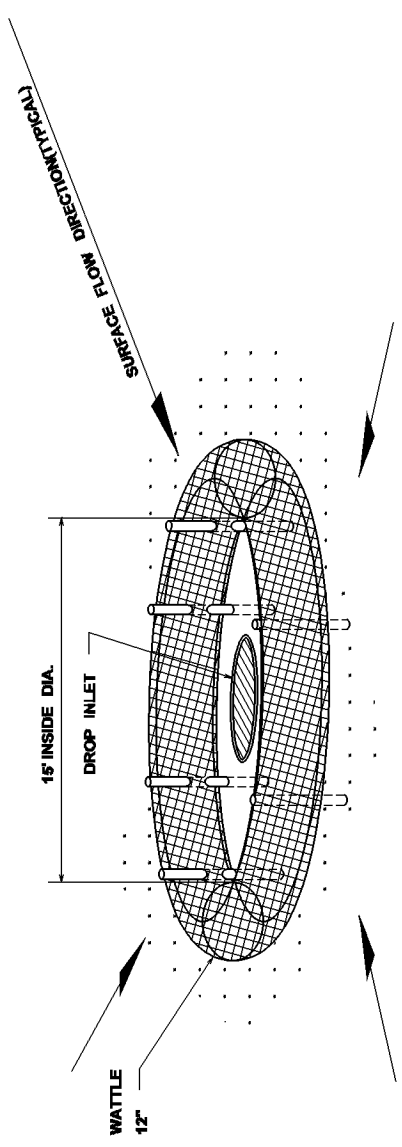

DROP INLET PROTECTION

- NOTES:
1. ANCHORING STAKES SHALL BE SIZED, SPACED, AND BE OF A MATERIAL THAT EFFECTIVELY SECURES THE WATTLE STAKE SPACING SHALL BE A MAXIMUM OF THREE FEET.
 2. OVERLAP ENDS OF WATTLES PER MANUFACTURERS' RECOMMENDATIONS (1" MIN., 3" MAX.).
 3. TRENCHING OF WATTLES MAY BE NECESSARY IF PIPING BECOMES EVIDENT.

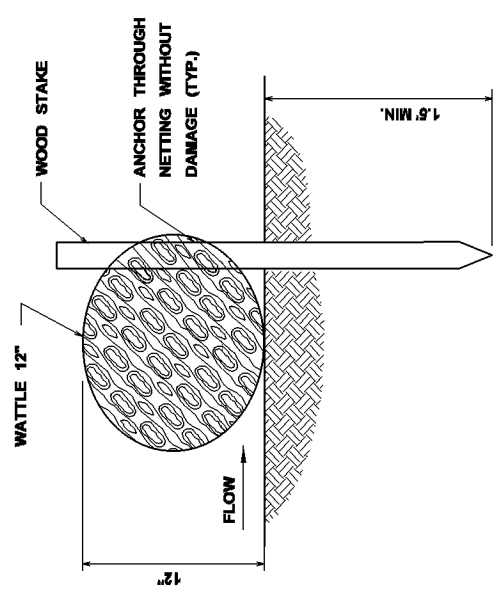

SECTION B-B

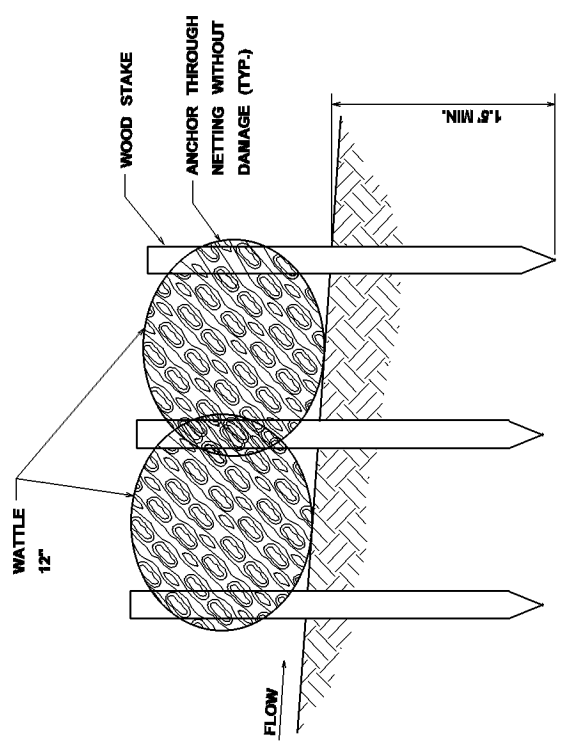

SECTION A-A

MISSISSIPPI DEPARTMENT OF TRANSPORTATION		WORKING NUMBER
INLET PROTECTION DETAILS OF WATTLES		ECD-12
DATE	FILENAME: EROSION CONTROL/ECD-12.DGN	SHEET NUMBER
BY	DESIGN TEAM	CHECKED
REVISION	DATE	DATE

- NOTES:
1. TEMPORARY DIVERSION CHANNELS MAY BE USED TO DIVERT NORMAL STREAM PATH FLOW FROM AN ERODIBLE AREA UNTIL SUCH AREAS CAN BE STABILIZED.
 2. TYPE III FILTER FABRIC OR PRE-FAB DITCH LINER MAY BE USED FOR CHANNEL LINING.
 3. RIP-RAP WITH FILTER FABRIC MAY BE USED FOR CHANNEL FLOW VELOCITIES OF 3.0 FPS TO 9.0 FPS. THE RIP-RAP SHALL BE SIZED 300 LB
 4. LOCATIONS OR TYPES OF TEMPORARY DIVERSION WILL NOT BE SHOWN ON THE PLANS
 5. ENGINEER CHANNEL SHALL BE STABILIZED AND INSPECTED BY THE ENGINEER BEFORE FLOW IS DIVERTED.
 6. DURING CONSTRUCTION OF DIVERSION CHANNEL, DAMAGE TO THE EXISTING STREAM, CANOPY REMOVAL, AND DEPTH OF THE CHANNEL CONSTRUCTION SHALL BE MINIMIZED.
 7. CONSTRUCTION OF THE CHANNEL RELOCATIONS AND CULVERTS SHALL PROCEED AS FOLLOWS:
 - 7.1. CONSTRUCT A MEANDERING TEMPORARY CHANNEL CHANGE ADJACENT TO THE PROPOSED CULVERT TO DIVERT WATER TEMPORARILY DURING THE CULVERT CONSTRUCTION.
 - 7.2. RELOCATE CHANNEL AND CONSTRUCT CULVERT SIMULTANEOUSLY. IN ACCORDANCE WITH THE STANDARD SPECIFICATIONS.
 - 7.3. SOD AND/OR RIP-RAP RECONSTRUCTED BANKS AT TRANSITIONS. THE UPPER CHANNEL PLUG IS TO REMAIN IN PLACE UNTIL SUBNOTE (7.4) THROUGH (7.4) UNDER THIS HEADING ARE COMPLETED TO INSURE THAT ALL CONSTRUCTION IS IN THE DRY.
 - 7.4. IF AN EARTH PLUG IS NECESSARY AT THE DOWNSTREAM END OF THE CHANNEL IT SHOULD BE REMOVED FIRST, THEN REMOVE THE UPPER PLUG TO RELEASE WATER INTO THE RECONSTRUCTED CHANNEL.
 - 7.5 PLUGS SHOULD REMAIN IN PLACE UNTIL PERMANENT STABILIZATION OF THE NEW WATER COURSE IS COMPLETED. REMOVAL OF PLUGS SHOULD ONLY BE PERFORMED FOLLOWING ACCEPTANCE OF ALL STABILIZATION WORK BY THE ENGINEER.
 8. THE DETAILS PROVIDED DEPICT TYPICAL TEMPORARY DIVERSION CHANNELS.
 9. THE CONTRACTOR MAY PROPOSE THE USE OF OTHER DIVERSION OPTIONS SUCH AS PIPING, PUMPING OR STAGED CONSTRUCTION.
 10. THE EFFECTIVE AREA OF FLOW IN THE TEMPORARY CHANNEL OR CULVERT SHALL BE AT LEAST ONE-HALF THAT OF THE EXISTING STRUCTURE.

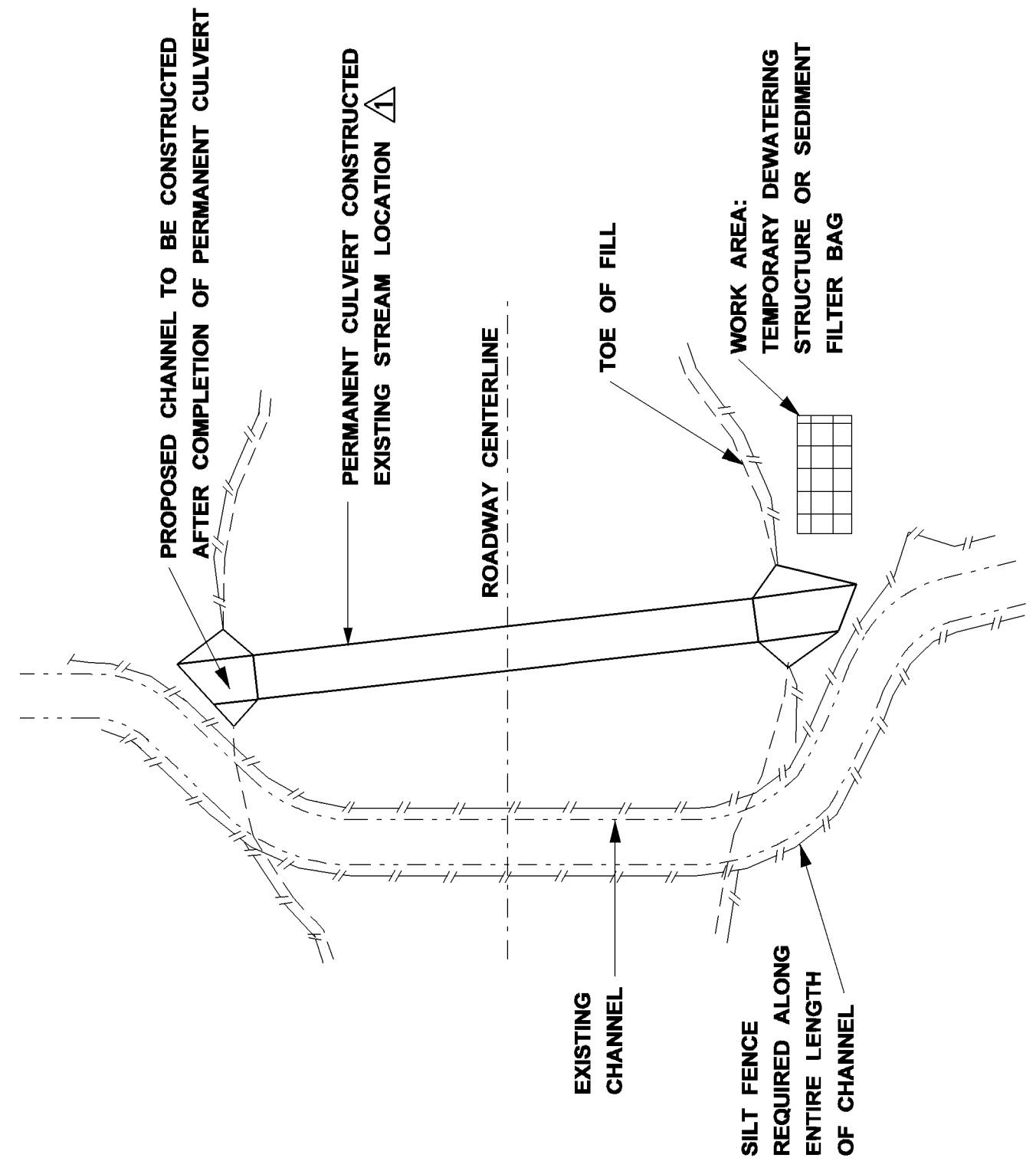

CULVERT CONSTRUCTED OUTSIDE EXISTING STREAM

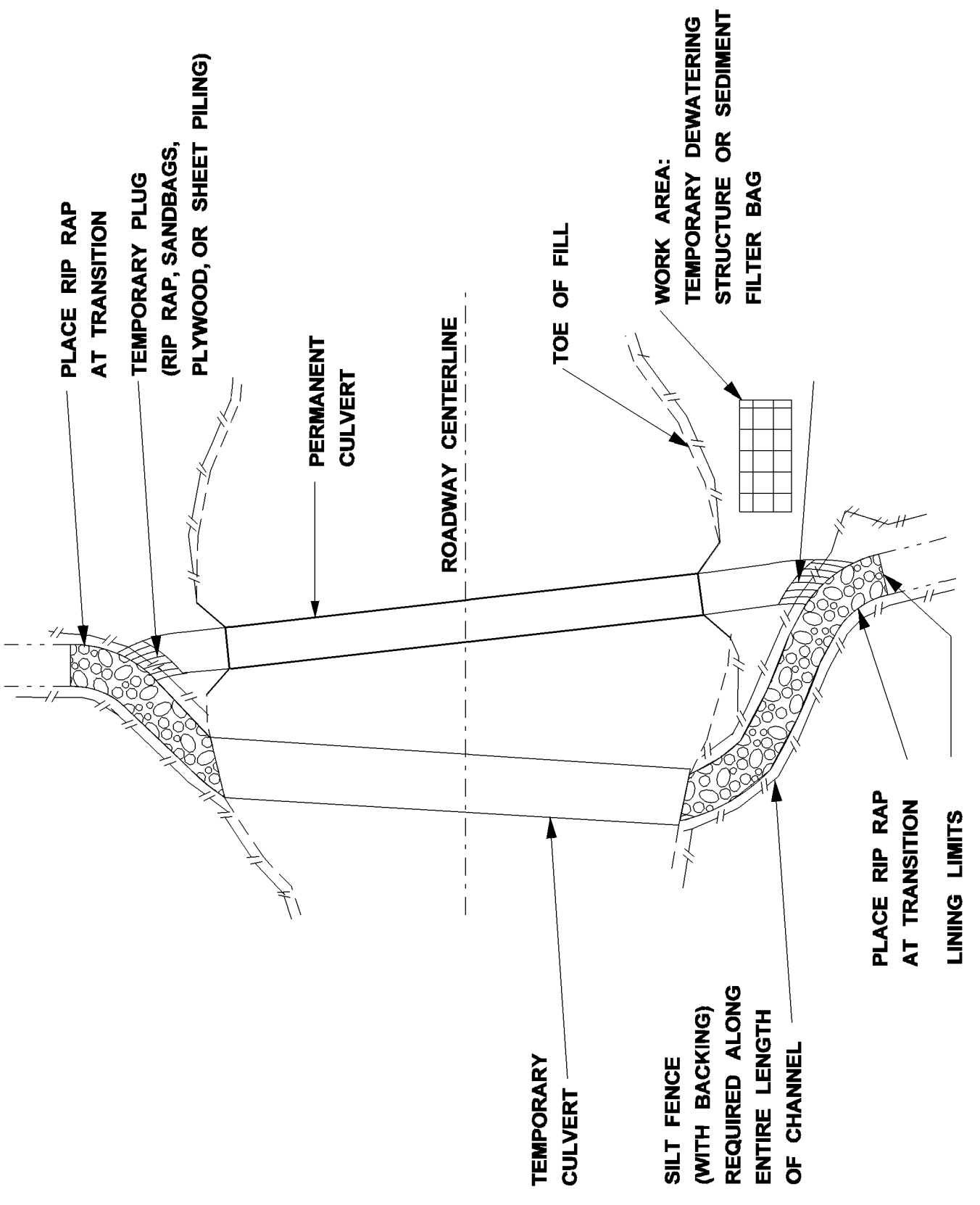

TEMPORARY CULVERT USED DURING CONSTRUCTION

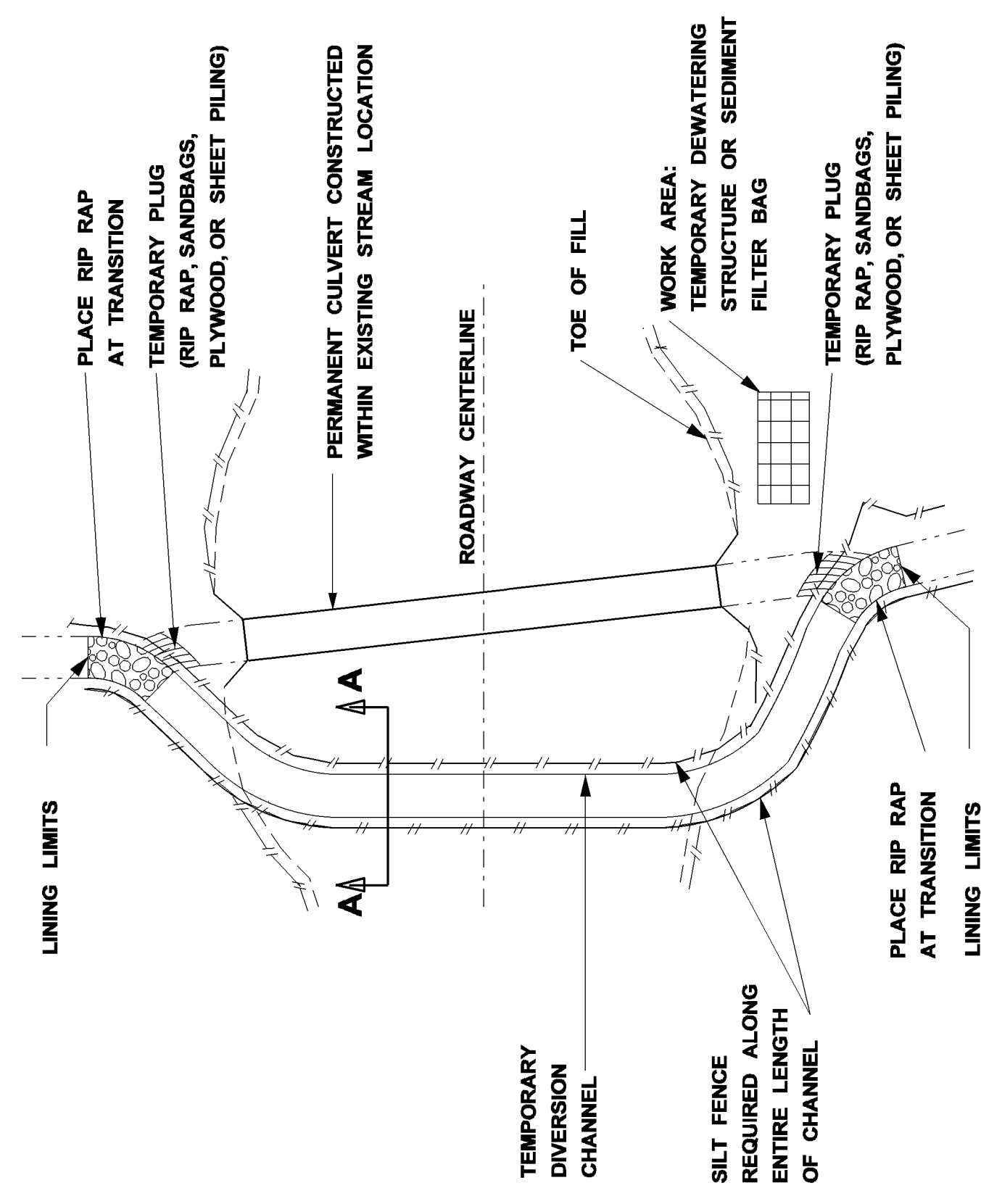

CULVERT CONSTRUCTED WITHIN EXISTING STREAM

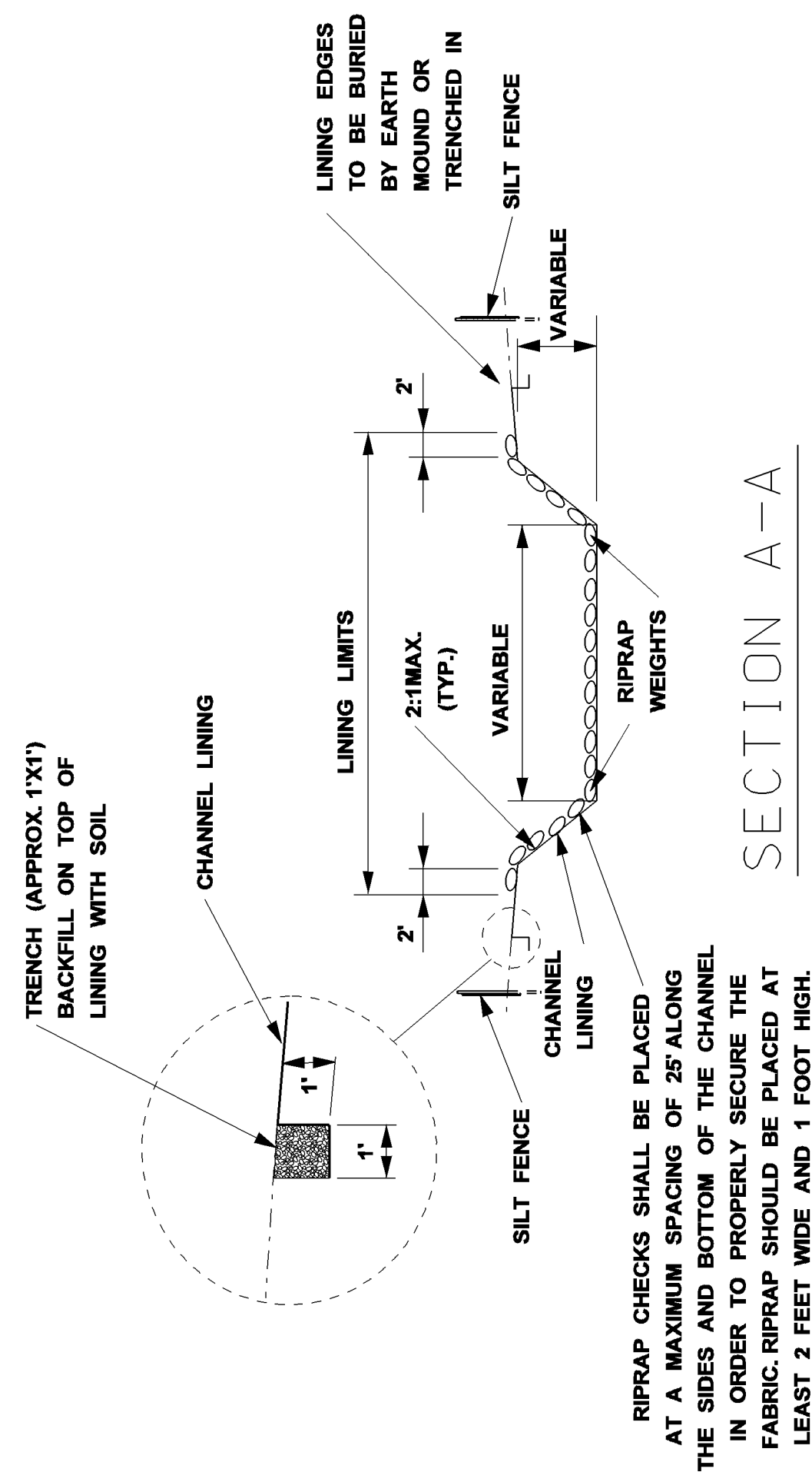

TEMPORARY DIVERSION CHANNEL WITH GEOTEXTILE FABRIC

MISSISSIPPI DEPARTMENT OF TRANSPORTATION	
TEMPORARY STREAM DIVERSION	
BY: JSS	DATE: 08/16/10
REVISION:	DESIGN TEAM
revised text	CHECKED
	DATE
	FILENAME: EROSION CONTROL/ECD-17.DGN
	WORKING NUMBER: ECD-17
	SHEET NUMBER

FLOATING TURBIDITY CURTAIN

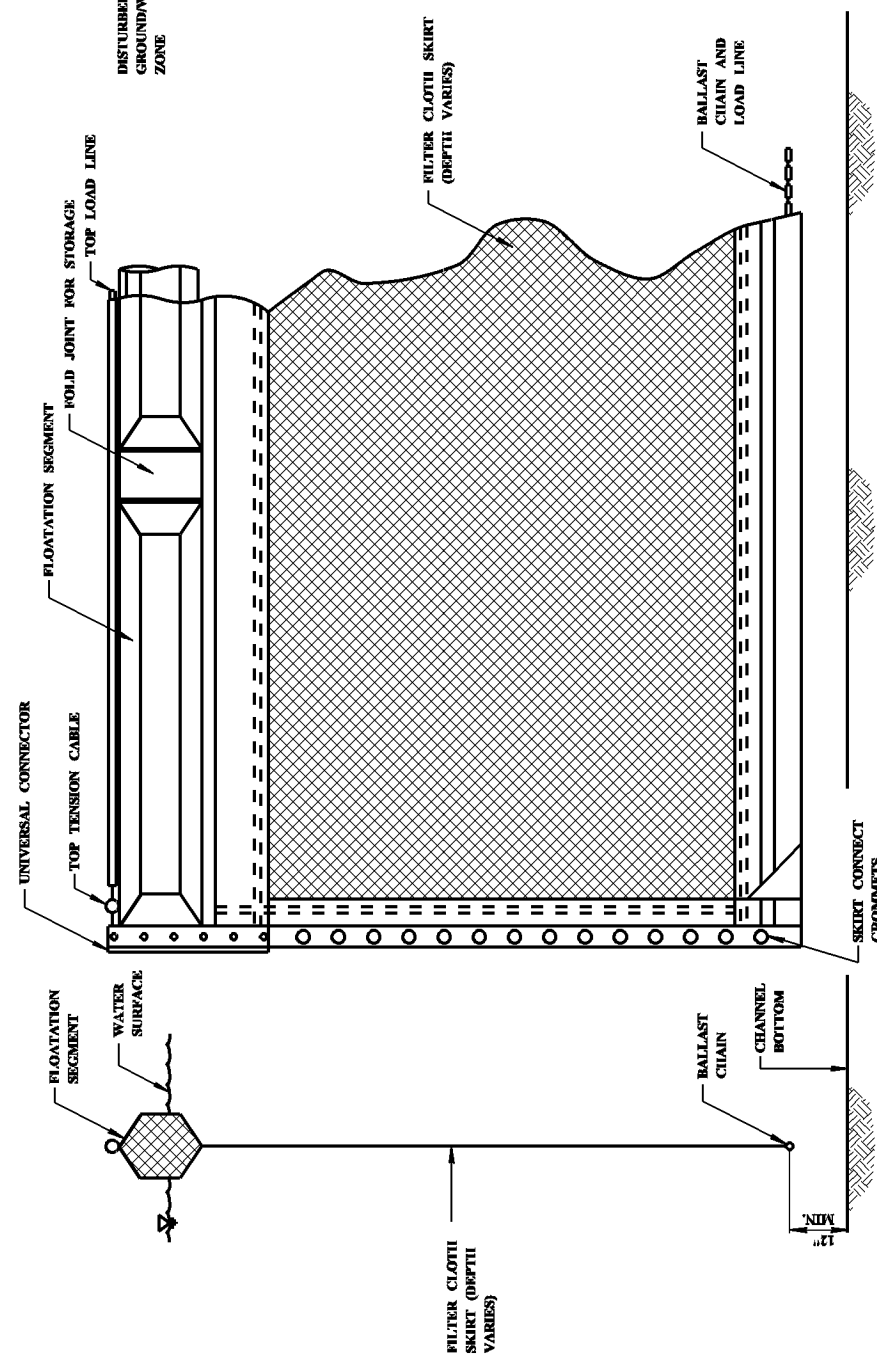

TYPICAL ANCHORING PLAN FOR SHORELINE/RIVER EDGE WORK

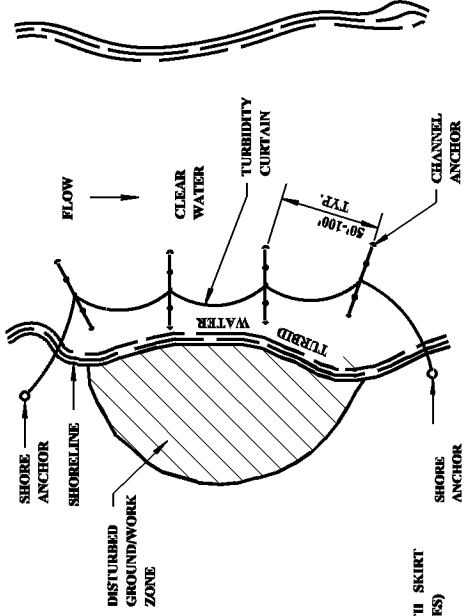

PLAN VIEW

TYPICAL ANCHORING PLAN FOR MID CHANNEL WORK (BRIDGE PIER, CAISSON, ETC.)

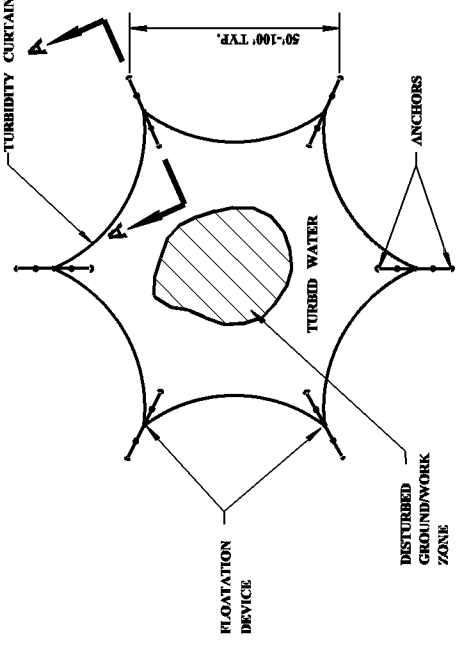

PLAN VIEW

TYPICAL ANCHORING SECTION

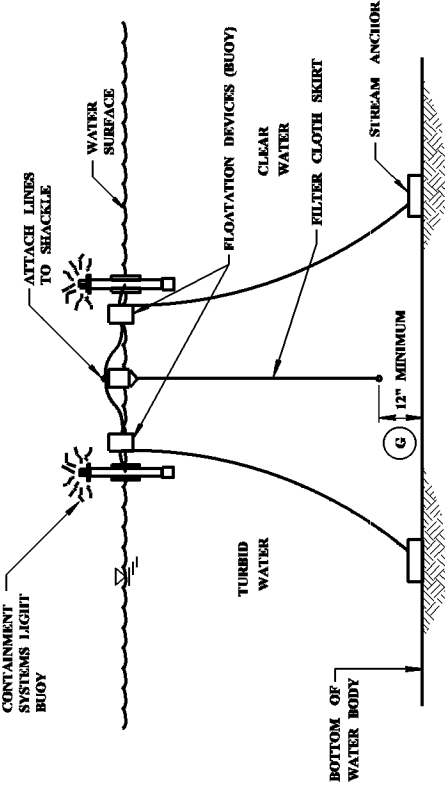

SECTION A-A

AUTOMATIC FLASHING LIGHT BUOY (ON AT DUSK-OFF AT DAWN) 100\"/>

EROSION CONTROL PLAN LEGEND:  FLOATING TURBIDITY CURTAIN

FLOATING TURBIDITY CURTAIN GENERAL NOTES

- A FLOATING TURBIDITY CURTAINS (ALSO KNOWN AS TURBIDITY BARRIERS OR SILT CURTAINS) CREATE A BARRIER TO PREVENT TURBID WATER FROM ENTERING CLEAR WATER. FLOATING TURBIDITY CURTAINS SHOULD BE USED TO ISOLATE ACTIVE CONSTRUCTION AREAS WITHIN OR ADJACENT TO A BODY OF WATER TO MINIMIZE THE MIGRATION OF SILT LADEN WATER OUT OF THE CONSTRUCTION ZONE.
- B TURBIDITY CURTAINS SHALL NOT BE INSTALLED PERPENDICULAR ACROSS THE MAIN FLOW OF A SIGNIFICANT BODY OF MOVING WATER.
- C FLOATING TURBIDITY CURTAINS SHALL NO BE USED WHERE THE ANTICIPATED FLOW VELOCITIES WILL EXCEED 5 FT/SEC.
- D TURBIDITY CURTAINS SHALL BE ANCHORED TO PREVENT DRIFT SHOREWARD OR DOWNSTREAM. ANCHORAGE SHALL BE INSTALLED ON BOTH SHORE AND STREAM SIDE. CURTAINS SHALL BE INSTALLED AS CLOSE TO PROJECT SITE AS POSSIBLE. BARRIERS SHOULD BE A BRIGHT COLOR (YELLOW OR "INTERNATIONAL" ORANGE ARE RECOMMENDED) THAT WILL ATTRACT THE ATTENTION OF NEARBY BOATERS.
- E SHORE ANCHORS SHALL CONSIST OF A POST WITH DEADMAN OR APPROVED EQUAL STREAM ANCHORS SHALL BE OF SUFFICIENT SIZE TO STABILIZE THE BARRIER WITH NUMBER AND SPACING DEPENDENT ON WATERWAY VELOCITIES AND MANUFACTURER'S RECOMMENDATIONS.
- F IN SHALLOW WATER (2 FEET OF DEPTH OR LESS) A TURBIDITY CURTAIN MAY BE INSTALLED ON STAKES DRIVEN INTO THE BED OF THE WATER BODY.
- G FABRIC SECTIONS SHALL BE CONNECTED END TO END WITH MINIMUM 0" DIAMETER POLYPROPYLENE ROPE. FABRIC SHALL BE SEAMED TOGETHER IN A MANNER THAT RETAINS THE OVERALL TENSILE STRENGTH.
- H DESIGN OF CURTAIN AND ANCHORAGE SHALL BE IN ACCORDANCE WITH MANUFACTURER'S RECOMMENDATIONS. FILTER CLOTH SKIRT SHOULD BE ABLE TO WITHSTAND THE FORCES IMPARTED ON IT DUE TO THE EXPECTED WIND VELOCITY OR STREAM VELOCITY. FABRIC SHALL BE MADE OF A NON-DETERIORATING MATERIAL, SUCH AS PLASTIC OR NYLON, WHICH WILL ALLOW WATER TO PASS THROUGH WHILE STILL RETAINING SEDIMENT.
- I THE TURBIDITY CURTAIN AND ADJACENT WORK AREAS SHALL NOT BE DISTURBED 12 HOURS PRIOR TO REMOVAL FROM WATER BODY. MAINTENANCE SHALL BE PERFORMED AS NEEDED. CONTRACTOR SHALL REMOVE THE CURTAIN AT COMPLETION OF WORK IN A MANNER THAT WILL PREVENT SITUATION OF THE WATERWAY. DURING REMOVAL, EXTREME CARE SHOULD BE TAKEN NOT TO DISTURB ANY SEDIMENT DEPOSITS.
- J MAINTAIN 12" MINIMUM GAP BETWEEN SKIRT BOTTOM AND CHANNEL BOTTOM TO PREVENT ACCUMULATED SEDIMENT FROM PULLING TOP OF CURTAIN BELOW WATER SURFACE.
- K IN WIND OR WAVE ACTION SITUATIONS, THE MAXIMUM DEPTH OF THE CURTAIN SHALL BE 12 FEET.
- L CONCENTRATED FLOWS SHALL NOT DISCHARGE BEYOND FLOATING TURBIDITY CURTAIN. CURTAINS ARE NOT TO BE INSTALLED ACROSS FLOWING BODY OF WATER.
- M WHEN INSTALLED IN A NAVIGABLE WATERWAY, BUOYS SHOULD BE LIT ACCORDING TO REGULATORY AGENCY STANDARDS.
- N WHEN ESTIMATING THE LENGTH OF TURBIDITY CURTAIN, ALLOW 10 TO 20 PERCENT VARIANCE IN STRAIGHT LINE MEASUREMENT.
- O PAYMENT FOR FLOATING TURBIDITY CURTAIN SHALL INCLUDE ALL MATERIAL AND LABOR NECESSARY FOR CONSTRUCTION, MAINTENANCE, AND REMOVAL OF TURBIDITY CURTAINS.
- P ONLY FLOATING TURBIDITY CURTAINS LISTED ON THE APPROVED PRODUCTS LIST MAY BE USED.

MISSISSIPPI DEPARTMENT OF TRANSPORTATION

FLOATING TURBIDITY CURTAIN

BY	REVISION	DATE	CHECKED	DATE

WORKING NUMBER: **ECD-19**

FILENAME: **EROSION CONTROL\ECD-19.DGN**

DESIGN TEAM: _____

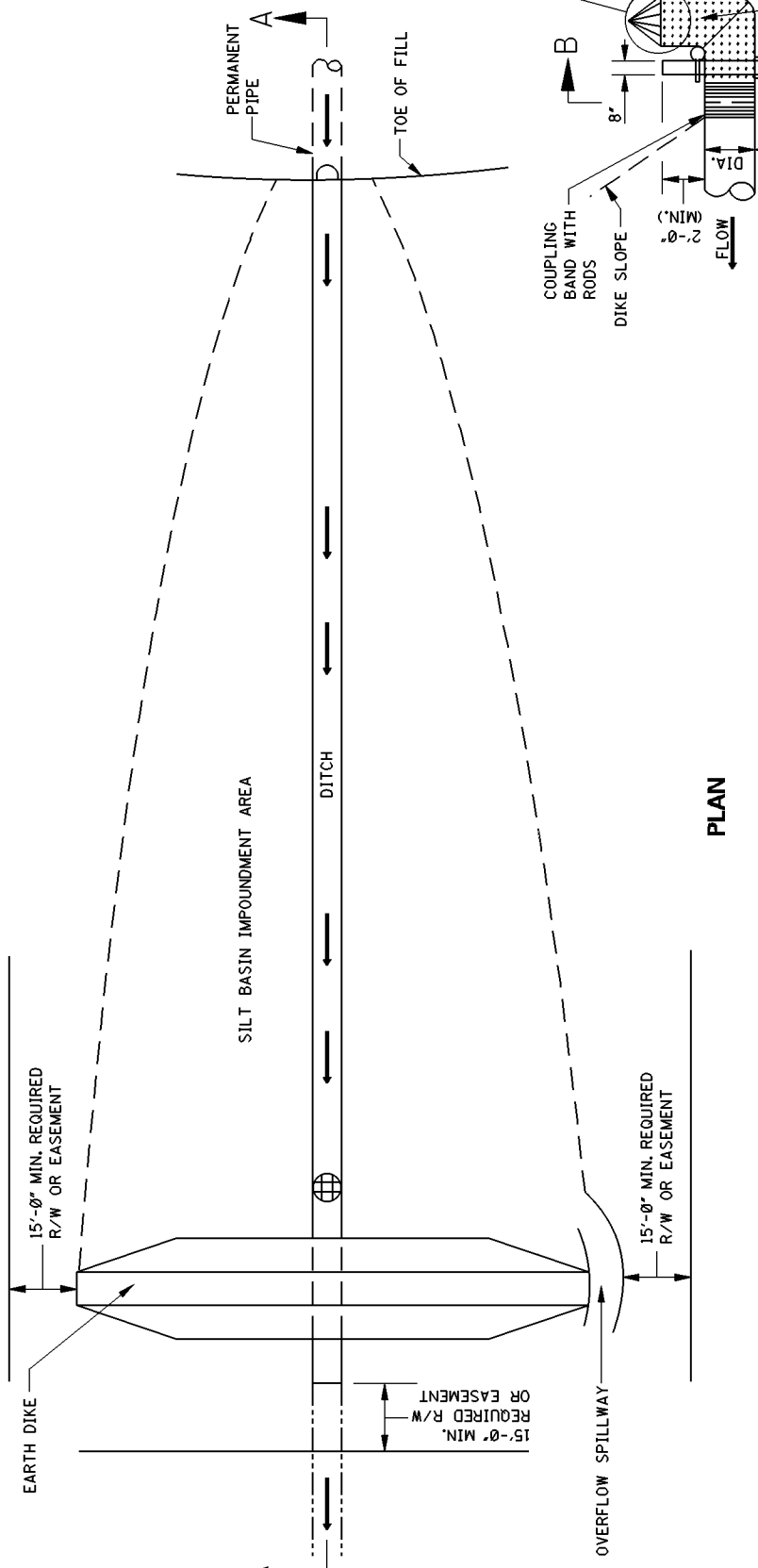

PLAN

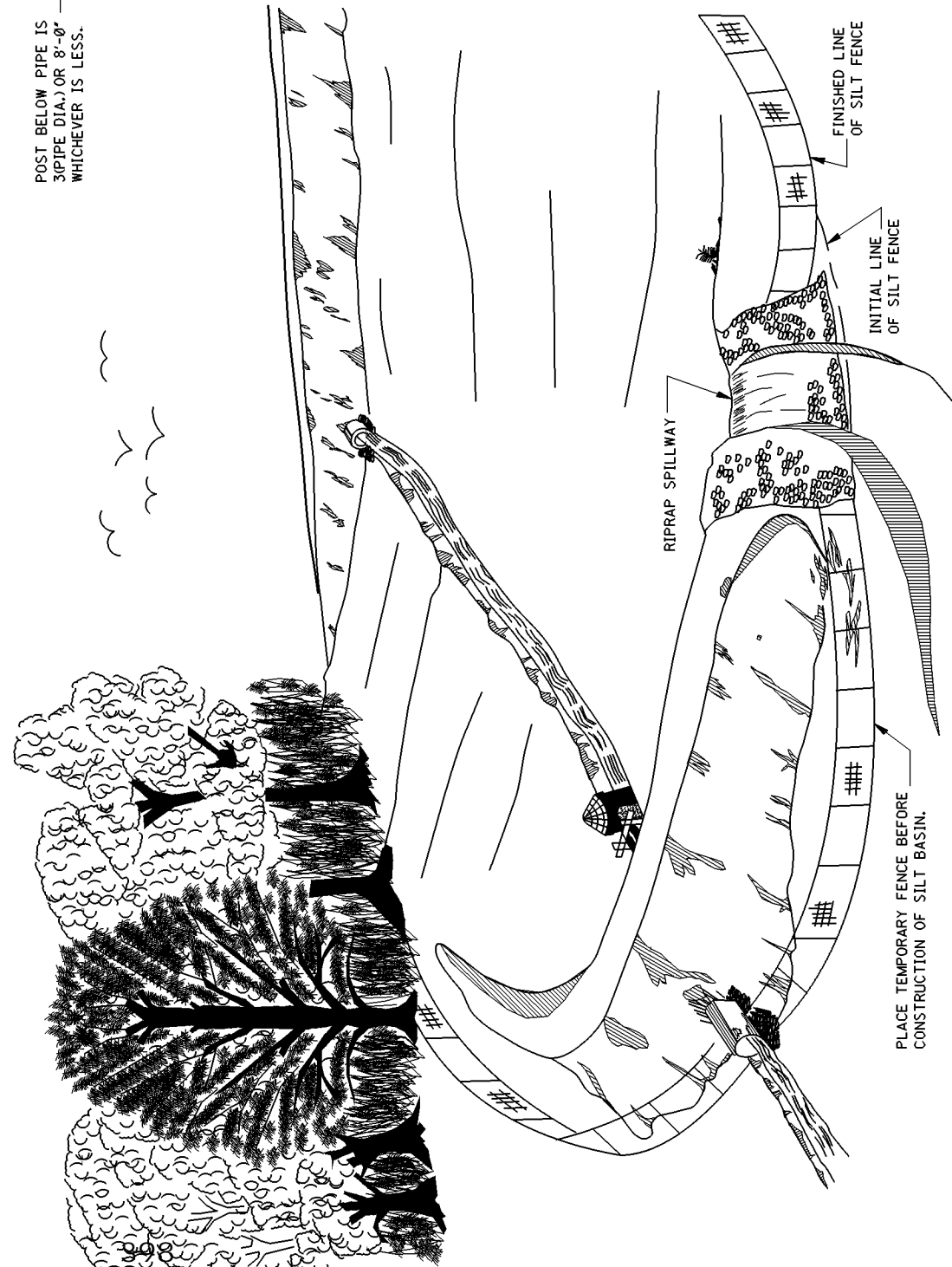

TEMPORARY SILT BASIN (TYPE B)

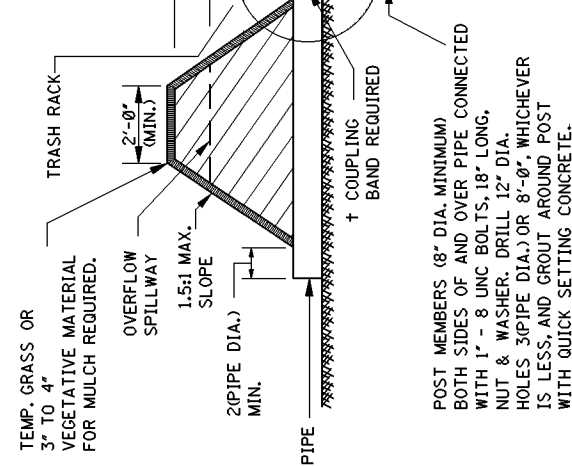

SECTION A-A

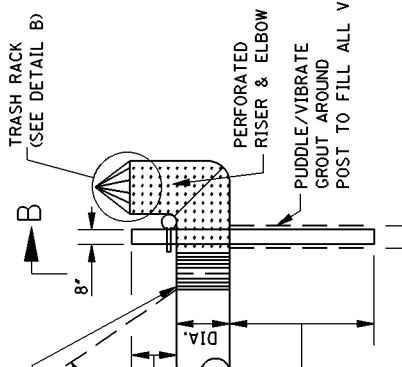

SECTION B-B

DETAIL A

PIPE ANCHORAGE

GENERAL NOTES:

1. PROVIDE OVERFLOW SPILLWAY IN NATURAL GROUND AT A MINIMUM OF 1'-0" BELOW TOP OF DIKE. CROSS-SECTIONAL AREA OF SPILLWAY IS EQUAL TO 1.5 TIMES THE AREA OF THE OUTLET PIPE MINIMUM. RIPRAP SHALL BE REQUIRED AT THE SPILLWAY. AFTER THE PURPOSE OF THE SILT BASIN HAS BEEN SERVED, THE DIKE AND RIPRAP MAY REMAIN IN PLACE AT THE DISCRETION OF THE ENGINEER, BUT THE DRAIN PIPE WITH RISER SHALL BE REMOVED AND THE NEWLY DISTURBED AREA REVEGETATED.
2. BASIN AND DIKE DIMENSIONS DO NOT REQUIRE CONSTRUCTION TO NEAT LINES.
3. THE SILT BASIN MAY BE CONSTRUCTED IN ANY SHAPE WITH THE DIKE EXTENDING ALONG ONE OR MORE SIDES AS LONG AS THE LENGTH MEASURED IN THE DIRECTION OF FLOW IS APPROXIMATELY TWICE THE WIDTH AND THE IMPOUNDMENT AREA AND DEPTH AT LEAST AS LARGE AS INDICATED.
4. MINIMUM DIMENSIONS FOR SILT BASIN (TYPE B) ARE AS FOLLOWS:

PIPE	* * D (ft-in)	H (ft-in)	* AREA (ft ²)	LENGTH (ft)	COUPLING RODS/SIDE
15"	4'-0"	1'-0"	310	12'	2 & 2
18"	5'-0"	1'-0"	550	12'	2 & 2
24"	5'-0"	1'-0"	1100	12'	2 & 2
30"	6'-0"	1'-6"	1850	24'	3 & 3
36"	6'-0"	1'-6"	2800	24'	3 & 3
42"	7'-0"	2'-0"	4200	24'	3 & 3
48"	8'-0"	2'-0"	6200	24'	3 & 3

- NOTES:
- * 1. IMPOUNDMENT SURFACE AREAS ARE MEASURED AT ELEVATION OF TOP OF ELBOW RISER.
 - ** 2. RISER REQUIRED WHERE MINIMUM "D" DIMENSION IS EXCEEDED. LENGTH OF RISER IS EQUAL TO THE AMOUNT THAT MINIMUM "D" DIMENSION IS EXCEEDED.
 - + 3. COUPLING RODS TO BE 1/2" DIAMETER MINIMUM WITH LUGS.

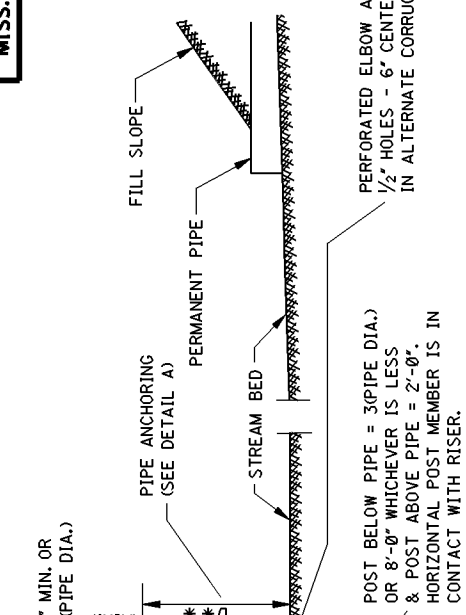

DETAIL B
TRASH RACK INSTALLATION

* 4 BAR LAYOUT SHOWN IS SUGGESTED. HOWEVER, OTHER LAYOUTS MAY BE USED PROVIDED OPENINGS ARE APPROXIMATELY 64 in².

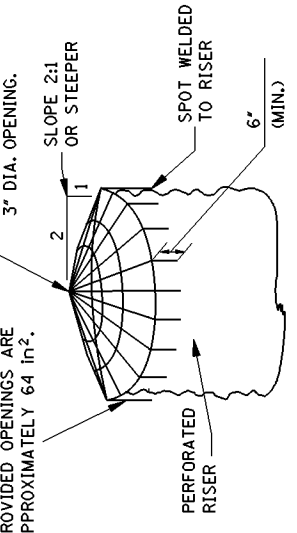

5. IN SELECTING BASIN SIZE, CONSIDERATION MUST BE GIVEN TO THE AREA DISCHARGING INTO THE BASIN OTHER THAN THAT WHICH COMES THROUGH THE PIPE UNDER THE ROADWAY. THIS WILL AT TIMES NECESSITATE A LARGER BASIN AND OUTLET PIPE SECTION.
6. THE DIKE SHALL BE CONSTRUCTED OF A MATERIAL SUITABLE FOR ROADWAY EMBANKMENT.
7. SILT BASIN (TYPE B) REQUIRED AT LOCATION(S) INDICATED ON PLANS.
8. THE CONTRACTOR SHALL BE REQUIRED TO FURNISH ALL MATERIALS AND PERFORM ALL WORK FOR THE PROPER INSTALLATION, MAINTENANCE AND REMOVAL OF TEMPORARY EROSION CONTROL MEASURES NECESSARY TO CONTROL SILTATION.
9. THE USE OF THE TEMPORARY EROSION CONTROL MEASURE SHOWN ON THIS SHEET WILL ONLY BE REQUIRED AND MEASURED FOR SEPARATE PAYMENT WHEN AN APPROPRIATE PAY ITEM IS INCLUDED IN THE BID SCHEDULE OF THE PROPOSAL.
10. RIPRAP AND TEMPORARY SILT FENCE, USED IN CONJUNCTION WITH TYPE B SILT BASINS AS SHOWN BY THE DETAILS ON THIS SHEET, WILL NOT BE MEASURED FOR SEPARATE PAYMENT. THEIR COST SHALL BE INCLUDED IN THE PRICE BID FOR TYPE B SILT BASIN.

MISSISSIPPI DEPARTMENT OF TRANSPORTATION
ROADWAY DESIGN DIVISION
STANDARD PLAN

TYPICAL TEMPORARY EROSION CONTROL MEASURES (TYPE B SILT BASIN)

WORKING NUMBER
TEC-3

ISSUE DATE: OCTOBER 1, 1998

SHEET NUMBER
144

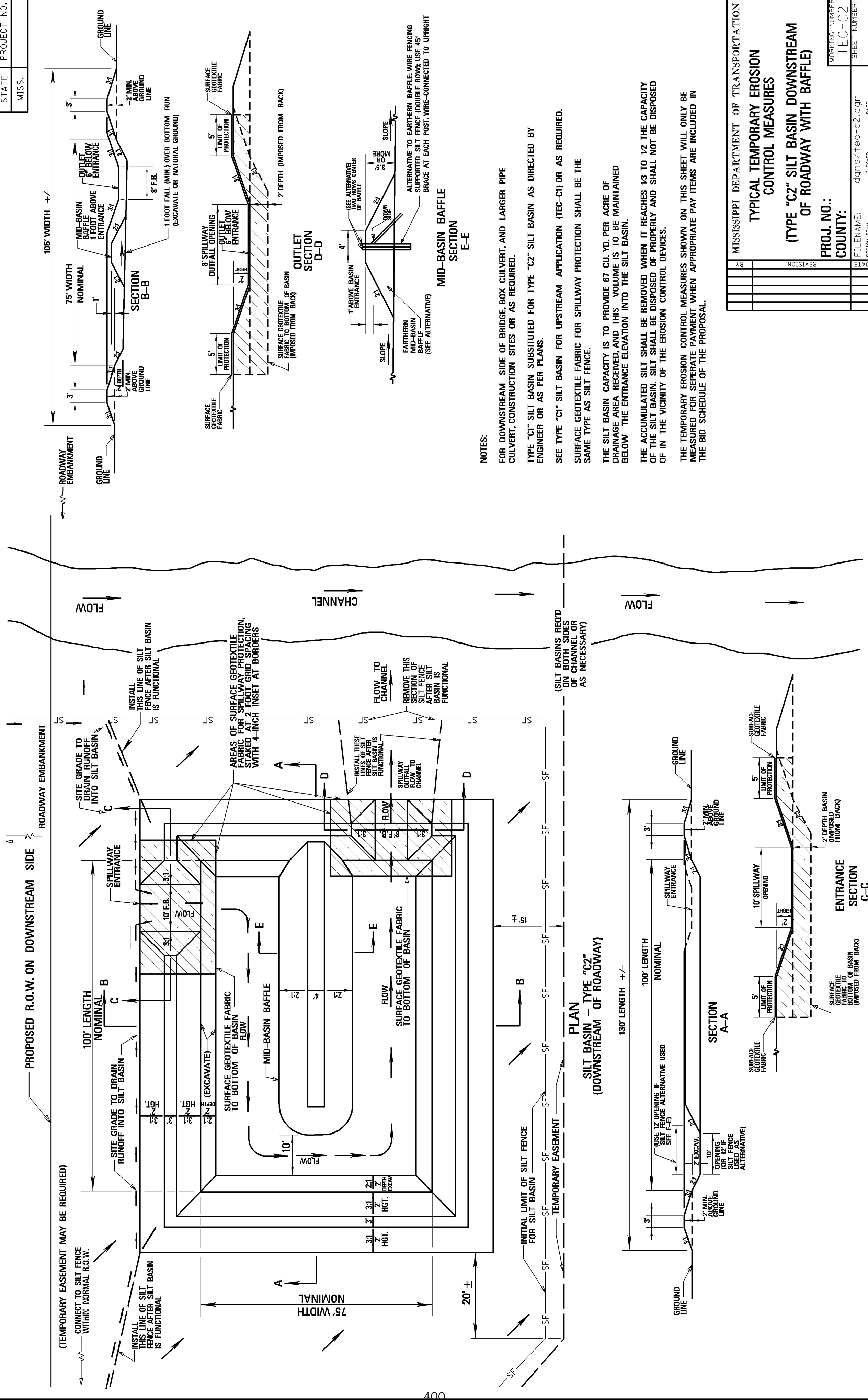

PLAN
SILT BASIN - TYPE "C2"
(DOWNSTREAM OF ROADWAY)

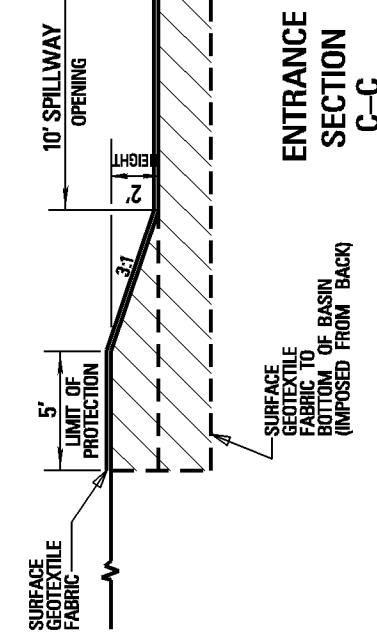
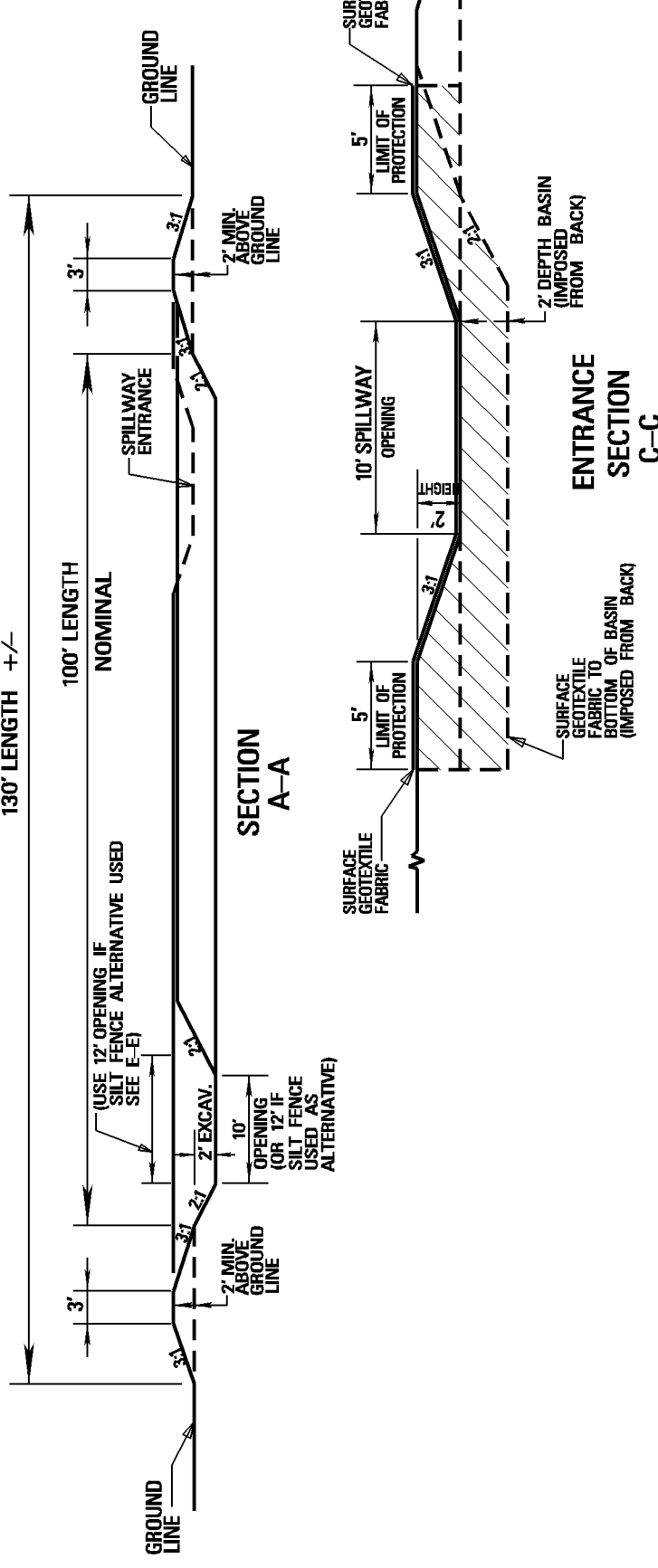

NOTES:

FOR DOWNSTREAM SIDE OF BRIDGE, BOX CULVERT, AND LARGER PIPE CULVERT, CONSTRUCTION SITES OR AS REQUIRED.

TYPE "C1" SILT BASIN SUBSTITUTED FOR TYPE "C2" SILT BASIN AS DIRECTED BY ENGINEER OR AS PER PLANS.

SEE TYPE "C1" SILT BASIN FOR UPSTREAM APPLICATION (TEC-C1) OR AS REQUIRED.

SURFACE GEOTEXTILE FABRIC FOR SPILLWAY PROTECTION SHALL BE THE SAME TYPE AS SILT FENCE.

THE SILT BASIN CAPACITY IS TO PROVIDE 67 CU. YD. PER ACRE OF DRAINAGE AREA RECEIVED, AND THIS VOLUME IS TO BE MAINTAINED BELOW THE ENTRANCE ELEVATION INTO THE SILT BASIN.

THE ACCUMULATED SILT SHALL BE REMOVED WHEN IT REACHES 1/3 TO 1/2 THE CAPACITY OF THE SILT BASIN. SILT SHALL BE DISPOSED OF PROPERLY AND SHALL NOT BE DISPOSED OF IN THE VICINITY OF THE EROSION CONTROL DEVICES.

THE TEMPORARY EROSION CONTROL MEASURES SHOWN ON THIS SHEET WILL ONLY BE MEASURED FOR SEPARATE PAYMENT WHEN APPROPRIATE PAY ITEMS ARE INCLUDED IN THE BID SCHEDULE OF THE PROPOSAL.

MISSISSIPPI DEPARTMENT OF TRANSPORTATION

TYPICAL TEMPORARY EROSION CONTROL MEASURES
(TYPE "C2" SILT BASIN DOWNSTREAM OF ROADWAY WITH BAFFLE)

PROJ. NO.:
COUNTY:

BY	REVISION	DATE	DESIGN TEAM	CHECKED	DATE

WORKING NUMBER: TEC-C2
SHEET NUMBER:

FILENAME: dmsn/tec-c2.dgn
DESIGN TEAM:

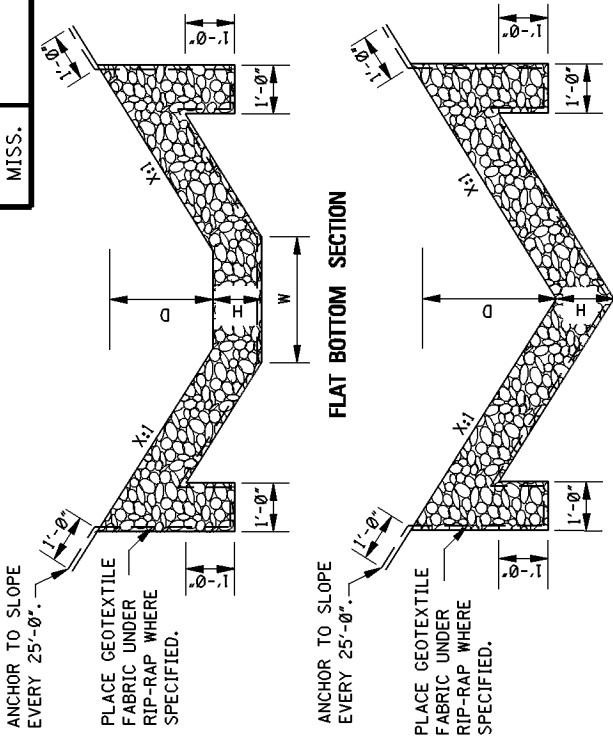

**"V" TYPE SECTION
RIP-RAP TREATMENT**

NOTES:
1. DIMENSIONS D, W AND X ARE VARIABLE AND ARE SHOWN ELSEWHERE ON THE PLANS.
2. THE RIP-RAP SIZE AND MINIMUM DEPTH "H" FOR RIP-RAP TREATMENT ARE AS FOLLOWS.

RIP-RAP SIZE & MINIMUM DEPTH "H"	RIP-RAP SIZE (lbs)
12"	1000
18"	3000

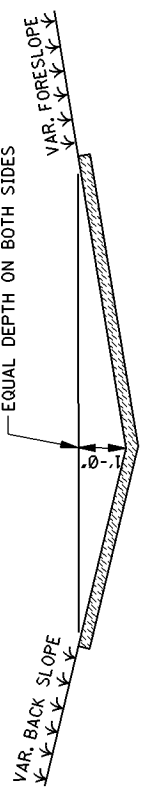

SOLID SOD TREATMENT

GENERAL NOTE:
1. FOR LOCATION OF APPROPRIATE DITCH TREATMENTS, SEE PLAN SHEETS AS DENOTED BY THE FOLLOWING LEGEND OR AS DIRECTED BY THE ENGINEER:

- DITCH LINER
- SOLID SOD
- CONCRETE PAVED DITCH
- RIP-RAP

MISSISSIPPI DEPARTMENT OF TRANSPORTATION
**DETAILS OF TYPICAL
DITCH TREATMENTS**

DATE	DESIGN TEAM	CHECKED	DATE

FILENAME: EROSION CONTROL.DT-1.DGN
SHEET NUMBER
DT-1
WORKING NUMBER

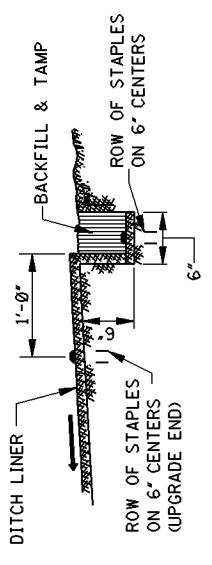

ANCHOR TRENCH DETAIL

NOTE: ANCHOR TRENCH REQUIRED AT THE BEGINNING AND ENDING OF EACH AREA TO BE COVERED, EXCEPT DOWNSTREAM END ADJOINING A STRUCTURE.

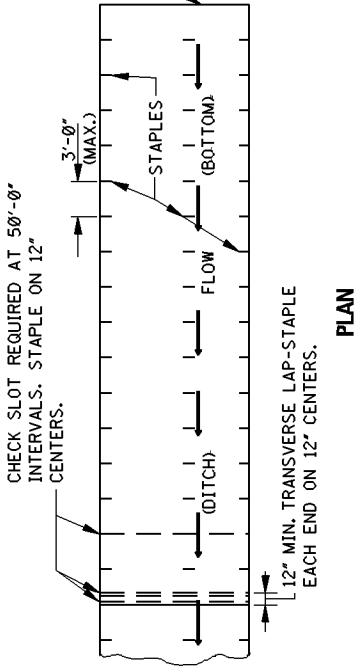

PLAN

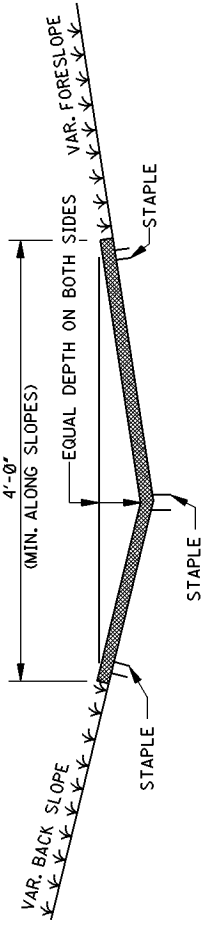

SECTION

DITCH LINER TREATMENT

(EXCELSIOR BLANKET, JUTE MESH OR EROSION CONTROL FABRIC)
NOTE: DITCHES TREATED WITH DITCH LINER WILL BE VEGETATED PRIOR TO TREATMENT, UNLESS OTHERWISE INDICATED.

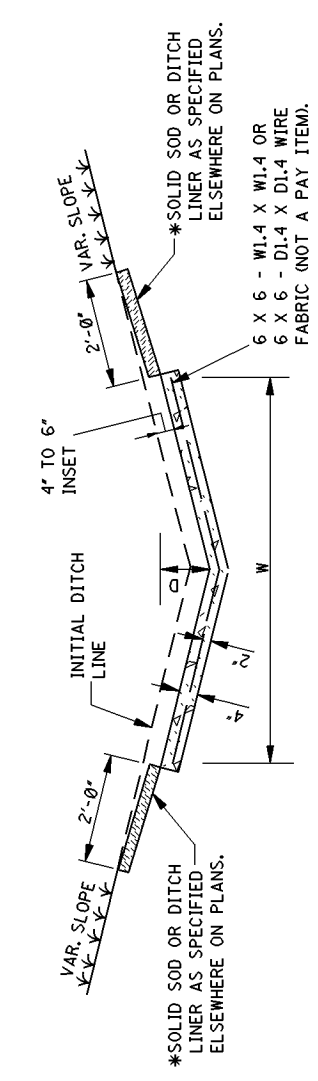

"V" TYPE SECTION

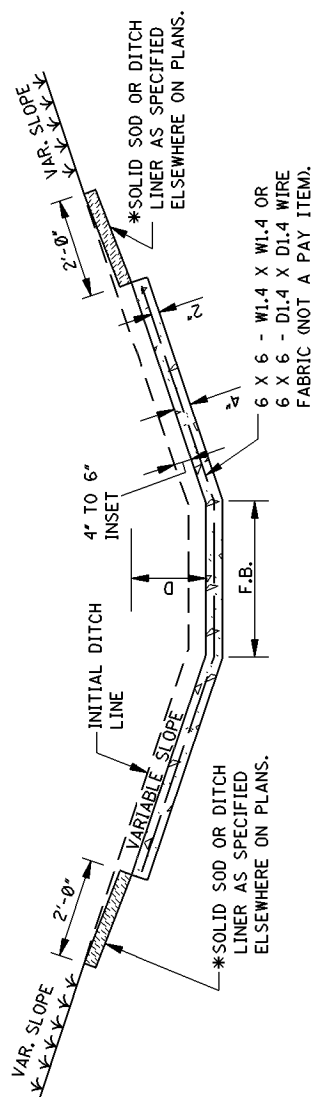

FLAT BOTTOM SECTION

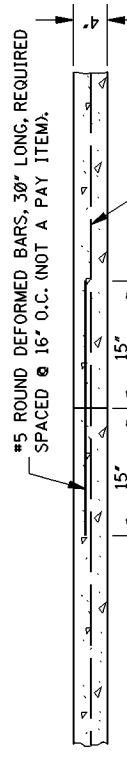

DETAIL OF CONSTRUCTION JOINT

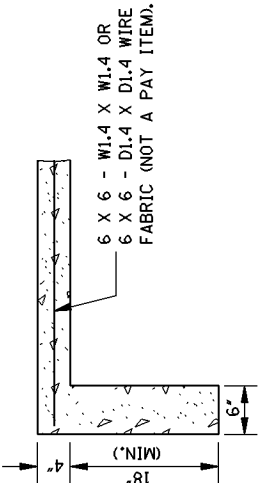

DETAIL OF TOE WALL

NOTE: TOE WALL REQUIRED UPSTREAM AND DOWNSTREAM.

CONCRETE PAVED DITCH

- NOTES:
- CONCRETE PAVED DITCHES SHALL BE GROOVED AT 20'-0" INTERVALS. THE GROOVES SHALL BE CUT TO A DEPTH OF NOT LESS THAN 1".
 - DIMENSIONS D & W ARE AS FOLLOWS:
D (MINIMUM) = 6"
D (NOMINAL) = 9"
W (MINIMUM) = 24"
 - CHAIR SUPPORTS FOR THE WIRE MESH WILL NOT BE REQUIRED, HOWEVER, THE CONTRACTOR SHALL PLACE THE WIRE MESH IN A SATISFACTORY AND WORKMANLIKE MANNER TO ENSURE THAT THE FINAL POSITION IS REASONABLY NEAR THE POSITION INDICATED.
 - CENTER ROW OF STAPLES MAY BE OMITTED ON DITCH LINER.

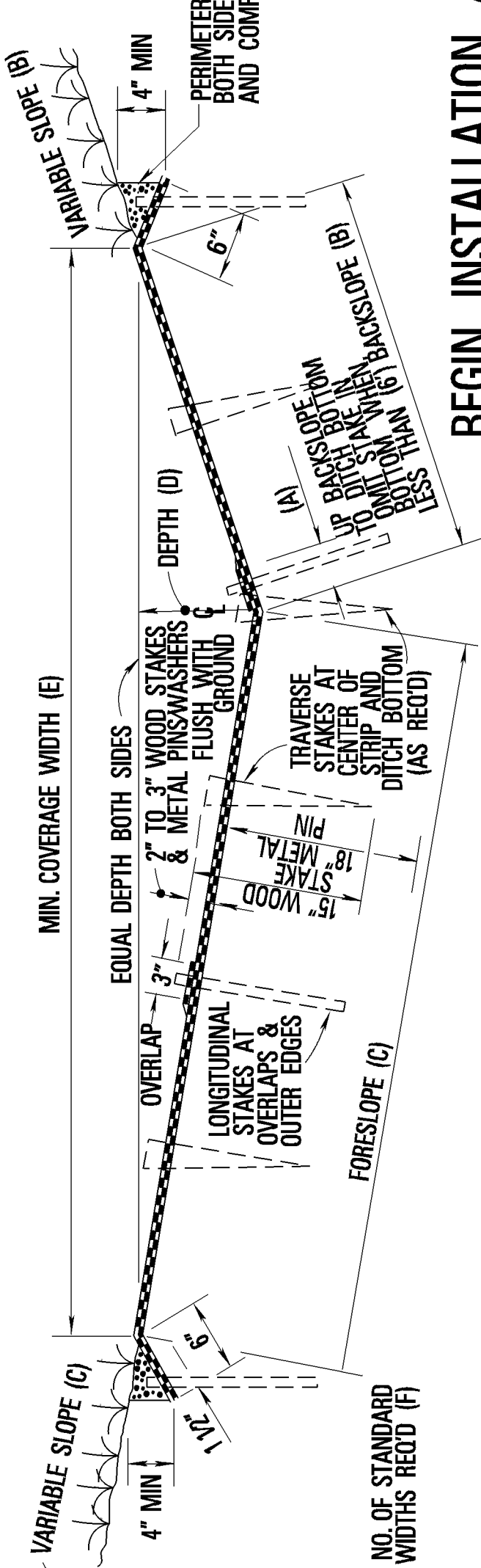

S E C T I O N 9 0 3
PERFORMANCE AND PAYMENT BOND

CONTRACT BOND FOR: _____

LOCATED IN THE COUNTY(IES) OF: _____

STATE OF MISSISSIPPI,

COUNTY OF HINDS

Know all men by these presents: that we, _____
(Contractor)

_____ Principal, a _____
residing at _____ in the State of _____
and _____
(Surety)

residing at _____ in the State of _____,
authorized to do business in the State of Mississippi, under the laws thereof, as surety, are held and firmly bound
unto the State of Mississippi in the sum of _____

(\$ _____) Dollars, lawful money of the United States of America, to be paid
to it for which payment well and truly to be made, we bind ourselves, our heirs, administrators, successors, or
assigns jointly and severally by these presents.

Signed and sealed this the ____ day of _____ A.D. _____.

The conditions of this bond are such, that whereas the said _____
principal, has (have) entered into a contract with the Mississippi Transportation Commission, bearing the date of
_____ day of _____ A.D. _____ hereto annexed, for the construction of certain projects(s)
in the State of Mississippi as mentioned in said contract in accordance with the Contract Documents therefor, on
file in the offices of the Mississippi Department of Transportation, Jackson, Mississippi.

Now therefore, if the above bounden _____
_____ in all things shall stand to and abide by and well and truly observe,
do keep and perform all and singular the terms, covenants, conditions, guarantees and agreements in said contract,
contained on his (their) part to be observed, done, kept and performed and each of them, at the time and in the
manner and form and furnish all of the material and equipment specified in said contract in strict accordance with
the terms of said contract which said plans, specifications and special provisions are included in and form a part of
said contract and shall maintain the said work contemplated until its final completion and acceptance as specified in
Subsection 109.11 of the approved specifications, and save harmless said Mississippi Transportation Commission
from any loss or damage arising out of or occasioned by the negligence, wrongful or criminal act, overcharge, fraud,
or any other loss or damage whatsoever, on the part of said principal (s), his (their) agents, servants, or employees in
the performance of said work or in any manner connected therewith, and shall be liable and responsible in a civil

SECTION 903 - CONTINUED

action instituted by the State at the instance of the Mississippi Transportation Commission or any officer of the State authorized in such cases, for double any amount in money or property, the State may lose or be overcharged or otherwise defrauded of, by reason of wrongful or criminal act, if any, of the Contractor(s), his (their) agents or employees, and shall promptly pay the said agents, servants and employees and all persons furnishing labor, material, equipment or supplies therefor, including premiums incurred, for Surety Bonds, Liability Insurance, and Workmen's Compensation Insurance; with the additional obligation that such Contractor shall promptly make payment of all taxes, licenses, assessments, contributions, damages, any liquidated damages which may arise prior to any termination of said principal's contract, any liquidated damages which may arise after termination of the said principal's contract due to default on the part of said principal, penalties and interest thereon, when and as the same may be due this state, or any county, municipality, board, department, commission or political subdivision: in the course of the performance of said work and in accordance with Sections 31-5-51 et seq. Mississippi Code of 1972, and other State statutes applicable thereto, and shall carry out to the letter and to the satisfaction of the Executive Director of the Mississippi Department of Transportation, all, each and every one of the stipulations, obligations, conditions, covenants and agreements and terms of said contract in accordance with the terms thereof and all of the expense and cost and attorney's fee that may be incurred in the enforcement of the performance of said contract, or in the enforcement of the conditions and obligations of this bond, then this obligation shall be null and void, otherwise to be and remain in full force and virtue.

Witness our signatures and seals this the _____ day of _____ A.D. _____.

_____	_____
(Contractors) Principal	Surety
By _____	By _____
	(Signature) Attorney in Fact
	Address _____

Title _____	_____
(Contractor's Seal)	(Printed) MS Agent

	(Signature) MS Agent
	Address _____

	(Surety Seal)

	Mississippi Insurance ID Number

KNOW ALL MEN BY THESE PRESENTS, that we _____
Contractor

Address

City, State ZIP

as Principal, hereinafter called the Principal, and _____
Surety

a corporation duly organized under the laws of the state of _____

as Surety, hereinafter called the Surety, are held and firmly bound unto State of Mississippi, Jackson, Mississippi

As Oblige, hereinafter called Oblige, in the sum of **Five Per Cent (5%) of Amount Bid**

Dollars (\$ _____)

for the payment of which sum will and truly to be made, the said Principal and said Surety, bind ourselves, our heirs, executors, administrators, successors and assigns, jointly and severally, firmly by these presents.

WHEREAS, the Principal has submitted a bid for Project Nos. DB/IM-0055-02(228)/105444-305 and DB/IM-0055-02(228)/105444306

NOW THEREFORE, the condition of this obligation is such that if the aforesaid Principal shall be awarded the contract, the said Principal will, within the time required, enter into a formal contract and give a good and sufficient bond to secure the performance of the terms and conditions of the contract, then this obligation to be void; otherwise the Principal and Surety will pay unto the Oblige the difference in money between the amount of the bid of the said Principal and the amount for which the Oblige legally contracts with another party to perform the work if the latter amount be in excess of the former, but in no event shall liability hereunder exceed the penal sum hereof.

Signed and sealed this _____ day of _____, 20____

(Principal) (Seal)

(Witness)

By: _____
(Name) (Title)

(Surety) (Seal)

(Witness)

By: _____
(Attorney-in-Fact)

MS Agent

Mississippi Insurance ID Number